

**MECHANISM
AND THEORY
IN ORGANIC
CHEMISTRY**

Thomas H. Lowry

Kathleen Schueller Richardson

MECHANISM

AND THEORY

IN

ORGANIC CHEMISTRY

THOMAS H. LOWRY

Smith College

and

KATHLEEN SCHUELLER RICHARDSON

The Ohio State University

HARPER & ROW, PUBLISHERS
New York, Hagerstown, San Francisco, London

To Nancy and Frank

Sponsoring Editor: John A. Woods
Special Projects Editor: Carol J. Dempster
Project Editor: Brenda Goldberg
Designer: T. R. Funderburk
Production Supervisor: Will C. Jomarrón
Compositor: William Clowes & Sons Limited
Printer and Binder: Halliday Lithograph Corporation
Art Studio: Vantage Art Inc.

MECHANISM AND THEORY IN ORGANIC CHEMISTRY

Copyright © 1976 by Thomas H. Lowry and Kathleen Schueller Richardson

All rights reserved. Printed in the United States of America. No part of this book may be used or reproduced in any manner whatsoever without written permission except in the case of brief quotations embodied in critical articles and reviews. For information address Harper & Row, Publishers, Inc., 10 East 53rd Street, New York, N. Y. 10022.

Library of Congress Cataloging in Publication Data

Lowry, Thomas H.

Mechanism and theory in organic chemistry.

Includes bibliographical references and index.

I. Chemistry, Physical organic. I. Richardson, Kathleen Schueller, joint author. II. Title.

QD476.L68 547'.1'3 75-43926

ISBN 0-06-044082-1

CONTENTS

Preface ix

1 THE COVALENT BOND 1

- 1.1 MODELS OF CHEMICAL BONDING 1
- 1.2 MOLECULAR ORBITALS 9
- 1.3 HYBRID ORBITALS 20
- 1.4 DELOCALIZED π BONDING 27
- 1.5 AROMATICITY 28
- PROBLEMS 40

Appendix 1: Hybrid Orbitals 43

Appendix 2: Molecular Orbital Theory 50

2 SOME FUNDAMENTALS OF PHYSICAL ORGANIC CHEMISTRY 57

- 2.1 STEREOCHEMISTRY 57
- 2.2 LINEAR FREE-ENERGY RELATIONSHIPS 60
- 2.3 THERMOCHEMISTRY 71
- 2.4 SOLUTIONS 84
- 2.5 KINETICS 90
- 2.6 INTERPRETATION OF RATE CONSTANTS 94
- 2.7 ISOTOPE EFFECTS 105
- PROBLEMS 111

Appendix 1: Derivation of the Transition State Theory Expression for a Rate Constant 113

Appendix 2: The Transition State Theory of Isotope Effects 120

3 ACIDS AND BASES 124

3.1 BRØNSTED ACIDS AND BASES 124

3.2 STRENGTHS OF WEAK BRØNSTED BASES 129

3.3 STRENGTHS OF WEAK BRØNSTED ACIDS 138

3.4 SUBSTITUENT EFFECTS ON STRENGTHS OF BRØNSTED ACIDS AND BASES 150

3.5 LEWIS ACIDS AND BASES 163

PROBLEMS 168

4 BIMOLECULAR SUBSTITUTION REACTIONS 170

4.1 S_N1 and S_N2 SUBSTITUTION MECHANISMS 171

4.2 STEREOCHEMISTRY OF THE S_N2 REACTION 174

4.3 THE SOLVENT, SUBSTRATE, NUCLEOPHILE, AND LEAVING GROUP 177

4.4 BIMOLECULAR NUCLEOPHILIC SUBSTITUTION AT SULFUR 194

4.5 BIMOLECULAR ELECTROPHILIC SUBSTITUTION AT SATURATED CARBON 203

PROBLEMS 210

5 UNIMOLECULAR SUBSTITUTIONS AND RELATED REACTIONS 213

5.1 LIMITING UNIMOLECULAR NUCLEOPHILIC REACTIONS—KINETICS AND STEREOCHEMISTRY 213

5.2 LIMITING UNIMOLECULAR NUCLEOPHILIC REACTIONS—EFFECTS OF STRUCTURE AND SOLVENT 222

5.3 CARBOCATIONS 233

5.4 MECHANISMS INTERMEDIATE BETWEEN S_N1 AND S_N2 237

5.5 UNIMOLECULAR ELECTROPHILIC SUBSTITUTIONS—CARBANIONS 250

5.6 CARBENES 256

PROBLEMS 265

6 INTRAMOLECULAR REARRANGEMENTS 268

6.1 1,2-SHIFTS IN CARBENIUM IONS 268

6.2 CARBONIUM IONS 288

6.3 MIGRATIONS TO CARBONYL CARBON 316

6.4 REARRANGEMENT TO ELECTRON-DEFICIENT NITROGEN AND OXYGEN 318

PROBLEMS 332

7 ADDITION AND ELIMINATION REACTIONS 337

7.1 ELECTROPHILIC ADDITION TO DOUBLE AND TRIPLE BONDS 337

7.2 1,2-ELIMINATION REACTIONS 355

7.3 NUCLEOPHILIC ADDITION TO MULTIPLE BONDS 377

- 7.4 ELECTROPHILIC AROMATIC SUBSTITUTION 379
- 7.5 NUCLEOPHILIC AROMATIC SUBSTITUTION 395
- PROBLEMS 399
- 8 REACTIONS OF CARBONYL COMPOUNDS 402**
 - 8.1 HYDRATION AND ACID-BASE CATALYSIS 403
 - 8.2 OTHER SIMPLE ADDITIONS 416
 - 8.3 ADDITION FOLLOWED BY ELIMINATION 424
 - 8.4 ADDITION OF NITROGEN NUCLEOPHILES 432
 - 8.5 CARBOXYLIC ACID DERIVATIVES 439
 - 8.6 ENOLS, ENOLATES, AND ADDITION OF CARBON NUCLEOPHILES TO C=O 449
 - PROBLEMS 459
- 9 RADICAL REACTIONS 462**
 - 9.1 CHARACTERISTICS OF ORGANIC FREE RADICALS 462
 - 9.2 RADICAL REACTIONS 475
 - 9.3 FREE-RADICAL SUBSTITUTIONS 497
 - 9.4 RADICAL ADDITIONS AND ELIMINATIONS 506
 - 9.5 REARRANGEMENTS OF RADICALS 517
 - PROBLEMS 524

Appendix 1: Chemically Induced Dynamic Nuclear Polarization (CIDNP) 527
- 10 PERTURBATION THEORY AND SYMMETRY 538**
 - 10.1 PERTURBATION THEORY 538
 - 10.2 SYMMETRY 541
 - 10.3 INTERACTIONS BETWEEN MOLECULES 552
 - 10.4 APPLICATION OF PERTURBATION THEORY AND SYMMETRY TO π SYSTEMS 559
 - PROBLEMS 566
- 11 THE THEORY OF PERICYCLIC REACTIONS 568**
 - 11.1 DEFINITIONS 569
 - 11.2 PERTURBATION THEORY IN PERICYCLIC REACTIONS 579
 - 11.3 CORRELATION DIAGRAMS AND PERICYCLIC SELECTION RULES 581
 - 11.4 INTERACTION DIAGRAMS AND THE GENERALIZED WOODWARD-HOFFMANN PERICYCLIC SELECTION RULES 596
 - 11.5 AROMATIC AND ANTIAROMATIC TRANSITION STATES 602
 - 11.6 COMPARISON OF THE WOODWARD-HOFFMANN AND DEWAR-ZIMMERMAN PERICYCLIC SELECTION RULES 611
 - 11.7 CORRELATION OF ELECTRONIC STATES 617
 - PROBLEMS 623
- 12 APPLICATIONS OF THE PERICYCLIC SELECTION RULES 626**
 - 12.1 CYCLOADDITIONS 626
 - 12.2 ELECTROCYCLIC REACTIONS 645

viii Contents

12.3 SIGMATROPIC REACTIONS 657
PROBLEMS 677

13 PHOTOCHEMISTRY 681

13.1 LIGHT ABSORPTION 681

13.2 UNIMOLECULAR PHOTOPHYSICAL PROCESSES 687

13.3 BIMOLECULAR PHOTOPHYSICAL PROCESSES 693

13.4 PHOTOCHEMICAL REACTIONS 706
PROBLEMS 729

Index 731

PREFACE

This book is intended as a text for undergraduate and first-year graduate students who have completed a one-year course in organic chemistry. Its aim is to provide a structure that will help the student to organize and interrelate the factual information obtained in the earlier course and serve as a basis for study in greater depth of individual organic reactions and of methods by which chemists obtain information about chemical processes.

The primary focus of the book is on reaction mechanisms, not only because knowledge of mechanism is essential to understanding chemical processes but also because theories about reaction mechanisms can explain diverse chemical phenomena in terms of a relatively small number of general principles. It is this latter capability of mechanistic theory which makes it important as an organizing device for the subject of organic chemistry as a whole.

In treating mechanisms of the important classes of organic reactions, we have tried to emphasize the experimental evidence upon which mechanistic ideas are built and to point out areas of uncertainty and controversy where more work still needs to be done. In this way we hope to avoid giving the impression that all organic mechanisms are well understood and completely agreed upon but instead to convey the idea that the field is a dynamic one, still very much alive and filled with surprises, excitement, and knotty problems.

The organization of the book is traditional. We have, however, been selective in our choice of topics in order to be able to devote a significant portion of the book to the pericyclic reaction theory and its applications and to include a chapter on photochemistry.

The pericyclic theory is certainly the most important development in mechanistic organic chemistry in the past ten years. Because it is our belief that

the ideas and method of thinking associated with the pericyclic theory will have an increasing impact in both organic and inorganic chemistry in the future, we have given a more detailed discussion of its purely theoretical aspects than has heretofore been customary in books of this kind. This discussion includes both the Woodward–Hoffmann approach and the Dewar–Zimmerman aromaticity approach and makes the connection between them. Our treatment requires as background a more sophisticated understanding of covalent bonding than is ordinarily given in introductory courses; we have therefore included an extensive presentation of bonding theory. It begins at a basic level with a review of familiar concepts in Chapter 1 and introduces in Chapter 10 the terminology and ideas needed to understand the pericyclic theory and its ramifications. The treatment is qualitative throughout. Although quantitative molecular orbital calculations are not needed for our purposes, Appendix 2 to Chapter 1 summarizes the molecular orbital calculation methods in general use. The Hückel MO method is covered in sufficient detail to allow the reader to apply it to simple systems.

Another innovation in this text is the use of three-dimensional reaction coordinate diagrams, pioneered by Thornton, More O'Ferrall, and Jencks, in the discussions of nucleophilic substitutions, eliminations, and acid catalysis of carbonyl additions. We hope that the examples may lead to more widespread use of these highly informative diagrams.

A chapter on photochemistry provides a discussion of photophysical processes needed as background for this increasingly important area of chemistry and treats the main categories of light-induced reactions.

The text assumes elementary knowledge of the common organic spectroscopic techniques. Nevertheless, we have included a description of the recently developed method of chemically induced dynamic nuclear polarization (CIDNP), which has already proved to be of great importance in the study of radical reactions and which has not yet found its way into books covering spectroscopy of organic compounds.

Problems of varying difficulty have been included at the ends of the chapters. Some problems illustrate points discussed in the text, but others are meant to extend the text by leading the student to investigate reactions, or even whole categories of reactions, which we have had to omit because of limitations of space. References to review articles and to original literature are given for all problems except those restricted to illustration of points that the text discusses in detail. Problems that represent significant extensions of the text are included in the index.

The book is extensively footnoted. It is neither possible nor desirable in a book of this kind to present exhaustive reviews of the topics taken up, and we have made no effort to give complete references. We have tried to include references to review articles and monographs wherever recent ones are available, to provide key references to the original literature for the ideas discussed, and to give sources for all factual information presented. The text also contains numerous cross references.

The amount of material included is sufficient for a full-year course. For a one-semester course, after review of the first two chapters, material may be chosen to emphasize heterolytic reactions (Chapters 3–8), to cover a broader

range including radicals and photochemistry (selections from Chapters 3–8 plus 9 and 13), or to focus primarily on pericyclic reactions (Chapters 10–12). In selecting material for a one-semester course, the following sections should be considered for possible omission: 3.5, 4.4, 4.5, 5.6, 6.3, 7.3, 7.5, 8.3, 9.5, 10.4, 11.6, 11.7.

We would like to thank the following people for reviewing parts of the manuscript and for providing helpful comments: Professors D. E. Applequist, C. W. Beck, J. C. Gilbert, R. W. Holder, W. P. Jencks, J. R. Keeffe, C. Levin, F. B. Mallory, D. R. McKelvey, N. A. Porter, P. v. R. Schleyer, J. Swenton, and T. T. Tidwell. We are particularly grateful to Professor N. A. Porter, who reviewed and commented on the entire manuscript. We owe special thanks to Professor Charles Levin for many enlightening discussions and to Carol Dempster for essential help and encouragement.

Thomas H. Lowry
Kathleen Schueller Richardson

MECHANISM AND THEORY IN ORGANIC CHEMISTRY

Chapter 1

THE COVALENT BOND

Because the covalent bond is of central importance to organic chemistry, we begin with a review of bonding theory. Later, in Chapter 10, we shall return to develop certain aspects of the theory further in preparation for the discussion of pericyclic reactions.

1.1 MODELS OF CHEMICAL BONDING

Understanding and progress in natural science rest largely on models. A little reflection will make it clear that much of chemical thinking is in terms of models, and that the models useful in chemistry are of many kinds. Although we cannot see atoms, we have many excellent reasons for believing in them, and when we think about them we think in terms of models. For some purposes a very simple model suffices. Understanding stoichiometry, for example, requires only the idea of atoms as small lumps of matter that combine with each other in definite proportions and that have definite weights. The mechanism by which the atoms are held together in compounds is not of central importance for this purpose. When thinking about stereochemistry, we are likely to use an actual physical model consisting of small balls of wood or plastic held together by springs or sticks. Now the relative weights of atoms are immaterial, and we do not bother to reproduce them in the model; instead we try to have the holes drilled carefully so that the model will show the geometrical properties of the molecules. Still other models are entirely mathematical. We think of chemical rate processes in terms of sets of differential equations, and the details of chemical bonding require still more abstract mathematical manipulations. The point to understand is that there may be many ways of building a model for a given phenomenon, none of which is com-

2 THE COVALENT BOND

plete but each of which serves its special purpose in helping us understand some aspect of the physical reality.

The Electron Pair Bond—Lewis Structures

The familiar Lewis structure is the simplest bonding model in common use in organic chemistry. It is based on the idea that, at the simplest level, the ionic bonding force arises from the electrostatic attraction between ions of opposite charge, and the covalent bonding force arises from sharing of electron pairs between atoms.

The starting point for the Lewis structure is a notation for an atom and its valence electrons. The element symbol represents the core, that is, the nucleus and all the inner-shell electrons. The core carries a number of positive charges equal to the number of valence electrons. This positive charge is called the core charge. Valence electrons are shown explicitly. For elements in the third and later rows of the periodic table, the *d* electrons in atoms of Main Groups III, IV, V, VI, and VII are counted as part of the core. Thus:

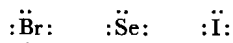

Ions are obtained by adding or removing electrons. The charge on an ion is given by

$$\text{charge} = \text{core charge} - \text{number of electrons shown explicitly.}$$

An ionic compound is indicated by writing the Lewis structures for the two ions.

A covalent bond model is constructed by allowing atoms to share pairs of electrons. Ordinarily, a shared pair is designated by a line:



All valence electrons of all atoms in the structure must be shown explicitly. Those electrons not in shared covalent bonds are indicated as dots, for example:

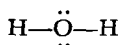

If an ion contains two or more atoms covalently bonded to each other, the total charge on the ion must equal the total core charge less the total number of electrons, shared and unshared:

$$\begin{array}{r} (\text{H—}\ddot{\text{O}}\text{:})^- \\ \text{H core} = +1 \\ \text{O core} = +6 \\ \hline \text{total core} = +7 \\ \text{number of electrons} = -8 \\ \hline \text{total charge} = -1 \end{array}$$

In order to write correct Lewis structures, two more concepts are needed. First, consider the total number of electrons in the immediate neighborhood of each atom. This number is called the *valence-shell occupancy* of the atom, and to find it, all unshared electrons around the atom and all electrons in bonds leading

to the atom must be counted. The valence-shell occupancy must not exceed 2 for hydrogen and must not exceed 8 for atoms of the first row of the periodic table. For elements of the second and later rows, the valence-shell occupancy may exceed 8. The structures

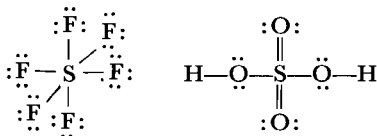

are acceptable.

The second idea is that of formal charge. For purposes of determining formal charge, partition all the electrons into groups as follows: Assign to each atom all of its unshared pair electrons and half of all electrons in bonds leading to it. Call the number of electrons assigned to the atom by this process its *electron ownership*. The formal charge of each atom is then given by

$$\text{formal charge} = \text{core charge} - \text{electron ownership}$$

To illustrate formal charge, consider the hydroxide ion, OH^- . The electron ownership of H is 1, its core charge is +1, and its formal charge is therefore zero. The electron ownership of oxygen is 7, and the core charge is +6; therefore the formal charge is -1. All nonzero formal charges must be shown explicitly in the structure. The reader should verify the formal charges shown in the following examples:

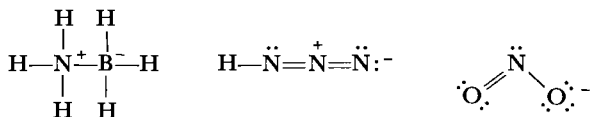

The algebraic sum of all formal charges in a structure is equal to the total charge.

Formal charge is primarily useful as a bookkeeping device for electrons, but it also gives a rough guide to the charge distribution within a molecule.

In writing Lewis structures, the following procedure is to be followed:

1. Count the total number of valence electrons contributed by the electrically neutral atoms. If the species being considered is an ion, add one electron to the total for each negative charge; subtract one for each positive charge.

2. Write the core symbols for the atoms and fill in the number of electrons determined in Step 1. The electrons should be added so as to make the valence-shell occupancy of hydrogen 2 and the valence-shell occupancy of other atoms not less than 8 wherever possible.

3. Valence-shell occupancy must not exceed 2 for hydrogen and 8 for a first-row atom; for a second-row atom it may be 10 or 12.

4. Maximize the number of bonds, and minimize the number of unpaired electrons, always taking care not to violate Rule 3.

5. Find the formal charge on each atom.

We shall illustrate the procedure with two examples.

4 THE COVALENT BOND

Example 1. NO₂

STEP 1 17 valence electrons, 0 charge = 17 electrons

STEP 2 $\ddot{\text{O}}=\ddot{\text{N}}-\ddot{\text{O}}:$

(Formation of another bond, $\ddot{\text{O}}=\ddot{\text{N}}=\ddot{\text{O}}$, would give nitrogen valence-shell occupancy 9.)

STEP 3 Formal charge:

Left O Ownership 6 0 charge

Right O Ownership 7 -1 charge

N Ownership 4 +1 charge

Correct Lewis Structure:

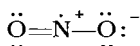

Example 2. CO₃²⁻ Ion

STEP 1 22 valence electrons, +2 electrons for charge, =24 electrons.

STEP 2
$$\begin{array}{c} :\ddot{\text{O}}: \\ | \\ :\ddot{\text{O}}-\text{C}=\ddot{\text{O}} \end{array}$$

(More bonds to C would exceed its valence-shell limit.)

STEP 3 Formal charge:

$:\ddot{\text{O}}-$ Ownership 7 -1 charge

$:\ddot{\text{O}}-$ Ownership 7 -1 charge

$=\ddot{\text{O}}$ Ownership 6 0 charge

C Ownership 4 0 charge

Correct Lewis Structure:

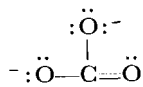

Resonance

The Lewis structure notation is useful because it conveys the essential qualitative information about properties of chemical compounds. The main features of the chemical properties of the groups that make up organic molecules,

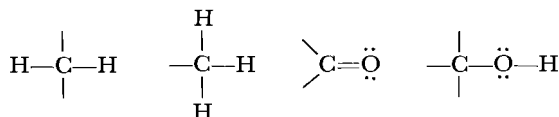

and so forth, are to a first approximation constant from molecule to molecule, and one can therefore tell immediately from the Lewis structure of a substance that one has never encountered before roughly what the chemical properties will be.

There is a class of structures, however, for which the properties are not those expected from the Lewis structure. A familiar example is benzene, for which the heat of hydrogenation (Equation 1.1) is less exothermic by about 37 kcal mole⁻¹ than one would have expected from Lewis structure **1** on the basis of the measured

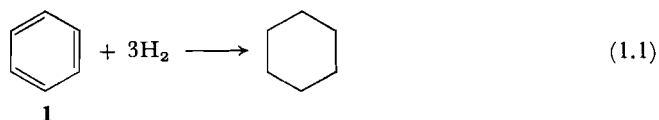

heat of hydrogenation of ethylene. The thermochemical properties of various types of bonds are in most instances transferable with good accuracy from molecule to molecule; a discrepancy of this magnitude therefore requires a fundamental modification of the bonding model.

The difficulty with model **1** for benzene is that there is another Lewis structure, **2**, which is identical to **1** except for the placement of the double bonds.

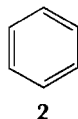

Whenever there are two alternative Lewis structures, one alone will be an inaccurate representation of the molecular structure. A more accurate picture will be obtained by the superposition of the two structures into a new model, which for benzene is indicated by **3**. The superposition of two or more Lewis structures into a composite picture is called *resonance*.

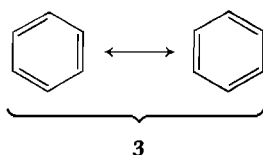

This terminology is well established, but unfortunate, because the term resonance when applied to a pair of pictures tends to convey the idea of a changing back and forth with time. It is therefore difficult to avoid the pitfall of thinking of the benzene molecule as a structure with three conventional double bonds, of the ethylene type, jumping rapidly back and forth from one location to another. This idea is incorrect. The electrons in the molecule move in a field of force created by the six carbon and six hydrogen nuclei arranged around a regular hexagon (**4**). Each of the six sides of the hexagon is entirely equivalent to each

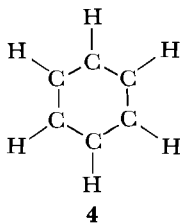

other side; there is no reason why electrons should, even momentarily, seek out

6 THE COVALENT BOND

three sides and make them different from the other three, as the two alternative pictures **3** seem to imply that they do.

The symmetry of the ring of nuclei (**4**) is called a sixfold symmetry because rotating the picture by one-sixth of a circle will give the identical picture again. This sixfold symmetry must be reflected in the electron distribution. A less misleading picture would be **5**, in which the circle in the middle of the ring implies a



5

distribution of the six double bond electrons of the same symmetry as the arrangement of nuclei. We shall nevertheless usually continue to use the notation **3**, as it has certain advantages for thinking about reactions.

The most important features of structures for which resonance is needed are, first, that the molecule is more stable (of lower energy) than one would expect from looking at one of the individual structures, and second, that the actual distribution of electrons in the molecule is different from what one would expect on the basis of one of the structures. Since the composite picture shows that certain electrons are free to move over a larger area of the molecule than a single one of the structures implies, resonance is often referred to as delocalization. We shall have more to say about delocalization later in connection with molecular orbitals.

While the benzene ring is the most familiar example of the necessity for modifying the Lewis structure language by the addition of the resonance concept, there are many others. The carboxylic acids, for example, are much stronger acids than the alcohols; this difference must be due largely to greater stability of the carboxylate ion (**6**) over the alkoxide ion (**7**); it is the possibility of writing two equivalent Lewis structures for the carboxylate ion that alerts us to this difference.

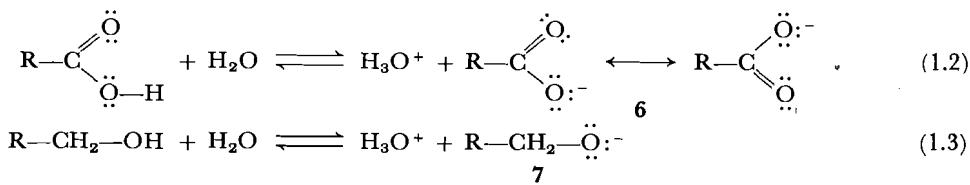

Another example is the allylic system. The allyl cation (**8**), anion (**9**), and

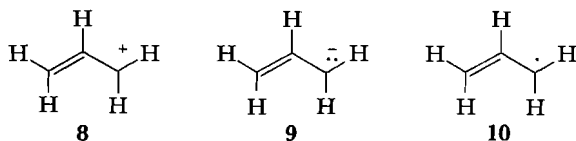

radical (**10**), are all more stable than their saturated counterparts. Again, there is for each an alternative structure:

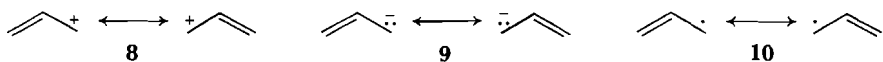

3. Where two structures with formal charge have the same number of bonds and approximately the same charge separation, the structure with charge on the more electronegative atom will usually be somewhat lower in energy, but the difference will ordinarily be small enough that both structures must be included in the composite picture. Thus in $17a \leftrightarrow 17b$, $17a$ should be more stable, but the

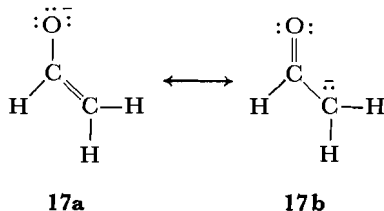

chemistry of the ion can be understood only if it is described by the superposition of both structures.

4. All four groups attached to a pair of atoms joined by a double bond in any structure must lie in the same plane. For example, the structure **18b** cannot

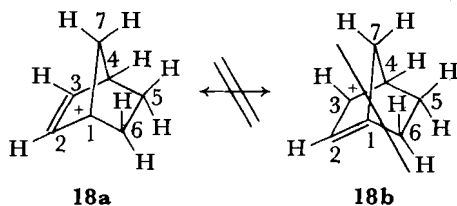

contribute, because the bridged ring prevents carbons 6 and 7 from lying in the same plane as carbon 3 and the hydrogen on carbon 2. The impossibility of structures with double bonds at bridgeheads of small bridged rings is known as *Bredt's rule*.¹ Double bonds can occur at a bridgehead if the rings are sufficiently large.

Molecular Geometry

Lewis structures provide a simple method of estimating molecular shapes. The geometry about any atom covalently bonded to two or more other atoms is found by counting the number of electron groups around the atom. Each unshared pair counts as one group, and each bond, whether single or multiple, counts as one group. The number of electron groups around an atom is therefore equal to the sum of the number of electron pairs on the atom and the number of other atoms bonded to it. The geometry is linear if the number of electron groups is two, trigonal if the number is three, and tetrahedral if the number is four.

The rule is based on the electron-pair repulsion model, which postulates that because electron pairs repel each other, they will try to stay as far apart as possible. In trigonal and tetrahedral geometries, the shape will be exactly trigonal (120° bond angles), or exactly tetrahedral (109.5° bond angles) if the electron groups are all equivalent, as for example in BH_3 or CH_3^+ (trigonal), or in CH_4 or NH_4^+ (tetrahedral).

¹ (a) F. S. Fawcett, *Chem. Rev.*, **47**, 219 (1950); (b) J. R. Wiseman and W. A. Pletcher, *J. Amer. Chem. Soc.*, **92**, 956 (1970); (c) C. B. Quinn and J. R. Wiseman, *J. Amer. Chem. Soc.*, **95**, 6120 (1973); (d) C. B. Quinn, J. R. Wiseman, and J. C. Calabrese, *J. Amer. Chem. Soc.*, **95**, 6121 (1973).

If the groups are not all equivalent, the angles will deviate from the ideal values. Thus in NH_3 (four electron groups, three in N—H bonds, one an unshared pair), the unshared pair, being attracted only by the nitrogen nucleus, will be closer to the nitrogen on the average than will the bonding pairs, which are also attracted by a hydrogen nucleus. Therefore the repulsion between the unshared pair and a bonding pair is greater than between two bonding pairs, and the bonding pairs will be pushed closer to each other. The H—N—H angle should therefore be less than 109.5° . It is found experimentally to be 107° . Similarly, in H_2O (four electron groups, two unshared pairs, and two O—H bonds), the angle is 104.5° .

Ambiguity may arise when more than one structure contributes. Then unshared pairs in one structure may become multiple bonds in another, so that the number of electron groups around a given atom is not the same in both structures. An example is methyl azide (**19**). The central nitrogen is clearly linear (two electron groups), but the nitrogen bonded to CH_3 has three electron groups in

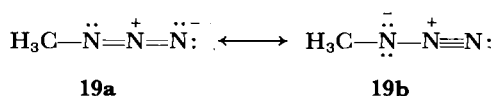

19a and four in **19b**. In such a situation, the number of electron groups is determined from the structure with the *larger number of bonds*. Thus the nitrogen in question in **19** is trigonal, not tetrahedral.

Conventions for Structural Formulas

This book contains large numbers of Lewis structural formulas. Frequently we shall not write out the full Lewis structure; unshared pairs of electrons not shown explicitly are implied. When there are two or more contributing structures, we shall show them all only if that is essential to the point being illustrated; again, it will be assumed that the reader will understand that the missing structures are implied.

1.2 MOLECULAR ORBITALS

Lewis structures serve admirably for many aspects of mechanistic organic chemistry. Frequently, however, we need a more accurate bonding model.

Models Based on the Quantum Theory

The description of chemical bonding must ultimately be based on an understanding of the motions of electrons. In order to improve our model, we need to appeal to the quantum theory, which summarizes the current understanding of the behavior of particles of atomic and subatomic size.

The quantum theory provides the mathematical framework for describing the motions of electrons in molecules. When several electrons are present, all interacting strongly with each other through their mutual electrostatic repulsion, the complexity is so great that exact solutions cannot be found. Therefore approximate methods must be used even for simple molecules. These methods

take various forms, ranging from complex *ab initio* calculations, which begin from first principles and have no parameters adjusted to fit experimental data, to highly approximate methods such as the Hückel theory, which is discussed further in Appendix 2. The more sophisticated of these methods now can give results of quite good accuracy for small molecules, but they require extensive use of computing equipment.² Such methods are hardly suited to day-to-day qualitative chemical thinking. Furthermore, the most generally applicable and therefore most powerful methods are frequently simple and qualitative.

Our ambitions in looking at bonding from the point of view of the quantum theory are therefore modest. We want to make simple qualitative arguments that will provide a practical bonding model.

Atomic Orbitals

The quantum theory specifies the mathematical machinery required to obtain a complete description of the hydrogen atom. There are a large number of functions that are solutions to the appropriate equation; they are functions of the x , y , and z coordinates of a coordinate system centered at the nucleus.³ Each of these functions describes a possible condition, or state, of the electron in the atom, and each has associated with it an energy, which is the total energy (kinetic plus potential) of the electron when it is in the state described by the function in question.

The functions we are talking about are the familiar $1s$, $2s$, $2p$, $3s$, ... atomic orbitals, which are illustrated in textbooks by diagrams like those in Figure 1.1. Each orbital function (or *wave function*) is a solution to the quantum mechanical equation for the hydrogen atom called the Schrödinger equation. The functions are ordinarily designated by a symbol such as φ , χ , ψ , and so on. We shall call atomic orbitals φ or χ , and designate by a subscript the orbital meant, as for example φ_{1s} , φ_{2s} , and so on. Later, we may abbreviate the notation by simply using the symbols $1s$, $2s$, ..., to indicate the corresponding orbital functions. Each function has a certain numerical value at every point in space; the value at any point can be calculated once the orbital function is known. We shall never need to know these values, and shall therefore not give the formulas; they can be found in other sources.⁴ The important things for our purposes are, first, that the numerical values are positive in certain regions of space and negative in other regions, and second, that the value of each function approaches zero

² A number of texts cover methods for obtaining complete orbital descriptions of molecules. Examples, in approximate order of increasing coverage, are (a) A. Liberles, *Introduction to Molecular-Orbital Theory*, Holt, Rinehart, and Winston, New York, 1966; (b) J. D. Roberts, *Notes on Molecular Orbital Theory*, W. A. Benjamin, Menlo Park, Calif., 1962; (c) K. B. Wiberg, *Physical Organic Chemistry*, Wiley, New York, 1964; (d) A. Streitwieser, Jr., *Molecular Orbital Theory for Organic Chemists*, Wiley, New York, 1961; (e) M. J. S. Dewar, *The Molecular Orbital Theory of Organic Chemistry*, McGraw-Hill, New York, 1969; (f) P. O'D. Offenhardt, *Atomic and Molecular Orbital Theory*, McGraw-Hill, New York, 1970; (g) S. P. McGlynn, L. G. Vanquickenborne, M. Kinoshita, and D. G. Carroll, *Introduction to Applied Quantum Chemistry*, Holt, Rinehart, and Winston, New York, 1972.

³ Actually, the origin is at the center of mass, which, because the nucleus is much more massive than the electron, is very close to the nucleus.

⁴ See, for example, Wiberg, *Physical Organic Chemistry*, pp. 17, 19, and 25.

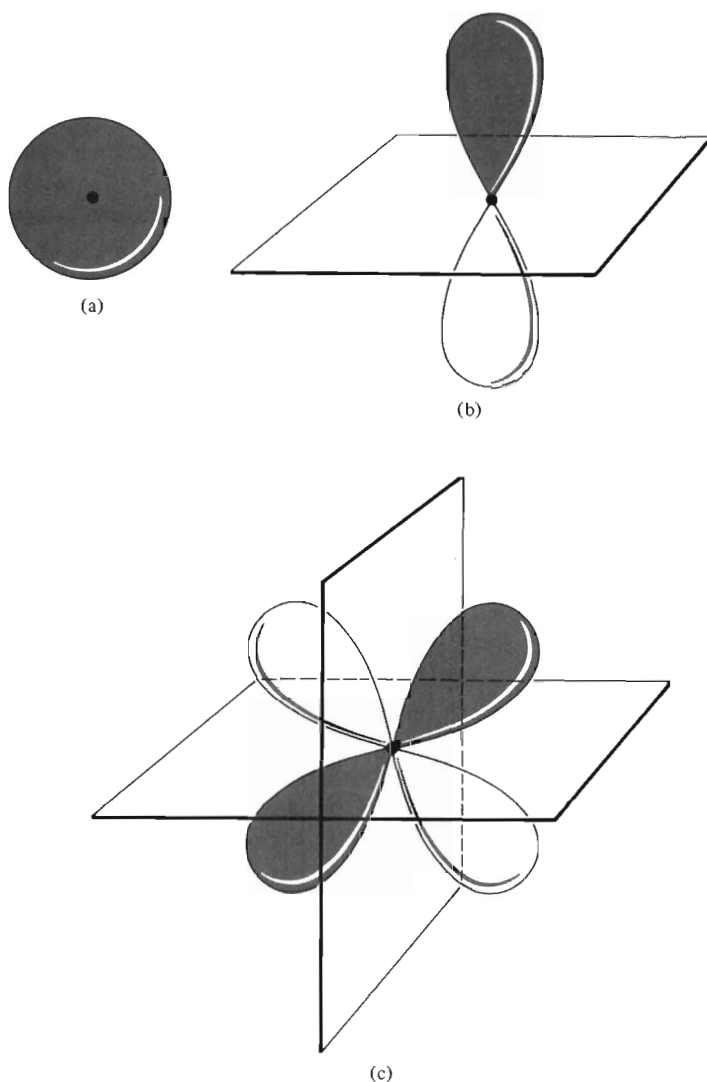

Figure 1.1 Hydrogen atomic orbital functions. (a) $1s$; (b) $2p$; (c) $3d$. The edges drawn are artificial, because orbitals have no edges but merely decrease in magnitude as distance from the nucleus increases. The important features of the orbitals are the nodal planes indicated, and the algebraic signs of the orbital functions, positive in the shaded regions and negative in the unshaded regions.

as one moves farther from the nucleus. In Figure 1.1, and in other orbital diagrams used throughout this book, positive regions are shaded and negative regions are unshaded.

Imagine walking around inside an orbital, and suppose that there is some way of sensing the value—positive, negative, or zero—of the orbital function as you walk from point to point. On moving from a positive region to a negative region, you must pass through some point where the value is zero. The collections

of all adjacent points at which a function is zero are called *nodes*; they are surfaces in three-dimensional space, and most of the important ones for our purposes are planes, like those shown in Figure 1.1 for the p and d orbitals illustrated. (Nodes can also be spherical, and of other shapes, but these are of less concern to us.)

The Physical Significance of Atomic Orbital Functions

The fact that an orbital function φ is of different algebraic sign in different regions has no particular physical significance for the behavior of an electron that finds itself in the state defined by the orbital. (We shall see shortly that the significance of the signs comes from the way in which orbitals can be combined with each other.) The quantity that has physical meaning is the value at each point of the function φ^2 , which is positive everywhere, since the square of a negative number is positive. The squared function, φ^2 , gives the probability of finding the electron at various points in space. Diagrams like that in Figure 1.2, with shading of varying density showing the relative probability of finding the electron in various regions or, more succinctly, the *electron distribution* or *electron density*, are actually pictures of φ^2 , not of φ itself. The general shape of φ^2 will be similar to the shape of φ . The orbitals and their squares have no edges, even though definite outlines are usually drawn in diagrams; the values merely approach closer and closer to zero as one goes farther and farther from the nucleus.

Extension to Other Atoms

The hydrogen atomic orbitals would not do us a great deal of good if orbitals of other atoms were radically different, since in that case different pictures would be required for each atom. But the feature of the hydrogen atom problem that determines the most important characteristics of the hydrogen atom orbitals is the spherical symmetry. Since all the atoms are spherically symmetric, the atomic orbitals of all atoms are similar, the main difference being in their radial dependence, that is, in how rapidly they approach zero as one moves away from the nucleus. Because the radial dependence is of minimal importance in qualitative

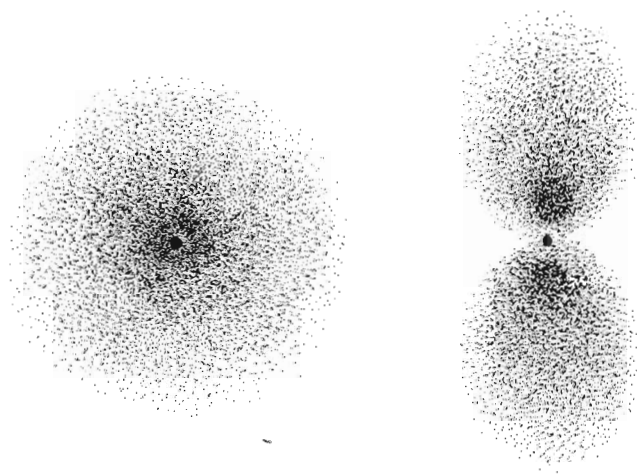

Figure 1.2 Electron density, φ^2 , for $1s$ and $2p$ atomic orbitals. The density of shading is roughly proportional to φ^2 .

applications, one may simply use orbitals of the shapes found for hydrogen to describe behavior of electrons in all the atoms.

Ground and Excited States

We know that an electron in a hydrogen atom in a stationary state will be described by one of the atomic orbital functions φ_{1s} , φ_{2s} , φ_{2p_x} , and so forth.⁵ We can make this statement in a more abbreviated form by saying that the electron is in one of the orbitals φ_{1s} , φ_{2s} , φ_{2p_x} , . . . , and we shall use this more economical kind of statement henceforth.

The orbital that has associated with it the lowest energy is φ_{1s} ; if the electron is in this orbital, it has the lowest total energy possible, and we say the atom is in its *electronic ground state*. If we were to give the electron more energy, say enough to put it in the φ_{2p_x} orbital, the atom would be in an *electronic excited state*. In general, for any atom or molecule, the state in which all electrons are in the lowest possible energy orbitals (remembering always that the Pauli exclusion principle prevents more than two electrons from occupying the same orbital) is the *electronic ground state*. Any higher-energy state is an *electronic excited state*.

An Orbital Model for the Covalent Bond

Suppose that we bring together two ground-state hydrogen atoms. Initially, the two electrons are in φ_{1s} orbitals centered on their respective nuclei. We shall call one atom A and the other B, so that the orbitals are φ_{1sA} and φ_{1sB} . When the atoms are very close, say within 1 \AA ($=10^{-8} \text{ cm}$) of each other, each electron will feel strongly the attractive force of the other nucleus as well as of its own. Clearly, then, the spherical φ_{1s} orbitals will no longer be appropriate to the description of the electron motions. We need to find new orbital functions appropriate to the new situation, but we would prefer to do so in the simplest way possible, since going back to first principles and calculating the correct new orbital functions is likely to prove an arduous task.

We therefore make a guess that a possible description for a new orbital function will be obtained by finding at each point in space the value of φ_{1sA} and of φ_{1sB} and adding the two numbers together. This process will give us a new orbital function, which, since φ_{1sA} and φ_{1sB} are both positive everywhere, will also be positive everywhere. Figure 1.3 illustrates the procedure. Mathematically, the statement of what we have done is Equation 1.4:

$$\psi_{\text{MO}} = \varphi_{1sA} + \varphi_{1sB} \quad (1.4)$$

The symbol MO means that the new function is a *molecular orbital*; a molecular orbital is any orbital function that extends over more than one atom. Since the technical term for a sum of functions of the type 1.4 is a *linear combination*, the procedure of adding up atomic orbital functions is called *linear combination of atomic orbitals*, or *LCAO*.

This simple procedure turns out to fit quite naturally into the framework of the quantum theory, which with little effort provides a method for finding the

⁵ We assume from here on that the reader is familiar with the number and shape of each type of atomic orbital function. This information may be found in standard introductory college chemistry texts.

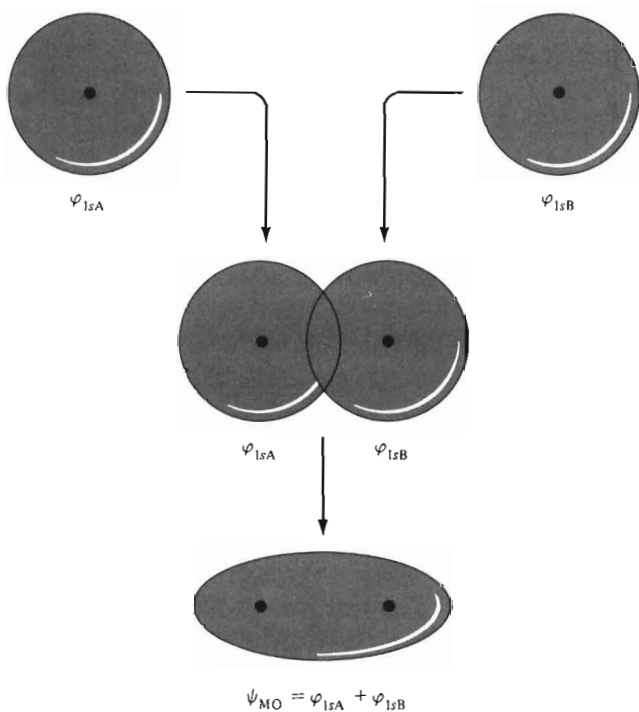

Figure 1.3 The linear combination of 1s orbital functions on hydrogen atoms A and B to yield a new orbital function, $\psi_{MO} = \varphi_{1sA} + \varphi_{1sB}$.

energy associated with the new orbital ψ_{MO} . This energy is lower than the energy of either of the original orbitals φ_{1sA} , φ_{1sB} .

Instead of adding φ_{1sA} and φ_{1sB} , we might have subtracted them. We would then have obtained Equation 1.5:

$$\psi_{MO}^* = \varphi_{1sA} - \varphi_{1sB} \quad (1.5)$$

Figure 1.4 illustrates the formation of this combination. Note that there is a node in this molecular orbital, because at any point equidistant from the two nuclei the value of φ_{1sA} is numerically equal to the value of φ_{1sB} , so that $\varphi_{1sA} - \varphi_{1sB}$ is zero.

The procedures of the quantum theory require that the negative combination be made as well as the positive, and they show also that the energy associated with ψ_{MO}^* will be higher than that of φ_{1sA} and φ_{1sB} .

Energies of Molecular Orbitals

We can summarize the process of constructing our bonding model in an energy-level diagram. Figure 1.5 introduces the conventions we shall use for showing the formation of new orbitals by combining others. On either side we place the starting orbitals, and at the center the orbitals resulting from the combination process. In Figure 1.5 we have also shown orbital occupancies: Before the interaction, we have one electron in φ_{1sA} and one in φ_{1sB} ; afterward we can place both electrons in ψ_{MO} to obtain the ground state of the H_2 molecule, which will be of

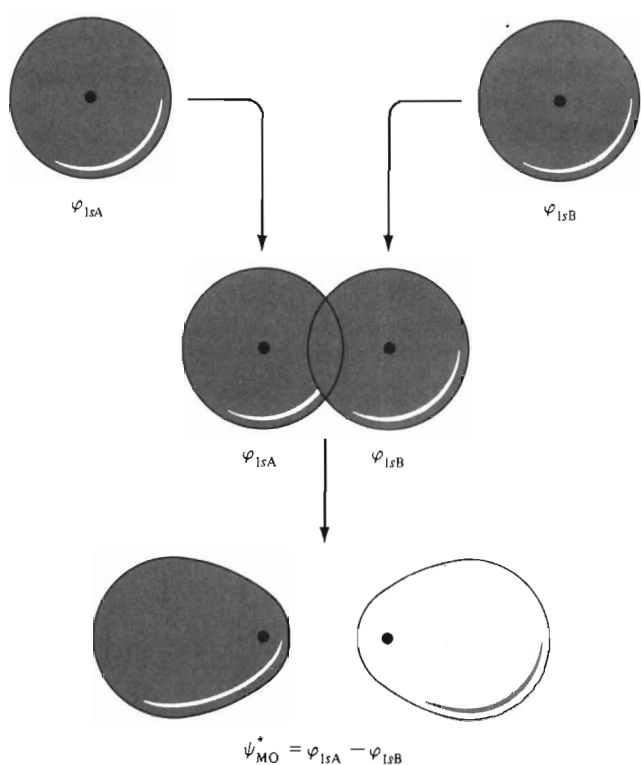

Figure 1.4 The linear combination of $1s$ orbital functions on hydrogen atoms A and B to yield orbital function $\psi_{MO}^* = \varphi_{1sA} - \varphi_{1sB}$.

lower energy than the separated atoms by an amount $2 \Delta E$ (two electrons each decrease in energy by ΔE).⁶

The process of forming ground-state H_2 would be described in our LCAO model by saying that H_A , with its electron in φ_{1sA} , and H_B , with its electron in φ_{1sB} , will come together to give H_2 with a pair of electrons in ψ_{MO} , and will in the process give off energy $2 \Delta E$ to the surroundings. We can also obtain models for a singly excited state and for a doubly excited state of H_2 by adding energy $2 \Delta E$ or $4 \Delta E$ to the ground-state molecule and placing either one or both electrons in ψ_{MO}^* .

Electrons in ψ_{MO} are stabilizing for the molecule, and electrons in ψ_{MO}^* are destabilizing. Therefore we call ψ_{MO} a bonding orbital and ψ_{MO}^* an antibonding orbital. In antibonding orbitals there is always a node between the nuclei, so that

⁶ The energy change on formation of the molecule, known from experiment to be $104 \text{ kcal mole}^{-1}$, will not actually be equal to $2 \Delta E$, because the quantum mechanical procedures count the mutual repulsion of the electrons twice and neglect the mutual repulsion of the nuclei. The two corrections to $2 \Delta E$ are opposite in sign and roughly cancel, but they are both large numbers (on the order of $400\text{--}450 \text{ kcal mole}^{-1}$ for H_2), and their difference (about $35 \text{ kcal mole}^{-1}$) is significant. The actual energy lowering is less than $2 \Delta E$ by this amount; in other words, for hydrogen the actual experimental dissociation energy is $104 \text{ kcal mole}^{-1}$, but $2 \Delta E$ calculated from theory is about $139 \text{ kcal mole}^{-1}$ and ΔE is about $69 \text{ kcal mole}^{-1}$. See C. A. Coulson, *Valence*, 2nd ed., Oxford University Press, London, 1963, p. 90.

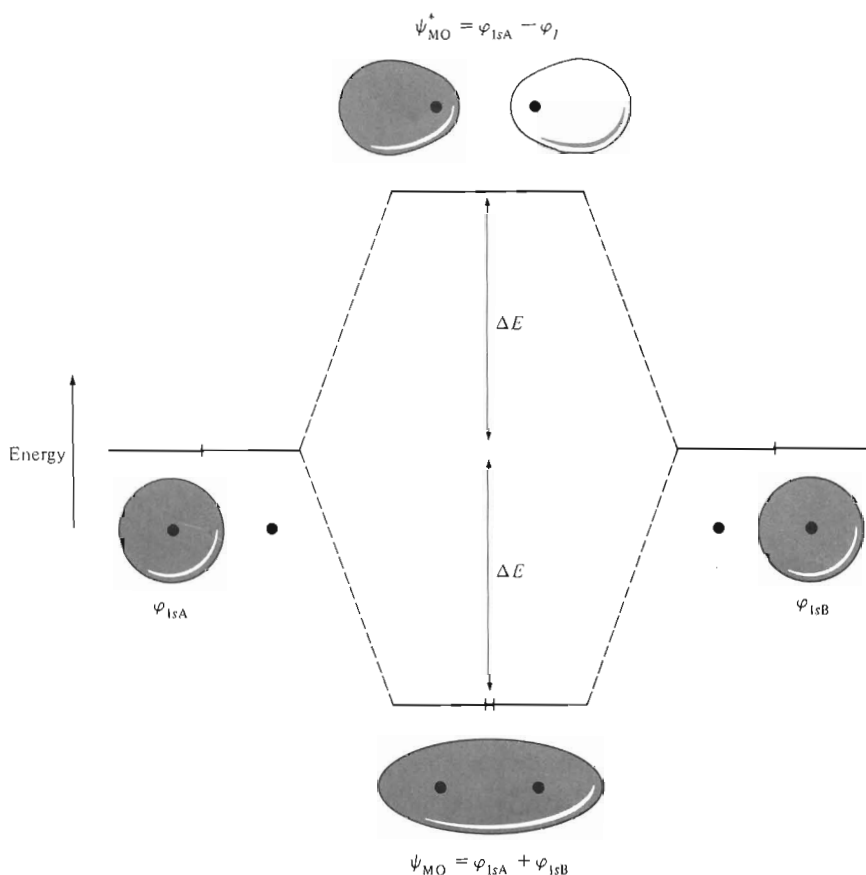

Figure 1.5 The energy-level diagram for the interaction of φ_{1sA} with φ_{1sB} . On either side are the atomic orbitals before interaction; at the center are the two molecular orbitals. Orbital occupancies are indicated for the two separate hydrogen atoms and for the molecule.

electrons are excluded from that region, whereas bonding orbitals have no such node and concentrate electrons between the nuclei.

Interaction of Orbitals

There is an alternative way of looking at the process described in Figure 1.5 which we shall find useful in subsequent discussions. We can think of the two orbitals φ_{1sA} and φ_{1sB} as interacting with each other to produce the two new orbitals ψ_{MO} and ψ_{MO}^* . The interaction has associated with it an energy change ΔE ; measuring from the energy of the orbitals φ_{1sA} and φ_{1sB} before the interaction occurs, ψ_{MO} moves down by interaction energy ΔE and ψ_{MO}^* moves up by interaction energy ΔE .⁷

⁷ A somewhat more careful treatment shows that ψ_{MO}^* will actually have moved up above the φ_{1sA} level by somewhat more than ψ_{MO} moved down. This fact will be important in certain applications later, but need not concern us now.

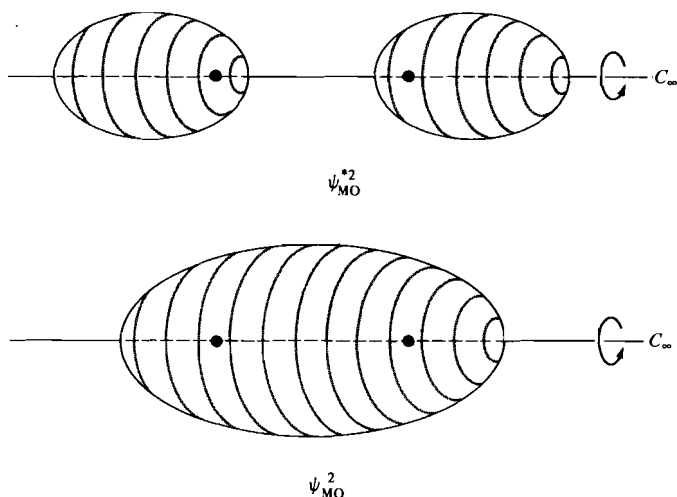

Figure 1.6 The three-dimensional shapes of ψ_{MO}^2 and ψ_{MO}^{*2} . Each has infinite-fold rotational symmetry, because one can rotate each picture around the internuclear axis in an infinite number of steps and have at every step an identical picture.

As we have noted above, ΔE can be calculated, but for our purposes we need only to know what quantities affect its magnitude. The interaction energy is greater the more strongly the two interacting orbitals overlap; overlap is large when both orbitals have large values in the same region of space. The overlap of two orbital functions φ_1 and φ_2 is obtained by multiplying the values of the two functions at each point and summing the products over all points, in other words by integrating over all the spatial coordinates the quantity $\varphi_1\varphi_2$.

The second factor affecting the magnitude of ΔE is whether or not the two interacting orbitals are of the same or different energy. The interaction is maximum when the energies of the interacting pair are the same, and becomes smaller the farther apart in energy they are. We shall return to consider the overlap and the energy differences between the initial orbitals in more detail in Chapter 10.

Basis Functions

The initial functions taken for the starting point in the model-building process are called *basis functions*. We shall use this terminology henceforth. The reason for introducing a new term instead of just continuing to call the starting functions atomic orbitals is that molecular orbitals can themselves serve as starting functions in an interaction model.

The H_2 model has illustrated an important point about orbital interactions which must be remembered: Whenever basis orbital functions interact to form new orbital functions, the number of new functions obtained is equal to the number of basis functions used.

σ Bonds and π Bonds

In Figure 1.6 are shown the three-dimensional shapes of the electron distributions ψ_{MO}^2 and ψ_{MO}^{*2} corresponding to the H_2 molecular orbitals. Suppose that we were

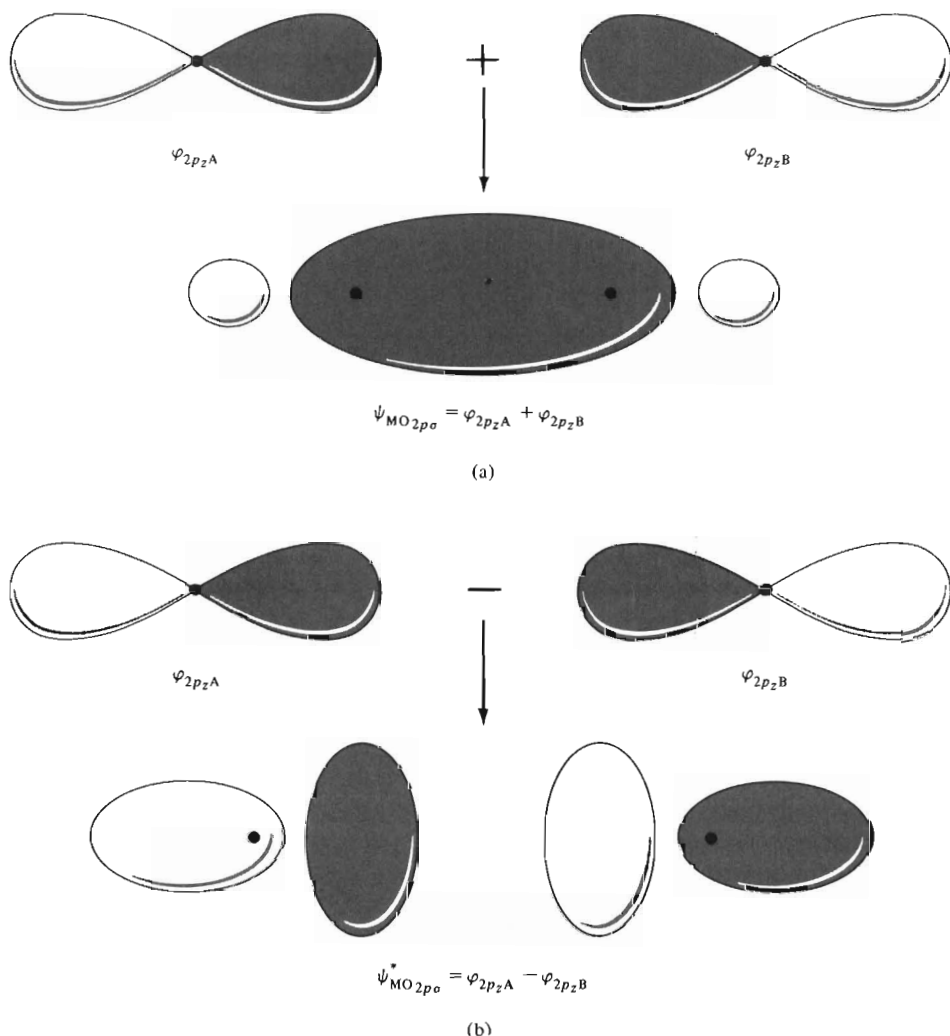

Figure 1.7 Combination of two p orbitals to give σ molecular orbitals. (a) Bonding combination. (b) Antibonding combination.

to rotate one of these pictures around an axis coinciding with the line joining the nuclei. We can rotate around this axis by any angle at all, and we shall get an identical picture. If you were to close your eyes while the rotation was done and then to open them, you would have no way of telling that any change had been made. To state this idea another way, we can say that we could divide one full rotation around the axis into an infinite number of steps, and have after each step an identical picture.

This property of the diagrams in Figure 1.6 is called a *symmetry property*. The axis of rotation is called a *symmetry element*. There are various kinds of symmetry elements; an axis is designated by the letter C . Since this particular axis is an infinite-fold rotation axis, in the sense specified above, it is called a C_∞ axis. The

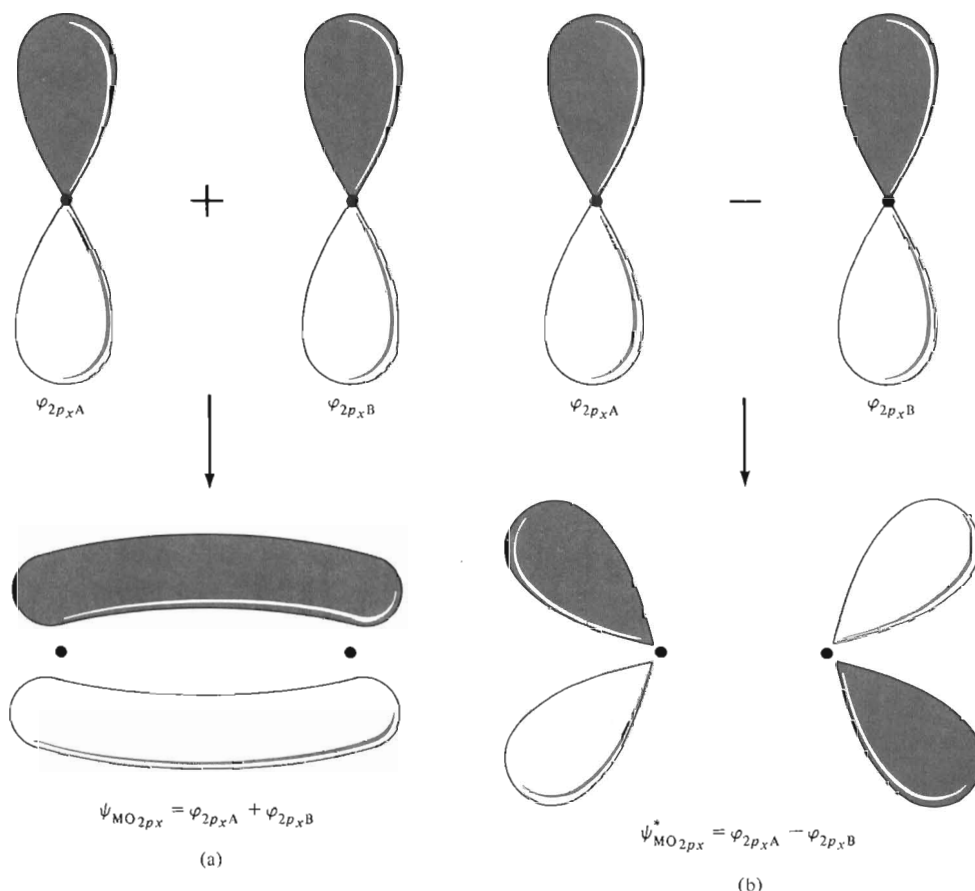

Figure 1.8 Combination of p orbitals to give π molecular orbitals. (a) Bonding combination. (b) Antibonding combination.

process of carrying out a change on an object that leaves the object looking exactly as before, in this case rotation by an arbitrary angle, is called a *symmetry operation*.

Any molecular orbital that has the symmetry property shown in Figure 1.6 is called a σ orbital. Both ψ_{MO} and ψ_{MO}^* of our hydrogen molecule model are σ orbitals.

Suppose that we make a molecular orbital by combining p orbitals on two atoms. We can do this in one of two ways. If we choose the p orbitals that are oriented toward each other (Figure 1.7), we get MO's with the same C_∞ symmetry we had before. But if the p orbitals are oriented as shown in Figure 1.8, we get a new type of molecular orbital.

Figure 1.9 shows the three-dimensional shape of the electron distributions $\psi_{MO2p_x}^2$ and $\psi_{MO2p_x}^{*2}$. Now the symmetry is different: One full rotation about the internuclear line must be divided into two equal steps if an identical picture is to be obtained after each step. This symmetry is a twofold rotation, and the symmetry element is called a C_2 axis. An orbital with this kind of symmetry is called a π orbital. Atomic orbitals of the s type can form only σ molecular orbitals; atomic

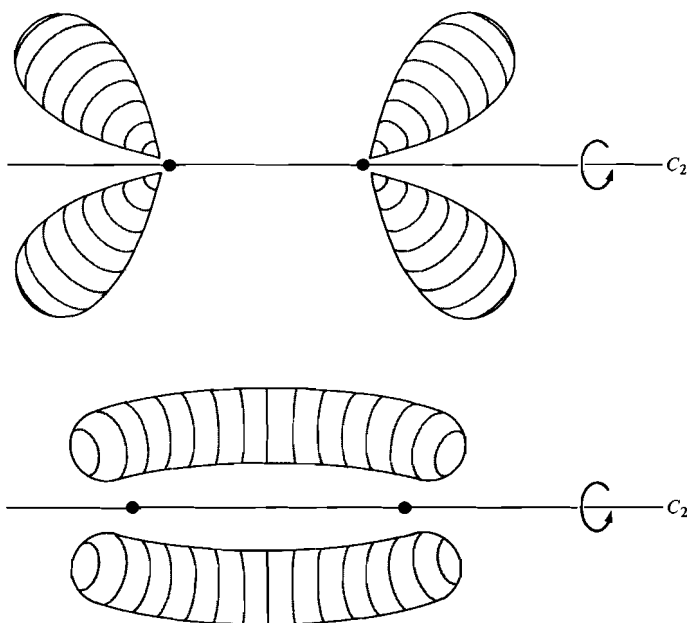
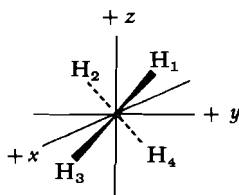

Figure 1.9 The symmetry of the electron distributions $\psi_{MO_{2p_x}}^2$ and $\psi_{MO_{2p_x}}^{*2}$. Rotational symmetry is C_2 .

orbitals of the p type can form either σ or π orbitals, depending on their orientation relative to each other. Because the overlap of p orbitals interacting in the π manner is smaller than overlap in the σ manner, the ΔE for interaction in π MO formation is usually less than in σ MO formation.

1.3 HYBRID ORBITALS

Suppose that we wish to construct an LCAO bonding model for methane. We set up the problem by defining an x, y, z coordinate system and placing the carbon at the origin. The molecule is tetrahedral, as determined from the electron-pair repulsion model. The orientation of the molecule is arbitrary; we choose to arrange it as shown in 21, with the hydrogen atoms in the $+x, +y, +z$ quadrant, the $-x, -y, +z$ quadrant, the $+x, -y, -z$ quadrant, and the $-x, +y, -z$ quadrant.



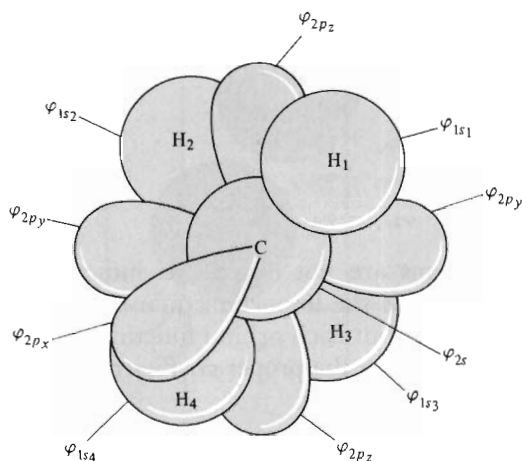

Figure 1.10 The valence atomic orbitals of the carbon and four hydrogens in methane.

We have on each hydrogen a $1s$ orbital, φ_{H1s} , and on the carbon a $2s$, $2p_x$, $2p_y$, and $2p_z$ (Figure 1.10).

The Need for Hybrid Orbitals

We could simply proceed to inspect these orbitals to see which overlap with each other, and then begin to make molecular orbitals in the way described in the previous section. Unfortunately, the situation is now quite complicated. The φ_{1s1} orbital of hydrogen number 1 interacts with *all four* of the carbon valence orbitals.

The quantum theory gives procedures for dealing with this situation; for calculations done with the aid of a computer, there is no disadvantage in using the orbitals in Figure 1.10 directly. But the algebraic manipulations required are cumbersome; we are looking for a simpler model that will allow us to see quickly and clearly what the final outcome of this complex set of interactions will be.

Constructing Hybrids

The strategy we adopt is to look first at the atomic orbitals of the central atom, and to decide on the basis of the geometry which orbitals are going to interact with an orbital on a given ligand atom. For methane set up as in **21**, all four carbon orbitals will be involved in bonding to H_1 . We then simply add together the four carbon orbitals to obtain a new orbital, χ_1 , which will have the shape shown in Figure 1.11. The new function is called a *hybrid orbital*, and is designated in this instance as sp^3 because it is formed from an s and three p orbitals.

The process of forming hybrids is not the same as the orbital interaction process that occurs on bringing two atoms together. There is no molecular orbital formation involved, because we are still talking about only one atom, and there is no energy lowering. The energy of a hybrid orbital is *between* the energies of the orbitals from which it is made, rather than being higher or lower.

The reader should convince himself that the following four ways of adding together the s and p orbitals of the carbon will give four hybrid orbitals, each

identical in shape to $\chi_{sp^3_1}$, shown in Figure 1.11, but each oriented toward a different one of the four hydrogen atoms:

$$\begin{aligned}\chi_{sp^3_1} &= \varphi_{2s} + \varphi_{2p_x} + \varphi_{2p_y} + \varphi_{2p_z} \\ \chi_{sp^3_2} &= \varphi_{2s} - \varphi_{2p_x} - \varphi_{2p_y} + \varphi_{2p_z} \\ \chi_{sp^3_3} &= \varphi_{2s} + \varphi_{2p_x} - \varphi_{2p_y} - \varphi_{2p_z} \\ \chi_{sp^3_4} &= \varphi_{2s} - \varphi_{2p_x} + \varphi_{2p_y} - \varphi_{2p_z}\end{aligned}\quad (1.6)$$

The actual correct mathematical forms are not exactly as indicated in Equations 1.6. The sign of each term, which is the important quantity for our present purpose, is correctly represented there, but each orbital function must be multiplied by a coefficient. The method of finding the proper coefficients for any desired geometry is given in Appendix 1 to this chapter.

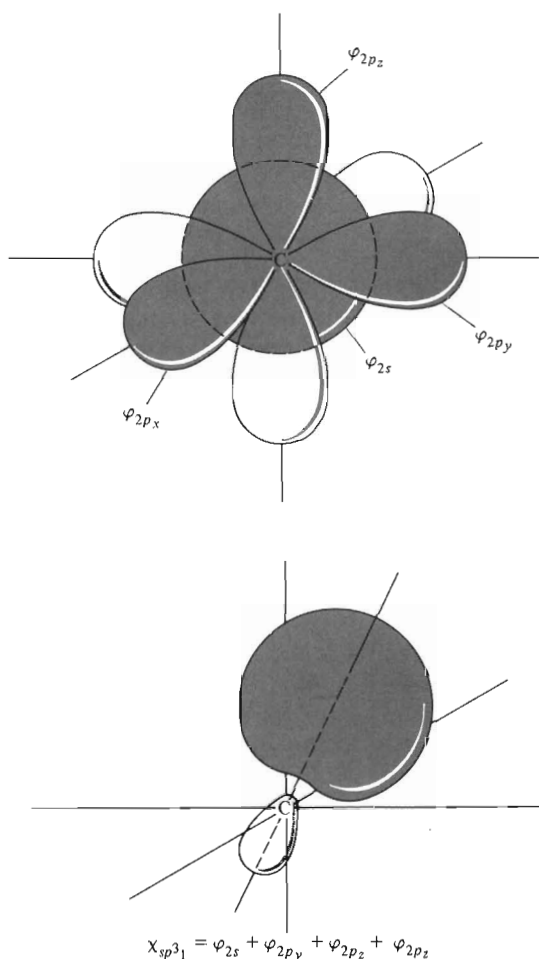

Figure 1.11 The formation of an sp^3 hybrid by adding together the four valence atomic orbitals. Orbital shapes and locations of the nodes are approximate in these diagrams. For a more accurate description, see Wiberg, *Physical Organic Chemistry*, pp. 29–33.

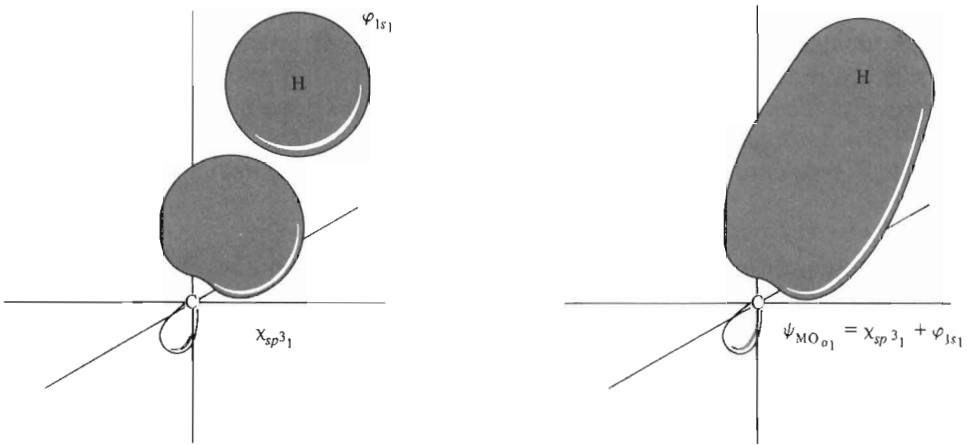

Figure 1.12 Formation of a bonding molecular orbital from φ_{1s1} and $\chi_{sp^3_1}$.

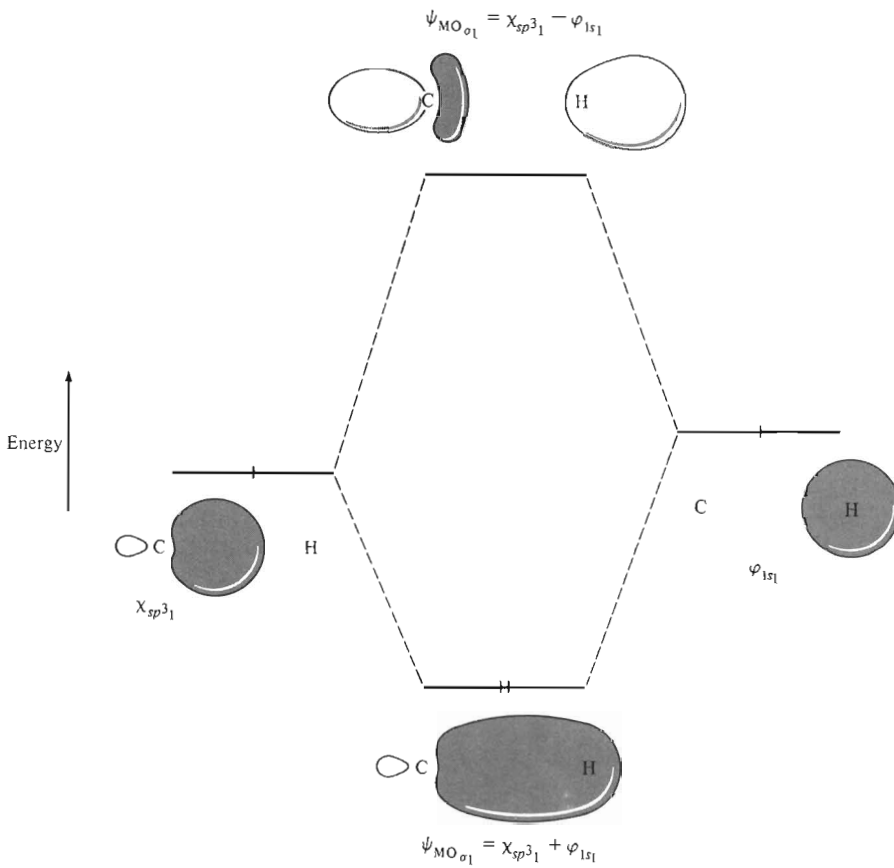

Figure 1.13 The energy relationships in MO formation from $\chi_{sp^3_1}$ and φ_{1s1} .

The advantage we gain by making hybrid orbitals is that we now have four new atomic orbitals on carbon, each one oriented directly toward one of the hydrogen atoms. Each hybrid will have a large overlap and therefore a large interaction with one, but only one, hydrogen. Our complicated original problem, in which each hydrogen $1s$ orbital had to interact with all four carbon atomic orbitals, is now replaced by four separate but simple problems.

MOs from Hybrid Orbitals

We can now proceed to make molecular orbitals in the same way we did for H_2 . Figure 1.12 shows the form of the bonding molecular orbital obtained from φ_{1s1} and $\chi_{sp^3_1}$; there will also be an antibonding combination which has a node between the atoms. The energy changes (Figure 1.13) follow the pattern we found in H_2 . The only difference is that now the two interacting atomic orbitals are not the same and have different energies. The energy difference in this instance is not large, and makes no fundamental change in our model. We shall return to this point in Chapter 10. Note that our new molecular orbitals have infinite-fold symmetry about the C—H axis, and so are σ orbitals.

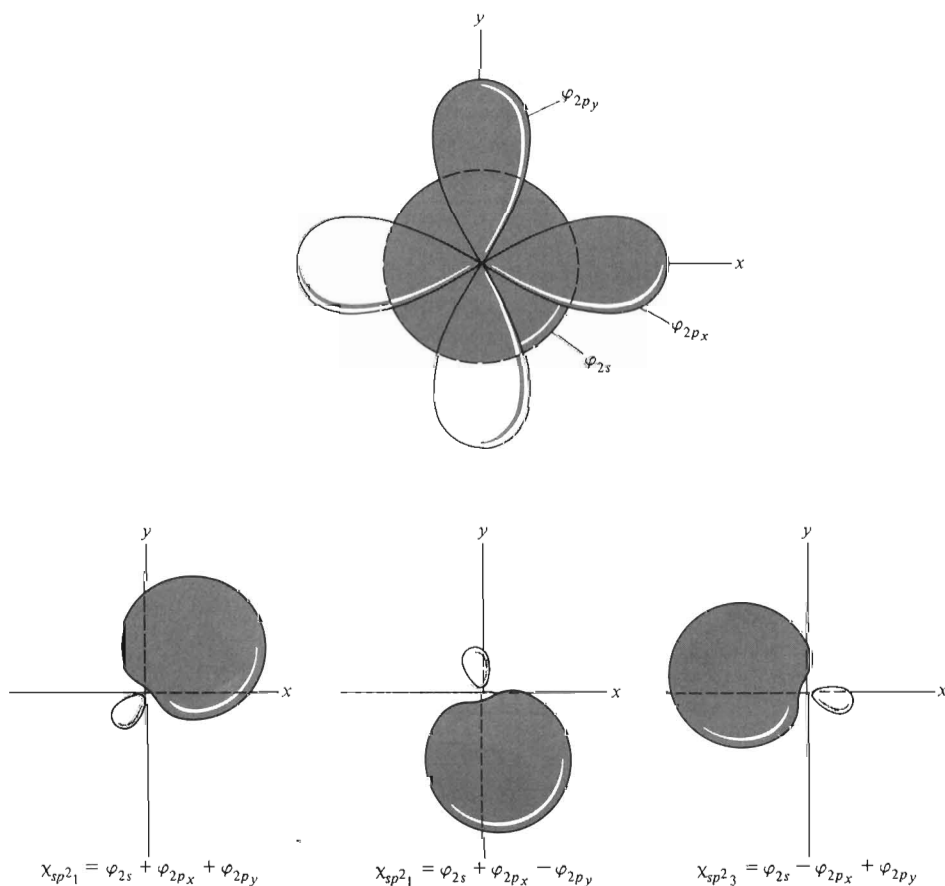

Figure 1.14 Formation of sp^2 hybrids from an s and two p orbitals.

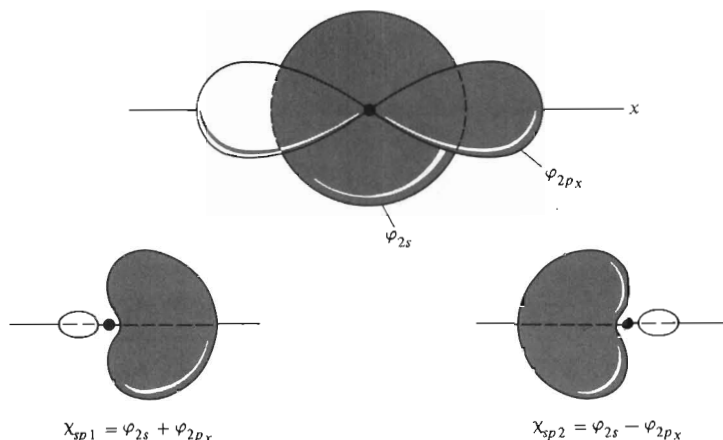

Figure 1.15 Formation of sp hybrids from an s and one p orbital.

The reader should now complete the bonding model for CH_4 by constructing a bonding–antibonding pair for each of the other three interacting pairs of atomic orbitals.

Other Types of Hybridization

A hybridization scheme can be constructed for each of the various possible geometries about the central atom. The sp^3 hybridization discussed above gives hybrids oriented at 109.5° angles to each other, and is appropriate to tetrahedral atoms. For trigonal atoms, the two p orbitals lying in the plane containing the nuclei are combined with the s to yield three sp^2 hybrids, as shown in Figure 1.14. For a linear geometry, the appropriate hybridization is sp (Figure 1.15).

The relative contributions of s and p orbitals to the hybrids is different for the different types of hybridization. An sp^3 hybrid contains a larger proportion of p and a smaller proportion of s than an sp^2 , which in turn contains more p and less s than an sp . Since s electrons can penetrate closer to the nucleus than p electrons, which have a node at the nucleus, s electrons are held more tightly. Therefore an atom is effectively more electronegative in bonds that use a larger proportion of s . Appendix 1 to this chapter gives a systematic procedure for specifying the proportions of s and p , and also shows how the s and p contributions change with changing geometry.

σ And π Bonding. Ethylene

The ethylene molecule will illustrate construction of a model containing both σ and π bonding. The Lewis structure (22) shows that each carbon should be approximately trigonal. Therefore we need sp^2 hybrids on each carbon. Figure

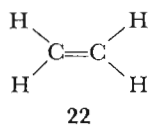

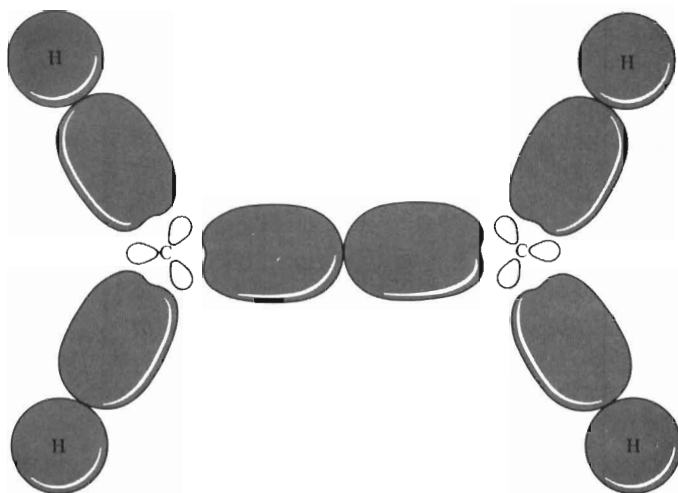

Figure 1.16 The basis orbitals for the σ MO's of ethylene.

1.16 shows these hybrids, together with the hydrogen $1s$ orbitals. The orbitals are allowed to interact in pairs, each pair yielding a bonding and an antibonding σ MO. There remain two p orbitals, one on each carbon, which were not used in the hybridization. These can overlap to form a π bonding–antibonding pair; this process is the same as illustrated earlier in Figure 1.8. Now we have obtained five bonding and five antibonding σ MO's and one bonding and one antibonding π MO. These can all be put on an approximate energy-level diagram as in Figure 1.17, which also shows how the 12 valence electrons are assigned to the molecular orbitals in the electronic ground state.

The energy levels shown in Figure 1.17 are not accurate; actually the σ_{CH} levels will be at different energies rather than all the same as shown in the figure.

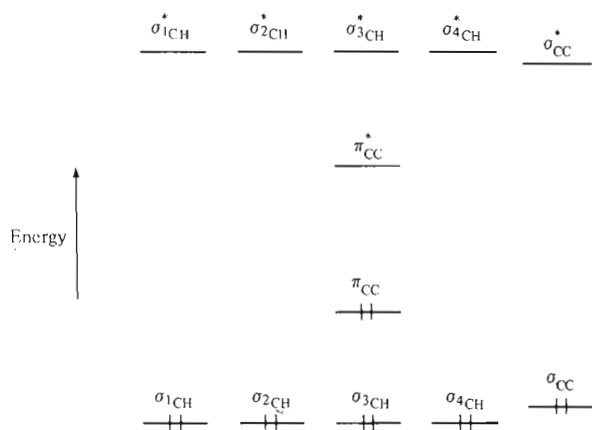
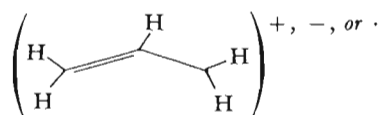

Figure 1.17 Energy-level diagram for the bonding model of ethylene. The σ_{CH} levels are not actually all at the same energy, but are lower than π_{CC} .

But the important point for most purposes is that the highest-energy bonding MO and the lowest-energy antibonding MO in ethylene will be the π and π^* levels, with the σ 's lower than the π and the σ^* 's higher than the π^* .

1.4 DELOCALIZED π BONDING

In the allyl system (23), each carbon is trigonal, and each uses sp^2 hybrids to make bonds to its neighbors. The procedure outlined in the previous section is



23

therefore adequate for constructing the σ MO's. The system of σ orbitals obtained is called the σ framework. After constructing the σ framework, a p orbital remains on each carbon. These p orbitals are the basis orbitals for the π system of molecular orbitals.

Formation of π Systems

In allyl, the three basis p orbitals can be symbolized as shown in 24. Now there is no way to avoid the problem of the central p orbital interacting with more than one other orbital. One approach is to go to the quantum theory rules and work

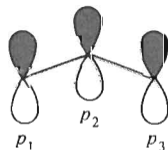

24

through the prescribed procedures to find how the three orbitals will combine. The method, at an approximate level, is the *Hückel theory*. It is described in detail in the references cited earlier (see footnote 2, p. 10), and a brief derivation and an example are given in Appendix 2. Here, we illustrate the results for some simple systems; later, in Chapter 10, we shall develop a method of obtaining the same results qualitatively in a simple way.

The first rule to remember in making π system orbitals is that the number of MO's is going to be the same as the number of basis p orbitals used. Thus, for allyl we shall get three π MO's. The lowest-energy one will be the combination

$$\psi_{\text{MO}_1} = p_1 + p_2 + p_3 \quad (1.7)$$

It will have the shape shown in 25, and it will be bonding.

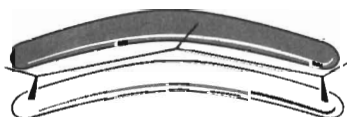

25

The next-higher energy MO is

$$\psi_{\text{MO}_2} = p_1 - p_3 \quad (1.8)$$

It looks like 26:

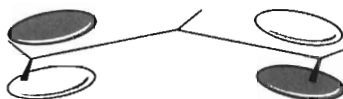

26

ψ_{MO_2} has a node cutting across it and passing through the central carbon; basis orbital p_2 does not contribute to this MO. This orbital is nonbonding. Its energy is the same as that of the basis orbitals themselves, so that electrons in it do not contribute to bonding. The third MO is

$$\psi_{\text{MO}_3} = p_1 - p_2 + p_3 \quad (1.9)$$

and looks like 27:



27

It has a node between each bonded pair of carbons and is antibonding. Figure 1.18 shows these π MO's in an energy-level diagram.

In the allyl cation, with two π electrons, ψ_{MO_1} is occupied; in the radical, with three π electrons, one electron is in the nonbonding ψ_{MO_2} , and in the anion, with four π electrons, there are two in ψ_{MO_2} . Note that the nonbonding ψ_{MO_2} is concentrated at the ends of the chain; the molecular orbital pictures for these species thus correspond closely to the resonance pictures (see 8, 9, 10, p. 6), which show the charge or unpaired electron to be concentrated at the ends.

Figures 1.19 and 1.20 show the π molecular orbitals for butadiene and pentadienyl. In each case the lowest-energy orbital has no vertical nodes, and each higher-energy orbital has one more vertical node than the orbital below it had, with the highest-energy orbital always having a node between every adjacent pair of atoms. Chains with an odd number of atoms have a nonbonding orbital, in which there is no contribution from alternate p orbitals.

The π molecular orbitals in these systems extend over several atoms, rather than encompassing only two, as have the MO's we considered earlier. Orbitals that extend over more than two atoms are said to be *delocalized*.

1.5 AROMATICITY

The concept of aromaticity has been extremely fruitful for both theoretical and experimental organic chemists. Aromatic compounds are cyclic unsaturated molecules characterized by certain magnetic effects and by substantially lower chemical reactivity and greater thermodynamic stability than would be expected from localized bond models.

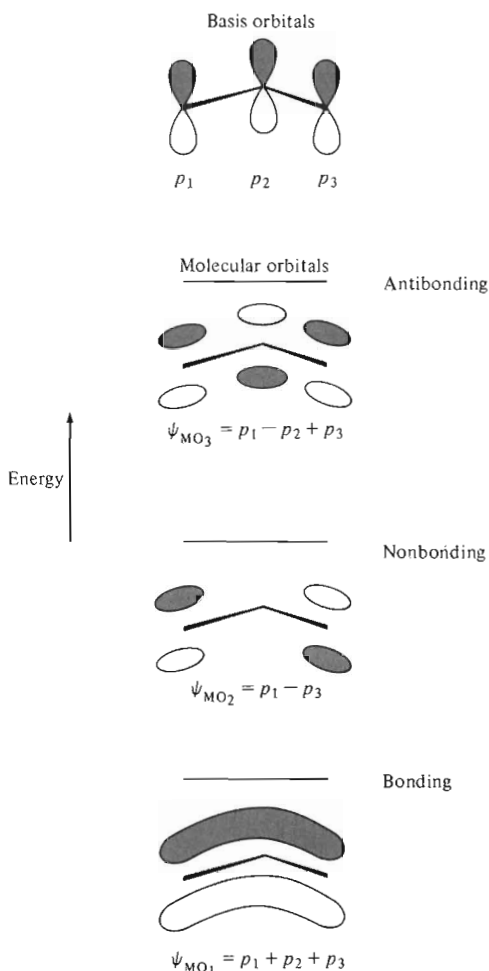

Figure 1.18 The π MO's of the allyl system. The basis orbitals from which the π MO's are constructed are shown at the top of the figure, and below are the molecular orbitals in an energy-level diagram.

Resonance and Aromaticity

The familiar properties of benzene illustrate the characteristics of aromatic compounds. Benzene is much less reactive toward electrophiles, such as molecular halogens, than are simple olefins; and the heat evolved on hydrogenation is less by $37 \text{ kcal mole}^{-1}$ than predicted for a cyclic C_6H_6 with three localized ethylenic-type double bonds. Furthermore, the nuclear magnetic resonance spectrum of benzene and its derivatives shows the protons bonded to the ring to be experiencing a stronger effective magnetic field than do protons attached to simple olefins.

As we have seen, these properties are accounted for in the resonance picture by modifying the model through inclusion of a second structure with double bonds in the alternative locations.

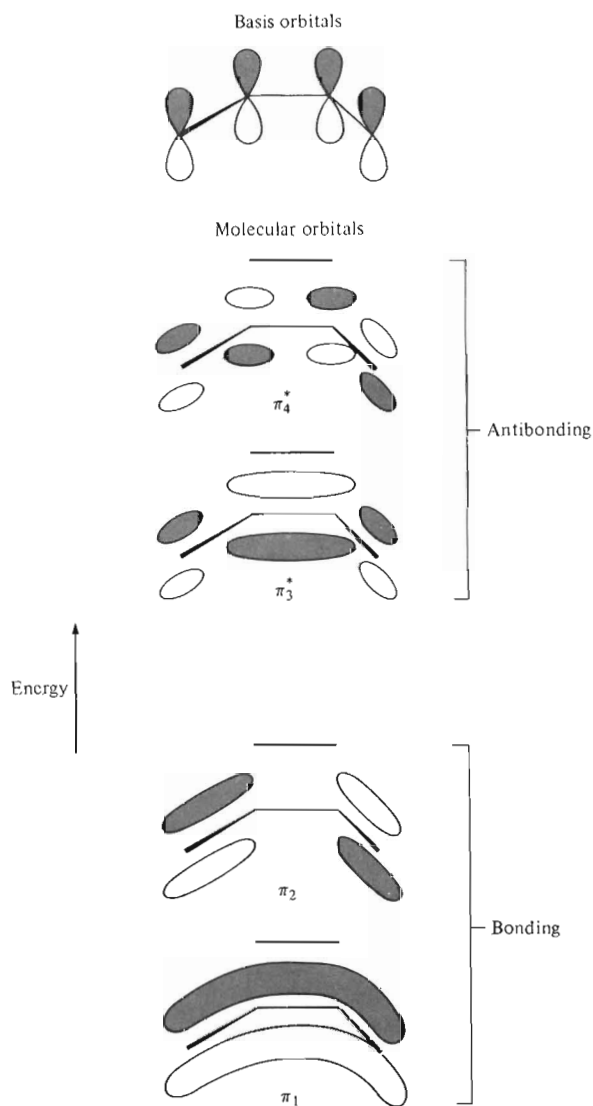

Figure 1.19 The π MO's for butadiene.

The reader will also be aware that not all cyclic conjugated molecules for which such equivalent structures may be written share with benzene these special properties. For example, cyclobutadiene (**28**) eluded synthesis for many years; when finally prepared, it and its simple derivatives proved to be extremely



reactive and capable of existence only when immobilized by freezing in an inert

matrix at very low temperature.⁸ Cyclooctatetraene, though a stable compound, does not have a planar ring; whatever stabilization we might have expected it to gain from the delocalization $29 \leftrightarrow 30$ is evidently not sufficient to cause the

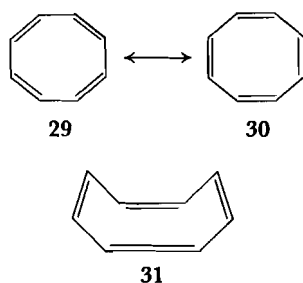

molecule to abandon its tub-shaped conformation (31) for the planar structure that would allow cyclic conjugation.

The simple resonance theory fails to explain the singular lack of effectiveness of delocalization in cyclobutadiene and cyclooctatetraene, but we may turn to molecular orbitals for the solution.

π -Electron Theory and the Hückel $4n + 2$ Rule

In order to construct a bonding model for a planar conjugated ring, we follow the procedure outlined for the allyl system in the previous section and make the choice of sp^2 hybridization on each carbon. The σ framework is then constructed from these sp^2 hybrids and the hydrogen $1s$ orbitals, leaving a p orbital on each carbon. We next concentrate on the interactions among these p orbitals.⁴

Erich Hückel developed this theory in the 1930s. He discovered that the energies of the π molecular orbitals for any regular plane polygon with an even number of atoms will fall in the pattern 32.⁹ A polygon with an odd number of atoms gives the pattern 33. These patterns, a single lowest level with higher levels

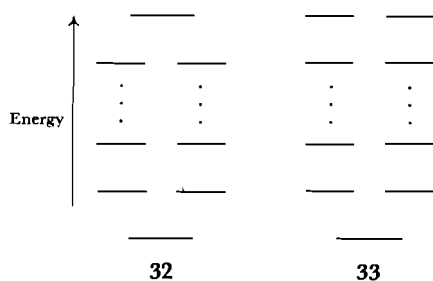

⁸ (a) L. Watts, J. D. Fitzpatrick, and R. Pettit, *J. Amer. Chem. Soc.*, **87**, 3253 (1965); (b) O. L. Chapman, C. L. McIntosh, and J. Pacansky, *J. Amer. Chem. Soc.*, **95**, 614 (1973); (c) G. Maier and M. Schneider, *Angew. Chem. Int. Ed.*, **10**, 809 (1971). For a summary of attempts to prepare cyclobutadiene, see (d) M. P. Cava and M. J. Mitchell, *Cyclobutadiene and Related Compounds*, Academic Press, New York, 1967.

⁹ (a) E. Hückel, *Z. Physik*, **70**, 204 (1931); (b) E. Hückel, *Z. Physik*, **76**, 628 (1932); (c) E. Hückel, *Z. Electrochem.*, **43**, 752 (1937).

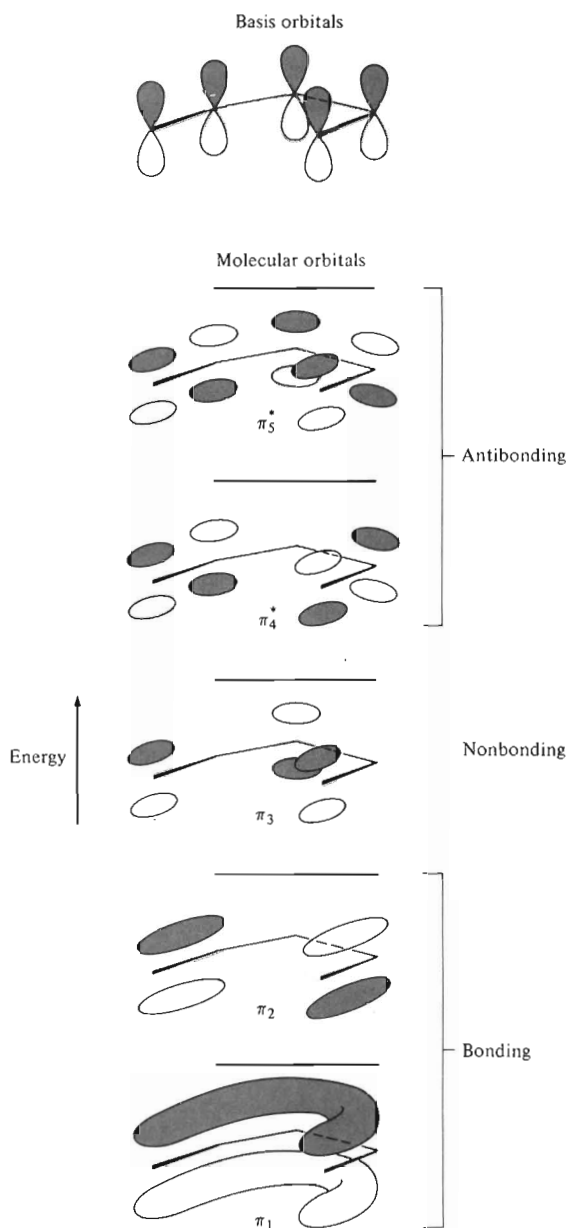
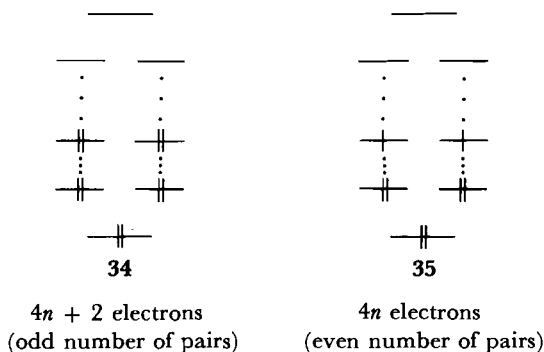

Figure 1.20 The π MO's for pentadienyl.

in pairs of the same energy (*degenerate* pairs), is actually a consequence of the n -fold symmetry of the C_nH_n rings.

Hückel noted that if electron pairs are filled into the energy-level pattern **32** or **33**, a closed-shell structure (all electrons paired) will result only when the total number of pairs is odd (total number of electrons = $4n + 2$, $n = 0, 1, 2, \dots$); if the number of pairs is even (total number of electrons = $4n$, $n = 0, 1, 2, \dots$),

the last pair will be the only occupants of a doubly degenerate level and so one electron will go into each orbital with spins parallel. Diagrams 34 and 35 show the level filling for $4n + 2$ and $4n$ electrons, respectively.



Because open-shell molecules are ordinarily highly reactive, the $4n$ electron rings should be chemically unstable.

When the π electron energy of a conjugated C_nH_n ring is calculated from the energy-level diagram, it is found to be different from the π energy calculated for an open-chain C_nH_{n+2} polyene or from the π energy of $n/2$ ethylene molecules. The difference is termed the *resonance energy*. The simple Hückel molecular orbital theory yields unreliable energies, but more careful calculations show that the $4n + 2$ rings are stabilized compared with the open-chain analog, whereas the $4n$ systems are destabilized.¹⁰ Theory thus provides an energy criterion for classification of cyclic conjugated systems as aromatic or antiaromatic: A molecule is aromatic if it is thermodynamically more stable than expected for the open-chain analog, and it is antiaromatic if it is thermodynamically less stable. A compound showing neither stabilization nor destabilization would be classed as nonaromatic.

A second criterion of aromaticity comes from analysis of the influence of a magnetic field on the π electron cloud. Theory suggests that a magnetic field perpendicular to the ring plane will cause the electrons to behave as though they were circulating around the ring and generating their own small magnetic field, which will be superimposed on the applied field.¹¹ The term *ring current* is commonly applied to this phenomenon.

The direction of this induced magnetic field depends on the number of π electrons. In $4n + 2$ rings it is in the direction opposite to the applied field (the rings are *diamagnetic*), whereas in $4n$ rings it is in the same direction as the applied field (*paramagnetic* rings). Figure 1.21 illustrates these two situations and shows how the induced fields affect the total field at protons attached to the ring. Because the magnetic lines of force must make closed loops, the induced field is in opposite directions for protons inside and outside the ring. Note that in $4n + 2$

¹⁰ See, for example, (a) M. J. S. Dewar and G. J. Gleicher, *J. Amer. Chem. Soc.*, **87**, 685 (1965); for discussion of the various approaches to π electron molecular orbital theory, see (b) Streitwieser, *Molecular Orbital Theory for Organic Chemists*, and (c) L. Salem, *The Molecular Orbital Theory of Conjugated Systems*, W. A. Benjamin, Menlo Park, Calif., 1966.

¹¹ J. A. Pople and K. G. Untch, *J. Amer. Chem. Soc.*, **88**, 4811 (1966).

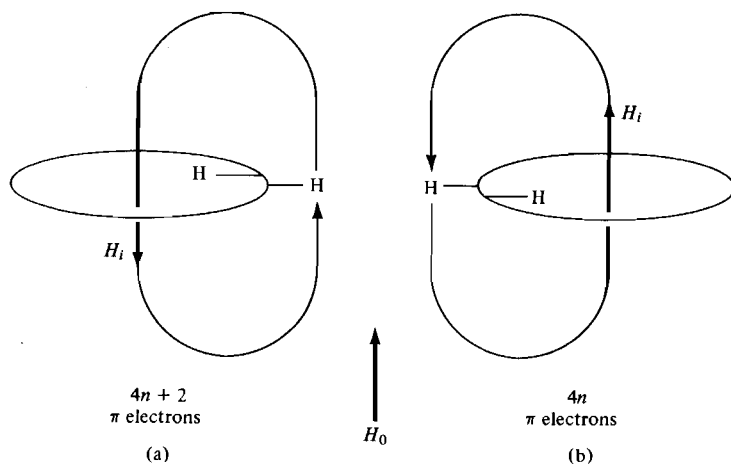

Figure 1.21 Induced fields caused by ring currents in cyclic conjugated molecules. (a) Diamagnetic $4n + 2$ ring. The induced field H_i opposes the applied field H_0 for protons inside the ring and adds to it for protons outside. (b) Paramagnetic $4n$ ring. The induced field H_i adds to the applied field H_0 inside but opposes it outside the ring.

rings the induced field adds to the applied field for outside protons but is opposed to the applied field inside the ring. The situation is reversed in $4n$ rings.

Theory of aromaticity is not restricted to the simple planar conjugated rings. Any system that has extra stability by virtue of being cyclic would be classed as aromatic. The *homoaromatics* form one such category; they are systems in which the π system is interrupted at one or more points by a saturated center but in which geometry still permits significant overlap of the p orbitals across the insulating gap.¹² Although there are a number of homoaromatic systems known, it will be sufficient for our purposes to restrict attention to the monocyclic conjugated rings C_nH_n and their derivatives. These compounds are known as *annulenes*; the nomenclature convention is to designate the ring size by a number in square brackets. Thus [n]annulene is the ring C_nH_n .

Some Examples of Aromatic and Antiaromatic Systems: Neutral Even-Membered Rings

For benzene, [6]annulene, with six π electrons ($4n + 2$, $n = 1$), the theory clearly meets both tests. As we have pointed out, there is a substantial stabilization of about 37 kcal mole⁻¹ compared with a hypothetical localized model. The familiar chemical properties also point to a strong tendency for maintenance of the six π electron unsaturated system. The proton magnetic resonance spectrum of benzene and its derivatives shows the proton resonances in the range of $\delta = +7$ to $+8$ ppm (downfield from tetramethylsilane), 1–2 ppm lower than protons attached to nonbenzenoid double bonds. Referring to Figure 1.21a, we can see that the prediction is in agreement with this result. The induced field adds

¹² Review: S. Winstein, *Quart. Rev.*, **23**, 141 (1969).

outside the ring so that a smaller applied field is required to reach resonance, hence a downfield shift. There is, of course, no possibility of having a proton inside a ring this small.

Cyclobutadiene, [4]annulene, is so far too elusive for the kinds of investigations one would like to be able to carry out. But the great difficulty that chemists have experienced in its preparation alone justifies the conclusion that it lacks any aromatic stabilization. The compound can now be prepared by oxidation of cyclobutadieneiron tricarbonyl (**36**);¹³ it dimerizes instantaneously but is stable

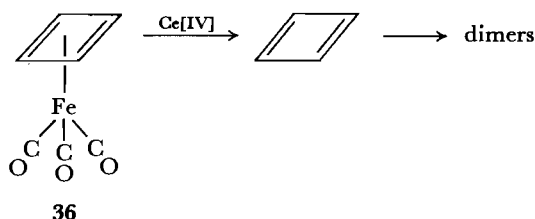

when prepared in a dilute argon matrix below 35°K.¹⁴ Infrared and ultraviolet spectra have been recorded, but magnetic resonance presents a more difficult problem, and no pmr spectrum has been obtained.

Ronald Breslow and his collaborators have given some attention to the problem of estimating the degree of destabilization of cyclobutadiene with respect to nonconjugated models. They have concluded from electrochemical measurements of oxidation-reduction potentials of the system **37** \rightleftharpoons **38**, of which only the quinone **38** has the cyclobutadiene fragment, that the C₄H₄ ring is destabilized by some 12–16 kcal mole⁻¹ and so is definitely antiaromatic.¹⁵

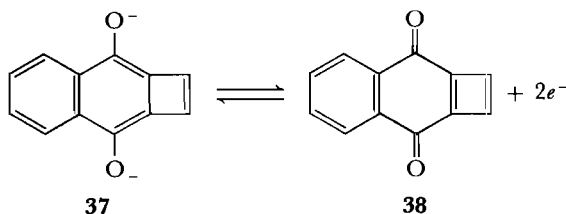

Cyclooctatetraene, as we have noted earlier, avoids the difficulty that we would predict it would encounter if it were planar. It takes up a nonplanar conformation in which the double bonds are effectively isolated from each other by twisting; in this way the p orbitals of one do not interact appreciably with those of the next. The molecule has conventional single and double bonds and behaves chemically like a typical olefin. One might argue that this evidence is only suggestive, because the angle strain which would be introduced were the ring to become planar could be the cause of its preferred shape. But as we shall see, the angle

¹³ For other methods of preparation see (a) C. Y. Lin and A. Krantz, *J. Chem. Soc. Chem. Comm.*, 1111 (1972); (b) S. Masamune, M. Suda, H. Ona, and L. M. Leichter, *J. Chem. Soc. Chem. Comm.*, 1268 (1972); (c) see also note 8(a), p. 31.

¹⁴ See note 8(b), p. 31.

¹⁵ R. Breslow, D. R. Murayama, S. Murahashi, and R. Grubbs, *J. Amer. Chem. Soc.*, **95**, 6688 (1973).

strain is not sufficient to overcome the tendency toward planarity for an eight-membered ring with $4n + 2\pi$ electrons.

A number of larger cyclic conjugated systems have been prepared, many of them by Sondheimer and co-workers.¹⁶ [10]Annulene and [12]annulene are subject to considerable steric difficulties and probably are not planar, but the larger molecules are big enough to accommodate hydrogen atoms inside the rings and so can have trans double bonds and still be planar or nearly so. Likely conformations for some of these compounds are shown in Structures 39, 40, and 41.

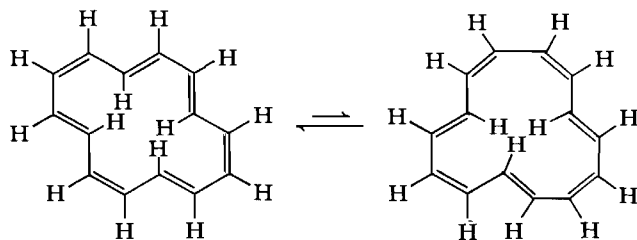

[14]annulene
39

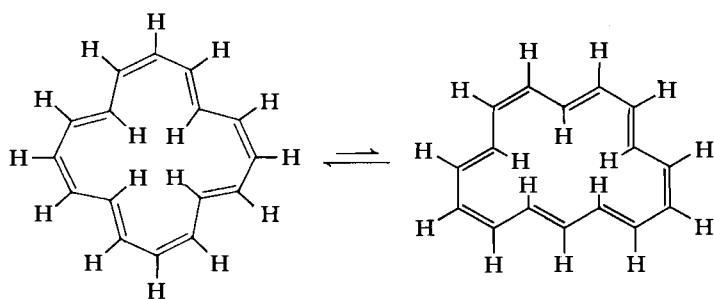

[16]annulene
40

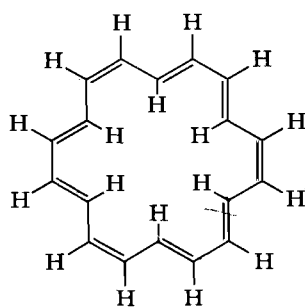

[18]annulene
41

Annulenes as large as the 30-membered ring have been prepared, and many dehydroannulenes, which contain one or more triple bonds, are also known.

¹⁶ F. Sondheimer, *Acts. Chem. Res.*, 5, 81 (1972).

(These latter substances are actually intermediates in the preparation of the annulenes themselves.)

These large rings, even the $4n + 2$ ones, do not show the kind of chemical stability that benzene has, although [18]annulene does undergo electrophilic substitutions. Ring currents provide the most useful criterion for testing their aromaticity. The molecules have protons both inside and outside the ring. Conformational equilibria such as those indicated in **39** and **40** exchange the inner and outer protons rapidly at room temperature, but at lower temperatures the rates are sufficiently slow that the two types of proton can be observed. The spectra provide a dramatic confirmation of theory. The [14], [18], and [22]annulenes, $4n + 2$ systems, have outside proton resonances between about $\delta = +7.8$ and $\delta = +9.6$ ppm, shifts somewhat larger than those in benzene, whereas the inside protons appear between $\delta = -0.4$ and $\delta = -3$ ppm.¹⁷ (Positive δ values are downfield from tetramethylsilane (TMS); negative δ values are upfield.) The $4n$ rings [16] and [24]annulene have outside protons at $\delta = +4.7$ to $\delta = +5.3$ ppm and inside protons at much lower field, $\delta = +10$ to $\delta = +12$ ppm.

Even-Membered Rings: Cations and Anions

Addition of two electrons to, or removal of two electrons from, a $4n$ antiaromatic ring converts it to a $4n + 2$ system, which should be aromatic. Several examples of such ions are known.

Tetramethylcyclobutadiene dication (**43**), has been prepared by Olah and co-workers by dissolving the dichloride (**42**) in a mixture of antimony penta-

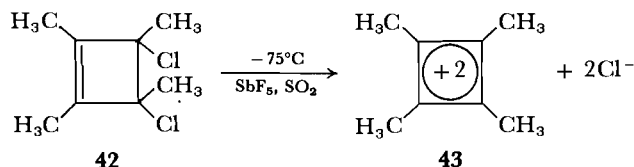

fluoride and sulfur dioxide at low temperature.¹⁸ It was identified by its proton magnetic resonance spectrum, a single peak at $\delta = +3.7$ ppm. The tetraphenyl dication has also been observed.¹⁹ A report of the dianion **44**, a six π electron system, has appeared.²⁰



44

Addition of two electrons to cyclooctatetraene yields the dianion **45**, which shows a single peak in the proton magnetic resonance spectrum.²¹ The conclusion

¹⁷ See note 16.

¹⁸ G. A. Olah, J. M. Bollinger, and A. M. White, *J. Amer. Chem. Soc.*, **91**, 3667 (1969).

¹⁹ G. A. Olah and G. D. Mateescu, *J. Amer. Chem. Soc.*, **92**, 1430 (1970).

²⁰ J. S. McKennis, L. Brener, J. R. Schweiger, and R. Pettit, *J. Chem. Soc. Chem. Comm.*, 365 (1972).

²¹ T. J. Katz, *J. Amer. Chem. Soc.*, **82**, 3784 (1960).

that the ion is a planar regular octagon is confirmed by the X-ray crystallographic

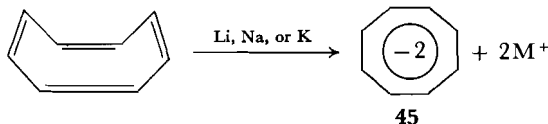

structure determination of the 1,3,5,7-tetramethylcyclooctatetraenyl dianion, which shows the eight-membered ring in a planar conformation with equal bond lengths.²² Note that the energy gain associated with establishment of the conjugated $4n + 2$ π electron aromatic system is sufficient to overcome the angle strain, which tends to prevent a planar structure.

Dianions of several of the large ring annulenes have also been prepared.²³ The $4n + 2$ system [18]annulene, which has outer protons at $\delta = +9.3$ ppm and inner protons at $\delta = -3$ ppm, is converted by potassium to the dianion, a $4n$ system with outer protons at $\delta = -1$ ppm and inner protons at $\delta = +29$ ppm, the lowest field resonance known for a proton bound to carbon. (The largest known upfield shift, $\delta = -9$ ppm, occurs for the inner protons of an 18π electron ($4n + 2$) monoanion.²⁴)

Another intriguing ion, hexachlorobenzene dication (46), a four π electron system, has been observed by Wasserman and his collaborators. As predicted by the simple molecular orbital energy-level pattern, the ion has two unpaired electrons.²⁵

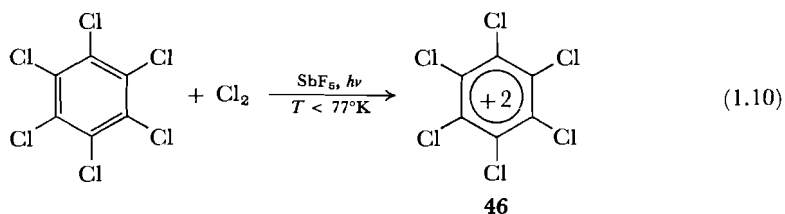

Odd-Membered Rings

Neutral rings composed of an odd number of C—H groups have an odd number of electrons and hence cannot be closed-shell molecules. In study of odd-membered rings, attention has focused on ions with even numbers of electrons, obtained by processes like those indicated in Equations 1.11 and 1.12. Rings containing a

²² S. Z. Goldberg, K. N. Raymond, C. A. Harmon, and D. H. Templeton, *J. Amer. Chem. Soc.*, **96**, 1348 (1974).

²³ See note 16, p. 36.

²⁴ See note 16, p. 36.

²⁵ E. Wasserman, R. S. Hutton, V. J. Kuck, and E. A. Chandross, *J. Amer. Chem. Soc.*, **96**, 1965 (1974). Careful theoretical analysis suggests that the open-shell systems, which simple theory predicts will have one electron in each of two degenerate levels, can distort from the regular polygon geometry by moving to a structure with alternating bond lengths, thereby removing the degeneracy and causing the electrons to pair in the lower level. This distortion seems to occur in some antiaromatic systems but not in others.

- (b) In each molecule that has a delocalized bonding system, identify the orbitals that interact to form the delocalized molecular orbitals.

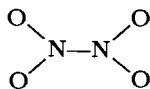

K_2CO_3	Sodium nitrate
Allene	$(\text{H}_3\text{C})_3\text{OBF}_4$
Butadiene	Benzyl cation
Sodium phenoxide	Phenyl anion
Nitrobenzene	3,5-di- <i>tert</i> -butyl-4-nitrophenoxide
$\text{N}=\text{N}=\text{O}$	

- What kinds of symmetry are possible for interactions of d orbitals?
- In the pentadienyl radical, predict the distribution of the unpaired electron (a) from the resonance model, and (b) from the molecular orbital model.
- Construct a complete orbital model for HN_3 , showing both σ and π molecular orbitals, and giving an approximate energy-level diagram showing electron occupancy. Compare the MO model with the resonance model.
- Construct a MO model for twisted ethylene, in which the two CH_2 groups lie in mutually perpendicular planes. Why does the molecule prefer coplanarity?
- Explain why dehydroannulenes, which have some of the double bonds of the annulene replaced by triple bonds, can be considered in aromaticity theory as equivalent to the parent annulene. What advantages might dehydroannulenes have over annulenes in the study of aromaticity?

Problems 7–11 require the material in Appendix 1.

- Verify that the hybrid orbital in Equation A1.9 (p. 46) is normalized for any values of m , θ , ϕ .
- Write the expression for a normalized sp^2 hybrid orbital oriented along the line from the origin to the point $(-2, 3, -1)$.
- Write the expression for a normalized hybrid orbital with 28 percent s character lying in the xy plane at an angle of 60° from the x axis.
- If s , p_x , p_y , p_z orbitals are to be hybridized, and the fractional s character of three hybrids are specified, what remains to be specified before the hybrid set can be written explicitly?
- What are the fractional s and p characters of a pair of equivalent hybrids with an angle of 100° between them? If the other two hybrids are required to be equivalent to each other, what are their fractional s and p characters, and what is the angle between them?

Problems 12 and 13 require the material in Appendix 2.

- Find the Hückel energy levels and molecular orbitals for butadiene, cyclobutadiene, and pentatrienyl.
- In the Hückel theory the π electron energy is defined as the sum of the orbital energies of all the π electrons. Thus for ethylene, with two electrons in an orbital of energy β , the π electron energy is 2β . Resonance energy is the difference between the calculated π electron energy and the π electron energy the system would have if the electrons were in localized ethylene double bonds. Find the resonance energies for the systems in Problem 12.

REFERENCES FOR PROBLEMS

6. F. Sondheimer, *Accts. Chem. Res.*, **5**, 81 (1972).
- 12 and 13. A. Liberles, *Introduction to Molecular Orbital Theory*, Holt, Rinehart, and Winston, New York, 1966; J. D. Roberts, *Notes on Molecular Orbital Calculations*, W. A. Benjamin, Menlo Park, Calif., 1962.

Appendix 1

HYBRID

ORBITALS^a

In order to obtain correct expressions for hybrid orbitals, we first need to describe more precisely than has been done in Section 1.2 some properties of orbitals. Recall that φ^2 , the square of an orbital function, gives the probability of finding the electron in each region of space. If we were to add up the values of this function over all points, we would have the total probability of finding the electron, which should equal unity. Orbitals are ordinarily constructed so as to satisfy this requirement; when they are, they are said to be *normalized*. The normalization condition is Equation A1.1, where $d\tau$ signifies integration over all coordinates.

$$\text{Normalization: } \int \varphi^2 d\tau = 1 \quad (\text{A1.1})$$

A second condition, which does not apply generally to orbitals but which does apply to different atomic orbitals *on the same atom* is that they do not overlap with each other. The correct terminology for orbitals that have zero overlap is that they are *orthogonal*. We have seen that the overlap of two orbitals is found by integrating over space the product $\varphi_1\varphi_2$. Since our *s* and *p* orbitals, and also the resulting hybrids, are on the same atom, we require for any pair in the *s*, *p* set and also for any pair in the hybrid set that Equation A1.2 be satisfied:

$$\text{Orthogonality: } \int \varphi_1\varphi_2 d\tau = 0 \quad (\text{A1.2})$$

We now write a general formulation for our set of hybrid orbitals. Each hybrid, χ_i , is going to be written as a sum of contributions from the *s*, p_x , p_y , p_z atomic orbitals, each with a coefficient that tells the extent of its contribution.

^a The discussion partly follows C. Hsu and M. Orchin, *J. Chem. Educ.*, **50**, 114 (1973).

The hybrids therefore have the form of Equations A1.3.

$$\begin{aligned}\chi_1 &= a_{11}s + a_{12}p_x + a_{13}p_y + a_{14}p_z \\ \chi_2 &= a_{21}s + a_{22}p_x + a_{23}p_y + a_{24}p_z \\ \chi_3 &= a_{31}s + a_{32}p_x + a_{33}p_y + a_{34}p_z \\ \chi_4 &= a_{41}s + a_{42}p_x + a_{43}p_y + a_{44}p_z\end{aligned}\quad (\text{A1.3})$$

We assume that s, p_x, p_y, p_z are all normalized and mutually orthogonal. The requirement that the χ_i will also be normalized and mutually orthogonal then leads to the following conditions:

$$\text{Normalization of } \chi_i: \quad a_{i1}^2 + a_{i2}^2 + a_{i3}^2 + a_{i4}^2 = 1 \quad (\text{A1.4})$$

$$\text{Orthogonality of } \chi_i \text{ and } \chi_j: \quad a_{i1}a_{j1} + a_{i2}a_{j2} + a_{i3}a_{j3} + a_{i4}a_{j4} = 0 \quad (\text{A1.5})$$

(The reader familiar with vectors will recognize that, if the χ_i are thought of as vectors written in terms of the set of unit vectors s, p_x, p_y, p_z , Equation A1.4 is just the requirement that χ_i be of unit length, and Equation A1.5 is the requirement that the dot product $\chi_i \cdot \chi_j$ be zero.)

Since the sums of squares of the a coefficients of a given hybrid is unity (equation A1.4), it is reasonable to take the squares of the coefficients as giving the contributions of the orbitals of the s, p_x, p_y, p_z set to the hybrids. We therefore define the fractional s character of hybrid χ_i as a_{i1}^2 and the fractional p character as $a_{i2}^2 + a_{i3}^2 + a_{i4}^2$. The orthogonality and normalization conditions guarantee that the sum of squares of a coefficients down a column in A1.3 will be unity, just as it is along a row; the fractional contribution of a given member of the s, p_x, p_y, p_z set summed over all the hybrids (for example $a_{11}^2 + a_{21}^2 + a_{31}^2 + a_{41}^2$ for the s -orbital contributions) therefore will always be unity.

Equations A1.3 can be put in a more convenient form in the following way. We note that because the s orbital is spherically symmetrical, the directional

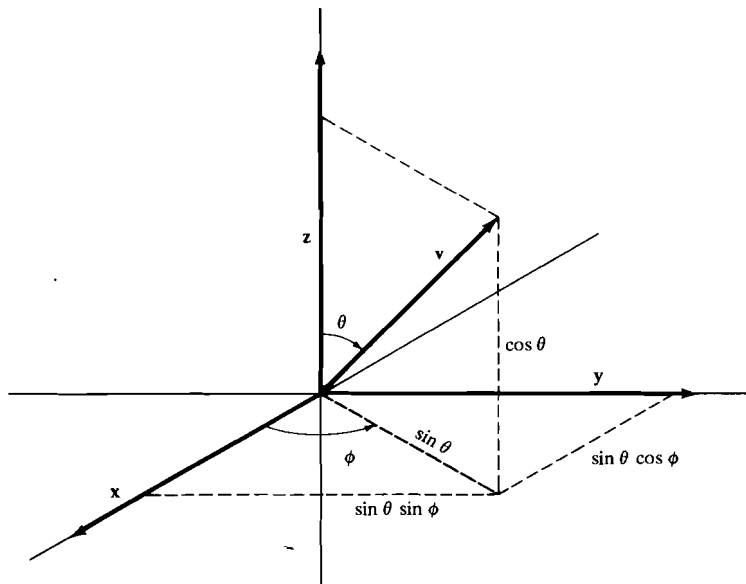

Figure A1.1 The vector \mathbf{v} , of unit length, is expressed in polar coordinates in terms of unit vectors $\mathbf{x}, \mathbf{y}, \mathbf{z}$ as $\mathbf{v} = \sin \theta \cos \phi \mathbf{x} + \sin \theta \sin \phi \mathbf{y} + \cos \theta \mathbf{z}$.

properties of a hybrid are entirely determined by the relative contributions of p_x , p_y , and p_z . It is therefore convenient to think of three-dimensional vectors oriented along the directions in which we wish our hybrids to point. (It is important to understand that we are now talking about vectors in ordinary three-dimensional space.)

These vectors can be written in terms of vectors along the x , y , and z directions using polar coordinates θ and ϕ , as indicated in Equation A1.6 and illustrated in Figure A1.1.

$$\mathbf{v} = \sin \theta \cos \phi \mathbf{x} + \sin \theta \sin \phi \mathbf{y} + \cos \theta \mathbf{z} \quad (\text{A1.6})$$

The reader can verify that \mathbf{v} defined in this way is normalized (of unit length).

Now we wish to write an expression for an orbital oriented along the direction defined by vector \mathbf{v} . This task is easily accomplished if we replace our unit vectors \mathbf{x} , \mathbf{y} , \mathbf{z} by the orbital functions p_x , p_y , p_z . These orbitals add just like the unit vectors to produce a new function, Equation A1.7, with the usual p -orbital shape, but pointing in the direction of \mathbf{v} , as illustrated in Figure A1.2. Note that η is normalized.

$$\eta = \sin \theta \cos \phi p_x + \sin \theta \sin \phi p_y + \cos \theta p_z \quad (\text{A1.7})$$

If we now want to introduce s character into the orbital η , the direction will remain as before; adding in some s only expands one lobe (on the side where s and η have the same sign) and contracts the other, at the same time moving the node away from the nucleus. The new orbital is most conveniently defined by

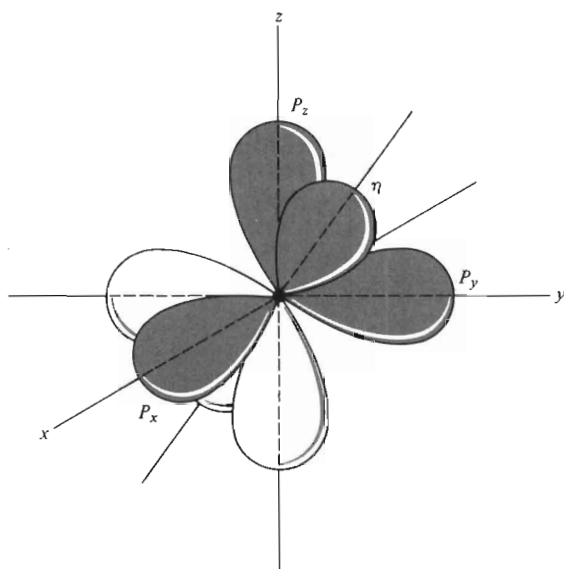

Figure A1.2 The orbital η , oriented in the direction of vector \mathbf{v} (Figure A1.1), is expressed as a combination of the p_x , p_y , and p_z orbitals by $\eta = \sin \theta \cos \phi p_x + \sin \theta \sin \phi p_y + \cos \theta p_z$. Positive lobes are shaded, negative lobes are unshaded. Orbital shapes are not accurately reproduced; see Wiberg, *Physical Organic Chemistry*, pp. 29–33, for more accurate contour diagrams.

Equation A1.8, and the hybrid is illustrated in Figure A1.3. In Equation A1.9,

$$\chi = \sqrt{\frac{1}{1+m}} s + \sqrt{\frac{m}{1+m}} \eta \quad (\text{A1.8})$$

$$= \sqrt{\frac{1}{1+m}} s + \sqrt{\frac{m}{1+m}} \{ \sin \theta \cos \phi p_x + \sin \theta \sin \phi p_y + \cos \theta p_z \} \quad (\text{A1.9})$$

we have simply substituted for η by its equivalent from Equation A1.7 in order to arrive at a general expression for the hybrid in terms of the original set s, p_x, p_y, p_z .

The reason for expressing the relative contributions of s and p in terms of the awkward-looking factors $\sqrt{1/(1+m)}$ and $\sqrt{m/(1+m)}$ is that this form guarantees that the generalized hybrid A1.9 will be normalized. (See Problem 1.7.) We have thus built in automatically one of the restraints on our hybrids. The quantity m is the *hybridization index*, and is the number that appears as the superscript in the standard designation of hybrid type. Thus an sp^3 orbital, $m = 3$, always has the form

$$\sqrt{\frac{1}{4}} s + \sqrt{\frac{3}{4}} \{ \sin \theta \cos \phi p_x + \sin \theta \sin \phi p_y + \cos \theta p_z \}$$

an sp^2 orbital, $m = 2$, is always

$$\sqrt{\frac{1}{3}} s + \sqrt{\frac{2}{3}} \{ \sin \theta \cos \phi p_x + \sin \theta \sin \phi p_y + \cos \theta p_z \}$$

(Note that ordinarily one chooses a coordinate system in such a way that the sp^2 hybrids will lie in, for example, the xy plane; then the angle θ is $\pi/2$ and the coefficient of p_z in the hybrids is zero. It is not necessary to follow this procedure, and the general sp^2 hybrid will have contributions from all three p orbitals.)

We say that two hybrid orbitals are *equivalent* if they have the same hybridization index m . Recalling that the squares of the coefficients of a given orbital summed over the whole hybridized set must equal unity, we can easily see that

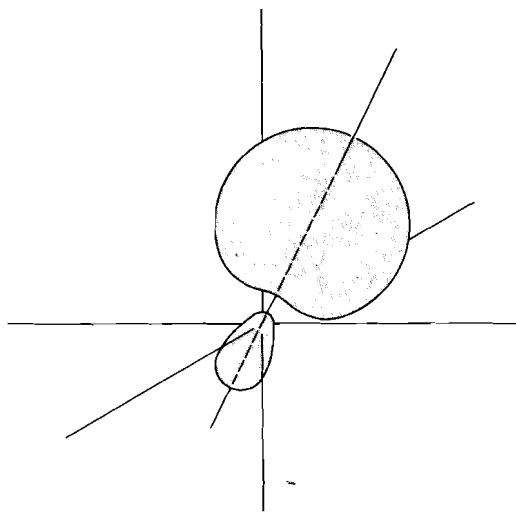

Figure A1.3 The hybrid orbital $\chi = \sqrt{1/(1+m)}s + \sqrt{m/(1+m)}\eta$, or $\chi = \sqrt{1/(1+m)}s + \sqrt{m/(1+m)}\{\sin \theta \cos \phi p_x + \sin \theta \sin \phi p_y + \cos \theta p_z\}$.

the only way to have four equivalent hybrids is to let the coefficient of s be $\sqrt{\frac{1}{4}}$ in each; these are the familiar sp^3 orbitals.

We can use the generalized expression for hybrids to find the relation between hybridization indices and angle between two hybrids χ_1 and χ_2 (Equations A1.10). Since the expressions in braces are equivalent to ordinary three-dimensional vectors of unit length, the three-dimensional vector dot product, found by

$$\chi_1 = \sqrt{\frac{1}{1+m_1}} s + \sqrt{\frac{m_1}{1+m_1}} \{\sin \theta_1 \cos \phi_1 p_x + \sin \theta_1 \sin \phi_1 p_y + \cos \theta_1 p_z\} \quad (\text{A1.10})$$

$$\chi_2 = \sqrt{\frac{1}{1+m_2}} s + \sqrt{\frac{m_2}{1+m_2}} \{\sin \theta_2 \cos \phi_2 p_x + \sin \theta_2 \sin \phi_2 p_y + \cos \theta_2 p_z\}$$

summing the products of coefficients appearing inside the braces, must be equal to the cosine of the angle α between the vectors (Equation A1.11).^b But the hybrids are directed along these vectors, so the angle between the hybrids is also

$$\cos \alpha = \sin \theta_1 \cos \phi_1 \sin \theta_2 \cos \phi_2 + \sin \theta_1 \sin \phi_1 \sin \theta_2 \sin \phi_2 + \cos \theta_1 \cos \theta_2 \quad (\text{A1.11})$$

α . We now bring in the requirement A1.5 that the two hybrids be orthogonal. This condition gives Equation A1.12, which can be immediately simplified be-

$$\begin{aligned} \chi_1 \cdot \chi_2 &= \sqrt{\frac{1}{1+m_1}} \sqrt{\frac{1}{1+m_2}} + \sqrt{\frac{m_1}{1+m_1}} \sqrt{\frac{m_2}{1+m_2}} \{\sin \theta_1 \cos \phi_1 \sin \theta_2 \cos \phi_2 \\ &\quad + \sin \theta_1 \sin \phi_1 \sin \theta_2 \sin \phi_2 + \cos \theta_1 \cos \theta_2\} \\ &= 0 \end{aligned} \quad (\text{A1.12})$$

cause the expression in braces is equal to $\cos \alpha$ from Equation A1.11. Equations A1.13 through A1.16 then follow.

$$0 = \sqrt{\frac{1}{1+m_1}} \sqrt{\frac{1}{1+m_2}} + \sqrt{\frac{m_1}{1+m_1}} \sqrt{\frac{m_2}{1+m_2}} \{\cos \alpha\} \quad (\text{A1.13})$$

$$0 = \sqrt{\frac{1}{1+m_1}} \sqrt{\frac{1}{1+m_2}} [1 + \sqrt{m_1} \sqrt{m_2} \cos \alpha] \quad (\text{A1.14})$$

$$0 = 1 + \sqrt{m_1} \sqrt{m_2} \cos \alpha \quad (\text{A1.15})$$

$$\cos \alpha = \frac{-1}{\sqrt{m_1 m_2}} \quad (\text{A1.16})$$

If the two orbitals are equivalent, $m_1 = m_2 = m$, Equation A1.16 reduces to the even simpler expression A1.17. *The angle between two equivalent hybrids completely*

$$\cos \alpha = \frac{-1}{m} \quad (\text{A1.17})$$

^b Proof may be found, for example, in G. B. Thomas, Jr., *Calculus and Analytic Geometry*, Addison-Wesley, Reading, Mass., 1953, p. 447.

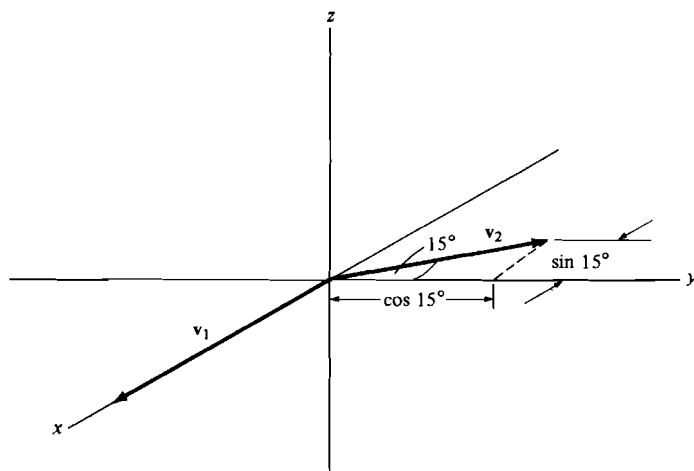

Figure A1.4 Orbitals χ_1 and χ_2 are to point along directions \mathbf{v}_1 and \mathbf{v}_2 , with an angle of 105° between them.

$$\begin{aligned}\mathbf{v}_1 &= \mathbf{x} \\ \mathbf{v}_2 &= -\sin 15^\circ \mathbf{x} + \cos 15^\circ \mathbf{y}\end{aligned}$$

determines the hybridization index, and conversely. We have just seen that four equivalent hybrids must be sp^3 ; it is now clear that the angle between any two must satisfy

$$\begin{aligned}\cos \alpha &= -\frac{1}{3} \\ \alpha &= 109.5^\circ\end{aligned}$$

the tetrahedral angle.

It is an easy matter to write the correct expressions for a pair of equivalent hybrids with a given angle α between them. Hybridization index m is found immediately from Equation A1.17. A direction (θ_1, ϕ_1) must be chosen for the first hybrid, and a direction (θ_2, ϕ_2) for the second found such that the angle between them will be α . The orientation of the hybrids with respect to the coordinate system is arbitrary; it will be easiest to set up the orbitals if they are oriented so that the first points along one of the axes (say x) and the second lies in one of the coordinate planes (say x, y), or if the two are placed in one of the coordinate planes with a coordinate axis bisecting the angle α .

To illustrate with a concrete example, suppose that we wish to have $\alpha = 105^\circ$. In Figure A1.4, we orient the first hybrid along the x axis (along the direction $\mathbf{v}_1 = \mathbf{x}$) and the second at an angle of 105° to it in the xy plane (along the direction \mathbf{v}_2). Equation A1.17 gives

$$\frac{1}{m} = -\cos 105^\circ \quad (\text{A1.18})$$

$$\frac{1}{m} = 0.259 \quad (\text{A1.19})$$

$$m = 3.86 \quad (\text{A1.20})$$

The hybrids are then

$$\chi_1 = \sqrt{\frac{1}{1 + 3.86}} s + \sqrt{\frac{3.86}{1 + 3.86}} \{p_x\} \quad (\text{A1.21})$$

$$\chi_2 = \sqrt{\frac{1}{1 + 3.86}} s + \sqrt{\frac{3.86}{1 + 3.86}} \{-\sin 15^\circ p_x + \cos 15^\circ p_y\} \quad (\text{A1.22})$$

or

$$\chi_1 = \sqrt{0.206} s + \sqrt{0.794} p_x \quad (\text{A1.23})$$

$$\chi_2 = \sqrt{0.206} s + \sqrt{0.794} \{-0.259 p_x + 0.966 p_y\} \quad (\text{A1.24})$$

The hybrids are $sp^{3.86}$, the fractional s character is 20.6 percent, and the fractional p character is 79.4 percent.

Appendix 2

MOLECULAR

ORBITAL THEORY^a

The electronic state functions of a molecule are those functions Ψ which satisfy the Schrödinger equation:

$$\mathcal{H}_e \Psi = E_e \Psi \quad (\text{A2.1})$$

Here E_e is the total electronic energy and \mathcal{H}_e is the electronic Hamiltonian operator.^b The state function Ψ is a function of the coordinates of all the electrons. \mathcal{H}_e is a prescription for carrying out on Ψ a sequence of mathematical operations (partial differentiation with respect to the various coordinates and division by electron–electron and electron–nuclear separations) that is determined from the laws of mechanics and from the properties (number of electrons, number and positions of nuclei) of the particular molecule being considered. The Hamiltonian operator, though it may be quite complicated for a large molecule, can be written relatively easily; the unknown quantities in the equation are Ψ and E_e . In general, there will be many possible functions Ψ that are solutions for a given \mathcal{H}_e . Each of them represents a different possible state of the molecule, and each has its associated energy. (From this point on we shall consider the electronic ground state only.) Because the complexity of the many-particle molecular systems is so great, it is impossible to solve A2.1 for Ψ and E . Approximate methods must be used if there is to be any hope of progress.

^a For further information consult the sources cited in footnote 2, p. 10.

^b Equation A2.1 has already been simplified by making the assumption, known as the Born-Oppenheimer approximation, that nuclear and electron motions can be considered separately. Equation A2.1 applies only to electron motions; the nuclei are considered to be in fixed locations.

THE ORBITAL APPROXIMATION

The first approximation made in simplifying the task of solving for Ψ is the *orbital approximation*. Each of the M electrons of the molecule is assumed to be described by a molecular orbital function ψ ; the total wave function for the electronic state is the product of ψ 's for the individual electrons (Equation A2.2).^c

$$\Psi = \psi_1(1)\psi_1(2)\psi_2(3) \dots \psi_{M/2}(M) \quad (\text{A2.2})$$

The problem of finding the orbital functions ψ_i is commonly solved in one of two ways. Both use the *variation principle*. The variation principle states that whenever an approximate function is substituted for ψ in the expression

$$\mathcal{H}\psi = E\psi \quad (\text{A2.3})$$

where \mathcal{H} now refers to any Hamiltonian operator, the value of the energy E obtained will be greater than the true energy of the correct lowest energy wave function. Hence, the best result possible with an approximate wave function of a particular type will be obtained when it is chosen so as to minimize E . The more rigorous approach to finding the orbital functions is the Hartree-Fock-Roothaan method. It applies the variation principle to Equation A2.1, with Ψ expressed as in A2.2, and yields a new result of the form A2.3, where \mathcal{H} becomes the Hartree-Fock or self-consistent field operator, \mathcal{H}_{SCF} , and the molecular orbitals ψ_i represent the best solution possible within the orbital approximation.^d A simpler procedure is to assume an approximate Hamiltonian, $\mathcal{H}_{\text{approx}}$, which can be put directly in place of \mathcal{H} in A2.3. Hence, both approaches lead to the form A2.3, which must now be solved for ψ and E .

THE LCAO APPROXIMATION

The next approximation is the expression of each molecular orbital ψ as a *linear combination of atomic orbitals* (LCAO) (Equation A2.4), where φ_j are atomic orbital functions and c_j are coefficients that give the contribution of each atomic orbital to the molecular orbital. The φ_j are the *basis functions* discussed in Section 1.2. Valence atomic orbitals are ordinarily chosen for the basis.

$$\psi = \sum c_j \varphi_j \quad (\text{A2.4})$$

We always require that orbital functions be normalized. Because the probability of finding the electron in orbital ψ near a particular point is given by the value of ψ^2 at that point and because the total probability of finding the electron

^c When electron spin is properly taken into account, the total wave function for the state must be an *antisymmetrized* product of the orbital functions. Antisymmetrization automatically incorporates the Pauli exclusion principle. In Hückel theory, where orbitals are not properly antisymmetrized, it is necessary to add the extra restriction that electrons be assigned no more than two to an orbital and that spins of electrons occupying the same orbital be paired.

^d Because \mathcal{H}_{SCF} depends on its own solutions ψ , an iterative procedure of successive approximations is required. For derivations, see the sources cited in notes 2 (f), and 2 (g), p. 10.

somewhere must be unity, Equation A2.5 must hold, where $d\tau$ indicates a multiple

$$\int \psi^2 d\tau = 1 \quad (\text{A2.5})$$

integration throughout all space over all the coordinates of the electron.^e It is an easy matter to normalize an orbital function; if ψ is not normalized, $\psi/\sqrt{\int\psi^2d\tau}$ will be. In practice, normalized atomic orbital functions φ_j are chosen initially; then the ψ 's are normalized when Equation A2.6 is satisfied.

$$\sum_j c_j^2 = 1 \quad (\text{A2.6})$$

THE SECULAR EQUATION

We now return to Equation A2.3 and substitute into it Equation A2.4. We then obtain A2.7, where N is the total number of basis orbitals being used. The variation principle now has to be applied to A2.7 to find the values of the c 's which will give the best ψ 's possible with the chosen basis. The energy is minimized simultaneously with respect to all the c 's by carrying out a partial differentiation with respect to each c and making the derivatives of the energy satisfy A2.8. The result, after some manipulations, is a set of N equations of the form A2.9, where the index i takes a different value for each equation.

$$\mathcal{H} \sum_{j=1}^N c_j \varphi_j = E \sum_{j=1}^N c_j \varphi_j \quad (\text{A2.7})$$

$$\frac{\partial E}{\partial c_j} = 0 \quad \text{for each } j = 1, 2, \dots, N \quad (\text{A2.8})$$

$$\sum_{j=1}^N c_j \int \varphi_i \mathcal{H} \varphi_j d\tau = \sum_{j=1}^N E c_j \int \varphi_i \varphi_j d\tau \quad (\text{A2.9})$$

We now introduce the following new notation.

$$\int \varphi_i \varphi_j d\tau \equiv \langle \varphi_i | \varphi_j \rangle \equiv S_{ij} \quad (\text{A2.10})$$

$$\int \varphi_i \mathcal{H} \varphi_j d\tau \equiv \langle \varphi_i | \mathcal{H} | \varphi_j \rangle \equiv H_{ij} \quad (\text{A2.11})$$

S_{ij} is the *overlap integral*, and H_{ij} is called the *Hamiltonian matrix element* between basis functions i and j . We can now rewrite A2.9 as A2.12:

$$\sum_{j=1}^N c_j H_{ij} = \sum_{j=1}^N E c_j S_{ij} \quad (\text{A2.12})$$

Rearranging, we have:

$$\sum_{j=1}^N c_j (H_{ij} - E S_{ij}) = 0 \quad (\text{A2.13})$$

^e Because orbital functions can be complex (that is, they can contain the quantity $\sqrt{-1}$), one must actually use $\psi^* \psi$ instead of ψ^2 . The functions one ordinarily encounters in approximate molecular orbital theories are real; therefore this distinction makes no practical difference for our purposes.

Remember that there are N of these equations, one for each of the N possible values of i . If we regard the c_j 's as unknowns, these equations constitute a set of N linear homogeneous equations in N unknowns. The set has solutions for those values of E for which the determinant

$$\begin{vmatrix} H_{11} - ES_{11} & H_{12} - ES_{12} & H_{13} - ES_{13} & \dots \\ H_{21} - ES_{21} & H_{22} - ES_{22} & \dots & \\ \vdots & \vdots & & \\ \vdots & \vdots & & \end{vmatrix} \quad (\text{A2.14})$$

is zero; in more compact notation,

$$\det |H_{ij} - ES_{ij}| = 0 \quad (\text{A2.15})$$

This is the *secular equation*.

Solution of the secular equation amounts to finding the roots of an N th order equation in E . The N roots are the energies of the N molecular orbitals; the forms of the orbitals in terms of the basis atomic orbitals φ_j are found by substituting each value of E , in turn, back into Equations A2.13 and solving for the c 's using the additional condition that each MO ψ_i is to be normalized,

$$\sum_{j=1}^N c_{ij}^2 = 1 \quad (\text{A2.16})$$

Electrons are then assigned, two to each molecular orbital starting from the lowest energy.

Standard computer methods are available to solve Equation A2.15 if numerical values can be found for H_{ij} and S_{ij} . The S_{ij} can be determined easily with the aid of the computer, but the H_{ij} , which represent the interactions between the basis orbitals, are more difficult to obtain. A number of methods can be used to deal with this problem.

THE HÜCKEL METHOD

The Hückel method is the simplest of the quantitative MO techniques. It has the following characteristics:

1. Only π electrons are treated.
2. The basis consists of a p orbital on each carbon atom of the π system.
3. All overlaps, S_{ij} , $i \neq j$, are assumed to be zero; overlaps S_{ii} are unity because the basis orbitals are normalized.
4. Interactions H_{ij} , $i \neq j$, are assumed to be zero except for pairs of basis orbitals i and j that are on carbons directly bonded to each other. All H_{ij} for bonded pairs are assumed to have the same value, which is not calculated but is simply called β . (β represents an energy lowering and, therefore, is negative.)
5. H_{ii} , which represents the energy of an electron in the basis orbital i before any interaction with its neighbors occurs, is the same for all i (because all basis orbitals are the same). It is called α .

The secular equation then takes the form of the N -by- N determinantal Equation A2.17. The asterisk in row i , column j is zero if atom i is not bonded to atom j ,

$$\begin{vmatrix} \alpha - E & * & * & \dots \\ * & \alpha - E & * & \dots \\ * & * & \alpha - E & \dots \\ \vdots & \vdots & \vdots & \ddots \end{vmatrix} = 0 \quad (\text{A2.17})$$

and it is β if i is bonded to j . A further simplification of the algebraic manipulations required is obtained by setting the zero of energy equal to α and the unit of energy equal to β . (That is, we measure energy relative to α in units of β .) Then we have Equation A2.18, where $*_{ij}$ is zero if i and j are not bonded and unity if they are.

$$\begin{vmatrix} -E & * & * & \dots \\ * & -E & * & \dots \\ * & * & -E & \dots \\ \vdots & \vdots & \vdots & \ddots \end{vmatrix} = 0 \quad (\text{A2.18})$$

The Hückel orbitals have a number of properties that make them particularly convenient starting points for arguments of a qualitative or semiquantitative nature about conjugated systems.⁷ Hückel calculations are the only ones that are practical to do without the aid of a computer, and then only when determinants are of an order no larger than about four.⁸ The Hückel method gives rather poor energies and orbital functions but does reproduce faithfully symmetry properties of orbitals. Despite its many deficiencies, the method has been successful in correlating a variety of experimental data and has pointed the way to much interesting experimental chemistry.

THE ALLYL SYSTEM IN THE HÜCKEL APPROXIMATION

As an example of the Hückel method we will examine the allyl system. There are three basis orbitals, numbered as shown in 1. Atoms 1 and 2 are bonded to each

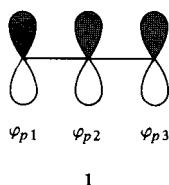

⁷ M. J. S. Dewar, *The Molecular Orbital Theory of Organic Chemistry*, McGraw-Hill, New York, 1969.

⁸ Symmetry properties can sometimes be used to reduce the size of determinants.

other, as are 2 and 3; 1 and 3 are not bonded. The secular equation is A2.19.

$$\begin{vmatrix} -E & 1 & 0 \\ 1 & -E & 1 \\ 0 & 1 & -E \end{vmatrix} = 0 \quad (\text{A2.19})$$

Expansion of the determinant gives:

$$-E^3 + 2E = 0 \quad (\text{A2.20})$$

or:

$$E(E^2 - 2) = 0 \quad (\text{A2.21})$$

The roots are:

$$\begin{aligned} E &= -\sqrt{2} \\ E &= 0 \\ E &= +\sqrt{2} \end{aligned} \quad (\text{A2.22})$$

The energies, relative to α , are therefore $-\sqrt{2}\beta$, 0, and $+\sqrt{2}\beta$; because β is a negative energy, the first of these is the highest energy and the third is the lowest.

To find the orbitals, we substitute each E , in turn, into the set of Equations A2.23:

$$\begin{aligned} -c_1E + c_2 + 0 &= 0 \\ c_1 - c_2E + c_3 &= 0 \\ 0 + c_2 - c_3E &= 0 \end{aligned} \quad (\text{A2.23})$$

$E = -\sqrt{2}$ gives the relationships A2.24:

$$\begin{aligned} c_2 &= -\sqrt{2}c_1 \\ c_3 &= c_1 \end{aligned} \quad (\text{A2.24})$$

The other information we have about the coefficients is the normalization condition:

$$c_1^2 + c_2^2 + c_3^2 = 1 \quad (\text{A2.25})$$

Combining Equations A2.24 and A2.25, we obtain the coefficients for the highest energy MO:

$$\begin{aligned} c_1 &= 1/2 \\ c_2 &= -\sqrt{2}/2 = -1/\sqrt{2} \\ c_3 &= 1/2 \end{aligned} \quad (\text{A2.26})$$

The coefficients for the other orbitals are obtained in the same way starting with $E = 0$ and $E = +\sqrt{2}$. The orbitals are, in order of decreasing energy, measured relative to α as the zero of energy:

$$\begin{aligned} E_3 &= -\sqrt{2}\beta & \psi_3 &= 1/2\varphi_{p_1} - 1/\sqrt{2}\varphi_{p_2} + 1/2\varphi_{p_3} \\ E_2 &= 0 & \psi_2 &= 1/\sqrt{2}\varphi_{p_1} - 1/\sqrt{2}\varphi_{p_3} \\ E_1 &= +\sqrt{2}\beta & \psi_1 &= 1/2\varphi_{p_1} + 1/\sqrt{2}\varphi_{p_2} + 1/2\varphi_{p_3} \end{aligned} \quad (\text{A2.27})$$

These are the orbitals shown in Figure 1.18.

THE EXTENDED HÜCKEL METHOD

The extended Hückel method, developed by Hoffmann,^h has the following characteristics:

1. All valence orbitals are included in the basis. The method is not restricted to π systems.
2. All overlaps S_{ij} are calculated and included.
3. Energies H_{ii} of an electron in each of the basis orbitals are estimated empirically from spectroscopic data.
4. Interactions H_{ij} are approximated as a simple function of S_{ij} , H_{ii} , and H_{jj} .

This method provides a practical way of carrying out rapid calculations on moderately large organic molecules. Although energies are still not particularly reliable, energy differences within a series of similar compounds are revealing.

Hückel and extended Hückel methods are termed *semi-empirical* because they rely on experimental data for the quantification of parameters. There are other semi-empirical methods, such as CNDO, MINDO, INDO, in which experimental data are still used, but more care is taken in evaluating the H_{ij} . These methods are self-consistent field procedures based on \mathcal{H}_{SCF} . They are discussed in various works on molecular orbital theory.^l

AB INITIO METHODS

Ab initio methods calculate all quantities needed from first principles and use no experimentally determined parameters. The computations require more machine time and are therefore more expensive than semi-empirical ones. Good energies can now be obtained for small molecules by these techniques. The reader is referred to specialized treatments for further information.^l

^h R. Hoffmann, *J. Chem. Phys.*, **39**, 1397 (1963).

^l See note 2, p. 10.

^l For an introduction, see W. G. Richards and J. A. Horsley, *Ab initio Molecular Orbital Calculations for Chemists*, Oxford University Press, London, 1970.

Chapter 2

SOME FUNDAMENTALS

OF PHYSICAL

ORGANIC CHEMISTRY

In this chapter we review several aspects of the physical chemistry of organic compounds that are particularly useful in the investigation of reaction mechanisms.

2.1 STEREOCHEMISTRY

Because of the excellent introduction to stereochemistry that is included in most introductory organic textbooks, we shall limit our discussion to reviewing the meaning of a number of terms. The reader who wishes more information is referred to other sources.¹

Two compounds are *stereoisomers* of one another if the bonding arrangement in one is identical to that in the other except in the way the atoms are oriented in space. Thus, **1** and **2**, **3** and **4**, **5** and **6**, **7** and **8** are four pairs of stereoisomers. There are two types of stereoisomers: enantiomers and diastereomers.

Enantiomers are nonsuperimposable mirror images of one another. Thus, for example, *R*-lactic acid (**1**) is the enantiomer of *S*-lactic acid (**2**). And allene **3** is the enantiomer of allene **4**. Molecules that are not superimposable on their mirror

¹ For the best discussions in introductory textbooks, see: (a) R. T. Morrison and R. N. Boyd, *Organic Chemistry*, 3rd edn., Allyn & Bacon, Boston, 1973, pp. 73–80, 115–140, 225–246; (b) J. B. Hendrickson, D. J. Cram, and G. S. Hammond, *Organic Chemistry*, 3rd edn., McGraw-Hill, New York, 1970, pp. 175–230; (c) N. L. Allinger, M. P. Cava, D. C. DeJong, C. R. Johnson, N. A. Lebel, and C. L. Stevens, *Organic Chemistry*, Worth, New York, 1971, pp. 105–126. More thorough introductions are available in the two small books; (d) G. Natta and M. Farina, *Stereochemistry*, Harper & Row, New York, 1972; (e) K. Mislow, *Introduction to Stereochemistry*, W. A. Benjamin, Menlo Park, Calif., 1966. A number of larger, more advanced treatments are also available. See, for example: (f) M. S. Newman, *Steric Effects in Organic Chemistry*, Wiley, New York, 1956; (g) E. L. Eliel, *Stereochemistry of Carbon Compounds*, McGraw-Hill, New York, 1962.

images are *chiral*, whereas molecules that are superimposable on their mirror images are *achiral*. A tetrahedral atom with four different substituents is called a *chiral center*. Thus, the central carbons in *R*- and *S*-lactic acids (**1** and **2**) are chiral

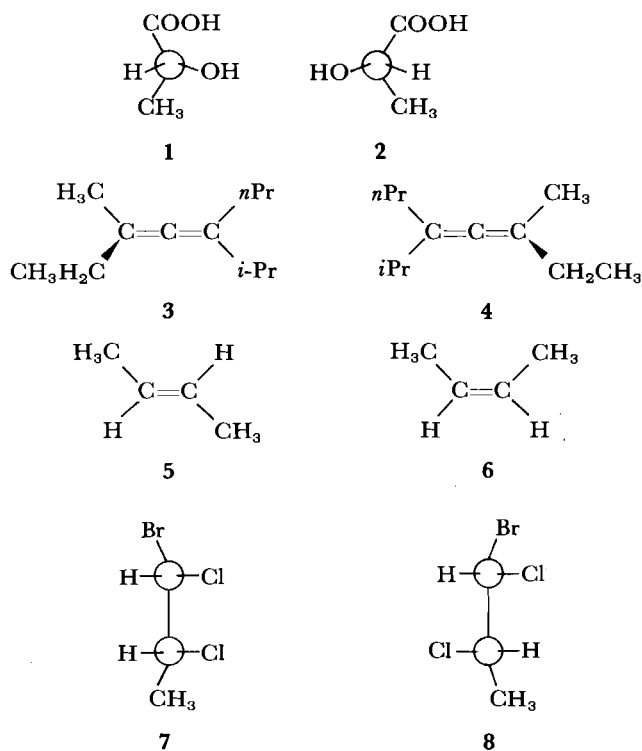

centers. The allenes **3** and **4** are chiral molecules although they do not have a chiral center. A mixture that contains equal amounts of both enantiomers is called a *racemic mixture*.

Stereoisomers that are not mirror images of each other are called *diastereomers*. Thus geometrical isomers (e.g., **5** and **6**) are diastereomers, as are molecules that have two or more chiral centers but that are not enantiomers. For example, **7** and **8** are diastereomers of one another.

A molecule that has two or more chiral centers so arranged that one-half of the molecule is the mirror image of the other half is achiral. Such a molecule is called a *meso* molecule.

Let us now define three terms that refer to reactions: stereoselective, stereospecific and stereoelectronic. There has been a difference of opinion about the use of the first two; we shall use the definitions suggested by Zimmerman² and now adopted by most authors.

The terms stereoselective and stereospecific properly refer only to reactions in which diastereomerically different materials may be formed or destroyed during the course of the reaction. *Stereoselective reactions* are all those in which one diastereomer (or one enantiomeric pair of diastereomers) is formed or destroyed

² H. E. Zimmerman, L. Singer, and B. S. Thyagarajan, *J. Amer. Chem. Soc.*, **81**, 108 (1959).

in considerable preference to others that might have been formed or destroyed. Thus, for example, bromination of *trans*-2-butene might give either racemic or *meso*-2,3-dibromobutane. However, the *meso* compound is produced stereoselectively, as shown in Equation 2.1. Similarly, Equation 2.2 shows that *cis*-2-

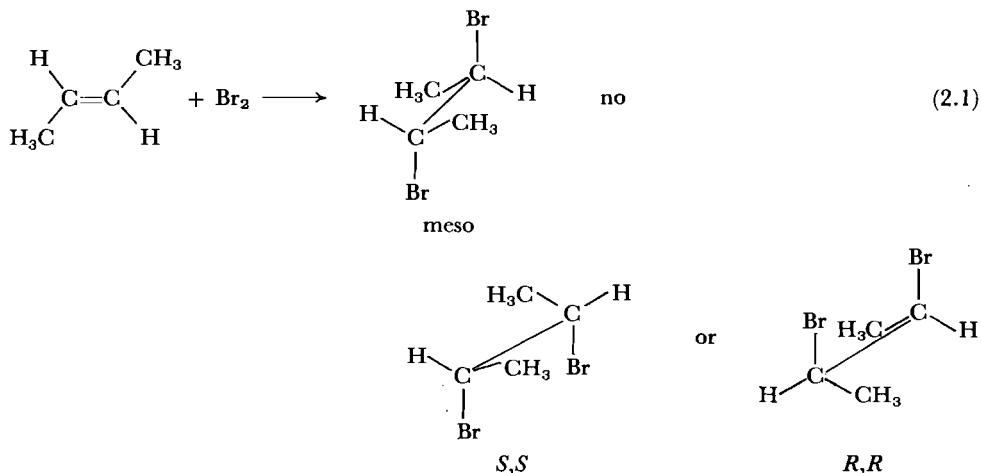

butene on bromination gives only racemic 2,3-dibromobutane. Another example

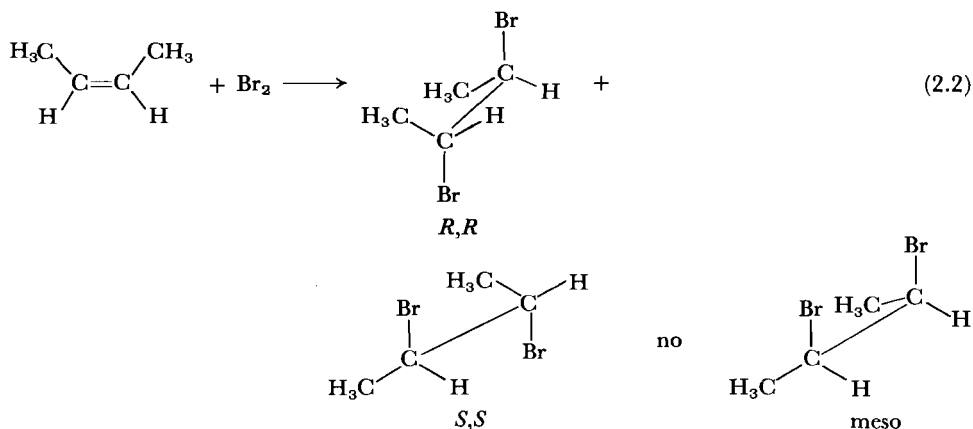

of a stereoselective reaction is loss of *p*-toluenesulfonic acid

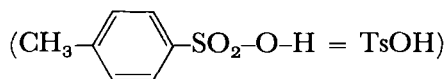

from *trans*-2-phenylcyclohexyl "tosylate" (Equation 2.3). Only *cis*-1-phenylcyclohexene is produced. Likewise, as Equation 2.3 shows, *cis*-2-phenylcyclohexyl tosylate also loses TsOH stereoselectively to form *cis*-1-phenylcyclohexene.

In a *stereospecific* reaction diastereomerically different starting materials give diastereomerically different products. Thus the bromination of the 2-butenes (Equations 2.1 and 2.2) is stereospecific, since one geometrical isomer gives one product and the other isomer a diastereomerically different product. Elimination of TsOH from the two 2-phenylcyclohexyl tosylates, however, is not stereospecific.

As Equation 2.3 shows, both compounds give the same product. All stereospecific reactions must be stereoselective, but the reverse is not true.³

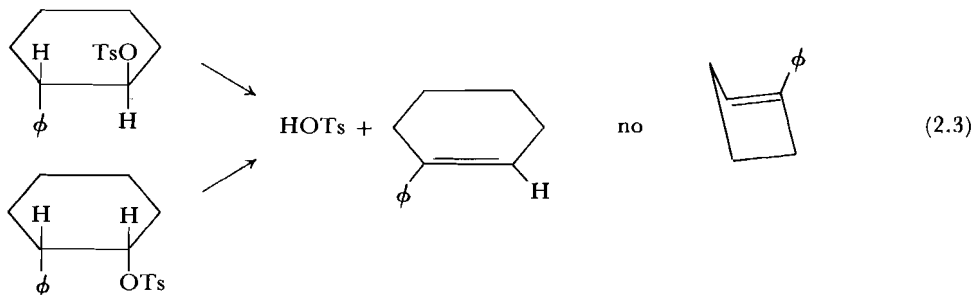

The term *stereoelectronic* refers to the effect of orbital overlap requirements on the steric course of a reaction. Thus, because of stereoelectronic effects, the S_N2 substitution gives inversion (see Section 4.2) and E_2 elimination proceeds most readily when the angle between the leaving groups is 0° or 180° (see Chapter 7, p. 369). Stereoelectronic effects also play an important role in pericyclic reactions, which are the subject of Chapters 11 and 12.

2.2 LINEAR FREE-ENERGY RELATIONSHIPS⁴

A problem that has challenged chemists for years is the determination of the electronic influence that substituents exert on the rate and course of a reaction. One of the difficulties involved in determining electronic substituent effects is that if the substituent is located close to the reaction center it may affect the reaction by purely steric processes, so that electronic effects are masked; if placed far away in order to avoid steric problems, the electronic effects will be severely attenuated.

In 1937 Hammett recognized⁵ that the electronic influence of a substituent, X, might be assessed by studying reactions in a side chain at Y in benzene derivatives (9 and 10).

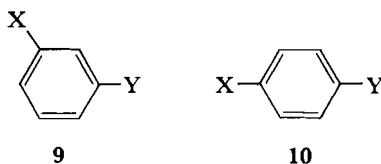

The substituent X is separated physically from the reaction site, but its electron-

³ Reactions may be "partially", "90 percent," "60 percent," etc., stereoselective or stereospecific.

⁴ For reviews see: (a) J. Shorter, *Quart. Rev. (London)*, **24**, 433 (1970); (b) P. R. Wells, *Linear Free Energy Relationships*, Academic Press, New York, 1968; (c) L. P. Hammett, *Physical Organic Chemistry*, 2nd edn., McGraw-Hill, New York, 1970, pp. 347ff; (d) C. D. Ritchie and W. F. Sager, *Prog. Phys. Org. Chem.*, **2**, 323 (1964); (e) J. E. Leffer and E. Grunwald, *Rates and Equilibria of Organic Reactions*, Wiley, New York, 1963; (f) H. H. Jaffé, *Chem. Rev.*, **53**, 191 (1953). For theoretical discussions see: (g) S. Ehrenson, R. T. C. Brownlee, and R. W. Taft, *Prog. Phys. Org. Chem.*, **10**, 1 (1973); (h) M. Godfrey, *Tetrahedron Lett.*, 753 (1972); (i) S. Ehrenson, *Prog. Phys. Org. Chem.*, **2**, 195 (1964).

⁵ L. P. Hammett, *J. Amer. Chem. Soc.*, **59**, 96 (1937).

donating or -withdrawing influence is transmitted through the relatively polarizable π electron system. The Hammett approach is to take as a standard reaction for evaluation of substituent effects the dissociation of substituted benzoic acids (9 and 10, Y = COOH) at 25°C in H₂O. Substitution of an electron-withdrawing group (such as nitro) in the para position of benzoic acid causes an increase in strength of the acid, while an electron-donating group (for example, amino) decreases the strength. The same substituents in the meta position have slightly different effects. Ortho substituents are not included, because their proximity to the reaction site introduces interactions not present if the substituent is at the meta or para position.⁶

If the free-energy change on dissociation of unsubstituted benzoic acid (X = H) is designated as ΔG_0° , the free energy on dissociation of a substituted benzoic acid (ΔG°) can be considered to be ΔG_0° plus an increment, $\Delta\Delta G^\circ$, con-

$$\Delta G^\circ = \Delta G_0^\circ + \Delta\Delta G^\circ \quad (2.4)$$

tributed by the substituent (Equation 2.4). Because the substituent X will make different contributions at the meta and para positions, it is always necessary to designate the position of substitution.

In order to bring the relationship (2.4) into more convenient form, a parameter σ is defined for each substituent according to Equation 2.5, so that equation 2.4 becomes Equation 2.6.

$$\Delta\Delta G^\circ = -2.303RT\sigma \quad (2.5)$$

$$-\Delta G_x^\circ = -\Delta G_0^\circ + 2.303RT\sigma \quad (2.6)$$

By using the relationship 2.7 between free energy and equilibrium, Equation 2.6 can be rewritten as Equation 2.8, which in turn simplifies to Equation 2.9.

$$-\Delta G_x^\circ = 2.303RT \log_{10} K \quad (2.7)$$

$$2.303RT \log_{10} K = 2.303RT \log_{10} K_0 + 2.303RT\sigma \quad (2.8)$$

$$\log_{10} \frac{K}{K_0} = \rho K_0 - \rho K = \sigma \quad (2.9)$$

Table 2.1 lists σ constants for some of the common substituents.

If we now examine the effect of substituents on another reaction, for example acid dissociation of phenylacetic acids (Equation 2.10), we can anticipate that the

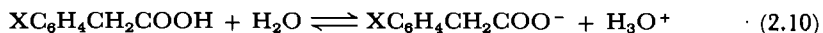

various substituents will exert the same kind of effects on these equilibrium constants as they did on the benzoic acid equilibrium constants; but the greater separation between substitution site and reaction site in the phenylacetic acids makes the reaction less sensitive to the substituent effects. The increment $2.303RT\sigma$, which was appropriate for benzoic acid dissociations, must now be multiplied by a factor ρ which characterizes the sensitivity of the new reaction to electron donation and withdrawal. We can therefore write Equation 2.11,

$$-\Delta G^{\circ'} = -\Delta G_0^{\circ'} + 2.303RT\rho\sigma \quad (2.11)$$

$\Delta G^{\circ'}$ is the free-energy change for the new reaction with substituent X and

⁶ The ortho effect is not entirely steric in origin. See M. Charton, *Prog. Phys. Org. Chem.*, **8**, 235 (1971).

Table 2.1 σ VALUES OF COMMON SUBSTITUENTS

Substituent	σ_{meta}	σ_{para}	σ^{+a}	σ^{-a}
N(CH ₃) ₂	-0.21	-0.83	-1.7	—
NH ₂	-0.16	-0.66	-1.3	—
CH ₃	-0.07	-0.17	-0.31	—
OH	-0.12	-0.37	-0.92	—
C ₆ H ₅	0.06	-0.01	-0.17	—
OCH ₃	0.12	-0.27	-0.78	-0.2
F	0.34	0.06	-0.07	-0.02
I	0.35	0.18	0.13	—
CO ₂ H	0.37	0.45	0.48	0.68
Cl	0.37	0.23	0.11	—
COCH ₃	0.38	0.50	—	0.87
Br	0.39	0.23	0.15	—
CO ₂ R	0.37	0.45	0.48	0.68
CF ₃	0.43	0.54	—	—
CN	0.56	0.66	0.66	0.90
NO ₂	0.71	0.78	0.79	1.24

SOURCE: Values are those given by C. D. Ritchie and W. F. Sager, *Prog. Phys. Org. Chem.*, 2, 323 (1964). Reproduced by permission of Wiley-Interscience.

^a σ^{+} and σ^{-} values are given for para substituents only. σ^{+} values for some meta substituents have been measured, but because direct resonance interaction between meta substituents is impossible they do not differ appreciably from the σ_{meta} values.

ΔG_0° is the free-energy change for the new reaction with no substituents. Rewriting Equation 2.11 as before, we have the relationship in the more useful form of Equation 2.12:

$$\log_{10} \frac{K'}{K_0} = \rho\sigma \quad (2.12)$$

Equations 2.11 and 2.12 express a linear relationship of free energies known as the Hammett σ - ρ relationship, or simply as the Hammett equation. It can be applied to reaction rates of substituted aromatic compounds as well as to equilibrium constants, and we shall find that it is a very useful tool for obtaining information about reaction mechanisms. (See, for example, Problem 2.1.)

Usually the most convenient way to use the Hammett equation is to plot $\log K/K_0$, or just $\log K$ (for equilibria) or $\log k/k_0$, or just $\log k$ (for rates) of the reaction of interest on the vertical axis and σ values for the substituents on the horizontal axis. A straight line indicates that the free-energy relationship of Equation 2.11 is valid. The slope of the line is ρ for the reaction. A positive value of ρ means that the reaction responds to substituents in the same sense as does benzoic acid ionization; that is, the equilibrium constant (or reaction rate) is increased by electron-withdrawing groups. If $\rho > 1$, then the reaction is more sensitive to the effect of the substituent than benzoic acid dissociation; if $0 < \rho < 1$, then electron-withdrawing groups still increase the rate or equilibrium constant but less than in benzoic acid dissociation. A negative ρ shows that electron-donating groups increase the reaction constant. A small ρ often means that the mechanism of the reaction involves radical intermediates or a cyclic transition state with little charge separation. Sometimes the plot of $\log k$ vs. σ changes slope more or less abruptly as substituents are varied, so that two straight lines are

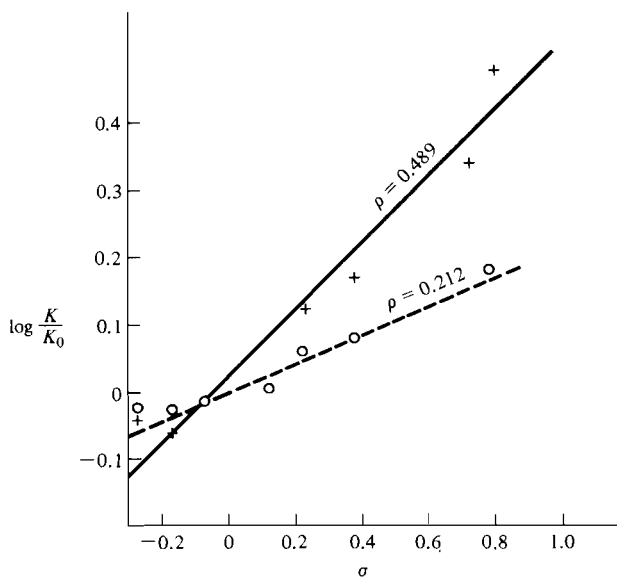
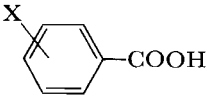
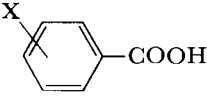
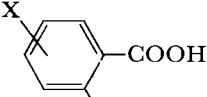
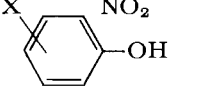

Figure 2.1 Plot of K/K_0 vs. σ constants for dissociation of $X-C_6H_4CH_2COOH$ (\times) and of $X-C_6H_4CH_2CH_2COOH$ (\circ). The data are from J. F. J. Dippy and J. E. Page, *J. Chem. Soc.*, 357 (1938), and the ρ -values from a least-squares analysis of the data by H. H. Jaffe, *J. Chem. Phys.*, 21, 415 (1953).

obtained. The reason for this behavior usually is that the mechanism is changing in response to the varying electron demand of the substituents.

Figure 2.1 shows the results of application of the method to ring-substituted phenylacetic and 3-phenylpropionic acids. The ρ values are positive for both

Table 2.2 ρ VALUES FOR ACID DISSOCIATIONS

Acid	Solvent	Temp ($^{\circ}C$)	ρ
	H_2O	25	1.00 ^v
	C_2H_5OH	25	1.957
	H_2O	25	0.905
	H_2O	25	2.113

SOURCE: H. H. Jaffe, *Chem. Rev.*, 53, 191 (1953), where more complete data may be found. Reproduced by permission of the American Chemical Society.

Table 2.3 ρ VALUES DERIVED FROM RATES OF HETEROLYTIC REACTIONS

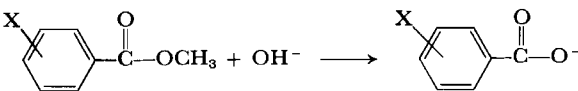
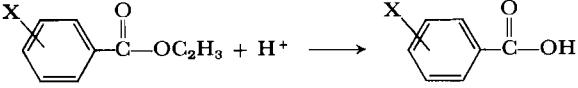
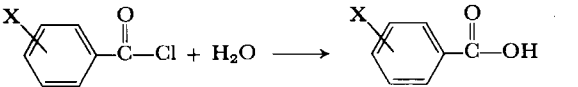
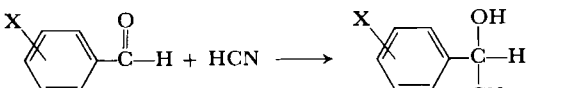
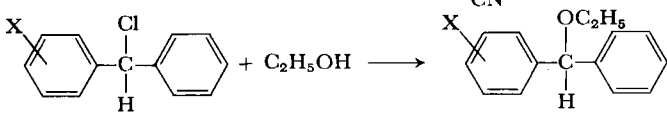
Reaction	Solvent	Temp (°C)	ρ
	60% acetone,	25	2.229
	60% acetone,	100	0.106
	50% acetone,	0	0.797
	95% ethanol,	20	2.329
	ethanol,	25	-5.090

SOURCE: H. H. Jaffe, *Chem. Rev.*, 53, 191 (1953), where more complete data may be found. Reproduced by permission of the American Chemical Society.

reactions but decrease in magnitude as the substituted ring is placed farther from the reaction site. Tables 2.2 and 2.3 list several additional ρ values for the correlation of equilibrium constants and reaction rate constants, respectively. Note, for example, in Table 2.2 that ρ for the dissociation of substituted benzoic acids is much higher in ethanol than it is in water. This is because acid strength in the less ionizing solvent, ethanol, is more dependent on any help it can get from substituents than it is in water.

σ^+ and σ^- Constants

When the reaction site comes into direct resonance with the substituent, the σ constants of the substituents do not succeed in correlating equilibrium or rate constants. For example a *p*-nitro group increases the ionization constant of phenol much more than would be predicted from the $\sigma_{p-\text{NO}_2}$ constant obtained from the ionization of *p*-nitrobenzoic acid. The reason is readily understood when one realizes that the *p*-nitrophenoxide ion has a resonance structure (**11**) in which the nitro group participates in *through-resonance*⁷ with the O⁻. The extra stabilization of the anion provided by this structure is not included in the $\sigma_{p-\text{NO}_2}$ constant

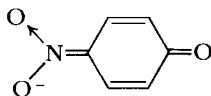
**11**

⁷ This term was introduced by J. Clark and D. D. Perrin, *Quart. Rev.* (London), 18, 295 (1964).

because the COO^- group in the benzoate anion cannot come into direct resonance interaction with any ring substituent. Similarly, a *p*-methoxide group is much more effective at increasing the rate of ionization of triphenylmethyl chloride than would be predicted from the $\sigma_p\text{-OCH}_3$ constant (see Equation 2.13).

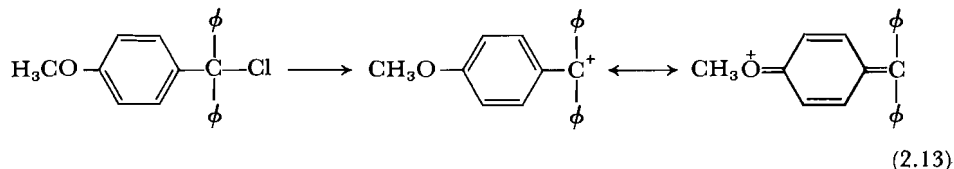

Several investigators found⁸ that rate and equilibrium constants can be better correlated by the Hammett equation if two new types of σ constants are introduced. When there is through-resonance between a reaction site that becomes electron-rich and a substituent electron-withdrawing by resonance, the σ^- constant should be used. The standard reactions for the evaluation of σ^- constants are the ionizations of para-substituted phenols and of para-substituted anilinium ions.⁹ The σ^+ constant should be used whenever a substituent electron-donating by resonance is para to a reaction site that becomes electron-deficient, and when through-resonance is possible between the two groups. The standard reaction for the evaluation of σ^+ is the solvolysis of para-substituted *t*-cumyl chlorides in 90 percent aqueous acetone (Equation 2.14).¹⁰ Table 2.1 lists a number of σ^+ and σ^- constants.

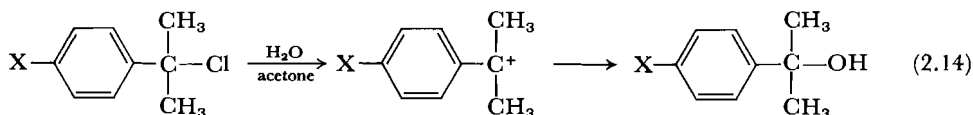
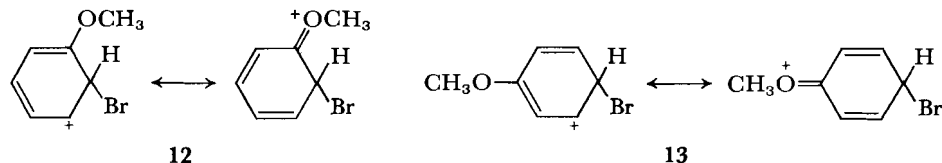

Figure 2.2, in which σ constants are plotted against $\log k/k_0$, for the bromination of monosubstituted benzenes, shows an example of the usefulness of these new parameters. As can be seen from Structures 12 and 13—which are representations of the intermediates in the ortho and para bromination of anisole—substituents electron-donating by resonance ortho or para to the entering bromine can stabilize the positive charge in the intermediate and therefore also in the transition state by through-resonance.



In Figure 2.2a, in which Hammett σ constants are plotted, there is only a scatter of points; but in Figure 2.2b σ^+ parameters are used and a straight line is obtained.

⁸ For reviews see (a) Note 4(d), p. 60; (b) L. M. Stock and H. C. Brown, *Advan. Phys. Org. Chem.*, **1**, 35 (1963).

⁹ See note 4(f), p. 60.

¹⁰ H. C. Brown and Y. Okamoto, *J. Amer. Chem. Soc.*, **80**, 4979 (1958).

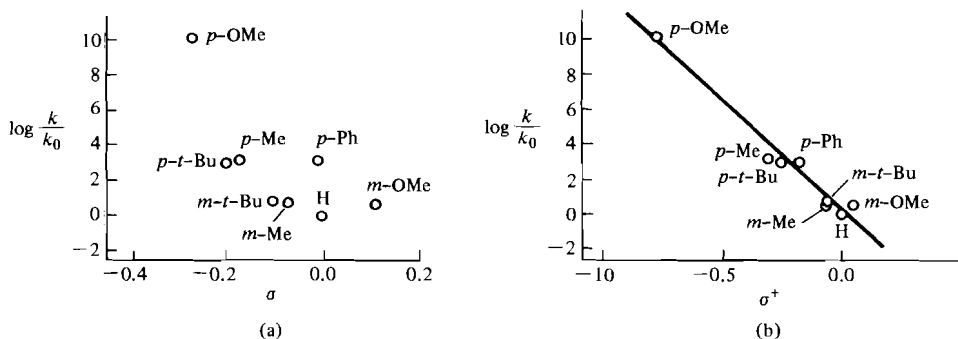
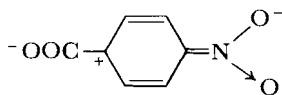

Figure 2.2 Bromination of monosubstituted benzenes in acetic acid. From H. C. Brown and Y. Okamoto, *J. Amer. Chem. Soc.*, **80**, 4979 (1958). Reprinted by permission of the American Chemical Society.

σ^n and σ^o Constants

σ^+ and σ^- constants have been widely and successfully used. However, they have also been strongly criticized by Wepster¹¹ and by Taft.¹² Both investigators predicted that the ability of a substituent to interact with a reaction site by resonance should depend on the exact nature of the reaction as well as on the substituent and there should, therefore, be a whole spectrum of σ values for every substituent. Wepster introduced the σ^n constant as the "normal" σ value, representative only of inductive effects and free of all resonance effects. The constants for *m*-Cl, *m*-CH₃, and *m*-NO₂ were taken by Wepster as primary σ^n values.¹³ The σ_{para} constants were rejected because, even in the absence of through-resonance, resonance can effect the electron supply at the site of reaction. (Consider, for example, the contribution from Structure 14 to the anion of *p*-nitrobenzoic acid.



14

There is no through-resonance between the nitro group and the negative charge on the carboxylate group. However, the partial positive charge, which results from electron-withdrawing resonance by the nitro group, on the ring carbon that bears the carboxylate does stabilize the negative charge.) Using only the primary σ^n values, ρ for any reaction of interest is calculated. Once ρ for a reaction is known, the σ constants of all other substituents for that reaction can be found.

¹¹ (a) H. van Bekkum, P. E. Verkade, and B. M. Wepster, *Rec. Trav. Chim. Pays-Bas*, **78**, 815 (1959); (b) A. J. Hoefnagel, J. C. Monshouwer, E. C. G. Snorn, and B. M. Wepster, *J. Amer. Chem. Soc.*, **95**, 5350 (1973).

¹² R. W. Taft, Jr. and I. C. Lewis, *J. Amer. Chem. Soc.*, **80**, 2436 (1958); **81**, 5343 (1959); R. W. Taft, Jr. and I. C. Lewis, *Tetrahedron*, **5**, 210 (1959).

¹³ The σ constants obtained for substituents electron-donating by resonance that are para to a reaction site that becomes electron-rich, and for substituents electron-withdrawing by resonance that are para to a reaction site that becomes electron-deficient, were also taken as σ^n values, since in these cases there would be no stabilization by resonance.

Table 2.4 σ^n and σ° VALUES

Substituent	σ^n	σ°	Substituent	σ^n	σ°
<i>m</i> -CH ₃	-0.07	-0.07	<i>m</i> -COCH ₃	0.38	0.34
H	0.00	0.00	<i>m</i> -NO ₂	0.71	0.70
<i>m</i> -F	0.34	0.35	<i>p</i> -COCH ₃	0.50	0.46
<i>m</i> -Cl	0.37	0.37	<i>p</i> -NO ₂	0.78	0.82
<i>m</i> -Br	0.39	0.38			
<i>m</i> -I	0.35	0.35			

SOURCE: P. R. Wells, *Linear Free Energy Relationships*, Academic Press, New York, 1968. Reproduced by permission of Academic Press and P. R. Wells.

The spectrum of σ values for a single substituent that was predicted was indeed found.

Taft separated the resonance from the inductive substituent effects and proposed Equation 2.15. The inductive parameter, σ_I , is based on σ^* obtained from aliphatic systems (see p. 68).¹⁴

$$\sigma^\circ = \sigma_R^\circ + \sigma_I \quad (2.15)$$

The constant σ° is another "normal" substituent constant determined by choosing only reaction series in which at least one methylene group insulates the reaction site from the aromatic ring. The resonance parameter, σ_R° , is determined from Equation 2.15 and is the resonance contribution of a substituent when it is not directly conjugated with the reaction site.¹⁵ Table 2.4 lists a number of σ^n and σ° values. Note the close correspondence between the two.

Linear Free-Energy Relationships for Aliphatic Systems— σ^* Constants

In the 1950s Taft devised a method of extending linear free-energy relationships to aliphatic systems.¹⁶ He suggested that, since the electronic nature of substituents has little effect on the rate of acid-catalyzed hydrolysis of meta- or para-substituted benzoates (ρ values are near 0, see Table 2.3), the electronic nature of substituents will also have little effect on acid-catalyzed hydrolysis of aliphatic esters. All rate changes due to substituents in the latter reactions are, therefore, probably due to steric factors.¹⁷ Taft defined E_s , a steric substituent constant, by Equation 2.16

$$E_s = \log \left(\frac{k}{k_0} \right)_A \quad (2.16)$$

in which k and k_0 are the rate constants for hydrolysis of XCOOR and CH₃COOR, respectively, and in which the subscript A denotes acid-catalyzed

¹⁴ The σ_I constant is defined as $\sigma_{I(X)} = 0.54\sigma^*_{(XCH_2)}$.

¹⁵ See note 12, p. 66.

¹⁶ Taft followed a suggestion of Ingold (C. K. Ingold, *J. Chem. Soc.*, 1032 (1930). R. W. Taft, Jr., *J. Amer. Chem. Soc.*, 74, 2729, 3120 (1952); 75, 4231 (1953).

¹⁷ For criticisms of this assumption see notes 4(a) and 4(f), p. 60.

hydrolysis. Table 2.5 gives a number of E_s values. The rates of other reactions in which the polar effect of substituents is small can be correlated by E_s .¹⁸

Now that the steric parameter can be evaluated, the inductive parameter is available. Taft noted that the transition-state structures for acid- and base-catalyzed hydrolysis of esters (**15** and **16**, respectively) differ from each other by only tiny protons. Therefore the steric effect of a substituent should be approx-

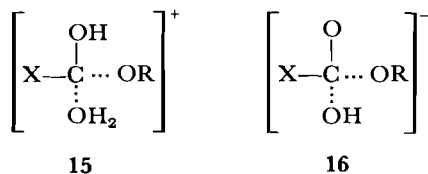

imately the same in the two types of hydrolysis. But in base-catalyzed hydrolysis the electronic influence of a substituent cannot be neglected, as can be seen from the large values of ρ for base-catalyzed hydrolysis of *m*- or *p*-substituted benzoates (Table 2.3). The polar substituent constant, σ^* , was therefore defined as

$$\sigma^* = \frac{\log \left(\frac{k}{k_0} \right)_B - \log \left(\frac{k}{k_0} \right)_A}{2.48} \quad (2.17)$$

Table 2.5 STERIC AND POLAR PARAMETERS FOR ALIPHATIC SYSTEMS

X	E_s	σ^*
H	+1.24	+0.49
CH ₃	0.00	0.00
CH ₃ CH ₂	-0.07	-0.10
<i>i</i> -C ₃ H ₇	-0.47	-0.19
<i>t</i> -C ₄ H ₉	-1.54	-0.30
<i>n</i> -C ₃ H ₇	-0.36	-0.115
<i>n</i> -C ₄ H ₉	-0.39	-0.13
<i>i</i> -C ₄ H ₉	-0.93	-0.125
<i>neo</i> -C ₅ H ₁₁	-1.74	-0.165
ClCH ₂	-0.24	+1.05
ICH ₂	-0.37	+0.85
Cl ₂ CH	-1.54	+1.94
Cl ₃ C	-2.06	+2.65
CH ₃ OCH ₂	-0.19	+0.52
C ₆ H ₅ CH ₂	-0.38	+0.215
C ₆ H ₅ CH ₂ CH ₂	-0.38	+0.08
CH ₃ CH=CH	-1.63	+0.36
C ₆ H ₅	-2.55	+0.60

SOURCE: J. Shorter, *Quart. Rev.* (London), **24**, 433 (1970), using data of R. W. Taft, in *Steric Effects in Organic Chemistry*, M. S. Newman, Ed., Wiley, New York, 1956, chap. 13. Reproduced by permission of the Chemical Society, Wiley-Interscience, and J. Shorter.

¹⁸ Better correlations are usually obtained by using modified steric parameters that recognize a contribution to E_s from the hyperconjugative effect of α hydrogens. See note 4(a), p. 60. T. Fujita, C. Takayama, and M. Nakajima, *J. Org. Chem.*, **38**, 1623 (1973).

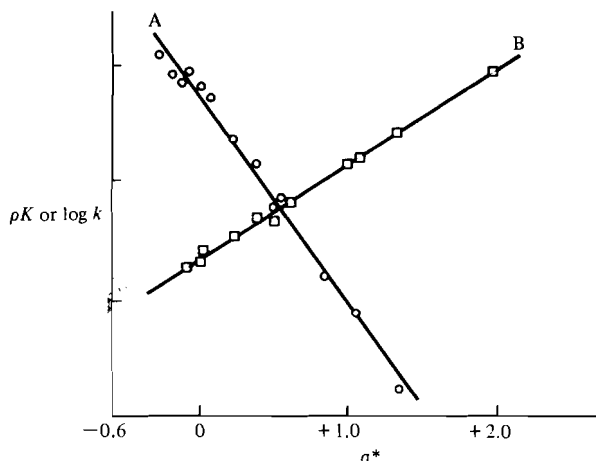

Figure 2.3 The divisions on the ordinate are 1.00 units of pK or $\log k$ apart. The relative positions of the lines with respect to the ordinate are arbitrary. A: pK , aliphatic carboxylic acids (XCO_2H), water 25°C vs. σ^* . B: $\log k$, catalysis of dehydration of acetaldehyde hydrate by XCO_2H , aqueous acetone, 25°C vs. σ^* . From J. Shorter, *Quart. Rev. (London)*, **24**, 433 (1970). Reprinted by permission of J. Shorter and The Chemical Society.

The subscript B denotes base-catalyzed hydrolysis, and the factor 2.48 is present in order that the σ and σ^* constants of a substituent will have approximately the same value. Table 2.5 lists a number of σ^* constants.¹⁹

Taft found that the rate or equilibrium constants for a variety of reactions of aliphatic compounds conform to Equation 2.18 or Equation 2.19, respectively.

$$\log \frac{k}{k_0} = \sigma^* \rho^* \quad (2.18)$$

$$\log \frac{K}{K_0} = \sigma^* \rho^* \quad (2.19)$$

For example, Figure 2.3 shows plots of the σ^* constants of X vs. $\log pK$ of aliphatic carboxylic acids (XCO_2H) and vs. $\log k$ for the dehydration of acetaldehyde hydrate by XCO_2H . Deviations from Equations 2.18 and 2.19 occur when the rate of reaction or position of equilibrium becomes dependent on steric factors. For example, Taft studied the enthalpies of dissociation, ΔH_d , of the addition compounds formed between boron trimethyl and amines ($X^1X^2X^3N$) and found that when the amine is ammonia or a straight-chain primary amine the dissociation conforms to Equation 2.20, in which $\sum \sigma^*$ is the sum of the σ^* values for the

$$\Delta \Delta H_d = (\sum \sigma^*) \rho^* \quad (2.20)$$

¹⁹ Note that in Table 2.5 all alkyl groups have small negative σ^* values. It has been argued that these values, which often do not give good rate and equilibrium constant correlations, should properly be zero for all alkyl groups. For a review see note 4(a), p. 60. But also S. Fliszar, *J. Amer. Chem. Soc.*, **94**, 1068 (1972).

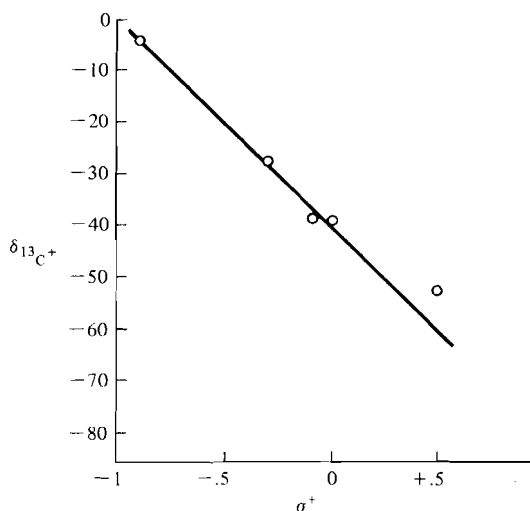

Figure 2.4 Chemical shift of cationic carbon in **17** vs. σ^+ . From G. A. Olah, R. D. Porter, C. L. Jeuell, and A. M. White, *J. Amer. Chem. Soc.*, **94**, 2044 (1972). Reprinted by permission of the American Chemical Society.

groups X^1 , X^2 , and X^3 . But branched-chain and secondary or tertiary amines show marked deviations. These deviations were attributed directly to steric strain in the complex.²⁰

The widest applicability of σ^* is found when Equation 2.21 is used. δ is a proportionality constant representative of the susceptibility of the reaction to steric factors. Equation 2.21 states that the free energy of activation of a reaction with a substituted compound relative to that with an unsubstituted compound depends on independent contributions from polar and steric effects.

$$\log \frac{k}{k_0} = \sigma^* \rho^* + \delta E_s \quad (2.21)$$

Physical phenomena other than rates and equilibrium constants can be correlated by Hammett-type relationships. For example, as Figure 2.4 shows, in ^{13}C nuclear magnetic resonance spectroscopy (called Cmr) the chemical shift of the cationic carbon in **17** is correlated by Brown's σ^+ values.²¹ And the C=O

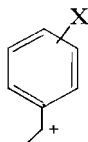

17

infrared stretching frequency in XCOCH_3 correlates well with Taft's σ^* values.²²

²⁰ Taft, *J. Amer. Chem. Soc.*, **75**, 4231 (1953).

²¹ G. A. Olah, R. D. Porter, C. L. Jeuell, and A. M. White, *J. Amer. Chem. Soc.*, **94**, 2044 (1972).

²² D. G. O'Sullivan and P. W. Sadler, *J. Chem. Soc.*, 4144 (1957).

The Hammett and Taft equations are not the only linear free-energy relationships known. We shall encounter others—for example, the Brønsted relations, and the Grunwald-Winstein and Swain-Scott equations later in this book.

2.3 THERMOCHEMISTRY²³

Of importance to the problem of relating structure and reactivity is the thermochemistry of the reaction—that is, the net enthalpy and entropy changes that occur upon the making of new bonds and the breaking of old ones. If we consider the reaction in Equation 2.22, for example, a large positive standard free-energy



change for the reaction, ΔG° , means that it will not take place. On the other hand, if ΔG° is large and negative, the likelihood is that it will occur.²⁴ ΔG° in turn is a function of ΔH° and ΔS° the standard enthalpy and entropy of reaction, respectively (Equation 2.23).

$$\Delta G^\circ = \Delta H^\circ - T\Delta S^\circ \quad (2.23)$$

ΔH° is a function of the heats of formation of the molecules being formed or destroyed, and ΔS° is a function of the entropies of the molecules being formed or destroyed.²⁵ Thus for the reaction in Equation 2.22,

$$\Delta H^\circ = \Delta H_f^\circ (C) + \Delta H_f^\circ (D) - \Delta H_f^\circ (A) - \Delta H_f^\circ (B) \quad (2.24)$$

where $\Delta H_f^\circ (X)$ is the standard heat of formation of X. Similarly,

$$\Delta S^\circ = S^\circ (C) + S^\circ (D) - S^\circ (A) - S^\circ (B) \quad (2.25)$$

where $S^\circ(X)$ is the standard entropy of X.²⁶

Experimental heats of formation are not available for all compounds, but, by Benson's additivity rules, ΔH_f° for any molecule in the gas phase can be calculated. When an accurate experimental value is known, the calculated value is almost always to within a few tenths of a kilocalorie of it, and usually the agreement is even better.

Benson's approach is to determine the ΔH_f° of a molecule by adding together the ΔH_f° 's of the various groups in the molecule. A group is defined as an atom and its ligands. For example, CH_3CH_3 is made up of two identical groups. The central atom in the group is carbon, and the ligands are carbon and three

²³ (a) S. W. Benson, F. R. Cruickshank, D. M. Golden, G. R. Haugen, H. E. O'Neal, A. S. Rodgers, R. Shaw, and R. Walsh, *Chem. Rev.*, **69**, 279 (1969); (b) S. W. Benson, *J. Chem. Educ.*, **42**, 502 (1965).

²⁴ Even if ΔG is a large negative quantity the reaction is, of course, not necessarily fast. The rate depends on the activation barrier that the reactants must overcome to reach the transition state. If the barrier is too high, then no matter how exothermic the reaction is, it cannot take place. However, in the absence of special effects there is usually a qualitative correlation between a reaction's net energy change and its energy of activation. This point is discussed further in Section 2.6.

²⁵ The enthalpy change involved in the formation of one mole of a substance from the elements is called the heat of formation of the substance. The standard heat of formation is the heat of formation when all substances in the reaction are in their standard states.

²⁶ The standard entropy of a substance is its entropy in the state specified based on $S^\circ = 0$ at 0°K.

hydrogens. By Benson's notation this group is designated $C-(H)_3(C)$: the central atom in the group is given first and then the ligand atoms in parentheses. ΔH_f° of each group is calculated from experimentally determined ΔH_f° 's of compounds that contain that group. Then ΔH_f° for a new molecule in the gas phase is obtained by simply adding together the contributions from each group. ΔH_f° for the $C-(H)_3(C)$ group is -10.08 kcal mole $^{-1}$. Thus ethane is calculated to have a ΔH_f° of -20.16 kcal mole $^{-1}$. Propane also has two $C-(H)_3(C)$ groups and a $C-(H)_2(C)_2$ group ($\Delta H_f^\circ = -4.95$ kcal mole $^{-1}$). Therefore ΔH_f° ($CH_3CH_2CH_3$) = $-20.16 - 4.95 = -25.11$ kcal mole $^{-1}$. The experimental ΔH_f° 's for ethane and propane are -20.24 and -24.82 kcal mole $^{-1}$, respectively. Benson's additivity rules do not apply to condensed-phase compounds because of the contribution of solvation and of lattice and hydrogen bond energies to $\Delta H_f^\circ(X)$ in the liquid and solid phases. These contributions are, of course, not additive.

Tables 2.6 through 2.10 (see pp. 75-83) list ΔH_f° values for a large number of groups (see Section 9.1 for additivity data for radicals). In these tables, C_d refers to a carbon that is forming a carbon-carbon double bond. The notation $C_d-(H)_2(C_d)$ is shortened to $C_d-(H)_2$, since all carbon-carbon double bonds are between two sp^2 carbons. Similarly, $C_t-(X)$ refers to a carbon triply bonded to another sp carbon and to an X ligand; $C_B-(X)$ refers to an aromatic ring carbon bonded to two other ring carbons and to a substituent X; and C_a refers to the central carbon of the allenic group $C=C=C$. Other group abbreviations are noted at the end of the appropriate table.

In simply adding together the ΔH_f° 's of all the groups in a molecule to obtain the ΔH_f° of the molecule, we make the assumption that only the nearest neighbors of a bond affect that bond. This is not always true, and we shall now discuss the more important corrections that must be applied if the group additivity scheme for molecular enthalpies is to be used successfully.

Alkanes

In an alkane, gauche interactions may raise the enthalpy content of the molecule. The correction is made as follows. Arrange the alkane in its most stable conformation, sight along each of the nonterminal chain carbon-carbon bonds, and count the number of gauche interactions. Then add $+0.80$ kcal mole $^{-1}$ to the calculated ΔH_f° of the compound for each gauche interaction. Thus, for example, in its most stable conformation *n*-butane (**18**) (and all unbranched open-chain alkanes) has no gauche interactions, and no gauche corrections should be applied. The most stable conformer of 2,3-dimethylbutane (**19**) has two gauche interactions. Thus to obtain the ΔH° for the molecule, we add together the group ΔH_f°

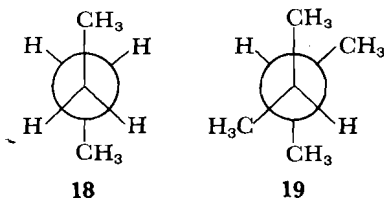

contributions and $+1.60$ for two gauche corrections:

$$\begin{array}{r}
 4 \text{ C}-(\text{H})_3(\text{C}) = -40.32 \\
 2 \text{ C}-(\text{H})(\text{C})_3 = -3.80 \\
 2 \text{ gauche corrections} = +1.60 \\
 \hline
 \Delta H_f^\circ (2,3\text{-dimethylbutane}) = -42.52 \text{ kcal mole}^{-1}
 \end{array}$$

The experimental value is $-42.49 \text{ kcal mole}^{-1}$.

Alkenes

There are two types of corrections that are sometimes necessary in calculating ΔH_f° for alkenes. For a compound that contains a cis double bond, a correction factor of $+1.00$ must be added. (If one or both of the cis substituents is *t*-butyl, the correction factor is larger: see Table 2.6, footnote a.) For example, the ΔH_f° (*cis*-2-butene) is calculated as follows:

$$\begin{array}{r}
 2 \text{ C}-(\text{H}_3)(\text{C}) = -20.16 \\
 2 \text{ C}_d-(\text{H})(\text{C}) = +17.18 \\
 1 \text{ cis correction} = +1.00 \\
 \hline
 \Delta H_f^\circ (\textit{cis}\text{-2-butene}) = -1.98 \text{ kcal mole}^{-1}
 \end{array}$$

The experimental value is $-1.67 \text{ kcal mole}^{-1}$. Note that there is no ΔH_f° for $\text{C}-(\text{H})_3(\text{C}_d)$ in Table 2.6; a methyl bonded to an sp^2 carbon has the same ΔH_f° group value as a methyl bonded to an sp^3 carbon. This assumption was made in the original determination of ΔH_f° group values.

If one side of the double bond is substituted as in **20** or **21**, in which R stands for an alkyl group, an alkene gauche correction of $0.50 \text{ kcal mole}^{-1}$ must be added. Thus the calculated ΔH_f° for 2,3-dimethylbut-1-ene (**22**) is as follows:

$$\begin{array}{r}
 3 \text{ C}-(\text{H})_3(\text{C}) = -30.24 \\
 1 \text{ C}_d-(\text{H})_2 = +6.26 \\
 1 \text{ C}_d-(\text{C})_2 = +10.34 \\
 1 \text{ C}-(\text{C}_d)(\text{C}_2)(\text{H}) = -1.48 \\
 1 \text{ alkene gauche correction} = +0.50 \\
 \hline
 \Delta H_f^\circ (2,3\text{-dimethylbut-1-ene}) = -14.62 \text{ kcal mole}^{-1}
 \end{array}$$

The experimental value is $-15.85 \text{ kcal mole}^{-1}$.

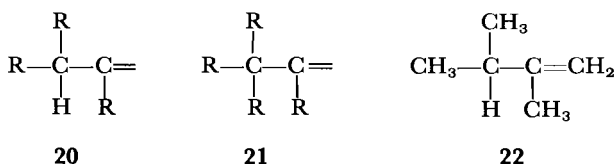

Aromatics

In alkylated benzenes a correction factor of 0.57 must be applied if two substituents are ortho to each other. For example, ΔH_f° of 1,2-dimethylbenzene is calculated as follows:

$$\begin{array}{r}
 4 \text{ C}_B-(\text{H}) = +13.20 \\
 2 \text{ C}_B-(\text{C}) = +11.02 \\
 2 \text{ C}(\text{H})_3(\text{C}) = -20.16 \\
 1 \text{ ortho correction} = +0.57 \\
 \hline
 \Delta H_f^\circ (1,2\text{-dimethylbenzene}) = +4.63 \text{ kcal mole}^{-1}
 \end{array}$$

The experimental value is $+4.54 \text{ kcal mole}^{-1}$.

Note again, $\text{C}-(\text{H})_3(\text{C}_\text{B})$ is assumed to be equal to $\text{C}-(\text{H})_3(\text{C})$.

Cycloalkanes

Correction factors must be applied for ring strain. These are given in Table 2.6. Contributions to ΔH_f° due to gauche interactions between substituents and between substituent and ring must also be taken into account. (Contributions from ring-ring gauche interactions are included in the ring strain.) Thus, for example, in the most stable conformation of *trans*-1,4-dimethylcyclohexane (**23**) both CH_3 's are equatorial and no gauche interactions exist between the methyl and the ring carbons. In *cis*-1,4-dimethylcyclohexane (**24**), one of the methyls must be axial. Sighting along the C_1-C_2 bond, as in **25**, we see that there is one

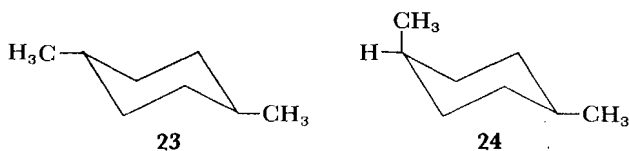

methyl-ring gauche interaction. Likewise, sighting along the C_1-C_6 bond as in **26**, we see another methyl-ring gauche interaction. Thus ΔH_f° (*cis*-1,4-dimethyl-

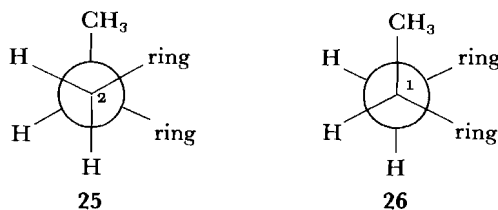

cyclohexane) is calculated as follows:

$$\begin{array}{r}
 2 \text{ C}-(\text{H})_3(\text{C}) = -20.16 \\
 4 \text{ C}-(\text{H})_2(\text{C})_2 = -19.80 \\
 2 \text{ C}-(\text{H})(\text{C})_3 = -3.80 \\
 \text{cyclohexane ring strain} = 0.00 \\
 2 \text{ alkane gauche corrections} = +1.60 \\
 \hline
 \Delta H_f^\circ (\text{cis-1,4-dimethylcyclohexane}) = -42.16 \text{ kcal mole}^{-1}
 \end{array}$$

The experimental value is $-42.22 \text{ kcal mole}^{-1}$. (The calculated value for the *trans* isomer is $(-42.16 - 1.60) = -43.76 \text{ kcal mole}^{-1}$, and the experimental value is $-44.12 \text{ kcal mole}^{-1}$.)

Compounds Containing Heteroatoms

The examples we have discussed have all been hydrocarbons, and all the group enthalpy values have been obtained from Table 2.6. However, by using Tables 2.7–2.10, ΔH_f° for a wide variety of compounds containing N, O, S, and the halogens can be calculated. The procedure is just the same as for the hydrocarbons; all necessary correction factors are given in the tables. In the reference from which Tables 2.6–2.10 are taken, there are tables giving group enthalpy and entropy values for still other types of heteroatoms. There the reader can also find a very

Table 2.6 HYDROCARBON GROUPS

Group	ΔH_{f298}°	S_{298}°
C-(H) ₃ (C)	-10.08	30.41
C-(H) ₂ (C) ₂	-4.95	9.42
C-(H)(C) ₃	-1.90	-12.07
C-(C) ₄	0.50	-35.10
C _d -(H) ₂	6.26	27.61
C _d -(H)(C)	8.59	7.97
C _d -(C) ₂	10.34	-12.7
C _d -(C _d)(H)	6.78	6.38
C _d -(C _d)(C)	8.88	-14.6
[C _d -(C _B)(H)]	6.78	6.4
C _d -(C _B)(C)	8.64	(-14.6)
[C _d -(C _t)(H)]	6.78	6.4
C-(C _d)(C)(H) ₂	-4.76	9.8
C-(C _d) ₂ (H) ₂	-4.29	(10.2)
C-(C _d)(C _B)(H) ₂	-4.29	(10.2)
C-(C _t)(C)(H) ₂	-4.73	10.3
C-(C _B)(C)(H) ₂	-4.86	9.3
C-(C _d)(C) ₂ (H)	-1.48	(-11.7)
C-(C _t)(C) ₂ (H)	-1.72	(-11.2)
C-(C _B)(C) ₂ (H)	-0.98	(-12.2)
C-(C _d)(C) ₃	1.68	(-34.72)
C-(C _B)(C) ₃	2.81	(-35.18)
C _t -(H)	26.93	24.7
C _t -(C)	27.55	6.35
C _t -(C _d)	29.20	(6.43)
C _t -(C _B)	(29.20)	6.43
C _B -(H)	3.30	11.53
C _B -(C)	5.51	-7.69
C _B -(C _d)	5.68	-7.80
[C _B -(C _t)]	5.7	-7.80
C _B -(C _B)	4.96	-8.64
C _a	34.20	6.0
Next-Nearest Neighbor Corrections		
Alkane gauche correction	0.80	
Alkene gauche correction	0.50	
cis Correction	1.00 ^a	^b
ortho Correction	0.57	-1.61
Corrections to be Applied to Ring Compound Estimates		
Ring (σ)	ΔH_{f298}°	S_{298}°
Cyclopropane (6)	27.6	32.1
Methylenecyclopropene	40.9	
Cyclopropene (2)	53.7	33.6
Cyclobutane (8)	26.2	29.8
Cyclobutene (2)	29.8	29.0
Cyclopentane (10)	6.3	27.3
Cyclopentene (2)	5.9	25.8
Cyclopentadiene	6.0	
Cyclohexane (6)	0	18.8
Cyclohexene (2)	1.4	21.5

Table 2.6 (Continued)

Ring (σ)	ΔH_{f298}°	S_{298}°
Cyclohexadiene-1,3	4.8	
Cyclohexadiene-1,4	0.5	
Cycloheptane (1)	6.4	15.9
Cycloheptene	5.4	
Cycloheptadiene-1,3	6.6	
Cycloheptatriene-1,3,5 (1)	4.7	23.7
Cyclooctane (8)	9.9	16.5
<i>cis</i> -Cyclooctene	6.0	
<i>trans</i> -Cyclooctene	15.3	
Cyclooctatriene-1,3,5	8.9	
Cyclooctatetraene	17.1	
Cyclononane	12.8	
<i>cis</i> -Cyclononene	9.9	
<i>trans</i> -Cyclononene	12.8	
Spiropentane (4)	63.5	67.6
Bicyclo[1.1.0]butane (2)	67.0	69.2
Bicyclo[2.1.0]pentane	55.3	
Bicyclo[3.1.0]hexane	32.7	
Bicyclo[4.1.0]heptane	28.9	
Bicyclo[5.1.0]octane	29.6	
Bicyclo[6.1.0]nonane	31.1	

SOURCE: S. W. Benson, F. R. Cruickshank, D. M. Golden, G. R. Haugen, H. E. O'Neal, A. S. Rodgers, R. Shaw, and R. Walsh, *Chem. Rev.*, **69**, 279 (1969). Reproduced by permission of the American Chemical Society.

^a When one of the groups is *t*-butyl, *cis* correction = 4.00; when both are *t*-butyl, *cis* correction = ~10.00; and when there are two corrections around one double bond, the total correction is 3.00.

^b + 1.2 for but-2-ene, 0 for all other 2-enes, and -0.6 for 3-enes.

Table 2.7 OXYGEN-CONTAINING GROUPS

Group	ΔH_f°	S°
CO-(CO)(C)	-29.2	
CO-(O)(C _d)	-33.5	
CO-(O)(C _B)	-46.0	
CO-(O)(C)	-33.4	14.78
[CO-(O)(H)]	-29.5	34.93
CO-(C _d)(H)	-31.7	
CO-(C _B) ₂	-39.1	
CO-(C _B)(C)	-37.6	
[CO-(C _B)(H)]	-31.7	
CO-(C) ₂	-31.5	15.01
CO-(C)(H)	-29.6	34.93
CO-(H) ₂	-27.7	53.67
O-(CO) ₂	-50.9	
O-(CO)(O)	-19.0	
[O-(CO)(C _d)]	-41.3	
O-(CO)(C)	-41.3	8.39
O-(CO)(H)	-60.3	24.52
O-(O)(O)	(19.0)	(9.4)
O-(O)(C)	(-4.5)	(9.4)

Table 2.7 (Continued)









Group	ΔH_f°	S°
O-(O)(H)	-16.27	27.85
O-(C _d) ₂	-32.8	
O-(C _d)(C)	-31.3	
O-(C _B) ₂	-19.3	
O-(C _B)(C)	-22.6	
[O-(C _B)(H)]	-37.9	29.1
O-(C) ₂	-23.7	8.68
O-(C)(H)	-37.88	29.07
C _d -(CO)(O)	6.3	
C _d -(CO)(C)	9.4	
[C _d -(CO)(H)]	7.7	
[C _d -(O)(C _d)]	8.9	
[C _d -(O)(C)]	10.3	
[C _d -(O)(H)]	8.6	
C _B -(CO)	9.7	
C _B -(O)	-1.8	-10.2
C-(CO) ₂ (H) ₂	-7.2	
C-(CO)(C) ₃	1.58	
C-(CO)(C) ₂ (H)	-1.83 ^t	-12.0
C-(CO)(C)(H) ₂	-5.0	9.6
[C-(CO)(H) ₃]	-10.08	30.41
C-(O) ₂ (C) ₂	-16.8	
C-(O) ₂ (C)(H)	-17.2	
C-(O) ₂ (H) ₂	-17.7	
C-(O)(C _B)(H) ₂	-6.6	9.7
C-(O)(C _d)(H) ₂	-6.9	
C-(O)(C) ₃	-6.60	-33.56
C-(O)(C) ₂ (H)	-7.00	-11.00
C-(O)(C)(H) ₂	-8.5	10.3
[C-(O)(H) ₃]	-10.08	30.41
Strain		
Ether oxygen <i>gauche</i>	0.3	
Ditertiary ethers	8.4	
	27.6	31.4
	26.4	27.7
	6.7	
	2.2	
	3.5	

Table 2.7 (Continued)

Group	ΔH_f°	S°
	5.4	
	3.4	
	-6.2	
	2.5	
	6.0	
	3.4	
	1.1	
	1.4	
	4.6	

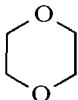
SOURCE: S. W. Benson, F. R. Cruickshank, D. M. Golden, G. R. Haugen, H. E. O'Neal, A. S. Rodgers, R. Shaw, and R. Walsh, *Chem. Rev.*, **69**, 279 (1969). Reproduced by permission of the American Chemical Society.

Table 2.8 NITROGEN-CONTAINING GROUPS^{a-e}

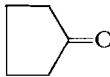
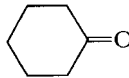
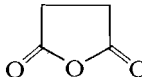
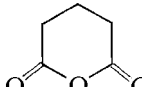
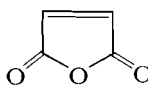
Group	ΔH_f°	S°
[C-(N)(H) ₃]	-10.08	30.41
C-(N)(C)(H) ₂	-6.6	(9.8) ^d
C-(N)(C) ₂ (H)	-5.2	(-11.7) ^d
C-(N)(C) ₃	-3.2	(-34.1) ^d
C-(N _A)(C)(H) ₂	(-5.5)	(9.8)

Table 2.8 (Continued)

Group	ΔH_f°	S°
C-(N _A)(C) ₂ (H)	(-3.3)	(-11.7)
C-(N _A)(C) ₃	(-1.9)	(-34.7)
N-(C)(H) ₂	4.8	29.71
N-(C) ₂ (H)	15.4	8.94
N-(C) ₃	24.4	-13.46
N-(N)(H) ₂	11.4	29.13
N-(N)(C)(H)	20.9	9.61
N-(N)(C) ₂	29.2	-13.80
N-(N)(C _B)(H)	22.1	
N _I -(H)		
N _I -(C)	21.3	
N _I -(C _B) ^e	16.7	
N _A -(H)	25.1	26.8
N _A -(C)	(32.5)	(8.0)
N-(C _B)(H) ₂	4.8	29.71
N-(C _B)(C)(H)	14.9	
N-(C _B)(C) ₂	26.2	
N-(C _B) ₂ (H)	16.3	
C _B -(N)	-0.5	-9.69
N _A -(N)	23.0	
CO-(N)(H)	-29.6	34.93
CO-(N)(C)	-32.8	16.2
N-(CO)(H) ₂	-14.9	24.69
N-(CO)(C)(H)	-4.4	(3.9) ^d
N-(CO)(C) ₂		
N-(CO)(C _B)(H)	+0.4	
N-(CO) ₂ (H)	-18.5	
N-(CO) ₂ (C)	-5.9	
N-(CO) ₂ (C _B)	-0.5	
C-(CN)(C)(H) ₂	22.5	40.20
C-(CN)(C) ₂ (H)	25.8	19.80
C-(CN)(C) ₂		-2.80
C-(CN) ₂ (C) ₂		28.40
C _d -(CN)(H)	37.4	36.58
C _d -(CN) ₂	84.1	
C _d -(NO ₂)(H)		44.4
C _B -(CN)	35.8	20.50
C _r -(CN)	63.8	35.40
C-(NO ₂)(C)(H) ₂	-15.1	(48.4) ^d
C-(NO ₂)(C) ₂ (H)	-15.8	(26.9) ^d
C-(NO) ₂ (C) ₂		(3.9) ^d
C-(NO ₂) ₂ (C)(H)	-14.9	
O-(NO)(C)	-5.9	41.9
O-(NO) ₂ (C)	-19.4	48.50

Corrections to be Applied to Ring Compound Estimates

Ethylene imine





27.7

(31.6)^a

Azetidine

(26.2)^d(29.3)^a

Table 2.8 (Continued)

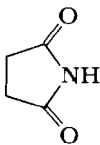
Group	ΔH_f°	S°
Pyrrolidine 	6.8	26.7
Piperidine 	1.0	
	3.4	
	8.5	

SOURCE: S. W. Benson, F. R. Cruickshank, D. M. Golden, G. R. Haugen, H. E. O'Neal, A. S. Rodgers, R. Shaw, and R. Walsh, *Chem. Rev.*, **69**, 279 (1969). Reproduced by permission of the American Chemical Society.

^a N_I = double-bonded nitrogen in imines; $N_I-(C_B)$ = pyridine N. N_A = double-bonded nitrogen in azo compounds.

^b No cis corrections applied to imines or azo compounds.

^c gauche corrections of $+0.8$ kcal mole⁻¹ to ΔH_f° applied just as for hydrocarbons.

^d Estimates.

^e For ortho or para substitution in pyridine add -1.5 kcal mole⁻¹ per group.

Table 2.9 HALOGEN-CONTAINING GROUPS

Group	ΔH_f°	S°
$C_d-(F)_2$	-77.5	37.3
$C_d-(Cl)_2$	-1.8	42.1
$C_d-(Br)_2$		47.6
$C_d-(F)(Cl)$		39.8
$C_d-(F)(Br)$		42.5
$C_d-(Cl)(Br)$		45.1
$C_d-(F)(H)$	-37.6	32.8
$C_d-(Cl)(H)$	2.1	35.4
$C_d-(Br)(H)$	12.7	38.3
$C_d-(I)(H)$	24.5	40.5
$C_t-(Cl)$		33.4
$C_t-(Br)$		36.1
$C_t-(I)$		37.9
$C_B-(F)$	-42.8	16.1

Table 2.9 (Continued)

Group	ΔH_f°	S°
$C_B-(Cl)$	-3.8	18.9
$C_B-(Br)$	10.7	21.6
$C_B-(I)$	24.0	23.7
$C-(C_B)(F)_3$	-162.7	42.8
$C-(C_B)(Br)(H)_2$	-6.9	
$C-(C_B)(I)(H)_2$	8.4	
$C-(F)_3(C)$	-158.4	42.5
$C-(F)_2(H)(C)$	(-109.3)	39.1
$C-(F)(H)_2(C)$	-51.8	35.4
$C-(F)_2(C)_2$	-97.0	17.8
$C-(F)(H)(C)_2$	-48.4	(14.0)
$C-(F)(C)_3$	-43.9	
$C-(F)_2(Cl)(C)$	-106.3	40.5
$C-(Cl)_3(C)$	-20.7	50.4
$C-(Cl)_2(H)(C)$	(-18.9)	43.7
$C-(Cl)(H)_2(C)$	-15.6	37.8
$C-(Cl)_2(C)_2$	(-19.5)	
$C-(Cl)(H)(C)_2$	-12.8	17.6
$C-(Cl)(C)_3$	-12.8	-5.4
$C-(Br)_3(C)$		55.7
$C-(Br)(H)_2(C)$	-5.4	40.8
$C-(Br)(H)(C)_2$	-3.4	
$C-(Br)(C)_3$	-0.4	-2.0
$C-(I)(H)_2(C)$	7.95	42.5
$C-(I)(H)(C)_2$	10.7	22.2
$C-(I)(C)_3$	13.0	(0.0)
$C-(Cl)(Br)(H)(C)$		45.7
$N-(F)_2(C)$	-7.8	
$C-(Cl)(C)(O)(H)$	-22.3	15.4
Corrections for Next-Nearest Neighbors		
<i>ortho</i> (F)(F)	5.0	0
<i>ortho</i> (Cl)(Cl)	2.2	
<i>ortho</i> (alk)(halogen)	0.6	
<i>cis</i> (halogen) (halogen)	(0)	
<i>cis</i> (halogen)(alk)	(0)	
<i>gauche</i> (halogen)(alk)	0.0	0
<i>gauche</i> (halogen)		
(exclusive of F)	1.0	
<i>gauche</i> (F) (halogen)	0.0	

SOURCE: S. W. Benson, F. R. Cruickshank, D. M. Golden, G. R. Haugen, H. E. O'Neal, A. S. Rodgers, R. Shaw, and R. Walsh, *Chem. Rev.*, **69**, 279 (1969). Reproduced by permission of the American Chemical Society.

Table 2.10 SULFUR-CONTAINING GROUPS

Group	ΔH_f°	S°
$[C-(H)_3(S)]$	-10.08	30.41
$C-(C)(H)_2(S)$	-5.65	9.88
$C-(C)_2(H)(S)$	-2.64	-11.32
$C-(C)_3(S)$	-0.55	-34.41
$C-(C_B)(H)_2(S)$	-4.73	
$C-(C_d)(H)_2(S)$	-6.45	

Table 2.10 (Continued)









Group	ΔH_f°	S°
[C _B -(S)]	-1.8	10.20
[C _d -(H)(S)]	8.56	8.0
C _d -(C)(S)	10.93	-12.41
S-(C)(H)	4.62	32.73
S-(C _B)(H)	11.96	12.66
S-(C) ₂	11.51	13.15
S-(C)(C _d)	9.97	
S-(C _d) ₂	-4.54	16.48
S-(C _B)(C)	19.16	
S-(C _B) ₂	25.90	
S-(S)(C)	7.05	12.37
S-(S)(C _B)	14.5	
S-(S) ₂	3.04	13.36
[C-(SO)(H) ₃]	-10.08	30.41
C-(C)(SO)(H) ₂	-7.72	
C-(C) ₃ (SO)	-3.05	
C-(C _d)(SO)(H) ₂	-7.35	
[C _B -(SO)]	2.3	
SO-(C) ₂	-14.41	18.10
SO-(C _B) ₂	-12.0	
[C-(SO ₂)(H) ₃]	-10.08	30.41
C-(C)(SO ₂)(H) ₂	-7.68	
C-(C) ₂ (SO ₂)(H)	-2.62	
C-(C) ₃ (SO ₂)	-0.61	
C-(C _d)(SO ₂)(H) ₂	-7.14	
C-(C _B)(SO ₂)(H) ₂	-5.54	
[C _B -(SO ₂)]	2.3	
C _d -(H)(SO ₂)	12.53	
C _d -(C)(SO ₂)	14.47	
SO ₂ -(C) ₂	-69.74	20.90
SO ₂ -(C)(C _B)	-72.29	
SO ₂ -(C _B) ₂	-68.58	
[SO ₂ -(C _d)(C _B)]	-68.58	
SO ₂ -(C _d) ₂	-73.58	
SO ₂ -(SO ₂)(C _B)	-76.25	
[CO-(S)(C)]	-31.56	15.43
S-(H)(CO)	-1.41	31.20
C-(S)(F) ₃		38.9
S-(C)(CN)	37.18	41.06
[CS-(N) ₂]	-31.56	15.43
N-(CS)(H) ₂	12.78	29.19
[S-(S)(N)]	-4.90	
N-(S)(C) ₂	29.9	
[SO-(N) ₃]	-31.56	
N-(SO)(C) ₂	16.0	
[SO ₂ -(N) ₂]	-31.56	
N-(SO ₂)(C) ₂	-20.4	
Organosulfur Compounds Ring Corrections		
Ring (σ)	ΔH_f°	S°
(a)  (2)	17.7	29.47

Table 2.10 (Continued)

Ring (σ)	ΔH_f°	S°
(b)  (2)	19.37	27.18
(c)  (2)	1.73	23.56
(d)  (2)	0	17.46
(e)  (2)	3.89	
(f)  (2)	5.07	
(g)  (1)	5.07	
(h)  (2)	5.74	
(i)  (2)	1.73	

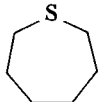
SOURCE: S. W. Benson, F. R. Cruickshank, D. M. Golden, G. R. Haugen, H. E. O'Neal, A. S. Rodgers, R. Shaw, and R. Walsh, *Chem. Rev.*, **69**, 279 (1969). Reproduced by permission of the American Chemical Society.

large number of compounds listed with their estimated and observed enthalpies and entropies of formation.

Entropy

In this section we have so far emphasized only the ΔH° and ΔH_f° of the reaction components. This is because the entropy change in many reactions is small and can often be neglected in comparison to the enthalpy change. When S° 's are of interest, they too can be estimated by Benson's additivity rules. In order to calculate S° for a molecule, the group S° contributions are added together just as they are for ΔH_f° , but now a correction for the overall rotational symmetry (σ) of the molecule must be added. The correction is $-R \ln \sigma$, where σ is the product

of all the rotational degeneracies of the molecule. For example, in acetone the molecule as a whole has a twofold axis of symmetry (this is called the external axis). Each of the two methyl groups has a threefold axis of symmetry (called internal axes). Thus for acetone σ is $2 \times 3 \times 3$ and S° is calculated:

$$\begin{array}{r} 2 \text{ C-(H)}_3\text{(C)} = +60.82 \\ 1 \text{ CO-(C)}_2 = +15.01 \\ -R \ln \sigma = -R \ln 18 = -5.74 \\ \hline S^\circ (\text{acetone}) = +70.09 \text{ cal mole}^{-1} \text{ }^\circ\text{K}^{-1} \end{array}$$

The experimental value is $70.5 \text{ cal mole}^{-1} \text{ }^\circ\text{K}^{-1}$.

If a molecule is optically active, $R \ln n$ must be added to its entropy estimate, where n is the total number of stereoisomers of equal energy.

Guide to the Use of the Group Tables (Tables 2.6–2.10)

1. ΔH_f° and S° are the heat of formation and entropy, respectively, of a group when that group is in a molecule in its standard state of hypothetical ideal gas at 1 atm pressure and 25°C . All values of ΔH_f° are in kilocalories per mole, and all values of S° are in calories per mole per degree (K). For a simple method of converting S° and ΔH_f° to other temperatures, see Benson et al., *Chem. Rev.*, **69** (1969), p. 313.

2. In order to assign values to all groups, some groups have had to be assigned arbitrary values. Groups in brackets in Tables 2.6–2.10 are those groups. Estimated values obtained from a single compound are in parentheses.

2.4 SOLUTIONS²⁷

The thermochemical additivity scheme outlined in the previous section is based on gas-phase data. Since most organic reactions are carried out in solution, it would be most useful to be able to understand and predict the thermochemical changes that molecules, ions, and transition states undergo when dissolved in various solvents. Our knowledge of the structure of liquids and of their interactions on the molecular level with solutes is still too incomplete to permit more than a very rough qualitative answer to this problem. We shall proceed by discussing briefly the influence on solvent properties of the most important parameters characterizing liquids.

Dielectric Constant

The first property of solvents to be considered is the dielectric constant, ϵ . The dielectric constant of a substance measures the reduction of the strength of the electric field surrounding a charged particle immersed in the substance, compared to the field strength around the same particle in a vacuum. The dielectric constant is a macroscopic property; that is, its definition and measurement

²⁷ The following discussions of solvent effects will provide further information: (a) T. C. Waddington, *Non-Aqueous Solvents*, Thomas-Nelson, London, 1969; (b) E. M. Kosower, *An Introduction to Physical Organic Chemistry*, Wiley, New York, 1968, p. 259; (c) T. C. Waddington, Ed., *Non-Aqueous Solvent Systems*, Academic, London, 1965; (d) E. S. Amis and J. F. Hinton, *Solvent Effects on Chemical Phenomena*, Academic, New York, 1973; (e) J. F. Coetzee and C. D. Ritchie, Eds., *Solute-Solvent Interactions*, Marcel Dekker, New York, 1969; (f) A. J. Parker, *Chem. Rev.*, **69**, 1 (1969).

assume that the substance of interest is continuous, with no microscopic structure. Electrostatic attractions and repulsions between ions are smaller the higher the dielectric constant, and ions of opposite charge therefore have a greater tendency to dissociate when the dielectric constant is larger. Table 2.11 lists dielectric constants for some common solvents.

The dielectric constant gives only a rough guide to solvent properties, and does not correlate well with measured effects of solvents on reaction rates. It is nevertheless useful for making a division of solvents into two broad categories: polar and nonpolar. In nonpolar solvents, $\epsilon < \sim 15$, ionic substances will be highly associated. Indeed, they will be very sparingly soluble in most of these solvents except as, for example in the case of acetic acid, when hydrogen bonding is available, and even then solubility is low. Ionic substances are more soluble in solvents of high dielectric constant, and the ions are dissociated.

Dipole Moment and Polarizability

In order to gain a better understanding of solution phenomena, it is necessary to evaluate solvent properties on the molecular level. Here the most important properties are the dipole moment, μ , and the molecular polarizability. Values are listed in Table 2.11.

The dipole moment measures the internal charge separation of the molecules and is important in evaluating how the solvent molecules will cluster around a

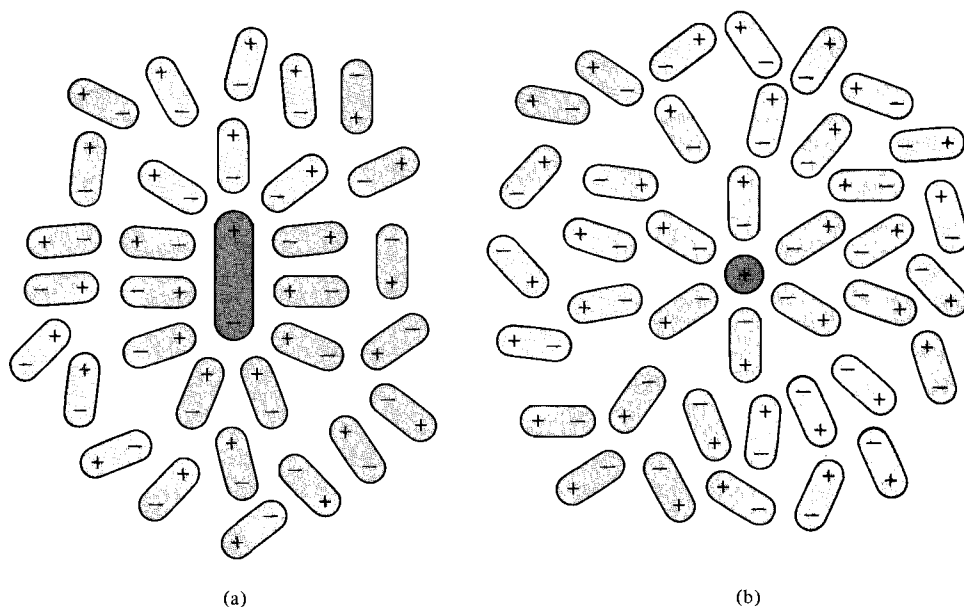
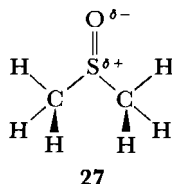

Figure 2.5 Ordering of solvent molecules around (a) a dipolar solute molecule and (b) a solute positive ion. The orientation will be most pronounced in the innermost shell of solvent molecules and will become increasingly random as the distance from the solute particle increases. The strength of the interaction will depend on the molecular sizes and shapes and on the magnitudes of the dipole moments of both solutes and solvent particles.

solute particle that itself has a dipole moment or a net charge. The solvent dipoles will tend to orient themselves around the solute in the manner indicated in Figure 2.5. The first solvent layer will be the most highly ordered, with randomness increasing as the influence of the solute particle decreases with increasing distance. A smaller solute ion will generate a more intense electric field than will a large one, and so will have a stronger and more far-ranging capacity to orient solvent dipoles around it. In the solvent molecule itself, one end of the dipole may be exposed while the other end is buried inside the bulk of the molecule. In dimethylsulfoxide, for instance, the negative oxygen end of the dipole is exposed (27), whereas the positive end is not; this solvent interacts much more strongly





with the cations of an ionic solute than with the anions. Formation of solvation layers around the solute particles will be accompanied by heat evolution (negative ΔH) and an increase in order (negative ΔS).

Table 2.11 DIELECTRIC CONSTANT, DIPOLE MOMENT, AND MOLECULAR POLARIZABILITY FOR SELECTED SOLVENTS^a

Solvent	ϵ^b	μ (debyes)	Polarizability ^c ($\text{cm}^3 \times 10^{24}$)
Nonpolar Protic^d			
	6.15 ^e	1.68	5.16
	12.47	1.66	8.82
	13.3	1.55	12.46
	15.0	1.86	11.33
	9.78 ^f	1.45	11.11 ^g
Nonpolar Aprotic			
	2.24 ^e	0	10.49
	12.4 ^h	2.37	9.55
$n\text{-C}_6\text{H}_{14}$	1.88	0.085	11.87
<i>cyclo</i> - C_6H_{12}	2.02 ^e	—	10.99
$\phi\text{-H}$	2.28	0	10.39
$(\text{C}_2\text{H}_5)_2\text{O}$	4.34 ^e	1.15	8.92

Table 2.11 (Continued)

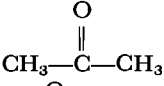
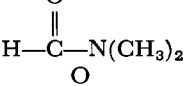
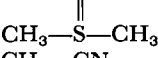
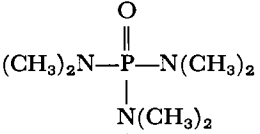
Solvent	ϵ^b	μ (debyes)	Polarizability ^c ($\text{cm}^3 \times 10^{24}$)
	2.21	0.45	8.60
$\text{CH}_3\text{O}-\text{CH}_2\text{CH}_2-\text{OCH}_3$	7.20	1.71	9.56
$\text{CH}_3\text{O}-(\text{CH}_2\text{CH}_2-\text{O})_2\text{CH}_3$	—	1.97	13.79
Dipolar Protic			
H_2O^k	78.5	1.84	1.48
HCOOH	58.5 ^l	1.82	3.39
CH_3OH	32.70	2.87	3.26
$\text{C}_2\text{H}_5\text{OH}$	24.55	1.66	5.13
	111.0 ^e	3.37	4.22
Dipolar Aprotic			
	20.70	2.69	6.41
	36.71	3.86	7.90
	46.68	3.9	7.99
CH_3-CN	37.5 ^e	3.44	4.41
CH_3NO_2	35.87 ^j	3.56	4.95
	30. ^e	5.54	18.90 ^e
(hexamethylphosphoramide)			

^a With the exception of the polarizabilities, data are from J. A. Riddick and W. B. Bunger, *Organic Solvents*, 3rd ed., Vol. II of A. Weissberger, Ed., *Techniques of Chemistry*, Wiley-Interscience, New York, 1970. Other physical constants may also be found in this source.

^b $T = 25^\circ\text{C}$ except where noted.

^c Calculated from the refractive index n according to the formula

$$\text{Polarizability} = \frac{n^2 - 1}{n^2 + 2} \frac{M}{d} \frac{3}{4\pi N_0}$$

where M = molecular weight; d = density; and N_0 = Avagadro's number. See E. A. Moelwyn-Hughes, *Physical Chemistry*, 2nd ed., Pergamon Press, Elmsford, N.Y., 1961, p. 382. $T = 25^\circ\text{C}$ except where noted.

^d The dividing line between nonpolar and dipolar solvents is arbitrarily set at $\epsilon = 15$. See A. J. Parker, *Chem. Rev.*, **69**, 1 (1969).

^e $T = 20^\circ\text{C}$.

^f $T = 60^\circ\text{C}$.

^g $T = 45^\circ\text{C}$.

^h $T = 21^\circ\text{C}$.

ⁱ $T = 16^\circ\text{C}$.

^j $T = 30^\circ\text{C}$.

^k Data from A. J. Parker, *Chem. Rev.*, **69**, 1 (1969).

Polarizability is a measure of the ease with which the electrons of a molecule are distorted. It is the basis for evaluating the nonspecific attraction forces (London dispersion forces) that arise when two molecules approach each other. Each molecule distorts the electron cloud of the other and thereby induces an instantaneous dipole. The induced dipoles then attract each other. Dispersion forces are weak and are most important for the nonpolar solvents where other solvation forces are absent. They do, nevertheless, become stronger the larger the electron cloud, and they may also become important for some of the higher-molecular-weight polar solvents. Large solute particles such as iodide ion interact by this mechanism more strongly than do small ones such as fluoride ion. Furthermore, solvent polarizability may influence rates of certain types of reactions because transition states may be of different polarizability from reactants and so be differently solvated.

Hydrogen Bonding

Hydrogen bonding probably has a greater influence on solvent-solute interactions than any other single solvent property. Solvents that have O—H or N—H bonds are hydrogen bond donors, whereas most hydrogens bound to carbon are too weakly acidic to form hydrogen bonds. Any site with unshared electrons is a potential hydrogen bond acceptor, although the more strongly basic and the less polarizable the acceptor site the stronger will be the hydrogen bond.²⁸

We class as *protic* those solvents that are good hydrogen bond donors and as *aprotic* those that are not.²⁹ Since the protic solvents have hydrogen bound to oxygen or nitrogen, they are also good hydrogen bond acceptors; the aprotic solvents may or may not be hydrogen bond acceptors.

Because negative ions have extra electrons, they are hydrogen bond acceptors and can be expected to be strongly solvated by protic solvents. Many neutral molecules also contain basic sites that will act as acceptors. Aprotic solvents, on the other hand, will be less able to solvate negative ions and basic molecules. Positive ions will ordinarily be solvated by dipolar interactions with the polar solvents, whether protic or not. Protic solutes will ordinarily interact by hydrogen bonding with protic solvents.

Solvent Structure

Dipole-dipole interactions between solvent molecules, and, in the case of protic solvents, intermolecular hydrogen bonding, lead to a certain amount of structure in pure solvents. Water, which is both an excellent hydrogen bond donor and acceptor, is perhaps the foremost example. It exhibits structure very like that in the ice crystal over rather extended regions, although of course the structure is a dynamic one in the sense that molecules are continually leaving and joining the structured regions.

When a solute is introduced into a solvent, the structure of the solvent will be disturbed in some way, and it will be the energy and entropy changes that accompany this disturbance, together with those arising from the new interactions

²⁸ For further discussion of these concepts see Section 3.5.

²⁹ Note that aprotic solvents may nevertheless contain hydrogen.

of solvent with solute, that determine the thermodynamic properties of the solution. Thermodynamic measurements yield the total enthalpies and entropies of solution, or of transfer of a solute from one solvent to another, but do not reveal the origin of the changes. Some of the data are difficult to interpret, and no really satisfactory theory is available. For example, negative entropies of solution show that there is a net *increase* in the amount of ordering upon dissolving nonpolar solutes in water, whereas exothermic enthalpies indicate favorable energy changes. These results are just the opposite of what one might have predicted by arguing that the main effect of introducing a nonpolar molecule would be to break up the water structure and hence to raise the energy while decreasing order by breaking hydrogen bonds. Ions (except for very small ones such as Li^+) cause a net *decrease* in the amount of structure, even though there must be a considerable amount of organization of water molecules around the ion.³⁰ These phenomena clearly require further investigation.

Protic and Dipolar Aprotic Solvents

It is useful to classify the more polar solvents ($\epsilon > \sim 15$) into two categories depending on whether they are protic or aprotic. It is found that reactions involving bases, as for example $\text{S}_{\text{N}}2$ substitutions (Chapter 4), E_2 eliminations (Chapter 7), and substitutions at carbonyl groups (Chapter 8), proceed much faster in dipolar aprotic than in protic solvents, typically by factors of three to four powers of ten and sometimes by as much as six powers of ten.³¹

The phenomenon can be explained by considering the various aspects of solvent-solute interactions that we have discussed. The reactions typically take place through the attack of an anionic reagent on a neutral molecule. The protic solvents solvate the anions strongly by hydrogen bonding, whereas the aprotic solvents cannot. Furthermore, the aprotic dipolar solvents, although they ordinarily have large dipole moments, are relatively ineffective at solvating the negative ions by dipole interactions because the positive ends of the dipoles are usually buried in the middle of the molecule. The dipolar aprotic solvents, on the other hand, are effective at solvating the positive counter ion because the negative end of the dipole is ordinarily an exposed oxygen or nitrogen atom. The result of these differences is that the anions are more free of encumbrance by solvation in the dipolar aprotic solvents, and less energy is required to clear solvent molecules out of the way so that reaction can occur.

Measures of Solvating Ability

Because solvent-solute interactions are so complex, relatively little progress has been made in understanding them quantitatively from first principles. A useful, if somewhat unsatisfying approach, is to assign parameters characterizing solvating ability on the basis of the measurement of some chemical or physical property that, one hopes, is closely related at the molecular level to the phenomenon under study.

One approach is to take the rates of a particular standard reaction in various

³⁰ E. A. Arnett and D. R. McKelvey, in *Solute-Solvent Interactions*, Coetzee and Ritchie, Eds., p. 349.

³¹ See note 27(f), p. 84.

solvents as characterizing the solvents, and then to see whether these parameters will yield a linear correlation with rates of some closely related reaction in those same solvents. This method is the basis of the Grunwald-Winstein = **Y** scale, which we shall discuss further in Chapter 5. Another method is to measure the energy change of an electronic transition in a reference molecule between two states that differ in their ability to interact with solvent. Kosower's **Z** scale is of this kind.³² These solvent scales are linear free-energy relationships entirely analogous to those discussed in Section 2.2. They give only limited insight into the molecular basis of solvation, but are particularly useful in assessing reaction mechanisms.

2.5 KINETICS

The study of reaction rates has two purposes: first, to compare the form of the rate equation with predictions of the various mechanisms under consideration, and second, to measure numerical values of rate constants and to interpret them in terms of elementary reaction steps.

The Rate Equation

The interpretation of kinetic data begins with a hypothetical sequence of *elementary reaction steps*, each characterized by two *microscopic rate constants*, one for the forward and one for the reverse reaction. From this proposed mechanism a rate equation is derived, predicting the dependence of the observed reaction rate on concentrations and on microscopic rate constants, and its form is tested against the observations. If the form of the rate equation meets the test of experiment, it may be possible to derive from the data numerical values for the microscopic rate constants of the proposed elementary reaction steps. While inconsistency is clear grounds for modifying or rejecting a mechanistic hypothesis, agreement does not prove the proposed mechanism correct.

The unimolecular reaction Suppose we postulate that a given reaction consists of the single step



The rate of disappearance of A, $-d[A]/dt$, is given by Equation 2.27 and the rate of disappearance of B, $-d[B]/dt$, by Equation 2.28.³³

$$-\frac{d[A]}{dt} = k_1[A] - k_{-1}[B] \quad (2.27)$$

$$-\frac{d[B]}{dt} = -k_1[A] + k_{-1}[B] \quad (2.28)$$

For the rate equation to compare with experiment we could choose either of these, depending upon whether the time dependence of [A] or of [B] is more convenient to measure.

³² Kosower, *An Introduction to Physical Organic Chemistry*, p. 293.

³³ It is merely a matter of convenience whether rates are expressed as rates of appearance, $+d[X]/dt$, or as rates of disappearance, $-d[X]/dt$, of a reactant or product.

Equations 2.27 and 2.28 constitute a mathematical model for the dynamics of the reaction of interest. Note that the predicted rates of change of the constituent concentrations are given by sums of terms, each of which contains only the first power of one of the concentrations. The predicted kinetics is therefore said to be first-order. In this example of a single-step mechanism, the origin of the prediction of first-order kinetics is that A changes to B and B to A without the intervention of any third substance. An elementary reaction step in which a single substance changes to some other substance or substances without the intervention of anything else is said to be a *unimolecular* step. It is essential to maintain a distinction between *molecularity*, a concept applying to the nature of a single step in the mechanistic hypothesis, and kinetic *order*, a term describing the experimentally determined dependence of rate of the reaction (which may be a complex series of steps) on concentration. The mechanistic chemist uses kinetic order along with other tools to try to establish a probable sequence of steps and the molecularity of each, but the relationship between kinetic order and molecularity is often not as simple as in the example of Equation 2.26.

Rate equations like 2.27 and 2.28, obtained from a proposed set of elementary reaction steps, are differential equations. Although for our purposes in this book we shall require only differential rate equations, it is usually more convenient in interpreting raw experimental data to have the equations in integrated form. Methods of integration of rate equations can be found in the literature.³⁴

Macroscopic and microscopic rate constants Except in the simplest mechanisms, the observed rate constant for the reaction as a whole will not correspond to any one of the microscopic rate constants k characterizing the individual steps. The term *observed rate constant*, k_{obs} , is used for the overall rate constant for the complete reaction.

Simplification of kinetic equations It is a common practice in writing mechanisms to simplify them by making various assumptions about the relative size of rate constants. Such assumptions are justified on the basis of the same chemical intuition that led to the mechanistic proposal in the first place, and are properly regarded as part of the mechanism. Suppose, for example, that in Equation 2.26 we had reason to believe that the reaction of B to A was sufficiently slow that it would not occur to a measurable extent over the time scale being used to study the kinetics. We might then feel justified in omitting the k_{-1} step altogether and writing Equations 2.29 and 2.30:



$$-\frac{d[A]}{dt} = k_1[A] \quad (2.30)$$

The predicted kinetics is still first-order, but the equation is simpler. Now the observed rate constant is identical with the microscopic constant k_1 .

³⁴ See for example (a) K. J. Laidler, *Chemical Kinetics*, 2nd ed., McGraw-Hill, New York, 1965, chap. 1; (b) G. M. Fleck, *Chemical Reaction Mechanisms*, Holt, Rinehart, and Winston, New York, 1971.

The principle of microscopic reversibility, required by the laws of thermodynamics, specifies that there must be a reverse for every microscopic process. It is therefore strictly speaking incorrect to omit reverse steps, and doing so is justified only when the omitted reverse step is occurring so slowly as to have no observable effect on the reaction during the time it will be under observation.

The bimolecular reaction We move next to a slightly more complex case, a single step with more than one reactant (Equation 2.31). The rate equation is 2.32; if the reverse reaction may be safely omitted, these equations sim-



$$-\frac{d[A]}{dt} = k_1[A][B] - k_{-1}[C][D] \quad (2.32)$$

ply to 2.33 and 2.34. The reaction 2.33 is *bimolecular*: Interaction of A with B is required. The predicted kinetic behavior (Equation 2.34) is *second-order* overall,

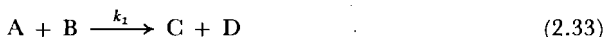

$$-\frac{d[A]}{dt} = k_1[A][B] \quad (2.34)$$

first-order in [A] and first-order in [B], and the observed second-order rate constant, k_{obs} , is equal to the microscopic constant k_1 .

The pseudo first-order reaction It may be possible in a reaction in which two substances take part to arrange that one concentration is effectively constant during the kinetic experiment. The most obvious example is when one reactant can be buffered, as in an acid-catalyzed process, but it can also be accomplished simply by having reagent B present in large excess over A, so that the proportional change in [B] is very small while the proportional change in [A] is large. Then the constant concentration becomes effectively part of the rate constant and the rate equation 2.34 reduces to

$$-\frac{d[A]}{dt} = k_{\text{obs}}[A] \quad (2.35)$$

$$k_{\text{obs}} = k_1[B] \quad [B] \text{ constant} \quad (2.36)$$

The predicted kinetic behavior under these circumstances is therefore first-order, with a first-order k_{obs} related to the microscopic second-order constant k_1 by Equation 2.36. Such reactions are said to follow *pseudo first-order* kinetics.

Multistep Reactions

Kinetic treatment is more difficult for mechanisms with more than one elementary step. Here we shall restrict the discussion to two commonly encountered special cases. Let us look first at a simple two-step process (Equations 2.37 and 2.38) in which we are justified by the chemistry in ignoring reverse reactions.



Suppose that the second step is much faster than the first. We would expect on the basis of an intuitive approach that the overall reaction rate would then depend only on k_1 , because every B molecule that is formed in the initial slow step goes instantly to C. We would say under these circumstances that the first step is rate-determining.

The stationary-state approximation Kinetic analysis of Equations 2.37–2.38, first step rate-determining, takes the following form. Because B is consumed as fast as it forms, its concentration is always very close to zero and therefore approximately constant. We assume that

$$\frac{d[\text{B}]}{dt} = 0 \quad (2.39)$$

This assumption is known as the *stationary-state approximation*, and is valid for highly reactive intermediates. We then write from the second step Equation 2.40

$$\frac{d[\text{C}]}{dt} = k_2[\text{B}] \quad (2.40)$$

for the rate of product formation. But because B is a reactive intermediate, its concentration will be difficult to measure; we require a rate equation expressed in terms of measurable concentrations. We therefore write, from Equations 2.37 and 2.38,

$$\frac{d[\text{B}]}{dt} = k_1[\text{A}] - k_2[\text{B}] \quad (2.41)$$

and, from Equation 2.39,

$$\frac{d[\text{B}]}{dt} = k_1[\text{A}] - k_2[\text{B}] = 0 \quad (2.42)$$

The stationary-state approximation thus allows us to equate $k_1[\text{A}]$ with $k_2[\text{B}]$. The rates of formation and of disappearance of the reactive intermediate B are equal. We can therefore write instead of 2.40 the final rate equation 2.43:

$$\frac{d[\text{C}]}{dt} = k_1[\text{A}] \quad (2.43)$$

Note that overall kinetic behavior is unaffected by events following a true rate-determining step.

Suppose now that B is still a reactive intermediate, but the reverse of the first step must be considered (Equations 2.44 and 2.45). There is now a competition



between two pathways: B may go on to C or return to A. Even though B still does not accumulate, it is no longer true that every A reacting leads directly to C. The first step is not strictly rate-determining, and the rate constant for the second step enters into the rate equation (Problem 2).

If, in the two-step mechanism in Equations 2.37–2.38, it is not justifiable to assume that B is consumed as fast as formed, [B] will increase and then decrease; the rate of disappearance of A will not equal the rate of appearance of C, and the stationary-state approximation is not valid. This situation requires a more general approach.³⁵

Preliminary equilibrium In a second common limiting case of the two-step mechanism, the second step is slow. Then ordinarily the reverse of the first step will be important, so we need to use Equations 2.44–2.45. With the first step and its reverse much faster than the second step, nearly all B formed returns to A. Now there is an equilibrium always maintained between A and B and the second step is rate-determining. We can therefore write an equilibrium constant for Equation 2.44,

$$K = \frac{[B]}{[A]} = \frac{k_1}{k_{-1}} \quad (2.46)$$

Then since

$$\frac{d[C]}{dt} = k_2[B] \quad (2.47)$$

we can at once write the rate equation 2.48 for rate of formation of C in terms of starting material A.

$$\frac{d[C]}{dt} = k_2K[A] \quad (2.48)$$

The mechanism thus predicts first-order behavior, with an observed rate constant

$$k_{\text{obs}} = k_2K \quad (2.49)$$

If the equilibrium constant K can be measured independently, k_2 can be recovered.

A judicious combination of the stationary-state, preliminary-equilibrium, and rate-determining step concepts will often yield the rate equation for more complex reaction schemes. An example is given in Problem 6.

2.6 INTERPRETATION OF RATE CONSTANTS

The utility of rate constants for understanding reaction mechanisms depends largely on interpreting them in terms of energies. Energy information is ordinarily obtained from rate data by either of two methods, one empirical and the other more theoretical.

The Arrhenius Equation

The temperature dependence of observed rate constants follows the Arrhenius equation (2.50) with good accuracy for most reactions. A and E_a are parameters determined experimentally, R is the gas constant, $1.986 \text{ cal } ^\circ\text{K}^{-1} \text{ mole}^{-1}$, and

$$k_{\text{obs}} = A \exp\left(-\frac{E_a}{RT}\right) \quad (2.50)$$

³⁵ See note 34.

T is the temperature in degrees Kelvin. The units of A , called the *pre-exponential factor*, are the same as those of k_{obs} : for a first-order rate constant, time^{-1} ; for a second-order rate constant, $l \text{ mole}^{-1} \text{ time}^{-1}$. We use the notation k_{obs} to emphasize that the equation applies to the observed rate constant, which may or may not be simply related to the microscopic k 's characterizing the individual steps of a reaction sequence.

If we write Equation 2.50 in the form of Equation 2.51, we see at once a resemblance to the familiar relation 2.52 between the equilibrium constant of a

$$-E_a = RT \ln \left(\frac{k_{\text{obs}}}{A} \right) \quad (2.51)$$

$$-\Delta G^\circ = RT \ln K \quad (2.52)$$

reaction and its free-energy change. Hence it is natural to interpret E_a as an energy. This energy is called the *Arrhenius activation energy*, or simply *activation energy*, and may be crudely interpreted as the height of an energy barrier over which reactants must pass on their way to products. Yet because k_{obs} will not in general correspond to the microscopic constant for a single step, the origin of the activation energy on the molecular level is not well defined. To obtain a more precise idea of the dynamic behavior of molecules during a reaction, we turn to the transition-state theory.

Transition State Theory³⁶

The transition state theory is confined to consideration of single elementary reaction steps, and is meaningful only when applied to a single microscopic rate constant. The theory postulates that when two molecules come together in a collision that leads to products (or when a single molecule in a unimolecular step follows the motions that cause the chemical change), they pass through a configuration of maximum potential energy called the *transition state*. In order to understand this concept fully, we must first digress to consider some ideas about potential energy surfaces.

Potential energy surfaces Because each of the N atoms in a molecule can move in three mutually perpendicular and therefore independent directions, a molecule has a total of $3N$ degrees of freedom. But since we think of a molecule as a unit, it is useful to divide these degrees of freedom into three categories. If the atoms were fixed relative to each other, the position of the rigid molecule in space would be defined by specifying six quantities: the three cartesian coordinates of its center of mass and three rotational angles to indicate its orientation in space. Hence there remain $3N - 6$ degrees of freedom which are internal vibrational motions of the atoms with respect to each other. (A linear molecule

³⁶ Transition state theory is discussed in standard texts on physical chemistry, kinetics, and physical organic chemistry. See, for example, (a) W. J. Moore, *Physical Chemistry*, 3rd ed., Prentice-Hall, Englewood Cliffs, N.J., 1962, p. 296; (b) S. W. Benson, *Thermochemical Kinetics*, Wiley, New York, 1968; (c) K. J. Laidler, *Chemical Kinetics*, 2nd ed., McGraw-Hill, New York, 1965; (d) K. B. Wiberg, *Physical Organic Chemistry*, Wiley, New York, 1964; (e) L. P. Hammett, *Physical Organic Chemistry*, 2nd ed., McGraw-Hill, New York, 1970. For a different approach to chemical dynamics, see (f) D. L. Bunker, *Accts. Chem. Res.*, **7**, 195 (1974).

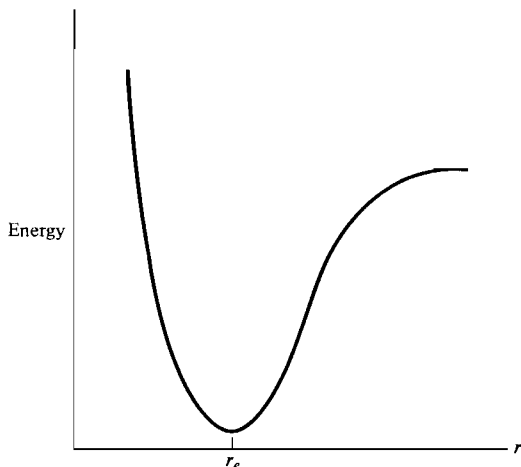

Figure 2.6 Potential energy of a diatomic molecule as a function of internuclear separation r . The equilibrium separation is r_e . A normal mode in a polyatomic molecule would have a similar potential curve, with a parameter characterizing the phase of the motion replacing r .

has only two rotational coordinates, hence $3N - 5$ vibrational degrees of freedom. We shall continue to say $3N - 6$, with the understanding that $3N - 5$ is to be substituted if the molecule is linear.)

The total molecular vibration is complex, but to a good approximation the vibration may be divided into $3N - 6$ independent *normal modes*, with the entire vibration being a superposition of these.³⁷ Each normal mode will in general involve many atoms, and may include bond stretching or bending or both, but as all motions are in phase with each other, just one parameter suffices to follow the vibration of a single mode, and each mode can be thought of as being essentially equivalent to the stretching vibration of a diatomic molecule. The appropriate model for vibration of a diatomic is two masses joined by a spring, with restoring force proportional to the displacement from the equilibrium separation.

The potential energy of such an oscillator can be plotted as a function of the separation r , or, for a normal mode in a polyatomic molecule, as a function of a parameter characterizing the phase of the oscillation. For a simple harmonic oscillator, the potential energy function is parabolic, but for a molecule its shape is that indicated in Figure 2.6. The true curve is close to a parabola at the bottom, and it is for this reason that the assumption of simple harmonic motion is justified for vibrations of low amplitude.

For a polyatomic molecule there will be a potential energy curve like that of Figure 2.6 for each of the $3N - 6$ vibrational modes. The potential energy is therefore characterized by a surface in $3N - 6 + 1$ -dimensional space. To plot such a surface is clearly impossible; we must be content with slices through it along the coordinates of the various normal modes, each of which will resemble Figure 2.6.

³⁷ The vibrations are separable if they follow simple harmonic motion. Molecular vibrations are not quite harmonic, but are nearly so. Everything that follows will assume harmonic vibration.

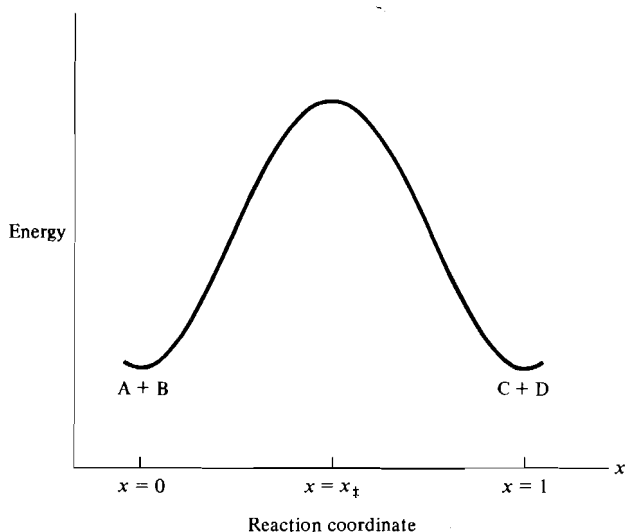

Figure 2.7 The reaction coordinate diagram for the reaction $A + B \rightleftharpoons C + D$.

The reaction coordinate When two molecules come together and react, it is the potential energy surface for the whole process that is of interest. Let us imagine a reaction in which A and B come together and the constituent atoms move over the potential energy surface of the combined system to produce C and D. We shall suppose that we have identified the particular set of atomic motions that has to occur to accomplish this change, and we make a slice through the surface along the dimension of this particular motion. We shall find that the shape of the surface along the line of the slice is something like that shown in Figure 2.7. The motion of atoms characterizing the change is called the *reaction coordinate*. It is convenient to define a parameter x that characterizes progress of the system along the reaction coordinate. The graph of potential energy as a function of x is the *reaction coordinate diagram*.³⁸

When A and B are separate and not yet interacting, we are at the left-hand side of the diagram, $x = 0$; as they come together in a reactive collision, the potential energy rises as the atoms begin to execute the motion that will carry

³⁸ We shall have occasion to use reaction coordinate diagrams frequently throughout this book. While we shall sometimes, as here, be plotting potential energy as a function of reaction coordinate, we shall often want to use a more comprehensive quantity such as enthalpy or free energy. The internal energy E of a system is the sum of the potential and kinetic energies of its constituent parts:

$$E = k.e. + p.e. \quad (1)$$

Its enthalpy is a function of its internal energy, pressure, and volume:

$$H = E + PV \quad (2)$$

Its free energy depends on both its enthalpy and its entropy:

$$G = H - TS \quad (3)$$

The free energy includes all the other energy terms, and any changes in the individual terms will be reflected in it. Thus free energy can always be used as the y coordinate in a reaction coordinate diagram. When the changes being considered chiefly affect one of the less comprehensive terms, it may be more meaningful to plot that energy term against the reaction coordinate.

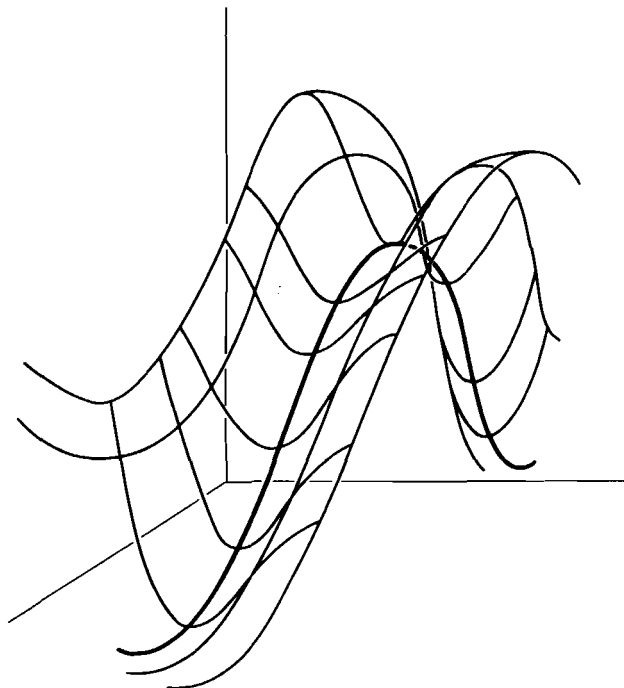

Figure 2.8 A three-dimensional reaction coordinate diagram. The reaction coordinate is a path following the lowest altitude line up one valley, over the pass, and down the other.

over to products. At some configuration the potential passes through a maximum, and then falls as we proceed to the right, finally reaching a minimum again with separated products C and D, $x = 1$. An entirely similar process can be imagined for a unimolecular reaction. The configuration of atoms corresponding to the maximum in the reaction coordinate diagram is the transition state, symbolized by \ddagger . It occurs at $x = x_{\ddagger}$.

There are two perhaps obvious but easily overlooked points about the reaction coordinate diagram that must be stressed. First, it is only a one-dimensional slice of a $3N - 6 + 1$ -dimensional surface. (N is the total number of atoms in A and B.) We can imagine, at each point of the line, motions off the line corresponding to vibrations other than the single one that is carrying the molecules over to products. These motions are all ordinary vibrations, having nothing to do (in a first approximation at least) with the reaction, and proceeding quite independently of it. If we assume that the reaction coordinate corresponds to a normal mode of the reacting system,³⁹ the reaction coordinate is "perpendicular" (in $3N - 6$ -dimensional space) to each of these other normal modes. Our curve passes along the equilibrium position of each of the other vibrations, so that if we were to leave the reaction coordinate line and follow the potential energy surface in the direction of some other mode, the energy would always go up.

³⁹ This assumption is implicit in the transition state theory, although it may not be entirely correct.

The situation can be visualized if only one vibrational degree of freedom besides the reaction coordinate is included. Then we have the three-dimensional potential energy surface of Figure 2.8, two valleys meeting over a mountain pass.⁴⁰ If we climb along the reaction coordinate out of one valley over the pass into the other, we go over an energy maximum along the reaction coordinate, but the surface rises in the perpendicular direction and we are therefore following a potential energy minimum with respect to the motion perpendicular to the reaction coordinate.

The second point about the surface is that it shows only the potential energy. The total energy of the molecular system is the sum of its kinetic and potential energies. The molecules exchange kinetic energy by collisions, and are distributed over a range of total energies, with many at low energies and fewer at higher energies. It is tempting to think of a reaction as following the path of a pack horse up out of the left-hand valley and over the pass into the right-hand one. This model is quite inappropriate; a much better way to think of the situation is to imagine many birds flying in the valleys at various levels, the levels representing the various possible total energies. The individual birds can go up or down by receiving or giving up some energy to their surroundings, but the vertical distribution of birds is in equilibrium and remains unchanged. The birds are flying around at random, and those that are high enough may in their wanderings happen to sail over the pass and join the population in the other valley. The rate of passage of the birds from one side to the other depends on the height of the pass and on the vertical distribution of the birds. In the molecular system the vertical distribution is determined by the temperature.⁴¹

Thermodynamics of the Transition State

In developing the transition state theory, we shall take advantage of the fact that most of the motions in a reacting molecular system are ordinary vibrations, rotations, and translations. Only the one normal mode corresponding to the reaction coordinate is doing something peculiar by coming apart to form new molecules. We shall postulate therefore that the molecules going over the barrier are in equilibrium with all the other reactant molecules, just as in our bird analogy we said that the birds that can get over the pass are just those that happen to be high enough up and headed in the right direction.

We assume that in Reaction 2.53 there are at any instant some molecules



⁴⁰ This surface could never be the complete one in a molecular system, as it would require that $3N - 6 + 1 = 3$ (nonlinear) or $3N - 5 + 1 = 3$ (linear), neither of which have solutions for N an integer. A three-dimensional reaction coordinate diagram like Figure 2.8 is thus always only a projection of a surface of higher dimensionality, just as the two-dimensional one is.

⁴¹ We must also remember that, although we tend to think of the atoms as classical particles, their motions are actually determined by the rules of quantum mechanics. If we tried to follow in detail the motions of the atoms in a molecule crossing the barrier with just enough total energy to get over, we would come up against the uncertainty principle just as we do in trying to follow electron motions, and would be unable to say just how the atoms got from one place to the other. For further discussion see W. F. Sheehan, *J. Chem. Educ.*, **47**, 254 (1970).

at the transition state going in each direction over the barrier, and we shall concentrate on one direction only, $A \rightarrow B$. We are therefore dealing with rate constant k_1 ; exactly the same arguments will apply to the $A \leftarrow B$ reaction and k_{-1} . We suppose that the transition state molecules moving from left to right, A^\ddagger , are at equilibrium with the bulk of the A molecules in the restricted sense specified above. The concentration $[A^\ddagger]$ can therefore be written in terms of an equilibrium constant, K^\ddagger (Equation (2.54)). The rate of the reaction from left to right is

$$[A^\ddagger] = K^\ddagger[A] \quad (2.54)$$

$k^\ddagger[A^\ddagger]$, the concentration of molecules at the transition state multiplied by a rate constant characterizing their rate of passage over the barrier. Then since $k_1[A]$ is the conventional reaction rate,

$$k_1[A] = k^\ddagger[A^\ddagger] \quad (2.55)$$

and, substituting for $[A^\ddagger]$ from Equation 2.54, and cancelling $[A]$ from both sides, we find Equation 2.56 relating the first-order rate constant to properties of the transition state.

$$k_1 = k^\ddagger K^\ddagger \quad (2.56)$$

The equilibrium constant K^\ddagger is then analyzed by the methods of statistical thermodynamics to separate out the contribution of the reaction coordinate from other contributions. The rate constant k^\ddagger is also calculated by statistical thermodynamic methods. These calculations are given in Appendix 1 to this chapter. The results of the analysis are expressed by Equation 2.57, where k is the Boltz-

$$k_1 = \frac{kT}{h} K^\ddagger \quad (2.57)$$

mann constant, h is Planck's constant, T is the Kelvin temperature, and K^\ddagger is a new equilibrium constant that excludes the contributions from the reaction coordinate. The new equilibrium constant K^\ddagger can be written in terms of a free energy of activation, ΔG^\ddagger (Equation 2.58), and ΔG^\ddagger can in turn be divided into

$$\Delta G^\ddagger = -RT \ln K^\ddagger \quad (2.58)$$

$$\Delta G^\ddagger = \Delta H^\ddagger - T \Delta S^\ddagger \quad (2.59)$$

$$k_1 = \frac{kT}{h} \exp\left(-\frac{\Delta G^\ddagger}{RT}\right) \quad (2.60)$$

$$k_1 = \frac{kT}{h} \exp\left(-\frac{\Delta H^\ddagger}{RT}\right) \exp\left(\frac{\Delta S^\ddagger}{R}\right) \quad (2.61)$$

contributions from enthalpy of activation, ΔH^\ddagger , and entropy of activation, ΔS^\ddagger (Equation 2.59). Equations 2.60 and 2.61 then follow. Equation 2.60 is called the Eyring equation, after Henry Eyring, who was instrumental in the development of the transition state theory.

Table 2.12 DIFFERENCES IN ΔH^\ddagger OR E_a AND IN ΔS^\ddagger CORRESPONDING TO VARIOUS RATE CONSTANT RATIOS FOR TWO ELEMENTARY REACTION STEPS, a AND b

k_a/k_b	$\Delta H_b^\ddagger - \Delta H_a^\ddagger$, or $E_{ab} - E_{aa}$ (kcal mole ⁻¹ , 300°K, constant ΔS^\ddagger or A)
2	0.41
10	1.37
10 ²	2.74
10 ⁴	5.49
10 ⁶	8.23
k_a/k_b	$\Delta S_a^\ddagger - \Delta S_b^\ddagger$ (entropy units, e.u., cal mole ⁻¹ °K ⁻¹ constant ΔH^\ddagger)
2	1.38
10	4.57
10 ²	9.15
10 ⁴	18.29
10 ⁶	27.44

Comparison between the transition state expression (2.61) and the Arrhenius equation (2.50) may be made if both are applied to the microscopic rate constant for a single reaction step.⁴² The correspondence is as follows:⁴³

$$A = \frac{e\mathbf{k}T}{h} \exp\left(\frac{\Delta S^\ddagger}{R}\right) \quad (2.62)$$

$$E_a = \Delta H^\ddagger + RT \quad (2.63)$$

The term RT is small at ordinary temperatures; in the neighborhood of 300°K the difference between E_a and ΔH^\ddagger is only about 0.6 kcal mole⁻¹. The factor $\mathbf{k}T/h$ is equal to 10^{12.8} sec⁻¹ at 300°K, and $e\mathbf{k}T/h$ is 10^{13.2} sec⁻¹ at this temperature. These figures should thus represent roughly the rate to be expected for a gas-phase reaction step of zero enthalpy and entropy of activation.

Magnitudes of kinetic quantities Because rates of different reactions are often compared, it is well to have an idea of the relationship between a given rate ratio and the difference in activation parameters. Table 2.12 gives some values. Note particularly the relatively small differences in activation energy or enthalpy that correspond to even rather large ratios of rates. The following relation may sometimes be useful:

$$\Delta E_a \approx 1.37 \log\left(\frac{k_a}{k_b}\right) \quad (2.64)$$

where ΔE_a is the activation energy difference between reactions a and b in kcal mole⁻¹.

⁴² Recall that the Arrhenius equation applies to any rate constant, but the transition state theory treats only rate constants for individual steps.

⁴³ See note 36(b), p. 95.

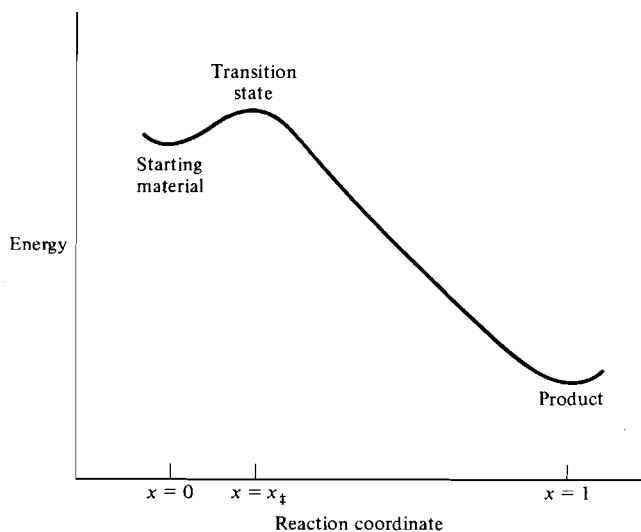

(a)

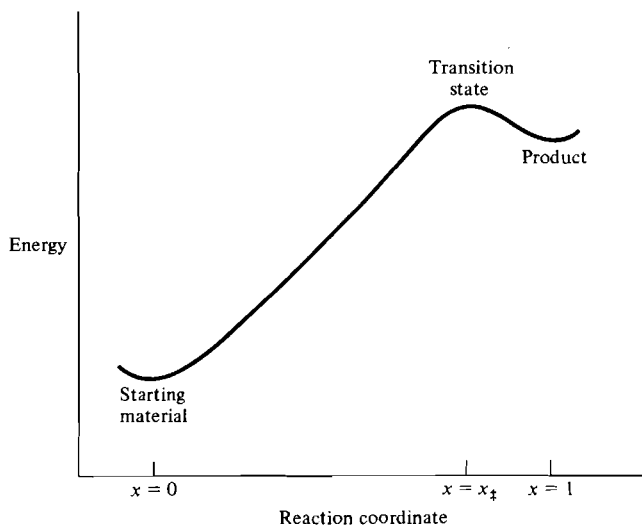

(b)

Figure 2.9 In an exothermic reaction (a), the Hammond postulate assumes that the transition state should resemble the starting material, whereas in an endothermic process (b), it should resemble the product.

The Hammond Postulate

Consider a reaction in which starting materials and products lie at significantly different energies. We have no *a priori* way of predicting, short of carrying out time-consuming and expensive calculations, where along the reaction coordinate the transition state will occur. But it seems intuitively reasonable that if the starting materials are of high energy (exothermic reaction), relatively little change

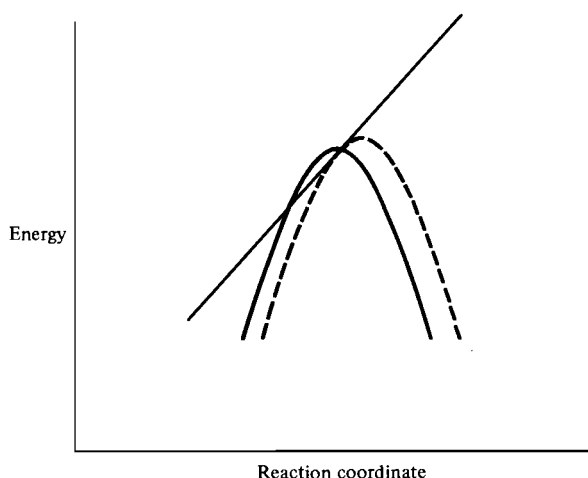

Figure 2.10 Addition to the reaction coordinate potential (solid curve) of a perturbation of positive slope makes the reaction toward the right more difficult and shifts the transition state to the right (dashed curve). Reprinted with permission from E. R. Thornton, *J. Amer. Chem. Soc.*, **89**, 2915 (1967). Copyright by the American Chemical Society.

of geometry will be required to reach the transition state, whereas if the reaction is endothermic, the reorganization required will be considerable and the transition state will not be reached until the geometry already closely resembles the high-energy products. This idea, illustrated in Figure 2.9, is known as the *Hammond postulate*.⁴⁴

A reaction that is highly exothermic is expected on the basis of the Hammond postulate to have a small activation energy and therefore a high rate. Chemists therefore sometimes speak of a feature of a structure that makes a large exothermic contribution to the equilibrium free-energy change as a *driving force* for the reaction. The formation of a particularly strong bond, or relief of an unfavorable steric interaction, might constitute a driving force. It is well to remember that there is no direct connection between equilibrium thermodynamics and rate; the driving force idea is therefore only a rough qualitative one and must be used cautiously.

Reacting Bond Rules

It is often useful to have the Hammond postulate stated in the context of a small change in structure or *perturbation*, brought about, for example, by changing a substituent. Thornton has given an analysis that we follow here.⁴⁵ We approximate our potential energy curve in the region of the transition state by a parabola, opening downward as shown in Figure 2.10. We then suppose that we make some small change in structure that makes it more difficult to proceed to the right. This change is equivalent to raising the right-hand side of the reaction coordinate

⁴⁴ G. S. Hammond, *J. Amer. Chem. Soc.*, **77**, 334 (1955).

⁴⁵ E. R. Thornton, *J. Amer. Chem. Soc.*, **89**, 2915 (1967).

curve more than the left-hand side, and can be accomplished by adding to the free energy at each point along the curve an increment $\delta\Delta G^\circ$ that increases to the right. Here the symbol δ signifies the effect on the quantity ΔG° of the structural change.⁴⁶ The simplest approach is to make the increment increase linearly with x , that is,

$$\delta \Delta G^\circ = mx \quad (2.65)$$

where x is the reaction parameter defined earlier (Figure 2.7), and m is the slope, positive in the present example. In Figure 2.10 the straight line superimposed on the reaction coordinate potential curve represents the perturbation $\delta\Delta G^\circ$. If we place the origin at the vertex of the parabola, it is easy to verify by inspection that the result of adding the perturbation to the potential energy curve will be to shift its maximum, and thus the transition state, to the right (dashed curve). A perturbation with a negative slope, that is, a structural change making motion from left to right easier, will shift the curve to the left.

It may in some instances be of interest to know how structural changes affect the position of the transition state on the potential energy surface with respect to degrees of freedom other than the reaction coordinate. Recall that these other degrees of freedom correspond to ordinary vibrations. They cut across the surface perpendicular to the reaction coordinate and are valleys rather than hills. Suppose that we make a change in structure that will make a certain bond, not corresponding to the one breaking, more difficult to stretch. We show in Figure 2.11 the potential surface cut along the stretching degree of freedom, with a perturbation

$$\delta \Delta G^\circ = mz \quad (2.66)$$

where m is positive. Now the perturbed potential (dashed curve) is shifted to the left. Making the bond more difficult to stretch has changed the structure of the transition state so that the equilibrium bond distance is shorter.

These arguments are summarized as the *reacting bond rules*:⁴⁷

1. For an internal motion of a molecule that corresponds to progress over a transition state (energy maximum), any change that makes the motion more difficult will lead to a new molecular geometry at the energy maximum in which the motion has proceeded farther. Changes that make the motion less difficult have the opposite effect. (This rule corresponds to the Hammond postulate.)

2. For an internal motion of a molecule that corresponds to a vibration, any change that tends to force a change in the equilibrium point of the vibration in a particular direction will do so.

3. Effects on reacting bonds (bonds made or broken in the reaction) are the most significant; most strongly influenced are reacting bonds nearest the site of structural change.

These rules will be useful when we wish to analyze reaction paths in terms of motion along more than one dimension of a potential energy surface. The need

⁴⁶ δ is known as a *Leffler-Grunwald operator*, and is used to designate the change in any quantity resulting from a structural change. See J. E. Leffler and E. Grunwald, *Rates and Equilibria of Organic Reactions*, Wiley, New York, 1963, p. 26.

⁴⁷ See note 45, p. 103.

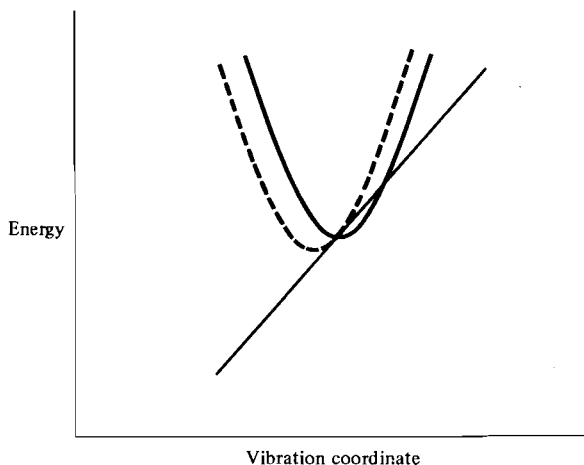

Figure 2.11 Addition to a vibration potential (solid curve) of a perturbation of positive slope makes bond stretching more difficult and decreases the equilibrium separation (dashed curve). Reprinted with permission from E. R. Thornton, *J. Amer. Chem. Soc.*, **89**, 2915 (1967). Copyright by the American Chemical Society.

for such analysis arises in the study of reactions such as nucleophilic substitution, elimination, and acid-catalyzed addition to carbonyl, where a process can occur either by a stepwise route (S_N1 substitution, E_1 elimination) or by a concerted route (S_N2 substitution, E_2 elimination). Applications are discussed in Sections 5.4, 7.2, and 8.1.

2.7 ISOTOPE EFFECTS

The kinetic isotope effect, a change of rate that occurs upon isotopic substitution, is a widely used tool for elucidating reaction mechanism.⁴⁸ The most common isotopic substitution is D for H, although isotope effects for heavier atoms have been measured. Our discussion will be in terms of hydrogen isotope effects; the same principles apply to other atoms.

To a good approximation, substitution of one isotope for another does not alter the potential energy surface. The electronic structure, and thus all binding forces, remain the same. All differences are attributable solely to the change in mass, which manifests itself primarily in the frequencies of vibrational modes. For a hypothetical model of a small mass m attached to a much larger mass by a spring of force constant k , the classical vibrational frequency is given by:⁴⁹

$$\nu = \frac{1}{2\pi} \sqrt{\frac{k}{m}} \quad (2.67)$$

⁴⁸ For general treatments of the isotope effect, see (a) K. B. Wiberg, *Physical Organic Chemistry*, Wiley, New York, 1964, p. 273 and p. 351; (b) L. Melander, *Isotope Effects on Reaction Rates*, Ronald Press, New York, 1960; (c) F. H. Westheimer, *Chem. Rev.*, **61**, 265 (1961); (d) J. Bigeleisen and M. Wolfsberg, *Advan. Chem. Phys.*, **1**, 15 (1958), (e) C. J. Collins and N. S. Bowman, Eds., *Isotope Effects in Chemical Reactions*, ACS Monograph 167, Van Nostrand Reinhold, New York, 1970.

⁴⁹ If the two masses joined by the spring are comparable, m in Equation 2.67 must be replaced by the

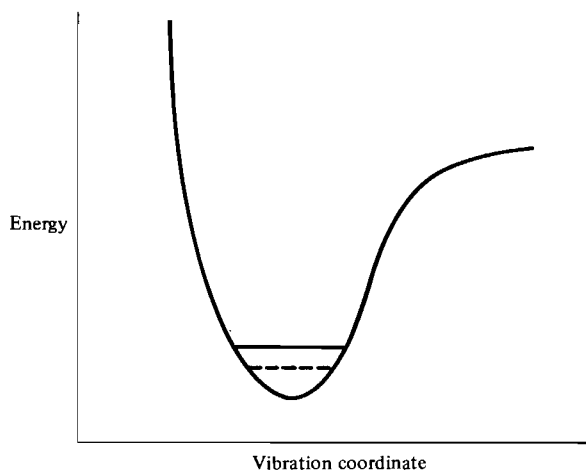

Figure 2.12 The zero-point energy is proportional to ν and thus to $\sqrt{1/m}$; the C—D bond therefore has a lower zero-point energy than the C—H bond.

The quantum mechanical treatment of the same model leads to energy levels

$$\epsilon_n = (n + \frac{1}{2})h\nu \quad n = 0, 1, 2, \dots \quad (2.68)$$

and thus to energy-level separations $\Delta\epsilon = h\nu$, where ν is the classical frequency given by Equation 2.67. Energies are measured from the lowest point on the potential energy curve.

An important feature of the vibrational energy levels is that the energy of the lowest possible level lies $\frac{1}{2}h\nu$ above the minimum of the potential curve. This zero-point energy, is by Equation 2.67, inversely proportional to the square root of the mass.

Primary Isotope Effects

Figure 2.12 illustrates the zero-point energy level for a C—H stretching vibration and compares it with the zero-point energy of the same stretch for a C—D bond. In a reaction in which the C—H (C—D) bond breaks, there will be a *primary isotope effect*. The stretching vibration of the reactants is converted to the translational motion over the barrier, and the zero-point energy disappears for that particular degree of freedom. Since the C—H molecule starts out at a higher energy, its activation energy is lower, and $k_{\text{H}}/k_{\text{D}}$ will be greater than 1.

We can easily calculate the isotope effect to be expected were this loss of zero-point energy the sole contributor. The C—D frequency should be smaller than the C—H frequency by a factor of roughly $1/\sqrt{2} = 1/1.41$ according to Equation 2.67; the observed ratio is closer to $1/1.35$.⁵⁰ The zero-point energy

reduced mass,

$$\mu = \frac{m_1 m_2}{m_1 + m_2}$$

When one of the masses is much larger than the other, as would be the case for a hydrogen attached to a large molecule μ is approximately equal to the smaller mass.

⁵⁰ A. Streitwieser, Jr., R. H. Jagow, R. C. Fahey, and S. Suzuki, *J. Amer. Chem. Soc.*, **80**, 2326 (1958).

difference is therefore⁵¹

$$\Delta\epsilon_0 = \frac{1}{2}hc(\nu_H - \nu_D) = \frac{1}{2}hc\left(1 - \frac{1}{1.35}\right)\nu_H \quad (2.69)$$

The resulting isotope effect would be approximately⁵²

$$\frac{k_H}{k_D} \approx \exp\left[-\frac{hc}{2kT}\left(1 - \frac{1}{1.35}\right)\nu_H\right] = \exp\left(-\frac{0.1865}{T}\nu_H\right) \quad (2.70)$$

Since the C—H stretching vibration appears in the infrared spectrum around 3000 cm^{-1} , the isotope effect at $T = 300^\circ\text{K}$ would be

$$\frac{k_H}{k_D} \approx \exp\left[-\frac{0.1865}{300}(3000)\right] = 6.4 \quad (2.71)$$

This model is, however, too crude to account for the observed range of isotope effects. There are other changes occurring in the vibrations, and a more careful treatment must take them into account.

Appendix 2 to this chapter gives a derivation that shows that the isotope effect is more closely approximated by Equation 2.72. The Π symbols signify a

$$\frac{k_H}{k_D} \approx \prod_i^{\ddagger} \exp\left[-\frac{1}{2}(u_{iH} - u_{iD})\right] \prod_i^{\ddagger} \exp\left[+\frac{1}{2}(u_{iH} - u_{iD})\right] \quad (2.72)$$

product of terms; the first is a product over normal modes of vibration of the transition state, and the second over normal modes of the reactants. The quantity u_i is defined as $h\nu_i/kT$, where ν_i is the frequency of normal mode i ; each of the exponential terms thus contains a difference in vibrational frequency between the hydrogen and the deuterium compound. The products are over bound vibrations only. In other words, the reaction coordinate itself, which is a vibration in the reactants but not in the transition state, contributes only to the reactant part of Equation 2.72. It is necessary to include in Equation 2.72 only those vibrations that involve changes of force constants at isotopically substituted positions. An expression for the isotope effect on an equilibrium is given in Appendix 2.

The following qualitative statement of the direction of an isotope effect is sometimes useful. The heavy isotope will concentrate at that site where it is bound more strongly, that is, has the larger force constant and frequency. For a kinetic effect, this statement means that deuterium will prefer the reactant, where the force constant is higher, and the hydrogen will prefer the transition state, where the force constant is lower; the hydrogen compound will react faster. For an equilibrium,



if the force constant is higher in AH(D) than in BH(D), the deuterium will prefer to be in A and the hydrogen will prefer to be in B; $K_{H/D}$ will be greater than 1.

⁵¹ Multiplication by the speed of light, c , converts frequency expressed in cm^{-1} to sec^{-1} .

⁵² The units of $h\nu$ are erg molecule^{-1} . To convert to cal mole^{-1} , multiply by 1.439×10^{16} ; then the gas constant $R = 1.987\text{ cal mole}^{-1} \text{ }^\circ\text{K}^{-1}$ must be used in place of k .

Isotope effects in linear transition states Let us now analyze the kinetic isotope effect in a simple system, a transfer of hydrogen from AH to B through a linear transition state (Equation 2.74).⁵³ We assume that A and B are polyatomic fragments. In the reactants we have to consider the A—H stretching

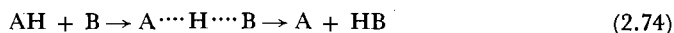

and A—H bending modes. In the transition state, the A—H stretch has become the reaction coordinate (28),

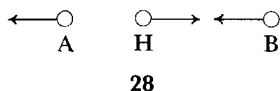

and contributes nothing to the transition state term in Equation 2.72, leaving $\exp[+\frac{1}{2}(u_{iH} - u_{iD})]$ for this mode to contribute to the reactant term. It is this factor that we evaluated earlier as being about 6.4. But there are also in the transition state other vibrations to be considered. There will be two degenerate bends, 29 and 30, which are identical but occur in mutually perpendicular

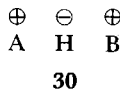
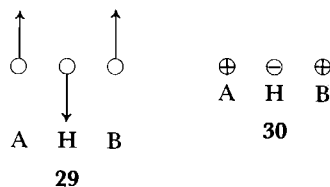

planes. These motions are not present in the reactants, and it is difficult to know how to deal with them. They are, however, roughly comparable to the reactant A—H bending; and since bending frequencies are lower than stretching and therefore contribute less to the isotope effect in any event, bending frequencies are usually considered to cancel approximately between reactant and transition state when a primary isotope effect is being evaluated.⁵⁴

We are then left with one final transition state vibration, a symmetric stretch (31), which has no counterpart in the reactants. If the transition state is

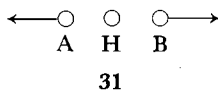

highly symmetric, so that the A \cdots H and the H \cdots B force constants are equal, this stretch will involve only A and B moving in and out together, with no motion of the H (or D). The frequency will then be the same for H and D, and its contribution to the transition state term in Equation 2.72 will cancel. We shall then be left with only the reaction coordinate mode, and an isotope effect around 6.4. If the transition state is not symmetric, the H (D) will be closer to A or to B; then the H (D) will move in the symmetric stretch and since $\nu_H > \nu_D$, $\exp[-\frac{1}{2}(u_H - u_D)]$

⁵³ See (a) note 48(b, c), p. 105.

⁵⁴ See Wiberg, *Physical Organic Chemistry*, pp. 332–361, for calculations that roughly justify this assumption for a specific example.

for this mode will be less than 1. Part of the contribution from the reactant zero-point energy of the reaction coordinate mode will be canceled and the isotope effect will be lowered. In the limit that the transition state is nearly the same as reactant, the symmetric stretch (32) will involve nearly as much motion of H or

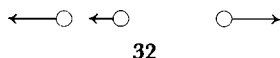

D as the reactant stretch, and its zero-point difference will largely cancel the contribution from the reactant stretch zero-point energy. The isotope effect, in this simple model at least, thus becomes a rough measure of the position of the transition state along the reaction coordinate. The isotope effect is expected to be largest for the most symmetrical location of the transition state, and smaller the closer the transition state is to either reactant or product.

Primary isotope effects in non-linear transition states If the transition state is nonlinear, the vibration corresponding to the symmetric stretch looks like 33. Now even for the symmetrical case, the H (D) moves with relatively high

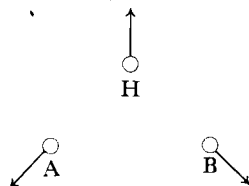

frequency, and this mode cancels most of the zero-point contribution from the reaction coordinate mode of the reactants. Hence a bent transition state should show a small isotope effect. This mode is furthermore little affected by dissymmetry, and so the isotope effect for a nonlinear transition state will not be a sensitive indicator of position of the transition state along the reaction coordinate.⁵⁵

Secondary Isotope Effects⁵⁶

A *secondary isotope effect* is one that results from isotopic substitution at a bond not being broken in the reaction. As the reaction coordinate, not being affected by the substitution, does not make any contribution, the secondary effects must arise solely from changes of zero-point energies of ordinary vibrations. Thus if an isotopically substituted C—H bond experiences a change of force constant on going from reactant to transition state, the effect is approximately

$$\frac{k_{\text{H}}}{k_{\text{D}}} = \exp \left\{ -\frac{1}{2} [u_{\text{tH}} - u_{\text{tD}} - (u_{\text{rH}} - u_{\text{rD}})] \right\} \quad (2.75)$$

or, using the approximation that $\nu_{\text{D}} = \nu_{\text{H}}/1.35$,

$$\frac{k_{\text{H}}}{k_{\text{D}}} = \exp \left[-\frac{0.1865}{T} (\nu_{\text{tH}} - \nu_{\text{rH}}) \right] \quad (2.76)$$

⁵⁵ R. A. More O'Ferrall, *J. Chem. Soc. B*, 785 (1970).

⁵⁶ For a review of secondary isotope effects, see E. A. Halevi, *Prog. Phys. Org. Chem.*, **1**, 109 (1963).

Any vibration for which the frequency decreases on going to the transition state contributes a factor greater than 1 to k_H/k_D , and any vibration for which the frequency increases contributes a factor less than 1. A commonly observed secondary isotope effect occurs when deuterium substitution is made at a carbon that changes hybridization, as in Equations 2.77 and 2.78.

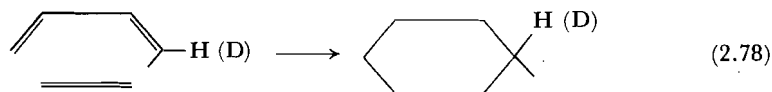
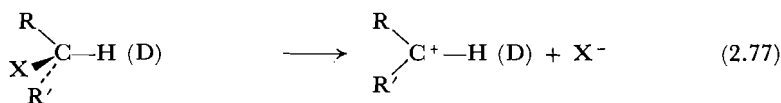

Streitwieser and collaborators have analyzed this process and concluded that, in going from sp^3 to sp^2 (Equation 2.77) the three C—H vibrations, one stretch and two bends, change as indicated below:⁵⁷

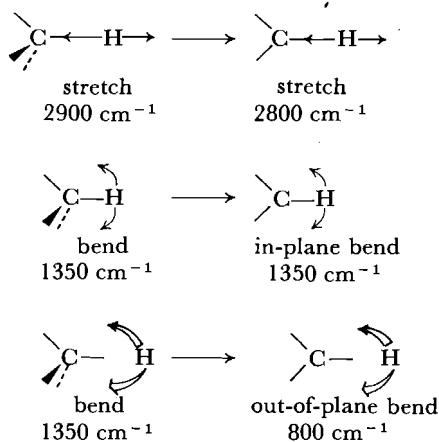

The first change is small and the second nearly zero; the last one is significant and would contribute a factor of approximately

$$\frac{k_H}{k_D} = \exp \left[- \frac{0.1865}{T} (800 - 1350) \right] = 1.41$$

at 300°K if the transition state were very close to sp^2 hybridized product. The isotope effect will be smaller if the transition state comes earlier; it is typically around 1.15 to 1.25 for reactions of the type of Equation 2.77. (See Section 5.2 for further discussion.) For a reaction in which hybridization changes from sp^2 to sp^3 , as in 2.78, the effect will be inverse, k_H/k_D less than 1, with a minimum of roughly $1/1.41 = 0.71$ for a transition state closely resembling sp^3 hybridized product, but typical values being between 0.8 and 0.9.

⁵⁷ See note 50, p. 106.

Substitution of deuterium at the β position leads to the β deuterium isotope effect in reactions like 2.79.

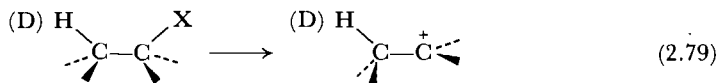

Here the C—H bond is weakened and the frequencies lowered by delocalization of electron density toward the positively charged center (hyperconjugation; see Section 10.2 for further discussion). A bending mode is probably again the most important one;⁵⁸ $k_{\text{H}}/k_{\text{D}}$ is greater than 1, values ranging up to about 1.4 for favorably situated hydrogens,⁵⁹ but more typically on the order of 1.1.

Solvent Isotope Effects

Isotope effects are frequently observed when reactions are carried out in solvents with O—H (O—D) groups. The reader is referred to the literature for further information.⁶⁰

PROBLEMS

1. Cyanohydrin formation, shown below, may involve rate-determining attack of either H^+ or ^-CN . From the ρ value for the formation of cyanohydrins from substituted benzaldehydes (Table 2.3), which step do you think is rate-determining?

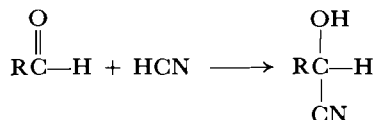

2. Derive a rate equation for formation of C in the following mechanism, assuming the stationary state for B:

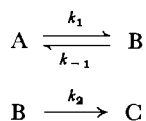

3. Derive a rate equation for formation of C in the following mechanism, assuming the stationary state for B and constant concentrations of D and E:

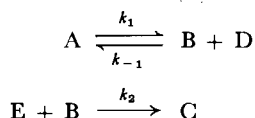

4. Derive the rate equation for rate of formation of E in terms of concentrations of reactants A and B in the following mechanism, assuming that the rates of steps k_1 and

⁵⁸ See note 50, p. 106.

⁵⁹ V. J. Shiner, Jr. and J. G. Jewett, *J. Amer. Chem. Soc.*, **86**, 945 (1964).

⁶⁰ (a) R. L. Schowen, *Prog. Phys. Org. Chem.*, **9**, 275 (1972); see also (b) P. M. Laughton and R. E. Robertson, in *Solute-Solvent Interactions*, J. F. Coetzee and C. D. Ritchie, Eds., Marcel Dekker, New York, 1969, p. 399.

k_{-1} are both fast compared with the rate of step k_2 . What is the kinetic order?

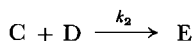
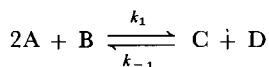

5. Define the terms *microscopic rate constant* and *observed rate constant*.

6. Derive the rate equation for formation of F in terms of concentrations of A, B, and D in the following mechanisms, assuming that A, B, and C are in equilibrium and E is a highly reactive intermediate.

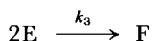
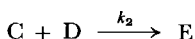
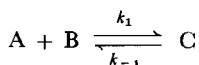

7. Estimate the heat of hydrogenation of benzene and of a hypothetical benzene with three fixed double bonds, each reacting with three moles of H_2 to yield cyclohexane.

8. Verify analytically that the effect of adding a linear perturbation of the form $y = mx$ to a parabola is to maintain its curvature but to shift it in the sense concluded in the text, p. 104. The general formula for a parabola is

$$Ax^2 + Dx + Ey + F = 0$$

or

$$(x - h)^2 = 4p(y - k)$$

where $4p = -E/A$, $h = -D/2A$, $k = D^2/4AE - F/E$. The parabola opens upward if p is positive and downward if p is negative; the vertex is at $x = h$, $y = k$.

9. Verify the expression for the equilibrium isotope effect, $K_{H/D}$ (Equation A2.15 in Appendix 2).

10. Verify by reference to the equilibrium isotope effect equation, A2.15 in Appendix 2, the statement that the heavy isotope will concentrate, relative to the light, at that site where it is more strongly bound.

11. Rationalize the observation that D_3O^+ is a stronger acid than H_3O^+ .

12. Verify that a decrease in H—C (D—C) vibrational frequency on dissociation will cause the observed secondary equilibrium isotope effect $K_H/K_D > 1$ for dissociation of HCOOH (DCOOH).

13. Estimate (a) ΔH_f° for triethylamine; (b) S° for 1,1-dimethylhydrazine.

REFERENCES FOR PROBLEMS

8. G. B. Thomas, Jr., *Calculus and Analytic Geometry*, Addison-Wesley, Reading, Mass., 1953, p. 237.
9. K. B. Wiberg, *Physical Organic Chemistry*, Wiley, New York, 1964, p. 273.
13. S. W. Benson, F. R. Cruickshank, D. M. Golden, G. R. Haugen, H. E. O'Neal, A. S. Rodgers, R. Shaw, and R. Walsh, *Chem. Rev.*, **69**, 279 (1969).

Appendix 1

DERIVATION OF THE TRANSITION STATE THEORY EXPRESSION FOR A RATE CONSTANT^a

In order to analyze the transition state equilibrium, we need to know how a collection of molecules divides up the available energy.

THE BOLTZMANN DISTRIBUTION

Molecules distribute their total energy among translational, rotational, vibrational, and electronic motions. These motions are all quantized, with energy-level separations very small for translation, larger for rotation, still larger for vibration, and very large for electronic motion. There are therefore many discrete energy states available. At very low temperature, approaching absolute zero, nearly all the molecules are in their lowest energy state; but as the temperature is raised, the molecules acquire more energy and begin to populate higher states. The ratio of numbers of molecules in any two states depends on the energy difference between the states and on the temperature, and is given by the Boltzmann distribution law,

$$\frac{n_2}{n_1} = \exp \left[\frac{-(\epsilon_2 - \epsilon_1)}{kT} \right] \quad (\text{A1.1})$$

Here n_1 is the number of molecules in state 1, energy ϵ_1 , n_2 is the number of molecules in state 2, energy ϵ_2 , k is the Boltzmann constant, 1.3806×10^{-16} erg $^\circ\text{K}^{-1}$, and T is the absolute temperature in degrees Kelvin.^b

^a Derivations may be found in the sources cited in note 36 of Chapter 2.

^b For a derivation see K. B. Wiberg, *Physical Organic Chemistry*, Wiley, New York, 1964, p. 211, or W. J. Moore, *Physical Chemistry*, 3rd ed., Prentice-Hall, Englewood Cliffs, N.J., 1962, p. 619.

Let us assume that we have two isomeric substances A and B in equilibrium at very low temperature, so that we can say that for practical purposes all molecules are in their lowest energy states. Then we could regard A and B as two energy states of a system, and since there are only two populated states, the equilibrium constant K , the ratio of the number of B molecules to the number of A molecules, would be given by Equation A1.2,

$$K = \frac{N_B}{N_A} = \exp \left[\frac{-(\epsilon_{0B} - \epsilon_{0A})}{kT} \right] \quad (\text{A1.2})$$

The quantity ϵ_{0B} is the energy of the lowest state of B, and ϵ_{0A} is the energy of the lowest state of A. As it is more convenient to have energies on a molar basis, we multiply the energies and the Boltzmann constant by Avagadro's number, N_0 , and since kN_0 is equal to the gas constant R , 1.986 cal °K mole⁻¹, we obtain Equation A1.3:

$$K = \exp \left[\frac{-(E_{0B}^\circ - E_{0A}^\circ)}{RT} \right] \quad (\text{A1.3})$$

E_0° is the standard state energy at 0°K. Equation A1.3 may be written in the form A1.4, and since at absolute zero $\Delta E_0^\circ = \Delta H_0^\circ = \Delta G_0^\circ$, this equation is

$$-\Delta E_0^\circ = RT \ln K \quad (\text{A1.4})$$

indeed the familiar thermodynamic expression for the equilibrium constant.

The Partition Function

The example we have used is of course unrealistic; we are interested in what goes on at temperatures above absolute zero, where many energy levels of the molecules are populated. All we need do to correct our equilibrium constant A1.3 is to find out how many molecules of A and of B are in each energy level at the temperature of interest. The total number of molecules of A, N_A , is the sum of numbers of molecules in each energy state,

$$N_A = n_{0A} + n_{1A} + n_{2A} + \dots \quad (\text{A1.5})$$

So far we have assumed that each state has a different energy, but this will not always be true. We have to allow for *degeneracies*, that is, groups of more than one state at the same energy. When two states have the same energy, their populations must be identical; we therefore modify Equation A1.5 to A1.6, where g_{iA} is the

$$N_A = g_{0A}n_{0A} + g_{1A}n_{1A} + g_{2A}n_{2A} + \dots \quad (\text{A1.6})$$

number of states that have energy ϵ_{iA} , and n_{iA} is the number of molecules occupying a single state of energy ϵ_{iA} . Since the Boltzmann distribution deals with ratios of numbers in various states, we divide both sides of Equation A1.6 by n_{0A} and obtain Equation A1.7, which gives the ratio of the total number of molecules to

$$\frac{N_A}{n_{0A}} = g_{0A} + g_{1A} \frac{n_{1A}}{n_{0A}} + g_{2A} \frac{n_{2A}}{n_{0A}} + \dots \quad (\text{A1.7})$$

the number in the lowest energy state. Then, using Equation A1.1, we obtain

$$\frac{N_A}{n_{0A}} = g_{0A} + g_{1A} \exp\left[\frac{-(\epsilon_{1A} - \epsilon_{0A})}{kT}\right] + g_{2A} \exp\left[\frac{-(\epsilon_{2A} - \epsilon_{0A})}{kT}\right] + \dots \quad (\text{A1.8})$$

or

$$\frac{N_A}{n_{0A}} = \sum_i g_{iA} \exp\left[\frac{-(\epsilon_{iA} - \epsilon_{0A})}{kT}\right] \quad i = 0, 1, 2, \dots \quad (\text{A1.9})$$

The ratio N_A/n_{0A} is defined as the partition function for A, Q_A ,

$$Q_A = \frac{N_A}{n_{0A}} = \sum_i g_{iA} \exp\left[\frac{-(\epsilon_{iA} - \epsilon_{0A})}{kT}\right] \quad (\text{A1.10})$$

If we want to know the equilibrium constant for the isomerization $A \rightleftharpoons B$, we need again $K = N_B/N_A$. But we have N_A and N_B summed up over all the energy states in the partition functions,

$$N_A = n_{0A} Q_A \quad (\text{A1.11})$$

$$N_B = n_{0B} Q_B \quad (\text{A1.12})$$

and the equilibrium constant is given by Equation A1.13:

$$K = \frac{N_B}{N_A} = \frac{n_{0B} Q_B}{n_{0A} Q_A} \quad (\text{A1.13})$$

The ratio n_{0B}/n_{0A} , the numbers in the lowest states, is, as we have already seen, just $\exp[-(E_{0B}^\circ - E_{0A}^\circ)/RT]$, so our equilibrium constant is

$$K = \frac{Q_B}{Q_A} \exp\left[\frac{-(E_{0B}^\circ - E_{0A}^\circ)}{RT}\right] \quad (\text{A1.14})$$

or

$$RT \ln K = -\Delta E_0^\circ + RT \ln\left(\frac{Q_B}{Q_A}\right) \quad (\text{A1.15})$$

For an isomerization, in which there is no change in the number of molecules, the expression A1.15 is equal to $-\Delta G_T^\circ$. When the number of molecules changes, Equation A1.15 must be modified to Equation A1.16.^c

$$RT \ln K = -\Delta G_T^\circ = -\Delta E_0^\circ + \Delta(PV) + RT \ln\left(\frac{Q_B}{Q_A}\right) \quad (\text{A1.16})$$

The Components of the Partition Function

For thinking about transition states, it is useful to divide the energy levels into categories, and to associate a fraction of the partition function with each category.

^c The other thermodynamic functions are readily derived from Equation A1.16. See, for example, Wiberg, *Physical Organic Chemistry*, p. 216.

Each energy level has contributions from translational, rotational, vibrational, and electronic substates,

$$\epsilon_i = \epsilon_{it} + \epsilon_{ir} + \epsilon_{iv} + \epsilon_{ie} \quad (\text{A1.17})$$

If the state multiplicity g_i is the product of the multiplicities of the substates, each term in the partition function sum can be written in terms of these energies as in Equation A1.18,

$$g_i \exp\left[\frac{-(\epsilon_i - \epsilon_0)}{kT}\right] = g_{it} \exp\left[\frac{-(\epsilon_{it} - \epsilon_{0t})}{kT}\right] g_{ir} \exp\left[\frac{-(\epsilon_{ir} - \epsilon_{0r})}{kT}\right] g_{iv} \exp\left[\frac{-(\epsilon_{iv} - \epsilon_{0v})}{kT}\right] \\ \times g_{ie} \exp\left[\frac{-(\epsilon_{ie} - \epsilon_{0e})}{kT}\right] \quad (\text{A1.18})$$

There is a term like Equation A1.18 for each energy level, and there is an energy level for every combination of each ϵ_{it} , ϵ_{ir} , ϵ_{iv} , ϵ_{ie} with every other, so the whole partition function is a multiple sum over all combinations,

$$Q = \sum_{\epsilon_{it}} g_{it} \exp\left[\frac{-(\epsilon_{it} - \epsilon_{0t})}{kT}\right] \sum_{\epsilon_{ir}} g_{ir} \exp\left[\frac{-(\epsilon_{ir} - \epsilon_{0r})}{kT}\right] \sum_{\epsilon_{iv}} g_{iv} \exp\left[\frac{-(\epsilon_{iv} - \epsilon_{0v})}{kT}\right] \\ \times \sum_{\epsilon_{ie}} g_{ie} \exp\left[\frac{-(\epsilon_{ie} - \epsilon_{0e})}{kT}\right] \quad (\text{A1.19})$$

or

$$Q = f_t f_r f_v f_e \quad (\text{A1.20})$$

where the f 's are separated partition functions for the different kinds of motion.

We shall need to know how to evaluate these separated partition functions. The translational energy levels can be derived from the quantum mechanical solution for a particle in a box; they are so closely spaced that the partition function can be evaluated in closed form by integration, and has the value

$$f_t = \left(\frac{2\pi M k T}{h^2}\right)^{1/2} a \quad (\text{A1.21})$$

for each dimension, where M is the mass, h is Planck's constant, and a is the length of the box. For three dimensions,^d

$$f_t = \left(\frac{2\pi M k T}{h^2}\right)^{3/2} V \quad (\text{A1.22})$$

where V is the volume.

The rotational partition function, found in a similar way, is^e

$$f_r = \left(\frac{8\pi k T}{h^2}\right)^{3/2} \frac{(I_x I_y I_z)^{1/2}}{\sigma} \quad (\text{A1.23})$$

where I_x , I_y , I_z are the moments of inertia about three mutually perpendicular

^d This value is, strictly speaking, correct only for the gas phase. See, for example, Moore, *Physical Chemistry*, p. 627.

^e Moore, *Physical Chemistry*, p. 630; Wiberg, *Physical Organic Chemistry*, p. 221.

axes and σ is the symmetry number, the number of equivalent ways of orienting the molecule.

The vibrational partition function, which is the one of most concern for our purposes, is found by summing over the vibrational energy levels for each vibrational mode and multiplying together the results for all the modes. Assuming simple harmonic motion, the lowest energy level for a normal mode, the *zero-point* energy, is as energy $\epsilon_0 = \frac{1}{2}h\nu$, measured from the minimum of the potential energy. Here ν is the excitation frequency for the vibration (equal to the frequency observed for that mode in the infrared or Raman spectrum). The other levels are spaced upwards from this one at intervals of $h\nu$. The levels thus fall at integral multiples of $h\nu$ above the lowest and, since there are no degeneracies, the vibrational partition function for each normal mode is

$$f_v^{\text{mode } i} = \sum_{n=0}^{\infty} \exp -\frac{nh\nu_i}{kT} \quad (\text{A1.24})$$

Since an infinite sum of terms of the form e^{-ax} converges to $1/(1 - e^{-ax})$, the partition function A1.24 is more simply written

$$f_v^{\text{mode } i} = [1 - \exp(-u_i)]^{-1} \quad (\text{A1.25})$$

where $u_i = h\nu_i/kT$. The total vibrational partition function is then a product of terms for the $3N - 6$ modes,

$$f_v = \prod_{i=1}^{3N-6} [1 - \exp(-u_i)]^{-1} \quad (\text{A1.26})$$

The electronic partition function can be evaluated by summing over spectroscopically determined electronic states, but as the electronic energy-level separations are large, the number of molecules in excited electronic states is negligibly small at ordinary temperatures and the electronic partition function is unity and will be ignored henceforth.

THE TRANSITION STATE EQUILIBRIUM

Now consider Reaction A1.27 in the k_1 direction.

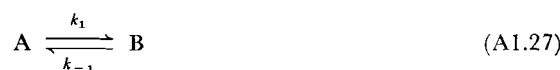

We have from Section 2.6 the following relations:

$$[\text{A}^\ddagger] = K_\ddagger[\text{A}] \quad (\text{A1.28})$$

$$k_1[\text{A}] = k^\ddagger[\text{A}^\ddagger] \quad (\text{A1.29})$$

$$k_1 = k^\ddagger K_\ddagger \quad (\text{A1.30})$$

We express the equilibrium constant K_\ddagger in terms of the partition function ratio Q_\ddagger/Q_A to yield Equation A1.31, where ΔE_0^\ddagger is the difference between the lowest

$$k_1 = k^\ddagger \frac{Q_\ddagger}{Q_A} \exp -\frac{\Delta E_0^\ddagger}{RT} \quad (\text{A1.31})$$

energy level of A and the lowest energy level of the transition state.

Now we must analyze Q_{\ddagger} . It contains the usual translational and rotational functions, f_t^{\ddagger} and f_r^{\ddagger} ; the electronic contribution f_e^{\ddagger} is unity. It is in the vibrational part that the difference from the ordinary stable molecule appears. Since one degree of freedom (that corresponding to the reaction coordinate) is no longer a vibration, there are only $3N - 7$ vibrations in Q_{\ddagger} , and these contribute in the usual way according to Equation A1.32. The motion along the reaction coordinate is

$$f_v^{\ddagger} = \prod_{i=1}^{3N_{\ddagger}-7} [1 - \exp(-u_{i\ddagger})]^{-1} \quad (\text{A1.32})$$

much more like a translation than a vibration and its contribution, $f_{\text{R.C.}}$, is therefore written as a one-dimensional translational function (p. 116),

$$f_{\text{R.C.}} = \frac{(2m_{\ddagger}kT)^{1/2}}{h} \delta \quad (\text{A1.33})$$

where δ is an arbitrary interval measured along the reaction coordinate at the top of the barrier. (We shall see later that the exact value of δ is immaterial.)

The expression for k_1 can now be written in terms of a reduced partition function, Q^{\ddagger} , which contains only the translational, rotational, and vibrational contributions an ordinary molecule would have, and the special contribution $f_{\text{R.C.}}$:

$$k_1 = k^{\ddagger} \frac{(2m_{\ddagger}kT)^{1/2}}{h} \delta \frac{Q^{\ddagger}}{Q_A} \exp -\frac{\Delta E_0^{\ddagger}}{RT} \quad (\text{A1.34})$$

Next we examine k^{\ddagger} . At the top of the barrier, in the interval δ , there will be transition state molecules moving both to the right, in the direction $A \rightarrow B$, and to the left, in the direction $A \leftarrow B$. We want to know the average velocity of motion of those that are moving from left to right. The energy of motion of one of the transition state molecules is $\frac{1}{2}m_{\ddagger}v^2$, where v is its velocity. Positive v corresponds to motion from left to right, negative from right to left. The average we shall find with the aid of a velocity distribution function, that is, a function that for each velocity is proportional to the probability of finding that velocity. When the velocity is v , the energy of motion is $\frac{1}{2}mv^2$. The Boltzmann distribution gives the ratio of the number of transition states with velocity v to the number with zero velocity as

$$\frac{N_v}{N_0} = \exp -\frac{\frac{1}{2}m_{\ddagger}v^2}{kT} \quad (\text{A1.35})$$

A plot of this function against velocity is the required distribution, and the area under the curve between v and $v + dv$ is, in the limit as $dv \rightarrow 0$, proportional to the probability of finding a transition state with velocity v . The average is found by summing over all velocities the product of velocity times the probability of finding that velocity. Since the total probability of finding some velocity should be unity, the result must be divided by the total area under the curve to correct for the lack of normalization. The desired average, \bar{v} is then given by Equation A1.36,

$$\bar{v} = \frac{\int_0^{\infty} v \exp(-\frac{1}{2}mv^2/kT) dv}{\int_0^{\infty} \exp(-\frac{1}{2}mv^2/kT) dv} \quad (\text{A1.36})$$

where the limits of integration in the numerator are set at 0 to $+\infty$ because we are interested only in positive v . Evaluation of the integrals yields Equation A1.37:

$$\bar{v} = \frac{kT/m_{\ddagger}}{(2\pi kT/m_{\ddagger})^{1/2}} = \left(\frac{kT}{2\pi m_{\ddagger}}\right)^{1/2} \quad (\text{A1.37})$$

The rate at which transition states pass over the barrier from left to right is just their velocity, \bar{v} , divided by the distance they must go, which we called δ above in the partition function. Therefore

$$k^{\ddagger} = \frac{1}{\delta} \left(\frac{kT}{2\pi m_{\ddagger}}\right)^{1/2} \quad (\text{A1.38})$$

and, from Equation A1.34,

$$k_1 = \frac{1}{\delta} \left(\frac{kT}{2\pi m_{\ddagger}}\right)^{1/2} \frac{(2\pi m_{\ddagger} kT)^{1/2}}{h} \delta \frac{Q^{\ddagger}}{Q_A} \exp\left(-\frac{\Delta E_{\ddagger}^{\ddagger}}{RT}\right) \quad (\text{A1.39})$$

Equation A1.39 reduces to Equation A1.40:

$$k_1 = \frac{kT}{h} \frac{Q^{\ddagger}}{Q_A} \exp\left(-\frac{\Delta E_{\ddagger}^{\ddagger}}{RT}\right) \quad (\text{A1.40})$$

Another way to express this result is to define a new equilibrium constant, K^{\ddagger} , which includes all features of the transition state except the reaction coordinate, and write

$$k_1 = \frac{kT}{h} K^{\ddagger} \quad (\text{A1.41})$$

We then define free energy of activation as the free energy of the transition state excluding the reaction coordinate mode, so that Equations A1.42 and A1.43 hold.

$$\Delta G^{\ddagger} = -RT \ln K^{\ddagger} \quad (\text{A1.42})$$

$$K^{\ddagger} = \exp\left(\frac{-\Delta G^{\ddagger}}{RT}\right) \quad (\text{A1.43})$$

A factor κ , called the *transmission coefficient*, is sometimes included in the expression for k_1 to allow for the possibility that some transition states may be reflected back at the barrier, or that some may tunnel through it even though classically they do not have the requisite energy. These corrections are usually considered to be small, and we shall simply disregard them. We leave it as an exercise to the reader to extend the transition state treatment to bimolecular reactions.

Appendix 2

THE TRANSITION

STATE THEORY OF

ISOTOPE EFFECTS

We begin with the transition state theory result for the rate constant, Equation A1.40. We shall need to consider bimolecular processes, $A + B \rightarrow C$, for which the proper adaptation of Equation A1.40 is Equation A2.1. The quantity ΔE_0^\ddagger is

$$k = \frac{kT}{h} \frac{Q^\ddagger}{Q_A Q_B} \exp\left(-\frac{\Delta E_0^\ddagger}{RT}\right) \quad (\text{A2.1})$$

the energy difference from the lowest level of the reactants up to the lowest energy level of the transition state. But each of these lowest levels is above the potential energy curve by the sum of the zero-point vibrational energies of all the modes. It is in these zero-point energies that the differences between the H and D compounds lie; we must therefore measure energies instead from the potential energy surface, which is the same for both. The quantity $\Delta E_0^\ddagger/RT$ is given by

$$\frac{\Delta E_0^\ddagger}{RT} = \frac{(\epsilon_{0\ddagger} - \epsilon_{0r})}{kT} \quad (\text{A2.2})$$

where $\epsilon_{0\ddagger}$ is the zero-point energy of the transition state and ϵ_{0r} is the zero-point energy of reactants. Also,

$$\frac{\epsilon_{0\ddagger}}{kT} = \sum_i^{3N_{\ddagger}-7} \frac{\frac{1}{2}h\nu_{i\ddagger}}{kT} + \frac{E_{\ddagger}}{RT} \quad (\text{A2.3})$$

and

$$\frac{\epsilon_{0r}}{kT} = \sum_i^{3N_r-6} \frac{\frac{1}{2}h\nu_{ir}}{kT} + \frac{E_r}{RT} \quad (\text{A2.4})$$

The transition state sum omits the reaction coordinate degree of freedom since it is not a bound vibration and does not contribute to the zero-point energy in the transition state. E_{\ddagger} and E_r are respectively the energy of the potential energy surface at transition state and reactants. Then,

$$\frac{\Delta E_0^\ddagger}{RT} = \frac{1}{kT} \left[\sum_i^{3N_{\ddagger}-7} \frac{1}{2} h\nu_{i\ddagger} - \sum_i^{3N_r-6} \frac{1}{2} h\nu_{ir} \right] + \frac{\Delta E}{RT} \quad (\text{A2.5})$$

and

$$\exp\left(-\frac{\Delta E_0^\ddagger}{RT}\right) = \exp\left[-\frac{1}{kT} \left(\sum_i^{3N_{\ddagger}-7} \frac{1}{2} h\nu_{i\ddagger} - \sum_i^{3N_r-6} \frac{1}{2} h\nu_{ir} \right) - \frac{\Delta E}{RT}\right] \quad (\text{A2.6})$$

or

$$\exp\left(-\frac{\Delta E_0^\ddagger}{RT}\right) = \prod_i^{3N_{\ddagger}-7} \exp\left(-\frac{1}{2} u_{i\ddagger}\right) \prod_i^{3N_r-6} \exp\left(\frac{1}{2} u_{ir}\right) \exp\left(-\frac{\Delta E}{RT}\right) \quad (\text{A2.7})$$

where $u_i = h\nu_i/kT$, and ΔE is the energy difference along the potential surface from reactants to transition state. The expression for k is now given by Equation A2.8:

$$k = \frac{kT}{h} \frac{Q^\ddagger}{Q_A Q_B} \prod_i^{3N_{\ddagger}-7} \exp\left(-\frac{1}{2} u_{i\ddagger}\right) \prod_i^{3N_r-6} \exp\left(\frac{1}{2} u_{ir}\right) \exp\left(-\frac{\Delta E}{RT}\right) \quad (\text{A2.8})$$

The isotope effect is now found by taking the ratio of rate constants for the two isotopic systems (Equation A2.9).

$$\frac{k_H}{k_D} = \frac{Q_{AD} Q_{\ddagger H}}{Q_{AH} Q_{\ddagger D}} \prod_i^{3N_{\ddagger}-7} \exp\left[-\frac{1}{2}(u_{iH} - u_{iD})\right] \prod_i^{3N_r-6} \exp\left[+\frac{1}{2}(u_{iH} - u_{iD})\right] \quad (\text{A2.9})$$

The energy difference ΔE is independent of isotopic substitution and cancels. We have assumed that the isotopic substitution is in A, so Q_B cancels also.

We now refer to Appendix 1 to write the partition functions in terms of their translational, rotational, and vibrational components. Of the quantities appearing in the expressions for these components, only the molecular mass M , the moments of inertia I , the vibrational frequencies u_i , and the symmetry numbers σ are different for the isotopic molecules; all other factors cancel, leaving Equation A2.10.

$$\frac{k_H}{k_D} = \frac{\sigma_H}{\sigma_D} \left(\frac{M_D}{M_H}\right)^{3/2} \left(\frac{I_{xD} I_{yD} I_{zD}}{I_{xH} I_{yH} I_{zH}}\right)^{1/2} \left(\frac{M_H}{M_D}\right)^{3/2} \left(\frac{I_{xH} I_{yH} I_{zH}}{I_{xD} I_{yD} I_{zD}}\right)^{1/2} \prod_i^{3N_{\ddagger}-7} \exp\left[-\frac{1}{2}(u_{iH} - u_{iD})_{\ddagger}\right] \\ \times \frac{1 - \exp(-u_{iD})_{\ddagger}}{1 - \exp(-u_{iH})_{\ddagger}} \prod_i^{3N_r-6} \exp\left[+\frac{1}{2}(u_{iH} - u_{iD})_r\right] \frac{1 - \exp(-u_{iH})_r}{1 - \exp(-u_{iD})_r} \quad (\text{A2.10})$$

This expression can fortunately be simplified by use of a theorem known as the Teller-Redlich rule, which expresses the molecular mass and moment of inertia ratios in terms of a ratio of a product of all the atomic masses m_j and the vibrational frequencies:^a

^a (a) K. B. Wiberg, *Physical Organic Chemistry*, Wiley, New York, 1964, p. 275; (b) J. Bigeleisen and M. Wolfsberg, *Advan. Chem. Phys.*, 1, 15 (1958).

$$\left(\frac{M_H}{M_D}\right)^{3/2} \left(\frac{I_{xH}I_{yH}I_{zH}}{I_{xD}I_{yD}I_{zD}}\right)^{1/2} = \prod_j^N \left(\frac{m_{jH}}{m_{jD}}\right)^{3/2} \prod_i^{3N-6} \left(\frac{\nu_{iH}}{\nu_{iD}}\right) \quad (\text{A2.11})$$

For the transition state, of course, one of the $3N - 6$ vibrations is really a translation; for the moment we single it out and write for its frequency ratio $\nu_{LH}^\ddagger/\nu_{LD}^\ddagger$. When Equation A2.11 is substituted into Equation A2.10, the products of atomic masses will cancel, leaving Equation A2.12:

$$\frac{k_H}{k_D} = \frac{\sigma_H}{\sigma_D} \frac{\nu_{LH}^\ddagger}{\nu_{LD}^\ddagger} \prod_i^{3N_t^\ddagger-7} \frac{\nu_{iH}}{\nu_{iD}} \exp\left[-\frac{1}{2}(u_{iH} - u_{iD})_t^\ddagger\right] \frac{1 - \exp(-u_{iD}^\ddagger)}{1 - \exp(-u_{iH}^\ddagger)} \prod_i^{3N_r-6} \frac{\nu_{iD}}{\nu_{iH}} \times \exp\left[+\frac{1}{2}(u_{iH} - u_{iD})_r\right] \frac{1 - \exp(-u_{iH}^r)}{1 - \exp(-u_{iD}^r)} \quad (\text{A2.12})$$

This expression gives the isotope effect in terms of vibrational frequencies only; if the molecules are simple enough, a complete vibrational analysis and direct calculation of the isotope effect will be possible. But for most purposes we want an expression that will be easier to apply. Some simplification can be achieved by noting that for all those vibrational modes that involve no substantial motion at the isotopically substituted position, $\nu_{iH} = \nu_{iD}$ (and therefore also $u_{iH} = u_{iD}$) in both reactant and transition state. These modes will therefore cancel and need not be considered further. Moreover, any mode that does involve motion at the isotopically substituted position but that has the same force constant in reactant and transition state will have ν_H in the reactant equal to ν_H in the transition state and likewise for ν_D , and will also cancel. We therefore need consider only those modes for which force constants of vibrations involving the isotopically substituted position change on going from reactant to transition state. For vibrations involving hydrogen, most of which have frequencies above 1000 cm^{-1} , the factor $1 - e^{-u}$ is approximately unity. Furthermore, since all the ratios ν_H/ν_D should be about $\sqrt{2}$, they will approximately cancel.^b If we ignore for the moment the symmetry number ratio, which can always be put in later if needed, we then have

$$\frac{k_H}{k_D} \approx \prod_i^\ddagger \exp\left[-\frac{1}{2}(u_{iH} - u_{iD})_t^\ddagger\right] \prod_i^r \exp\left[+\frac{1}{2}(u_{iH} - u_{iD})_r\right] \quad (\text{A2.13})$$

where the products are over only those vibrations that involve force constant changes at isotopically substituted positions.

It is frequently also necessary to assess isotope effects on equilibria. For an equilibrium



the appropriate expression is^c

$$K_{H/D} = \prod_i^{3N_A-6} \frac{\nu_{iAD}}{\nu_{iAH}} \exp\left[+\frac{1}{2}(u_{iAH} - u_{iAD})\right] \frac{1 - \exp(-u_{iAH})}{1 - \exp(-u_{iAD})} \prod_i^{3N_B-6} \frac{\nu_{iBH}}{\nu_{iBD}} \times \exp\left[-\frac{1}{2}(u_{iBH} - u_{iBD})\right] \frac{1 - \exp(-u_{iBD})}{1 - \exp(-u_{iBH})} \quad (\text{A2.15})$$

^b See (a) L. Melander, *Isotope Effects on Reaction Rates*, Ronald Press, New York, 1960, p. 38; (b) J. Bigeleisen, *Pure Appl. Chem.*, **8**, 217 (1964), for further discussion.

^c Wiberg, *Physical Organic Chemistry*, p. 275.

Again the terms $1 - e^{-u}$ will all be close to unity and the ratios $\nu_{\text{H}}/\nu_{\text{D}}$ should all be close to $\sqrt{2}$, leaving

$$K_{\text{H/D}} \approx \prod_i^{3N_{\text{A}}-6} \exp \left[+\frac{1}{2}(u_{\text{IAH}} - u_{\text{IAD}}) \right] \prod_i^{3N_{\text{B}}-6} \exp \left[-\frac{1}{2}(u_{\text{IBH}} - u_{\text{IBD}}) \right] \quad (\text{A2.16})$$

Chapter 3

ACIDS AND

BASES

3.1 BRØNSTED ACIDS AND BASES

Of the concepts that chemists use to make sense of chemical transformations, ideas about acids and bases are among the most fruitful. Nearly all of the heterolytic reactions that we shall be considering can be thought of as acid-base processes; it is therefore appropriate to begin our discussion of the chemical properties of organic compounds with a review of these ideas and of their applications in organic chemistry.

Definition of Brønsted Acids and Bases

Acids and bases have been known for centuries, but the definitions in common use today are of comparatively recent origin. In 1923 J. N. Brønsted proposed the following definitions:¹

An acid is a proton donor.

A base is a proton acceptor.

An acid HA is thus any substance that reacts according to Equation 3.1, and a base B is any substance that reacts according to Equation 3.2:



If one confines one's attention to the liquid phase, however, these idealized reactions apparently never occur. The proton, H^+ , does not exist free in solution,

¹ J. N. Brønsted, *Rec. Trav. Chim.*, 42, 718 (1923).

but rather is always solvated by at least one molecule of some other species. Thus in water protons exist as hydronium ions, H_3O^+ ; in ammonia as ammonium, NH_4^+ ; in alcohols as ROH_2^+ .^{2,3} Clearly, in each of these cases the solvating molecule has acted as a base according to the Brønsted definition. The small size and consequent large electrostatic field of the proton makes it seem very likely that in solution association of H^+ with a base is a general phenomenon.⁴ It is therefore more reasonable to represent the actual process of dissociation of an acid (acetic acid, for example) in a solvent such as water as shown in Equation 3.3. Here the acid donates a proton and the base accepts it; this chemical change constitutes an acid–base reaction in the Brønsted sense.

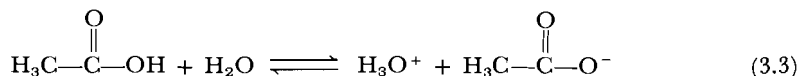

If we look again at Equation 3.3, we can see that we should consider the reverse process as an acid–base reaction just as the forward process is. The acetate ion is a base that can accept a proton from the acid H_3O^+ . This reciprocal relationship is emphasized by the terminology applied to processes like that in Equation 3.3: Acetate ion is called the conjugate base of the acid CH_3COOH , and H_3O^+ is called the conjugate acid of the base H_2O .

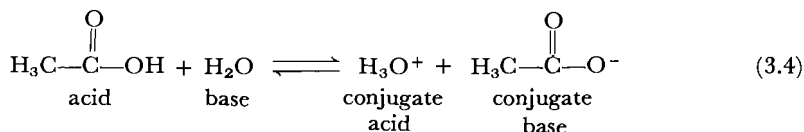

In considering an acid–base reaction, it is important to realize that the choice of which acid is to be called the conjugate acid is completely arbitrary. In Equation 3.4 we could just as well have decided to call H_2O the conjugate base of the acid H_3O^+ and CH_3COOH the conjugate acid of the base CH_3COO^- . It would perhaps be better to emphasize the fundamental symmetry of the situation by writing Equation 3.5:

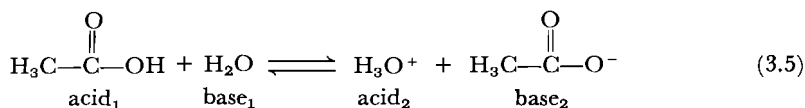

However, the conjugate acid–conjugate base nomenclature is convenient, and we shall continue to use it.

We now need to generalize our ideas in various ways. First, it is clear that it is not always necessary that the molecules and ions involved be of the charge types shown in the example that has been used so far. Acids and bases can have

² See (a) R. P. Bell, *The Proton in Chemistry*, 2nd ed., Cornell University Press, Ithaca, N.Y., 1973, p. 13; (b) M. Eigen, *Angew. Chem. Int. Ed.*, **3**, 1 (1964).

³ The exact degree of solvation is not known; we use these designations for convenience, although some formula such as $\text{H}(\text{H}_2\text{O})_n^+$ might in fact be more accurate. The symbol H^+ is also commonly used to represent the proton; this notation should be understood as an abbreviation for the solvated species that is actually present.

⁴ G. A. Olah, A. M. White, and D. H. O'Brien, *Chem. Rev.*, **70**, 561 (1970), review evidence for coordination of protons with a large number of substances.

any of a variety of
Equations 3.6–3.9.

the equilibria shown in

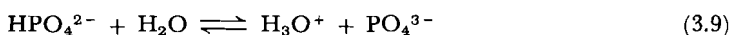
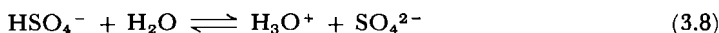
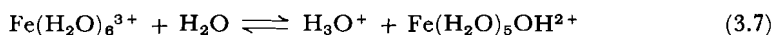

In general we might write:



where m and n can each be a positive or negative integer or zero.

Next, we must recognize that many molecules that we ordinarily think of as exhibiting neither acidic nor basic behavior are in fact acids or bases, or, frequently, both. For example, acetone, which is neutral in water solution, reacts as a base in sulfuric acid according to the equilibrium 3.11; and in dimethylsulfide containing sodium methoxide, acetone is an acid (Equation 3.12).⁵

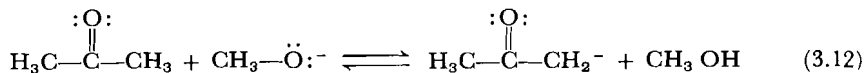
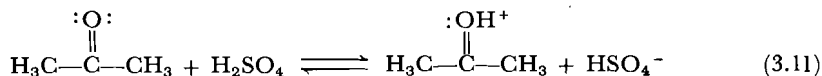

Logical extension of these ideas leads to the conclusion that acetic acid is a base as well as an acid, and that aniline, a substance ordinarily considered as a base, can also act as an acid (Equations 3.13 and 3.14).

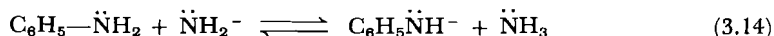
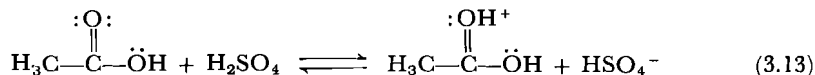

Indeed, one may conclude that any molecule containing hydrogen is a potential Brønsted acid, whereas any molecule at all is a potential Brønsted base.

Acid and Base Strength

For acids that can be studied in aqueous solution, we measure the strength by the magnitude of the equilibrium constant for dissociation, K_a . This quantity is defined by first writing the equilibrium constant K'_a for Reaction 3.15, using

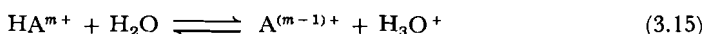

$$K'_a = \frac{a_{\text{A}^{(m-1)+}} a_{\text{H}_3\text{O}^+}}{a_{\text{HA}^{m+}} a_{\text{H}_2\text{O}^+}} \quad (3.16)$$

$$K_a = \frac{a_{\text{A}^{(m-1)+}} a_{\text{H}_3\text{O}^+}}{a_{\text{HA}^{m+}}} \quad (3.17)$$

⁵ Later in this chapter we shall consider the experimental methods of detecting reactions like 3.11 and 3.12 and the problem of measurement of their equilibrium constants.

activities,⁶ and then converting to the more usual form given in Equation 3.17 by incorporating the water activity, which is essentially constant in dilute solution when water is the solvent, into the equilibrium constant. It is often convenient to write K_a in terms of concentrations and activity coefficients, as indicated in Equation 3.18.⁷

$$K_a = \frac{[A^{(m-1)+}][H_3O^+]\gamma_{A^{(m-1)+}}\gamma_{H_3O^+}}{[HA^{m+}]\gamma_{HA^{m+}}} \quad (3.18)$$

The standard state is defined as the hypothetical state that would exist if the solute were at a concentration of 1 M, but with the molecules experiencing the environment of an extremely dilute solution; with this standard state, activity coefficients approach unity with increasing dilution. For electrolytes in dilute solution in water, the departure of the coefficients from unity can be calculated from the Debye-Hückel relationship.⁸

It is possible to define another equilibrium constant, K_c (Equation 3.19), which does not include the activity coefficients and hence will not be a true con-

$$K_c = \frac{[A^{(m-1)+}][H_3O^+]}{[HA^{m+}]} \quad (3.19)$$

stant except in very dilute solutions, where it approaches the thermodynamic K_a that we have been considering so far. The constant K_c is often used for convenience, but it is not satisfactory for careful work, nor where comparisons between different solvents must be made.

Base strengths can be defined similarly by the equilibrium constant for Reaction 3.20:



$$K'_b = \frac{a_{BH^{(m+1)+}} a_{OH^-}}{a_{B^{m+}} a_{H_2O}} \quad (3.21)$$

Or, adopting the same convention as before with respect to the water activity,

$$K_b = \frac{a_{BH^{(m+1)+}} a_{OH^-}}{a_{B^{m+}}} \quad (3.22)$$

However, it is more convenient to consider instead of Reaction 3.20 the acid dissociation of the acid $BH^{(m+1)+}$:

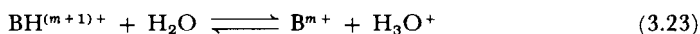

$$K_a = \frac{a_{B^{m+}} a_{H_3O^+}}{a_{BH^{(m+1)+}}} \quad (3.24)$$

If K_a for equilibrium 3.23 is known, K_b , as defined by Equation 3.22, can easily be found by use of the constant K_w , the ionization constant of pure water. K_w is

⁶ W. J. Moore, *Physical Chemistry*, 3rd ed., Prentice-Hall, Englewood Cliffs, N.J., 1962, p. 191.

⁷ The activity coefficient γ is defined so that $a = \gamma c$, where a is activity and c is concentration. See Moore, *Physical Chemistry*, p. 198.

⁸ See Moore, *Physical Chemistry*, p. 351.

defined by Equations 3.25 and 3.26, and has been carefully measured at various temperatures.



$$K_w = a_{\text{H}_3\text{O}^+} a_{\text{OH}^-}$$

It has the value $10^{-14.00}$ at 25°C .⁹ From Equations 3.22, 3.24, and 3.26, to verify that the relation between K_b of a substance and K_a of its conjugate acid is Equation 3.27:

$$K_a K_b = K_w$$

In order to avoid proliferation of tables, it is customary to report only one constant for each conjugate acid–conjugate base pair. The reader may easily verify that if acid A is a stronger acid than acid B, the conjugate base of A will be a weaker base than the conjugate base of B.

The Leveling Effect

We are now in a position to consider the experimental problems involved in measuring equilibrium constants for acids of differing strengths. One may use any of a number of methods of determining the concentrations of the various species involved in the reaction; the most common procedure for aqueous solutions is to use the glass electrode, which allows a convenient and accurate determination of hydrogen ion activity over a wide range.¹⁰ Other possibilities include spectrophotometric determinations of acid and conjugate base, and conductimetric measurement of ion concentrations.

It generally happens that the range of acidity that can be determined in a given solvent is limited by the acid–base reactions of the solvent itself. Consider, for example, the hypothetical situation of two acids, HA_1 and HA_2 , with dissociation constants of 10^{+2} and 10^{+3} , respectively ($\text{p}K_a = -2$ and -3 , respectively).¹¹ If we add enough of each of these acids to water to give solutions $0.1 M$ in total acid, the solutions will be respectively $0.09990 M$ and $0.09999 M$ in hydrogen ion, a difference of only 0.0004 pH unit. This difference is too small to measure; the most one can say is that both substances, being stronger acids than H_3O^+ , behave as strong acids in water, and are essentially completely dissociated. Note that, if the two acids are again separated by one $\text{p}K$ unit, but this time have dissociation constants of 10^{-4} and 10^{-5} ($\text{p}K_a = +4$ and $+5$), the pH of the two solutions will differ by an easily measurable 0.5 unit. Similar difficulties arise with very weak acids; in this case the amount of H_3O^+ produced by dissociation of the acid is less than the amount present by virtue of the ionization of water itself (Equation 3.25) and so cannot be determined. As a rough rule we can state that in water solution it is possible to measure strengths only of those acids that are stronger than water and weaker than hydronium ion; by the same token,

⁹ H. S. Harned and R. A. Robinson, *Trans. Faraday Soc.*, **36**, 973 (1940).

¹⁰ See, for example, H. H. Willard, L. L. Merritt, Jr., and J. A. Dean, *Instrumental Methods of Analysis*, 4th ed., Van Nostrand Reinhold, New York, 1965, p. 589.

¹¹ $\text{p}K_a$ is defined by the equation:

$$\text{p}K_a = -\log K_a$$

A $\text{p}K$ difference of one unit thus corresponds to a factor of ten difference in K_a .

bases can be studied in water only if they are stronger bases than water and weaker than OH^- .

The phenomenon described above for water also applies to other amphoteric solvents. It is termed the *leveling effect*, and may be summarized by the following statements:

1. No acid stronger than the conjugate acid of a solvent can exist in appreciable concentration in that solvent.
2. No base stronger than the conjugate base of a solvent can exist in appreciable concentration in that solvent.

Useful correlaries of these statements are the following:

1. Relative strengths of acids stronger than the conjugate acid of a solvent cannot be determined in that solvent.
2. Relative strengths of bases stronger than the conjugate base of the solvent cannot be determined in that solvent.

The acids in which we are interested span a range of roughly 60 p*K* units, from the strongest acids (HI , HClO_4) to the weakest (methane, cyclohexane), and since there is no single solvent that is suitable for the entire range, it is necessary to use several different solvents and to try to make connections among the results obtained.

Water is taken as the standard solvent for setting up a scale of acidity. It has the advantage, in addition to convenience, of having a high dielectric constant and being effective in solvating ions. As we noted in Section 2.4 (p. 85), the result of these properties is that positive and negative ions separate, and complications that result from association of ions in pairs or in larger aggregates are avoided.¹² For acids too strong to be investigated in water solution, more acidic media such as acetic acid or mixtures of water with sulfuric or perchloric acid are commonly used; for very weak acids, solvents such as liquid ammonia, dimethylsulfoxide, and cyclohexylamine have been employed.

The experimental procedures and the results obtained with some of these solvents are discussed in Sections 3.2 and 3.3. We note here only that the task of relating the results of acidity measurements obtained in different solvents is by no means a simple one, and that it has not proved possible to establish a scale that provides unambiguously and quantitatively relative acidities of substances over the whole range of interest to chemists. Thus the relative acidities of two acids may be different in different solvents, and we may have to be content with qualitative results if we wish to generalize about acid strengths over wide ranges. If, however, we are willing to restrict our attention to acids that can all be investigated in the same solvent, it will be possible to obtain quantitative results.

3.2 STRENGTHS OF WEAK BRØNSTED BASES

A variety of organic reactions, including dehydration of alcohols, cleavage of ethers, many additions to olefins, a number of nucleophilic substitutions, and various rearrangements, are catalyzed by acids. Since the substrates in these

¹² I. M. Kolthoff and S. Bruckenstein, *J. Amer. Chem. Soc.*, **78**, 1 (1956).

processes are bases, it is reasonable to postulate that the reactions involve acid-base interactions. In order to obtain further information about the detailed course of these types of reactions, it is often desirable to be able to make quantitative measurements of the acid-base properties of the substances involved.

Acidity Functions

One solution to the problem of achieving appreciable concentrations of the protonated form of very weak bases is to use as a solvent a mixture of water with some strong mineral acid. It can be demonstrated by measurement of freezing-point depressions¹³ that many organic compounds that contain basic atoms such as N, O, or S, but that are too weakly basic to be protonated to a significant extent in water, are essentially completely converted to their conjugate acids in concentrated sulfuric acid.¹⁴ In appropriately chosen mixtures of water and sulfuric acid, appreciable concentrations of both base and conjugate acid may be expected to be present. In order to study these phenomena, one must have a procedure for determining acidity over a very wide range of proton-donating capacity, from pure water to pure sulfuric acid.

Hammett and Deyrup, in 1932, were the first to propose a method of determining quantitatively acid-base behavior in water-strong acid mixtures.¹⁵⁻¹⁷ In order to understand their contribution, we begin with the general expression for the equilibrium constant for the dissociation of an acid (compare Equation 3.16):



$$K_a = \frac{a_{\text{A}} a_{\text{SH}^+}}{a_{\text{AH}^+} a_{\text{S}}} \quad (3.29)$$

or

$$K_a = \frac{a_{\text{SH}^+} [\text{A}] \gamma_{\text{A}}}{a_{\text{S}} [\text{AH}^+] \gamma_{\text{AH}^+}} \quad (3.30)$$

We have chosen to write the reaction in the particular form 3.28 because this form corresponds to acids and bases of the same charge type as those on which Hammett and Deyrup based their original work. AH^+ corresponds to the protonated form of the weak base (for example, $(\text{CH}_3)_2\text{C}=\text{OH}^+$, $p\text{-NO}_2\text{-C}_6\text{H}_5\text{NH}_3^+$,

¹³ For a discussion of freezing-point depression, see W. J. Moore, *Physical Chemistry*, 3rd ed., Prentice-Hall, Englewood Cliffs, N.J., 1962, p. 132.

¹⁴ For example, the observation that the freezing point of a 1 molal solution of acetone in sulfuric acid is depressed by twice the molal freezing-point depression constant of sulfuric acid is interpreted in terms of the reaction



This equilibrium lies far to the right; 2 moles of ions are produced for each mole of acetone added. Similar results are obtained with many other compounds that are neutral in water but contain unshared electron pairs.

¹⁵ L. P. Hammett and A. J. Deyrup, *J. Amer. Chem. Soc.*, **54**, 2721 (1932).

¹⁶ L. P. Hammett, *Physical Organic Chemistry*, 2nd ed., McGraw-Hill, New York, 1970, chapter 9.

¹⁷ For reviews, see (a) M. A. Paul and F. A. Long, *Chem. Rev.*, **57**, 1 (1957); (b) R. H. Boyd, in *Solute-Solvent Interactions*, J. F. Coetzee and C. D. Ritchie, Eds., Marcel Dekker, New York, 1969, p. 97; (c) V. A. Palm, Ü. L. Haldna, and A. J. Talvik, in *The Chemistry of the Carbonyl Group*, S. Patai, Ed., Wiley-Interscience, London, 1966 (applications to carbonyl compounds only).

etc.), A to the free base form, S to some base present in the solvent (H_2O molecules or HSO_4^- ions), and SH^+ to the conjugate acids of these species (H_3O^+ , H_2SO_4). Note that the nature of S and SH^+ is not well defined, since in mixed solvents each consists of more than one species; however, the proton-donating ability of SH^+ and the proton-accepting ability of S, whatever they may be, together determine the effectiveness of the particular solvent mixture in protonating the base A, and so are characteristic of that solvent mixture. It is this "protonation effectiveness" that Hammett and Deyrup first set out to measure.

The next step is to choose a series of bases, $A_1, A_2, A_3, \dots, A_n, \dots$, each weaker than the previous one. We also require that these substances absorb light in the visible or ultraviolet region, and that the absorption spectra of the free bases differ from the spectra of their respective conjugate acids. The reason for this latter requirement is that we must have some means of determining the concentrations $[A]$ and $[\text{AH}^+]$ for each of the base-conjugate acid pairs; the visible-ultraviolet spectrophotometric method is convenient and is the one that has been employed most frequently, although there are other methods. Hammett and Deyrup picked as their series of bases various substituted anilines with increasing numbers of electron-withdrawing substituents to provide successively weaker bases. It is essential to the method that the first base, A_1 , be sufficiently strong that the acid dissociation constant of its conjugate acid can be determined in pure water. In dilute aqueous solution, SH^+ in Equation 3.28 is H_3O^+ , S is H_2O , and the activity coefficients approach unity, so the problem reduces to the relatively straightforward one discussed in Section 3.1. We next go to a solvent containing a small amount of sulfuric acid, for example 10 percent of H_2SO_4 , in which the base A_1 will still give appreciable concentrations of both the conjugate acid and conjugate base forms, and that will also allow measurements to be made on the weaker base A_2 , which is too weak to give measurable amounts of $A_2\text{H}^+$ in pure water.

We may now write two equations of the type 3.30 describing the behavior of our two bases in the new solvent:

$$K_{a_{A_1\text{H}^+}} = \frac{a_{\text{SH}^+} [A_1] \gamma_{A_1}}{a_{\text{S}} [A_1\text{H}^+] \gamma_{A_1\text{H}^+}} \quad (3.31)$$

$$K_{a_{A_2\text{H}^+}} = \frac{a_{\text{SH}^+} [A_2] \gamma_{A_2}}{a_{\text{S}} [A_2\text{H}^+] \gamma_{A_2\text{H}^+}} \quad (3.32)$$

Note that $K_{a_{A_1\text{H}^+}}$ is known from the measurements in dilute water solution; we have defined the quantities in the equations in such a way that the K_a 's are truly constants (at constant temperature and pressure), and all nonideal behavior resulting from changing the solvent is incorporated into the activities. Furthermore, the concentrations $[A_1]$, $[A_1\text{H}^+]$, $[A_2]$, $[A_2\text{H}^+]$ are directly measurable spectrophotometrically. If we divide Equation 3.31 by Equation 3.32, we obtain Equation 3.33:

$$\frac{K_{a_{A_1\text{H}^+}}}{K_{a_{A_2\text{H}^+}}} = \frac{[A_1][A_2\text{H}^+] \gamma_{A_1} \gamma_{A_2\text{H}^+}}{[A_2][A_1\text{H}^+] \gamma_{A_2} \gamma_{A_1\text{H}^+}} \quad (3.33)$$

In Equation 3.33 all quantities are known or measurable except $K_{a_{A_2\text{H}^+}}$ and the ratio involving activity coefficients.

If it were possible to obtain the activity coefficients, Equation 3.33 would provide a way of obtaining $K_{a_{A_2H^+}}$. In dilute aqueous solution the Debye-Hückel theory, which is based on calculation of interionic forces in a medium containing dissociated ions, provides a method for estimating activity coefficients of ions.¹⁸ However, even for ionic strengths as low as 0.01 there are significant deviations from the theory.¹⁹ In the strong acid-water mixtures under consideration here, the concentration of ionic species (H_3O^+ , HSO_4^-) is of necessity high; thus, even if the concentrations of the acids and bases under study are kept small (as they must in any case be in order for the spectrophotometric measurements to be reliable), the Debye-Hückel theory is of no help. It is possible, however, to make the following qualitative argument. The departure of the activity coefficients from unity is the result of some nonideal behavior of the species involved. Departures from ideality therefore depend on the structure, and probably particularly on the charges, of the components. If A_1 and A_2 (and thus also A_1H^+ and A_2H^+) are sufficiently close in structure, one might guess that in a given solvent the ratio $\gamma_{A_1}/\gamma_{A_1H^+}$ would be approximately the same as $\gamma_{A_2}/\gamma_{A_2H^+}$. If this were the case, the ratio of activity coefficients in Equation 3.33 would equal unity and the equation would become

$$\frac{K_{a_{A_1H^+}}}{K_{a_{A_2H^+}}} = \frac{[A_1][A_2H^+]}{[A_2][A_1H^+]} \quad (3.34)$$

An experimental check on this assumption about activity coefficients is possible over a limited range of solvent acidity. If the composition of water-sulfuric acid mixtures is varied over the range in which all four species, A_1 , A_2 , A_1H^+ , and A_2H^+ are present in appreciable concentration, then, since $K_{a_{A_1H^+}}/K_{a_{A_2H^+}}$ is (by definition) constant, a constant ratio $[A_1][A_2H^+]/[A_2][A_1H^+]$ implies that the assumption of the ratio of γ 's being constant is correct in this range of solvents. Experimentally, for bases that are substituted anilines this test is fairly successful, a result that supports the validity of the method. The question of how similar two compounds must be to be "sufficiently close in structure" will be considered later.

Proceeding with our analysis, we find that if we can assume that Equation 3.34 is valid, we know all quantities necessary to obtain $K_{a_{A_2H^+}}$, the equilibrium constant for the second base. This base is now used in conjunction with a third base, A_3 , in a solvent system containing a larger proportion of strong acid, and the procedure is continued until equilibrium constants are established for the whole range of bases.

Having found equilibrium constants for the series of bases, we may now use them to characterize the proton-donating ability of any mixture of sulfuric acid and water. Rearranging Equation 3.30, we have

$$K_a \frac{[AH^+]}{[A]} = \frac{a_{SH^+} \gamma_A}{a_S \gamma_{AH^+}} \quad (3.35)$$

The quantity on the right side of Equation 3.35 is defined as h_0 ; it gives the

¹⁸ See note 8, p. 127.

¹⁹ Hammett, *Physical Organic Chemistry*, p. 192.

desired information about proton-donating ability.²⁰

$$h_0 = K_a \frac{[\text{AH}^+]}{[\text{A}]} \quad (3.36)$$

Because of the magnitudes of the numbers involved, it is more convenient to use a logarithmic scale. A new quantity, H_0 , is therefore defined by Equation 3.37.

$$H_0 \equiv -\log_{10} h_0 = -\log_{10} \left\{ K_a \frac{[\text{AH}^+]}{[\text{A}]} \right\} \quad (3.37)$$

or

$$H_0 = \text{p}K_a + \log_{10} \frac{[\text{A}]}{[\text{AH}^+]} \quad (3.38)$$

H_0 is known as the Hammett acidity function, and the series of substituted anilines used to establish the scale are called Hammett indicators.

The procedure outlined above serves to define H_0 for mixtures of water and various strong acids. Once H_0 has been found for a number of different mixtures, one can obtain, by use of Equation 3.38, the $\text{p}K_a$ for bases other than those used in setting up the scale. All that is needed is a method of measuring the ratio $[\text{A}]/[\text{AH}^+]$, together with the assumption that the ratio of the activity coefficients of the new base and its conjugate acid is the same as that of the indicator bases. Ranges of $\text{p}K_a$ values that have been found for various types of compounds are given in Table 3.2 in Section 3.4. Values for particular compounds may be found in the reviews by Arnett²¹ and by Paul and Long,²² where references to the original literature are given.

Other Acidity Scales

We return now briefly to the question of uniqueness of the H_0 scale. We have seen that for the treatment to be successful, the different bases involved in determining the H_0 scale, and also those bases that are to be investigated using the scale, must be of sufficiently similar structure that the activity coefficient ratio of Equation 3.33 will be unity. It has become increasingly evident as data have accumulated that this requirement is more restricting than one might have hoped. Arnett and Mach,²³ using a set of *N,N*-dialkylnitroanilines and *N*-alkylnitroanilines as

²⁰ The equations are usually written in such a way that Equation 3.35 comes out:

$$K_a \frac{[\text{AH}^+]}{[\text{A}]} = a_{\text{H}^+} \frac{\gamma_{\text{A}}}{\gamma_{\text{AH}^+}} \equiv h_0$$

This relationship results if the original acid dissociation is written:



We have chosen the formulation of Equation 3.28 because it seems to be more consistent with our discussion in Section 3.1 about the nature of Brønsted acid–base reactions. Since the quantity h_0 is empirically determined and cannot be broken down experimentally into its component parts, it makes little difference in practice which derivation is used. For direct measurements of hydrogen ion activity coefficients in these solvents, see T. A. Modro, K. Yates, and J. Janata, *J. Amer. Chem. Soc.*, **97**, 1492 (1975).

²¹ E. M. Arnett, *Prog. Phys. Org. Chem.*, **1**, 223 (1963).

²² See note 17 (a), p. 130.

²³ E. M. Arnett and G. W. Mach, *J. Amer. Chem. Soc.*, **86**, 2671 (1964).

indicator bases, found an acidity scale, designated H''' , which is different from H_0 . A group of cyclic amines, indoles of general structure **1**, were investigated by Hinman and Lang:²⁴

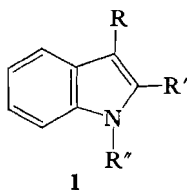

these indicators gave still another acidity scale, denoted H_I , which differed slightly from the H''' scale. Another scale, H_A , was established by Yates, Stevens, and Katritzky²⁵ with a series of amides as indicators. Still another function, H_R , is based on the behavior of triarylcarbinols. These substances, studied by Deno, Jaruzelski, and Schriesheim,²⁶ typically react according to Equation 3.39 to form water (which is converted partly to oxonium ion) and a carbocation. The H_R function thus includes the activity of water in addition to the quantities of

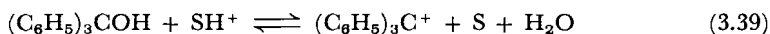

Equation 3.38. A slightly different function, H'_R , is derived from H_R by subtraction of the logarithm of water activity (Equation 3.40).

$$H'_R = H_R - \log a_{\text{H}_2\text{O}} \quad (3.40)$$

Hydrocarbons containing carbon-carbon double bonds can be protonated in strong acid media,²⁷ and a scale designated H_C appropriate to these substances has been established.²⁸

Whereas sulfuric acid has been the most frequently used acid, acidity function scales have been set up for other strong acid mixtures. Of particular interest have been the *superacid* media usually prepared from mixtures of fluoro-sulfuric acid, HSO_3F , with various Lewis acids such as SO_3 or SbF_5 . These media, the most acidic known, have made possible direct observation of highly reactive carbocations (see Section 5.4), and the protonation of extremely weak bases.²⁹ Figure 3.1 shows the behavior of some of the different acidity functions in sulfuric acid-water mixtures, Figure 3.2 gives the behavior of H_0 in mixtures of water with various strong acids, and Figure 3.3 presents data for mixtures of HSO_3F with SbF_5 .^{30, 31}

The proliferation of acidity scales, each with an equally sound basis and no one of which can claim to be any more fundamental or correct than any other, is a rather disappointing development. It nevertheless illustrates the point discussed

²⁴ R. L. Hinman and J. Lang, *J. Amer. Chem. Soc.*, **86**, 3796 (1964).

²⁵ K. Yates, J. B. Stevens, and A. R. Katritzky, *Can. J. Chem.*, **42**, 1957 (1964).

²⁶ N. C. Deno, J. J. Jaruzelski, and A. Schriesheim, *J. Amer. Chem. Soc.*, **77**, 3044 (1955).

²⁷ (a) H. H. Perkampus, *Adv. Phys. Org. Chem.*, **4**, 195 (1966); (b) D. M. Brouwer, E. L. Mackor, and C. MacLean, in *Carbonium Ions*, Vol. II, G. A. Olah and P. v. R. Schleyer, Eds., Wiley-Interscience, New York, 1970, p. 848.

²⁸ M. T. Reagan, *J. Amer. Chem. Soc.*, **91**, 5506 (1969).

²⁹ G. A. Olah and J. Shen, *J. Amer. Chem. Soc.*, **95**, 3582 (1973).

³⁰ Superacid mixtures: R. J. Gillespie and T. E. Peel, *J. Amer. Chem. Soc.*, **95**, 5173 (1973).

³¹ For a more complete discussion of the various acidity functions, see Hammett, *Physical Organic Chemistry*, chapter 9.

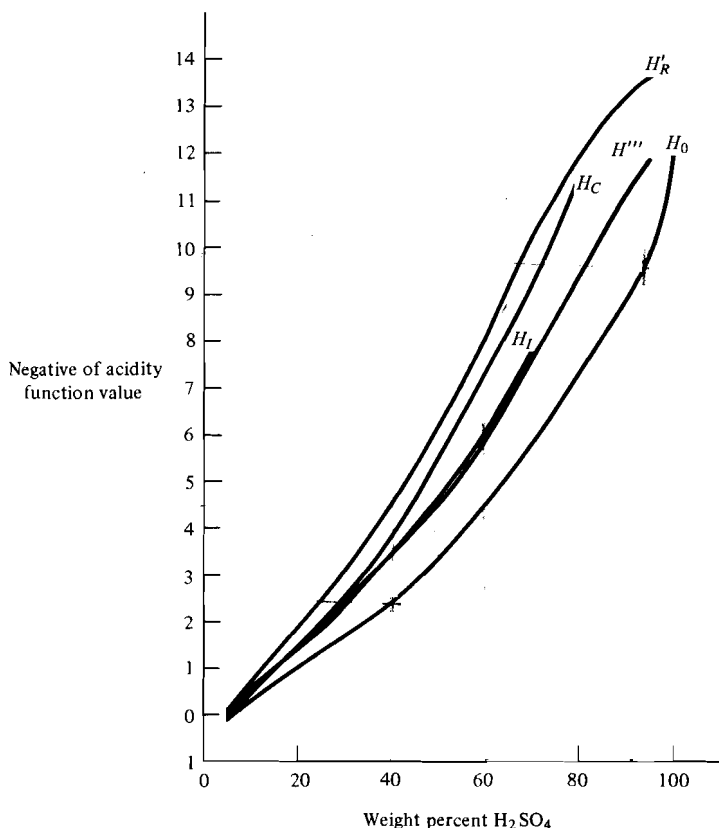

Figure 3.1 Values of various acidity functions in mixtures of water and sulfuric acid. Data for H_0 , H'' , H_1 , and H'_r are from L. P. Hammett, *Physical Organic Chemistry*, 2nd ed., McGraw-Hill, New York, 1970, p. 271; data for H_c are from M. T. Reagan, *J. Amer. Chem. Soc.*, **91**, 5506 (1969). Adapted by permission of McGraw-Hill.

in Section 2.4, that the details of solvent-solute interaction is an area of chemistry where much fundamental work remains to be done.

In principle, the acidity scale concept could be a very useful one in the investigation of reaction mechanisms. The logarithm of the rate of a reaction suspected of proceeding by way of the conjugate acid of the substrate can be measured in media of different acidity and plotted against H_0 or some other appropriate acidity function. A linear correlation would then be good evidence that the conjugate acid was indeed involved. A number of such studies have been done, often successfully, but it is becoming increasingly clear that the results of such investigations must be interpreted with caution unless the substrate is structurally very closely related to the indicator bases used in setting up the acidity scale. The generality of the method is thus severely reduced.

Measurements in Nonaqueous Solvents

An alternative to the acidity function method for making measurements with weak base-strong acid conjugate pairs is to choose a pure solvent that is more

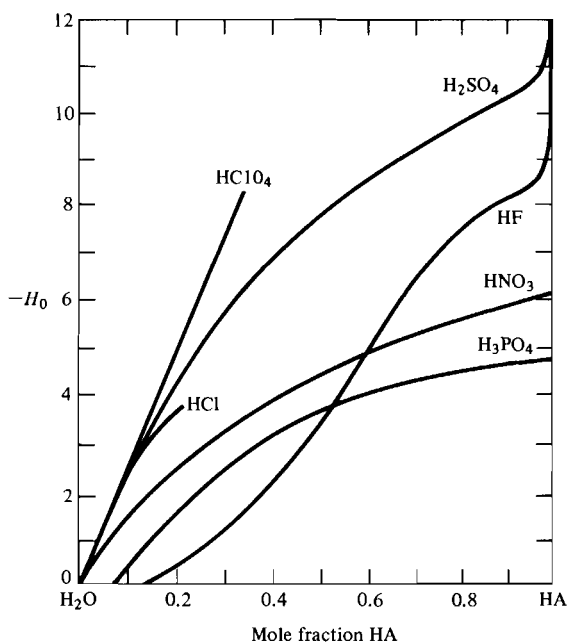

Figure 3.2 The H_0 acidity function for mixtures of water with various acids. From G. A. Olah, *Friedel-Crafts Chemistry*, Wiley, New York, 1973, p. 368. Copyright © 1973, John Wiley & Sons. Reprinted by permission of John Wiley & Sons, Inc.

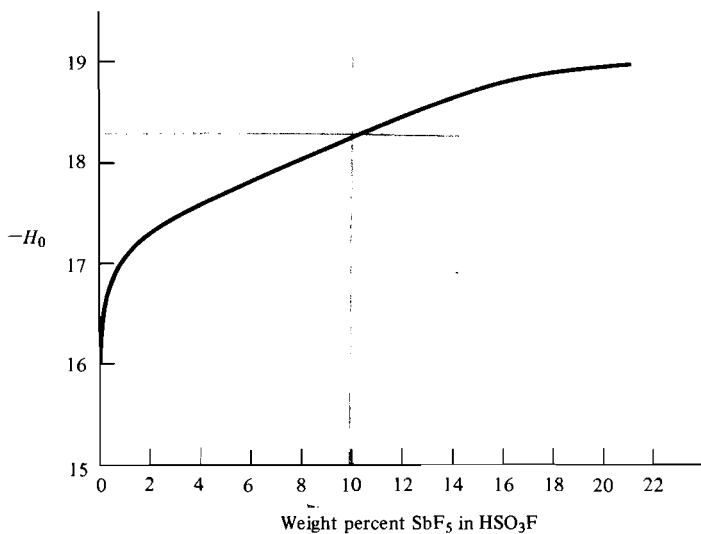

Figure 3.3 The H_0 acidity function for mixtures of SbF_5 and HSO_3F . Data are from R. J. Gillespie and T. E. Peel, *J. Amer. Chem. Soc.*, **95**, 5173 (1973).

acidic and less basic than water. The convenient glass electrode and pH meter can often be used successfully in nonaqueous media as long as the reference solution used for standardization of the meter employs the same solvent.³² The pH values determined, however, will be characteristic of the particular solvent system and will not be directly transferable to the water scale. Acetic acid has been used as a solvent for determining relative acidities of strong acids. The mineral acids HClO₄, HBr, and HCl, which all behave as strong acids in water, are found to differ significantly in acidity.³³ The use of a single solvent avoids the difficulties inherent in making comparisons between different solvent systems, as is done in work with acid-water mixtures, but at the same time the range of acidities that can be considered is more limited. Furthermore, complications arise if the dielectric constant is low (acetic acid $\epsilon = 6.2$ compared with $\epsilon = 78.5$ for water);³⁴ there is then extensive ion pairing.³⁵

Acid-base reactions have been studied in other nonaqueous solvents, such as acetonitrile, methanol, ethanol, dimethylformamide, and dimethylsulfoxide.³⁶ When acids whose strength can also be measured in water are studied in these solvents, the constants obtained are generally quite different, as would be expected from the widely different dielectric constants and varying solvating power of the different solvents. However, if the *relative* acidities of two compounds in water and another solvent are compared, the difference in pK_a between the two acids is usually approximately independent of solvent (within about one pK unit) *as long as the acids being compared are of the same charge type and are very similar in structure*.³⁷ For example, two particular substituted carboxylic acids may be expected to differ in acidity by roughly the same amount in dimethylformamide as they do in water, even though the values of pK_a found in the two solvents will be quite different;³⁸ but no such correlation would be expected if the comparison were between a carboxylic acid and an anilinium ion (different charge type) or between a carboxylic acid and a phenol (same charge type but different structural type). It should be noted, however, that there appear to be exceptions even to this rough rule-of-thumb.³⁹

Other methods of making quantitative measurements on weak bases, less

³² (a) Hammett, *Physical Organic Chemistry*, p. 265; (b) J. F. Coetzee, *Prog. Phys. Org. Chem.*, **4**, 64 (1967); (c) I. M. Kolthoff and T. B. Reddy, *Inorg. Chem.*, **1**, 189 (1962); (d) C. D. Ritchie and R. E. Uschold, *J. Am. Chem. Soc.*, **89**, 1721, 2752 (1967).

³³ R. P. Bell, *The Proton in Chemistry*, 2nd ed., Cornell University Press, Ithaca, N.Y., 1973, p. 46.

³⁴ See Table 2.11 (Section 2.4).

³⁵ In acetic acid it is possible to measure separately the equilibrium constant of proton transfer to form an ion pair and the constant for dissociation of ion pairs to form free ions. [I. M. Kolthoff and S. Bruckenstein, *J. Amer. Chem. Soc.*, **78**, 1 (1956); S. Bruckenstein and I. M. Kolthoff, *J. Amer. Chem. Soc.*, **78**, 10 (1956)]. G. W. Ceska and E. Grunwald, *J. Amer. Chem. Soc.*, **89**, 1371, 1377 (1967) applied this technique to a number of substituted anilines and concluded that the equilibrium constant of the ionization step, rather than the overall acid dissociation constant, is the quantity that should be considered in discussions of effects of structural changes on acidity.

³⁶ (a) M. M. Davis, *Acid-Base Behavior in Aprotic Organic Solvents*, Nat. Bur. Stds. Monograph 105, 1968; (b) I. M. Kolthoff, M. K. Chantooni, Jr., and S. Bhowmik, *J. Amer. Chem. Soc.*, **90**, 23 (1968); (c) J. F. Coetzee and G. R. Padmanabhan, *J. Amer. Chem. Soc.*, **87**, 5005 (1965); (d) B. W. Clare, D. Cook, E. C. F. Ko, Y. C. Mac, and A. J. Parker, *J. Amer. Chem. Soc.*, **88**, 1911 (1966); (e) C. D. Ritchie and G. H. Megerle, *J. Amer. Chem. Soc.*, **89**, 1447, 1452 (1967).

³⁷ Bell, *The Proton in Chemistry*, p. 56; see also footnotes 36 (c) and 36 (d).

³⁸ See note 36 (d).

³⁹ See notes 36 (c) and 36 (d).

commonly used than those described here, have been reviewed by Arnett.⁴⁰ The reader is referred to that article for further information.

Heats of Protonation

Arnett has summarized the difficulties inherent in the currently available methods of dealing with weak bases in solution.⁴¹ He notes, for example, that the pK_a values given in the literature for ketones, a very important class of compounds that undergo a variety of acid-catalyzed reactions, vary over an unacceptably wide range. The variations arise not only from the activity coefficient problems mentioned above, but also from such practical problems as the effect of differing media on position of the absorption peaks in the ultraviolet spectrum. Arnett has proposed an alternative to the acidity function method for finding pK_a values for weak bases.⁴² He has measured the heats of protonation of a number of weak bases in FSO_3H , in which most of the bases of interest are known from freezing-point depression, electrical conductivity, ultraviolet spectroscopy, and nuclear magnetic resonance measurements to be completely protonated. He finds a good correlation of these heats of protonation with recorded pK_a values for series like the original Hammett nitroaniline indicators that are well behaved in acidity function experiments. The heat of protonation method has the advantage over the acidity function procedure that all measurements are made in the same solvent; Arnett proposes that the pK_a values obtained for ketones by the heat of protonation procedure are more reliable than the older acidity function data.

3.3 STRENGTHS OF WEAK BRØNSTED ACIDS⁴³

The earliest attempts to evaluate quantitatively the acidity of very weak acids were contemporaneous with Hammett's pioneering work with weak bases. Conant and Wheland⁴⁴ published the first investigations in this area in 1932, and their results were extended and refined a few years later by McEwen.^{45, 46} Since organometallic compounds of the alkali metals behave chemically like carbanions, these investigators reasoned that if an organosodium or organopotassium compound, R_1M , were mixed with a hydrocarbon, R_2H , the equilibrium constant for the resulting reaction, Equation 3.41, would be a measure of the relative acidities of the two hydrocarbons R_1H and R_2H .

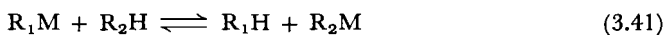

The equilibrium constant for Equation 3.41 does not measure directly the pK_a difference between R_1H and R_2H , because the pK_a is defined in terms of the

⁴⁰ See note 21, p. 133.

⁴¹ (a) E. M. Arnett, R. P. Quirk, and J. J. Burke, *J. Amer. Chem. Soc.*, **92**, 1260 (1970); (b) E. M. Arnett, R. P. Quirk, and J. W. Larsen, *ibid.*, p. 3977.

⁴² See note 41.

⁴³ For reviews see: (a) A. Streitwieser, Jr., and J. H. Hammons, *Prog. Phys. Org. Chem.*, **3**, 41 (1965); (b) H. Fischer and D. Rewicki, *Prog. in Org. Chem.* (Cook and Carruthers, Eds.), **7**, 116 (1968); (c) J. R. Jones, *The Ionisation of Carbon Acids*, Academic Press, London, 1973.

⁴⁴ J. B. Conant and G. W. Wheland, *J. Amer. Chem. Soc.*, **54**, 1212 (1932).

⁴⁵ W. K. McEwen, *J. Amer. Chem. Soc.*, **58**, 1124 (1936).

⁴⁶ See D. J. Cram, *Fundamentals of Carbanion Chemistry*, Academic Press, New York, 1965, for discussion of these results.

dissociated ions (Equation 3.42). Ether and benzene were used as solvents, and more recent evidence⁴⁷ indicates that the organometallics probably exist almost

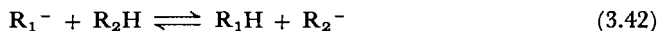

entirely as ion pairs in nonpolar solvents. Conant and Wheland were aware of the dissociation problem; on the basis of some earlier conductivity measurements,⁴⁸ they assumed that the dissociation constants for the various organometallics would be about the same, and that equilibrium constants for Reaction 3.41 would give reasonably accurate measures of pK_a differences. On the basis of this assumption, McEwen determined pK_a values for a number of carbon acids; he was also able to relate the acidities of the carbon acids studied with those of several weak oxygen acids⁴⁹ by studying equilibria such as Equation 3.43.



Further experiments designed to elucidate acid-base relationships among weak acids have been carried out more recently by Streitwieser and his co-workers.⁵⁰ They studied the equilibrium shown in Equation 3.44, with cyclohexylamine as solvent and lithium or cesium cyclohexylamide as base. Using spectrophotometric methods to evaluate the position of the equilibrium, they were able to find relative pK_a values for a number of hydrocarbons in which the conjugate base is, in most cases, a conjugated aromatic anion. In order to attach

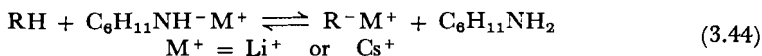

definite pK_a values to the results, these authors took as a reference point the value of $pK_a = 18.5$ reported by Langford and Burwell⁵¹ for 9-phenylfluorene (2). This value was determined in a solvent consisting of a mixture of water and

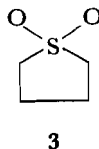
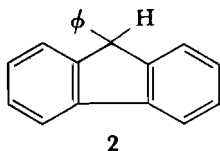

sulfolane (3) using the indicator methods described below. When McEwen's results are placed on a scale with 9-phenylfluorene having a pK_a of 18.5, the agreement with Streitwieser's results is reasonably good up to pK_a about 31 (triphenylmethane).

⁴⁷ T. E. Hogen-Esch and J. Smid, *J. Amer. Chem. Soc.*, **87**, 669 (1965).

⁴⁸ K. Ziegler and H. Wollschitt, *Ann.*, **479**, 123 (1930).

⁴⁹ We denote acids in which the acidic proton is attached to carbon as carbon acids, those with the proton attached to oxygen as oxygen acids, and so forth for acids of other types.

⁵⁰ See, for example: (a) A. Streitwieser, Jr., J. I. Brauman, J. H. Hammons, and A. H. Pudjaatmaka, *J. Amer. Chem. Soc.*, **87**, 384 (1965); (b) A. Streitwieser, Jr., J. H. Hammons, E. Ciuffarin, and J. I. Brauman, *J. Amer. Chem. Soc.*, **89**, 59 (1967); (c) A. Streitwieser, Jr., E. Ciuffarin, and J. H. Hammons, *J. Amer. Chem. Soc.*, **89**, 63 (1967); (d) A. Streitwieser, Jr., and D. M. E. Reuben, *J. Amer. Chem. Soc.*, **93**, 1794 (1971); (e) A. Streitwieser, Jr., J. R. Murdoch, G. Häfelinger, and C. J. Chang, *J. Amer. Chem. Soc.*, **95**, 4248 (1973); (f) Acidities found by these methods are ion pair acidities and do not represent dissociation to free ions. See A. Streitwieser, Jr., and S. P. Ewing, *J. Amer. Chem. Soc.*, **97**, 190 (1975).

⁵¹ C. H. Langford and R. L. Burwell, Jr., *J. Amer. Chem. Soc.*, **82**, 1503 (1960).

H_- Acidity Functions

Others have approached the problem from a slightly different viewpoint. This alternative method is an extension to basic media of the acidity function techniques discussed in the previous section.⁵² Solvents containing dimethylsulfoxide mixed with water, methanol, or ethanol and a base (potassium hydroxide, methoxide, or ethoxide) have been most commonly used, although other substances, such as sulfolane, have also been employed. Spectrophotometric measurements of concentrations of acid and conjugate base forms of an appropriate series of indicators establish an acidity function, called H_- , for mixtures containing varying proportions of the solvents. The indicators are usually substituted anilines, the same class of compound as serves to establish the H_0 scale in acidic mixtures; here, however, the anilines are acting as acids instead of as bases (Equation 3.45).

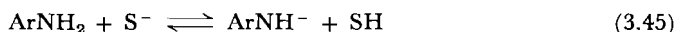

Once established, the H_- scale is used to find $\text{p}K_a$ values for weak acids. A number of measurements have been made by various groups.⁵³⁻⁵⁷ The results obtained at first appeared to disagree with Streitwieser's, but revision of values for some compounds on the basis of further measurements brought the results of the two methods into fairly good agreement. At the same time, however, it became clear that the problems discussed in the previous sections relating to the different behavior of substances of different structural type also apply to the H_- scale work.⁵⁸ The activity coefficient ratio evidently is not the same for carbon acids as for the nitrogen acids used to establish the scale.⁵⁹ Thus the $\text{p}K_a$ values found by these methods, while probably internally consistent for similar compounds, are not on a firm basis with respect to their absolute relationship to the water scale.

Arnett and his collaborators have extended the heat of protonation concept (Section 3.2) to weak acids by measuring heats of deprotonation, ΔH_D , of weak acids in dimethylsulfoxide containing the dimethylsulfoxide conjugate base, $\text{H}_3\text{CSOCH}_2^-$.⁶⁰ The results correlate well with $\text{p}K_a$ values of the amines used

⁵² For reviews, see: (a) K. Bowden, *Chem. Rev.*, **66**, 119 (1966); (b) C. H. Rochester, *Quart. Rev. (London)*, **20**, 511 (1966); (c) J. R. Jones, *Prog. Phys. Org. Chem.*, **9**, 241 (1972).

⁵³ (a) See note 51, p. 139; (b) R. Stewart, J. P. O'Donnell, D. J. Cram, and B. Rickborn, *Tetrahedron*, **18**, 917 (1962).

⁵⁴ E. C. Steiner and J. M. Gilbert, *J. Amer. Chem. Soc.*, **87**, 382 (1965).

⁵⁵ E. C. Steiner and J. D. Starkey, *J. Amer. Chem. Soc.*, **89**, 2751 (1967).

⁵⁶ (a) C. D. Ritchie and R. E. Uschold, *J. Amer. Chem. Soc.*, **89**, 2752 (1967); (b) C. D. Ritchie and R. E. Uschold, *J. Amer. Chem. Soc.*, **90**, 2821 (1968); (c) M. M. Kreevoy and E. H. Baughman, *J. Amer. Chem. Soc.*, **95**, 8178 (1973).

⁵⁷ R. Kuhn and D. Rewicki, *Ann.*, **704**, 9 (1967); **706**, 250 (1967).

⁵⁸ See note 55, 56.

⁵⁹ H_- is defined by the equation

$$H_- = -\log \left(a_{\text{H}^+} + \frac{\gamma \text{A}^-}{\gamma \text{AH}} \right)$$

(The derivation is analogous to that given in Section 3.3 for H_0 .) The method will be successful only if the activity coefficient ratio is the same for all acids investigated as it is for the acids used as indicators. Since this requirement is evidently not met, it may not be possible to establish a unique solution $\text{p}K$ scale for weak acids by using H_- .

⁶⁰ E. M. Arnett, T. Q. Moriarity, L. E. Small, J. P. Rudolph, and R. P. Quirk, *J. Amer. Chem. Soc.*, **95**, 1492 (1973).

to set up the H_- scale. Furthermore, the slope of the line correlating ΔH_D with pK_a is nearly the same as the slope of the correlation between heat of protonation in HSO_3F and pK_a for the weak bases. This latter result increases confidence in the heat of protonation method as a valid way of measuring acid strength over a very wide range.

The Brønsted Catalysis Law

The experimental work described up to this point has been limited to those carbon acids that are more acidic than pK_a about 33. Most of these compounds owe their acidity to some structural feature that allows the negative charge of the conjugate base to be delocalized. We turn now to a brief discussion of a method by which measurements can be extended, at least in a semiquantitative way, into the region of still weaker acids.

In the acid-base reaction 3.46, it would seem reasonable that if the rate (k_1) at which a proton is removed by a particular base B^{n+} were compared for

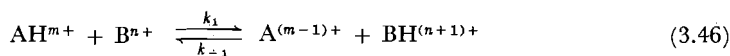

various acids AH^{m+} , the base might remove the proton more rapidly from the stronger acids. Relationships between rate of an acid-base reaction and an equilibrium have been observed in many cases, and are frequently found to obey an equation known as the Brønsted catalysis law:

$$k = CK_a^\alpha \quad (3.47)$$

or

$$\log k = \alpha \log K_a + \log C \quad (3.48)$$

where k is the rate constant for the reaction, K_a is the acid dissociation constant, and C is a constant of proportionality. If such a relationship could be shown to hold between acid strength and rate of transfer of the proton to some particular base, a means would be available to find equilibrium acidities through kinetic measurements.

An appreciation for the form of the catalysis law may be gained by consideration of the energy relationships involved. In Figure 3.4 is plotted schematically the free energy (ΔG) vs. reaction coordinate for proton transfer reactions between a series of acids, A_nH , and a single base, B . The differing pK_a values of the acids are reflected in the different free-energy changes in going from reactants to products, $\Delta G_1^\circ, \Delta G_2^\circ, \dots, \Delta G_n^\circ, \dots$, and are caused by structural differences among the acids A_nH and among the conjugate bases A_n^- . If one assumes that the factors that cause these free-energy differences also cause the differences in the transition-state free energies, it is reasonable to suppose as a first approximation that the activation free energy for proton transfer, ΔG_n^\ddagger , might be related to the ΔG_n° in a linear fashion. This relationship is expressed in Equation 3.49, where we have arbitrarily chosen the first acid, A_1H , as a reference compound for the series.

$$\Delta G_1^\ddagger - \Delta G_n^\ddagger = \alpha(\Delta G_1^\circ - \Delta G_n^\circ) \quad (3.49)$$

We have from equilibrium thermodynamics Relation 3.50 between standard free-energy change, ΔG° , and equilibrium constant, K , and from transition-state

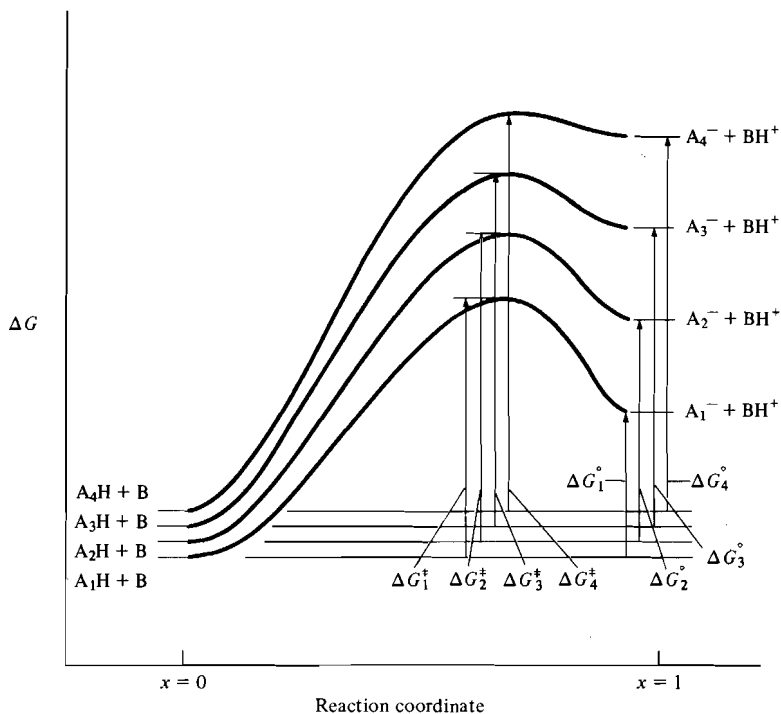

Figure 3.4 Hypothetical free energy vs. reaction coordinate curves for proton transfer from four different acids, A_1H , A_2H , A_3H , A_4H , to base B . The Brønsted catalysis law presumes that the effects of structural change on the transition-state free energies will be some constant fraction of their effects on the overall free-energy changes.

theory Equation 3.51 (compare Equation 2.60, p. 100), where ΔG^\ddagger is the free energy of activation, k is the rate constant, k is the Boltzmann constant, and h is Planck's constant.

$$-\Delta G^\circ = 2.303RT \log K \quad (3.50)$$

$$-\Delta G^\ddagger = 2.303(RT \log k - RT \log kT/h) \quad (3.51)$$

By substituting Equations 3.50 and 3.51 in Equation 3.49 we obtain Equation 3.52:

$$\log k_n - \log k_1 = \alpha(\log K_n - \log K_1) \quad (3.52)$$

The acid A_1H serves as our standard for comparison of all the others, so that $\log k_1$ and $\log K_1$ are constants for a series of measurements; therefore we can write Equation 3.53 (where C is a constant), which is equivalent to Equation 3.48 and, when written in exponential form, to Equation 3.47.⁶¹

$$\log k_n = \alpha \log K_n + \log C \quad (3.53)$$

⁶¹ An alternative way of expressing the argument presented here is to assume that ΔG^\ddagger is some unspecified function of ΔG° ,

$$\Delta G^\ddagger = f(\Delta G^\circ)$$

and to expand that function in a Taylor series about the reference point ΔG_1° :

$$\Delta G^\ddagger = \text{constant} + \alpha(\Delta G^\circ - \Delta G_1^\circ) + \alpha'(\Delta G^\circ - \Delta G_1^\circ)^2 + \alpha''(\Delta G^\circ - \Delta G_1^\circ)^3 + \dots$$

The Brønsted law is a linear free-energy relationship, similar in form to the Hammett and Taft correlations discussed in Section 2.2. We emphasize that the connection between rate and equilibrium expressed by Equation 3.48 is in no sense predicted by or derived from the laws of equilibrium thermodynamics. The relationship is an empirical one that must be verified experimentally in each particular case, and that is subject to severe limitations. We have assumed in drawing Figure 3.4 and in making the arguments we have presented rationalizing the catalysis law that the position of the transition state along the reaction coordinate will not change as the acid strengths change. We have seen in Section 2.6, where we considered the Hammond postulate, that this assumption is unlikely to be true if we make more than a rather small change in the reactant-to-product free-energy difference. As a result, we can expect that over a wide range of acidities α will not be a constant. It should be close to unity for a very endothermic process of type 3.46 (the transition state closely resembles $A^{(m-1)+} + BH^{(n+1)+}$ and the entire ΔG° differences show up in ΔG^\ddagger), and close to zero for a very exothermic process (the transition state closely resembles $AH^{m+} + B^{n+}$ and none of the ΔG° differences show up in ΔG^\ddagger). For carbon acids, α changes relatively slowly with changing equilibrium constant;⁶² we must nevertheless proceed cautiously if we wish to use the catalysis law to assist us in estimating equilibrium acidities, and we expect difficulties if the range of equilibrium constants is large. We shall return to consider these points in more detail in Section 8.1.

Kinetic Acidity

The Brønsted catalysis law can be applied to the problem of determination of acidity of very weak acids in the following way. First, a suitable base is chosen; the base must be sufficiently strong to remove protons from the carbon acids in question at a measurable rate. The acids to be investigated are then prepared with deuterium or tritium substituted for hydrogen, and the rate of exchange of the isotopic label out of the carbon acid in the presence of the base is measured.

Experiments of this type have been carried out with weak acids by various workers.⁶³⁻⁶⁶ In order to use the kinetic data to obtain information about equilibria, it is clearly necessary to know whether the catalysis law (Equation 3.48) holds for the system under study and, if it does, what the value of the constant α is.

The approximation involved in stating the catalysis law is equivalent to dropping terms of order higher than the first in the power-series expansion:

$$\Delta G^\ddagger \approx \text{constant} + \alpha(\Delta G^\circ - \Delta G_1^\circ)$$

This expression leads to Equation 3.53.

⁶² M. Eigen, *Angew. Chem. Int. Ed.*, **3**, 1 (1964).

⁶³ R. G. Pearson and R. L. Dillon, *J. Amer. Chem. Soc.*, **75**, 2439 (1953).

⁶⁴ A. I. Shatenshtein, *Adv. Phys. Org. Chem.*, **1**, 155 (1963).

⁶⁵ See for example: (a) A. Streitwieser, Jr., R. A. Caldwell, R. G. Lawler, and G. R. Ziegler, *J. Amer. Chem. Soc.*, **87**, 5399 (1965); (b) A. Streitwieser, Jr., W. B. Hollyhead, G. Sonnichsen, A. H. Pudjaatmaka, C. J. Chang, and T. L. Kruger, *J. Amer. Chem. Soc.*, **93**, 5096 (1971); (c) A. Streitwieser, Jr., and W. C. Langworthy, *J. Amer. Chem. Soc.*, **85**, 1757, (1963); (d) A. Streitwieser, Jr., R. A. Caldwell, and M. R. Granger, *J. Amer. Chem. Soc.*, **86**, 3578 (1964); (e) A. Streitwieser, Jr., and D. Holtz, *J. Amer. Chem. Soc.*, **89**, 692 (1967); (f) A. Streitwieser, Jr., A. P. Marchand, and A. H. Pudjaatmaka, *J. Amer. Chem. Soc.*, **89**, 693 (1967); (g) A. Streitwieser, Jr., and F. Mares, *J. Amer. Chem. Soc.*, **90**, 644, 2444 (1968). See also references cited in Table 3.1.

⁶⁶ R. E. Dessy, Y. Okuzumi, and A. Chen, *J. Amer. Chem. Soc.*, **84**, 2899 (1962).

Thus it is not possible to use the method to determine pK 's without first making measurements on a number of compounds of known acid dissociation constant. Pearson and Dillon⁶⁷ collected data for exchange rates and equilibrium constants of a number of carbon acids in the pK_a range 4–20. These compounds all contained electron-withdrawing groups (carbonyl, nitro, cyano, trifluoromethyl, etc.); the correlation of rate and pK_a was only rough. The problem is presumably one of differences in behavior arising from variations in structure. Shatenshtein measured exchange rates of a number of carbon acids in liquid ammonia;⁶⁸ his work demonstrated clearly the acidic properties of even saturated hydrocarbons, and allowed a qualitative measure of relative acidity of various types of carbon-hydrogen bonds.

Streitwieser and co-workers have extended their measurements of equilibrium acidities in cyclohexylamine to determination of exchange rates.⁶⁹ They have made quantitative correlations between exchange rate and the pK_a 's determined by equilibrium methods for various aromatic compounds and have thus been able to verify that the Brønsted relation holds for these substances and to find Brønsted coefficients α for various types of compounds. A third method for evaluating pK_a of weak acids, which has been used by Applequist⁷⁰ and by Dessy,⁷¹ involves the study of exchange reactions of organometallic compounds (Equations 3.54 and 3.55).

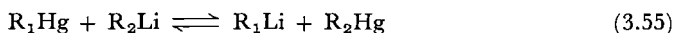
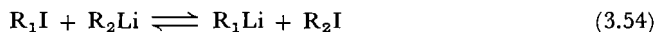

The MSAD Scale

In 1965, Cram established a scale of acidities reaching to the very weak carbon acids by combining data from the various methods.⁷² The basis of the scale is the value of $pK_a = 18.5$ found by Langford and Burwell for 9-phenylfluorene (2),⁷³ and it includes the equilibrium measurements of Streitwieser and others up to pK_a 33. Table 3.1 records some selected equilibrium values in this range. Beyond pK_a 33, direct equilibrium methods fail and only the kinetic and organometallic techniques can be used. Cram compared Streitwieser's exchange-rate measurements for triphenylmethane and for cumene (4),⁷⁴

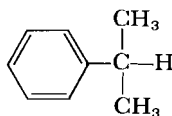

4

⁶⁷ See note 63, p. 143.

⁶⁸ See note 64, p. 143.

⁶⁹ See note 65, p. 143.

⁷⁰ D. E. Applequist and D. F. O'Brien, *J. Amer. Chem. Soc.*, **85**, 743 (1963).

⁷¹ (a) R. M. Salinger and R. E. Dessy, *Tetrahedron Lett.*, 729 (1963); (b) R. E. Dessy, W. Kitching, T. Psarras, R. Salinger, A. Chen, and T. Chivers, *J. Amer. Chem. Soc.*, **88**, 460 (1966).

⁷² D. J. Cram, *Fundamentals of Carbanion Chemistry*, Academic Press, New York, 1965, p. 19.

⁷³ See note 51, p. 139.

⁷⁴ See note 65 (d), p. 143.

with measurements of McEwen on organometallic equilibria.⁷⁵ McEwen's pK_a values for the two compounds differ by about 4.5 units, while Streitwieser's exchange rates differ by about five powers of ten. The Brønsted α calculated from these results is 1.1. Benzene has an exchange rate close to that of cumene, and toluene exchanges somewhat more rapidly; these compounds would fit into the scale at about pK_a 36 and 34, respectively. Cram then extended the scale to still weaker acids for which exchange rates were known from Streitwieser's work,⁷⁶ and concluded that cyclopentane and cyclohexane had pK_a 's of about 43 and 44 (relative to triphenylmethane = 31.5). Cram then noted that the equilibrium measurements of Applequist on reaction 3.54 and of Dessy on Reaction 3.55 correlated well with the scale, and was therefore able to assign pK_a 's to several other compounds. The final list of acidities Cram named the MSAD scale; it served for a number of years as the best available guide to pK_a 's of the very weak acids.⁷⁷

The breakdown of the MSAD scale In 1971, Streitwieser and his collaborators reported new Brønsted catalysis law correlations for exchange rates of substituted fluorenes and of polyarylmethanes in methanol–sodium methoxide. These compounds all have pK_a 's in the range that can be determined by equilibrium methods; the values of α were 0.37 for the fluorenes and 0.58 for the polyarylmethanes.⁷⁸ Both correlations are accurately linear over ranges of nearly ten pK units, and are clearly not two parts of a single line of varying slope. The authors proposed that the difference in slope results from the different position of the transition state along the reaction coordinate for proton transfer in the two series. The fluorenes, which have the extra anion-stabilizing influence of a cyclopentadienide ring (Section 1.5, p. 39), reach the transition state relatively early, and the polyarylmethanes, somewhat less effective in anion stabilization, reach the transition state only when proton transfer is further advanced.

Then, in 1973, Streitwieser reported that the polyarylmethane exchange rates measured in cyclohexylamine–cyclohexylamide correlate with equilibrium pK values with $\alpha = 0.31$.⁷⁹ Apparently, when the proton is removed by cyclohexylamide, the polyarylmethanes have early transition states, just as the fluorenes did for proton removal by the weaker base methoxide.⁸⁰ A short extrapolation of the Brønsted correlation led to a pK_a for toluene of 40.9, about seven units higher than the value assigned in the MSAD scale. Furthermore, if we

⁷⁵ See note 45, p. 138.

⁷⁶ (a) See note 65 (d), p. 143; (b) A. Streitwieser, Jr., W. R. Young, and R. A. Caldwell, *J. Amer. Chem. Soc.*, **91**, 527 (1969); (c) A. Streitwieser, Jr., R. A. Caldwell, and W. R. Young, *J. Amer. Chem. Soc.*, **91**, 529 (1969).

⁷⁷ MSAD stands for McEwen, Streitwieser, Applequist, and Dessy.

⁷⁸ (a) See note 65 (b), p. 143; (b) A. Streitwieser, Jr., W. B. Hollyhead, A. H. Pudjaatmaka, P. H. Owens, T. L. Kruger, P. A. Rubenstein, R. A. MacQuarrie, M. L. Brokaw, W. K. C. Chu, and H. M. Niemeyer, *J. Amer. Chem. Soc.*, **93**, 5088 (1971).

⁷⁹ A. Streitwieser, Jr., M. R. Granger, F. Mares, and R. A. Wolf, *J. Amer. Chem. Soc.*, **95**, 4257 (1973).

⁸⁰ The situation is complicated by the finding of a large isotope effect, $k_H/k_D = 11$, indicating a transition state symmetrical with respect to the position of the proton between the acid and the base. Streitwieser proposed that at the transition state the incipient anion is still pyramidal, so that little charge can be delocalized onto the aryl rings. At the transition state, most of the negative charge therefore still resides on the base, hence α is low even though proton transfer is further advanced.

Table 3.1 APPROXIMATE pK_a VALUES OF WEAK HYDROCARBON ACIDS¹







Compound (Acidic H indicated)	pK_a^2	Method ³	References
Cyclopentadiene 	18 ^a	ex	D
9-Phenylfluorene 	18.5	H_- , eq	L&B, S ₂ , R&U, S&S
Indene 	19.9	eq, H_-	S ₂ , R&U, S&S
Phenylacetylene $\phi-C\equiv C-H$	23.2 ^b	eq	S ₇
Fluorene 	22.7	eq, H_-	S ₂ , R&U, S&S
Acetylene $H-C\equiv C-H$	24 ^c	eq	W&H
1,1,3-Triphenylpropene 	26.6	eq	S ₂
Triphenylmethane ϕ_3CH	31.5	eq, ex, H_-	S ₂ , S ₁ , R&U
Diphenylmethane ϕ_2CH_2	33.1	eq, ex, H_-	S ₈ , S ₁ , S&S
Cycloheptatriene 	33-41 ^d	eq	D&R
Toluene $\phi-CH_3$	40.9	ex	S ₁ , S ₈
Benzene $\phi-H$	43	ex	S ₉
Ethylene $H_2C=CH_2$	44	ex	S ₁₀
Cumene 	47.8	ex	S ₁

Table 3.1 (Continued)

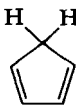
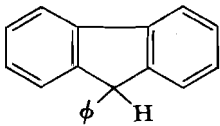
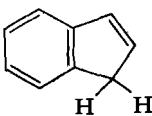
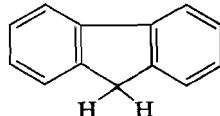
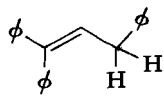
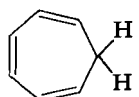
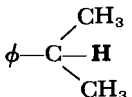
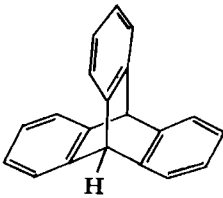
Compound (Acidic H indicated)	pK_a^2	Method ³	References ⁴
Triptcene 	49.7	ex	S ₁ , S ₅
Cyclopropane 	46	ex	S ₄
Methane CH ₄	48	ex	S ₁₁
Triphenylcyclopropane 	50	^e	B&B
Cyclobutane 	50	ex	S ₄
Cyclopentane 	51	ex	S ₄
Cyclohexane 	52	ex	S ₃

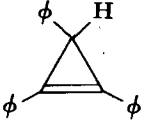
¹ Values up to pK_a 33 (diphenylmethane) are those reported for equilibrium methods, and were measured either directly using the H_- acidity function or by comparing acidity with 9-phenylfluorene. Above pK_a 33, we assume $\alpha = 0.3$ for toluene, cumene, and triptcene, and base other values on $pK_a = 43$ for benzene and an assumed α of 0.9. The scale is based on the Langford and Burwell value of 18.5 for pK_a of 9-phenylfluorene.

² Rounded to three significant figures. Although four significant figures are given in some of the original papers cited, a comprehensive scale of greater precision does not appear justified at this time.

³ Method code:

eq = equilibrium methods related to the water pK scale by direct or indirect comparison with 9-phenylfluorene.

ex = H-D or H-T exchange rate.

H_- = equilibrium measurement using H_- acidity function.

⁴ References:

B&B: R. Breslow and K. Balasubramanian, *J. Amer. Chem. Soc.*, **91**, 5182 (1969).

D: R. E. Dessy, Y. Okazumi, and A. Chen, *J. Amer. Chem. Soc.*, **84**, 2899 (1962).

D&R: H. J. Dauben and M. R. Rifi, *J. Amer. Chem. Soc.*, **85**, 3041 (1963).

L&B: C. H. Langford and R. L. Burwell, Jr., *J. Amer. Chem. Soc.*, **82**, 1503 (1960).

R&U: C. D. Ritchie and R. E. Uschold, *J. Amer. Chem. Soc.*, **89**, 2752 (1967).

S&S: E. C. Steiner and J. D. Starkey, *J. Amer. Chem. Soc.*, **89**, 2751 (1967); E. C. Steiner and J. M. Gilbert, *J. Amer. Chem. Soc.*, **87**, 382 (1965).

W&H: N. S. Wooding and W. E. C. Higginson, *J. Chem. Soc.*, 774, (1952).

S₁: A. Streitwieser, Jr., R. A. Caldwell, and M. R. Granger, *J. Amer. Chem. Soc.*, **86**, 3578 (1964).

S₂: A. Streitwieser, Jr., E. Ciuffarin, and J. H. Hammons, *J. Amer. Chem. Soc.*, **89**, 63 (1967).

assume that the line continues with slope $\alpha = 0.3$, we find pK_a 48 for cumene, over ten units higher than the MSAD value. The MSAD scale, based on what is evidently much too high a value for α above pK_a 31, is therefore in error above that point.

If we accept Streitwieser's results, we are faced with a dilemma for acids weaker than cumene. There is an indication from results of exchange rates in fluorobenzenes that when the anion is not delocalized, α will be roughly 0.9; these measurements yield $pK_a = 43$ for benzene.⁸¹ If we assume that α will continue to be 0.9 for the weaker saturated carbon acids, which also yield non-delocalized anions, we can revise the MSAD scale for these substances. In Table 3.1 we list equilibrium pK_a values for some selected compounds. These numbers correspond closely to Cram's scale below pK 31, with some modifications to take account of more recent data; they should give reasonably reliable relative acidities up to toluene. One must, nevertheless, always remember that they are tied to the water pK scale through the value listed for 9-phenylfluorene. This pK is determined by acidity function methods and is subject to all the uncertainties attendant on those measurements.⁸² Beyond pK_a 41, the scale is based on $pK_a = 43$ for benzene, assuming $\alpha = 0.9$. The results of Dessy and of Applequist do not correlate as well with the revised scale as they did with MSAD, and no attempt has been made to include them. It must be emphasized strongly that the values listed in the high pK_a range are approximate estimates only, and likely to be changed, perhaps drastically, by the results of further experimental work. It is also important to realize that even at the low end of the scale, values represent dissociation to ion pairs and depend on the cation and on solution phenomena. Relative acidities reported in different solvent systems may differ substantially.⁸³

⁸¹ A. Streitwieser, Jr., P. J. Scannon, and H. M. Niemeyer, *J. Amer. Chem. Soc.*, **94**, 7936 (1972).

⁸² It should be noted that measurements reported by Ritchie and Uschold (notes 56 (a), 56 (b), p. 140) yielded a value of 16.4 for the pK_a of 9-phenylfluorene; if this value is used instead of the earlier one of Langford and Burwell, the entire scale of Table 3.1 is lowered by two pK units. The revision has not been made here, as it seems likely that future work will result in further changes. See also note 55, p. 140.

⁸³ (a) F. G. Bordwell and W. S. Matthews, *J. Amer. Chem. Soc.*, **96**, 1214 (1974); (b) F. G. Bordwell, W. S. Matthews, and N. R. Vanier, *J. Amer. Chem. Soc.*, **97**, 442 (1975).

S₃: A. Streitwieser, Jr., W. R. Young, and R. A. Caldwell, *J. Amer. Chem. Soc.*, **91**, 527 (1969).

S₄: A. Streitwieser, Jr., R. A. Caldwell, and W. R. Young, *J. Amer. Chem. Soc.*, **91**, 529 (1969).

S₅: A. Streitwieser, Jr., and G. R. Ziegler, *J. Amer. Chem. Soc.*, **91**, 5081 (1969).

S₆: A. Streitwieser, Jr., W. B. Hollyhead, G. Sonnichsen, A. H. Pudjaatmaka, C. J. Chang, and T. L. Kruger, *J. Amer. Chem. Soc.*, **93**, 5096 (1971).

S₇: A. Streitwieser, Jr., and D. M. E. Reuben, *J. Amer. Chem. Soc.*, **93**, 1794 (1971).

S₈: A. Streitwieser, Jr., M. R. Granger, F. Mares, and R. A. Wolf, *J. Amer. Chem. Soc.*, **95**, 4257 (1973).

S₉: A. Streitwieser, Jr., P. J. Scannon, and H. M. Niemeyer, *J. Amer. Chem. Soc.*, **94**, 7936 (1972).

S₁₀: M. J. Maskornick and A. Streitwieser, Jr., *Tetrahedron Lett.*, 1625 (1972).

S₁₁: A. Streitwieser, Jr., and D. R. Taylor, *J. Chem. Soc. D*, 1248 (1970).

^a Calculated from data of Ref. D assuming pK of indene ≈ 20 and of fluorene ≈ 23 .

^b The value given is that found in cyclohexylamine. F. G. Bordwell and W. S. Matthews, *J. Amer. Chem. Soc.*, **96**, 1214 (1974), report 29 (corrected to the present scale) in dimethylsulfoxide.

^c In liquid NH_3 ; corrected to triphenylmethane = 31.

^d Reported to be between diphenylmethane and toluene.

^e Estimated by B&B from electrochemical data.



3.4 SUBSTITUENT EFFECTS ON STRENGTHS OF BRØNSTED ACIDS AND BASES

Acid-base reactions have long served as a starting point for consideration of the effects of changes in a structure on the course of chemical reactions. Table 3.2 summarizes solution data for a variety of Brønsted acids and bases; because of the problems of measurement, any such table necessarily contains a fair amount of uncertainty. The pK_a values that fall between 2 and 10 may be used with considerable confidence, since they are based on accurate measurements in dilute aqueous solutions; the values outside this range must be regarded with a certain amount of skepticism. As we have noted in the two previous sections, uncertainties

Table 3.2^a SOLUTION DISSOCIATION CONSTANTS OF ACIDS AND BASES

Conjugate Acid	Conjugate Base	pK_a	References ^b
RNO_2H^+	RNO_2	-12	1, 2
$RC\equiv NH^+$	$RC\equiv N$	-12	3
HI	I^-	-9	5
HBr	Br^-	-8	5
HCl	Cl^-	-7	5
		-6 to -8	1
	(G = H, R, Ar, OR, OH)		
$ArOH_2^+$	$ArOH$	-7	1, 6
RSH_2^+	RSH	-7	1
$ArOR^+$	$ArOR$	-6 to -7	1, 6, 7
	ROR	-2 to -4	1, 4, 7
	ROH	-2 to -3	1, 4
		0 to -2	1
$ArNH_3^+$	$ArNH_2$	3 to 5	8, 1
HF	F^-	3.17	5
$RCOOH$	$RCOO^-$	4 to 5	8
H_2S	HS^-	7.0	5
$ArSH$	ArS^-	8	8
HCN	CN^-	9.22	5
NH_4^+	NH_3	9.24	5
RNH_3^+	RNH_2	10 to 12	1, 8
$ArOH$	ArO^-	9 to 11	8
		9	9

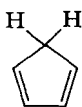
Table 3.2^a (Continued)

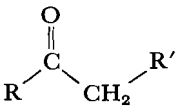
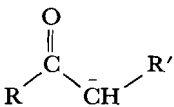
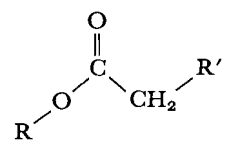
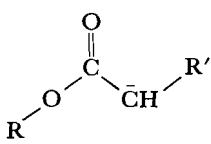
Conjugate Acid	Conjugate Base	pK _a	References ^b
RCH ₂ NO ₂	RCHNO ₂ ⁻	10	9
RSH	RS ⁻	12	8
H ₂ O	OH ⁻	16	10
ROH	RO ⁻	17 to 20	10
		18	11
ArNH ₂	ArNH ⁻	18 to ~28	12, 13
		19 to 20	9, 14
		25	9
CH ₃ SO ₂ CH ₃	CH ₃ SO ₂ CH ₂ ⁻	29	15
φ ₃ CH	φ ₃ C ⁻	31	11
CH ₃ SOCH ₃	CH ₃ SOCH ₂ ⁻	33	16
NH ₃	NH ₂ ⁻	33	5
φCH ₃	φCH ₂ ⁻	41	11
φH	φ ⁻	43	11
CH ₄	CH ₃ ⁻	48	11
cyclo-C ₆ H ₁₂	cyclo-C ₆ H ₁₁ ⁻	52	11

^a Values less than ~3 and greater than ~10 are approximate, and values at the extremes of the scale probably have only qualitative significance. Complications of pK data may be found in D. D. Perrin, *Dissociation Constants of Organic Bases in Aqueous Solution*, Butterworths, London, 1965; G. Kortum, W. Vogel, and K. Andrussov, *Dissociation Constants of Organic Acids in Aqueous Solution*, Butterworths, London, 1961; and in Refs. 1, 5, 8, and 9.

^b References.

1. E. M. Arnett, *Prog. Phys. Org. Chem.*, **1**, 223 (1963).
2. N. C. Deno, R. W. Gaugler, and T. J. Schulze, *J. Org. Chem.*, **31**, 1968 (1966).
3. N. C. Deno, R. W. Gaugler, and M. J. Wisotsky, *J. Org. Chem.*, **31**, 1967 (1966).
4. N. C. Deno and J. O. Turner, *J. Org. Chem.*, **31**, 1969 (1966).
5. D. D. Perrin, *Dissociation Constants of Inorganic Acids and Bases in Aqueous Solution*, Butterworths, London, 1969.
6. E. M. Arnett and C. Y. Wu, *J. Amer. Chem. Soc.*, **82**, 5660 (1960).
7. E. M. Arnett and C. Y. Wu, *J. Amer. Chem. Soc.*, **82**, 4999 (1960).
8. H. C. Brown, D. H. McDaniel, and O. Häflinger, *Determination of Organic Structures by Physical Methods*, E. A. Braude and F. C. Nachod, Eds., Academic Press, New York, 1955, p. 567.
9. R. G. Pearson and R. G. Dillon, *J. Amer. Chem. Soc.*, **75**, 2439 (1953).
10. See Table 3.6.
11. See Table 3.1.
12. K. Bowden, *Chem. Rev.*, **66**, 119 (1966).
13. Data of D. Dolman and R. Stewart, *Can. J. Chem.*, **45**, 911 (1967) and of T. Birchall and W. L. Jolly, *J. Amer. Chem. Soc.*, **88**, 5439 (1966) indicate a pK_a of roughly 27–28 for aniline and 28–29 for 4-methylaniline. pK_a of 4-nitroaniline is about 18 (Ref. 12).
14. W. K. McEwen, *J. Amer. Chem. Soc.*, **58**, 1124 (1936).
15. F. G. Bordwell, R. H. Imes, and E. C. Steiner, *J. Amer. Chem. Soc.*, **89**, 3905 (1967).
16. R. Stewart and J. R. Jones, *J. Amer. Chem. Soc.*, **89**, 5069 (1967).

Table 3.3 APPROXIMATE pK_a VALUES FOR HYDRIDES

Group IV	Group V	Group VI	Group VII
CH ₄ 48 ^a	NH ₃ 33 ^b	H ₂ O 16 ^c	HF 3.17 ^b
	PH ₃ 29 ^{c, d}	H ₂ S 7.0 ^b	HCl -7 ^b
		H ₂ Se 3.9 ^c	HBr -8 ^b
		H ₂ Te 2.6 ^c	HI -9 ^b

^a See Table 3.1.^b See Table 3.2.^c D. D. Perrin, *Dissociation Constants of Inorganic Acids and Bases in Aqueous Solution*, Butterworths, London, 1969.^d The order PH₃ more acidic than NH₃ also holds in the gas phase. See D. Holtz, J. L. Beauchamp, and J. R. Eyler, *J. Amer. Chem. Soc.*, **92**, 7045 (1970).^e See Table 3.6.**Table 3.4** ELECTRONEGATIVITIES (PAULING SCALE)

Group IV	Group V	Group VI	Group VII
C 2.5	N 3.0	O 3.5	F 4.0
	P 2.1	S 2.5	Cl 3.0
		Se 2.4	Br 2.8
		Te 2.1	I 2.5

SOURCE: Reprinted from L. Pauling, *The Nature of the Chemical Bond*, 3rd ed., Cornell University Press, Ithaca, N.Y., 1960, p. 93, copyright 1960 by Cornell University Press. Used by permission of Cornell University Press.

become severe for very strong and very weak acids; the extreme values have only qualitative significance.

In Table 3.2 we follow the convention of giving the strength of a base in terms of the pK_a of the conjugate acid. It is useful to keep in mind that the weaker the base, the stronger is its conjugate acid. Hence the weakest bases and strongest acids (those with negative pK_a) appear at the beginning of the table, whereas the strongest bases and weakest acids (large positive pK_a) are at the end. Since many compounds are both acids and bases, it is worthwhile to note that although there is a definite relationship between strength of a base and strength of the *conjugate acid of that base*, there is not any quantitative correlation between the strength of a given substance as a base and the strength *of the same substance* as an acid, although it is often true that a strongly acidic molecule will be weakly basic and vice versa.⁸⁴

Acid Strengths of Simple Hydrides

It is useful to begin the discussion of substituent effects on acidity by examining briefly the solution acidities of hydrides of some elements of Groups IV, V, VI, and VII, given in Table 3.3. These values span a very wide range and are subject to considerable uncertainty, but the trends are clear. In a given row, the hydrides become more acidic as one moves to the right. This trend parallels the electronegativity of the atom to which the hydrogen is bonded (Table 3.4). A possible interpretation of the trend is that in each such series the increasing nuclear charge holds the valence electrons, all of which have the same principal quantum

⁸⁴ (a) E. M. Arnett, *Prog. Phys. Org. Chem.*, **1**, 223 (1963); (b) R. J. Gillespie, in *Friedel-Crafts and Related Reactions*, Vol. 1, G. A. Olah, Ed., Wiley-Interscience, New York, 1963, p. 181.

Table 3.5 BOND DISSOCIATION ENERGIES (KCAL MOLE⁻¹)^a

Group IV	Group V	Group VI	Group VII
CH ₃ —H 101	NH ₂ —H 100	HO—H 116	H—F 134
	PH ₃ ~ 77 ^b	HS—H ~ 90	H—Cl 102
		H ₂ Se ~ 66 ^b	H—Br 86
		H ₂ Te ~ 57 ^b	H—I 71

^a T. L. Cottrell, *The Strengths of Chemical Bonds*, Butterworths, London, 1954.

^b Average bond energy.

number, more and more strongly, so that negative ions become more and more favorable compared with the covalently bonded nonionized compounds. The electronegativity analogy, however, clearly fails in comparisons among members of a given group. The atoms become less electronegative as one goes down a column of the table, but the hydrides become stronger acids. Carbon and iodine have the same electronegativity on the Pauling scale, but the acidities of CH₄ and HI differ by something approaching 60 powers of ten. The beginning of an explanation can be found in the bond dissociation energies of the hydrides (Table 3.5). The decreasing electronegativity is apparently more than compensated by a weaker bond to hydrogen.⁸⁵ One may rationalize the observations in a rough way by saying that on going to larger atoms with valence electrons in higher principal quantum levels and hence farther from the nucleus, the overlap with the orbital on the small hydrogen atom becomes less favorable and the bonds become weaker.

(Gas-Phase Acidity)

It can be seen from the foregoing discussion that the interpretations of the observed acidities leave something to be desired even for such a fundamental series of compounds as the simple hydrides. The matter has been reopened in recent years by the development of techniques for measuring acidities in the gas phase.⁸⁶ The available results reemphasize the fact, already well known from previous work, that solvation factors have a profound influence on the course of acid-base reactions. But the gas-phase experiments do more than this; they call into question some of the fundamental assumptions and interpretations that have long been used to account for observed acidities in terms of molecular structure.

As an example, let us consider the effect on acidity of substituting one hydrogen of H₂O by various organic groups. Table 3.6 presents the available data for relative acidities of the simple alcohols in solution, whereas Table 3.7 shows the relationships in the gas phase. On the basis of the solution data alone, one would conclude that substitution by successively more bulky groups causes a steady lowering of acidity, although the relative positions of water and methanol

⁸⁵ For a more complete analysis, see R. P. Bell, *The Proton in Chemistry*, Cornell University Press, Ithaca, N.Y., 1959, p. 90.

⁸⁶ J. I. Brauman and L. K. Blair, *J. Amer. Chem. Soc.*, **92**, 5986 (1970).

Table 3.6 SOLUTION ACIDITIES OF WATER AND THE SIMPLE ALCOHOLS

Compound	pK_a	K_e^a
H ₂ O	15.7 ^b	1.20
CH ₃ OH	16 ^c 15.5 ^e	4.0
CH ₃ CH ₂ OH	18 ^d (16) ^f	0.95
(CH ₃) ₂ CHOH	18 ^d	(0.076)
(CH ₃) ₃ COH	19 ^d	—

^a J. Hine and M. Hine, *J. Amer. Chem. Soc.*, **74**, 5266 (1952). In isopropyl alcohol,

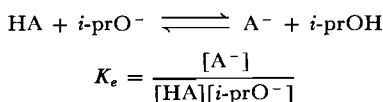

The value for isopropyl alcohol is determined by the definition of K_e .

^b Calculated for

$$K_a = \frac{[H_3O^+][OH^-]}{[H_2O]}$$

using $K_w = 10^{-14}$ and $[H_2O] = 55.5 M$.

^c A. Unmack, *Z. Phys. Chem.*, **129**, 349 (1927); **131**, 371 (1928); **133**, 45 (1928).

^d W. K. McEwen, *J. Amer. Chem. Soc.*, **58**, 1124 (1936). Measured in benzene using Unmack's value for CH₃OH as standard.

^e P. Ballinger and F. A. Long, *J. Amer. Chem. Soc.*, **82**, 795 (1960). Measured by conductivity in water.

^f Ref. *d*, by extrapolation of a correlation with Taft's σ^* parameters (see text).

Table 3.7 RELATIVE GAS-PHASE ACIDITIES OF ALCOHOLS

	Acidity Order ^a	ΔpK_a (gas) ^b
Strongest acid	$\phi\text{OH} \gg$	
	(CH ₃) ₃ COH >	
	(CH ₃) ₂ CHOH >	
	CH ₃ CH ₂ OH >	1
	CH ₃ OH >	0.5
Weakest acid	H ₂ O	

^a Determined by J. I. Brauman and L. K. Blair, *J. Amer. Chem. Soc.*, **92**, 5986 (1970) using ion cyclotron resonance spectroscopy.

^b D. K. Bohme, E. Lee-Ruff, and L. B. Young, *J. Amer. Chem. Soc.*, **93**, 4608 (1971). The technique for the quantitative measurements was the flowing afterglow method. See D. K. Bohme and L. B. Young, *J. Amer. Chem. Soc.*, **92**, 3301 (1970).

are somewhat uncertain. Before the advent of the gas-phase measurements, these data were the only ones available and were generally interpreted in terms of the inductive effects of the alkyl groups. It is well known, for example, that increasing alkyl substitution stabilizes carbocations (see Section 5.3), and so it was presumed that an alkyl group, being evidently electron-donating, should destabilize a negative charge. Hence it was reasonable that the alcohols with more or larger groups should have less tendency to form a negative ion by loss of a proton and hence should be less acidic. This interpretation was apparently supported by the establishment of a correlation between alcohol acidity and the Taft σ^* inductive parameter (see Section 2.2, p. 67), although it should be pointed out that the

Table 3.8 ORDER OF ACIDITY IN THE GAS PHASE FOR SELECTED COMPOUNDS^a

Most acidic: $\text{CH}_3(\text{CH}_2)_3\text{SH}$
 CH_3NO_2



HCCl_3

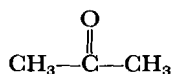

CH_3CN

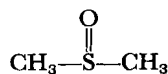

$\text{HC}\equiv\text{CH}$; $(\text{CH}_3)_3\text{COH}$; $(\text{CH}_3)_2\text{CHOH}$

$\text{CH}_3\text{CH}_2\text{OH}$

CH_3OH



ϕCH_3

H_2O

ϕH

H_2

NH_3

Least acidic: $\text{H}_2\text{C}=\text{CH}_2$, , , CH_4

^a D. K. Bohme, E. Lee-Ruff, and L. B. Young, *J. Amer. Chem. Soc.*, **94**, 5153 (1972).

correlation was made up of alcohols of the structure RCH_2OH and included only one of the substances in Table 3.6, namely methanol.⁸⁷

This interpretation is again one that attributes the observed effects solely to the intrinsic properties of the acid and conjugate base and ignores solvation. The solvation might in fact be expected to be quite important, since in all likelihood the bulky $(\text{CH}_3)_3\text{CO}^-$ ion will be much less well solvated than the OH^- ion. The intrinsic basicity of OH^- will thus be reduced by solvation more than will that of $(\text{CH}_3)_3\text{CO}^-$. The gas-phase results of Brauman and Blair (Table 3.7), show that in the absence of solvent, water is the weakest acid (OH^- the strongest base) and *tert*-butyl alcohol the strongest acid [$(\text{CH}_3)_3\text{CO}^-$ the weakest base]. If we assume that the gas-phase order reflects intrinsic molecular properties, we must conclude that preferential solvation is indeed reversing the order in solution. Brauman and Blair feel that the inductive effects have been misinterpreted in the past, and that alkyl groups are better able to stabilize *both* positive and negative charge than is hydrogen. They attribute this ability to the increasing polarizability of the alkyl groups as they become larger, and they give the outline of a theoretical interpretation of the effect.

⁸⁷ P. Ballinger and F. A. Long, *J. Amer. Chem. Soc.*, **82**, 795 (1960).

Table 3.8 lists comparative gas-phase acidities for a variety of compounds. Comparison of the relative gas-phase acidities with the solution pK_a values given in Table 3.2 reveals a number of changes in order. The most striking difference is the position of water, which, in comparison with other compounds, is a very much weaker acid in the gas phase than in the liquid phase. One may conclude that the strong propensity for water to solvate ions and polar molecules, particularly through hydrogen bonding, influences its acid-base properties so strongly as to overshadow other effects arising from the internal structure and bonding.

The conclusion that should be drawn from this discussion is that there are two kinds of acidity that must not be confused: (1) an *intrinsic* acidity, which is best approximated by gas-phase measurements and which reflects the properties of the ions and molecules in isolation, and (2) a *practical* liquid-phase acidity in which solvation effects may play the dominant role. In interpretation of structure-reactivity relationships, the liquid-phase acidity will probably be misleading unless the structures being compared are very similar; for thinking about chemical behavior in solution, however, the liquid-phase acidities are clearly the important ones.

Acidities of Amines

Acidities of amines in solution are less well known than those of alcohols. Streitwieser and co-workers report that cyclohexylamine is somewhat less acidic than triphenylmethane,⁸⁸ but there is little information available about the effects of structural variation on acidity. In the gas phase, Brauman and Blair found the order (most acidic to least acidic) $(C_2H_5)_2NH > (CH_3)_3CCH_2NH_2 \geq (CH_3)_3CNH_2 \geq (CH_3)_2NH \geq (CH_3)CHNH_2 > CH_3CH_2CH_2NH_2 > C_2H_5NH_2 > CH_3NH_2 > NH_3$.⁸⁹ Water falls between diethylamine and ammonia. The observed order is generally consistent with the theory that the charged conjugate base is better stabilized by more and larger alkyl groups. In the gas phase the amines are apparently of comparable acidity to the alcohols, whereas in solution they are much weaker acids.

Acidities of Carbon Acids



Another class of acids of interest in organic chemistry is the group of carbon acids. Here we may discern three kinds of effects on acidity. The first of these is illustrated by the acidity of methane ($pK_a \approx 48$) compared with that of cyclohexane ($pK_a \approx 52$) (Table 3.1). It would appear that the trend is in the direction of decreasing acid strength with substitution of hydrogen by alkyl. Note that the tendency here is in the direction opposite to the effect in alcohols if we take Brauman's gas-phase results to be the more accurate indication of intrinsic acid strength. The hydrocarbon data are from solution measurements subject to considerable uncertainty, and the differences are small. It seems risky to interpret the results in terms of intrinsic molecular properties.

A second effect of structure on acidity is evident from the data in Table 3.9. Here the differences are considered to be due primarily to the change in hybrid-

⁸⁸ A. Streitwieser, Jr., J. I. Brauman, J. H. Hammons, and A. H. Pudjaatmaka, *J. Amer. Chem. Soc.*, **87**, 384 (1965).

⁸⁹ J. I. Brauman and L. K. Blair, *J. Amer. Chem. Soc.*, **91**, 2126 (1969).

Table 3.9 ACIDITIES OF SELECTED HYDROCARBONS

Compound	Approximate pK_a^a
$C_6H_5C\equiv CH$	23
C_6H_6	43
$H_2C=CH_2$	44
	46
	52

^a See Table 3.1.

ization of the orbital that bears the negative charge in the conjugate base. The large contribution of the s orbital in the sp -hybridized carbon of acetylene results in greater electronegativity than is found in hybrids with high p -orbital contributions, because the s -orbital function puts the electrons on the average nearer to the nucleus. A regular trend toward weaker acids is evident from the data as the hybridization changes from sp ($C_6H_5C\equiv CH$) to sp^2 ($H_2C=CH_2$ and C_6H_6) to sp^3 (cyclohexane). Although we are still dealing with solution values, the interpretation in terms of molecular structure may be considered to be more reliable in this case than for the alcohols or saturated hydrocarbons, as the differences observed are larger.

The final effect to be noted in the carbon acids, and the most important one from the point of view of organic reactions in general, is illustrated by the data in Table 3.10. It is a well-known feature of organic molecules that certain electron-withdrawing groups increase the acidity of neighboring carbon-hydrogen bonds. A few of these groups are represented in Table 3.10, which also indicates the cumulative effects observed when more than one such group is bonded to the same carbon. The acidifying groups shown have unsaturated structures containing nitrogen or oxygen or both, and the acid-strengthening effect is attributable primarily to the stabilization of the conjugate base by delocalization of the negative charge onto an electronegative center, as illustrated in the alternative formulations 5 and 6.

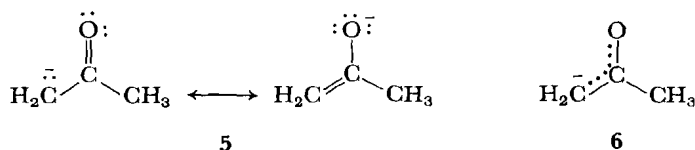

Again, solution acidities are being interpreted in terms of intrinsic properties; however, the differences are large enough (CH_4 to acetone over 20 pK units) that we may feel fairly confident of our theory in this case.

Carboxylic Acids

Another important class of organic acids are the carboxylic acids. Since the pK_a 's of these substances fall in the range 4–5, their acidities can be determined with

Table 3.10 ACIDITIES OF CARBON ACIDS CONTAINING ELECTRON-WITHDRAWING GROUPS

Compound	pK_a
CH_3NO_2	11
$\text{NO}_2\text{—CH}_2\text{—NO}_2$	4
$\text{CH}(\text{NO}_2)_3$	0
$\text{CH}_3\text{—}\overset{\text{O}}{\parallel}\text{C}\text{—CH}_3$	20
$\text{CH}_3\text{—}\overset{\text{O}}{\parallel}\text{C}\text{—CH}_2\text{—}\overset{\text{O}}{\parallel}\text{C}\text{—CH}_3$	9
$\text{CH}(\overset{\text{O}}{\parallel}\text{C—CH}_3)_3$	6
$\text{CH}_2\text{SO}_2\text{CH}_3$	29 ^a
$\text{CH}_2(\text{SO}_2\text{CH}_3)_2$	14
$\text{CH}(\text{SO}_2\text{CH}_3)_3$	0
$\text{CH}_3\text{C}\equiv\text{N}$	25
$\text{CH}_2(\text{C}\equiv\text{N})_2$	12
$\text{CH}(\text{C}\equiv\text{N})_3$	0

SOURCE: Reprinted with permission from R. G. Pearson and R. L. Dillon, *J. Amer. Chem. Soc.*, **75**, 2439 (1953). Copyright by the American Chemical Society.

^a See Ref. 15 in Table 3.2.

precision and compared with considerable confidence, despite the fact that the differences are small.⁹⁰ The pK_a 's of a very large number of carboxylic acids have been determined; we list in Table 3.11 only a few representative values to illustrate trends.⁹¹ The data indicate that the effect of electron-withdrawing substituents is to increase acid strength, even though direct conjugative delocalization of charge is not possible, as it is in the substituted carbon acids considered above. Again, one must be very careful to keep solvation factors constant in making comparisons if interpretations in terms of molecular structure are to be made; the most careful and informative studies of the carboxylic acids have been carried out in series in which the structural changes occur as far from the reaction site as possible, as for example in ring systems such as 7.⁹²

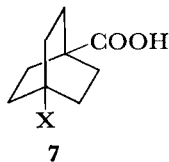

⁹⁰ The greatly increased acidity of the carboxylic acids over water and the alcohols is accounted for by delocalization of charge in the conjugate base, as indicated by Structures a.

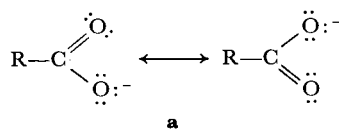

⁹¹ References to compilations are given in Table 3.2, note a.

⁹² (a) H. D. Holtz and L. M. Stock, *J. Amer. Chem. Soc.*, **86**, 5188 (1964); (b) R. Golden and L. M.

Table 3.11 ACID DISSOCIATION CONSTANTS OF SOME REPRESENTATIVE CARBOXYLIC ACIDS

Compound	pK_a^a
HCOOH	3.77
CH ₃ COOH	4.76
CH ₃ CH ₂ COOH	4.88
CH ₃ CH ₂ CH ₂ COOH	4.82
CH ₃ CH ₂ CH ₂ CH ₂ COOH	4.86
H ₃ N ⁺ CH ₂ COOH	2.31
O ₂ NCH ₂ COOH	1.68
ClCH ₂ COOH	2.86
Cl ₂ CHCOOH	1.29
Cl ₃ CCOOH	0.65
⁻ OOCCH ₂ COOH	5.69
φCOOH	4.20
<i>p</i> -(CH ₃) ₃ N ⁺ φCOOH	3.43
<i>p</i> - ⁻ OOCφCOOH	4.82

^a H. C. Brown, D. H. McDaniel, and O. Häflinger, *Determination of Organic Structures by Physical Methods*, Vol. 1, E. A. Braude and F. C. Nachod, Eds., Academic Press, New York, 1955, p. 567.

Basicities

We now turn to a brief consideration of the uncharged Brønsted bases. There is less quantitative information about solution basicity of the simple hydrides than about their acidities; it is only possible to make semiquantitative comparisons. The available data are given in Table 3.12; the only really reliable value is that of ammonia. Despite the uncertain nature of the information, we can see repeated here the same trend as with the acidities of the hydrides; in a given row in the periodic table the basicity decreases as electronegativity (and acidity) increases. Comparing the data for the hydrides within a group, we find again the lack of consistency with electronegativity that appeared in the acid-strength data. Phosphorus bases are weaker than the corresponding nitrogen bases, although phosphorus is less electronegative than nitrogen; similarly, although there are no reliable data for H₂S itself, in solution the sulfur bases are in general weaker than oxygen bases.⁹³

Nitrogen and Phosphorus Bases

The effect in the liquid phase of substituting hydrogen by alkyl groups on the nitrogen and phosphorus bases is illustrated by the solution data presented in Table 3.13. The phosphorus basicities are much more strongly affected than are the nitrogen. The tertiary amine (CH₃)₃N is in an anomalous position with respect to the other amines. We suspect immediately that solvation is the culprit. In the gas phase, the amine order is (most basic to least) tertiary > secondary >

Stock, *J. Amer. Chem. Soc.*, **88**, 5928 (1966); (c) F. W. Baker, R. C. Parish, and L. M. Stock, *J. Amer. Chem. Soc.*, **89**, 5677 (1967).

⁹³ See note 84 (a), p. 151.

Table 3.12 APPROXIMATE pK_a VALUES OF CONJUGATE ACIDS OF SOME SIMPLE HYDRIDES

Group V		Group VI	Group VII
NH_3	9.24 ^a	H_2O -7 ^c	HF (-9) ^e
PH_3 ^d	~ 14 ^b	-1.74 ^f	

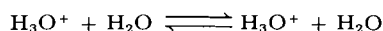
^a See Table 3.2.^b Estimated from exchange rate measurements by R. E. Weston and J. Bigeleisen, *J. Amer. Chem. Soc.*, **76**, 3074 (1954).^c E. M. Arnett, R. P. Quirk, and J. J. Burke, *J. Amer. Chem. Soc.*, **92**, 1260 (1970).^d Relative basicities in the gas phase are consistent with the solution results: D. Holtz and J. L. Beauchamp, *J. Amer. Chem. Soc.*, **91**, 5913 (1969); D. Holtz, J. L. Beauchamp, and J. R. Eyler, *J. Amer. Chem. Soc.*, **92**, 7045 (1970).^e D. D. Perrin, *Dissociation Constants of Inorganic Acids and Bases in Aqueous Solution*, Butterworths, London, 1969.^f Calculated from the equilibrium:

$$K' = 1 = \frac{[\text{H}_3\text{O}^+][\text{H}_2\text{O}]}{[\text{H}_3\text{O}^+][\text{H}_2\text{O}]}$$

$$K_a = 55.5 = \frac{[\text{H}_3\text{O}^+][\text{H}_2\text{O}]}{[\text{H}_3\text{O}^+]}$$

$$pK_a = -1.74$$

Table 3.13 SOLUTION pK_a VALUES OF CONJUGATE ACIDS OF SOME NITROGEN AND PHOSPHORUS BASES

Base	pK_a (BH^+)	Base	pK_a (BH^+)
NH_3	9.24 ^a	PH_3	~ -13 ^b
CH_3NH_2	10.6 ^c	$n\text{-C}_4\text{H}_9\text{PH}_2$	0 ^d
$(\text{CH}_3)_2\text{NH}$	10.7 ^c	$(n\text{-C}_4\text{H}_9)_2\text{PH}$	4.5 ^d
$(\text{CH}_3)_3\text{N}$	9.8 ^c	$(n\text{-C}_4\text{H}_9)_3\text{P}$	8.4 ^d

^a See Table 3.2.^b See Table 3.12.^c D. D. Perrin, *Dissociation Constants of Organic Bases in Aqueous Solution*, Butterworths, London, 1965. Values at 25°C.^d C. A. Streuli, *Anal. Chem.*, **32**, 985 (1960). Determined by titration in nitromethane and corrected to water solution.

primary > ammonia.⁹⁴ The phosphines have the same basicity order in the gas phase as in solution, tertiary \gg phosphine.⁹⁵

Arnett has presented an analysis of the solvation thermochemistry of the amines and their conjugate acids.⁹⁶ Table 3.14 gives Arnett's data for the four

⁹⁴ (a) E. M. Arnett, F. M. Jones, III, M. Taagepera, W. G. Henderson, J. L. Beauchamp, D. Holtz, and R. W. Taft, *J. Amer. Chem. Soc.*, **94**, 4724 (1972); (b) D. H. Aue, H. M. Webb, and M. T. Bowers, *J. Amer. Chem. Soc.*, **94**, 4726 (1972); (c) W. G. Henderson, M. Taagepera, D. Holtz, R. T. Melver, Jr., J. L. Beauchamp, and R. W. Taft, *J. Amer. Chem. Soc.*, **94**, 4728 (1972).

⁹⁵ E. M. Arnett, *Accts. Chem. Res.*, **6**, 404 (1973). Gas-phase data are reported for $(\text{CH}_3)_3\text{P}$ and PH_3 only, but heat of protonation results indicate that secondary and primary phosphines will fall in that order between these two.

⁹⁶ See note 94 (a).

Table 3.14 FREE ENERGIES OF IONIZATION AND SOLVATION OF AMINES AND AMMONIUM IONS IN THE GAS AND LIQUID PHASES

Amine	$\delta\Delta G_{ig}$	$\delta\Delta G_{tw}$	$\delta\Delta G_s(B)$	$\delta\Delta G_s(BH^+)$
NH ₃	0	0	0	0
CH ₃ NH ₂	9.5	1.92	-0.27	7.3
(CH ₃) ₂ NH	15.8	2.09	0.00	13.7
(CH ₃) ₃ N	20.4	0.75	1.07	20.7

SOURCE: Reprinted with permission from E. M. Arnett, F. M. Jones, III, M. Taagepera, W. G. Henderson, J. L. Beauchamp, D. Holtz, and R. W. Taft, *J. Amer. Chem. Soc.*, **94**, 4724 (1972). Copyright by the American Chemical Society. Values in kcal mole⁻¹ at 25°C. See text for explanation of symbols.

Table 3.15 ENTHALPY AND ENTROPY CONTRIBUTIONS TO RELATIVE FREE ENERGIES OF SOLUTION OF AMMONIUM IONS

Amine	$\delta\Delta H_s(BH^+)$	$-\delta T\Delta S_s(BH^+)$
NH ₃	0	0
CH ₃ NH ₂	6.0	1.3
(CH ₃) ₂ NH	11.2	2.6
(CH ₃) ₃ N	18.6	2.1

SOURCE: Reprinted with permission from E. M. Arnett, F. M. Jones, III, M. Taagepera, W. G. Henderson, J. L. Beauchamp, D. Holtz, and R. W. Taft, *J. Amer. Chem. Soc.*, **94**, 4724 (1972). Copyright by the American Chemical Society. Values in kcal mole⁻¹ at 25°C. See text for explanation of symbols.

processes of Equations 3.56 through 3.59. The subscript *w* refers to water solution,

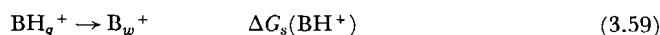

g to gas phase, *i* to the ionization process, and *s* to the transfer from gas to solution. Values reported in Table 3.14 are $\delta\Delta G$, free energies measured relative to the value for NH₃. The more positive $\delta\Delta G_i$, the smaller the tendency for BH⁺ to ionize, hence the stronger the base. The more positive $\delta\Delta G_s$, the more reluctant is that species to enter solution from the gas phase.

The first column of Table 3.14 reflects the gas-phase order, (CH₃)₃N most basic. The second column reflects the solution basicities (compare Table 3.13). The third column reveals that the differences in free energies of solution among the free bases are small. In the fourth column we find large differences among solvation free energies of the ions BH⁺. The more substituted BH⁺, the less favorable is its transfer to solution. Therefore, in solution the more substituted amines will be reduced in basicity compared with their gas-phase behavior, because the solvation of BH⁺ becomes poorer the more highly substituted it is. Note that the solvation free-energy differences very nearly cancel the intrinsic basicity differences revealed by the gas-phase ionization free-energy differences in the first column. The observed solution order (second column) results from the small free-energy variations remaining after combining two large, opposing terms [$\delta\Delta G_{ig}$ and $\delta\Delta G_s(BH^+)$] and one small term [$\delta\Delta G_s(B)$].

Table 3.16 ENTHALPY AND ENTROPY CONTRIBUTIONS TO RELATIVE FREE ENERGIES OF SOLUTION OF AMINES

Amine	$\delta\Delta H_s(\text{B})$	$-\delta T\Delta S_s(\text{B})$
NH_3	0	0
CH_3NH_2	-2.57	2.30
$(\text{CH}_3)_2\text{NH}$	-4.72	4.72
$(\text{CH}_3)_3\text{N}$	-4.67	5.76

SOURCE: Reprinted with permission from E. M. Arnett, F. M. Jones, III, M. Taagepera, W. G. Henderson, J. L. Beauchamp, D. Holtz, and R. W. Taft, *J. Amer. Chem. Soc.*, **94**, 4724 (1972). Copyright by the American Chemical Society. Values in kcal mole⁻¹ at 25°C. See text for explanation of symbols.

Table 3.15 dissects the important $\delta\Delta G_s(\text{BH}^+)$ term into enthalpy and entropy contributions. Increasing substitution on BH^+ makes both of these quantities less favorable in the gas \rightarrow solution direction. For the bases themselves, on the other hand, the solution enthalpies and entropies are in opposition (Table 3.16), enthalpies being more favorable to the solution process the more substituents, but entropies becoming less favorable with more substituents. The cancelation of these opposing effects leaves the small $\delta\Delta G_s(\text{B})$ values shown in Table 3.14. As we have noted in Section 2.4, these results are not easily interpreted at the molecular level, although the most important effect, that on solution free energy of BH^+ , is undoubtedly caused by decreasing opportunity for hydrogen bonding as hydrogens are replaced by alkyl groups.⁹⁷

Oxygen and Sulfur Bases

The oxygen and sulfur bases are weaker than the nitrogen bases, and accurate solution basicities are not available. Arnett's heat of protonation studies indicate that the order of decreasing basicity is $\text{ROR} > \text{ROH} > \text{H}_2\text{O}$,⁹⁸ a result that is in agreement with gas-phase measurements.⁹⁹ Hydrogen sulfide in the gas phase has basicity comparable to that of water (Table 3.18), and substitution of H by alkyl produces stronger gas-phase bases just as does similar substitution on oxygen.

Comparisons among the alcohols are difficult to make in solution. Titration in acetic acid indicates an order of basicity isopropyl alcohol $>$ ethyl $>$ methyl, but water was found to be a stronger base than any of these alcohols,¹⁰⁰ a result in disagreement with the gas-phase data. In the gas phase (Table 3.18), the basicity order (strongest base to weakest) is $(\text{CH}_3)_3\text{COH} > (\text{CH}_3)_2\text{CHOH} > \text{CH}_3\text{CH}_2\text{OH} > \text{CH}_3\text{OH} > \text{H}_2\text{O}$. Again, more and larger alkyl groups seem to stabilize charge.

Substitution by an aromatic group has a marked effect on solution base strength. One might be tempted to attribute the low basicity of aniline, di- and triphenylamines, and phenol compared with reference compounds (Table 3.17) to partial delocalization of the nonbonded electron pair on the nitrogen or oxygen into the π orbital system of the ring. But gas-phase results indicate the basicity

⁹⁷ (a) See note 94 (a), p. 159; (b) R. W. Taft, M. Taagepera, K. D. Summerhays, and J. Mitsky, *J. Amer. Chem. Soc.*, **95**, 3811 (1973).

⁹⁸ E. M. Arnett, R. P. Quirk, and J. J. Burke, *J. Amer. Chem. Soc.*, **92**, 1260 (1970).

⁹⁹ M. S. B. Munson, *J. Amer. Chem. Soc.*, **87**, 2332 (1965).

¹⁰⁰ I. M. Kolthoff and S. Bruckenstein, *J. Amer. Chem. Soc.*, **78**, 1 (1956).

Table 3.17 THE EFFECT OF PHENYL SUBSTITUTION ON SOLUTION BASICITY OF OXYGEN AND NITROGEN BASES

Compound	p <i>K</i> _a
C ₂ H ₅ OH	-5 ^a
C ₆ H ₅ OH	-7 ^b
NH ₃	9.24 ^b
C ₆ H ₅ NH ₂	4.60 ^c
(C ₆ H ₅) ₂ NH	0.79 ^c
(C ₆ H ₅) ₃ N	~ -5 ^d

^a E. M. Arnett, R. P. Quirk, and J. W. Larsen, *J. Amer. Chem. Soc.*, **92**, 1260 (1970).

^b See Table 3.2.

^c D. D. Perrin, *Dissociation Constants of Organic Bases in Aqueous Solution*, Butterworths, London, 1965.

^d Estimated from data of Arnett *et al.*, (note a).

Table 3.18 GAS-PHASE BASICITIES OF SELECTED COMPOUNDS

Compound	Proton Affinity ^a (kcal mole ⁻¹)	
CH ₄	127	Increasing basicity ↓
H ₂ C=CH ₂	159	
CH ₃ Cl	164	
H ₂ O	165	
H ₂ S	170	
HCOOH	177	
CH ₃ -CH=CH ₂	182	
CH ₃ OH	182	
CH ₃ SH	185 ^b	
PH ₃	185, ^b 188 ^c	
CH ₃ COOH	186	
CH ₃ CH ₂ OH	190	
CH ₃ -O-CH ₃	191	
(CH ₃) ₂ CHOH	193	
CH ₃ COCH ₃	195	
CH ₃ -S-CH ₃	197 ^b	
(CH ₃) ₃ COH	202	
CH ₃ CH ₂ -O-CH ₂ CH ₃	205	
NH ₃	207	
CH ₃ PH ₂	207 ^c	
φNH ₂	216 ^b	↑ Decreasing basicity
φ ₂ NH	^a	
CH ₃ NH ₂	216 ^b	
φ ₃ N	^a	
(CH ₃) ₂ PH	219 ^c	
(CH ₃) ₂ NH	222 ^b	
(CH ₃) ₃ N	227 ^b	
(CH ₃) ₃ P	228 ^c	

^a Except where noted, data are from the compilation of J. Long and B. Munson, *J. Amer. Chem. Soc.*, **95**, 2427 (1973).

^b E. M. Arnett, *Accs. Chem. Res.*, **6**, 404 (1973).

^c R. H. Staley and J. L. Beauchamp, *J. Amer. Chem. Soc.*, **96**, 6252 (1974).

^d I. Dzidic, *J. Amer. Chem. Soc.*, **94**, 8333 (1972). Only relative basicities reported for these compounds.

order $\phi_3\text{N} > \phi_2\text{NH}$, ϕNH_2 , and warn us that the solution order is probably again caused by solvation and not by internal electron distribution properties of the bases.¹⁰¹

The carbonyl bases constitute another important class of weak bases that present interesting possibilities for investigation of structural effects. In solution, experiments with these compounds are subject to severe difficulties. The result is a serious lack of agreement among different investigators about $\text{p}K_a$. Arnett and co-workers point out that $\text{p}K_a$ values reported for acetophenone cover a range of over four units (-3.65 to -7.99), while those for acetone span seven units (-0.2 to -7.2).¹⁰² In view of these uncertainties, it is impossible to say whether aldehydes, ketones, or carboxylic acids are the most basic in solution. Gas-phase data are available for some of these substances.

Table 3.18 summarizes gas-phase basicities for a number of compounds. It is possible to measure relative gas-phase basicities quantitatively, and the table includes proton affinity, which is the negative of the enthalpy change for reaction 3.60.¹⁰³

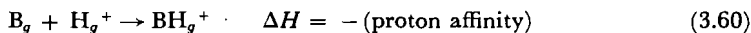

Table 3.18 contains data for three carbon bases: propene, ethylene, and methane. The position of methane indicates that the saturated hydrocarbons, among the weakest of the Brønsted acids, are also among the weakest bases. The unsaturated hydrocarbons have electrons in higher energy orbitals and accept a proton more easily. There is information available, primarily from acidity function techniques, about solution basicities of a number of unsaturated hydrocarbons.¹⁰⁴

3.5 LEWIS ACIDS AND BASES¹⁰⁵

In 1923 G. N. Lewis proposed a definition of acids and bases somewhat different from that of Brønsted:¹⁰⁶

An acid is an electron-pair acceptor.

A base is an electron-pair donor.

Lewis acids are thus electron-deficient molecules or ions such as BF_3 or carbocations, whereas Lewis bases are molecules or ions containing available electrons, such as amines, ethers, alkoxide ions, and so forth. A Lewis acid–base reaction is the combination of an acid and a base to form a complex, or adduct. The stabilities of these adducts depend on the structures of the constituent acid and base and vary over a wide range. Some examples of Lewis acid–base reactions are given in Table 3.19. Lewis acid–base reactions abound in organic chemistry:

¹⁰¹ I. Dzidic, *J. Amer. Chem. Soc.*, **94**, 8333 (1972).

¹⁰² E. M. Arnett, R. P. Quirk, and J. W. Larsen, *J. Amer. Chem. Soc.*, **92**, 3977 (1970).

¹⁰³ See note 94 (b), p. 159.

¹⁰⁴ For further details see note 84 (a), p. 151.

¹⁰⁵ A general discussion of Lewis acids and bases is given by R. J. Gillespie in *Friedel-Crafts and Related Reactions*, Vol. 1, G. A. Olah, Ed., Wiley-Interscience, New York, 1963, p. 169.

¹⁰⁶ G. N. Lewis, *Valence and the Structure of Atoms and Molecules*, American Chemical Society Monograph, The Chemical Catalog Co., New York, 1923. Lewis also gave a definition equivalent to that of Brønsted at this time, but he considered the electron-pair definition to be more general.

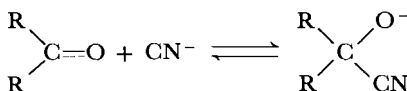
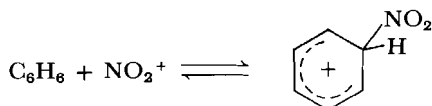
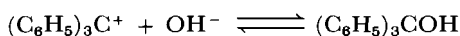
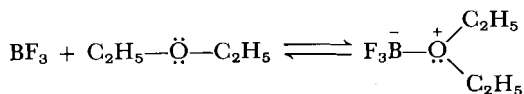
Table 3.19 EXAMPLES OF LEWIS ACID-BASE REACTIONS

the electrophiles (for example NO_2^+ , carbocations, Ag^+ , B_2H_6 , carbonyl carbon) and nucleophiles (OH^- , Cl^- , amines, carbanions, and many others), which are of such great importance in organic reactions, are Lewis acids and bases, respectively. The theory of these interactions, still in the process of being developed, may well prove to be of very general application.

The relationship between the Brønsted definition and the Lewis definition is a subtle one, which has caused some confusion and controversy over the years. There is no particular problem as far as bases are concerned, for it is clear that the two definitions refer to the same substances. Molecules with available electrons are capable of accepting a proton and also of coordinating with other electron-deficient centers, and so fit both definitions. It is with acids that the difficulties arise. The proton is itself a Lewis acid, and the prototype acid-base reactions of Equation 3.1 and 3.2 are clearly acid-base reactions in the Lewis sense, with H^+ the acid, A^- or B the base, and HA and BH^+ the acid-base complexes. For these reasons Lewis¹⁰⁷ and others¹⁰⁸ have considered the Brønsted acid-base reactions to be special cases of the more general category covered by the Lewis definition. Adherents of the Brønsted theory, however, maintain that since Brønsted acid-base reactions do not involve the bare proton, and since Brønsted acids are not, in general, Lewis acids, it is better to regard the two definitions as distinct.¹⁰⁹

The problem is that a substance HA undergoing a reaction in which it behaves as a Brønsted acid is not behaving as an acid in the Lewis sense; it is, however, behaving as a Lewis acid-base adduct. The issue is further clouded by the fact that HA can enter into reactions in which it does behave as a Lewis acid, as for example in the formation of a hydrogen bond (Equation 3.61); in this case it is not, however, behaving as a Brønsted acid, since the proton remains

¹⁰⁷ See note 106.

¹⁰⁸ (a) W. F. Luder and S. Zuffanti, *The Electronic Theory of Acids and Bases*, Wiley, New York, 1946; W. F. Luder, *Chem. Rev.*, **27**, 547 (1940); (b) D. P. N. Satchell and R. S. Satchell, *Quart. Rev. (London)*, **25**, 171 (1971).

¹⁰⁹ (a) R. P. Bell, *The Proton in Chemistry*, 2nd ed., Cornell University Press, Ithaca, N.Y., 1973, p. 7; (b) I. M. Kolthoff, *J. Phys. Chem.*, **48**, 51 (1944).

more strongly bonded to A than it is to B. In this book we shall maintain the



distinction between the two definitions and shall follow the usual convention that the unmodified term *acid* will refer to a Brønsted acid, while Lewis acids will be specified as such.

Strengths of Lewis Acids and Bases

Because the Lewis acid–base concept is an extremely useful one in chemistry, quantitative relationships of the types discussed in the previous sections for Brønsted acids and bases would be helpful. The task of classifying the Lewis acids and bases according to some criterion of strength has nevertheless proved to be a difficult one, and methods being developed still yield largely qualitative results. Brønsted acid–base reactions always involve transfer of a proton; this common feature allows meaningful quantitative comparisons of strengths to be made. Different Lewis acid–base reactions, on the other hand, do not necessarily have any feature in common, and the result is that the term “strength” does not have a well-defined meaning.

The problem may be illustrated by a simple example.¹¹⁰ Suppose that we wish to compare the “coordinating power” of two Lewis bases, say an amine, NR_3 , and a phosphine, PR_3 . We might do this by comparing the equilibrium



constants for Reactions 3.62 and 3.63 of the two bases, B and B', with the same Lewis acid, for example BF_3 . Quantitative data are not always available; but it is often possible to make qualitative decisions about orders of reactivity. The information we have shows that the nitrogen base should be judged to have the greater coordinating power, since the equilibrium constant is greater for the formation of nitrogen base complex.¹¹¹ A similar qualitative result is found with H^+ as the reference acid.¹¹² If, on the other hand, the equilibrium constants for a nitrogen and a phosphorus base with Ag^+ are measured, it is found that with respect to this Lewis acid the phosphine has much greater coordinating power than does the amine. A similar situation arises with another set of bases, the halide ions. If H^+ is taken as the reference acid, fluoride is the most effective base in solution, followed by chloride, bromide, and iodide. With silver ion, however, the order is exactly reversed; iodide forms the most stable complex and fluoride the least stable.¹¹³

Hard and Soft Lewis Acids and Bases

Despite the apparent chaos of the picture presented by these results, it is possible to find some qualitative relationships that are useful. Schwarzenbach,¹¹⁴ and also

¹¹⁰ S. Ahrland, J. Chatt, and N. R. Davies, *Quart. Rev.* (London), **12**, 265 (1958).

¹¹¹ W. A. G. Graham and F. G. A. Stone, *J. Inorg. Nuclear Chem.*, **3**, 164 (1956).

¹¹² See Table 3.13 for solution data and Table 3.18 for gas-phase data.

¹¹³ See note 110.

¹¹⁴ (a) G. Schwarzenbach, *Experientia*, Suppl., **5**, 162 (1956); (b) G. Schwarzenbach, *Advan. Inorg.*

Ahrland, Chatt, and Davies,¹¹⁵ classified Lewis acids into two categories, Class *a* and Class *b*. Class *a* acceptors are those that form their most stable complexes with donors of the first row of the periodic table: N, O, and F. Class *b* acids complex best with donors of the second or subsequent row: P, S, Cl, Br, I.¹¹⁶

This classification scheme for Lewis acids has been generalized and extended by R. G. Pearson.¹¹⁷ He proposes that each Lewis acid and base be characterized by two parameters, one of which is referred to as *strength* and the other of which is called *softness*. Thus the equilibrium constant for a simple acid-base reaction (Equation 3.62) would be a function of four parameters, two for each partner.

The next step in Pearson's argument is to classify acids and bases as *hard* or *soft* according to their properties. Hard acids correspond roughly in their behavior to the Class *a* acids of Schwarzenbach and of Ahrland, Chatt and Davies. They are characterized by small acceptor atoms that have outer electrons not easily excited and that bear considerable positive charge. Soft acids have acceptor atoms of lower positive charge, large size, and with easily excited outer electrons. Hard and soft bases are defined analogously. Hard bases contain highly electronegative donor atoms of low polarizability,¹¹⁸ are typically difficult to oxidize, and have no empty low-energy orbitals available; soft bases are polarizable, have less electronegative donor atoms, and have empty orbitals of low energy and electrons that are more easily removed by oxidizing agents. Table 3.20 gives Pearson's classification of acids and bases into the hard and soft categories.

Having defined the terminology, we may now state Pearson's *principle of hard and soft acids and bases* (commonly abbreviated HSAB principle): Hard acids prefer to bind to hard bases and soft acids prefer to bind to soft bases.¹¹⁹

Shortcomings of the HSAB principle Despite the apparent success of the HSAB principle, there are difficulties. The proposed scheme is one in which two parameters, strength and softness, characterize each acid and each base. Although published discussions¹²⁰ have been specific about how softness is determined, they have said much less about the strength parameter, and most of the applications and examples have been considered mainly from the point of view of the hardness or softness of the acids and bases concerned.

The only satisfactory way to handle the situation would appear to be to establish numerical scales for both strength and hardness. Although limited work along these lines has been done,¹²¹ it does not appear possible to extend the quantitative correlations to cover the wide range of reactions that seem to fit in at

Chem. Radiochem., **3**, 257 (1961); (c) G. Schwarzenbach and M. Schellenberg, *Helv. Chim. Acta*, **48**, 28 (1965).

¹¹⁵ See note 110, p. 165.

¹¹⁶ See also J. O. Edwards and R. G. Pearson, *J. Amer. Chem. Soc.*, **84**, 16 (1962).

¹¹⁷ (a) R. G. Pearson, *J. Amer. Chem. Soc.*, **85**, 3533 (1963); (b) R. G. Pearson and J. Songstad, *J. Amer. Chem. Soc.*, **89**, 1827 (1967); (c) R. G. Pearson, *Survey of Progress in Chemistry*, **5**, 1 (1969).

¹¹⁸ See Section 2.4.

¹¹⁹ See note 117 (c).

¹²⁰ See note 117.

¹²¹ See, for example: (a) J. O. Edwards, *J. Amer. Chem. Soc.*, **76**, 1540 (1954); (b) R. S. Drago and B. B. Wayland, *J. Amer. Chem. Soc.*, **87**, 3571 (1965).

Table 3.20 PEARSON'S CLASSIFICATION OF LEWIS ACIDS AND BASES

Hard	Borderline	Soft
	Acids	
H ⁺ , Li ⁺ , Na ⁺ , K ⁺	Fe ²⁺ , Co ²⁺ , Ni ²⁺	Cu ⁺ , Ag ⁺ , Hg ⁺
Be ²⁺ , Mg ²⁺ , Ca ²⁺ , Sr ²⁺ , Mn ²⁺	Cu ²⁺ , Zn ²⁺	Hg ²⁺
Al ³⁺ , Cr ³⁺ , Co ³⁺ , Fe ³⁺	Pb ²⁺ , Sn ²⁺	BH ₃ , RS ⁺ , I ⁺
BF ₃ , B(OR) ₃	B(CH ₃) ₃ , SO ₂	Br ⁺ , HO ⁺ , RO ⁺
Al(CH ₃) ₃ , AlCl ₃ , AlH ₃	NO ⁺ , R ₃ C ⁺	I ₂ , Br ₂
RPO ₂ ⁺ , ROPO ₂ ⁺	C ₆ H ₅ ⁺	Trinitrobenzene, etc.
RSO ₂ ⁺ , ROSO ₂ ⁺ , SO ₃		Chloranil, quinones, etc.
RCO ⁺ , CO ₂ , NC ⁺		Tetracyanoethylene, etc.
HX (hydrogen-bonding molecules)		CH ₂ , carbenes
	Bases	
H ₂ O, OH ⁻ , F ⁻	C ₆ H ₅ NH ₂ , C ₅ H ₅ N	R ₂ S, RSH, RS ⁻
CH ₃ COO ⁻ , PO ₄ ³⁻ , SO ₄ ²⁻	N ₃ ⁻ , Br ⁻ , NO ₂ ⁻	I ⁻ , SCN ⁻ , S ₂ O ₃ ⁻
Cl ⁻ , CO ₃ ²⁻ , ClO ₄ ⁻ , NO ₃ ⁻	SO ₃ ²⁻	R ₃ P, (RO) ₃ P
ROH, RO ⁻ , R ₂ O	N ₂	CN ⁻ , RNC, CO
NH ₃ , RNH ₂		C ₂ H ₄ , C ₆ H ₆
		H ⁻ , R ⁻

SOURCE: R. G. Pearson, *Survey of Progress in Chemistry*, 5, 1 (1969). Reproduced by permission of Academic Press and R. G. Pearson.

least a qualitative way with the hard-soft principle.¹²² Pearson has emphasized that the HSAB principle is meant to be used only qualitatively, as a way of systematizing experimental results, and we should heed this warning.¹²³

Applications of the HSAB principle In considering Brønsted acidities, we have already met some equilibria to which we can apply the hard-soft ideas. In Table 3.3 we noted that within a given column of the periodic table, the hydrides become more acidic as one moves down. The negative ions in the lower rows are softer bases than the corresponding ones in the upper rows (H₂P⁻ is softer than H₂N⁻; HS⁻ is softer than HO⁻), and the softer bases bond less strongly to the hard proton. The limited gas-phase data (Table 3.8) suggest that the same order applies: RSH is a stronger gas-phase acid than ROH. Similarly, the hard neutral nitrogen is more basic toward hard proton than is softer neutral phosphorus, both in the liquid (Table 3.12) and in the gas (Table 3.18). Neutral oxygen and sulfur bases, however, appear to be of comparable basicity toward the proton in the gas phase (Table 3.18). We shall find other applications for the HSAB principle in later chapters.

The theoretical basis for the hard-soft principle It is worthwhile at this point to discuss briefly some of the theoretical concepts behind the hard-soft

¹²² (a) R. G. Pearson, H. Sobel, and J. Songstad, *J. Amer. Chem. Soc.*, **90**, 319 (1968); (b) C. D. Ritchie, *Accts. Chem. Res.*, **5**, 348 (1972).

¹²³ Pearson's hard-soft scheme has been criticized: (a) R. J. P. Williams and J. D. Hale, *Structure and Bonding*, Vol. 1, Springer-Verlag, Berlin, 1966, p. 249; (b) R. S. Drago and R. A. Kabler, *Inorg. Chem.*, **11**, 3144 (1972); (c) R. G. Pearson, *Inorg. Chem.*, **11**, 3146 (1972); (d) R. S. Drago, *Inorg. Chem.*, **12**, 2211 (1973).

principle. As we have emphasized, the principle is a statement summarizing experimental facts and cannot at present be explained in detail at the molecular level. Yet there are general trends in properties of acids and bases that correspond to their classification as hard and soft, and we might therefore look for a qualitative theoretical explanation.

Although complete understanding can come only with full comprehension of chemical bonding itself, it is possible to identify various factors that appear to be of particular importance to the stability of Lewis acid–base complexes. These factors are discussed in a number of places in the chemical literature; we shall summarize them briefly here and refer the reader to the original papers for more detailed discussion.¹²⁴ The central theme of current thinking about the nature of the bonding may be referred to as the ionic–covalent theory; it maintains that hard–hard interactions involve strong ionic bonding, whereas soft–soft interactions occur mainly through covalent bonding. Speaking more specifically, one may say that the sites of interaction between a hard acid and a hard base combine relatively large charges with small size; the result is that electrostatic (coulombic) forces are large. A strong, highly ionic bond results. In a soft–soft interaction, on the other hand, the easily polarized orbitals of the acid and base interact strongly to produce a bonding orbital extending over both atoms, the electron pair is effectively shared, and good covalent bonding results. The strengths of soft–soft interactions are enhanced when, in addition to those electrons directly involved in the formation of the σ bond, the acceptor has unshared electrons and the donor has low-lying vacant orbitals. These features allow covalent π bonding by donation of electrons by the acid back to the base, with resulting increase in stability of the complex. This factor is most important in compounds in which the acid is a transition metal ion.¹²⁵

PROBLEMS

1. Using the pK_a values in the table below, find, with the aid of Figure 3.1, (a) the fraction of each compound protonated in 60 percent H_2SO_4 ; (b) the H_2SO_4 –water mixture required to protonate 40 percent of 4,4'-dinitrobenzophenone.

Compound	pK_a of Conjugate Acid ^c
Diethyl ether	– 3.6
Acetophenone	– 6.1
4,4'-Dinitrobenzophenone	– 10.1

^c E. M. Arnett, *Prog. Phys. Org. Chem.*, **1**, 223 (1963).

2. A 0.01 molal solution of ϕ_3COH in H_2SO_4 freezes at $10.09^\circ C$. The freezing point of pure H_2SO_4 is $10.36^\circ C$, and the molal freezing-point depression constant is $6.81^\circ C$. Explain.

3. What would be the pK_a of a base that was 25 percent protonated in HSO_3F containing 10 percent by weight SbF_5 ?

¹²⁴ See (a) note 110, p. 165, (b) K. S. Pitzer, *J. Chem. Phys.*, **23**, 1735 (1955); (c) K. S. Pitzer and E. Catalano, *J. Amer. Chem. Soc.*, **78**, 4844 (1956); (d) R. S. Mulliken, *J. Amer. Chem. Soc.*, **77**, 884 (1955). For a summary see Pearson, notes 117 (a) and 117 (c), p. 166.

¹²⁵ S. Ahrland, *Structure and Bonding*, Vol. 1, Springer-Verlag, Berlin, 1966, p. 207.

4. Draw orbital structures for ϕCH_2^- and for ϕ^- , and explain on the basis of the structures why ϕH would be expected to be a weaker acid than ϕCH_3 and why α might be different for the two compounds.

5. In cyclopropane, the C—C—C bond angle is 60° , but it is thought that the angle between the orbitals is greater, that is, that the bonds are bent outwards so that the electron density is not a maximum along the C—C line but rather is maximum along some curve passing outside the C—C line. If the H—C—H bond angles are 119° , find the angle between the two hybrids the carbon uses to form C—C bonds to its neighbors. Find the percent s character of the C—C and of the C—H bonds, and compare the percent s character of the C—H bonds with that of C—H bonds in acetylene, ethylene, and cyclohexane. Compare these results to the acidities in Table 3.9. (Information needed to solve this problem is in Appendix 1 to Chapter 1.)

REFERENCES FOR PROBLEMS

5. See Appendix 1, Chapter 1. The H—C—H bond angle quoted is the average of values obtained by O. Hassel and H. Viervoll, *Acta Chem. Scand.*, **1**, 149 (1947) (118.2° , electron diffraction) and by Hs. H. Günthard, R. C. Lord, and T. K. McCubbin, Jr., *J. Chem. Phys.*, **25**, 768 (1956) (120° , vibration-rotation spectrum).

Chapter 4

BIMOLECULAR

SUBSTITUTION

REACTIONS

A large number of organic reactions, differing often in mechanism and in the nature of the attacking reagent, are overall substitution reactions on carbon in which Y replaces X. Equation 4.1, which, in order to be as general as possible, ignores charges, bonding electrons, and substituent groups, is a schematized representation of these displacements.



Nucleophilic aliphatic substitution is the displacement from saturated carbon of a group with its bonding electrons by a group with an extra pair of electrons (Equation 4.2).

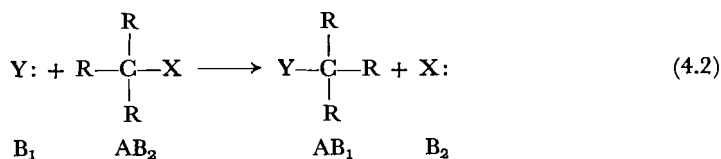

Since both the entering group (or *nucleophile*) and the leaving group are Lewis bases, Equation (4.2) is an example of a Lewis acid–base reaction in which one base replaces another in the Lewis acid–base adduct. Reactions corresponding to Equation 4.2 fall mainly into four charge types.¹ In these the Lewis bases are either uncharged or carry a single negative charge.²

¹ E. D. Hughes and C. K. Ingold, *J. Chem. Soc.*, 244 (1935).

² Some few nucleophiles such as $S_2O_3^{2-}$ carry a double negative charge.

Type	Y	X	Example
1	Negative	Negative	$I^- + RCl \longrightarrow R-I + Cl^-$
2	Neutral	Negative	$H_2O + R-I \longrightarrow R-\overset{+}{O}H_2 + I^-$
3	Negative	Neutral	$Cl^- + RNH_3^+ \longrightarrow R-Cl + NH_3$
4	Neutral	Neutral	$NH_3 + R-\overset{+}{S}R_2 \longrightarrow RNH_3^+ + SR_2$

4.1 S_N1 AND S_N2 SUBSTITUTION MECHANISMS³

In 1933 the two still widely accepted mechanisms for nucleophilic displacement reactions were proposed by Hughes, Ingold, and Patel.⁴ They found that decomposition of quaternary ammonium salts, R₄N⁺Y⁻, to give R₃N and RY exhibited two different kinds of kinetic behavior depending on the ammonium salt used. For example, when methyl alcohol was formed from trimethyl-*n*-decylammonium hydroxide (Equation 4.3), the rate of formation of methyl alcohol was found to be second-order, first-order each in trimethyl-*n*-decylammonium cation and in hydroxide ion as in Equation 4.4. On the other hand, the rate of formation of diphenylmethanol from benzhydryltrimethylammonium

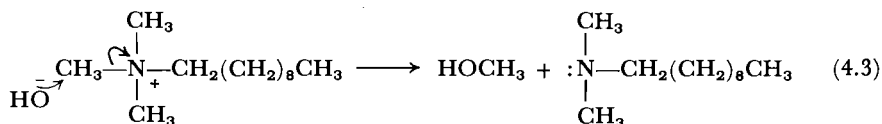

$$\text{rate} = k(\text{CH}_3)_3\overset{+}{\text{N}}\text{C}_{10}\text{H}_{21}[\text{OH}^-] \quad (4.4)$$

hydroxide was found to be overall first-order—dependent only on the ammonium ion concentration as in Equation 4.6. Added hydroxide ion did not change the rate. This and related evidence led the authors to postulate that these reactions,

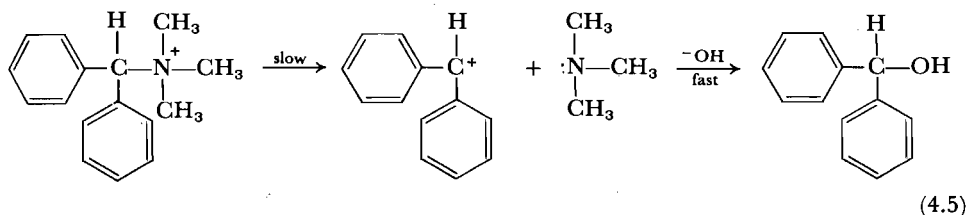

$$\text{rate} = k_1[\phi_2\text{CHN}^+(\text{CH}_3)_3] \quad (4.6)$$

so closely related in starting materials and products, nevertheless proceed by two different mechanisms.

In the decomposition of trimethyl-*n*-decylammonium hydroxide (Equation 4.3), they suggested, OH⁻ attacks one of the methyl groups, forcing the substituted amine to depart. Both ammonium and hydroxide ions are part of the

³ Comprehensive reviews of S_N2 substitution can be found in: (a) S. R. Hartshorn, *Aliphatic Nucleophilic Substitution*, Cambridge University Press, London, 1973; (b) A. Streitwieser, *Solvolytic Displacement Reactions*, McGraw-Hill, New York, 1962; (c) C. K. Ingold, *Structure and Mechanism in Organic Chemistry*, 2nd ed., Cornell University Press, Ithaca, N.Y., 1969.

⁴ E. D. Hughes, C. K. Ingold, and C. S. Patel, *J. Chem. Soc.*, 526 (1933).

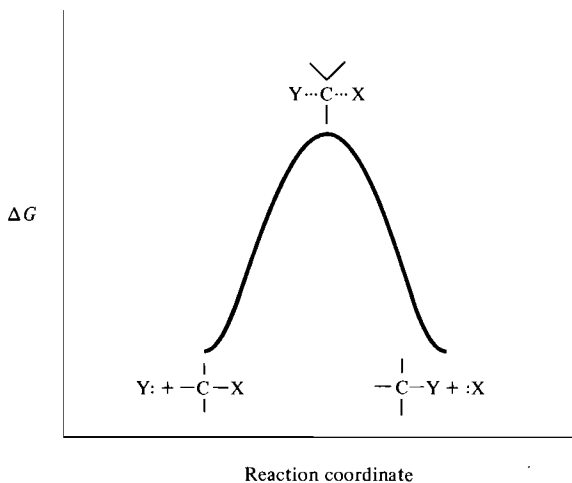

Figure 4.1 Proposed reaction coordinate diagram for the S_N2 reaction.

activated complex of this single-step reaction, and therefore both enter into the rate equation.

The decomposition of benzhydryltrimethylammonium hydroxide (Equation 4.5), on the other hand, according to Ingold, proceeds by initial slow formation of the relatively stable diphenylmethyl carbocation⁵ and subsequent fast attack on the carbocation by hydroxide. Because hydroxide is not part of the activated complex of the slow step of this reaction, it does not enter into the rate equation.

Hughes and Ingold, in 1935, went on to postulate that these mechanisms, or a combination of them in which the nucleophile plays an intermediate role in the departure of the leaving group, are general for all aliphatic nucleophilic substitutions.⁶

Broadly, then, if the substitution site is primary, and therefore access to it is not hindered sterically, the nucleophile approaches it and, by donation of its electron pair, forms a partial bond to carbon while the leaving-group—carbon bond begins to break (Equation 4.7). At the transition state, both bonds partially

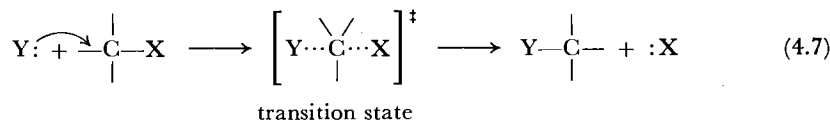

exist, although bond making and bond breaking need not have occurred to the same extent. When the reaction is over, the role of the Lewis bases is reversed from that in the starting material: Y is sharing its lone pair but X is not. Thus Y is one unit less and X one unit more negatively charged. This is called the S_N2 (substitution-nucleophilic-bimolecular) mechanism.

The reaction coordinate diagram that corresponds to this proposed mechanism for the direct displacement reaction is shown in Figure 4.1. Although

⁵ We use the term *carbocation* to refer to any cationic carbon species. For more about the nomenclature of carbocations, see Chapter 6, p. 288.

⁶ J. L. Gleave, E. D. Hughes, and C. K. Ingold, *J. Chem. Soc.*, 236 (1935).

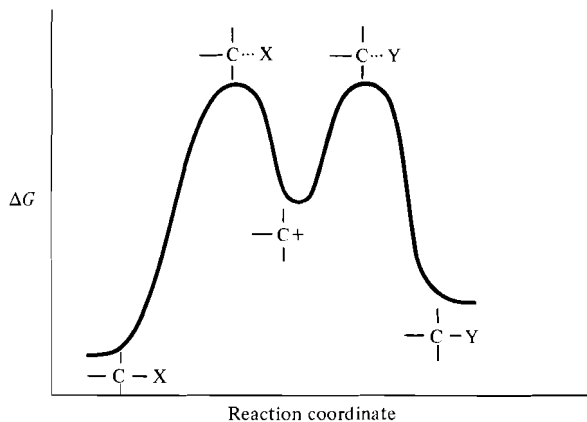

Figure 4.2 Proposed reaction coordinate diagram for the S_N1 reaction.

the figure indicates that there is no energy minimum on the reaction coordinate between reactants and products, we cannot be absolutely sure that this is an accurate representation. A small energy dip prior to rate-determining attack of Y: on the substrate would be very difficult to detect experimentally.⁷

The second mechanism is the usual pathway if the substitution site has three alkyl groups on it or is conjugated with two aromatic rings. In this case the bond to the leaving group cleaves heterolytically and a carbocation is formed. Then, in a second step, the nucleophile attacks this highly reactive intermediate as shown in Equation 4.5. In Lewis acid–base language, Reaction 4.5 can be described as follows: The Lewis acid–base adduct dissociates to a Lewis acid (the carbocation) and a Lewis base (the leaving group); the carbocation then immediately forms a second Lewis acid–base adduct with a new base (the nucleophile). The net result of the reaction, as in Reaction 4.3, is that the two Lewis bases have exchanged roles.

Figure 4.2 shows the reaction coordinate diagram for this mechanism. The carbocation is a real intermediate and thus lies at an energy minimum; energy maxima occur both when the C—X bond is stretched, and when the C—Y bond is formed. This process will be considered in detail in Chapter 5. A number of modifications of the original Ingold S_N1 mechanism must be made to accommodate the results of more recent investigations.

The mechanism shown in Reaction 4.7 is still widely accepted as one of the two general mechanisms for nucleophilic aliphatic substitution. It is widely accepted today because in the intervening years a large bulk of experimental evi-

⁷ Sneen and Larsen have proposed that processes that are called S_N2 may involve initial rapid formation of an ion pair followed by rate-determining attack of a nucleophile on the ion pair as in the following equation:

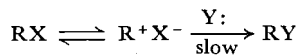

We mention the Sneen-Larsen mechanism again in Section 5.4. It is controversial, and for the purposes of the discussion in this chapter we shall use the traditional Ingold S_N2 model. The case for the ion-pair S_N2 mechanism is given by: R. A. Sneen and J. W. Larsen, *J. Amer. Chem. Soc.*, **91**, 362, 6031 (1969); R. A. Sneen, G. R. Felt, W. C. Dickason, *J. Amer. Chem. Soc.*, **95**, 638 (1973); and R. A. Sneen, *Acta. Chem. Res.*, **6**, 46 (1973). For one of the arguments against it, see V. F. Raean, T. Juhlke, F. J. Brown, and C. J. Collins, *J. Amer. Chem. Soc.*, **96**, 5928 (1974).

dence has been found that suggests that this is indeed a good description of the pathway of a class of displacement reactions. We shall examine the evidence below, but first, since this is the first chapter on reaction mechanisms, let us emphasize that a mechanism is "good" only insofar as it explains the experimental data, and that, therefore, although the experimental results that follow can be thought of as the "characteristics" of the S_N^2 mechanism, they are in fact the observable data on whose basis it has been conjectured. The data are facts; the mechanism is a theory deduced from those facts.

4.2 STEREOCHEMISTRY OF THE S_N^2 REACTION

In the 1890s, many years before the mechanism of direct substitution was proposed by Hughes and Ingold, Walden had observed that some reactions of optically active compounds give products of opposite absolute configuration from the starting materials.⁸ Walden, however, was not able to discover what conditions brought about this inversion of configuration. His task was complicated by the fact that two compounds of the same absolute configuration may nevertheless have opposite signs of optical rotation. In the following 40 years a great deal of work and thought was given to the problem of the relation of Walden inversion, as it is still called, to mechanism.⁹ Then, in 1935, Hughes and co-workers in ingenious experiments clearly showed that Walden inversion occurs in direct nucleophilic substitution.¹⁰

These workers studied the exchange reaction of optically active *s*-octyl iodide with radioactive iodide ion in acetone (Equation 4.8) and found that: (1) the kinetics are second-order, first-order each in octyl iodide and in iodide ion,

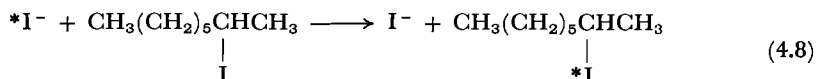

and thus the mechanism is bimolecular; and (2) the rate of racemization is twice the rate of incorporation of labeled iodide ion into the organic molecule. The rate of racemization must be twice the rate of inversion. (If an optically active compound begins to racemize, each molecule that undergoes inversion is one of a racemic pair of molecules; for example, pure levorotatory starting material is 100 percent racemized when only 50 percent of it has been converted to the dextrorotatory isomer.) So, if the rate of racemization is twice the rate of incorporation of radioactive iodide, then *each attacking iodide ion inverts the molecule it enters*.

This one-to-one correlation of inversion with displacement must mean that the incoming iodide enters the molecule from the side of the substitution site opposite to the departing iodide every single time. It initially attacks the back lobe of the sp^3 orbital used for bonding with the iodide. The transition state proposed by Hughes and co-workers is shown in **1**. Carbon has rehybridized and is

⁸ P. Walden, *Chem. Ber.*, **26**, 210 (1893); **29**, 133 (1896); **32**, 1855 (1899).

⁹ For a comprehensive summary of this work see Ingold, *Structure and Mechanism in Organic Chemistry*, pp. 509ff.

¹⁰ (a) E. D. Hughes, F. Juliusburger, S. Masterman, B. Topley, and J. Weiss, *J. Chem. Soc.*, 1525 (1935); (b) E. D. Hughes, F. Juliusburger, A. D. Scott, B. Topley, and J. Weiss, *J. Chem. Soc.*, 1173 (1936); (c) W. A. Cowdrey, E. D. Hughes, T. P. Nevell, and C. L. Wilson, *J. Chem. Soc.*, 209 (1938).



using three sp^2 orbitals for bonding with the nonreacting ligands and the remaining p orbital for forming partial bonds with X and Y. The geometry is that of a trigonal bipyramid with the entering and leaving groups in the apical positions. Because of its accordance with experimental facts, and because of its compatibility with our ideas about bonding, this transition state has been universally accepted. See Section 10.3 for a further discussion of the S_N2 transition state.

Inversion of configuration in the displacement of iodide by radioactive iodide and in all reactions of charge type 1 might be explained on the grounds that the bipyramidal transition state shown in **1** allows the entering and leaving

SCHEME 1

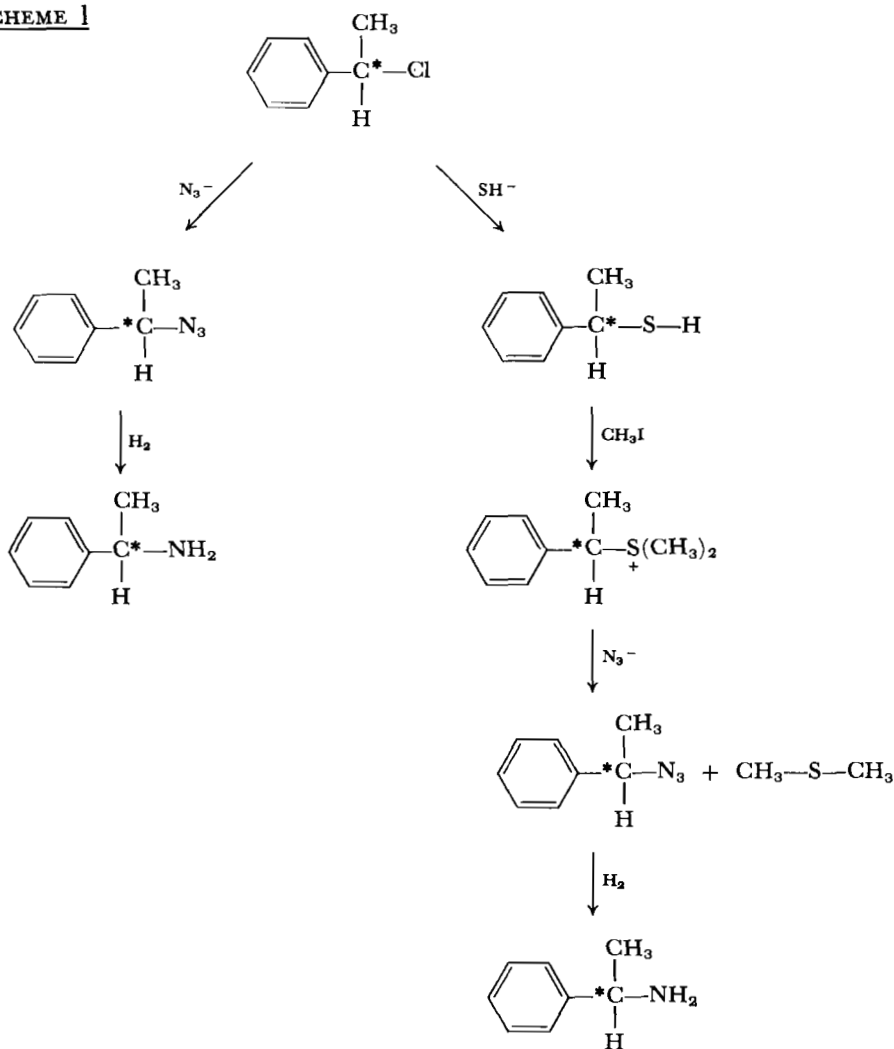

groups, both of which carry a partial negative charge, to be as far away from each other as possible, thus minimizing electrostatic repulsion.¹¹ That this explanation is not correct is shown by the fact that even reactions of charge type 3, in which the entering and leaving groups bear opposite charges, go by inversion.¹² Hughes and co-workers carried out the reactions shown in Scheme 1.

A sample of optically active 1-phenylethyl chloride was converted to the corresponding azide with sodium azide while another was converted to the thiol with sodium hydrogen sulfide. Both of these second-order reactions are of charge type 1, processes already shown to proceed with inversion. Thus both the thiol and the azide have the configuration opposite to that of the starting chloride. The azide was then reduced with hydrogen over platinum to the corresponding amine, and the thiol was converted to the dimethylsulfonium salt. Neither of these processes disturbs the chiral center, and therefore both of these compounds have the opposite configuration to that of the starting material. Then, in another second-order substitution reaction, the sulfonium salt was converted to the azide and the azide reduced to the amine. This amine had the *opposite* configuration of the amine produced by the first route, and therefore the substitution (of charge type 3) of azide ion on the sulfonium salt must occur with inversion of configuration.

There is now a great deal of evidence that all S_N2 reactions of all charge types proceed with inversion.¹³

Substitution in Bridged Ring Compounds

Proof that a site incapable of undergoing inversion is also incapable of undergoing a second-order substitution reaction has been obtained from bicyclic compounds. The bridgehead carbon of rigid bicyclic systems cannot invert without fragmenting the molecule, and indeed, compounds such as 1-bromotriptycene (2) and 7,7-dimethyl-[2.2.1]-bicycloheptyl-1-*p*-toluenesulfonate (3) are completely inert when treated with a nucleophile under S_N2 conditions.¹⁴

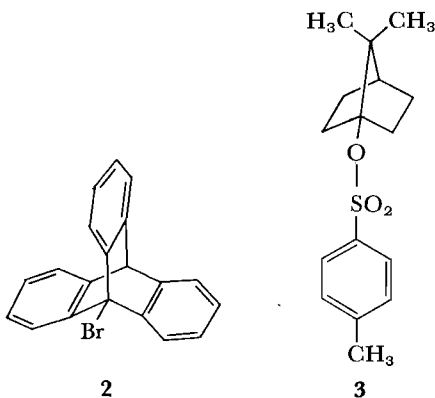

¹¹ N. Meer and M. Polanyi, *Z. Phys. Chem.*, **B19**, 164 (1932).

¹² S. H. Harvey, P. A. T. Hoye, E. D. Hughes, and C. K. Ingold, *J. Chem. Soc.*, 800 (1960).

¹³ See (a) note 10, p. 174; (b) note 12; (c) H. M. R. Hoffmann and E. D. Hughes, *J. Chem. Soc.*, 1252, 1259 (1964).

¹⁴ (a) P. D. Bartlett and L. H. Knox, *J. Amer. Chem. Soc.*, **61**, 3184 (1939); (b) P. D. Bartlett and E. S. Lewis, *J. Amer. Chem. Soc.*, **72**, 1005 (1950).

4.3 THE SOLVENT, SUBSTRATE, NUCLEOPHILE, AND LEAVING GROUP

The nature of the solvent and the structures of the substrate, nucleophile, and leaving group all help determine whether a nucleophilic displacement proceeds by a unimolecular or bimolecular pathway. They also all affect the rate of reaction.

The Solvent¹⁵

In solvating a charged species, a solvent disperses the charge over a larger area, which lowers the energy of the system. For example, when a sodium ion is dissolved in water, the positive charge on the sodium is dispersed among many water molecules. This is shown schematically in 4.

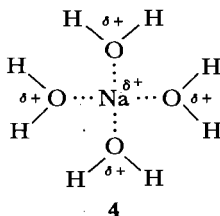

The effect that increasing the solvent polarity has on the reaction rate depends in part on the relative charge densities in the starting material and in the transition state. If the starting materials have a high charge density but in the activated complex the charge is already dispersed, a more polar solvent should lower the energy of the starting material more than the energy of the transition state. The result would be an increase in activation energy and a decrease in rate. This situation is shown in Figure 4.3a. On the other hand, if the transition state has a higher charge density than the starting material, increasing solvent polarity should lower the activation energy and increase the rate (Figure 4.3b).

S_N2 -reactions of charge types 1, 3, and 4 (see p. 171) all have more highly dispersed charge in the transition state than in the ground state. The effect on

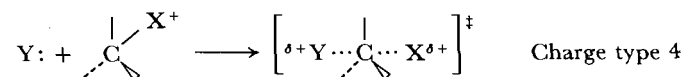
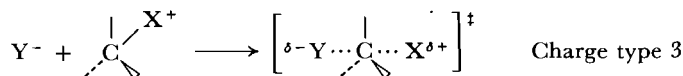
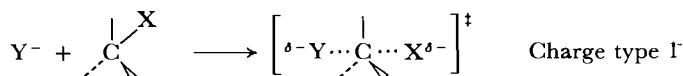

them of changing solvent polarity is therefore described by Figure 4.3a; an increase in solvent polarity should be accompanied by a decrease in reaction rate.

The only S_N2 reactions in which the transition states have a higher charge

¹⁵ For a recent review of solvent effects on S_N2 reactions see A. J. Parker, *Advan. Phys. Org. Chem.*, **5**, 173 (1967).

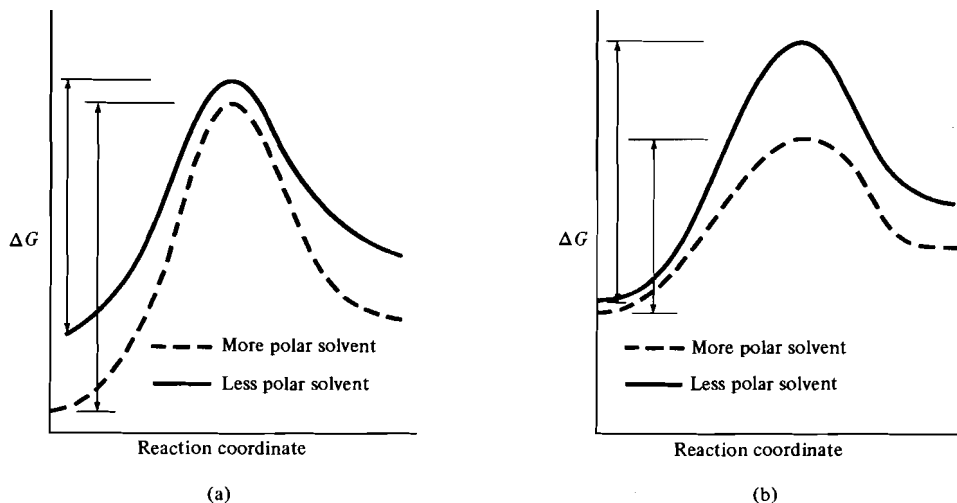
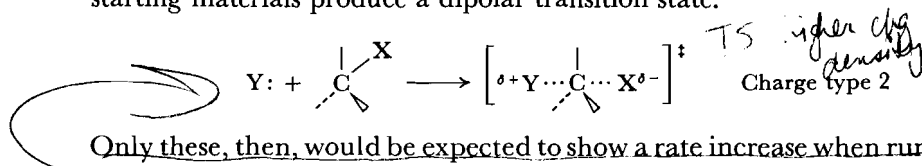

Figure 4.3 (a) Reaction coordinate diagram for a reaction in which starting material has a higher charge density than transition state. (b) Reaction coordinate diagram for a reaction in which the transition state has a higher charge density than the starting materials.

density than the starting materials are those of charge type 2 in which two neutral starting materials produce a dipolar transition state.



Only these, then, would be expected to show a rate increase when run in a more polar solvent.

These predictions of effect of solvent polarity on reaction rates were first made by Hughes and Ingold in 1935. They searched the literature of direct displacement reactions and found that for charge types 1–3 the experimental facts agreed with their predictions. For example, the reaction of ethyl iodide with triethylamine (Equation 4.9) an S_N2 displacement of type 2, does proceed more

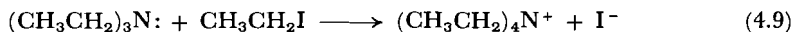

rapidly in alcohols than in hydrocarbons;¹⁶ and on the other hand, both the rate of bromine exchange between radioactive bromide ion and *n*-butyl bromide in acetone (Equation 4.10), a substitution of charge type 1, and the rate of alkaline

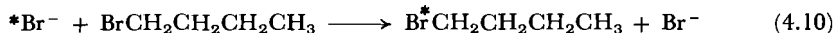

hydrolysis of trimethylsulfonium ion (Equation 4.11) in water/methanol (charge



type 3), are slower if water is added to the solvent.¹⁷

¹⁶ N. Menshutkin, *Z. Physik. Chem.*, 5, 589 (1890).

¹⁷ (a) L. J. LeRoux and S. Sugden, *J. Chem. Soc.*, 1279 (1939); (b) L. J. LeRoux, C. S. Lu, S. Sugden, and R. H. K. Thomson, *J. Chem. Soc.*, 586 (1945); (c) Y. Pocker and A. J. Parker, *J. Org. Chem.*, 31, 1526 (1966).

It is only more recently that reactions of Charge type 4 have been known and studied, but the theory proposed by Hughes and Ingold predicted the results accurately here too, for the reaction of trimethylamine with trimethylsulfonium ion (Equation 4.12) proceeds more rapidly in nonpolar than in polar solvents.¹⁸

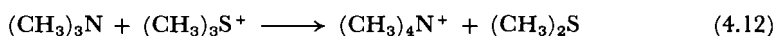

In fact, most of the data that have accumulated since 1935 are qualitatively in accord with their predictions,¹⁹ but the predictions should not be used indiscriminately without considering the effect the solvent may have on nucleophile and leaving-group reactivity (see pp. 190–194).

Substrate Alkylation

It is a well-established fact that S_N2 reactions occur less readily in molecules where the α or β carbons bear alkyl substituents. For example, the relative reactivities shown in Table 4.1 are derived from studies of 15 different S_N2 reactions in various solvents. Several explanations have been proposed for this trend. The first supposes that alkyl groups bonded to saturated carbon are electron-donating.²⁰ According to this hypothesis, in the ground state the central carbon is slightly electron-deficient because of the electron-withdrawing ability of the leaving group, but in the activated complex the positive charge on the carbon has diminished due to the presence of a second Lewis base with its unshared pair of electrons. Thus electron-donating groups stabilize the ground state more than the transition state and thereby increase the activation energy.²¹

However, recent experiments show that the polar²² influence of a methyl

Table 4.1 AVERAGE RELATIVE S_N2 RATES OF ALKYL SYSTEMS

R in R—X	Relative Rate
Methyl	1
Ethyl	3.3×10^{-2}
<i>n</i> -Propyl	1.3×10^{-2}
<i>i</i> -Propyl	8.4×10^{-4}
<i>t</i> -Butyl	5.5×10^{-5a}
Neopentyl	3.3×10^{-7}
Allyl	1.3
Benzyl	4.0

SOURCE: Data from A. Streitwieser, *Solvolytic Displacement Reactions*, McGraw-Hill, New York, 1962, p. 13. Reproduced by permission of McGraw-Hill.

^a This value is not from Streitwieser but is the reactivity of *t*-butyl bromide to S_N2 substitution by free Cl^- in DMF at 25°C relative to the reactivity of CH_3Br under the same conditions [D. Cook and A. J. Parker, *J. Chem. Soc. B*, 142 (1968)]. This value is corrected for the substitution that actually precedes by an elimination addition mechanism.

¹⁸ E. D. Hughes and D. J. Whittingham, *J. Chem. Soc.*, 806 (1960).

¹⁹ For other examples see: (a) note 15, p. 177; (b) C. K. Ingold, *Structure and Mechanism in Organic Chemistry*, 2nd ed., Cornell University Press, Ithaca, N.Y., 1969, pp. 457–463.

²⁰ (a) C. N. Hinshelwood, K. J. Laidler, and E. W. Timm, *J. Chem. Soc.*, 848 (1938); (b) P. B. D. de la Mare, L. Fowden, E. D. Hughes, C. K. Ingold, and J. D. H. Mackie, *J. Chem. Soc.*, 3200 (1955).

²¹ A. Streitwieser, *Solvolytic Displacement Reactions*, McGraw-Hill, New York, 1962, p. 14.

²² The term *polar effect* refers to the influence, other than steric, that nonconjugated substituents exert on reaction rates. It does not define whether the mechanism for its transmission is through bonds (inductive effect) or through space (field effect).

group when bound to sp^3 carbon is not electron-donating. Alkyl groups, due to their greater polarizability than hydrogen, appear to be either electron-withdrawing or electron-donating depending on the electronic demands of the neighboring atoms²³ (see Section 3.4). In any case the difference between the polar effect of methyl and that of hydrogen is very small—much too small to account for the large retardation observed with increasing substitution.²⁴ This is especially obvious in the neopentyl system, where the branching is one carbon atom removed from the reaction site but the rate of substitution is ca. 10^{-5} times slower than in the ethyl system.

An explanation standing on firmer experimental ground is that the decrease in rate with increasing substitution is caused by nonbonding interactions in the transition state. This explanation was first proposed by Dostrovsky, Hughes, and Ingold²⁵ and was later refined in a series of eight papers²⁶ that were then summarized by Ingold.²⁷

In the ground state all H—C—H and H—C—X bond angles in CH_3X are, of course, approximately 109.5° . The activated complex of an $\text{S}_{\text{N}}2$ reaction on this substrate is more crowded: the H—C—X bond angles have decreased to 90° , whereas the H—C—H bond angles increase to 120° and an additional atom or group of atoms (Y:) is included which also forms an angle of only 90° with the protons. Ingold et al. calculated that in CH_3X , because the protons are small, there is little, if any, increase of nonbonding interaction between X and Y and the protons in going from the ground state to the transition state. However, when one of the H's is replaced by the much larger CH_3 group (i.e., when $\text{CH}_3\text{CH}_2\text{X}$ is the substrate), the interference between X and Y and the methyl group does increase as the angle between them decreases. This leads to (1) compressions of the covalent bonds to lengths shorter than normal and (2) a corresponding increase in potential energy.²⁸ Thus the activated complex of the ethyl system has a higher potential energy relative to the starting material than that of the methyl system.

A closely related argument for the decrease in rates with increasing substitution, put forward by Bauer, Ivanoff, and Magat,²⁹ is that it is not the enthalpy (through the potential energy), but the entropy of activation that is affected. They propose that the greater number of atoms associated with the transition state as compared to the ground state restricts the motion of these atoms; this

²³ (a) H. Kwart and L. J. Miller, *J. Amer. Chem. Soc.*, **83**, 4552 (1961); (b) H. Kwart and T. Take-shita, *J. Amer. Chem. Soc.*, **86**, 1161 (1964); (c) R. C. Fort and P. v. R. Schleyer, *J. Amer. Chem. Soc.*, **86**, 4194 (1964); (d) V. W. Laurie and J. S. Muenter, *J. Amer. Chem. Soc.*, **88**, 2883 (1966); (e) J. I. Brauman and L. K. Blair, *J. Amer. Chem. Soc.*, **90**, 6561 (1968); (f) N. C. Baird, *Can. J. Chem.*, **47**, 2306 (1969).

²⁴ (a) H. D. Holtz and L. M. Stock, *J. Amer. Chem. Soc.*, **87**, 2404 (1965); (b) H. J. Hinze, M. A. Whitehead, and H. H. Jaffé, *J. Amer. Chem. Soc.*, **85**, 148 (1963).

²⁵ I. Dostrovsky, E. D. Hughes, and C. K. Ingold, *J. Chem. Soc.*, 173 (1946).

²⁶ P. B. D. de la Mare, L. Fowden, E. D. Hughes, C. K. Ingold, and J. D. H. Mackie, *J. Chem. Soc.*, 3169 (1955) *et seq.* See also C. K. Ingold, *Structure and Mechanism in Organic Chemistry*, pp. 544ff.

²⁷ C. K. Ingold, *Quart. Rev.* (London), **11**, 1 (1957); see also D. Cook and A. J. Parker, *J. Chem. Soc. B*, 142 (1968).

²⁸ See Figure 2.0.

²⁹ N. Ivanoff and M. Magat, *J. Chim. Phys.*, **47**, 914 (1950); E. Bauer and M. Magat, *J. Chim. Phys.*, **47**, 922 (1950).

causes a decrease in the entropy of the system, which in turn raises the free energy of the transition state.

Streitwieser points out that these enthalpy and entropy effects are inter-related.³⁰ If, in the transition state of a direct displacement reaction of Y: on $\text{CH}_3\text{CH}_2\text{X}$, the C—X and C—Y bonding distances were identical to those in a similar substitution on CH_3X , the nonbonding interactions would be so great as to cause a large decrease in the freedom of the CH_3 group and thus a large decrease in entropy. If, however, the distances between C and X and Y were so great at the transition state that no decrease in entropy occurred, there would be little bonding between C and X and between C and Y; in such a case the potential energy and thus the enthalpy of the transition state would be raised. What probably happens is that a compromise is achieved and the system adopts that configuration for the transition state that has the smallest increase in free energy.

When studying Table 4.1 it may be surprising to see that neopentyl systems, in which all the substituents are in the β position, are substituted more slowly than *t*-butyl systems in which the substituents are directly on the reaction site. Apparently, steric hindrance is less important when the larger substituents are α , because in the activated complex they all lie in a plane perpendicular to X and Y and thus are fairly well out of the way; only one β substituent can lie in this plane, as shown in Figure 4.4. If there are only one or two β substituents, it is still possible to rotate them out of the way of entering and leaving groups. However, when there are three, as in the neopentyl group, it is not possible, and substantial steric hindrance occurs in the transition state.³¹

Heteroatoms in the Substrate

If the suggestion mentioned on p. 179, that there is less positive charge on the central carbon in the transition state than in the ground state, is correct, then electron-withdrawing substituents should decrease the rate of $\text{S}_{\text{N}}2$ substitutions.

A variety of experiments testing this suggestion have been carried out, giving inconsistent results. Sometimes electron-withdrawing substituents accelerate and sometimes they decelerate $\text{S}_{\text{N}}2$ reactions.³²

For example, the rate of displacement of bromide by thiophenoxide ion in 1-bromo-2-chloroethane is slowed down by a factor of 5 compared to substitution in the structurally similar 1-bromopropane (Equations 4.13 and 4.14).³³ But the

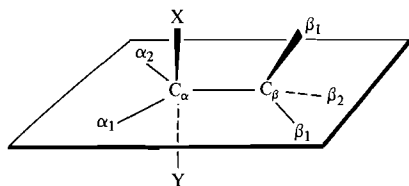

Figure 4.4 Transition state for $\text{S}_{\text{N}}2$ substitution in the neopentyl system.

³⁰ A. Streitwieser, *Solvent Displacement Reactions*, p. 23.

³¹ C. K. Ingold, *Structure and Mechanism in Organic Chemistry*, pp. 547ff.

³² For a summary see Streitwieser, *Solvent Displacement Reactions*, pp. 16–20.

³³ J. Hine and W. H. Brader, Jr., *J. Amer. Chem. Soc.*, 75, 3964 (1953).

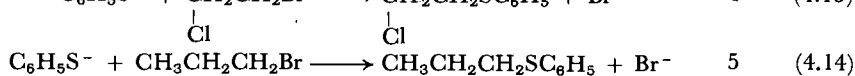
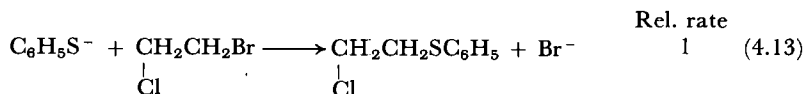

rate of reaction of *p*-chlorobenzyl chloride with thiosulfate is 1.4 times the rate of the unsubstituted compound (Equations 4.15 and 4.16)³⁴

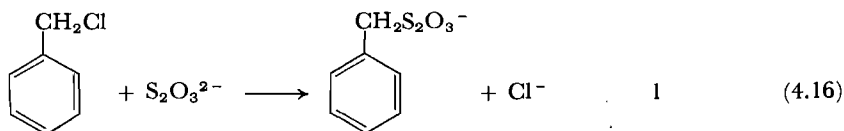
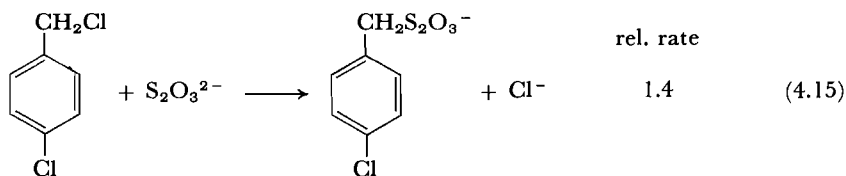

In fact, as can be seen from Table 4.2, all *para*-substituted benzyl chlorides, whether the substituent be electron-donating or -withdrawing,³⁵ react faster than the unsubstituted compound with thiosulfate.

Possibly one of the reasons for this apparent inconsistency in experimental results is that the view of the transition state represented above is correct for some, but not all, $\text{S}_\text{N}2$ reactions.

As we know, in the activated complex of an $\text{S}_\text{N}2$ reaction, bond making and bond breaking have not necessarily occurred to the same extent. If the entering group (Y) is very nucleophilic and donates electrons more than the leaving group (X) is withdrawing them, then the positive charge on the carbon should

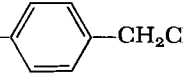
Table 4.2 RELATIVE RATES OF REACTION OF X--CH₂Cl WITH S₂O₃²⁻ IN 60% AQUEOUS ACETONE

X	Relative Rate
- <i>t</i> -Bu	1.29
-CH ₃	1.56
- <i>i</i> -C ₃ H ₇	1.21
	1.47
-H	1.00
-F	1.25
-Cl	1.43
-NO ₂	2.55

SOURCE: R. Fuchs and D. M. Carleton, *J. Amer. Chem. Soc.*, **85**, 104 (1963). Reproduced by permission of the American Chemical Society.

³⁴ R. Fuchs and D. M. Carleton, *J. Amer. Chem. Soc.*, **85**, 104 (1963).

³⁵ Methyl attached to an *sp* or *sp*² carbon seems always to be electron-releasing, if not by electron transfer, by polarization of the π -electron system. See, for example, the calculations of Hoffmann: L. Libit and R. Hoffmann, *J. Amer. Chem. Soc.*, **96**, 1370 (1974).

decrease and we have the situation already discussed above in which electron-withdrawing groups increase the rate; but if X is an excellent leaving group and withdraws electrons more than Y supplies them, then the partial positive charge on the reacting carbon should increase and electron-withdrawing substituents should decrease the rate.³⁶ (Of course, if the situation just described becomes very pronounced, the mechanism will change to S_N1 .) The nature of the substrate also plays a role in determining the relative extents of bond making and breaking. If it can form a relatively stable carbocation, bond breaking is likely to have proceeded further. Thus it is not surprising that the rates of S_N2 reactions that differ in nucleophile, leaving group, and/or substrate show a variable dependence on the polar influence of substituents.

Another reason for the apparent inconsistencies in experimental data is that, depending on the nature and position of the substituent, steric and conjugative effects often outweigh polar influences. In order to study pure polar effects, Holtz and Stock have carried out rate studies of displacements by thiophenoxide ion on 4-Z-bicyclo-[2.2.2]-octylmethyl toluenesulfonate (Equation 4.17).³⁷

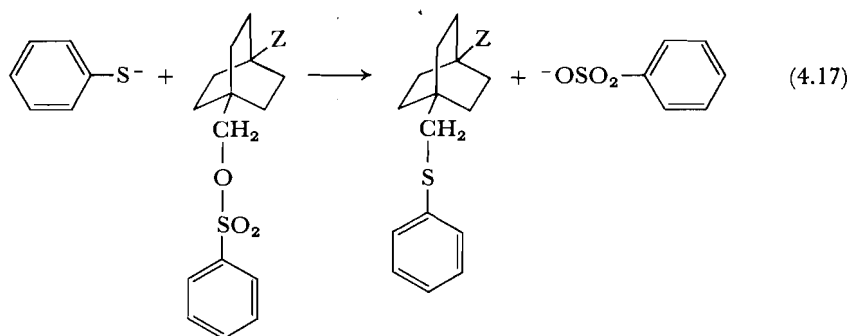

This system has the virtues of (1) being completely rigid so that changing Z does not change the steric environment of the transition state and (2) having the substituent so far removed from the reaction site through saturated bonds that conjugation is impossible. They found that although alkyl substituents had little effect on the reaction rate, electron-withdrawing groups in general did increase

Table 4.3 RELATIVE RATES OF 4-Z-Bicyclo[2.2.2]OCTYLMETHYL
TOLUENESULFONATE WITH THIOPHENOXIDE ION

Z	Relative Rate
H	1.00
CH ₃	1.07
CH ₂ OH	1.17
CO ₂ Et	1.52
Cl	1.84
Br	2.01

SOURCE: H. O. Holtz and L. M. Stock, *J. Amer. Chem. Soc.*, **87**, 2404 (1965). Reproduced by permission of the American Chemical Society.

³⁶ C. G. Swain and W. P. Langsdorf, Jr., *J. Amer. Chem. Soc.*, **73**, 2813 (1951). See, for example, the calculations of R. F. W. Bader, A. J. Duke, and R. R. Messer, *J. Amer. Chem. Soc.*, **95**, 7715 (1973).

³⁷ See note 24 (a), p. 180.

the rate (see Table 4.3). In these displacements thiophenoxide, which is an excellent nucleophile (see p. 189), is always the attacking reagent and therefore the results are not surprising within the context of the above argument.

Carbonyl or Cyano Substitution

Compounds that have an α -carbonyl or α -nitrile group are usually particularly reactive in S_N2 reactions. For example, when treated with potassium iodide in

acetone, α -chloroacetone ($\text{ClCH}_2\overset{\text{O}}{\parallel}\text{CCH}_3$) reacts 35,000, and α -chloroacetonitrile ($\text{ClCH}_2\text{C}\equiv\text{N}$) 3000 times faster than *n*-butyl chloride.³⁸ The probable reason for this increased reactivity is that there is partial bonding between the incoming nucleophile and the electrophilic carbon of the carbonyl or cyano group in the transition state. For example, Figure 4.5 shows an orbital representation of the activated complex for the displacement of chloride by iodide in α -chloroacetone.

Bartlett and Trachtenberg have studied the kinetics of Reactions 4.18 and 4.19, and their results provide strong support for this hypothesis.³⁹ When 7,5-dinitro-3-coumaranone (5) reacts with potassium iodide in acetone (Reaction 4.18), the enthalpy of activation is 20 kcal mole⁻¹ higher than when ω -(4-aceto-2,6-dinitro)-phenoxyacetophenone (6) undergoes the analogous reaction (Reaction 4.19).

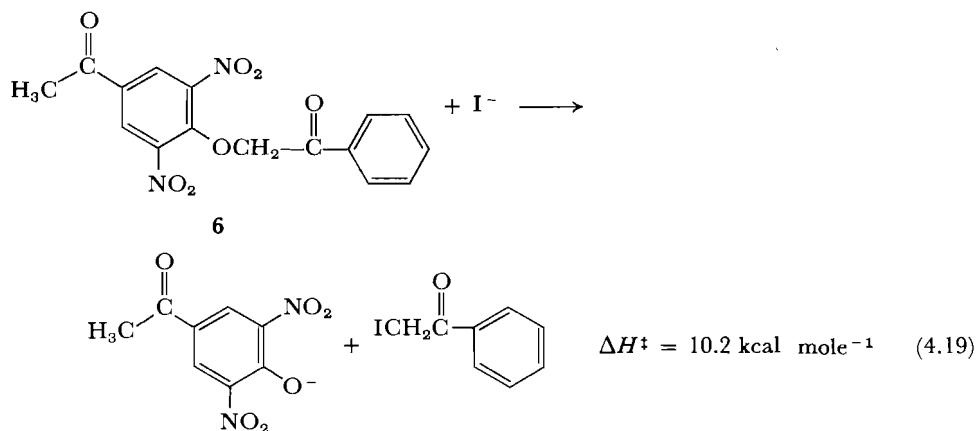
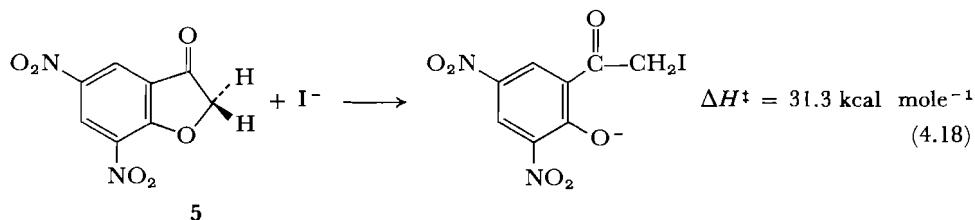

³⁸ J. B. Conant, W. R. Kirner, and R. E. Hussey, *J. Amer. Chem. Soc.*, **47**, 488 (1925).

³⁹ P. D. Bartlett and E. D. Trachtenberg, *J. Amer. Chem. Soc.*, **80**, 5808 (1958).

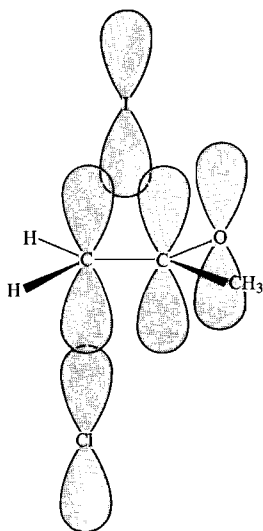

Figure 4.5 Transition state for S_N2 displacement of iodide ion on α -chloroacetone.

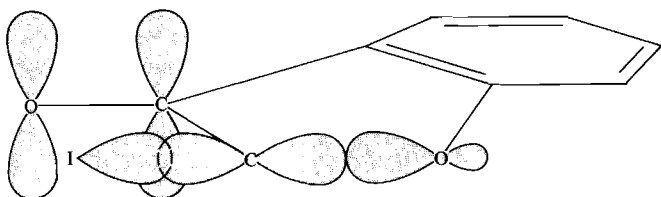

Figure 4.6 Transition state for S_N2 displacement of iodide ion on 7,5-dinitro-3-coumarone.

In order to carry out a backside displacement on **5**, the iodide must attack the reacting carbon in the plane of the ring. The carbonyl π bond is, however, perpendicular to the plane of the ring and, due to the rigid ring structure of **5**, cannot rotate to overlap with the incoming iodide. The transition state for this reaction is shown in Figure 4.6. On the other hand, the activated complex of iodide substitution on **6** is probably very similar to that of substitution on α -chloroacetone (Figure 4.5).

Nucleophilicity⁴⁰

In an S_N2 reaction the role of the entering Lewis base is to use its unshared pair of electrons to “push” away the leaving Lewis base with its bonding pair. Thus a good nucleophile is one that readily donates its unshared pair to the substrate, allowing rapid reaction. If S_N2 reactions on carbon only are considered, a reagent that is a good nucleophile for one substrate is usually a good nucleophile for all substrates *in the same type of solvent*. In fact, Swain and Scott have proposed that the nucleophilicity of a reagent can be represented by a constant value, n , which holds for carbon S_N2 reactions in protic solvents in general. The rate of an

⁴⁰ Two recent reviews of nucleophilicity are (a) R. G. Pearson, H. Sobel, and J. Songstad, *J. Amer. Chem. Soc.*, **90**, 319 (1968); (b) K. M. Ibne-Rasa, *J. Chem. Educ.*, **44**, 89 (1967).

S_N2 reaction in a protic solvent can be predicted quantitatively if the n value of the attacking reagent and a second parameter, s , which represents the sensitivity of the substrate to the reagent's nucleophilicity, are known.⁴¹ The quantitative relationship between these two parameters and the rate is the linear free-energy relationship (see Section 2.2)

$$\log \frac{k}{k_0} = ns$$



in which k is the rate of an S_N2 reaction in which the nucleophile has nucleophilicity n and the substrate has sensitivity s . The constant k_0 is the rate of the standard reaction to which all others are compared. Swain and Scott have chosen the reaction of methyl bromide with water at 25°C as that reaction. The substrate, methyl bromide, is arbitrarily assigned an s value of 1.

The parameter n for a given nucleophile, Y, then is defined by the following equation:

$$n = \log \frac{k_{\text{CH}_3\text{Br} + \text{Y}}}{k_{\text{CH}_3\text{Br} + \text{H}_2\text{O}}} \quad (4.20)$$

To determine n directly for a specific nucleophile, its rate of reaction with methyl bromide is measured at 25°C; the log of the ratio of this rate to the rate of reaction of the same substrate with H_2O gives n . If Y is a better nucleophile than water, n will be positive; if Y is a worse nucleophile, n will be negative. Water itself has an n value of zero. In Table 4.4 are listed the majority of the n values

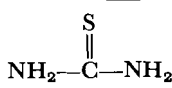
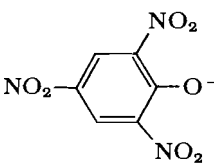
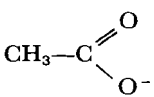
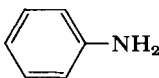
Table 4.4 NUCLEOPHILIC CONSTANTS (n VALUES)

Nucleophile	n	Nucleophile	n
H_2O	0.00		4.1
	1.9	HO^-	4.20
	2.72		4.49
Cl^-	3.04	I^-	5.04
	3.6	HS^-	5.1
Br^-	3.89		

SOURCE: Data from C. G. Swain and C. B. Scott, *J. Amer. Chem. Soc.*, 75, 141 (1953). Reproduced by permission of the American Chemical Society.

⁴¹ C. G. Swain and C. B. Scott, *J. Amer. Chem. Soc.*, 75, 141 (1953).

Table 4.5 NUCLEOPHILIC CONSTANTS ($n_{\text{CH}_3\text{I}}$ Values)





Nucleophile	$n_{\text{CH}_3\text{I}}$	n_{Pt}^a	$\text{p}K_a$ of Conjugate Acid in Methanol
CH_3OH	0.0	0.0	-1.7
NO_3^-	(1.5)	—	-1.3
CO	< 2.0	< 2.0	—
$\text{C}_6\text{H}_{11}\text{NC}$	< 2.0	6.34	—
$\phi_3\text{Sb}$	< 2.0	6.79	—
F^-	~ 2.7	< 2.2	3.45
SO_4^{2-}	3.5	—	2.0
SnCl_3^-	~ 3.84	5.44	—
	4.3	< 2.0	4.75
Cl^-	4.37	3.04	-5.7
	4.5	—	4.19
$\phi_3\text{As}$	4.77	6.89	—
$(\phi\text{CH}_2)_2\text{S}$	4.84	3.43	—
Imidazole	4.97	3.44	7.10
$\phi\text{SO}_2\text{NH}^-$	5.1	—	8.5
$(\text{CH}_3\text{O})_3\text{P}$	5.2	7.23	—
$(\phi\text{CH}_2)_2\text{Se}$	5.23	5.53	—
Pyridine	5.23	3.19	5.23
$(\text{CH}_3\text{CH}_2)_2\text{S}$	5.34	4.52	—
NO_2^-	5.35	3.22	3.37
	5.42	5.02	—
NH_3	5.50	3.07	9.25
$(\text{CH}_3)_2\text{S}$	5.54	4.87	-5.3
	5.64	—	5.06
	5.66	5.14	-4.8
	5.70	3.16	4.58
	5.70	4.15	—
	5.75	—	9.89
N_3^-	5.78	3.58	4.74
Br^-	5.79	4.18	-7.77
CH_3O^-	6.29	< 2.4	15.7
$(\text{CH}_3)_2\text{Se}$	6.32	5.70	—
NH_2OH	6.60	3.85	5.82
NH_2NH_2	6.61	3.86	7.93
$(\text{CH}_3\text{CH}_2)_3\text{N}$	6.66	—	10.7

Table 4.5 (Continued)

Nucleophile	$n_{\text{CH}_3\text{I}}$	n_{Pt}^a	$\text{p}K_a$ of Conjugate Acid in Methanol
SCN ⁻	6.70	5.75	-0.7
CN ⁻	6.70	7.14	9.3
$\phi\text{SO}_2\text{NCl}^-$	6.80	—	3.0
$(\text{C}_2\text{H}_5)_3\text{As}$	6.90	7.68	2.6
$\phi_3\text{P}$	7.00	8.93	2.73
$(\text{C}_2\text{H}_5)_2\text{NH}$	~ 7.00	—	11.0
$(\text{CH}_3\text{O})_2\text{PO}^-$	7.00	5.0	—
pyrrolidene	7.23	—	11.27
SC(NH ₂) ₂	7.27	7.17	-0.96
Piperidine	7.30	3.13	11.21
I ⁻	7.42	5.46	-10.7
SeCN ⁻	7.85	7.11	—
(HS ⁻)	(8.)	—	7.8
SO ₃ ²⁻	8.53	5.79	7.26
$[(\text{C}_2\text{H}_5)_2\text{N}]_3\text{P}$	8.54	4.54	—
$(\text{C}_4\text{H}_9)_3\text{P}$	8.69	8.96	8.43
$(\text{C}_2\text{H}_5)_3\text{P}$	8.72	8.99	8.69
S ₂ O ₃ ²⁻	8.95	7.34	1.9
	9.92	7.17	6.52
	~ 10.7	—	—

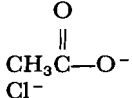
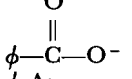
SOURCE: Data from R. G. Pearson, H. Sobel and J. Songstad, *J. Amer. Chem. Soc.*, **90**, 319 (1968). Reproduced by permission of the American Chemical Society.

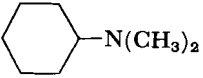
$$^a n_{\text{Pt}} = \log \frac{k_{\text{Pt}(\text{Py})_2\text{Cl}_2 + \text{Y}}}{k_{\text{Pt}(\text{Py})_2\text{Cl}_2 + \text{CH}_3\text{OH}}}$$

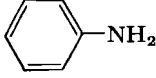
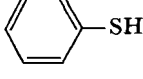
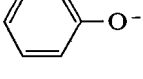
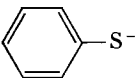
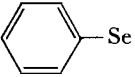
that have been determined. Since so few are known, they are of limited usefulness. Table 4.5, however, gives some of the more plentiful, analogous $n_{\text{CH}_3\text{I}}$ values,⁴² which are defined in just the same way as n values except that the arbitrarily chosen standard reaction is the displacement on CH₃I by methanol in methanol solvent.⁴³ Thus



$$n_{\text{CH}_3\text{I}} = \log \frac{k_{\text{CH}_3\text{I} + \text{Y}}}{k_{\text{CH}_3\text{I} + \text{CH}_3\text{OH}}} \quad (4.21)$$

The s parameter for a particular substrate RX is determined by measuring the rate of a number of S_N2 reactions of RX with nucleophiles of known n . $\log k/k_0$ is determined for each reaction, and these values are plotted against the corresponding n values. The best straight line that can be drawn through those points has slope s . A substrate that is more dependent than methyl bromide on the nucleophilicity of the attacking group will have an s value greater than 1, and one that is less dependent will have a smaller value. Table 4.6 lists s values for a few substrates.

⁴² See note 40 (a), p. 185.

⁴³ There is a linear relationship between Swain's n values and Pearson's $n_{\text{CH}_3\text{I}}$ values: $n_{\text{CH}_3\text{I}} = 1.4 n$.

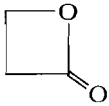
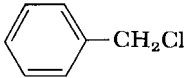
Table 4.6 SUBSTRATE PARAMETERS FOR NUCLEOPHILIC ATTACK

Substrate		<i>s</i>
CH ₃ CH ₂ OTs	(Ethyl toluenesulfonate)	0.66
	(β-propiolactone)	0.77
	(Benzyl chloride)	0.87
ClCH ₂ CH ₂ S ⁺ 	(Mustard cation)	0.95
CH ₃ Br	(Methyl bromide)	1.00

SOURCE: C. G. Swain and C. B. Scott, *J. Amer. Chem. Soc.*, 75, 141 (1953). Reproduced by permission of the American Chemical Society.

The first four compounds have lower *s* values than methyl bromide because each is quite reactive in itself and therefore is not very dependent on help from the nucleophile: *p*-toluenesulfonate is a good leaving group and does not need much assistance to begin to depart; ring strain in propiolactone and in the mustard cation make a ring-opening S_N2 reaction very favorable; and the transition state of benzyl chloride is stabilized by resonance and therefore is easily reached.

To get a better understanding of what the Swain–Scott equation means, we have rewritten it in Equation 4.22 in the form that makes the linear free-energy relationship more apparent.

$$\Delta G^\ddagger = -2.303(RT)sn + \Delta G_0^\ddagger \quad (4.22)$$

ΔG^\ddagger and ΔG_0^\ddagger are the free energies of activation of the reaction under consideration and of the standard reaction, respectively. The latter is, of course, a constant, and at constant temperature, the quantity RT is also constant. Therefore, if a series of displacements are carried out on the same substrate in protic solvents but with different nucleophiles, Equation 4.22 says that the free energy of activation depends linearly on the power of the nucleophile. Likewise, if the nucleophile and solvent are kept constant but the substrate is varied, the equation says that the free energy of activation depends linearly on the susceptibility of the substrate to changes in nucleophilicity.

Use of the Swain–Scott equation can identify powerful nucleophiles in protic solvents, but it does not tell us why they are so. On first consideration we might expect that a strong base toward a proton would also be a good nucleophile. But in protic solvents the correlation of nucleophilicity with basicity is not good. In Table 4.5 the nucleophiles are arranged in order of increasing $n_{\text{CH}_3\text{I}}$ values, but a glance at the right-hand column shows that the $\text{p}K_a$'s of their conjugate acids jump around. Further analysis of Table 4.5 shows that atoms in a single row of the periodic table carrying like charges do decrease in both nucleophilicity and basicity going from left to right (compare, for example, methoxide ($n_{\text{CH}_3\text{I}} = 6.29$, $\text{p}K_a = 15.7$) with fluoride ion ($n_{\text{CH}_3\text{I}} = 2.7$, $\text{p}K_a = 3.45$)). However, in a single group nucleophilicity increases but basicity decreases in going

down the column. For example, the nucleophilicity of the halogens increases in the order $F^- < Cl^- < Br^- < I^-$ but the order of the basicity is exactly the opposite, $I^- < Br^- < Cl^- < F^-$.

An explanation that has been frequently given for the observed order of nucleophilicity in protic solvents (as in Tables 4.4 and 4.5) is that a good nucleophile must be polarizable. But the role of the polarizability and even its direction have received varying interpretations. The most familiar hypothesis is that, as the reaction commences, the large electron cloud of the polarizable nucleophile is distorted toward the substitution site, resulting in appreciable bonding between the entering reagent and the substrate with little attendant increase in steric strain at the transition state. More recently, Swain and Scott have suggested that polarization of the nonbonding electrons on the nucleophile *away* from the substrate at the transition state reduces the electrostatic repulsion between the two negatively charged species—the nucleophile and the leaving group—thus reducing the energy of the transition state and increasing the rate of reaction.⁴⁴ Edwards and Pearson have, however, pointed out that if electrostatic repulsion were diminished in this way, so too would bonding between nucleophile and substrate in the transition state be diminished and the balance might well not be favorable. These authors suggest that the electrostatic repulsion considered by Swain is negligible compared to the much greater repulsion due to the Pauli exclusion principle between the electrons around the nucleophile and those around the substrate needing to occupy the same space at the same time. They conclude that it is the low-lying empty orbitals of polarizable nucleophiles that make them more reactive. In the transition state the entering group can accommodate some of its lone pairs in those of its low-lying empty orbitals that are directed more away from the substrate than the ground-state orbitals would be—with a resultant decrease in energy.⁴⁵

When S_N2 reactions are carried out in aprotic solvents, the nucleophilicity of reagents is dramatically different from that in protic solvents, and the n and n_{CH_3I} values of Tables 4.4 and 4.5 do not apply. The requirement that a base must be polarizable in order to be a good nucleophile becomes much less important, and there is a better correlation between proton basicity and nucleophilicity. For example, $SeCN^-$ reacts 4000 times as fast as Cl^- with methyl iodide in methanol at 0°C, but in dimethylformamide (DMF) also at 0°C, Cl^- reacts twice as fast as $SeCN^-$.⁴⁶ Even the order of halide reactivity can be reversed. Bromide reacts 18 times as fast as Cl^- with methyl iodide in methanol, but in DMF, Cl^- reacts twice as fast as Br^- .⁴⁷

The apparent cause for this striking behavior is the difference in degree of solvation of the small negative ions in the two kinds of solvents—protic and aprotic.⁴⁸ In protic solvents such as methanol or water, these ions are highly solvated by hydrogen bonding (see Section 2.4). Thus their effective sizes are very large and their negative charges dispersed.⁴⁹ Solvation decreases in the same order

⁴⁴ See note 41, p. 186.

⁴⁵ J. O. Edwards and R. G. Pearson, *J. Amer. Chem. Soc.*, **84**, 16 (1962).

⁴⁶ B. O. Coniglio, D. E. Giles, W. R. McDonald, and A. J. Parker, *J. Chem. Soc. B*, 152 (1966).

⁴⁷ A. J. Parker, *J. Chem. Soc. A*, 220, (1966).

⁴⁸ A. J. Parker, *Quart. Rev. (London)*, **16**, 163 (1962).

⁴⁹ See also D. K. Bohme and L. B. Young, *J. Amer. Chem. Soc.*, **92**, 7354 (1970).

as charge density: OH^- , $\text{F}^- \gg \text{Cl}^- > \text{Br}^- > \text{I}^- > \text{SeCN}^-$. The large ions, which are both relatively unsolvated and more polarizable, are much better nucleophiles. However, in aprotic solvents there is no possibility for stabilization of the negative charge on the small ions by hydrogen bonding, and they become more reactive, sometimes even overtaking the more polarizable larger ions.⁵⁰

Pearson and Songstad have suggested that the nucleophilicity of a reagent can also be described in terms of hard and soft acid and base theory.⁵¹ In Lewis acid-base terms, the mechanism of an $\text{S}_{\text{N}}2$ displacement can be written as in Equation 4.23. We already know that methyl cations (and, by analogy, other

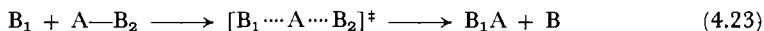

alkyl cations) are considered moderately soft acids. If we make the reasonable assumption that the charge on the alkyl group does not change much in going from the ground state to the transition state, an alkyl group will also be soft in the transition state of an $\text{S}_{\text{N}}2$ reaction. Solvents such as methanol and water act as hard acids when their protons are used for hydrogen bonding, and therefore hard bases such as F^- or OH^- interact preferentially with them rather than with moderately soft alkyl substrates. Aprotic solvents such as dimethyl sulfoxide are very soft acids: when displacements are run in them, the hard bases do not interact with them and thus are freer to react with alkyl substrates.

Note that the n_{Pt} values in Table 4.5, which give relative rates for Reaction 4.24 with various bases in methanol, are highest for very soft bases [e.g., $(\text{C}_6\text{H}_5)_3\text{P}$,



$(\text{C}_2\text{H}_5)_3\text{As}$] which carry no charge on the donor atom and which have little attraction for the proton. Thus compared to Pt^{II} , CH_3^+ is only a moderately soft acid. It is thus apparent that nucleophilic strength at one substrate should not parallel the strength at another unless the two substrates are of comparable hardness or softness.

Edwards has proposed an equation for the correlation of $\text{S}_{\text{N}}2$ reaction rates that can be used in different types of solvent systems and that emphasizes the dependence of nucleophilicity on basicity and polarizability.⁵² The equation is

$$\log \frac{k}{k_0} = \alpha E_n + \beta H \quad (4.25)$$

where H is the $\text{p}K_a$ of the conjugate acid of the nucleophile plus 1.74 and E_n is a parameter that measures polarizability. Edwards first suggested that E_n be defined in terms of the oxidation potential of the nucleophile, but more recently proposed a new definition based on the molar refractivity of the nucleophile. The constants α and β are determined experimentally for each substrate to give the best fit with experimental data. An advantage of the two-parameter equation is that it allows for a variation in relative nucleophilic reactivity when the sub-

⁵⁰ For further examples of the difficulty in assigning a reagent with an "intrinsic nucleophilicity," see C. D. Ritchie, *Accts. Chem. Res.*, **5**, 348 (1972).

⁵¹ R. G. Pearson and J. Songstad, *J. Amer. Chem. Soc.*, **89**, 1827 (1967).

⁵² J. O. Edwards, *J. Amer. Chem. Soc.*, **76**, 1540 (1954); J. O. Edwards, *J. Amer. Chem. Soc.*, **78**, 1819 (1956). For another theoretical treatment of nucleophilic reactivities, see R. F. Hudson, *Chimia*, **16**, 173 (1962).

strate is changed since the magnitude of α relative to β may change. A disadvantage is the larger number of parameters. The effect of solvent on nucleophilic reactivity is implicitly taken into consideration in the Edwards equation if H and E_n are determined in the same solvent system used for the S_N2 reactions.

The Leaving Group

Since the leaving group begins to pull a pair of electrons toward itself in the transition state of an S_N2 reaction, it is to be expected that the best leaving groups will be those that can best stabilize an extra pair of electrons, that is, weak Lewis bases. This is usually the case. For example, Tables 4.7 and 4.8 indicate that the reactivity of the halogens seems always to be $I > Br > Cl > F$. Furthermore, groups that have a positive charge in the original molecule but become small neutral molecules after they have departed, such as $-\overset{\oplus}{S}R_2$, $-\overset{\oplus}{O}H_2$, and $-\overset{\oplus}{N}_2$, often make good leaving groups. This can be very useful because displacements with leaving groups such as $-\overset{\oplus}{O}H$, $-\overset{\oplus}{O}R$, and $-\overset{\oplus}{S}H$ do not occur readily because OH^- , OR^- , and SH^- are strong bases. If such groups are simply protonated, they can often be displaced.

However, one cannot predict the relative reactivities of two leaving groups simply by a comparison of the pK_a 's of their conjugate acids. And indeed it would be surprising if one could, since we are here again dealing with the strengths of $C-X$, not $H-X$ bonds. But this is not the only problem, as an examination of Tables 4.7 and 4.8 reveals. The relative reactivities of the leaving groups are dependent on the nucleophile and on the solvent. For example, in Table 4.7 we see that in ethanol with *p*-toluenethiolate as the nucleophile, the reactivity of *p*-toluenesulfonate ("tosylate," OTs) as a leaving group lies between that of bromide and that of chloride (cf. reactions 1, 3, and 5)—approximately what would be expected from the pK_a values—but in the same solvent with ethoxide ion as the nucleophile, tosylate becomes more reactive than iodide (Reactions 2, 4, 6 in Table 4.7). The explanation suggested by Hoffmann is that the reactivity of tosylate relative to the halides is a function of the amount of substrate-leaving-group bond breaking in the transition state.⁵³ When the attacking reagent is the excellent nucleophile, *p*-toluenethiolate (n_{CH_3I} of $C_6H_5S^- = 9.92$), according to Hammond's postulate, the transition state occurs very early in the course of the reaction, before there has been much bond breaking. Then tosylate behaves normally in comparison to the halides. When the much poorer

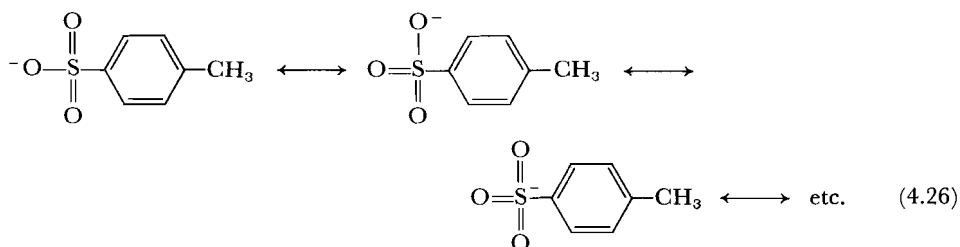

⁵³ H. M. R. Hoffmann, *J. Chem. Soc.*, 6753 (1965) and references therein. In Section 5.2 we conclude that although k_{OTs}/k_{Br} is a good measure of the extent of bond breaking in S_N2 reactions, this criterion cannot be extended to S_N1 reactions.

Table 4.7 DEPENDENCE OF LEAVING-GROUP REACTIVITY ON THE NUCLEOPHILE

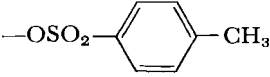
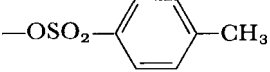
Leaving Group, X	Reaction Number	Substrate and Nucleo- phile ^a	Temp. (°C)	k_X/k_{Br}	Ref. ^b
I	1	$n\text{C}_3\text{H}_7\text{X} + p\text{-CH}_3\text{C}_6\text{H}_4\text{S}^-$	25	3.5	^b
I	2	$\text{C}_2\text{H}_5\text{X} + \text{C}_2\text{H}_5\text{O}^-$	25	1.9	^c
Br				1.0	
Cl	3	$n\text{C}_3\text{H}_7\text{X} + p\text{-CH}_3\text{C}_6\text{H}_4\text{S}^-$	25	0.0074	^b
Cl	4	$\text{C}_2\text{H}_5\text{X} + \text{C}_2\text{H}_5\text{O}^-$	40	0.0024	^c
	5	$n\text{C}_3\text{H}_7\text{X} + p\text{-CH}_3\text{C}_6\text{H}_4\text{S}^-$	25	0.44	^b
	6	$\text{C}_2\text{H}_5\text{X} + \text{C}_2\text{H}_5\text{O}^-$	25	3.6	^d

^a All reactions were run in ethanol solvent.

^b H. M. R. Hoffmann, *J. Chem. Soc.*, 6753 (1965), and references therein.

^c A. Streitwieser, *Solvolytic Displacement Reactions*, McGraw-Hill, New York, 1962, pp. 30-31 and references therein.

^d The relative reactivity here was estimated by using the $k_{\text{OSO}_2\text{-Br}}/k_{\text{Br}}$ value of 5.8 calculated by Streitwieser (Ref. *c* above, p. 30) and multiplying that by 0.63, the relative reactivity of tosylate to benzene sulfonate (M. S. Morgan and L. H. Cretcher, *J. Amer. Chem. Soc.*, 70, 375 (1948)). Since the latter value is for reaction at 35°C, the real $k_{\text{OTs}}/k_{\text{Br}}$ value might be a little smaller.

Table 4.8 EFFECT OF SOLVENT ON LEAVING-GROUP REACTIVITY

Reaction	Solvent	$10^4 k_2$ (0°C)	$k_{\text{DMF}}/k_{\text{MeOH}}$
$\text{CH}_3\text{I} + \text{N}_3^-$	DMF	3.1×10^3	1×10^5
$\text{CH}_3\text{I} + \text{N}_3^-$	Methanol	3.0×10^{-2}	
$\text{CH}_3\text{Br} + \text{N}_3^-$	DMF	460	1.7×10^4
$\text{CH}_3\text{Br} + \text{N}_3^-$	Methanol	2.7×10^{-2}	
$\text{CH}_3\text{Cl} + \text{N}_3^-$	DMF	1.0	5×10^3
$\text{CH}_3\text{Cl} + \text{N}_3^-$	Methanol	2.0×10^{-4}	
$\text{CH}_3\text{I} + \text{SCN}^-$	DMF	69	130
$\text{CH}_3\text{I} + \text{SCN}^-$	Methanol	0.30	
$\text{CH}_3\text{Br} + \text{SCN}^-$	DMF	9.8	98
$\text{CH}_3\text{Br} + \text{SCN}^-$	Methanol	0.10	
$\text{CH}_3\text{Cl} + \text{SCN}^-$	DMF	2.0×10^{-2}	40
$\text{CH}_3\text{Cl} + \text{SCN}^-$	Methanol	4.9×10^{-4}	

SOURCE: The data in the Table are from B. O. Coniglio, D. E. Giles, W. R. McDonald, and A. J. Parker, *J. Chem. Soc. B*, 152 (1966). Reproduced by permission of The Chemical Society and A. J. Parker.

nucleophile, ethoxide ($n_{\text{CH}_3\text{I}}$ of $\text{CH}_3\text{O}^- = 6.29$), is used, the leaving group already has a substantial negative charge on it in the transition state. In such cases tosylate, which is able to delocalize the charge by resonance, thereby decreasing the electrostatic repulsion between entering and leaving groups, is a better leaving group than the halides (see Equation 4.26).

Now let us turn to the effect of solvent on leaving-group activity. Examples of the pertinent experimental data for $\text{S}_{\text{N}}2$ reactions of charge type I are shown in Table 4.8. As we would predict from the previous discussion for reactions of

this charge type (see p. 178), changing from the polar solvent methanol to the nonpolar solvent DMF greatly increases the rates of all the reactions. However, note that in the series of displacements by azide ion, when the leaving group is iodide, the rate is increased 10^5 times by the solvent change; when it is bromide, 1.7×10^4 times; and when chloride is departing, the factor is only 5×10^3 . A similar series is observed when thiocyanate is the nucleophile. The explanation for this is very similar to that given for the solvent dependence of nucleophilicity. Apparently methanol is able to solvate the smaller activated complex $[Y \cdots CH_3 \cdots Cl]^-$ much better than it can $[Y \cdots CH_3 \cdots I]^-$. Therefore, although changing solvents from DMF to methanol is unfavorable for all the reactions in Table 4.8, it is not as unfavorable for methyl chloride, where the transition state can be effectively solvated, as for methyl iodide, where it cannot.

4.4 BIMOLECULAR NUCLEOPHILIC SUBSTITUTION AT SULFUR⁵⁴

There has been great interest in recent years in bimolecular nucleophilic displacement reactions on organic compounds where the site of substitution is not carbon but oxygen, sulfur, or silicon. Since there is not room to discuss each of these reactions here, we shall briefly consider bimolecular nucleophilic displacements on sulfur as an example and refer the reader to recent reviews of displacement at oxygen⁵⁵ and silicon.⁵⁶

Bimolecular displacements on sulfur occur when sulfur is di-, tri-, or tetra-coordinated. Examples are shown in Equations 4.27–4.29.⁵⁷

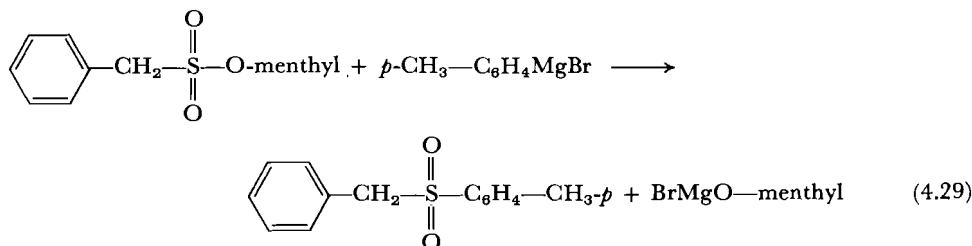
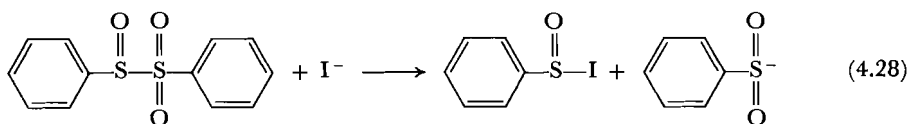
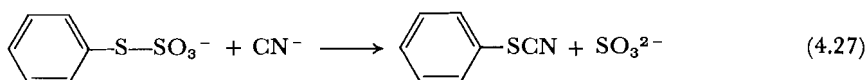

⁵⁴ (a) E. Ciuffarin and A. Fava, *Prog. Phys. Org. Chem.*, **6**, 81 (1968); (b) W. A. Pryor, *Mechanism of Sulfur Reactions*, McGraw-Hill, New York, 1962, pp. 59–70; (c) W. A. Pryor and K. Smith, *J. Amer. Chem. Soc.*, **92**, 2731 (1970).

⁵⁵ For recent reviews of nucleophilic attack on oxygen, see: (a) R. Curci and J. O. Edwards, in *Organic Peroxides*, Vol. 1, D. Swern, Ed., Wiley-Interscience, New York, 1970, p. 199; (b) J. B. Lee and B. C. Uff, *Quart. Rev. (London)*, **21**, 429 (1967); (c) E. J. Behrman and J. O. Edwards, *Prog. Phys. Org. Chem.*, **4**, 93 (1967); (d) J. O. Edwards, in *Peroxide Reaction Mechanisms*, J. O. Edwards, Ed., Wiley-Interscience, New York, 1962, p. 67.

⁵⁶ For a comprehensive review of substitution reactions at silicon, see L. H. Sommer, *Stereochemistry, Mechanism and Silicon*, McGraw-Hill, New York, 1965.

⁵⁷ (a) J. L. Kice and J. M. Anderson, *J. Org. Chem.*, **33**, 3331 (1968); (b) J. L. Kice and G. Guaraldi,

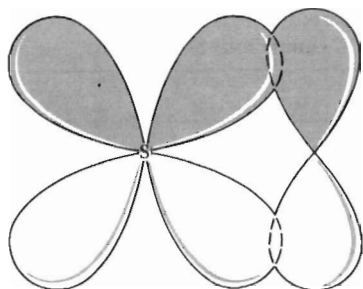
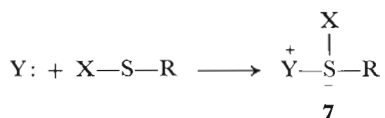

Figure 4.7 Overlap of a d orbital on sulfur with a p orbital on an entering nucleophile.

Dicoordinated Sulfur

In its outer electronic shell divalent sulfur has two s and four p electrons, and it also has five empty $3d$ orbitals. A bimolecular nucleophilic displacement reaction on sulfur might then occur in a single step; or an intermediate such as **7**, in which the sulfur accepts the pair of electrons of the entering Lewis base into one of its



empty d orbitals, might be on the reaction path. For example, Figure 4.7 shows the overlap of an empty $3d$ orbital with a full p orbital on an incoming nucleophile.

The available evidence suggests that a one-step displacement is the usual pathway, but that some reactions may involve an intermediate.^{58, 59} For example, if **7** does lie on the reaction path, then electron-withdrawing substituents on sulfur should stabilize it and the transition states for its formation and decomposition: The reaction should be faster than if there are electron-releasing groups on sulfur. The data in Table 4.9, however, show that for Reaction 4.27 the rate is accelerated by electron-withdrawing and electron-donating substituents in much the same way as are rates of direct displacements on para-substituted benzyl chlorides. An intermediate such as **7** thus seems precluded from the pathway for this reaction. Substitutions on divalent sulfur normally proceed in a one-step displacement in which both bond making and bond breaking occur at the transition state. When electron-donating substituents are present in the substrate, bond breaking is further advanced than bond making; and when electron-withdrawing groups are there, the opposite is true. In either case the transition state can be stabilized (see also Section 4.3, p. 183).

J. Amer. Chem. Soc., **90**, 4076 (1968); (c) M. A. Sabol and K. K. Andersen, *J. Amer. Chem. Soc.*, **91**, 3603 (1969).

⁵⁸ For recent summaries of cases in which an intermediate may be involved in nucleophilic substitution on dicoordinate sulfur, see: (a) E. Ciuffarin and F. Griselli, *J. Amer. Chem. Soc.*, **92**, 6015 (1970); (b) L. Senatore, E. Ciuffarin, and A. Fava, *J. Amer. Chem. Soc.*, **92**, 3035 (1970); (c) E. Ciuffarin, *J. Org. Chem.*, **35**, 2006 (1970).

⁵⁹ Pryor has suggested that the addition-elimination mechanism involving intermediate **7** occurs when the attacking group is highly nucleophilic, the leaving group poor, and the central sulfur highly electronegative (see note 54 (c), p. 194). These same criteria for a two step mechanism would also arise from a consideration of a two-dimensional reaction coordinate diagram.

Table 4.9 EFFECT OF ELECTRON-DONATING AND -WITHDRAWING SUBSTITUENTS ON THE RATE OF DISPLACEMENT REACTIONS ON CARBON AND SULFUR

Z	k_Z/k_H	
	$\text{CN}^- + \text{Z}-\text{C}_6\text{H}_4-\text{S}-\text{SO}_3^- \longrightarrow \text{Z}-\text{C}_6\text{H}_4-\text{SCN} + \text{SO}_3^{2-}$ *	$\text{S}_2\text{O}_3^{2-} + \text{Z}-\text{C}_6\text{H}_4-\text{CH}_2\text{Cl} \longrightarrow \text{Z}-\text{C}_6\text{H}_4-\text{CH}_2\text{S}_2\text{O}_3^- + \text{Cl}^-$ *
CH ₃	1.1	1.5
H	1.0	1.0
Cl	1.8	1.4
Br	1.3	—
NO ₂	1.3	2.1

* Data from M. A. Sabol and K. K. Andersen, *J. Amer. Chem. Soc.*, **91**, 3603 (1969).

* Data from R. Fuchs and D. M. Carletan, *J. Amer. Chem. Soc.*, **85**, 104 (1963).

Reproduced by permission of the American Chemical Society.

Table 4.10 COMPARISON OF THE RATES OF S_N2 REACTIONS AT SULFUR AND AT CARBON

R	Relative Rates			
	$\text{R}-\text{S}-\text{SO}_3^- + \text{SO}_3^{2-}$	$\text{R}-\text{S}-\text{SR} + ^-\text{SR}'$	$\text{RSCN} + \text{C}_4\text{H}_9\text{NH}_2$	$\text{RCH}_2\text{X} + \text{Y}^-$
CH ₃	100			100
C ₂ H ₅	50			40
<i>n</i> -C ₄ H ₉		40		
<i>i</i> -C ₃ H ₇	0.7		1.0	3.0
<i>t</i> -C ₄ H ₉	0.0006	0.00015	0.000125	0.0011

SOURCE: Data from E. Ciuffarin and A. Fava, *Prog. Phys. Org. Chem.*, **6**, 81 (1968). Reproduced by permission of Wiley-Interscience.

Even in a one-step S_N2 displacement, sulfur might use one of its empty *d* orbitals to accept the incoming pair of electrons at the same time as the leaving group begins to break away. If this did occur, backside displacement, which occurs in the S_N2 displacement on carbon because of the stereoelectronic requirements of the transition state, would not be required, and the nucleophile could enter forming a very small angle with the leaving group. Evidence against even this kind of participation of the *d* orbitals comes from the decrease in rates for Reactions 4.30–4.32 as the substrates are increasingly substituted with alkyl groups. As Table 4.10 shows, the decreases in rate due to increasing steric

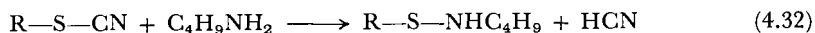
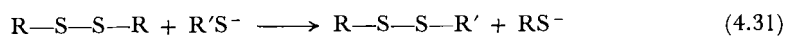
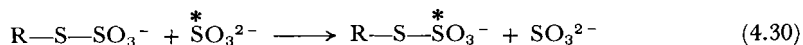

requirements of the central sulfur run parallel to those of analogous substitutions on carbon.⁶⁰ The similarity in relative rates probably arises from a similarity in transition states—that is, bimolecular displacement at divalent sulfur, as at tetrahedral carbon, occurs from the back side (8).

⁶⁰ For similar data for other displacements on dicoordinated sulfur, see: (a) C. Brown and D. R. Hogg, *Chem. Commun.*, 38 (1967); (b) E. Ciuffarin and A. Fava, *Prog. Phys. Org. Chem.*, **6**, 81 (1968), p. 86.

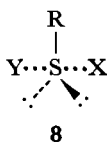

If the entering and leaving groups made an angle considerably less than 180° in substitution on sulfur, then the bulky R groups could have more space, reducing the steric effect of R. It might be thought that backside attack is preferred in Reactions 4.30 and 4.31 in order to minimize the electrostatic repulsion of the entering and leaving groups, both of which bear partial negative charges. But in the transition state of Reaction 4.32 these groups carry opposite charges (**9**), and electrostatic forces would bring them as close together as possible. The fact that

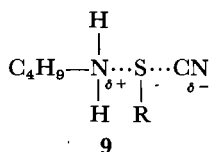

the steric effect of substituents is about the same for this reaction as for the others shows that frontside S_N2 displacement probably does not occur even when the conditions for it are most favorable and therefore that *d* orbitals are usually not employed.⁶¹

Tricoordinated Sulfur⁶²

The mechanisms of nucleophilic displacements on tricoordinated sulfur are not yet fully understood. The stereochemistry can be determined by studying the relative configuration of starting materials and products.⁶³ The substituents attached to tricoordinated sulfur form a tetrahedron with the lone pair occupying one of the apices (**10**) but, unlike its nitrogen-containing analog, the sulfur

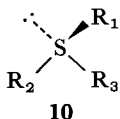

tetrahedron inverts only at high temperatures. Therefore sulfur compounds that have three different substituents (actually four counting the lone pair) on sulfur

⁶¹ See D. R. Hogg and P. W. Vipond, *Int. J. Sulfur Chem. C.*, **6**, 17 (1971) for additional evidence that the transition state is linear.

⁶² It might be useful at this point to review bonding in sulfur compounds. Remember that

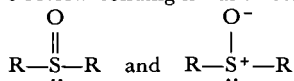

are two ways of writing the same compound. Writing the first structure implies back bonding between a pair of electrons on oxygen and a *d* orbital on sulfur.

⁶³ K. K. Andersen, *Int. J. Sulfur Chem. B*, **6**, 69 (1971); T. R. Williams, A. Nudelman, R. E. Booms, and D. J. Cram, *J. Amer. Chem. Soc.*, **94**, 4684 (1972) and references therein; D. J. Cram, J. Day, D. C. Garwood, D. R. Rayner, D. M. v. Schritlz, T. R. Williams, A. Nudelman, F. G. Yamagishi, R. E. Booms, and M. R. Jones, *Int. J. Sulfur Chem. C*, **7**, 103 (1972).

occur in resolvable enantiomeric pairs, and those in which sulfur is part of a substituted ring system form isolable geometric (*cis*-*trans*) isomers. In most cases, the product of a nucleophilic substitution on tricoordinated sulfur is found to have the opposite configuration from the starting material.

For example, by optical rotary dispersion studies, Mislow has shown that Reaction 4.33 goes with 100 percent inversion of configuration.⁶⁴

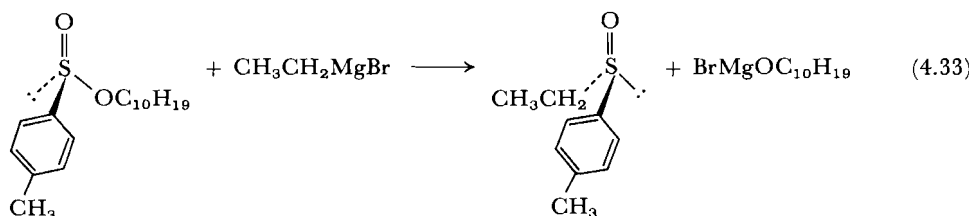

Similarly, Johnson has carried out the following two-step isomerization:⁶⁵

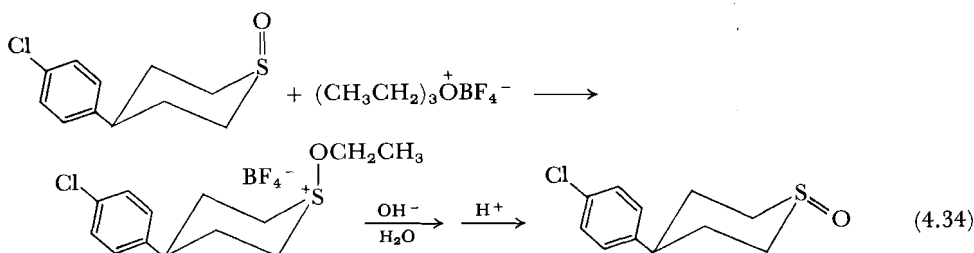

The product was obtained completely inverted in 93 percent yield from the sulfonium ion. Since inversion on sulfur could not have taken place in the O-alkylation step, which involves only the oxygen atom, it must have occurred during the displacement of $-\text{OCH}_2\text{CH}_3$ by $-\text{OH}$.

What is the structure of the transition state or intermediate that leads to inversion? All stable tetracoordinated sulfur compounds closely resemble trigonal bipyramids.⁶⁶ Thus it seems most likely that the tetracoordinated species leading to substitution on tricoordinated sulfur will also be a trigonal bipyramid. We might immediately assume that the position the entering and leaving groups take up in this structure is the same as their position in the transition state for S_N2 substitution at carbon—that is, that the transition state or intermediate would be **11** in which the entering and leaving groups occupy the apical positions.

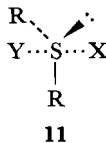

⁶⁴ K. Mislow, M. M. Greene, P. Laur, J. T. Mellilo, T. Simmons, and A. L. Ternay, Jr., *J. Amer. Chem. Soc.*, **87**, 1958 (1965).

⁶⁵ C. R. Johnson, *J. Amer. Chem. Soc.*, **85**, 1020 (1963).

⁶⁶ D. J. Cram, J. Day, D. R. Rayner, D. M. v. Schrititz, D. J. Duchamp, and D. C. Garwood, *J. Amer. Chem. Soc.*, **92**, 7369 (1970).

But Westheimer has pointed out that inversion would also result if the entering and leaving groups occupy radial positions as in **12**.⁶⁷

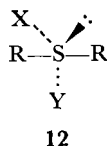

Some displacements on tricoordinated sulfur in which entering and leaving groups are linked proceed with inversion on sulfur. These apparently must have a transition state similar to **12**. For example, in Reaction 4.35 the entering and leaving groups are most likely part of the same six-membered ring in the activated complex—a formation that cannot be accommodated by **11** (180° bond angles between X and Y) but can be by **12**.⁶⁸ Cram has suggested that if the entering and

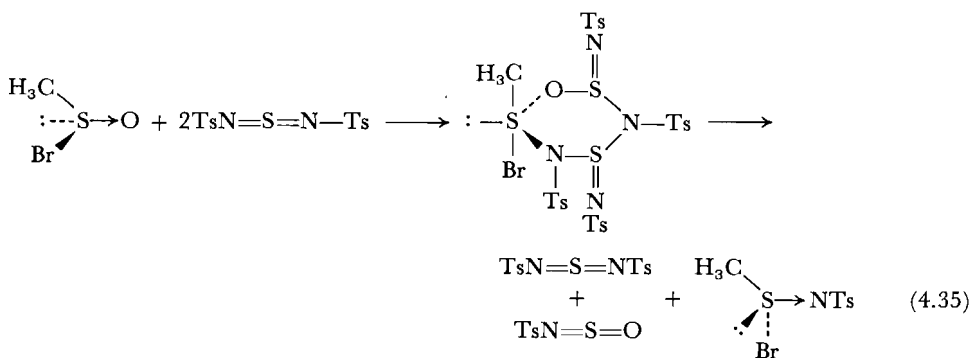

leaving groups are the most electronegative groups of the trigonal bipyramid and if the entering and leaving groups are not tied together in a ring system, then structure **11** is of lower energy. If either of these conditions is not fulfilled, then **12** may be more stable.

Retention of configuration can only occur, in a reaction that has a trigonal bipyramidal transition state, if the leaving group occupies an apical, and the entering group a radial position (or vice versa), as in **13**. Three cases of retention

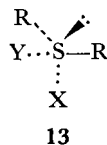

⁶⁷ (a) P. C. Haake and F. H. Westheimer, *J. Amer. Chem. Soc.*, **83**, 1102 (1961). (b) The electron pair in **12** is shown in the equatorial rather than in the axial position because the axial positions are preferred by the more electronegative groups and the equatorial by the more electropositive groups. (c) The structure shown in **11** arises from attack of the nucleophile on the face of the tetrahedron opposite to the apex occupied by the leaving group. We have already discussed the simple bonding model for **11** in Section 4.2 (p. 175); it is readily apparent from this model that **11** could be a transition state for nucleophilic substitution on any sp^3 hybridized atom. The structures **12** and **13**, on the other hand, arise from attack of the nucleophile on an edge of the tetrahedron. If the central atom is carbon or some other element that does not have empty d orbitals, then there is no simple bonding model that corresponds to **12** or **13**; if d orbitals are present, oriented toward the edge of the tetrahedron being attacked, they can accept the electrons of the nucleophile.

⁶⁸ See note 63, p. 197 and 66, p. 198.

starting material. Thus **15** must either be formed in a slow, nonreversible first step, or **15** is a transition state, not an intermediate.⁷¹

Kice, however, has suggested that this ¹⁸O exchange experiment is inconclusive.⁷² If hydroxide ion attacks **14**, the most likely first intermediate would be **17**, in which the five-membered ring spans an apical and an equatorial position and in which O⁻ and the electron pair (which are less electronegative than OH⁷³) occupy equatorial positions. This intermediate is *not* isoenergetic with **18**, the

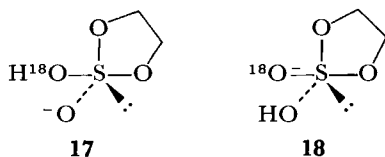

result of a simple proton transfer, because in **18** the most electronegative ligand, OH, occupies an equatorial position.⁷⁴ Kice suggests that **17** might be formed in a rapid preequilibrium, and its presence might not be detected in the experiment described above.

Tetracoordinated Sulfur

The mechanism of nucleophilic displacements on tetracoordinated sulfur has not yet been much studied, but the formation of an intermediate seems possible.

For example, when sulfonate esters are hydrolyzed with ¹⁸O-enriched hydroxide (Reaction 4.38) the product sulfonic acids contain ¹⁸O but the starting material recovered after 50 percent reaction does not.⁷⁵ By the arguments outlined on p. 200 this *might* be evidence for either a one-step displacement or a two-step mechanism with the first step rate-determining. The latter is made more

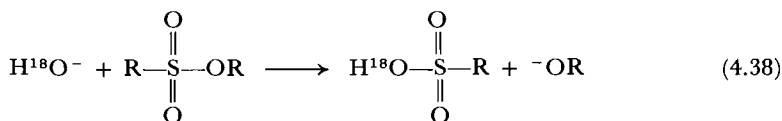

plausible by the work of Ciuffarin, who has studied the reactions of several nucleophiles with **19** and has found that the rates of displacement of X are very similar for X = Cl, Br, and I. If departure of the leaving group were involved in

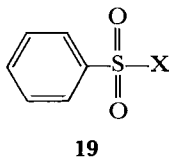

⁷¹ In other reactions on tricoordinate sulfur, not yet well understood, intermediates analogous to **15** are formed. See, for example, B. M. Trost, R. LaRochelle, and R. C. Atkins, *J. Amer. Chem. Soc.*, **91**, 2175 (1969) and references in this paper and in E. N. Givens and H. Kwart, *J. Amer. Chem. Soc.*, **90**, 378, 386 (1968). See also N. E. Hester, *Int. J. Sulfur Chem.*, **8**, 119 (1973).

⁷² J. L. Kice and C. A. Walters, *J. Amer. Chem. Soc.*, **94**, 590 (1972).

⁷³ See note 67 (b), p. 199.

⁷⁴ See note 67 (b), p. 199.

⁷⁵ D. R. Christman and S. Oae, *Chem. Ind. (London)*, 1251 (1959).

the rate-determining step, one would expect that the rates of reaction would decrease in the order $I > Br > Cl$.⁷⁶ Ciuffarin and co-workers interpret their results as evidence for a reaction path in which the formation of the intermediate is rate-determining.

The usual stereochemical course for substitution on tetracoordinated sulfur seems to be inversion.^{76,77} For example, Sabol and Andersen showed, by optical rotary dispersion measurements, that the product of reaction 4.39 has the configuration opposite to that of the starting material.⁷⁸

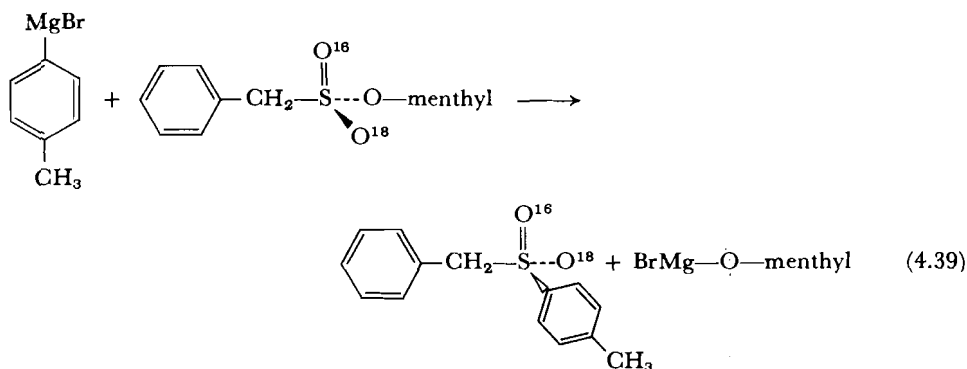

The Nucleophile in Displacement Reactions on Sulfur

The relative reactivities of nucleophiles toward sulfur differ a great deal depending on whether the sulfur is di-, tri-, or tetracoordinated. This is to be expected from the theory of hard and soft acids and bases. As the oxidation state

of sulfur in the series $-\text{S}-$, $\begin{array}{c} \text{O} \\ \parallel \\ -\text{S}- \end{array}$, $\begin{array}{c} \text{O} \quad \text{O} \\ \parallel \quad \parallel \\ -\text{S}- \\ \parallel \\ \text{O} \end{array}$ increases, so also does the hardness of

sulfur as a Lewis acid. Table 4.11 shows the relative reactivities of some nucleophiles toward sulfenyl, sulfinyl, and sulfonyl sulfur, all in 60 percent aqueous dioxane. Note the great increase in rate on sulfenyl sulfur ($-\text{S}-$) as the nucleophile becomes softer and more polarizable. For harder sulfinyl sulfur, the rate increase is less pronounced and, as has been pointed out by Kice, in polar solvents, the relative reactivities of nucleophiles toward this oxidation state of sulfur are very similar to those toward sp^3 hybridized carbon.⁷⁹ Finally, note that for hard sulfonyl sulfur the rate with fluoride is 10^5 times faster than with chloride.⁸⁰

⁷⁶ E. Ciuffarin, L. Senatore, and M. Isola, *J. Chem. Soc., Perkin 2*, 468 (1972).

⁷⁷ M. J. Jones and D. J. Cram, *J. Amer. Chem. Soc.*, **96**, 2183 (1974). See also note 57 (c), p. 195.

⁷⁸ See note 57 (c), p. 195.

⁷⁹ J. L. Kice, G. J. Kasperek, and D. Patterson, *J. Amer. Chem. Soc.*, **91**, 5516 (1969) and references therein.

⁸⁰ With the exception of F^- , the relative reactivities of nucleophiles toward sulfonyl sulfur are very similar to their relative reactivities in the same solvent toward carbonyl carbon. J. L. Kice and E. Legan, *J. Amer. Chem. Soc.*, **95**, 3912 (1974).

Table 4.11 RELATIVE RATES OF REACTION OF VARIOUS NUCLEOPHILES WITH DIFFERENT OXIDATION STATES OF SULFUR IN 60% AQUEOUS DIOXANE

Nucleophile (Y)	k_Y/k_{Cl}			
	Toward —S— ^a	Toward $\begin{array}{c} \text{O} \\ \\ \text{—S—}^b \end{array}$	Toward $\begin{array}{c} \text{O} \\ \\ \text{—S—}^b \\ \\ \text{O} \end{array}$	Toward $sp^3 C^c$
Cl ⁻	1.0	1.0	1.0	1.0
Br ⁻	35.0	5.5	5.6	7.0
SCN ⁻	5.4×10^3			
I ⁻	1.4×10^4			100
OAc ⁻		0.77	6.2×10^3	0.47
F ⁻		0.38	3.7×10^5	—
H ₂ O		8.5×10^{-6}	1.2×10^{-1}	1×10^{-3}

^a J. L. Kice and G. B. Large, *J. Amer. Chem. Soc.*, **90**, 4069 (1968).

^b J. L. Kice, G. J. Kasperek, and D. Patterson, *J. Amer. Chem. Soc.*, **91**, 5516 (1969).

^c Data from C. G. Swain and C. B. Scott, *J. Amer. Chem. Soc.*, **75**, 141 (1953).

Reproduced by permission of the American Chemical Society.

4.5 BIMOLECULAR ELECTROPHILIC SUBSTITUTION AT SATURATED CARBON⁸¹

There are two polar alternatives for simple substitution on saturated carbon. In the first the leaving group is more electronegative than carbon and therefore departs, taking with it the pair of electrons that formerly bound it to carbon. To make up the deficiency the group entering must bear an extra pair of electrons. This is, of course, a description of aliphatic nucleophilic substitution. In the second alternative, the leaving group, less electronegative than carbon, departs stripped of the bonding electrons. To bond with carbon the entering group must now be able to accept an extra pair of electrons. The latter alternative is aliphatic electrophilic substitution. Because most elements less electronegative than carbon are metallic, electrophilic substitution ordinarily occurs on organometallic compounds.

In analogy to the traditional terms S_N1 and S_N2 , which refer to the extreme aliphatic substitution mechanisms, workers in the field of electrophilic substitution refer to S_E1 (for substitution–electrophilic–unimolecular) and S_E2 (substitution–electrophilic–bimolecular) mechanisms. Equations 4.40 and 4.41

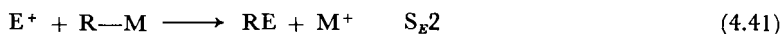
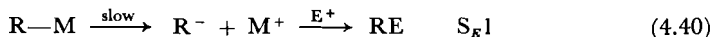

show these mechanisms in their simplest representations. In this chapter we are concerned mainly with one-step, second-order substitutions, but as we shall see,

⁸¹ For recent reviews of electrophilic substitution see (a) F. R. Jensen and B. Rickborn, *Electrophilic Substitution of Organomercurials*, McGraw-Hill, New York, 1968; (b) O. A. Reutov, *Pure and Appl. Chem.*, **17**, 79 (1968); (c) D. S. Matteson, *Organometal. Chem. Rev. A.*, **4**, 263 (1969); (d) C. K. Ingold, *Structure and Mechanism in Organic Chemistry*, 2nd ed., Cornell University Press, Ithaca, N.Y., 1969, pp. 563–584.

most of these reactions do not follow the reaction path implied in Equation 4.41. Rather, the path usually followed includes a cyclic transition state (Equation 4.42) in which the electrophile enters as the metallic leaving group departs *while*

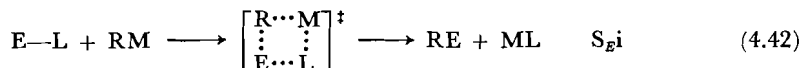

at the same time a ligand originally attached to the electrophile is transferred to the leaving group. Thus, it is not necessary that the electrophile lack a pair of electrons at the start of the reaction; loss of the ligand with its bonding electrons during the course of the reaction enables the electrophile to take over the pair of electrons on carbon formerly used for bonding to the leaving group. We shall call the mechanism shown in Equation 4.42 the S_{Ei} mechanism (in which the "i" is for "internal").

Although nucleophilic substitutions have been much studied for over 40 years, the corresponding electrophilic substitutions aroused little interest until the 1950's. Since then, because mercury usually forms truly covalent bonds⁸² and because organomercurials can be prepared in optically active form and do not subsequently racemize, the majority of mechanistic studies in this area have used organomercurials as the substrate. Thus, to stay in the most brightly lighted area of a field, at best dimly lighted, we shall limit our short discussion of bimolecular electrophilic aliphatic substitutions almost entirely to reactions of organomercurials.

Electrophilic Cleavage of Organomercurials

Mercury compounds are often used as electrophiles in displacements on organomercurials. There are five possible combinations of reactants in such "mercury exchange" reactions. A dialkylmercurial substrate may be attacked either by a mercury salt (Reaction 4.43) or by a monoalkylmercurial (Reaction 4.44); and likewise a monoalkylmercurial may react either with a mercury salt or with another monoalkylmercurial (Reactions 4.45 and 4.46). Finally, a dialkylmercurial may react with another dialkylmercurial (Reaction 4.47). (In Reactions 4.43–4.47 and in other reactions in this section, one of the reactants, and the fragments derived from that reactant in the products, are written in italics. This is done to make it easier to follow the course of the reaction.)

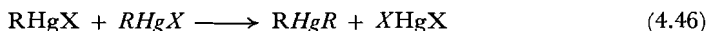
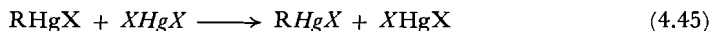
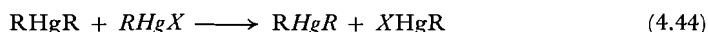
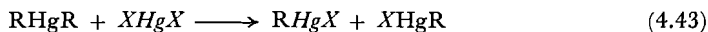

⁸² In the gas phase, divalent mercury has been shown to be linear and therefore to be *sp* hybridized. However, in solution the X—R—X, R—Hg—X, or R—Hg—R bond angle in divalent mercury compounds varies from 130 to 180°. The variation in geometry is not yet entirely understood, so we shall follow Jensen's example and assume that, even in solution, divalent mercury is *sp* hybridized and that if a divalent mercury compound donates one empty orbital to coordinate with a Lewis base it rehybridizes to *sp*² (F. R. Jensen and B. Rickborn, *Electrophilic Substitution of Organomercurials*, pp. 35, 36).

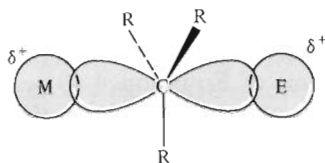

Figure 4.8 Transition state for backside S_E2 displacement.

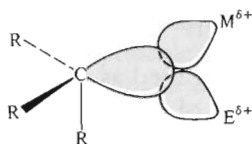
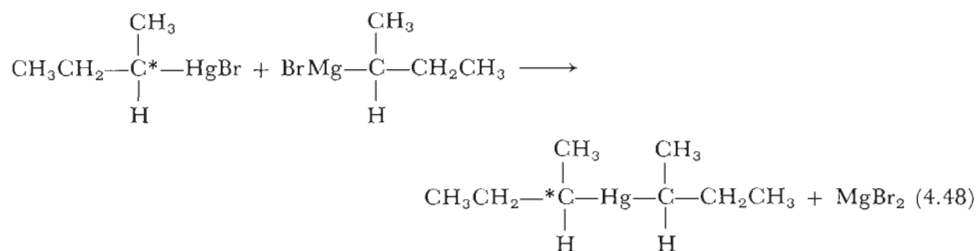

Figure 4.9 Transition state for frontside S_E2 displacement.

We shall only discuss experiments that shed light on the first three types (Reactions 4.43–4.45), but the characteristics of all five types of mercury exchange reactions seem to be very similar.

The first question we shall ask is whether bimolecular mercury exchanges proceed with retention or inversion of configuration at the central carbon. We shall then see if we can decide whether the transition state is open (S_E2 mechanism) or cyclic (S_{Ei} mechanism). If the reactions proceed with inversion of configuration, then the mechanism must be S_E2 . The geometry of the activated complex leading to inversion would be very similar to that leading to S_N2 substitution. The electrophile, attacking the carbon from the back side, would cause carbon to rehybridize from sp^3 to sp^2 so that the remaining p orbital could be shared by it and the leaving group (Figure 4.8). The difference between this transition state and the transition state for backside displacement in the S_N2 reaction is, of course, that in the S_E2 reaction the three participating atomic orbitals share a total of two electrons whereas in the S_N2 reaction they share a total of four. Retention of configuration could result from either an S_E2 or an S_{Ei} mechanism. In either case the electrophile would attack the sp^3 orbital used in bonding with the leaving group from the front side (Figure 4.9).

The first detailed study of the stereochemistry of a mercury exchange reaction that was known to be bimolecular was carried out as follows.⁸³ Di-*s*-butylmercury was prepared by reacting optically active *s*-butylmercuric bromide with racemic *s*-butylmagnesium bromide as shown in Equation 4.48.



⁸³ (a) H. B. Charman, E. D. Hughes, and C. K. Ingold, *J. Chem. Soc.*, 2530 (1959); (b) F. R. Jensen, *J. Amer. Chem. Soc.*, 82, 2469 (1960); (c) O. A. Reutov and E. V. Ugl'ova, *Bull. Acad. Sci. USSR, Chem. Div. Sci.*, 1628 (1959).

Since the mercury-carbon bond is not disturbed in any way in this reaction, one (and only one) of the *s*-butyl groups in the di-*s*-butylmercury should have an optically active center. The mercury exchange reaction of Equation 4.49 was then carried out on the di-*s*-butylmercury thus formed, and the optical rotation

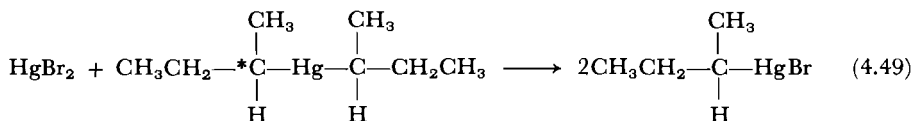

of the product was compared to that of *s*-butylmercuric bromide used as starting material. If the substitution had proceeded with retention of configuration (Equation 4.50), then the specific rotation of the product would be half that of

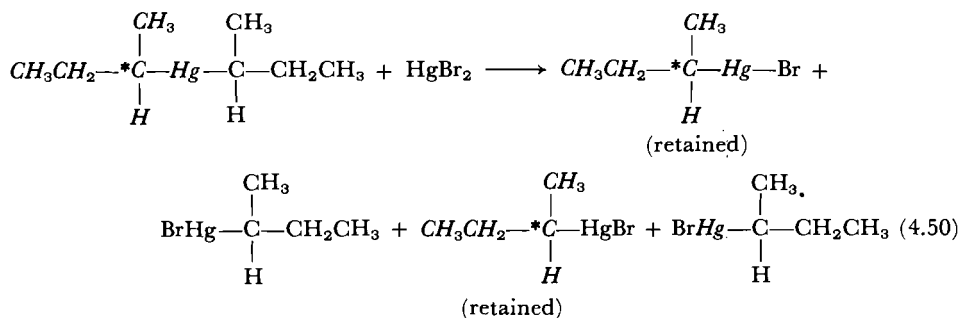

the original *s*-butylmercuric bromide. If the substitution had proceeded with racemization (Equation 4.51), the specific rotation should be one-quarter that of

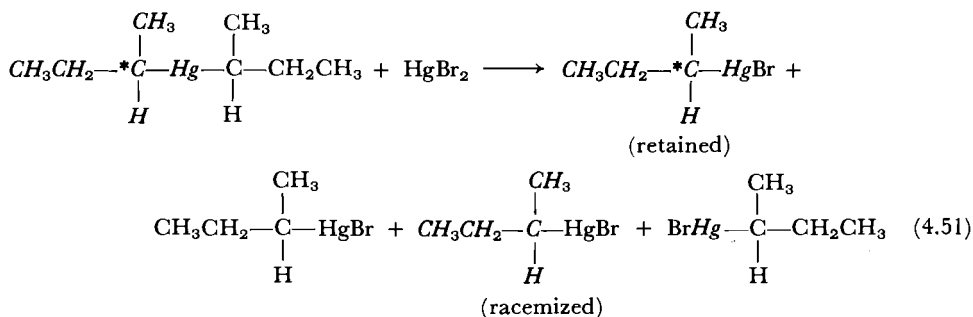

the starting material. Finally, if the substitution had proceeded with inversion (Equation 4.52), the product should be racemic.

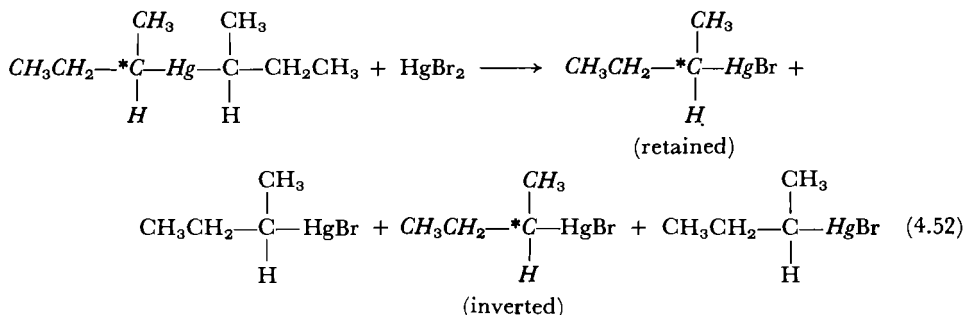

The specific rotation of the initial *s*-butyl bromide used by Charman, Hughes, and Ingold was -15.2° . The specific rotation of the product of the mercury exchange reaction was exactly half that, -7.6° . When mercuric acetate or mercuric nitrate was used as the cleaving salt, the products showed a specific rotation of -7.5° and -7.8° , respectively. Thus this electrophilic substitution clearly proceeds with retention of configuration.

Stereochemical studies on other mercury exchange reactions have been carried out, and all point to retention as the predominant pathway.⁸⁴

A possible "justification" for frontside attack in electrophilic substitution is that *ab initio* molecular orbital calculations for the CH_5^+ cation, the species that would be formed if H^+ attacked methane, indicate that the most stable structure would not be a trigonal bipyramid, in which carbon uses a *p* orbital to bond to two protons, but would be a relatively unsymmetrical structure that has a smallest H—C—H bond angle of about 37° (Figure 4.10).⁸⁵ For further discussion of $\text{S}_{\text{E}}2$ substitution on carbon, see Section 10.3.⁸⁶

Let us now turn to whether the transition state is open ($\text{S}_{\text{E}}2$) or cyclic ($\text{S}_{\text{E}}\text{i}$). The exchange of radioactive mercury shown in Equation 4.53 is a second-

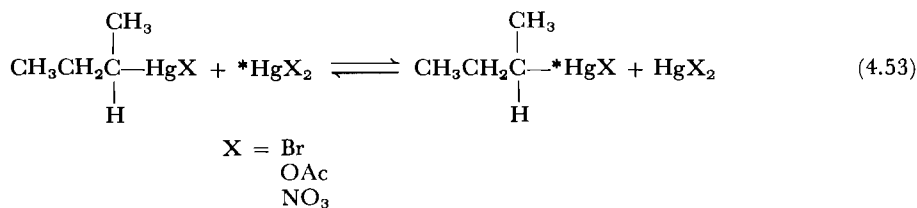

order reaction.⁸⁷ Furthermore, it is identical in the forward and reverse directions. Ingold reasoned that the mercury coordinated with the anion of highest ionizing ability would be the most electrophilic and, therefore, if the $\text{S}_{\text{E}}2$

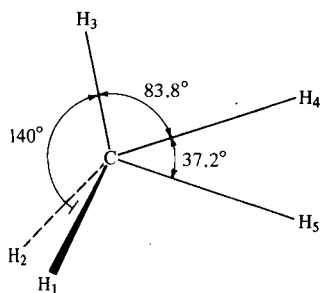

Figure 4.10 Optimum structure for CH_5^+ . From W. A. Lathan, W. J. Hehre, and J. A. Pople, *Tetrahedron Lett.*, 2699 (1970). Reproduced by permission of Pergamon Press.

⁸⁴ (a) H. B. Charman, E. D. Hughes, C. K. Ingold, and F. G. Thorpe, *J. Chem. Soc.*, 1121 (1961); (b) E. D. Hughes, C. K. Ingold, F. G. Thorpe, and H. C. Volger, *J. Chem. Soc.*, 1133 (1961); (c) E. D. Hughes, C. K. Ingold, and R. M. G. Roberts, *J. Chem. Soc.*, 3900 (1964).

⁸⁵ W. A. Lathan, W. J. Hehre, and J. A. Pople, *Tetrahedron Lett.*, 2699 (1970). See also A. V. Kemp-Jones, N. Nakamura, and S. Masamune, *J. Chem. Soc. D*, 109 (1974) and references therein.

⁸⁶ F. R. Jensen and B. Rickborn, *Electrophilic Substitution of Organomercurials*, pp. 153ff.

⁸⁷ See note 84 (b).

mechanism were followed the rates should be $\text{HgBr}_2 < \text{Hg}(\text{OAc})_2 < \text{Hg}(\text{NO}_3)_2$. He reasoned further that the anion of lowest ionizing ability would be the best coordinator and therefore if the mechanism is S_Ei the rates should be reversed: $\text{HgBr}_2 > \text{Hg}(\text{OAc})_2 > \text{Hg}(\text{NO}_3)_2$. The order found was $\text{HgBr}_2 < \text{Hg}(\text{OAc})_2 < \text{Hg}(\text{NO}_3)_2$. The open S_E2 mechanism, originally proposed by Ingold, and shown in Equation 4.54, cannot be correct because the mechanism in the forward direction would be different from that in the reverse direction and therefore the law of microscopic reversibility would be defied.⁸⁸ Jensen also ruled out a

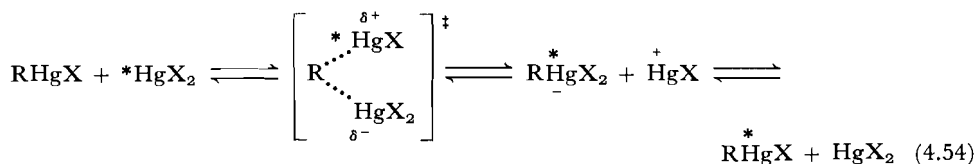

revised mechanism proposed by Ingold,⁸⁹ shown in Scheme 2, because the rate of reaction is not depressed by addition of X^- . (A higher concentration of X^- would drive the first equilibrium to the left and thereby decrease the overall rate

SCHEME 2

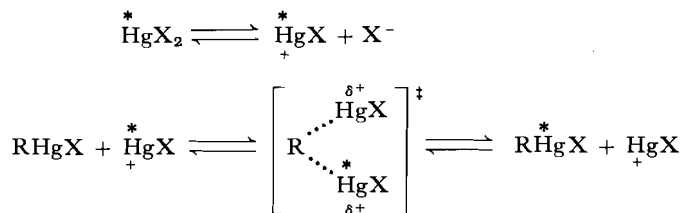

of reaction. Jensen and Rickborn suggest that, contrary to Ingold's conclusions, the transition state shown in **20** might well accommodate the experimental results.⁹⁰ They dispute the original assumption made by Ingold that the ionizing

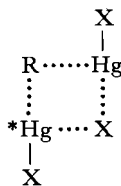

20

and bridging abilities of anions are inversely proportional to one another; they suggest that the capacity of nitro and acetate groups to form six-membered rings when bridging (as shown in **21** and **22**, respectively) might make them better coordinators than halide ions, which can form only four-membered rings. They point out that the electrophilicity of the attacking mercury is also important in

⁸⁸ (a) See note 81 (c) and F. R. Jensen and B. Rickborn, *Electrophilic Substitution of Organomercurials*, pp. 153ff; (b) the law of microscopic reversibility states that in a reversible reaction, if a certain percentage of the molecules follow one path in the forward direction, the same percentage will follow that path in the reverse direction.

⁸⁹ See note 81 (d), p. 203.

⁹⁰ See note 86, p. 207.

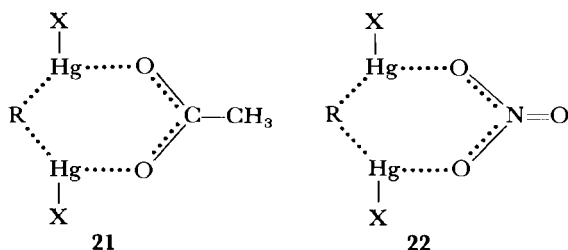

the S_Ei mechanism of mercury exchange and might be more important than the coordinating power of the anions.

If all three alkyl groups are identical, mercury exchanges of the type shown in Equation 4.44 are also identical in the forward and reverse directions. The law of microscopic reversibility taken in conjunction with the kinetics of the reaction again suggest a cyclic transition state (by the arguments outlined above), but the observed order of reactivity of the electrophiles again is $RHgBr < RHg(OAc)_2 < RHgNO_3$. It therefore seems likely that even reactions such as those shown in Equation 4.49 and Equation 4.43, in which the forward and reverse reactions are different but in which the order of reactivity of the mercury salts is the same as in Reaction 4.53,⁹¹ proceed through a cyclic S_Ei mechanism. In fact, since almost all bimolecular electrophilic substitutions on carbon in organometallic compounds of which the stereochemistry have been studied proceed with retention of configuration, the transition state of Figure 4.9 may be general for substitutions in organometallics.

Bimolecular Electrophilic Substitutions at Carbon-Hydrogen Bonds

Recently Olah has found a means of studying electrophilic bimolecular substitutions on the C—H and the unstrained C—C bond and concluded that the “triangular” transition state shown in Figure 4.9 is also involved here.⁹² For example, in $DF-SbF_5$, a superacid medium,⁹³ adamantane rapidly exchanges hydrogen for deuterium with great preference for the bridgehead positions, as shown in Equation 4.55. In this rigid bicyclic system, backside attack is improbable. There is no strong base, so a carbanion cannot form. Structure 23 then seems like the most likely representation of the transition state.

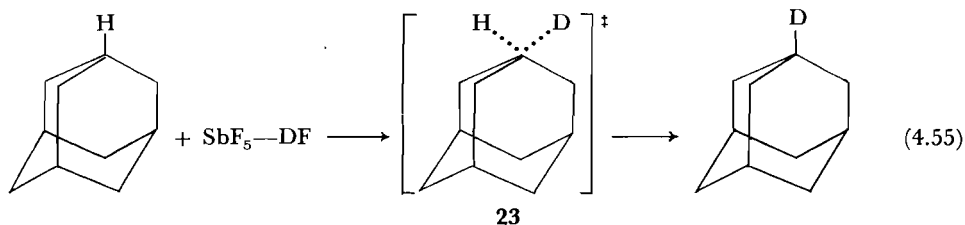

⁹¹ See note 83 (a), p. 205.

⁹² G. A. Olah, Y. Halpern, J. Shen, and Y. K. Mo, *J. Amer. Chem. Soc.*, **93**, 1251 (1971). See also G. A. Olah and J. A. Olah, *J. Amer. Chem. Soc.*, **93**, 1256 (1971) and G. A. Olah and H. Lin, *J. Amer. Chem. Soc.*, **93**, 1259 (1971). For a discussion of attack of H^+ on a strained (cyclopropane) C—C bond, see Section 6.2.

⁹³ Antimony pentafluoride (SbF_5) is a strong Lewis acid, so the equilibrium

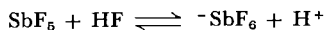

lies to the right, giving rise to unsolvated and therefore very reactive protons.

PROBLEMS

1. Predict which would be more reactive as a nucleophile in S_N2 substitution:

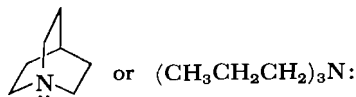

2. Suggest an explanation for the fact that the order of reactivity of the halides toward *n*-butyl brosylate in acetone is $\text{Cl}^- > \text{Br}^- > \text{I}^-$ when $(\text{C}_4\text{H}_9)_4\text{N}^+$ is the cation of the halide salt but $\text{I}^- > \text{Br}^- > \text{Cl}^-$ when Li^+ is the cation.

3. Suggest a reason for the secondary isotope effect, $k_{\text{H}}/k_{\text{D}} = 1.10$ in the reactions:

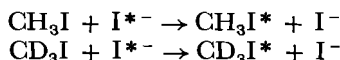

4. Nucleophiles such as NH_2OH and NH_2NH_2 , which have an electronegative atom with one or more pairs of unshared electrons adjacent to the nucleophilic center, are more reactive than might be expected from the nature of the nucleophilic center, as can be seen from Table 4.5. Suggest a reason for this increased reactivity (this phenomenon is called the α -effect).

5. Silicon compounds of the type R_3SiOR undergo nucleophilic substitution. From the following experimental observations, decide whether the most likely mechanism is

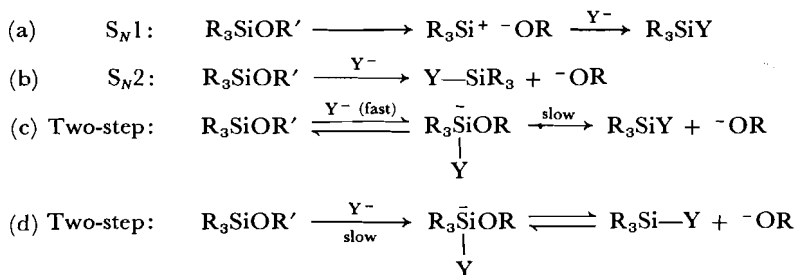

Experimental observations:

(a) Substitution almost always proceeds with retention or inversion—never with racemization.

(b) The reaction shown below gives only the product depicted. No

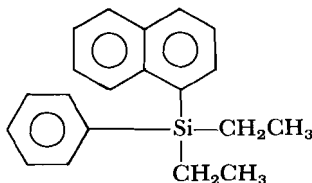

is formed.

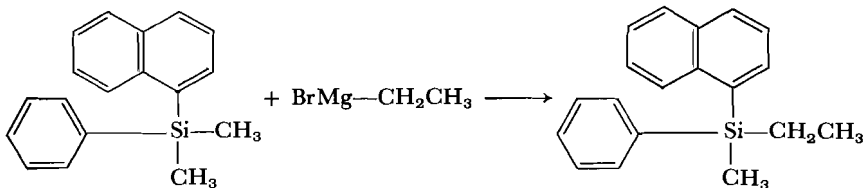

5. L. H. Sommer, *Stereochemistry, Mechanism, and Silicon*, McGraw-Hill, New York, 1965, pp. 48ff; p. 67.
6. L. H. Sommer and H. Fujimoto, *J. Amer. Chem. Soc.*, **90**, 982 (1968).
7. J. O. Edwards, in *Peroxide Reaction Mechanisms*, J. O. Edwards, Ed., Wiley-Interscience, New York, 1962, pp. 68-69.
8. R. G. Pearson and J. Songstad, *J. Amer. Chem. Soc.*, **89**, 1827 (1967).
9. E. D. Hughes and H. C. Volger, *J. Chem. Soc.*, 2359 (1961).

Chapter 5

UNIMOLECULAR

SUBSTITUTIONS

AND RELATED

REACTIONS

In this chapter we take up unimolecular and borderline substitutions and discuss carbocations, carbanions, and carbenes, three of the important reactive organic intermediates.

5.1 LIMITING UNIMOLECULAR NUCLEOPHILIC REACTIONS. KINETICS AND STEREOCHEMISTRY¹

Diphenylchloromethane (benzhydryl chloride, **1**), when dissolved in solvents such as aqueous ethanol, aqueous acetone, acetic acid, or formic acid, undergoes substitution of chloride by a nucleophilic group derived from the solvent.

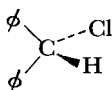

Equation 5.1, in which SOH stands for a molecule of some hydroxylic solvent, illustrates the process. This type of reaction, where the solvent takes the role of the

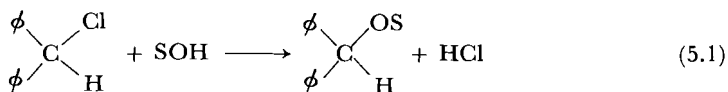

nucleophile (Lewis base) in the substitution, is called *solvolysis*.

¹ Unimolecular substitutions are discussed in detail in the following sources: (a) C. A. Bunton, *Nucleophilic Substitution at a Saturated Carbon Atom*, Elsevier, Amsterdam, 1963; (b) C. K. Ingold, *Structure and Mechanism in Organic Chemistry*, 2nd ed., Cornell University Press, Ithaca, N.Y., 1969; (c) A. Streitwieser, Jr., *Solvolytic Displacement Reactions*, McGraw-Hill, New York, 1962; (d) E. R. Thornton, *Solvolysis Mechanisms*, Ronald Press, New York, 1964.

The observed kinetics of the solvolysis is first-order in the benzhydryl chloride. This fact alone tells little about the mechanism because the nucleophile, being the solvent, is always present in large excess. As we have seen in Section 2.5 (p. 92), its concentration therefore undergoes a negligible proportional change and will not enter into the rate expression even if it is involved at or before the rate-determining step. Added nucleophiles have relatively small effects on the rate, and rates with various nucleophilic salts differ only slightly from each other. Most added salts accelerate the process, but common ion salts (chlorides in the case of benzhydryl chloride) make it slower. Addition of sodium azide causes formation of some benzhydryl azide, but affects the rate in the same way as other non-common ion salts.² The stereochemistry of the substitution can be investigated by starting with a chiral analog such as *p*-chlorobenzhydryl chloride. The solvolysis products are almost completely racemic. Although these results have been known for many years,³ a number of questions about details of mechanism remain unanswered.

The S_N1 Mechanism

Early investigators, notably Hughes, Ingold, and co-workers, accounted for the solvolysis results by proposing the S_N1 mechanism,⁴ which postulates a rate-determining dissociation to a carbocation followed by rapid capture of the ion by a nucleophile. Equations 5.2 and 5.3 delineate the S_N1 route for the case of ion capture by solvent.

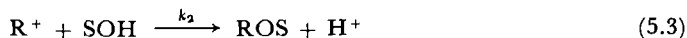

The reverse of the second step, although it should be included to be rigorously correct, is frequently omitted because the final product in many cases is sufficiently unreactive that no experimentally significant amount will return to carbocation during the time the reaction is under observation.

This simple two-step mechanism, when combined with the stationary-state assumption for the presumably highly reactive positive ion (see Section 2.5, p. 93), leads to the prediction given in Equation 5.4 for the rate of product formation. (See Problem 1.) The term in parentheses in Equation 5.4 will

$$\text{rate of product formation} \quad \frac{d[\text{P}]}{dt} = k_1[\text{RCl}] \left(1 + \frac{k_{-1}[\text{X}]}{k_2[\text{SOH}]} \right)^{-1} \quad (5.4)$$

reduce to unity whenever $k_2[\text{SOH}] \gg k_{-1}[\text{Cl}^-]$; in that case a simple first-order

² (a) L. C. Bateman, E. D. Hughes, and C. K. Ingold, *J. Chem. Soc.*, 974 (1940); (b) C. G. Swain, C. B. Scott, and K. H. Lohmann, *J. Amer. Chem. Soc.*, 75, 136 (1953); (c) D. Kovačević, Z. Majerski, S. Borčić, and D. E. Sunko, *Tetrahedron*, 28, 2469 (1972).

³ For early work on benzhydryl solvolysis, see L. C. Bateman, M. G. Church, E. D. Hughes, C. K. Ingold, and N. A. Taher, *J. Chem. Soc.*, 979 (1940), and references cited therein.

⁴ The mechanism was proposed by S. C. J. Olivier and G. Berger, *Rec. Trav. Chim.*, 45, 712 (1926); A. M. Ward, *J. Chem. Soc.*, 2285 (1927); and C. K. Ingold, *Ann. Repts. Chem. Soc.*, 24, 156 (1927). It was set out in detail by E. D. Hughes, C. K. Ingold, and C. S. Patel, *J. Chem. Soc.*, 526 (1933); the S_N1 terminology was introduced by J. L. Gleave, E. D. Hughes, and C. K. Ingold, *J. Chem. Soc.*, 236 (1935).

kinetic behavior is predicted, and this is usually what is observed. A sufficiently large added concentration of the leaving group (in this case Cl^-) might lead to a rate depression, called a *common ion effect*; it was to this cause that Hughes and Ingold attributed the observed rate decrease for benzhydryl chloride with added chloride salts.⁵ Azide ion diverts the carbocation to stable alkyl azide; the amount of azide formed is consistent only with its formation from an intermediate, presumed to be the R^+ ion, which also produces the solvolysis product.⁶ The stereochemistry of the benzhydryl reactions is also consistent with the Ingold mechanism. As we shall see in more detail in Section 5.3, there is now abundant evidence that carbocations exist and that they prefer a geometry in which the cationic carbon and the three atoms attached to it are coplanar. A carbon cation in this preferred conformation has a plane of symmetry and so cannot be chiral; attack on the ion by a nucleophile from the two sides of the plane, yielding the two enantiomers of the product (Equation 5.5), must occur at equal rates.

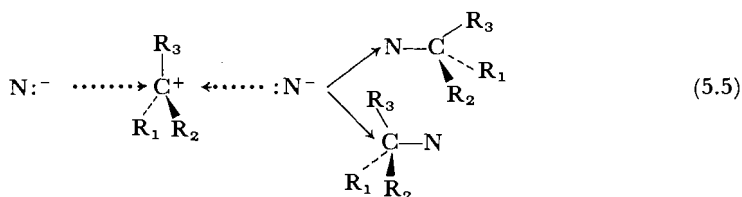

Using rate, product, and stereochemical evidence, Hughes, Ingold, and their co-workers assigned mechanisms to a number of systems and pointed out that many cases could not be clearly categorized as either $\text{S}_{\text{N}}1$ or $\text{S}_{\text{N}}2$.⁷

It is now recognized that the two-step sequence of Equations 5.2 and 5.3 is oversimplified, and that a good deal more needs to be said about the details of the mechanism. In the first place, it is clear that when the ionization occurs, dipolar solvent molecules will be more strongly attracted to the ions than they were to the neutral substrate, and there will be a change in solvation. But ultimately, in the product, a solvent molecule will become bonded to the cationic center; it will be a difficult matter to determine experimentally whether some bonding of solvent to carbon, more specific than the general solvation forces, is occurring simultaneously with the departure of the leaving group and so is assisting ionization. If this assistance by solvent is occurring, the process has some of the characteristics of an $\text{S}_{\text{N}}2$ reaction, and should not be classified as pure $\text{S}_{\text{N}}1$. We shall return to this point in Section 5.4; for the time being, it is useful to postulate a mechanism at the $\text{S}_{\text{N}}1$ end of this range, just as in Chapter 4 we considered a mechanism at the $\text{S}_{\text{N}}2$ end. We therefore define as a *limiting unimolecular* ($\text{S}_{\text{N}}1$) mechanism a process in which the ionization yields solvated ions without any bonding by solvent molecules to the developing cationic center other than those general noncovalent, nondirectional interactions involved in solvation.

In view of evidence that we shall consider in more detail in Section 5.4, it appears that the early work placed in the limiting class some systems that do not really belong there, and that probably limiting reactions are restricted to tri-

⁵ See note 3.

⁶ See note 2(a).

⁷ C. K. Ingold, *Structure and Mechanism in Organic Chemistry*, pp. 427-457.

arylmethyl, benzhydryl,⁸ tertiary alkyl, and allylic systems. Even the limiting S_N1 process is not without complication, however, because it is possible to show that, in some instances at least, the ionization process consists of more than one step.

Ion Pairs

If two chemical processes occur through the same intermediate, the products should be identical. In solvolysis reactions of systems bearing hydrogen on the β carbon, elimination,⁹ which consists of loss of a proton to give an olefin, generally accompanies substitution. We illustrate this process for solvolysis of *t*-butyl halide in Scheme 1. Intermediacy of free carbocations requires the distribution of

SCHEME 1

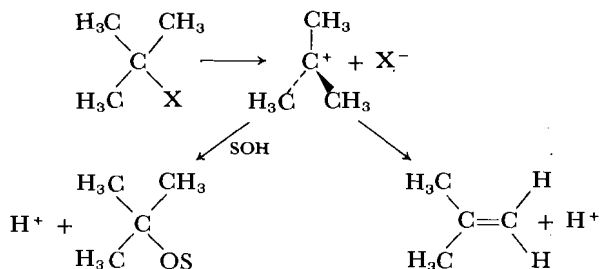

products between elimination and substitution to be independent of the leaving group X. Table 5.1 gives results of tests of this prediction for various solvents. The data are in agreement with the free ion mechanism for the high-dielectric-constant solvent water; for solvents of lower dielectric constant, such as ethanol and acetic acid, they are not.

A second difficulty arises from consideration of allylic systems. Because the resulting cationic center is stabilized by interaction with the π electrons, allylic halides ionize readily to produce the delocalized allylic ion, 2. The free ion theory predicts that isomeric allylic halides that give the same intermediate upon ionization should yield a product distribution independent of the isomeric origin of the ion. Scheme 2 illustrates the argument. The prediction is sometimes, but

Table 5.1 PARTITION BETWEEN ELIMINATION AND SUBSTITUTION IN *t*-BUTYL-X SOLVOLYSIS

X in <i>t</i> -bu-X	Mole Percent Olefin		
	H ₂ O 75°C	C ₂ H ₅ OH 75°C	CH ₃ COOH 75°C
Cl	7.6	44.2	73
Br	6.6	36.0	69.5
I	6.0	32.3	—
S ⁺ (CH ₃) ₃ ClO ₄ ⁻	6.5	17.8	11.7

SOURCE: Reprinted with permission from M. Cocivera and S. Winstein, *J. Amer. Chem. Soc.*, 85, 1702 (1963). Copyright by the American Chemical Society.

⁸ For evidence that even benzhydryl systems may not always solvolyze by the limiting route, see D. J. McLennan and P. L. Martin, *Tetrahedron Lett.*, 4215 (1973).

⁹ See Chapter 7.

not always, verified in practice; there is a marked tendency in many systems to favor the unrearranged product.¹⁰

SCHEME 2

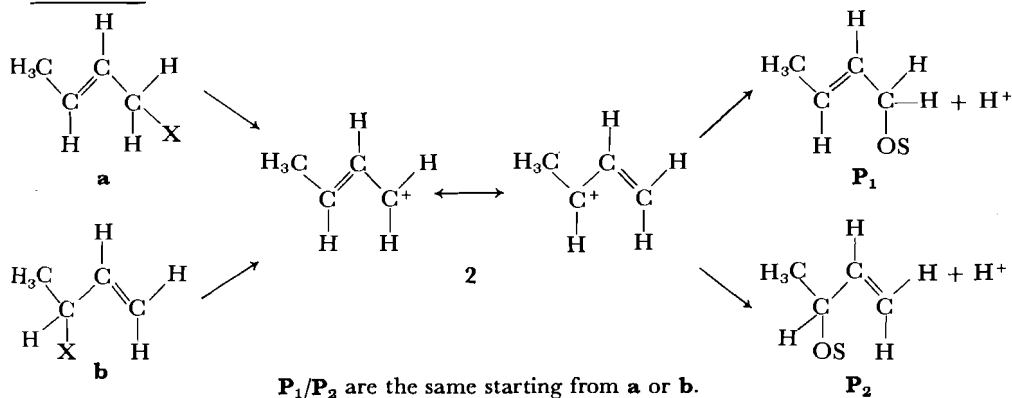

Finally, we note that although solvolysis products of chiral benzhydryl derivatives in good dissociating solvents are almost completely racemic, the situation is different for other systems classified by Ingold and Hughes as S_N1 . Ingold lists a number of these cases, and states the rule that "... mechanism S_N1 involves inversion of configuration mixed with racemization in any proportions to both limits. . ."¹¹ In view of more recent work discussed in Section 5.4, we would have to reclassify some of the " S_N1 " examples into a borderline category; nevertheless, the variety of stereochemical result of substitution through carbocations seems well established.¹²

The mechanistic hypothesis that explains the discrepancies we have described is the *ion pair*. In 1940 Hammett applied this idea to solvolysis in a form close to that now accepted.¹³ According to the ion-pair hypothesis, a dissociation of a covalent molecule RX should proceed through at least two stages: first, the ionization to an ion pair, in which the specific directed valence forces binding X to carbon are overcome and the Lewis acid R^+ and Lewis base X^- are left still close together and attracted by nondirectional ionic forces; and second, dissociation, in which the two ions separate.¹⁴

The ion-pair proposal is helpful in accounting for the experiments cited above.¹⁵ If the second step in a substitution (or elimination) takes place from the ion pair instead of from the free ion, the departing group will still be sufficiently closely associated with the carbocation to affect the partition between the two alternative pathways. Failure to find complete racemization is also reasonable, because the ion pair, in contrast to the free ion, is still chiral. Granted that it will racemize rapidly, the substitution may nevertheless occur before chirality is lost,

¹⁰ R. H. DeWolfe and W. G. Young, *Chem. Rev.*, **56**, 753 (1956), give an extensive table (pp. 794-796).

¹¹ C. K. Ingold, *Structure and Mechanism in Organic Chemistry*, pp. 521, 525.

¹² A. Streitwieser, *Solvolytic Displacement Reactions*, p. 59.

¹³ L. P. Hammett, *Physical Organic Chemistry*, 1st ed., McGraw-Hill, New York, 1940, pp. 171-173.

¹⁴ For a general discussion of ion pairs see (a) M. Szwarc, *Accts. Chem. Res.*, **2**, 87 (1969); (b) M. Szwarc, Ed., *Ions and Ion Pairs in Organic Reactions*, Vol. I, Wiley-Interscience, New York, 1972.

¹⁵ L. P. Hammett, *Physical Organic Chemistry*, 2nd ed., McGraw-Hill, New York, 1970, pp. 157-158.

Table 5.2 RATE PROCESSES IN SOLVOLYSIS REACTIONS

Reaction ^a	Rate Constant Notation
$\text{RX} + \text{SOH} \longrightarrow \text{ROS} + \text{HX}$	k_t
$d\text{-RX or } l\text{-RX} \longrightarrow \text{optically inactive products}$	k_a
$d\text{-RX or } l\text{-RX} \longrightarrow dl\text{-RX}$	k_{rao}
$\text{RX} + {}^*\text{X}^- \rightleftharpoons \text{R}-{}^*\text{X} + \text{X}^-$	k_{ex}
$\text{R}-\text{O}-\overset{\text{*O}}{\parallel}{\text{C}}-\text{Ar} \rightleftharpoons \text{R}-\text{*O}-\overset{\text{O}}{\parallel}{\text{C}}-\text{Ar}$	k_{eq}

^a * denotes isotopically labeled atom; *d*- or *l*- indicates a chiral and *dl*- a racemic substance.

and preference for backside attack (Chapter 4) means that net inversion will occur. Ion pairs in which the anion remains closer to the carbon to which it was originally attached could likewise accommodate the allylic product spread.

In Scheme 3 we modify the simple S_N1 mechanism to include the ion-pair idea. Change of substrate structure so as to make the carbocation less reactive,

SCHEME 3

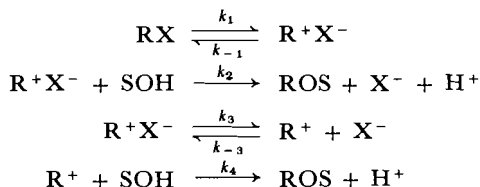

or change of the solvent so as to aid ion separation, will favor the dissociation step k_3 relative to direct reaction of the ion pair (k_2), and will give results more characteristic of the free ions. Elimination can occur in competition with substitution either at the ion-pair stage or at the free-ion stage.

Winstein and his research group elaborated the ion-pair mechanism in a series of experiments reported during the 1950s and 1960s.¹⁶ Several kinds of kinetic information about solvolysis reactions can be obtained in addition to the rate of product formation, k_t , determined by titration of acid formed. These various rates are summarized in Table 5.2. Winstein's group found that for substrates that have the leaving group bound to a chiral center, k_a frequently exceeds k_t by substantial factors.¹⁷ For example, with *p*-chlorobenzhydryl chloride in acetic acid, the ratio k_a/k_t is between 30 and 70, and is about 5 in aqueous acetone.¹⁸ The excess of rate of loss of optical activity, k_a , over rate of product formation, k_t , means that some process racemizes the substrate more rapidly than the substrate can form products. The observation that in these same systems k_a is also larger than k_{ex} rules out the possibility that racemization occurs

¹⁶ For a summary and complete references, see P. D. Bartlett, "The Scientific Work of Saul Winstein," *J. Amer. Chem. Soc.*, **94**, 2161 (1972).

¹⁷ (a) S. Winstein and D. Trifan, *J. Amer. Chem. Soc.*, **74**, 1154 (1952); (b) S. Winstein and K. C. Schreiber, *J. Amer. Chem. Soc.*, **74**, 2165 (1952).

¹⁸ S. Winstein, J. S. Gall, M. Hojo, and S. Smith, *J. Amer. Chem. Soc.*, **82**, 1010 (1960).

through free ions.¹⁹ If free ions were forming, the X^- anions would become equivalent to any other X^- ions present; if isotopically labeled $*X^-$ ions are added, the process shown in Equation 5.6 would have to occur. Since the experimental results show that racemization is faster than this process, there must be



present some intermediate or intermediates, presumably ion pairs, in which the C—X bond is broken, but in which the X^- ion is still closely associated with the particular C^+ ion to which it was bonded and to which it can return. It is important to note that formation of ion pairs and their return to the covalently bonded state does not give rise to the common ion rate depression.²⁰ As long as the X^- ion remains associated with a particular carbocation in the ion pair, it is part of a species chemically distinct from the free X^- ions.

Excess of rate of racemization over rate of product formation supports the idea of ion pairs that can return to substrate; nevertheless, as it is possible that some, or even most, of the ion pairs return without racemizing (Scheme 4), considerable doubt remains about k_i , the rate of formation of the ion pairs. The difficulty is that there is no way to detect the event represented by k_i if it is followed immediately by k_{-i} . We shall know that something has happened only when k_i is followed by k_r or by k_p . If k_{-i} competes with these processes, some ionization will go undetected.

SCHEME 4

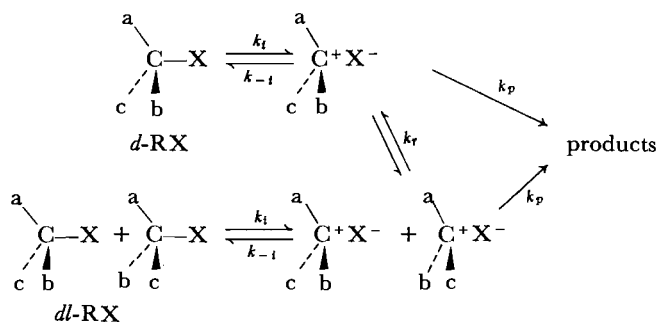

Goering and his collaborators developed a method for finding a better approximation to the ionization rate.²¹ Their technique uses as leaving group an aryl ester, usually a *p*-nitrobenzoate. Equation 5.7 illustrates that if one oxygen of the carboxyl group in the substrate is labeled, ionization and return to the covalent state may bring about equilibration of the label between the two oxygens. The structural change necessary to make the two oxygens equivalent

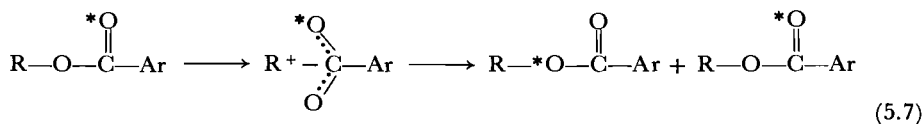

¹⁹ See note 18.

²⁰ S. Winstein, E. Clippinger, A. H. Fainberg, R. Heck, and G. C. Robinson, *J. Amer. Chem. Soc.*, **78**, 328 (1956).

²¹ (a) H. L. Goering, R. G. Briody, and J. F. Levy, *J. Amer. Chem. Soc.*, **85**, 3059 (1963); (b) H. L. Goering and H. Hopf, *J. Amer. Chem. Soc.*, **93**, 1224 (1971).

in the ion pair is undoubtedly less than that required for racemization (Scheme 4), where the cation must turn over. Indeed, in various substituted benzhydryl systems, racemization of unreacted substrate is slower than equilibration of the oxygens.²² The α -phenylethyl systems yield similar results.²³ Oxygen equilibration thus provides a more sensitive test for ionization followed by return than does loss of chirality. It should nevertheless be pointed out that even this technique is not definitive. It is still possible that, after the ionization but before the two oxygens become equivalent, there might be time for the oxygen originally bonded to carbon to return.

Allylic systems have also provided fertile ground for investigation of ion-pair phenomena. Young, Winstein, and Goering established the importance of ion pairs in solvolysis of these compounds. They showed that ion pairs are responsible for the rearrangement of α,α -dimethylallyl chloride to γ,γ -dimethylallyl chloride (Equation 5.8).²⁴ Goering's labeling methods have subsequently supplied a number of details about allylic ion-pair structure.²⁵

One further detail of the ion-pair mechanism remains. Winstein's work demonstrated that, in some systems at least, there is more than one kind of ion pair on the solvolysis pathway. The evidence originates mainly with the effect of added salts on rates. Nearby ions affect the free energy of an ion in solution; hence, a change in the concentration of dissolved salt will alter the rate of any elementary step in which ions form or are destroyed. For S_N1 solvolyses, the rate increases with addition of non-common ion salt. In the usual solvolysis solvents, for example acetic acid, aqueous acetone, and ethanol, the increase follows the linear Equation 5.8, where k_{salt} is the rate constant with added salt and k_0 is the rate constant in the absence of salt.²⁶

$$k_{\text{salt}} = k_0(1 + b[\text{salt}]) \quad (5.8)$$

Certain systems depart from this behavior. Addition of a low concentration of a non-common ion salt such as lithium perchlorate causes a large increase in k_t , but as more salt is added the increase levels off and finally parallels the expected linear relation. This special salt effect²⁷ is illustrated in Figure 5.1 for solvolysis of the rearranging system 3. Note that k_{α} exhibits only the normal linear salt

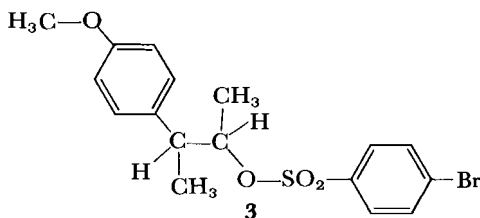

²² See note 21, p. 219.

²³ H. L. Goering, R. G. Briody, and G. Sandrock, *J. Amer. Chem. Soc.*, **92**, 7401 (1970).

²⁴ W. G. Young, S. Winstein, and H. L. Goering, *J. Amer. Chem. Soc.*, **73**, 1958 (1951).

²⁵ (a) H. L. Goering and E. C. Linsay, *J. Amer. Chem. Soc.*, **91**, 7435 (1969); (b) H. L. Goering, G. S. Koermer, and E. C. Linsay, *J. Amer. Chem. Soc.*, **93**, 1230 (1971); (c) H. L. Goering, M. M. Pombo, and K. D. McMichael, *J. Amer. Chem. Soc.*, **85**, 965 (1963).

²⁶ (a) A. H. Fainberg and S. Winstein, *J. Amer. Chem. Soc.*, **78**, 2763, 2780 (1956). Salt effects in nonpolar solvents such as ether are of dramatic magnitude, and follow a more complex relationship. See S. Winstein, E. C. Friedrich, and S. Smith, *J. Amer. Chem. Soc.*, **86**, 305 (1964). In water, the relationship is logarithmic. See note 13, Chapter 7. (b) C. L. Perrin and J. Pressing, *J. Amer. Chem. Soc.*, **93**, 5705 (1971) discuss the mechanism of the linear salt effect.

²⁷ S. Winstein and G. C. Robinson, *J. Amer. Chem. Soc.*, **80**, 169 (1958).

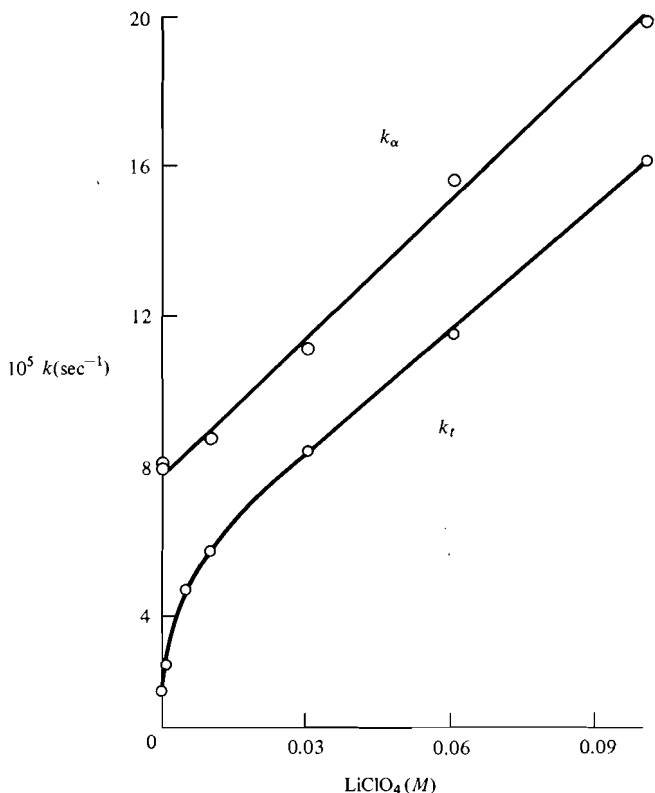
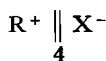

Figure 5.1 Effect of added LiClO_4 on k_α and k_t in solvolysis of *threo*-3-*p*-anisyl-2-butyl-*p*-bromobenzenesulfonate (**3**) in acetic acid. Reprinted with permission from S. Winstein and G. C. Robinson, *J. Amer. Chem. Soc.*, **80**, 169 (1958). Copyright by the American Chemical Society.

effect. A related phenomenon is the *induced common ion effect*. Addition of X^- ions to RX solvolysis in the presence of lithium perchlorate may partly cancel the special salt effect rate acceleration even though X^- ions do not depress the rate in the absence of the perchlorate.²⁸ These results require a second kind of ion pair, called a *solvent-separated* or *external ion pair* (**4**), in which a solvent molecule is between the two ions.



Scheme 5 depicts Winstein's complete solvolysis mechanism.²⁹ Ion-pair return can be from the intimate ion pair (*ion-pair return* or *internal return*), from the external ion pair (*external ion-pair return*), or from the free ions (*external ion return*). The term *external return* refers to the sum of external ion-pair return and external ion return. The special salt effect operates by diversion of the external ion pair, probably through the mechanism shown in Equation 5.9, so that it can no longer

²⁸ S. Winstein, P. E. Klinedinst, Jr., and G. C. Robinson, *J. Amer. Chem. Soc.*, **83**, 885 (1961).

²⁹ See note 27.

return to RX .³⁰ The net rate of disappearance of RX therefore increases more

SCHEME 5³¹

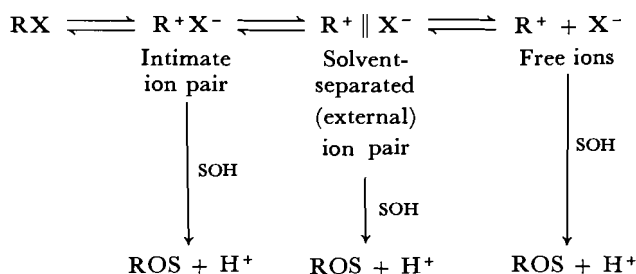

than it would if the new salt were exerting only the normal linear salt effect. Racemization and oxygen equilibration occur through the intimate ion pair and are not subject to the special salt effect.³² The origin of the induced common ion

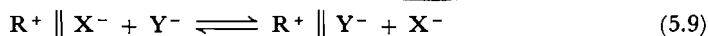

effect lies in the production through Equation 5.9 of free X^- ions; added X^- reverses 5.9 by the usual mass law mechanism, fewer ion pairs are diverted, more can return to RX , and part of the acceleration caused by Y^- is canceled. Benzhydryl systems show special salt effects with added azide through Equation 5.10; in this case the $R^+ \parallel N_3^-$ ion pair collapses to RN_3 , which is stable and accumulates as one of the products.³³

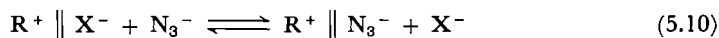

ulates as one of the products.³³

It should be pointed out that not all solvolyzing systems will exhibit the phenomena associated with Scheme 5; except for those systems that yield relatively stable carbocations, capture by the solvent at an early stage will preclude observation of some or all of these subtle effects.

5.2 LIMITING UNIMOLECULAR NUCLEOPHILIC REACTIONS. EFFECTS OF STRUCTURE AND SOLVENT

In the previous section we defined a limiting unimolecular substitution as one in which the leaving group departs with no assistance from solvent other than non-covalent solvation of the incipient ions. We shall return in Section 5.4 to the problem of how to decide experimentally whether a reaction is following the limiting pathway; here we want to look at predictions of the limiting S_N1 mechanism concerning the influence of structures and conditions on rates and on products.



³⁰ See note 28, p. 221.

³¹ Adapted with permission from S. Winstein and G. C. Robinson, *J. Amer. Chem. Soc.*, **80**, 175 (1958). Copyright by the American Chemical Society.

³² In certain favorable cases of rearranging systems, the occurrence of internal return distinct from external ion-pair return can be demonstrated without recourse to optical rotation or isotopic labeling experiments. See S. Winstein and A. H. Fainberg, *J. Amer. Chem. Soc.*, **80**, 459 (1958); S. Winstein, P. E. Klinedinst, Jr., and E. Clippinger, *J. Amer. Chem. Soc.*, **83**, 4986 (1961).

³³ See note 17(b), p. 218.

Table 5.3 RELATIVE REACTION RATES FOR SOME COMMON LEAVING GROUPS IN S_N1 REACTIONS^a

Group	Approximate k_X/k_{Br}	References
$-\text{OSO}_2\text{CF}_3$ ($-\text{OTf}$, triflate)	5×10^8	<i>b</i>
$-\text{OSO}_2$ -  -Br ($-\text{OBs}$, brosylate)	1.5×10^4	<i>c</i>
$-\text{OSO}_2$ -  -CH ₃ ($-\text{OTs}$, tosylate)	5×10^3	<i>b, c</i>
Br	1	<i>b</i>
Cl	2.5×10^{-2}	<i>b, d</i>
$-\text{O}-\overset{\text{O}}{\parallel}{\text{C}}-\text{C}_6\text{H}_4-\text{NO}_2$ ($-\text{OPNB}$)	2×10^{-6}	<i>e</i>

^a Relative rates are approximate because they are not independent of the structure of the rest of the solvolyzing molecule. All comparisons except $-\text{OBs}$ and $-\text{OPNB}$ are for bridgehead solvolyses. *p*-Bromobenzenesulfonate is compared with $-\text{OTs}$ for 3-anisyl-2-butyl; $-\text{OPNB}$ is compared with $-\text{Cl}$ for benzhydryl (data for chloride obtained by extrapolation).

^b R. C. Bingham and P. v. R. Schleyer, *J. Amer. Chem. Soc.*, **93**, 3189 (1971).

^c S. Winstein and G. C. Robinson, *J. Amer. Chem. Soc.*, **80**, 169 (1958).

^d L. C. Bateman, M. G. Church, E. D. Hughes, C. K. Ingold, and N. A. Taher, *J. Chem. Soc.*, 979 (1940).

^e H. L. Goering and H. Hopf, *J. Amer. Chem. Soc.*, **93**, 1224 (1971).

The Leaving Group

The simple S_N1 mechanism, without ion pairs, predicts that the leaving group should not affect the products; we have seen in the previous section how the presence of ion pairs modifies this anticipated behavior. Since the leaving group is involved in the rate-determining step, it should have an important influence on rate. The experimental results confirm this prediction.

We have considered in Section 4.3 (p. 192) the structural features that make a good leaving group for S_N2 substitutions; most of the same arguments hold for S_N1 reactions. For a substitution to follow the S_N1 path, it is generally necessary that X be one of the better leaving groups, for example a halide ion, a weakly basic oxyanion, or a neutral oxygen, nitrogen, or sulfur leaving group such as H_2O , N_2 , or SR_2 . Table 5.3 lists a few of the common anionic leaving groups with approximate relative reactivities. As the ratios are subject to changes with variation of solvent and substrate structure, these data have only qualitative significance. Comparison with Table 4.7 (p. 193) shows that the S_N1 rate is much more sensitive to the nature of the leaving group than is the S_N2 rate. ~~✱~~

H. M. R. Hoffmann investigated the variation in the tosylate to bromide

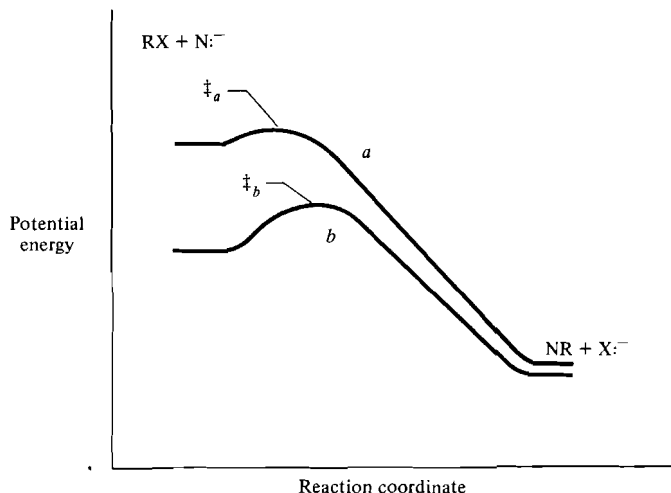

Figure 5.2 S_N2 reaction. Curve *a*: Good nucleophile causes rapid reaction; transition state is early, charge separation small. Curve *b*: Poor nucleophile results in slower reaction; transition state is later, charge separation large.

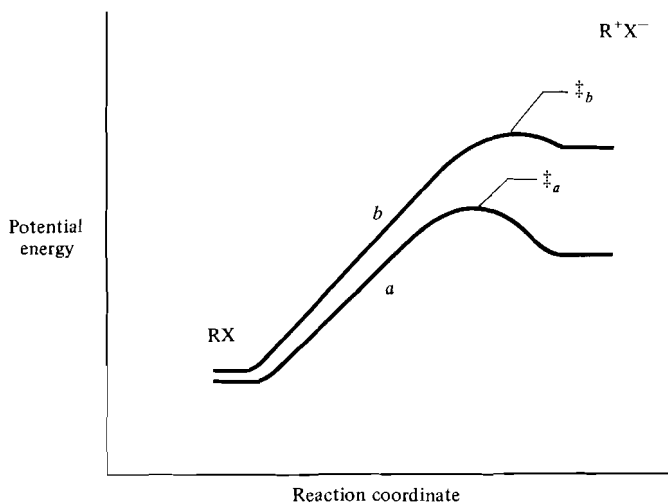

Figure 5.3 S_N1 reaction. Curve *a*: Stable ion gives rapid reaction; transition state is early, charge separation small. Curve *b*: High-energy ion causes less rapid reaction; transition state is late, charge separation large.

rate ratio (k_{OTs}/k_{Br}) and concluded that a large ratio is characteristic of a large degree of charge development on the leaving group in the transition state. (See the discussion for S_N2 reactions in Section 4.3, p. 192.) For solvolysis reactions in the absence of a strong nucleophile he found that the large ratios occurred with those substrate structures and solvents that had high reaction rates, and because he considered the cause of the difference between the two leaving groups to be the more effective negative charge stabilization in the larger arenesulfonate ion,

he stated that "the faster an S_N1 . . . reaction, the more ionic its transition state."³⁴

Since Hoffmann's work appeared, the k_{OTs}/k_{Br} ratio has come into use as one of the tools for measuring transition state charge separation. Nevertheless, we might profitably examine the argument more closely. In Figures 5.2 and 5.3 the Hammond postulate is the guide for constructing reaction coordinate diagrams of S_N2 and S_N1 pathways in which some feature of the substrate structure or (in the S_N2 case) entering group nucleophilicity causes a change of rate. As we have seen in Section 4.3, Hoffmann's proposal is in accord with the rationale provided by these diagrams for the S_N2 process (Figure 5.2): The reactions with better nucleophiles (curve *a*) are expected to have earlier transition states with less charge development on the leaving group; these are the cases with small k_{OTs}/k_{Br} ratios. The faster S_N1 reactions (Figure 5.3) should also be those with less charge development (curve *a*); experimentally, these are the ones with large k_{OTs}/k_{Br} ratios.

Using dependence of rate on solvent, a technique we discuss further in Section 5.4, Bingham and Schleyer were unable to detect any significant variation in transition state charge separation in a series of bridgehead derivatives of varying reactivity.³⁵ They also pointed out a difficulty arising from Hoffmann's having based his conclusions on data drawn from reactions of tertiary, secondary, and even primary substrates. Hoffmann had assumed that reactions carried out in solvents favorable to ion formation (such as water or formic acid) would be limiting S_N1 processes, and had concluded that the differences in k_{OTs}/k_{Br} that he observed with different substrates arose primarily from different amounts of charge separation at the transition state. It now appears that at least the primary substrates, and probably also the secondary ones, solvolyze with substantial assistance by nucleophilic attack of solvent. Bingham and Schleyer have proposed that the more bulky tosylate is subject to greater crowding in a tertiary substrate than is bromide, and that these steric effects are largely responsible for the variations in k_{OTs}/k_{Br} ratio.³⁶ Our conclusion is that, as a measure of transition state charge separation in limiting S_N1 reactions, the k_{OTs}/k_{Br} ratio is of little use. We shall return to the problem of location of the transition state along the reaction coordinate in Section 5.4.

An important neutral leaving group is N_2 . Diazotization of alkyl amines (Equation 5.11) leads to the unstable alkyl diazonium ions, which immediately lose nitrogen, leaving carbocations.

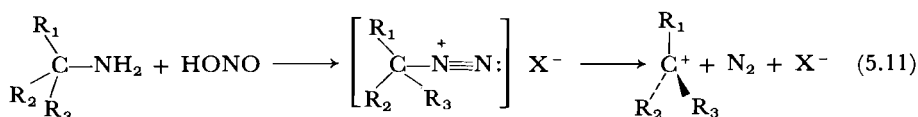

Interpretation of the reactions of these ions has proved difficult. Product distributions and stereochemistry differ from those typical of solvolysis;³⁷ the large energy

³⁴ H. M. R. Hoffmann, *J. Chem. Soc.*, 6753, 6762 (1965).

³⁵ R. C. Bingham and P. v. R. Schleyer, *J. Amer. Chem. Soc.*, **93**, 3189 (1971).

³⁶ See note 35 and J. Slutsky, R. C. Bingham, P. v. R. Schleyer, W. C. Dickason, and H. C. Brown, *J. Amer. Chem. Soc.*, **96**, 1969 (1974).

³⁷ For further discussion see Section 6.1.

Table 5.4 SOLVOLYSIS RATES OF ALKYL CHLORIDES^a

Compound	R = H	R = CH ₃	R = ϕ	$k_{\text{CH}_3}/k_{\text{H}}$	k_{ϕ}/k_{CH_3}
$\begin{array}{c} \text{CH}_3 \quad \text{R} \\ \diagdown \quad / \\ \text{C} \\ / \quad \diagdown \\ \text{CH}_3 \quad \text{Cl} \end{array}$	1.57×10^{-6}	0.086	394	55,000	4580
$\begin{array}{c} \text{CH}_3 \quad \text{R} \\ \diagdown \quad / \\ \text{C} \\ / \quad \diagdown \\ \phi \quad \text{Cl} \end{array}$	0.216	394	19,900	1,800	50
$\begin{array}{c} \phi \quad \text{R} \\ \diagdown \quad / \\ \text{C} \\ / \quad \diagdown \\ \phi \quad \text{Cl} \end{array}$	575	19,900	578,000	34.6	29

SOURCE: Reprinted with permission from H. C. Brown and M. Rei, *J. Amer. Chem. Soc.*, **86**, 5008 (1964). Copyright by the American Chemical Society.

^a First-order rate constants, corrected to 25°C in ethanol, $10^8 \times \text{sec}^{-1}$.

release that attends loss of the stable N₂ molecule may leave the ion in a vibrationally excited state (the *hot ion* theory),³⁸ or some products may arise from the diazonium ion directly.³⁹ It is also likely that ion-pair phenomena play an important role.⁴⁰ Collins⁴¹ and Moss⁴² have reviewed aspects of the subject, and Friedman⁴³ has discussed it at length. The field is one with much room for further investigation.

The Substrate

In an S_N1 reaction the low-energy substrate ionizes to the high-energy ion pair. The Hammond postulate predicts that the transition state should resemble the ion pair (see Figure 5.3); hence any structural change that lowers the carbocation energy should lower transition state energy and increase reaction rate. The evidence provides unequivocal confirmation of this prediction. Schleyer and co-workers⁴⁴ estimate that for limiting S_N1 reactions, with no assistance to ionization by nucleophiles, the substitution of H by CH₃ on the reacting carbon accelerates the rate by a factor of 10⁸, a difference in activation energy of about 11 kcal mole⁻¹. Other data of a similar sort, but subject to uncertainty because of uncertain mechanisms, are given by Brown and Rei.⁴⁵ Some of this information is reproduced in Table 5.4. The differences are not as large as that given by Schleyer, because reactions of secondary substrates are being accelerated by nucleophilic attack of solvent; nevertheless, the trends are clear.

³⁸ D. Semenow, C.-H. Shih, and W. G. Young, *J. Amer. Chem. Soc.*, **80**, 5472 (1958).

³⁹ (a) A. Streitwieser, Jr. and W. D. Schaeffer, *J. Amer. Chem. Soc.*, **79**, 2888 (1957); (b) A. Streitwieser, Jr., *J. Org. Chem.*, **22**, 861 (1957).

⁴⁰ C. J. Collins, *Accts. Chem. Res.*, **4**, 315 (1971).

⁴¹ See note 40.

⁴² R. A. Moss, *Chem. & Eng. News*, **49**, No. 48, p. 28 (1971).

⁴³ L. Friedman, in *Carbonium Ions*, G. A. Olah and P. v. R. Schleyer, Eds., Wiley-Interscience, New York, 1970, Vol. II, p. 655.

⁴⁴ J. L. Fry, E. M. Engler, and P. v. R. Schleyer, *J. Amer. Chem. Soc.*, **94**, 4628 (1972).

⁴⁵ (a) H. C. Brown and M. Rei, *J. Amer. Chem. Soc.*, **86**, 5008 (1964); (b) See also G. A. Olah, P. W. Westerman, and J. Nishimura, *J. Amer. Chem. Soc.*, **96**, 3548 (1974).

Whereas substitution of hydrogen directly attached to the cationic center by alkyl or aryl has a large stabilizing effect, substituents at more remote positions are more subtle in their influence. We might expect, on the basis of the ability of alkyl groups to stabilize charge, that cation **6** should be more stable than cation **5**. This prediction is indeed correct for the isolated ions in the gas phase. In



solution the order is reversed, and **5** is more stable.⁴⁶

Arnett has observed that heats of reaction for carbocation formation in highly acidic media (Equation 5.12) correlate well with solvolysis rates.⁴⁷ This

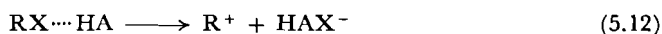

result supports the idea that ion and solvolysis transition state are closely related structurally, and that we can safely use ideas about ion stability to predict solvolysis rates and vice versa.

When atoms with unshared pairs of electrons are bonded to the reaction center, two effects must be considered: the inductive effect, which is usually electron-withdrawing, and the electron-donating conjugative effect (7). For the more basic atoms, O, N, S, conjugation is dominant, as the relative solvolysis

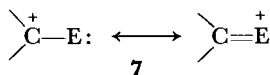

rates of **8** and **9** show. Insulation from the conjugative influence by one CH_2

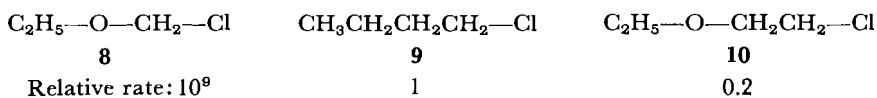

group (**10**) leaves the inductive effect to cause a rate depression.⁴⁸ Mechanisms are unlikely to be limiting in **9** and **10**, but should be more nearly so in **8**; the relative rates therefore probably have only qualitative significance. With α -halogens, the two effects are more nearly balanced. Fluorine is highly electronegative and decreases the rate slightly despite its unshared electrons; chlorine and bromine increase rates, but much less than does oxygen (k_X/k_H ratios 10 to 500), presumably because of the less effective overlap with carbon of the large $3p$ or $4p$ orbitals that contain the unshared pairs in these atoms.⁴⁹ Chemical shifts in ^{13}C nuclear magnetic resonance spectra independently demonstrate the decreasing effectiveness of donation of electron density by conjugation to an adjacent positive carbon in the order $\text{F} > \text{Cl} > \text{Br}$.⁵⁰

Another important consequence of structural change, first observed and

⁴⁶ J. W. Larsen, P. A. Bouis, M. W. Grant, and C. A. Lane, *J. Amer. Chem. Soc.*, **93**, 2067 (1971).

⁴⁷ E. M. Arnett and J. W. Larsen, in *Carbonium Ions*, G. A. Olah and P. v. R. Schleyer, Eds., Vol. I, p. 441.

⁴⁸ A. Streitwieser, Jr., *Solvolytic Displacement Reactions*, pp. 102-103.

⁴⁹ See note 48.

⁵⁰ G. A. Olah, Y. K. Mo, and Y. Halpern, *J. Amer. Chem. Soc.*, **94**, 3551 (1972).

Table 5.5 APPROXIMATE SOLVOLYSIS RATES OF BRIDGEHEAD SYSTEMS RELATIVE TO *t*-BUTYL

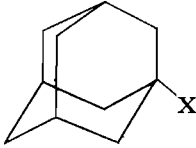
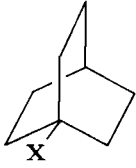
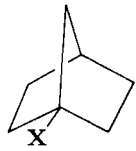
Structure	Relative Rate ^a
$(\text{CH}_3)_3\text{C}-\text{X}$	1
	10^{-3}
	10^{-7}
	10^{-13}

^a Calculated for tosylates in acetic acid at 70°C using data of R. C. Bingham and P. v. R. Schleyer, *J. Amer. Chem. Soc.*, **93**, 3189 (1971) and of E. Grunwald and S. Winstein, *J. Amer. Chem. Soc.*, **70**, 846 (1948).

explained by Bartlett and Knox for the apocamphyl system (**11**), is the resistance to cation formation at a bridgehead position.⁵¹ Table 5.5 lists approximate

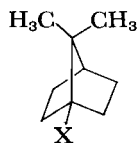
**11**

rates for some bridgehead systems relative to *t*-butyl. A carbocation should prefer to be planar, and planarity in these structures entails a large increase in ring strain. The systems with the greatest strain increase upon passing from ground state to transition state react slowest. Reaction rates and calculated strain energies correlate well.⁵²

The bridgehead ions, even though they cannot achieve a coplanar geometry, are nevertheless stabilized by hyperconjugative electron donation from attached groups. In bridgehead systems, the conformation is fixed by the rings, and the transition state for S_N1 solvolysis is usually **12**. The numbering in **12** is keyed to the

⁵¹ P. D. Bartlett and L. H. Knox, *J. Amer. Chem. Soc.*, **61**, 3184 (1939).

⁵² See note 35, p. 225.

1-adamantyl cation (**13**), a typical bridgehead ion. The carbon C₃ is in the trans

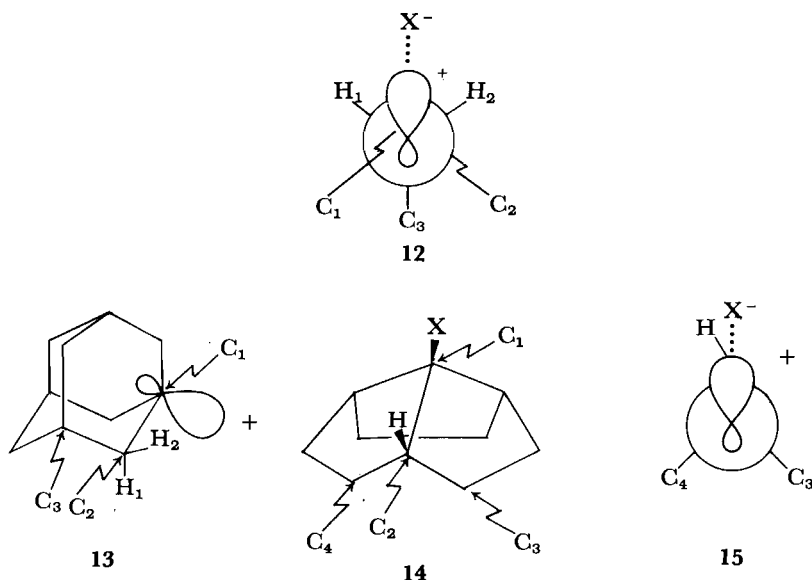

periplanar position with respect to the leaving group. The system **14**, which solvolyzes at roughly 3×10^{-5} times the rate of 1-adamantyl (**13**), has the conformation **15**, with a cis periplanar hydrogen and no trans periplanar group. It thus appears that hyperconjugative electron donation occurs more readily at the back of an incipient electron-deficient center than at the front,⁵³ just as in S_N2 substitutions attack by nucleophile from the side opposite the departing group is more favorable than attack from the same side.

The influence of electron-donating and -withdrawing groups can best be studied by use of the Hammett and Taft linear free-energy relationships, which were discussed in Chapter 2 (p. 60). Studies in the bridgehead bicyclo-[2.2.2]octyl (**16**) and adamantyl (**17**) series have been carried out by Schleyer and Woodworth.⁵⁴ Correlations with the Taft inductive $\sigma^*_{\text{CH}_2}$ parameter had the negative slope expected for a reaction accelerated by electron-donating groups. The electron-donating inductive effect of the alkyl groups increases along the

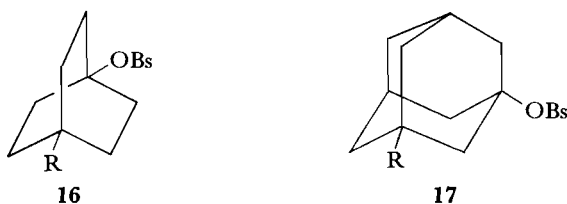

series methyl < ethyl < isopropyl < *t*-butyl. The rate differences on which this order is based are small, a factor of 2 between methyl and *t*-butyl in **16** and of 3 in **17**. The position of hydrogen in the series is different in **16** and **17**; this fact, and

⁵³ See note 35, and W. Parker, R. L. Tranter, C. I. F. Watt, L. W. K. Chang, and P. v. R. Schleyer, *J. Amer. Chem. Soc.*, **96**, 7121 (1974).

⁵⁴ P. v. R. Schleyer and C. W. Woodworth, *J. Amer. Chem. Soc.*, **90**, 6528 (1968).

the small rate differences, make it unclear whether alkyl groups are electron-donating or -withdrawing compared to hydrogen in these compounds.

The Hammett σ - ρ correlation has proved useful in studying substituent effects of aryl-substituted systems.⁵⁵ In Section 6.1 we consider applications of this linear free-energy relationship to solvolysis with rearrangement.

Isotopic substitution will also affect rates.⁵⁶ Most of the isotope effects observed in S_N1 substitutions are for H-D substitution; the isotopically substituted bond is not broken in the reaction, and the observed secondary isotope effect ratios (Section 2.7, p. 109) k_H/k_D are less than 1.5. Substitution of H by D on the carbon to which the leaving group is attached leads to the α -isotope effect, with k_H/k_D ratios of between 1.22 and 1.25 for systems with sulfonate leaving groups which appear to react by a limiting S_N1 mechanism, and somewhat lower (Cl \approx 1.15, Br \approx 1.13) for limiting reactions with halide leaving groups.⁵⁷ As we have seen in Section 2.7, the origin of the rate change is in the out of plane bending vibration, which decreases in frequency on going from the sp^3 -hybridized starting material to the transition state, where hybridization is approaching sp^2 . The presence of the leaving group and an entering nucleophile nearby stiffens the bond and makes the frequency change smaller; hence S_N2 reactions show little or no rate change on isotopic substitution. The α -isotope effect is thus a measure of the degree of participation by nucleophile at the transition state.⁵⁸ Substitution of D for H at the β -carbon produces effects typically around k_H/k_D 1.07 per deuterium, but as high as 1.44 for favorable conformations. These effects are thought to reflect delocalization of the positive charge to the $\beta=C-H$ bonds, a point we shall consider further in Section 10.2, and thus to measure the degree of charge development at the transition state.⁵⁹ This interpretation has, however, been questioned.⁶⁰

The Entering Group

The limiting S_N1 mechanism predicts that an added nucleophile, unless it is the common ion, will have no effect on reaction rate. We have seen in Section 5.1 how the inclusion in the mechanism of ion pairs accounts for the observed deviations from this principle; the point of interest here is the product distribution obtained when more than one nucleophile is present.

If none of the products re-ionize to a detectable extent during the time the system is under observation, their relative amounts will be kinetically controlled

⁵⁵ (a) A. Streitwieser, Jr., H. A. Hammond, R. H. Jagow, R. M. Williams, R. G. Jesaitis, C. J. Chang, and R. Wolf, *J. Amer. Chem. Soc.*, **92**, 5141 (1970); (b) Streitwieser, *Solvolytic Displacement Reactions*, pp. 179-180.

⁵⁶ For discussions see: (a) H. Simon and D. Palm, *Angew. Chem. Int. Ed.*, **5**, 920 (1966); (b) A. Streitwieser, *Solvolytic Displacement Reactions*, pp. 172-174 (α effects); pp. 98-101 (β effects).

⁵⁷ (a) J. M. Harris, R. E. Hall, and P. v. R. Schleyer, *J. Amer. Chem. Soc.*, **93**, 2551 (1971); (b) V. J. Shiner, Jr., and R. D. Fisher, *J. Amer. Chem. Soc.*, **93**, 2553 (1971); (c) T. W. Bentley, S. H. Liggero, M. A. Imhoff, and P. v. R. Schleyer, *J. Amer. Chem. Soc.*, **96**, 1970 (1974); (d) E. A. Halevi, *Prog. Phys. Org. Chem.*, **1**, 109 (1963); (e) V. J. Shiner, Jr., W. E. Buddenbaum, B. L. Murr, and G. Lamaty, *J. Amer. Chem. Soc.*, **90**, 418 (1968); (f) A. Streitwieser, Jr. and G. A. Dafforn, *Tetrahedron Lett.*, 1263 (1969); (g) G. A. Dafforn and A. Streitwieser, Jr., *Tetrahedron Lett.*, 3159 (1970).

⁵⁸ See note 56.

⁵⁹ See note 56 and (a) V. J. Shiner, Jr., *J. Amer. Chem. Soc.*, **82**, 2655 (1960); (b) V. J. Shiner and J. G. Jewett, *J. Amer. Chem. Soc.*, **86**, 945 (1964).

⁶⁰ L. S. Bartell, *Tetrahedron Lett.*, No. 6, 13 (1960).

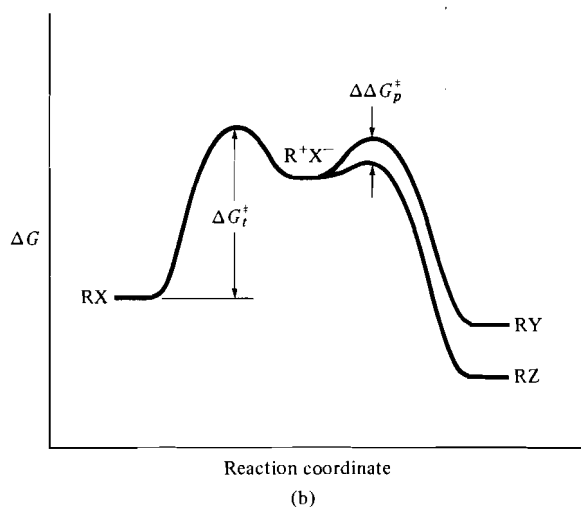
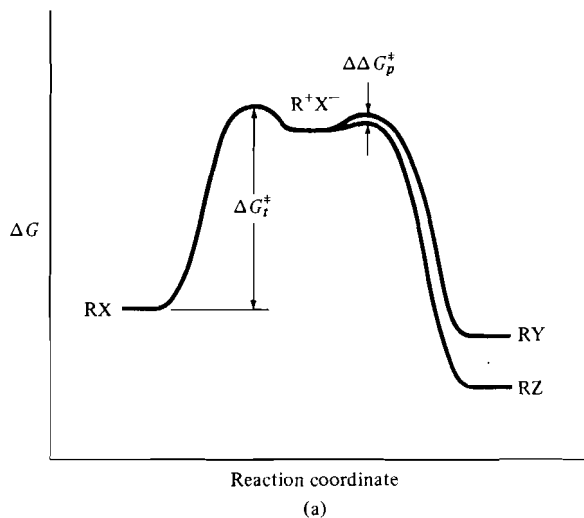

Figure 5.4 (a) A slow ionization (large ΔG_i^\ddagger) yields a high-energy intermediate which is relatively unselective (small $\Delta\Delta G_p^\ddagger$) and reacts with Y and Z at nearly equal rates. (b) Rapid ionization (small ΔG_i^\ddagger) produces a more stable intermediate which is more discriminating (large $\Delta\Delta G_p^\ddagger$) and favors combination with Z strongly over Y.

and will be in direct proportion to the relative rates of reaction of the intermediate with the different nucleophiles. On the basis of the Hammond postulate, we anticipate that a highly reactive intermediate, facing low activation barriers, will find small differences between various paths and will be relatively nondiscriminating in its choice of reaction partner; whereas a less reactive one, confronted with higher barriers, will encounter larger differences and be more particular. When coupled with the expectation that a less reactive ion forms faster, this principle predicts a correlation between solvolysis rate and selectivity for S_N1 processes. Figure 5.4 illustrates the reasoning and Figure 5.5 presents the experimental

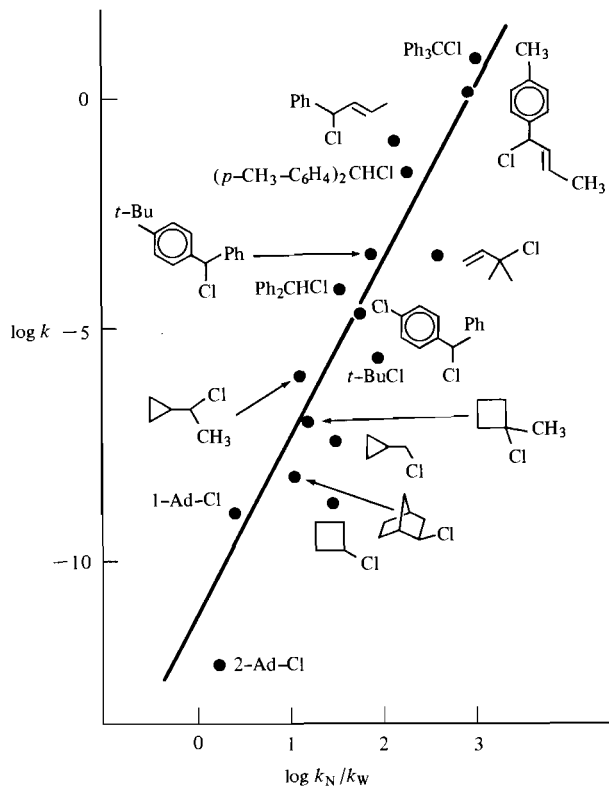

Figure 5.5 Correlation between stability, measured by solvolysis rate in 80 percent aqueous acetone, and selectivity, determined by relative rate of reaction with azide ion (k_N) and water (k_W), for carbocations derived from alkyl chlorides. Reprinted with permission from D. J. Raber, J. M. Harris, R. E. Hall, and P. v. R. Schleyer, *J. Amer. Chem. Soc.*, **93**, 4821 (1971). Copyright by the American Chemical Society.

evidence.⁶¹ Caution is necessary in using this argument, because solvation has not been taken into account.

The Solvent

The solvent is a component of critical importance in S_N1 reactions. A high dielectric constant favors charge separation; ability to solvate ions is also essential for rapid reaction. The nucleophilicity, on the other hand, should not affect a limiting S_N1 process. Grunwald and Winstein developed a linear free-energy relation (Equation 5.13) for solvent ionizing power, defined in terms of the solvolysis rate of *t*-butyl chloride, a system assumed to react by a limiting mechanism.⁶² In Equation 5.13, k_S is the solvolysis rate in the solvent S; $k_{80\% \text{ EtOH}}$ is

$$\log \frac{k_S}{k_{80\% \text{ EtOH}}} = mY \quad (5.13)$$

⁶¹ D. J. Raber, J. M. Harris, R. E. Hall, and P. v. R. Schleyer, *J. Amer. Chem. Soc.*, **93**, 4821 (1971).

⁶² E. Grunwald and S. Winstein, *J. Amer. Chem. Soc.*, **70**, 846 (1948); a compilation of Y values may be found in A. H. Fainberg and S. Winstein, *J. Amer. Chem. Soc.*, **78**, 2770 (1956).

the rate in the standard solvent, 80 percent aqueous ethanol; m measures the sensitivity of the particular system to solvent change; and Y is the ionizing power of solvent S , determined from t -butyl chloride solvolysis rates by defining $m = 1$ for this substrate.

In addition to allowing comparison among experiments carried out in different solvents, the m - Y system serves as an important tool for study of mechanism. Sensitivity to ionizing power, measured by m , is an index of the degree of charge separation at the transition state. The ratio of rates in two solvents of equal Y but different nucleophilicity provides evidence about nucleophilic assistance by a solvent molecule during the ionization.

Other solvent parameters based on the influence of solvent on electronic excitation energies have been developed by Kosower;⁶³ Smith, Fainberg, and Winstein;⁶⁴ and Dimroth and co-workers.⁶⁵

Despite its usefulness, the Y parameter system is not without flaw. Like most linear free-energy correlations, it fails if rigorously applied to compounds of diverse structural types. Thus when a given substrate is studied in different solvent systems (for example acetone-water, ethanol-water, acetic acid-formic acid), slightly different slopes m are obtained.⁶⁶

5.3 CARBOCATIONS

The chemistry of carbocations has been intensively studied, and the literature is vast. We can do no more here than summarize some of the important features of the field. A comprehensive review in four volumes covers the area in detail.⁶⁷

The nomenclature of positive carbon ions in general use up to the 1970s is not consistent with the naming of other types of positive ions. We follow Olah's suggestions in using the term *carbocation* in place of the formerly used *carbonium ion* as the generic name for ions with positive charge on carbon.⁶⁸ There are two types of carbocation: the *carbenium* ions, in which the positive carbon has coordination number 3, as in trimethylcarbenium ion (t -butyl cation) (18); and

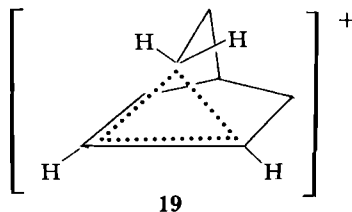
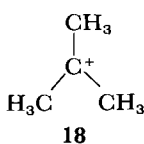

⁶³ (a) E. M. Kosower, *J. Amer. Chem. Soc.*, **80**, 3253, 3261, 3267 (1958); (b) E. M. Kosower, *An Introduction to Physical Organic Chemistry*, Wiley, New York, 1968, p. 295; solvation is discussed in detail beginning on p. 260.

⁶⁴ S. G. Smith, A. H. Fainberg, and S. Winstein, *J. Amer. Chem. Soc.*, **83**, 618 (1961).

⁶⁵ K. Dimroth, C. Reichardt, T. Siepmann, and F. Bohlmann, *Justus Liebigs Ann. Chem.*, **661**, 1 (1963).

⁶⁶ A. H. Fainberg and S. Winstein, *J. Amer. Chem. Soc.*, **79**, 1597, 1602, 1608 (1957).

⁶⁷ (a) G. A. Olah and P. v. R. Schleyer, Eds., *Carbonium Ions*, Wiley-Interscience, New York, Vol. I, 1968; Vol. II, 1970; Vol. III, 1972; Vol. IV, 1973. Other reviews: (b) D. Bethell and V. Gold, *Carbonium Ions*, Academic Press, London, 1967; (c) N. C. Deno, *Prog. Phys. Org. Chem.*, **2**, 129 (1964).

⁶⁸ G. A. Olah, *J. Amer. Chem. Soc.*, **94**, 808 (1972).

the *carbonium* ions, in which the positive carbon or carbons has coordination number 4 or 5, as in the bridged structure 19. The former structures, for many years designated *classical* ions, have ordinary two-electron bonds; the latter, known earlier as *nonclassical* ions, have a three-center, two-electron bond.⁶⁹ Carbenium ions derived from alkenes by protonation may also be called *alkenium* ions.

The Existence of Carbocations

Most carbocations are too reactive to be directly observable in ordinary solvents, and until relatively recently evidence has been obtained indirectly, primarily through the study of reaction kinetics and trapping processes, experiments discussed in Sections 5.1, 5.2, and 5.4. Nevertheless, a few types of compounds have long been known to produce observable concentrations of positive ions relatively easily. The triarylmethyl derivatives were the first of this type to be investigated; the halides ionize readily in non-nucleophilic solvents such as sulfur dioxide,⁷⁰ and the alcohols yield solutions of the ions in concentrated sulfuric acid. Early observations by the freezing-point depression technique (see Section 3.2, p. 130) established that each mole of triphenyl carbinol yields 4 moles of ions in sulfuric acid, the reaction presumably being by way of Equation 5.14.⁷¹ Results in methane-sulfonic acid are similar.⁷²

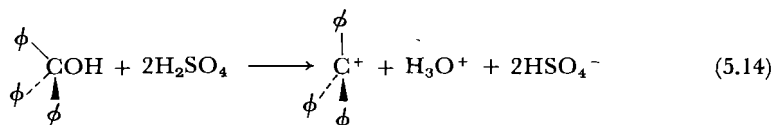

The cryoscopic method is also applicable to other triarylmethyl systems, to some diarylmethyl and allylic ions, and, when ortho substituents are present, to aryl acylium ions (20) (Equation 5.15);⁷³ unfortunately, side reactions frustrate most attempts to generate carbocations in sulfuric acid.

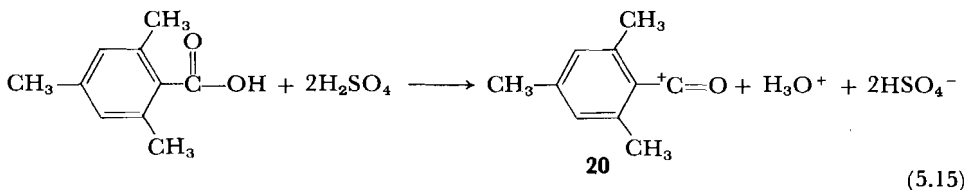

More recently, development of the superacid solvent systems has permitted the preparation at low temperature of stable solutions of carbocations of many structural types. The solvents ordinarily used consist of the strong Lewis acid antimony pentafluoride with or without an added protonic acid, usually hydro-

⁶⁹ See note 68.

⁷⁰ N. N. Lichtin, *Prog. Phys. Org. Chem.*, **1**, 75 (1963).

⁷¹ (a) A. Hantzsch, *Z. Physik. Chem.*, **61**, 257 (1907); (b) L. P. Hammett and A. J. Deyrup, *J. Amer. Chem. Soc.*, **55**, 1900 (1933).

⁷² R. A. Craig, A. B. Garrett, and M. S. Newman, *J. Amer. Chem. Soc.*, **72**, 163 (1950).

⁷³ (a) H. P. Treffers and L. P. Hammett, *J. Amer. Chem. Soc.*, **59**, 1708 (1937); (b) M. S. Newman and N. C. Deno, *J. Amer. Chem. Soc.*, **73**, 3644 (1951); (c) N. C. Deno, H. G. Richey, Jr., J. D. Hodge, and M. J. Wisotsky, *J. Amer. Chem. Soc.*, **84**, 1498 (1962).

fluoric or fluorosulfuric acid. A substance of very low basicity such as SO_2 , SO_2ClF , or SO_2F_2 serves as diluent when required. As we have seen in Section 3.2 (p. 134), these solvent systems are considerably more acidic than concentrated sulfuric acid as measured by the H_0 acidity function.⁷⁴ Olah and his co-workers have made extensive contributions to this field.⁷⁵ The ready availability of solutions of many types of carbocations has made possible spectroscopic observations of a greatly expanded variety of structures. Nuclear magnetic resonance, both proton and ^{13}C , has been fruitful and has yielded information not only about structure but also about rearrangement processes; other methods, particularly infrared and Raman spectroscopy, have proved informative as well. X-Ray photoelectron spectroscopy (electron spectroscopy for chemical analysis, ESCA), which measures binding energies of $1s$ electrons of the carbon atoms, yields information about delocalization of charge within the ion.⁷⁶

Structures of Carbocations

The salient feature of the structure of the carbenium ions is their preference for coplanarity of the cationic carbon and the three attached atoms. Structural theory in its simplest form, the principle of minimum electron-pair interaction (see Section 1.1, p. 8), predicts a planar sp^2 hybridized structure. Analogy with the boranes is in agreement: Planar⁷⁷ $(\text{CH}_3)_3\text{B}$ is isoelectronic with $(\text{CH}_3)_3\text{C}^+$, which ought therefore to be planar also. More sophisticated theoretical computations agree with these simple arguments.⁷⁸ We have seen in Section 5.2 that the indirect evidence from rates of formation of bridgehead ions supports the idea of preferred planarity. Spectroscopic investigation of ions in strong acid solutions furnishes more direct evidence. Olah and his collaborators have recorded the infrared and Raman spectra of $(\text{CH}_3)_3\text{C}^+$; the close similarity to spectra of $(\text{CH}_3)_3\text{B}$ confirms planarity of the ion.⁷⁹

In allylic systems, favorable overlap of the p orbitals of the π system should require a coplanar arrangement of the three sp^2 carbons and their five substituent atoms; evidence that such a structure is indeed preferred comes, for example, from proton magnetic resonance observations that demonstrate barriers to bond rotation in the isomeric dimethylallyl ions **21**, **22**, and **23**. These ions form stereospecifically from the three dimethylcyclopropyl chlorides (Section 12.2), and barriers to rotation about the partial double bonds are sufficiently high to prevent interconversion at low temperature. At -10°C , **21**, the least stable isomer,

⁷⁴ R. J. Gillespie and T. E. Peel, *Advan. Phys. Org. Chem.*, **9**, 1 (1971). See Figure 3.3, p. 136.

⁷⁵ For reviews see (a) G. A. Olah and J. A. Olah in *Carbonium Ions*, Olah and Schleyer, Eds., Vol. II, p. 715; (b) R. J. Gillespie, *Accts. Chem. Res.*, **1**, 202 (1968).

⁷⁶ See the following reviews in Olah and Schleyer, Eds., *Carbonium Ions*, Vol. I: (a) electronic spectra, G. A. Olah, C. U. Pittman, Jr., and M. C. R. Symons, p. 153; (b) vibrational spectra, J. C. Evans, p. 223; (c) NMR spectra, G. K. Fraenkel and D. G. Farnum, p. 237; a review of applications of all the spectroscopic techniques to carbocation structures and reactions is (d) G. A. Olah, *Angew. Chem. Int. Ed.*, **12**, 173 (1973).

⁷⁷ H. A. Levy and L. O. Brockway, *J. Amer. Chem. Soc.*, **59**, 2085 (1937).

⁷⁸ See, for example: (a) J. E. Williams, Jr., R. Sustmann, L. C. Allen, and P. v. R. Schleyer, *J. Amer. Chem. Soc.*, **91**, 1037 (1969); (b) L. Radom, J. A. Pople, V. Buss, and P. v. R. Schleyer, *J. Amer. Chem. Soc.*, **94**, 311 (1972); (c) L. Radom, P. C. Hariharan, J. A. Pople, and P. v. R. Schleyer, *J. Amer. Chem. Soc.*, **95**, 6531 (1973); for a review, see (d) V. Buss, P. v. R. Schleyer, and L. C. Allen, *Top. Stereochem.*, **7**, 253 (1973).

⁷⁹ G. A. Olah, J. R. DeMember, A. Commeyras, and J. L. Briles, *J. Amer. Chem. Soc.*, **93**, 459 (1971).

changes with a half-life of about 10 min to the more stable *cis,trans* isomer, **22**, and this in turn at +35°C converts to **23**.⁸⁰

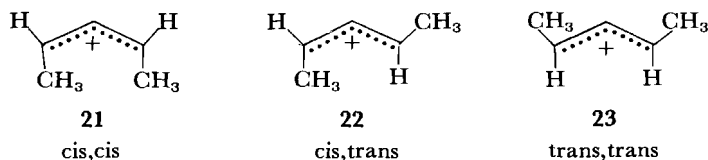

Similar considerations might be expected to apply to the triarylmethyl ions. The most favorable charge delocalization would be obtained if the rings were all coplanar. But inspection of a model shows that a completely planar triphenylmethyl ion can be made only at the expense of unacceptable crowding of the ortho hydrogens.⁸¹ Triphenylmethyl ions are sufficiently stable to be isolated as salts in the crystalline state. In the solid perchlorate, the actual structure, although coplanar about the central cationic carbon, has the rings twisted out of this plane by an angle of about 32°. ⁸² In solution, nuclear magnetic resonance evidence, obtained with ring-fluorinated derivatives, suggests a similar structure, with a barrier to rotation of all three rings to the enantiomeric conformation (**24** \rightleftharpoons **25**) of about 9 kcal mole⁻¹.⁸³

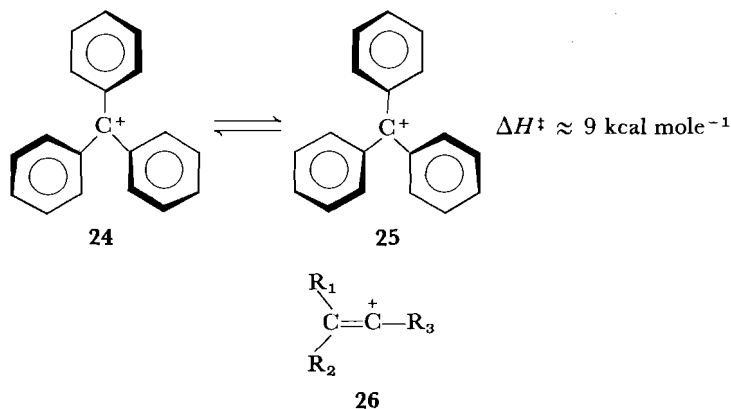

Carbocations with trivalent carbon may have carbon with coordination number 2. Acyl ions have already been mentioned; the vinyl cations, or carbynium ions (**26**), have been detected as intermediates in addition of electrophiles to acetylenes and allenes and in solvolysis reactions with the highly reactive trifluoromethanesulfonate (triflate) leaving group.⁸⁴ Vinyl cations are expected

⁸⁰ P. v. R. Schleyer, T. M. Su, M. Saunders, and J. C. Rosenfeld, *J. Amer. Chem. Soc.*, **91**, 5174 (1969).

⁸¹ G. N. Lewis and M. Calvin, *Chem. Rev.*, **25**, 273 (1939).

⁸² A. H. Gomes de Mesquita, C. H. MacGillavry, and K. Eriks, *Acta Cryst.*, **18**, 437 (1965).

⁸³ I. I. Schuster, A. K. Colter, and R. J. Kurland, *J. Amer. Chem. Soc.*, **90**, 4679 (1968).

⁸⁴ (a) P. J. Stang and R. Summerville, *J. Amer. Chem. Soc.*, **91**, 4600 (1969); (b) R. H. Summerville and P. v. R. Schleyer, *J. Amer. Chem. Soc.*, **94**, 3629 (1972); (c) T. C. Clarke, D. R. Kelsey, and R. G. Bergman, *J. Amer. Chem. Soc.*, **94**, 3626 (1972); (d) T. C. Clarke and R. G. Bergman, *J. Amer. Chem. Soc.*, **94**, 3627 (1972); (e) R. H. Summerville, C. A. Senkler, P. v. R. Schleyer, T. E. Dueber, and P. J. Stang, *J. Amer. Chem. Soc.*, **96**, 1100 (1974); (f) R. H. Summerville and P. v. R. Schleyer, *J. Amer. Chem. Soc.*, **96**, 1110 (1974). For reviews, see: (g) G. Modena and U. Tonellato, *Advan. Phys. Org. Chem.*, **9**, 185 (1971); (h) M. Hanack, *Accts. Chem. Res.*, **3**, 209 (1970).

on the basis of detailed molecular orbital calculations to be linear if R_1 and R_2 are the same,⁸⁵ but will probably not be exactly linear if $R_1 \neq R_2$.⁸⁶

When the electrons of a bond within the ion but removed from the site of binding of the leaving group interact with the charged center, the charge is distributed over several carbons, each of which will then have coordination number 4 or 5. Equations 5.16, 5.17, and 5.18 illustrate the formation of some ions of this type. Intensive research into the properties of these carbonium ions

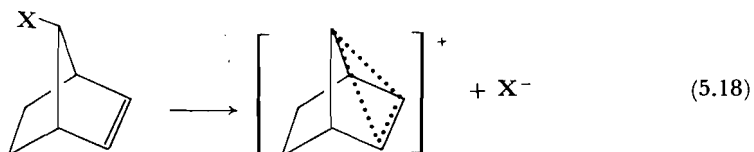
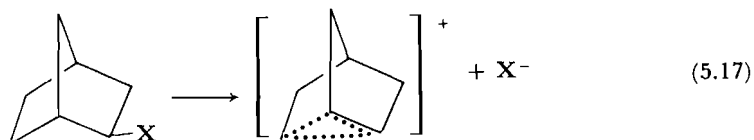

dates from the proposal by Winstein and Trifan in 1949 of the process shown in Equation 5.17 to account for solvolysis rates and stereochemistry in the bicyclo[2.2.1]heptyl system.⁸⁷ The existence of the bridged structures has been a matter of controversy;⁸⁸ although some objections remain,⁸⁹ the weight of the evidence, including direct spectroscopic observation, now appears to have established their importance.⁹⁰ Because the carbonium ions arise in rearranging systems, we reserve more detailed discussion to Chapter 6.

Formation and Reactions of Carbocations

It is appropriate to summarize at this point the chemistry of carbocations. Table 5.6 lists the principal means of generating these intermediates and their most important reactions.

5.4 MECHANISMS INTERMEDIATE BETWEEN S_N1 AND S_N2

Up to this point we have confined our discussion of nucleophilic substitution to those reactions that appear to follow either an extreme S_N2 process (Chapter 4) or the limiting S_N1 path. There is a middle ground; many substitutions have some of the characteristics of each extreme but belong to neither.

⁸⁵ W. A. Latham, W. J. Hehre, and J. A. Pople, *J. Amer. Chem. Soc.*, **93**, 808 (1971).

⁸⁶ See note 84(f).

⁸⁷ S. Winstein and D. S. Trifan, *J. Amer. Chem. Soc.*, **71**, 2953 (1949).

⁸⁸ (a) P. D. Bartlett, *Nonclassical Ions*, W. A. Benjamin, Menlo Park, Calif., 1965; (b) H. C. Brown, *Acts. Chem. Res.*, **6**, 377 (1973); (c) D. Lenoir, P. Mison, E. Hyson, P. v. R. Schleyer, M. Saunders, P. Vogel, and L. A. Telkowski, *J. Amer. Chem. Soc.*, **96**, 2157 (1974); (d) G. D. Sargent, in *Carbonium Ions*, Olah and Schleyer, Eds., Vol. III, p. 1099.

⁸⁹ See note 88(b).

⁹⁰ See note 76(d), p. 235.

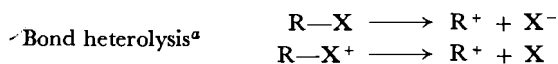
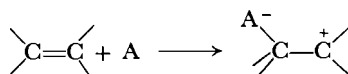
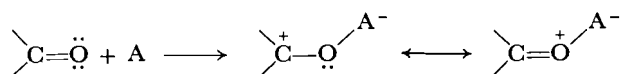
Table 5.6 FORMATION AND REACTIONS OF CARBOCATIONSAddition to C=C^bAddition to C=O^c

Reactions Regenerating Carbocations

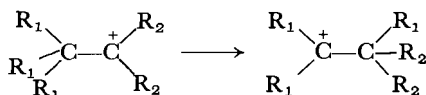
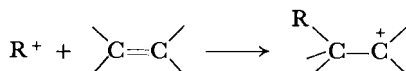
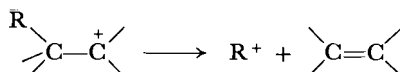
Hydrogen transfer^dRearrangement^eAddition^bFragmentation^b

Reactions Destroying Carbocations

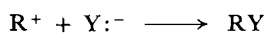
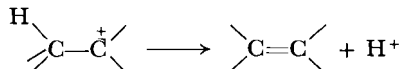
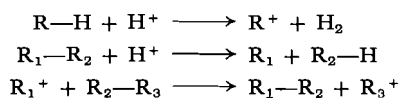
Combination with Lewis base^aElimination^b^a Chapter 5.^b Chapter 7.^c Chapter 8.^d C. D. Nenitzescu, in *Carbonium Ions*, G. A. Olah and P. v. R. Schleyer, Eds., Wiley-Interscience, New York, 1970, Vol. II, p. 463; see also D. M. Brouwer and H. Hogeveen, *Prog. Phys. Org. Chem.*, **9**, 179 (1972), who also review the following less commonly encountered electrophilic substitution reactions:^e Chapter 6.

Solvolysis Mechanisms

The problem of how to classify and account for this intermediate behavior continues to plague chemists interested in mechanism. The greatest difficulty arises for solvolysis, because the kinetic behavior with respect to solvent cannot be determined; we shall be concerned here primarily with reactions of this type.

An obvious possibility is that in some cases S_N2 and limiting S_N1 processes occur simultaneously. This idea does not seem to have been particularly fruitful.⁹¹ Most discussions of the problem assume that there is a range of mechanism possible between the extremes, and that even in intermediate cases some particular mechanism prevails.⁹²

Three central themes are important in the mechanistic investigations. The first possibility is that there is an experimentally detectable distinction between cases in which a particular solvent molecule assists departure of the leaving group by forming a covalent bond to carbon at the transition state, and cases in which the solvent stabilizes the transition state and resulting ion pair only by nonspecific electrostatic solvation interactions.⁹³ This hypothesis allows for a range of behavior by postulating that bonding to the leaving group, and, in the solvent-assisted cases, to solvent, may be strong or weak, and by allowing the intervention of ion-pair intermediates. Figure 5.6 summarizes the argument in the form of reaction coordinate diagrams.

The second alternative is that there is only one mechanism; specific bonding to some nucleophile always assists the breaking of the C—X bond, even if only slightly. S_N2 behavior arises from a "tight" transition state with both entering and leaving groups close and strongly interacting; S_N1 behavior is the result of a "loose" transition state, C—X bond nearly completely broken, and S—C bond only just starting to form.⁹⁴ Again, the initial product can be an ion pair. We outline this proposal in Figure 5.7. Comparison of Figures 5.6 and 5.7 will show that the only real distinction between alternatives 1 and 2 is in their description of the S_N1 process.

Finally, a third idea, not a separate mechanism but a concept that can be applied to either of the other two, is that an ion pair is always formed first, so that even the "pure" S_N2 reaction has an intermediate. This possibility is shown in Figure 5.8.

The tools used in investigating the mechanistic problem are those we have

⁹¹ For a contrary view, see (a) G. Kohnstam, A. Queen, and B. Shillaker, *Proc. Chem. Soc.*, 157 (1959); (b) B. J. Gregory, G. Kohnstam, M. Paddon-Row, and A. Queen, *Chem. Commun.*, 1032 (1970); and for a refutation of their interpretation, (c) R. A. Sneen and J. W. Larsen, *J. Amer. Chem. Soc.*, **91**, 6031 (1969); (d) R. A. Sneen and H. M. Robbins, *J. Amer. Chem. Soc.*, **94**, 7868 (1972).

⁹² The concepts associated with mechanism are statistical; a mechanism is an average path for a large number of molecules. On a molecular level, individual molecules follow different paths across the potential energy surface. (Refer to the discussion in Section 2.6, p. 99). By a "single mechanism" we mean a valley across the potential energy surface with a high point lower than the high points of other valleys by an energy large compared to kT . Two simultaneous mechanisms would occur if there were two valleys leading from reactant to product with high points of nearly the same energy but separated from each other by hills high compared to kT .

⁹³ (a) C. K. Ingold, *Structure and Mechanism in Organic Chemistry*, 2nd ed., Cornell University Press, Ithaca, N.Y., 1969, chap. VII; (b) W. v. E. Doering and H. H. Zeiss, *J. Amer. Chem. Soc.*, **75**, 4733 (1953).

⁹⁴ (a) E. R. Thornton, *J. Amer. Chem. Soc.*, **89**, 2915 (1967); (b) G. J. Frisone and E. R. Thornton, *J. Amer. Chem. Soc.*, **90**, 1211 (1968).

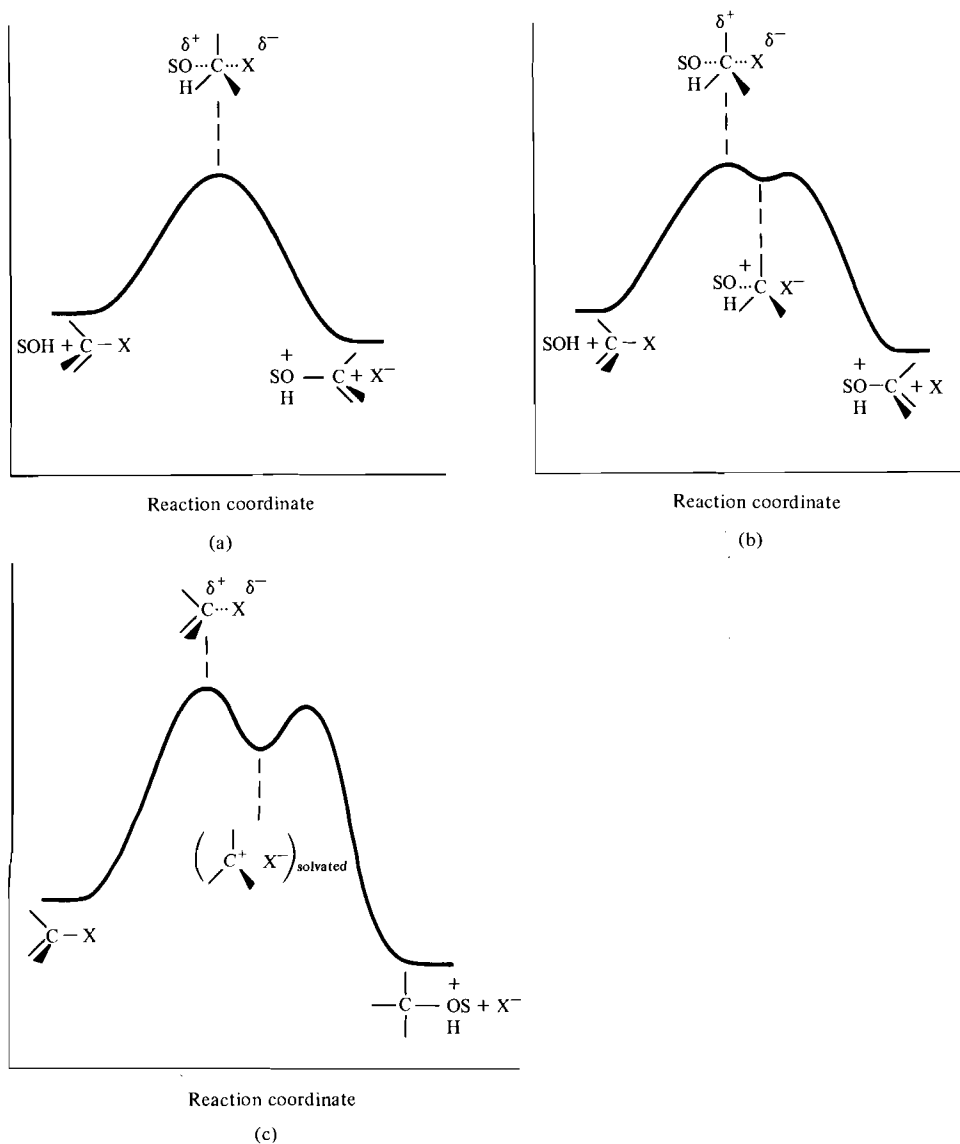

Figure 5.6 Distinct mechanisms. (a) S_N2 . (b) Ionization to an ion pair with nucleophilic participation by solvent. (c) Limiting S_N1 .

discussed in previous sections. Stereochemistry, effect on rate and product distribution of added salts, influence of structure and of leaving group on kinetics and products, sensitivity to solvent ionizing power and nucleophilicity, and isotope effects are all brought to bear. Despite this broad range of available methods, the ambiguities remain and there is still room for much experimental innovation.

Solvent-Assisted Ionization

Investigations reported by Schleyer and a number of co-workers have contributed significantly to clarification of some of the points in question. A study of

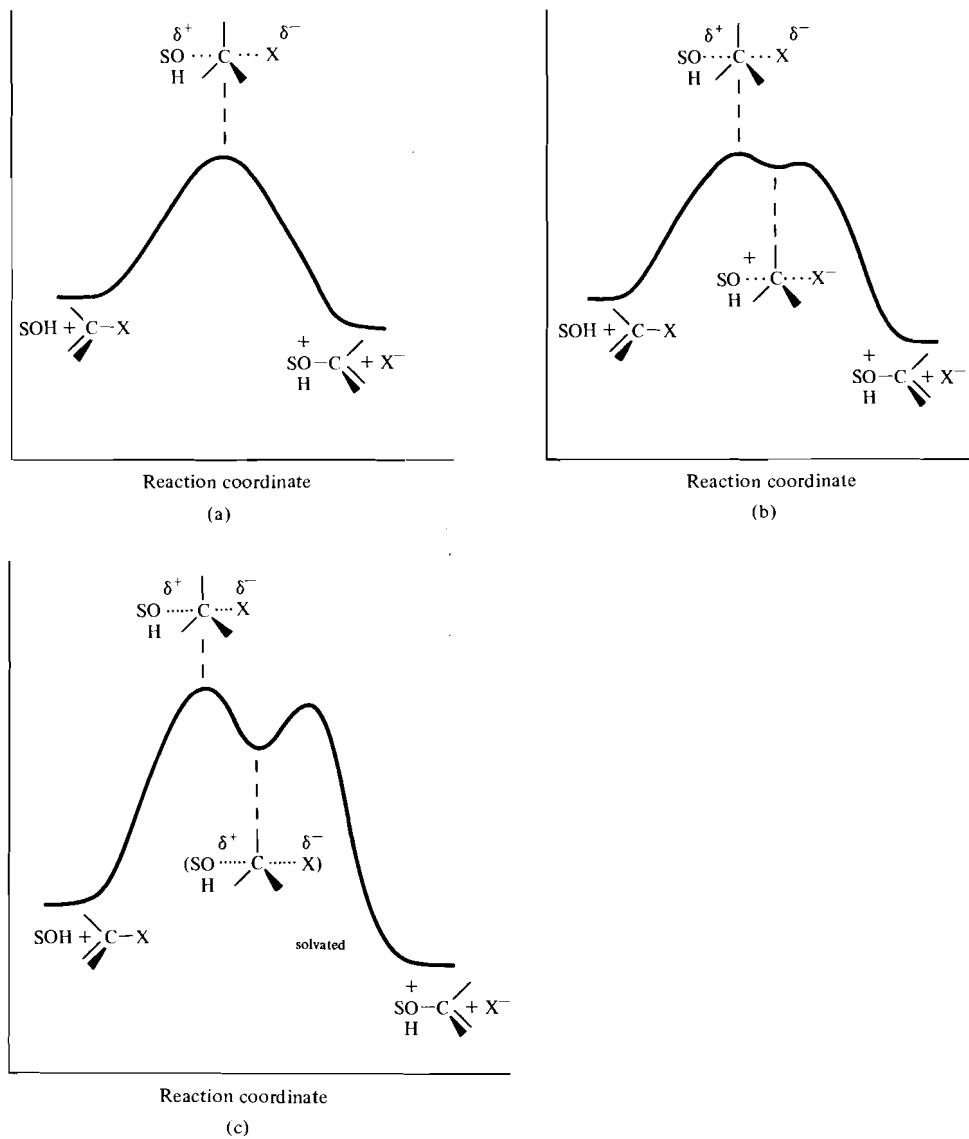
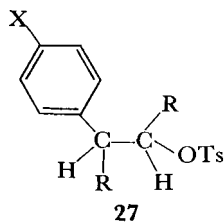

Figure 5.7 Single mechanism. (a) S_N2 . (b) Intermediate. (c) S_N1 .

rearrangements occurring during solvolysis of tosylates bearing substituted phenyl groups on the β -carbon (**27**) led them to suspect that nucleophilic assis-



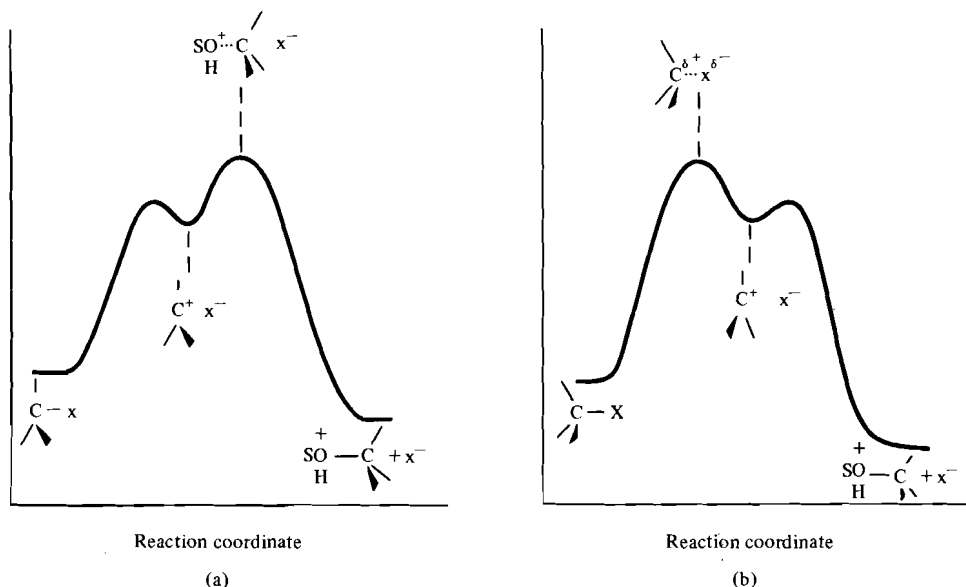
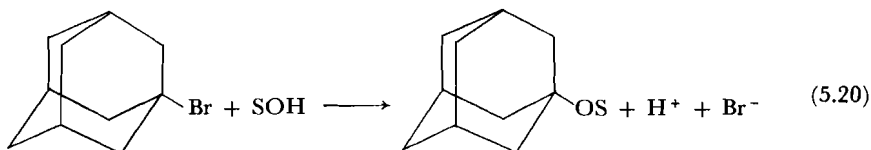
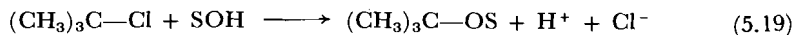

Figure 5.8 All reactions by way of ion pairs. (a) S_N2 , rate-determining attack on ion pair. (b) S_N1 , rate-determining ion-pair formation.

tance to ionization by solvent (Figure 5.6b) is more general than had previously been thought.⁹⁵ (These rearrangement experiments are discussed in Section 6.1.)

Their approach in looking into the problem further was to find structures in which specific covalent bonding to the back side of the carbon undergoing substitution is difficult or impossible. As models for reactions at tertiary carbon they chose bridgehead substitutions. We have seen in Section 5.2 that rates in these systems are retarded, in some cases by many powers of ten, because of the increase in strain upon ionization. But the important point in the present context is that it is impossible for a solvent molecule to approach from the back side of a bridgehead carbon; the only possibilities are frontside attack, known to be strongly disfavored (Section 4.2), or limiting S_N1 solvolysis with nonspecific solvation.

If *t*-butyl chloride solvolyzes by a mechanism like that depicted in Figure 5.6c, without any significant nucleophilic assistance at the transition state, the sensitivity to changes of solvent nucleophilicity ought to be the same as for the bridgehead systems. This is the result found when the reactions of *t*-butyl chloride (Equation 5.19) and adamantyl bromide (Equation 5.20) were compared.⁹⁶ The



⁹⁵ D. J. Raber, J. M. Harris, and P. v. R. Schleyer, *J. Amer. Chem. Soc.*, **93**, 4829 (1971), and references cited therein.

⁹⁶ D. J. Raber, R. C. Bingham, J. M. Harris, J. L. Fry, and P. v. R. Schleyer, *J. Amer. Chem. Soc.*, **92**, 5977 (1970).

correlation between Y and rate of Reaction 5.20 is excellent over a wide variety of solvents of varying nucleophilicity; if *t*-butyl chloride were subject to nucleophilic assistance, the Y values would reflect this fact and would not correlate adamantyl rates for solvents of different nucleophilicity. For very strongly ionizing solvents such as trifluoroethanol, trifluoroacetic acid, and hexafluoro-2-propanol, the correlation fails.⁹⁷ The reason proposed is that in these solvents the *t*-butyl substrates are undergoing elimination by attack of solvent on a proton. The adamantyl systems can neither solvolyze with nucleophilic assistance nor eliminate, and it has therefore been proposed that 1-adamantyl (or 2-adamantyl, see below) tosylate be the standard for the Y scale.⁹⁸ This revised Y scale measures solvent ionizing power only and does not include any contribution from solvent nucleophilicity.

In order to extend this line of argument to secondary systems, Schleyer and his collaborators chose the 2-adamantyl structure (**28**). They reasoned that the

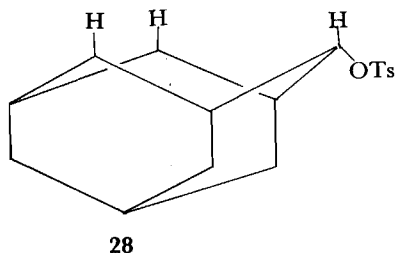

axial hydrogens in this rigid molecule would block backside approach of a nucleophile. Indeed, they found that 2-adamantyl tosylate solvolysis rates correlated with those of 1-adamantyl, showing the same lack of sensitivity to solvent nucleophilicity. Open-chain secondary tosylates, for example isopropyl, proved to be markedly sensitive to nucleophilicity.⁹⁹ These compounds react at different rates in solvents of the same Y but different nucleophilicity; therefore the solvent must be assisting the departure of the leaving group by nucleophilic attack, as suggested in Figure 5.6a or 5.6b.

Use of other methods has contributed further to the emerging picture of solvolysis of most secondary systems as being solvent-assisted. For example, the solvolysis rate acceleration on substituting α -hydrogen by CH_3 in 2-adamantyl bromide is $10^{7.5}$, much larger than that found for other secondary-tertiary pairs such as isopropyl-*t*-butyl. In molecules less hindered than 2-adamantyl, the secondary substrate is accelerated by nucleophilic attack of solvent.¹⁰⁰ Rate accelerations and product distributions found on adding azide ion to solvolysis mixtures (Problem 4) also provide confirmatory evidence for these conclu-

⁹⁷ (a) J. M. Harris, D. J. Raber, W. C. Neal, Jr., and M. D. Dukes, *Tetrahedron Lett.*, 2331 (1974); (b) F. L. Schadt, P. v. R. Schleyer, and T. W. Bentley, *Tetrahedron Lett.*, 2335 (1974).

⁹⁸ See note 97.

⁹⁹ (a) J. L. Fry, C. J. Lancelot, L. K. M. Lam, J. M. Harris, R. C. Bingham, D. J. Raber, R. E. Hall, and P. v. R. Schleyer, *J. Amer. Chem. Soc.*, **92**, 2538 (1970); (b) P. v. R. Schleyer, J. L. Fry, L. K. M. Lam, and C. J. Lancelot, *J. Amer. Chem. Soc.*, **92**, 2542 (1970).

¹⁰⁰ J. L. Fry, J. M. Harris, R. C. Bingham, and P. v. R. Schleyer, *J. Amer. Chem. Soc.*, **92**, 2540 (1970).

sions.¹⁰¹ Evidently, earlier arguments in the literature based on the assumption that secondary systems are limiting or close to it must be reevaluated in the light of these findings. It also seems quite clear that, despite earlier reports,¹⁰² primary systems do not follow a limiting mechanism, even in acidic solvents.

As we shall see in more detail in Chapter 6, there are structures in which an internal nucleophile, in the form of a neighboring group such as phenyl, assists the ionization. In these instances, the neighboring group takes up the space at the side of the reacting carbon opposite the leaving group and so blocks solvent participation, while at the same time partly relieving the developing electron deficiency and so reducing the need of nucleophilic assistance by solvent. For molecules of this kind, then, secondary and even primary substrates can solvolyze without solvent participation, by a mechanism we may call S_N1 *with internal assistance*. This process may occur in competition with a path like that for ordinary primary and secondary substrates, in which solvent participates and the internal group does not.¹⁰³

Returning, then, to the two alternatives for solvolysis mechanisms with which we began this section, it appears that it is indeed possible to construct systems that solvolyze without nucleophilic assistance from solvent. For solvent-assisted reactions, the two alternatives are essentially equivalent; we can therefore choose the first alternative as being more consistent with current information.

The Ion-Pair Mechanism

The results we have cited do not bear on the ion-pair question. It is still possible that the reactions occurring with participation of nucleophile are attacks on a reversibly formed ion pair rather than on the covalent substrate. Sneen and Larsen found that 2-octyl methanesulfonate reacts in aqueous dioxane containing added azide ion to yield a mixture of 2-octyl alcohol and 2-octyl azide.¹⁰⁴ The water and azide ion are competing, as we would expect on the basis of the discussion above. But the ratio of the rate of disappearance of the methanesulfonate in the presence of azide to the rate in the absence of azide was that expected if there were an intermediate that could react in any one of three ways: return to substrate, combination with water, or combination with azide. (The derivation of the rate expressions is left to the reader in Problem 15.) Sneen and Larsen proposed that the intermediate is an ion pair. This finding, in a system that would have been expected to react by an S_N2 -like process, led them to propose that all nucleophilic substitutions, S_N2 and S_N1 alike, react through ion pairs. The characteristic S_N2 kinetic behavior would be the consequence of rate-determining attack by nucleophile on ion pair rather than on covalent substrate (Figure 5.8). Earlier, Swain and Kreevoy had suggested the possibility of rate-determining attack by methanol on ion pairs from triphenylmethyl chloride in benzene sol-

¹⁰¹ J. M. Harris, D. J. Raber, R. E. Hall, and P. v. R. Schleyer, *J. Amer. Chem. Soc.*, **92**, 5729 (1970).

¹⁰² See C. K. Ingold, *Structure and Mechanism in Organic Chemistry*, p. 436.

¹⁰³ (a) F. L. Schadt and P. v. R. Schleyer, *J. Amer. Chem. Soc.*, **95**, 7860 (1973); (b) G. A. Dafforn and A. Streitwieser, Jr., *Tetrahedron Lett.*, 3159 (1970); (c) P. C. Myhre and E. Evans, *J. Amer. Chem. Soc.*, **91**, 5641 (1969).

¹⁰⁴ (a) R. A. Sneen and J. W. Larsen, *J. Amer. Chem. Soc.*, **91**, 362, 6031 (1969); (b) R. A. Sneen, *Accts. Chem. Res.*, **6**, 46 (1973).

vent.¹⁰⁵ Shiner and his co-workers have also found evidence for rate-determining attack on ion pairs.¹⁰⁶

In analyzing their data, Sneen and Larsen had to correct for salt effects, since they were comparing rate with azide present to rate without.¹⁰⁷ Schleyer and co-workers have criticized Sneen's conclusions by pointing out the uncertainties involved in such corrections,¹⁰⁸ and Sneen has replied, justifying his earlier conclusions and presenting similar evidence for α -phenylethyl systems,¹⁰⁹ and for an allylic system.¹¹⁰ The question is far from settled, and will continue to be a subject of investigation.¹¹¹

Solvent Nucleophilicity

A point of key importance in study of solvolysis is the nucleophilicity of the solvent. Whereas the **Y** and other scales have been available for measuring ionizing power for some years, there has been no satisfactory scale for nucleophilicity. Swain, Mosely, and Bown attempted to set up an equation for correlation of solvolysis rates that included both nucleophilicity and ionizing power;¹¹² their system did not prove particularly helpful for understanding mechanism.¹¹³ The Swain-Scott equation, discussed in Chapter 4 (p. 185), was not evaluated for solvents.

For lack of a better system, the ratio of rate in an ethanol-water mixture of the same **Y** value as acetic acid to rate in the much less nucleophilic acetic acid, $(k_{\text{EtOH}}/k_{\text{AcOH}})_{\text{Y}}$, has served as a measure of sensitivity to solvent nucleophilicity. More recently, the problem has received renewed attention, and two groups have proposed possible approaches.¹¹⁴ Of the two proposals, that of Bentley, Schadt, and Schleyer is easier to apply. Their scheme defines the solvent nucleophilicity, **N**, by Equation 5.21, where k is the solvolysis rate constant of methyl tosylate in

$$\mathbf{N} = \log \left(\frac{k}{k_0} \right)_{\text{CH}_3\text{OTs}} - 0.3\mathbf{Y} \quad (5.21)$$

the solvent of interest, k_0 is the solvolysis rate constant of methyl tosylate in the reference solvent, and the term $-0.3\mathbf{Y}$ corrects for susceptibility to ionizing power. (The value 0.3 is m for methyl tosylate in the Winstein-Grunwald $m\mathbf{Y}$ correlation for the very non-nucleophilic solvents acetic acid and formic acid.) Methyl tosylate solvolysis thus serves as the standard reaction for determining nucleophilicity, just as t -butyl chloride solvolysis (now replaced by 2-adamantyl tosylate solvolysis) does for finding **Y**.

¹⁰⁵ C. G. Swain and M. M. Kreevoy, *J. Amer. Chem. Soc.*, **77**, 1122 (1955).

¹⁰⁶ (a) V. J. Shiner, Jr., R. D. Fisher, and W. Dowd, *J. Amer. Chem. Soc.*, **91**, 7748 (1969); (b) V. J. Shiner, Jr., S. R. Hartshorn, and P. C. Vogel, *J. Org. Chem.*, **38**, 3604 (1973).

¹⁰⁷ See note 104(a).

¹⁰⁸ D. J. Raber, J. M. Harris, R. E. Hall, and P. v. R. Schleyer, *J. Amer. Chem. Soc.*, **93**, 4821 (1971).

¹⁰⁹ R. A. Sneen and H. M. Robbins, *J. Amer. Chem. Soc.*, **94**, 7868 (1972).

¹¹⁰ R. A. Sneen and W. A. Bradley, *J. Amer. Chem. Soc.*, **94**, 6975 (1972).

¹¹¹ See, for example, W. T. Bentley, S. H. Liggero, M. A. Imhoff, and P. v. R. Schleyer, *J. Amer. Chem. Soc.*, **96**, 1970 (1974); (b) F. G. Bordwell and G. A. Pagani, *J. Amer. Chem. Soc.*, **97**, 118 (1975), and following papers.

¹¹² C. G. Swain, R. B. Mosely, and D. E. Bown, *J. Amer. Chem. Soc.*, **77**, 3731 (1955).

¹¹³ S. Winstein, A. H. Fainberg, and E. Grunwald, *J. Amer. Chem. Soc.*, **79**, 4146 (1957).

¹¹⁴ (a) P. E. Peterson and F. J. Waller, *J. Amer. Chem. Soc.*, **94**, 991 (1972); (b) T. W. Bentley, F. L. Schadt, and P. v. R. Schleyer, *J. Amer. Chem. Soc.*, **94**, 992 (1972).

Application of the Reacting Bond Rules .

It may be useful at this point to analyze the reaction coordinate in greater detail than we have done so far. We shall be making use of the reacting bond rules (Section 2.6, p. 104). Briefly summarized, the rules predict that (1) the effect of structural changes on location of the transition state with respect to the reaction coordinate should follow the Hammond postulate, that is, the *easier* a process the *less* advanced it will be at the transition state; and (2) the effect of structural change on location of the transition state with respect to a bound vibration will be opposite to the Hammond behavior, that is, the *easier* the process the *more* advanced it will be at the transition state. The discussion to follow is based on that of Thornton,¹¹⁵ but is extended through reaction coordinate diagrams of the kind proposed by More O'Ferrall¹¹⁶ and developed by Jencks.¹¹⁷

We want to consider a simplified nucleophilic substitution scheme consisting of the entering nucleophile, N, the carbon undergoing substitution, C, and the leaving group, X. An S_N2 reaction will have a transition state with both N and X partially bonded to C (29). The transition state may be tighter (30) or looser (31); it may also be unsymmetrical, with bond making to N more advanced (32)

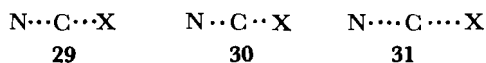

or less advanced (33) than bond breaking. An S_N1 reaction will have the C—X



bond partly broken, but no bonding to N, at the transition state of the ionization step (34). We shall represent the solvated ion pair that is the intermediate first



formed on ionization of C—X by 35; here N would be a solvating solvent molecule. We shall suppose that N does not move appreciably closer to C during the ionization, although we know this assumption to be an oversimplification, as is our neglect of other kinds of ion pairs.

There are two structural parameters of interest in this scheme: the N—C distance and the C—X distance. We construct in Figure 5.9 a diagram of the potential energy surface as a function of these two parameters for an S_N2 process. The horizontal plane represents the two coordinates, so that at the back left-hand corner are the reactants, N + C—X. Coming forward to the front of the diagram represents increasing the C—X distance, so that the left front corner is ion pair 35, with N still in its original position but the C—X bond broken. Going from left to right represents decreasing the N—C distance, so that at the right front is product, ⁺N—C + X⁻. At the back right is a hypothetical penta-coordinate state, with *both* N and X bonded to C. The height above the plane at each point represents the free energy for that particular combination of C—X

¹¹⁵ E. R. Thornton, *J. Amer. Chem. Soc.*, **89**, 2915 (1967).

¹¹⁶ R. A. More O'Ferrall, *J. Chem. Soc. B*, 274 (1970).

¹¹⁷ W. P. Jencks, *Chem. Rev.*, **72**, 705 (1972).

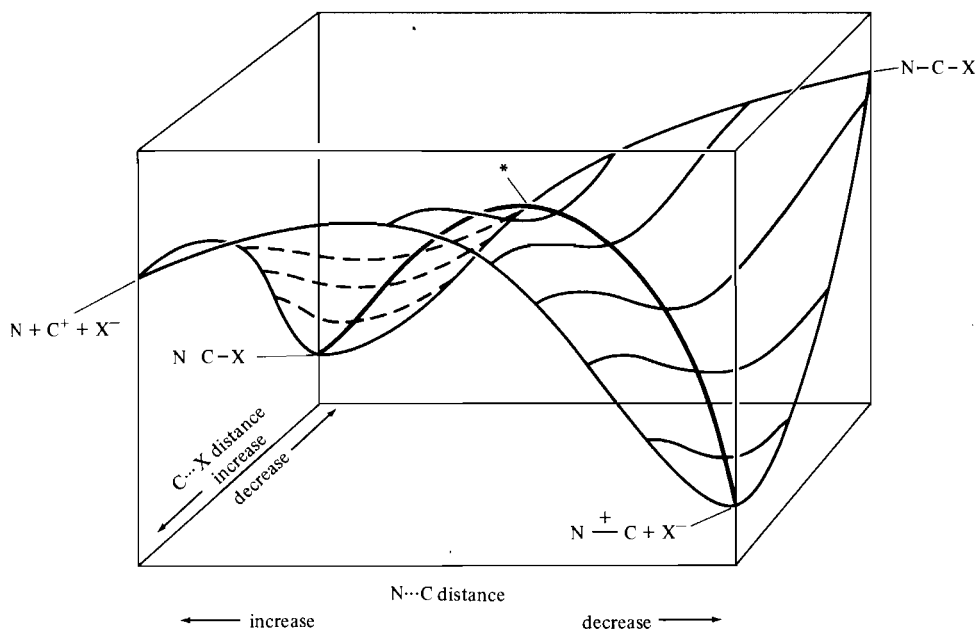

Figure 5.9 A hypothetical free-energy surface for an S_N2 reaction. Reaction starts at the back left-hand corner and proceeds along the heavy line over the surface, with simultaneous approach of N and departure of X , to the products at the front right-hand corner. The transition state is marked by *.

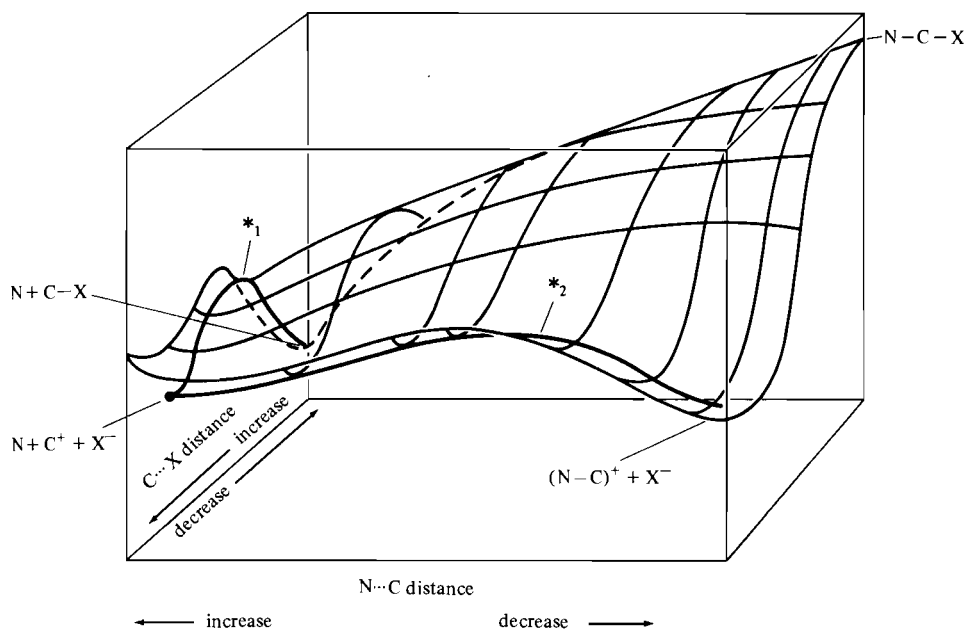

Figure 5.10 In the limiting S_N1 process, the most favorable path is, first, rate-determining breaking of the $C-X$ bond by passing over the transition state $*_1$ to the intermediate, $N + C-X$; then, proceeding in another step over a second barrier, $*_2$, to products.

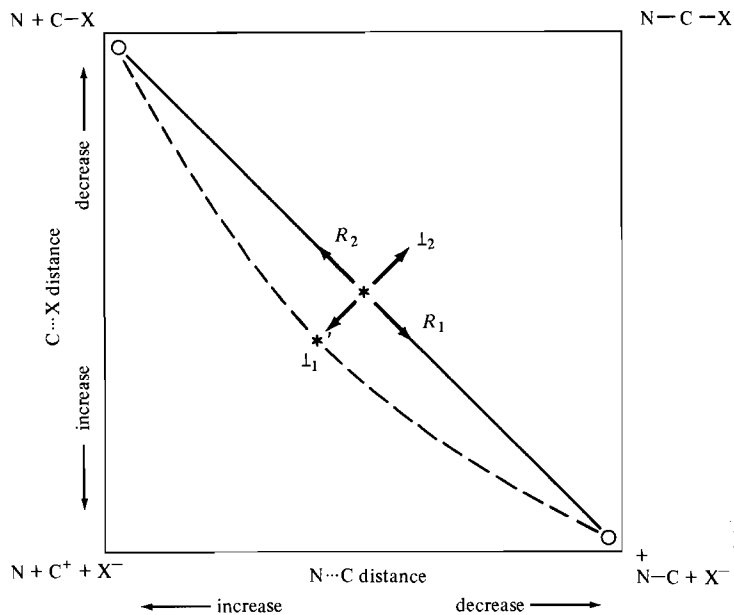
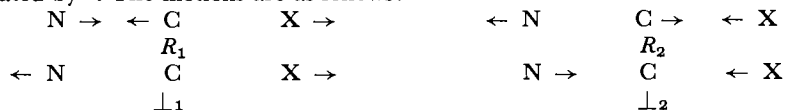

Figure 5.11 Projection of the S_N2 reaction coordinate (solid line). The transition state is indicated by *; in this example it is symmetric with respect to $N\cdots C$ bond making and $C\cdots X$ bond breaking (Structure 29). Energy minima are designated by \circ . The motions are as follows:



Electron supply to C favors \perp_1 and shifts the transition state to $*'$, and the reaction then follows the dashed curve.

and $N-C$ distances. The curve up over the saddle point at the center of the diagram represents the lowest energy pathway for the S_N2 reaction, with the transition state indicated by *. Figure 5.10 is a similar diagram for the limiting S_N1 process.

In order to study these diagrams further, we look directly down from above and project the reaction coordinate onto the horizontal plane.¹¹⁸ Since we need to retain the essential features of the potential energy, we indicate maxima of energy along the reaction coordinate by * and minima by \circ . Figure 5.11 is the projection of the S_N2 path, and Figure 5.12 is the projection of the S_N1 path.

Now we ask what the effect will be on the S_N2 process of electron donation to carbon. The motion along the reaction coordinate, R_1 , is **36**; R_2 is its reverse, **37**. Motion perpendicular to the reaction coordinate is the vibration represented by **38** and **39**; **38** represents a displacement toward the lower left of the diagram



¹¹⁸ See notes 116, 117.

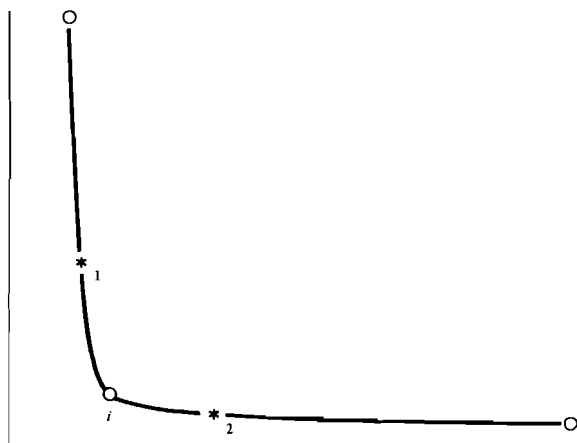
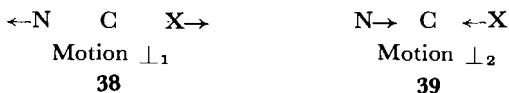

Figure 5.12 Projection of the limiting S_N1 reaction coordinate. Transition state of the rate-determining step is $*_1$. The central minimum, o_i , is the solvated ion pair.



and **39** is a displacement toward the upper right. These four motions we have indicated in Figure 5.11. Greater electron supply to C (for example from a more electron-releasing substituent) will make N less eager to bond and will allow X to depart more easily; since part of motion R_1 (or R_2) is helped and part is hindered, the position of the transition state along the reaction coordinate will be little affected. The same change, however, assists \perp_1 and makes \perp_2 less favorable; the transition state will therefore shift in the direction of \perp_1 , to $*'$. The new reaction coordinate, the dashed line in Figure 5.11 brings the system to a transition state that is still symmetric with respect to bond making and breaking, but is looser; that is, the bond to N is less formed and that to X is more broken at the transition state than before the structural change. Electron withdrawal at C will have the opposite effect.

If the structure is changed further, so as to make electron density even more available to C, the curve will eventually move all the way to the edge and will follow the line in Figure 5.12. The transition between S_N2 and S_N1 is perhaps most easily seen by starting from S_N1 , Figure 5.12. Suppose that we make C^+ a less good cation by electron withdrawal from C. At the ion-pair intermediate, o_i , all motions are bound vibrations. If C^+ is made a worse cation, N and X^- will tend to draw closer and the shift will be toward the upper right, to o'_i , Figure 5.13. At the same time, o'_i will be raised in energy compared with o_i , because the carbocation is less well stabilized. The transition state $*_1$ will also move. Motion along the reaction coordinate, R_a , is C—X breaking only, and it is hindered by making C^+ a poorer ion, so the transition state moves in the direction R_a . But motion \perp_b , Figure 5.13, is approach of N; it is a bound vibration and is assisted by making C^+ a poorer ion, and so the transition state should also move in direction \perp_b . Since motion along the reaction coordinate is expected to dominate when both kinds occur (rule 3, Section 2.6, p. 104), we expect the resultant

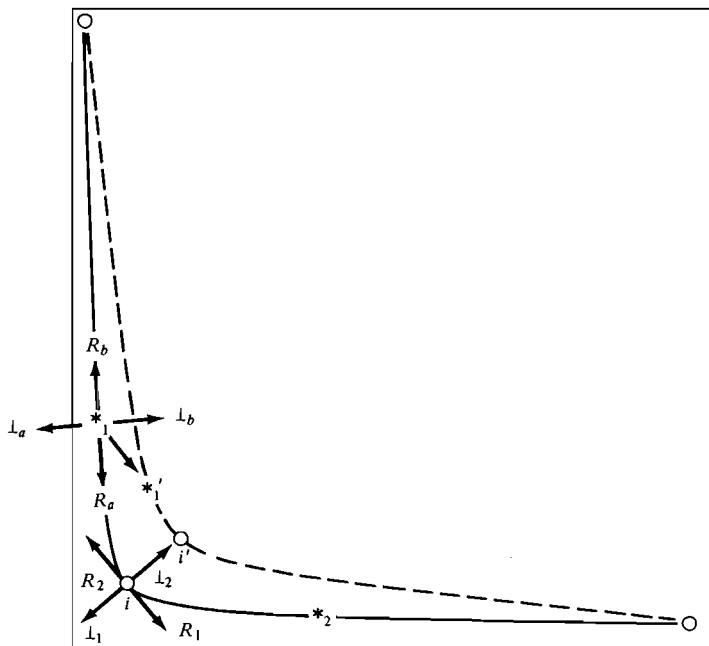

Figure 5.13 The effect on the location of the intermediate, o_i , of electron withdrawal at C^+ . Motions R_1 , R_2 , L_1 , and L_2 are the same as in Figure 5.11, but all are bound vibrations. The intermediate will shift in the direction of L_2 to o_i' . At the same time, the transition state $*_1$ will shift to $*_1'$. The new reaction coordinate is given by the dashed curve.

change to $*_1'$ in Figure 5.13, and the new reaction coordinate shown by the dashed curve.

If the process just described is continued, $*_1$ moves ever closer to o_i , while o_i increases in energy and the curve moves toward the center of the diagram. When minimum o_i disappears and only $*_1$ remains ($*_1$ will also at that point have merged with $*_2$, Figure 5.12), the mechanism is S_N2 . We leave it as an exercise for the reader to work out predictions of how the curves should change with the nature of the entering and leaving groups.

Sneen's ion-pair scheme can also be shown with these two-dimensional diagrams. According to his mechanism, all substitutions follow the path shown in Figure 5.12; the distinction between S_N1 and S_N2 behavior depends on whether $*_1$ or $*_2$ is higher, and variation in behavior depends on the relative positions along the curve, and the energies, of $*_1$, o_i , and $*_2$.

5.5 UNIMOLECULAR ELECTROPHILIC SUBSTITUTIONS—CARBANIONS

We may define a unimolecular electrophilic substitution, S_E1 , by Equations 5.22 and 5.23. The electrophilic substitutions have not been as thoroughly studied as



have the nucleophilic, and details of mechanism are not as well defined. Nevertheless, there are a number of transformations that can be profitably considered in terms of the S_E1 process.¹¹⁹

In Section 4.5 we discussed reactions in which electrophilic substitution of a metal ion takes place by a bimolecular pathway. The unimolecular substitution is less common, although there are some examples in cases where the carbanion is well stabilized.¹²⁰ For our purposes here the most important S_E1 reactions are those in which the leaving group is a proton or a neutral carbon molecule.

Proton Leaving Group

Cleavage of a carbon–hydrogen bond to yield a carbanion and proton is a Brønsted acid–base reaction (Equations 5.24 and 5.25). The mechanism is not

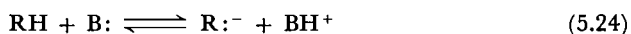

strictly speaking a unimolecular one, because there are two molecules taking part in the ionization step. It is, however, analogous to an acid-catalyzed nucleophilic substitution, in which a Lewis acid helps to pull off the leaving group. Those reactions are ordinarily included in the S_N1 category. We may therefore consider Reactions 5.24–5.25 in the present context.

The most elementary example of the electrophilic substitution with hydrogen leaving group is the exchange of one proton for another, a process that can be studied by isotopic labeling. We have considered in Section 3.3 the equilibrium aspects of C–H acidity; data were given there that allow a rough assessment of relative stabilities of various carbanion structures (Table 3.1, p. 146). The parallel between rates of proton removal and anion stability as measured by the acid dissociation constant was also considered there. In general, the more highly stabilized the anion the more rapidly a given base will produce it by proton removal.

The stereochemical outcome of a substitution by way of a carbanion depends on the geometrical preferences of the anion and on its degree of association with other species present in the medium. Elementary consideration of carbanion structure leads to the conclusion that $:\text{CH}_3^-$ and simple alkyl homologs should be pyramidal. The isoelectronic ammonia and amines undergo fast inversion; the same might be expected for carbanions $\mathbf{40} \rightleftharpoons \mathbf{41}$.¹²¹ If this change takes place rapidly, an anion generated from a chiral precursor would lose its configuration

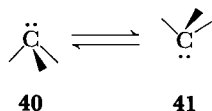

¹¹⁹ For a review of electrophilic substitution and the carbanion field, see D. J. Cram, *Fundamentals of Carbanion Chemistry*, Academic Press, New York, 1965.

¹²⁰ See, for example: (a) B. J. Gregory and C. K. Ingold, *J. Chem. Soc. B*, 276 (1969); (b) D. Dodd and M. D. Johnson, *J. Chem. Soc. B*, 1071 (1969); (c) D. Dodd, C. K. Ingold, and M. D. Johnson, *J. Chem. Soc. B*, 1076 (1969).

¹²¹ A. Rauk, L. C. Allen, and K. Mislow, *Angew. Chem. Int. Ed.*, **9**, 400 (1970) review theoretical and experimental aspects of pyramidal inversion.

and give racemic products on reaction with an electrophile. Attempts to prepare optically active Grignard reagents have been unsuccessful, except in the case of a cyclopropyl derivative such as **42**, where the increase in strain associated with the planar transition state (I strain¹²²) provides a sufficiently high barrier to inversion to maintain the stereochemistry.¹²³ The lithio-, and even sodio-derivatives of the cyclopropyl system also show sufficient stereochemical stability to give optically active products.¹²⁴ There is a certain amount of covalent character in the carbon-metal bonds, although it must be quite small in the organosodium compounds. The highly covalent organomercurials are readily prepared in optically active form without any special structural requirements.

Most of the work on stereochemistry of carbanions free of specific bonding to metals has been done with molecules that include a stabilizing group. Examples are shown in Structures **43**, **44**, and **45**. In these cases, because of the stabilization attained by favorable conjugation with the π electron systems, the ions are

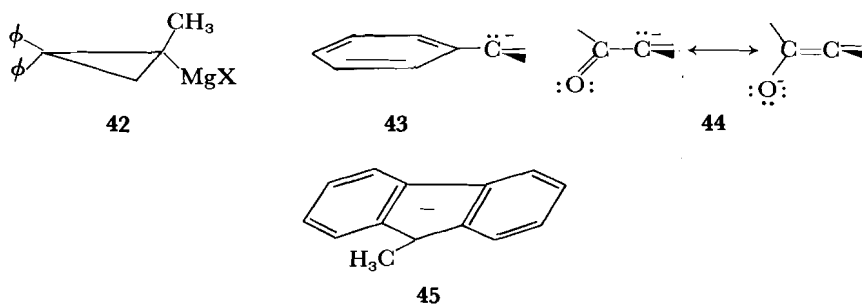

probably planar.¹²⁵ The situation for these structures is much like that of the carbocations, and we may expect ion-pairing phenomena to exert a strong influence on the stereochemistry. Indeed, the stereochemical consequences of generating anions at chiral centers in conjugation with π systems depend strongly on the base and solvent.¹²⁶

In the deuterated 9-methylfluorenyl system (**46**), Cram and co-workers found retention of configuration in tetrahydrofuran with ammonia or a primary amine as base.¹²⁷ Streitwieser has obtained similar results with benzyl systems in cyclohexylamine with cyclohexylamide as base.¹²⁸ Cram's proposed mechanism is shown in Scheme 6. In dimethylsulfoxide, the exchange and racemization

¹²² (a) H. C. Brown and M. Gerstein, *J. Amer. Chem. Soc.*, **72**, 2926 (1950); (b) H. C. Brown, R. S. Fletcher, and R. B. Johannesen, *J. Amer. Chem. Soc.*, **73**, 212 (1951).

¹²³ H. M. Walborsky and A. E. Young, *J. Amer. Chem. Soc.*, **86**, 3288 (1964).

¹²⁴ (a) H. M. Walborsky, F. J. Impastato, and A. E. Young, *J. Amer. Chem. Soc.*, **86**, 3283 (1964);

(b) J. B. Pierce and H. M. Walborsky, *J. Org. Chem.*, **33**, 1962 (1968).

¹²⁵ A fluorine substituent, however, has the opposite effect on geometry. Pyramidal ions are stabilized by fluorine and planar ions destabilized; conjugation with the filled p orbitals on fluorine is unfavorable. See A. Streitwieser, Jr., and F. Mares, *J. Amer. Chem. Soc.*, **90**, 2444 (1968). Chlorine, bromine, and iodine apparently stabilize an adjacent carbanion more than does fluorine, presumably because the destabilizing p orbital overlap is less effective with the larger halogens (see Section 5.2, p. 227). J. Hine, N. W. Burske, M. Hine, and P. B. Langford, *J. Amer. Chem. Soc.*, **79**, 1406 (1957).

¹²⁶ See Cram, *Fundamentals of Carbanion Chemistry*, chap. III, for a summary of results and discussion of mechanisms.

¹²⁷ (a) D. J. Cram and L. Gosser, *J. Amer. Chem. Soc.*, **85**, 3890 (1963); (b) D. J. Cram and L. Gosser, *J. Amer. Chem. Soc.*, **86**, 5445 (1964).

¹²⁸ A. Streitwieser, Jr., and J. H. Hammons, *Prog. Phys. Org. Chem.*, **3**, 41 (1965).

SCHEME 6

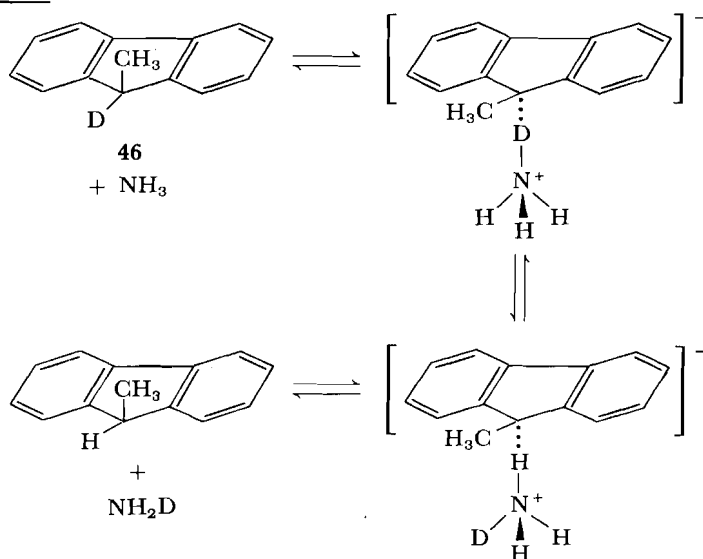

rates are equal; the anions must in this case become racemic before reprotonation. The more polar solvent presumably allows the ion pairs to dissociate, or at least to last long enough to lose chirality.¹²⁹ In a fairly acidic protic solvent such as methanol, inversion occurs by the process indicated in Scheme 7.¹³⁰

SCHEME 7

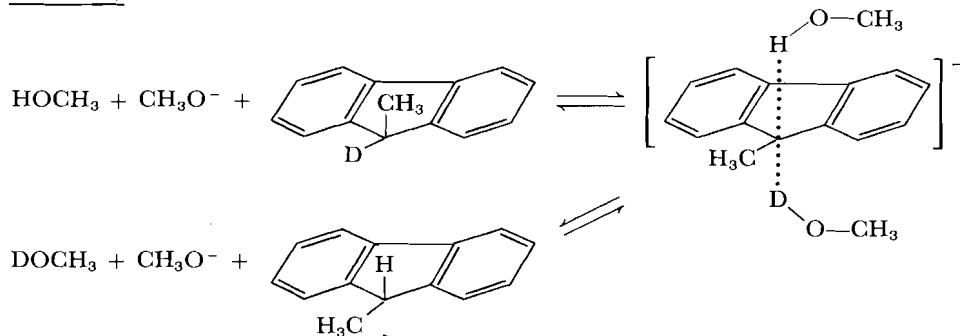

Finally, in certain cases, such as in Structure 47, in which the ion pair can easily lose its chirality without dissociating, Cram has identified a process that causes racemization to be faster than exchange.¹³¹ More than one of these processes can occur simultaneously.¹³²

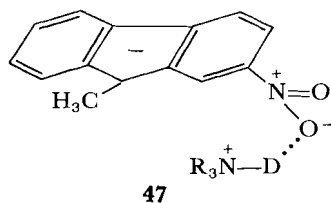

¹²⁹ See note 127.

¹³⁰ D. J. Cram and L. Gosser, *J. Amer. Chem. Soc.*, **86**, 5457 (1964).

¹³¹ K. C. Chu and D. J. Cram, *J. Amer. Chem. Soc.*, **94**, 3521 (1972).

¹³² J. N. Roitman and D. J. Cram, *J. Amer. Chem. Soc.*, **93**, 2225 (1971).

Anions stabilized by adjacent carbonyl groups (44) usually give racemization no matter what the solvent. The charge is distributed between carbon and oxygen; the hard proton acid prefers the hard end of the ambident base and adds to the oxygen.¹³³ An enol results, and it lasts long enough before changing to the more stable keto form for its environment to become symmetric.¹³⁴ Cyclopropyl and vinyl anions, for example 48 and 49, have a greater tendency to maintain their configuration than do ions without these special structural features.¹³⁵

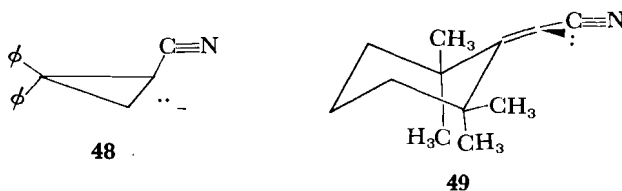

Reprotonation is, of course, not the only possible fate of carbanions. The variety of their reactions makes them highly useful intermediates in synthesis.¹³⁶

Carbon Leaving Groups

A number of reactions of the general type shown in Equation 5.26 lead to carbanions by loss of a carbon group. These processes occur when $R:^-$ is a stabilized carbanion; they can also be considered as the reverse of nucleophilic additions to carbonyl (Chapter 8).

Cram and co-workers have investigated these reactions with ketone leaving groups ($R_1, R_2 =$ alkyl or aryl) and find that, as with the deprotonation route,

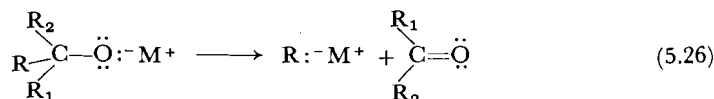

the stereochemical consequences depend on the conditions. In a relatively non-polar and weakly basic solvent such as *t*-butyl alcohol, the metal ion is closely associated with the leaving group and with a solvent molecule and guides a proton donor to the side from which the leaving group departed. The result is retention (Scheme 8).¹³⁷ In better-ionizing solvents, the ion pairs can dissociate,

¹³³ (a) M. Eigen, *Angew. Chem. Int. Ed.*, **3**, 1 (1964); (b) R. G. Pearson, *Survey Prog. Chem.*, **5**, 1 (1969); see Section 3.5 for discussion of the hard-soft principle.

¹³⁴ D. J. Cram, B. Rickborn, C. A. Kingsbury, and P. Haberfield, *J. Amer. Chem. Soc.*, **83**, 3678 (1961).

¹³⁵ (a) H. M. Walborsky and J. M. Motes, *J. Amer. Chem. Soc.*, **92**, 2445 (1970); (b) J. M. Motes and H. M. Walborsky, *J. Amer. Chem. Soc.*, **92**, 3697 (1970); (c) H. M. Walborsky and L. M. Turner, *J. Amer. Chem. Soc.*, **94**, 2273 (1972).

¹³⁶ See, for example, (a) H. O. House, *Modern Synthetic Reactions*, 2nd ed., W. A. Benjamin, Menlo Park, Calif., 1972; (b) D. C. Ayres, *Carbanions in Synthesis*, Oldbourne Press, London, 1966.

¹³⁷ (a) D. J. Cram, J. L. Mateos, F. Hauck, A. Langemann, K. R. Kopecky, W. D. Nielsen, and J. Allinger, *J. Amer. Chem. Soc.*, **81**, 5774 (1959); (b) J. N. Roitman and D. J. Cram, *J. Amer. Chem. Soc.*, **93**, 2231 (1971).

SCHEME 8

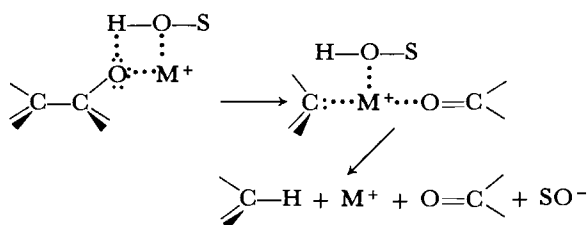

and racemization results if the solvent is aprotic and inversion if the solvent can donate a proton from the back side.¹³⁸

A variation of the general carbon leaving group scheme of Equation 5.26 is decarboxylation (Equations 5.27 and 5.28).¹³⁹ In order for the fragmentation

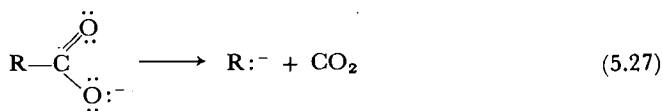

to occur readily, the carbanion must be stabilized. Structures 50–55 show some of the types of acids that decarboxylate easily. In many of these structures, a

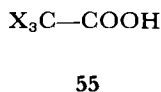
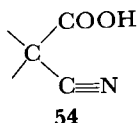
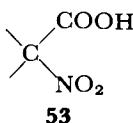
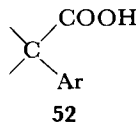
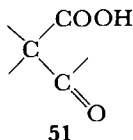
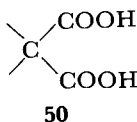

mechanism is available for decarboxylation of the free acid as well as of the conjugate base. An intramolecular proton transfer (Equation 5.29) leads directly to the enol of the decarboxylated product.¹⁴⁰

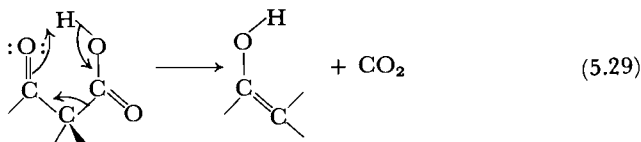

In Chapter 8 we shall consider a number of other processes analogous to Equation 5.26 but in which the initial alkoxide is itself an intermediate arising from attack of a nucleophile on a carbonyl group.

¹³⁸ See note 137(a).

¹³⁹ For a review of decarboxylation, see B. R. Brown, *Quart. Rev.* (London), 5, 131 (1951).

¹⁴⁰ F. H. Westheimer and W. A. Jones, *J. Amer. Chem. Soc.*, 63, 3283 (1941).

5.6 CARBENES

We consider in this section a third reactive intermediate, the carbene.¹⁴¹ A carbene is a molecule containing a divalent carbon that bears an unshared pair of electrons. (Structure 56) Carbenes may be considered as the conjugate bases of

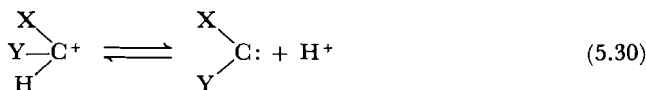

carbocations (Equation 5.30), although most known carbenes do not in practice arise in this way;¹⁴² they are also related to carbanions through an α elimination (Equation 5.31), a route that is experimentally practicable.

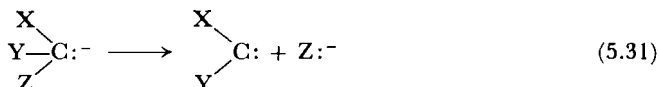

Carbenes are highly reactive, have short lifetimes, and undergo characteristic chemical changes, the most important of which are listed with examples in Table 5.7. Monovalent nitrogen intermediates (57), called nitrenes, are also known; their chemistry is in many ways similar to that of carbenes.¹⁴³

Formation of Carbenes

Hine and his co-workers showed in the 1950s by kinetic and trapping experiments that dichloromethylene, $:\text{CCl}_2$, is an intermediate in the reaction of haloforms with base in aqueous solution.¹⁴⁴ Scheme 9 depicts for chloroform the mechanism they proposed. If the first step is a rapid equilibrium and k_2 is rate-determining, the observed second-order kinetics are consistent with the mechanism,¹⁴⁵ as are a number of other results.¹⁴⁶

¹⁴¹ The term *carbene* is used here as a generic designation; individual carbenes are named as substituted methylenes. For reviews of carbene chemistry, see: (a) D. Bethell, *Advan. Phys. Org. Chem.*, **7**, 153 (1969); (b) G. L. Closs, *Top. Stereochem.*, **3**, 193 (1968); (c) W. Kirmse, *Carbene Chemistry*, 2nd ed., Academic Press, New York, 1971; (d) J. Hine, *Divalent Carbon*, Ronald Press, New York, 1964; (e) M. Jones and R. A. Moss, Eds., *Carbenes*, Wiley, New York, 1973, Vol. I.

¹⁴² Certain types of carbocations can be deprotonated, with formation of typical carbene products. See R. A. Olofson, S. W. Walinsky, J. P. Marino, and J. L. Jernow, *J. Amer. Chem. Soc.*, **90**, 6554 (1968).

¹⁴³ Nitrene chemistry is discussed in *Nitrenes*, W. Lwowski, Ed., Wiley-Interscience, New York, 1970.

¹⁴⁴ (a) J. Hine, *J. Amer. Chem. Soc.*, **72**, 2438 (1950); (b) J. Hine and A. M. Dowell, Jr., *J. Amer. Chem. Soc.*, **76**, 2688 (1954); (c) J. Hine, A. M. Dowell, Jr., and J. E. Singley, Jr., *J. Amer. Chem. Soc.*, **78**, 479 (1956).

¹⁴⁵ See note 144(a).

¹⁴⁶ (a) J. Hine, N. W. Burske, M. Hine, and P. B. Langford, *J. Amer. Chem. Soc.*, **79**, 1406 (1957), and references to earlier work cited therein; (b) E. D. Bergmann, D. Ginsberg, and D. Lavie, *J. Amer. Chem. Soc.*, **72**, 5012 (1950); (c) R. Lombard and R. Boesch, *Bull. Soc. Chim. France*, 733 (1953); and (d) J. Hine and P. B. Langford, *J. Amer. Chem. Soc.*, **79**, 5497 (1957).

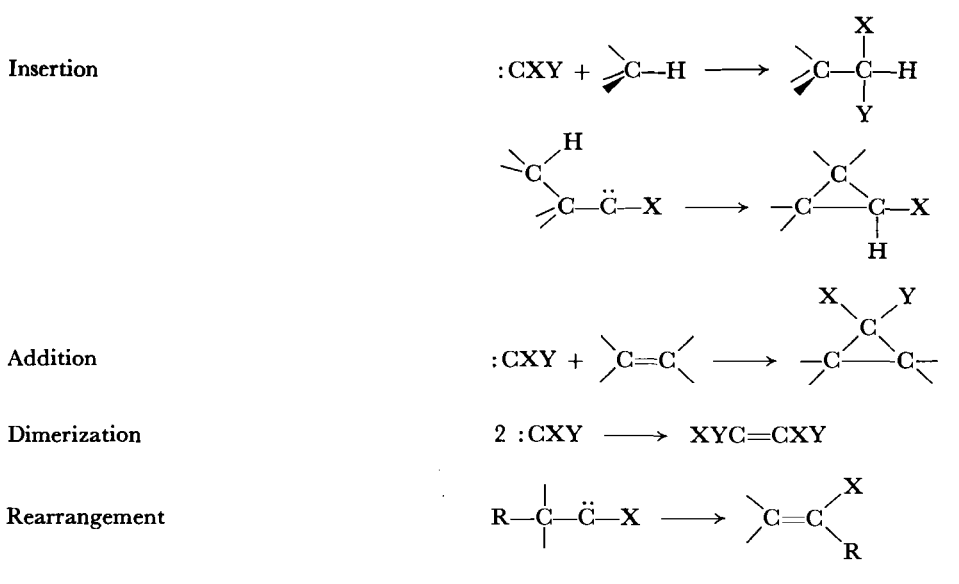
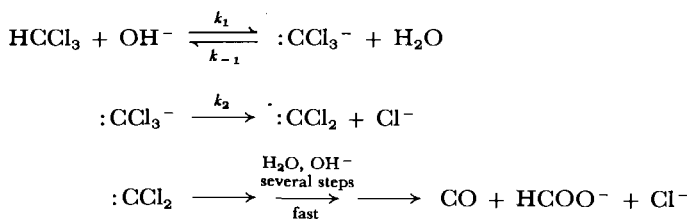
Table 5.7 CHARACTERISTIC REACTIONS OF CARBENES**SCHEME 9**

The α -elimination method is mainly applicable to the halomethylenes. A closely related method of obtaining intermediates of the carbene type is through organometallic derivatives of general structure **58**, where X is a halogen and M is a metal, usually Li, Zn, or Sn. These compounds, when heated in the presence of

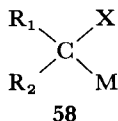

appropriate substrates, yield typical carbene products.¹⁴⁷ In many of these cases, however, it is thought that the free carbene $: \text{CR}_1\text{R}_2$ is not involved, but that the reaction takes place with the organometallic **58** directly. These reactions are termed *carbenoid* to distinguish them from those of free carbenes. The trihalomethylmercury compounds, however, are an exception.¹⁴⁸

¹⁴⁷ See note 141(a).

¹⁴⁸ D. Seyferth, J. Y. Mui, and J. M. Burlitch, *J. Amer. Chem. Soc.*, **89**, 4953 (1967).

The second important route to carbenes is by decomposition of diazo compounds (59) according to Equation 5.32.¹⁴⁹

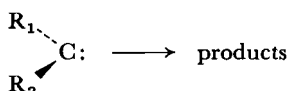
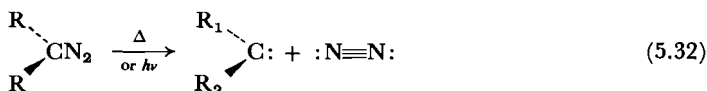
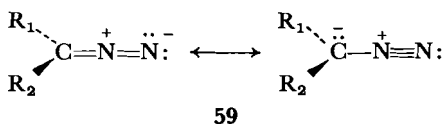

Structure of Carbenes

A carbene carbon uses two of its four valence orbitals for bonding to the attached groups. If the two remaining orbitals are of nearly equal energy, the two unshared electrons should prefer to go one into each with spins parallel (Hund's rule); if the energies are sufficiently different, the electrons will pair and occupy the orbital of lower energy. A structure with two unpaired electrons is said to be in a *triplet state*, a situation well known from spectroscopic observations of excited atoms and molecules, but relatively rare in ground-state chemistry.¹⁵⁰

Herzberg provided the first definitive evidence on the geometry of $:CH_2$ through his observation of absorption spectra of both the lowest-energy triplet and the lowest-energy singlet.¹⁵¹ The precise geometry of the triplet could not be determined, but Herzberg originally concluded that it is linear or nearly so; the spectra did furnish an accurate measurement of the structure of the higher-energy singlet and showed the H—C—H angle to be 102.4°. Structural information is also available for a number of halomethylenes from absorption spectra.¹⁵² Electron paramagnetic resonance spectroscopy (epr) is a second technique that has yielded information on carbene structures.¹⁵³ Similar in principle to nuclear magnetic resonance, epr detects energy changes accompanying changes in electron spin states in a magnetic field. Triplet spectra are characteristic and easily identified.¹⁵⁴ Wasserman and co-workers observed ground-state CH_2 by

¹⁴⁹ Photochemical reactions, indicated in reaction schemes by the symbol $h\nu$, are considered in Chapter 13. For the present, it is sufficient to note that absorption of light transforms a molecule to an excited state, which, in the case of diazo compounds, has sufficient energy for rupture of the C—N bond. Generation of carbenes from diazo compounds is reviewed by W. J. Baron, M. R. DeCamp, M. E. Hendrick, M. Jones, Jr., R. H. Levin, and M. B. Sohn, in Jones and Moss, Eds., *Carbenes*, Vol. 1, p. 1.

¹⁵⁰ An important exception is O_2 , which has a triplet ground state.

¹⁵¹ (a) G. Herzberg and J. Shoosmith, *Nature*, **183**, 1801 (1959); (b) G. Herzberg, *Proc. Roy. Soc.*, **A262**, 291 (1961); (c) G. Herzberg and J. W. C. Johns, *Proc. Roy. Soc.*, **A295**, 107 (1966).

¹⁵² A summary of structural results may be found in Bethel, *Advan. Phys. Org. Chem.*, **7**, 153 (1969).

¹⁵³ Epr spectroscopy is discussed in a number of sources; for a brief introduction see D. J. Pasto and C. R. Johnson, *Organic Structure Determination*, Prentice-Hall, Englewood Cliffs, N.J., 1969, chap. 6.

¹⁵⁴ A. Carrington and A. D. McLachlan, *Introduction to Magnetic Resonance*, Harper & Row, New York, 1967, chapter 8.

electron paramagnetic resonance and concluded, contrary to Herzberg's original determination, that the triplet is nonlinear, with a H—C—H angle of about 136° .¹⁵⁵ Herzberg reinterpreted the ultraviolet data and found that a nonlinear structure is consistent with the spectrum.¹⁵⁶ The picture that emerges for other carbenes is that halomethylenes are ground-state singlets with bond angles in the range $100\text{--}110^\circ$, whereas methylene, arylmethylenes, and probably also alkylmethylenes¹⁵⁷ are ground-state triplets with bond angles $130\text{--}180^\circ$ and have excited singlet states with angles of $100\text{--}110^\circ$. Accurate quantum mechanical calculations reproduce the experimental results well for $:\text{CH}_2$, $:\text{CHF}$, and $:\text{CF}_2$.¹⁵⁸ Structures **60** and **61** show the probable orbital occupancies for singlet and triplet carbenes, respectively.

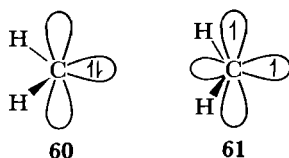

Reactions of Carbenes

The first carbene reaction to be considered is insertion (Equation 5.33). It was first

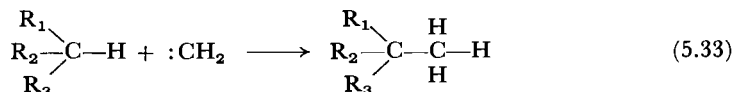

reported in 1942 by Meerwein and co-workers,¹⁵⁹ but its importance was not recognized until Doering investigated the reaction and noted that in the liquid phase $:\text{CH}_2$ generated by photolysis of diazomethane attacks the various types of C—H bonds of hydrocarbons with no discrimination.¹⁶⁰ More extensive results of Richardson, Simmons, and Dvoretzky have confirmed this finding.¹⁶¹ In the gas phase, the reaction is more selective, and when measures are taken to increase the lifetime of the $:\text{CH}_2$ intermediates by addition of an inert gas, so that more of the initially formed unselective singlet has time to decay to the somewhat less reactive triplet ground state, the insertion becomes more selective still.¹⁶² Table 5.8 presents representative experimental results. Insertion is common for

¹⁵⁵ E. Wasserman, V. J. Kuck, R. S. Hutton, and W. A. Yager, *J. Amer. Chem. Soc.*, **92**, 7491 (1970).

¹⁵⁶ G. Herzberg and J. W. C. Johns, *J. Chem. Phys.*, **54**, 2276 (1971).

¹⁵⁷ (a) See note 155; (b) C. A. Hutchinson, Jr., and B. E. Kohler, *J. Chem. Phys.*, **51**, 3327 (1969);

(c) R. Hoffmann, G. D. Zeiss, and G. W. Van Dine, *J. Amer. Chem. Soc.*, **90**, 1485 (1968).

¹⁵⁸ (a) J. F. Harrison and L. C. Allen, *J. Amer. Chem. Soc.*, **91**, 807 (1969); (b) C. F. Bender, H. F. Schaefer III, D. F. Franceschetti, and L. C. Allen, *J. Amer. Chem. Soc.*, **94**, 6888 (1972); (c) M. J. S. Dewar, R. C. Haddon, and P. K. Weiner, *J. Amer. Chem. Soc.*, **96**, 253 (1974); (d) J. F. Harrison, *J. Amer. Chem. Soc.*, **93**, 4112 (1971).











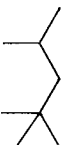
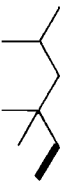

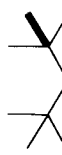
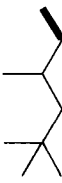

¹⁵⁹ H. Meerwein, H. Rathjen, and H. Werner, *Chem. Ber.*, **75**, 1610 (1942).

¹⁶⁰ W. v. E. Doering, R. G. Buttery, R. G. Laughlin, and N. Chaudhuri, *J. Amer. Chem. Soc.*, **78**, 3224 (1956).

¹⁶¹ D. B. Richardson, M. C. Simmons, and I. Dvoretzky, *J. Amer. Chem. Soc.*, **82**, 5001 (1960); **83**, 1934 (1961).

¹⁶² (a) H. M. Frey and G. B. Kistiakowsky, *J. Amer. Chem. Soc.*, **79**, 6373 (1957); (b) H. M. Frey, *J. Amer. Chem. Soc.*, **80**, 5005 (1958).

Table 5.8 SELECTIVITY OF INSERTION OF :CH₃ INTO C—H BONDS

Substrate	State	Method ^a	Product	Type of C—H bond reacting ^b	Number of equivalent bonds	Calculated yield (%) ^c	Observed yield (%)	Reference
	Liquid	A		1	9	50.0	51	<i>d</i>
				2	2	11.1	10	
				3	1	5.6	4	
				1	6	33.3	35	
	Gas	B		1	6	75	72	<i>e</i>
				2	2	25	28	
	Gas	B		1	9	90	86	<i>e</i>
				3	1	10	14	
	Gas	C		1	6	75	63	<i>f</i>
				2	2	25	37	
	Gas	D		1	6	75	57	<i>f</i>
				2	2	25	43	

^a A: Liquid-phase photolysis of CH₂N₂. B: Gas-phase photolysis of CH₂N₂. C: Gas-phase photolysis of CH₂CO. D: Gas-phase photolysis of CH₂CO with inert gas (CO₂) in eightfold excess over propane.

^b 1 = primary; 2 = secondary; 3 = tertiary.

^c Assuming random attack.

^d D. R. Richardson, M. C. Szwarc, and I. Duncanson, *J. Amer. Chem. Soc.*, **82**, 1024 (1961).

^e Assuming random attack.

^f Assuming random attack.

methylene and carbon-substituted methylenes and can occur either inter- or intramolecularly.

When the carbene is in the triplet state, a hydrogen abstraction to yield a radical pair (Equation 5.34) seems a reasonable possibility for the insertion

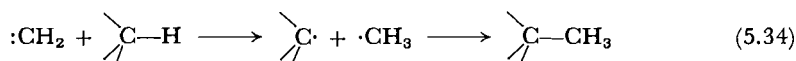

mechanism. The singlet-state carbenes, however, insert into the C—H bond with retention of configuration, and a single-step process is likely.¹⁶³ The attack of the singlet carbene on the C—H bond could occur either through the occupied hybrid (62) or through the vacant *p* orbital (63); the latter possibility, which

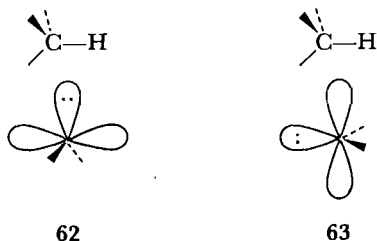

would be electrophilic S_E2 substitution, is in better accord with the strongly electrophilic character of carbenes and with the frontside attack required by the stereochemistry. Theoretical calculations of Hoffmann and co-workers suggest that attack is initially mainly at the hydrogen end of the C—H bond (64), and that transfer of the hydrogen to the incoming CH_2 runs ahead of C—C bond making.¹⁶⁴ This proposal is similar to one by DeMore and Benson.¹⁶⁵ Dihalocarbenes do not insert as readily as does $:\text{CH}_2$;¹⁶⁶ carbenoids usually do not insert.¹⁶⁷

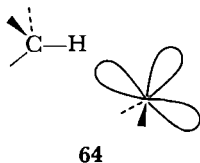

A second characteristic reaction of carbenes is addition to olefins to yield cyclopropanes. Singlet carbenes might react as either nucleophiles or electrophiles; triplets may be expected to behave like free radicals. The data in Table 5.9, showing the increase in rate of addition on substitution of electron-donating

¹⁶³ (a) Kirmse, *Carbene Chemistry*, p. 220; (b) P. S. Skell and R. C. Woodworth, *J. Amer. Chem. Soc.*, **78**, 4496 (1956) (Structures I and II in this paper are reversed. See p. 6427.); (c) W. v. E. Doering and H. Prinzbach, *Tetrahedron*, **6**, 24 (1959); (d) C. D. Gutsche, G. L. Bachman, W. Udell, and S. Bäuerlein, *J. Amer. Chem. Soc.*, **93**, 5172 (1971).











¹⁶⁴ R. C. Dobson, D. M. Hays, and R. Hoffmann, *J. Amer. Chem. Soc.*, **93**, 6188 (1971). See also note 158(b), p. 259.

¹⁶⁵ (a) W. B. DeMore and S. W. Benson, *Advan. Photochem.*, **2**, 219 (1964); for further discussion of the insertion pathway, see (b) E. A. Hill, *J. Org. Chem.*, **37**, 4008 (1972).

¹⁶⁶ V. Franzen and R. Edens, *Justus Liebigs Ann. Chem.*, **729**, 33 (1969).

¹⁶⁷ L. Friedman, R. J. Honour, and J. G. Berger, *J. Amer. Chem. Soc.*, **92**, 4640 (1970), and references cited therein.

Table 5.9 RELATIVE REACTIVITIES OF CARBENES WITH OLEFINS

Carbene	Olefin										Reference	
												
:CF ₂				1.0	12.8							<i>a</i>
:CCl ₂		0.14	1.0		8.3			23		54		<i>b</i>
:CCl ₂	0.24		1.0		2.05		3.53		21.5			<i>c</i>
:CBr ₂		0.17	1.0		3.7			7.4		6.9		<i>b</i>
ICH ₂ ZnI	0.39		1.0			2.53		2.18		1.29		<i>d</i>

^a From $\text{F}_2\text{C} \begin{array}{c} \diagup \text{N} \\ \parallel \\ \diagdown \text{N} \end{array}$, *hv*. R. A. Mitsch, *J. Amer. Chem. Soc.*, **87**, 758 (1965).

^b From HCCl₃ or HCBBr₃, base. W. v. E. Doering and W. A. Henderson, Jr., *J. Amer. Chem. Soc.*, **80**, 5274 (1958).

^c From $\phi\text{HgCCl}_2\text{Br}$. D. Seyferth and J. M. Burlitch, *J. Amer. Chem. Soc.*, **86**, 2730 (1964).

^d E. P. Blanchard and H. E. Simmons, *J. Amer. Chem. Soc.*, **86**, 1337 (1964).

alkyl groups in the olefin, demonstrate that the methylenes and carbenoids are in practice strong electrophiles. Reactivity of carbenoids is lower with the highly substituted olefins, a result of steric hindrance considered to be evidence that they are not free carbenes.¹⁶⁸

A structure with unshared pairs of electrons adjacent to the carbene center (65) should be much less electrophilic. Although systems of this type have not been thoroughly investigated, the available evidence indicates that they have reduced electrophilicity.¹⁶⁹

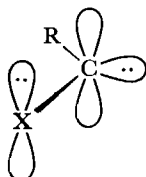

65

A second question posed by the olefin additions is one of stereochemistry. A concerted ring formation of the type shown in Equation 5.35 implies stereospecific cis addition, a suggestion first made in 1956 by Skell and Woodward.¹⁷⁰

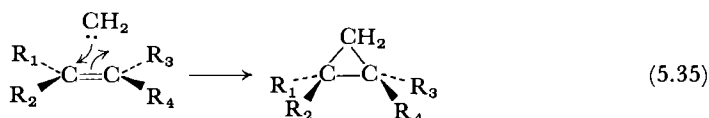

With a triplet carbene, however, the spin state of one of the electrons must change before bonding can be completed; if this process takes long enough for rotation to occur about bonds in the intermediate, a mixture of products should result (Scheme 10).¹⁷¹ It should be pointed out that this argument is not without flaw; the singlet is not required to react stereospecifically simply because it can,

SCHEME 10

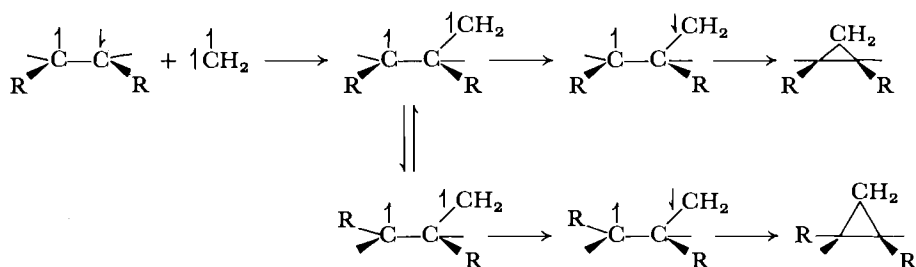



¹⁶⁸ See note 167.

¹⁶⁹ (a) U. Schöllkopf and E. Wiskott, *Angew. Chem. Int. Ed.*, **2**, 485 (1963); (b) D. Seebach, *Angew. Chem. Int. Ed.*, **6**, 443 (1967); see also (c) R. Gleiter and R. Hoffmann, *J. Amer. Chem. Soc.*, **90**, 5457 (1968); (d) H. J. Schönherr and H. W. Wanzlick, *Chem. Ber.*, **103**, 1037 (1970).

¹⁷⁰ (a) See note 163(b); (b) R. Hoffmann, *J. Amer. Chem. Soc.*, **90**, 1475 (1968), argues on the basis of orbital symmetry that the approach cannot be symmetrical, and that the $:\text{CH}_2$ must initially be closer to one end of the olefin than to the other; the one-step stereospecific nature of the addition is not affected by this argument.

¹⁷¹ R. Hoffmann, note 170(b), gives a more rigorous discussion of the additions and reaches the same conclusions regarding stereochemistry.

Table 5.10 STEREOCHEMISTRY OF ADDITION OF CARBENES TO *cis*- AND *trans*-2- BUTENE

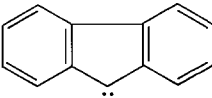
Carbene	Probable Multiplicity, Ground State	Multiplicity, Reactive State ^a	Phase	Conditions	Products, Percent <i>cis</i> Addition		References
					to 	to 	
:CH ₂	Triplet	Singlet	Gas	500 mm pressure	83	95	<i>b</i>
:CH ₂		Triplet	Gas	> 2000 mm; excess argon	51	—	<i>c</i>
:CH ₂		Singlet	Liquid		100	100	<i>d</i>
:CBr ₂	Singlet	(Singlet)	Liquid	α -Elimination	100	100	<i>e</i>
:CCl ₂		(Singlet)	Liquid	From ϕ HgCCl ₂ Br	100	100	<i>f</i>
:CF ₂	Singlet	Singlet	Liquid	From 	100	100	<i>g</i>
:C(CN) ₂	Triplet ^h	(Singlet)	Liquid	Pure olefin as solvent	92	94	<i>i</i>
:C(CN) ₂		(Triplet)	Liquid	Olefin diluted 100:1 with <i>c</i> -C ₆ H ₁₂	30	70	<i>i</i>
	Triplet ^j	Singlet ^k	Liquid	Butadiene added	~98	—	<i>l</i>
		Triplet	Liquid	Diluted with C ₆ F ₆	21	88	<i>l, m</i>

^a Parentheses indicate that reactive state is deduced from stereochemistry of olefin addition.

^b H. M. Frey, *Proc. Roy. Soc.*, **A251**, 575 (1959).

^c H. M. Frey, *J. Amer. Chem. Soc.*, **82**, 5947 (1960).

^d P. S. Skell and R. C. Woodworth, *J. Amer. Chem. Soc.*, **78**, 4496, 6427 (1956).

^e P. S. Skell and A. Y. Garner, *J. Amer. Chem. Soc.*, **78**, 3409, 5430 (1956); W. v. E. Doering and P. LaFlamme, *J. Amer. Chem. Soc.*, **78**, 5447 (1956). It is possible that this α -elimination does not involve a free carbene.

^f D. Seyferth and J. M. Burlitch, *J. Amer. Chem. Soc.*, **86**, 2730 (1964).

^g R. A. Mitsch, *J. Amer. Chem. Soc.*, **87**, 758 (1965).

^h E. Wasserman, L. Barash, and W. A. Yager, *J. Amer. Chem. Soc.*, **87**, 2075 (1965).

ⁱ E. Ciganek, *J. Amer. Chem. Soc.*, **88**, 1979 (1966).

^j R. W. Brandon, G. L. Closs, G. E. Davoust, C. A. Hutchison, Jr., B. E. Kohler, and R. Silbey, *J. Chem. Phys.*, **43**, 2006 (1965).

^k Butadiene is an effective scavenger for triplets.

^l M. Jones, Jr., and K. R. Rettig, *J. Amer. Chem. Soc.*, **87**, 4015 (1965).

^m M. Jones, Jr., and K. R. Rettig, *J. Amer. Chem. Soc.*, **87**, 4013 (1965).

nor must the triplet necessarily add with loss of stereochemistry.¹⁷² Table 5.10 presents the data. It will be noted that, with the exception of dicyanomethylene, loss of stereochemistry is not complete in triplet additions. The rates of spin inversion and bond rotation must be of comparable magnitudes. We discuss this point further in Section 12.1. Stereochemistry of the concerted additions is also considered further in Section 12.1. Carbenoids add stereospecifically,¹⁷³ but since free carbenes are not involved, the singlet-triplet considerations do not apply.

PROBLEMS

1. Show that the simple limiting S_N1 mechanism predicts the kinetic behavior given in Equation 5.4, p. 214.

2. Explain the rate ratio for compounds **1** and **2** estimated for limiting solvolysis.

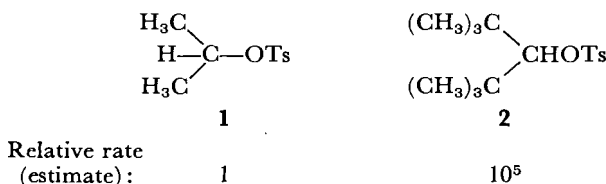

3. Explain the rate ratio for compounds **3** and **4** estimated for limiting S_N1 solvolysis by correcting the cyclopropyl system for anchimeric assistance which occurs when the ring opens.

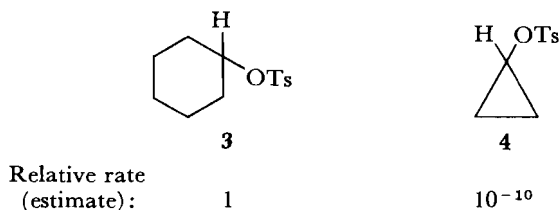

4. Solvolysis rates of isopropyl tosylate and 2-adamantyl tosylate (**28**, p. 243) in 80 percent ethanol are measured with and without added azide. Define rate enhancement, R.E., as the ratio of rate with azide to rate without, and designate by f_{RN_3} the fraction of alkyl azide in the product. Explain the significance of the fact that the isopropyl results fit the equation

$$1 - \frac{1}{\text{R.E.}} = f_{RN_3}$$

while the 2-adamantyl results do not.

5. Explain why the carbene **5** does not react with cyclohexene in the manner of ordinary carbenes, but does react with dimethyl fumarate (**6**) and maleate (**7**) to yield spiropentanes (**8**).

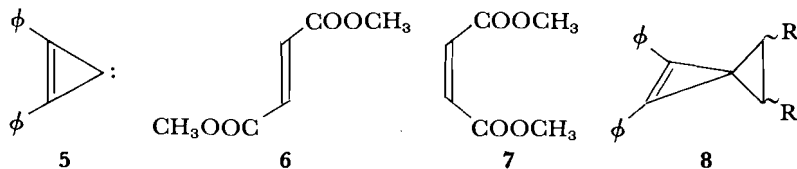

¹⁷² See note 141(b), p. 256 and note 171.

¹⁷³ G. L. Closs and L. E. Closs, *Angew. Chem. Int. Ed.*, **1**, 334 (1962).

6. Explain the relative rates of solvolysis of tosylates **9** and **10**.

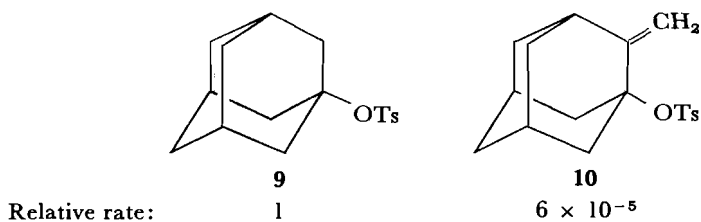

7. Explain why the β -keto acid **11** does not decarboxylate at 300°C, whereas **12** does so readily below 100°C.

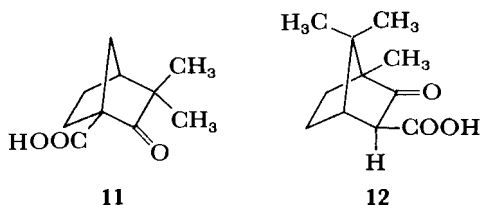

8. Use the reacting bond rule to predict the effect on position of transition state of electron supply at nucleophile and at leaving group in the example considered in the text, pp. 246–250.

9. Predict the products formed by reaction of ground-state carbon atoms with *cis*-2-butene and with *trans*-2-butene.

10. Propose a mechanism to account for the following result:

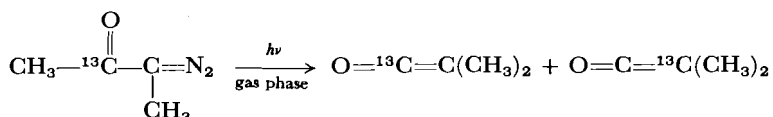

11. Using the reacting bond rules, analyze the change in location of the S_N2 transition state expected when the nucleophile is replaced by a better one. Compare the prediction with Hoffmann's analysis of the $k_{\text{OTs}}/k_{\text{Br}}$ ratio (Section 4.3, p. 192).

12. Show how reaction paths with transition states in which $\text{N}\cdots\text{C}$ bond making has progressed to a greater or lesser extent than $\text{C}\cdots\text{X}$ bond breaking are accommodated in a two-dimensional reaction coordinate diagram.

13. Explain why 1-adamantyl and 2-adamantyl derivatives cannot undergo elimination during solvolysis.

14. Alcohols react with thionyl chloride to yield the unstable chlorosulfite ions (13), which react further to the alkyl chloride and SO_2 . (Rearrangement and elimination can also occur.) In dioxane, the product is formed with retention of configuration

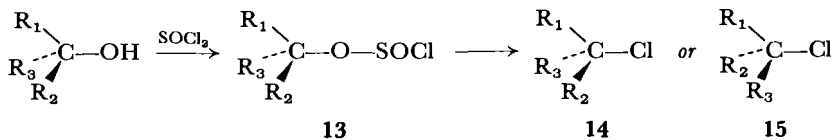

(14). If pyridinium hydrochloride is present, configuration is inverted (15). Explain.

15. For each of the following possible mechanisms for competitive reaction of a substrate RX with solvent, S , and with added nucleophile, N , find the predicted ratio of

rate of disappearance of RX in the presence of N to rate of disappearance of RX in the absence of N.

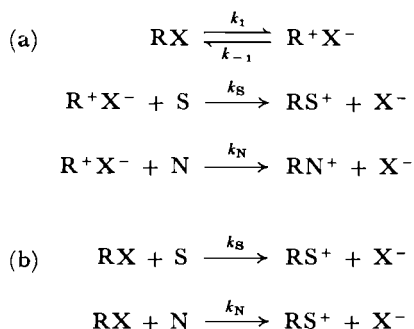

REFERENCES FOR PROBLEMS

- S. H. Liggero, J. J. Harper, P. v. R. Schleyer, A. P. Krapcho, and D. E. Horn, *J. Amer. Chem. Soc.*, **92**, 3789 (1970).
- P. v. R. Schleyer, F. W. Sliwinski, G. W. Van Dine, U. Schöllkopf, J. Paust, and K. Fellenberger, *J. Amer. Chem. Soc.*, **94**, 125 (1972).
- J. M. Harris, D. J. Raber, R. E. Hall, and P. v. R. Schleyer, *J. Amer. Chem. Soc.*, **92**, 5729 (1970).
- W. M. Jones, M. E. Stowe, E. E. Wells, Jr., and E. W. Lester, *J. Amer. Chem. Soc.*, **90**, 1849 (1968).
- V. Buss, R. Gleiter, and P. v. R. Schleyer, *J. Amer. Chem. Soc.*, **93**, 3927 (1971).
- F. S. Fawcett, *Chem. Rev.*, **47**, 219 (1950).
- P. S. Skell and R. R. Engel, *J. Amer. Chem. Soc.*, **87**, 1135 (1965).
- (a) I. G. Csizmadia, J. Font, and O. P. Strausz, *J. Amer. Chem. Soc.*, **90**, 7360 (1968); (b) J. Fenwick, G. Frater, K. Ogi, and O. P. Strausz, *J. Amer. Chem. Soc.*, **95**, 124 (1973); (c) I. G. Csizmadia, H. E. Gunning, R. K. Gosavi, and O. P. Strausz, *J. Amer. Chem. Soc.*, **95**, 133 (1973).
- (a) D. J. Cram, *J. Amer. Chem. Soc.*, **75**, 332 (1953); (b) C. C. Lee and A. J. Finlayson, *Can. J. Chem.*, **39**, 260 (1961); (c) C. C. Lee, J. W. Clayton, D. G. Lee, and A. J. Finlayson, *Tetrahedron*, **18**, 1395 (1962); (d) C. E. Boozer and E. S. Lewis, *J. Amer. Chem. Soc.*, **75**, 3182 (1953).
- R. A. Sneen and J. W. Larsen, *J. Amer. Chem. Soc.*, **91**, 362 (1969).

Chapter 6

INTRAMOLECULAR REARRANGEMENTS

In this chapter we shall discuss intramolecular rearrangements to electron-deficient carbon, nitrogen, and oxygen.

6.1 1,2-SHIFTS IN CARBENIUM IONS¹

The intramolecular migration, shown in Equation 6.1, of a hydrogen, an alkyl, or an aryl group with its pair of electrons from a β carbon (*migration origin*) to the adjacent carbocationic center (*migration terminus*) is called a 1,2-shift (or in the case of migration of an alkyl or an aryl group, a Wagner-Meerwein shift).

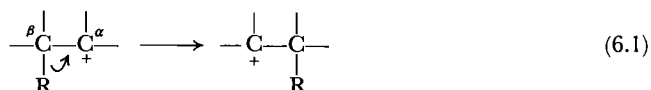

The new carbocation thus formed can subsequently add to a Lewis base, lose a proton from an adjacent atom, or rearrange further.

The first such rearrangement to be studied was that of pinacol (1) to pinacolone (2) in acid solution (Equation 6.2).²

¹ For review articles, see: (a) J. L. Fry and G. J. Karabatsos, in *Carbonium Ions*, G. A. Olah and P. v. R. Schleyer, Eds., Wiley-Interscience, New York, 1970, Vol. II, p. 521; (b) C. J. Collins, *Quart. Rev. (London)*, **14**, 357 (1960); (c) D. M. Brouwer and H. Hogeveen, *Prog. Phys. Org. Chem.*, **9**, 179 (1972); and (d) S. P. McManus, *Organic Reactive Intermediates*, Academic Press, New York, 1973.

² R. Fittig, *Justus Liebigs Ann. Chem.*, **114**, 54 (1860).

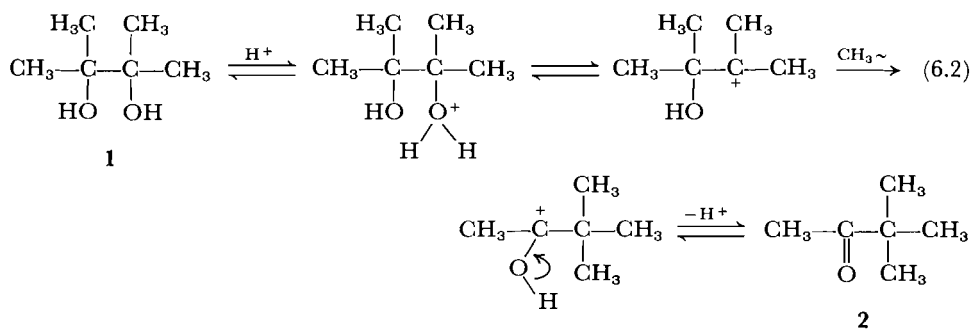

The name "pinacol rearrangement" is now given to the general type of rearrangement exemplified by Equation 6.2, in which the methyl groups on the 1,2-diol may be replaced by other alkyl, hydrogen, or aryl groups.

In the pinacol rearrangement the driving force to migration is the formation of a carbonyl group. The driving force to migration in solvolyses and similar reactions is usually the formation of a more stable carbocation. Since the energy differences between a tertiary and a secondary and between a secondary and a primary carbocation are ca. 16 kcal mole⁻¹ each,³ rearrangements converting a less to a more highly substituted carbocation are exothermic. Thus, for example, reaction of neopentyl iodide with silver nitrate gives entirely rearranged products (Equation 6.3).⁴

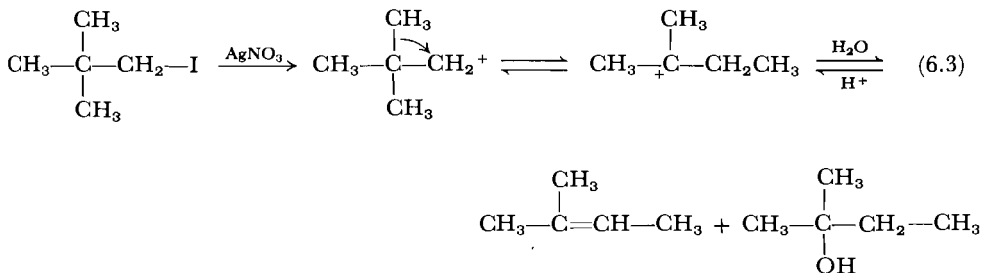

Similarly, the dehydration of 1-butanol leads to 2-butenes (Equation 6.4).^{5,6}

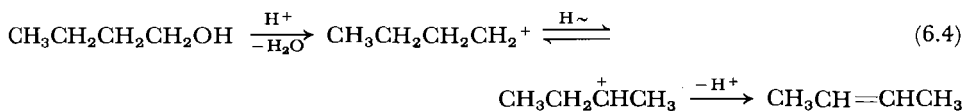

Vinyl cations are less stable than their aliphatic counterparts. Therefore solvolysis of 1-methyl-2,2-diphenylethenyl triflate (trifluoromethylsulfonate)

³ (a) F. D. Lossing and G. P. Semeluk, *Can. J. Chem.*, **48**, 955 (1970); (b) L. Radom, J. A. Pople, and P. v. R. Schleyer, *J. Amer. Chem. Soc.*, **94**, 5935 (1972).

⁴ F. C. Whitmore, E. L. Wittle, and A. H. Popkin, *J. Amer. Chem. Soc.*, **61**, 1586 (1939).

⁵ F. C. Whitmore, *J. Amer. Chem. Soc.*, **54**, 3274 (1932).

⁶ Although the reactions shown in Equations 6.3 and 6.4, and in some equations and schemes found later in this chapter depict a primary carbocation as an intermediate, it is not certain whether these highly unstable species exist in solution. Both reactions may involve migration concerted with departure of the leaving group. See (a) P. Ausloos, R. E. Rebbert, L. W. Sieck, and T. O. Tiernan, *J. Amer. Chem. Soc.*, **94**, 8939 (1972) and references therein; (b) P. C. Hariharan, L. Radom, J. A. Pople, and P. v. R. Schleyer, *J. Amer. Chem. Soc.*, **96**, 599 (1974).

leads to the rearranged product phenyl 1-phenylethyl ketone.⁷ Apparently the mechanism is that shown in Equation 6.5. A 1,2-shift converts one vinyl cation to another, but the rearranged one is stabilized by conjugation with a benzene ring.

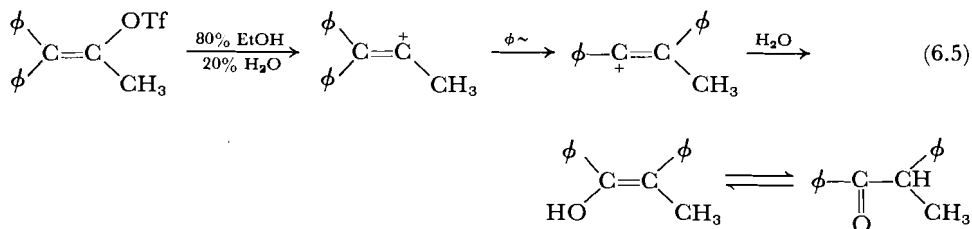

Under the long-lived conditions of carbocations in superacid (Section 5.3, p. 235), 1,2-shifts interconverting ions of like stability also occur and are very rapid. For example, at -180°C the five methyl groups of 2,3,3-trimethylbutyl cation have only one peak in the nmr. This observation implies that the methyl shift in Equation 6.6 occurs at the rate of $75 \times 10^3 \text{ sec}^{-1}$ with an activation barrier of $< 5 \text{ kcal mole}^{-1}$.⁸

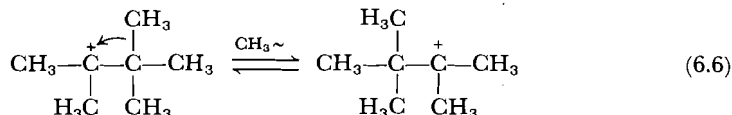

Occasionally rearrangements from more stable to less stable carbocations occur, but only if (1) the energy difference between them is not too large or (2) the carbocation that rearranges has no other possible rapid reactions open to it.⁹ For example, in superacid medium, in the temperature range $0-40^\circ\text{C}$, the proton nmr spectrum of isopropyl cation indicates that the two types of protons are exchanging rapidly. The activation energy for the process was found to be $16 \text{ kcal mole}^{-1}$. In addition to other processes, the equilibrium shown in Equation 6.7 apparently occurs.¹⁰ In the superacid medium, no Lewis base is available

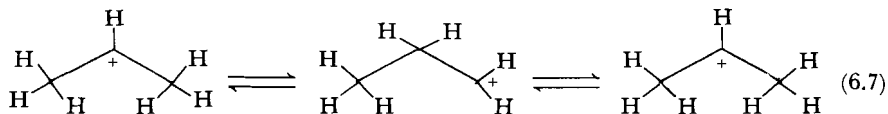

either to add to the carbocation or to accept a proton from it in an elimination reaction, and in the absence of such competing reactions there is ample time for the endothermic 1,2-hydride shift to take place.

1,2-Shifts have stereochemical as well as energetic requirements. In order for such rearrangements to occur, the C—Z (Z = migrating group) bond at the migration origin must lie in, or almost in, the plane described by the vacant p orbital on the adjacent carbon and the $\text{C}_\alpha-\text{C}_\beta$ bond as in Figure 6.1—that is, the dihedral angle between Z and the empty p orbital must be 0° . For example,

⁷ M. A. Imhoff, R. H. Summerville, P. v. R. Schleyer, A. G. Martinez, M. Hanack, T. E. Dueber, and P. J. Stang, *J. Amer. Chem. Soc.*, **92**, 3802 (1970).

⁸ G. A. Olah and J. Lukas, *J. Amer. Chem. Soc.*, **89**, 4739 (1967).

⁹ For references to a number of such rearrangements, see (a) note 3(b) and (b) M. Saunders, P. Vogel, E. L. Hagen, and J. Rosenfeld, *Accts. Chem. Res.*, **6**, 53 (1973).

¹⁰ See note 9(b).

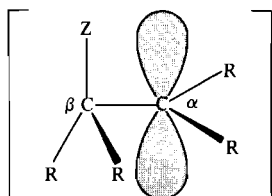
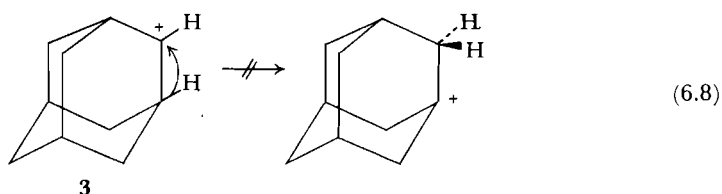
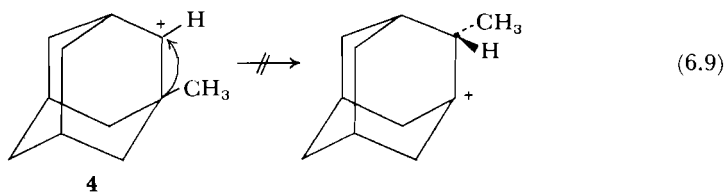

Figure 6.1 The ideal relationship of the empty p orbital to the migrating group (Z) for a 1,2-shift.

the apparent 1,2-hydride shift (Equation 6.8) in the 2-adamantyl cation (**3**) was shown to be entirely quenched in highly dilute solution.¹¹ Thus it must be an *inter-*, not an *intramolecular* reaction. Further, the apparent 1,2-methyl shift in the 2-methyladamantyl cation (**4**, Equation 6.9) has been shown by isotope



labeling to occur by a complicated skeletal rearrangement.¹² In both these cases the C—Z bond and the vacant p orbital, which in **3** and **4** is perpendicular to the plane of the page, form a dihedral angle of 90° .¹³ In this worst of all possible stereochemical situations the simple 1,2-shift cannot occur, and



rearrangement must take another pathway.

The Timing of the Migration in Acyclic Alkyl Systems

A common phenomenon in organic chemistry, illustrated further in Problems 6.1 and 6.2, is that a group adjacent to the leaving group acts as an intramolecular nucleophile. This can occur if the neighboring group has an unshared pair of electrons or a double bond, as shown, for example, in Equations 6.10 and 6.11. The cyclic structures **5** or **6** may sometimes be isolated, but more often are attacked by a nucleophile: The ring is opened and some (or all) of the product may be rearranged.

¹¹ P. v. R. Schleyer, L. K. M. Lam, D. J. Raber, J. L. Fry, M. A. McKervey, J. R. Alford, B. D. Cuddy, V. G. Keizer, H. W. Geluk, and J. L. M. A. Schlatman, *J. Amer. Chem. Soc.*, **92**, 5246 (1970).

¹² Z. Majerski, P. v. R. Schleyer, and A. P. Wolf, *J. Amer. Chem. Soc.*, **92**, 5731 (1970).

¹³ (a) See notes 11 and 12; (b) D. M. Brouwer and H. Hogeveen, *Rec. Trav. Chim. Pays-Bas*, **89**, 211 (1970).

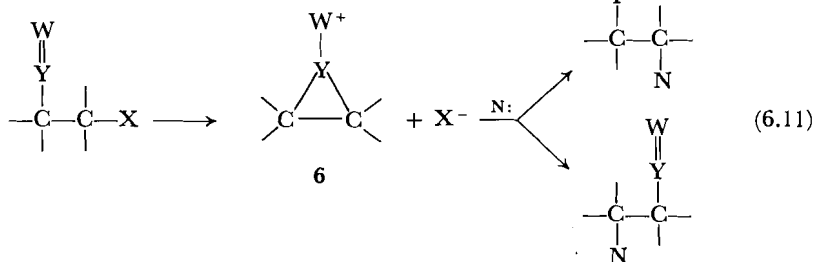
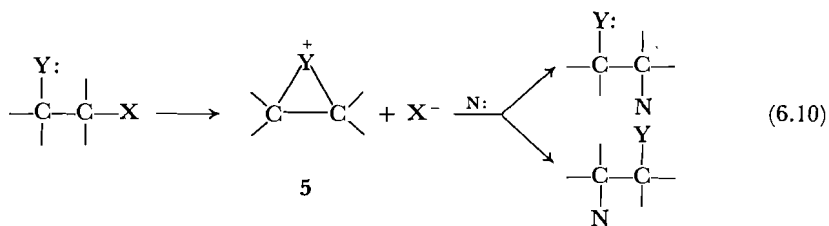

Because the effective concentration of the neighboring group is very high (it is always in the immediate vicinity of the reaction site) and because of the relatively small degree of reorganization required to reach the transition state (and, therefore, small entropy change), reactions of this type are often faster than intermolecular or unimolecular substitutions. The nucleophilic assistance of a neighboring group to departure of a leaving group is called *neighboring group participation* or *anchimeric assistance*.

Analogy with intramolecular nucleophilic substitution reactions raises two fundamental problems in the study of rearrangements. The first is whether, when a carbon or hydrogen migrates in an electron-deficient structure, it does so only after the cationic center has fully formed in a previous step, or whether it migrates simultaneously with departure of the leaving group, thus providing anchimeric assistance. Such participation is conceivable even though carbon and

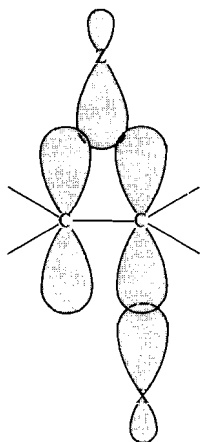
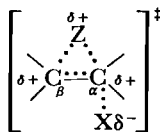

Figure 6.2 Orbital picture of the transition state for a 1,2-shift in which migration is concerted with ionization of the leaving group.

hydrogen have no unshared pairs: The pair of electrons the migrating group takes with it from the β to the α carbon is partially available to the α carbon at the transition state for the migration, as illustrated in Structure 7 and in Figure 6.2.



7

Winstein suggested that hyperconjugation and bridging might be descriptions of a single delocalization phenomenon: In the former there is little movement of the participating group, and in bridging there is much.¹⁴ This idea is illustrated in Figure 6.3.

A second related, but distinct, question is whether there is an energy minimum on the reaction path when the migrating group is bonded to both migration origin and terminus—that is, whether there is a bridged intermediate (8).

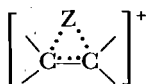

8

If the migrating group does provide anchimeric assistance, certain consequences should follow. One is kinetic: The rate should be faster than the rate of an exactly analogous, but unassisted, reaction. Another is stereochemical: Neighboring-group participation is an intramolecular S_N2 displacement and therefore the migration terminus should be inverted by the rearrangement. Or, looking at it another way, two closely related molecules may react by different paths if in one the neighboring group can attack the leaving group from the back side, but in the other it cannot adopt that position. Most experiments designed to determine whether anchimeric assistance occurs or not have centered on the kinetics

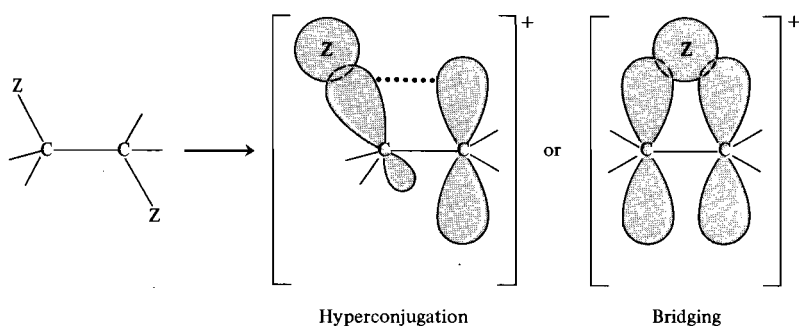
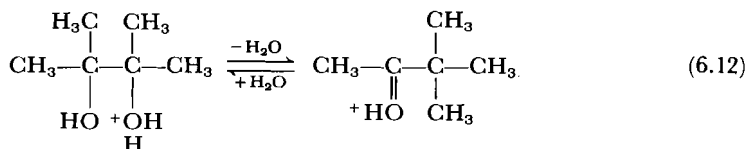

Figure 6.3 Illustration of the idea that bridging and hyperconjugation may be descriptions of a single delocalization phenomenon.

¹⁴ (a) S. Winstein, B. K. Morse, E. Grunwald, K. C. Schreiber, and J. Corse, *J. Amer. Chem. Soc.*, **74**, 1113 (1952). (b) For further discussion of this point, see D. E. Eaton and T. G. Traylor, *J. Amer. Chem. Soc.*, **96**, 1226 (1974) and references therein.

and/or stereochemistry of the reaction under consideration. Rate acceleration is often difficult to ascertain because of problems in predicting the rate of the non-assisted reaction. Inversion of configuration is, of course, experimentally observable only in chiral systems, but in systems that are achiral the stereochemistry of the reaction can often be determined by isotope labeling.

Experiments indicate that in open-chain and unstrained cyclic compounds, hydride and alkyl groups usually do not provide anchimeric assistance if the leaving group is on a secondary or tertiary carbon.¹⁵ (For a discussion of participation in strained cyclic systems, see Section 6.2.) Early evidence against neighboring-group participation by alkyl groups came from oxygen-exchange studies in the pinacol rearrangement. When pinacol was allowed to rearrange in acidic ¹⁸O-labeled water, recovered, unreacted pinacol was found to contain ¹⁸O. This result is consistent with formation of a carbocation that either rearranges to pinacolone or adds water to return to pinacol as shown in Equation 6.2. The possibility that ionization and rearrangement occur in the same step as shown in Equation 6.12 and that the ¹⁸O is incorporated during a reverse rearrangement of pinacolone to pinacol is excluded thus: The addition of pinacolone to the



reaction system does not affect the rate of rearrangement, and therefore the rearrangement cannot be reversible.¹⁶

Stereochemical evidence confirms that neither alkyl nor hydride provides anchimeric assistance in the pinacol rearrangement. Compounds **9** and **10** both

SCHEME 1

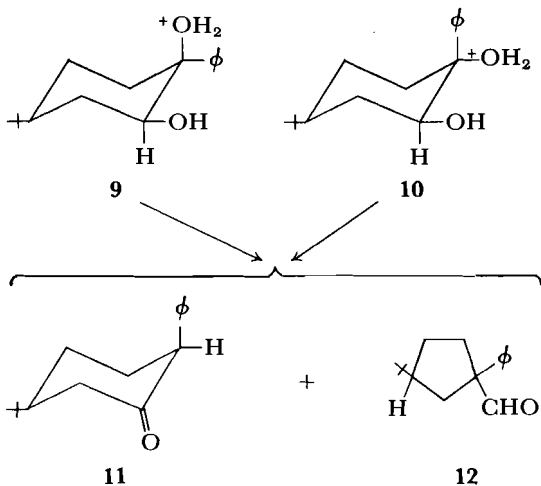

¹⁵ As indicated in note 5, there is still controversy over the existence of primary carbocations in solution. For cases when some participation by neighboring hydride or alkyl in the formation of secondary or tertiary carbocations has been suggested see, for example, (a) V. J. Shiner, Jr., and J. G. Jewett, *J. Amer. Chem. Soc.*, **87**, 1382 (1965); (b) note 13(a), p. 271; (c) S. Winstein and H. Marshall, *J. Amer. Chem. Soc.*, **74**, 1120 (1952).

¹⁶ C. A. Bunton, T. Hadwick, D. R. Llewellyn, and Y. Pocker, *Chem. Ind. (London)*, 547 (1956).

give the same products, **11** and **12**, in the same ratio (9:1) when they undergo the pinacol rearrangement with BF_3 -ether complex, as shown in Scheme 1.¹⁷ (Note that the hydroxy group lost here, as usual, is the one that gives the most stable carbocation.¹⁸) If the migrating group provided anchimeric assistance, it would have to come in from the back side of the departing $-\text{OH}_2^+$. In Compound **9** the group that can come in from the back side is the hydride, and Compound **11** should be the principal product. Conversely, in Compound **10** it is the alkyl chain of the ring that can come in from the back side, and the chief product should be Compound **12**. The fact that the products are formed in a constant ratio indicates that a common intermediate—presumably the planar carbocation—must be formed from both starting materials.¹⁹ More direct stereochemical evidence has been provided by Kirmse and co-workers. Chiral (*S*)-2-methylbutan-1,2-diol (**13**) rearranges to racemic 2-methylbutanal (**14**) as shown in Equation 6.13.²⁰

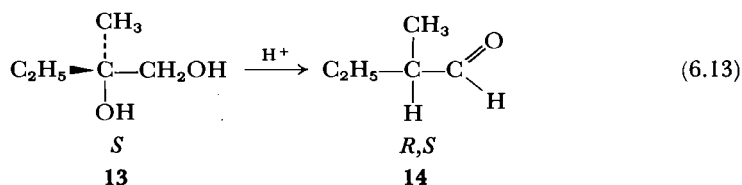

(See also pp. 281–284.)

Aryl Participation—The Phenonium Ion Controversy²¹

A question that has aroused considerable controversy in the past 25 years is whether aryl groups can provide anchimeric assistance and if so under what conditions. The controversy began in 1949 when Cram solvolyzed the *L*-threo and *L*-erythro isomers of 3-phenyl-2-butyl tosylate in acetic acid. *L*-*Threo*-tosylate gave 96 percent racemic *threo*-acetate (plus olefins), whereas the *L*-erythro isomer gave 98 percent *L*-*erythro*-acetate.²² To explain the experimental facts, Cram postulated that neighboring phenyl begins a backside migration to C_α as the tosylate departs. At the first energy maximum both the tosylate and the phenyl

¹⁷ P. L. Barili, G. Berti, B. Macchia, F. Macchia, and L. Monti, *J. Chem. Soc. C*, 1168 (1970).

¹⁸ (a) See note 1(b), p. 268, for examples and exceptions; for another exception see (b) W. M. Schubert and P. H. LeFevre, *J. Amer. Chem. Soc.*, **94**, 1639 (1972).

¹⁹ Departure of the leaving group is apparently rate-determining when the first-formed carbocation is not particularly stabilized. This is shown by the fact that the rate of rearrangement of alkyl glycols is dependent on the concentration of

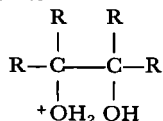

[J. F. Duncan and K. R. Lynn, *J. Chem. Soc.*, 3512, 3519 (1956); J. B. Ley and C. A. Vernon, *Chem. Ind. (London)*, 146 (1956).] That the rate-determining step can be the migration when the first-formed carbocation is particularly stable has been shown by Schubert and LeFevre [note 18(b)]. These workers subjected 1,1-diphenyl-2-methyl-1,2-propanediol to the pinacol rearrangement and found that deuterium substitution in the migrating methyls caused the reaction to slow down.

²⁰ W. Kirmse, H. Arold, and B. Kornrumpf, *Chem. Ber.*, **104**, 1783 (1971).

²¹ C. J. Lancelot, D. J. Cram, and P. v. R. Schleyer, in *Carbonium Ions*, G. A. Olah and P. v. R. Schleyer, Eds., Wiley-Interscience, New York, 1972, Vol. III.

²² D. J. Cram, *J. Amer. Chem. Soc.*, **71**, 3863 (1949).

groups are partially bonded to the α carbon. After heterolysis of the carbon-tosylate bond is complete, an intermediate *phenonium ion* is formed in which the phenyl is equally bonded to both the α and β carbons. The phenonium ion formed from the *L-threo*-tosylate (Equation 6.14) has a plane of symmetry perpendicular to and bisecting the $C_\alpha-C_\beta$ bond and therefore must yield racemic products.

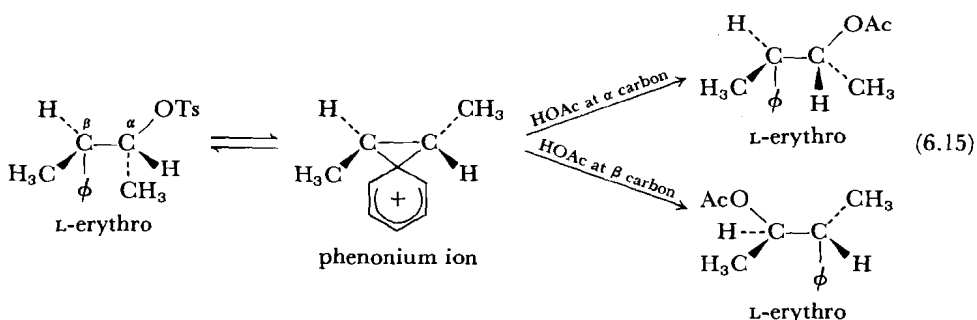
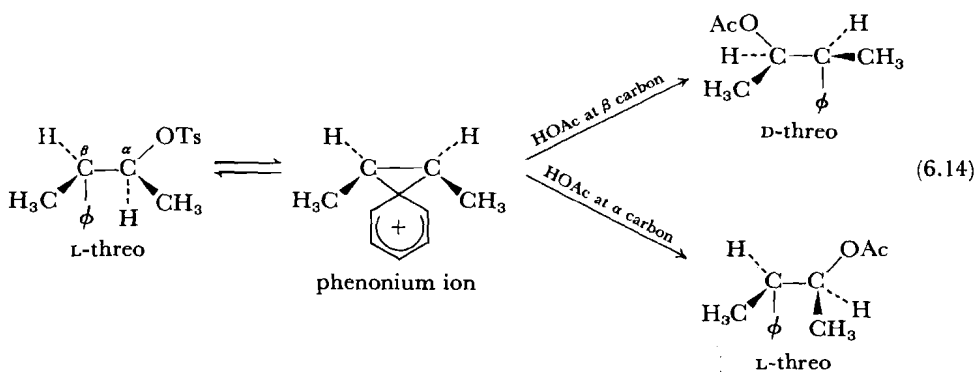

The phenonium ion from the *L-erythro*-tosylate is chiral (Equation 6.15) and can give chiral products. Examination of the two possible paths of attack of acetic acid (it must come from the opposite side from the bulky phenyl ring) in each of the intermediates confirms that the products expected from them are those that are observed experimentally.

Cram provided further evidence for the existence of a phenonium ion intermediate by isolating starting tosylate after reaction had proceeded for 1.5 half-lives; he found that the *L-threo*-tosylate was 94 percent racemized but the *L-erythro*-tosylate was still optically pure.²³ These results can be easily understood if it is assumed that the starting material first forms a phenonium-tosylate intimate ion pair, which can either revert to starting materials or go on to products. The achiral ion pair from the *threo*-tosylate will return to racemic starting material whereas the chiral intermediate from the erythro isomer will return to optically active starting material.

Winstein provided powerful support for the phenonium ion hypothesis in 1952. He followed the rate of solvolysis of *threo*-3-phenyl-2-butyl tosylate both titrimetrically, by titrating the toluenesulfonic acid formed, and polarimetrically

²³ D. J. Cram, *J. Amer. Chem. Soc.*, **74**, 2129 (1952).

by watching the rate of loss of optical activity. He found that the polarimetric rate was five times the titrametric rate and concluded that the intermediate phenonium ion is formed rapidly but reverts back to starting materials four times more often than it goes on to products. That both solvolysis and racemization occur through a common intermediate seemed most probable because of the similar sensitivity of the rates of both reactions to solvent polarity.²⁴

The concept of an intermediate phenonium ion was, at first, controversial, and its chief detractor was H. C. Brown.²⁵ Although 3-phenyl-2-butyl tosylate showed the stereochemical behavior expected if an intermediate phenonium ion were formed, it did not, in his opinion, show the rate acceleration that should attend anchimeric assistance to ionization of the tosylate.²⁶ Brown said that the stereochemical results could be accounted for by invoking rapidly equilibrating open carbocations (15). According to his explanation, ionization of the tosylate

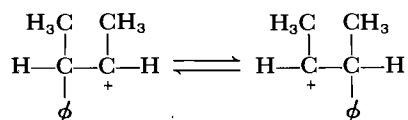

15

occurs, for steric reasons, only when the phenyl and the tosylate are trans to each other. The phenyl then migrates rapidly back and forth, blocking solvent attack from the back side by the "windshield wiper effect." Rotation about the $C_\alpha-C_\beta$ bond does not occur because (1) the rapid phenyl transfer hinders it and (2) the large phenyl group must remain trans to the large, departing, tosylate group. Solvent attack from the back side, relative to the tosylate, is blocked by the phenyl group. Eventually, solvent attacks the α or β carbon from the front side, giving the stereochemical results obtained by Cram and by Winstein.

More recently, studies initiated by Schleyer²⁷ and completed by Brown and Schleyer²⁸ have convinced Brown of the existence of the phenonium ion. Schleyer, Brown, and their co-workers determined the rates and products of aceto-

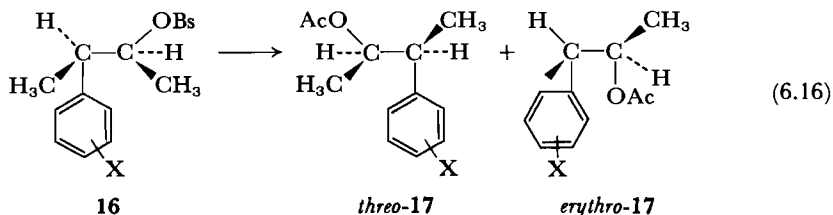

²⁴ S. Winstein and K. C. Schreiber, *J. Amer. Chem. Soc.*, **74**, 2165 (1952).

²⁵ (a) H. C. Brown, *Chem. Soc. (London), Spec. Publ.*, **16**, 140 (1962); (b) H. C. Brown, K. J. Morgan, and F. J. Chloupek, *J. Amer. Chem. Soc.*, **87**, 2137 (1965).

²⁶ The solvolysis of 3-phenyl-2-butyl tosylate is only half as fast as that of 2-butyl tosylate. However, Winstein suggested that the inductive effect of the phenyl group should retard the rate by a factor of ten and that neighboring-group participation therefore has given a fivefold rate enhancement [see note 14(a), p. 273]. See p. 280 for the actual rate enhancement.

²⁷ (a) C. J. Lancelot and P. v. R. Schleyer, *J. Amer. Chem. Soc.*, **91**, 4291, 4296 (1969); (b) C. J. Lancelot, J. J. Harper, and P. v. R. Schleyer, *J. Amer. Chem. Soc.*, **91**, 4294 (1969); (c) P. v. R. Schleyer and C. J. Lancelot, *J. Amer. Chem. Soc.*, **91**, 4297 (1969).

²⁸ (a) H. C. Brown, C. J. Kim, C. J. Lancelot, and P. v. R. Schleyer, *J. Amer. Chem. Soc.*, **92**, 5244 (1970); (b) H. C. Brown and C. J. Kim, *J. Amer. Chem. Soc.*, **93**, 5765 (1971).

lysis of *threo*-3-aryl-2-butyl brosylate (**16**) with a number of different X substituents. Their goal was to calculate from both product and kinetic data the amount of aryl participation in ionization and then to compare the results. If both methods gave the same answer, that would be convincing evidence for the phenonium ion.²⁹

They analyzed the product data by assuming that all the *threo*-acetate formed arises from a phenonium ion and all the *erythro*-acetate from backside assistance of the solvent to ionization. Then the percentage of aryl participation is synonymous with the percentage of *threo*-acetate in the product. The product analyses for acetolysis at 75°C are in the sixth column of Table 6.1.

The rate data were analyzed by assuming Equation 6.17. In this equation k_t is the titrametric rate constant for product formation, k_s is the solvent-assisted ionization constant, and Fk_Δ is the fraction of the aryl-assisted rate constant that gives rise to product (as opposed to the fraction that gives starting material through internal return).

$$k_t = k_s + Fk_\Delta \quad (6.17)$$

The constant k_t is determined experimentally, and k_s can be calculated by use of a Hammett plot as described below. Then Fk_Δ can be calculated by simply subtracting k_s from k_t . If Fk_Δ is the rate of formation of anchimerically assisted solvolysis product, it should lead to *threo*-acetate. The product arising from k_s should lead to *erythro*-acetate. Therefore the fraction of *threo*-acetate expected can be calculated by $Fk_\Delta/(Fk_\Delta + k_s)$ or Fk_Δ/k_t . Column five of Table 6.1 shows the calculated fraction of *threo*-acetate.

In order to find k_s for each compound, the logs of the k_t 's for acetolysis of **16** were determined and plotted against the Hammett σ constants of the X substituents (Figure 6.4). For electron-withdrawing X the plot is a straight line with a negative slope. This is just what would be expected from an aryl-non-assisted pathway in which a negative inductive effect from the phenyl ring decreases the rate of ionization (cf. the effect of substituents on the ionization of

Table 6.1 RATES AND PRODUCTS OF ACETOLYSIS OF SUBSTITUTED *threo*-3-PHENYL-2-BUTYL BROSYLATES (**16**) AT 75.0°C

16 X =	$k_t \times 10^5$	$k_s \times 10^5$	$Fk_\Delta \times 10^5$	$Fk_\Delta/k_t \times 100$	Percent <i>threo</i> - 17 -acetate
<i>p</i> -MeO	1060	14.9	1045	99	100
<i>p</i> -Me	81.4	10.7	70.7	87	88
<i>m</i> -Me	28.2	7.66	20.5	73	68
H	18.0	6.08	11.9	66	59
<i>p</i> -Cl	4.53	2.85	1.68	37	39
<i>m</i> -Cl	2.05	2.05			12
<i>m</i> -CF ₃	1.38	1.38			6
<i>p</i> -CF ₃	1.26	1.26			11
<i>p</i> -NO ₂	0.495	0.495			1
<i>m,m'</i> -(CF ₃) ₂	0.330	0.330			1

SOURCE: H. C. Brown, C. J. Kim, C. J. Lancelot, and P. v. R. Schleyer, *J. Amer. Chem. Soc.*, **92**, 5244 (1970). Reprinted by permission of the American Chemical Society.

²⁹ See note 28.

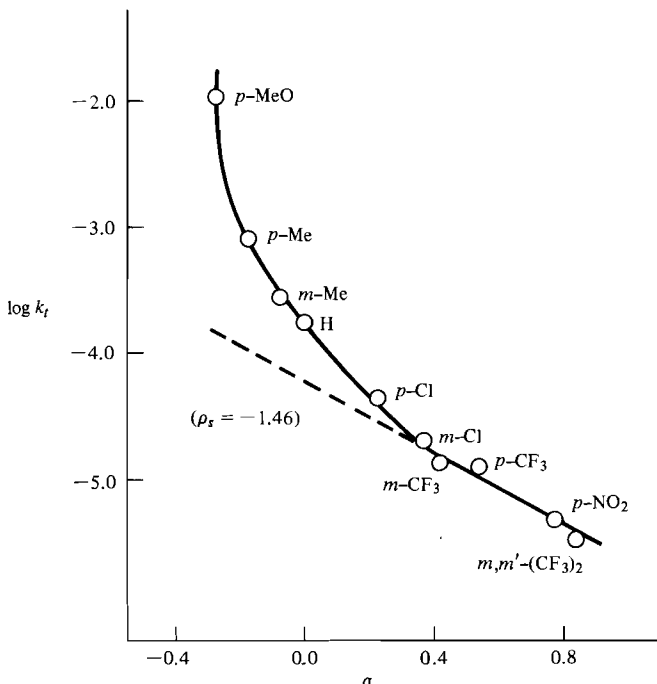

Figure 6.4 Logs of the rates of acetolysis of *threo*-3-aryl-2-butyl brosylates (**16**) at 75.0°C vs. the σ constants of the X substituent. From H. C. Brown, C. J. Kim, C. J. Lancelot, and P. v. R. Schleyer, *J. Amer. Chem. Soc.*, **92**, 5244 (1970). Reprinted by permission of the American Chemical Society.

benzoic acid, Section 2.2). Thus, for electron-withdrawing X, k_s equals k_t . The rates of solvolysis of **16** when X is electron-donating, however, are faster than would be predicted from simple inductive effects. The deviations are ascribed by Brown and Schleyer to anchimeric assistance: The extrapolation of the line correlating the σ constants with the log of the rates when X is electron-withdrawing is taken as defining the k_s contribution when X is electron-donating. For example, the *p*-methoxy substituent has a σ constant of -0.27 . On the extrapolated line this corresponds to $\log k_s = -3.83$ or $k_s = 1.49 \times 10^{-4}$. Experimentally, k_t is found to be 106.0×10^{-4} , thus $Fk_\Delta = 104.5 \times 10^{-4}$. Data for the other substituents are found in Table 6.1.

The excellent correlation between the percentage of anchimeric assistance calculated from the rate (column 5) and product (column 6) data is compelling evidence that the above analyses are accurate and thus that separate, discrete pathways for solvolysis exist—one solvent-assisted and one aryl-assisted.³⁰

Note that a very small rate enhancement corresponds to a large contribution of anchimerically assisted component.³¹ For example, the titrimetric rate

³⁰ The solvent-assisted mechanism for the solvolysis of secondary systems that have no neighboring groups has been confirmed; see Section 5.4, p. 243, and (a) D. J. Raber, J. M. Harris, and P. v. R. Schleyer, *J. Amer. Chem. Soc.*, **93**, 4829 (1971); (b) note 27(b).

³¹ See note 27(c), p. 277.

constant for solvolysis of **16** ($X = H$) is only 18.0/6.08 times faster than the solvolytic rate constant—a rate enhancement of about three. This corresponds to 59 percent anchimeric assistance.

Primary β -aryl tosylates have also been shown to undergo solvolysis by two distinct pathways—aryl- and solvent-assisted.³² Tertiary β -aryl tosylates, however, ionize to a stable carbocation and seem to require no assistance in isomerization.³³

The unsubstituted phenonium ion, as well as other phenonium ions substituted with electron-donating groups, have been recently observed as stable ions in superacid medium.³⁴ That the structure is actually **18** and not an unsymmetrically bridged ion (**19**) nor a nonclassical ion (**20**) (see Section 6.2) in which there are three-center bonds was shown by the nmr evidence. The ring carbon that is bonded to the aliphatic carbons was established by ¹³C shifts to be tetrahedral in nature; and ¹³C and proton chemical shifts in the ring were similar to those of cations shown to have Structure **21**.

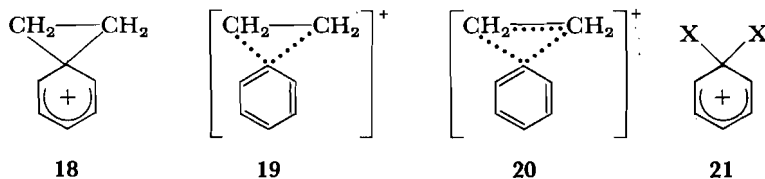

Stereochemistry³⁵

The central carbon of the migrating group and the carbons of the migration terminus and of the migration origin all undergo bonding changes during a Wagner-Meerwein shift, and the stereochemistry at each may change.

The orbital picture we have previously formulated (Figure 6.2) predicts that the stereochemistry of the migrating group will be retained during the migration since, in this picture, the migrating group uses the same lobe of the same orbital to bond to both migration origin and migration terminus. Predominant retention is in fact observed, but some racemization may occur. For example, in the semipinacol rearrangement³⁶ of (3*S*)-1-amino-2,3-dimethyl-2-pentanol (**22**), the product **23** that arises from migration of the *S*-butyl group accounts for 33 percent of the product. The chirality of the *S*-butyl group in **23** is only 86–88 percent retained.³⁷ Kirmse and co-workers have proposed that the pathway for

³² J. M. Harris, F. L. Schadt, P. v. R. Schleyer, and C. J. Lancelot, *J. Amer. Chem. Soc.*, **91**, 7508 (1969).

³³ H. C. Brown and C. J. Kim, *J. Amer. Chem. Soc.*, **90**, 2082 (1968).

³⁴ (a) G. A. Olah and R. D. Porter, *J. Amer. Chem. Soc.*, **93**, 6877 (1971) and references therein; (b) G. A. Olah, *Angew. Chem. Int. Ed.*, **12**, 173 (1973).

³⁵ D. J. Cram, in *Steric Effects in Organic Chemistry*, M. S. Newman, Ed., Wiley, New York, 1956.

³⁶ The semipinacol rearrangement is the rearrangement that ensues when a β -amino alcohol is deaminated as in the following equation. See Problem 6.4.

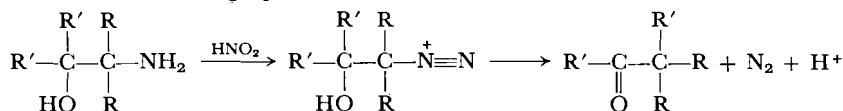

³⁷ W. Kirmse and W. Gruber, *Chem. Ber.*, **106**, 1365 (1973); W. Kirmse, W. Gruber, and J. Knist, *Chem. Ber.*, **106**, 1376 (1973).

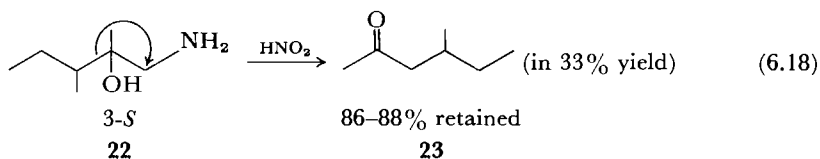

racemization involves the cyclopropanol **24** as an intermediate. Their proposed mechanism is abbreviated in Equation 6.19.³⁸ The intermediacy of **24** is supported by the fact that deuterium is incorporated into **23** when the deamination is carried out in D_2O .

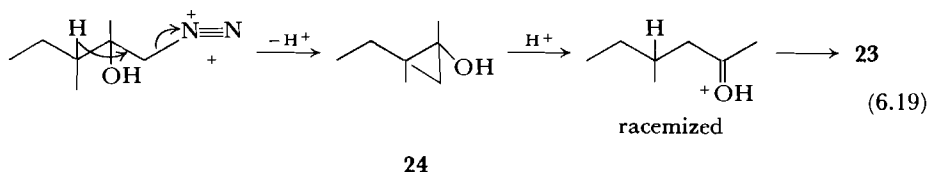

The stereochemistry at the migration terminus depends on the relative timing of the leaving group's departure and the 1,2-shift. In the

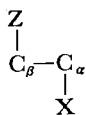

system, if Z begins to migrate before X has completely departed, the migration terminus, C_α , will be inverted. We have already seen in Cram's work that phenyl migration with neighboring-group participation leads to an inverted migration terminus. If, however, X departs before Z begins to move, either retention or inversion can occur at C_α . If the lifetime of the carbocation is very short, retention will result if Z was cis to the leaving group in the unreacted starting material (Equation 6.20) and inversion will result if Z was trans (Equation 6.21).

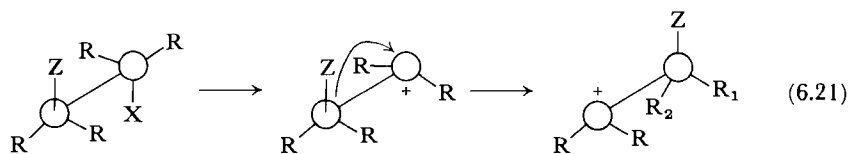
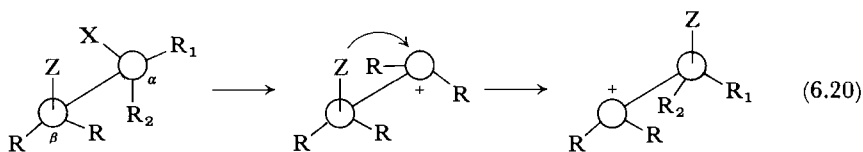

If the C_α carbocation has a long lifetime and there is free rotation about the $\text{C}_\alpha\text{—C}_\beta$ bond, the relative amounts of retention and inversion will depend on

³⁸ Kirmse and co-workers suggest that **24** is formed and destroyed via a protonated cyclopropane (see Section 6.2, p. 310).

whether the transition state leading to retention or inversion is more stable. If they are of equal energy, racemization should result; we have already seen an example of this in Equation 6.13.

Deamination of amines often gives rise to "hot," short-lived carbocations (Section 5.2, p. 226). Deamination of (+)-1,1-diphenyl-2-amino-1-propanol specifically labeled with ^{14}C in one of the two phenyl groups (**25**) gives α -phenylpropiophenone as product, 88 percent of it inverted and 12 percent retained. All the inverted ketone comes from migration of the ^{14}C -labeled phenyl and all the retained from migration of the unlabeled phenyl group (Equation 6.22).³⁹ This

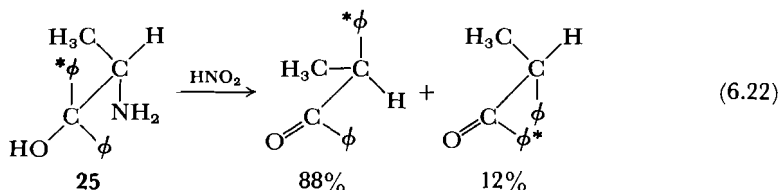

behavior can be understood if we look at the ground state of **25**. The most stable of the three staggered rotamers of **25** is **25a** (in this conformation each of the large phenyl groups has one small proton next to it), and therefore most of the amine molecules adopt this conformation. When the free carbocation is formed from **25a** there is not time for rotation about the $\text{C}_\beta\text{—C}_\alpha$ bond before a phenyl group migrates. The labeled phenyl is backside to the original amine group, and

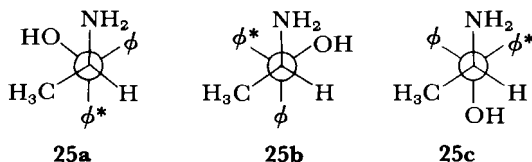

migration of it gives inversion. The unlabeled phenyl is frontside, and its migration gives retention.

The first-formed carbocation from the deamination of *threo*-1-amino-1-phenyl-2-*p*-tolyl-2-propanol (**26**) is stabilized by resonance and longer lived than the carbocation formed from the deamination of **25**. In rotamers **26b** and **26c** the bulky phenyl and *p*-tolyl groups are next to each other, and thus again the ground state amine will be almost entirely in the conformation represented by rotamer **26a**. The carbocation formed from **26a** presumably has time to rotate about the

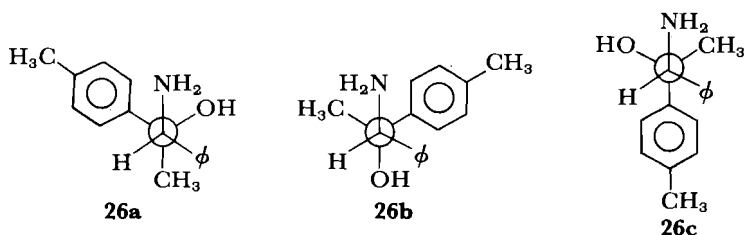

³⁹ B. M. Benjamin, H. J. Schaeffer, and C. J. Collins, *J. Amer. Chem. Soc.*, **79**, 6160 (1957).

C_α — C_β bond before the migration because, although the product of tolyl migration is formed in >80 percent yield, 58 percent of it is retained and 42 percent inverted. Scheme 2 shows the probable reason for the predominance of the retained product. In the transition state for it (27) the two large groups (phenyl and methyl) are trans to each other but in the transition state for inversion (28) they are cis.⁴⁰

SCHEME 2

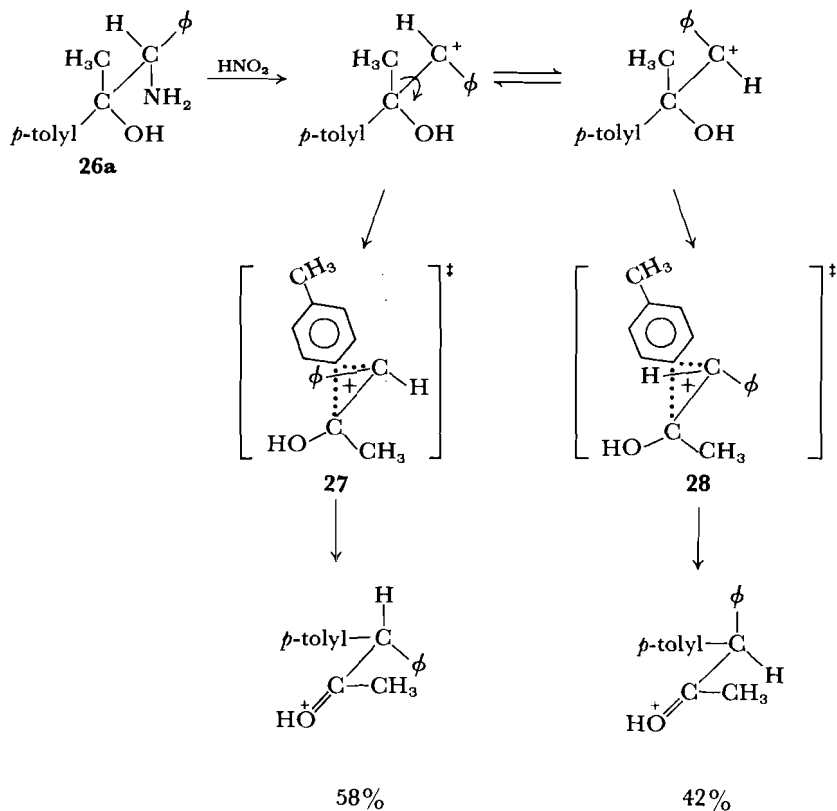

The absence of neighboring-group participation in deamination reactions seems to be a fairly general phenomenon in the chemistry of these "hot" ions, although when the neighboring group is as reactive as *p*-methoxyphenyl some participation may occur.⁴¹

When the steric effects in the transition states for retention and inversion are of equal energy, attack of a migrating group on a hot carbocation occurs preferentially from the back side. For example, (*R*)-1-amino-2-methylbutanol-1 (29), is deaminated in aqueous HClO_4 to afford 2-methylbutanal, 14, (16 percent) with 30 percent inversion of configuration at C_α .⁴²

⁴⁰ B. M. Benjamin and C. J. Collins, *J. Amer. Chem. Soc.*, **83**, 3662 (1961).

⁴¹ P. I. Pollak and D. Y. Curtin, *J. Amer. Chem. Soc.*, **72**, 961 (1950).

⁴² See note 20, p. 275.

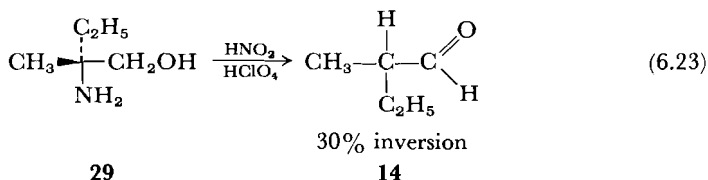

(Comparison of Equations 6.23 and 6.13 shows how the stereochemistry at C_α may depend on the lifetime of the carbocation.)

The stereochemistry at the migration origin cannot always be studied because, as in the pinacol and semipinacol rearrangements and as in Wagner-Meerwein shifts where migration is followed by loss of a proton, the migration origin often becomes trigonal in the product. When it is tetrahedral in the product its stereochemistry varies and is not yet fully understood. If the nucleophile attacks before the migrating group has fully departed, then it must come in from the back side and give inversion at the migration origin. We saw a dramatic example of this in Cram's work on the solvolysis of 3-phenyl-2-butyl tosylate, in which solvent attacks the phenonium ion directly and the migration origin, C_β , is almost entirely inverted. If the migrating group has completely departed from the migration origin before the nucleophile attacks *and* there is time for rotation about the C_α — C_β bond, then racemization should result. (If there is not time for free rotation, attack from one side might be less hindered than attack from the other.) Racemization at C_β occurs, for example, in the deamination of (*S*)-1-amino-2-cyclohexylbutane (**30**), which affords, among other products, racemic 2-cyclohexylbutan-2-ol (**31**).⁴³

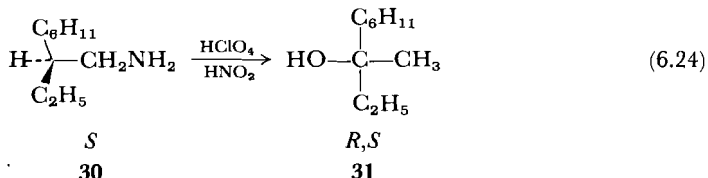

A number of cases have been found in which 1,2-hydride shifts occur with retention at C_β . For example, (*S*)-6-(aminomethyl)-2-methyloctane (**32**) is deaminated in aqueous perchloric acid to give 2,6-dimethyloctan-6-ol in 35 percent yield. This product is formed with 41 percent retention at C_β . No fully satisfactory explanation for the retention has been proposed.⁴⁴

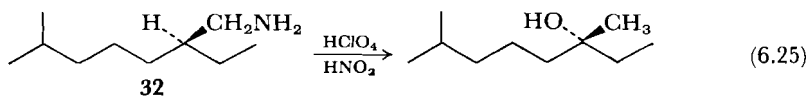

Migratory Aptitudes

The relative ease with which alkyl and aryl groups migrate is called their *migratory aptitude*. Unfortunately, migratory aptitudes are not absolute quantities; values determined in one reaction under one set of conditions may differ enor-

⁴³ W. Kirmse and W. Gruber, *Chem. Ber.*, **104**, 1789 (1971).

⁴⁴ W. Kirmse and H. Arold, *Chem. Ber.*, **104**, 1800 (1971).

mously from values in another reaction or even in the same reaction under other conditions.

Both "intermolecular" and intramolecular migratory aptitudes have been studied in the pinacol rearrangement. For determination of the latter, a pinacol in which the β carbon is substituted with two different R groups is used, and the product is analyzed to see in what proportion the two groups have migrated. It is necessary to use symmetrical pinacols, (33) and compare the migration of R_1 and R_2 . If unsymmetrical pinacols (34) are used, the group with the higher migratory aptitude may not be able to migrate. For example, if 1,1-dimethyl-2,2-diphenylethylene glycol is treated with H_2SO_4 in acetic anhydride, only methyl

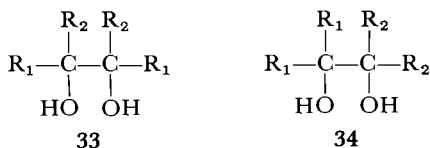

migration occurs.⁴⁵ This does not mean that methyl has the higher migratory aptitude, but simply that the more stable diphenyl-substituted cation (35) is formed in preference to the dimethyl-substituted cation (36), as shown in Equation 6.26. In 35 only methyl migration is possible.

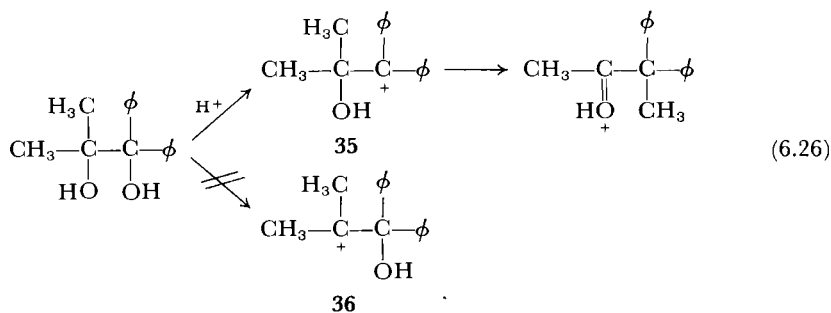

By analyzing the products of ten symmetrical glycols of the type of Structure 33 Bachmann determined the following migratory aptitudes relative to phenyl: *p*-ethoxyphenyl, 500; anisyl, 500; *p*-tolyl, 15.7; *p*-biphenyl, 11.5; *m*-tolyl, 1.95; *m*-methoxyphenyl, 1.6; phenyl, 1.0; *p*-chlorophenyl, 0.66; *m*-chlorophenyl, 0.⁴⁶

"Intermolecular" migratory aptitudes in the pinacol rearrangement have been determined by comparing the rates of rearrangement of different pinacols, each with four identical substituents of the type 37.

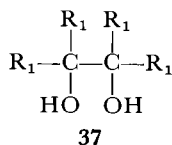

⁴⁵ Ramart-Lucas and M. F. Salmon-Legagneur, *Compt. Rend.*, **188**, 1301 (1929).

⁴⁶ W. E. Bachmann and J. W. Ferguson, *J. Amer. Chem. Soc.*, **56**, 2081 (1934).

The migratory aptitudes obtained in this way were *p*-anisyl, 880; *p*-tolyl, 40; phenyl, 1; *p*-chlorophenyl, 0.⁴⁷ Depovere points out that the larger values for the migratory aptitudes of *p*-anisyl and *p*-tolyl here as compared to Bachmann's data are due to the twofold role of the electron-donating groups in **37**: They migrate better from the β carbon and they facilitate ionization at the α carbon.

We have already mentioned that migratory aptitudes are dependent on the reaction and on the conditions under which the reaction is carried out. An example of the latter type of variation is that in the pinacol rearrangement of triphenylethylene glycol, the phenyl/hydrogen migration ratio may vary by a factor of 180 (from 7.33 to 0.41) when the catalyst is changed from concentrated sulfuric acid to HCl in water/dioxane.⁴⁸

A striking example of the former type of variation can be gained from a comparison of the migratory aptitudes in the pinacol rearrangement (see above) with those in a deamination reaction. For example, the semipinacol rearrangement of **38** gives the following migratory aptitudes: *p*-anisyl, 1.5; *p*-tolyl, 1.3; phenyl, 1; *p*-chlorophenyl, 0.9.⁴⁹

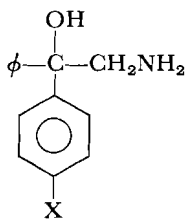

38

Generally, deamination reactions show a lower selectivity than pinacol and Wagner–Meerwein rearrangements. This has been explained in two ways. First, the “hot” carbocation theory says that carbocations formed from deamination are of extremely high energy and therefore lacking in discrimination.⁵⁰ Huisgen, on the other hand, has proposed that in deamination, because the energy of ionization is very low, the absolute differences in the activation energies for the possible subsequent reactions are small. This follows if one assumes a constant ratio between the activation energies of the various steps on the reaction path.⁵¹ (See also Section 5.2, p. 226.)

A novel method of measuring migratory aptitudes has been published by Shubin and co-workers.⁵² They studied the temperature at which the two methyls of **39** became equivalent in superacid solution in the nmr and found the following results for various substituents X: H, 70°C; CH₃, -100°C; Cl, -55°C; F, -70°C; CF₃, 0°C.

⁴⁷ P. Depovere and R. Devis, *Bull. Soc. Chim. France*, 479 (1969).

⁴⁸ C. J. Collins, *J. Amer. Chem. Soc.*, **77**, 5517 (1955).

⁴⁹ D. Y. Curtin and M. C. Crew, *J. Amer. Chem. Soc.*, **76**, 3719 (1954).

⁵⁰ D. Semenov, C.-H. Shih, and W. G. Young, *J. Amer. Chem. Soc.*, **80**, 5472 (1958).

⁵¹ R. Huisgen and C. Rüdhardt, *Justus Liebigs Ann. Chem.*, **601**, 1 (1956).

⁵² V. G. Shubin, D. V. Korchagina, G. I. Borodkin, B. G. Derendjaev, and V. A. Koptuyug, *J. Chem. Soc., D*, 696 (1970).

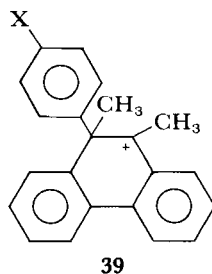

Memory Effects⁵³

Heretofore we have been concerned mainly with single rearrangements. Multiple rearrangements also occur, in which the carbocation formed after the initial migration rearranges again (and again) before products are formed. Some of these consecutive rearrangements are remarkable in that presumably identical carbocations, which arise by rearrangement from different starting materials, retain a memory of their antecedent and give different second rearrangements.

For example, deamination of *syn*- and *anti*-2-norbornenyl-7-carbinyl amines (**40** and **41**) both give twice-rearranged products (Equations 6.27 and 6.28). The first rearrangement in both deaminations is a ring expansion to give **42**.

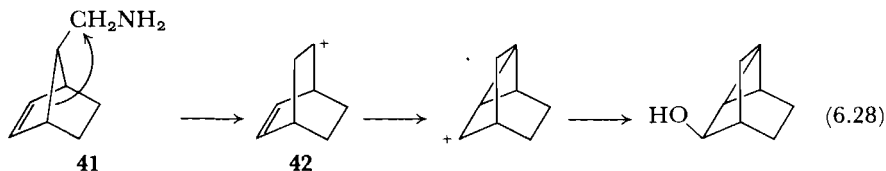
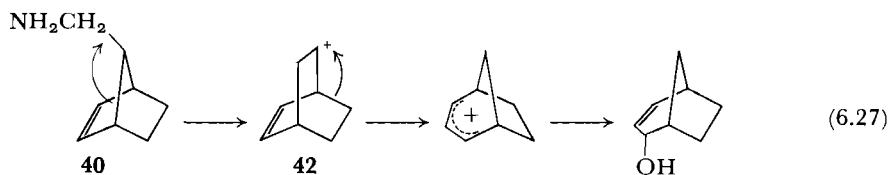

If **42** is symmetrical, as would be expected if a flat carbocation were formed, both reactions should go on to give the same products. But they do not.⁵⁴

The cause of the memory effect is not well understood. Berson has suggested that the symmetrical ion **42** is not the first-formed cation in both reactions, but that twisted cations that can rearrange further before they undergo the readjustments that convert them to **42** are formed first. In this view **40** would first form **43**, in which the σ bond is better able to migrate than the π bond, whereas **41** would first form **44**, in which the π bond is better situated for migration.⁵⁵

⁵³ For a review, see J. A. Berson, *Angew. Chem. Int. Ed.*, **7**, 779 (1968).

⁵⁴ J. A. Berson, J. J. Gajewski, and D. S. Donald, *J. Amer. Chem. Soc.*, **91**, 5550 (1969).

⁵⁵ See (a) note 53; (b) note 54; (c) J. A. Berson, J. M. McKenna, and H. Junge, *J. Amer. Chem. Soc.*, **93**, 1296 (1971).

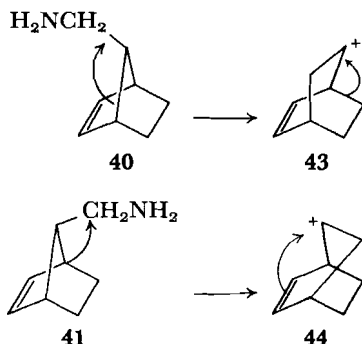

Collins, on the other hand, has proposed that the memory effect can be explained, at least for some systems, by "counter-ion control": The leaving group stays near the site of ionization and thereby influences the future steric course of the reaction.⁵⁶

6.2 CARBONIUM IONS⁵⁷⁻⁶⁰

In this section we shall discuss carbocations in which at least one carbon, through a three-center bond (see Section 5.3) is coordinated to four or five atoms. By Olah's terminology these are "carbonium ions" as opposed to tricoordinated "carbenium ions."⁶¹ By older terminology the more highly coordinated carbocations are called "nonclassical carbonium ions" to differentiate them from the tricoordinated "classical carbonium ions."

Homoallylic Carbonium Ions⁶²

In 1946 Shoppee noted that the reaction of 3- β -cholesteryl chloride with acetate ion proceeds entirely with retention of configuration (Equation 6.29). Substitutions on the analogous saturated compound proceed with the expected

⁵⁶ C. J. Collins, I. T. Glover, M. D. Eckart, V. F. Raaen, B. M. Benjamin, and B. S. Benjaminov, *J. Amer. Chem. Soc.*, **94**, 899 (1972).

⁵⁷ For a review on the general subject, see P. D. Bartlett, *Nonclassical Ions*, W. A. Benjamin, Menlo Park, Calif., 1965.

⁵⁸ For reviews of homoallylic and small-ring participation, see: (a) R. Breslow, in *Molecular Rearrangements*, P. Mayo, Ed., Wiley-Interscience, New York, 1963, Vol. 1, p. 233; (b) M. Hanack and H.-J. Schneider, *Angew. Chem., Int. Ed.*, **6**, 666 (1967); (c) R. R. Story and B. C. Clark, in *Carbonium Ions*, G. A. Olah and P. v. R. Schleyer, Eds., Wiley-Interscience, New York, 1972, Vol. III, p. 1007; (d) K. B. Wiberg, B. A. Hess, and A. J. Ashe, in *Carbonium Ions*, Olah and Schleyer, Eds., Vol. III, p. 1295; (e) H. G. Rickey, in *Carbonium Ions*, Olah and Schleyer, Eds., Vol. III, p. 1201.

⁵⁹ For reviews of bicyclic carbonium ions, see: (a) J. A. Berson in *Molecular Rearrangements*, P. Mayo, Ed., N.Y., Vol. I, p. 111; (b) G. D. Sargent, *Quart. Rev.* (London), **20**, p. 301 (1966); (c) G. D. Sargent, in *Carbonium Ions*, Olah and Schleyer, Eds., Vol. III, p. 1099.

⁶⁰ For an opposing view, see (a) note 25(a), p. 277; (b) H. C. Brown, *Chem. & Eng. News*, **45**, Feb. 13, p. 87 (1967); (c) H. C. Brown, *Acts. Chem. Res.*, **6**, 377 (1973); (d) E. N. Peters and H. C. Brown, *J. Amer. Chem. Soc.*, **96**, 263, 265 (1974); (e) H. C. Brown, M. Ravindranathan, and E. N. Peters, *J. Amer. Chem. Soc.*, **96**, 7351 (1974).

⁶¹ G. A. Olah, *J. Amer. Chem. Soc.*, **94**, 808 (1972).

⁶² See note 58.

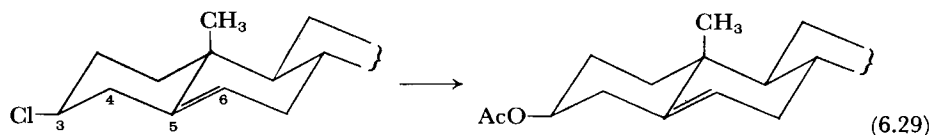

inversion. Shoppee postulated some sort of assistance from the 5,6-double bond to explain these results.⁶³

Winstein investigated the kinetics and products of 3- β -cholesteryl substitutions further. He found that under certain conditions 3- β -cholesteryl tosylate (or chloride) is acetylated to the cholesteryl *i*-acetate (Equation 6.30), and that this reaction is 100 times faster than the solvolysis of cyclohexyl tosylate. Moreover,

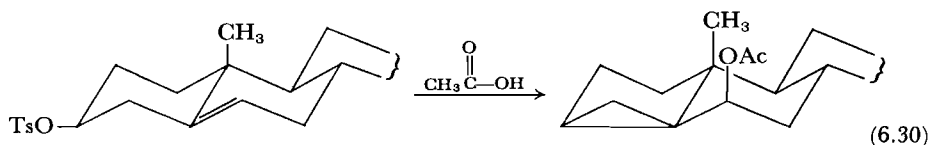

if the conditions are slightly varied, the *i*-acetate undergoes rearrangement to form 3- β -cholesteryl acetate, also at an enhanced rate.⁶⁴ Rate enhancement for Reaction 6.30 might be explained if solvolysis of the tosylate leads immediately to the rearranged ion **45**, and if this ion is for some reason particularly stable. Its formation would then be the driving force for the reaction. However, this explanation cannot be correct. If the driving force for acceleration of Reaction 6.30 is the formation of cation **45**, then the reverse ring opening of the *i*-acetate should not have a comparable driving force, but it does. Winstein suggested that a stabilized intermediate was common to both reactions and was responsible for their accelerated rates.



But what is the nature of the intermediate? A π bond between the empty p orbital on C₃ and the p orbital on C₅ could not impart such stability, because π overlap falls off rapidly with distance. Winstein suggested that the empty p orbital on C₃ overlaps in an end-on, or σ , fashion with the p orbital on C₅, while at the same time the 5,6- π bond is maintained, resulting in a two-electron,

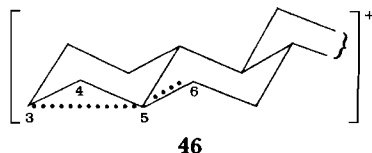

⁶³ C. W. Shoppee, *J. Chem. Soc.*, 1147 (1946).

⁶⁴ S. Winstein and R. Adams, *J. Amer. Chem. Soc.*, **70**, 838 (1948).

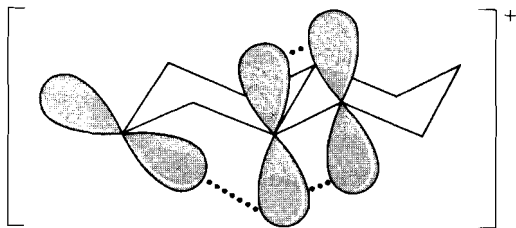

Figure 6.5 Orbital picture of homoallylic participation in the cholesteryl system.

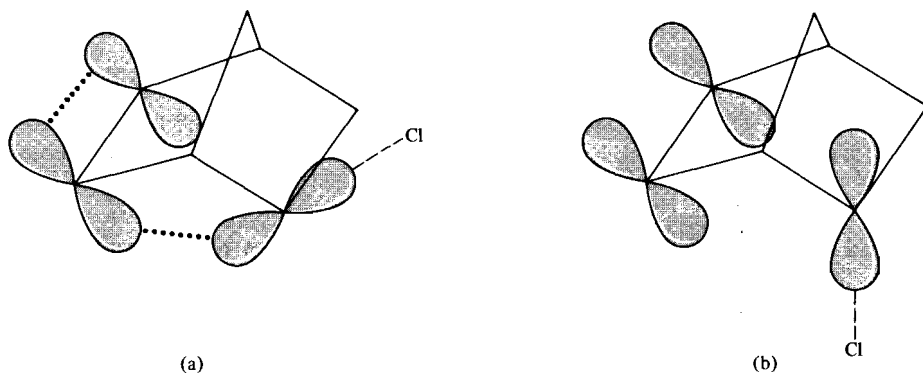

Figure 6.6 (a) Orbital picture of the transition state of solvolysis of *exo*-5-norbornenyl halides. (b) Orbital picture of the transition state of solvolysis of *endo*-5-norbornenyl halides.

three-center bond.⁶⁵ This structure is shown in an orbital representation in Figure 6.5 and in a dotted-line representation⁶⁶ in Structure 46.

Intermediate 46 is responsible for the retention of configuration observed by Shoppee. The 5,6-double bond that has displaced the leaving group from the back side now shields this side from attack by the entering group, thus leaving the front side as the only available route to substitution.

Because positive charge is delocalized by a *p* orbital one carbon atom further removed than the allylic position, the kind of bonding shown in 46 is called homoallylic (the *homo* is for homologous) participation. In this intermediate both C₃ and C₅ are coordinated to four atoms, and thus it is a carbonium ion.

The work on the cholesterol system stimulated investigation of other examples of homoallylic participation. Roberts found that *exo*-5- and *endo*-5-bicyclo[2.2.1]heptenyl (i.e., *exo*-5- and *endo*-5-norbornenyl) halides (47 and 48) both solvolyze in aqueous ethanol to give the same product (49); the *exo* compound (47) solvolyzes about ten times more rapidly than the *endo* compound (48). Roberts pointed out that backside homoallylic participation in ionization was possible in 47 but not in 48 (see Figure 6.6). Once 48 has ionized it can, in a second

⁶⁵ M. Simonetta and S. Winstein, *J. Amer. Chem. Soc.*, **76**, 18 (1954).

⁶⁶ In this book we shall use the convention that a dotted line means a partial bond. Thus in Structure 46 there is a partial bond between C₃ and C₅ and a partial double bond between C₅ and C₆. For another convention see note 61, p. 288.

step, form either the rearranged carbonium ion **50** or the same carbonium ion formed in the solvolysis of **47**. Thus both compounds give the same product.⁶⁷

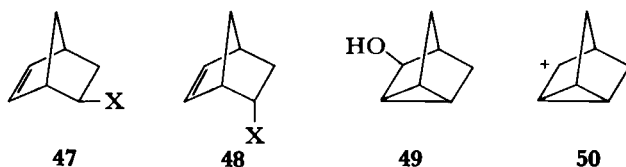

A much more spectacular driving force was found in the acetolysis of *anti*-7-norbornenyl tosylate (**51**). This compound solvolyzes 10^{11} times faster than the saturated analog and gives as the sole product the *anti*-acetate, **52**.⁶⁸ Winstein attributed the enormously accelerated rate to powerful anchimeric assistance of both *p* orbitals of the 2,3-double bond.

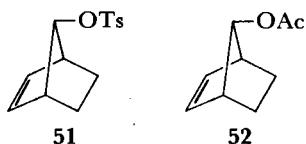

Carbon-7 is located on a plane that bisects the 2,3-bond and is in fact homoallylic to both sides of the double bond. Therefore a developing *p* orbital on it is in a position to overlap equally with each of the *p* orbitals of the double bond as is shown in Figure 6.7. No attack of solvent at C₂ or C₃ occurs in this system to give a three-membered ring analogous to *i*-cholesteryl derivatives and to **49** because the resulting carbon skeleton would be too strained. The fact that the product is 100 percent *anti*-acetate is a result of the back side of C₇ being hindered by the three-center bond that is fully formed in the intermediate carbonium ion.

Figures 6.6a and 6.7 show two kinds of homoallylic participation. We shall see below (p. 296) that other structures have also been proposed for this type of delocalized bonding.

There are strict geometrical requirements for homoallylic participation. For example, Bartlett and Rice found no indication of homoallylic participation on solvolysis of **53** in aqueous acids. Apparently the strain energy of bonding is greater than the stabilization so obtained.⁶⁹

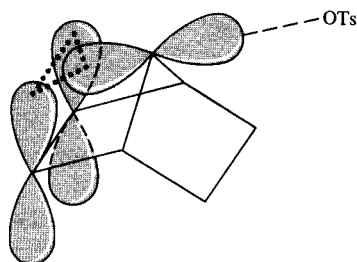
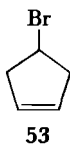

Figure 6.7 Transition state for solvolysis of *anti*-7-norbornenyl tosylate.

⁶⁷ J. D. Roberts, W. Bennett, and R. Armstrong, *J. Amer. Chem. Soc.*, **72**, 3329 (1950).

⁶⁸ (a) S. Winstein, M. Shatavsky, C. Norton, and R. B. Woodward, *J. Amer. Chem. Soc.*, **77**, 4183 (1955); (b) S. Winstein and M. Shatavsky, *J. Amer. Chem. Soc.*, **78**, 592 (1956).

⁶⁹ P. D. Bartlett and M. R. Rice, *J. Org. Chem.*, **28**, 3351 (1963).



The importance for homoallylic participation of the exact position of the p orbitals of the double bond in relation to the developing p orbital at the reaction site is also shown by the rate change attendant on puckering of the five-membered ring in the series, **54**, **55**, and **56**.⁷⁰ In the lower homologs of these bi-

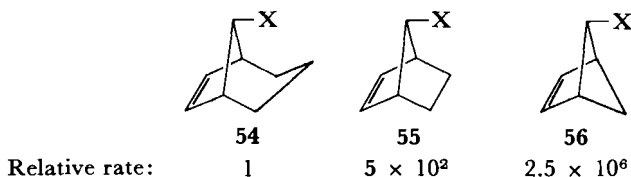

cycloalkenes the five-membered ring is more puckered than in the higher homologs, and backside participation is facilitated.

Electron demand at the incipient carbocation is also important in determining whether or not homoallylic participation takes place. Gassman and Fentiman have plotted the logs of the rates of solvolysis of both **57** and **58** in dioxane-water vs. the Hammett σ^+ constants of the X substituents. They

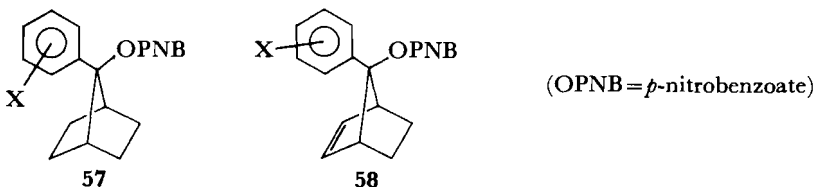

found that for all X's the logs of the rates of solvolysis of **57** fall on a straight line, as would be expected if the variations in rate were due to the electron-donating ability of X alone (see Section 2.2). The logs of the rates of **58** when X is a *p*-N,N-dimethyl or a *p*-methoxy group fall on the same straight line, signifying that the mechanism of ionization is the same as that of **57**. However, the logs of the rates of ionization of **58** when X is hydrogen, *p*-trifluoromethyl, or 3,5-bis-(trifluoromethyl) deviate from the line and are much larger than would be expected from the Hammett correlation.⁷¹ Apparently, when X is electron-donating, participation of the double bond is not required for ionization: The carbenium ion is more stable than the carbonium ion. However, when X is electron-withdrawing, the carbenium ion is destabilized and the carbonium ion becomes the favored intermediate.

Double bonds further removed from the incipient carbocation than the homoallylic position can also assist in ionization if the geometry of the system allows it. For example *trans*-5-decen-1-yl *p*-nitrobenzoate (**59**) solvolyzes 1500 times faster than the corresponding saturated compound in aqueous acetone. The product is *trans,trans*-1-decalol (**60**). If after 12 half-lives the product is iso-

⁷⁰ B. A. Hess, Jr., *J. Amer. Chem. Soc.*, **91**, 5657 (1969) and references therein.

⁷¹ P. G. Gassman and A. F. Fentiman, Jr., *J. Amer. Chem. Soc.*, **92**, 2549 (1970).

lated, a *p*-nitrobenzoate derivative is found which has the structure **61**. Furthermore, if the original *p*-nitrobenzoate has ^{18}O in the carbonyl carbon, it is found incompletely scrambled in **61**. These facts lead us to conclude that the rearrangement occurs in an intimate ion pair of which the ion **62** is the cation.⁷²

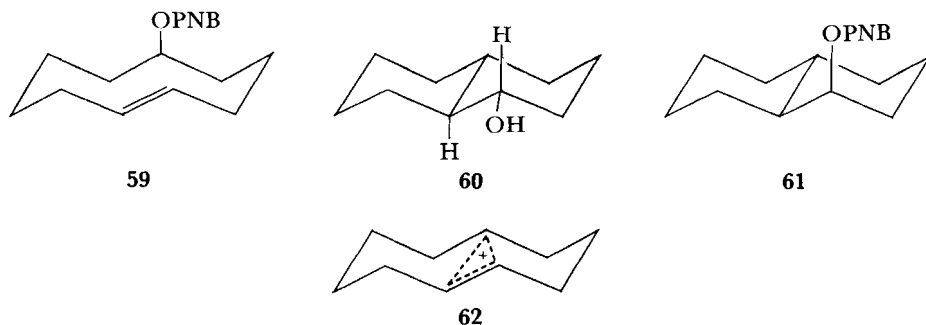

The Cyclopropylcarbinyl Cation

In 1951 Roberts observed that most cationic reactions of cyclopropylcarbinyl and of cyclobutyl derivatives give the same products in nearly the same ratio.⁷³ For example, cyclopropylcarbinyl and cyclobutyl amines on deamination form the products shown in Equation 6.31.⁷⁴ Moreover, when allylcarbinyl tosylate (**63**)

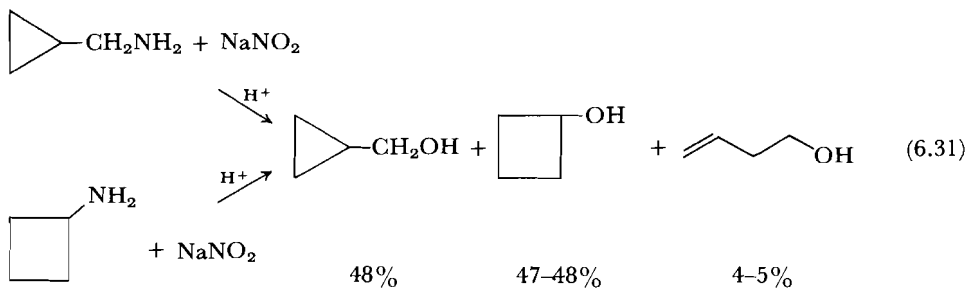

is solvolysed in 98 percent formic acid, the products shown in Equation 6.31 are again formed, and their ratio is similar to that of Equation 6.31.

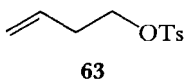

If solvolysis of **63** is carried out in more nucleophilic solvents (formic acid is strongly ionizing but weakly nucleophilic), predominant $\text{S}_{\text{N}}2$ reaction is observed.⁷⁵

When cyclopropylcarbinyl amine labeled with ^{14}C in the 4-position is deaminated, the label is found to be scrambled in the products so that the three methylene groups have almost—but not quite—achieved equivalence. The

⁷² H. L. Goering and W. D. Closson, *J. Amer. Chem. Soc.*, **83**, 3511 (1961).

⁷³ J. D. Roberts and R. H. Mazur, *J. Amer. Chem. Soc.*, **73**, 2509 (1951).

⁷⁴ R. H. Mazur, W. N. White, D. A. Semenow, C. C. Lee, M. S. Silver, and J. D. Roberts, *J. Amer. Chem. Soc.*, **81**, 4390 (1959).

⁷⁵ K. L. Servis and J. D. Roberts, *J. Amer. Chem. Soc.*, **86**, 3773 (1964).

results are shown in Equation 6.32, in which the numbers at the carbons of the products refer to the percent ^{14}C found at that position in that product.⁷⁶

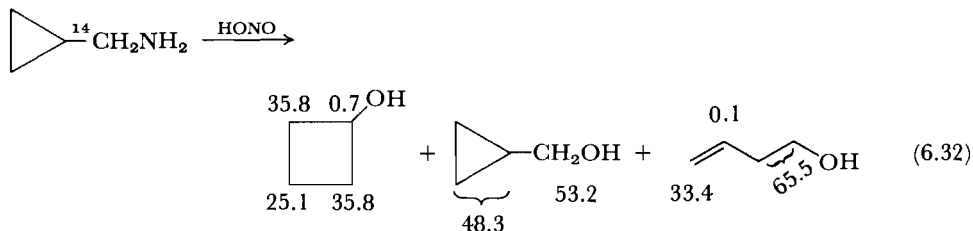

A set of rapidly equilibrating carbenium ions might account for the rearrangements and the label scrambling; but this cannot be the correct explanation, for cyclopropylcarbinyl, cyclobutyl, and allylcarbinyl systems all solvolyze much more rapidly than would be expected from model compounds. Thus, for example, the rate of solvolysis of cyclopropylcarbinyl tosylate is 10^6 times that of the solvent-assisted solvolysis of isobutyl tosylate.⁷⁷ Cyclobutyl tosylate solvolyzes 11 times

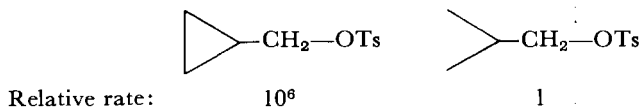

more rapidly than cyclohexyl tosylate.⁷⁸ And allylcarbinyl tosylate in 98 percent

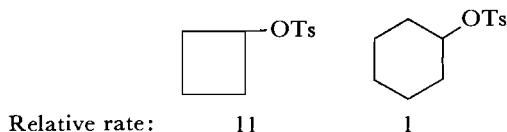

HCOOH solvolyzes 3.7 times faster than its saturated analog, in spite of the electron-withdrawing effect of the double bond.⁷⁹

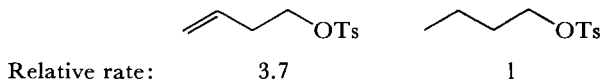

Roberts suggested that a set of charge-delocalized, rapidly equilibrating carbonium ions, which he called *bicyclobutonium ions*, are the first-formed ions from all three systems. In Scheme 3 are shown the bicyclobutonium ions formed from the deamination of ^{14}C -labeled cyclopropylcarbinyl amine (Equation 6.32). According to Roberts, there would be two equivalent first-formed carbonium ions: A three-center bond could be formed from the developing empty orbital on C_4 and either orbitals on C_1 and C_3 (path a) or orbitals on C_1 and C_2 (path b). Once these carbonium ions were formed, they could be converted to any of the other carbonium ions in Scheme 3. Equilibration arrows should be shown between all the structures, but their inclusion would further confuse this already conceptually difficult scheme. Figure 6.8 shows an orbital representation of bicyclobutonium ion (64).

⁷⁶ See note 74, p. 293.

⁷⁷ D. D. Roberts, *J. Org. Chem.*, **29**, 294 (1964); **30**, 23 (1965).

⁷⁸ H. C. Brown and G. Ham, *J. Amer. Chem. Soc.*, **78**, 2735 (1956).

⁷⁹ See note 75, p. 293.

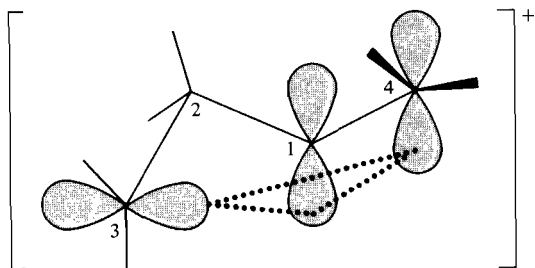
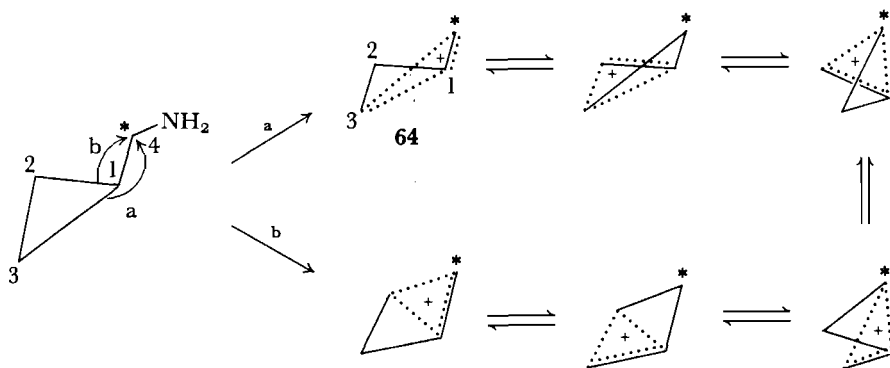

Figure 6.8 Orbital representation of the bicyclobutonium ion. From R. H. Mazur, W. N. White, D. A. Semonow, C. C. Lee, M. S. Silver, and J. D. Roberts, *J. Amer. Chem. Soc.*, **81**, 4390 (1959). Reprinted by permission of the American Chemical Society.

SCHEME 3



Positive charge in each of the bicyclobutonium ions would be distributed between the three carbon atoms of the three-center bond. For example, the positive charge on carbonium ion **64** would be delocalized over C_4 , C_1 , and C_3 . If water attacked this ion at C_4 , unrearranged cyclopropylcarbinol would be obtained; if water attacked at C_1 , cyclobutanol would be the product; and if it attacked at C_3 , allylcarbinol would be formed (Scheme 4). Addition of water to

SCHEME 4

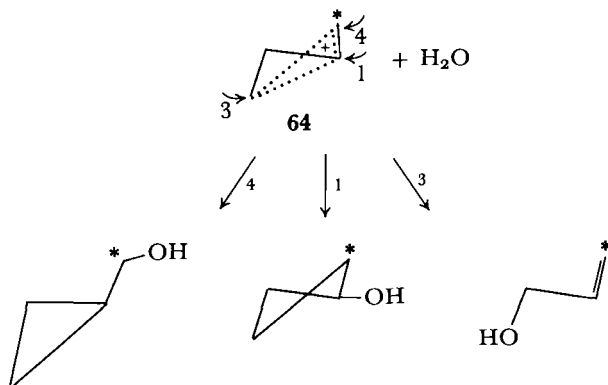

each of the bicyclobutonium ions would give the same three products, but the ^{14}C label would be scrambled differently in each.

Note that if the bicyclobutonium ion were formed directly upon ionization of an allylcarbinyl derivative, it would be a case of homoallylic participation in an acyclic system. In fact, the bicyclobutonium ion is similar to the carbonium ion proposed by Winstein for homoallylic participation in the 7-norbornenyl system—cf. Figures 6.7 and 6.8 and Structures 65 and 66. The difference between them is that 66 is more symmetrical.

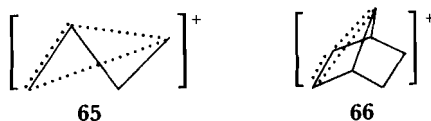

Since Roberts' work, a great deal of evidence, both experimental and theoretical, has accumulated that indicates that the bicyclobutonium ion is not the first-formed ion upon solvolysis of unstrained cyclopropylcarbinyl systems. Instead, the structure of the ion apparently is the bisected cyclopropylcarbinyl cation, which is shown in a dotted-line formulation in 67 and in an orbital diagram in Figure 6.9. (See also Section 10.6.)

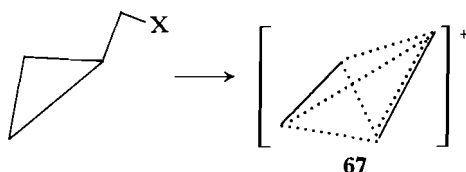

A comparison of Figures 6.8 and 6.9 shows that the bisected cyclopropylcarbinyl cation differs from the bicyclobutonium ion in several ways. For example, in the bisected cyclopropylcarbinyl cation, the carbinyl carbon (C_4) and its substituents lie above or below the ring in a plane that is perpendicular to the plane of the ring and bisects C_1 and the C_2-C_3 bond. The vacant p orbital is parallel to the plane of the ring and to the C_2-C_3 bond. By π overlap with the C—C bonding orbitals of the cyclopropane ring, which, because of angle strain, have an abnormal amount of p character,⁸⁰ the positive charge at C_4 is delocalized to all three ring carbons. In the bicyclobutonium ion, C_4 is not equi-

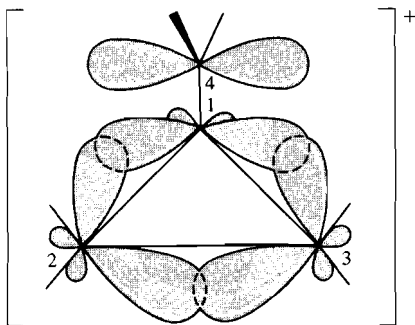
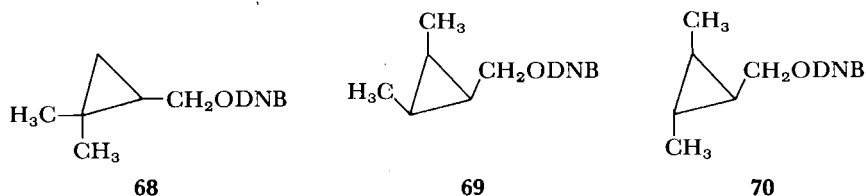

Figure 6.9 Orbital representation of the bisected cyclopropylcarbinyl cation.

⁸⁰ (a) D. Peters, *Tetrahedron*, **19**, 1539 (1963); (b) M. Randi and A. Maksić, *Theor. Chim. Acta*, **3**, 59 (1965); (c) A. D. Walsh, *Trans. Faraday Soc.*, **45**, 179 (1949); (d) L. I. Ingraham, in *Steric Effects in Organic Chemistry*, M. S. Newman, Ed., Wiley, New York, 1956, chap. 11; (e) C. A. Coulson and W. E. Moffitt, *Phil. Mag.*, **40**, 1 (1949); (f) R. Hoffmann and R. B. Davidson, *J. Amer. Chem. Soc.*, **93**, 5699 (1971).

distant from C_2 and from C_3 ; the vacant p orbital on C_4 is almost *perpendicular* to the plane of the ring. Furthermore, positive charge at C_4 in a single bicyclobutonium ion can be delocalized to C_1 and to either C_2 or C_3 but not to both.

Some of the evidence for the bisected cyclopropylcarbiny cation follows. That the charge can be delocalized to both C_2 and C_3 simultaneously has been shown by the work of Schleyer and Van Dine.⁸¹ These workers studied the solvolysis of cyclopropylcarbiny 3,5-dinitrobenzoates and found that methyl substituents accelerated the rate by an amount dependent only on the number of such substituents and not on their position. Thus **68**, **69**, and **70** react at almost the same rate. If the transition state for ionization were similar to the bicyclobutonium ion, two methyl groups at C_2 should accelerate the rate more than one at C_2 and one at C_3 . A symmetrical transition state for ionization similar to the bisected cyclopropylcarbiny cation (**67**) in which the charge is delocalized over all four carbon atoms best explains the results.



That maximum acceleration occurs when the vacant p orbital is parallel to the plane of the cyclopropyl ring can be seen from the solvolysis of spiro[cyclopropane-1,2'-adamantyl] chloride (**71**). The carbocation formed by departure of Cl^- is unable to adopt the geometry of the bisected cyclopropylcarbiny cation, but can orient its empty p orbital properly to form the bicyclobutonium ion. This compound solvolyzes 10^3 times more slowly than 1-adamantyl chloride.⁸² On the other hand, **72** solvolyzes 10^5 times faster than **73**. The cation from **72** does have its p orbital parallel to the plane of the ring as in the bisected cyclopropylcarbiny cation.⁸³



Other structures have also been suggested as intermediates in cyclopropylcarbiny and cyclobutyl solvolyses.⁸⁴ Winstein has pointed out that the nature of the intermediate cation may differ with the geometrical requirements of the

⁸¹ P. v. R. Schleyer and G. W. Van Dine, *J. Amer. Chem. Soc.*, **88**, 2321 (1966).

⁸² B. R. Ree and J. C. Martin, *J. Amer. Chem. Soc.*, **92**, 1660 (1970); V. Buss, R. Gleiter, P. v. R. Schleyer, *J. Amer. Chem. Soc.*, **93**, 3927 (1971) and references therein.

⁸³ Y. E. Rhodes and V. G. DiFate, *J. Amer. Chem. Soc.*, **94**, 7582 (1972).

⁸⁴ (a) Z. Majerski, S. Borčić, and D. E. Sunko, *J. Chem. Soc. D*, 1636 (1970); (b) C. D. Poulter, E. C. Friedrich, and S. Winstein, *J. Amer. Chem. Soc.*, **92**, 4274 (1970); (c) C. D. Poulter and S. Winstein, *J. Amer. Chem. Soc.*, **92**, 4282 (1970); (d) Z. Majerski and P. v. R. Schleyer, *J. Amer. Chem. Soc.*, **93**, 665 (1971); (e) J. E. Baldwin and W. D. Foglesong, *J. Amer. Chem. Soc.*, **90**, 4303, 4311 (1968).

starting material.⁸⁵ Indeed, Figure 6.10 presents the results of CNDO calculations on the barrier to rotation of the carbinyl group.⁸⁶ It appears that a 30° rotation from the symmetrical structure ($\alpha = 0^\circ$, see **74**) leads to only a small decrease in stabilization.

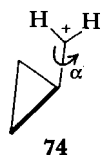

Is the cyclopropylcarbinyl system also the first-formed ion in solvolysis of cyclobutyl derivatives? The evidence is conflicting. Majerski, Borčić, and Sunko studied the reactions shown in Equations 6.33 and 6.34 and found that when the starting material is the cyclopropylcarbinyl methanesulfonate, the label scrambling is less complete in the cyclopropylcarbinol than in the cyclobutanol; similarly, cyclobutyl methanesulfonate gives less label scrambling in the cyclobutanol than in the cyclopropylcarbinol.⁸⁷ (In Equation 6.33, the numbers show the distribution of the CD₂ group. In Equation 6.34, they show the distribution of the CH₂ group.)

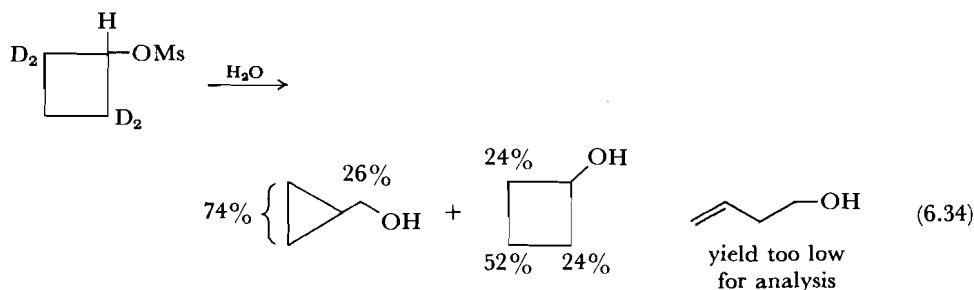
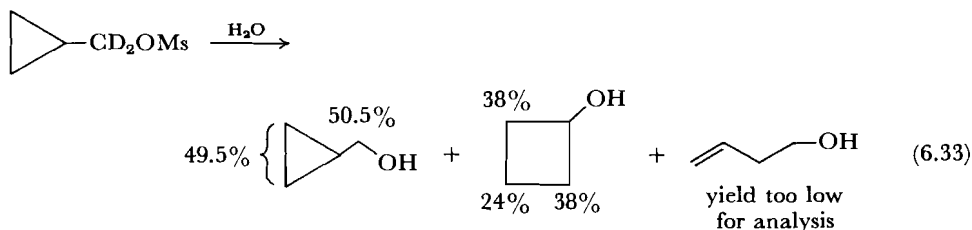

This would make it appear that cyclopropyl and cyclobutyl derivatives each solvolyze to give ions that are similar in structure to the starting material. Solvent capture may occur at this stage. If it does not, the first-formed ion rearranges.

On the other hand, there is now a good deal of evidence that the solvolysis of most cyclobutyl derivatives does lead directly to the cyclopropylcarbinyl cation. For example, orbital symmetry considerations (Section 11.3) indicate that the conversion of cyclobutyl cations into cyclopropylcarbinyl cations should occur by disrotatory ring opening as shown in Figure 6.11; but any steric factors that would hinder such a process decelerate most cyclobutyl solvolyses. Thus

⁸⁵ See note 84(b).

⁸⁶ K. B. Wiberg and J. G. Pfeiffer, *J. Amer. Chem. Soc.*, **92**, 553 (1970).

⁸⁷ See note 84(a), p. 297.

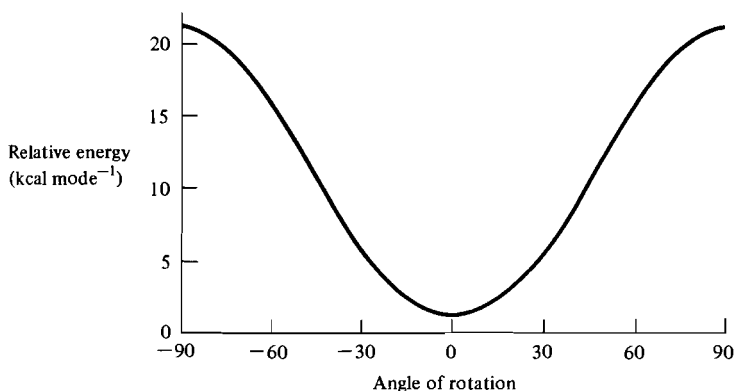
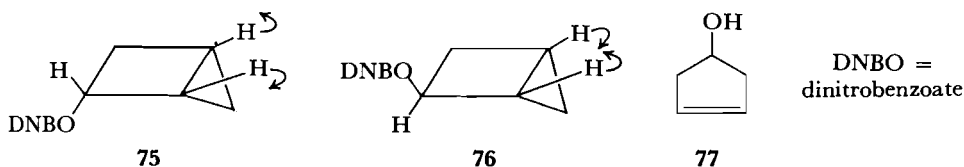

Figure 6.10 Change in energy of the cyclopropylcarbinyl cation as the cationic center is rotated. From K. B. Wiberg and J. G. Pfeiffer, *J. Amer. Chem. Soc.*, **92**, 553 (1970). Reprinted by permission of the American Chemical Society.

both **75** and **76** solvolyze in acetone/water to give 3-cyclopentenol (**77**), but **75** solvolyzes 10^7 times faster than **76**.⁸⁸ In **75**, to overlap with the back side of the developing p orbital, the orbitals of the bond being broken must turn in such a way as to move the bridgehead hydrogens away from each other. In **76**, however, the same process would require that the bridgehead hydrogens move toward each other. This is energetically unfavorable.



Cyclobutyl cations certainly do exist if they are especially stabilized. For example, 1-phenylcyclobutyl cation shows no tendency to rearrange in superacid solution.⁸⁹

If two different $C_4H_7^+$ ions may exist, which is the more stable? The fact that most cyclobutyl derivatives seem to solvolyze directly to the cyclopropylcarbinyl cation strongly suggests that that ion is the more stabilized. Nuclear magnetic resonance studies, however, give conflicting information. The spectrum of the unsubstituted cyclopropylcarbinyl cation in superacid solution is most

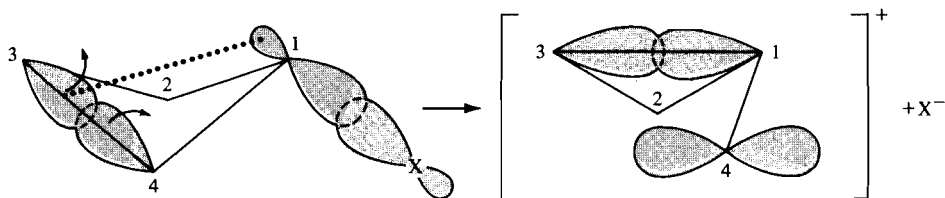

Figure 6.11 Orbital symmetry allowed (disrotatory) opening of a cyclobutyl cation. Note that the orbitals of the C—C bond being broken overlap with the back side of the orbital used for bonding to the departing group.

⁸⁸ (a) K. B. Wiberg, V. Z. Williams, Jr., and L. E. Friedrich, *J. Amer. Chem. Soc.*, **90**, 5338 (1968); (b) *J. Amer. Chem. Soc.*, **92**, 564 (1970).

⁸⁹ G. A. Olah, C. L. Jeuell, D. P. Kelly, and R. D. Porter, *J. Amer. Chem. Soc.*, **94**, 146 (1972).

consistent with it being a set of equilibrating bicyclobutonium ions.⁹⁰ The spectrum of the cation derived from 1-methylcyclobutyl chloride is best explained if the cyclobutyl cation is in rapid equilibrium with the corresponding cyclopropylcarbinyl cation and the equilibrium favors the former, as shown in Equation 6.35.⁹¹



The nmr spectrum of the 4,4-dimethylcyclopropylcarbinyl cation in superacid is only in agreement with the bisected structure of the ion (**78**). In Structure **78** the two methyl groups are not equivalent—one is cis to the cyclopropyl ring

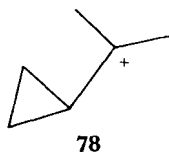

and the other is trans. Indeed, the nmr spectrum shows two different peaks due to methyl groups separated by 0.54 ppm, which do not coalesce up to -30°C , at which temperature ring opening occurs.⁹²

Molecular orbital calculations suggest that for the parent ion and for methylated ions, **78** and **79**, the bisected cyclopropylcarbinyl structure is the structure of lowest energy.⁹³ They also predict that the cyclopropylcarbinyl-

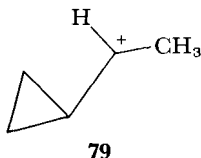

cyclopropylcarbinyl conversions, which we know must occur from label scrambling experiments (Equation 6.32) and other rearrangements, have as a transition state a puckered cyclobutyl cation.⁹⁴ Figure 6.12 shows the proposed reaction coordinate diagram for the parent system and the *gem*-dimethyl system. The most stable cation in the latter system, in agreement with Olah's work, is that which is stabilized by having the *gem*-dimethyl group on the same carbon as the positive charge.

The Norbornyl Cation⁹⁵

In discussing the cyclopropylcarbinyl cation before the norbornyl cation we have, chronologically, put the cart before the horse. The first experimentally documented example of anchimeric assistance by a C—C σ bond was announced by Winstein and Trifan in 1949.⁹⁶ These workers studied the solvolysis of *exo*- and

⁹⁰ See note 89, but see also W. J. Hehre and P. C. Hiberty, *J. Amer. Chem. Soc.*, **96**, 302 (1974).

⁹¹ M. Saunders and J. Rosenfeld, *J. Amer. Chem. Soc.*, **92**, 2548 (1970).

⁹² (a) See note 34, p. 280; (b) C. U. Pittman, Jr., and G. A. Olah, *J. Amer. Chem. Soc.*, **87**, 2998 (1965).

⁹³ (a) See note 58(e), p. 288; (b) W. J. Hehre and P. C. Hiberty, *J. Amer. Chem. Soc.*, **96**, 302 (1974).

⁹⁴ See note 93(b).

⁹⁵ See note 59(c), p. 288.

⁹⁶ S. Winstein and D. S. Trifan, *J. Amer. Chem. Soc.*, **71**, 2953 (1949).

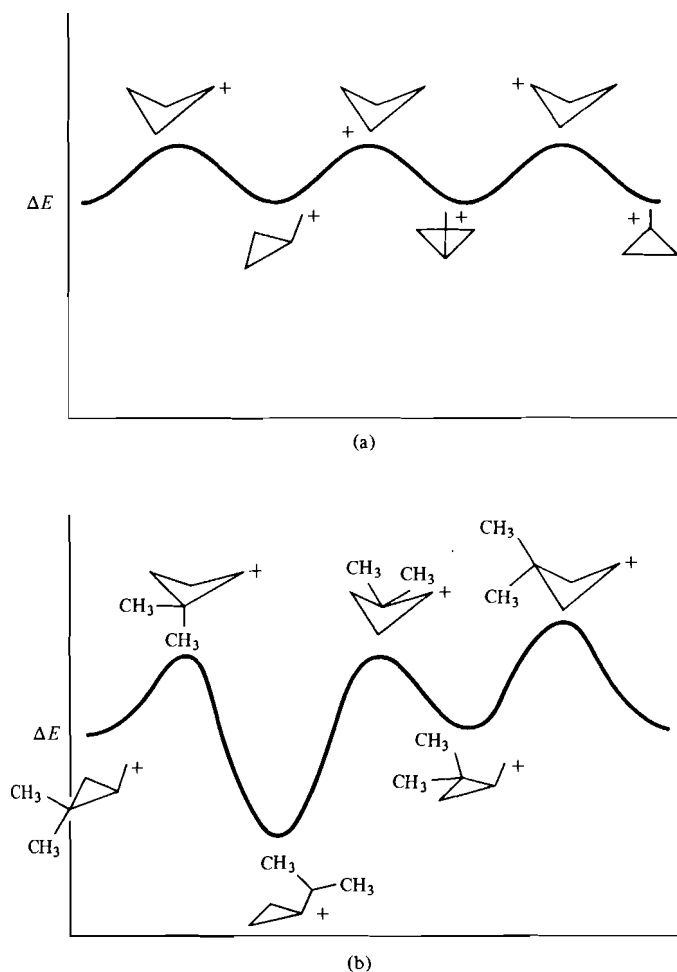

Figure 6.12 (a) Rearrangement in the cyclopropylcarbinyl system. (b) Rearrangement in the dimethyl cyclopropylcarbinyl system. From W. J. Hehre and P. C. Hiberty, *J. Amer. Chem. Soc.*, **96**, 302 (1974). Reprinted by permission of the American Chemical Society.

endo-2-norbornyl arenesulfonates (**80** and **81**, respectively) and found that the reactions had these interesting characteristics: (1) the *exo* compound solvolyzes 350 times more rapidly than the *endo* compound; (2) both *exo* and *endo* starting materials give exclusively (>99.9 percent) *exo* product as shown in Equation 6.36; (3) chiral *exo* starting material gives entirely racemic product, but the product from *endo* starting material retains some chirality; and (4) chiral *exo* starting material, recovered before complete reaction, is partially racemized. The ratio of polarimetric and titrametric rate constants in acetic acid is 4.6. Since recovered, unreacted *endo* starting material is not racemized, the rate of ionization of **80** relative to the rate of ionization of **81** in acetic acid is not 350 but 350×4.6 or 1550.⁹⁷

⁹⁷ (a) See note 96; (b) S. Winstein and D. Trifan, *J. Amer. Chem. Soc.*, **74**, 1147, 1154 (1952); (c) S. Winstein, E. Clippinger, R. Howe, and E. Vogelfanger, *J. Amer. Chem. Soc.*, **87**, 376 (1965).

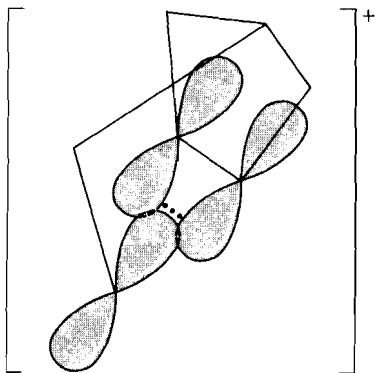
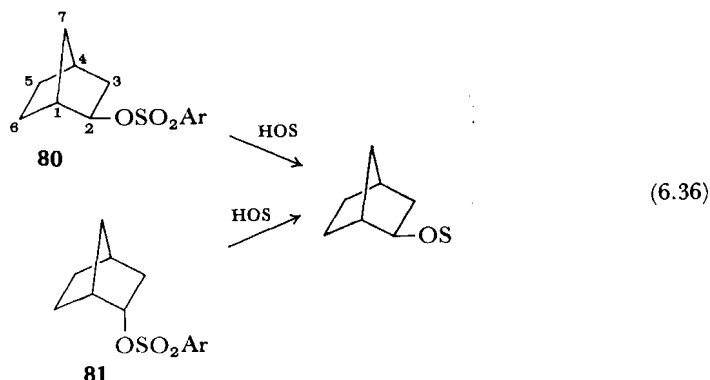
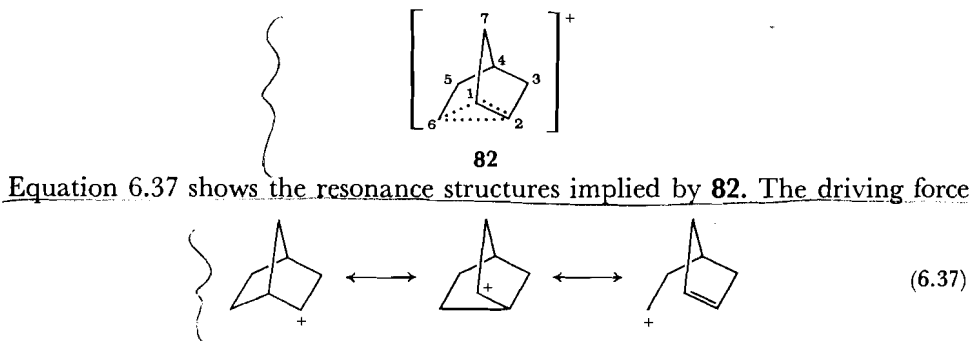

Figure 6.13 Orbital picture of the norbornyl cation.



Winstein pointed out that these observations are all consistent if, in the solvolysis of 80, the 1,6-bond assists in the ionization and the "norbornonium" ion, shown in 82 and Figure 6.13, is the first-formed intermediate.



for the rearrangement would be the relief of skeletal strain.

The explanations, in terms of 82, of the observed differences between the exo and endo brosylates (80 and 81) follow.

Rate In the *exo*-norbornyl arenesulfonates, the C₁—C₆ bond is in the trans-periplanar orientation to the leaving group and therefore in the optimum position to provide anchimeric assistance. The C₁—C₆ bond is not properly oriented for anchimeric assistance in the *endo*-norbornyl arenesulfonate; and although the C₁—C₇ bond is not badly oriented, the rearranged ion (83) re-

sulting from participation of this bond is more highly strained than the starting material. Thus, according to Winstein the *endo*-norbornyl derivative first ionizes to the charge-localized carbenium ion (83). Once formed, this ion can rearrange

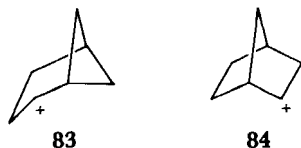

to the more stable carbonium ion (82).⁹⁸ Figure 6.14 shows the proposed reaction coordinate diagrams for solvolysis of the *exo*- and *endo*-norbornyl sulfonates.

Product The product from solvent attack on the carbonium ion 82 must be from the *exo* direction since the *endo* side would be hindered by the three-centered bond.⁹⁹

Stereochemistry The norbornonium ion has a plane of symmetry. This can perhaps be seen most readily if 82 is rotated about the C₁—C₄ axis, as shown in Equation 6.38. Thus chiral starting material should give racemic product if the intermediate 82 lies on the reaction path: Solvent attack at C₂ yields product of retained configuration, but attack at the equivalent site, C₁, yields inverted product. If the chiral norbornonium ion (84) were the intermediate, solvent attack could occur only at C₂ and retained product would be obtained.¹⁰⁰ As we have already seen, the product from chiral *exo* starting material is entirely racemic. The *exo*-norbornyl derivatives obtained from *endo* starting material

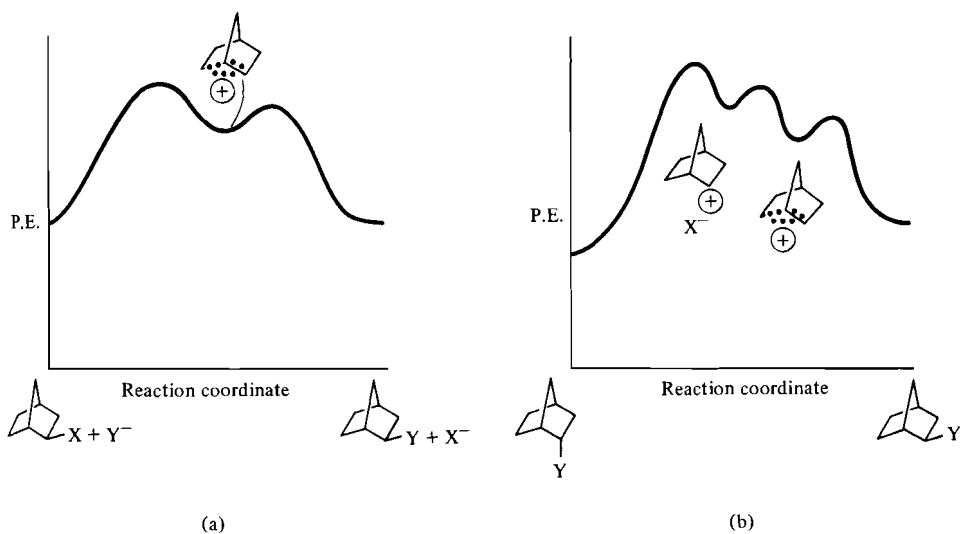
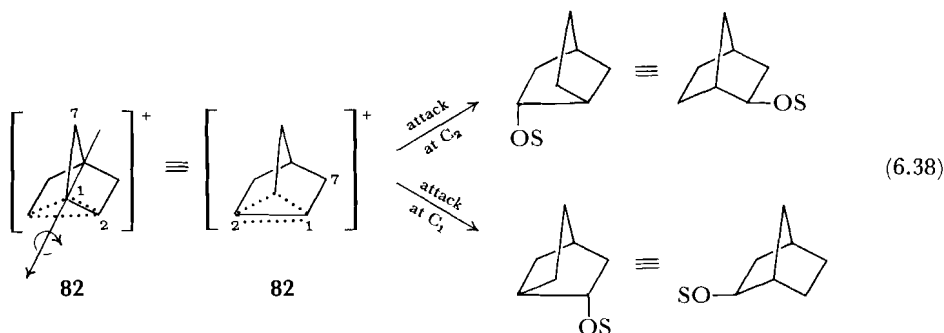

Figure 6.14 (a) Probable reaction coordinate diagram for the solvolysis of *exo*-2-norbornyl derivatives. (b) Probable reaction coordinate diagram for solvolysis of *endo*-2-norbornyl derivatives.

⁹⁸ See note 96, p. 300, and note 97, p. 301.

⁹⁹ See note 96, p. 300, and note 97, p. 301.

¹⁰⁰ See note 96, p. 300, and note 97, p. 301.



are about 87 percent racemized in strongly nucleophilic solvents. Thus most of the product is indeed formed by the reaction path shown in Figure 6.14b, but some solvent must also attack C₂ before the carbonium ion has had time to rearrange. Less nucleophilic solvents give a greater extent of racemization.¹⁰¹

Isomerization of starting material Partial racemization of recovered *exo* starting material is consistent with the hypothesis that a norbornonium ion is formed immediately on ionization if it is further postulated that an intimate ion pair is the first ionic species on the reaction path. Internal return from the achiral norbornonium–arenesulfonate intimate ion pair must give racemized starting material.¹⁰²

If the norbornyl cation is formed on solvolysis of *exo*-norbornyl derivatives, C₂ should become equivalent to C₁ and C₇ to C₃. In a most elegant tracer experiment, Roberts and Lee synthesized *exo*-2-norbornyl-[2,3-¹⁴C] brosylate (**85**), solvolyzed it in acetic acid, and degraded the product. Equation 6.39 shows the product distribution expected if the symmetrical carbonium ion (**82**) were formed. The label was found not only at C₁, C₂, C₃, and C₇, but also at C₅ and

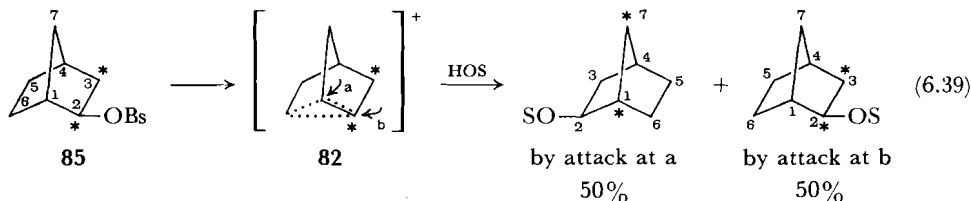

C₆. To account for this Roberts suggested that 6,2- or 6,1-hydride shifts occur in the carbonium ion simultaneously with the rearrangement of Equation 6.39 as shown in Equation 6.40.¹⁰³

Although cationic reactions of 2-*exo*-norbornyl arenesulfonates have characteristics that would be associated with a charge-delocalized carbonium ion intermediate—driving force, stereospecific product formation, rearranged products, internal return to rearranged starting material, and special chiral characteristics—a storm of controversy has raged over its existence. Its opponents, of whom H. C. Brown is the chief, have maintained that the postulation of a bridged carbonium ion intermediate is not necessary to explain the characteristics of the

¹⁰¹ See note 97, p. 301.

¹⁰² See note 97, p. 301.

¹⁰³ J. D. Roberts and C. C. Lee, *J. Amer. Chem. Soc.*, **73**, 5009 (1951); (b) J. D. Roberts, C. C. Lee, and W. H. Saunders, Jr., *J. Amer. Chem. Soc.*, **76**, 4501 (1954).

norbornyl system. He has argued that the $k_{\text{exo}}/k_{\text{endo}}$ rate ratio in solvolyses of norbornyl derivatives is large, not because k_{exo} is particularly great but because k_{endo} is particularly small. In his view a 2-*endo* substituent experiences steric

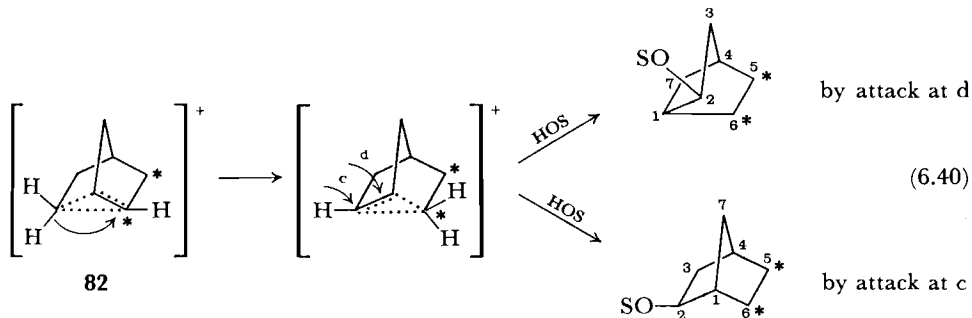

hindrance to ionization by the three endo protons. He suggests, furthermore, that the peculiar U-shaped structure of the $C_6-C_1-C_2$ segment hinders endo approach of a nucleophile to the classical 2-norbornyl cation and thus exo product is formed. Finally, he proposes that the skeletal rearrangements and loss of chirality are consistent with rapid 1,2-Wagner-Meerwein shifts as shown in Equation 6.41.¹⁰⁴

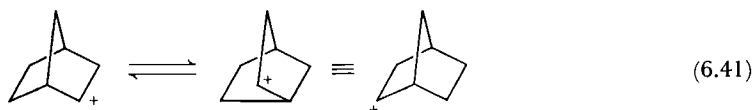

Note that the two carbenium ions in Equation 6.41 are mirror images of one another. The carbonium ion (82) would then be a transition state for Equation 6.41, not a stabilized intermediate.

The investigation of the 2-norbornyl cation has been intensive and detailed. Sargent says, it "may well be the most thoroughly investigated yet least thoroughly understood reactive intermediate known to organic chemists. Seldom, if ever, has a single species been the subject of so many ingenious experiments conceived by so many eminent investigators utilizing such a variety of sophisticated methods. Despite the intensity of this effort, the structure of the 2-norbornyl cation remains an enigma."¹⁰⁵ However, most workers in the field now agree that when a secondary *exo*-norbornyl derivative is solvolyzed, the bridged carbonium ion is formed as an intermediate. We shall only touch on the controversy momentarily and give examples of experiments carried out to clarify one of its aspects—is the large *exo/endo* rate ratio due to a remarkably large (assisted) *exo* rate or a remarkably small (hindered) *endo* rate? For more detailed presentations, the reader is referred to the references cited in notes 59. and 60, p. 288.

A number of cases of steric deceleration of solvolysis have been reported. For example, the nonbonded strain in 87 is approximately 1.9 kcal mole⁻¹ greater than that in 86. Assuming that the strain is fully relieved in the transition state for ionization, one would predict that the rate of solvolysis of the *endo*-tosylate (87) should exceed that of the *exo*-tosylate (86) by a factor of ~25.

¹⁰⁴ See note 60, p. 288.

¹⁰⁵ See note 59(c), p. 288.

The *exo* compound actually solvolyzes 5.7 times faster than the *endo* compound. Since there is no obvious route for σ bond participation here, it appears that there must be an increase in nonbonded strain in the transition state of **87** of $RT \ln 5.7$ or ~ 1 kcal mole $^{-1}$.¹⁰⁶

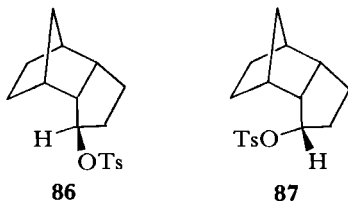

As Sargent has pointed out, experiments and examination of molecular models both indicate that this system should offer more extreme steric hindrance to *endo* ionization than the norbornyl system does. One kcal mole $^{-1}$, then, is an upper limit for the increase in nonbonded interaction experienced by the leaving group in going from the ground to the transition state in *endo*-2-norbornyl tosylate.¹⁰⁷ But 1 kcal mole $^{-1}$ cannot be responsible for the *exo/endo* ionization rate ratio of 1550 reported by Winstein and Trifan, a ratio since corroborated by hundreds of other studies.

More recently Nordlander and co-workers adopted a different approach to determine whether *endo* ionization of 2-norbornyl derivatives is hindered.¹⁰⁸ They solvolyzed *exo*- and *endo*-2-norbornyl tosylate in the strongly ionizing but very weakly nucleophilic solvent, trifluoroacetic acid, and found the *exo/endo* rate ratio to be 1120. They then compared the rates of solvolysis of *endo*-2-norbornyl tosylate and of 2-adamantyl tosylate in two solvents—trifluoroacetic acid and much more nucleophilic acetic acid. Using an analysis suggested by Schleyer,¹⁰⁹ they reasoned that if ionization of *endo*-2-norbornyl tosylate is sterically hindered, its rate should show a large dependence on the nucleophilicity of the solvent. But 2-adamantyl tosylate cannot solvolyze with solvent assistance (see Section 5.4, p. 243). Thus the ratio of the rate of solvolysis of *endo*-2-norbornyl tosylate to the rate of solvolysis of 2-adamantyl tosylate should be much larger in acetic acid than in trifluoroacetic acid. In fact, the ratio is 30 times greater in acetic acid than in trifluoroacetic acid. If the rates of solvolyses of *trans*-2-methylcyclopentyl tosylate (**88**) and 2-adamantyl tosylate are compared in the same two solvents, the ratio of rates is 31 times greater in acetic acid. Thus *endo*-2-norbornyl tosylate seems to be acting normally—that is, like other secondary tosylates with a branch in the β position.

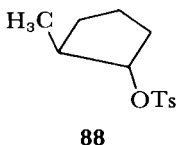

¹⁰⁶ H. C. Brown, I. Rothberg, P. v. R. Schleyer, M. M. Donaldson, and J. J. Harper, *Proc. Nat. Acad. Sci. U.S.*, **56**, 1653 (1967).

¹⁰⁷ See note 59(c), p. 288.

¹⁰⁸ J. E. Nordlander, R. R. Gruetzmacher, W. J. Kelly, and S. P. Jindal, *J. Amer. Chem. Soc.*, **96**, 181 (1974).

¹⁰⁹ P. v. R. Schleyer, J. L. Fry, L. K. M. Lam, and C. J. Lancelot, *J. Amer. Chem. Soc.*, **92**, 2542 (1970).

There are abundant examples that show that classical nonbridged 2-norbornenium ions certainly do exist if there is an alkyl or other electron-releasing group on C₂.¹¹⁰ For example, optically active **89** solvolyses with partial retention of configuration. Thus the carbenium ion must be formed in spite of the fact that C₆ is an excellent bridging group.¹¹¹

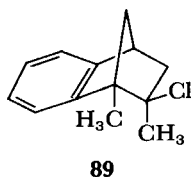

When 2-norbornyl fluoride is dissolved in superacid solution, a carbocation is obtained as shown in Equation 6.42. This ion has been examined by a number of physical methods, and the data are consistent with its structure being the bridged ion, **82**.¹¹² For example, the ion has been examined by ESCA

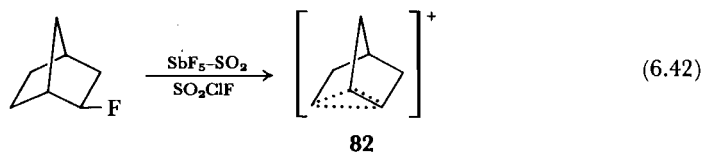

(electron spectroscopy for chemical analysis). By this method one can determine the energy required to remove inner shell electrons from around the nucleus. A sample is exposed to high-energy X-rays of known wavelength, which cause electrons to be ejected from the molecule. The energy conservation expression for the photoemission process can be expressed by

$$E_{h\nu} = E_{\text{kin}} + E_b + E_\phi \quad (6.43)$$

where $E_{h\nu}$, E_{kin} , and E_b are the X-ray energy, the kinetic energy of the electron emitted, and the binding energy of the electron emitted, respectively. E_ϕ is a constant for a given system and can be determined. An electron multiplier detector counts the emitted electrons, and an electron energy analyzer determines the kinetic energies of the emitted electrons. Thus E_b can be determined from Equation 6.43.¹¹³

The energy required to remove a 1s electron from a hydrocarbon is almost a constant. For example, by ESCA one cannot distinguish between benzene and neopentane. In classical, nonresonance-stabilized carbocations, the positive charge is usually centered on a single atom, and thus more energy must be applied to remove an electron from this atom than from its uncharged neighbors. Figure 6.15 shows the carbon 1s electron spectrum for the *t*-butyl cation. The positive carbon is well separated from the carbons of the methyl groups. Figure 6.16

¹¹⁰ For a study of how electron-releasing a 2-substituent must be for a 2-norbornyl derivative to ionize to the unbridged derivative, see D. G. Farnum and A. D. Wolf, *J. Amer. Chem. Soc.*, **96**, 5166 (1974).

¹¹¹ H. L. Goering, C.-S. Chan, and J. V. Clevenger, *J. Amer. Chem. Soc.*, **96**, 7602 (1974).

¹¹² G. A. Olah, G. Liang, G. D. Mateescu, and J. L. Riemenschneider, *J. Amer. Chem. Soc.*, **95**, 8698 (1973) and references therein.

¹¹³ For a review of ESCA studies, see J. M. Hollander and W. L. Jolly, *Accts. Chem. Res.*, **3**, 193 (1970).

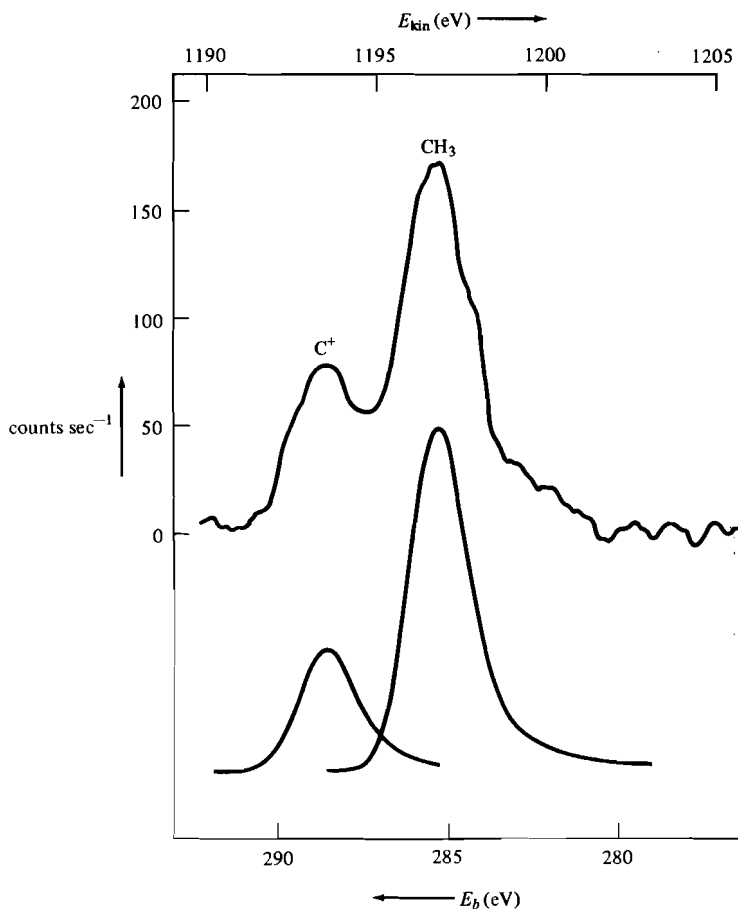

Figure 6.15 Carbon 1s electron spectrum (ESCA) of the *t*-butyl cation. From G. A. Olah, *Angew. Chem. Int. Ed.*, **12**, 173 (1973). Reproduced by permission of Verlag Chemie, GMBH.

shows the carbon 1s electron spectrum for the 2-methylnorbornyl cation and the norbornyl cation. The former is a classical ion (see p. 307) and has a spectrum similar to that of the *t*-butyl cation. The electron spectrum of the norbornyl cation, by comparison, has no high binding center. Olah says, "Since in electron spectroscopy the time scale of the measured ionization processes is of the order of 10^{-16} sec, definite ionic species can be characterized regardless of possible intra and intermolecular interactions (e.g., Wagner-Meerwein rearrangements, hydrogen shifts, proton exchange, etc.), which have no effect. Thus, ESCA spectroscopy gives an indisputable, direct answer to the long debated question of the 'nonclassical' nature of the norbornyl cation independent of any equilibration process."¹¹⁴

The nmr and Raman spectra of the parent norbornyl cation in superacid is also most consistent with the bridged structure **82**.¹¹⁵ The nmr spectra of a num-

¹¹⁴ See note 34(b), p. 280.

¹¹⁵ See note 112, p. 307.

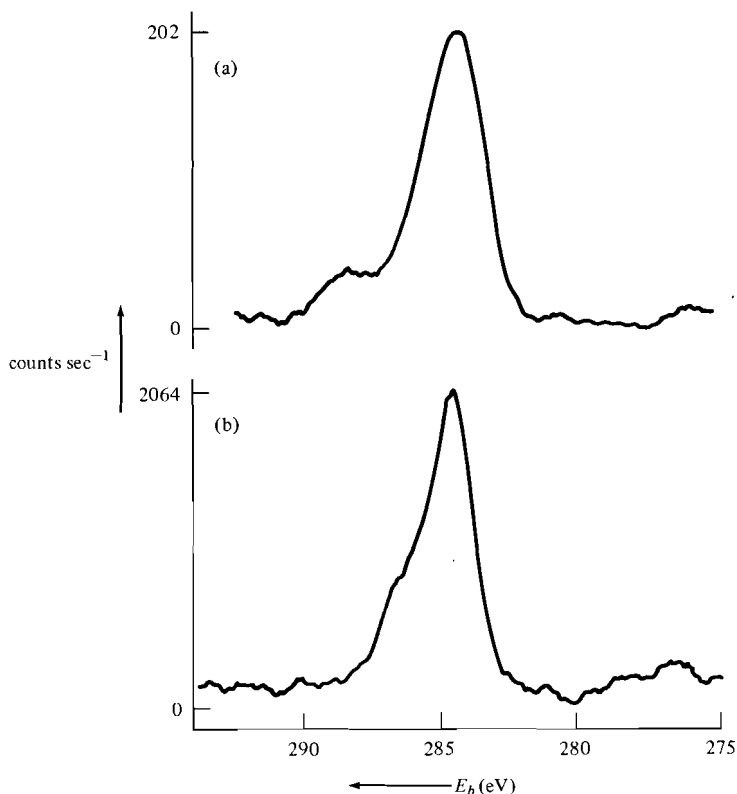
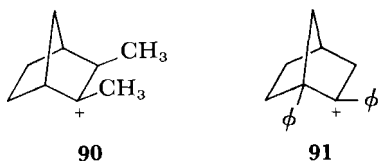

Figure 6.16 Carbon 1s electron spectrum (ESCA) of (a) the 2-methylnorbornyl cation and (b) the norbornyl cation. From G. A. Olah, *Angew. Chem. Int. Ed.*, **12**, 173 (1973). Reproduced by permission of Verlag Chemie, GMBH.

ber of stabilized 2-norbornyl cations in superacid have also been determined. For example, **90** and **91** have both been characterized as rapidly equilibrating carbenium ions by ^1H and ^{13}C nmr spectroscopy.¹¹⁶



The Bicyclo[2.2.2]octyl System

Since *exo*-2-norbornyl arenesulfonates apparently do solvolyze with anchimeric assistance, the less strained 2-bicyclo[2.2.2]octyl derivatives (**92**) are of interest. In this system no comparison of the rates of *exo* and *endo* derivatives can be made, since a substituent *exo* to one bridge is *endo* to the other. Stereochemical studies are, however, possible. If the carbonium ion (**93**) were formed from chiral **92** by participation of the $\text{C}_1\text{—C}_6$ bond, it would be chiral. Scheme 5 shows that attack at C_2 of **93** should give retained bicyclo[2.2.2.]octyl solvolysis products (**92a**), and attack at C_1 should give chiral *exo*-2-bicyclo[3.2.1]octyl

¹¹⁶ G. A. Olah and G. Liang, *J. Amer. Chem. Soc.*, **96**, 189, 195 (1974).

derivatives (94). The carbenium ion (95) derived from 92, on the other hand, is achiral, and once it is formed it can only give rise to racemic products.

SCHEME 5

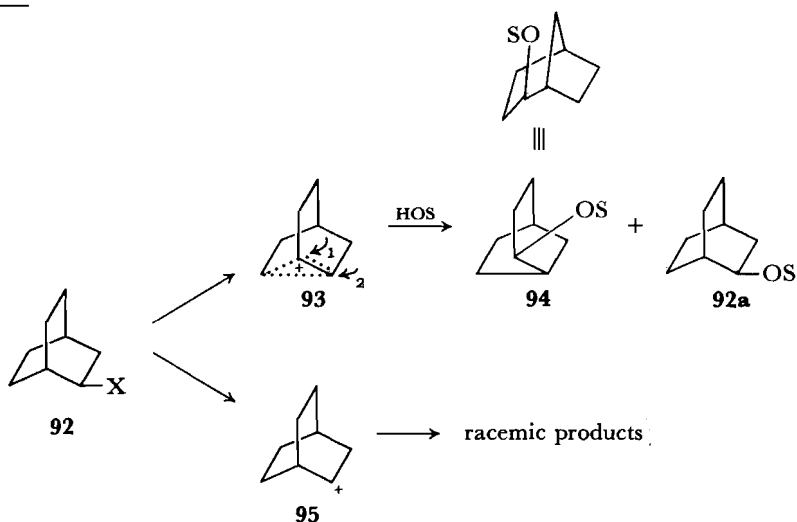

Two laboratories, those of Walborsky and of Goering, simultaneously investigated the stereochemistry of solvolysis of optically active bicyclo[2.2.2]-octyl arenesulfonates, and both found that the product consists of only two compounds: 2-bicyclo[2.2.2]octyl and *exo*-2-bicyclo[3.2.1] derivatives. The [2.2.2] system is largely retained although there is some attendant racemization, and the [3.2.1] system is also chiral but again partially racemized. Both groups concluded that ionization at C₂ is assisted by the C₁—C₆ bond and that the product is formed mainly by solvent attack on the intermediate carbonium ion(93). Some "leakage" of the carbonium ion to the symmetrical carbenium ion (95) does, however, seem to take place, and from this the racemized products are formed.¹¹⁷

Protonated Cyclopropanes¹¹⁸

Deamination of 1-aminopropane-1-¹⁴C gives unscrambled 2-propanol and partially scrambled 1-propanol as shown in Equation 6.44. (The numbers at the carbons of the 1-propanol indicate the percentage of ¹⁴C found at each position.)¹¹⁹ The 2-propanol almost surely arises from a 1,2-hydride shift.

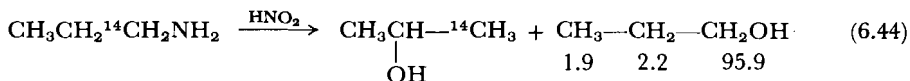

The label at C₃ of the primary alcohol could arise from a 1,3-hydride shift, but no simple hydride shift can bring about the label at C₂.

Aboderin and Baird suggested the mechanism of Scheme 6 for the label scrambling in Equation 6.44.¹²⁰ In each of the *edge-protonated cyclopropanes* (96a-

¹¹⁷ (a) H. M. Walborsky, M. E. Baum, and A. A. Youssef, *J. Amer. Chem. Soc.*, **83**, 988 (1961); (b) H. L. Goering and M. F. Sloan, *J. Amer. Chem. Soc.*, **83**, 1397 (1961).

¹¹⁸ See note 1(a), p. 268 and note 9(a), p. 270.

¹¹⁹ (a) C. C. Lee and J. E. Kruger, *J. Amer. Chem. Soc.*, **87**, 3986 (1965); (b) C. C. Lee and J. E. Kruger, *Tetrahedron*, **23**, 2539 (1967).

¹²⁰ (a) See note 6, p. 269; (b) A. A. Aboderin and R. L. Baird, *J. Amer. Chem. Soc.*, **86**, 2300 (1964).

96c), two carbons are tetracoordinated; the third participant in the three-center bond is hydrogen. Figure 6.17 shows an orbital diagram of Structure 96a.

SCHEME 6

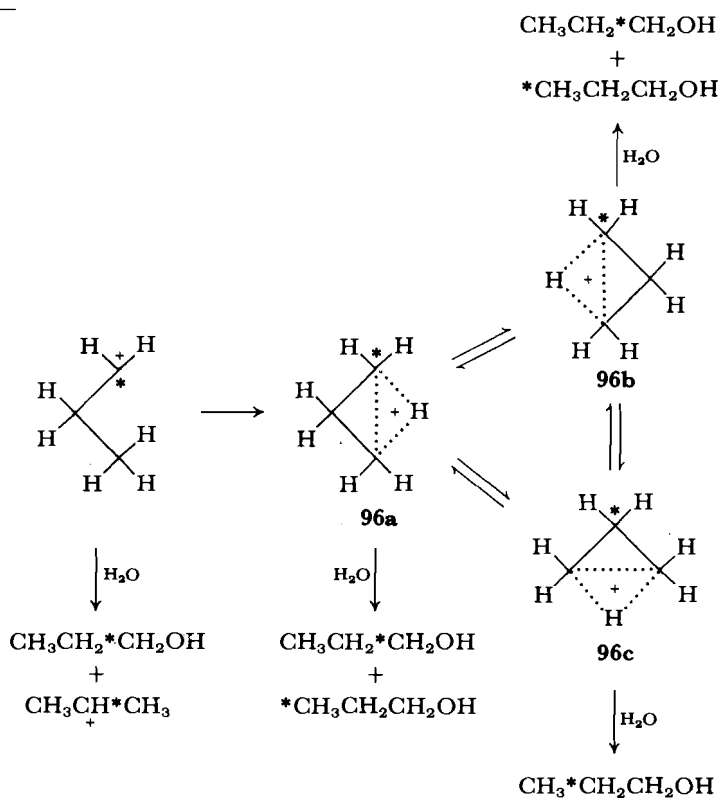

In the product-determining step of Scheme 6, the nucleophilic oxygen of water attacks one of the carbons; this carbon then withdraws its orbital from the three-center bond and an ordinary σ bond is formed between the remaining carbon and the hydrogen.

Another mechanism, that shown in Scheme 7, has also been suggested for the label scrambling of Equation 6.44. In each of the *corner-protonated cyclopropanes* (96a-97c), all three participants in the three-center bond are carbon.

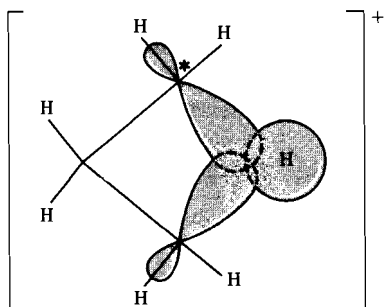
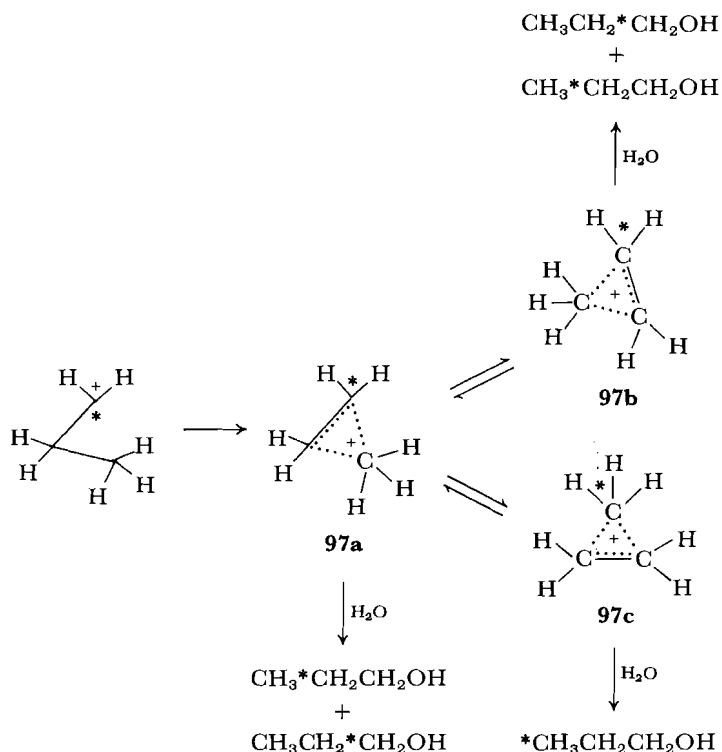

Figure 6.17 Orbital picture of edge-protonated cyclopropane.

Structures **96a–96c** would be the transition states for the interconversions of Structures **97a–97c**.

SCHEME 7



Ab initio molecular orbital calculations carried out by Pople, Schleyer, and co-workers predict that the most stable form of C_3H_7^+ is the 2-propyl cation **98**. The second most stable structure they found to be the corner-protonated cyclo-



propane, **97**. The calculations suggest that **97** lies at an energy minimum and thus is an intermediate, not merely a transition state, but that **96** is probably not an intermediate. Figure 6.18 shows some of the structures and their calculated relative energies.¹²¹

A number of other reactions have been postulated to involve protonated cyclopropanes as intermediates.¹²² For example, nmr studies of the *sec*-butyl cation in superacid show that from -100 to -40°C a process, with an activation energy of 7 kcal mole^{-1} , occurs that scrambles all the protons. The activation energy is too low for the scrambling to occur by the mechanism shown in Equa-

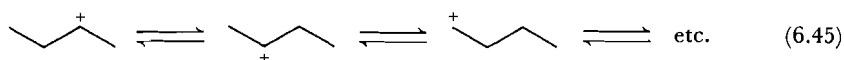

¹²¹ P. C. Hariharan, L. Radoni, J. A. Pople, P. v. R. Schleyer, *J. Amer. Chem. Soc.*, **96**, 599 (1974).

¹²² For a recent example, see: C. H. DePuy, A. H. Andrist, and P. C. Fünfschilling, *J. Amer. Chem. Soc.*, **96**, 948 (1974).

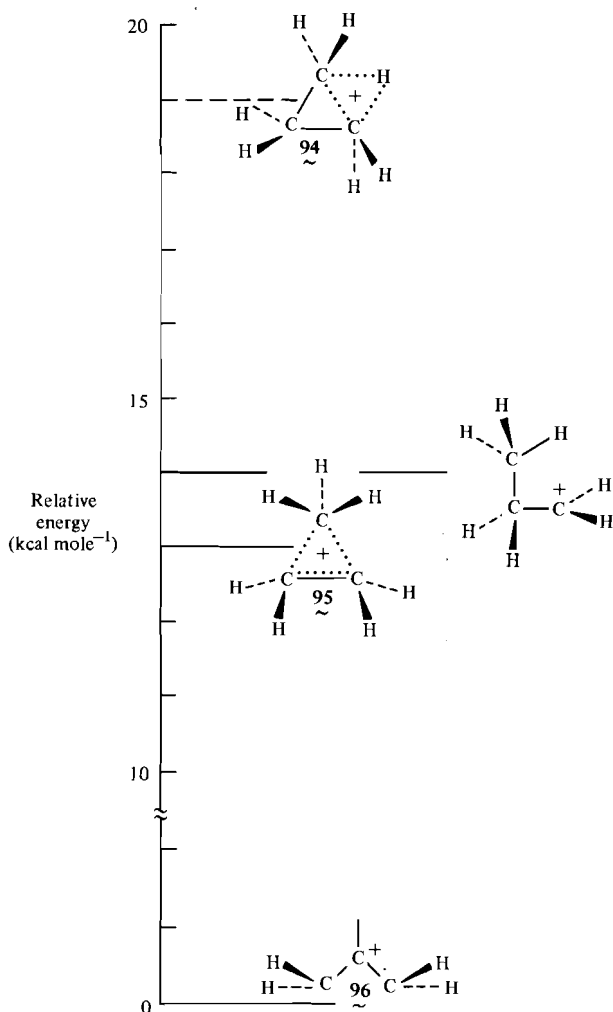

Figure 6.18 Relative energies of various $C_3H_7^+$ ions. Data from P. C. Hariharan, L. Radom, J. A. Pople, and P. v. R. Schleyer, *J. Amer. Chem. Soc.*, **96**, 599 (1974). Reprinted by permission of the American Chemical Society.

tion 6.45 (see p. 270). Saunders suggests that the most probable mechanism is that shown in Scheme 8.¹²³

1,3-Hydride shifts can take place directly, without the intervention of a carbonium ion intermediate, if the geometry of the system is favorable. For example, in the solvolysis of cyclohexyl-2,6-d₂ tosylate in 97 percent acetic acid, 1,3-hydride shifts have been reported to account for 33 percent of the product.¹²⁴ If this is so, it must be because the reaction is made facile by the proximity of the 3-axial hydrogen to the empty *p* orbital.

¹²³ See note 9(b), p. 270.

¹²⁴ Y. G. Bundel, V. A. Savin, A. A. Lubovich, and O. A. Reutov, *Proc. Acad. Sci. USSR Chem. Sect.* (in English), **165**, 1180 (1965).

SCHEME 8

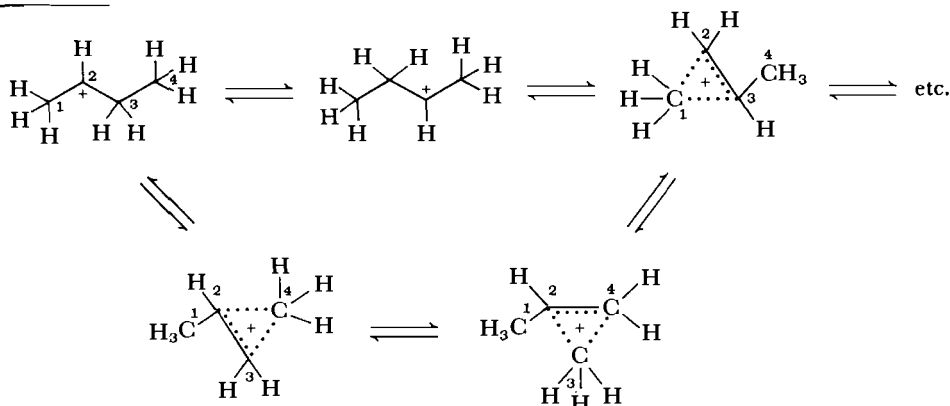

Hydride shifts of higher order than 1,3 occur if (1) the migration origin and the migration terminus are close together and (2) the geometry of the system allows overlap of the orbitals of hydrogen and of the migration terminus. Because of the proximity requirement such shifts are rare in acyclic systems¹²⁵ in nucleophilic solvents,¹²⁶ but in reactions of medium ring (7–12 carbon atoms)

SCHEME 9

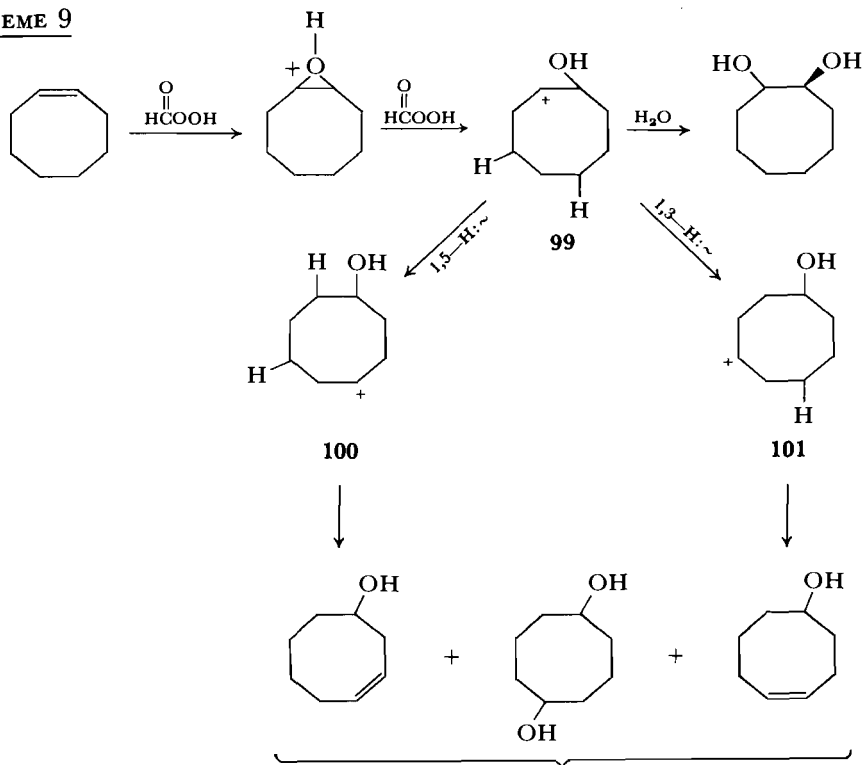

¹²⁵ For a summary of these, see J. L. Fry and G. J. Karabatsos, in Olah and Schleyer, Eds., *Carbonium Ions*, Vol. II, pp. 555–557.

¹²⁶ Saunders and Stofko have observed 1,3-, 1,4-, and 1,5-intramolecular shifts from tertiary to tertiary center in superacid and have calculated the activation barriers to be 8.5, 12–13, and 6–7 kcal mole⁻¹, respectively. (M. Saunders and J. J. Stofko, Jr., *J. Amer. Chem. Soc.*, **95**, 252 (1973)).

carbocations, 1,3-, 1,4-, 1,5- and 1,6-hydride shifts occur readily.¹²⁷ "Transannular shifts" were first noted when unexpected products were found^{128, 129} in the peroxyformic acid oxidation of medium-ring alkenes. For example, cyclooctene gave, in addition to minor amounts of the expected *trans*-1,2-diol, cyclooctane-*cis*-1,4-diol and 3- and 4-cyclooctene-ols. Either a 1,3- or 1,5-hydride shift could bring about formation of the 1,4-diol and of the unsaturated alcohols (see Scheme 9). That both orders of hydride shift take place in this reaction was shown by Cope and co-workers, who treated 5,6-d₂-cyclooctene oxide (**102**) with 90 percent formic acid and, by determining the position of deuterium in the

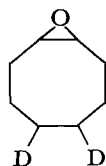
**102**

products, ascertained that 1,5-migration accounted for 94 percent of the formation of 3-cycloocten-1-ol and 61 percent of the 1,4-diol.¹³⁰

The fact that only *trans*-1,2- and *cis*-1,4-glycols are obtained implies that they cannot actually be formed by the simplified mechanism in Scheme 9. The carbenium ions **99–101** should give a mixture of *cis* and *trans* glycols. However, the reaction can be neither entirely concerted, as shown for a 1,5-hydride shift in Equation 6.46, nor involve initial formation of a carbonium ion, as shown in Equation 6.47: The k_H/k_D isotope effects are too small for C—H bond breaking

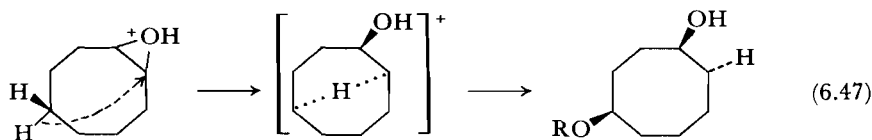
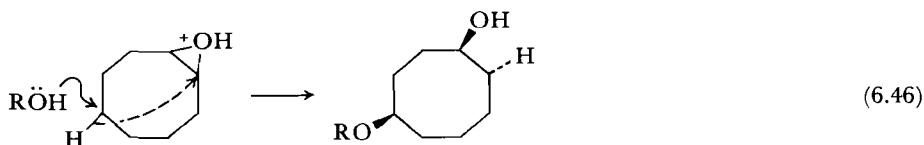

to be involved in the rate-determining step.¹³¹ The mechanism is probably similar to that shown in Equation 6.48, in which the slow step is breaking of the C—O bond (although some stereochemical-preserving attraction remains).

¹²⁷ For reviews, see: (a) V. Prelog and J. G. Traynham, in *Molecular Rearrangements*, P. Mayo, Ed., Wiley-Interscience, New York, 1963, Vol. I, p. 593; (b) A. C. Cope, M. M. Martin, and M. A. McKerver, *Quart. Rev.* (London), **20**, 119 (1966).

¹²⁸ (a) A. C. Cope, S. W. Fenton, and C. F. Spencer, *J. Amer. Chem. Soc.*, **74**, 5884 (1952); (b) A. C. Cope, A. H. Keough, P. E. Peterson, H. E. Simmons, Jr., and G. W. Wood, *J. Amer. Chem. Soc.*, **79**, 3900 (1957).

¹²⁹ V. Prelog and K. Schenker, *Helv. Chim. Acta*, **35**, 2044 (1952).

¹³⁰ A. C. Cope, G. A. Berchtold, P. E. Peterson, and S. H. Sharman, *J. Amer. Chem. Soc.*, **82**, 6366 (1960).

¹³¹ A. A. Roberts and C. B. Anderson, *Tetrahedron Lett.*, 3883 (1969).

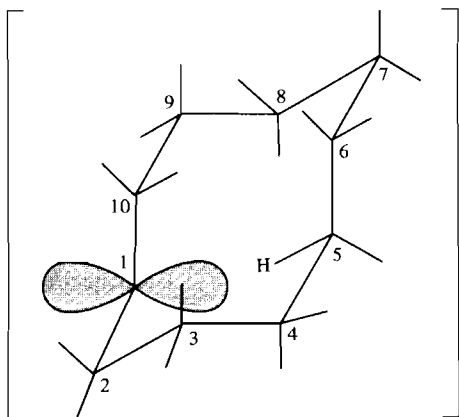
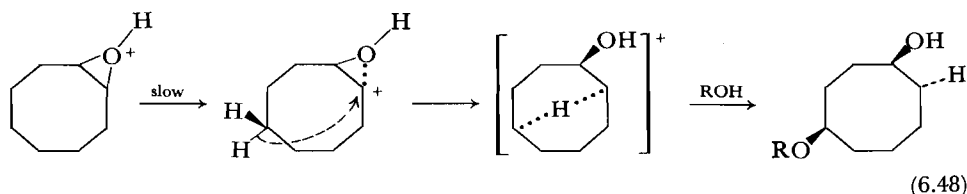

Figure 6.19 The cyclodecyl cation. From J. D. Dunitz and V. Prelog, *Angew. Chem.*, **72**, 896 (1960). Reproduced by permission of Verlag Chemie, GMBH.

Then, in a subsequent fast step, a carbonium ion is formed that is attacked from the back side by solvent.



In some transannular hydride shifts, hydride participation in the rate-determining step does, however, seem to occur.¹³²

Higher-order shifts are facile in medium-sized rings. The geometry of the ring forces some of the transannular hydrogens to be within it, close to the lobe of the empty *p* orbital, which also protrudes into it. For example, the cyclodecyl cation has approximately the structure shown in Figure 6.19.¹³³ The 5-intra-annular hydrogen need hardly move to become bonded to the 1-carbon.

6.3 MIGRATIONS TO CARBONYL CARBON¹³⁴

In the previous sections of this chapter we discussed migrations to electron-deficient carbon in which the electron deficiency was a result of departure of a leaving group with its pair of electrons. Although a carbonyl carbon is slightly electron-deficient because of the electron-withdrawing ability of the oxygen, migrations to it in uncharged ground-state compounds do not occur. However, if (1) the carbonyl compound is converted to its conjugate acid (Equation 6.49) so that a full positive charge resides on it or (2) the migration origin is made

¹³² (a) N. L. Allinger and W. Szkrybalo, *Tetrahedron*, **24**, 4699 (1968); (b) N. L. Allinger and S. Greenberg, *J. Amer. Chem. Soc.*, **84**, 2394 (1962).

¹³³ J. D. Dunitz and V. Prelog, *Angew. Chem.*, **72**, 896 (1960).

¹³⁴ For a general review, see: C. J. Collins and J. F. Eastham, in *The Chemistry of the Carbonyl Group*, S. Patai, Ed., Wiley-Interscience, New York, 1966, Vol. I, p. 761.

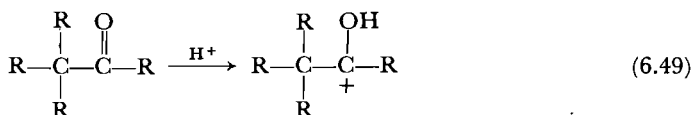

especially electron-rich, increasing the tendency of a group to migrate with its pair of electrons, rearrangements do occur. The aldehyde-ketone rearrangement (Problem 16) is an example of the first type, and the benzoic acid rearrangement is an example of the second type.

Benzilic Acid Rearrangement¹³⁵

Liebig observed the first intramolecular rearrangement in 1838 when he found that benzil in basic solution forms a new compound.¹³⁶ In 1870 Jena correctly established the product of the reaction as benzilic acid, but proposed an incorrect structure for the starting material to avoid postulating a skeletal rearrangement.¹³⁷ In 1928 Ingold proposed the mechanism shown in Equation 6.50, which today is solidly supported by experimental evidence.¹³⁸

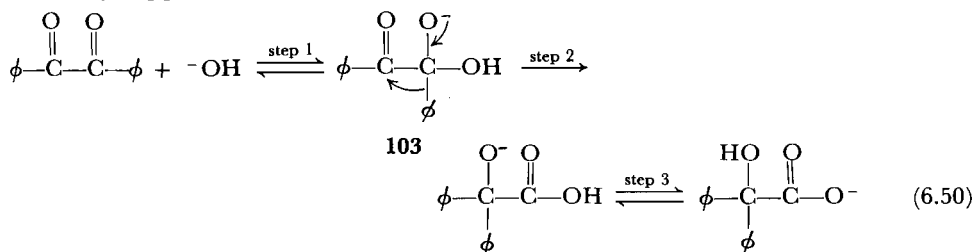

The reaction is second-order overall, first-order each in benzil and in base.¹³⁹ This is consistent with any of the three steps being rate-determining, since each depends on the concentrations of benzil and either of free base or of base that has already added to the benzil. Roberts and Urey carried out the rearrangement with ¹⁸O-labeled base and found that the label was incorporated into unreacted benzil at a faster rate than that of the rearrangement.¹⁴⁰ Thus the first step must be rapid and reversible (although the first intermediate must exist long enough for the facile proton exchange,

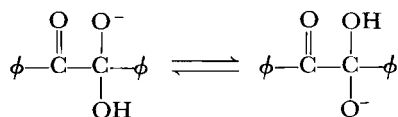

to take place). That step 3 is not rate-determining was shown by Hine, who used ⁻OD as base and found no deuterium isotope effect.¹⁴¹ By elimination, that leaves the migration, step 2, as the rate-determining process.

An interesting aspect of this rearrangement is that the phenyl group with the lower electron-donating ability usually migrates. For example, in **104** the

¹³⁵ For a review, see S. Selman and J. F. Eastham, *Quart. Rev.* (London), **14**, 221 (1960).

¹³⁶ J. Liebig, *Justus Liebigs Ann. Chem.*, **25**, 1 (1838).

¹³⁷ A. Jena, *Justus Liebigs Ann. Chem.*, **155**, 77 (1870).

¹³⁸ C. K. Ingold, *Ann. Rept. Chem. Soc.*, **25**, 124 (1928).

¹³⁹ F. H. Westheimer, *J. Amer. Chem. Soc.*, **58**, 2209 (1936).

¹⁴⁰ I. Roberts and H. C. Urey, *J. Amer. Chem. Soc.*, **60**, 880 (1938).

¹⁴¹ J. Hine and H. W. Haworth, *J. Amer. Chem. Soc.*, **80**, 2274 (1958).

substituted phenyl migrates 81 percent of the time if Z is *m*-chloro, but only 31 percent of the time if Z is *p*-methoxy.¹⁴² (Note that which group migrates can be determined only if one of the carbonyl carbons is labeled with ¹⁴C.) Consideration of the mechanism in Equation 6.50 explains the anomaly.

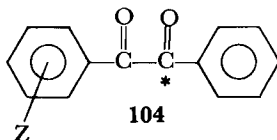

If the second step is rate-determining, then the observed rate is given in Equation 6.51,

$$k_{\text{obs}} = k_2[103] \quad (6.51)$$

where k_2 is the rate constant for step 2. The concentration of **103** is given by Equation 6.52

$$[103] = K_1[\text{benzil}] [\text{OH}^-] \quad (6.52)$$

in which K_1 is the equilibrium constant for step 1. Substituting Equation 6.52 into Equation 6.51, we obtain Equation 6.53: The observed rate is dependent on the equilibrium constant for the formation of **103** as well as on the rate of migration of the aryl group.

$$k_{\text{obs}} = k_2 K_1 [\text{benzil}] [\text{OH}^-] \quad (6.53)$$

If the substituted phenyl is to migrate, then the intermediate **103a** must be formed; migration of the phenyl requires **103b**. Electron-withdrawing substituents will increase K_1 for the formation of **103a**; if K_1 is increased more than k_2 is decreased, more substituted phenyl will migrate than unsubstituted phenyl.

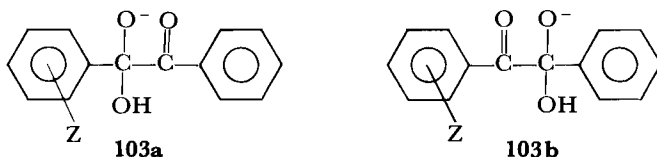

6.4 REARRANGEMENTS TO ELECTRON-DEFICIENT NITROGEN AND OXYGEN¹⁴³

Our consideration of rearrangements to electron-deficient heteroatoms must be brief. In discussing migrations to electron-deficient nitrogen, we first discuss three rearrangements that occur in carbonyl derivatives, the Beckmann, Hofmann, and Schmidt rearrangements, and then consider rearrangements of nitrenium ions.

¹⁴² M. T. Clark, E. C. Hendley, and O. K. Neville, *J. Amer. Chem. Soc.*, **77**, 3280 (1955).

¹⁴³ For a general review, see: (a) P. A. S. Smith, in *Molecular Rearrangements*, P. Mayo, Ed., Wiley-Interscience, New York, 1963, Vol. 1, p. 457. For reviews of rearrangements to electron-deficient nitrogen, see: (b) D. V. Banthorpe, in *The Chemistry of the Amino Group*, S. Patai, Ed., Wiley-Interscience, New York, 1968, p. 623. For a review of rearrangements to electron-deficient oxygen, see: (c) J. B. Lee and B. C. Uff, *Quart. Rev. (London)*, **21**, 429 (1967); (d) R. Curci and J. O. Edwards, in *Organic Peroxides*, D. Swern, Ed., Wiley-Interscience, New York, 1970, Vol. 1, p. 199.

Because of the high electronegativity of oxygen, an O—X bond will cleave heterolytically, producing a positive oxygen, only if X is an excellent leaving group. As a result, electron-deficient oxygen is formed most frequently in reactions of peresters and aromatic peroxides, R—O—O—R' (R' = aryl or acyl). In these compounds, when $^-OR'$ departs, the negative charge on the leaving group is stabilized by resonance. Even here heterolytic cleavages are not universal: The energy required for a heterolytic cleavage in the absence of anchimeric assistance is ca. 50 kcal mole $^{-1}$,¹⁴⁴ whereas the energy for a homolytic cleavage to two alkoxy radicals is only ca. 30–40 kcal mole $^{-1}$.¹⁴⁵ Thus heterolytic cleavage usually takes place only with anchimeric assistance.

The Beckmann Rearrangement¹⁴⁶

The acid-catalyzed conversion of ketoximes and aldoximes to amides or amines (the amide is often hydrolyzed to the corresponding amine under the reaction conditions) is known as the Beckmann rearrangement after its discoverer.¹⁴⁷ The reaction and its widely accepted mechanism are shown in Equation 6.54.

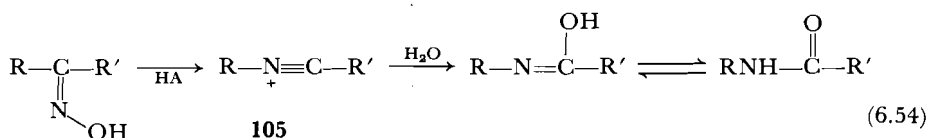

The observation that picryl ethers of oximes (**106**) rearrange without a catalyst established that the role of the catalyst was to convert the hydroxyl

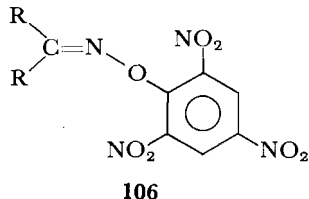

into a better leaving group.¹⁴⁸ Some acids catalyze by simply protonating the oxime as in **107**. Other acids may esterify the oximes. For example, Schofield

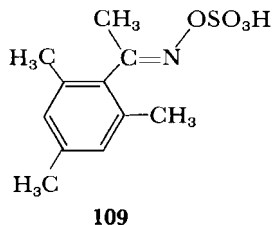
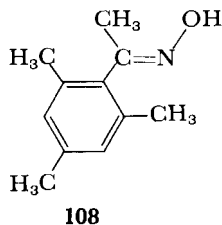
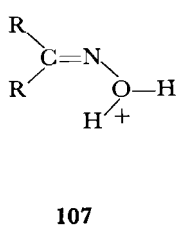

¹⁴⁴ E. Hedaya and S. Winstein, *J. Amer. Chem. Soc.*, **89**, 1661, 5314 (1967).

¹⁴⁵ S. W. Benson and R. Shaw, in *Organic Peroxides*, D. Swern, Ed., Wiley-Interscience, New York, 1970, Vol. 1, p. 147.

¹⁴⁶ L. G. Donaruma and W. Z. Heldt, *Org. Reactions*, **11**, 1 (1960).

¹⁴⁷ E. Beckmann, *Ber. Deut. Chem. Ges.*, **20**, 1507 (1887).

¹⁴⁸ A. W. Chapman and F. A. Fidler, *J. Chem. Soc.*, 448 (1936).

has suggested¹⁴⁹ that catalysis of **108** by sulfuric acid is due to the preliminary conversion of **108** to **109**.¹⁵⁰

The oxime of an aldehyde or ketone can often be separated into two geometrical isomers, the syn and anti forms. When the Beckmann rearrangement is carried out under nonisomerizing conditions, it is always the groups anti to the —OH that migrate.¹⁵¹ For example, Curtin and co-workers carried out Beckmann rearrangements on **110** and **111** in the solid phase by gently heating crystals of the compounds. The conditions do not allow interconversion of **110** and **111**; in **110** only the phenyl group migrates, whereas in **111** it is the *p*-bromophenyl group that shifts.¹⁵²

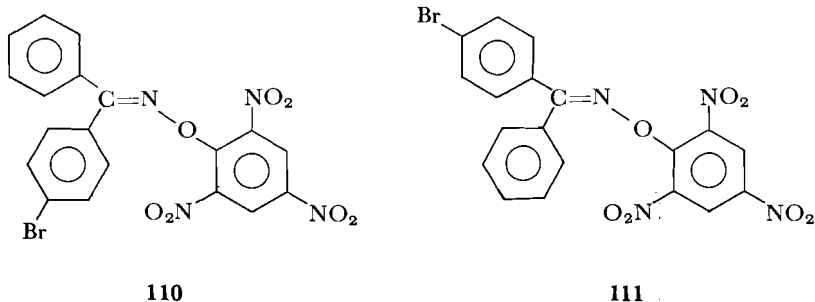

When the catalyst is a Brønsted acid, migration is not stereospecific. Under these conditions, syn and anti forms are readily interconverted, presumably via the pathway shown in Equation 6.55.

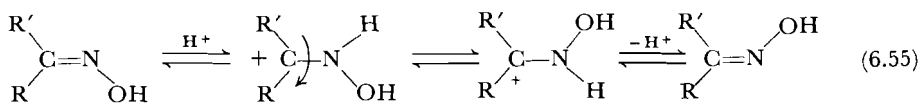

The stereochemistry of the reaction indicates that rearrangement is concerted with departure of the leaving group, as is implied by Step 1 of Equation 6.54. The question then remains whether this step or another is rate-determining. An answer can be found in the effect of the nature of the migrating group on the rate of reaction. If the migration step is rapid, it should not matter to the overall rate whether an electron-rich or an electron-poor group is migrating. On the other hand, if migration is the slow step, electron-donating substituents in the migrating group should increase the rate, and electron-withdrawing substituents should decrease it. Kinetic studies of the rearrangements of meta- and para-substituted acetophenone oximes (**112**) in concentrated H_2SO_4 show that the rates do indeed vary with the electron-donating ability of the substituents and that a fairly good correlation exists between the rates of rearrangement and the Hammett σ^+ constants for the substituents as shown in Figure 6.20. This observation indicates that some participation by phenyl occurs in the rate-determining step and suggests **113** as the transition state.¹⁵³ Not all Beckmann re-

¹⁴⁹ B. J. Gregory, R. B. Moodie, and K. Schofield, *J. Chem. Soc., B*, 338 (1970).

¹⁵⁰ This intermediate has been observed in the nmr. See Y. Yukawa and T. Ando, *J. Chem. Soc., D*, 1601 (1971).

¹⁵¹ See note 143(a), (b), p. 318, and note 146, p. 319.

¹⁵² J. D. McCullough, Jr., D. Y. Curtin, and I. C. Paul, *J. Amer. Chem. Soc.*, **94**, 874 (1972).

¹⁵³ See note 149.

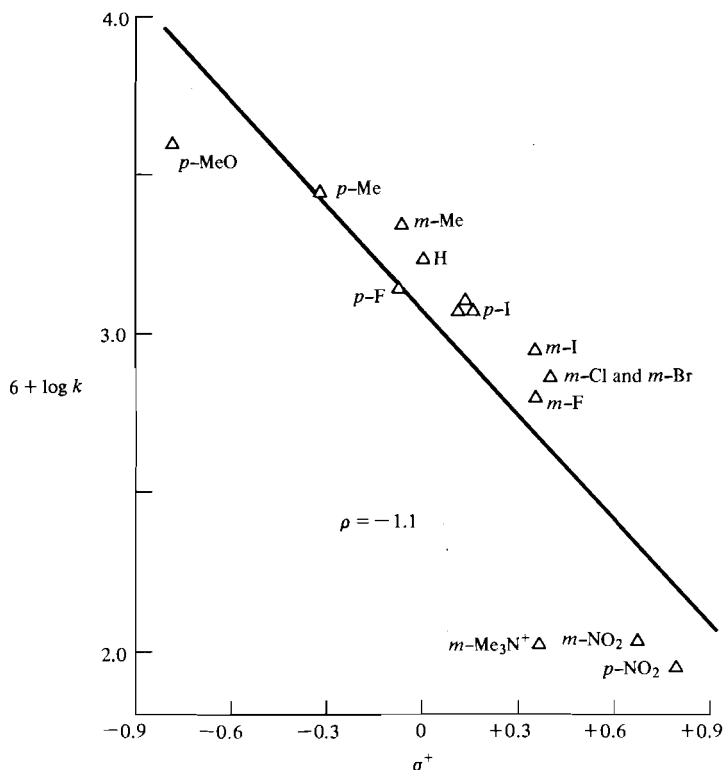
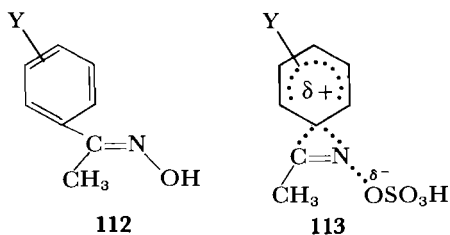

Figure 6.20 Plot of $\log k$ vs. σ^+ for the Beckmann rearrangement of acetophenone oximes in 98.2 percent sulfuric acid at 80°C. From B. J. Gregory, R. B. Moodie, and K. Schofield, *J. Chem. Soc.*, **13**, 338 (1970). Reprinted by permission of K. Schofield and The Chemical Society.

arrangements need necessarily, however, have the same rate-determining step.¹⁵⁴



That intermediate **105** in Equation 6.54 is formed in the Beckmann rearrangement has been amply demonstrated both by diverting it to other products¹⁵⁵ and by direct observation by nmr.¹⁵⁶

If the mechanism in Equation 6.54 is correct, then oxygen transfer should be an intermolecular process. And in fact, when unlabeled acetophenone

¹⁵⁴ See note 143(a), p. 318.

¹⁵⁵ (a) A. Werner and A. Piguët, *Ber. Deut. Chem. Ges.*, **37**, 4295 (1904); (b) R. M. Palmere, R. T. Conley, and J. L. Rabinowitz, *J. Org. Chem.*, **37**, 4095 (1972).

¹⁵⁶ B. J. Gregory, R. B. Moodie, and K. Schofield, *J. Chem. Soc., D*, 645 (1969).

oximes (**112**) are allowed to rearrange in ^{18}O -enriched solvent, the product amide contains the same percentage of ^{18}O as the solvent.¹⁵⁷ Alkyl or aryl migration, on the other hand, must be intramolecular, since a chiral migrating group retains its chirality during the migration.¹⁵⁸

The Hofmann Rearrangement¹⁵⁹

In 1882 Hofmann discovered that when amides are treated with bromine in basic solution, they are converted to amines with one carbon less than the starting amide.¹⁶⁰ He also isolated the N-bromo amine (**114**) and the isocyanate (**115**) as intermediates on the reaction path. The mechanism in Equation 6.56 accounts for the products and the intermediates. This reaction (or the analogous rearrangement of the N-chloro amine) is now known as the Hofmann rearrangement or, because of its synthetic usefulness in eliminating a carbon atom, the Hofmann degradation.

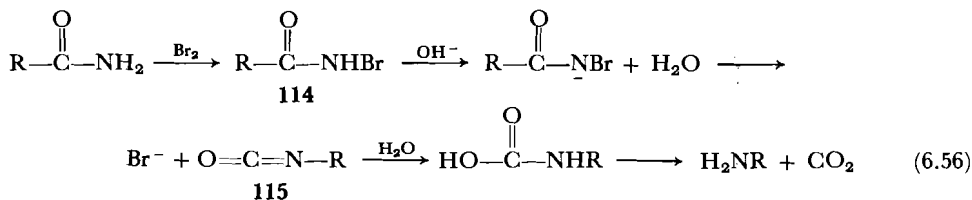

In a most convincing demonstration of the intramolecularity of the migration step, Wallis and Moyer carried out the Hofmann degradation on chiral **116**. This compound can be prepared in optically active form because the groups in the ortho position of the phenyl ring hinder the rotation that would convert **116** to its mirror image **117**. During rearrangement **116** would lose chirality if the

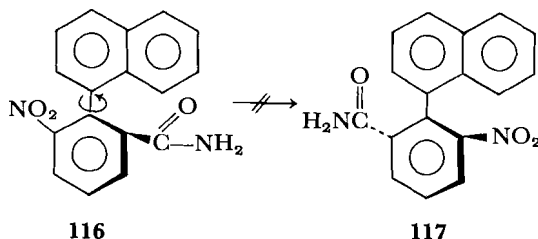

migrating bond simply stretched enough to allow rotation about itself. However, loss of chirality is not observed: **116** rearranges with retention of configuration.¹⁶¹

There is a question whether Equation 6.56 shows all the intermediates on the reaction path. If, instead of rearrangement being concerted with loss of halide ion as shown in Equation 6.56, the halide ion departed first, then a nitrene¹⁶² would be formed as shown in Equation 6.57. To date no nitrene inter-

¹⁵⁷ See note 149, p. 320.

¹⁵⁸ (a) A. Campbell and J. Kenyon, *J. Chem. Soc.*, 25 (1946); (b) J. Kenyon and D. P. Young, *J. Chem. Soc.*, 263 (1941).

¹⁵⁹ E. S. Wallis and J. F. Lane, *Org. Reactions*, **3**, 267 (1946).

¹⁶⁰ A. W. Hofmann, *Ber. Deut. Chem. Ges.*, **15**, 762 (1882).

¹⁶¹ E. S. Wallis and W. W. Moyer, *J. Amer. Chem. Soc.*, **55**, 2598 (1933).

¹⁶² A "nitrene" is a nitrogen-containing compound in which the nitrogen has only a sextet of electrons. Such a species is neutral but electron-deficient; cf. carbenes (Section 5.6).

mediate in the Hofmann reaction has been proved, but the possibility remains that it is at least sometimes formed.

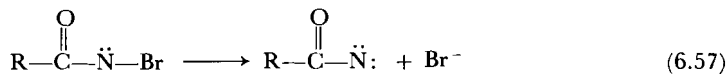

The Schmidt Rearrangements¹⁶³

The group of rearrangements brought about by treatment of aldehydes, ketones, or carboxylic acids with hydrogen azide are known as Schmidt rearrangements. All are acid-catalyzed and all involve addition of HN_3 to the carbonyl group followed by dehydration. They are shown in Equations 6.58–6.60.

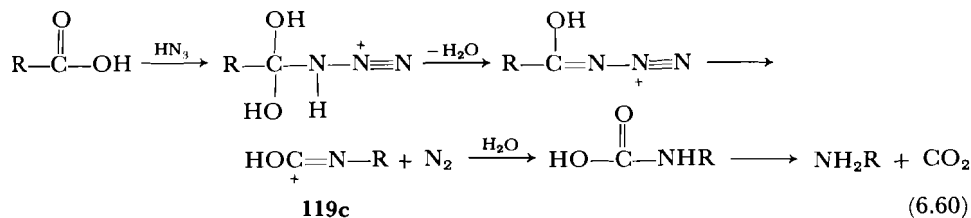
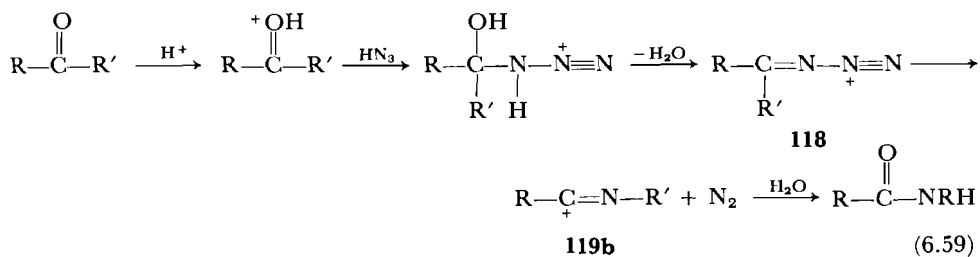
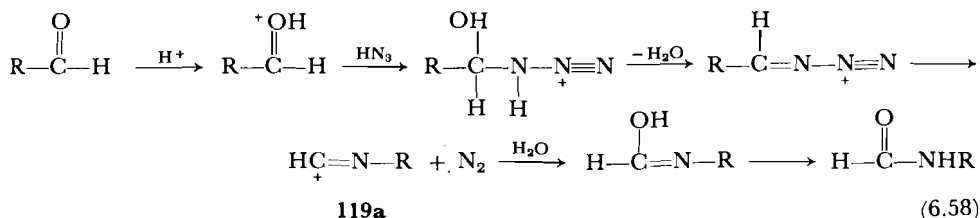

Although mechanisms can be formulated that do not involve dehydration and subsequent formation of the intermediates **119a–119c** there is strong evidence that these steps take place. For example, tetrazoles, which are formed from **119** as shown in Equation 6.61, have been isolated as side products. Further evidence for the dehydration step was obtained by Hassner and co-workers,

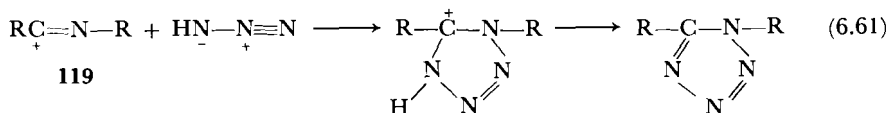

¹⁶³ H. Wolff, *Org. Reactions*, **3**, 307 (1946).

who showed that acid-catalyzed rearrangement of vinyl azides gives the same products in the same ratio as the Schmidt rearrangement of the corresponding ketone under the same conditions. He postulated that the reaction paths of the two rearrangements converge at the common intermediate **118** as shown in Scheme 10.¹⁶⁴

SCHEME 10

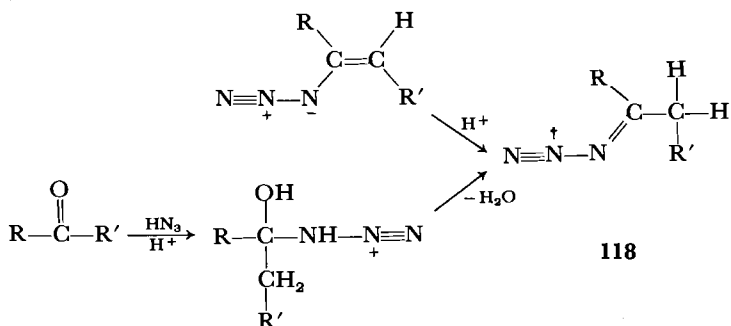

In the Schmidt rearrangement of carboxylic acids the formation of the adduct is apparently usually not rate-determining. The evidence for this comes from studies of the comparative rate of nitrogen evolution from HN_3 in the presence and in the absence of carboxylic acids: When *m*- or *p*-nitrobenzoic acid is added to HN_3 in H_2SO_4 , the rate of nitrogen evolution decreases. Thus HN_3 must be rapidly converted to an adduct from which loss of nitrogen is slower than from HN_3 itself. Moreover, the adduct, to be formed at all, must be formed more rapidly than N_2 is lost from HN_3 .¹⁶⁵

The intramolecularity of the migration step in the Schmidt rearrangements has been convincingly demonstrated by showing the retention of chirality of the migrating group.¹⁶⁶

In the Schmidt rearrangement of ketones the larger group, irrespective of its nature, tends to migrate. Apparently the intermediate **118** is formed so that the bulkier aryl or alkyl group is trans to the N_2 group. Then, as in the Beckmann rearrangement, the group trans to the leaving group prefers to migrate. The barriers to interconversion of the cis and trans forms are, however, lower in the Schmidt than in the Beckmann rearrangement.¹⁶⁷

Nitrenium Ions¹⁶⁸

The nitrenium ion (**120**) is isoelectronic with the carbocation. Until the middle 1960s it was unknown, but at that time Gassman began an intensive investigation

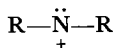
**120**

¹⁶⁴ A. Hassner, E. S. Ferdinandi, and R. J. Isbister, *J. Amer. Chem. Soc.*, **92**, 1672 (1970).

¹⁶⁵ L. H. Briggs and J. W. Lyttleton, *J. Chem. Soc.*, 421 (1943). But see also V. A. Ostrovskii, A. S. Enin, and G. I. Koldobski, *J. Org. Chem., U.S.S.R.*, **9**, 827 (1973).

¹⁶⁶ See note 143(a), (b), p. 318.

¹⁶⁷ See note 164.

¹⁶⁸ P. G. Gassman, *Accts. Chem. Res.*, **3**, 26 (1970).

to determine whether or not it exists. Since nitrogen is more electronegative than carbon, it was to be expected that the nitrenium ion would be less stable than its carbon analog.

Gassman and Fox first synthesized and then solvolyzed N-chloroisoquinuclidine (**121**). In refluxing methanolic silver nitrate, **121** is converted in 60 percent yield to the rearranged product, **122**, as shown in Equation 6.62.¹⁶⁹ Since alkyl groups do not migrate to radical centers, this rearrangement clearly indicates

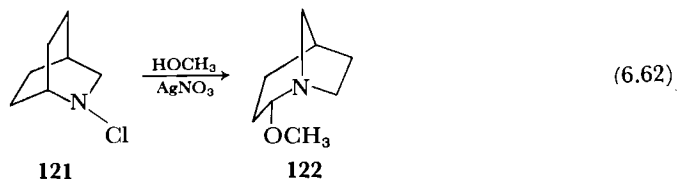

that an electron-deficient nitrogen must have been formed. What it does not indicate is whether the reaction occurred via the nitrenium ion (**123**), as a discrete intermediate, or whether rearrangement is concerted with departure of the leaving group and **124** is the first-formed ion.



A nitrenium ion is unusual in that it has both a positive charge and a non-bonding pair. If the nitrenium ion (**123**) were formed, it must initially be produced in the singlet state—that is, the lone pair must initially have its spins paired as shown in **123s**. But if the lifetime of **123s** were long enough, spin inversion to **123t** might occur. (See Section 5.6, p. 258 and Section 13.2, p. 691). The

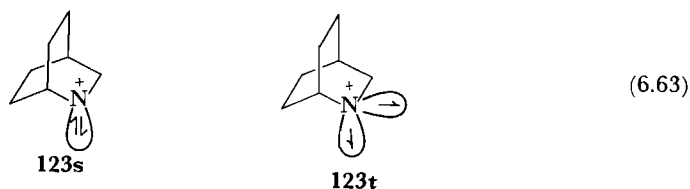

singlet should be similar to a carbocation in character, but the triplet should behave like a nitrogen radical.

Gassman and Cryberg solvolyzed **125** in a number of solvents containing methanol.¹⁷⁰ The predominant products were **126**, **127**, and **128**. The first two, **126** and **127**, are solvolysis products derived from rearrangement to electron-deficient nitrogen. But **128** almost surely results from hydrogen abstraction from the solvent. The proposed mechanisms for their formation are shown in Scheme 11.

When the solvent is methanol–benzene, the products **126** and **127** predominate. Their combined yield is 8.2 times greater than the yield of **128**. However, when a bromine-containing solvent is mixed with the methanol, the

¹⁶⁹ P. G. Gassman and B. L. Fox, *J. Amer. Chem. Soc.*, **89**, 338 (1967).

¹⁷⁰ P. G. Gassman and R. L. Cryberg, *J. Amer. Chem. Soc.*, **91**, 5176 (1969).

SCHEME 11

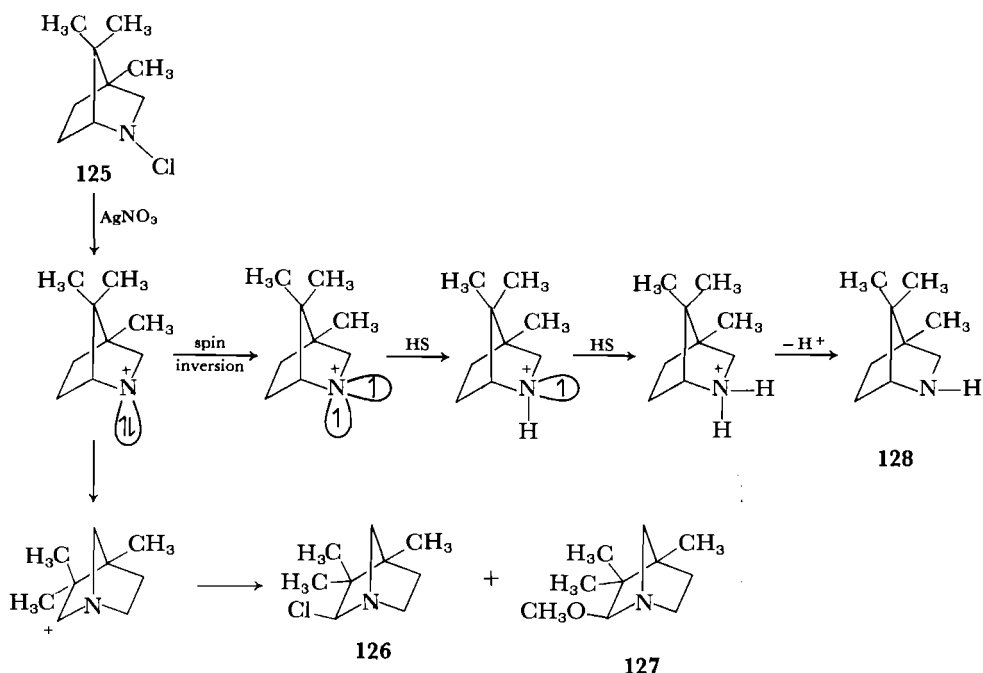

relative yields change drastically. Table 6.2 gives the data. (Bromine, a "heavy atom," is known to catalyze singlet-triplet conversions—see Section 13.1, p. 687.) Thus in bromoform-methanol the ratio (126 + 127)/128 is only 0.02. This experiment indicates that a nitrenium ion must exist as a discrete intermediate—with a long enough lifetime to undergo spin inversion.

Nitrenium ions can also be generated by solvolyzing esters of N,N-dialkylhydroxylamines. 3,5-Dinitrobenzoates (129) were found to be the most useful hydroxylamine derivatives.¹⁷¹

Table 6.2 PRODUCTS FROM SOLVOLYSIS OF 125

Solvents	Percent yield			$\frac{126 + 127}{128}$
	126	127	128	
$\text{CH}_3\text{OH}-\text{C}_6\text{H}_{12}$	56	10	8	8.2
$\text{CH}_3\text{OH}-p\text{Br}_2\text{C}_6\text{H}_4$	33	10	25	1.7
$\text{CH}_3\text{OH}-\text{CCl}_4$	13	< 1	59	0.22
$\text{CH}_3\text{OH}-\text{CHCl}_3$	4	< 1	63	0.06
$\text{CH}_3\text{OH}-\text{CHBr}_3$	~ 1	< 1	45	0.02
$\text{CH}_3\text{OH}-\text{CH}_3\text{OH}$	59	20	7	11.3

SOURCE: P. G. Gassman, *Accts. Chem. Res.*, **3**, 26 (1970). Reprinted by permission of the American Chemical Society.

¹⁷¹ P. G. Gassman and G. D. Hartman *J. Amer. Chem. Soc.*, **95**, 449 (1973).

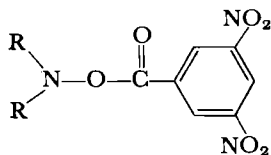

129

Heterolytic Peroxyester Decomposition: The Criegee Rearrangement

In 1944 Criegee observed that *trans*-9-decalyl peroxyesters rearrange on standing to 1,6-epoxycyclodecyl esters.¹⁷² Further study of the reaction showed that it has the characteristics of an ionic rather than a radical pathway: The rate is

proportional to the anionic stability of $^-\text{O}-\overset{\text{O}}{\parallel}{\text{C}}-\text{R}$ and increases with the polarity of the solvent.¹⁷³ Because no products were obtained that were the result of solvent intervention or of exchange with added salts, the reaction was postulated to have only intimate ion-pair intermediates as shown in Equation 6.64.¹⁷⁴

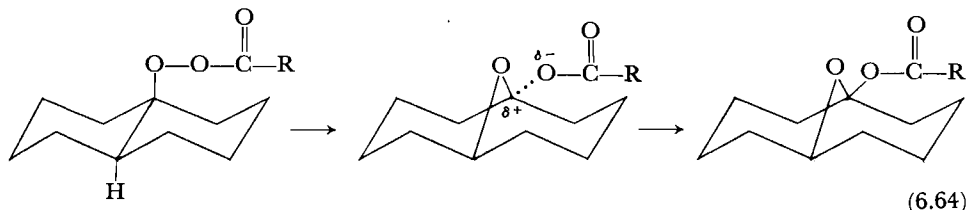

Denney showed that if the carbonyl oxygen in *trans*-9-decalyl peroxybenzoate is labeled with ^{18}O , almost all the label is found in the carbonyl oxygen of the product.¹⁷⁵ This experiment dramatically demonstrates the closeness with which

Table 6.3 RELATIVE RATES OF REARRANGEMENT REACTIONS WITH DIFFERENT MIGRATING GROUPS

	Ionic Decomposition of	Pinacol Rearrangement of	Acetolysis of	Lossen Rearrangement of
R			$(\text{CH}_3)_2\text{CRCH}_2\text{OTs}$	
Me	1	1	1	0.03
Et	45	17	—	1
<i>i</i> -Pr	2.9×10^3	—	5.3	14.9
<i>t</i> -Bu	2.3×10^5	4000	—	12.0
$\text{CH}_2-\phi$	1.6×10^3	—	0.16	—
ϕ	1.1×10^5	—	335	12.2

SOURCE: A. E. Hedaya and S. Winstein, *J. Amer. Chem. Soc.*, **89**, 1661 (1967). Reprinted by permission of the American Chemical Society.

¹⁷² R. Criegee, *Ber. Deut. Chem. Ges.*, **77**, 722 (1944).

¹⁷³ R. Criegee and R. Kaspar, *Justus Liebigs Ann. Chem.*, **560**, 127 (1948).

¹⁷⁴ P. D. Bartlett and J. L. Kice, *J. Amer. Chem. Soc.*, **75**, 5591 (1953); (b) H. L. Goering and A. C. Olson, *J. Amer. Chem. Soc.*, **75**, 5853 (1953).

¹⁷⁵ D. B. Denney and D. G. Denney, *J. Amer. Chem. Soc.*, **79**, 4806 (1957).

the carboxylate anion must be connected to the decalyl cation during the rearrangement.

Winstein investigated the peroxybenzoate rearrangements further to see if there was neighboring-group participation in departure of the leaving group. He studied the products from rearrangement of 2-R-2-propyl-*p*-nitroperoxybenzoates and found that the more electron-donating R is, the greater is its migratory aptitude. Equation 6.65 shows the principal products formed if R is more electron-donating than methyl.

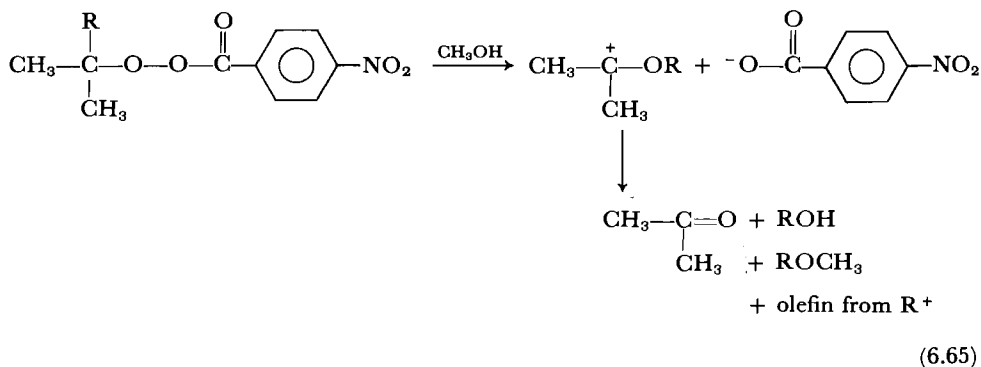

Winstein also found that the rate is highly dependent on the electron-donating ability of R—much more so than the rates of other intramolecular rearrangements (see Table 6.3). He therefore postulated that the migrating alkyl group provides anchimeric assistance to the departure of the nitrobenzoate anion and that the transition state for the rearrangement can be represented by a bridged structure such as **130**.

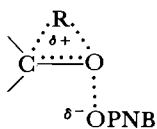

130

Winstein estimated the rate acceleration due to anchimeric assistance in ionic perester decompositions as follows. By using Equation 6.66, in which the first term on the right-hand side is the difference in homolytic dissociation

$$\Delta\Delta E_H = (\Delta E_{oo} - \Delta E_{co}) + (I_o - I_c) \quad (6.66)$$

energies between peroxide and carbon–oxygen bonds and the second term is the ionization potential difference between oxygen and carbon, he estimated that the differences in energies of heterolysis of peroxide and carbon–oxygen bonds ($\Delta\Delta E_H$) should be 22 kcal mole⁻¹ (peroxide bond breaking being more costly). He then compared the observed enthalpies of activation (ΔH^\ddagger) of acetolysis of neopentyl tosylate (**131**) and *t*-butyl pertosylate (**132**) and assumed that they are a measure of the energies of heterolysis. He found that ΔH^\ddagger for **131** was 10 kcal higher than for **132**. Thus methyl assistance is responsible for lowering the ΔH^\ddagger for heterolysis of **132** by ca. 32 kcal mole⁻¹, which corresponds to a rate acceleration of 10²³.¹⁷⁶

¹⁷⁶ See note 144, p. 319.

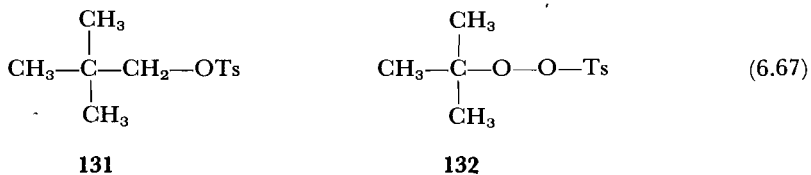

Acid-catalyzed decompositions of hydroperoxides in which the leaving group is water also take place. An example is shown in Equation 6.68. That the pathway is actually one of migration concerted with departure of water as shown, and does not include intervention of the high-energy species RO^+ ,

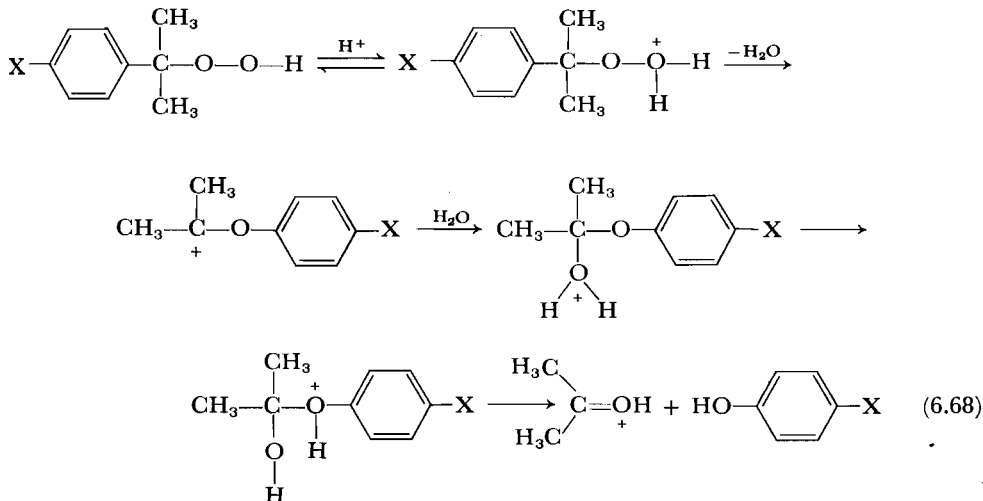

has been demonstrated by the fact that the rates of rearrangement of Reaction 6.68 correlate with the σ^+ constants of the X substituent.¹⁷⁷

The Baeyer-Villiger Oxidation¹⁷⁸

In 1899 Baeyer and Villiger observed that peroxy acids convert ketones to esters.¹⁷⁹ The reaction is first-order each in ketone and in peroxy acid, and it is general acid catalyzed. Criegee first suggested the mechanism shown in Equation 6.69. The role of the acid catalyst is to protonate the leaving group, thereby facilitating its departure.¹⁸⁰

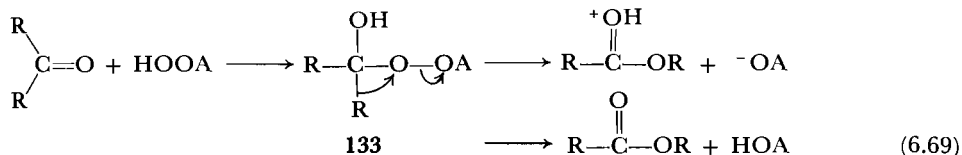

The intermediate **133** has never been directly observed in a rearrangement reaction, but analogous structures are known for the addition of peroxyacetic

¹⁷⁷ A. W. de Ruyter van Steveninck and E. C. Kooyman, *Rec. Trav. Chim. Pays-Bas*, **79**, 413 (1960).

¹⁷⁸ C. H. Hassall, *Org. Reactions*, **9**, 73 (1957).

¹⁷⁹ A. Baeyer and V. Villiger, *Ber. Deut. Chem. Ges.*, **32**, 3625 (1899).

¹⁸⁰ M. F. Hawthorne and W. D. Emmons, *J. Amer. Chem. Soc.*, **80**, 6398 (1958).

acid to aldehydes.¹⁸¹ Doering and Dorfman provided strong support for the mechanism of Equation 6.69 when they showed that oxidation of benzophenone labeled with ¹⁸O gave phenyl benzoate in which all of the ¹⁸O was retained in the carboxyl group (Equation 6.70).¹⁸² This ruled out symmetrical species such as **134** as intermediates on the reaction path.

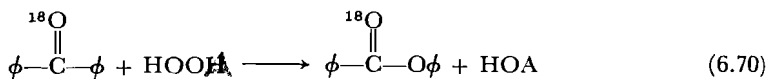
**134**

The question remains: Is the formation of **133** or its destruction rate-determining? Experiment indicates that rearrangement is concerted and that in the oxidation of most ketones rearrangement is rate-determining.

For example, Palmer and Fry oxidized para-substituted acetophenones-1-¹⁴C as shown in Equation 6.71 and compared these rates of oxidation with the

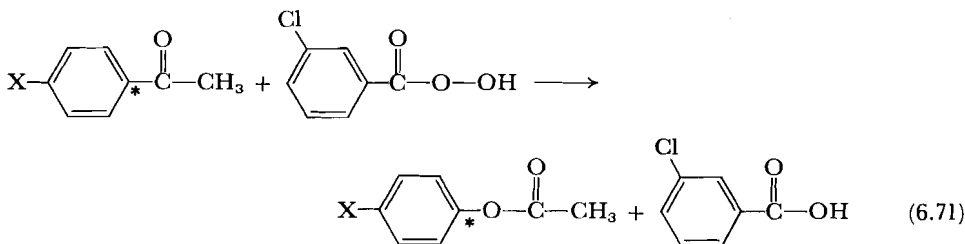

rates of oxidation of the unlabeled ketones.¹⁸³ As shown in Table 6.4, for all substituents except *p*-OCH₃, there is a significant ¹⁴C isotope effect. Thus for all the acetophenones other than the *p*-OCH₃-substituted one, the rate-determining step is rearrangement. Rate-determining formation of **133** would not give an isotope effect, since this step does not involve significant bond alteration at the labeled position.

Table 6.4 ISOTOPE EFFECTS FOR THE OXIDATION OF PARA-SUBSTITUTED ACETOPHENONES-1-¹⁴C WITH *m*-CHLOROBENZOIC ACID IN CHLOROFORM AT 32°C (EQUATION 6.71)

X	k_{12}/k_{14}
CH ₃ O	0.998
CH ₃	1.032
H	1.048
Cl	1.050
CN	1.084

SOURCE: B. W. Palmer and A. Fry, *J. Amer. Chem. Soc.*, **92**, 2580 (1970). Reprinted by permission of the American Chemical Society.

¹⁸¹ B. Phillips, F. C. Frostick, Jr., and P. S. Starcher, *J. Amer. Chem. Soc.*, **79**, 5982 (1957).

¹⁸² W. v. E. Doering and E. Dorfman, *J. Amer. Chem. Soc.*, **75**, 5595 (1953).

¹⁸³ B. W. Palmer and A. Fry, *J. Amer. Chem. Soc.*, **92**, 2580 (1970).

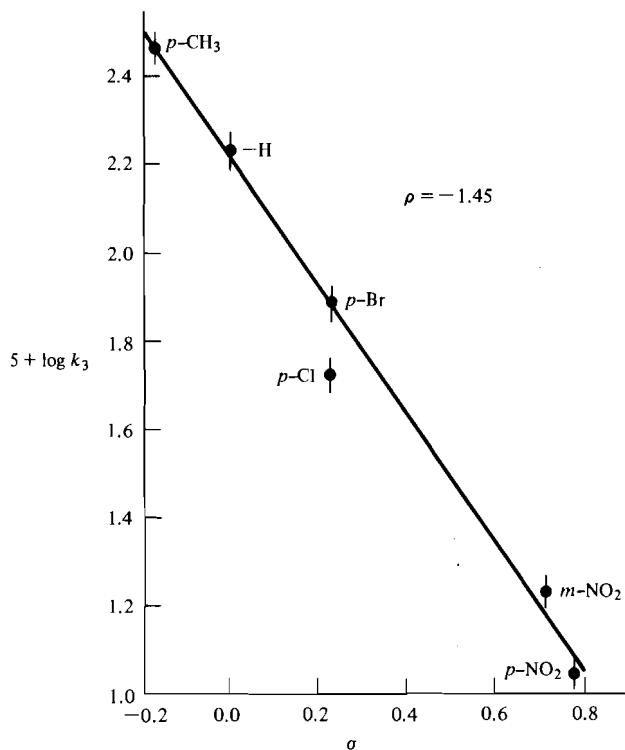

Figure 6.21 Plot of $\log k$ vs. σ for the Baeyer-Villiger oxidation of substituted acetophenones by CF_3COOOH in acetonitrile at 29.8°C . From M. F. Hawthorne and W. D. Emmons, *J. Amer. Chem. Soc.*, **80**, 6398 (1958). Reprinted by permission of the American Chemical Society.

Further evidence for the mechanism of Equation 6.69 with the second step rate-determining is provided by substituent effects on the rate. For example, Figure 6.21 shows a plot of the logs of the rates of oxidation of substituted acetophenones by trifluoroperoxyacetic acid vs. the σ values of the substituents. The ρ value is negative, indicating that electron-donating substituents in the migrating group increase the rate.¹⁸⁴ Furthermore, the rate of oxidation of cyclohexanone with peroxyacetic acid is only 1/200th as fast as the rate with trifluoroperoxyacetic acid. The greater basicity of the unfluorinated acid should make it a better nucleophile toward the carbonyl group, and if formation of **133** were rate-determining, it should be the better oxidizing agent. On the other hand, the electron-withdrawing ability of the $-\text{CF}_3$ group should make trifluoroacetic acid the better leaving group, and thus if rearrangement concerted with $\text{O}-\text{O}$ bond breaking is the rate-determining step, the trifluoroperoxyacetic acid should be the better oxidizing agent, as observed.¹⁸⁵

Formation of the intermediate may become rate-determining if the migrating group is especially reactive. For example when *p*-hydroxybenzaldehyde is oxidized by perbenzoic acid, the products are those shown in Equation 6.72. Over the pH range 2–7, the rate of this reaction, instead of showing acid catalysis,

¹⁸⁴ See note 180, p. 329.

¹⁸⁵ See note 180, p. 329.

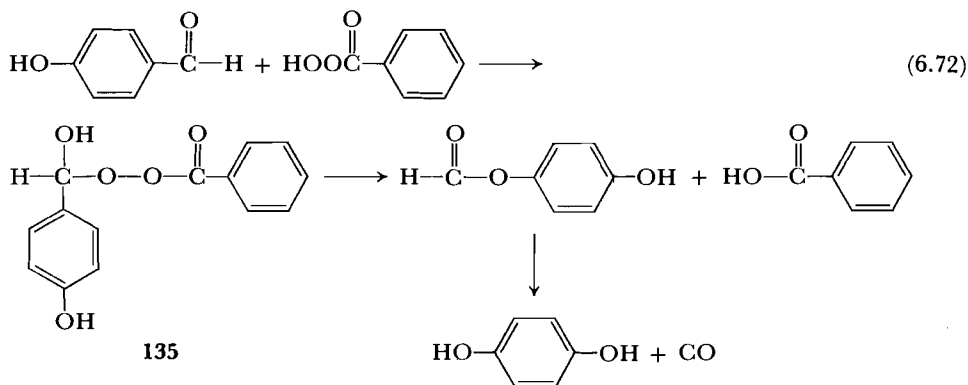

is *faster* at higher pH. Ogata and Sawaki suggest that their data are consistent with rate-determining formation of **135**. This step would be accelerated in less acidic solution because the peroxybenzoic acid would be more dissociated. They also suggest that rate-determining formation of the intermediate adduct in Equation 6.71 when X = OCH₃ is responsible for the unit ¹⁴C isotope effect observed in that reaction.¹⁸⁶

Theoretical calculations¹⁸⁷ and secondary deuterium isotope effects¹⁸⁸ are also in agreement with the mechanism of Equation 6.69, as is the fact that the chirality of a migrating group is retained.¹⁸⁹

PROBLEMS

1. Mustard gas (**1**) owes its deadliness to the fact that it immediately gives off HCl when it mixes with atmospheric moisture. 1,5-Dichloropentane (**2**) hydrolyzes much more slowly. Explain.

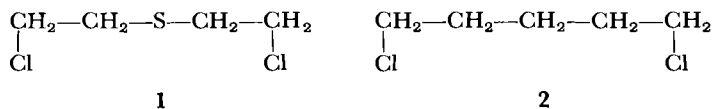

2. Acetolysis of **3** is a stereospecific reaction and gives only **4**. Explain.

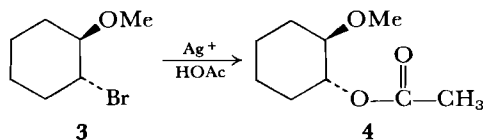

3. Explain the following observation: The trifluoroacetoxy group on *trans*-2-trifluoroacetoxyethyl tosylate (**5**) is 30 times more rate-retarding (relative to cyclohexyl tosylate) in strongly ionizing trifluoroacetic acid than in formic acid.

¹⁸⁶ Y. Ogata and Y. Sawaki, *J. Amer. Chem. Soc.*, **94**, 4189 (1972).

¹⁸⁷ V. A. Stoute, M. A. Winnik, and I. G. Csizmadia, *J. Amer. Chem. Soc.*, **96**, 6388 (1974).

¹⁸⁸ M. A. Winnik, V. Stoute, and P. Fitzgerald, *J. Amer. Chem. Soc.*, **96**, 1977 (1974).

¹⁸⁹ See note 143(a), (c), and (d), p. 318.

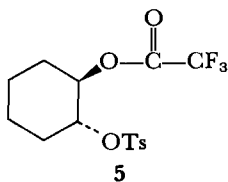

4. All five of the following reactions give pinacol and pinacolone. The products are formed in a similar ratio from each reaction. Write a mechanism for each reaction. What does the constant ratio of products tell you about any intermediate that may be formed?

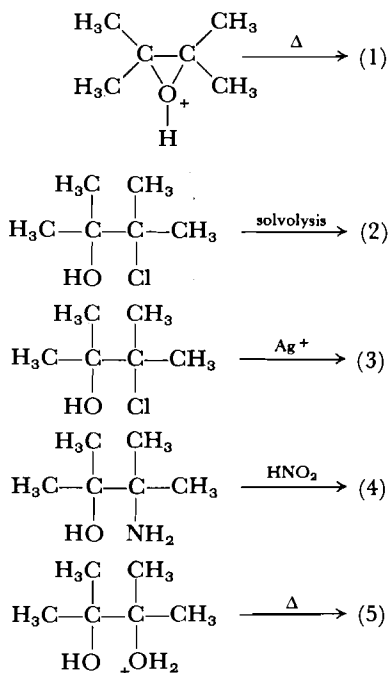

5. Explain why the migratory aptitude of the *o*-anisyl group is only 0.3 in the pinacol rearrangement.

6. Predict the products expected from (a) S_N1 and (b) S_N2 substitutions of acetic acid on *L*-threo- and *L*-erythro-3-phenyl-2-butyl tosylate and compare with the results actually obtained in Section 6.1, p. 275.

7. The titrimetric first-order rate constant for the solvolysis of cyclopropylcarbinyl benzenesulfonate decreases with time. Explain.

8. Explain the following facts: (a) Acetolysis of **6** and **7** gives only **8**. (b) The rate of acetolysis of **6** relative to **7** is ca. 44. (c) When **6a** is solvolyzed, the product has the deuterium scrambled equally over carbons 1, 3, and 5.

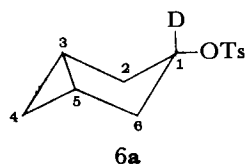
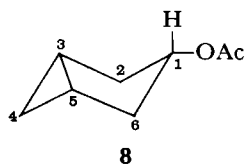
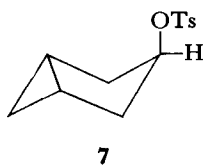
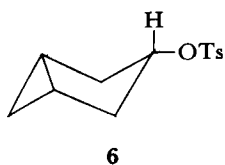

9. The norbornonium ion is also formed as an intermediate in the solvolysis of a monocyclic arenesulfonate. This pathway is called the π -route to the norbornonium ion. What is the starting material for the π -route to this ion?

10. Predict the products, and whether each will be chiral or not, from the solvolysis of (a) optically active **9**; (b) optically active **9a**. How would you synthesize the solvolysis intermediates by the π -route? (See Problem 9.)

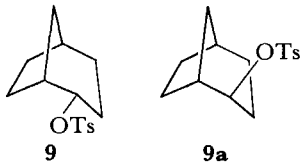

11. Write mechanisms for Reactions 6 and 7.

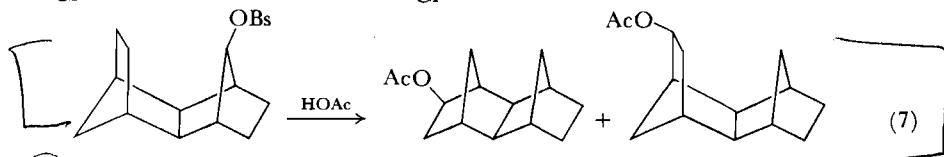
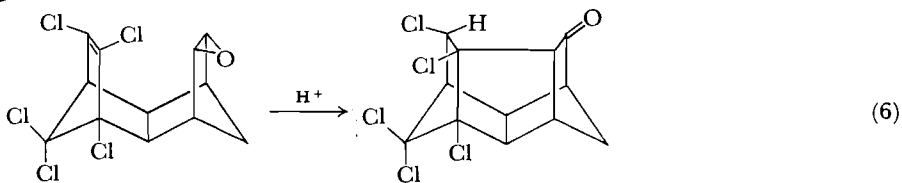

12. Treatment of ketone **10**, labeled with ^{14}C in the 9-position, with acid gives the alcohol **11** with the label equally scrambled between the positions shown. Write a mechanism for this reaction.

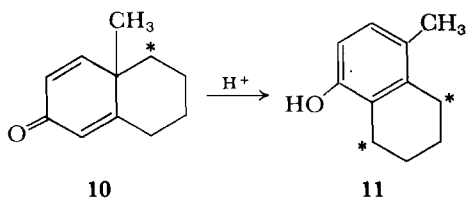

13. Write a mechanism for Reaction 8.

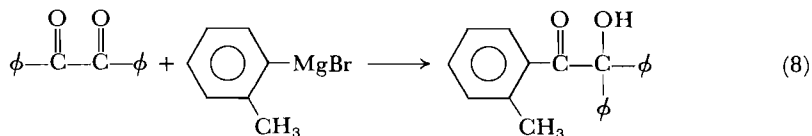

14. The rearrangement of α -diazoketones to carboxylic acids or esters shown in Equation 9 is known as the Wolff rearrangement.

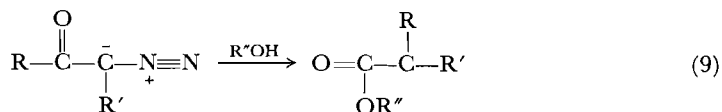

Taking into account the following facts, suggest a mechanism for the Wolff rearrangement. (a) The kinetics are clearly first-order in substrate and first-order overall. (b) In

aprotic media ketenes can sometimes be isolated. (c) The rate of rearrangement of **12** is almost identical whether Z is $-\text{OCH}_3$ or $-\text{NO}_2$. (d) The rate of rearrangement of **13** is much faster if Z is $-\text{OCH}_3$ than if it is $-\text{NO}_2$.

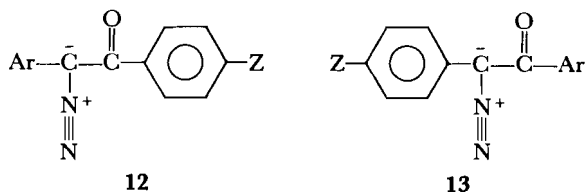

15. Write a mechanism for the reaction below.

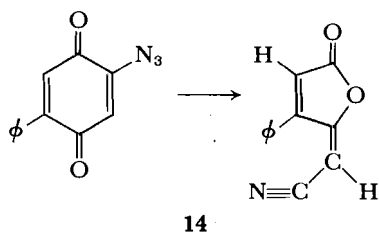

16. Propose a mechanism for the reaction in Equation 10, an example of the *aldehyde-ketone rearrangement*.

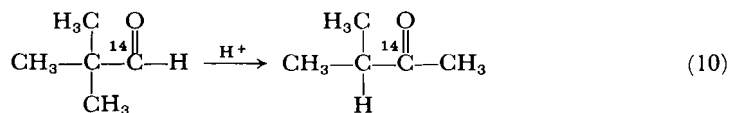

17. Propose a mechanism for the reaction in Equation 11, an example of the *Lossen rearrangement*.

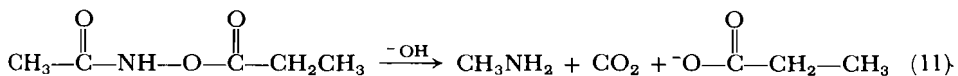

18. Propose a mechanism for the reaction in Equation 12, an example of the *Curtius rearrangement*.

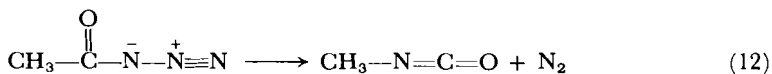

19. Propose a mechanism for the following reaction.

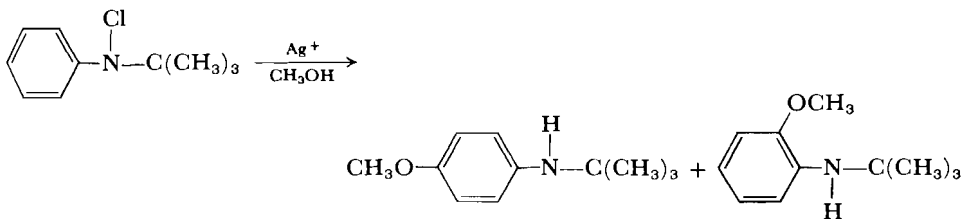

20. Would you expect the cyclopropyl group to participate in the solvolysis of 15? Why or why not?

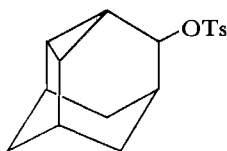

15

REFERENCES FOR PROBLEMS

1. P. D. Bartlett and C. G. Swain, *J. Amer. Chem. Soc.*, **71**, 1406 (1949).
2. S. Winstein and R. B. Henderson, *J. Amer. Chem. Soc.*, **65**, 2196 (1943).
3. D. D. Roberts and W. Hendrickson, *J. Org. Chem.*, **34**, 2415 (1969).
4. Y. Pocker, *Chem. & Ind. (London)*, 332 (1959).
5. W. E. Bachmann and J. W. Ferguson, *J. Amer. Chem. Soc.*, **56**, 2081 (1934).
7. C. G. Bergstrom and S. Siegel, *J. Amer. Chem. Soc.*, **74**, 145 (1952).
8. S. Winstein and J. Sonnenberg, *J. Amer. Chem. Soc.*, **83**, 3235, 3244 (1961).
9. R. G. Lawton, *J. Amer. Chem. Soc.*, **83**, 2399 (1961); P. D. Bartlett and S. Bank, *J. Amer. Chem. Soc.*, **83**, 2592 (1961).
10. H. L. Goering and G. N. Fickes, *J. Amer. Chem. Soc.*, **90**, 2856 (1968).
11. (a) R. C. Cookson and E. Crundell, *Chem. Ind. (London)*, 703 (1959); (b) S. Winstein and R. L. Hansen, *J. Amer. Chem. Soc.*, **82**, 6206 (1960).
12. R. Futaki, *Tetrahedron Lett.*, 3059 (1964).
13. J. F. Eastham, J. E. Huffaker, V. F. Raaen, and C. J. Collins, *J. Amer. Chem. Soc.*, **78**, 4323 (1956).
14. A. Melzer and E. F. Jenny, *Tetrahedron Lett.*, 4503 (1968).
15. H. W. Moore, H. R. Shelden, D. W. Deters, and R. J. Wikholm, *J. Amer. Chem. Soc.*, **92**, 1675 (1970).
16. M. Oka and A. Fry, *J. Org. Chem.*, **35**, 2801 (1970).
17. H. L. Yale, *Chem. Rev.*, **33**, 209 (1943).
18. A. A. Bothner-by and L. Friedman, *J. Amer. Chem. Soc.*, **73**, 5391 (1951).
19. P. G. Gassman, G. A. Campbell, and R. C. Frederick, *J. Amer. Chem. Soc.*, **94**, 3884 (1972).
20. J. E. Baldwin and W. D. Foglesong, *J. Amer. Chem. Soc.*, **90**, 4303 (1968).

Chapter 7

ADDITION AND ELIMINATION REACTIONS

In this chapter we shall discuss the destruction and formation of carbon-carbon multiple bonds by addition and elimination reactions, respectively. The mechanism of aromatic substitution in which addition and elimination occur as separate steps will also be discussed.

7.1 ELECTROPHILIC ADDITION TO DOUBLE AND TRIPLE BONDS¹

Carbon-carbon π bonds are relatively weak (~ 65 kcal/mole⁻¹). They are also, unless substituted by strong electron-withdrawing groups, electron-rich. For these reasons addition to them by electrophilic reagents usually occurs readily. The exact mechanism of addition depends on the reagent.

Hydration

The acid-catalyzed addition of water to a double bond is kinetically second-order, first-order each in olefin and in H_3O^+ .² This fact is equally consistent with the concerted addition of a proton and a water molecule from the same H_3O^+ and with initial attack of a proton to one side of the double bond followed by

¹ (a) P. B. D. de la Mare and R. Bolton, *Electrophilic Additions to Unsaturated Systems*, Elsevier, Amsterdam, 1966; (b) R. C. Fahey, in *Topics in Stereochemistry*, E. L. Eliel and N. L. Allinger, Eds., Wiley-Interscience, New York, 1968, Vol. 3, p. 237; (c) R. Bolton, in *Comprehensive Chemical Kinetics*, C. H. Bamford and C. F. H. Tipper, Eds., Elsevier, New York, 1973, Vol. 9, chap. 1.

² See note 1(a).

addition of water. The latter mechanism, to which a formidable body of evidence points, is shown in Equation 7.1.

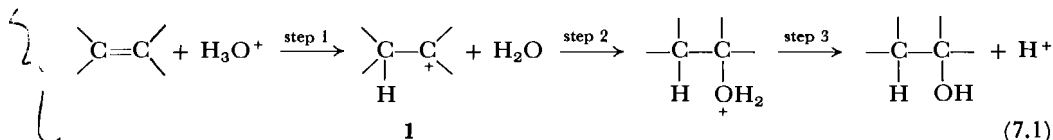

For example, the rate of hydration increases if the double bond bears electron-releasing substituents. Schubert, Lamm, and Keeffe have found that for a series of para-substituted styrenes (2), a linear correlation exists between

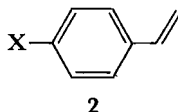

$\log k$ of hydration and the σ^+ constants of the substituent with slope $\rho = -3.58$. The linear correlation with σ^+ rather than with σ and the large negative value of ρ both indicate that a high positive charge density is located on the carbon alpha to the ring in the transition state.³

Furthermore, the accelerating effect of electron-donating substituents is cumulative only if the substituents are on the same side of the double bond (see Table 7.1).⁴ Thus isobutylene is 10^3 – 10^4 times more reactive than propylene, whereas the 2-butenes are of comparable reactivity to propylene. This is consistent only with an asymmetric transition state in which the positive charge is localized on one carbon of the original double bond. In accord with the substituent effects of Table 7.1, hydration always gives *regiospecific*⁵ Markownikoff addition; that is, the proton adds to the less substituted side of the double bond. Also in agreement with a cationic intermediate but not with concerted addition is the fact that Wagner–Meerwein rearrangements sometimes occur during hydration.⁶

The question of which step of Equation 7.1 is rate-determining remains. Schubert found that when styrene- β,β - d_2 (3) is hydrated, the recovered, unreacted 3 has not lost deuterons to the solvent.⁷ If the protonated species (1) were

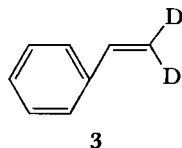

³ (a) W. M. Schubert, B. Lamm, and J. R. Keeffe, *J. Amer. Chem. Soc.*, **86**, 4727 (1964); (b) W. M. Schubert and B. Lamm, *J. Amer. Chem. Soc.*, **88**, 120 (1966); (c) W. M. Schubert and J. R. Keeffe, *J. Amer. Chem. Soc.*, **94**, 559 (1972).

⁴ Unpublished results of R. W. Taft, Jr., cited in P. D. Bartlett and G. D. Sargent, *J. Amer. Chem. Soc.*, **87**, 1297 (1965).

⁵ *Regiospecific* is a term introduced by A. Hassner, *J. Org. Chem.*, **33**, 2684 (1968). If bonds can be made or broken in two or more different orientations but only one of the possible isomers is formed, the reaction is regiospecific. If there is a significant preponderance of one isomer formed, Hassner calls that reaction regioselective. Most workers use only the former term with qualifying adjectives such as "high" or "low."

⁶ See note 1(a), p. 337.

⁷ See note 3.

Table 7.1 EFFECT OF METHYL SUBSTITUTION ON THE RATE OF HYDRATION OF CARBON-CARBON DOUBLE BONDS

Olefins	Relative Rate
$(\text{CH}_3)_2\text{C}=\text{CH}_2$ $\text{CH}_3\text{CH}=\text{CH}_2$	10^3-10^4
$\frac{\begin{array}{c} \text{H}_3\text{C} \quad \text{H} \\ \diagdown \quad / \\ \text{C}=\text{C} \\ / \quad \diagdown \\ \text{H} \quad \text{CH}_3 \end{array}}{\text{CH}_3\text{CH}=\text{CH}_2}$	0.71
$\frac{\begin{array}{c} \text{H}_3\text{C} \quad \text{CH}_3 \\ \diagdown \quad / \\ \text{C}=\text{C} \\ / \quad \diagdown \\ \text{H} \quad \text{H} \end{array}}{\text{CH}_3\text{CH}=\text{CH}_2}$	1.68
$\frac{\begin{array}{c} \text{H}_3\text{C} \quad \text{CH}_3 \\ \diagdown \quad / \\ \text{C}=\text{C} \\ / \quad \diagdown \\ \text{H}_3\text{C} \quad \text{H} \end{array}}{\text{CH}_3\text{CH}=\text{CH}_2}$	0.67
$\frac{\begin{array}{c} \text{H}_3\text{C} \\ \\ \text{C}=\text{CH}_2 \\ \\ \text{H}_3\text{C} \end{array}}{\text{CH}_3\text{CH}=\text{CH}_2}$	
$\frac{\begin{array}{c} \text{H}_3\text{C} \quad \text{CH}_3 \\ \diagdown \quad / \\ \text{C}=\text{C} \\ / \quad \diagdown \\ \text{H}_3\text{C} \quad \text{H} \end{array}}{\text{CH}_3\text{HC}=\text{CHCH}_3}$	10^3-10^4

SOURCE: Unpublished results of R. W. Taft, Jr., cited in P. D. Bartlett and G. D. Sargent, *J. Amer. Chem. Soc.*, **87**, 1297 (1965). Reprinted by permission of the American Chemical Society.

formed by a rapid equilibrium prior to the rate-determining process, then deuterons as well as protons should be lost from the intermediate carbocation in the reverse of step 1 in Equation 7.1. Furthermore when the substituted unlabeled styrenes are hydrated in deuterated solvents, the solvent deuterium isotope effects, $k_{\text{H}_3\text{O}^+}/k_{\text{D}_3\text{O}^+}$, range in value from 2 to 4. Thus the first step is rate-determining. This conclusion is extended to hydration of simple (nonaryl-substituted) alkenes by the fact that when 2-methylbutene-1 is subjected to hydration conditions and recovered after 50 percent reaction, the starting material has not isomerized to

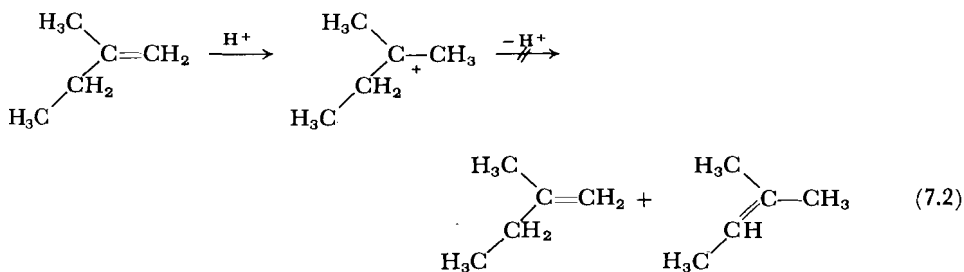

Table 7.2 RELATIVE RATES OF HYDRATION OF ALKENES AND ALKYNES

Alkene Alkyne	Relative Rate
$\frac{\phi\text{-CH=CH}_2}{\phi\text{C}\equiv\text{CH}}$	0.55–0.65
$\frac{\phi\text{CH=CHCH}_3}{\phi\text{C}\equiv\text{CCH}_3}$	1.5
$\frac{n\text{BuCH=CH}_2}{n\text{BuC}\equiv\text{CH}}$	3.6
$\frac{\text{EtCH=CHEt}}{\text{EtC}\equiv\text{CEt}}$	13–19

SOURCE: K. Yates, G. H. Schmid, T. W. Regulski, D. G. Garratt, Hei-Wun Leung, and R. McDonald, *J. Amer. Chem. Soc.*, **95**, 160 (1973). Reprinted by permission of the American Chemical Society.

2-methylbutene-2 as would be expected if step 1 of Equation 7.1 were a rapid equilibrium (see Equation 7.2).⁸ Hydration, then, is an example of a reaction that proceeds via an Ad_E2 (addition–electrophilic–second-order) mechanism.

Taft originally suggested⁹ that the mechanism for hydration involves an additional step, namely the rapid, reversible formation of a π complex from a proton and the olefin, and that this complex then rearranges, in the rate-determining step, to the carbocation as shown in Equation 7.3. This is consistent with all the data discussed so far, but it has recently been shown to be incorrect. The

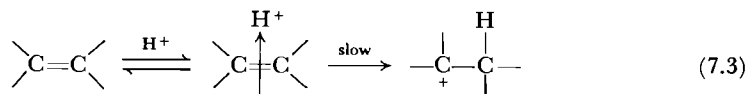

concentration of the π complex, like the equilibrium concentration of any acid, is determined solely by the pH. If its rearrangement is rate-determining, the rate should depend on the concentrations of alkene and of H_3O^+ . If proton abstraction is rate-determining, the rate should depend on the concentrations of alkene and of all the acid present—hydronium ion and undissociated acid. (Catalysis by H_3O^+ only is called *specific acid catalysis*; catalysis by H_3O^+ and undissociated acid is called *general acid catalysis*. These phenomena are discussed in greater detail in Chapter 8.) Kresge and co-workers studied the hydration of *trans*-cyclooctene and of 2,3-dimethyl-2-butene in phosphoric acid–bisulfate buffer solutions in which the amount of undissociated acid varied and found that the reactions exhibit general acid catalysis.¹⁰ This behavior parallels that observed earlier in the hydration of styrene and substituted styrenes.¹¹

⁸ J. B. Levy, R. W. Taft, Jr., and L. P. Hammett, *J. Amer. Chem. Soc.*, **75**, 1253 (1953).

⁹ R. W. Taft, Jr., *J. Amer. Chem. Soc.*, **74**, 5372 (1952).

¹⁰ A. J. Kresge, Y. Chiang, P. H. Fitzgerald, R. S. McDonald, and G. H. Schmid, *J. Amer. Chem. Soc.*, **93**, 4907 (1971).

¹¹ See note 3(a), (c), p. 338.

Alkynes generally undergo acid-catalyzed hydration to form vinyl alcohols, which rapidly rearrange to ketones. These hydrations exhibit general acid catalysis,¹² and unreacted acetylenes recovered after partial reaction have not exchanged deuterium with the solvent.¹³ Noyce and Schiavelli have found that the rate of hydration of ring-substituted phenylacetylenes is very dependent on the nature of the substituent, giving a linear correlation with σ^+ ($\rho = -3.84$).¹⁴ Thus all the evidence points to the transient slow formation of the unstable vinyl cation in a mechanism entirely analogous to that for hydration of alkenes as shown in Equation 7.4. As Table 7.2 shows, the rate of hydration of alkynes is also

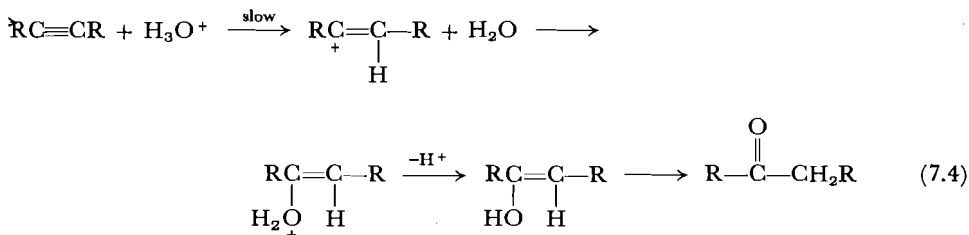

comparable to that of alkenes.¹⁵ This is most surprising in view of the much greater stability of a tricoordinated as opposed to a vinyl carbocation.

Addition of Hydrohalides

The addition of HX to double bonds in the dark and in the absence of free-radical initiators is closely related to hydration: The orientation of the elements of HX in the adduct always corresponds to Markownikoff addition;¹⁶ no deuterium exchange with solvent is found in unreacted olefins recovered after partial reaction, nor is recovered starting material isomerized after partial reaction.¹⁷ However, the addition of HX apparently can proceed by a number of different mechanisms depending on the nature of the substrate and on the reaction conditions. Thus when HCl is added to *t*-butylethylene in acetic acid, the rate is first-order in each reactant and the products are those shown in Equation 7.5.¹⁸ Since **4** and **6** were demonstrated to be stable to the reaction conditions, the rearranged product (**5**) can be formed only if a carbocationic intermediate is formed during reaction. However, the carbocation exists almost solely in an intimate ion pair, and the rate of collapse of the ion pair to products must be faster than, or comparable to, the rate of diffusion of Cl^- away from the carbocation. This must be so because the ratio of chloride to acetate products is unaffected by

¹² (a) W. Drenth and H. Hogeveen, *Rec. Trav. Chim.*, **79**, 1002 (1960); (b) E. J. Stamhuis and W. Drenth, *Rec. Trav. Chim.*, **80**, 797 (1961); (c) E. J. Stamhuis and W. Drenth, *Rec. Trav. Chim.*, **82**, 394 (1963); (d) H. Hogeveen and W. Drenth, *Rec. Trav. Chim.*, **82**, 410 (1963); (e) D. S. Noyce and M. D. Schiavelli, *J. Amer. Chem. Soc.*, **90**, 1020 (1968).

¹³ See note 12(d).

¹⁴ See note 12(e).

¹⁵ (a) Note 12(a); (b) D. S. Noyce, M. A. Matesich, M. D. Schiavelli, and P. E. Peterson, *J. Amer. Chem. Soc.*, **87**, 2295 (1965); (c) K. Yates, G. H. Schmid, T. W. Regulski, D. G. Garratt, H.-W. Leung, and R. McDonald, *J. Amer. Chem. Soc.*, **95**, 160 (1973).

¹⁶ See note 1(a), p. 337.

¹⁷ Y. Pocker, K. D. Stevens, and J. J. Champoux, *J. Amer. Chem. Soc.*, **91**, 4199 (1969).

¹⁸ (a) R. C. Fahey and C. A. McPherson, *J. Amer. Chem. Soc.*, **91**, 3865 (1969); (b) Rearranged acetate corresponding to **5** is not stable to the reaction conditions but reacts with Cl^- to form **5**.

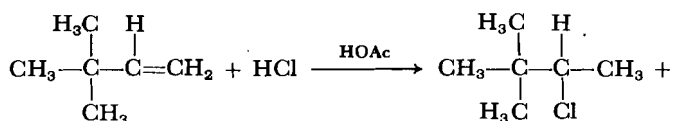

Relative amounts:

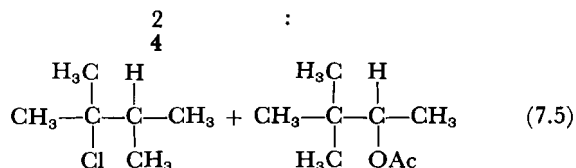

Relative amounts:

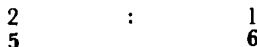

the concentration of HCl or by added chloride ion in the form of tetramethylammonium chloride. If the nature of the products depended on the environment outside the ion pair, the ratio of chloride to acetate would increase with increasing chloride ion concentration in the solution. Such rapid collapse of the carbocation implies that the addition of the proton to the olefin is rate-determining. This conclusion is supported by the fact that an isotope effect of $k_{\text{H}}/k_{\text{D}} = 1.15$ is found when the rate of addition of HCl in acetic acid is compared with the rate of addition of DCl in DOAc. Thus the mechanism can be classified as $\text{A}_{\text{d}}\text{E}_2$ and is shown in Scheme 1.¹⁹

SCHEME 1

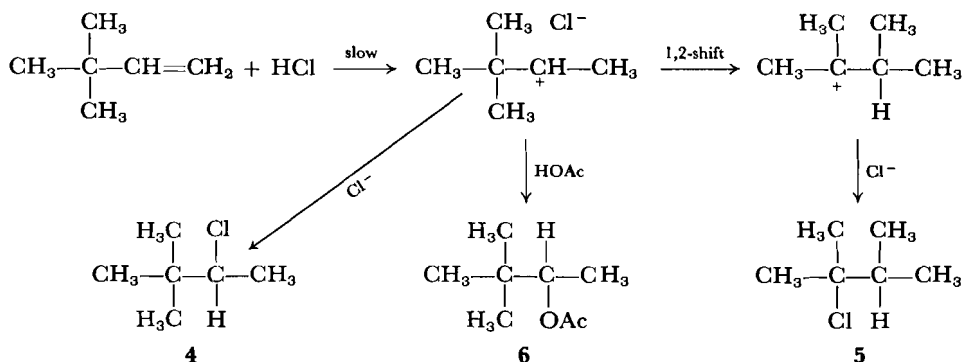

When HCl is added to cyclohexene under the same conditions as were employed in the addition to *t*-butylethylene, the nature of the products is similar (Equation 7.6), but some of the other characteristics of the reaction are quite

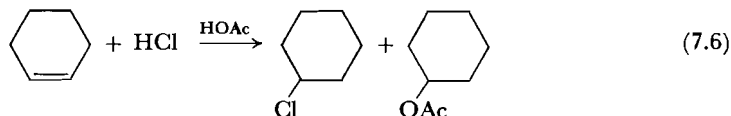

different. In this case the ratio of cyclohexyl chloride to cyclohexyl acetate is low (0.3) at low HCl concentrations and in the absence of added chloride ion, but it increases sharply to approximately 2 if the reaction mixture is made 0.226 *M* in

¹⁹ See note 18 (a).

tetramethylammonium chloride (TMAC). Furthermore, if the stereochemistry of the reaction is studied by using cyclohexene-1,3,3-d₃ as substrate, the five products shown in Equation 7.7 are always found but their relative amounts depend

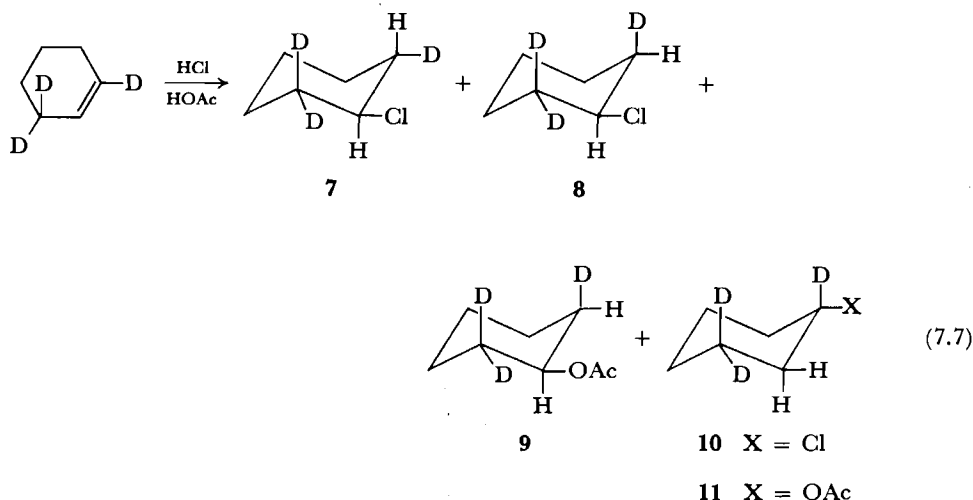

strongly on the chloride ion concentration. Thus the ratio of cyclohexyl chloride derived from syn addition (7), relative to that formed by anti addition (8), decreases markedly with chloride ion concentration whereas the ratio of the syn-formed chloride adduct (7) to the anti-formed acetate adduct (9) remains unchanged. (Note that 10 and 11 tell us nothing about the stereochemistry of addition but, since the amount of 10 formed by syn addition relative to that formed by anti addition should be equal to the ratio of 7:8, we can focus our discussion on 7, 8, and 9 alone.) No acetate formed by syn addition is found.²⁰

Analysis of the rate and product data show that the rate equation is composed of three terms (Equation 7.8); each includes the concentrations of olefin and of acid, but one also includes the concentration of chloride ion and another the concentration of acetic acid.²¹

$$\text{rate} = k_1[\text{HCl}][\text{olefin}] + k_2[\text{HCl}][\text{olefin}][\text{Cl}^-] + k_3[\text{HCl}][\text{olefin}][\text{HOAc}] \quad (7.8)$$

Fahey has suggested that all the facts are consistent with the products being formed by three competing reactions. The first, responsible for the second-order rate term, is an ion-pair mechanism like that found in the hydrochlorination of *t*-butylethylene. Such a pathway, which involves collapse of the ion pair (see above), accounts for the *syn*-HCl adduct and some of the *anti*-HCl adduct. The second and third reactions, responsible for the second and third terms in the rate

²⁰ R. C. Fahey, M. W. Monahan, and C. A. McPherson, *J. Amer. Chem. Soc.*, **92**, 2810 (1970); R. C. Fahey and M. W. Monahan, *J. Amer. Chem. Soc.*, **92**, 2816 (1970).

²¹ This is actually a simplified form of the rate equation for Reaction 7.6. Fahey found that it is not the concentration of HCl, but its activity as represented by Satchell's acidity function, *A* [D. P. N. Satchell, *J. Chem. Soc.*, 1916 (1958)], that should be included in each term of the rate equation. See note 20.

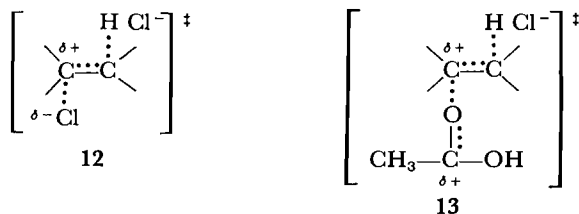

equation and leading to *anti*-HCl and *anti*-HOAc adducts, respectively, are termolecular processes with transition states **12** and **13**.



Such mechanisms are called Ad3 (addition-termolecular). Ad3 transition states analogous to **12** and **13** but leading to *syn* adducts are precluded by the steric requirements of the addends.²² Thus increased chloride ion concentration increases the contribution of the second term of the rate equation relative to the other two, and *anti*-HCl adduct is formed more rapidly than *syn*-HCl or -HOAc adducts.

Why does hydrochlorination of *t*-butylethylene not also proceed in part by a termolecular mechanism? The apparent reason is shown in Table 7.3: The carbocation formed from *t*-butylethylene is more stable than the cyclohexyl cation, and therefore k_1 of Equation 7.8 is larger for *t*-butylethylene. Furthermore, *t*-butylethylene has a small k_2 because of steric interference of the bulky *t*-butyl group in a termolecular transition state. Table 7.3 gives the estimated rate constants, k_1 , k_2 , and k_3 of Equation 7.8 for four olefins. The rate constant, k_1 , decreases with the ability of the substrate to stabilize a positive charge. The larger value of k_2 for 1,2-dimethylcyclohexene than for cyclohexene means that the β carbon in the transition state of the Ad3 mechanism has some cationic character

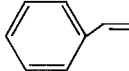
Table 7.3 ESTIMATED RATE CONSTANTS FOR ADDITION TO OLEFINS IN HCl/HOAc SOLUTIONS AT 25°C

Olefin	$10^8 k_1$ $M^{-1} \text{ sec}^{-1}$	k_2 $M^{-2} \text{ sec}^{-1}$	$10^8 k_3$ $M^{-2} \text{ sec}^{-1}$
	22,000	1.8	700
	2,300	<0.1	
	8	<10 ⁻⁵	
	2.4	1.0 × 10 ⁻³	1.3

SOURCE: R. C. Fahey and C. A. McPherson, *J. Amer. Chem. Soc.*, **93**, 2445 (1971). Reprinted by permission of the American Chemical Society.

²² See note 20, p. 343.

as shown in 12.²³ This conclusion is consistent with the universality of Markownikoff addition in hydrochlorinations.

With a variety of different mechanisms available, it is not surprising that the characteristics of hydrochlorination depend on the reaction conditions. Thus, in nitromethane, a medium that gives extensive Wagner–Meerwein shifts during hydrochlorination, olefins react according to the third-order rate law,

$$k = [\text{olefin}][\text{HCl}]^2$$

The fact that rearrangements occur implicates a carbocation intermediate. When the reaction is carried out with DCl, olefin recovered after several half-lives contains no deuterium. Thus, formation of the intermediate must be rate-determining. Apparently, the role of the second HCl molecule is to assist the first in ionizing, and the HCl_2^- anion is produced as shown in Equation 7.9. Predominant anti addition is observed—presumably because a third HCl attacks from the back side in a second fast step.²⁴

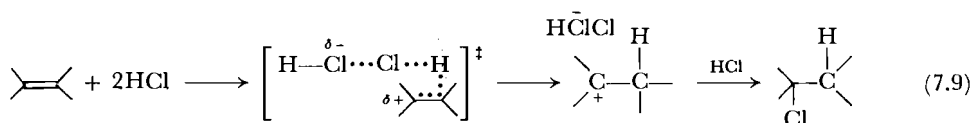

The characteristics of the addition of HBr to double bonds are similar to those of the addition of HCl. However, in acetic acid 1,2-dimethylcyclohexene gives more anti addition if HBr is the addend.²⁵ Also, as Figure 7.1 shows, when HX is added to a double bond in acetic acid, the ratio of alkyl halide to alkyl acetate increases sharply as the concentration of HBr is increased but is almost independent of the concentration of HCl. Fahey suggests that the much larger acid dissociation constant of HBr ($\Delta K_d = 10^3$ – 10^4) is responsible for both of these facts. Hydrobromic acid acts as a better halide source, and Ad₃ addition is favored.²⁶

Electrophilic addition of HCl to triple bonds can apparently also go by bi- or termolecular mechanisms. Thus in acetic acid 3-hexyne (14) gives predominantly anti addition through an Ad₃ pathway, but 1-phenylpropyne (15), which can form the resonance-stabilized vinyl cation (16), gives predominantly syn addition through an ion pair Ad₂ mechanism.²⁷

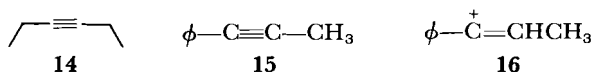

Addition of Halogens

Bromination of double bonds is strongly accelerated by electron-releasing substituents and retarded by electron-withdrawing ones (see Tables 7.4 and 7.7) and is therefore clearly an electrophilic addition. The rate of reaction is always

²³ R. C. Fahey and C. A. McPherson, *J. Amer. Chem. Soc.*, **93**, 2445 (1971).

²⁴ Y. Pocker and K. D. Stevens, *J. Amer. Chem. Soc.*, **91**, 4205 (1969).

²⁵ R. C. Fahey and R. A. Smith, *J. Amer. Chem. Soc.*, **86**, 5035 (1964).

²⁶ R. C. Fahey, C. A. McPherson, and R. A. Smith, *J. Amer. Chem. Soc.*, **96**, 4534 (1974); see also D. J. Pasto, G. R. Meyer, and B. Lepska, *J. Amer. Chem. Soc.*, **96**, 1858 (1974).

²⁷ R. C. Fahey and D.-J. Lee, *J. Amer. Chem. Soc.*, **88**, 5555 (1966); **89**, 2780 (1967); **90**, 2124 (1968).

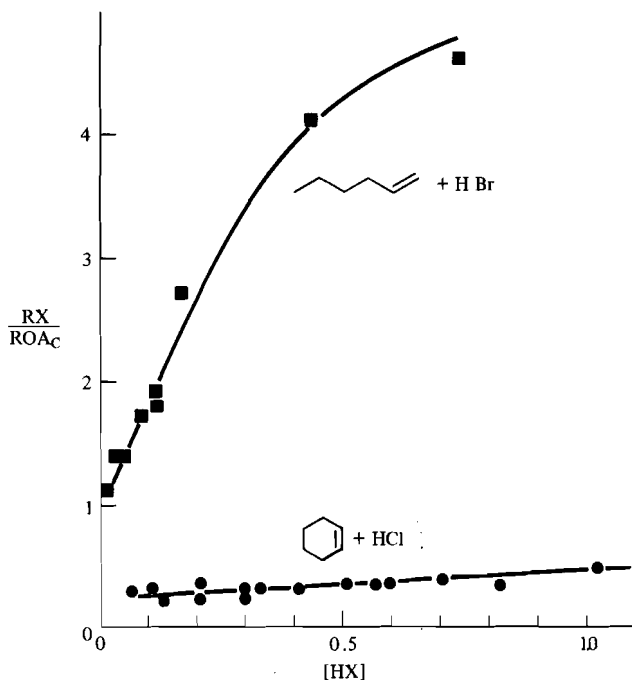

Figure 7.1 Variation in the alkyl halide to alkyl acetate product ratio with HX concentration for reaction in HOAc at 25°C. From R. C. Fahey, C. A. McPherson, and R. A. Smith, *J. Amer. Chem. Soc.*, **96**, 4534 (1973). Reprinted by permission of the American Chemical Society.

first-order in olefin, but for olefins of widely different reactivity it can be either first- or second-order in molecular bromine depending on the reaction conditions. At low concentrations of bromine and in water and alcoholic solvents, the rate expression is second-order overall and first-order in bromine. Under these conditions, then, addition occurs by an $A_{d,2}$ mechanism. However, in less polar solvents (e.g., acetic acid) or when the bromine concentration is high, a second

Table 7.4 RELATIVE RATES OF SECOND-ORDER REACTIONS WITH BROMINE IN WATER AT 25°C

R in $RCH=CH_2$	Relative Rate
CH_3	11.4
CH_2OH	1.7
H	1.0
CH_2CN	1.1×10^{-3}
$CO_2CH_2CH_3$	3×10^{-7}

SOURCE: Data of J. R. Atkinson and R. P. Bell, *J. Chem. Soc.*, 3260 (1963). Table reproduced from P. B. D. de la Mare and R. Bolton, *Electrophilic Additions to Unsaturated Systems*, Elsevier, Amsterdam, 1966, p. 115. Reprinted by permission of The Chemical Society, Elsevier, R. P. Bell, and P. B. D. de la Mare.

molecule of bromine helps to polarize the first in the transition state as in **17**.²⁸

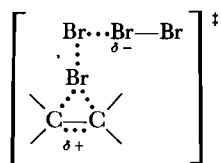

17

In the presence of added nucleophiles or in hydroxylic solvents, a mixture of products is often obtained, as shown in Equation 7.10.

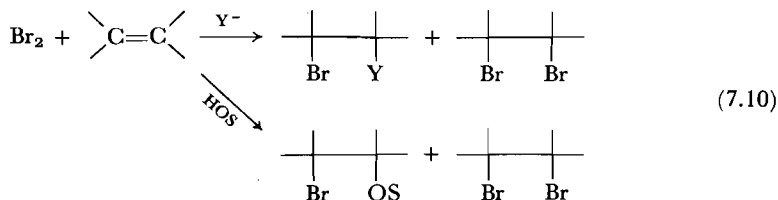

Bromine normally adds anti to a nonconjugated alkene. For example, *cis*-2-butene gives exclusively the *D,L*-2,3-dibromobutanes (Equation 7.11), whereas *trans*-2-butene gives only the corresponding meso compound (Equation 7.12).²⁹ Similarly, 4-*t*-butylcyclohexene gives only the *trans* dibromides (**18** and **19**).³⁰

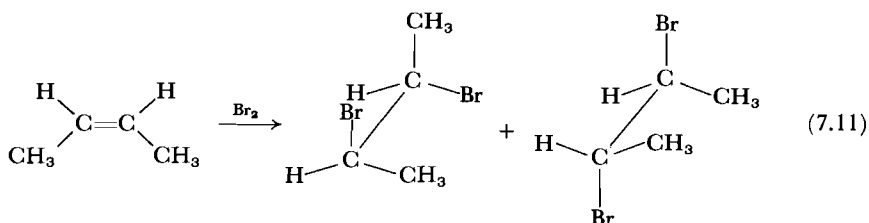

²⁸ (a) See note 1(a), p. 337. (b) Olah has obtained competitive rate data for the addition of bromine to a series of alkenes in 1,1,2-trichloro-trifluoroethane solution at -35°C . The rate of bromination of 2,3-dimethyl-2-butene relative to that of ethene was 5680, whereas the relative rates of these compounds in methanol are 1.8×10^6 (Table 7.7). Olah concluded that in nonpolar medium the olefinic carbons bear only a small positive charge in the transition state and suggested that his data could be explained by initial formation of a π complex that then cleaves to the bromonium ion as in the following equation:

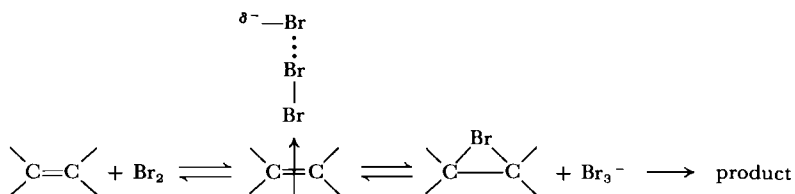

The transition state would resemble the π complex. [G. A. Olah and T. R. Hockswender, Jr., *J. Amer. Chem. Soc.*, **96**, 3574 (1974) and references therein.]

²⁹ (a) W. G. Young, R. T. Dillon, and H. J. Lucas, *J. Amer. Chem. Soc.*, **51**, 2528 (1929); (b) R. T. Dillon, W. G. Young, and H. J. Lucas, *J. Amer. Chem. Soc.*, **52**, 1953 (1930); (c) J. H. Rolston and Y. Yates, *J. Amer. Chem. Soc.*, **91**, 1469 (1969).

³⁰ E. L. Eliel and R. G. Haber, *J. Org. Chem.*, **24**, 143 (1959).

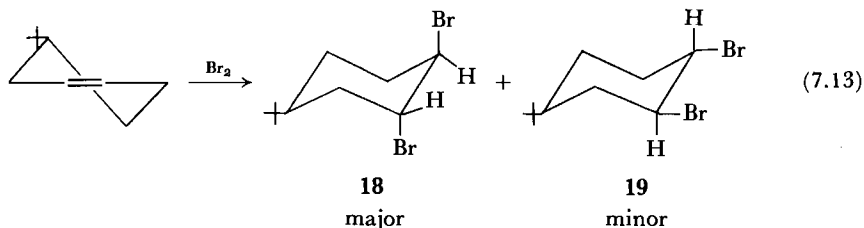
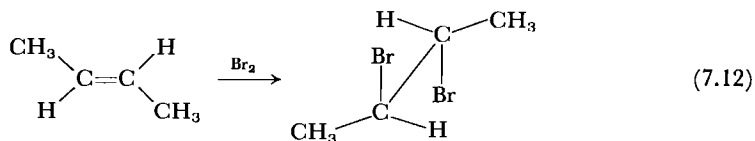

In 1937 Roberts and Kimball pointed out that the observed stereochemistry is incompatible with the formation of an intermediate carbocation (20) (Equation 7.14) and suggested that an intermediate "bromonium ion" (21) is formed in which the entering bromine, using one of its unshared electron pairs, bonds to both carbons of the double bond (Equation 7.15). Rotation about the $C_\alpha-C_\beta$ bond is impossible in 21, and Br^- must attack back side from the Br^+ to give anti addition.³¹

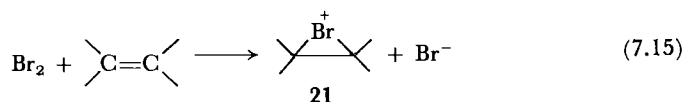
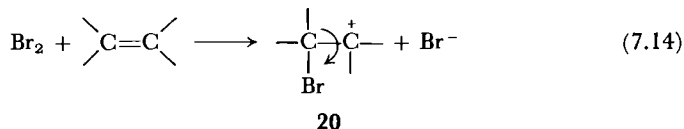

The bromonium ion concept does rationalize the stereochemistry of bromine additions to double bonds very satisfactorily if it is recognized that olefins that can form highly stabilized carbocations need not form such a structure. As already noted, nonconjugated olefins give predominantly anti addition. Conjugated olefins, in which the intermediate carbocation would be stabilized by resonance, however, give a mixture of syn and anti adducts.

For example, both *cis*- and *trans*-phenylpropene give a mixture of *threo*- and *erythro*-1,2-dibromo-1-phenylpropane with bromine in acetic acid in the ratios indicated in Equation 7.16.³² Note that in both these compounds anti addition still predominates, and that an equilibrium mixture of syn and anti adduct is not obtained. The results cited in Table 7.5 show that if the β carbon is made even more able to stabilize a positive charge, the amount of anti addition decreases still further.

The solvent also affects the stereochemistry. Bromination of *cis*- and *trans*-2-butenes gives 100 percent anti addition even in solvents of very high ionizing

³¹ I. Roberts and G. E. Kimball, *J. Amer. Chem. Soc.*, **59**, 947 (1937).

³² See note 29(c), p. 347.

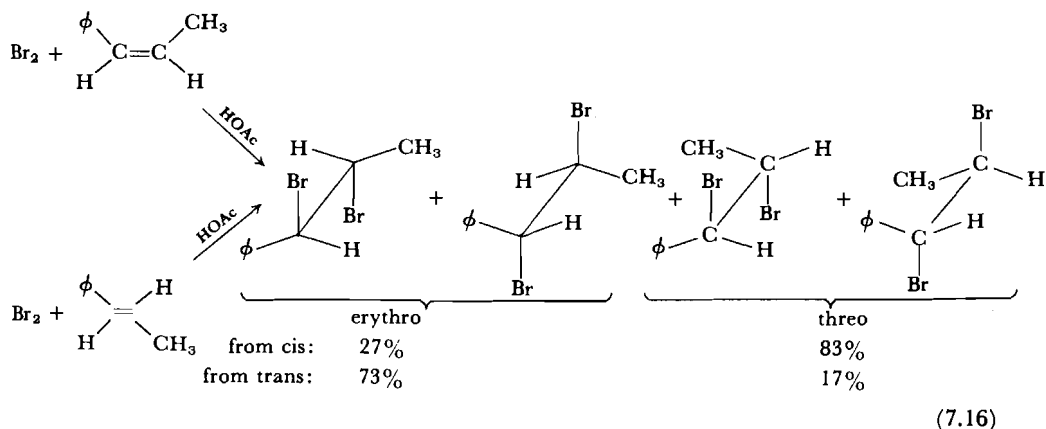

power but, as Table 7.6 shows, the amount of anti addition to *cis*-phenylpropene goes down as the dielectric constant of the medium increases.³³

Yates suggests that weak bridging between the bromine and the β carbon may occur in the intermediate even when the β carbon bears a benzene ring as shown in 22. But as the β carbon becomes less electron-deficient or as the solvating power of the solvent increases, this bridging becomes less important and the stereoselectivity decreases.³⁴

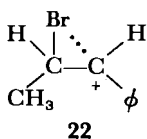

Although the stereochemistry of bromination of alkenes could result from a freely rotating carbocation and a cyclic bromonium ion competing with each

Table 7.5 STEREOCHEMISTRY OF DIBROMOADDUCTS FROM OLEFIN AND BROMINE IN ACETIC ACID AT 25°C

Olefin	Percent Anti Addition	Olefin	Percent Anti Addition
$ \begin{array}{c} \text{H} \quad \text{H} \\ \diagdown \quad \diagup \\ \text{C}=\text{C} \\ \diagup \quad \diagdown \\ \text{H}_3\text{C} \quad \text{CH}_3 \end{array} $	100	$ \begin{array}{c} \text{H} \quad \text{CH}_3 \\ \diagdown \quad \diagup \\ \text{C}=\text{C} \\ \diagup \quad \diagdown \\ \phi \quad \text{H} \end{array} $	83
$ \begin{array}{c} \text{H} \quad \text{CH}_3 \\ \diagdown \quad \diagup \\ \text{C}=\text{C} \\ \diagup \quad \diagdown \\ \text{H}_3\text{C} \quad \text{H} \end{array} $	100	$ \begin{array}{c} \text{H}_3\text{C} \quad \text{H} \\ \diagdown \quad \diagup \\ \text{C}=\text{C} \\ \diagup \quad \diagdown \\ \phi \quad \text{CH}_3 \end{array} $	63
$ \begin{array}{c} \text{H} \quad \text{H} \\ \diagdown \quad \diagup \\ \text{C}=\text{C} \\ \diagup \quad \diagdown \\ \phi \quad \text{CH}_3 \end{array} $	73	$ \begin{array}{c} \text{H}_3\text{C} \quad \text{CH}_3 \\ \diagdown \quad \diagup \\ \text{C}=\text{C} \\ \diagup \quad \diagdown \\ \phi \quad \text{H} \end{array} $	68

SOURCE: J. H. Rolston and K. Yates, *J. Amer. Chem. Soc.*, **91**, 1469 (1969). Reprinted by permission of the American Chemical Society.

³³ J. H. Rolston and K. Yates, *J. Amer. Chem. Soc.*, **91**, 1477, 1483 (1969).

³⁴ See note 29, p. 347, and note 33.

Table 7.6 STEREOCHEMISTRY OF DIBROMOADDUCT OF *cis*-PHENYLPROPENE IN VARIOUS SOLVENTS

Solvent	Dielectric Constant	Percent Anti Addition
Acetic acid	6.2	73
Tetrachloroethane	8.2	66
Methylene chloride	9.1	70
Acetic anhydride	21	49
Nitrobenzene	35	45

SOURCE: J. H. Rolston and K. Yates, *J. Amer. Chem. Soc.*, **91**, 1477 (1969). Reprinted by permission of the American Chemical Society.

Table 7.7 RELATIVE RATES OF BROMINATION OF ALKYL-SUBSTITUTED OLEFINS WITH MOLECULAR BROMINE IN METHANOLIC SODIUM BROMIDE AT 25°C

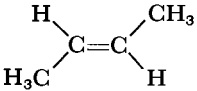
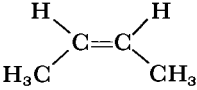
Olefin	Relative Rate	Olefin	Relative Rate
CH ₂ =CH ₂	1	(CH ₃) ₂ C=CH ₂	5,400
CH ₂ =CH-CH ₃	61	(CH ₃) ₂ C=CHCH ₃	130,000
	1,700	(CH ₃) ₂ C=C(CH ₃) ₂	1,800,000
	2,600		

SOURCE: Data from J.-E. Dubois and G. Mouvier, *Bull. Soc. Chim. France*, 1426 (1968). Reprinted by permission of the Société Chimique de France.

other as intermediates, stereochemistry alone is not conclusive evidence for a bromonium ion. For example, the stereochemistry could also be a result of competition between Ad₃ and Ad_E2 mechanisms. Olefins that cannot form stable carbocations might react via an Ad₃ pathway to give anti addition, whereas conjugated olefins might form carbocations via the Ad_E2 mechanism to give nonstereoselective addition.

There is, however, other evidence that speaks for the bromonium ion concept and against competition between Ad_E2 and Ad₃ pathways.³⁵ We have already noted that, in polar solvents, addition of bromine to multiple bonds is first-order in bromine when bromine is present in low concentration. Moreover, as Table 7.7 shows, increasing the number of substituents on the double bond cumulatively increases the rate of bromination of nonconjugated olefins in polar solvents irrespective of whether each new substituent is on the same or on the other olefinic carbon as the last.³⁶ Dubois has found that the bimolecular rate constants for addition of bromine to alkyl substituted ethylenes are correlated by

$$\log k_2 = -2.99 \sum \sigma^* + 7.61$$

³⁵ For a summary, see R. C. Fahey and H.-J. Schneider, *J. Amer. Chem. Soc.*, **90**, 4429 (1968).

³⁶ J.-E. Dubois and G. Mouvier, *Bull. Soc. Chim. France*, 1426 (1968).

where $\sum \sigma^*$ represents the sum of the Taft σ^* values for the four substituents on the double bond.³⁷ Thus, in the transition state the positive charge is distributed over both carbons of the double bond—a very different situation from that obtaining in hydration or hydrochlorination of double bonds (see, for example, Table 7.1).

From the stereochemical evidence we might expect that the effect of substituents on the rate of bromination of substituted styrenes in polar solvents would not be cumulative.³⁸ And, indeed, **23**, **24**, and **25**, when brominated under the conditions of Table 7.7, have the relative rates shown. Furthermore, the logs of the rates of bromination of ring-substituted styrenes show a linear correlation

$\phi\text{CH}=\text{CH}_2$	$\phi\text{CH}_3\text{C}=\text{CH}_2$	$\phi\text{CH}=\text{CHCH}_3$
23	24	25
Relative rates: 1	87	25

with the σ^+ constants of the substituents with slope $\rho \approx -4.5$.³⁹

Another piece of evidence for the bromonium ion is that addition is less regioselective when bromine is the electrophile than when H_3O^+ attacks. With molecular bromine we cannot, of course, observe the site at which the original electrophilic bromine attacks, but with unsymmetrical reactants such as HOBr or BrCl we can. Thus, for example, the addition of BrCl to propene in aqueous HCl gives only 54 percent of the Markownikoff addition product (**26**) and 46 percent of the anti-Markownikoff product (**27**).⁴⁰ The chloride ion apparently has the

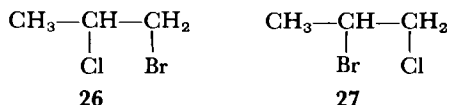

choice of attacking either of two carbons, both of which carry approximately equal positive charges—a situation that would exist in the bromonium ion.

Recently Olah has observed the unsubstituted bromonium ion and several alkylated bromonium ions by nmr spectroscopy after dissolving α -bromohalides in $\text{SbF}_5\text{-SO}_2$ solution at low temperatures.⁴¹ All four hydrogens of the unsubstituted ion were equivalent.

The bromonium ion (**28**) has actually been isolated as the tribromide salt.

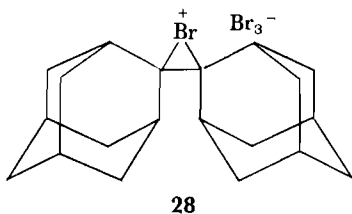

This ion is stable because it cannot be attacked from the back side.⁴²

³⁷ J.-E. Dubois and E. Goetz, *J. Chim. Phys.*, **63**, 780 (1966).

³⁸ J.-E. Dubois, J. Toullec, and G. Barbier, *Tetrahedron Lett.*, 4485 (1970).

³⁹ J. A. Pincock and K. Yates, *Can. J. Chem.*, **48**, 2944 (1970).

⁴⁰ P. B. D. de la Mare and S. Galandauer, *J. Chem. Soc.*, 36 (1958).

⁴¹ G. A. Olah, J. M. Bollinger, and J. Brinich, *J. Amer. Chem. Soc.*, **90**, 2587 (1968); G. A. Olah and J. M. Bollinger, *J. Amer. Chem. Soc.*, **89**, 4744 (1967); **90**, 947 (1968).

⁴² J. Strating, J. H. Wieringa, and H. Wynberg, *J. Chem. Soc., D*, 907 (1969).

Molecular fluorine, because of its very low bond dissociation energy, usually reacts uncontrollably with organic compounds.⁴³ Merritt, however, has observed electrophilic addition of F_2 to *cis*- and *trans*-1-phenylpropenes at low temperatures. The mode of addition is predominantly syn. A fluoronium ion, in which the fluorine is positively charged, would be very unstable and apparently does not form.⁴⁴ Attempts to form a three-membered ring fluoronium ion in superacid medium have also failed.⁴⁵

Electrophilic addition of Cl_2 and I_2 to alkenes is similar in mechanism to the electrophilic addition of Br_2 .⁴⁶ The rate of chlorination in acetic acid is second-order, first-order each in olefin and in chlorine.⁴⁷ Predominantly anti addition to alkyl-substituted double bonds occurs, indicating that a chloronium ion is formed.⁴⁸ Further evidence for the chloronium ion is that addition of hypochlorous acid to double bonds is not entirely regiospecific. For example, addition to propene gives 91 percent of the Markownikoff product **29**, and 9 percent of the anti-Markownikoff product, **30**. Phenyl-substituted alkenes give a mixture of syn and anti adducts with Cl_2 as they do with Br_2 .⁴⁹

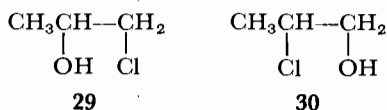

Iodination is usually second-⁵⁰ or third-⁵¹ order in I_2 . The role of the additional I_2 molecules, apparently, is to assist in breaking one I—I bond in the rate-determining step. Because iodine is less electronegative than bromine, the iodonium ion can compete with carbocation formation even when the bromonium ion cannot.⁵² Thus IN_3 with *cis*- β -deuterostyrene gives anti addition only, whereas BrN_3 with the same olefin gives a 1:1 mixture of syn and anti adducts.⁵³ Chloronium and iodonium ions have been observed in superacid medium.

Electrophilic additions of the halogens to alkynes have not been much studied. In acetic acid a given olefin reacts with bromine 10^3 to 10^5 times more rapidly than the corresponding acetylene. However, the relative rates are enormously solvent-dependent and decrease with solvent polarity. Thus bromination of styrene is 2590 times faster than bromination of phenylacetylene in acetic acid, but only 0.67 times as fast in H_2O . Solvation of the transition state must be

⁴³ See note 1(a), p. 337.

⁴⁴ R. F. Merritt, *J. Amer. Chem. Soc.*, **89**, 609 (1967).

⁴⁵ See note 41, p. 351.

⁴⁶ See note 1, p. 337. Chlorination of olefins in nonpolar media in the absence of radical inhibitors may proceed by a radical pathway. [M. L. Poutsma, *J. Amer. Chem. Soc.*, **87**, 2161, 2172 (1965).]

⁴⁷ I. R. C. McDonald, R. M. Milburn, and P. W. Robertson, *J. Chem. Soc.*, 2836 (1950) and earlier papers in this series (by Robertson and co-workers).

⁴⁸ (a) See note 35, p. 350; (b) R. C. Fahey and C. Schubert, *J. Amer. Chem. Soc.*, **87**, 5172 (1965); (c) R. C. Fahey, *J. Amer. Chem. Soc.*, **88**, 4681 (1966); (d) M. L. Poutsma and J. L. Kartch, *J. Amer. Chem. Soc.*, **89**, 6595 (1967).

⁴⁹ See note 35, p. 350, and note 48(b), (c).

⁵⁰ N. J. Bythell and P. W. Robertson, *J. Chem. Soc.*, 179 (1938).

⁵¹ (a) J. Gróh and J. Szelestey, *Z. Anorg. Allgem. Chem.*, **162**, 333 (1927); (b) J. Gróh, *Z. Anorg. Allgem. Chem.*, **162**, 287 (1927); (c) J. Gróh and E. Takács, *Z. Physik. Chem. Leibzig*, **149A**, 195 (1930).

⁵² See note 1(a), p. 337.

⁵³ A. Hassner, F. P. Boerwinkle, and A. B. Levy, *J. Amer. Chem. Soc.*, **92**, 4879 (1970).

very important. The rate trends in chlorination parallel those for bromination.⁵⁴ The limited facts available indicate that the mechanism is similar to that of addition to olefins. Pincock and Yates have studied the addition of bromine to a number of alkyl- and arylacetylenes in acetic acid. At low bromine concentrations the reaction is second-order, first-order each in Br₂ and in acetylene. Alkylacetylenes give only anti addition, indicating that a bromonium ion lies on the reaction path. Ring-substituted phenylacetylenes, however, give both syn and anti addition; and the logs of the rates correlate linearly with the σ⁺ constants of the substituents, giving a very large negative ρ value (-5.17). In these compounds, open vinyl cations are apparently formed as intermediates.⁵⁵

Hydroboration⁵⁶

The addition of a boron hydride across a double or triple bond (Equation 7.17) is called hydroboration.

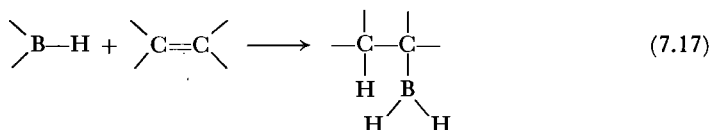

We include it here despite uncertainty about whether attack is initiated by electrophilic boron or nucleophilic hydrogen or both simultaneously.⁵⁷

In additions of diborane, the major product is formed by the attachment of boron to the less substituted carbon. For example, addition of diborane to 1-hexene (31) gives a product that has 94 percent of the boron attached to the terminal carbon. Similarly, diborane added to 2-methylbutene-2 (32) gives 98 percent of boron incorporation at C₃.⁵⁸

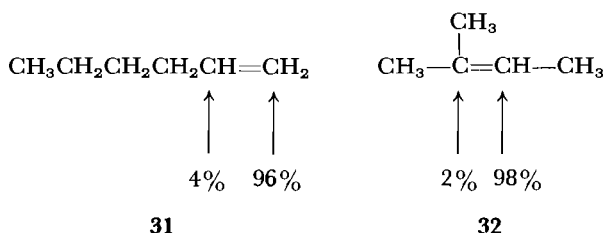

If, instead of diborane, a boron hydride substituted with bulky alkyl groups is added to a double bond, the regioselectivity increases. Thus *bis*(3-methyl-2-butyl)borane reacts with 1-hexene to give 99 percent terminal boron incorporation (Equation 7.18).⁵⁹

Electronic effects as well as steric effects are important in determining the orientation of addition as is shown, for example, by the data in Table 7.8. The regioselectivity is increased as 2-butene is substituted in the 1 position by increas-

⁵⁴ See note 15(c), p. 341.

⁵⁵ (a) J. A. Pincock and K. Yates, *Can. J. Chem.*, **48**, 3332 (1970); (b) J. A. Pincock and K. Yates, *J. Amer. Chem. Soc.*, **90**, 5643 (1968).

⁵⁶ H. C. Brown, *Hydroboration*, W. A. Benjamin, Menlo Park, Calif., 1962.

⁵⁷ See note 1(a), p. 337.

⁵⁸ H. C. Brown and G. Zweifel, *J. Amer. Chem. Soc.*, **82**, 4708 (1960).

⁵⁹ H. C. Brown and G. Zweifel, *J. Amer. Chem. Soc.*, **82**, 3222 (1960).

Table 7.8 ORIENTATION OF ADDITION OF DIBORANE TO SUBSTITUTED 2-BUTENES

X in CH ₃ CH=CHCH ₂ X	Percent of Boron in Position 2 of Product	Percent of Boron in Position 3 of Product
H	50	50
OEt	84	16
Oφ	86	14
OH	90	10
OCH ₂ φ	91	9
OAc	95	5
Cl	100	0

SOURCE: H. C. Brown and R. M. Gallivan, Jr., *J. Amer. Chem. Soc.*, **90**, 2906 (1968). Reprinted by permission of the American Chemical Society.

ingly strong electron-withdrawing groups.⁶⁰ Boron must then bear a partial positive charge in the transition state.

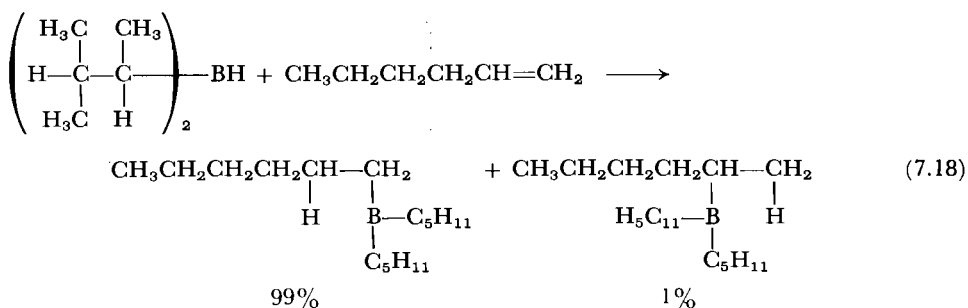

Hydroboration always gives syn addition of the elements of boron and hydrogen to a double bond. For example, hydroboration of 1-methylcyclopentene gives only the product shown in Equation 7.19.⁶¹

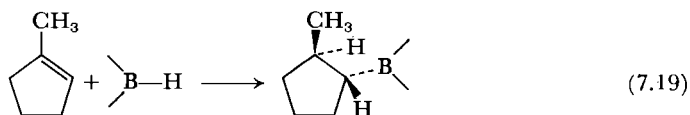

⁶⁰ H. C. Brown and R. M. Gallivan, Jr., *J. Amer. Chem. Soc.*, **90**, 2906 (1968).

⁶¹ H. C. Brown and G. Zweifel, *J. Amer. Chem. Soc.*, **81**, 247 (1959). This constant stereospecificity suggests a four-center transition state,

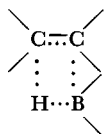

[A. Strietweiser, Jr., L. Verbit, and R. Bittman, *J. Org. Chem.*, **32**, 1530 (1967); D. J. Pasto, B. Lepeska, and T. C. Cheng, *J. Amer. Chem. Soc.*, **94**, 6083 (1972).] Direct concerted 2 + 2 cycloaddition of B—H to a carbon-carbon double bond involving only the orbitals of the B—H σ bond and the π orbital of the double bond is not allowed by orbital symmetry considerations. However, Pasto has suggested that the great exothermicity of hydroboration (e.g., $\text{BH}_3 + 3\text{CH}_2=\text{CH}_2 \longrightarrow \text{B}(\text{CH}_2\text{CH}_3)_3$, $\Delta H = -99 \text{ kcal mole}^{-1}$) means that the transition state would be very early on the reaction pathway and that orbital symmetry is either not developed sufficiently to control the course of the reaction or does not apply.

The work of H. C. Brown has made hydroboration an enormously useful synthetic reaction. Oxidation of the adduct with alkaline hydrogen peroxide removes the boron smoothly without rearrangement and replaces it by a hydroxy group. The oxidation proceeds entirely with retention of configuration. For example, the product of Reaction 7.19 is converted by oxidation to *trans*-2-methylcyclopentanol in high yields (Equation 7.20).

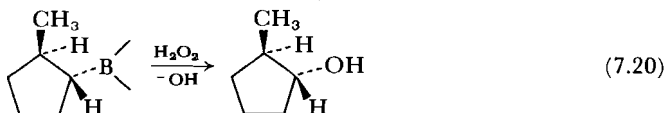

Thus hydroboration of a double bond followed by peroxide oxidation is a convenient procedure for converting the olefin into the alcohol corresponding to *anti*-Markownikoff addition of water.

Alkynes also react with boron hydrides bearing bulky organic groups to give attachment of boron to the less substituted position;⁶² *syn* addition is again the rule. The adducts can be smoothly converted to the *cis*-olefins by treatment with acetic acid at 0°C. (Equation 7.21).⁶³

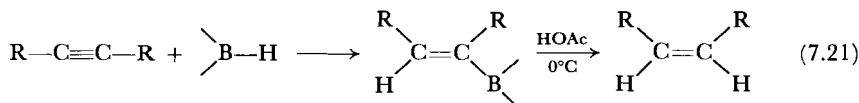

7.2 1,2-ELIMINATION REACTIONS⁶⁴

The opposite of an addition to a double bond is a 1,2-elimination reaction. In solution, where the reaction is promoted by solvent or by base, the most common eliminations (and those to which we shall limit our discussion) are those that involve loss of HX, although loss of X₂ from 1,2-dihalides and similar reactions are also well known. The mechanisms of eliminations of HX are of three main types: (1) The E₁ (elimination, first-order), shown in Equation 7.22, which is the reverse of the Ad_E2 reaction and which has the same first, and rate-determining,

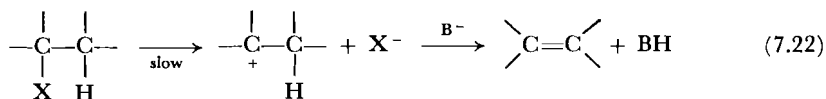

step as the S_N1 reaction; (2) the E₁cB (elimination, first-order, conjugate base) reaction of Equation 7.23, which involves initial abstraction of a proton followed

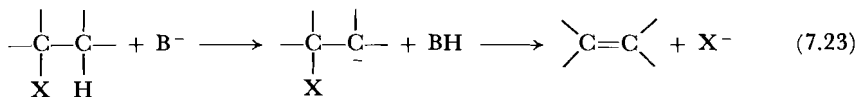

⁶² G. Zweifel, G. M. Clark, and N. L. Polston, *J. Amer. Chem. Soc.*, **93**, 3395 (1971).

⁶³ H. C. Brown and G. Zweifel, *J. Amer. Chem. Soc.*, **81**, 1512 (1959).

⁶⁴ For reviews, see: (a) W. H. Saunders, in *The Chemistry of Alkenes*, S. Patai, Ed., Wiley-Interscience, New York, 1964, p. 149; (b) D. V. Banthorpe, *Elimination Reactions*, Elsevier, Amsterdam, 1963; (c) J. F. Bunnett, *Survey Prog. Chem.*, **5**, 53 (1969); (d) W. H. Saunders, Jr., and A. F. Cockerill, *Mechanisms of Elimination Reactions*, Wiley-Interscience, New York, 1973; (e) A. F. Cockerill, in *Comprehensive Chemical Kinetics*, C. H. Bamford and C. F. H. Tippett, Eds., Elsevier, New York, 1963, Vol. 9, chap. 3.

by loss of X^- ; and (3), the E_2 (elimination, second-order) reaction shown in Equation 7.24, in which the base attacks the β proton at the same time as the $C-X$ bond cleaves.⁶⁵

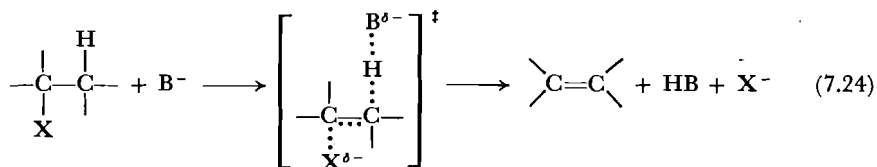

We shall discuss each of these mechanisms and also, very briefly, 1,2-eliminations that require assistance of neither solvent nor base.

The E_1 Reaction

As already noted in Section 5.1, solvolysis of alkyl derivatives often leads to a mixture of substitution and elimination products (see Scheme 1 of Chapter 5). It was also mentioned there that although the rate of solvolysis changes with the leaving group, when the solvent is of high dielectric constant the ratio of substitution to elimination products is independent of the leaving group. For example, in 80 percent aqueous ethanol, *t*-butyl iodide solvolyzes over 100 times as rapidly as *t*-butyl chloride, but the ratio of elimination to substitution products is the same for the chloride and iodide.⁶⁶ It was evidence of this sort that made early investigators postulate that first-order elimination (E_1) and first-order substitution (S_N1) share a preliminary, rate-determining step. Then, they suggested, in a second step, the fully solvated carbocation either adds solvent (S_N1 reaction) or gives up a proton to the solvent (E_1 reaction).

Further investigation, however, showed that in solvents of low ionizing power the ratio of substitution to elimination depends on the nature of the leaving group. For example, as Table 5.1 (p. 216) shows, in glacial acetic acid, when the leaving group is Cl^- , elimination accounts for 73 percent of the product; but when it is $\text{CH}_3-\text{S}-\text{CH}_3$, only 12 percent alkene is formed. These facts are consistent with formation of intimate ion pairs in the less dissociating solvents in which the leaving group is the base that removes the proton from the β carbon (see Section 5.1).

Whether a β proton is lost from the same or the opposite side of the molecule as the leaving group, that is, whether syn or anti elimination obtains in a E_1 mechanism depends on the reaction conditions. If a solvated, planar carbocation

⁶⁵ Sneen has suggested that most elimination reactions proceed by initial ionization of the leaving group to form an ion pair and that this first step (either fast or rate-determining) is followed by attack of base. Thus the S_N2 , S_N1 , E_2 , and E_1 reactions all proceed by one "merged" mechanism. For a discussion of this view, see Section 5.4, p. 244 and R. A. Sneen, *Accts. Chem. Res.*, **6**, 46 (1973). For further examples of cases where second-order eliminations apparently do proceed by slow base attack on an intimate ion pair, see K. Humski, V. Sendjarević, and V. J. Shiner, Jr., *J. Amer. Chem. Soc.*, **96**, 6186 (1974), and references therein; and W. T. Ford and R. J. Hauri, *J. Amer. Chem. Soc.*, **95**, 7381 (1973). Bordwell, on the other hand, suggests that most eliminations proceed either by initial isomerization of the leaving group or by initial abstraction of the proton and that very few eliminations are concerted. See F. G. Bordwell, *Accts. Chem. Res.*, **3**, 281 (1970) and F. G. Bordwell, *Accts. Chem. Res.*, **5**, 374 (1972). For the purposes of the discussion in this chapter, we shall use the classification scheme just outlined, which is accepted by most workers in the field.

⁶⁶ K. A. Cooper, E. D. Hughes, and C. K. Ingold, *J. Chem. Soc.*, 1280 (1937).

is formed, then the β proton lost to solvent in the second step should come with equal probability from either the same or the opposite side of the plane as the original leaving group. This prediction is in accord with experimental results.⁶⁷ If, however, an intimate ion pair is formed and the leaving group rather than the solvent acts as the base, then syn elimination should result. This prediction has also been borne out by experiment.⁶⁸ For example, Skell and Hall studied the elimination of *erythro*-3-d₁-2-butyl tosylate.⁶⁹ As shown in Scheme 2, syn elimination would give nondeuterated *cis*-2-butene and deuterated *trans*-2-butene, but anti elimination would yield deuterated *cis*- and nondeuterated *trans*-2-butene. In poorly ionizing nitromethane the product is almost entirely that of syn elimination; thus the tosylate pulls off the proton or deuterium from the same side of the molecule from which it departed. In aqueous ethanol, however, a mixture of syn and anti elimination products is obtained.⁷⁰

SCHEME 2

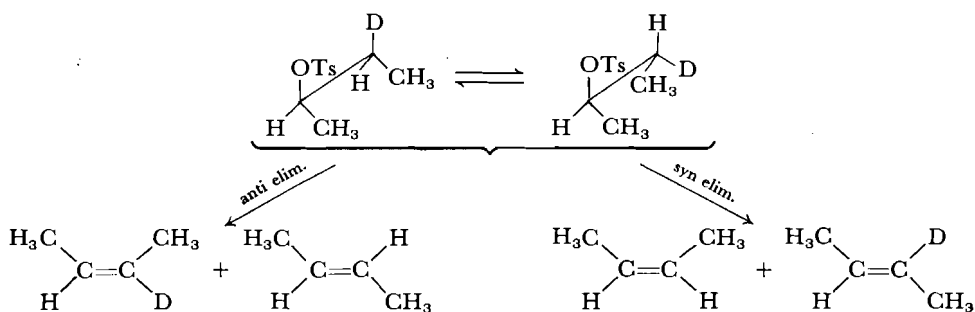

In elimination reactions in which a β hydrogen may be lost from one of two carbons, the question of which way the double bond will be oriented arises. Saytzeff's rule states that in E_1 reactions the double bond will be oriented toward the more highly substituted carbon. (Thus elimination that gives the more highly substituted of two possible products is called Saytzeff elimination. Elimination that gives the less substituted product is called Hofmann elimination.) It is easy to see why E_1 reaction usually leads to Saytzeff elimination. The transition state for the product-determining step has some double-bond character, and thus the lowest-energy transition state will be that leading to the most stable double bond. It is well substantiated that alkyl groups lower the energy of the double bond through hyperconjugation. Saytzeff's rule is, however, not necessarily obeyed when the carbocation remains part of an intimate ion pair. For example, elimination of HX from

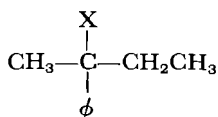

⁶⁷ See note 64, p. 355.

⁶⁸ (a) T. Cohen and A. R. Daniewski, *J. Amer. Chem. Soc.*, **91**, 533 (1969); (b) P. S. Skell and W. L. Hall, *J. Amer. Chem. Soc.*, **85**, 2851 (1963).

⁶⁹ See note 68(b).

⁷⁰ For a similar example, see Humski, et al., *J. Amer. Chem. Soc.*, **96**, 6186 (1974).

Table 7.9

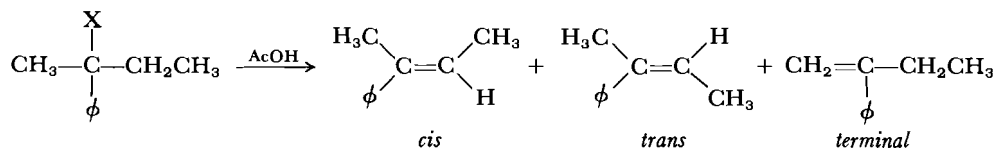

X	Percent cis	Percent trans	Percent terminal
Cl	68	9	23
OAc	53	2	45
NHNH ₂	40	0	60

SOURCE: D. J. Cram and M. R. V. Sahyun, *J. Amer. Chem. Soc.*, **85**, 1257 (1963). Reprinted by permission of the American Chemical Society.

in glacial acetic acid gives the products shown in Table 7.9. As the leaving group becomes more basic, Saytzeff elimination becomes less and less important and Hofmann product begins to predominate. The change in product composition can be explained by a consideration of Hammond's postulate. The more basic the counter-ion that pulls off the proton, the more the transition state for the product-determining step will look like carbocation and the less double-bond character it will have. Then the orientation of the double bond in the product depends more on the relative acidity of the two kinds of protons than on the relative stabilities of the possible double bonds. In solution the γ -methyl group renders the β -methylene hydrogens less acidic than the β -methyl hydrogens; thus the more basic the counter-ion the more terminal olefin results.

Carbanion Mechanisms⁷¹

If, instead of a good leaving group as is required for the E₁ reaction, a compound has a poor leaving group but a highly acidic proton, elimination may take place through the consecutive reactions shown in Equations 7.25 and 7.26. These are usually called E_{1cB} reactions but, depending on the relative magnitudes of

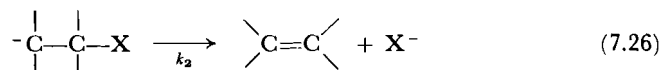
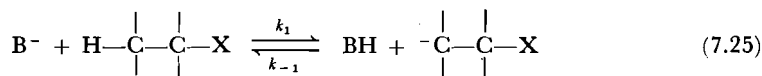

the rate constants and on the degree of separation between BH and the anion, Equations 7.25 and 7.26 actually describe four different mechanisms. Table 7.10 shows Bordwell's summary of the characteristics of these mechanisms.

If k_1 is much greater than both k_{-1} and k_2 of Equations 7.25 and 7.26—that is, if the β hydrogen is very acidic but the leaving group is poor—then if sufficient base is present, formation of the anion will be almost complete before

⁷¹ D. J. McLennan, *Quart. Rev.*, **21**, 490 (1967).

Table 7.10 CARBANION ELIMINATION MECHANISMS

Descriptive Title	Kinetic Order	Symbol	k_H/k_D	Element Effect ^a
First-order anion	1st	(E ₁) _{anion}	1.0	Substantial
Preequilibrium anion ("reversible" anion)	2nd	(E ₁ cB) _R	1.0	Substantial
Preequilibrium ion pair	2nd	(E ₁ cB) _{IP}	1-2	Substantial
Second-order anion	2nd	(E ₁ cB) _I	2-8	Small

SOURCE: F. G. Bordwell, *Accts. Chem. Res.*, 5, 374 (1972). Reprinted by permission of the American Chemical Society.

^a The element effect is defined as k_x/k_y , where k_x and k_y are the rates of elimination of HX and HY (X and Y are different elements), respectively, from a single substrate.

loss of X begins. An example of a reaction that goes by this [the (E₁)_{anion}] mechanism is shown in Equations 7.27 and 7.28.⁷² This reaction proceeds at the same rate with triethyl- or with tri-*n*-butylamine. Furthermore, if more than an

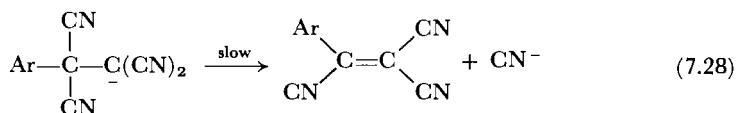
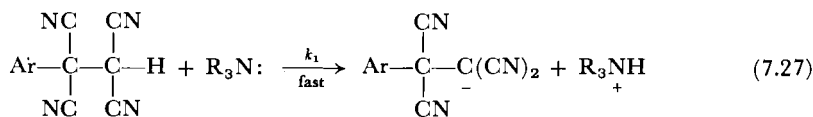

equimolar amount of base is present, the rate is independent of the base concentration and is equal to $k_2[\text{SH}]$, where HS is the substrate.⁷³ Both these facts indicate that abstraction of the proton, which is rendered highly acidic by two electron-withdrawing groups, is not involved in the rate-determining step. The (E₁)_{anion} mechanism is rare because of the high acidity required of the β hydrogen.⁷⁴

In the other three variations of the carbanion mechanism, an equilibrium concentration of carbanion is formed, which then either returns to starting material or decomposes to products.

If the β proton is slightly less acidic than required for the (E₁)_{anion} mechanism and k_{-1} is comparable to k_1 but k_2 is still small, the anion forms from the starting material in a rapid equilibrium and the leaving group departs in a subsequent slow step. This is called the (E₁cB)_R ("R" for "reversible") mechanism. Because k_2 is much smaller than k_1 and k_{-1} , we can assume that k_2 does not affect the equilibrium concentration of the anion of the substrate, S⁻; then

⁷² Z. Rappoport and E. Shohamy, *J. Chem. Soc., B*, 2060 (1971).

⁷³ Actually, in this case one does not need an equimolar quantity of base, because HCN is such a weak acid that free base is continually reformed by $\text{R}_3\text{NH}^+ + \text{CN}^- \longrightarrow \text{R}_3\text{N} + \text{HCN}$.

⁷⁴ See also, however: (a) F. G. Bordwell, K. C. Yee, and A. C. Knipe, *J. Amer. Chem. Soc.*, 92, 5945 (1970); (b) F. G. Bordwell, M. M. Vestling, and K. C. Yee, *J. Amer. Chem. Soc.*, 92, 5950 (1970).

the concentration of S^- can be found according to Equation 7.29 and the rate of elimination will be that of Equation 7.30.⁷⁵

$$[S^-] = \frac{k_1[HS][B]}{k_{-1}[BH^+]} \quad (7.29)$$

$$\text{rate} = \frac{k_2 k_1 [HS][B]}{k_{-1}[BH^+]} \quad (7.30)$$

Examination of Equation 7.30 shows that the rate of an $(E_1cB)_R$ reaction should be independent of the base concentration if the buffer ratio, B/BH^+ is kept constant—that is, the reaction should exhibit specific base catalysis (see Section 7.1, p. 340 and Chapter 8, p. 405). An example of such a reaction is elimination of methanol from **33**. Not only is specific base catalysis observed, but

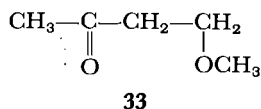

also, in agreement with rapid and reversible formation of carbanion, in deuterated solvent the rate of incorporation of deuterium into the substrate is 226 times faster than the rate of elimination.⁷⁶

The $(E_1cB)_{ip}$ mechanism is a close cousin of the $(E_1cB)_R$ mechanism. The difference is that in the former the free anion is not formed but exists as an ion pair with the protonated base as counter-ion. An example of a reaction that goes by this mechanism is the formation of bromoacetylene from *cis*-1,2-dibromoethylene and triethylamine (Equation 7.31).⁷⁷ If the rate of elimination from deuterated 1,2-dibromoethylene is compared to the rate from nondeuterated material, $k_H/k_D \approx 1$. Therefore proton abstraction is not involved in the rate-determining step. Because added $\text{Et}_3\text{N}^+\text{X}^-$ does not affect the rate and be-

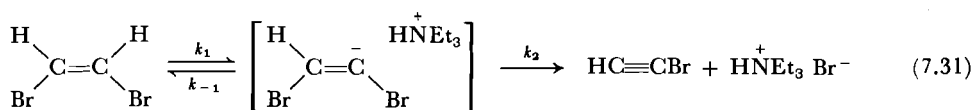

cause deuterium exchange with solvent does not take place, the $(E_1cB)_R$ mechanism cannot be involved. Apparently the intimate ion pair either goes back to starting material or loses Br^- in a slow step; free carbanion is not formed.

Finally, there is the $(E_1cB)_I$ (“I” for “irreversible”) mechanism, in which the leaving group is so good that proton abstraction becomes rate-determining.

⁷⁵ Note that in this and the following E_1cB mechanisms the rates are not really independent of the base concentration and therefore the “1” part of the classification may be misleading, but it is analogous to the S_E1 reaction of Equations 5.24 and 5.25.

⁷⁶ L. R. Fedor, *J. Amer. Chem. Soc.*, **91**, 908 (1969). For other examples of the $(E_1cB)_R$ mechanism, see J. Crosby and C. J. M. Stirling, *J. Chem. Soc., B*, 671, 679 (1970).

⁷⁷ W. K. Kwok, W. G. Lee, and S. I. Miller, *J. Amer. Chem. Soc.*, **91**, 468 (1969).

For this case ($k_2 \gg k_1, k_{-1}$) the rate equation reduces to Equation 7.32. Reac-

$$\text{rate} = k_1[\text{B}][\text{HS}] \quad (7.32)$$

tions of this sort, then, should be dependent on the base concentration—that is, they should be general-base catalyzed. Elimination of benzoic acid from **34**

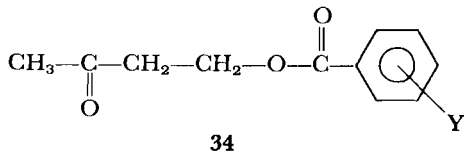

exhibits general base catalysis. It therefore does not go by an $(E_1cB)_R$ mechanism. Although the E_2 mechanism is also general-base catalyzed, it is excluded, because the rate is independent of the nature of the substituents on the phenyl ring. The rates of authentic E_2 reactions, in which carbon-leaving-group bond breaking is involved in the rate-determining step, do depend on the nature of the leaving group.⁷⁸ An $(E_1cB)_I$ mechanism thus seems indicated.⁷⁹ Note that **34** differs from **33** only in that benzoate is a much better leaving group than methoxide. This is only one example of several in the literature that show how sensitive the various carbanion elimination mechanisms are to changes in the structure of the reactants and to the reaction conditions.⁸⁰

Carbanion mechanisms may give either syn or anti elimination. For example, Hunter and Shearing studied the butoxide-catalyzed elimination of methanol from **35** and **36**. Since deuterium exchange with solvent is in close competition with elimination, the mechanism is probably $(E_1cB)_R$. The ratio of syn/anti

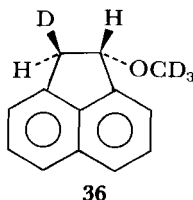
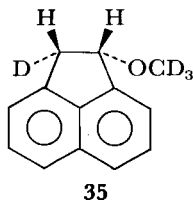

elimination varies by a factor of approximately 75, depending on the cation of the butoxide salt, and decreases in the order, $\text{Li}^+ > \text{K}^+ > \text{Cs}^+ > (\text{CH}_3)_4\text{N}^+$. Hunter and Shearing attribute the changing stereochemistry to the tendency of the cation to coordinate with the methoxy group of the substrate. Li^+ , which has the strongest coordinating ability, gives mostly syn elimination; $(\text{CH}_3)_4\text{N}^+$, which has the weakest, gives predominantly anti.⁸¹

In the carbanionic mechanisms for elimination, if the substrate has two proton-bearing β carbons, the more acidic protons will be removed. Thus in alkylated substrates the double bond will be oriented toward the less substituted carbon and Hofmann elimination is obtained.

⁷⁸ A. K. Colter and D. R. McKelvey, *Can. J. Chem.*, **43**, 1282 (1965).

⁷⁹ R. C. Cavestri and L. R. Fedor, *J. Amer. Chem. Soc.*, **92**, 610 (1970).

⁸⁰ See also L. R. Fedor and W. R. Glave, *J. Amer. Chem. Soc.*, **93**, 985 (1971) and note 74(b), p. 359.

⁸¹ D. H. Hunter and D. J. Shearing, *J. Amer. Chem. Soc.*, **93**, 2348 (1971); D. H. Hunter and D. J. Shearing, *J. Amer. Chem. Soc.*, **95**, 8333 (1973).

Table 7.11 HAMMETT ρ CONSTANTS FOR REACTION 7.33

X	ρ
I	+2.07
Br	2.14
OTs	2.27
Cl	2.61
S(CH ₃) ₂	2.75
F	3.12
N(CH ₃) ₃	3.77

SOURCE: W. H. Saunders, *The Chemistry of Alkenes*, S. Patai, Ed., Wiley-Interscience, New York, 1964, p. 155, Table 1. Reprinted by permission of Wiley-Interscience.

E₂ Eliminations⁸²

The rates of a large number of eliminations are (1) second-order, first-order each in base and in substrate; (2) decreased if β -deuterium is substituted for β -hydrogen; and (3) strongly dependent on the nature of the leaving group. The mechanism of these reactions (shown in Equation 7.24), in which C—H and C—X bond breaking are concerted, is E₂.

Substituent and isotope effects show that Equation 7.24 must actually describe a spectrum of transition states in which the relative extents of C—H and C—X bond breaking vary according to the specific substrate and to the reaction conditions. For example, a comparison of the rates of ethoxide-catalyzed elimination of HX from **37** and **38** in ethanol at 30°C shows that k_H/k_D varies from 3.0 when X = ⁺N(CH₃)₃ to 7.1 when X = Br.⁸³ Similarly, if X is kept constant,

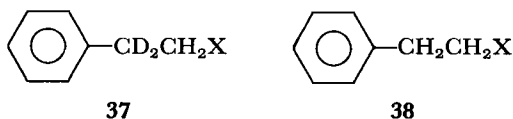

the logs of the rates of Reaction 7.33 correlate linearly with the σ values of the substituents, but the slopes of the correlation lines depend on X and are given in Table 7.11. The extent of bond breaking in the transition state must, then, depend on X.



The E₁cB-E₁ elimination spectrum Several investigators suggested that the spectrum of E₂ transition states ranges from one similar to that of E₁cB elimination, in which C—H bond breaking has proceeded considerably further

⁸² See note 64, p. 355, and D. V. Banthorpe, in *Studies on Chemical Structure and Reactivity*, J. H. Ridd, Ed., Methuen, London, 1966, p. 33; N. A. LeBel, in *Advances in Alicyclic Chem.*, 3, H. Hart and G. J. Karabatsos, Eds., Academic Press, New York, 1971, p. 196.

⁸³ W. H. Saunders, Jr., and D. H. Edison, *J. Amer. Chem. Soc.*, **82**, 138 (1960).

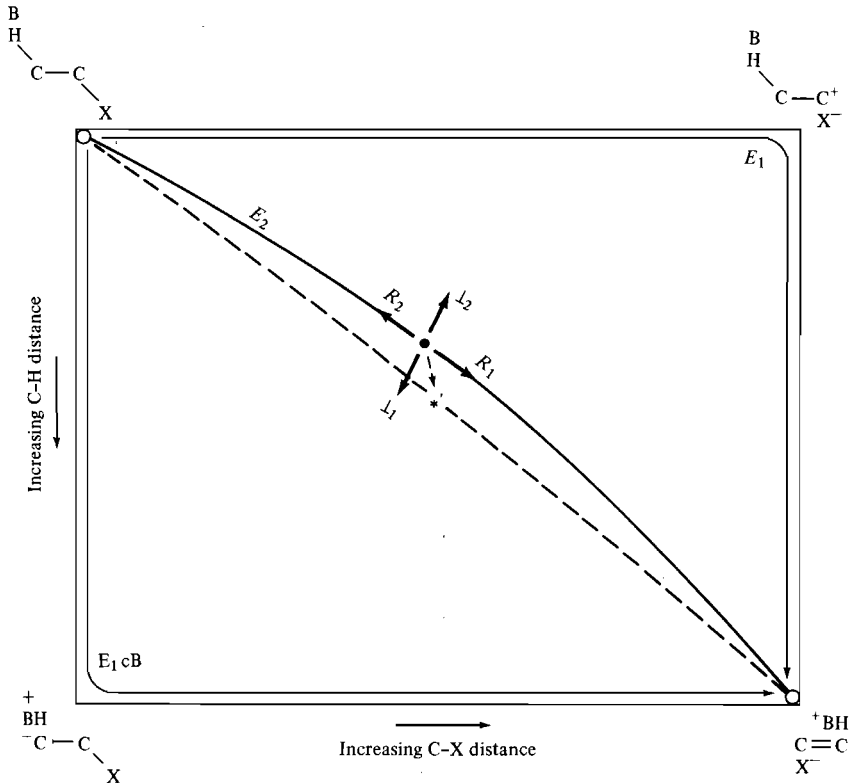
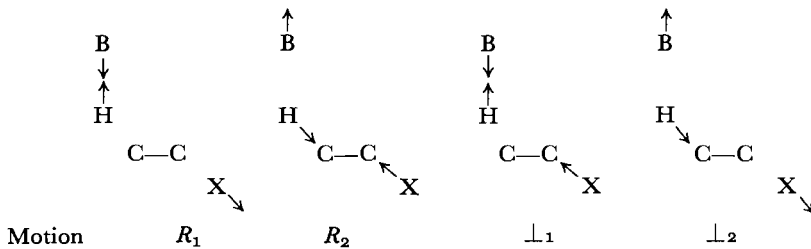
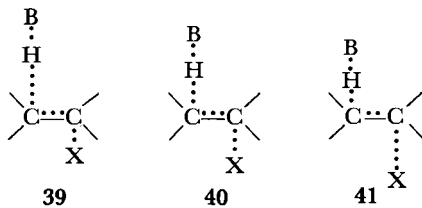

Figure 7.2 Projection in the horizontal plane of the E_2 reaction path. A poorer leaving group will facilitate motions R_2 and \perp_1 , causing shift of the transition state to * and change of the reaction path from the solid curve to the dashed curve.



than C—X bond breaking (39) to one similar to that of the E_1 reaction, 41.⁸⁴ Intermediate would be the fully concerted transition state 40.



⁸⁴ See note 64, p. 355.

The reacting bond rule, discussed in Section 2.5 (p. 103) and in Section 5.4 (p. 246) can be used to predict the effect on the E_2 reaction of changing the leaving group.⁸⁵ As in Chapter 2, the concerted reaction is broken down into the two stepwise mechanisms of which it is a composite. The E_2 reaction described here is a composite of the E_1 and E_{1cB} mechanisms. In Figure 7.2 the starting material is placed at the top left and the product at the bottom right of a two-dimensional projection of the energy surface for an E_2 elimination. At each of the two remaining corners is placed one of the two intermediates that would obtain if the reaction were stepwise. The two reaction pathways along the edges from starting material to product describe the stepwise reactions. A diagonal pathway describes the concerted reaction. Reacting bond rule 1 (equivalent to Hammond's postulate) tells us that a poorer leaving group, which makes motion over the transition state more difficult, will cause the transition state to come later on the reaction path—that is, will shift it in the direction indicated by arrow R_1 . But leaving group motion is also involved in the vibration designated by \perp_1 and \perp_2 ; reacting bond rule 2 states that a change in structure that tends to shift the equilibrium point of a vibration will do so. The poorer the leaving group, the more the equilibrium point of the vibration of the reaction path will be shifted along \perp_1 (toward the E_{1cB} mechanism). The composite result of the poorer leaving group on the transition state, then, will be to move it to point $*$. The extent of C—X bond breaking is not much affected, but the C—H bond is more broken and the carbanion character of the transition state increased.

The predictions of the reacting bond rules are borne out by the ρ values of Table 7.11. More negative charge is localized on C_β when the leaving group is the less reactive $^+N(CH_3)_3$ than when it is the more reactive I^- . The isotope effects mentioned above fit this explanation if it is assumed that when Br^- is the leaving group the proton is approximately half transferred at the transition state. The smaller value of k_H/k_D when $^+N(CH_3)_3$ departs is a result of an unsymmetrical transition state in which the proton is more than half transferred.

The Winstein-Parker elimination spectrum More recently, Winstein and Parker have proposed that the spectrum of E_2 transition states is actually wider than had been previously supposed.⁸⁶ They observed that not only strong proton bases (i.e., hard bases) such as hydroxide and alkoxide, which have traditionally been used as catalysts for the E_2 reaction, but also bases weak toward hydrogen but strong toward carbon (soft bases) are very effective in catalyzing E_2 reactions. For example, *t*-butyl bromide, which had been thought to undergo only E_1 elimination, actually eliminates by a bimolecular mechanism in which Cl^- is a more effective catalyst than *p*-nitrophenoxide although the latter is 10^{10} times stronger as a hydrogen base.⁸⁷ The Winstein-Parker spectrum extends from the E_{1cB} -like transition state (39)—called by them E_2H —to one in which the base is pushing out the leaving group rather than attacking the proton (43). The latter is designated E_2C . In the center of the

⁸⁵ See R. A. More O'Ferrall, *J. Chem. Soc., B*, 274 (1970) for a slightly different treatment.

⁸⁶ P. Beltrame, G. Biale, D. J. Lloyd, A. J. Parker, M. Ruane, and S. Winstein, *J. Amer. Chem. Soc.*, **94**, 2240 (1972) and references therein.

⁸⁷ A. J. Parker, M. Ruane, D. A. Palmer, and S. Winstein, *J. Amer. Chem. Soc.*, **94**, 2228 (1972).

Winstein-Parker spectrum is the E_2 transition state (**42**), in which the base pulls off the proton and pushes off the leaving group simultaneously.⁸⁸

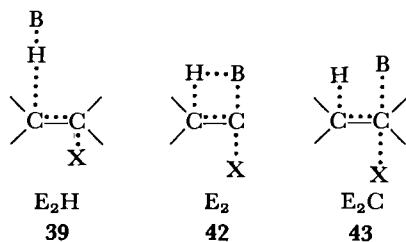

When a hard base is used as catalyst, the reaction will be more E_2H -like, whereas a soft base will cause it to be E_2C -like. Weakly acidic substrates and good leaving groups also shift the reaction path to a more E_2C -like mechanism.

When hard bases are the catalysts, the rate of elimination of a compound depends on the proton basicity of the catalyst as shown in Equation 7.34 (where k^E is the rate constant for bimolecular elimination):⁸⁹

$$\log k^E = \log pK_A + \text{constant} \quad (7.34)$$

Conversely, when soft bases are used, elimination rates, as would be expected from transition state **43**, show no such correlation. Instead there is a relationship between the rate of elimination and the rate of S_N2 substitution by the base as shown in Equation 7.35 (where k^S is the rate constant for bimolecular substitution and X is a constant):

$$\log k^E = X \log k^S + \text{constant} \quad (7.35)$$

For example, Figure 7.3 shows a plot of $\log k^E$ vs. $\log k^S$ for cyclohexyl tosylate with a number of soft bases.⁹⁰

Abstraction of the β proton in E_2C reactions has a low isotope effect. For example, Reaction 7.36 has a k_H/k_D of only 2.3⁹¹ This is consistent with the iso-

⁸⁸ Bunnett has contended that weak base-catalyzed eliminations do not involve bonding between the base and C_α but considers them to be part of the E_2 spectrum of which **39** and **41** are extremes. Bunnett suggests that weak hydrogen bases are good catalysts only when the leaving group is so good as to make possible a transition state in which the $C_\beta-H$ bond breaking is very small. As evidence for his point of view he cites, for example, the facts that: (1) the rate of theophenoxide-catalyzed elimination of HBr from **1** is approximately five times faster than from **2**; (2) in contrast, S_N2 substitution is predominant with **2** but undetectable with **1** [J. F. Bunnett and D. L. Eck, *J. Amer. Chem. Soc.*, **95**, 1897, 1900 (1975)]. Bunnett maintains that if the E_2C transition state involves partial bonding of the base to C_β , steric effects on the E_2C transition state should be similar to those on the S_N2 transition state. It is difficult to assess this argument because in the looser E_2C transition state (see p. 366) the nucleophile would be farther away from the *t*-butyl group. For a further discussion of this controversy, see W. T. Ford, *Accts. Chem. Res.*, **6**, 410 (1973).

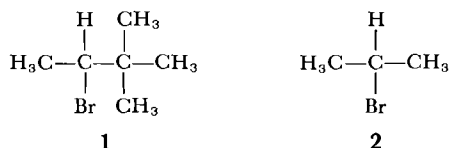

⁸⁹ This is the Bronsted relationship.

⁹⁰ A. J. Parker, M. Ruane, G. Biale, and S. Winstein, *Tetrahedron Lett.*, 2113 (1968).

⁹¹ G. Biale, A. J. Parker, I. D. R. Stevens, J. Takahashi, and S. Winstein, *J. Amer. Chem. Soc.*, **94**, 2235 (1972).

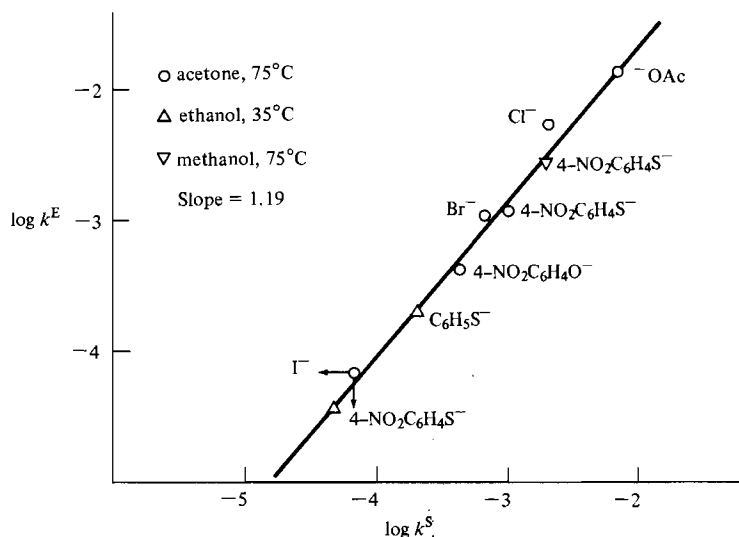
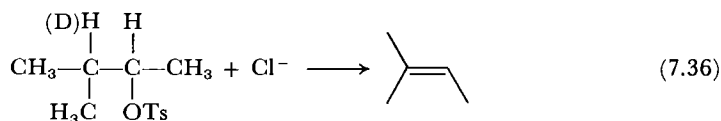

Figure 7.3 Relationship between elimination and substitution rates of cyclohexyl tosylates with soft bases. From A. J. Parker, M. Ruane, G. Biale, and S. Winstein, *Tetrahedron Lett.*, 2113 (1968). Reprinted by permission of Pergamon Press.

tope effect expected from a nonlinear configuration of carbon, hydrogen, and base in the transition state.⁹²



From the effect of changing solvents on rates, it is apparent that an E_2C transition state is loose—that is, both base and leaving group are solvated ions. For example, elimination of toluenesulfonic acid from cyclohexyl tosylate by Cl^- proceeds only approximately 50 times faster in acetone than in methanol. Compare this with the rate enhancement of about 10^6 when the S_N2 reaction of CH_3OTs is transferred from protic to aprotic solvent.⁹³ (See also Section 4.3.) This indicates that the double bond must be highly developed in the transition state.)

Orientation of double bonds If the double bond can be oriented toward either of two carbons in an E_2 reaction, the product depends on where the transition state of the particular reaction lies in the spectrum. Since all E_2 transition states have some double-bond character, the relative stability of the possible double bonds will always be of some importance to product determination. In an E_2C reaction the double bond is apparently so highly developed at the transition state that the relative olefin stability is the controlling factor in deciding the product. In an E_2H reaction, however, the relative acidity of the two kinds of

⁹² See Section 2.7 and R. A. More O'Ferrall, *J. Chem. Soc., B*, 785 (1970).

⁹³ See note 86, p. 364.

Table 7.12 ORIENTATION OF THE DOUBLE BOND IN THE PRODUCTS OF REACTION 7.37

X	2-Hexene/ 1-Hexene
F	0.43
Cl	2.0
Br	2.6
I	4.2

SOURCE: R. A. Bartsch and J. F. Bunnett, *J. Amer. Chem. Soc.*, **90**, 408 (1968). Reprinted by permission of the American Chemical Society.

Table 7.13 PRODUCTS OF REACTION 7.38 WITH VARIOUS BASES

Base	Solvent	Percent (CH ₃) ₂ C=CHCH ₃	Percent (CH ₃) ₂ CHCH=CH ₂
N(Bu) ₄ Br	Acetone	99.7	0.3
N(Bu) ₄ Cl	Acetone	99.2	0.8
NaOEt	Ethanol	82	18
KOtBu	<i>t</i> -Butanol	23.1	76.9

SOURCE: G. Biale, D. Cook, D. J. Lloyd, A. J. Parker, I. D. R. Stevens, J. Takahashi, and S. Winstein, *J. Amer. Chem. Soc.*, **93**, 4735 (1971). Reprinted by permission of the American Chemical Society.

hydrogens is of overriding importance to product determination. Since the acidity of the proton, the reactivity of the leaving group, and the strength of the base all help determine where the transition state lies in the spectrum, all of these affect the ratio of Hofmann to Saytzeff product.

The strong electron-withdrawing ability of fluorine, which renders the β protons acidic, the low reactivity of this halogen as a leaving group, and the strength of the base toward hydrogen assures that Reaction 7.37, when X = F, lies well toward the E₂H end of the spectrum. The data in Table 7.12 show that,

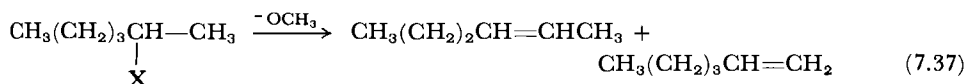

as expected, the more acidic primary protons are lost preferentially to the less acidic secondary ones, giving predominantly Hofmann-type product. In the series of increasing atomic weight, the halogens become simultaneously less electron-withdrawing and better as leaving groups; therefore as the fluorine is substituted in turn by Cl, Br, and I, Reaction 7.37 moves more toward the E₂C end of the spectrum and Saytzeff products become more important.⁹⁴

The importance of the base in determining the nature of the transition state and thereby the product can be seen from Table 7.13. When Reaction 7.38 is carried out with KO-*t*Bu in *t*-butanol (E₂H conditions), 76.9 percent Hofmann olefin is obtained. However, when the same reaction is carried out with ⁺N(Bu)₄ Br⁻ (E₂C conditions), 97.3 percent Saytzeff product is obtained. The

⁹⁴ R. A. Bartsch and J. F. Bunnett, *J. Amer. Chem. Soc.*, **90**, 408 (1968).

proportion of Saytzeff olefin in the ammonium bromide-catalyzed elimination is even higher than when the same substrate undergoes E_1 elimination.⁹⁵

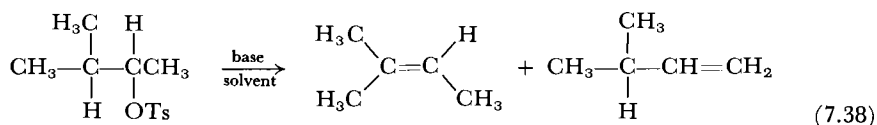

H. C. Brown has suggested that steric factors are of primary and almost sole importance in determining the position of the double bond. According to Brown, Hofmann product predominates when a large leaving group makes it even more difficult for the base to abstract the more hindered protons.⁹⁶ He has asserted that data similar to those of Table 7.12, which seem at first glance to be contrary to his theory, support it further: He says that fluorine takes up more space in the transition state than iodine because fluorine is more solvated.⁹⁷ However, the entropies of activation for Reaction 7.37 with $X = \text{F}, \text{Cl}, \text{Br},$ or I are all very similar; therefore increased solvation of fluorine seems not to be the proper explanation for the preponderance of Hofmann product when $X = \text{F}$.⁹⁸

More recently, Bartsch and co-workers have shown that in $E_2\text{H}$ eliminations of HI from 2-iodobutane, the positional orientation of the double bond is controlled almost entirely by the strength of the base (if the attacking atom is kept constant) unless really oversized bases are used.⁹⁹ In Table 7.14 are listed some of

Table 7.14 RELATIVE OLEFINIC PROPORTIONS FROM REACTIONS OF 2-IODOBUTANE WITH OXYANION BASES IN DIMETHYL SULFOXIDE AT 50.0°C

System	Base	pK_a of Conjugate Acid in DMSO	Percent 1-Butene in Total Butenes	<i>trans</i> -2-Butene: <i>cis</i> -2-Butene
1	Potassium <i>p</i> -nitrobenzoate	8.9	5.8 ± 0.1	3.51
2	Potassium benzoate	11.0	7.2 ± 0.2	3.24
3	Potassium <i>p</i> -nitrophenoxide	11.0	7.5 ± 0.1	3.58
4	Potassium <i>o</i> -nitrophenoxide	11.0	7.5 ± 0.2	3.82
5	Potassium acetate	11.6	7.4 ± 0.1	3.47
6	Potassium <i>p</i> -aminobenzoate	12.7	8.0 ± 0.2	3.42
7	Potassium 2,6-di- <i>tert</i> -butylphenoxide	15.0	19.2 ± 0.4	3.70
8	Potassium phenoxide	16.4	11.4 ± 0.2	3.34
9	Sodium 2,2,2-trifluoroethoxide	21.6	14.3 ± 0.2	3.32
10	Sodium methoxide	27.0	17.0 ± 0.5	3.14
11	Sodium ethoxide	27.4	17.1 ± 0.4	3.31
12	Sodium <i>n</i> -propoxide	28.0	18.5 ± 0.3	3.34
13	Potassium <i>tert</i> -butoxide	29.2	20.7 ± 0.4	3.00

SOURCE: R. A. Bartsch, G. M. Pruss, B. A. Bushaw, and K. E. Wieggers, *J. Amer. Chem. Soc.*, **95**, 3405 (1973). Reprinted by permission of the American Chemical Society.

⁹⁵ G. Biale, D. Cook, D. J. Lloyd, A. J. Parker, I. D. R. Stevens, J. Takahashi, and S. Winstein, *J. Amer. Chem. Soc.*, **93**, 4735 (1971).

⁹⁶ See note 82, p. 362.

⁹⁷ H. C. Brown and R. L. Klimisch, *J. Amer. Chem. Soc.*, **88**, 1425 (1966).

⁹⁸ See note 94, p. 367.

⁹⁹ (a) R. A. Bartsch, G. M. Pruss, B. A. Bushaw, and K. E. Wieggers, *J. Amer. Chem. Soc.*, **95**, 3405 (1973); (b) R. A. Bartsch, K. E. Wieggers, and D. R. Guritz, *J. Amer. Chem. Soc.*, **96**, 430 (1974).

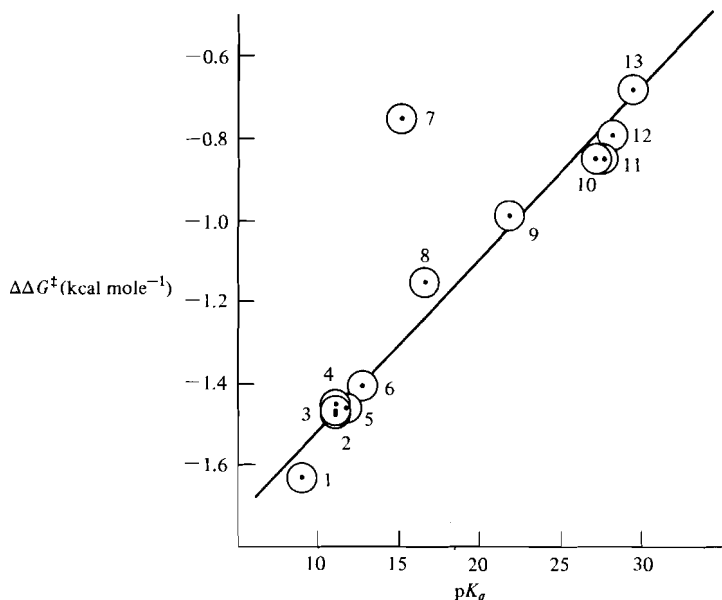

Figure 7.4 Plot of the free-energy difference for formation of 1-butene and *trans*-2-butene vs. the pK_a of the conjugate acid of the base. System numbers refer to Table 7.14. From R. A. Bartsch, G. M. Pruss, B. A. Bushaw, and K. E. Wieggers, *J. Amer. Chem. Soc.*, **95**, 3405 (1973). Reprinted by permission of the American Chemical Society.

the oxyanion bases studied, the pK_a 's of their conjugate acids, and the products obtained. The ratio of *trans*-2-butene to *cis*-2-butene remains approximately constant, but the percentage of 1-butene changes by almost fourfold over the range of bases studied. From the product composition, Bartsch determined, for each reaction system, the difference in the free energies of activation for the formation of 1-butene and *trans*-2-butene. In Figure 7.4 these values are plotted against the pK_a 's of the conjugate acids of the bases. A good straight line is obtained for all the bases studied except 2,6-di-*t*-butylphenoxide, for which the difference in energies of activation is smaller than would be expected from the pK_a of 2,6-di-*t*-butylphenol.

Stereochemistry¹⁰⁰ Since all E_2 transition states have some double-bond character, E_2 eliminations, if they are to go at all well, require that H and X be either syn- or anti-periplanar in the transition state. The two geometries for transition states of the E_2H reaction are shown in Figure 7.5a and 7.5b. All other things being equal, anti elimination is expected to be of lower energy than syn elimination, since the transition state leading to the former (Figure 7.5b) is entirely staggered whereas the transition state leading to the latter (Figure 7.5a) is partially eclipsed.¹⁰¹ For the E_2C reaction, only anti elimination via a transi-

¹⁰⁰ For reviews, see: (a) J. Sicher, *Angew. Chem. Int. Ed.*, **11**, 200 (1972); (b) S. Wolfe, *Accts. Chem. Res.*, **5**, 102 (1972).

¹⁰¹ J. Hine, *J. Amer. Chem. Soc.*, **88**, 5525 (1966).

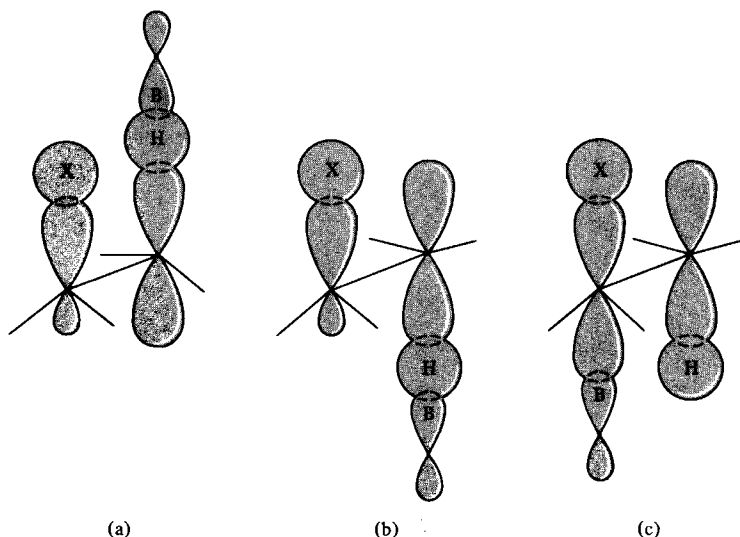
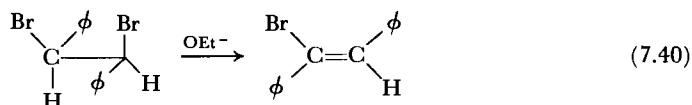
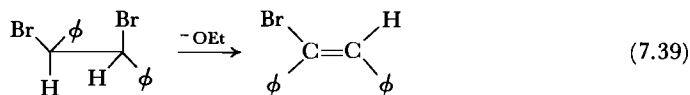

Figure 7.5 (a) Transition state for E_2H -syn elimination. (b) Transition state for E_2H -anti elimination. (c) Transition state for E_2C elimination.

tion state similar to that shown in Figure 7.5c is expected, since base attacks the molecule backside to the leaving group but frontside to the β hydrogen.

Let us now turn to the experimental results to see if these predictions are borne out in fact. It has long been known that E_2H reactions normally give preferentially anti elimination. For example, reaction of *meso*-stilbene dibromide with potassium ethoxide gives *cis*-bromostilbene (Reaction 7.39), whereas reaction of the *D,L*-dibromide gives the *trans* product (Reaction 7.40).¹⁰² A multitude of other examples exist—see, for example, note 64 (p. 355) and note 82 (p. 362).



E_2H reactions do, however, give syn elimination when: (1) an H—X dihedral angle of 0° is achievable but one of 180° is not or, put another way, H and X can become syn-periplanar but not trans-periplanar; (2) a syn hydrogen is much more reactive than the anti ones; (3) syn elimination is favored for steric reasons; and (4) an anionic base that remains coordinated with its cation, that, in turn, is coordinated with the leaving group, is used as catalyst. The very great importance of category 4 has only begun to be fully realized in the early 1970s.

¹⁰² P. Pfeiffer, *Z. Physik. Chem. Leipzig*, **48**, 40 (1904).

An example of category 1 is found in the observation by Brown and Liu that eliminations from the rigid ring system **44**, induced by the sodium salt of 2-cyclohexylcyclohexanol in triglyme, produces norbornene (98 percent) but no 2-deuteronorbornene.¹⁰³ The dihedral angle between D and tosylate is 0°, but

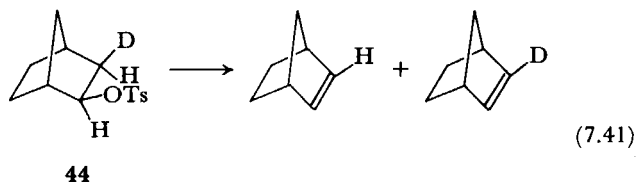

Crown ether present:	No	98%	0%
	Yes	70%	27.2%

that between H and tosylate is 120°. However, when the *crown ether* (**45**), which is an excellent complexing agent for sodium ion, is added to the reaction the amount of syn elimination drops to 70 percent (the sodium ion fits into the center of the crown ether molecule). Apparently, coordination of the sodium ion to both the leaving group and the base in the transition state, as in **46**, is responsible for some of the syn elimination from **44** in the absence of crown ether (category 4 above).¹⁰⁴

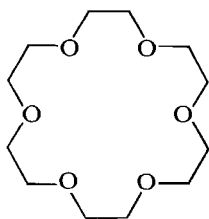
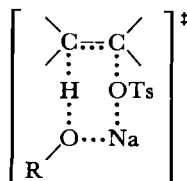
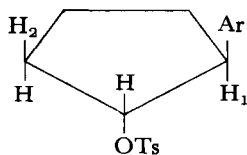
**45****46****47**

Category 2 is exemplified by E₂ elimination from **47**, in which the tosylate group can become periplanar with either H₁ or H₂. However, H₁ is activated and

¹⁰³ H. C. Brown and K.-J. Liu, *J. Amer. Chem. Soc.*, **92**, 200 (1970).

¹⁰⁴ R. A. Bartsch and R. H. Kayser, *J. Amer. Chem. Soc.*, **96**, 4346 (1974). When the leaving group is positively charged, reduced ion pairing reduces the amount of syn elimination: J. K. Borchardt and W. H. Saunders, *J. Amer. Chem. Soc.*, **96**, 3912 (1974).

H₂ is not; when treated with potassium *t*-butoxide in *t*-butanol at 50°C, elimination of H₁ is greatly preferred.¹⁰⁵ However, when the crown ether, **48**, is added, the amount of syn elimination is reduced. The results shown below are obtained.

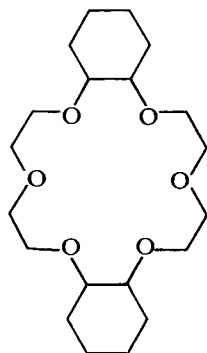
**48**

Again coordination of the cation must be partially responsible for the syn elimination.¹⁰⁶

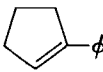
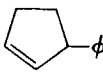
Product of Elimination from 47		
[48], <i>M</i>		
0.00	89.2	10.8
0.031	46.5	53.5
0.10	30.1	69.9
0.22	30.8	69.2

SOURCE: From R. A. Bartsch, E. A. Mintz, and R. M. Parlman, *J. Amer. Chem. Soc.*, **96**, 4249 (1974). Reprinted by permission of the American Chemical Society.

The role of steric factors in determining the syn/anti ratio has been investigated by Saunders and co-workers. From experiments with deuterated substrates they calculated that formation of 3-hexene from *t*-pentoxide-catalyzed decomposition of 3-*n*-hexyltrimethylammonium iodide (**49**) proceeds 83 percent by syn and 17 percent by anti elimination. They also found that syn elimination gives almost entirely trans olefin, but anti elimination gives cis product, a phenomenon noted previously and called the syn-anti dichotomy. Saunders proposed that the reason for the small amount of anti elimination is that the bulky trimethylammonium group forces the terminal methyl groups on the *n*-hexyl moiety as far away from it as possible, and thus hinders approach to an anti hydrogen. (The two staggered rotamers of **49** in which one hydrogen is anti are shown in **49a** and **49b**.) The anti hydrogen is less hindered in **49b**, so that the anti elimination that does take place gives cis olefin. The major pathway, syn elimination, could occur from rotamers **49a**, **49b**, or **49c**, but syn elimination from **49b** or loss of H₁ from

¹⁰⁵ C. H. DePuy, R. D. Thurn, and G. F. Morris, *J. Amer. Chem. Soc.*, **84**, 1314 (1962).

¹⁰⁶ R. A. Bartsch, E. A. Mintz, and R. M. Parlman, *J. Amer. Chem. Soc.*, **96**, 4249 (1974).

49c would cause the two alkyl groups to be eclipsed in the transition state. These are the two pathways for syn elimination leading to cis olefin. Syn elimination from **49a** and loss of H₂ from **49c** allows the two alkyl groups to be anti in

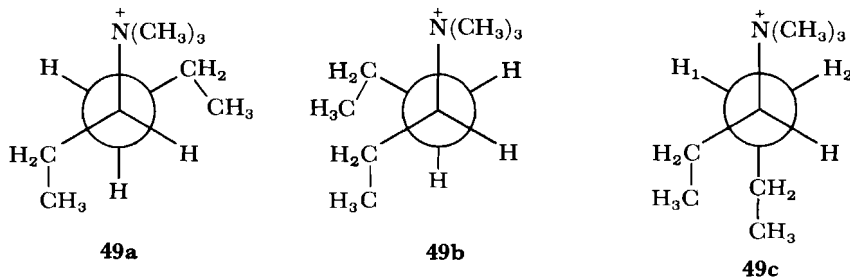

the transition state. Therefore syn elimination gives trans olefin.¹⁰⁷ In accord with Saunders' theory, other bulky ammonium salts also show the syn-anti dichotomy, whereas unhindered ones appear to eliminate entirely anti.¹⁰⁸

E₂C reactions give entirely anti elimination. This fact seems to be universal, and the need for anti elimination is even more important than formation of the most stable product.^{109, 110} Thus, for example, **50** with N(Bu)₄Cl gives >99.9 percent **51**, whereas the other diastereomer, **52**, gives >99.9 percent **53**.¹¹¹ Of course, **51** is the more stable olefin.

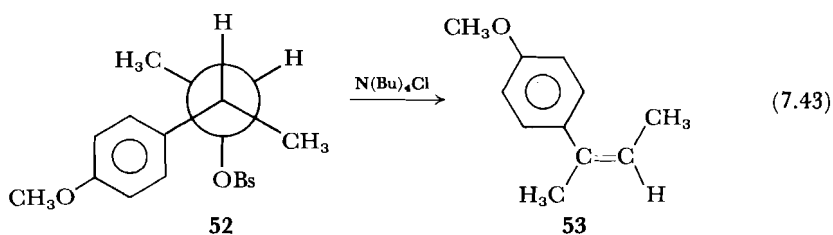
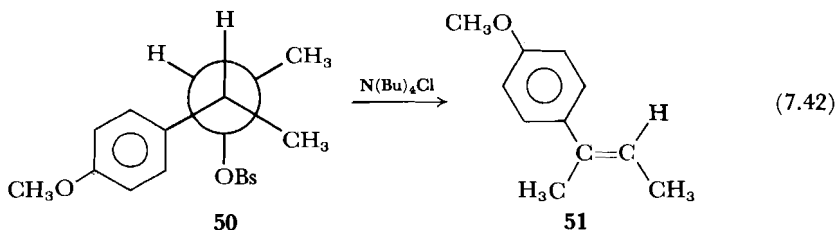

Because of the greater acidity of a vinylic than an alkyl proton, vinyl halides, RHC=CRX, are more likely than alkyl halides to undergo E₁cB elimination. However, when the proton is not rendered even more acidic by a vicinal electron-withdrawing group, and when the basic catalyst is not too strong, E₂ reaction obtains. Then anti elimination is much the preferred pathway.

¹⁰⁷ D. S. Bailey and W. H. Saunders, Jr., *J. Amer. Chem. Soc.*, **92**, 6904 (1970).

¹⁰⁸ D. S. Bailey, F. C. Montgomery, G. W. Chodak, and W. H. Saunders, Jr., *J. Amer. Chem. Soc.* **92**, 6911 (1970).

¹⁰⁹ See (a) note 86, p. 364; (b) note 95, p. 368.

¹¹⁰ G. Biale, A. J. Parker, S. G. Smith, I. D. R. Stevens, and S. Winstein, *J. Amer. Chem. Soc.*, **92**, 115 (1970).

¹¹¹ See note 95, p. 368.

Thus, for example, **54** gives entirely **55** when treated with NaOMe in methanol, but under the same conditions **56** gives only the allene **57**.¹¹²

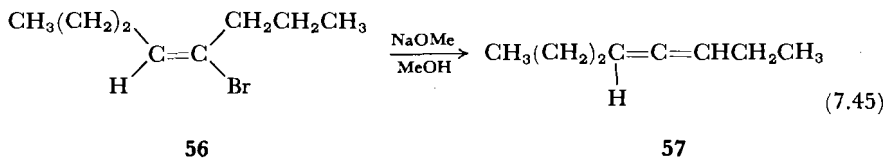
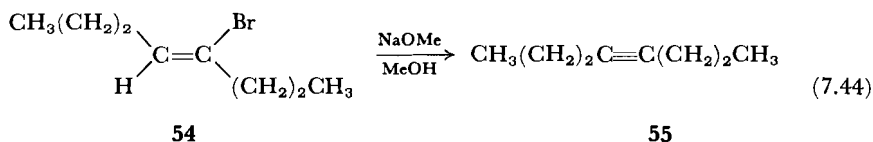

The substrate β -Alkyl substituents affect the rate of E_2 eliminations differently depending on the leaving group. In ammonium and sulfonium salts they have little effect (but generally decrease the rate slightly), whereas in halides and tosylates they usually increase the rates.¹¹³ These facts can be readily accommodated by the Winstein-Parker spectrum of transition states. The leaving group in an 'onium salt is relatively poor and strongly electron-withdrawing. Therefore eliminations from such compounds lie toward the $E_2\text{H}$ end of the spectrum and β -alkyl groups, which decrease the acidity of the β hydrogen, decrease the rate of elimination. Eliminations from halides and tosylates lie farther toward the $E_2\text{C}$ end of the spectrum, in which the double bond is more well developed. Since alkyl groups increase the stability of a double bond, β substituents increase the rate of these reactions.

α -Alkyl substituents have little effect on $E_2\text{H}$ -type reactions. However, they increase the rate of $E_2\text{C}$ -type reactions—again presumably because of the stabilizing effect of the alkyl group on the incipient double bond in the transition state.¹¹⁴ In terms of hard and soft acid-base theory, it might also be said that alkyl substituents on the carbon make that carbon a softer acid and thereby render it more susceptible to attack by a soft base. Thus **58** reacts approximately 250 times faster than **59** with $\text{N}(\text{Bu})_4\text{Cl}$.¹¹⁵

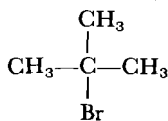
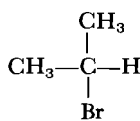
**58****59**

The leaving group The relative reactivity of a leaving group in an E_2 elimination depends on where, in the spectrum of transition states, the transition state of the particular reaction lies. If the reaction is very $E_2\text{C}$ -like, the reactivities

¹¹² S. W. Staley and R. F. Doherty, *J. Chem. Soc., D*, 288 (1969).

¹¹³ See note 82, p. 362.

¹¹⁴ See note 86, p. 364, and note 95, p. 368.

¹¹⁵ See note 95, p. 368.

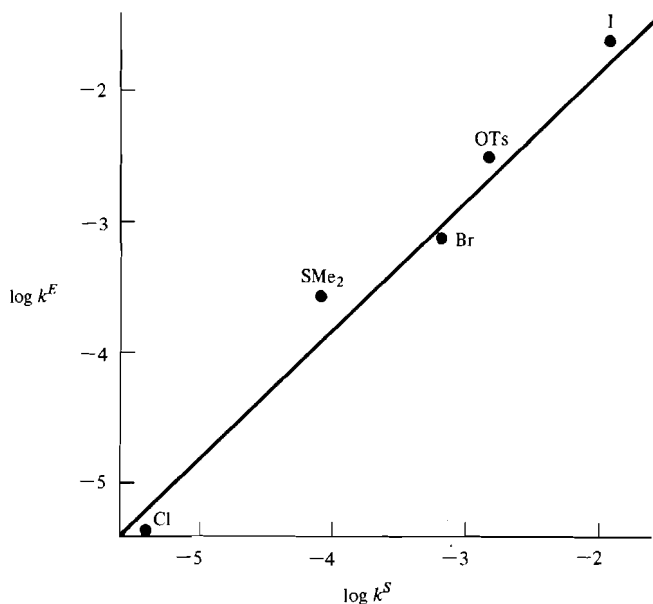

Figure 7.6 Response of rates of elimination of HX ($\log k^E$) and substitution ($\log k^S$) of cyclohexyl X, induced by NBu_4Cl in acetone containing lutidine at 75°C , to change of leaving group X. From P. Beltrame, G. Biale, D. J. Lloyd, A. J. Parker, M. Ruane, and S. Winstein, *J. Amer. Chem. Soc.*, **94**, 2228 (1972). Reprinted by permission of the American Chemical Society.

of the leaving groups correlate very well with their corresponding reactivities in the $\text{S}_{\text{N}}2$ reaction. For example, Figure 7.6 shows such a correlation between the rate of elimination of HX from cyclohexyl X by Cl^- and the rate of bimolecular substitution of X in cyclohexyl X by Cl^- . As might be expected, if elimination is more E_2H -like, no such correlation exists. Then the electron-withdrawing ability of X becomes of primary importance in determining reactivity.

Substitution vs. elimination Since in both $\text{S}_{\text{N}}2$ and E_2 reactions a Lewis base attacks the substrate and causes another Lewis base to depart from the substrate, these reactions naturally compete with one another. If it is kept in mind, as stated above, that α and β substituents increase the rate of E_2C reactions, have little effect on E_2H reactions, but retard $\text{S}_{\text{N}}2$ reactions, the predominant product can usually be predicted (see Table 7.15). Thus, *t*-alkyl halides give principally elimination products with all bases. Secondary substrates are borderline and favor either elimination or substitution depending on the exact reaction conditions. For example, if the attacking reagent is a hard base, elimination competes well with substitution. If a soft base is used, unhindered secondary substrates give predominantly substitution, but hindered substrates give predominantly elimination.

Eliminations from primary halides using soft bases do not take place at all, but eliminations using hard bases do.¹¹⁶

¹¹⁶ See note 95, p. 368.

Table 7.15 THE EFFECT OF SUBSTRATE AND BASE ON THE COMPETITION BETWEEN SUBSTITUTION AND ELIMINATION

Substrate	Carbon	Base	Solvent	Percent Elimination
$\begin{array}{c} \text{CH}_3 \\ \\ \text{CH}_3-\text{C}-\text{Br} \\ \\ \text{CH}_3 \end{array}$	3°	NBu ₄ Cl	Acetone	96
$\begin{array}{c} \text{CH}_3 \\ \\ \text{CH}_3-\text{C}-\text{Br} \\ \\ \text{CH}_3 \end{array}$	3°	NaOEt	HOEt	100
$\begin{array}{c} \text{CH}_3-\text{CH}-\text{CH}_3 \\ \\ \text{Br} \end{array}$	2°	NBu ₄ Cl	Acetone	0
$\begin{array}{c} \text{CH}_3-\text{CH}-\text{CH}_3 \\ \\ \text{Br} \end{array}$	2°	NaOEt	HOEt	75
$\begin{array}{c} \text{H} \\ \\ \text{CH}_3-\text{C}-\text{CH}-\text{CH}_3 \\ \quad \\ \text{H}_3\text{C} \quad \text{Br} \end{array}$	2°	NBu ₄ Cl	Acetone	51.4
$\begin{array}{c} \text{CH}_3 \\ \\ \text{CH}_3-\text{CH}-\text{C}-\text{CH}_3 \\ \quad \\ \text{Br} \quad \text{CH}_3 \end{array}$	2°	NBu ₄ Cl	Acetone	17.6
CH ₃ CH ₂ CH ₂ -Br	1°	NBu ₄ Cl	Acetone	0
CH ₃ CH ₂ CH ₂ -Br	1°	NaOEt	HOEt	8.8

SOURCE: G. Biale, D. Cook, D. J. Lloyd, A. J. Parker, I. D. R. Stevens, J. Takahashi, and S. Weinstein, *J. Amer. Chem. Soc.*, **93**, 4735 (1971), Table 1. Reprinted by permission of the American Chemical Society.

Pyrolysis of Esters¹¹⁷

Pyrolyses of esters (**60**) and xanthate esters (**61**), either in the gas phase or in solution, give 1,2-elimination (Equations 7.46 and 7.47). These reactions are

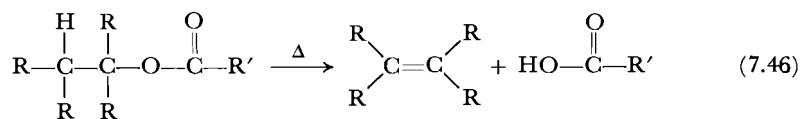

60

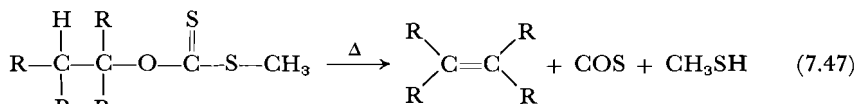

61

¹¹⁷ For a general review of olefin-forming eliminations in the gas phase, see: A. Maccoll, in *The Chemistry of Alkenes*, S. Patai, Ed., Wiley-Interscience, New York, 1964, p. 203; see also note 64(d) and 64(e), p. 355.

synthetically useful because, unlike E_1 and E_2 eliminations, there are no accompanying side reactions such as substitution or rearrangement. Both types of pyrolyses give predominantly Hofmann elimination. Xanthates decompose at considerably lower temperatures than the corresponding esters, and therefore often give a higher yield of olefin and a lower yield of tar. They are conveniently prepared *in situ* by the reactions shown in Equation 7.48.

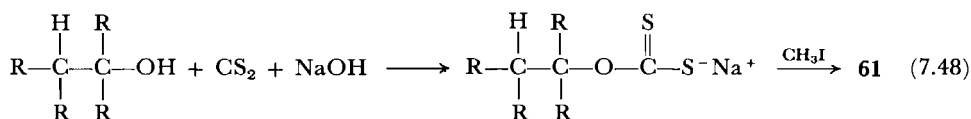

Isotope effects and the large negative entropies of activation for the pyrolyses make it appear probable that the transition states for Reactions 7.46 and 7.47 are **62** and **63**, respectively. Substituent effects, however, indicate that the transition states do have some polar character.

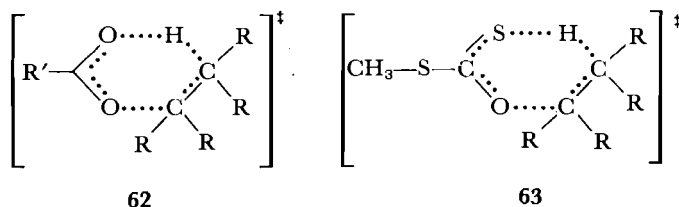

7.3 NUCLEOPHILIC ADDITION TO MULTIPLE BONDS¹¹⁸

When the electron density of a carbon-carbon bond is reduced by strongly electron-withdrawing substituents, nucleophilic attack at one of the vinylic or acetylenic carbons may occur. Electron withdrawal may be either by induction or by resonance. Examples of nucleophilic addition are shown in Equations 7.49-7.53.

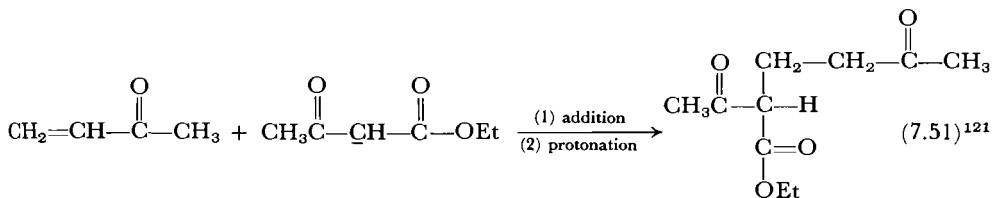
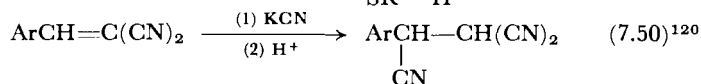
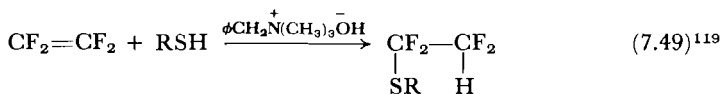

¹¹⁸ (a) S. Patai and Z. Rappoport, in *The Chemistry of Alkenes*, S. Patai, Ed., Wiley-Interscience, New York, 1964, p. 464; (b) E. Winterfeldt, *Angew. Chem. Int. Ed.*, **6**, 423 (1967).

¹¹⁹ W. K. R. Musgrave, *Quart. Rev.* (London), **8**, 331 (1954).

¹²⁰ See note 118(a).

¹²¹ J. A. Markisz and J. D. Gettler, *Can. J. Chem.*, **47**, 1965 (1969).

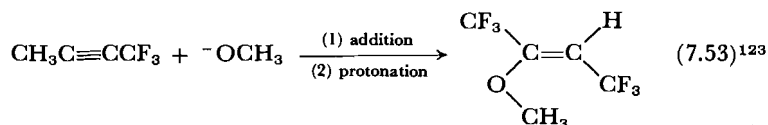
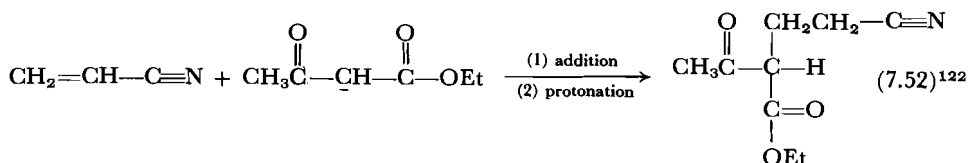

In general, the mechanisms of nucleophilic additions to double bonds have not been as much studied or systemized as those of electrophilic addition. Reactions 7.51 and 7.52 are examples of the very useful Michael condensation, in which a carbanion adds to an α,β -unsaturated carbonyl or nitrile compound. The usefulness of these reactions arises from the fact that the number of ways of building longer carbon chains from smaller ones is limited.

The mechanism of the Michael condensation is not actually a 1,2-addition as implied in Equations 7.51 and 7.52, but rather a 1,4-addition as shown in Equation 7.54. Protonation occurs first on the oxygen atom because **64b** contributes more to the overall structure of the anion than **64a**. The stereochemistry of 1,2-addition in the Michael condensation is therefore irrelevant to the mechanism of the condensation.¹²⁴ Other nucleophilic additions to alkenes¹²⁵ and alkynes¹²⁶ go either syn or anti depending on the particular reaction.

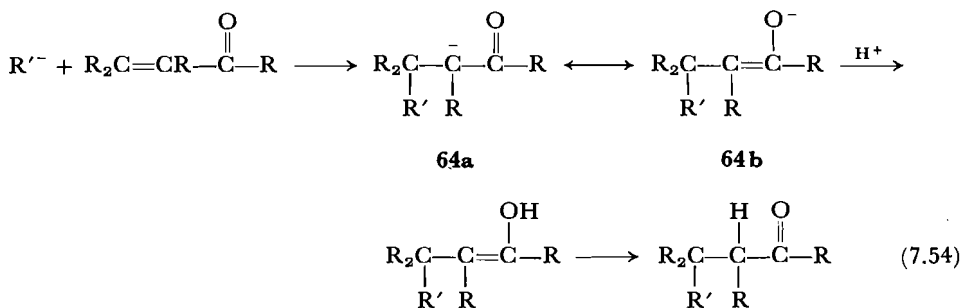

The rate-determining step in nucleophilic additions is usually nucleophilic attack on the multiple bond.¹²⁷ For example, the entropy of activation of a Michael condensation is always a large, negative quantity. This arises from the fact that in the transition state the five atoms, $\text{O}=\text{C}-\text{C}-\text{C}=\text{O}$ of the anion and the four atoms, $\text{C}=\text{C}-\text{C}=\text{O}$ (or $\text{C}=\text{C}-\text{C}=\text{N}$) of the α,β -unsaturated carbonyl (or nitrile) system are all restricted to one plane to allow maximum

¹²² See note 121.

¹²³ E. K. Raunio and T. G. Frey, *J. Org. Chem.*, **36**, 345 (1971).

¹²⁴ R. A. Abramovitch, M. M. Rogić, S. S. Singer, and N. Venkateswaran, *J. Org. Chem.*, **37**, 3577 (1972), and references therein.

¹²⁵ See note 118, p. 377.

¹²⁶ For example, see (a) E. Winterfeldt and H. Preuss, *Chem. Ber.*, **99**, 450 (1966); (b) K. Bowden and M. J. Price, *J. Chem. Soc., B*, 1466 (1970).

¹²⁷ See note 118, p. 377.

π -overlap.¹²⁸ Nucleophilic additions in which the second step, protonation of the intermediate carbanion, is rate-determining are also known.¹²⁹

7.4 ELECTROPHILIC AROMATIC SUBSTITUTION¹³⁰

The substitution of an electrophile for another group on an aromatic ring is electrophilic aromatic substitution (Equation 7.55). Although the leaving group is most often H^+ , it may also be another Lewis acid. Perrin has found that the order of leaving group abilities is $H^+ \gg I^+ > Br^+ > NO_2^+ > Cl^+$, which is

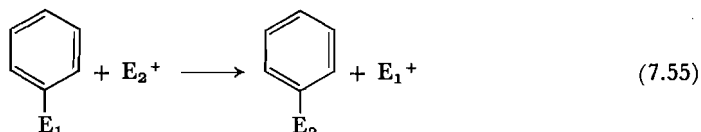

also the order of the ability of the group to bear a positive charge. When E_1 in Equation 7.55 is not H —that is, when an electrophile attacks a substituted aromatic ring, not ortho, meta, or para to the substituent but directly at the position bearing the substituent—then attack is at the *ipso* position.¹³¹

After a brief discussion of the nature of the attacking species in some of the most important types of electrophilic aromatic substitution, we shall examine the mechanism and the effect of substituents on rates and products.

Substitution by halogen may be carried out in three ways: (1) by molecular halogenation, in which polarized X_2 itself acts as the electrophile (Equation 7.56); (2) by molecular halogenation with a catalyst, in which the role of the catalyst is to polarize the halogen molecule; and (3) by positive halogenation in which the halogen is the cation of a salt.¹³²

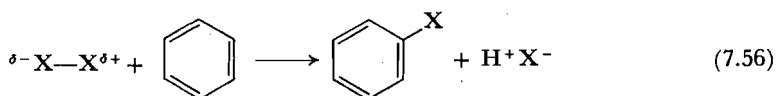

Iodination by molecular iodine is slow and operates only when the aromatic substrate is particularly reactive. Iodination can, however, be effected by using

ICl , CH_3COI or CF_3COI as reagents. Addition of zinc chloride to an iodination reaction in which ICl is the reagent increases the rate by assisting in breaking the $I-Cl$ bond.¹³³ Usually positive I^+ is the attacking reagent in these reactions.

Bromination with molecular bromine takes place readily. The reaction is

¹²⁸ See note 121, p. 377.

¹²⁹ L. A. Kaplan and H. B. Pickard, *J. Amer. Chem. Soc.*, **93**, 3447 (1971).

¹³⁰ For reviews, see: (a) L. Stock, *Aromatic Substitution Reactions*, Prentice-Hall, Englewood Cliffs, New Jersey, 1968; (b) R. O. C. Norman and R. Taylor, *Electrophilic Substitution in Benzenoid Compounds*, Elsevier, Amsterdam, 1965; (c) E. Berliner, *Prog. Phys. Org. Chem.*, **2**, 253 (1964); (d) L. M. Stock and H. C. Brown, *Adv. Phys. Org. Chem.*, **1**, 35 (1963). For deviations from the "normal" mechanism, see P. B. D. de la Mare, *Accts. Chem. Res.*, **7**, 361 (1974).

¹³¹ (a) C. L. Perrin, *J. Org. Chem.*, **36**, 420 (1971); (b) C. L. Perrin and G. A. Skinner, *J. Amer. Chem. Soc.*, **93**, 3389 (1971).

¹³² R. M. Keefer and L. J. Andrews, *J. Amer. Chem. Soc.*, **78**, 5623 (1956).

¹³³ J. R. Barnett, L. J. Andrews, and R. M. Keefer, *J. Amer. Chem. Soc.*, **94**, 6129 (1972).

normally carried out in acetic acid. Under these conditions the kinetics are second-order in bromine; the second molecule of Br_2 polarizes the first, and the overall reaction is that of Equation 7.57.

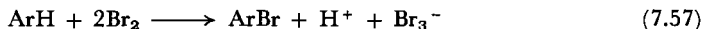

The addition of I_2 to the reaction mixture increases the rate, because I_2Br^- is

formed more readily than Br_3^- . HOBr , $\text{CH}_3\overset{\text{O}}{\parallel}\text{COBr}$ and $\text{CF}_3\overset{\text{O}}{\parallel}\text{COBr}$ can also all be used as sources of electrophilic bromine, the last being particularly reactive.¹³⁴ The attacking species is usually the entire molecule, but Br^+ may be formed at times.¹³⁵ Lewis acids such as AlCl_3 catalyze bromination by forming Br^+ as in Equation 7.58.

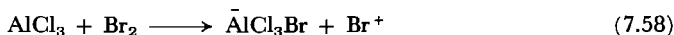

Chlorination with molecular chlorine also occurs readily and is usually first-order in Cl_2 . Apparently chlorine is electronegative enough so that an additional Cl_2 is not required to polarize the $\text{Cl}-\text{Cl}$ bond at the transition state. Stronger Lewis acids such as FeCl_3 do, however, catalyze the reaction by assisting in bond polarization. HOCl and CH_3COCl also act as chlorinating agents, but free Cl^+ is never formed. The reactive species from HOCl are Cl_2O (formed by dehydration of two molecules of acid) and $\text{H}_2\overset{+}{\text{O}}\text{Cl}$, both of which deliver Cl^+ to the aromatic π system.¹³⁶

Direct fluorination of aromatic rings is so exothermic that a tarry mixture of products is obtained. Reaction of benzene with the xenon fluorides, XeF_2 or XeF_4 , does give fluorobenzene, but the mechanism is probably free radical rather than polar.¹³⁷

Nitration of an aromatic ring¹³⁸ to give ArNO_2 is most often carried out with nitric acid in sulfuric acid; however, concentrated nitric acid, aqueous nitric acid, and nitric acid in polar organic solvents are also commonly used, as is preliminary nitrosation followed by oxidation of the aromatic nitroso compound (ArNO). Alkyl nitrates (RONO_2) are also nitrating agents in the presence of some Brønsted and Lewis acids.¹³⁹

When the reagent used is nitric acid, the attacking species is usually the nitronium ion, NO_2^+ . That this ion exists has been abundantly proven. For example, cryoscopic measurements show that each molecule of nitric acid dissolved in sulfuric acid gives rise to four ions. This result is best explained by the equilibria shown in Equations 7.59–7.61.¹⁴⁰ Raman spectra also show that in

¹³⁴ See note 133.

¹³⁵ See, however, H. M. Gilow and J. H. Ridd, *J. Chem. Soc., Perkin Trans. II*, 1321 (1973).

¹³⁶ C. G. Swain and D. R. Crist, *J. Amer. Chem. Soc.*, **94**, 3195 (1972).

¹³⁷ (a) M. J. Shaw, H. H. Hyman, and R. Filler, *J. Amer. Chem. Soc.*, **91**, 1563 (1969); (b) T. C. Shieh, E. D. Feit, C. L. Chernick, and N. C. Yang, *J. Org. Chem.*, **35**, 4020 (1970).

¹³⁸ For a review, see: J. G. Hoggett, R. B. Moodie, J. R. Penton, and K. Schofield, *Nitration and Aromatic Reactivity*, Cambridge University Press, London, 1971.

¹³⁹ G. A. Olah and H. C. Lin, *J. Amer. Chem. Soc.*, **96**, 2892 (1974) and references therein.

¹⁴⁰ R. J. Gillespie, J. Graham, E. D. Hughes, C. K. Ingold, and E. R. A. Peeling, *Nature*, **158**, 480 (1946).

highly acidic media nitric acid is completely converted to NO_2^+ .¹⁴¹ In fact, nitronium salts such as $\text{NO}_2^+\text{BF}_4^-$ have actually been isolated and can also be used for aromatic nitrations.¹⁴²

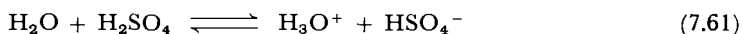
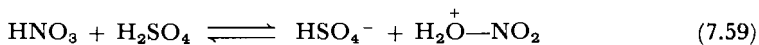

That the nitronium ion not only exists but also can be the reactive species has been shown. For example, the rate of nitration of toluene (and of other aromatics) in solutions of nitric acid in nitromethane were independent of the concentration of toluene.¹⁴³ Thus the slow step must be the formation of the reactive species *prior to* attack on the toluene ring. This rules out HNO_3 as the nitrating agent. That protonated nitric acid, formed as shown in Equation 7.62, is not the reactive species follows from the fact that the rate does not become first-order in

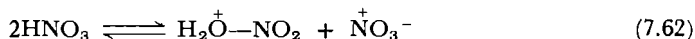

toluene when NO_3^- is added to the reaction. A rate first-order in toluene would be expected if $\text{H}_2\text{O}^+-\text{NO}_2$ were the nitrating agent, because the equilibrium in Equation 7.62 would be driven to the left and toluene would have to compete with NO_3^- for $\text{H}_2\text{O}^+-\text{NO}_2$ (see the discussion of the partition effect, p. 385).¹⁴⁴ Protonated nitric acid has also been ruled out as the reactive species in aqueous sulfuric acid. At various acid strengths the rate of nitration correlates with the acidity function H_B , which is defined by equilibria of the type shown in Equation 7.63, rather than with the acidity function H_0 , defined by equilibria of the type

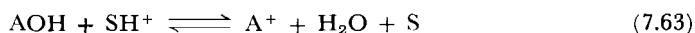

shown in Equation 7.64 (see Section 3.3).¹⁴⁵ The fact that nitronium salts are

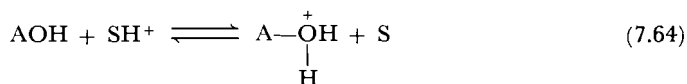

excellent nitrating agents is direct proof of the ability of NO_2^+ to substitute an aromatic ring.¹⁴⁶

Nitronium ion is not, however, invariably the reactive species. For example, nitric acid in acetic anhydride shows a greater than usual selectivity between toluene and benzene (see p. 394), indicating that another, less reactive, nitrating agent is formed.¹⁴⁷

Sulfonation of an aromatic substrate to produce ArSO_3H is usually brought about by reaction of the aromatic with concentrated sulfuric acid or with sulfur

¹⁴¹ C. K. Ingold and D. J. Millen, *J. Chem. Soc.*, 2612 (1950) and references therein.

¹⁴² G. A. Olah, S. Kuhn, and A. Mlinko, *J. Chem. Soc.*, 4257 (1956).

¹⁴³ G. Benford and C. K. Ingold, *J. Chem. Soc.*, 929 (1938).

¹⁴⁴ E. D. Hughes, C. K. Ingold, and R. I. Reed, *J. Chem. Soc.*, 2400 (1950).

¹⁴⁵ F. H. Westheimer and M. S. Kharasch, *J. Amer. Chem. Soc.*, **68**, 1871 (1946).

¹⁴⁶ See note 142.

¹⁴⁷ S. R. Hartshorn, R. B. Moodie, and K. Schofield, *J. Chem. Soc., B*, 1256 (1971).

trioxide in organic solvents.¹⁴⁸ When SO_3 is used in fairly dilute solution, the attacking species is SO_3 itself. In concentrated sulfuric acid, however, the mechanism is more complex. Fuming sulfuric acid (in which the mole fraction of $\text{SO}_3 > 0.5$) is actually a mixture of SO_3 and ionized and nonionized monomers, dimers, trimers, and tetramers of H_2SO_4 (the three latter formed by dehydration). As more water is added, the tetramer and trimer disappear, and the amount of dimer decreases. The reactive species in sulfuric acid thus depends on the amount of water in the acid and on the reactivity of the substrate. The reactive species in aqueous sulfuric acid are H_2SO_4^+ and $\text{H}_2\text{S}_2\text{O}_7$, the latter being more important at higher acid concentrations. In fuming sulfuric acid $\text{H}_3\text{S}_2\text{O}_7^+$ and $\text{H}_2\text{S}_4\text{O}_{13}$ are also involved.¹⁴⁹

Aromatic compounds are usually readily alkylated or acylated by a Friedel-Crafts reaction.¹⁵⁰ The combination of reagents used most commonly for aromatic alkylation is an alkyl halide with a strong Lewis acid (Equation 7.65). However, alkenes, alcohols, mercaptans, and a number of other types of organic

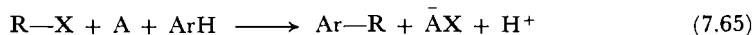

compounds also alkylate aromatic rings when a Friedel-Crafts catalyst is present. The order of reactivity of Lewis acids as catalysts varies from reaction to reaction but is most commonly $\text{AlCl}_3 > \text{SbCl}_5 > \text{FeCl}_3 > \text{TiCl}_2 > \text{SnCl}_4 > \text{TiCl}_4 > \text{TeCl}_4 > \text{BiCl}_3 > \text{ZnCl}_2$. The attacking species is sometimes the carbocation itself and sometimes an alkyl halide-Lewis acid complex (e.g., $\text{R-X} \cdots \overset{\delta+}{\text{Al}}\overset{\delta-}{\text{Cl}}_3$). For example, benzene reacts with *n*-propyl chloride at low temperatures to yield predominantly *n*-propylbenzene, but at higher temperatures cumene is the major product (Equation 7.66).¹⁵¹ Isomerization most probably occurs via a free carbocation.

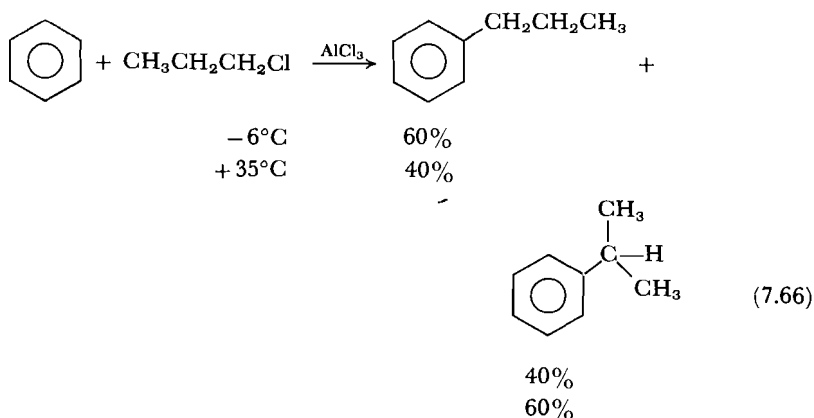

¹⁴⁸ For a review, see H. Cerfontain, *Mechanistic Aspects in Aromatic Sulfonation and Desulfonation*, Wiley-Interscience, New York, 1968.

¹⁴⁹ A. Koeberg-Telder and H. Cerfontain, *Rec. Trav. Chim.*, **90**, 193 (1971).

¹⁵⁰ For a comprehensive review of all aspects of the Friedel-Crafts reaction, see G. A. Olah, Ed., *Friedel-Crafts and Related Reactions*, Vols. 1-4, Wiley-Interscience, New York, 1963-1965.

¹⁵¹ V. N. Ipatieff, H. Pines, and L. Schmerling, *J. Org. Chem.*, **5**, 253 (1940).

Acylation is most often carried out with BF_3 or AlCl_3 and an acyl halide, anhydride, ester, or a carboxylic acid (Equation 7.67).

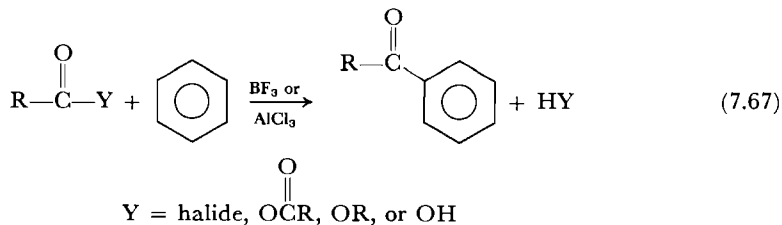

Apparently the attacking species is most often an acyl cation, $\text{R}-\overset{+}{\text{C}}=\text{O} \longleftrightarrow \text{R}-\overset{+}{\text{C}}\equiv\overset{-}{\text{O}}$.¹⁵²

The action of nitrous acid on aromatic amines produces aromatic diazonium ions (Equation 7.68), which are weak electrophiles. Correlation of the rate of



diazonium coupling, as Reaction 7.69 is called, with pH shows that the reactive species must be the free diazonium ion rather than ArN_2OH .¹⁵³

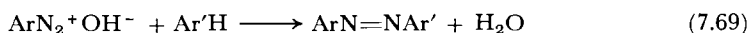

Some metals, such as mercury and thallium, that form covalent carbon-metal bonds react in electrophilic aromatic substitutions. Both ionic [e.g., $\text{Hg}(\text{ClO}_4)_2$] and covalent [e.g., $\text{Hg}(\text{OAc})_2$] mercuric compounds react; the attacking species, depending on the reagent and on the reaction conditions, may be Hg^{2+} , HgX^+ , or HgX_2 .¹⁵⁴ The only reagent that has been found to give high

yields of arylthallium compounds is $\text{Tl}(\overset{\text{O}}{\parallel}{\text{OCCF}_3})_3$.¹⁵⁵ The nature of the attacking species has not been studied, but presumably it is $\text{Tl}(\overset{\text{O}}{\parallel}{\text{OCCF}_3})_3$ or $\overset{+}{\text{Tl}}(\overset{\text{O}}{\parallel}{\text{OCCF}_3})_2$.

The products, $\text{ArTl}(\overset{\text{O}}{\parallel}{\text{OCCF}_3})_2$, are useful in organic synthesis because the thallium group can be introduced into a substituted aromatic ring highly regiospecifically and can then be replaced by another group such as I or CN. An example is shown in Scheme 3. Regiospecific introduction of aromatic substituents by direct means is often difficult to carry out (see p. 391).

¹⁵² F. R. Jensen and G. Goldman, in *Friedel-Crafts and Related Reactions*, G. A. Olah, Ed., Vol. 3, p. 1003.

¹⁵³ R. Wistar and P. D. Bartlett, *J. Amer. Chem. Soc.*, **63**, 413 (1941).

¹⁵⁴ (a) A. J. Kresge, M. Dubeck, and H. C. Brown, *J. Org. Chem.*, **32**, 745 (1967); (b) C. Perrin and F. H. Westheimer, *J. Amer. Chem. Soc.*, **85**, 2773 (1963).

¹⁵⁵ (a) E. C. Taylor and A. McKillop, *Acta. Chem. Res.*, **3**, 338 (1970); (b) A. McKillop, J. D. Hunt, M. J. Zelesko, J. S. Fowler, E. C. Taylor, G. McGillivray, and F. Kienzle, *J. Amer. Chem. Soc.*, **93**, 4841 (1971); (c) E. C. Taylor, F. Kienzle, R. L. Robey, A. McKillop, and J. D. Hunt, *J. Amer. Chem. Soc.*, **93**, 4845 (1971).

SCHEME 3

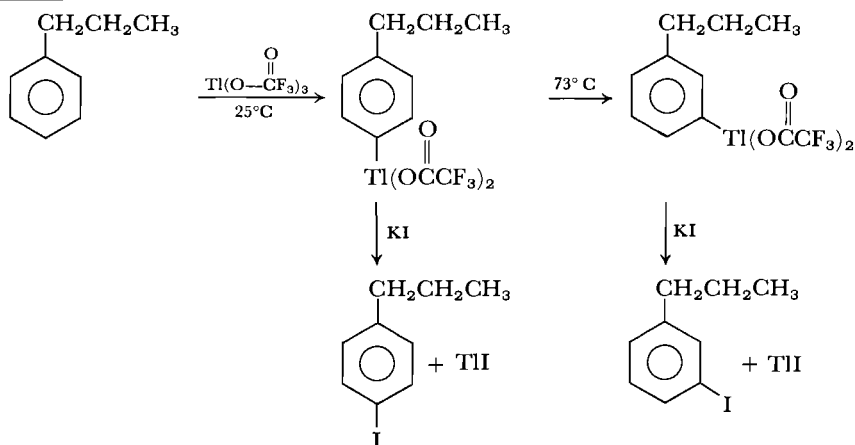

(Note that the replacement of Tf by I is an oxidation-reduction reaction.)

A priori, the two most likely mechanisms for electrophilic aromatic substitution on benzene, in the absence of strong base,¹⁵⁶ are (1) direct displacement, the transition state for which is shown in **65**, and (2) a two-step reaction in which

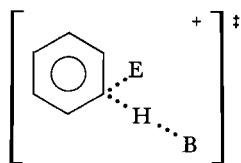

65

¹⁵⁶ At least two other special mechanisms exist that are not considered in this chapter. The first is electrophilic aromatic substitution via a carbanion. This pathway is sometimes followed if a strong base is present or if the substrate is a metal-substituted aromatic. For example, Mach and Bunnett have found that the presence of *t*-BuOK, *t*-BuOBr brominates 1,3,5-tribromobenzene by the mechanism shown below:

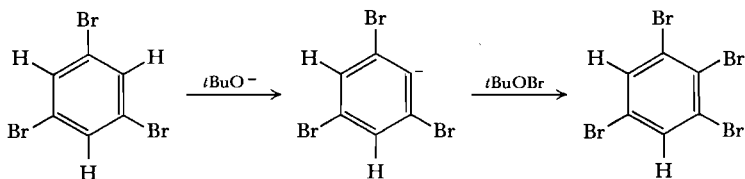

[M. H. Mach and J. F. Bunnett, *J. Amer. Chem. Soc.*, **96**, 936 (1974). For other examples see this paper and J. F. Bunnett, *Accts. Chem. Res.*, **5**, 139 (1972).]

The second special mechanism that we shall not consider is actually not a separate mechanism but is an electrophilic addition to one of the aromatic double bonds followed by an elimination reaction. An example is shown below:

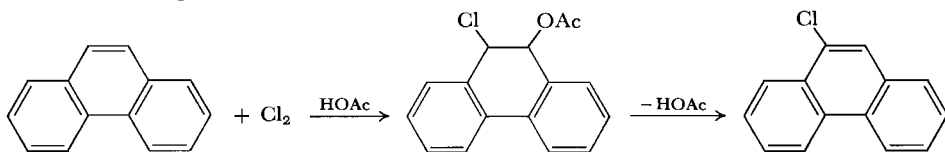

This reaction generally requires both a reactive electrophile and a reactive aromatic. For a discussion of it and the pitfalls of not recognizing that it occurs see ref. 1d.

the electrophile first forms some sort of intermediate complex with the aromatic ring and subsequently a proton is lost (Equation 7.70).

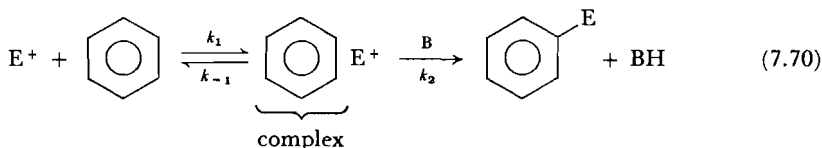

66

In experiments of major importance, first published in 1950, Melander found that in the nitration and bromination of a number of benzene derivatives the tritium isotope effect ($k_{\text{H}}/k_{\text{T}}$) is not 10–20 as is to be expected if carbon–hydrogen bond breaking occurs in the rate-determining step, but rather is less than 1.3. The direct displacement mechanism was thus ruled out, and the two-step mechanism of Equation 7.70 with the first step rate-determining was implicated.¹⁵⁷

Examination of the rate equation for the mechanism of Equation 7.70 reveals the probable origin of the small isotope effects observed by Melander. Using the steady-state approximation for the concentration of the intermediate complex (66), the observed rate is calculated to be

$$\text{rate} = [\text{Ar}][\text{E}^+] \frac{k_1(k_2[\text{B}]/k_{-1})}{1 + (k_2[\text{B}]/k_{-1})} \quad (7.71)$$

When the second step is very fast compared to the reverse of the first step—that is, when $k_2[\text{B}]/k_{-1} \gg 1$ —Equation 7.71 can be simplified to

$$\text{rate} = k_1[\text{Ar}][\text{E}^+] \quad (7.72)$$

In this case a primary isotope effect of 1.0 would be expected, since only the rate constant for the first step, in which no bond breaking occurs, is involved in the rate equation. When the reverse of the first step is very fast compared to the second step—that is, $k_2[\text{B}]/k_{-1} \ll 1$ —then the observed rate is linear with k_2 as shown in Equation 7.73.

$$\text{rate} = [\text{Ar}][\text{E}^+] \frac{k_1 k_2 [\text{B}]}{k_{-1}} \quad (7.73)$$

In this case a large isotope effect would be expected. If, however, $k_2[\text{B}] \approx k_{-1}$, then Equation 7.71 cannot be simplified, and the magnitude of k_2 will affect the overall rate albeit in a less than linear way. Then, even if $k_2 > k_{-1}$, some isotope effect should be observed. The small isotope effect of Melander's experiments make it appear that the first step is slower than the second, but that k_{-1} competes favorably with k_2 . When the second step becomes kinetically important in spite of the first step being the slow step, we have an example of the *partitioning effect*—so-called because the kinetic significance of the second step arises from the way in which the intermediate partitions itself. Since 1950 a very large number of electrophilic substitutions have been examined for isotope effects; in the absence of special circumstances (see below), the isotope effects found are usually very small.¹⁵⁸

¹⁵⁷ L. Melander, *Ark. Kemi*, **2**, 211 (1950).

¹⁵⁸ For reviews, see note 130(c) and H. Zollinger, *Adv. Phys. Org. Chem.*, **2**, 163 (1964).

Studies of the effect of base concentration on rate also provide strong support for the two-step mechanism. The simple displacement mechanism with transition state **65** should be first-order in base, as can be seen from the rate equation for this mechanism,

$$\text{rate} = k_3[\text{Ar}][\text{E}^+][\text{B}] \quad (7.74)$$

In the two-step mechanism, if $k_2[\text{B}]/k_{-1} \gg 1$, no base catalysis whatsoever should be observed; if $k_2[\text{B}]/k_{-1} \ll 1$, a linear dependence on base is expected; and if $k_2[\text{B}]/k_{-1} \approx 1$, nonlinear dependence on base should result.

Zollinger observed that Reaction 7.75 is not catalyzed by pyridine and does not show an isotope effect.¹⁵⁹ In this case the two-step mechanism must be operative, and k_2 is so large that $k_2[\text{B}]/k_{-1}$ is always much larger than 1 even at

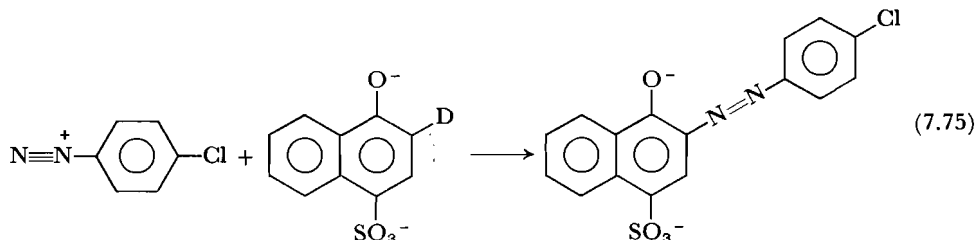

low base concentrations. For Reaction 7.76, however, there is a nonlinear correlation between rate and the concentration of pyridine. A deuterium isotope

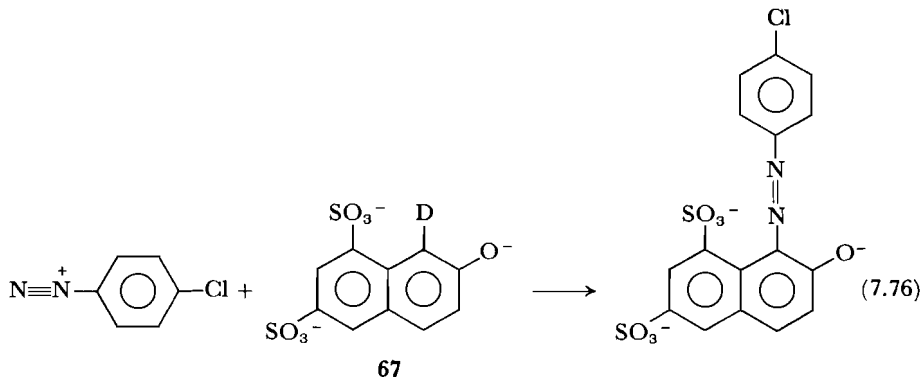

effect ($k_{\text{H}}/k_{\text{D}}$) of 6.55 was found for this reaction in pure water, but at pyridine concentrations of 0.0232 *M* and 0.905 *M* it decreased to 6.01 and 3.62, respectively.¹⁶⁰ The fact that the rate is not first-order in base rules out both a simple displacement mechanism and a two-step mechanism with proton loss rate-determining (see Equation 7.73). We shall return shortly to a consideration of why this reaction is catalyzed by base and has an isotope effect after we have ascertained the nature of the intermediate (**66**) in electrophilic aromatic substitutions.

Two possibilities for the intermediate complex (**66**) exist. The first is a π complex (**68**) in which the electrophile is coordinated with the entire π system or

¹⁵⁹ R. Ernst, O. A. Stamm, and H. Zollinger, *Helv. Chim. Acta.* **41**, 2274 (1958).

¹⁶⁰ H. Zollinger, *Helv. Chim. Acta.* **38**, 1597, 1623 (1955).

with a single π bond as shown in **68** and **69**.¹⁶¹ The second possibility for **66** is **70**, a σ complex in which the electrophile has formed a σ bond with one carbon of the aromatic ring.¹⁶²

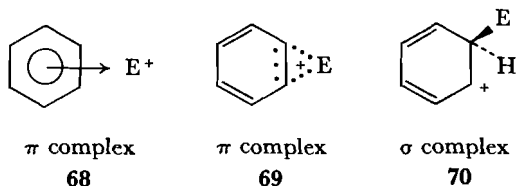

There is an abundance of evidence that both π complexes and σ complexes exist as stable species. For example, nmr studies have shown that the CH_2 protons of the ethyl fluoride–boron trifluoride complex absorb at slightly lower fields in the presence of toluene. Thus a new complex, which includes toluene and in which the CH_2 group bears more positive charge than it does in the absence of toluene, is formed. However, the aromatic protons of toluene absorb at almost the same frequency in the presence of $\text{BF}_3\text{-FCH}_2\text{CH}_3$ as in its absence;¹⁶³ thus, the new complex is probably that shown in **71**.

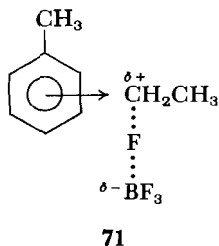

Another example is the complex that benzene forms with iodine. The infrared spectrum in a frozen nitrogen matrix shows that in the complex, the benzene symmetry in the ring plane is not altered. The π complex **72**, with the iodine axial, has been proposed as the structure.¹⁶⁴

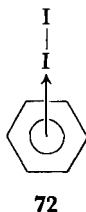

Sigma complexes have also been observed in the nmr. For example, when *m*-xylene is dissolved in $\text{HF} + \text{SbF}_5$ at -35°C , the proton magnetic resonance spectrum shown in Figure 7.7 is obtained. The peak at 4.7 ppp downfield from TMS is due to two paraffinic protons. The structure that best fits the spectrum

¹⁶¹ (a) G. A. Olah, S. Kobayashi, and M. Tashiro, *J. Amer. Chem. Soc.*, **94**, 7448 (1972); (b) D. V. Banthorpe, *Chem. Rev.*, **70**, 295 (1970).

¹⁶² G. A. Olah and Y. K. Mo, *J. Amer. Chem. Soc.*, **94**, 9241 (1972).

¹⁶³ T. Oyama and R. Nakane, *J. Org. Chem.*, **34**, 949 (1969).

¹⁶⁴ L. Fredin and B. Melander, *J. Amer. Chem. Soc.*, **96**, 1672 (1974).

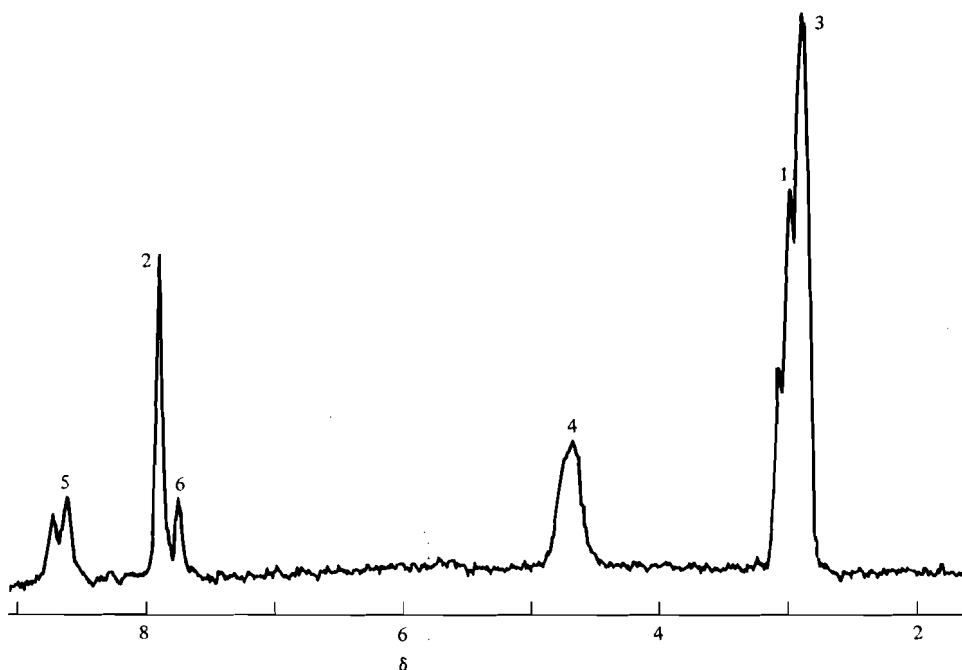
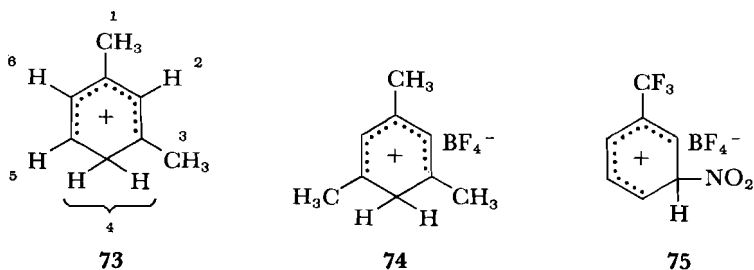

Figure 7.7 Proton magnetic resonance spectrum at 60 Mc/sec of the 4H^+ -*m*-xylenonium ion in $\text{HF} + \text{SbF}_5$ at -35°C . From D. M. Brouwer, E. L. Mackor, and C. MacLean, in *Carbonium Ions*, G. A. Olah and P. v. R. Schleyer, Eds., Wiley-Interscience, New York, 1970, Vol. 2, chap. 20. Reprinted by permission of Wiley-Interscience.

is **73**. At higher temperatures the spectra of aromatic σ complexes usually change; the lines broaden and eventually coalesce due to intramolecular hydrogen shifts.¹⁶⁵ A few stable σ complexes such as **74** and **75** have been prepared and isolated in the form of salts.¹⁶⁶



The fact that π and σ complexes do form is not proof that either or both are intermediates in electrophilic aromatic substitution. However, Table 7.16 gives strong evidence that σ complexes are the usual intermediate. Electron-donating groups greatly stabilize σ complexes of benzene derivatives but only slightly

¹⁶⁵ For reviews, see: (a) G. A. Olah, *Angew. Chem., Int. Ed.*, **12**, 173 (1973); (b) D. M. Brouwer, E. L. Mackor, and C. MacLean, in *Carbonium Ions*, G. A. Olah and P. v. R. Schleyer, Eds., Wiley-Interscience, New York, 1970, Vol. 2, chap. 20.

¹⁶⁶ G. A. Olah and S. J. Kuhn, *J. Amer. Chem. Soc.*, **80**, 6535, 6541 (1958).

Table 7.16 RELATIVE RATES OF AROMATIC SUBSTITUTIONS AND RELATIVE σ AND π COMPLEX STABILITIES OF METHYLBENZENES

Benzene Derivative	Relative σ Complex Stability (ArH + HF—BF ₃) ^a	Relative π Complex Stability with HCl ^a	Relative Rate of Bromination, Br ₂ in 85% HOAc	Relative Rate of Chlorination, Cl ₂ in HOAc
H	1	1.0	1	1
Methyl	790	1.5	605	340
1,2-Dimethyl	7,900	1.8	5,300	2,030
1,3-Dimethyl	1,000,000	2.0	514,000	180,000
1,4-Dimethyl	3,200	1.6	2,500	2,000
1,2,3-Trimethyl	2,000,000	2.4	1,670,000	—
1,2,4-Trimethyl	2,000,000	2.2	1,520,000	—
1,3,5-Trimethyl	630,000,000	2.6	189,000,000	30,000,000
1,2,3,4-Tetramethyl	20,000,000	2.6	11,000,000	—
1,2,3,5-Tetramethyl	2,000,000,000	2.7	420,000,000	—
1,2,4,5-Tetramethyl	10,000,000	2.8	2,830,000	1,580,000
Pentamethyl	2,000,000,000	—	810,000,000	134,000,000

SOURCE: G. A. Olah, *Accts. Chem. Res.*, **4**, 240 (1971). Reprinted by permission of the American Chemical Society.

^a From equilibrium constant measurements.

stabilize π complexes. Thus 1,2,3,5-tetramethylbenzene forms σ complexes that are 2 billion times more stable than those of toluene, but its π complexes are only more stable than those of toluene by a factor of 3. The rate of bromination of benzene derivatives also increases drastically with methyl substitution; and the relative rates are very similar to the relative stabilities of the σ complexes. Apparently the transition state resembles the σ complex. As Table 7.16 shows, there is also a close correlation between rates of chlorination in acetic acid and σ complex stability.

Now that we have determined that the intermediate in electrophilic aromatic substitution is usually a σ complex (see, however, p. 394), let us return to a consideration of Reaction 7.76. Two factors probably combine to cause the observed isotope effect and base catalysis. First, the strong electron-donating groups stabilize the intermediate **76** (Equation 7.77) and make departure of the proton more difficult than proton loss in many other electrophilic substitutions. [Remember, however, that $k_1 < k_2$ (see p. 386).] Second, steric interactions between the large diazonium group and the nearby substituents increase the rate

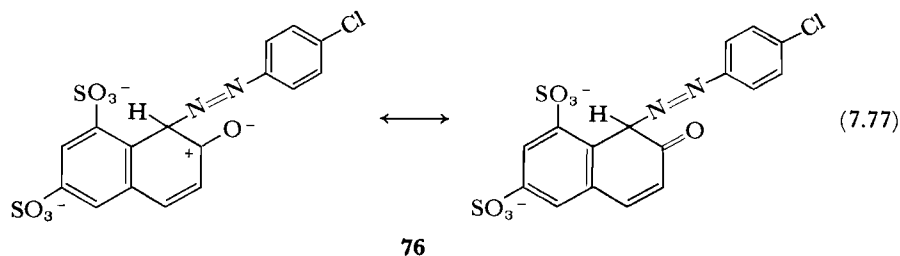

of decomposition (k_{-1}) of **76** back to starting material. Both factors, then, work together to cause $k_2[B]/k_{-1}$ in water to be small, and a large isotope effect is observed. As $[B]$ is increased, the ratio necessarily becomes larger and the isotope effect decreases.¹⁶⁷ The effect of steric factors on the size of the isotope effect is neatly demonstrated by the fact that the isotope effect for bromination of **77**, **78**, **79**, and **80** increases in the order $77 < 78 < 79 < 80$.¹⁶⁸

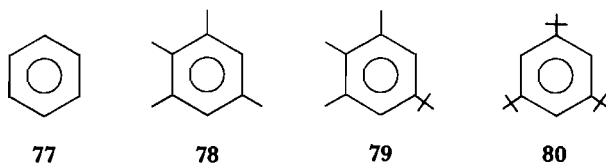

A few examples are known in which the second step of an electrophilic aromatic substitution is rate-determining. For example, **67** is brominated by Br_2 and BrOH at approximately the same rate, even though the latter is usually much the more reactive reagent. Moreover, the rate of reaction is first-order in base. These facts point to the two-step mechanism of Equation 7.70 with the second step rate-determining.¹⁶⁹

As has already been mentioned, in a two-step mechanism in which the first step is rate-determining, electron-donating groups on the aromatic ring increase the rate of electrophilic aromatic substitution. Likewise, electron-withdrawing groups decrease it. The overall rate enhancement (or diminution) arises from a sum of the group's inductive (I) and resonance (R) effects. Table 7.17 gives the relative rates of mononitration of a number of benzene derivatives.

Aromatic substituents that increase the rate relative to hydrogen direct the electrophile predominantly to the ortho and para positions. Substituents that

Table 7.17 RELATIVE RATES OF NITRATION OF BENZENE DERIVATIVES^a

R in $\text{C}_6\text{H}_5\text{R}$	Relative Rate
—OH	1000
— CH_3	25
— $\text{CH}_2\text{CO}_2\text{CH}_2\text{CH}_3$	3.8
—H	1
— CH_2Cl	0.71
— CH_2CN	0.35
—I	0.18
—Cl	0.033
— $\text{CO}_2\text{CH}_2\text{CH}_3$	0.0037
— $\text{CH}_2\text{N}^+(\text{CH}_3)_3$	2.6×10^{-5}
— NO_2	6×10^{-8}
— $\text{N}^+(\text{CH}_3)_3$	1.2×10^{-8}

SOURCE: C. K. Ingold, *Structure and Mechanism in Organic Chemistry*, 2nd ed., Cornell University Press, Ithaca, N.Y., 1969, p. 290. Reprinted by permission of Cornell University Press.

^a The reaction conditions were not the same for all the nitrations listed, and therefore the relative rates are only approximate. However, apparently none of the nitrations were carried out using conditions under which formation of $^+\text{NO}_2$ is rate-determining or using the very reactive, unselective $^+\text{NO}_2\text{X}^-$ salts.

¹⁶⁷ See note 160, p. 386.

¹⁶⁸ E. Baciocchi, G. I. Illuminati, G. Sleiter, and F. Stegel, *J. Amer. Chem. Soc.*, **89**, 125 (1967).

¹⁶⁹ M. Christen and H. Zollinger, *Helv. Chim. Acta*, **45**, 2057, 2066 (1962).

decrease the rate (except for the halogens, see Problem 7.11) direct the electrophile predominantly to the meta position. To understand why this is so, we must consider the nature of the transition state, but since the transition state is often similar to the σ complex we shall use the σ complex as a model for the transition state.

If the electrophile attacks the benzene ring at a position ortho or para to a $+I$ substituent (i.e., to one electron-donating by inductive effect), the activated complex will be similar to **81** or **82**, respectively. Resonance structures **81c** and **82c** are of particularly low energy because in these the positive charge is localized on the carbon that bears the $+I$ group. Attack at the meta position does not allow such a resonance structure to be drawn.

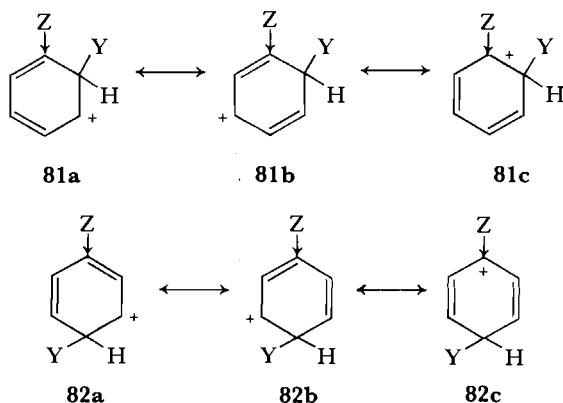

If attack is ortho or para to a group that is electron-donating by resonance ($-\text{O}-\text{R}$, $-\text{NR}_2$ are, for example, $+R$ groups) an additional resonance structure for the transition state can be drawn (**81d** or **82d**, respectively). There is no such stabilization for meta substitution.

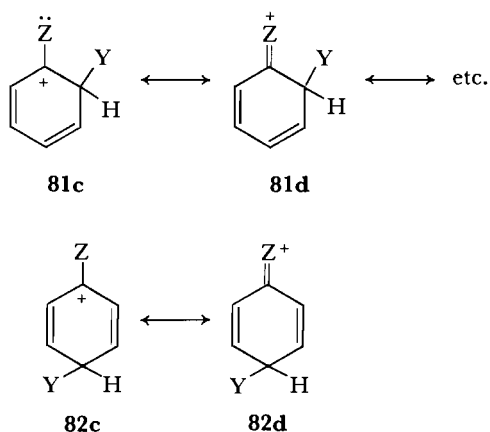

Now we can also understand why meta attack is preferred in a deactivated ring. Only if attack is at that position do none of the resonance structures of the transition state have a positive charge on that carbon that bears the electron-withdrawing group.

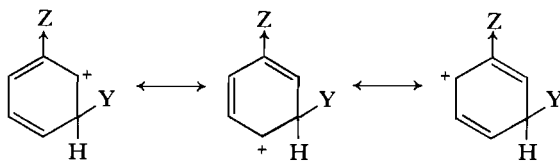

Because the rate of substitution varies with position, in a benzene derivative it is more informative and frequently more useful to talk about *partial rate factors* than about relative rates. A partial rate factor is defined as the rate *at one particular position* in the benzene derivative relative to the rate of substitution at one position in benzene. Let us, for example, calculate the para and meta partial rate factors (p_f and m_f , respectively) for bromination of toluene with bromine in aqueous acetic acid. Toluene brominates 605 times faster than benzene under these conditions. The product is 66.8 percent *p*-, 0.3 percent *m*-, and 32.9 percent *o*-bromotoluene. Attack at the para position of toluene occurs 0.668×605 times as fast as attack at all six positions of benzene but ($0.668 \times 605 \times 6 = 2420$) times as fast as at one position of benzene. Therefore $p_f^{\text{C}^{\text{H}_3}}$ for bromination of toluene under these conditions is 2420. There are only three times as many total carbons in benzene as meta carbons in toluene. Therefore $m_f^{\text{C}^{\text{H}_3}} = 0.003 \times 605 \times 3 = 5.5$. The definitions of the partial rate factors for monosubstituted benzenes ($\phi\text{-R}$) are given in Equations 7.78–7.80.

$$p_f^{\text{R}} = \frac{k_{\phi\text{-R}}}{k_{\phi\text{-H}/6}} \times \frac{\% \text{ para}}{100} \quad (7.78)$$

$$m_f^{\text{R}} = \frac{k_{\phi\text{-R}}}{k_{\phi\text{-H}/3}} \times \frac{\% \text{ meta}}{100} \quad (7.79)$$

$$o_f^{\text{R}} = \frac{k_{\phi\text{-R}}}{k_{\phi\text{-H}/3}} \times \frac{\% \text{ ortho}}{100} \quad (7.80)$$

The rates of electrophilic substitutions at the para and meta positions of benzene derivatives can be correlated by the linear free-energy relationships shown in Equations 7.81 and 7.82.¹⁷⁰

$$\log p_f^{\text{R}} = \sigma_p + \rho \quad (7.81)$$

$$\log m_f^{\text{R}} = \sigma_m + \rho \quad (7.82)$$

The substituents in a benzene derivative may affect the rate of electrophilic attack at the ortho position by steric interaction and secondary bonding (e.g., hydrogen bonding or charge-transfer complexing) as well as by electrical influence. Therefore σ_o^+ is not necessarily constant but depends on the size and nature of the electrophile, and a correlation of rates of ortho substitution is less satisfactory. (See Section 2.2, p. 61 and Figure 2.2.)

In general, the less reactive a reagent is, the more selective it is in attacking an activated rather than a deactivated site. In 1953 H. C. Brown observed that

$$S_f \equiv \log \frac{p_f^{\text{C}^{\text{H}_3}}}{m_f^{\text{C}^{\text{H}_3}}} \quad (7.83)$$

¹⁷⁰ See note 130(d), p. 379.

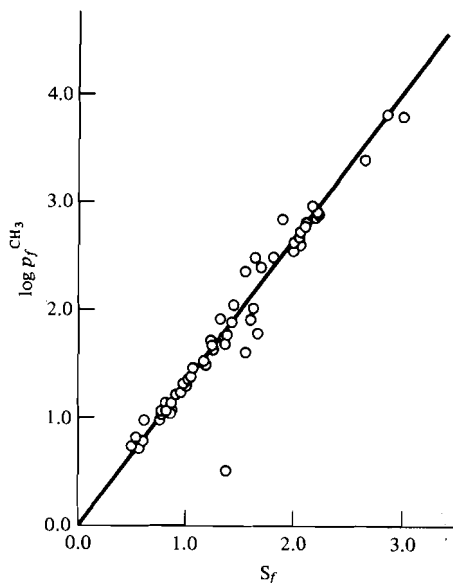

Figure 7.8 The relationship between S_f and $\log p_f^{\text{CH}_3}$ for a number of electrophiles. From L. M. Stock and H. C. Brown, *Advan. Phys. Org. Chem.*, **1**, 35 (1963). Reprinted by permission of Academic Press (London).

the selectivity of an electrophile in choosing between the para and meta positions of toluene is linearly related to its selectivity in choosing between toluene and benzene. If the *selectivity factor*, S_f , is defined by Equation 7.83, then the inter- and intramolecular selectivities are correlated by Equations 7.84 and 7.85 in which b and b' are empirical constants. These empirical equations can also be

$$\log p_f^{\text{CH}_3} = bS_f \quad (7.84)$$

$$\log m_f^{\text{CH}_3} = b'S_f \quad (7.85)$$

derived from the linear free-energy relationships of Equations 7.81 and 7.82.¹⁷¹ If, for example, 7.82 is subtracted from 7.81 and 7.81 is divided by the result, one obtains, after rearrangement

$$\log p_f^{\text{CH}_3} = \frac{\sigma^+_{\text{p}(\text{CH}_3)}}{\sigma^+_{\text{p}(\text{CH}_3)} - \sigma^+_{\text{m}(\text{CH}_3)}} \quad (7.86)$$

Thus b of Equation 7.84 is

$$b = \frac{\sigma^+_{\text{p}(\text{CH}_3)}}{\sigma^+_{\text{p}(\text{CH}_3)} - \sigma^+_{\text{m}(\text{CH}_3)}} \quad (7.87)$$

Figure 7.8 shows the straight line obtained when S_f , for a wide variety of nucleophiles, is plotted against the $p_f^{\text{CH}_3}$ factor for these reagents. One point deviates sharply from the line. That point corresponds to nitration with $\text{NO}_2^+\text{BF}_4^-$. (Similar deviations are also found for other highly reactive electrophiles not shown on this plot.¹⁷²) This reagent is very unselective in choosing

¹⁷¹ See note 130(d).

¹⁷² (a) G. A. Olah, *Accs. Chem. Res.*, **4**, 240 (1971); (b) G. A. Olah and S. Kobayashi, *J. Amer. Chem. Soc.*, **93**, 6964 (1971).

Table 7.18 RELATIVE RATES OF AROMATIC NITRATION OF BENZENE DERIVATIVES WITH $\text{NO}_2^+\text{BF}_4^-$ AND WITH $\text{CH}_3\text{ONO}_2\text{-BF}_3$

Benzene Derivative	$\text{NO}_2^+\text{BF}_4^-$ in Sulfolane ^a	$\text{CH}_3\text{ONO}_2\text{-BF}_3^b$ in Nitromethane
H	1.0	1.0
Methyl	1.6	25.5
1,2-Dimethyl	1.7	192.3
1,3-Dimethyl	1.6	285.5
1,4-Dimethyl	1.9	295.5
1,2,3-Trimethyl		914.6
1,2,4-Trimethyl		1076.2
1,3,5-Trimethyl	2.7	956.8
1,2,3,4-Tetramethyl		2154.5
1,2,3,5-Tetramethyl		1861.2
1,2,4,5-Tetramethyl		2188.3
Pentamethyl		2545.3

^a G. A. Olah, S. J. Kuhn, and S. H. Flood, *J. Amer. Chem. Soc.*, **83**, 4571 (1961).

^b G. A. Olah and H. C. Lin, *J. Amer. Chem. Soc.*, **96**, 2892 (1974).

Reprinted by permission of the American Chemical Society.

between toluene and benzene, but if it does choose toluene it is very selective in substituting at the ortho and para positions rather than the meta. Further study of this reagent reveals that it is only three times more reactive to 1,3,5-trimethylbenzene than it is to benzene. (Compare this to a factor of 2×10^6 when the electrophile is Br_2 in acetic acid, Table 7.16.) Relative rates of nitration of a number of methylated benzenes by $\text{NO}_2^+\text{BF}_4^-$ are shown in Table 7.18. Olah has attributed the low intermolecular selectivity to the transition state structure. He has suggested that when the electrophile is very reactive, the transition state resembles the starting material and is similar to a π complex. Since methylation does not much increase the stability of a π complex (Table 7.16), it would thus not much increase the rate of nitration.

According to Olah, the high intramolecular sensitivity arises from the orbital symmetry requirements of this transition state. The electrophile can only interact with two p orbitals that have the same sign in the highest occupied molecular orbital (83). Thus transition states 84 and 85 are possible, but 86 is not.

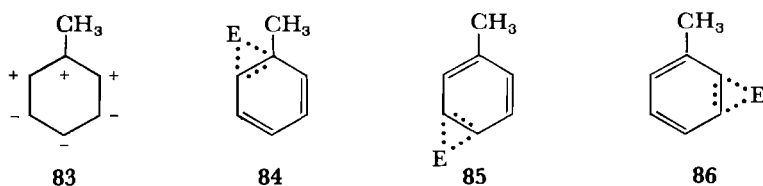

The activated complex 84 can open only to the ortho σ complex; 85 opens to the para and (less often) to the meta σ complex.¹⁷³

Olah's original experiments, in which the intermolecular selectivities were determined by direct competition for the electrophile by toluene and benzene, have given rise to controversy and criticism.¹⁷⁴ Schofield and Moodie suggested

¹⁷³ See note 161(a), p. 387.

¹⁷⁴ For a summary, see J. H. Ridd, *Accs. Chem. Res.*, **4**, 248 (1971) and also C. D. Johnson and K. Schofield, *J. Amer. Chem. Soc.*, **95**, 270 (1973).

that the reactions in question do have transition states similar to the σ complexes but are so fast that they are essentially over before the reactants are mixed; the ratio of products then depends on the local concentrations of the two aromatic substrates. To settle the controversy, Olah attempted to determine the rates of nitration of benzene and of toluene by $\text{NO}_2^+\text{BF}_4^-$ separately, but they were too fast for measurement. More recently, Olah and Lin carried out competitive nitrations using methyl nitrate (CH_3ONO_2) as a nitrating agent.¹⁷⁵ In the absence of catalysts this compound is inert to aromatic compounds, but in the presence of BF_3 it is highly reactive (see p. 380). Thus the aromatic compounds and the nitrating agent could be well mixed before the reaction was started. As Table 7.18 shows, the intramolecular selectivity of this nitrating agent is much greater than that of $\text{NO}_2^+\text{BF}_4^-$ and is apparently similar to that of more classical nitrating agents (see Table 7.17). For the purposes of settling the controversy, then, the results are inconclusive. Olah suggests that $\text{CH}_3\text{ONO}_2\text{-BF}_3$ is more selective than $\text{NO}_2^+\text{BF}_4^-$ because the nitrating agent is not free NO_2^+ but a polarized complex, **87**. Thus to reach the transition state the N—O bond must be

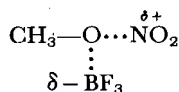
**87**

further weakened. It is possible, however, that poor mixing is responsible for the results with $\text{NO}_2^+\text{BF}_4^-$.¹⁷⁶

7.5 NUCLEOPHILIC AROMATIC SUBSTITUTION¹⁷⁷

Because H^- is not a good leaving group, nucleophilic displacements on unsubstituted aromatics rarely occur. However, if there is a suitable leaving group on the ring, nucleophilic aromatic substitution may take place by one of three mechanisms.

If the ring bears strongly electron-withdrawing substituents as well as a good leaving group, nucleophilic displacements (called $\text{S}_{\text{N}}\text{Ar}$ or activated aromatic nucleophilic substitutions) take place under mild conditions. The kinetics are second-order, first-order each in aromatic substrate and in nucleophile. An example is shown in Equation 7.88.¹⁷⁸ A body of evidence has been accumulated

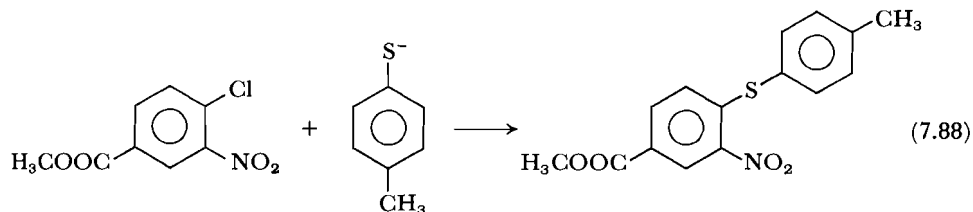

¹⁷⁵ See note 139, p. 380.

¹⁷⁶ For theoretical calculations having to do with this point see W. J. Hehre and P. C. Hiberty, *J. Amer. Chem. Soc.*, **96**, 7165 (1974).

¹⁷⁷ (a) J. Miller, *Nucleophilic Aromatic Substitution*, Elsevier, Amsterdam, 1968; (b) J. F. Bunnett, *Quart. Rev.* (London), **12**, 1 (1958).

¹⁷⁸ P. Carniti, P. Beltrame, and Z. Cabiddu, *J. Chem. Soc., Perkin II*, 1430 (1973).

that points to an addition elimination mechanism (Equation 7.89) for these reactions that is analogous to the mechanism for electrophilic aromatic substitution.

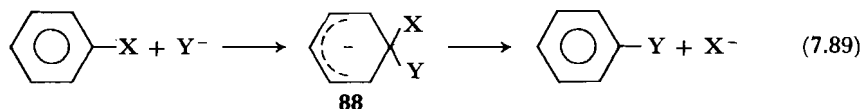

Meisenheimer first showed that σ complexes (**88**) can exist by isolating **89** in the form of a salt.¹⁷⁹ Since then a host of other *Meisenheimer complexes* have been isolated or identified by spectroscopy or other physical methods.¹⁸⁰ But the existence of Meisenheimer complexes does not prove that they lie on the reaction

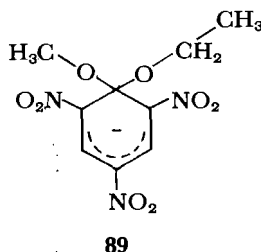

path of $S_N\text{Ar}$ reactions. That they do is corroborated by the relative reactivities of the halides as leaving groups. In a one-step displacement, the leaving group order should be the same as in aliphatic S_N2 reactions, that is, $\text{I} > \text{Br} > \text{Cl} > \text{F}$. However, fluorinated aromatics are often much the most reactive compounds. For example, Reaction 7.90 is 3300 times faster when $\text{X} = \text{F}$ than when $\text{X} = \text{I}$.

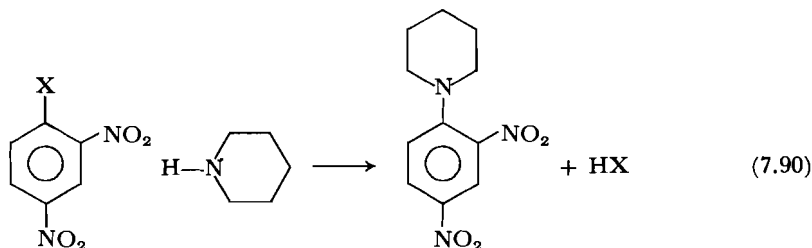

On the other hand, leaving groups that are similar in electronegativity but different in other chemical properties are similar in reactivity. As X in Reaction 7.90 is changed, the rate decreases in the order $\text{Br} > \text{Cl} > \text{—SO}_2\text{C}_6\text{H}_5 > \text{—OC}_6\text{H}_4\text{NO}_2\text{-}p > \text{I}$, but there is only a fivefold difference in reactivity between Br and I .¹⁸¹ The greater reactivity of fluorinated aromatics and the absence of an “element effect” point to a two-step mechanism in which expulsion of the leaving group is not involved in the rate-determining step.

The second step does become rate-determining when the nucleophile is more reactive or when the leaving group is poor. For example, E_A for Reaction 7.91, in which polarizable sulfur is the attacking atom, is $0.4 \text{ kcal mole}^{-1}$ greater

¹⁷⁹ J. Meisenheimer, *Ann.*, **323**, 205 (1902).

¹⁸⁰ (a) M. R. Crampton, *Adv. Phys. Org. Chem.*, **7**, 211 (1969); (b) M. J. Strauss, *Accts. Chem. Res.*, **7**, 181 (1974).

¹⁸¹ J. F. Bunnett, E. W. Garbisch, Jr., and K. M. Pruitt, *J. Amer. Chem. Soc.*, **79**, 385 (1957).

when $X = F$ than when $X = I$.¹⁸² Bunnett has demonstrated the effect of the mobility of the leaving group on the mechanism in a study of the effect of added base on the rate of Reaction 7.92. Expulsion of ArO^- is much easier from the

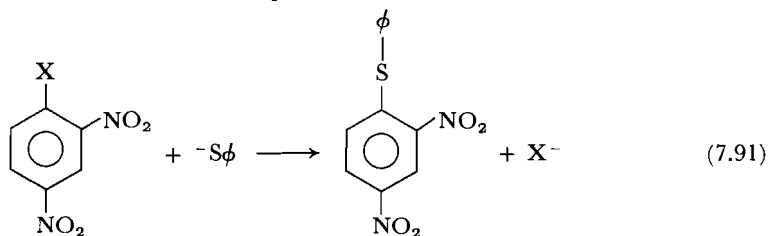

intermediate **92** than from **91**. Thus if loss of ArO^- is rate-limiting, Reaction 7.92 should be base-catalyzed. When **90a** is used as substrate, strong acceleration by base is observed; but when **90b** is the substrate, added base has almost no effect on rate.¹⁸³

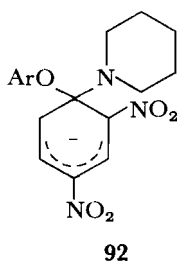
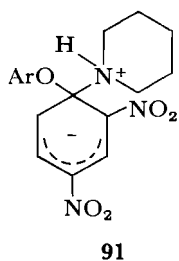
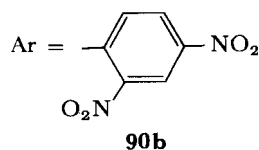
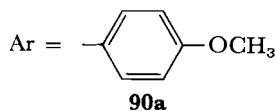
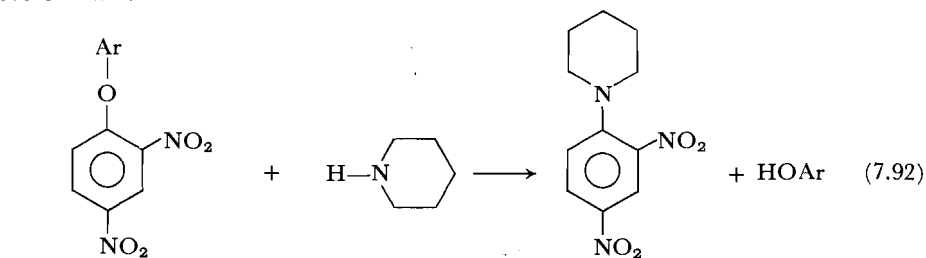

¹⁸² K. C. Ho, J. Miller, and K. W. Wong, *J. Chem. Soc., B*, 310 (1966).

¹⁸³ J. F. Bunnett and C. F. Bernasconi, *J. Org. Chem.*, **35**, 70 (1970). However, the reaction shown below, in which NO_2^- , a poor leaving group, departs, affords the product in 100 percent yield at 25°C in benzene. Lack of base catalysis indicates that the first step is rate-determining.

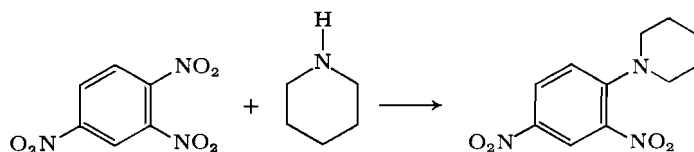

[F. Pietra and D. Vitali, *J. Chem. Soc., Perkin II*, 385 (1972).]

Roberts elucidated a second mechanism for nucleophilic aromatic substitution. Treatment of iodo-, bromo-, or chlorobenzene with potassium amide yields aniline. In 1953 Roberts observed that when chlorobenzene-1- ^{14}C is the substrate, approximately 50 percent of the ^{14}C in the product is found in the 1- and approximately 50 percent in the 2-position. The overall substitution then must go by an elimination-addition mechanism in which the highly strained intermediate, benzyne, is formed as shown in Equation 7.93.¹⁸⁴

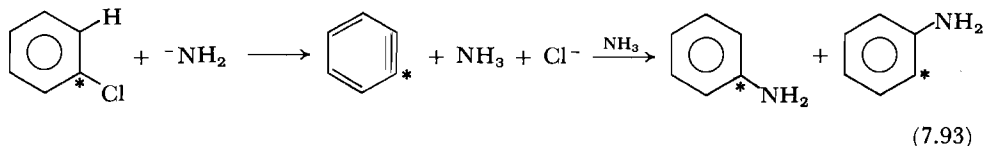

Comparison of the rates of formation of aniline from bromobenzene and bromobenzene-2-d gives $k_{\text{H}}/k_{\text{D}} = 5.5$; thus the proton is removed in the rate-determining step.¹⁸⁵ Fluorobenzene-2-d, however, exchanges its deuterium with solvent a million times faster than does deuterobenzene, but no aniline is formed.¹⁸⁶ Apparently, when the halogen is weakly electron-withdrawing but highly mobile, hydrogen abstraction is the slow step; when the halogen is strongly electron-withdrawing but unreactive as a leaving group, its expulsion is the slow step.

The presence of benzyne has been more directly demonstrated by trapping experiments. For example, the generation of benzyne in the presence of anthracene gives the Diels-Alder adduct, triptycene (Equation 7.94).¹⁸⁷

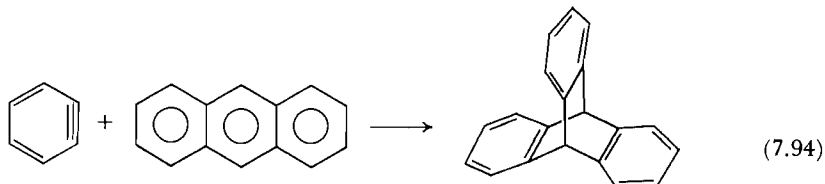

The third mechanism of nucleophilic aromatic substitution, specific for substitution on aromatic diazonium salts, is shown in Equation 7.95.

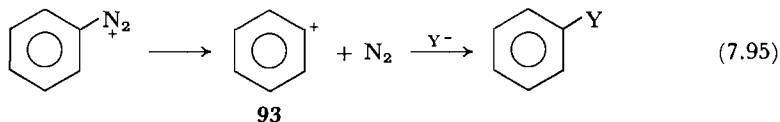

Apparently the leaving group must be as reactive as $-\text{N}_2^+$ in order that the strained intermediate **93** be formed.

¹⁸⁴ (a) J. D. Roberts, H. E. Simmons, Jr., L. A. Carlsmith, and C. W. Vaughan, *J. Amer. Chem. Soc.*, **75**, 3290 (1953); (b) J. D. Roberts, D. A. Semenow, H. E. Simmons, Jr., and L. A. Carlsmith, *J. Amer. Chem. Soc.*, **78**, 601 (1956); (c) J. D. Roberts, C. W. Vaughan, L. A. Carlsmith, and D. A. Semenow, *J. Amer. Chem. Soc.*, **78**, 611 (1956).

¹⁸⁵ See note 184(b).

¹⁸⁶ G. E. Hall, R. Piccolini, and J. D. Roberts, *J. Amer. Chem. Soc.*, **77**, 4540 (1955).

¹⁸⁷ (a) G. Wittig and K. Niethammer, *Chem. Ber.*, **93**, 944 (1960); (b) G. Wittig, H. Härle, E. Knauss, and K. Niethammer, *Chem. Ber.*, **93**, 951 (1960).

PROBLEMS

① Hydrochlorination of 1,2-dimethylcyclohexene gives a mixture of the two products shown in Equation 1. The ratio of 1 to 2 depends on the solvent and decreases in the order $\text{MeOH} > \text{AcOH} > \text{AcCl}$. Explain.

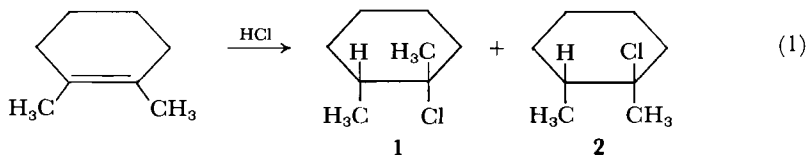

② The addition of 2,4-dinitrobenzenesulfonyl chloride to *cis*- and to *trans*-2-phenyl-2-butene gives the products shown below. Propose a mechanism for these reactions.

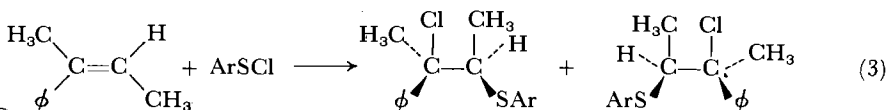
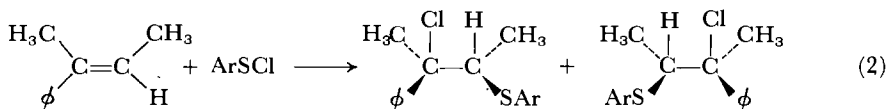

③ (a) Additions of Br_2 and ArSCl to [2.2.1]-bicycloheptene give the products shown in Equations 4 and 5, respectively. Give a mechanism for the products of Reaction 2 and explain why only the bromination gives rearrangement products.

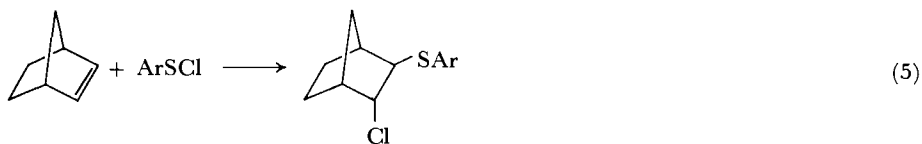
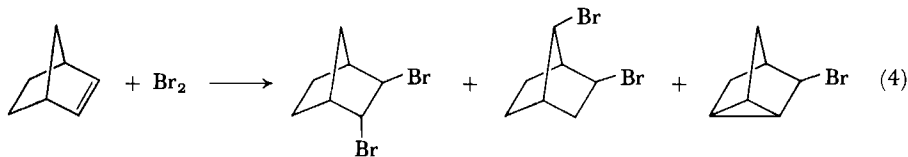

(b) $\triangle\text{-CH=CH}_2$ reacts 1000 times faster than $\phi\text{-CH=CH}_2$ with $\text{Br}_2\text{-HOAc}$ but only 3.8 times faster with *p*-Cl- $\text{C}_6\text{H}_5\text{SCl}$ in HOAc at 25°C . Explain.

④ Addition of hypochlorous acid to 3 gives the three products shown in Equation 6.

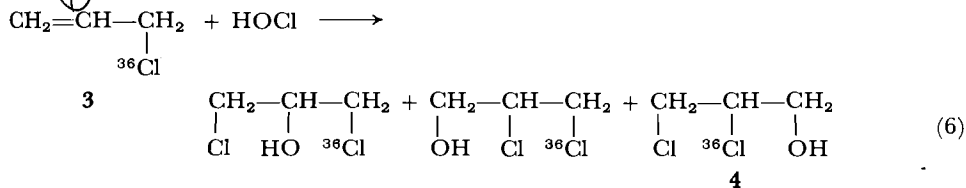

(a) Give a mechanism for the formation of 4.

(b) Much less rearrangement of ${}^{36}\text{Cl}$ occurs if 3 is treated with HOBr instead of HCl . Explain.

⑤ Bromination of 2-butene in acetic acid gives dibromide addition product

only. However, bromination of phenylethene under the same conditions gives the products shown in Equation 7. Explain the difference in behavior between 2-butene and phenylethene.

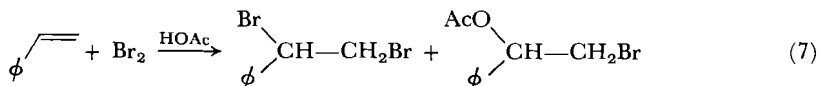

6. With what alkene would you begin and what synthetic method would you use to produce pure *threo*-3-*p*-anisyl-2-butanol? Pure *erythro*?

7. In the reaction of Equation 8, if R = *t*-butyl, the rate of reaction is independent of the concentration of base if more than an equimolar amount of base is present. If R = CH₃, however, the rate is dependent on added base up to high base concentrations. Explain.

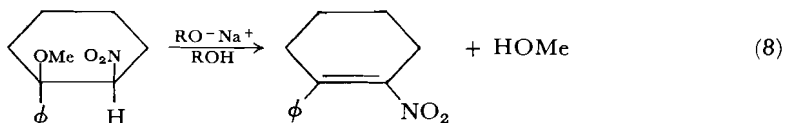

8. Explain why bromination of benzene with Br₂ has a ρ value of -12.1 , whereas bromination with HOBr has a ρ value of only -6.2 .

9. Decide for each of the compounds in Table 7.17 whether the substituent is $+I$ or $-I$, $+R$ or $-R$.

10. By drawing resonance structures for the respective σ complexes, decide whether attack is more likely at the 1- or the 2-position in electrophilic substitution on naphthalene.

11. Explain: The benzene halides undergo aromatic substitution more slowly than benzene but give predominantly ortho and para substitution.

12. Treatment of 1-chloronaphthalene with ethoxide ion gives no reaction. Treatment of 5 with ethoxide, however, gives the nucleophilic substitution product shown in Equation 9. Explain the difference in behavior between 1-chloronaphthalene and 5.

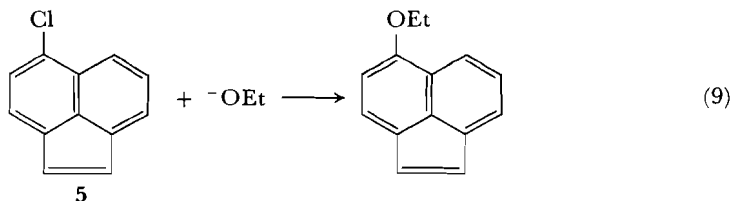

13. Predict the relative reactivities in nucleophilic substitution of Cl⁻ of: (a) 6a and 7a, 6b and 7b, 6c and 7c; (b) 6a, 6b, and 6c; (c) 6d and 6e.

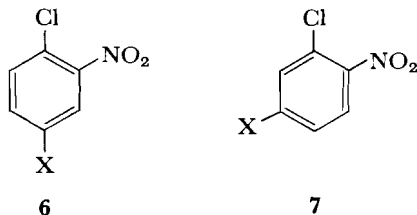

- a, X = CH₃
 b, X = CN
 c, X = NH₂
 d, X = N(CH₃)₃
 e, X = SO₂CH₃

14. In 80 percent aqueous ethanol, 3- β -tropanyl chloride gives the product shown in Equation 10 in 100 percent yield. Under the same conditions, 3- α -tropanyl chloride reacts at one twentieth the rate to give only the addition and elimination products shown in Equation 11. Formulate a mechanism for Reaction 10 and explain the difference between the mode of reaction of Reactions 10 and 11.

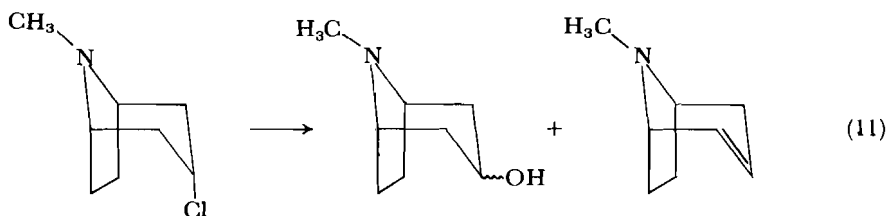
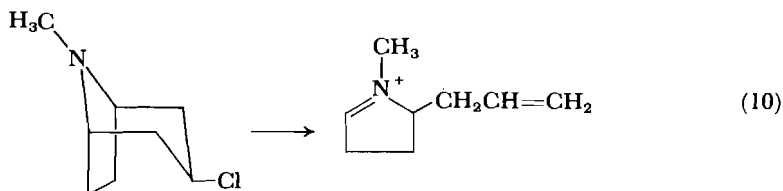

REFERENCES FOR PROBLEMS

1. R. C. Fahey and C. A. McPherson, *J. Amer. Chem. Soc.*, **93**, 2445 (1971).
2. D. J. Cram, *J. Amer. Chem. Soc.*, **71**, 3883 (1949).
3. (a) R. Kwart and R. K. Miller, *J. Amer. Chem. Soc.*, **78**, 5678 (1956); (b) D. G. Garratt, A. Modro, K. Oyama, G. H. Schmid, T. T. Tidwell, and K. Yates, *J. Amer. Chem. Soc.*, **96**, 5295 (1974).
4. C. A. Clarke and D. H. Williams, *J. Chem. Soc., B*, 1126 (1966).
5. J. H. Rolston and K. Yates, *J. Amer. Chem. Soc.*, **91**, 1469 (1969).
6. E. L. Allred, J. Sonnenberg, and S. Winstein, *J. Org. Chem.*, **25**, 26 (1960).
7. F. G. Bordwell, M. M. Vestling, and K. C. Yee, *J. Amer. Chem. Soc.*, **92**, 5950 (1970).
12. M. J. Perkins, *Chem. Commun.*, 231 (1971).
13. (a, b) W. Greizerstein, R. A. Bonelli, and J. A. Brioux, *J. Amer. Chem. Soc.*, **84**, 1026 (1962); (c) J. F. Bunnett, F. Draper, Jr., R. R. Ryason, P. Noble, Jr., R. G. Tonkyn, and R. E. Zahler, *J. Amer. Chem. Soc.*, **75**, 642 (1953).
14. G. A. Grob, *Theoretical Organic Chemistry—Kekulé Symposium*, London: Butterworths, 1959, p. 114.

Chapter 8

REACTIONS

OF CARBONYL

COMPOUNDS

Carbonyl compounds comprise a large and important class of organic substances, and the chemistry of this functional group is essential to the understanding of many chemical and biochemical processes.¹ In this chapter we use a few fundamental ideas of mechanism to correlate reactions of various carbonyl functional groups. We shall touch briefly on the closely related chemistry of carbon-nitrogen double bonds.

Carbonyl reactions may be understood in terms of two basic processes: addition of a nucleophile to the carbonyl carbon (Equation 8.1) and removal of a proton from the carbon adjacent to the carbonyl group (Equation 8.2). In the first process the carbonyl molecule is acting as a Lewis acid, and in the second

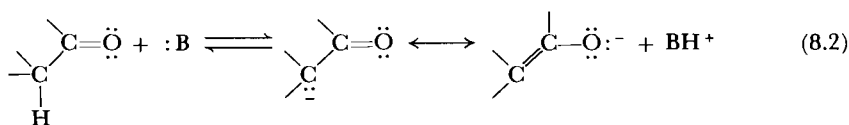

(which is, of course, possible only if the molecule bears an α -hydrogen) as a Brønsted acid. Both depend on the electron deficiency of the carbonyl carbon,

¹ Reviews of various aspects of carbonyl chemistry may be found in the following sources: (a) W. P. Jencks, *Catalysis in Chemistry and Enzymology*, McGraw-Hill, New York, 1969; (b) W. P. Jencks, *Prog. Phys. Org. Chem.*, **2**, 63 (1964); (c) R. P. Bell, *Advan. Phys. Org. Chem.*, **4**, 1 (1966); (d) S. Patai, Ed., *The Chemistry of the Carbonyl Group*, Vol. 1, and J. Zabicky, Ed., *The Chemistry of the Carbonyl Group*, Vol. 2, Wiley-Interscience, London, 1966 and 1970; (e) S. Patai, Ed., *The Chemistry of Acyl Halides*, Wiley-Interscience, London, 1972.

which is in turn caused by the electronegativity of the oxygen and its ability to accept a negative charge. The second reaction is readily reversible, and the first under most circumstances is also. Coordination of the carbonyl oxygen with a proton or some other Lewis acid will make the oxygen more electrophilic and may be expected to facilitate both addition of a nucleophile to the carbonyl carbon and removal of a proton from the α position. Catalysis by acids and bases is thus a central theme of carbonyl reactions.

8.1 HYDRATION AND ACID-BASE CATALYSIS

We consider first the simple addition of a nucleophile to a carbonyl carbon, preceded, accompanied, or followed by addition of a proton to the oxygen, and the reverse. The overall process (Equation 8.3) amounts to addition of $H-X$ to $C=O$. The reaction differs from the additions to $C=C$ discussed in Chapter 7 in two important respects. First, the nucleophile always becomes bonded to the

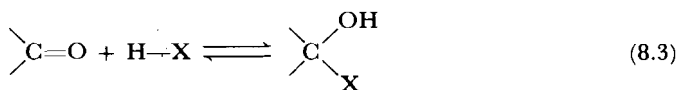

carbon and the proton to the oxygen, so there is no ambiguity concerning direction of addition; and second, the $C=O$ group is much more susceptible to attack by a nucleophile than is $C=C$.

Hydration

Water adds to the carbonyl group of aldehydes and ketones to yield hydrates (Equation 8.4). For ketones and aryl aldehydes, equilibrium constants of the

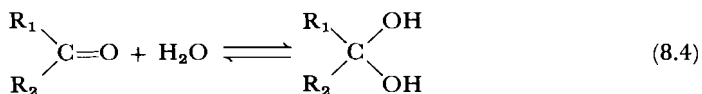

$R_1, R_2 = H, \text{ alkyl, aryl}$

reaction as written are much less than unity, but aliphatic aldehydes are appreciably hydrated in water solution. The equilibrium constant is larger for the lower aldehydes and is largest for formaldehyde. Some representative values are given in Table 8.1. Bulky groups and groups that donate electron density to the electron-deficient carbonyl carbon stabilize the carbonyl form, whereas substituting electron-withdrawing groups, or incorporating the carbonyl carbon in a strained ring,² favors the hydrate. Equilibrium constants correlate with Taft inductive and steric parameters.³

Mechanistic questions in the hydration-dehydration equilibrium center around the acid-base relationships and the precise sequence of events in the addition or elimination of the water molecule. Investigations have relied primarily on kinetics of aldehyde hydration to elucidate the mechanistic details;

² (a) H. C. Brown, R. S. Fletcher, and R. B. Johannesen, *J. Amer. Chem. Soc.*, **73**, 212 (1951); (b) J. F. Pazos, J. G. Pacifici, G. O. Pierson, D. R. Sclove, and F. D. Greene, *J. Org. Chem.*, **39**, 1990 (1974); see also (c) N. J. Turro and W. B. Hammond, *J. Amer. Chem. Soc.*, **88**, 3672 (1966).

³ (a) Y. Ogata and A. Kawasaki, in *The Chemistry of the Carbonyl Group*, Zabicky, Ed., Vol. 2, p. 1; (b) P. Greenzaid, Z. Luz, and D. Samuel, *J. Amer. Chem. Soc.*, **89**, 749 (1967).

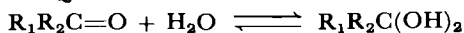
Table 8.1 APPROXIMATE EQUILIBRIUM CONSTANTS AT 25°C FOR THE REACTION

Carbonyl Compound	$K[H_2O] = \frac{[R_1R_2C(OH)_2]^a}{[R_1R_2C=O]}$
$\begin{array}{c} H \\ \diagdown \\ C=O \\ \diagup \\ H \end{array}$	2×10^3
$\begin{array}{c} H \\ \diagdown \\ C=O \\ \diagup \\ H_3C \end{array}$	1.3
$\begin{array}{c} H_3C \\ \diagdown \\ C=O \\ \diagup \\ H_3C \end{array}$	2×10^{-3}
$\begin{array}{c} H \\ \diagdown \\ C=O \\ \diagup \\ ClH_2C \end{array}$	37
$\begin{array}{c} H \\ \diagdown \\ C=O \\ \diagup \\ Cl_3C \end{array}$	2.8×10^4
$\begin{array}{c} H \\ \diagdown \\ C=O \\ \diagup \\ CH_3-H_2C \end{array}$	0.71
$\begin{array}{c} H \\ \diagdown \\ C=O \\ \diagup \\ H_3C \\ \\ C \\ / \backslash \\ H_3C \quad H \end{array}$	0.44 ^b
$\begin{array}{c} H \\ \diagdown \\ C=O \\ \diagup \\ H_3C \\ \\ C \\ / \backslash \\ H_3C \quad H_3C \end{array}$	0.24 ^b
$\begin{array}{c} H \\ \diagdown \\ C=O \\ \diagup \\ CHCl_2 \end{array}$	2.9
$\begin{array}{c} H_3C \\ \diagdown \\ C=O \\ \diagup \\ CH_2Cl \end{array}$	
$\begin{array}{c} CH_2Cl \\ \diagdown \\ C=O \\ \diagup \\ CH_2Cl \end{array}$	10

^a Except as noted, values are from R. P. Bell, *Advan. Phys. Org. Chem.*, **4**, 1 (1966).

^b P. Greenzaid, Z. Luz, and D. Samuel, *J. Amer. Chem. Soc.*, **89**, 749 (1967).

rates of reaction in both directions have been measured by spectroscopic methods,⁴ isotope exchange experiments,⁵ heat of reaction,⁶ volume change measure-

⁴ (a) P. Greenzaid, Z. Luz, and D. Samuel, *J. Amer. Chem. Soc.*, **89**, 756 (1967); (b) M.-L. Ahrens and H. Strehlow, *Disc. Faraday Soc.*, **39**, 112 (1965); (c) R. P. Bell and M. B. Jensen, *Proc. Roy. Soc.*, **A261**, 38 (1961).

⁵ M. Cohn and H. C. Urey, *J. Amer. Chem. Soc.*, **60**, 679 (1938).

⁶ R. P. Bell, M. H. Rand, and K. M. A. Wynne-Jones, *Trans. Faraday Soc.*, **52**, 1093 (1956).

ments,⁷ and by scavenging liberated aldehyde.⁸ The reaction is subject to general acid and general base catalysis.⁹

General Acid and Base Catalysis

We have already encountered general catalysis in Section 7.1 (p. 340). Because it is so important to the understanding of carbonyl reactions, we shall consider it here in more detail. The discussion will be restricted to aqueous solutions, because these have been the most thoroughly studied.

Suppose that acid catalyzes a reaction by forming the conjugate acid of the substrate in a rapid equilibrium preceding a slower step, as indicated in Scheme 1.

SCHEME 1

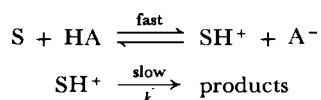

The reaction rate is given by Equation 8.5. Concentration $[\text{SH}^+]$ is in turn determined by the preliminary equilibrium, for which we may write the equilib-

$$\text{rate} = k[\text{SH}^+] \quad (8.5)$$

$$K = \frac{[\text{SH}^+][\text{A}^-]}{[\text{S}][\text{HA}]} \quad (8.6)$$

rium constant K (Equation 8.6). But concentrations $[\text{HA}]$ and $[\text{A}^-]$ are themselves related to $[\text{H}_3\text{O}^+]$ through the K_a for the acid HA (Equation 8.7). Combi-

$$K_{a_{\text{HA}}} = \frac{[\text{H}_3\text{O}^+][\text{A}^-]}{[\text{HA}]} \quad (8.7)$$

$$\frac{K}{K_{a_{\text{HA}}}} = \frac{[\text{SH}^+][\text{A}^-]}{[\text{S}][\text{HA}]} \frac{[\text{HA}]}{[\text{A}^-][\text{H}_3\text{O}^+]} \quad (8.8)$$

$$\frac{K}{K_{a_{\text{HA}}}} = \frac{[\text{SH}^+]}{[\text{S}][\text{H}_3\text{O}^+]} = \frac{1}{K_{a_{\text{SH}^+}}} \quad (8.9)$$

$$\text{rate} = \frac{k}{K_{a_{\text{SH}^+}}} [\text{S}][\text{H}_3\text{O}^+] \quad (8.10)$$

nation of Equations 8.6 and 8.7 shows that under these circumstances the concentration of reactive species, SH^+ , is actually determined by the H_3O^+ concentration and the K_a of SH^+ (Equations 8.8 and 8.9). The reaction rate (Equation 8.10) depends on the H_3O^+ concentration, and the reaction is said to be subject to *specific acid catalysis*. An entirely analogous argument can be made for a base-catalyzed reaction with a preliminary equilibrium to form the conjugate base of the substrate. Such a reaction shows *specific base catalysis*. Note that the mechanism of Scheme 1, which gives only specific catalysis, does not involve any proton transfer in the rate-determining step.

Another possibility is that the proton transfer itself constitutes the rate-determining step, or that the rate-determining step consists of proton transfer

⁷ R. P. Bell and B. de B. Darwent, *Trans. Faraday Soc.*, **46**, 34 (1950).

⁸ R. P. Bell and P. G. Evans, *Proc. Roy. Soc.*, **A291**, 297 (1966).

⁹ Discussions of the acid-base catalysis may be found in the reviews cited in note 1.

occurring simultaneously with some other process. An example is the deprotonation of carbon acids, which we discussed in Section 3.3 (p. 141), when we considered the Brønsted catalysis law relating the effectiveness of the catalyst to its equilibrium acidity. Under these circumstances each individual acid (or base) present in the system can act as a proton donor (or acceptor) in the rate-determining step, and the rate of this step then depends on each of these acids (bases) individually, as indicated in Equation 8.11 for an acid-catalyzed process. A reaction that follows Equation 8.11 is said to be subject to *general acid catalysis*; the analogous situation with base catalysis is *general base catalysis*.

$$\text{rate} = k_{\text{obs}} + k_{\text{H}^+}[\text{H}_3\text{O}^+] + k_1[\text{HA}_1] + k_2[\text{HA}_2] + \dots \quad (8.11)$$

The Brønsted catalysis law states that the individual catalytic constants, k_n , should be related to the equilibrium acidities by Equation 8.12, or, for a base-catalyzed process, by Equation 8.13. (See Section 3.3, p. 141, for further dis-

$$\text{Acid catalysis: } \log k_n = \alpha \log K_{a_n} + \log C \quad \text{or} \quad k_n = CK_{a_n}^\alpha \quad (8.12)$$

$$\text{Base catalysis: } \log k_n = -\beta \log K_{a_{\text{BH}^+}} + \log C' \quad \text{or} \quad k_n = C'K_{a_{\text{BH}^+}}^{-\beta} \quad (8.13)$$

cussion of these relations.) The Brønsted slope α (β for base catalysis) is a measure of the sensitivity of the reaction to the acid strengths of the various catalysts. If for a particular reaction α is near 1.0, most of the catalysis will be by the strongest acid (H_3O^+ in aqueous solution); catalysis by weaker acids will then be difficult or impossible to detect, and the situation will be indistinguishable kinetically from specific catalysis. If α is near zero, all acids will be equally effective, but since the solvent is present in much higher concentration than any other acid, it will be the predominant catalyst and again the catalysis by other acids will be difficult to detect.

The usual means of finding general catalysis is to measure reaction rate with various concentrations of the general acids or bases but a constant concentration of H_3O^+ . Since the pH depends only on the ratio of $[\text{HA}]$ to $[\text{A}^-]$ and not on the absolute concentrations, this requirement may be satisfied by the use of buffers. Catalytic rate constants have been measured for a number of acids and bases in aldehyde hydration-dehydration, notably by Bell and co-workers.¹⁰ For formaldehyde, $\alpha = 0.24$, $\beta = 0.40$; earlier work¹¹ gave for acetaldehyde $\alpha = 0.54$, $\beta = 0.45$ and for symmetrical dichloroacetone $\alpha = 0.27$, $\beta = 0.50$.

The observation of general catalysis means that proton transfer must be involved in the rate-determining step.¹² Much has been learned about kinetics of proton transfer from fast-reaction techniques developed largely by Eigen and co-workers; absolute rate constants for many proton transfers are known.¹³ The rates of simple proton transfers between oxygen atoms or oxygen and nitrogen are extremely fast, and become diffusion-controlled when the equilibrium constant is favorable in the direction in which the proton is being transferred. These observations have generally been considered to rule out a mech-

¹⁰ See note 8, p. 405.

¹¹ See note 6, p. 404, and note 4(c), p. 404.

¹² It may, of course, happen that no one step is rate-determining. The requirement then is that proton transfer must be part of at least one of the group of steps that together constitute the rate-determining process.

¹³ M. Eigen, *Angew. Chem. Int. Ed.*, **3**, 1 (1964).

anism for carbonyl hydration in which simple proton transfer is the rate-determining step (Scheme 2). Such a process would have to proceed faster than is

SCHEME 2

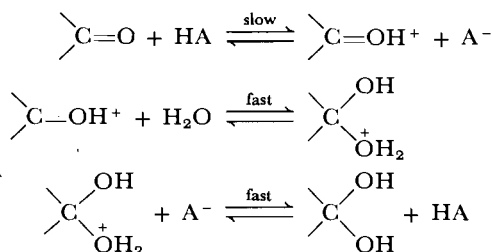

observed in order to be consistent with Eigen's data. There do, nevertheless, appear to be reactions in which simple proton transfer to or from a highly reactive intermediate is rate-determining, but which are nevertheless slow simply because the concentration of that intermediate is very small.¹⁴

Simultaneous Proton Transfer and Attack of Nucleophile

The alternative that appears to offer a consistent explanation for hydration is that proton transfer occurs simultaneously with addition of the nucleophile.

SCHEME 3

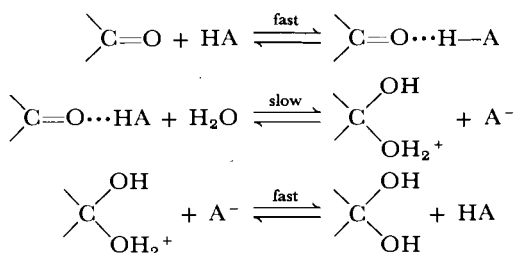

The mechanism shown in Scheme 3 envisions an association by hydrogen bonding between the catalyst and the carbonyl compound, followed by rate-determining attack of the nucleophile (H₂O) and simultaneous transfer of the proton. The rate of this step will depend on the nature and concentration of HA, and the mechanism is consistent with general catalysis. It should be noted that the reverse process consists of a specific acid plus a general base catalysis. A possible general base catalysis mechanism is shown in Scheme 4. The reverse is a specific base plus a general acid catalysis.

SCHEME 4

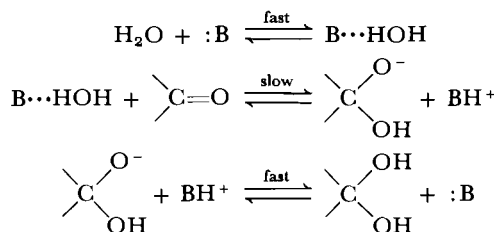

¹⁴ R. E. Barnett, *Accts. Chem. Res.*, **6**, 41 (1973).

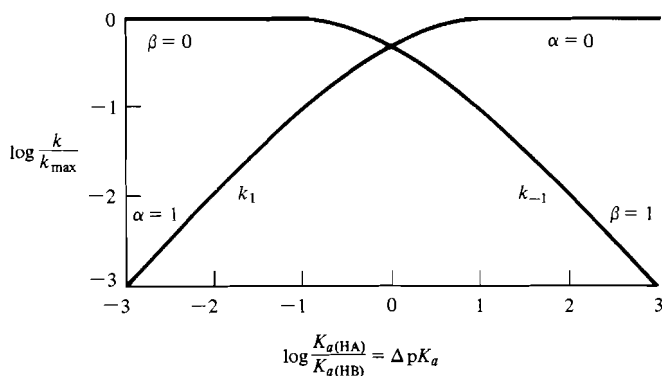
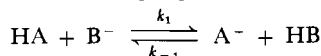

Figure 8.1 Logarithm of the rate of a simple proton transfer of the type



as a function of the relative strength of the acids HA and HB. When equilibrium lies toward the right ($\log [K_{a(\text{HA})}/K_{a(\text{HB})}]$ positive), k_1 is diffusion-controlled and $\alpha=0$; when equilibrium lies toward the left ($\log [K_{a(\text{HA})}/K_{a(\text{HB})}]$ negative), k_{-1} is diffusion-controlled and $\beta = 0$. From M. Eigen, *Angew. Chem., Int. Ed.*, **3**, 1 (1964). See also J. N. Brønsted and K. Pedersen, *Z. Phys. Chem.*, **108**, 185 (1924). (*Angewandte Chemie, International Edition in English*, Vol. 3 (1964), from the paper by M. Eigen beginning on p. 1. Reproduced by permission of Verlag Chemie, GMBH.)

The mechanism with simultaneous proton transfer and nucleophile attack helps account for another phenomenon observed by Eigen.¹⁵ He found that, for simple proton transfers between oxygen atoms or between oxygen and nitrogen atoms, the proton transfer rate responds as shown in Figure 8.1 to changes in relative acidity of the two acids.¹⁶ In Reaction 8.14, suppose that the structure of acid HA is varied so as to change its strength, but HA is kept substantially



$$\log k_1 - \log k_{-1} = \log K = \log \frac{K_{a\text{HA}}}{K_{a\text{HB}}} = \Delta pK_a \quad (8.15)$$

stronger than HB. Then the rate (k_1) of proton transfer from HA to B^- will be diffusion-controlled ($k_1 = k_{\text{max}}$) and will not change as HA changes. Interpreted from the point of view of the Brønsted catalysis law, a rate that is independent of acid strength means that $\alpha = 0$ (k_1 curve, right-hand side of Figure 8.1). The reverse reaction in this same region of relative acid strength would be considered a base catalysis by bases A^- of varying strength. Equation 8.15 shows that, with $k_1 = k_{\text{max}}$, $\log k_{-1}$ will be linearly related, with a slope of unity, to ΔpK_a when the latter is varied by changing A^- . Hence $\beta = 1$, as shown by the k_{-1} curve on the right side of Figure 8.1. The same reasoning, this time with HB as the stronger acid, generates the left side of the figure. Each curve changes slope from unity to zero over a relatively narrow range. These results are in accord with the interpretation based on the Hammond postulate in Section 3.3 (p. 141). Eigen's data suggest that in an acid-catalyzed reaction in which the

¹⁵ See note 13, p. 406.

¹⁶ If the acids are of different charge types, the curve is modified somewhat. See note 13.

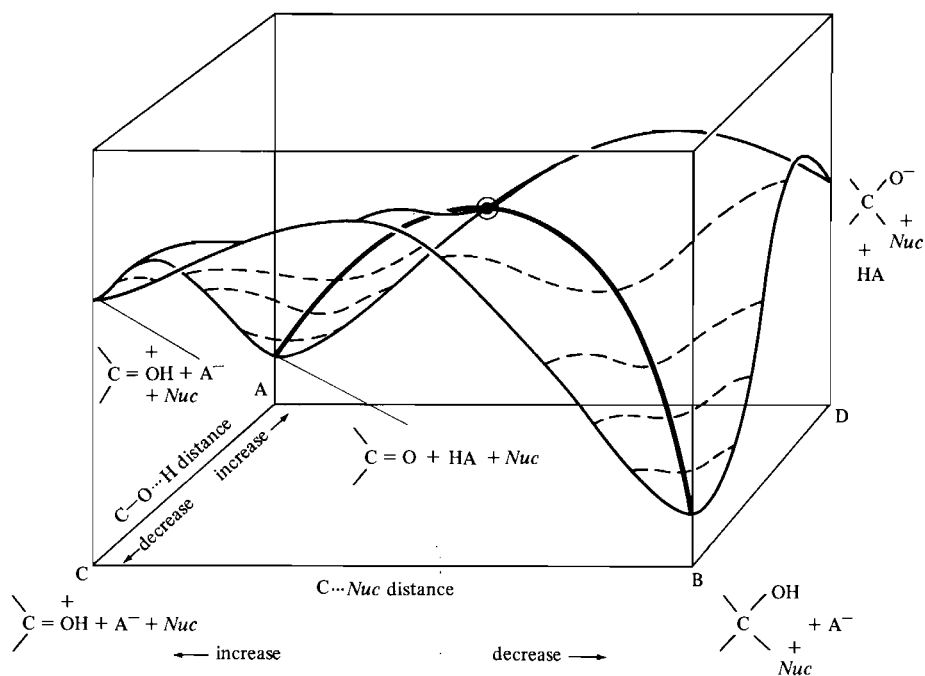

Figure 8.2 Energy surface for addition of nucleophile *Nuc* to a carbonyl with concerted proton transfer from an acid *HA*. The lowest-energy path is indicated by the heavy line from point A to point B. Points C and D are the high-energy intermediates of the two possible stepwise paths. The circled point is the transition state.

rate-determining step is a simple proton transfer between oxygens, the α relating rate (k_1) to strength of catalyst (K_{aHA}) should be either zero or unity if the catalyst, *HA*, is a much stronger or a much weaker acid than the protonated substrate, *HB*. Intermediate values of α should be found when the two are of similar strength.

Brønsted anticipated this kind of behavior when he originally proposed the catalysis law,¹⁷ but investigators in intervening years lost sight of the prediction because in many cases, as in carbonyl hydration, α is found to be constant and different from unity over quite a wide range of catalysts. The reason is that in these reactions some other process is occurring simultaneously with proton transfer. Figure 8.2 gives a schematic representation of the energy surface for a concerted addition and proton transfer; Figure 8.3 is the projection of the reaction coordinate in the horizontal plane.¹⁸ In the figures, the reaction begins with carbonyl compound, nucleophile, and acid catalyst (point A) and proceeds directly to point B by simultaneous addition of nucleophile and transfer of proton, thereby avoiding the higher-energy stepwise alternatives through points C and D.

¹⁷ J. N. Brønsted and K. Pedersen, *Z. Phys. Chem.*, **108**, 185 (1924).

¹⁸ For further discussion of three-dimensional reaction coordinate diagrams for these processes, see Section 5.4, p. 246, and (a) W. P. Jencks, *Chem. Rev.*, **72**, 705 (1972). (b) M. Choi and E. R. Thornton, *J. Amer. Chem. Soc.*, **96**, 1428 (1974), have suggested the possibility of more complex reaction paths with two consecutive transition states not separated by any energy minimum and with reaction coordinates perpendicular to each other on the potential energy surface.

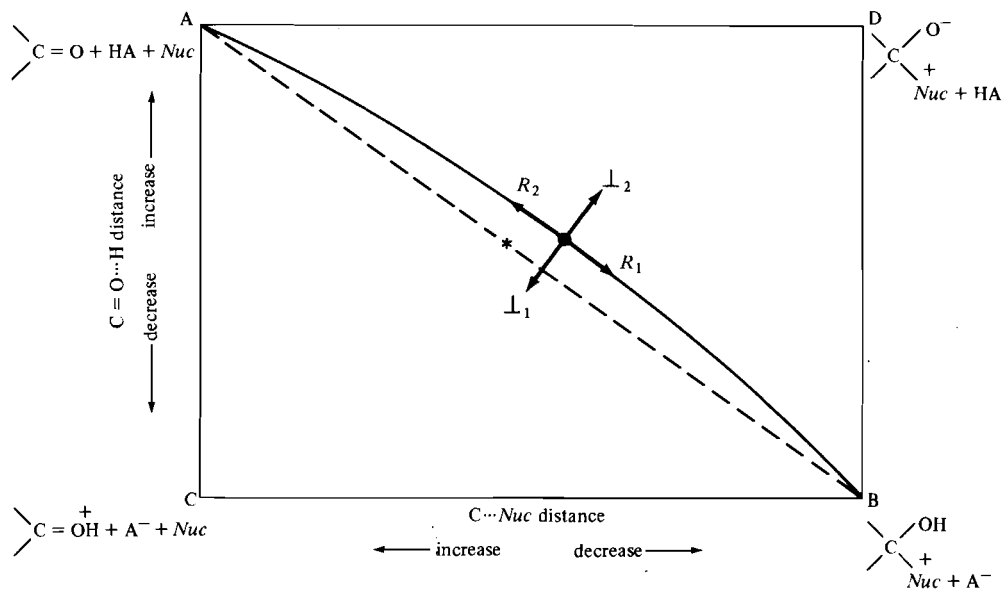
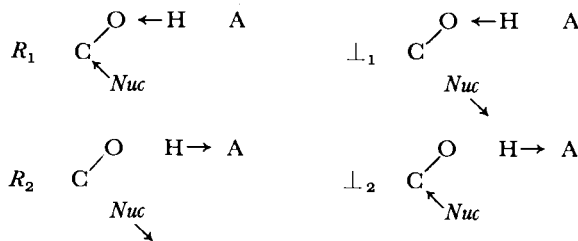

Figure 8.3



Projection in the horizontal plane of the reaction path shown in Figure 8.2. An increase in the strength of HA will facilitate motions R_1 and \perp_1 , causing shift of the transition state to $*$ and change of the reaction path from the solid curve to the dashed curve.

In order to relate the Brønsted coefficient α to the reaction coordinate diagrams, we interpret α as a measure of the position of the proton at the transition state, α near zero (HA very strong) indicating an earlier transition state with little proton transfer and α near unity (HA very weak) indicating a late transition state with proton nearly completely transferred. We have already given a partial justification for this interpretation of α in the discussion in Section 3.3; we shall return to this point again later. It is nevertheless important to emphasize here that in a process involving simultaneous proton transfer and nucleophilic addition, α measures only the degree of proton transfer at the transition state (location along the back-to-front coordinate in Figure 8.2 and along the top-to-bottom coordinate in Figure 8.3) and not the degree of bonding of the nucleophile.

As the proton is partly transferred at the transition state in Figure 8.3, α will have a value intermediate between zero and one. We may use the reacting bond rule discussed in Section 2.6 (p. 104) to find the effect of a change in strength of the catalyzing acid HA on the position of the transition state. Recall that reacting bond Rule 1 (equivalent to the Hammond postulate) states that a change in reactants that facilitates motion along the reaction coordinate (motion R_1 ,

Figure 8.3) will move the transition state to an earlier point. Since strengthening acid HA facilitates motion R_1 (transfer of proton from HA to carbonyl oxygen coupled with attack of nucleophile), the transition state will tend to come earlier with respect to this motion; that is, it will be shifted in the direction indicated by the arrow R_2 in Figure 8.3. But proton motion is also involved in the vibration designated by \perp_1 and \perp_2 in Figure 8.3; reacting bond Rule 2 states that change in structure will shift the transition state in the direction indicated by the change. Here, strengthening acid HA aids motion \perp_1 .

The composite result of the tendencies for transition state shift in the mutually perpendicular directions R_2 and \perp_1 is to move it to the point designated by * in Figure 8.3. The extent of proton transfer is thus not much changed from what it was before, despite the stronger acid HA. Therefore α will be relatively little affected by changes in strength of catalyzing acid and will not pass as quickly through the transition region (near $\Delta pK_a = 0$ in Figure 8.1) as it would have had the proton transfer not been coupled to nucleophile attack.

In some cases of general catalysis it is found that the final rapid proton transfer (for hydration, the last step of Scheme 3 or Scheme 4) occurs at a rate faster than would be possible if the conjugate base (or conjugate acid in a base catalysis) of the catalyst actually moved away from the immediate solvation shell of the substrate to become part of the general solution. Eigen has proposed that this last step may be accomplished simultaneously with the rate-determining step by means of a cyclic transition state that includes one or more extra water molecules, as indicated in the hydration case by Structure 1.¹⁹ When the catalyst is a carboxylic acid, the proton transfer from the catalyst may occur at one of the carboxylate oxygens while the other accepts the proton from the attacking nucleophile.

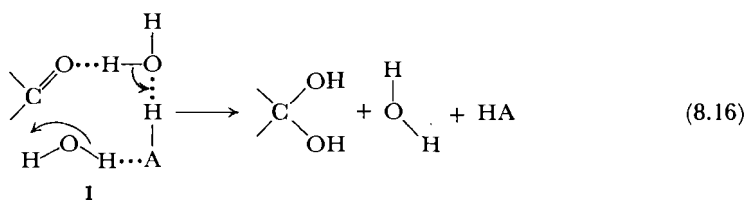

The Brønsted α and β as Measures of Transition State Location

We have made use above of the idea that the magnitude of α (or β) measures the extent of proton transfer at the transition state or, equivalently, of the position of the transition state along the proton-transfer reaction coordinate. Figures 8.4 and 8.5 show, respectively, the reaction coordinate diagrams drawn according to the Hammond postulate for Reaction 8.17 in the extreme cases where HX is a

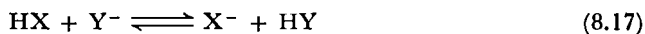

much weaker or a much stronger acid than HY. In the former case (Figure 8.4), α_{\ddagger} close to unity, small structural changes that alter the free energy of products, G_p° , will cause a similar change in transition state free energy, G_{\ddagger}° , whereas changes in reactant free energy, G_r° , will have little effect. This case corresponds

¹⁹ (a) M. Eigen, *Disc. Faraday Soc.*, **39**, 7 (1965); (b) R. P. Bell, J. P. Millington, and J. M. Pink, *Proc. Roy. Soc.*, **A303**, 1 (1968).

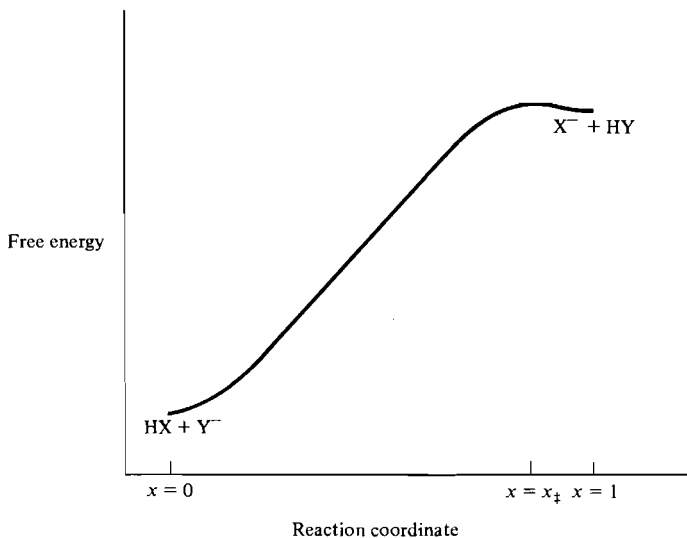

Figure 8.4 Reaction coordinate diagram for the proton transfer $\text{HX} + \text{Y}^- \rightleftharpoons \text{X}^- + \text{HY}$, where HX is a weaker acid than HY.

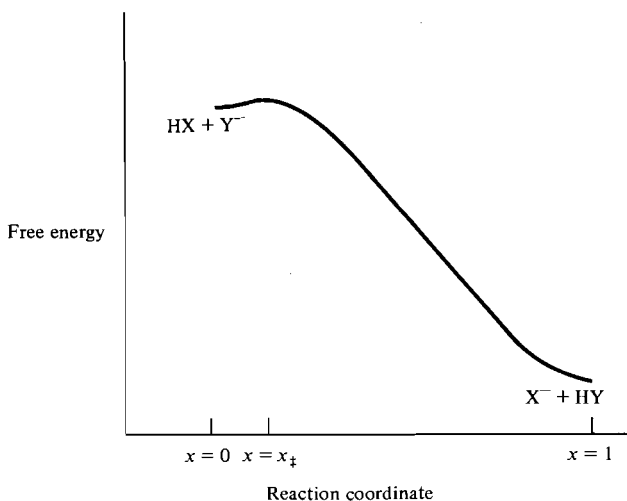

Figure 8.5 Reaction coordinate diagram for the proton transfer $\text{HX} + \text{Y}^- \rightleftharpoons \text{X}^- + \text{HY}$, where HX is a stronger acid than HY.

to $\alpha = 1$, $\beta = 0$ in Figure 8.1, that is, reverse reaction diffusion-controlled. Figure 8.5 depicts the opposite extreme, x_{\ddagger} close to zero, where G^{\ddagger} depends on G_r° and not G_p° ; this case corresponds to forward reaction diffusion-controlled, $\alpha = 0$ and $\beta = 1$ in Figure 8.1. In the intermediate region (center part of Figure 8.1), α varies from 1 to 0 as the transition state moves from being near products (Figure 8.4) to near reactants (Figure 8.5). If we let the symbol δ be an operator designating change in a thermodynamic quantity caused by structural change in

the molecules involved,²⁰ the predictions of the Hammond postulate may be roughly quantified by using α and β as the parameters relating G^\ddagger to G_p° and G_r° , as shown in Equation 8.18, where $0 < \alpha < 1$ and $0 < \beta < 1$.²¹ If we also assume that $\beta = 1 - \alpha$ (see Figure 8.1) and remember that $\Delta G^\ddagger = G^\ddagger - G_r^\circ$ and $\Delta G^\circ = G_p^\circ - G_r^\circ$, we obtain Equation 8.19 by subtracting δG_r° from both sides of

$$\delta G^\ddagger = \alpha \delta G_p^\circ + \beta \delta G_r^\circ \quad (8.18)$$

$$\delta G^\ddagger - \delta G_r^\circ = \alpha \delta G_p^\circ + (1 - \alpha) \delta G_r^\circ - \delta G_r^\circ \quad (8.19)$$

$$\delta G^\ddagger - \delta G_r^\circ = \alpha(\delta G_p^\circ - \delta G_r^\circ) \quad (8.20)$$

$$\delta \Delta G^\ddagger = \alpha \delta \Delta G^\circ \quad (8.21)$$

Equation 8.18 and find relation 8.21 between activation free energy, ΔG^\ddagger , and standard free energy change, ΔG° . This equation is equivalent to the Brønsted catalysis law as was shown in Section 3.3 (Equations 3.49 and 3.53), and we may conclude that an interpretation of α as a measure of the position of the transition state is consistent with the Hammond postulate.

It should be emphasized again that these arguments apply only to the proton transfer coordinate, and do not give information about the progress of another process that may be concerted with it.²² Another complication can arise when the proton transfer is to or from a soft center and accompanied by considerable redistribution of charge, as in a carbon acid with an anion-stabilizing group. Bordwell and co-workers have found values of α greater than unity and less than zero for deprotonation and protonation of nitroalkanes; the simple interpretation of this parameter that we have outlined clearly does not apply to such cases.²³ An alternative measure of position of transition state is the deuterium isotope effect; in a simple proton transfer, k_H/k_D should be at a maximum for a transition state in which the proton is midway between the two basic centers.²⁴ Again, however, the situation is more complex if another process is concerted with proton transfer.

The Mechanistic Ambiguity in General Catalysis

In addition to the problems of interpretation of α and β , certain other difficulties remain. We have assumed that the observation of general acid catalysis implies proton transfer from acid catalyst to substrate in the rate-determining step (Mechanism I, Scheme 5). Mechanism II in Scheme 5 shows that preliminary fast equilibrium yielding the conjugate acid of the substrate followed by a rate-determining step in which a proton is transferred from the protonated substrate to the conjugate base of the catalyst predicts the same dependence on substrate, catalyst, and nucleophile concentrations. Furthermore, the catalysis law (Equations 8.12 and 8.13) shows that when HA is changed, the observed rate constant of Mechanism I, k_1 , is proportional to $K_{a_{HA}}^\alpha$. In Mechanism II, k_1' is proportional

²⁰ J. E. Leffler and E. Grunwald, *Rates and Equilibria of Organic Reactions*, Wiley, New York, 1963, p. 26.

²¹ (a) Leffler and Grunwald, *Rates and Equilibria of Organic Reactions*, p. 156; (b) M. Bender, *Mechanisms of Homogeneous Catalysis from Protons to Proteins*, Wiley-Interscience, New York, 1971, p. 85.

²² For a discussion, see G. F. Lienhard and W. P. Jencks, *J. Amer. Chem. Soc.*, **88**, 3982 (1966).

²³ F. G. Bordwell, W. J. Boyle, Jr., and K. C. Yee, *J. Amer. Chem. Soc.*, **92**, 5926 (1970).

²⁴ (a) R. P. Bell, *Disc. Faraday Soc.*, **39**, 16 (1965); (b) R. A. More O'Ferrall and J. Kouba, *J. Chem. Soc. B*, 985 (1967); (c) F. H. Westheimer, *Chem. Rev.*, **61**, 265 (1961); see Section 2.7, p. 108.

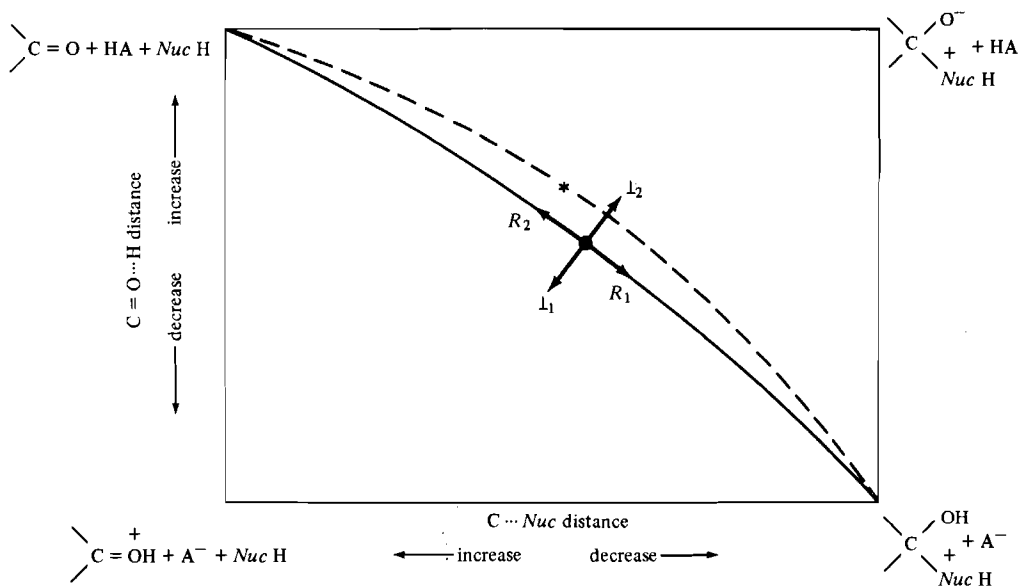
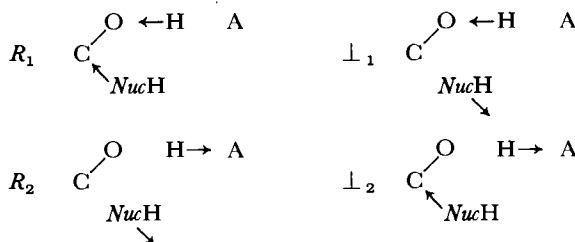
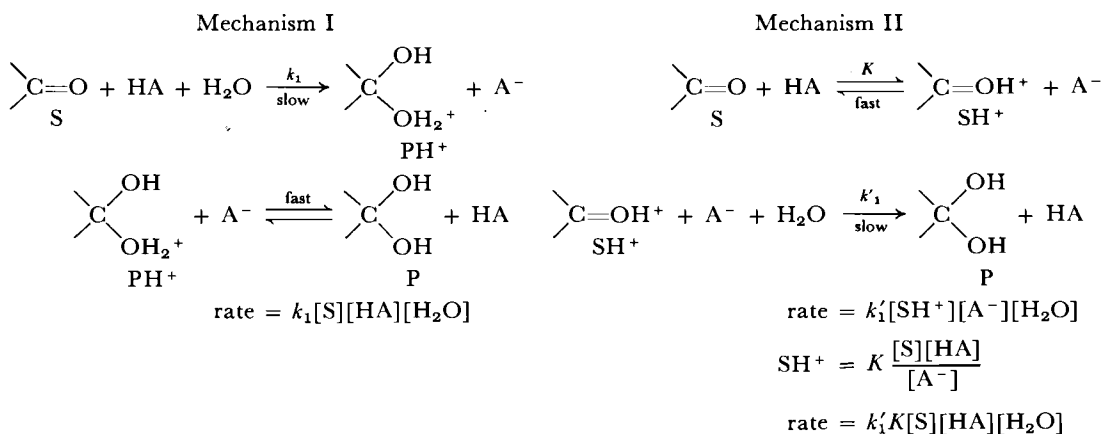

Figure 8.6



Projection in the horizontal plane of the three-dimensional reaction coordinate of the rate-determining step for Mechanism I, Scheme 5. Increasing nucleophilicity of *Nuc* will facilitate motions R_1 and L_2 , causing shift of transition state to $*$.

SCHEME 5²⁵

²⁵ The mechanisms are abbreviated by incorporating the hydrogen bonding equilibria of Schemes 3 and 4 into the proton-transfer step, and simplified by neglecting reverse reactions in the slow steps.

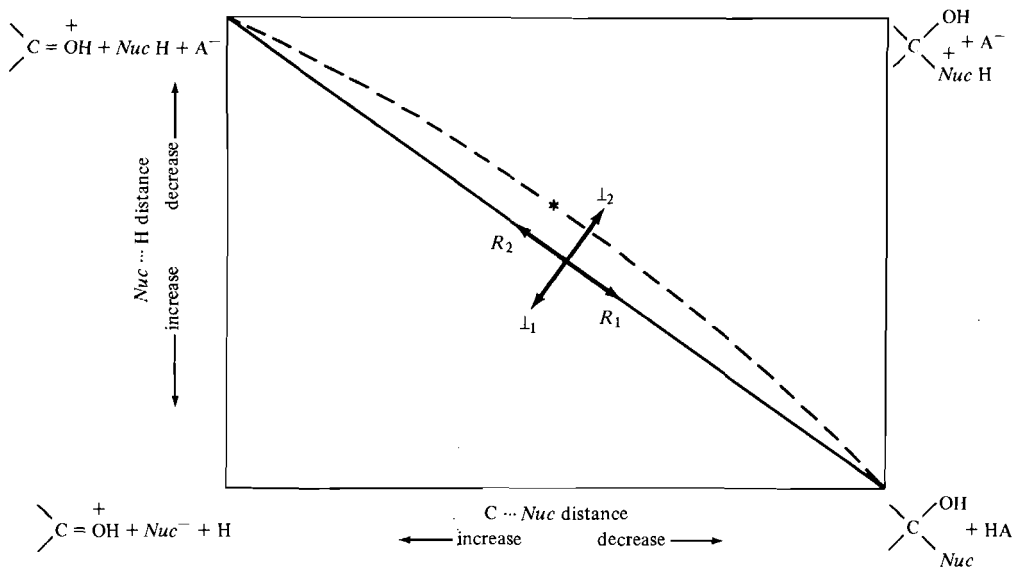
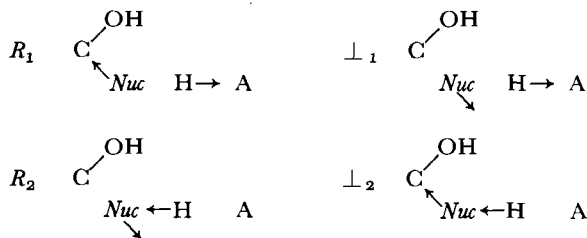

Figure 8.7



Projection of the reaction coordinate for the rate-determining step of Mechanism II, Scheme 5. Increasing nucleophilicity of *Nuc* will facilitate motions R_1 and \perp_2 , shifting transition state to $*$.

to $K_{a_{\text{HA}}}^{-\beta}$ whereas K is equal to $K_{a_{\text{HA}}}/K_{a_{\text{SH}^+}}$, and the observed rate constant, $k_1'K$, is therefore proportional to $K_{a_{\text{HA}}}^{1-\beta} = K_{a_{\text{HA}}}^{\alpha}$. The mechanisms therefore also predict the same dependence of rate on strength of the acid catalyst. The fundamental reason for this kinetic equivalence is that the stoichiometric composition of the transition states in the rate-determining steps are the same in both mechanisms. We may summarize this conclusion by stating that general acid catalysis is not distinguishable by kinetic measurements alone from specific acid plus general base catalysis. The reader may show by similar reasoning (Problem 13) that general base catalysis cannot be distinguished from specific base plus general acid catalysis.

One method of deciding between Mechanisms I and II is to look at the trend of α in acid-catalyzed additions of various nucleophiles to a carbonyl group.²⁶ It follows from the reacting bond rules that in true general acid catalysis (Mechanism I), the sensitivity of the rate to acidity of the catalyst, and therefore also α , should decrease as the species adding is made more nucleophilic. The reason is that this variation will cause the change in reaction coordinate shown in

²⁶ Jencks, *Catalysis in Chemistry and Enzymology*, pp. 195–197.

Table 8.2 DEPENDENCE OF BRØNSTED COEFFICIENT α ON BASICITY OF THE NUCLEOPHILE IN ADDITIONS TO C=O

Nucleophile	$pK_{a(NH^+)}$	Addition to	α
HOO ⁻	11.6	$\text{ClC}_6\text{H}_4\overset{\text{O}}{\parallel}\text{CH}$	0
RS ⁻	10	$\text{CH}_3\overset{\text{O}}{\parallel}\text{CH}$	0
ϕNHNH_2	5.2	$\phi\overset{\text{O}}{\parallel}\text{CH}$	0.2
$\text{H}_2\text{N}\overset{\text{O}}{\parallel}\text{CNH}_2$	0.2	$\text{CH}_3\overset{\text{O}}{\parallel}\text{CH}$	0.45
RSH	-7	$\text{CH}_3\overset{\text{O}}{\parallel}\text{CH}$	0.7
HOOH	-7	$\text{ClC}_6\text{H}_4\overset{\text{O}}{\parallel}\text{CH}$	1.0

SOURCE: W. P. Jencks, *Catalysis in Chemistry and Enzymology*, McGraw-Hill, New York, 1969, p. 198, where a more extensive table may be found. Reproduced by permission of McGraw-Hill.

Figure 8.6, so that in the transition state the proton will be transferred from the catalyst to a smaller extent and the acidity of the catalyst will not be so strongly felt. If, on the other hand, the reaction is actually specific acid- plus general base-catalyzed, (Mechanism II, Scheme 5), then analysis of Figure 8.7 shows that the sensitivity of rate to basicity of A⁻, and therefore also β , should decrease as the adding species is made more nucleophilic. But if this latter alternative were the correct mechanism and the reaction were erroneously regarded as a true general acid catalysis, one would find experimentally that α ($= 1 - \beta$) would increase with more nucleophilic adding reagents.

The experimental evidence favors the conclusion that in addition of nucleophiles to carbonyl groups the observed catalysis is true general acid catalysis. Table 8.2 presents selected data; α decreases with increasing nucleophilicity of the addend. More specific techniques applicable to particular reactions lead to the same conclusion.²⁷ For hydration, Mechanism I of Scheme 5, with true general acid catalysis in the forward direction and specific acid plus general base catalysis in the reverse direction, thus appears to be the most reasonable one.

8.2 OTHER SIMPLE ADDITIONS

The previous section considered the simple single-step addition of water to the carbonyl group. Certain other nucleophiles undergo similar simple additions.

²⁷ See, for example, W. P. Jencks, *Prog. Phys. Org. Chem.*, 2, 63 (1964), p. 90.

Addition of Cyanide and Sulfite

Aldehydes and unhindered aliphatic ketones or arylalkyl ketones add hydrogen cyanide to form cyanohydrins (Equation 8.22). As with hydration, the equilib-

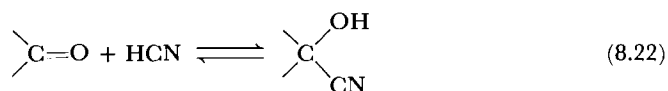

rium lies farther to the right for aldehydes than for ketones. The equilibrium constant K is decreased by electron-donating groups, which stabilize the electron-deficient carbonyl carbon, and by the presence of bulky groups, which will be pushed closer together by the change to tetrahedral cyanohydrin. Table 8.3 gives selected equilibrium constants. The reaction is of considerable synthetic utility, since the cyano group is readily hydrolyzed to yield an α -hydroxy acid.

The cyanide addition was one of the first organic reactions to be elucidated mechanistically. In 1903 Lapworth found that whereas a high concentration of undissociated HCN is desirable to assure a high yield of cyanohydrin, the reaction

Table 8.3 EQUILIBRIUM CONSTANTS AT 20°C IN 96 PERCENT ETHANOL FOR THE REACTION

$$\begin{array}{c} \text{R}_1 \\ \diagdown \\ \text{C}=\text{O} \\ \diagup \\ \text{R}_2 \end{array} + \text{HCN} \rightleftharpoons \begin{array}{c} \text{R}_1 \quad \text{OH} \\ \diagdown \quad / \\ \text{C} \\ \diagup \quad \diagdown \\ \text{R}_2 \quad \text{CN} \end{array}$$

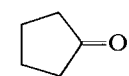
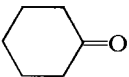
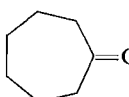
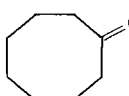
R ₁	R ₂	K	Reference
C ₆ H ₅	H	220	a
<i>p</i> -CH ₃ C ₆ H ₅	H	110	a
C ₆ H ₅	CH ₃	0.77	b
CH ₃	CH ₃	33	b
CH ₃	C ₂ H ₅	38	b
CH ₃	<i>i</i> -C ₃ H ₇	64	b
CH ₃	<i>t</i> -C ₄ H ₉	32	b
		48	c
		1000	c
		7.7	c
		1.16	c

^a J. W. Baker, *Tetrahedron*, 5, 135 (1959).

^b A. Lapworth and R. H. F. Manske, *J. Chem. Soc.*, 1976 (1930).

^c V. Prelog and M. Kobelt, *Helv. Chim. Acta*, 32, 1187 (1949).

rate depends on concentration of cyanide ion according to Equation 8.23.²⁸ His mechanism was essentially the same as the one accepted today (Scheme 6).²⁹

$$\text{rate} = k \left[\text{C}=\text{O} \right] [\text{CN}^-] \quad (8.23)$$

SCHEME 6

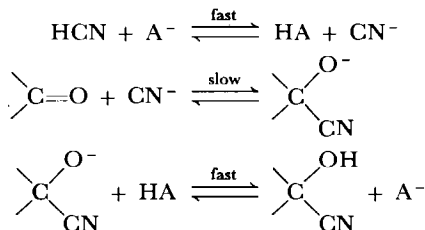

The reaction clearly should be subject to specific base catalysis, as is indeed observed. There is a possibility of general acid catalysis also; this process seems to be of only minor importance.³⁰

Sulfite ions also undergo simple addition to aldehydes and unhindered ketones. No evidence for significant general catalysis exists, although a thorough search does not appear to have been made. Stewart and Donnally have investigated the mechanism in some detail; the situation is complicated by the multiple acid-base equilibria possible, but the reaction appears to follow the general pattern of other simple additions.³¹ Equilibrium constants again show that the addition is more favorable with aldehydes than with ketones. The equilibrium constants (Table 8.4) correlate with the Taft σ^* inductive parameters.³² The bi-

Table 8.4 EQUILIBRIUM CONSTANTS AT 0°C FOR THE REACTION

$$\begin{array}{c} \text{R}_1 \\ \diagdown \\ \text{C}=\text{O} \\ \diagup \\ \text{R}_2 \end{array} + \text{HSO}_3^- \rightleftharpoons \begin{array}{c} \text{R}_1 \quad \text{OH} \\ \diagdown \quad \diagup \\ \text{C} \\ \diagup \quad \diagdown \\ \text{R}_2 \quad \text{SO}_3^- \end{array}$$

R ₁	R ₂	K ^a
H	CH ₃	800
CH ₃	CH ₃	200
CH ₃	C ₂ H ₅	40
CH ₃	<i>i</i> -C ₃ H ₇	8
CH ₃	<i>t</i> -C ₄ H ₉	1.6

^a Calculated from data of K. Arai, *Nippon Kagaku Zasshi*, **82**, 955 (1961) [*Chem. Abstr.*, **56**, 5623g (1962)].

²⁸ A. Lapworth, *J. Chem. Soc.*, **83**, 995 (1903).

²⁹ The observation of a low yield of chiral cyanohydrin when certain optically active amines are present requires a minor modification of the mechanism to allow for coordination of the carbonyl oxygen with a cation. See V. Prelog and M. Wilhelm, *Helv. Chim. Acta*, **37**, 1634 (1954); H. Hustedt and E. Pfeil, *Justus Liebigs Ann. Chem.*, **640**, 15 (1961).

³⁰ (a) W. J. Svirbely and J. F. Roth, *J. Amer. Chem. Soc.*, **75**, 3106 (1953); (b) W. J. Svirbely and F. H. Brock, *J. Amer. Chem. Soc.*, **77**, 5789 (1955).

³¹ (a) T. D. Stewart and L. H. Donnally, *J. Amer. Chem. Soc.*, **54**, 2333, 3555, 3559 (1932); (b) see also D. A. Blackadder and C. Hinshelwood, *J. Chem. Soc.*, 2720 (1958).

³² K. Arai, *Nippon Kagaku Zasshi*, **82**, 955 (1961) [*Chem. Abstr.*, **56**, 5623g (1962)].

sulfite adducts have been demonstrated by synthesis,³³ Raman spectroscopy,³⁴ and isotope effect measurements³⁵ to have the hydroxy sulfonic acid structure (2)

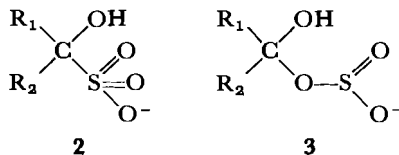

rather than the alternative hydroxy sulfite ester structure (3). Note that the softer sulfur center rather than the harder oxygen of the ambident sulfite prefers to be bonded to carbon.

Addition of Organometallics

Addition of organometallics will not be considered in detail here; we wish merely to note that additions of organolithium and organomagnesium compounds are analogous to the processes that have been considered up to this point.³⁶ Although the detailed structure of these organometallics may vary from one compound to another, and may in some cases be unknown, they consist essentially of a strong, soft carbon Lewis base coordinated to a hard metal ion Lewis acid.³⁷ Combination

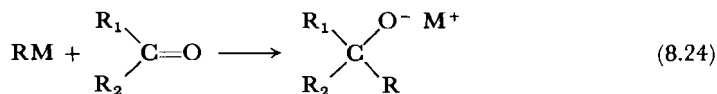

with a carbonyl compound (Equation 8.24) yields a bonding situation of so much lower energy that equilibrium constants are usually very large and the additions are for practical purposes irreversible. Acid-base catalysis of the type we have been considering is clearly out of the question here, as the reactions must be conducted under rigorously aprotic conditions if the organometallic reagent is not to be destroyed.

It should be noted that despite equilibria favorable to the adduct, the reactions are not without complications; because of the strongly basic properties of the organometallic, side reactions can occur. If the carbonyl compound bears α hydrogens, an enolate ion may result (Equation 8.25); the negative charge

³³ (a) W. M. Lauer and C. M. Langkammerer, *J. Amer. Chem. Soc.*, **57**, 2360 (1935); (b) R. L. Shriner and A. H. Land, *J. Org. Chem.*, **6**, 888 (1941).

³⁴ C. N. Caughlan and H. V. Tartar, *J. Amer. Chem. Soc.*, **63**, 1265 (1941).

³⁵ W. A. Sheppard and A. N. Bourns, *Can. J. Chem.*, **32**, 4 (1954).

³⁶ The mechanisms are complex, particularly in the organomagnesium (Grignard) reactions. Several reactive species are present, and the product metal alkoxide can complex with unreacted organometallic. Furthermore, trace transition metal impurities in the magnesium used to prepare Grignard reagents appear to facilitate electron transfer and may cause the reaction to proceed at least partly by a radical pathway. See (a) J. Laemmle, E. C. Ashby, and H. M. Neumann, *J. Amer. Chem. Soc.*, **93**, 5120 (1971); (b) E. C. Ashby, J. Laemmle, and H. M. Neumann, *Accts. Chem. Res.*, **7**, 272 (1974).

³⁷ In some other organometallics, for example the soft acid-soft base organomercury compounds, the carbon-metal bond has a high degree of covalent character and is sufficiently strong that these substances are considerably less reactive than substances of the organolithium or organomagnesium type.

then prevents addition. An α hydrogen in the organometallic may be transferred to the carbonyl carbon (Equation 8.26), giving reduction.³⁸

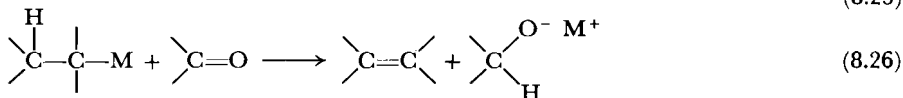
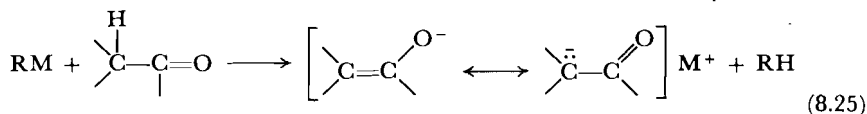

Oxidations and Reductions³⁹

Addition of hydride to the carbonyl carbon to form an alcohol, or the reverse, changes the oxidation state and so is usually classified separately from other carbonyl reactions. Some of these processes are nevertheless fundamentally similar to the ones we have been considering. Reductions by complex metal hydrides, such as lithium aluminum hydride or sodium borohydride, are additions of H^- (Equation 8.27); the metal hydride ion is simply a convenient source of this extremely basic species. The carbonyl oxygen takes the place of the hydride in coordination with the boron (or aluminum in the case of an aluminohydride), and the other hydrogens still available can add to carbonyl groups of

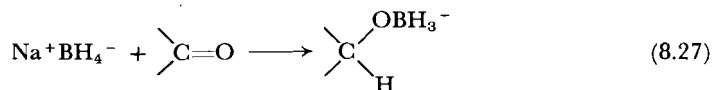

other molecules. The additions are effectively irreversible and usually free of side reactions. Many useful variations of these reagents are available for accomplishing specific synthetic tasks.⁴⁰

A reduction that also consists of hydride addition but in which the hydride donor is an alkoxide ion has found some synthetic use.⁴¹ Equation 8.28 shows this process, referred to as the Meerwein-Ponndorf-Verley reduction. The alkoxide

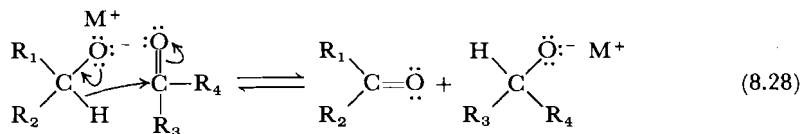

³⁸ For detailed discussions, see: (a) G. E. Coates, M. L. H. Green, and K. Wade, *Organometallic Compounds*, 3rd ed., Methuen, London, 1967, Vol. 1; (b) M. S. Kharasch and O. Reinmuth, *Grignard Reactions of Non-Metallic Substances*, Prentice-Hall, New York, 1954; (c) M. Cais and A. Mandelbaum, in *The Chemistry of the Carbonyl Group*, S. Patai, Ed., Vol. 1, Wiley-Interscience, London, 1966, Vol. 1, chap. 6.

³⁹ (a) Oxidations and reductions are considered in detail by H. O. House, *Modern Synthetic Reactions*, 2nd ed., W. A. Benjamin, Menlo Park, Calif., 1972; (b) reductions with borohydrides and aluminohydrides are discussed by H. C. Brown, *Boranes in Organic Chemistry*, Cornell University Press, Ithaca, N.Y., 1972; see also (c) C. F. Cullis and A. Fish, in *The Chemistry of the Carbonyl Group*, S. Patai, Ed., Vol. 1, chap. 2 (oxidations); (d) O. H. Wheeler, in *The Chemistry of the Carbonyl Group*, S. Patai, Ed., Vol. 1, chap. 11 (reductions); (e) N. G. Gaylord, *Reduction with Complex Metal Hydrides*, Wiley-Interscience, New York, 1956.

⁴⁰ See note 39(a), (b).

⁴¹ (a) Note 39(a); (b) A. L. Wilds, *Org. Reactions*, 2, 178 (1944); (c) C. Djerassi, *Org. Reactions*, 6, 207 (1951).

undergoes a reverse carbonyl addition and hence is oxidized; when looked at from this point of view, the transformation is called the Oppenauer oxidation. The equilibrium may be shifted in the desired direction by using an excess of one of the reagents.

An alternative and more generally used oxidation method employs chromic acid. This process is an exception to our general theme, because here the alcohol is transformed to a carbonyl group by removal of electron density from oxygen rather than from carbon. The first step has been shown to be a rapid equilibrium between the alcohol and its chromate ester, followed by rate-determining decomposition of the ester in the manner shown in Scheme 7.⁴² It will be noted that the species eliminated from the carbon that becomes the carbonyl carbon is a Lewis acid, not a Lewis base.

SCHEME 7

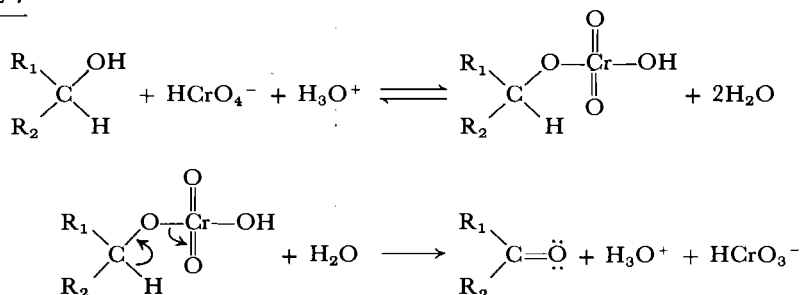

Stereochemistry of Addition

When an effectively irreversible addition, such as that of an organometallic or hydride, occurs in a cyclic structure or in a molecule that contains a chiral center, two isomers may form. Under these circumstances, the additions are stereoselective, and one of the isomers is formed in greater amount than the other. Cram and his collaborators have provided a rationalization for the observed isomer distribution that is useful in predicting the outcome of reactions of this type.⁴³ They proposed that the carbonyl oxygen in the substrate is coordinated to the Lewis acid part of the attacking reagent so that it has a large effective size. The preferred conformation of the carbonyl substrate will therefore be **4**, where **L**, **M**, and **S** are, respectively, the large, medium, and small groups on the chiral

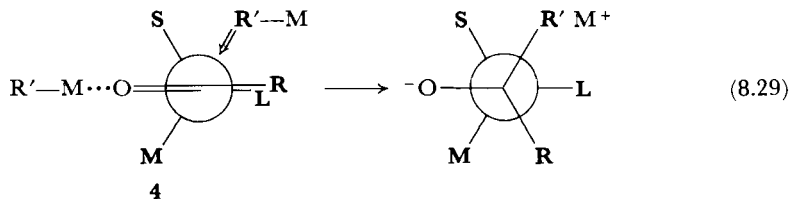

⁴² (a) A. Leo and F. H. Westheimer, *J. Amer. Chem. Soc.*, **74**, 4383 (1952); (b) M. Cohen and F. H. Westheimer, *J. Amer. Chem. Soc.*, **74**, 4387 (1952); (c) K. B. Wiberg, Ed., *Oxidation in Organic Chemistry*, Academic Press, New York, 1965; (d) R. Stewart, *Oxidation Mechanisms*, W. A. Benjamin, Menlo Park, Calif., 1964, chap. 4.

⁴³ (a) D. J. Cram and F. A. Abd Elhafez, *J. Amer. Chem. Soc.*, **74**, 5828 (1952); (b) D. J. Cram and F. D. Greene, *J. Amer. Chem. Soc.*, **75**, 6005 (1953).

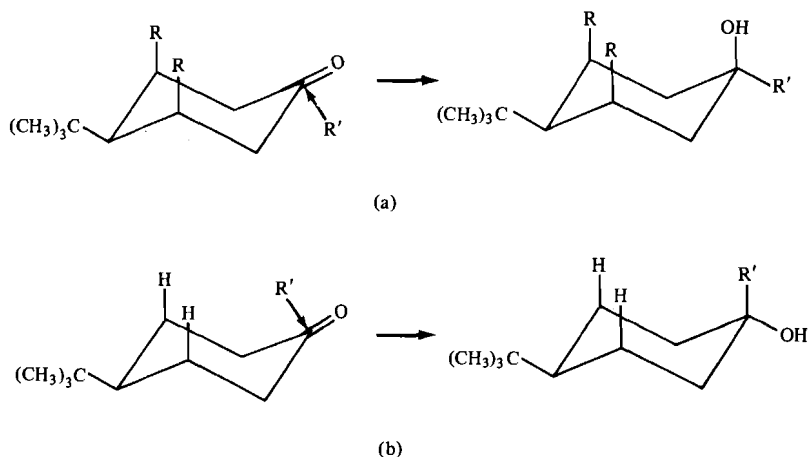

Figure 8.8 (a) Steric approach control. R' enters from the less hindered direction, giving the axial alcohol. This behavior is observed for bulky R' , such as Grignard reagents, $\text{LiAlH}(\text{OCH}_3)_3$, or when axial groups are large. (b) Product development control. R' enters from the axial direction, giving equatorial alcohol. Observed with small R' , such as LiAlH_4 , and small axial groups in the 3-position.

α carbon, and the incoming R' group will approach from the less hindered face onto the carbonyl carbon.

The Cram interpretation successfully predicts the results of a number of additions; it cannot, however, be readily applied to cyclic systems where conformational possibilities are limited. Dauben and co-workers⁴⁴ proposed that, depending upon the bulk of the entering reagent and the presence or absence of axial substituents on the ring two carbons removed from the site of attack, addition to a cyclohexanone could be subject to either *steric approach control* or *product development control*. Steric approach control directs the entering group to the less hindered equatorial position (Figure 8.8a). Product development control requires the nucleophile to enter from the more hindered axial direction so that the developing hydroxy group will be in the less hindered equatorial position (Figure 8.8b).⁴⁵ The proposal is designed to explain the predominant formation of the product with equatorial hydroxyl in metal hydride reductions of relatively unhindered ketones and of the product with axial hydroxyl from hindered ketones and when the entering group is bulky.

The Dauben proposal assumes implicitly that, in those reactions subject to steric approach control the transition state is close to reactants, whereas in those subject to product development control, it is close to product. Various investigators have pointed out that because additions of hydride and organometallics are highly exothermic, a reactantlike transition state is expected.⁴⁶ It seems unlikely that the transition state would undergo such a large change in response to a relatively minor change in structure, the fundamental nature of the process being

⁴⁴ W. G. Dauben, G. J. Fonken, and D. S. Noyce, *J. Amer. Chem. Soc.*, **78**, 2579 (1956).

⁴⁵ The terms *steric strain control* and *product stability control* are preferred by H. C. Brown and H. R. Deck, *J. Amer. Chem. Soc.*, **87**, 5620 (1965).

⁴⁶ (a) D. M. S. Wheeler and M. M. Wheeler, *J. Org. Chem.*, **27**, 3796 (1962); (b) E. L. Eliel and Y. Senda, *Tetrahedron*, **26**, 2411 (1970).

the same in all cases. Eliel and Senda found evidence to support their view that product development control is of little importance.⁴⁷ Other critics have proposed alternative explanations that permit one to suppose that the position of the transition state is approximately constant. They suggest that the stereochemistry is determined by a balance between steric interference with the approach of the reagent and the torsional, or eclipsing, effects that are introduced as new bonds form and that are not strongly dependent on the bulk of the groups.⁴⁸ Geneste, Lamaty, and Roque, on the other hand, have found independent evidence from linear free-energy correlations that the position of the transition state may indeed be significantly different for the various additions.⁴⁹ The matter is clearly more complex than it appeared initially, and the definitive theory has yet to be given.

Relative Affinity of Various Nucleophiles for the Carbonyl Group

It is appropriate at this point to summarize the tendency of various nucleophiles to add to the carbonyl group. In general, the strong bases (organometallics, hydrides, negative ions) are most effective; among the neutral nucleophiles, the soft ones, for example the sulfur bases, tend to be more effective in addition than the hard ones, for example the oxygen bases.

The strong nucleophiles are also the ones that Table 8.2 shows do not require general catalysis to accompany the addition. A general acid or base catalyst enters where it is needed to avoid formation of highly unstable intermediates.⁵⁰ Addition of a strongly basic nucleophile will lead to a relatively stable intermediate of the type **5**. There is no large pK change, and no general catalysis is

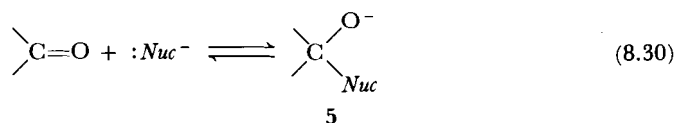

expected. A weak nucleophile, as for example a water molecule, would produce a high-energy intermediate (**6**) with the new basic site, —O^- , much more basic than the original Nuc—H was. Concerted acid catalysis (Equation 8.32) circum-

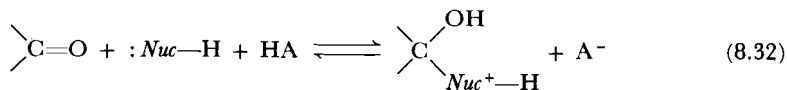
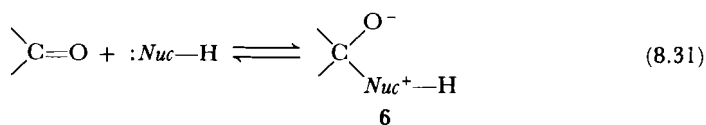

⁴⁷ See note 46(b).

⁴⁸ (a) J.-C. Richer, *J. Org. Chem.*, **30**, 324 (1965); (b) M. Chérest, H. Felkin, and N. Prudent, *Tetrahedron Lett.*, 2199 (1968); (c) M. Chérest and H. Felkin, *Tetrahedron Lett.*, 2205 (1968); (d) M. Chérest, H. Felkin, and C. Frajerman, *Tetrahedron Lett.*, 379 (1971); (e) M. Chérest and H. Felkin, *Tetrahedron Lett.*, 383 (1971); see also (f) R. A. Auerbach and C. A. Kingsbury, *Tetrahedron*, **29**, 1457 (1973).

⁴⁹ (a) P. Geneste, G. Lamaty, and J.-P. Roque, *Tetrahedron Lett.*, 5007, 5015 (1970); (b) P. Geneste, G. Lamaty, C. Moreau, and J.-P. Roque, *Tetrahedron Lett.*, 5011 (1970); (c) P. Geneste, G. Lamaty, and J.-P. Roque, *Tetrahedron*, **27**, 5539, 5561 (1971). See also (d) D. C. Wigfield, D. J. Phelps, R. E. Pottie, and R. Sander, *J. Amer. Chem. Soc.*, **97**, 897 (1975).

⁵⁰ (a) W. P. Jencks, *J. Amer. Chem. Soc.*, **94**, 4731 (1972); (b) W. P. Jencks, *Chem. Rev.*, **72**, 705 (1972).

vents this unfavorable situation. It is important to realize that these remarks apply only to simultaneous addition and proton transfer, and not to cases where general catalysis is the result of rate-determining proton transfer unaccompanied by another change.

8.3 ADDITION FOLLOWED BY ELIMINATION

Many carbonyl additions yield intermediates that undergo further transformations that restore the original carbonyl carbon to a doubly bonded state. These changes are fundamentally the same as the reverse steps of the additions considered in the previous sections, and differ only in that departure of some group other than the original nucleophile is possible. Equations 8.33 and 8.34, where *Nuc* and *Nuc'* are generalized nucleophiles, illustrate two possibilities.

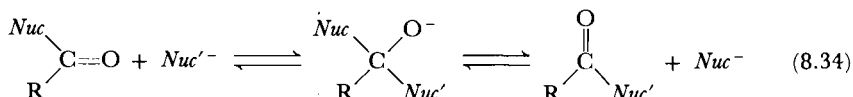
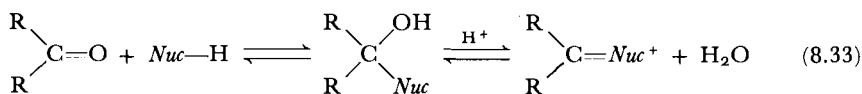

The product of the elimination step may still contain a highly electrophilic doubly bonded carbon, as would be the case in Equation 8.33. In that case, a third step may follow in which a second molecule of the nucleophile adds to yield a final product in which the original carbonyl carbon is tetrahedrally bonded (Equation 8.35). In this section we consider reactions of this kind, and in Sections 8.4 and 8.5 we take up reactions that stop at the stage indicated by Equation 8.33 or 8.34.

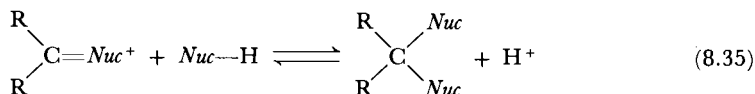

Acetals and Ketals

Addition of an alcohol to a carbonyl group is the most straightforward extension of the hydration process. The first product formed will be a hemiacetal (7); in the presence of an acid catalyst this intermediate may eliminate the OH

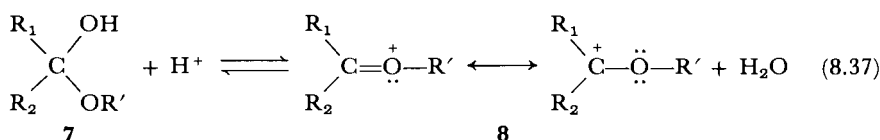
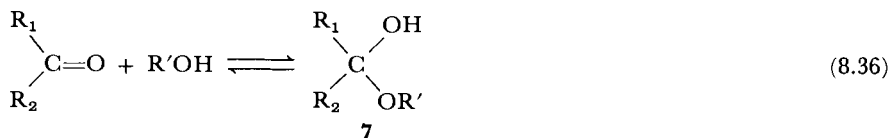

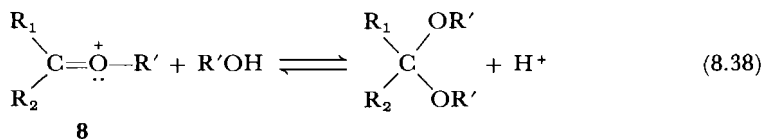

group to return to a structure with trigonal carbon, stabilized carbocation **8**. This ion will then react with a second molecule of the alcohol to yield the acetal or ketal. Hemiacetals and hemiketals, with a few exceptions, are not sufficiently stable to isolate in pure form; their presence in solution has been demonstrated by various physical measurements.⁵¹ Acetals and ketals are stable under neutral or basic conditions, although they undergo reaction back to alcohol and aldehyde or ketone in the presence of aqueous acid.

Since rapid conversion of hemiacetal to acetal requires more acidic conditions than does formation of the hemiacetal, it is possible to measure the rate of hemiacetal production without complication from the second stage of the reaction.⁵² As might be expected, the hemiacetal formation displays characteristics similar to those of hydration; general acid and general base catalysis are observed.⁵³

Cyclic hemiacetals and hemiketals with five- and six-membered rings formed by hydroxy aldehydes or hydroxy ketones are considerably more stable than their acyclic counterparts. The most important examples are the sugars.⁵⁴ Glucose exists largely in the pyranose form, of which there are two possible structures (**9** and **10**), called, respectively, α -glucose and β -glucose. The β form, having all hydroxyl groups equatorial, is slightly more stable. In neutral solution, the open-chain free aldehyde **11** accounts for only about 0.003 percent of the total at equilibrium,⁵⁵ although in 50 percent sulfuric acid it is the predominant

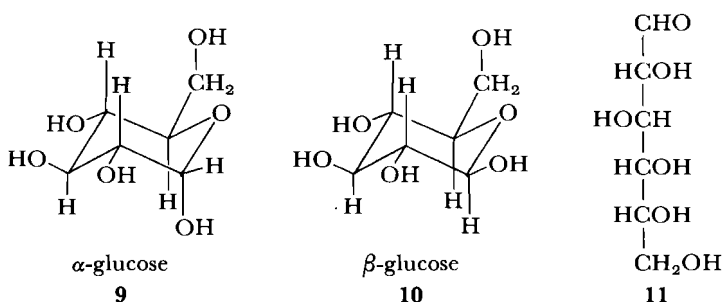

species.⁵⁶ The rate of interconversion of the α and β modifications is readily measured by following the change in optical rotation (mutarotation). The reaction must proceed through the open-chain hydroxy aldehyde, and so serves as a conveniently studied example of hemiacetal formation. Mutarotation of glucose was one of the early reactions to be investigated using modern ideas of

⁵¹ See, for example, G. W. Meadows and B. de B. Darwent, *Can. J. Chem.*, **30**, 501 (1952).

⁵² G. W. Meadows and B. de B. Darwent, *Trans. Faraday Soc.*, **48**, 1015 (1952).

⁵³ See note 52. For further references, see Y. Ogata and A. Kawasaki, in *The Chemistry of the Carbonyl Group*, J. Zabicky, Ed., Wiley-Interscience, London, 1970, Vol. 2, p 1.

⁵⁴ See B. Capon, *Chem. Rev.*, **69**, 407 (1969) for a comprehensive discussion of mechanism in carbohydrate chemistry.

⁵⁵ J. M. Los and K. Wiesner, *J. Amer. Chem. Soc.*, **75**, 6346 (1953).

⁵⁶ E. Pacsu and L. A. Hiller, Jr., *J. Amer. Chem. Soc.*, **70**, 523 (1948).

acid–base catalysis; it is subject to general acid catalysis with $\alpha = 0.27$ and to general base catalysis with $\beta = 0.36$.⁵⁷ The fact that α is not equal to $1 - \beta$ indicates that the acid- and base-catalyzed mechanisms differ by more than just a proton.⁵⁸ The acid catalysis is probably true general acid catalysis (see Section 8.1, p. 413), and base catalysis is true general base catalysis rather than specific base–general acid catalysis.⁵⁹

A possibility that was proposed quite early for the glucose mutarotation, and that could conceivably be of importance for other reactions, is simultaneous catalysis by an acid and a base. It will be recalled from Section 8.1 that hydration requires addition of a proton at one site and removal of a proton from another. If both these processes were to occur in one step, either by means of separate acid and base molecules acting together or by action of a single molecule containing both an acidic and a basic center, we would designate the process as a *concerted acid and base catalysis* (Equation 8.39).⁶⁰ Swain found that the rate of

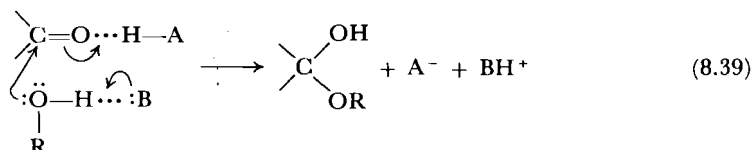

mutarotation of tetramethylglucose in benzene containing pyridine and phenol is third-order overall (Equation 8.40); he interpreted this result as showing

$$\text{rate} = k [\text{Me}_4\text{glucose}][\text{pyridine}][\text{phenol}] \quad (8.40)$$

the importance of the concerted mechanism 8.39 in aprotic solvents.⁶¹ Subsequent work has cast some doubt on this interpretation,⁶² and Bell and co-workers have shown that the proposal of concerted acid and base catalysis does not apply as generally as Swain had expected.⁶³ On the other hand, concerted catalysis does occur with substances that have an acidic and a basic site in the same molecule and in which the sites have a tautomeric relationship to each other.⁶⁴ An example of such a catalyst is 2-pyridone, which can catalyze a

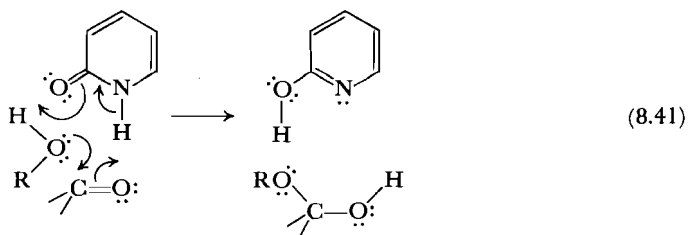

⁵⁷ (a) J. N. Brønsted and E. A. Guggenheim, *J. Amer. Chem. Soc.*, **49**, 2554 (1927); (b) T. M. Lowry, *J. Chem. Soc.*, 2554 (1927).

⁵⁸ W. P. Jencks, *Prog. Phys. Org. Chem.*, **2**, 63 (1964).

⁵⁹ See note 58.

⁶⁰ T. M. Lowry and I. J. Faulkner, *J. Chem. Soc.*, **127**, 2883 (1925).

⁶¹ (a) C. G. Swain, *J. Amer. Chem. Soc.*, **72**, 4578 (1950); (b) C. G. Swain and J. F. Brown, Jr., *J. Amer. Chem. Soc.*, **74**, 2534 (1952).

⁶² H. Anderson, C.-W. Su, and J. W. Watson, *J. Amer. Chem. Soc.*, **91**, 482 (1969).

⁶³ R. P. Bell and J. C. Clunie, *Proc. Roy. Soc.*, **A212**, 33 (1952).

⁶⁴ (a) C. G. Swain and J. F. Brown, Jr., *J. Amer. Chem. Soc.*, **74**, 2538 (1952); (b) P. R. Rony, *J. Amer. Chem. Soc.*, **91**, 6090 (1969); (c) P. R. Rony and R. O. Neff, *J. Amer. Chem. Soc.*, **95**, 2896 (1973).

nucleophile addition in the manner shown in Equation 8.41.⁶⁵ Carboxylic acids can also function in this way.⁶⁶ The evidence for such a process is the acceleration of reaction rate compared with what one would expect on the basis of the catalyst pK_a and the Brønsted α of the reaction being catalyzed. These examples of concerted acid and base catalysis have been found in nonaqueous solvents; although there is little evidence for it in aqueous reactions, it remains a possibility for catalysis by enzymes.⁶⁷ It should be noted that this concerted catalysis by two separate molecules, or by two separate sites on the same molecule, is not the same as the one-encounter process, discussed in Section 8.1 (p. 411), in which a single molecule acts successively as acid and base catalyst during the same encounter before the reaction partners can diffuse apart.

The second stage of acetal and ketal formation, the acid-catalyzed elimination of the hydroxyl group as a water molecule and addition of a second alcohol molecule to the resulting carbocation (Equations 8.37 and 8.38), is most conveniently investigated in the reverse direction starting from the acetal or ketal.⁶⁸ As Structures **12** and **13** indicate, it is conceivable that either of two bonds could be broken in the hydrolysis. One method of settling the ambiguity is to hydrolyze

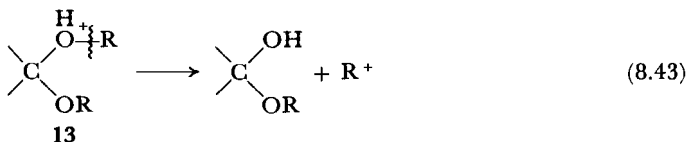
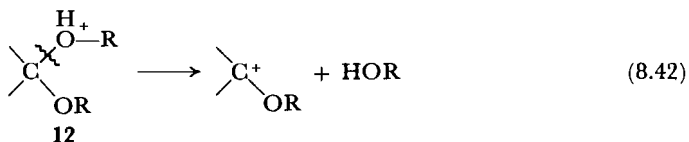

acetals in which R is bonded to oxygen at an asymmetric carbon; such experiments consistently show retained configuration, demonstrating cleavage of oxygen-carbonyl carbon bond (**12**) rather than oxygen-alkyl bond.⁶⁹ This type of cleavage is preferred even when R is chosen deliberately so as to make R^+ a good cation.⁷⁰ A second type of experiment is to use ^{18}O as a tracer; these investigations lead to the same conclusion.⁷¹

A somewhat more difficult question is that of the precise mechanism by which the carbonyl carbon-oxygen bond is cleaved. Scheme 8 illustrates three

⁶⁵ See note 64(a).

⁶⁶ See note 64(b), (c).

⁶⁷ (a) W. P. Jencks, *Catalysis in Chemistry and Enzymology*, McGraw-Hill, New York, 1969, pp. 211-217. (b) A report of concerted acid and base catalysis of an esterification has appeared: S. Milstien and L. A. Cohen, *J. Amer. Chem. Soc.*, **91**, 4585 (1969). (c) See also J. P. Fox and W. P. Jencks, *J. Amer. Chem. Soc.*, **96**, 1436 (1974), who have reported negative results in a case that should be favorably disposed toward concerted catalysis.

⁶⁸ E. H. Cordes, *Prog. Phys. Org. Chem.*, **4**, 1 (1967), has reviewed hydrolysis of acetals, ketals, and ortho esters.

⁶⁹ (a) J. M. O'Gorman and H. J. Lucas, *J. Amer. Chem. Soc.*, **72**, 5489 (1950); (b) H. K. Garner and H. J. Lucas, *J. Amer. Chem. Soc.*, **72**, 5497 (1950); (c) E. R. Alexander, H. M. Busch, and G. L. Webster, *J. Amer. Chem. Soc.*, **74**, 3173 (1952).

⁷⁰ J. D. Drumheller and L. J. Andrews, *J. Amer. Chem. Soc.*, **77**, 3290 (1955).

⁷¹ F. Stasiuk, W. A. Sheppard, and A. N. Bourns, *Can. J. Chem.*, **34**, 123 (1956).

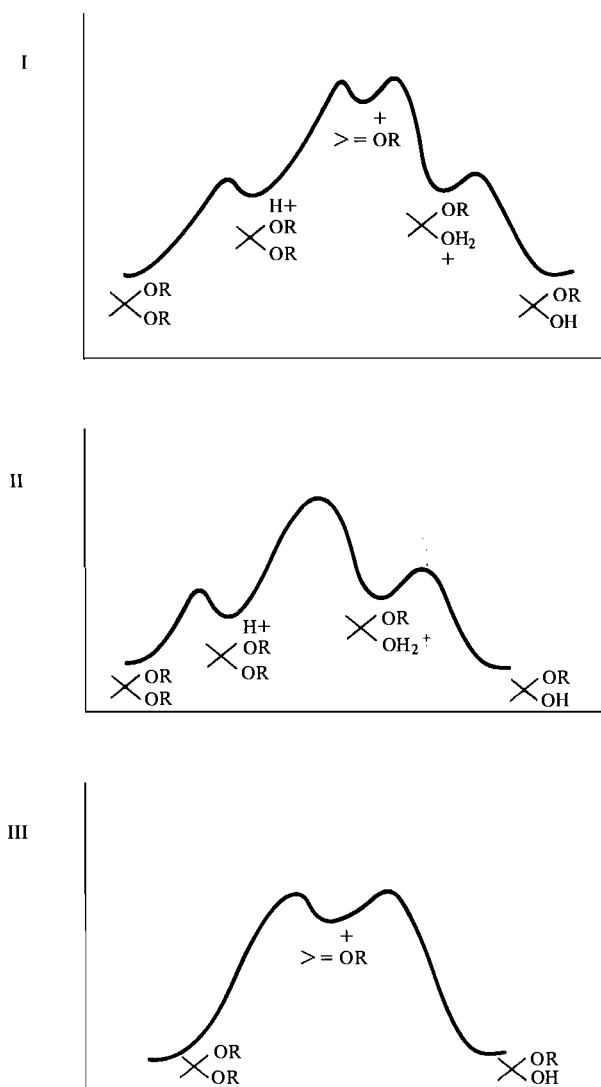

Figure 8.9 Possible mechanisms for cleavage of acetals and ketals. I: A-1, Mechanism I; II: A-2, Mechanism II; III: S_N2 , Mechanism III.

reasonable possibilities; these mechanisms are further clarified by schematic reaction coordinate diagrams in Figure 8.9. Mechanism I is a unimolecular S_N1 ionization of the acetal conjugate acid. It is designated the A-1 (acid-catalyzed unimolecular) mechanism. Mechanism II is an S_N2 displacement of ROH by H_2O , designated A-2, and Mechanism III is essentially a bimolecular electrophilic substitution by proton on the oxygen. Mechanisms I and II both predict specific acid catalysis, whereas Mechanism III leads to general acid catalysis.

Specific acid catalysis, but not general catalysis, is found for acetal and

SCHEME 8

Mechanism I: A-1

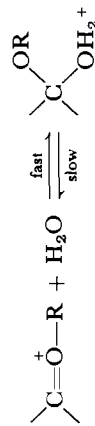
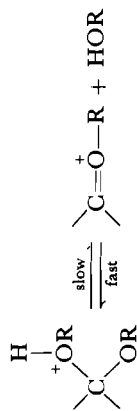
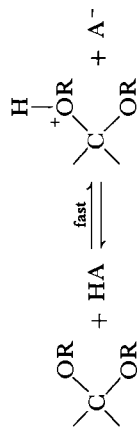

Mechanism II: A-2

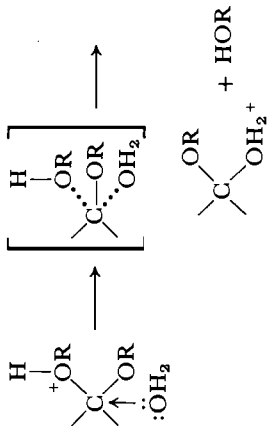
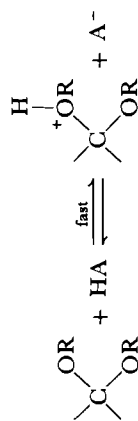
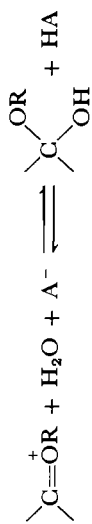
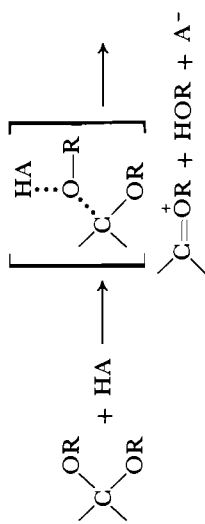
 Mechanism III: S_E2

ketal hydrolysis.⁷² (Exceptions to this statement for particular structures will be discussed below.) Mechanisms I and II therefore remain as possibilities. Of these, the A-1 process, Mechanism I, appears on the basis of a number of criteria to be the correct one for most acetals and ketals. Strong acceleration by electron donation in the carbonyl portion of the molecule has been demonstrated by Hammett σ - ρ and Taft σ^* - ρ^* correlations. For example, in hydrolysis of **14**, ρ is in the neighborhood of -3.3 , and in hydrolysis of **15**, ρ^* is near -3.6 .⁷³

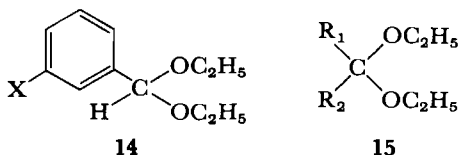

Entropies and volumes of activation,⁷⁴ though less reliable criteria, are in the range usually found for unimolecular reactions and do not agree with values expected for the A-2 process. Solvent isotope effects also are in agreement with the A-1 mechanism.⁷⁵

A criterion of mechanism based on the Hammett acidity function, H_0 (Section 3.2, p. 130), has long been used to decide the type of question raised by the choice between Mechanisms I and II in Scheme 8. Since in strongly acidic media the concentration of the protonated substrate should be proportional to h_0 , the reaction rate for a unimolecular decomposition of this protonated substrate (Mechanism I) should also be proportional to h_0 , whereas if a water molecule is required (Mechanism II), the rate should follow H_3O^+ concentration instead. This test, known as the Zucker-Hammett hypothesis,⁷⁶ when applied to acetal and ketal hydrolysis, appears to confirm the A-1 mechanism, since a linear relationship is found between rate constant and h_0 at high acidity.⁷⁷ Inconsistencies have nevertheless been found in application of the Zucker-Hammett hypothesis, for example failure of the plots of $\log k$ vs. $-H_0$ to have the theoretical slope of unity in a number of cases, and failure to predict consistent mechanisms for forward and reverse reactions; the method is therefore now considered to be of doubtful validity.⁷⁸ Bunnett has devised a more successful treatment (Equation 8.45), in which the parameter ω measures the extent of

$$\log k + H_0 = \omega \log a_{H_2O} \quad (8.44)$$

OR

$$\log k = \omega \log a_{H_2O} - H_0 \quad (8.45)$$

⁷² (a) K. Koehler and E. H. Cordes, reported in ref. 68, p. 32; (b) J. N. Brønsted and W. F. K. Wynne-Jones, *Trans. Faraday Soc.*, **25**, 59 (1929); (c) M. M. Kreevoy and R. W. Taft, Jr., *J. Amer. Chem. Soc.*, **77**, 3146 (1955); (d) T. H. Fife and L. K. Jao, *J. Org. Chem.*, **30**, 1492 (1965).

⁷³ (a) Note 72(d); (b) M. M. Kreevoy and R. W. Taft, Jr., *J. Amer. Chem. Soc.*, **77**, 5590 (1955).

⁷⁴ E. H. Cordes, *Prog. Phys. Org. Chem.*, **4**, 1 (1967), pp. 13, 14.

⁷⁵ (a) C. A. Bunton and V. J. Shiner, Jr., *J. Amer. Chem. Soc.*, **83**, 3207 (1961); (b) M. Kilpatrick, *J. Amer. Chem. Soc.*, **85**, 1036 (1963).

⁷⁶ L. Zucker and L. P. Hammett, *J. Amer. Chem. Soc.*, **61**, 2791 (1939).

⁷⁷ F. A. Long and M. A. Paul, *Chem. Rev.*, **57**, 935 (1957).

⁷⁸ For a discussion and references, see M. L. Bender, *Mechanisms of Homogeneous Catalysis from Protons to Proteins*, Wiley-Interscience, New York, 1971, p. 45.

participation of the water molecule in the transition state. The low value of ω found in acetal hydrolysis agrees with the A-1 mechanism.⁷⁹

General Catalysis in Acetal Hydrolysis

Increasing knowledge of enzyme mechanisms has spurred a renewed search for general acid catalysis in acetal hydrolysis. The active site in the enzyme lysozyme, which catalyzes hydrolysis of the acetal link in glycosides, has a carboxylic acid and a carboxylate anion in favorable positions to interact with the acetal group, one presumably by general acid catalysis and the other by electrostatic stabilization of the intermediate carbocation.⁸⁰ The proposed general catalysis in the enzyme would be more convincing if analogies could be found. Further investigation has led to discovery of general acid catalysis in a number of acetals and ketals in which either the carbocation stability is enhanced or oxygen basicity suppressed. Structures with phenol leaving groups constitute the majority of these cases.⁸¹ The mechanisms are presumably S_E2.⁸² There has been only limited success in the search for general catalysis and neighboring carboxylate stabilization in systems chosen as models for the lysozyme active site.⁸³

Thioacetals and Thioketals

As we pointed out in the previous section, thiols have a markedly greater tendency to add to carbonyl groups than do water and alcohols. The equilibrium constant for the exchange reaction 8.46 is estimated⁸⁴ to be about 2.5×10^4 .

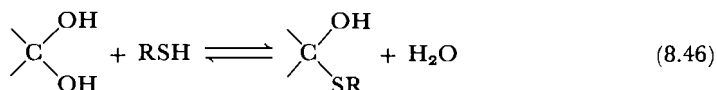

Addition of hydrogen sulfide and thiols is qualitatively similar to reaction with alcohols in that there are two stages, formation of hemithioacetal (or hemithio-ketal) followed by acid-catalyzed elimination of the hydroxy group and substitution of a second —SR (Equations 8.47 and 8.48). The transformation has been studied less extensively than hydration and acetal formation, and relatively little information on mechanism is available. The initial addition appears to be specific base-catalyzed, an observation that implies that RS⁻ is the species that adds. The situation is thus similar to cyanide addition. General acid catalysis has, however, been found at pH 1 to 2 for addition of weakly acidic alkyl thiols, and the reaction rate as a function of pH has a minimum and rises both on the

⁷⁹ J. F. Bunnett, *J. Amer. Chem. Soc.*, **83**, 4956 (1961), and following papers.

⁸⁰ (a) T. H. Fife, *Acts Chem. Res.*, **5**, 264 (1972); (b) B. M. Dunn and T. C. Bruice, *J. Amer. Chem. Soc.*, **92**, 2410, 6589 (1970). (c) See, however, G. M. Loudon, C. K. Smith, and S. E. Zimmerman, *J. Amer. Chem. Soc.*, **96**, 465 (1974), who find that electrostatic stabilization contributes only a small rate acceleration in a model system.

⁸¹ (a) A report of general acid catalysis of benzophenone diethylketal has appeared: R. H. DeWolfe, K. M. Ivanetich, and N. F. Perry, *J. Org. Chem.*, **34**, 848 (1969). (b) Ring strain can also make possible general acid catalysis. See R. F. Atkinson and T. C. Bruice, *J. Amer. Chem. Soc.*, **96**, 819 (1974).

⁸² See note 80(a).

⁸³ (a) See note 80; (b) B. Capon, M. C. Smith, E. Anderson, R. H. Dahm, and G. H. Sankey, *J. Chem. Soc. B*, 1038 (1969).

⁸⁴ W. P. Jencks, *Prog. Phys. Org. Chem.*, **2**, 63 (1964), p. 104.

basic and on the acidic side. General base catalysis was not found.⁸⁵ The acid catalysis presumably represents addition of undissociated RSH by a mechanism similar to the H₂O and ROH additions.

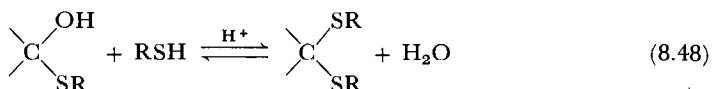
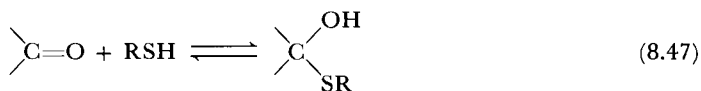

8.4 ADDITION OF NITROGEN NUCLEOPHILES

A number of important chemical and biochemical processes are initiated by addition of a nitrogen nucleophile to a carbonyl group.⁸⁶ These processes have been the subject of extensive study, and we shall not attempt to do more than outline the main features.

Addition of Nitrogen Nucleophiles to C=O

Addition of primary amines to carbonyl groups follows the pattern we have established for other nucleophiles with formation of a carbinolamine (Equation 8.49). These compounds are sufficiently stable to be isolated in some cases,⁸⁷

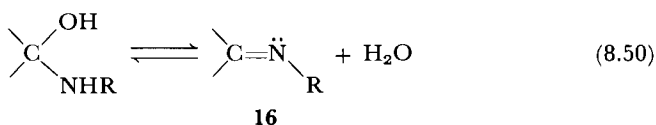
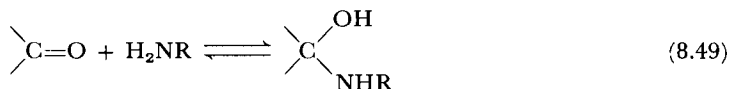

but they usually undergo an elimination to an imine (Equation 8.50). Note that this reaction is analogous to the elimination of H₂O in the second stage of acetal formation, except that here, because the nitrogen bears a proton that is lost to a base, a neutral molecule results rather than an ion. The imine structure **16** is usually unstable if the substituents on carbon and nitrogen are all alkyl or hydrogen. Imines with hydrogen attached to nitrogen have been demonstrated spectrophotometrically,⁸⁸ but they cannot ordinarily be isolated, as they undergo further condensations.⁸⁹ The imine is stabilized by one or more aryl groups

⁸⁵ G. E. Lienhard and W. P. Jencks, *J. Amer. Chem. Soc.*, **88**, 3982 (1966).

⁸⁶ Discussions of mechanisms of addition of nitrogen nucleophiles may be found in the following sources: (a) W. P. Jencks, *Catalysis in Chemistry and Enzymology*, McGraw-Hill, New York, 1969, p. 490ff; (b) W. P. Jencks, *Chem. Rev.*, **72**, 705 (1972); (c) W. P. Jencks, *Prog. Phys. Org. Chem.*, **2**, 63 (1964); (d) R. L. Reeves, *The Chemistry of the Carbonyl Group*, S. Patai, Ed., Wiley-Interscience, London, 1966, Vol. 1, p. 567; (e) M. L. Bender, *Mechanisms of Homogeneous Catalysis from Protons to Proteins*, Wiley, New York, 1971; (f) L. P. Hammett, *Physical Organic Chemistry*, 2nd ed., McGraw-Hill, New York, 1970, p. 336.

⁸⁷ (a) P. K. Chang and T. L. V. Ulbricht, *J. Amer. Chem. Soc.*, **80**, 976 (1958); (b) E. J. Poziomek, D. N. Kramer, B. W. Fromm, and W. A. Mosher, *J. Org. Chem.*, **26**, 423 (1961).

⁸⁸ R. K. McLeod and T. I. Crowell, *J. Org. Chem.*, **26**, 1094 (1961).

⁸⁹ F. Sachs and P. Steinert, *Ber.*, **37**, 1733 (1904).

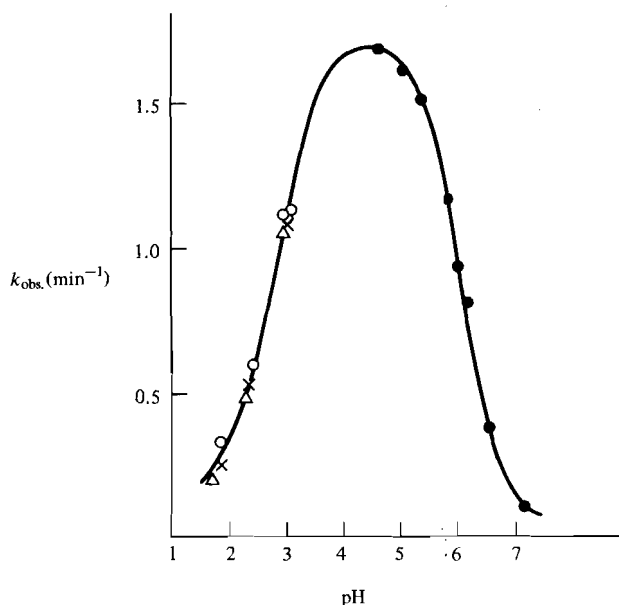
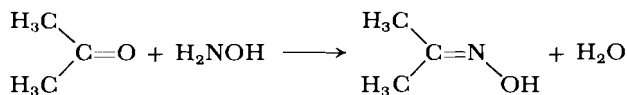
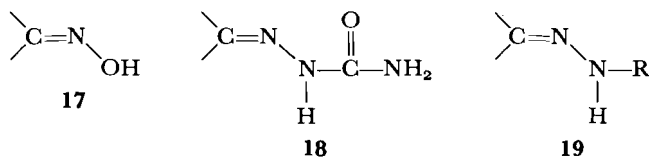

Figure 8.10 Dependence of rate on pH for the reaction



Reprinted with permission from W. P. Jencks, *J. Amer. Chem. Soc.*, **81**, 475 (1959). Copyright by the American Chemical Society.

attached to carbon or nitrogen, in which case the compounds are easily isolated and are called Schiff bases. Stabilization is also achieved if a hydroxyl or a second nitrogen is attached to the nitrogen. The most common of these structures are the oximes (**17**), semicarbazones (**18**), and hydrazones (**19**).



Another possible reaction of the carbinolamine, observed in the addition of amide or urea nitrogen, is substitution of the hydroxyl by a second molecule of the nucleophile (Equation 8.51). Addition of secondary amines leads to carbinol-

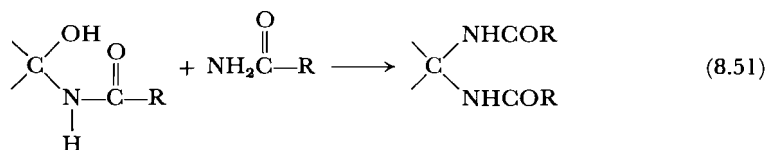

amines which cannot attain a neutral structure having a carbon–nitrogen double bond; if there is a hydrogen on the α carbon, elimination of water can occur in this direction to yield a product with a carbon–carbon double bond (Equation

8.52), a process similar to that which occurs in aldol-type condensations (see Table 8.8). The vinyl amines (**20**) are referred to as *enamines*; they find applica-

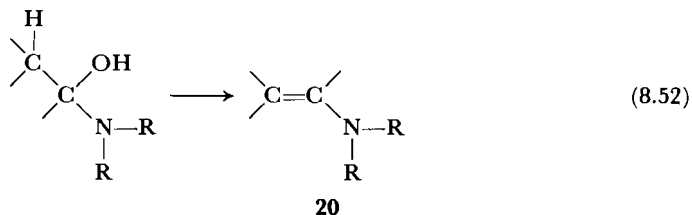

tion in synthesis.⁹⁰ In addition of tertiary amines, the carbinolamine is ionic and there is no possibility of formation of a neutral addition compound.

Addition of primary amines to carbonyl groups has been the subject of extensive study, notably by Jencks and co-workers.⁹¹ The most striking feature of these reactions is the characteristic maximum in the graph of reaction rate as a function of pH.⁹² Figure 8.10 illustrates the observations for the reaction of hydroxylamine with acetone. It is also found that the sensitivity of rate to acid catalysis,⁹³ and to substituent effects,⁹⁴ is different on either side of the maximum in the pH-rate curve. These phenomena may be understood in terms of the two-step nature of the reaction. In acetal formation, we saw in Section 8.3 that the second step is rate-limiting in the overall process, and it is relatively easy to study the two steps separately; here, the rates of the two steps are much more closely balanced, so that one or the other is rate-determining depending on the pH.

It is convenient for further analysis to divide the nitrogen nucleophiles into two categories: the strongly basic hydroxylamine and aliphatic amines,

SCHEME 9

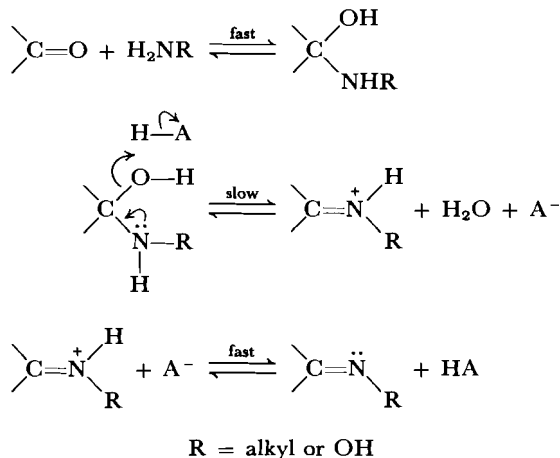

⁹⁰ See, for example, (a) J. Szmuszkoicz, *Advances in Organic Chemistry: Methods and Results*, Wiley-Interscience, New York, 1963, vol. 4, p. 1; (b) S. F. Dyke, *The Chemistry of Enamines*, Cambridge University Press, Cambridge, 1973.

⁹¹ See, for example, W. P. Jencks, *J. Amer. Chem. Soc.*, **81**, 475 (1959), and notes 86(a), (c), p. 432.

⁹² (a) See note 91; (b) E. Barrett and A. Lapworth, *J. Chem. Soc.*, **93**, 85 (1908); (c) J. B. Conant and P. D. Bartlett, *J. Amer. Chem. Soc.*, **54**, 2881 (1932); (d) J. C. Powers and F. H. Westheimer, *J. Amer. Chem. Soc.*, **82**, 5431 (1960).

⁹³ (a) See note 92(d); (b) E. H. Cordes and W. P. Jencks, *J. Amer. Chem. Soc.*, **84**, 832 (1962).

⁹⁴ (a) See note 93(b); (b) B. M. Anderson and W. P. Jencks, *J. Amer. Chem. Soc.*, **82**, 1773 (1960).

$pK_{a_{BH^+}}$ roughly 6 to 10, and the weakly basic semicarbazide and aryl amines, $pK_{a_{BH^+}}$ about 4. Considering the former class first, we find good evidence that in neutral solution, which is on the basic side of the maximum in the pH-rate curve, the second step (dehydration) is rate-determining. For example, it is observed that when the nucleophile and carbonyl compound are mixed in relatively concentrated solution, the characteristic absorption spectrum of the carbonyl group disappears rapidly, and the spectrum of the final product, the imine, appears much more slowly. The overall reaction is subject to general acid catalysis, and, as we show below, it is true general acid catalysis and not specific acid plus general base catalysis. The general catalysis must apply to the rate-determining dehydration step, and the mechanism must therefore be that shown in Scheme 9.⁹⁵ The value of α is 0.75 and of β is 0.27; the proton being donated by HA is thus probably close to the oxygen of the carbinolamine at the transition state of the slow step.⁹⁶ This evidence also establishes the mechanism for the reverse reaction, addition of water to C=N; note that it differs from addition to C=O in that an equilibrium protonation precedes the addition.

The fact that true general acid catalysis is correct for the slow step in Scheme 9 is established for the hydrolysis of benzylidene-*t*-butylamine (21) at pH 4 to 5, conditions sufficiently basic that hydration is still the rate-determining step, as shown in Scheme 9, but acidic enough that essentially all of the imine exists in the protonated form. Under these circumstances, the hydrolysis (reverse of Scheme 9) is subject to general base catalysis by acetate ion.⁹⁷ This

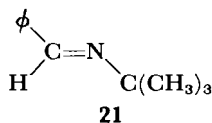

observation means that if the mechanism is that shown in Scheme 9, the base A^- is assisting in the reverse of the slow step by removing a proton from the attacking water molecule. If the true mechanism of the dehydration step had been specific acid plus general base catalysis in the forward direction (Scheme 10), the reverse reaction would have had to involve donation of a proton by the protonated

SCHEME 10

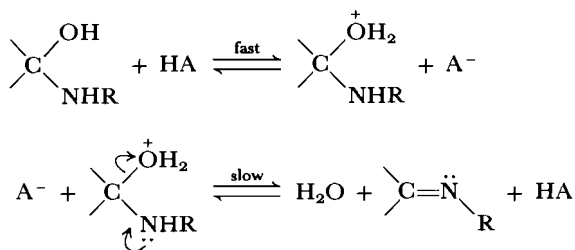

⁹⁵ (a) See note 93(b); (b) E. H. Cordes and W. P. Jencks, *J. Amer. Chem. Soc.*, **85**, 2843 (1963).

⁹⁶ (a) J. E. Reimann and W. P. Jencks, *J. Amer. Chem. Soc.*, **88**, 3973 (1966); (b) K. Koehler, W. Sandstrom, and E. H. Cordes, *J. Amer. Chem. Soc.*, **86**, 2413 (1964).

⁹⁷ See note 95(b).

catalyst HA to the nitrogen, and such a process can be ruled out in this instance because the nitrogen is already fully protonated at these pH values.⁹⁸

In more strongly basic solutions, above about pH 9, a pathway subject to neither acid nor base catalysis (Scheme 11) is observed.⁹⁹

SCHEME 11

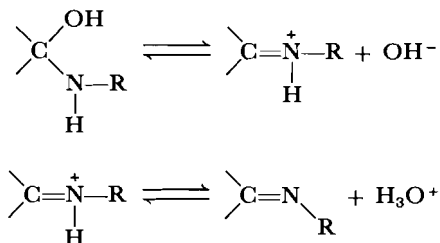

One might inquire at this point about the addition of a secondary amine, which cannot yield a stable neutral product by dehydration as the primary amine can. Diebler and Thorneley measured rate constants of the addition step for reaction of piperazine (22) with pyridine-4-aldehyde in the pH range 5.8–10.8, a range in which the addition step is very fast so that, for primary amines, the kinetics would be determined by the rate-limiting dehydration.¹⁰⁰ They were

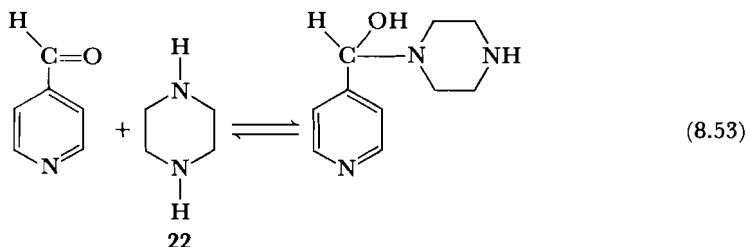

able to show, by use of fast-reaction measurement techniques, that the general base catalysis observed is a result of a simple rate-determining proton transfer in step 2 of Scheme 12. The rate constant for the actual addition (step 1) is on the order of $10^7 \text{ M}^{-1} \text{ sec}^{-1}$. Note that this reaction is in the category mentioned in Section 8.1, p. 407, in which a simple proton transfer involving a species present in low concentration is rate-determining. When no base catalyst is present, step 2 is still rate-determining, but it now consists of an intramolecular proton transfer from nitrogen to oxygen.

Returning now to primary amines, one finds that as the solution is made more acidic, the rate increases as a result of the acid catalysis of the dehydration step, until the maximum rate is attained, usually at pH between 2 and 5.¹⁰¹ The decrease of rate that occurs on further decrease of pH can be explained by assuming that whereas greater acidity facilitates the dehydration, it inhibits the addition step (Equation 8.49) because only the unprotonated amine is reactive. The first step then becomes rate-determining. In this pH region there is no

⁹⁸ See note 95(b), p. 435.

⁹⁹ See note 95(b), p. 435.

¹⁰⁰ H. Diebler and R. N. F. Thorneley, *J. Amer. Chem. Soc.*, **95**, 896 (1973).

¹⁰¹ See note 92(d), p. 434 and note 95(b), p. 435.

SCHEME 12

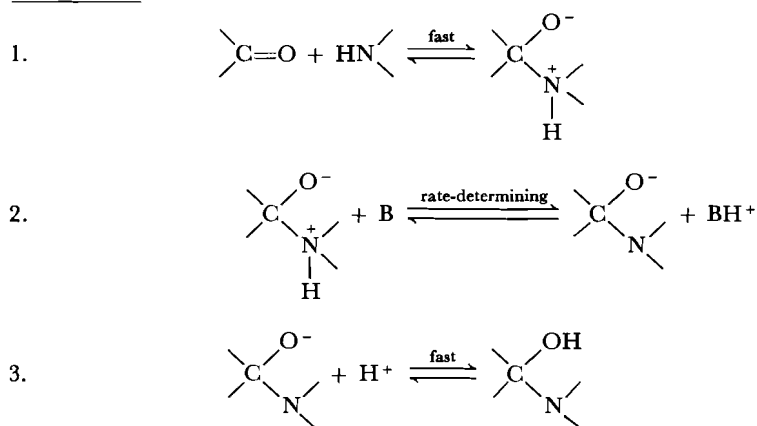

general catalysis with the more strongly basic aliphatic amines, and only a minor general acid catalysis for hydroxylamine addition.¹⁰² These bases, like cyanide ion, are strong enough not to require assistance by proton transfer in the rate-determining step; the mechanism is as shown in Equation 8.54. The intramolec-

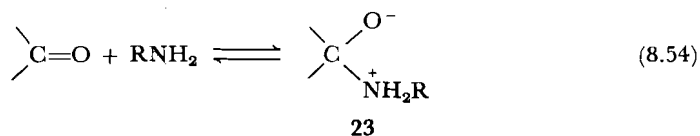

ular proton transfer from nitrogen to oxygen in intermediate **23** is presumed to be fast compared to the addition under these circumstances, although as we have noted above, it can be rate-determining above pH 5 when structural features cause the reaction to stop at the carbinolamine stage. The entire mechanism is shown in Scheme 13.

SCHEME 13

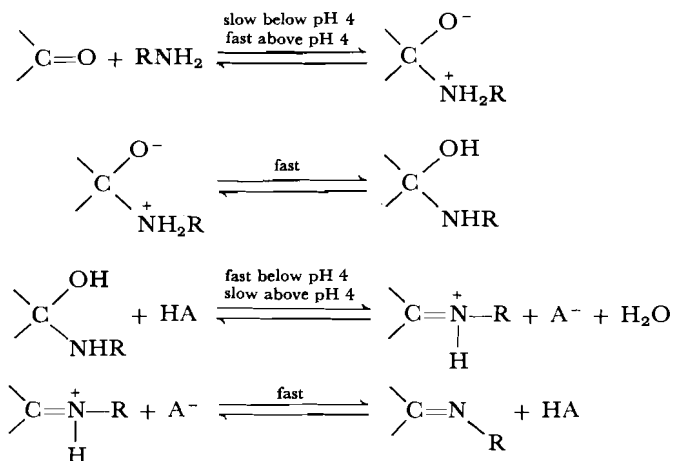

¹⁰² See note 86(c), p. 432.

The general pattern we have outlined holds true also for the more weakly basic nitrogen nucleophiles such as semicarbazide or aryl amines. The electron-withdrawing groups retard the addition step, in which the nitrogen unshared pair attacks carbon, but they also retard the dehydration, where again the unshared pair is acting in a nucleophilic manner to expel the hydroxyl group. The change from rate-determining addition to rate-determining dehydration is observed at roughly the same pH as for the more basic amines. The weaker bases, however, require more help from acid catalysts. In the addition step, general acid catalysis is found¹⁰³ with α about 0.25; in dehydration, general acid catalysis with the partial proton transfer ($\alpha = 0.75$) found with the more basic amines is no longer sufficient, α approaches 1.0, and the general catalysis gives way to specific hydronium ion catalysis.¹⁰⁴ By the same token, in the reverse process, starting from the imine structure, the protonated imine is so strongly electrophilic that it can be attacked by a water molecule with no help from a base catalyst. The detailed mechanism is given in Scheme 14.

SCHEME 14

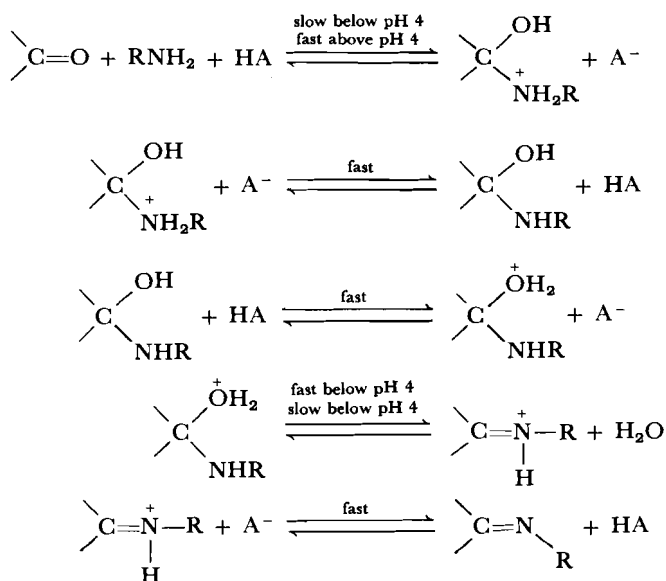

In strongly basic solution, pH roughly 10 to 12, the rate for additions of all but the strongly basic alkyl amines is observed to increase again.¹⁰⁵ In this case one is presumably dealing with the process shown in Scheme 15, which should be favored by electron-withdrawing groups on nitrogen.¹⁰⁶ And finally, it appears that in some cases at high pH this base-catalyzed dehydration becomes sufficiently fast that the initial addition is again rate-determining, but now, as in the case of addition of the secondary amine piperazine discussed above (Scheme 12), the

¹⁰³ E. H. Cordes and W. P. Jencks, *J. Amer. Chem. Soc.*, **84**, 4319 (1962).

¹⁰⁴ See note 94(b).

¹⁰⁵ (a) See note 92(b), p. 434; (b) see note 93(b), p. 434; (c) see note 94(b), p. 434; (d) A. Williams and M. L. Bender, *J. Amer. Chem. Soc.*, **88**, 2508 (1966).

¹⁰⁶ See note 94(b), p. 434.

SCHEME 15

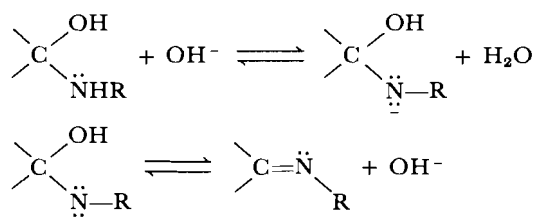

rate-determining step is not the actual addition but rather the proton transfer that follows it.¹⁰⁷

Nucleophilic Catalysis

It has been found that amines frequently are effective catalysts for addition of other nucleophiles to carbonyl groups.¹⁰⁸ The reason for this catalysis is that amines can add rapidly to the carbonyl compound to form an imine; the imine in turn is subject to the same kinds of addition reactions as are carbonyl compounds, but reacts faster because it is more easily protonated. Scheme 16 illus-

SCHEME 16

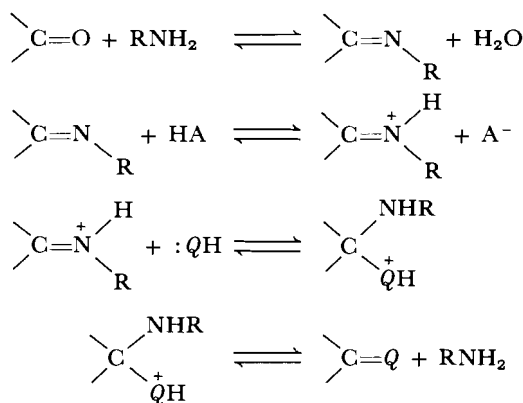

trates this process, which is referred to as *nucleophilic catalysis*. In order for nucleophilic catalysis of addition of *Q* to occur, it is necessary that (1) the rate of addition of the catalyst to the carbonyl group be greater than the rate of addition of *Q*; (2) that the protonated imine be more reactive than the carbonyl compound toward *Q*; and (3) that the equilibrium favor the *Q* addition more than amine addition.

8.5 CARBOXYLIC ACID DERIVATIVES

When the carbonyl group bears as one substituent a group that can potentially depart as a Lewis base, the most common result of addition of a nucleophile to the carbonyl carbon is elimination to regenerate a carbon-oxygen double bond

¹⁰⁷ J. M. Sayer and W. P. Jencks, *J. Amer. Chem. Soc.*, **95**, 5637 (1973).

¹⁰⁸ For a discussion, see Bender, *Mechanisms of Homogeneous Catalysis from Protons to Proteins*, p. 165.

SCHEME 17

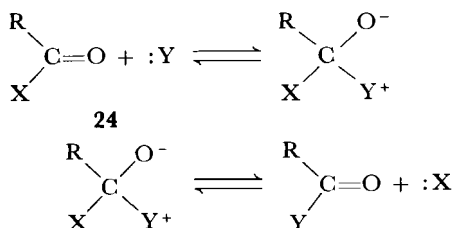

(Scheme 17). The starting material, intermediates, and products may be in various states of protonation, depending on the acidity of the medium and the nature of X and Y. An alternative mechanism, observed much less commonly, is a unimolecular S_N1 dissociation (Chapter 5) to an acylium ion (25, Scheme 18), which then reacts with a nucleophile to yield the same final result.

SCHEME 18

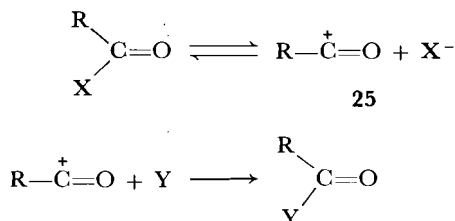

Structures **24** are conveniently thought of as derivatives of carboxylic acids, and include acids, esters, anhydrides, acyl halides, and amides. These structures (and others less commonly encountered) can be readily interconverted, either directly or indirectly; the number of different reactions is therefore large.¹⁰⁹ Because these processes occupy an important place in organic chemistry and because carboxylic acid derivatives are of central importance in biochemical systems and therefore of considerable interest in the study of enzyme action, they have been the subject of intensive investigation.¹¹⁰ We shall outline briefly the main features, and in order to give an idea of the kinds of mechanistic questions involved, we consider ester hydrolysis in somewhat greater detail.

The Addition Mechanism

The main feature of interest is the question whether, in the replacement of X by Y in Reaction 8.55, the substitution is an ordinary nucleophilic substitution, either S_N2 (Reaction 8.56), or S_N1 (Scheme 18), or a two-step process with addition of the nucleophile to give an approximately tetrahedral intermediate (**26**) followed

¹⁰⁹ Surveys outlining the general features of many of the reactions may be found in: (a) J. March, *Advanced Organic Chemistry: Reactions, Mechanisms, and Structure*, McGraw-Hill, New York, 1968; (b) D. P. N. Satchell, *Quart. Rev.* (London), **17**, 160 (1963).

¹¹⁰ Comprehensive discussions are to be found in: (a) M. L. Bender, *Mechanisms of Homogeneous Catalysis from Protons to Proteins*, Wiley, New York, 1971; (b) W. P. Jencks, *Catalysis in Chemistry and Enzymology*, McGraw-Hill, New York, 1969; (c) M. L. Bender, *Chem. Rev.*, **60**, 53 (1960). For more specialized treatments of particular aspects, see: (d) W. P. Jencks, *Chem. Rev.*, **72**, 705 (1972), general acid-base catalysis; (e) S. L. Johnson, *Advan. Phys. Org. Chem.*, **5**, 237 (1967), ester hydrolysis; (f) L. P. Hammett, *Physical Organic Chemistry*, 2nd ed., McGraw-Hill, New York, 1970, chap. 10, acid-base catalysis.

by elimination of the leaving group. The latter process, to which we shall refer as the *addition mechanism* or *stepwise mechanism*, is the one we would expect by analogy with the carbonyl reactions considered earlier in this chapter. Bender

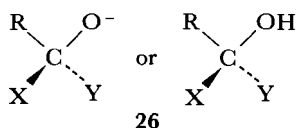
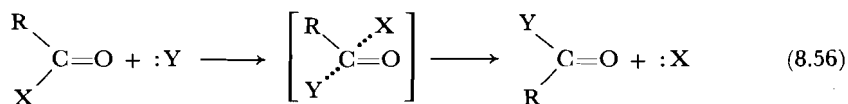
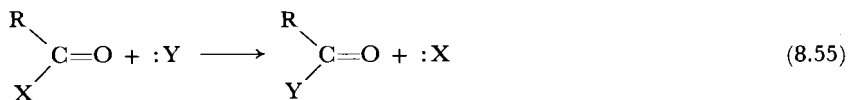

introduced an isotopic labeling method to demonstrate the presence of intermediate **26** in hydrolysis reactions.¹¹¹ Addition of water to a carbonyl oxygen-labeled substrate (Scheme 19) would yield an intermediate with two oxygens bonded to carbon; a simple proton transfer, which should be very rapid, would make these oxygens equivalent. Reversal of the addition step would then exchange the oxygen. A similar process, with one less proton, can be written for addition of

SCHEME 19

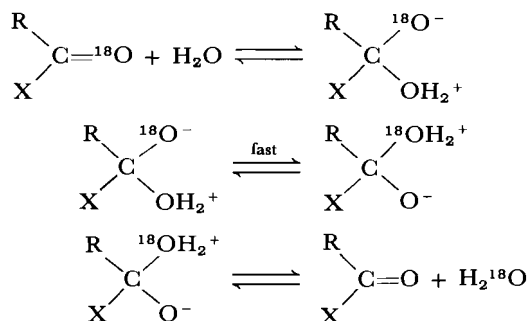

hydroxide ion. Bender found significant exchange in ester hydrolysis; exchange has also been found in hydrolysis of amides, acyl chlorides, and anhydrides.¹¹² Although oxygen exchange implies the existence of an intermediate, the converse is not necessarily true; the intermediate might continue on to product by elimination of X much faster than it reverts to starting material by elimination of H₂O (or OH⁻).¹¹³

Another way to demonstrate an intermediate is to show that there are two steps, one rate-determining under some conditions and the other under other

¹¹¹ M. L. Bender, *J. Amer. Chem. Soc.*, **73**, 1626 (1951).

¹¹² D. Samuel and B. L. Silver, *Advan. Phys. Org. Chem.*, **3**, 123 (1965).

¹¹³ Strictly speaking, the observation of exchange shows only that tetrahedral intermediate is present, not that it necessarily lies on the reaction path leading to product. But the possibility that the intermediate would be readily and reversibly formed yet not go on to product seems unreasonable.

conditions. It is now generally agreed that except in certain types of ester hydrolysis, which we consider in more detail below, and in certain reactions of acid halides,¹¹⁴ the addition mechanism applies.^{115,116}

The other important mechanistic question is one of catalysis by acids and bases. The situation is complicated because of the several possible sites of protonation. The substrate may be protonated on carbonyl oxygen and also on X if that group has unshared pairs, as it does in all the common cases; the nucleophile :Y may be protonated or not; the tetrahedral intermediate may be protonated in various possible ways; and either of the two steps may be rate-determining. It is therefore not surprising that the details are still under investigation.

The general features of catalysis for hydrolysis, the most thoroughly studied of the many possible reactions, are as follows. The nucleophile :Y must have available an unshared pair of electrons. This requirement usually presents no problem in hydrolysis, where there is always plenty of H₂O, but in concentrated acids, where a significant portion of the water is converted to H₃O⁺, the rate decreases.¹¹⁷ Because hydroxide ion is a much more effective nucleophile than water, bases catalyze the hydrolysis; this catalysis can take the form of general base catalysis and in some cases also nucleophilic catalysis.

Acids also catalyze the reaction by transferring a proton to the carbonyl group. It has generally been considered that the site of protonation is the carbonyl oxygen,¹¹⁸ but this point is by no means well established, and evidence for protonation of nitrogen in amide hydrolysis has appeared.¹¹⁹ In those special cases that do react by an S_N1 process (Scheme 18) rather than by the stepwise mechanism, acid catalysis presumably operates by protonation of the leaving group. Acid catalysis is expected to be effective for the less reactive carbonyl groups, as in esters and amides; for acid chlorides the electron-withdrawing halogen makes the unprotonated carbonyl so reactive that acid catalysis is not usually observed, except again in those cases where an S_N1 mechanism is being followed.¹²⁰

Nucleophilic catalysis is a process of particular significance in reactions of carboxylic acid derivatives. As an example we may cite hydrolysis catalyzed by a tertiary amine (Scheme 20). The catalysis is effective because initial attack of the amine will be faster than attack by the less nucleophilic water; the amine addition yields the intermediate **27** which, because of the positive charge, has an extremely reactive carbonyl group and is attacked by water much faster than the original compound. The fact that a given base is acting by nucleophilic catalysis

¹¹⁴ (a) M. L. Bender and M. C. Chen, *J. Amer. Chem. Soc.*, **85**, 30 (1963); (b) D. P. N. Satchell, *J. Chem. Soc.*, 558, 564 (1963).

¹¹⁵ Addition intermediates have been observed directly in favorable cases. See (a) M. L. Bender, *J. Amer. Chem. Soc.*, **75**, 5986 (1953); (b) G. A. Rogers and T. C. Bruice, *J. Amer. Chem. Soc.*, **95**, 4452 (1973); (c) N. Gravitz and W. P. Jencks, *J. Amer. Chem. Soc.*, **96**, 489, 499, 507 (1974).

¹¹⁶ C. R. Smith and K. Yates, *J. Amer. Chem. Soc.*, **94**, 8811 (1971), have reported evidence that amides may not always hydrolyze by the addition mechanism.

¹¹⁷ See, for example: (a) K. Yates, *Accts. Chem. Res.*, **4**, 136 (1971) (esters); (b) J. T. Edward and S. C. R. Meacock, *J. Chem. Soc.*, 2000 (1957) (amides).

¹¹⁸ See note 110(c), p. 440.

¹¹⁹ See note 116.

¹²⁰ See note 114(a).

SCHEME 20

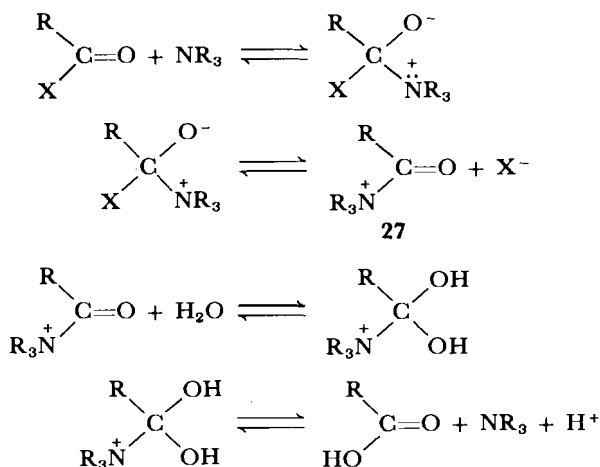

rather than by general base catalysis (removal of a proton from attacking H_2O) can be established by noting deviations from the Brønsted catalysis correlation that demonstrate that a given substance is markedly more effective as a catalyst than its proton basicity would indicate, or by structural variations that show the effectiveness as a catalyst to be more sensitive than proton basicity to steric effects.¹²¹

Electrophilic catalysis by Lewis acids is also observed; here no ambiguity arises with general acid catalysis, as Lewis acids and proton acids are not the same. An interesting example is the strong catalysis of thiolester hydrolysis by mercuric and silver ions. These soft acids presumably coordinate with the sulfur and, by virtue of the consequent electron withdrawal, make the carbonyl group much more susceptible to attack in the addition mechanism, or, in favorable cases, promote unimolecular $\text{S}_{\text{N}}1$ cleavage of the sulfur-carbon bond.¹²²

Ester Hydrolysis

We close this section with a somewhat more detailed consideration of ester hydrolysis as an example of the kinds of questions that arise in study of reactions of acid derivatives.¹²³

Ingold¹²⁴ classified the possible mechanisms of ester hydrolysis according to the scheme shown in Table 8.5. To his original eight categories a ninth, E1_{CB} , has been added more recently, and has been included in the table. The primary subdivision is made on the basis of whether the acyl-oxygen or the alkyl-oxygen bond is cleaved. This information may be obtained by isotope tracer studies using ^{18}O (Equation 8.57),¹²⁵ or by hydrolyzing an ester with an asym-

¹²¹ See, for example, Bender, *Mechanisms of Homogeneous Catalysis from Protons to Proteins*, chap. 6.

¹²² D. P. N. Satchell and I. I. Secemski, *Tetrahedron Lett.*, 1991 (1969).

¹²³ For reviews, see: C. H. Bamford and C. F. H. Tipper, Eds., *Ester Formation and Hydrolysis* (Comprehensive Chemical Kinetics, Vol. 10), American Elsevier, New York, 1972, chap. 2 (A. J. Kirby) and 3 (R. E. J. Talbot).

¹²⁴ C. K. Ingold, *Structure and Mechanism in Organic Chemistry*, 2nd ed., Cornell University Press, Ithaca, N.Y., 1969, p. 1131.

¹²⁵ See note 112, p. 441.

Table 8.5 MECHANISMS OF ESTER HYDROLYSIS

Cleavage	Mechanism	Condi- tions	Abbrevia- tion ^{a, b}
Acyl-oxygen cleavage	Addition	Acid	A _{AC} 2 ^d
		Base	B _{AC} 2 ^d
	Unimolecular	Acid	A _{AC} 1
		Base	B _{AC} 1
		Base	El _{CB} ^e
Alkyl-oxygen cleavage	Bimolecular (nucleophilic substitution)	Acid	A _{AL} 2
		Base	B _{AL} 2
	Unimolecular (nucleophilic substitution)	Acid	A _{AL} 1
		Base	B _{AL} 1

^a C. K. Ingold, *Structure and Mechanism in Organic Chemistry*, 2nd ed., Cornell University Press, Ithaca, N.Y., 1969, p. 1131.

^b A or B: acid or base catalysis; AC or AL: acyl-oxygen or alkyl-oxygen fission; 1 or 2: unimolecular or bimolecular. El_{CB} designates unimolecular elimination through the conjugate base.

metric carbon bonded to oxygen in the alcohol portion (Equation 8.58).¹²⁶ The reactions proceeding by alkyl-oxygen cleavage are, of course, nucleophilic substitutions at saturated carbon with carboxylate or carboxylic acid leaving groups; these processes have been considered in Chapters 4 and 5. They require the leaving group to be a particularly weak base (for example, *p*-nitrobenzoate) or the carbocation R⁺ to be well stabilized. Thus *t*-butyl esters usually hydrolyze by alkyl-oxygen cleavage.

¹²⁶ (a) B. Holmberg, *Ber.*, **45**, 2997 (1912). For other methods see (b) E. H. Ingold and C. K. Ingold, *J. Chem. Soc.*, 756 (1932); (c) O. R. Quayle and H. M. Norton, *J. Amer. Chem. Soc.*, **62**, 1170 (1940).

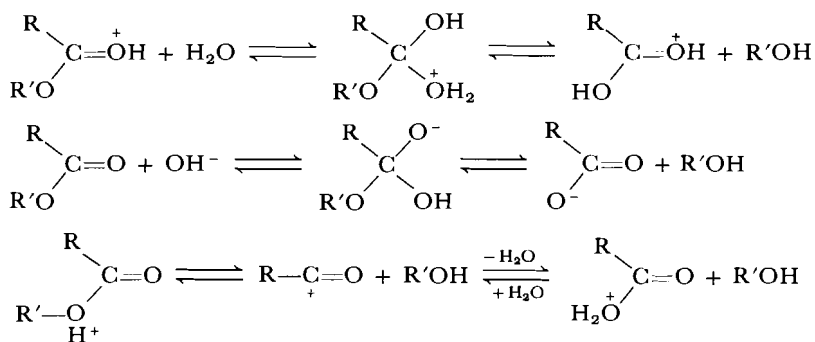
Mechanism^c

Not observed

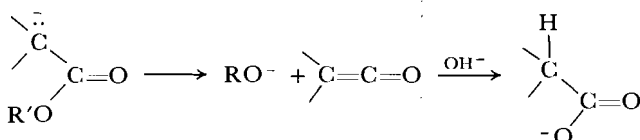

Not observed

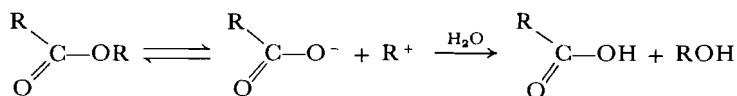
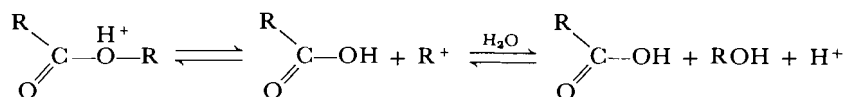
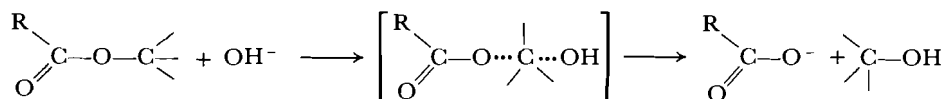

^c Mechanisms are schematic and do not show initial and final proton transfers that may occur between acid and base sites within an intermediate.

^d A_{AC}2 and B_{AC}2 are the most common ester hydrolysis mechanisms.

^e R. F. Pratt and T. C. Bruice, *J. Amer. Chem. Soc.*, **92**, 5956 (1970).

The most common ester hydrolyses involve acyl-oxygen cleavage and proceed by the A_{AC}2 mechanism under acid catalysis or the B_{AC}2 mechanism under base catalysis. These are the processes that involve the tetrahedral intermediate, demonstrated by the methods mentioned earlier. The third mechanism, A_{AC}1, occurs under special circumstances as we note below. The B_{AC}1 process presumably does not occur because it would require unimolecular departure of RO⁻, which is not a sufficiently good leaving group. Hydrolyses in basic medium are for practical purposes not reversible. The acid formed is immediately converted to the carboxylate ion, which has an unreactive carbonyl carbon on account of the negative charge.

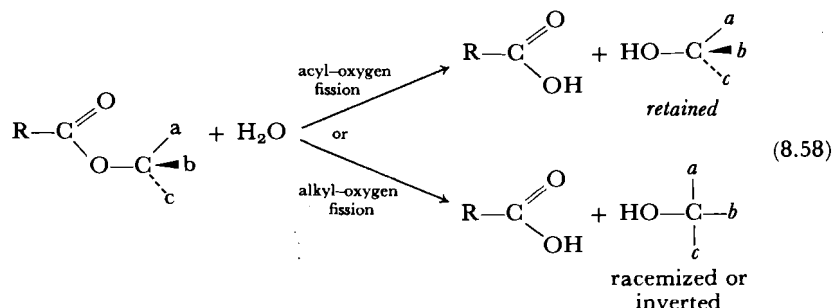
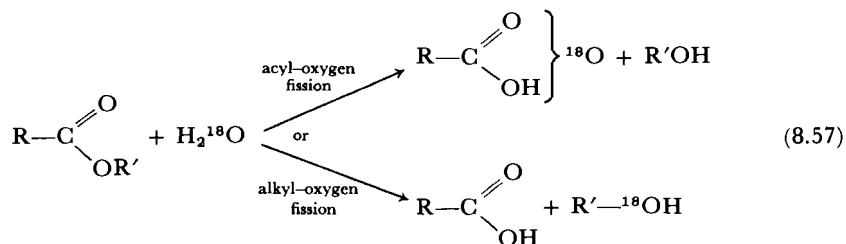

In base-catalyzed hydrolyses, general base catalysis is well established.¹²⁷ In a general base-catalyzed reaction of alcohols with ethyl trifluoroacetate (Scheme 21) it is possible to establish for pyridine catalysis that Mechanism I (true general base catalysis) is correct rather than the kinetically equivalent Mechanism II (specific base plus general acid catalysis). From the rate of the reaction and the p*K* of pyridine, one can show that the initial addition of RO⁻ in Mechanism II would have to occur with a rate constant of $7 \times 10^9 \text{ M}^{-1} \text{ sec}^{-1}$, nearly diffusion-controlled and unreasonably high for such a process.¹²⁸ It is therefore also likely that the general base-catalyzed hydrolysis proceeds by the true general base-catalyzed route. The points for hydroxide and for various other strong nucleophiles do not lie on the Brønsted law general base catalysis correlation line established for weaker nucleophiles; these strong nucleophiles are presumably entering as nucleophilic catalysts, by direct attack on the carbonyl group, rather than as general bases by removal of a proton from an attacking water molecule as in Mechanism I.¹²⁹

Ester hydrolysis would be expected to be subject to general acid catalysis, but this catalysis appears to have been conclusively demonstrated in relatively few cases.¹³⁰ Rather more is known about hydrolysis in strong acid solutions. Yates,¹³¹ for example, has reported data on hydrolysis of several acetates in strong acid solution and uses a modified Bunnett plot according to Equation 8.59 (or, for regions of acidity where a significant portion of the ester is protonated, Equation 8.60). In these equations, *mH*₀, with *m* = 0.62, is an acidity func-

¹²⁷ (a) W. P. Jencks and J. Carriuolo, *J. Amer. Chem. Soc.*, **83**, 1743 (1961); (b) S. L. Johnson, *Advan. Phys. Org. Chem.*, **5**, 237 (1967).

¹²⁸ S. L. Johnson, *J. Amer. Chem. Soc.*, **86**, 3819 (1964).

¹²⁹ (a) See note 127; (b) Bender, *Mechanisms of Homogeneous Catalysis from Protons to Proteins*, p. 155ff.

¹³⁰ For an example, see: S. Milstien and L. A. Cohen, *J. Amer. Chem. Soc.*, **94**, 9158 (1972).

¹³¹ See note 117(a), p. 442.

SCHEME 21

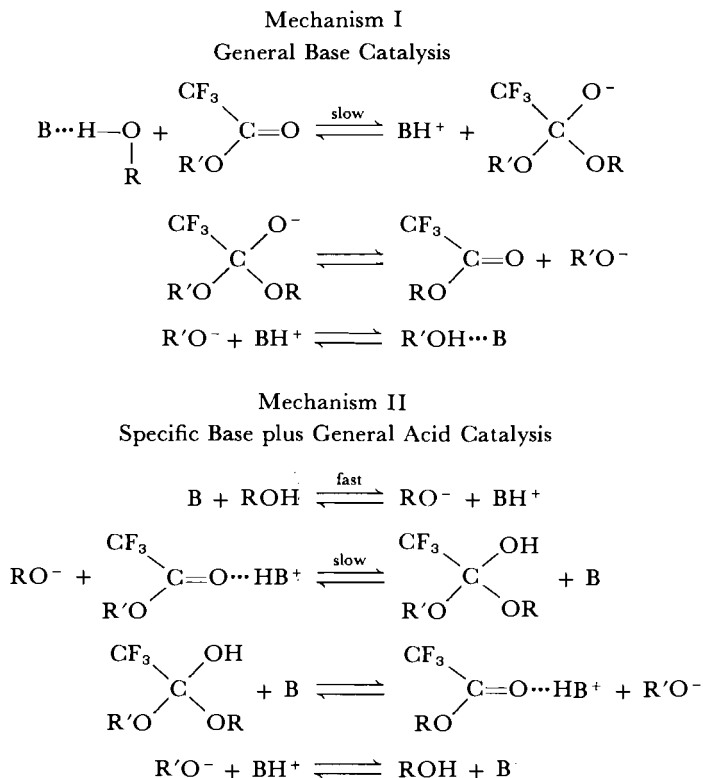

tion appropriate to ester protonation. Figure 8.11 shows plots of rate as a function of percent sulfuric acid in the medium and plots of Equation 8.59 for four different types of esters (**28**). In Types I and II, the initial increase of rate followed by a drop reflects the ordinary $A_{AC}2$ mechanism, catalyzed by acid but requiring as nucleophile free H_2O , which begins to become less available as the proportion of sulfuric acid increases. The final rise, which occurs for Type I and Type II esters, corresponds to a change to a mechanism not requiring nucleophilic participation of water, as shown by the break in the acidity function graph, for Type I presumably to $A_{AC}1$ and for Type II esters probably to $A_{AL}1$. For the

$$\log k + mH_0 = r \log a_{\text{H}_2\text{O}} + \text{Const.} \quad (8.59)$$

$$\log k - \log \frac{h_0^m}{K_{\text{SH}^+}^m + h_0^m} = r \log a_{\text{H}_2\text{O}} + \text{Const.} \quad (8.60)$$

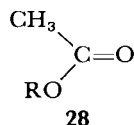

Type I	Type II	Type III	Type IV
R = primary alkyl	R = secondary alkyl, benzyl, allyl	R = vinyl, phenyl	R = <i>tert</i> -butyl, <i>p</i> -methoxyphenyl

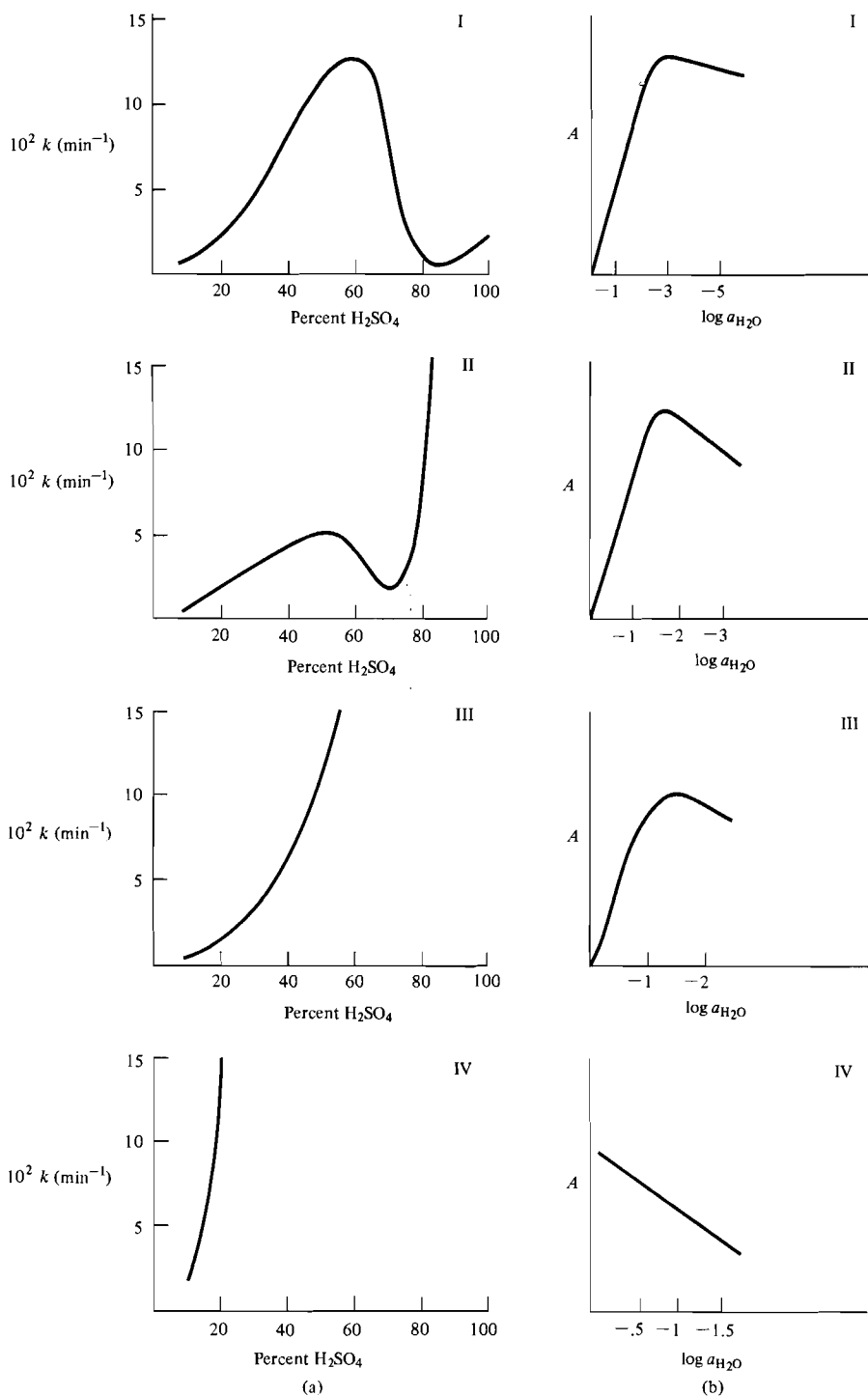

Figure 8.11 (a) Hydrolysis rates of esters of Types I through IV as a function of percent H₂SO₄. (b) Graphs of Equation 8.59 for esters of Types I through IV.

$$A = \log \frac{h_0^m}{K_{\text{SH}^+}^m + h_0^m}$$

Reprinted with permission from K. Yates, *Accts. Chem. Res.*, **4**, 136 (1971). Copyright by the American Chemical Society.

Type III esters, the acidity function plots demonstrate clearly that in these cases also a change in mechanism occurs; this fact is not evident from the graphs of rate vs. percent sulfuric acid, because the change occurs before the acid concentration becomes high enough to cause the decrease found with Types I and II. Since vinyl and phenyl cations are unlikely, Yates proposes a change to the $A_{AC}1$ mechanism, or, for the vinyl case, to a mechanism involving protonation of the carbon-carbon double bond. The *t*-butyl acetate, Type IV, hydrolyzes by the $A_{AL}1$ route over the whole range, a fact confirmed by isotope tracers,¹³² but uncertainty remains about the *p*-methoxyphenyl acetate, because although it behaves like the *t*-butyl ester, most of the reaction proceeds with acyl-oxygen cleavage.¹³³

Questions of general catalysis by the various acidic species present in strongly acid media such as sulfuric acid-water mixtures are beginning to be explored.¹³⁴

8.6 ENOLS, ENOLATES, AND ADDITION OF CARBON NUCLEOPHILES TO C=O

The second main aspect of reactions of carbonyl compounds is one we have already touched upon in Chapter 3. The carbonyl group increases the acidity of C—H bonds on a carbon directly attached to it by many powers of ten over an unactivated carbon-hydrogen bond. Removal of such a proton leaves the conjugated ambident enolate ion (29), which can be reprotonated either at the carbon, to give back the original keto tautomer, or at oxygen to give the enol (Equation 8.61).¹³⁵ Acid also promotes interconversion between enol and keto

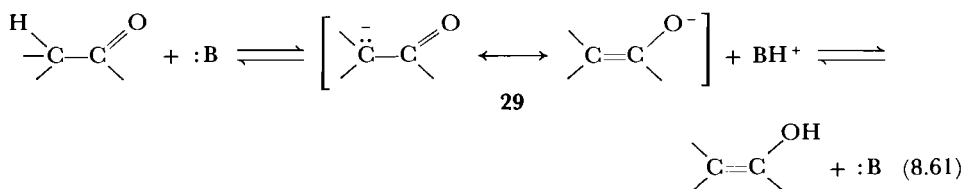

forms (Equation 8.62). In some cases it has proved possible by careful exclusion of acids and bases to isolate enol and keto forms,¹³⁶ but under ordinary circumstances there are sufficient acids or bases present to cause rapid interconversion.

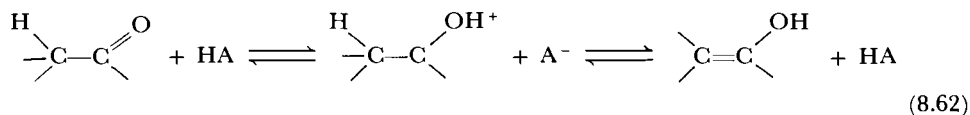

¹³² C. A. Bunton and J. L. Wood, *J. Chem. Soc.*, 1522 (1955).

¹³³ See note 117(a), p. 442.

¹³⁴ R. A. Cox, *J. Amer. Chem. Soc.*, **96**, 1059 (1974).

¹³⁵ (a) For a discussion of enolization, see S. Forsén and M. Nilsson, in *The Chemistry of the Carbonyl Group*, J. Zabicky, Ed., vol. 2, Wiley-Interscience, London, 1970, p. 157. (b) Preparative aspects of enols and particularly enolate ions are discussed in detail with numerous references to the literature in H. O. House, *Modern Synthetic Reactions*, 2nd ed., W. A. Benjamin, Menlo Park, Calif., 1972.

¹³⁶ (a) L. Knorr, O. Rothe, and H. Averbeck, *Ber.*, **44**, 1138 (1911); (b) K. H. Meyer and V. Schoeller, *Ber.*, **53**, 1410 (1920); (c) K. H. Meyer and H. Hopff, *Ber.*, **54**, 579 (1921); (d) for further examples, see: C. K. Ingold, *Structure and Mechanism in Organic Chemistry*, 2nd ed., Cornell University Press, Ithaca, N.Y., 1969, p. 794ff.

Table 8.6 APPROXIMATE VALUES OF KETO-ENOL EQUILIBRIUM CONSTANTS

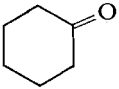
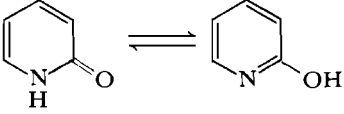
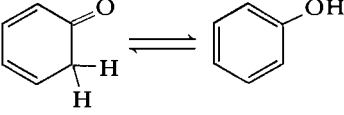
Compound	$K = [\text{enol}]/[\text{keto}]$	Reference
$\text{CH}_3\text{C}(=\text{O})\text{CH}_3$	$\leq 10^{-6}$	<i>a</i>
CH_3CHO	$< 10^{-7}$	<i>b</i>
	4×10^{-6}	<i>a</i>
$\phi\text{-C}(=\text{O})\text{CH}_3$	4×10^{-4}	<i>c</i>
$\text{CH}_3\text{-C}(=\text{O})\text{-CH}_2\text{-C}(=\text{O})\text{-CH}_3$	3.2	<i>c</i>
$\text{CH}_3\text{-C}(=\text{O})\text{-CH}_2\text{-C}(=\text{O})\text{-OR}$	0.09	<i>c</i>
	1.1×10^{-3}	<i>d</i>
	(10^{14})	<i>e</i>

^a R. P. Bell and P. W. Smith, *J. Chem. Soc. (B)*, 241 (1966).

^b A. Gero, *J. Org. Chem.*, **19**, 469 (1954).

^c A. Gero, *J. Org. Chem.*, **19**, 1960 (1954).

^d S. F. Mason, *J. Chem. Soc.*, 674 (1958).

^e Calculated from ΔG° estimated by J. B. Conant and G. B. Kistiakowsky, *Chem. Rev.*, **20**, 181 (1937).

Enols and Enolate Ions

Table 8.6 shows that the equilibrium mixture consists of almost entirely keto form in the case of simple aliphatic and aromatic ketones, whereas significant amounts of enol tautomer are present in β -diketones and β -ketoesters. In these latter cases, the enol contains a conjugated π electron system and an intramolecular hydrogen bond (30). Phenol exists entirely in the enol form, as the alter-

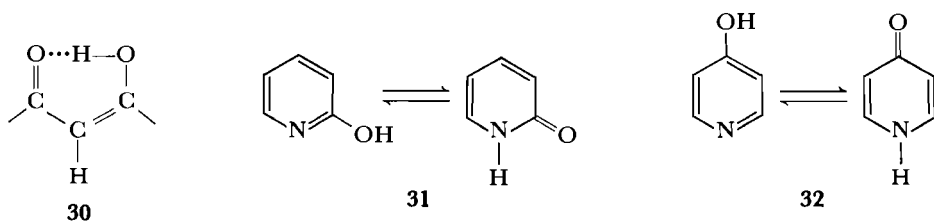

native keto structure would sacrifice the stability associated with the six π electron aromatic system; but in polycyclic phenols it has been possible in a number of cases to obtain keto forms,¹³⁷ and the keto form predominates for heterocyclic compounds such as **31** and **32**.¹³⁸

Several reactions of carbonyl compounds that have one or more α hydrogens proceed through the enol form. Reaction of ketones with chlorine, bromine, and iodine result in substitution of halogen for α hydrogen; rates are typically first-order in ketone and independent of halogen concentration and even of which halogen is used. Racemization of ketones with asymmetric centers adjacent to the

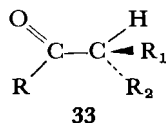

carbonyl group (**33**), and hydrogen–deuterium exchange at the α position, proceed at the same rate as halogenation.¹³⁹ It seems reasonable that all these processes involve the enol, with enol formation being the rate-determining step in each case.

The mechanism for halogenation is shown in Scheme 22. If the carbon α to the carbonyl bears more than one hydrogen, each is replaced by halogen in turn, but the first enolization is rate-determining overall.

SCHEME 22

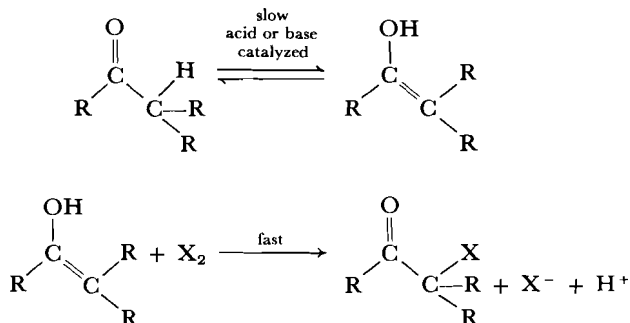

The enolization rate is subject to both general acid and general base catalysis.¹⁴⁰ Base catalysis presumably involves removal of a proton from carbon by the general base to yield the enolate, which will be in equilibrium with the enol. This equilibrium is expected to be rapid, as it involves proton transfer to and from oxygen; halogen can react either with enol, as shown in Scheme 22, or with enolate.

¹³⁷ Forsén and Nilsson, in *The Chemistry of the Carbonyl Group*, Zabicky, Ed., Vol. 2, p. 168.

¹³⁸ S. F. Mason, *J. Chem. Soc.*, 674 (1958).

¹³⁹ (a) R. P. Bell and K. Yates, *J. Chem. Soc.*, 1927 (1962); (b) C. K. Ingold and C. L. Wilson, *J. Chem. Soc.*, 773 (1934); (c) P. D. Bartlett and C. H. Stauffer, *J. Amer. Chem. Soc.*, **57**, 2580 (1935); (d) P. D. Bartlett, *J. Amer. Chem. Soc.*, **56**, 967 (1934); (e) S. K. Hsü and C. L. Wilson, *J. Chem. Soc.*, 623 (1936); (f) S. K. Hsü, C. K. Ingold, and C. L. Wilson, *J. Chem. Soc.*, 78 (1938).

¹⁴⁰ (a) R. P. Bell, *The Proton in Chemistry*, 2nd ed., Cornell University Press, Ithaca, New York, 1973, p. 141; 171; (b) R. P. Bell and H. F. F. Ridgewell, *Proc. Roy. Soc.*, **A298**, 178 (1967); (c) R. P. Bell, G. R. Hillier, J. W. Mansfield, and D. G. Street, *J. Chem. Soc. B*, 827 (1967); (d) R. P. Bell and O. M. Lidwell, *Proc. Roy. Soc.*, **A176**, 88 (1940).

SCHEME 23

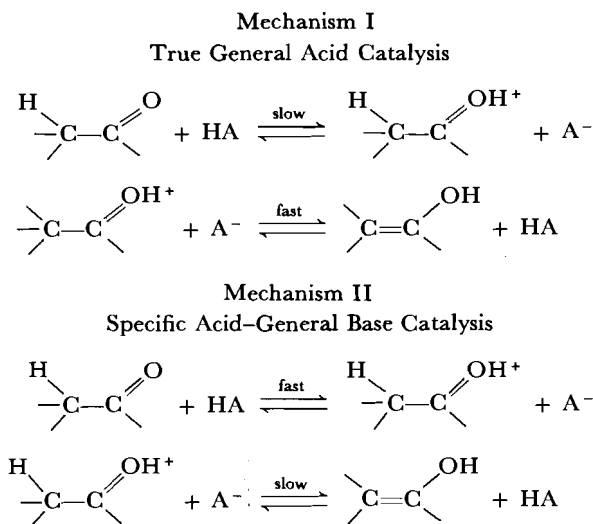

Acid catalysis could be either true general acid (Mechanism I, Scheme 23) or specific acid-general base (Mechanism II). Mechanism II, rate-determining removal of proton by A^- from protonated carbonyl compound, appears to be correct. One expects proton removal from carbon to be the slow process; this intuitive conclusion is substantiated by comparison of rate of hydrolysis of 1-methoxycyclohexane (Equation 8.63) with rate of ketonization of cyclohexanone enol (Equation 8.64). In Equation 8.63, the first step, addition of a proton to the $\text{C}=\text{C}$ double bond, is known to be rate-determining, and is analogous to the reverse of the second step of Mechanism II. Reaction 8.64 proceeds at the same rate as Reaction 8.63; it therefore seems likely that the addition of H^+ to $\text{C}=\text{C}$, and not deprotonation of the oxygen, is also the rate-determining step in Reaction 8.64.¹⁴¹ One may conclude, then, that in acid catalysis of enolization, Mechanism II is correct; that is, addition of proton to $\text{C}=\text{C}$ is rate-determining in the reverse direction, and proton removal from carbon is rate-determining in the forward direction.

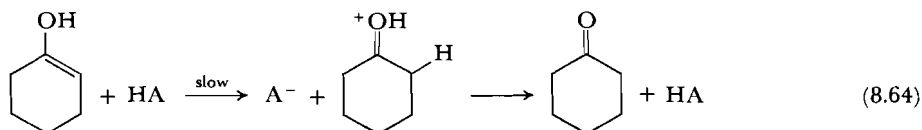
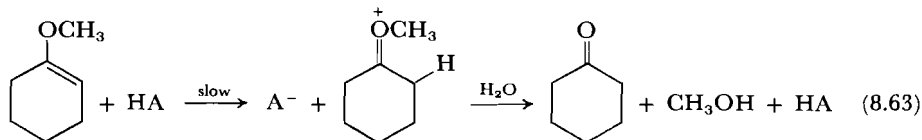

¹⁴¹ G. E. Lienhard and T.-C. Wang, *J. Amer. Chem. Soc.*, **91**, 1146 (1969).

As with the additions to carbonyl carbon, there is the possibility here of concerted catalysis through a transition state **34**, with an acid and a base simultaneously attacking. Early evidence was found by Dawson and Spivey, who

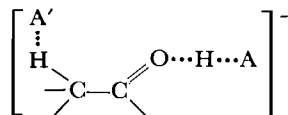
**34**

observed a small contribution to the rate of enolization of acetone of the form $k[\text{acetic acid}][\text{acetate}]$.¹⁴² Bell and Jones confirmed the finding,¹⁴³ and Swain proposed that such a mechanism should be quite general;¹⁴⁴ more recently, Banks has found an example in which the product term is more important.¹⁴⁵ However, a search by Coward and Bruice for intramolecular simultaneous acid and base catalysis in favorable structures failed to show it,¹⁴⁶ and it seems clear

Table 8.7 GROUPS THAT ACTIVATE α HYDROGEN TOWARD BASES

Group	G	Approximate pK_a of $\begin{array}{c} \text{H} \\ \diagup \quad \diagdown \\ \text{C} - \text{G}^a \end{array}$
Carbonyl	$\begin{array}{c} \text{O} \\ \parallel \\ -\text{C}-\text{H} \end{array}$	
	$\begin{array}{c} \text{O} \\ \parallel \\ -\text{C}-\text{R} \end{array}$	20-30
	$\begin{array}{c} \text{O} \\ \parallel \\ -\text{C}-\text{X} \\ (\text{X} = \text{hal.}, -\text{OR}, \\ \text{acyl}, \text{NH}_2) \end{array}$	
Nitrile	$-\text{C}\equiv\text{N}$	25
Sulfinyl	$\begin{array}{c} \text{O} \\ \parallel \\ -\text{S}- \end{array}$	33
Sulfonyl	$\begin{array}{c} \text{O} \\ \parallel \\ -\text{S}- \\ \parallel \\ \text{O} \end{array}$	29
Nitro	$-\text{NO}_2$	10
Iminium	$\begin{array}{c} + \\ \diagup \quad \diagdown \\ \text{N} \\ \parallel \\ -\text{C}- \end{array}$	<i>b</i>

^a See Tables 3.2, p. 149 and 3.10, p. 157.

^b These structures are sufficiently acidic to deprotonate in neutral solution to yield enamines.

¹⁴² H. M. Dawson and E. Spivey, *J. Chem. Soc.*, 2180 (1930).

¹⁴³ R. P. Bell and P. Jones, *J. Chem. Soc.*, 88 (1953).

¹⁴⁴ C. G. Swain, *J. Amer. Chem. Soc.*, 72, 4578 (1950).

¹⁴⁵ B. E. C. Banks, *J. Chem. Soc.*, 63 (1962).

¹⁴⁶ J. K. Coward and T. C. Bruice, *J. Amer. Chem. Soc.*, 91, 5339 (1969).

Table 8.8 CONDENSATION REACTIONS INVOLVING ACTIVE METHYLENE COMPOUNDS*

Active Methylene Compound	Product of Addition to	
	R'X	R'-C(=O)-R'' or R'-C(=O)-H
$\begin{array}{c} \text{H} \quad \text{X}^a \\ \diagdown \quad / \\ \text{C} \\ / \quad \diagdown \\ \text{H} \quad \text{Y} \end{array}$	$\begin{array}{c} \text{X} \quad \text{R}'^b \\ \diagdown \quad / \\ \text{C} \\ / \quad \diagdown \\ \text{Y} \quad \text{H} \end{array}$	$\begin{array}{c} \text{X} \quad \text{R}' \\ \diagdown \quad / \\ \text{H}-\text{C}-\text{C}-\text{OH} \\ / \quad \diagdown \\ \text{Y} \quad \text{R}'' \end{array} \longrightarrow \begin{array}{c} \text{X} \quad \text{R}' \\ \diagdown \quad / \\ \text{C}=\text{C} \\ / \quad \diagdown \\ \text{Y} \quad \text{R}'' \end{array} \quad c, d, e$
$\begin{array}{c} \text{H} \quad \text{COOR}_2 \\ \diagdown \quad / \\ \text{C} \\ / \quad \diagdown \\ \text{H} \quad \text{R}_1 \end{array}$	$\begin{array}{c} \text{R}_2\text{OOC} \quad \text{R}'^b \\ \diagdown \quad / \\ \text{C} \\ / \quad \diagdown \\ \text{R}_1 \quad \text{H} \end{array}$	$\begin{array}{c} \text{R}_2\text{OOC} \quad \text{R}' \\ \diagdown \quad / \\ \text{H}-\text{C}-\text{C}-\text{OH} \\ / \quad \diagdown \\ \text{R}_1 \quad \text{R}'' \end{array} \left(\begin{array}{c} \text{R}_2\text{OC} \quad \text{O} \cdots \text{M}^+ \\ \diagdown \quad / \\ \text{H}-\text{C}-\text{C}-\text{R}' \\ / \quad \diagdown \\ \text{R}_1 \quad \text{R}'' \end{array} \right)^{h, i}$
$\begin{array}{c} \text{O} \\ \\ \text{H} \quad \text{CR}_2 \\ \diagdown \quad / \\ \text{C} \\ / \quad \diagdown \\ \text{H} \quad \text{R}_1 \end{array}$ <p>or</p> $\begin{array}{c} \text{O} \\ \\ \text{H} \quad \text{CH} \\ \diagdown \quad / \\ \text{C} \\ / \quad \diagdown \\ \text{H} \quad \text{R}_1 \end{array}$	$\begin{array}{c} \text{R}_2\text{OC} \quad \text{R}'^k \\ \diagdown \quad / \\ \text{C} \\ / \quad \diagdown \\ \text{R}_1 \quad \text{H} \end{array}$	$\begin{array}{c} \text{R}_2\text{OC} \quad \text{R}' \\ \diagdown \quad / \\ \text{H}-\text{C}-\text{C}-\text{OH}^l \\ / \quad \diagdown \\ \text{R}_1 \quad \text{R}'' \end{array} \longrightarrow \begin{array}{c} \text{R}_2\text{OC} \quad \text{R}'^{m,n} \\ \diagdown \quad / \\ \text{C}=\text{C} \\ / \quad \diagdown \\ \text{R}_1 \quad \text{R}'' \end{array}$

* No attempt is made to include complete references. Discussions in *Organic Reactions* and in H. O. House, *Modern Synthetic Reactions*, 2nd ed., W. A. Benjamin, Menlo Park, Calif., 1972, will provide the reader with access to the literature.

^a X, Y are most commonly —COOR or —CN, but may be other anion-stabilizing groups.

^b A. C. Cope, H. L. Holmes, and H. O. House, *Org. Reactions*, **9**, 107 (1957); House, p. 510.

^c Commonly catalyzed by ammonia or an amine, the Knoevenagel reaction. Amine may in some cases act as proton acceptor, in other cases as nucleophilic catalyst. Dehydration usually occurs and shifts equilibrium in favor of product.

^d G. Jones, *Org. Reactions*, **15**, 204 (1967); House, p. 646.

^e F. Freeman, *Chem. Rev.*, **69**, 591 (1969).

^h The equilibrium is shifted to the right by formation of the stabilized enolate, which is not readily attacked by Z⁻. Acid catalysis is also possible for Z = hal., —OR. See House, p. 772.

that concerted catalysis is not common in aqueous solutions. Intramolecular catalysis by a single acidic or basic group is well established.

Enolate ions, which are usually strong nucleophiles, are more important in preparative applications than are the enols. In additions to carbonyl groups, the carbon end, rather than the oxygen end, attacks; but in S_N2 substitutions on alkyl halides, significant amounts of O-alkylation occur. The more acidic compounds, such as those with the β-dicarbonyl structure, yield enolates with the greater tendency toward O-alkylation. Protic solvents and small cations favor C-alkylation, because the harder oxygen base of the enolate coordinates more strongly than does the carbon with these hard Lewis acids.¹⁴⁷

¹⁴⁷ House, *Modern Synthetic Reactions*, p. 520.

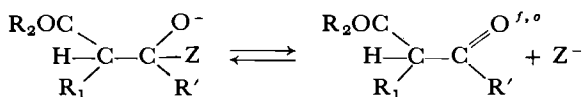
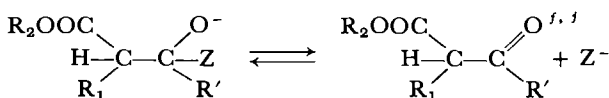
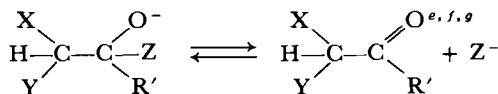
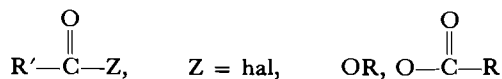

^g House, p. 756.

^h Generally carried out under basic conditions, often starting from the organozinc or organomagnesium derivative of an α -bromoester, the Reformatsky reaction. Equilibrium is shifted toward product by formation of a chelate structure with the metal ion.

ⁱ R. L. Shriner, *Org. Reactions*, **1**, 1 (1942); House, p. 671.

^j C. R. Hauser and B. E. Hudson, Jr., *Org. Reactions*, **1**, 266 (1942); House, p. 734, p. 762.

^k House, p. 546.

^l Aldol condensation. With aldehydes, successful with either acid or base catalysis.

^m With ketones, conditions (strong acid or strong base catalysis) under which dehydration occurs are usually used to shift equilibrium toward the product.

ⁿ A. J. Nielsen and W. J. Houlihan, *Org. Reactions*, **16**, 1 (1968); House, pp. 629–645.

^o C. R. Hauser, F. W. Swamer, and J. T. Adams, *Org. Reactions*, **8**, 59 (1954); House, pp. 747, 762.

Unsymmetrical ketones can yield two different enolates, and in some cases the one that is the less stable thermodynamically is formed faster.¹⁴⁸ Scheme 24 illustrates the example of 2-methylcyclopentanone. When this ketone is added slowly to excess *t*-butyllithium, the proton is removed preferentially from the less substituted carbon. If excess ketone is added, it can serve as a proton donor to allow equilibrium to be established, and nearly all the enolate is then the more highly substituted one.¹⁴⁹ It may be possible in some cases to take advantage of such a selective formation of one of two possible enolates in synthesis. A more general procedure is to use a compound in which the desired position is activated

¹⁴⁸ House, *Modern Synthetic Reactions*, pp. 501–502.

¹⁴⁹ H. O. House and B. M. Trost, *J. Org. Chem.*, **30**, 1341, 4395 (1965).

SCHEME 24

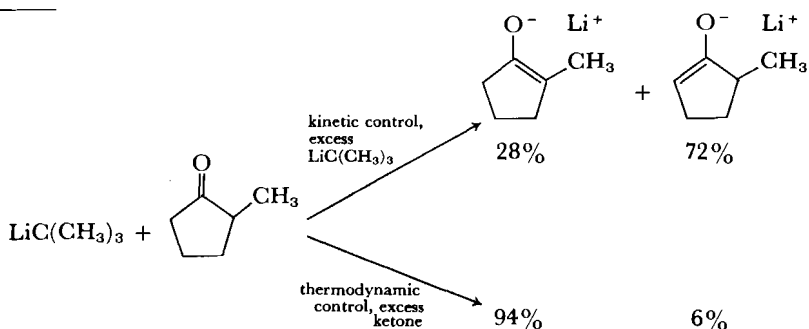

by two electron-withdrawing groups, for example in keto ester **35**, from which, with one equivalent of base, only one enolate will form. Excess base in such cases may yield a dienolate (**36**), which will react as a nucleophile preferentially at the less stabilized position (Equation 8.67).

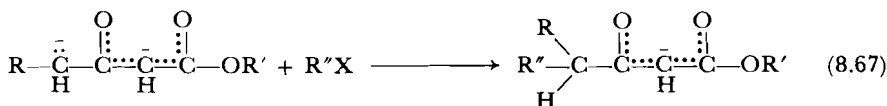
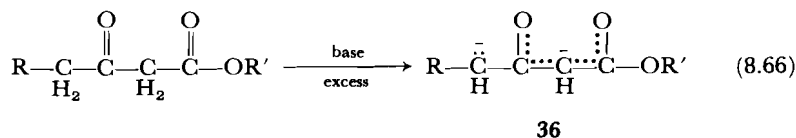
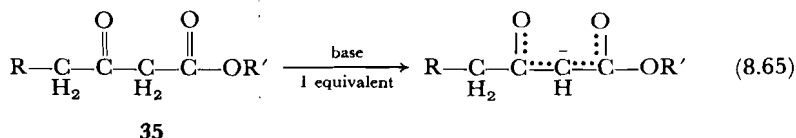

Molecules in which one or more electron-withdrawing groups activate α hydrogens are referred to as *active methylene* compounds. It is important to realize that a number of other electron-withdrawing groups in addition to carbonyl activate an α hydrogen sufficiently that carbanions can be obtained. Table 8.7 lists some of the more important groups of this kind. They span a spectrum from the weakly activating groups such as sulfinyl, which require alkali metal hydrides or alkyl lithiums for deprotonation, to the positively charged iminium group, which deprotonates readily, as indicated in Equation 8.68, to form stable enamines.¹⁵⁰

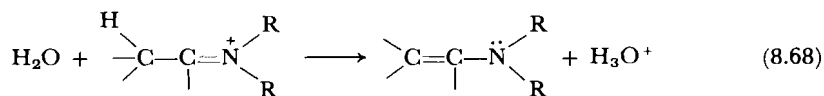

¹⁵⁰ (a) House, *Modern Synthetic Reactions*, pp. 570, 766; (b) note 90 (a); (c) A. G. Cook, Ed., *Enamines: Their Synthesis, Structure, and Reactions*, Marcel Dekker, New York, 1969; (d) S. F. Dyke, *The Chemistry of Enamines*, Cambridge University Press, Cambridge, 1973.

All of these active methylene compounds are capable of undergoing the typical reactions of nucleophiles, usually with basic catalysis through the enolate ion (or analogous anion in the case of the noncarbonyl groups), but in the case of aldehydes and ketones sometimes also with acid catalysis through the enol. These reactions constitute an important class of methods for formation of carbon-carbon bonds and have therefore received a great deal of study, much of it with the purpose of developing synthetic procedures. We shall not attempt to analyze these reactions in any detail; instead we summarize in Tables 8.8 and 8.9 some of the main features of a few of them for the purpose of illustrating how the principles that have been discussed in this and earlier chapters may be applied to correlating and classifying this rich array of organic reactions.

Table 8.9 OTHER CONDENSATION REACTIONS OF CARBONYL COMPOUNDS*

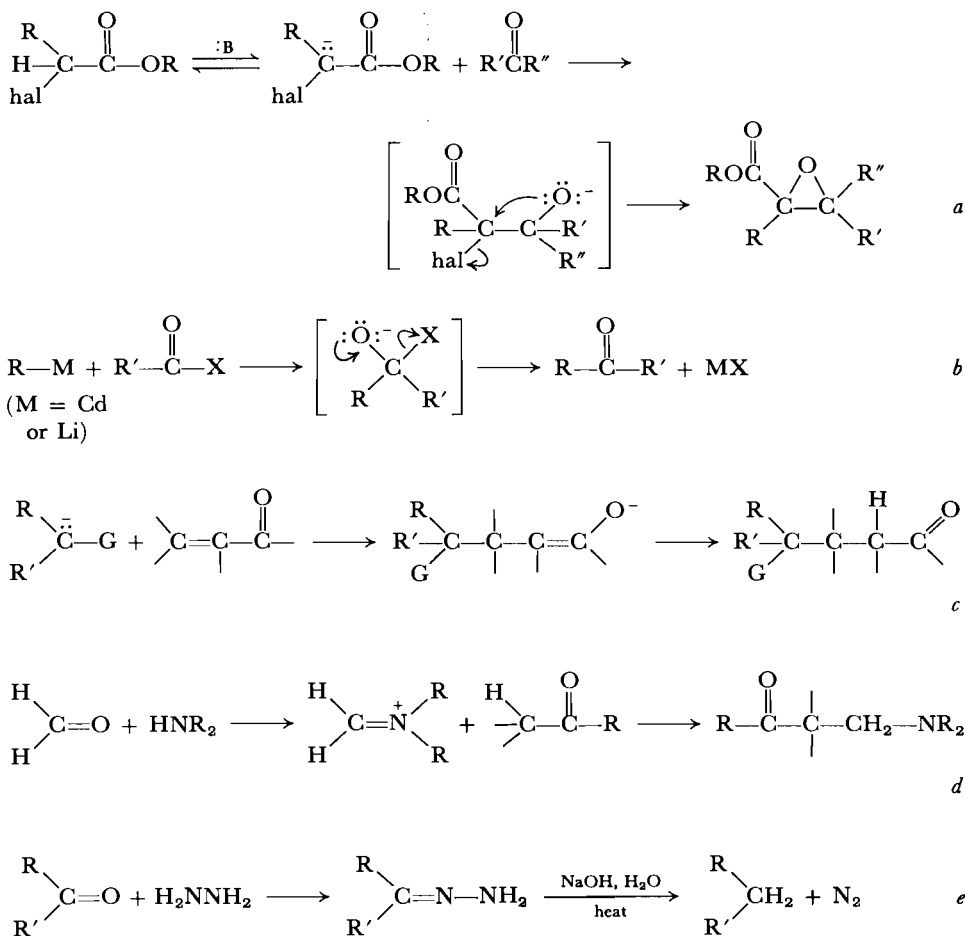
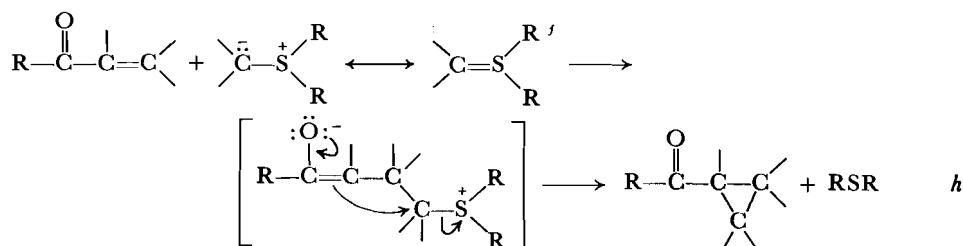
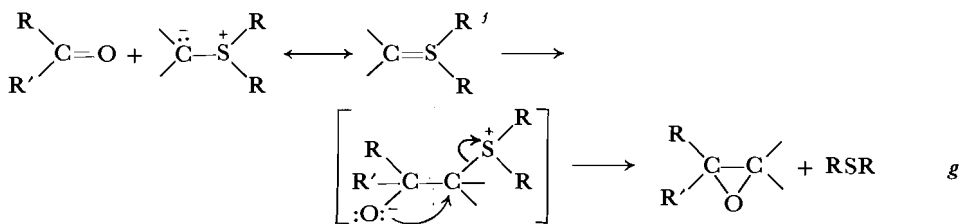
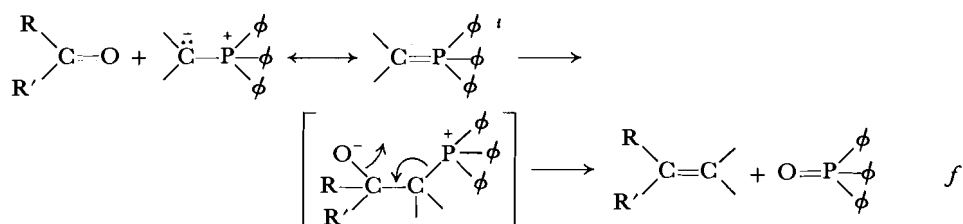

Table 8.9 (Continued)



* No attempt is made to include complete references. Discussions in *Organic Reactions* and in House, *Modern Synthetic Reactions*, 2nd ed., W. A. Benjamin, Menlo Park, Calif., 1972, will provide the reader with access to the literature.

^a Darzens condensation: M. S. Newman and B. J. Magerlein, *Org. Reactions*, 5, 413 (1949); House, p. 666.

^b M = Cd, X = hal: D. A. Shirley, *Org. Reactions*, 8, 28 (1954); M = Li, X = OH, M. J. Jorgenson, *Org. Reactions*, 18, 1 (1970).

^c Michael addition. Discussed in Section 7.3, p. 378. See also E. D. Bergmann, D. Ginsberg, and R. Pappo, *Org. Reactions*, 10, 179 (1959); House, p. 595.

^d Mannich reaction. The β -amino group of the product is readily eliminated to yield an α,β -unsaturated carbonyl structure. Frequently used in synthesis in conjunction with the Michael addition. F. F. Blicke, *Org. Reactions*, 1, 303 (1942); J. H. Brewster and E. L. Eliel, *Org. Reactions*, 7, 99 (1953); House, p. 654.

^e Wolff-Kishner reduction: D. Todd, *Org. Reactions*, 4, 378 (1948); House, p. 228.

^f Wittig reaction: A. Maercker, *Org. Reactions*, 14, 270 (1965); House, p. 682.

^g House, p. 709.

^h House, p. 719.

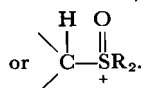
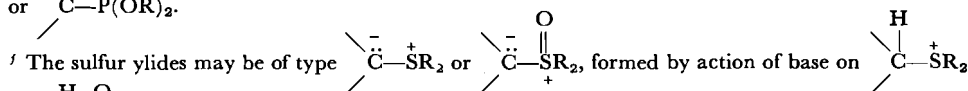
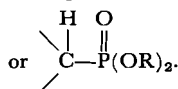
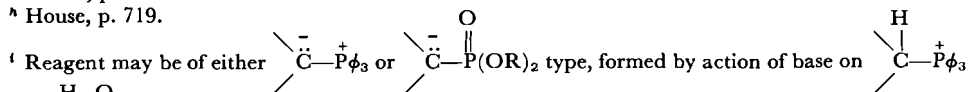

PROBLEMS

1. Explain why ethyl formate condenses with 2-methylcyclohexanone in the presence of base at the unsubstituted position:

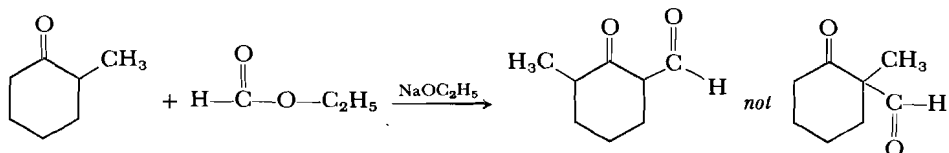

2. Propose a mechanism for the following transformation:

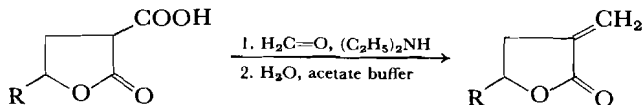

3. Propose a mechanism that will account for the product of the Stobbe condensation:

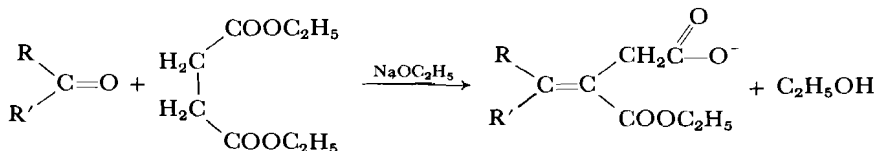

4. Anilinium ion, ϕNH_3^+ , catalyzes semicarbazone formation from benzaldehyde much more effectively than would be expected on the basis of its strength as an acid. Explain.

5. Propose a mechanism to account for the following transformation:

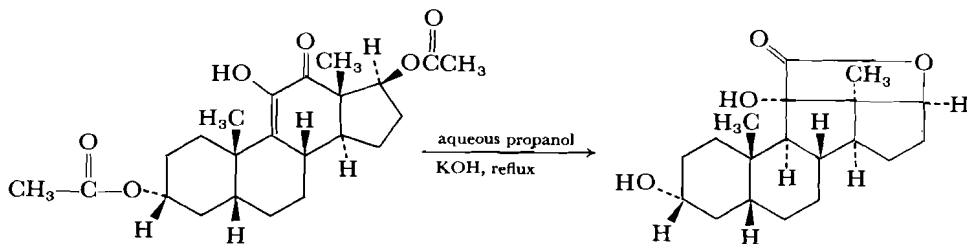

6. Propose a mechanism to account for the following transformation:

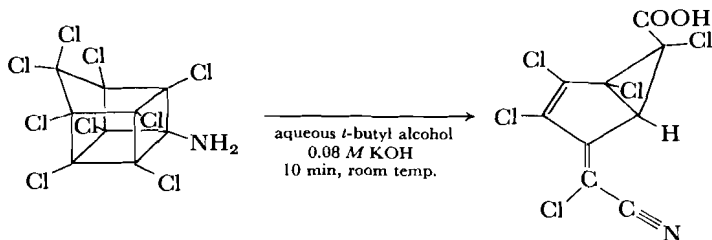

7. Explain why general acid catalysis is found in the hydrolysis of tropone diethylketal (1), despite the fact that hydrolysis of dialkyl ketals ordinarily shows only specific hydronium ion catalysis.

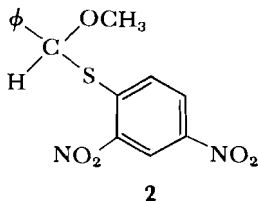
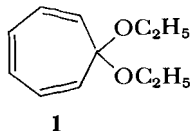

8. Explain why compound 2 hydrolyzes at a rate that is independent of pH in the range pH 1.5 to 0.1 M NaOH, despite the fact that as a general rule acetals and monothioacetals show strong acid catalysis.

9. Propose a mechanism for the benzoin condensation, which is specifically catalyzed by cyanide:

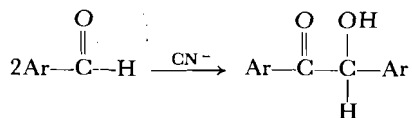

10. Propose a mechanism for the following transformation:

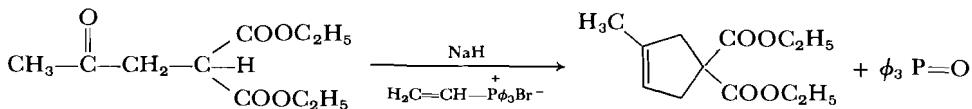

11. Propose mechanisms for the following:

(a) Favorskii rearrangement

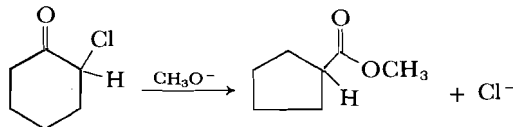

(b) α -Halosulfone rearrangement

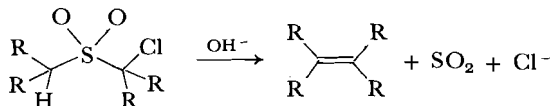

12. Explain the following transformation:

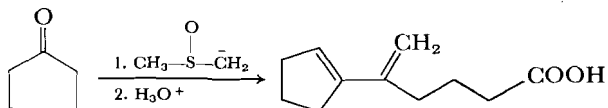

13. Show that a mechanism involving general base catalysis is indistinguishable kinetically from one involving a specific base-catalyzed step followed by a general acid-catalyzed step.

REFERENCES FOR PROBLEMS

1. H. O. House, *Modern Synthetic Reactions*, 2nd ed., W. A. Benjamin, Menlo Park, Calif., 1972, p. 750.
2. (a) J. Martin, P. C. Watts, and F. Johnson, *Chem. Commun.*, 27 (1970); (b) E. S. Behare and R. B. Miller, *Chem. Commun.*, 402 (1970).
3. W. S. Johnson and G. H. Daub, *Org. Reactions*, **6**, 1 (1951).
4. E. H. Cordes and W. P. Jencks, *J. Amer. Chem. Soc.*, **84**, 826 (1962).
5. P. Kurath, *J. Org. Chem.*, **32**, 3626 (1967).
6. K. V. Scherer, Jr., *Tetrahedron Lett.*, 2077 (1972).
7. T. H. Fife, *Accts. Chem. Res.*, **5**, 264 (1972).
8. T. H. Fife and E. Anderson, *J. Amer. Chem. Soc.*, **92**, 5464 (1970).
9. (a) A. Lapworth, *J. Chem. Soc.*, **83**, 995 (1903); (b) J. P. Kuebrich, R. L. Schowen, M. Wang, and M. E. Lupes, *J. Amer. Chem. Soc.*, **93**, 1214 (1971).
10. E. E. Schweizer and G. J. O'Neill, *J. Org. Chem.*, **30**, 2082 (1965).
11. (a) F. G. Bordwell, *Accts. Chem. Res.*, **3**, 281 (1970); (b) L. A. Paquette, *Accts. Chem. Res.*, **1**, 209 (1968).
12. W. T. Comer and D. L. Temple, *J. Org. Chem.*, **38**, 2121 (1973).

Chapter 9

RADICAL REACTIONS

The salient feature of the homolytic process is the presence of the free-radical intermediate. The lack of charge of radicals and the high reactivity of nearly all of those that become involved in a typical organic reaction lead to important differences between homolytic and heterolytic processes.

9.1 CHARACTERISTICS OF ORGANIC FREE RADICALS¹

The free-radical reaction is ordinarily initiated by a homolytic bond cleavage (Equation 9.1). The radicals may then undergo various processes, for example



substitution, addition, rearrangement, elimination, or fragmentation. Unlike the heterolytic counterparts, these processes seldom produce a stable species. The new radical is likely to be as reactive, or nearly so, as was the original one, and so another step will follow rapidly upon the first, producing still another reactive radical, which enters into a third step, and so on. The series ends when two

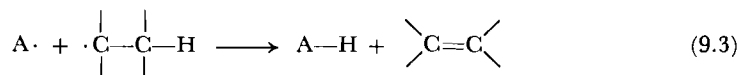

¹ Comprehensive treatments of free-radical chemistry will be found in: (a) C. Walling, *Free Radicals in Solution*, Wiley, New York, 1957; (b) E. S. Huyser, *Free-Radical Chain Reactions*, Wiley-Interscience, New York, 1970; (c) J. K. Kochi, Ed., *Free Radicals*, Vols. I and II, Wiley, New York, 1973; (d) W. A. Pryor, *Free Radicals*, McGraw-Hill, New York, 1966; (e) D. C. Nonhebel and J. C. Walton, *Free Radical Chemistry*, Cambridge University Press, Cambridge, 1974.

radicals encounter each other and either recombine (Equation 9.2) or disproportionate (Equation 9.3). The sequence of radical formation (*initiation*), successive steps generating new radicals (*propagation*), and return to stable molecular species (*termination*) is called a *chain reaction*; although not all radical processes are chain reactions, and nonradical transformations on occasion follow a chain path, chain reactions are so common in homolytic chemistry that we may regard them as typical of free-radical behavior.

The other important difference between heterolytic and free-radical reactions arises from the nature of the termination step. Two radicals, being uncharged and having each an odd number of electrons, can come together to form a stable neutral molecule without encountering any significant barrier; ions, on the other hand, cannot react with others of their own kind. Hence although it is quite common to find stable solutions containing high concentrations of ions, radicals, with a few important exceptions, can exist only in extremely low concentrations and then only when they are being continuously generated. Activation energies for the termination reactions (Equations 9.2 and 9.3) are very low, that for recombination of small alkyl radicals approaching zero. Under these circumstances the rate is limited by the rate at which radicals can come together through the medium; processes with vanishingly small activation energies are said to be *diffusion-controlled*. The diffusion-controlled rate depends on solvent viscosity, and is on the order of 10^9 to 10^{10} $\text{sec}^{-1} M^{-1}$ for typical solvents at ambient temperature.²

The very low activation energies of the termination reactions mean that the lifetimes of individual radicals are short; hence radical reactions competing with termination are necessarily extremely rapid, and the total time elapsed between the generation of a radical in an initiation step and its destruction or the termination of a chain it starts is typically on the order of 1 sec.³

Spectroscopic Investigation of Radical Structure

The rapid self-reaction of most organic radicals makes their direct observation difficult. Exceptions to this generalization are the relatively few radicals that are so highly stabilized that they exist in solution largely or completely in the monomeric radical form rather than as the dimers. Radical lifetimes can also be increased by the presence of bulky groups near the radical center.⁴ A few examples are shown in Structures 1 through 4. With radicals that lack this high degree of

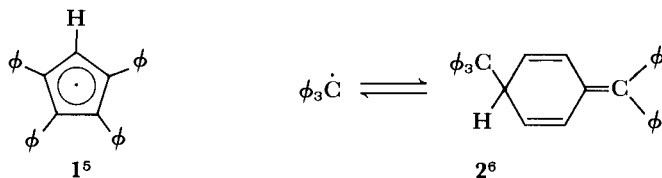

² K. U. Ingold, in *Free Radicals*, J. K. Kochi, Ed., Vol. I, p. 39.

³ Walling, *Free Radicals in Solution*, p. 37.

⁴ G. D. Mendenhall, D. Griller, and K. U. Ingold, *Chem. Brit.*, **10**, 248 (1974).

⁵ E. Müller and I. Müller-Rodloff, *Chem. Ber.*, **69**, 665 (1936).

⁶ (a) H. Lankamp, W. Th. Nauta, and C. MacLean, *Tetrahedron Lett.*, 249 (1968); (b) H. A. Staab, H. Brettschneider, and H. Brunner, *Chem. Ber.*, **103**, 1101 (1970); (c) J. M. McBride, *Tetrahedron*, **30**, 2009 (1974).

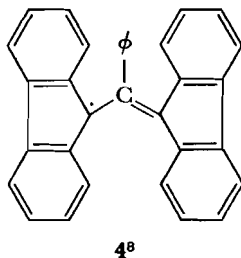
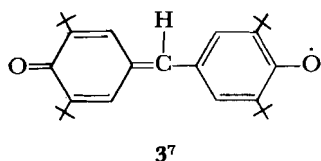

stabilization, it is necessary to circumvent the limitation imposed by rapid termination by using flow techniques, by immobilizing the radicals in an inert solid matrix, or by generating them rapidly, for example by an intense flash of light (flash photolysis) or with a pulse of energetic particles (pulse radiolysis).

Early structural information about the simple alkyl radicals was obtained by Herzberg, who observed the ultraviolet spectra of $\cdot\text{CH}_3$ and $\cdot\text{CD}_3$ in the gas phase by flash photolysis.⁹ Analysis of the fine structure led to the conclusion that the methyl radical is planar, a deviation from planarity of not more than 10° being consistent with the data.¹⁰ The infrared spectrum of $\cdot\text{CH}_3$ has also been recorded; it does not yield conclusive structural information.¹¹ Radicals trapped in a matrix of solid adamantane can be formed by X-irradiation of suitable precursors. In this way, spectra can be obtained at room temperature.¹²

Electron Paramagnetic Resonance

A more generally applicable technique for spectroscopic observation of radicals is *electron paramagnetic resonance* (epr, also known as *electron spin resonance*, esr).¹³ The method is in principle the same as nuclear magnetic resonance but relies on electron spin rather than nuclear spin. The spectrometer detects changes in energy states of the unpaired electron (a spin $\frac{1}{2}$ particle) in the presence of a magnetic field; because only unpaired electrons are detected, it is specific for radicals. If the unpaired electron is close to a proton or other magnetic nucleus, the resonance signal is split by a coupling similar to that which operates in nuclear resonance spectra. The coupling constants depend on the magnitude of the probability distribution function for the unpaired electron in the vicinity of the nucleus in question, and so provide information about structure in organic radicals.

⁷ P. D. Bartlett and T. Funahashi, *J. Amer. Chem. Soc.*, **84**, 2596 (1962).

⁸ C. F. Koelsch, *J. Amer. Chem. Soc.*, **79**, 4439 (1957).

⁹ G. Herzberg and J. Shoosmith, *Can. J. Phys.*, **34**, 523 (1956).

¹⁰ G. Herzberg, *Molecular Spectra and Molecular Structure*, D. Van Nostrand, Reinhold, New York, 1966, Vol. III.

¹¹ (a) D. E. Milligan and M. E. Jacox, *J. Chem. Phys.*, **47**, 5146 (1967); (b) L. Y. Tan, A. M. Winer, and G. C. Pimentel, *J. Chem. Phys.*, **57**, 4028 (1972).

¹² J. E. Jordan, D. W. Pratt, and D. E. Wood, *J. Amer. Chem. Soc.*, **96**, 5588 (1974).

¹³ For further details of techniques and results of epr spectroscopy, see: (a) H. Fischer, in *Free Radicals*, J. K. Kochi, Ed., Vol. II, p. 435; (b) H. M. Assenheim, *Introduction to Electron Spin Resonance*, Plenum Press, New York, 1967; (c) R. Bersohn, in *Determination of Organic Structures by Physical Methods*, Vol. 2, F. C. Nachod and W. D. Phillips, Eds., Academic Press, New York, 1962, p. 563; (d) G. A. Russell, in *Determination of Organic Structures by Physical Methods*, Vol. 3, F. C. Nachod and J. J. Zuckerman, Eds., Academic Press, New York, 1971, p. 293; (e) D. H. Geske, *Prog. Phys. Org. Chem.*, **4**, 125 (1967); (f) J. E. Wertz and J. R. Bolton, *Electron Spin Resonance: Elementary Theory and Practical Applications*, McGraw-Hill, New York, 1972.

Table 9.1 ELECTRON-PROTON AND ELECTRON-¹³C COUPLING CONSTANTS OF SOME ALKYL RADICALS (IN GAUSS)

Radical	$\text{>}\dot{\text{C}}\text{-H}^a$	$\text{H}\text{-}\dot{\text{C}}\text{-}$ ^b	$-\dot{\text{C}}\text{-}^b$
$\cdot\text{CH}_3$	23 ^{c, d}	—	38 ^e
$\text{CH}_3\text{CH}_2\cdot$	22 ^{c, d}	27 ^{c, d}	39 ^e
$\text{CH}_3\text{CH}_2\text{CH}_2\cdot$	22 ^{c, d}	30 ^{c, d}	—
$\begin{array}{c} \text{CH}_3 \\ \diagdown \\ \dot{\text{C}}\text{-H} \\ \diagup \\ \text{CH}_3 \end{array}$	22 ^{c, d}	25 ^{c, d}	41 ^h
$\begin{array}{c} \text{H} & & \text{H} \\ & \diagdown & / \\ & \text{C}=\text{C} \cdot \\ & / & \diagdown \\ \text{H} & & \end{array}$	13 ^e	—	108 ^e
$(\text{CH}_3)_3\text{C}\cdot$	—	23 ^{c, f}	45 ^{h, i}
$\cdot\text{CH}_2\text{F}$	21 ^g	—	55 ^g
$\cdot\text{CHF}_2$	22 ^g	—	149 ^g
$\cdot\text{CF}_3$	—	—	272 ^g

^a $a_{\text{H}\alpha}$ are expected to be negative except for $\cdot\text{CHF}_2$, which is probably positive. See Ref. g, p. 2710, and D. L. Beveridge, P. A. Dobosh, and J. A. Pople, *J. Chem. Phys.*, **48**, 4802 (1968).

^b $a_{\text{H}\beta}$ and $a_{13\text{C}}$ are expected to be positive.

^c R. W. Fessenden and R. H. Schuler, *J. Chem. Phys.*, **39**, 2147 (1963).

^d J. K. Kochi and P. J. Krusic, *J. Amer. Chem. Soc.*, **91**, 3940 (1969).

^e R. W. Fessenden, *J. Phys. Chem.*, **71**, 74 (1967).

^f H. Paul and H. Fischer, *Chem. Commun.*, 1038 (1971).

^g R. W. Fessenden and R. H. Schuler, *J. Chem. Phys.*, **43**, 2704 (1965).

^h H. Fischer, *Free Radicals*, J. K. Kochi, Ed., Vol. II, Wiley, New York, 1973, p. 443.

ⁱ D. E. Wood, L. F. Williams, R. F. Sprecher, and W. A. Latham, *J. Amer. Chem. Soc.*, **94**, 6241 (1972).

A great deal of the electron resonance work has been done with aromatic radical ions, produced by adding or removing a π electron from the neutral molecule by the action of a reducing or oxidizing agent.¹⁴ Correlation of data for many systems with molecular orbital calculations of π electron distributions has led to a quantitative expression, the McConnell relation (Equation 9.4), which

$$a_{\text{H}} = Q\rho \quad (9.4)$$

$$(Q \approx -22 \text{ G}^{15})$$

relates the coupling constant between the odd electron and a hydrogen nucleus attached to the ring, a_{H} , with unpaired electron density (*spin density*), ρ , at the carbon to which the hydrogen is bonded.¹⁶ Q (in gauss, G) is a constant characteristic of the coupling mechanism in a planar π radical. If the radical or radical ion has been prepared from a substrate enriched in ¹³C, a spin $\frac{1}{2}$ nucleus, couplings of the unpaired electron to carbon can be observed. The constants are correlated by an expression similar to, but somewhat more complex than, Equation 9.4.¹⁷

¹⁴ For a review of epr spectroscopy of radical ions, see: J. R. Bolton, in *Radical Ions*, E. T. Kaiser and L. Kevan, Eds., Wiley-Interscience, New York, 1968. Radical ion chemistry is considered further in Section 9.2.

¹⁵ J. A. Pople, D. I. Beveridge, and P. A. Dobosh, *J. Amer. Chem. Soc.*, **90**, 4201 (1968).

¹⁶ (a) H. M. McConnell, *J. Chem. Phys.*, **24**, 632, 764 (1956); (b) H. M. McConnell and D. B. Chesnut, *J. Chem. Phys.*, **28**, 107 (1958).

¹⁷ (a) M. Karplus and G. K. Fraenkel, *J. Chem. Phys.*, **35**, 1312 (1961); (b) Fischer, in *Free Radicals*, J. K. Kochi, Ed., Vol. II, p. 448.

Because of the problem of maintaining even the low concentrations (about $5 \times 10^{-7} M$) required for recording epr spectra, simple alkyl radicals can be observed only if the special methods mentioned earlier are used.¹⁸

The coupling constant between unpaired electron and α protons, a few of which are given in Table 9.1, is in most nonconjugated alkyl radicals 22–23 G. This is the value obtained from Equation 9.4 if it is assumed that the radical electron is localized at the α carbon ($\rho = 1$) and that the hybridization is trigonal as it is in the aromatic π radical ions on which the equation is based.

Alkyl radicals bearing β protons also show coupling to these positions. The coupling constants are ordinarily on the order of 25–30 G, somewhat larger than those to α protons.¹⁹ Such a large coupling might at first seem inconsistent with the idea that coupling depends on unpaired electron density, since one would expect to find very little delocalization to the β position in a saturated system. The β protons, however, do not lie in the nodal plane of the radical p orbital as the α protons do; their position (5) is much more favorable for interaction, and a small degree of delocalization causes substantial coupling. The delocalization here is

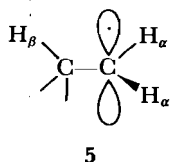

hyperconjugation, discussed further in Section 10.2; the β coupling is a convincing piece of evidence for such delocalization in radicals.

The magnitude of the coupling to the β proton will depend on the angle of rotation about the $C_\alpha-C_\beta$ bond; the coupling is largest when the $C_\beta-H_\beta$ bond is parallel to the axis of the p orbital containing the unpaired electron (6), and smallest when it is perpendicular (7). The relation between the coupling constant and the angle θ is given by Equation 9.5, where A and C are constants with values

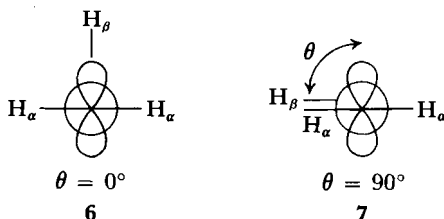

of 0–5 G and 40–45 G, respectively, and θ is the dihedral angle between the $C_\beta-H_\beta$ bond and the $C_\alpha-2p$ axis.

$$a_{H_\beta} = A + C \cos^2 \theta \quad (9.5)$$

This relation yields information about conformations in radicals.²⁰ When there

¹⁸ (a) See note 12, p. 464; (b) R. W. Fessenden and R. H. Schuler, *J. Chem. Phys.*, **39**, 2147 (1963); (c) J. K. Kochi and P. J. Krusic, *J. Amer. Chem. Soc.*, **91**, 3940 (1969); (d) D. J. Edge and J. K. Kochi, *J. Amer. Chem. Soc.*, **94**, 7695 (1972).

¹⁹ See note 18(c), (d). The algebraic sign is predicted theoretically to be opposite for α and β couplings. Few coupling constant signs have been determined experimentally.

²⁰ See, for example: D. Griller and K. U. Ingold, *J. Amer. Chem. Soc.*, **96**, 6715 (1974).

is free rotation about the $C_\alpha-C_\beta$ bond, $\cos^2 \theta$ in Equation 9.5 is replaced by $\frac{1}{2}$, its average value. Coupling constants to more remote protons are small, ordinarily less than 1 G.²¹

Carbon-13 couplings provide further useful information about carbon radicals. Table 9.1 includes some representative values. Theoretical considerations suggest that this parameter should be a sensitive function of hybridization at the radical center;²² the reason in qualitative terms is that deviation from planarity will introduce *s* character into the orbital carrying the unpaired electron and thus will bring that electron closer to the nucleus where it can couple more effectively with the nuclear spin. (Refer to the discussion of hybridization in Appendix 1, p. 43.) The most striking feature of the data in Table 9.1 is the large value of a_{13c} for $\cdot\text{CHF}_2$ and for $\cdot\text{CF}_3$. The results lead to the conclusion that these radicals are nonplanar, bond angles in $\cdot\text{CF}_3$ probably approaching the tetrahedral value.²³ The 45 G a_{13c} observed for the *t*-butyl radical is probably not enough higher than the value for $\cdot\text{CH}_3$ to imply nonplanarity.²⁴

Electron paramagnetic resonance will also detect molecules with two unpaired electrons. With a few exceptions (O_2 is one), molecules with an even number of electrons have all electrons paired in the lowest energy state. But in electronically excited states, and in the ground states of certain reactive intermediates (for example, CH_2 , Section 5.6), two electrons may be unpaired. As we have noted in Section 5.6, a molecule with two unpaired electrons is said to be in a *triplet state*. Electrons in a singlet-state species have no net magnetic moment and will not interact with a magnetic field; that is, a singlet molecule has only one magnetic energy state. But when a triplet-state species is placed in a magnetic field, there are three electron spin energy states. (A radical, with one unpaired electron, has just two energy states.) Transitions among these states of the triplet may be observed in the epr spectrum; they occur at different frequencies from that characteristic of radicals and so are readily distinguished.

Chemical Investigations of Radical Structure

In addition to the spectroscopic investigations, there have been attempts to obtain structural and stereochemical information about radicals by chemical means.²⁵ The approach generally taken is to generate radicals by one of the methods discussed in the next section at a carbon where stereochemistry can be determined. As an example, we may cite the experiment shown in Equation 9.6, in which an optically active aldehyde is heated in the presence of a source of radicals.²⁶ The reaction follows the chain pathway indicated in Scheme 1; the loss of chirality indicates that the radical is either planar or, if pyramidal, undergoes inversion rapidly with respect to the rate (on the order of 10^5 sec^{-1}) at which it abstracts a hydrogen atom from another molecule of aldehyde.

²¹ See note 18(c), (d).

²² (a) See note 17(a), p. 465; (b) D. M. Schrader and M. Karplus, *J. Chem. Phys.*, **40**, 1593 (1964).

²³ (a) R. W. Fessenden, *J. Phys. Chem.*, **71**, 74 (1967); (b) K. Morokuma, L. Pedersen, and M. Karplus, *J. Chem. Phys.*, **48**, 4801 (1964); (c) D. L. Beveridge, P. A. Dobosh, and J. A. Pople, *J. Chem. Phys.*, **48**, 4802 (1968).

²⁴ (a) See note 20; (b) D. E. Wood, L. F. Williams, R. F. Sprecher, and W. A. Latham, *J. Amer. Chem. Soc.*, **94**, 6241 (1972).

²⁵ For a summary, see: L. Kaplan, in *Free Radicals*, J. K. Kochi, Ed., Vol. II, p. 370.

²⁶ W. v. E. Doering, M. Farber, M. Sprecher, and K. B. Wiberg, *J. Amer. Chem. Soc.*, **74**, 3000 (1952).

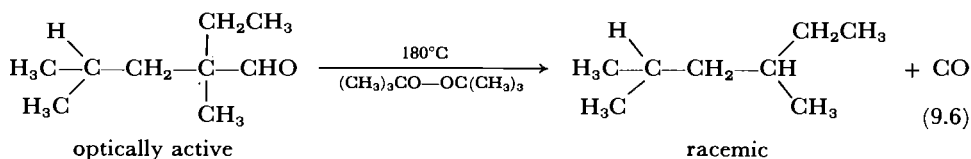

SCHEME 1

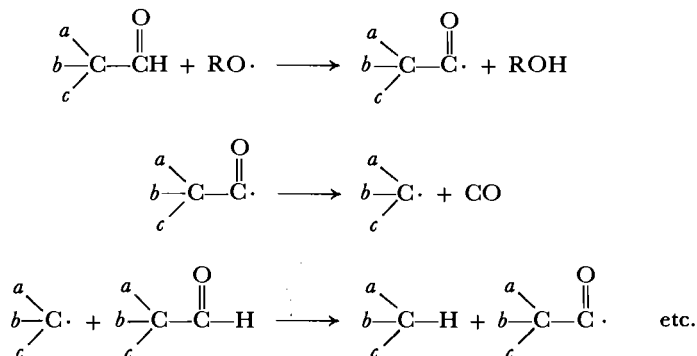
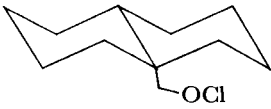
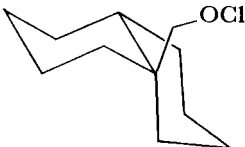

Table 9.2 presents the results of experiments with the 9-decalyl radical, generated as indicated in Scheme 2 from two isomeric precursors.²⁷ In this reaction, the alkyl radicals, which form by fragmentation of the alkoxy radical,

Table 9.2 PRODUCTS OF DECOMPOSITION OF *cis*- AND *trans*-9-DECALYLCARBINYL HYPOCHLORITE AT -40°C

Starting from	Concentration (M)	Products	
		<i>trans</i>	<i>cis</i>
 <i>trans</i>	0.009	27	1
	0.8	26	1
	3.3	32	1
 <i>cis</i>	0.008	29	1
	0.1	10	1
	1.0	1.7	1
	3.0	1.1	1

SOURCE: Reprinted with permission from F. D. Greene and N. N. Lowry, *J. Org. Chem.*, **32**, 875 (1967). Copyright by the American Chemical Society. Refer to this paper for results at other temperatures and concentrations.

²⁷ F. D. Greene and N. N. Lowry, *J. Org. Chem.*, **32**, 875 (1967).

SCHEME 2

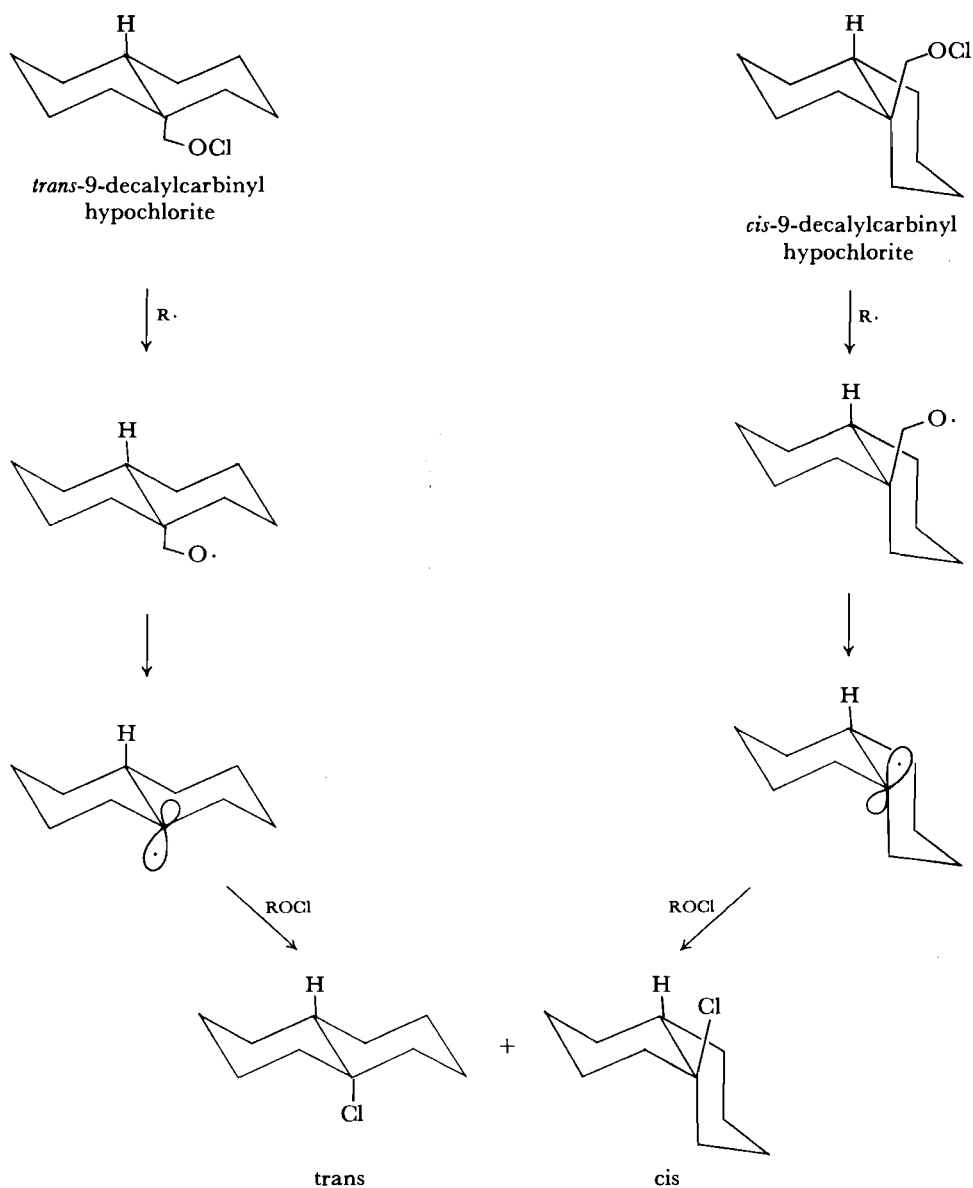

convert to stable products by abstracting a chlorine atom from a new molecule of hypochlorite, which in turn is left as a new alkoxy radical to continue the chain. The lifetime of the alkyl radicals is thus dependent on concentration of the hypochlorite; the results demonstrate that whereas the radical from *trans* precursor does not isomerize (product composition approximately independent of concentration), the radical arising from *cis* precursor isomerizes to the *trans* radical when the concentration of trapping hypochlorite is low but abstracts chlorine before it has time to do so when hypochlorite concentration is high. The barrier

to conversion from cis to trans radical is estimated at 3–6 kcal mole⁻¹.²⁸ Bartlett and co-workers found a similar result in the trapping of 9-decalyl radicals with varying pressures of oxygen.²⁹

One possible interpretation of these results is that the two tertiary decalyl radicals react differently because they are pyramidal (**8** and **9**); on the other hand, the hypothesis that the radicals are planar and differ only in ring con-

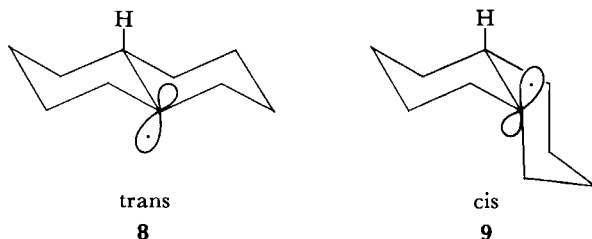

formation (**10** and **11**), explains the facts equally well, as the barrier to such a conversion might well be expected to be of the correct order of magnitude.³⁰

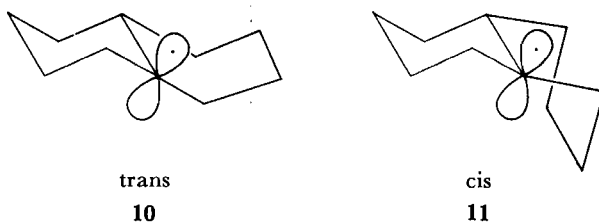

In summary, we must conclude that the inferences about radical geometry and stereochemistry that may be drawn from the available experimental information, both spectroscopic and chemical, are less firm than one might hope. It is reasonably clear that $\cdot\text{CH}_3$ is planar or close to it and that $\cdot\text{CF}_3$ (and probably also $\cdot\text{CHF}_2$) is nonplanar; for other radicals, particularly tertiary ones, the data are not entirely conclusive, but at least demonstrate that if the radicals are nonplanar they invert rapidly, probably faster than 10^5 sec^{-1} .

Chemically Induced Dynamic Nuclear Polarization³¹

Chemically induced dynamic nuclear polarization is a spectroscopic technique that takes advantage of the coupling between electron and nuclear spins to detect products of radical recombinations by nuclear resonance. It is suited to investigation of the dynamics of radical processes, particularly the events just preceding radical recombinations. First observed in 1967 by Bargon and Fischer³² and independently by Ward and Lawler,³³ the phenomenon consists of

²⁸ See note 27.

²⁹ P. D. Bartlett, R. E. Pincock, J. H. Rolston, W. G. Schindel, and L. A. Singer, *J. Amer. Chem. Soc.*, **87**, 2590 (1965).

³⁰ See note 27, p. 468.

³¹ For summaries, see: (a) H. R. Ward, in *Free Radicals*, J. K. Kochi, Ed., Vol. I, p. 239; (b) A. R. Lepley and G. L. Closs, Eds., *Chemically Induced Magnetic Polarization*, Wiley, New York, 1973; (c) D. Bethell and M. R. Brinkman, *Adv. Phys. Org. Chem.*, **10**, 53 (1973); (d) H. R. Ward, *Accts. Chem. Res.*, **5**, 18 (1972); (e) R. G. Lawler, *Accts. Chem. Res.*, **5**, 25 (1972).

³² (a) J. Bargon, H. Fischer, and U. Johnsen, *Z. Naturforsch.*, **22A**, 1551 (1967); (b) J. Bargon and H. Fischer, *Z. Naturforsch.*, **22A**, 1556 (1967); (c) H. Fischer and J. Bargon, *Accts. Chem. Res.*, **2**, 110 (1969).

³³ H. R. Ward and R. G. Lawler, *J. Amer. Chem. Soc.*, **89**, 5518 (1967).

alterations of the normal intensity patterns of the nuclear magnetic resonance spectrum, with lines occurring sometimes with enhanced absorption intensity and sometimes in emission when a reaction mixture is observed while a radical process is occurring. The currently accepted interpretation of the origin of these changes, proposed by Closs³⁴ and by Kaptein and Oosterhoff³⁵ rests on the concept of a *caged* or *geminate* radical pair.

When a pair of radicals is formed in solution by homolytic bond cleavage, it is surrounded by a cage of solvent molecules; there is a competition between recombination and diffusion out of the cage. A caged pair will also arise when two radicals diffuse together from the solution. Once in close association as a pair, interaction of the two electrons will produce either a singlet or a triplet state. The probability of recombination before escape from the cage depends on whether the interacting pair is a singlet, which has spins paired ready for bond formation, or a triplet, which has spins unpaired and so cannot bond. Because the electron and nuclear spins are coupled, the probability that a given pair will be a singlet, which is likely to recombine within the cage, or a triplet, which is likely to escape the cage, is affected by the nuclear spin states. The result is that radicals that happen to have their nuclei in certain spin states are likely to yield cage recombination product, whereas radicals with other nuclear spin states are likely to escape to react outside the cage and give noncage products. The various products of the reaction will therefore have abnormal populations of nuclear spin states immediately after formation; if the nuclear resonance spectrum is observed, one finds abnormal line intensities. Because this phenomenon promises to be an increasingly important one in the study of radical reactions, we give a more detailed account of the mechanism of its operation in the Appendix to this chapter.

Thermochemistry³⁶

Of fundamental importance to free-radical chemistry are bond dissociation energies and radical heats and entropies of formation. Bond dissociation energy is defined as the energy required to break a particular bond to form two radicals. More precisely, bond dissociation energy of the R—X bond, $D(\text{R—X})$, is the enthalpy change of Reaction 9.7.³⁷



Radical heats of formation are defined in the usual way, that is, as enthalpy of formation of the radical in question from the elements in their standard states. The heats of formation and the bond dissociation energies are derivable from each other and are based on the same data. Thus, in Reaction 9.7, the heat of formation of $\text{R}\cdot$ is readily found from the bond dissociation energy by means of the enthalpy cycle shown in Scheme 3 if heats of formation of R—X and $\text{X}\cdot$ are known; conversely, $D(\text{R—X})$ may be found once heats of formation of RX , $\text{R}\cdot$,

³⁴ G. L. Closs, *J. Amer. Chem. Soc.*, **91**, 4552 (1969).

³⁵ R. Kaptein and L. J. Oosterhoff, *Chem. Phys. Lett.*, **4**, 214 (1969).

³⁶ For reviews of radical thermochemistry, see: (a) S. W. Benson, *J. Chem. Educ.*, **42**, 502 (1965); (b) J. A. Kerr, *Chem. Rev.*, **66**, 465 (1966); (c) D. M. Golden and S. W. Benson, *Chem. Rev.*, **69**, 125 (1969); (d) H. E. O'Neal and S. W. Benson, in *Free Radicals*, J. K. Kochi, Ed., Vol. II, p. 275.

³⁷ It is important to distinguish *bond dissociation energy* from *average bond strength*, which is averaged over the bonds of a given type in the molecule.

Table 9.3 SELECTED BOND DISSOCIATION ENERGIES AND RADICAL HEATS OF FORMATION AT 25°C (KCAL MOLE⁻¹)^a

R·	D_{298} (R—H) ^b	ΔH_f° (R·) ^c
·CH ₃	104	34 ^d
·CH ₂ CH ₃	98	25 ^d
·CH ₂ CH ₂ CH ₃	98	23
$\begin{array}{c} \text{H}_3\text{C} \\ \diagdown \\ \text{C}\cdot \\ \diagup \\ \text{H}_3\text{C} \end{array}$	95	17.6 ^d
$\begin{array}{c} \text{H}_3\text{C} \\ \diagdown \\ \text{C}\cdot \\ \diagup \\ \text{H}_3\text{C} \end{array}$	92	8.2 ^d
$\begin{array}{c} \text{O} \\ \\ \text{CH}_3\text{C}\cdot \end{array}$	87	-5.2 ^d
φ·	112	80.0 ^d
·CF ₃	106	-111 ^{d, e}
·CCl ₃	96 ^f	
$\begin{array}{c} \text{CH} \\ // \quad \backslash \\ \text{H}_2\text{C} \quad \text{CH}_2 \end{array}$	89	41.4
·CH ₂ φ	85	44.6 ^d
·OCH ₂ CH ₃	110 ^g	
·OOR	89 ^g	
D(<i>t</i> -BuO- <i>o</i> - <i>t</i> -Bu)	37.5 ^h	
D(<i>t</i> -BuO-OH)	42 ^h	

^a Data from D. M. Golden and S. W. Benson, *Chem. Rev.*, **69**, 125 (1969), except where otherwise noted.

^b Reported uncertainty ± 1 kcal mole⁻¹.

^c Reported uncertainties ≤ 2 kcal mole⁻¹ in most cases.

^d Average of determinations by two or more methods.

^e Erroneously reported as positive in reference (a). See J. A. Kerr, *Chem. Rev.*, **66**, 465 (1966); H. E. O'Neal and S. W. Benson, in *Free Radicals*, J. K. Kochi, Ed., Wiley, New York, 1973, Vol. 11, p. 275.

^f S. W. Benson, *J. Chem. Educ.*, **42**, 502 (1965).

^g M. Simonyi and F. Tüdös, *Adv. Phys. Org. Chem.*, **9**, 135 (1971).

^h S. W. Benson, *J. Chem. Phys.*, **40**, 1007 (1964).

and X· are known. The same comments, of course, apply to the corresponding reaction entropies. Because of their lack of charge, radicals interact relatively

SCHEME 3

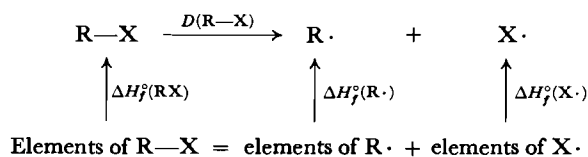

$$\Delta H_f^\circ(\text{RX}) + D(\text{R—X}) - \Delta H_f^\circ(\text{R}\cdot) - \Delta H_f^\circ(\text{X}\cdot) = 0 \quad (9.8)$$

$$D(\text{R—X}) = \Delta H_f^\circ(\text{R}\cdot) + \Delta H_f^\circ(\text{X}\cdot) - \Delta H_f^\circ(\text{RX}) \quad (9.9)$$

little with solvents, and so thermochemical data obtained from gas-phase reactions can be used reasonably confidently for solutions as well.

We shall not consider here the methods by which thermodynamic data are obtained for radicals; O'Neal and Benson have reviewed the various techniques and results.³⁸

Tables 9.3 and 9.4 list selected bond dissociation energies and radical heats of formation. Note particularly that the decrease in energy required to remove hydrogen in the series methane, primary, secondary, tertiary, parallels increasing radical stability, and that aldehydic, allylic, and benzylic hydrogens have bond dissociation energies substantially lower than do alkyl hydrogens.

Just as for molecules, it is possible to estimate radical heats of formation by summing group contributions. Radical entropies and heat capacities are also available by calculation.³⁹ Table 9.5 lists group contributions for radical heats of formation, ΔH_f° , and entropies, S° . The table is used in the way described in Section 2.3, p. 71; contributions for groups not involving the radical center are found from the tables in that section, and corrections for strain and gauche interactions are applied as noted there. The additional corrections given in Table 9.5 must be applied to S° .⁴⁰ Calculated values for radicals are not as accurate as for molecules; the results should be correct to ± 2 kcal mole⁻¹ for

Table 9.4 BOND DISSOCIATION ENERGIES OF HALOGEN COMPOUNDS (KCAL MOLE⁻¹)^a

	$D(\text{X—X})$		$D(\text{H—X})$		$D(\text{CH}_3\text{—X})$
F ₂	38	HF	136	CH ₃ F	108
Cl ₂	58	HCl	103	CH ₃ Cl	84
Br ₂	46	HBr	88	CH ₃ Br	70
I ₂	36	HI	71	CH ₃ I	56

	$D(\text{CH}_3\text{CH}_2\text{—X})$	$D\left(\begin{array}{c} \text{CH}_3 \\ \diagdown \\ \text{CH—X} \\ \diagup \\ \text{CH}_3 \end{array}\right)$	$D((\text{CH}_3)_3\text{C—X})$
F	106	105	—
Cl	82	81	78
Br	69	68	63
I	54	53	50

^a Data from S. W. Benson, *J. Chem. Educ.*, **42**, 502 (1965). See also: J. A. Kerr, *Chem. Rev.*, **66**, 465 (1966), and T. L. Cottrell, *The Strengths of Chemical Bonds*, Butterworths, London, 1954.

³⁸ See note 36(d), p. 471.

³⁹ See note 36(d), p. 471.

⁴⁰ See O'Neal and Benson, in *Free Radicals*, J. K. Kochi, Ed., Vol. II, p. 337, for more detailed discussion of corrections and for data required to correct to other temperatures.

Table 9.5 FREE RADICAL GROUP ADDITIVITIES^a

Radical	ΔH_{f298}°	S_{298}°	$DH^\circ(\text{C—H})^b$
[·C—(C)(H) ₂]	35.82	31.20	98
[·C—(C) ₂ (H)]	37.45	10.74	95
[·C—(C) ₃]	38.00	-10.77	92
[C—(C·)(H) ₃]	-10.08	30.41	—
[C—(C·)(C)(H) ₂]	-4.95	9.42	—
[C—(C·)(C) ₂ (H)]	-1.90	-12.07	—
[C—(C·)(C) ₃]	1.50	-35.10	—
[C—(O·)(C)(H) ₂]	6.1	36.4	—
[C—(O·)(C) ₂ (H)]	7.8	14.7	—
[C—(O·)(C) ₃]	8.6	-7.5	—
[C—(S·)(C)(H) ₂]	32.4	39.0	—
[C—(S·)(C) ₂ (H)]	35.5	17.8	—
[C—(S·)(C) ₃]	37.5	-5.3	—
[·C—(H ₂)(C _d)]	23.2	27.65	—
[·C—(H)(C)(C _d)]	25.5	7.02	—
[·C—(C) ₂ (C _d)]	24.8	-15.00	—
[C _d —(C·)(H)] ^c	8.59	7.97	—
[C _d —(C·)(C)]	10.34	-12.30	—
[·C—(C _B)(H) ₂]	23.0	26.85	85
[·C—(C _B)(C)(H)]	24.7	6.36	82
[·C—(C _B)(C) ₂]	25.5	-15.46	79
[C _B —C·] ^d	5.51	-7.69	—
[C—(·CO)(H) ₃]	-5.4	66.6	—
[C—(·CO)(C)(H) ₂]	-0.3	45.8	—
[C—(·CO)(C) ₂ (H)]	2.6	(23.7) ^e	—
[·N—(H)(C)]	(55.3) ^e	30.23	—
[·N—(C) ₂]	(58.4)	10.24	—
[C—(·N)(C)(H) ₂]	-6.6	9.8	—
[C—(·N)(C) ₂ (H)]	-5.2	-11.7	—
[C—(·N)(C) ₃]	(-3.2)	-34.1	—
[·C—(H) ₂ (CN)]	(54.2) ^f	58.5	—
[·C—(H)(C)(CN)]	(52.8) ^f	40.0	—
[·C—(C) ₂ (CN)]	(52.1) ^f	19.6	—
[·N—(H)(C _B)]	38.0	27.3	—
[·N—(C)(C _B)]	42.7	(6.5)	—
[C _B —N·]	-0.5	-9.69	—
[C—(CO ₂ ·)(H) ₃]	-49.7	71.4	—
[C—(CO ₂ ·)(H) ₂ (C)]	-43.9	49.8	—
[C—(CO ₂ ·)(H)(C) ₂]	-41.0	-12.1	—
[C—(N _A)(H) ₃]	-10.08	30.41	—
[C—(N _A)(C)(H) ₂]	-5.5	9.42	—
[C—(N _A)(C) ₂ (H)]	-3.3	-12.07	—
[C—(N _A)(C) ₃]	-1.9	-35.10	—
[N _A —C] ^g	32.5	8.0	—
[N _A —(N _A ·)(C)]	74.2	36.1	—

Mass corrections in conjugated systems

1. If the masses on each side of a resonance-stabilized bond in a radical have the same number of carbon atoms (i.e., are roughly equal), add 0.7 cal mole⁻¹ °K⁻¹ to the entropy; for example,

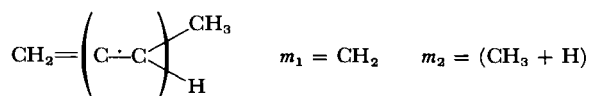
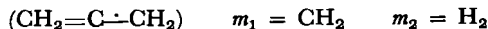

Table 9.5 (continued)

2. If the masses (on each side) differ by one carbon atom, add $0.3 \text{ cal mole}^{-1} \text{ }^\circ\text{K}^{-1}$ to S° ; for example,



Internal rotation barrier corrections^h



SOURCE: H. E. O'Neal and S. W. Benson, *Free Radicals*, J. K. Kochi, Ed., Wiley, New York, 1973, Vol. II, pp. 338-340. Copyright © 1973, John Wiley & Sons. Reprinted by permission of John Wiley & Sons, Inc.

^a Units are kcal mole⁻¹ for ΔH_f° and cal mole⁻¹ °K⁻¹ for S° .

^b Heat of formation group values are based on these (C—H) bond dissociation energies.

^c C_d = doubly bonded carbon.

^d C_B = carbon in a benzene ring.

^e Values in parentheses are best guesses.

^f Heats of formation assume resonance stabilizations: 10.8 kcal mole⁻¹ in ($\cdot\text{CH}_2\text{CN}$); 12.6 kcal mole⁻¹ in ($\text{CH}_3\dot{\text{C}}\text{HCN}$) and in [$(\text{CH}_3)_2\dot{\text{C}}\text{CN}$].

^g N_A = doubly bonded nitrogen in azo compounds.

^h This correction assumes that the barrier to rotation in the radical R· is two-thirds the barrier in the corresponding alkane RH. See O'Neal and Benson for further discussion of this point.

ΔH_f° and to $\pm 2 \text{ cal mole}^{-1} \text{ }^\circ\text{K}^{-1}$ for S° . The following example shows how the table is used to calculate thermodynamic properties for the 2-butyl radical (12).⁴¹

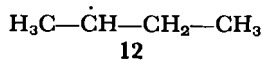

Group	Contribution to ΔH_f° (298°K)	Contribution to S° (298°K)
C—(C)(H) ₃	-10.08	30.41 (Table 2.6)
C—(C·)(H) ₃	-10.08	30.41
C—(C·)(C)(H) ₂	-4.95	9.42
·C—(C) ₂ (H)	+37.45	10.74
Barrier corrections:		
H ₃ C— $\overset{\cdot}{\text{C}}$		0.50
$\overset{\cdot}{\text{C}}$ —CH ₂ —CH ₃		0.50
Symmetry number = 3 × 3 = 9 (two internal threefold rotations of —CH ₃ groups) - R ln 9		
Estimates:	$\Delta H_f^\circ = + 12.3 \text{ kcal mole}^{-1}$; $S^\circ = 77.6 \text{ cal mole}^{-1} \text{ }^\circ\text{K}^{-1}$.	

9.2 RADICAL REACTIONS

As we have noted briefly in the previous section, radical reactions can be broken down into three stages: radical production, reactions yielding new radicals, and radical destruction. In this section we examine each of these steps in more detail.

⁴¹ From H. E. O'Neal and S. W. Benson, in *Free Radicals*, J. K. Kochi, Ed., Vol. II, p. 343. Copyright © 1973, John Wiley & Sons. Reprinted by permission of John Wiley & Sons, Inc.

Radical Production

The first radical source we shall consider is thermal homolysis. At sufficiently high temperatures, all chemical bonds will break to form radicals, but in the temperature range of ordinary solution chemistry, below 200°C, the bonds that will do so at reasonable rates are limited to a few types, the most common of which are the peroxy bond and the azo linkage.⁴² Substances that produce radicals easily in a thermal process are designated *initiators*. Equations 9.10–9.14 illustrate a few typical examples with activation parameters.

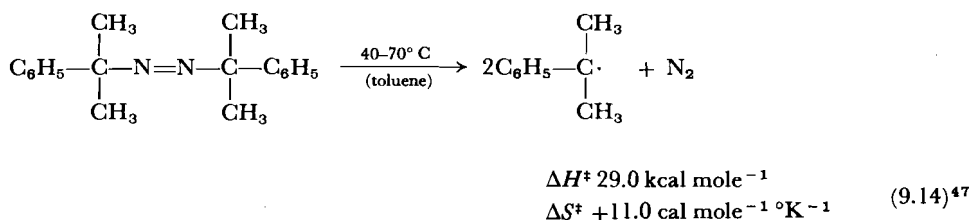
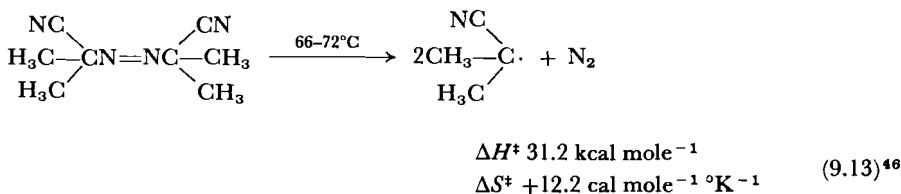
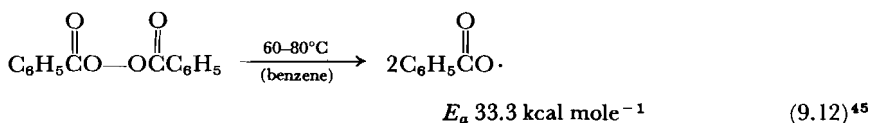
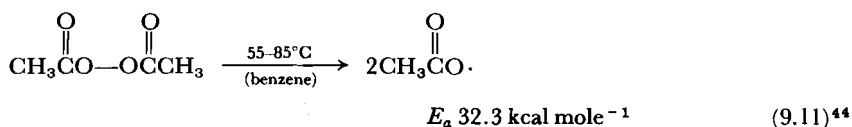
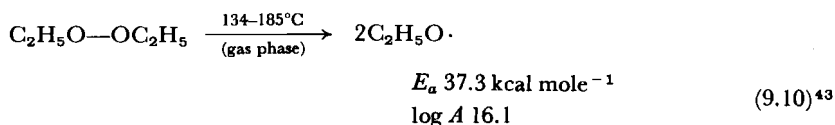

Complications arise in many of these decompositions because of other types of processes that can occur. There are, for example, heterolytic rearrangements of peroxyesters and diacyl peroxides (Equations 9.15 and 9.16), as well as base-catalyzed processes, for example Reaction 9.17. These reactions we mention only

⁴² For a review, see T. Koenig, in *Free Radicals*, J. K. Kochi, Ed., Wiley, New York, 1973, Vol. I, p. 113.

⁴³ C. Leggett and J. C. J. Thynne, *Trans. Faraday Soc.*, **63**, 2504 (1967).

⁴⁴ M. Levy, M. Steinberg, and M. Szwarc, *J. Amer. Chem. Soc.*, **76**, 5978 (1954).

⁴⁵ K. Nozaki and P. D. Bartlett, *J. Amer. Chem. Soc.*, **68**, 1686 (1946).

⁴⁶ R. C. Petersen, J. H. Markgraf, and S. D. Ross, *J. Amer. Chem. Soc.*, **83**, 3819 (1961).

⁴⁷ S. F. Nelsen and P. D. Bartlett, *J. Amer. Chem. Soc.*, **88**, 137 (1966).

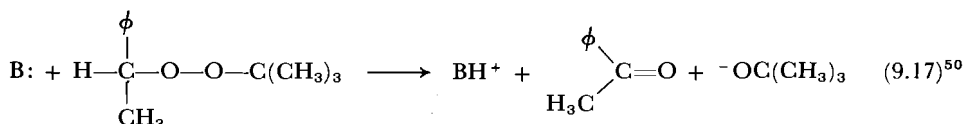
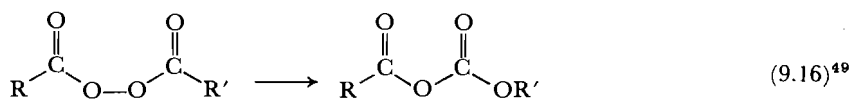
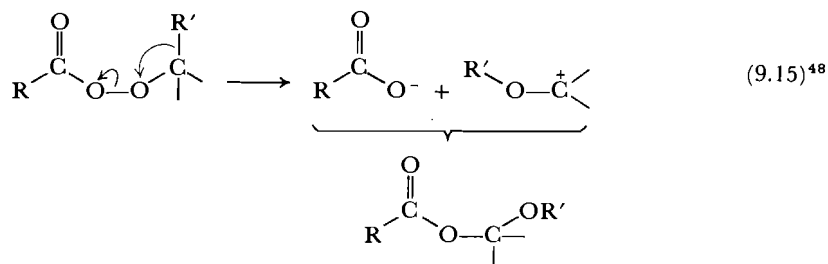

in passing, as they may be understood in terms of the ideas discussed in earlier chapters. Of more immediate concern are the *induced decompositions*, which are chain reactions arising because the radical products of an initial unimolecular decomposition can attack unreacted initiator molecules to yield new radicals that continue the chain. *t*-Butyl hydroperoxide, for example, decomposes when heated in a solvent at 150–180°C.⁵¹ The reaction does not follow first-order kinetics and

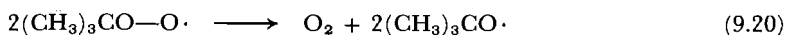
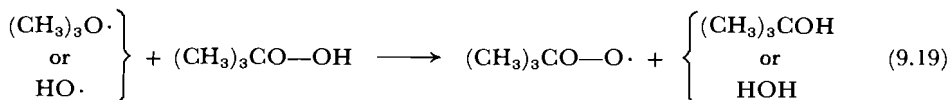
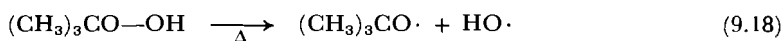

is a chain reaction initiated by a unimolecular decomposition of the peroxide (Equation 9.18) followed by attack of the radicals so produced on unreacted hydroperoxide (Equation 9.19). The peroxy radicals are known to react with each other according to Equation 9.20 to yield molecular oxygen and alkoxy radicals, which can return to attack more hydroperoxide.⁵² The chain nature of the decomposition is amply confirmed by the kinetics⁵³ and by the observation that it is accelerated by the addition of an independent source of radicals.⁵⁴ In

⁴⁸ (a) R. Criegee, *Justus Liebigs Ann. Chem.*, **560**, 127 (1948); (b) E. Heydaya and S. Winstein, *J. Amer. Chem. Soc.*, **89**, 1661 (1967).

⁴⁹ (a) J. E. Leffler, *J. Amer. Chem. Soc.*, **72**, 67 (1950); (b) F. D. Greene, H. P. Stein, C. C. Chu, and F. M. Vane, *J. Amer. Chem. Soc.*, **86**, 2080 (1964).

⁵⁰ N. Kornblum and H. E. DeLaMare, *J. Amer. Chem. Soc.*, **73**, 880 (1951).

⁵¹ (a) E. R. Bell, J. H. Raley, F. F. Rust, F. H. Seubold, and W. E. Vaughan, *Disc. Faraday Soc.*, **10**, 242 (1951); (b) S. W. Benson, *J. Chem. Phys.*, **40**, 1007 (1964).

⁵² We shall return to this reaction later when considering autoxidation in Section 9.3.

⁵³ See note 51(b).

⁵⁴ (a) R. Hiatt, J. Clipsham, and T. Visser, *Can. J. Chem.*, **42**, 2754 (1964); (b) P. D. Bartlett and P. Günther, *J. Amer. Chem. Soc.*, **88**, 3288 (1966).

other instances, solvent molecules may become involved in a chain decomposition.⁵⁵

The complexities of the chain induced decompositions can be minimized by choosing an initiator and solvent without easily abstracted hydrogens; under these conditions peroxy and azo compounds decompose unimolecularly at easily measured rates to provide convenient sources of radicals for use in studying other radical processes.

The unimolecular decompositions are nevertheless not without their complications. Consider, for example, the unimolecular decomposition of benzoyl peroxide in benzene or carbon tetrachloride, where good first-order kinetics indicate that the contribution of induced decomposition is small.⁵⁶ Initial homolysis of the O—O bond leads to two benzoyl radicals (Equation 9.21), which can fragment according to Equation 9.22 to yield phenyl radicals and carbon

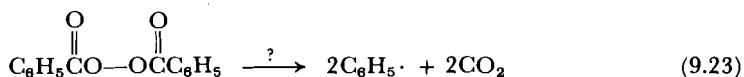
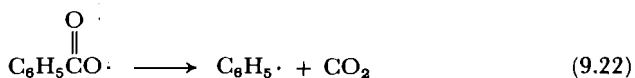
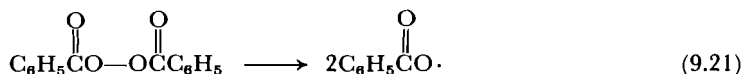

dioxide. It is conceivable, however, that the homolysis and fragmentation could be concerted so that the phenyl radicals and carbon dioxide are formed in a single step as illustrated by Equation 9.23.

For benzoyl peroxide, which decomposes at convenient rates in the neighborhood of 80°C, addition of iodine⁵⁷ or the stable radical galvinoxyl (**13**),⁵⁸ to the reaction reduces the yield of carbon dioxide.⁵⁹ One interpretation of this

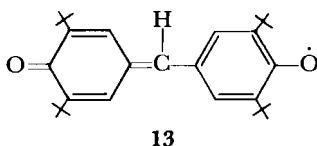

result is that the benzoyl radicals are being trapped before they can decarboxylate; it is nevertheless possible that the reduced carbon dioxide yield results from decomposition induced by the scavenger.⁶⁰ An alternative approach to the problem is to look for scrambling of ¹⁸O label between carbonyl and peroxy positions in unreacted peroxide. Such scrambling does indeed occur, and could be interpreted as in Equation 9.24 to imply nonconcerted reversible homolysis.⁶¹

⁵⁵ (a) W. E. Cass, *J. Amer. Chem. Soc.*, **69**, 500 (1947); (b) P. D. Bartlett and K. Nozaki, *J. Amer. Chem. Soc.*, **69**, 2299 (1947).

⁵⁶ G. S. Hammond and L. M. Soffer, *J. Amer. Chem. Soc.*, **72**, 4711 (1950).

⁵⁷ See note 56.

⁵⁸ H. J. Shine, J. A. Waters, and D. M. Hoffman, *J. Amer. Chem. Soc.*, **85**, 3613 (1963).

⁵⁹ Substances of this kind, which react at rates approaching diffusion control with radicals are referred to as scavengers.

⁶⁰ See note 58.

⁶¹ (a) J. C. Martin and J. H. Hargis, *J. Amer. Chem. Soc.*, **91**, 5399 (1969); (b) see also W. A. Pryor

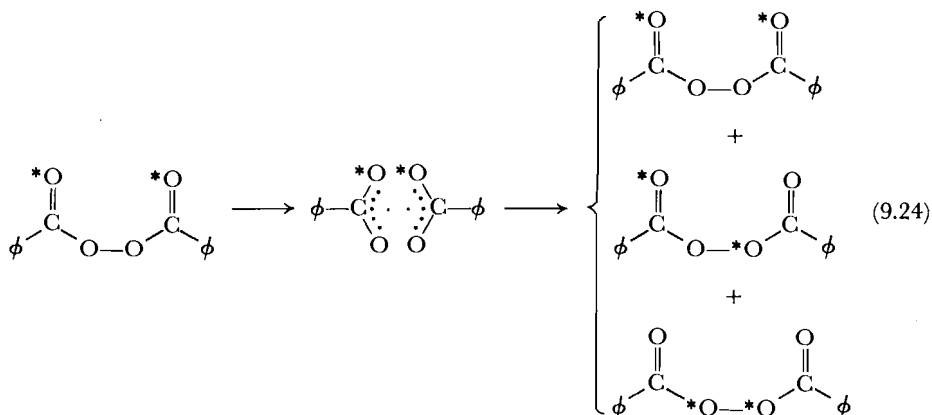

Goldstein and co-workers have pointed out that this oxygen exchange can take place at least partly through nonradical rearrangements 9.25 or 9.26,⁶² and isotope effects in acetyl peroxide decomposition are consistent with significant concerted decomposition.⁶³

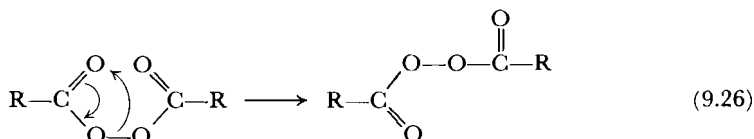
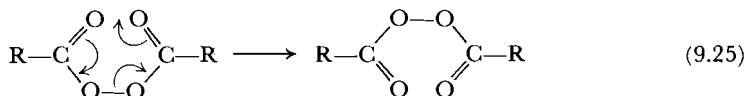

The CIDNP technique gives much useful information about diacyl peroxide decomposition. We shall discuss an example from the work of Ward, the decomposition of propionyl benzoyl peroxide (**14**), which in the presence of I_2 yields the products in Equation 9.27.⁶⁴ Figure 9.1 shows the proton magnetic resonance spectrum recorded while the reaction is occurring at 100°C . The first step

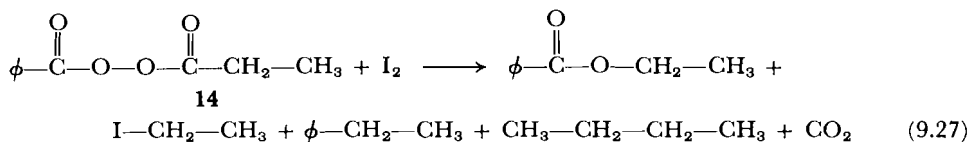

(Scheme 4) will be O—O bond homolysis to yield the caged radical pair **15**, which rapidly loses CO_2 to the new pair **16**. If we follow the CIDNP rules given in the Appendix to this chapter (Table A1.1), we find that the ethyl radical pro-

and K. Smith, *J. Amer. Chem. Soc.*, **92**, 5403 (1970), who discuss the influence of solvent viscosity on rate and the use of such data as a criterion for concertedness.

⁶² (a) M. J. Goldstein and H. A. Judson, *J. Amer. Chem. Soc.*, **92**, 4119, 4120 (1970); (b) M. J. Goldstein, M. DeCamp, and W. A. Haiby, *American Chemical Society, 168th Meeting, Atlantic City, N.J., September 9-13, 1974, Abstracts of Papers*, p. Orgn 53.

⁶³ (a) M. J. Goldstein, *Tetrahedron Lett.*, 1601 (1964); (b) M. J. Goldstein, H. A. Judson, and M. Yoshida, *J. Amer. Chem. Soc.*, **92**, 4122 (1970).

⁶⁴ H. R. Ward, *Accts. Chem. Res.*, **5**, 18 (1972).

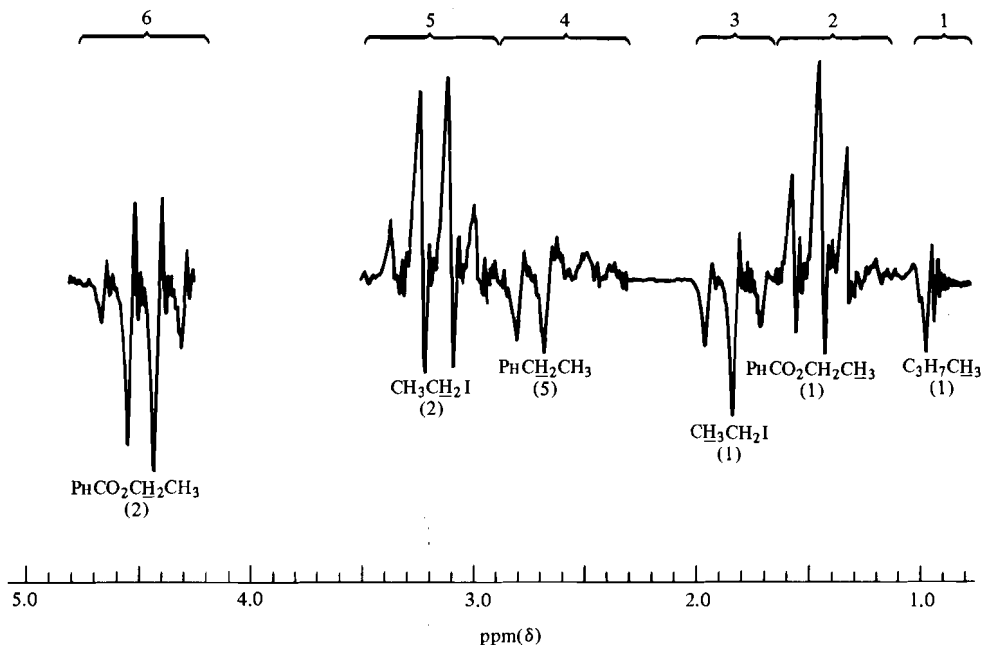

Figure 9.1 Spectrum recorded during the decomposition of a solution of propionyl benzoyl peroxide and iodine in *o*-dichlorobenzene at 100°C. The numbers in parentheses below the formulas indicate the relative spectrum amplitudes for the underlined protons. Spectrum groups referred to in the text are indicated at the top of the figure. Reprinted with permission from H. R. Ward, *Accts. Chem. Res.*, **5**, 18 (1972). Copyright by the American Chemical Society.

tons should acquire net polarization such that the CH_2 protons in products of reaction within the cage will appear in emission and the CH_3 protons in the same products will show enhanced absorption. (Benzoyl radical has the larger g , so Δg is negative. See Table A1.1 in the Appendix to this chapter.) This is indeed the result observed: The CH_2 of ethyl benzoate (17), group 6, gives emission, whereas the CH_3 of the same product, group 2, gives absorption. (A small multiplet effect could also be present, but is largely obscured by the net effect.) The result shows that the benzoyl radical is present in the cage, and clearly demonstrates the stepwise nature of the decomposition in this compound.⁶⁵

The caged pair **16** can lose the second CO_2 to yield a new pair **18**; **18** retains the net polarization of **16**, which was emission for the CH_2 , but now acquires in addition a multiplet effect in the sense E/A for the CH_2 group. The CH_2 in the product phenylethane (**19**), group 4 in the spectrum, shows superposition of the net emission, E , and a multiplet effect in the predicted sense \bar{E}/A . (The CH_3 of this product is evidently obscured by the CH_3 of the ethyl benzoate.) Ethyl radicals that escape from the cage either react with iodine to give ethyl iodide, groups 3 (CH_3) and 5 (CH_2), which shows net polarization just opposite

⁶⁵ Bartlett and co-workers have found chemical evidence for concerted decomposition of certain peroxy esters. See: (a) P. D. Bartlett and R. R. Hiatt, *J. Amer. Chem. Soc.*, **80**, 1398 (1958); (b) P. D. Bartlett and D. M. Simons, *J. Amer. Chem. Soc.*, **82**, 1753 (1960). See also note 63(b).

SCHEME 4

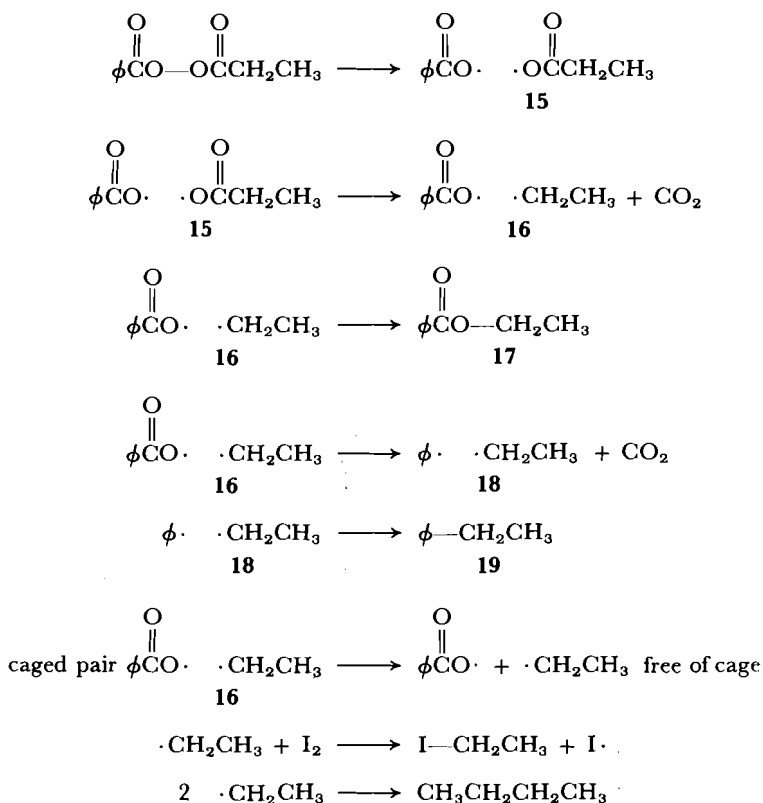

to that of the ethyl benzoate, or combine to give butane, of which the CH_3 can be seen in emission (group 1).

Azoalkanes

Similar questions of concertedness may be raised for decomposition of azoalkanes. In a concerted reaction (Equation 9.28), two C—N bonds would break simultaneously, whereas a stepwise process would produce first one $\text{R} \cdot$ radical

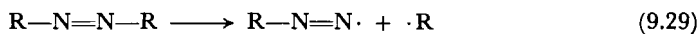
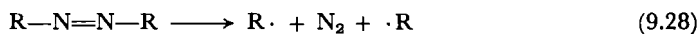

(Equation 9.29) and later the second (Equation 9.30). One test is to measure the effect on decomposition rate of changing one of the R groups. If $\text{R}-\text{N}=\text{N}-\text{R}$ and $\text{R}-\text{N}=\text{N}-\text{R}'$, where $\text{R} \cdot$ is a more highly stabilized radical than $\text{R}' \cdot$, are compared, a lower rate should be found for the unsymmetrical compound in a concerted decomposition; in a stepwise one the better radical $\text{R} \cdot$ should come off first in either compound, and the rate should be unaffected. The results support the concerted process (Equation 9.28) for the symmetrical azo compounds with $\text{R} \cdot$ a well-stabilized radical such as $\phi_2\dot{\text{C}}\text{CN}$, $\phi_2\dot{\text{C}}\text{H}$, and so forth, but leave

open the possibility that in the unsymmetrical cases the mechanism may change to the stepwise one.⁶⁶

Crawford and Tagaki have examined gas-phase decompositions of several azo compounds with $R = \text{CH}_3$, *t*-butyl, or allyl; they found that most of these compounds, both symmetric and unsymmetric, decompose by the nonconcerted path (Equation 9.29).⁶⁷ Seltzer found by studying secondary deuterium isotope effects that in unsymmetrical azo compounds in which one R group is a much better radical than the other, the bond breaking is stepwise.⁶⁸ In a compound such as **20**, substitution of the hydrogen on the α -phenylethyl side gives

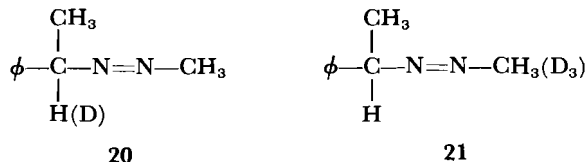

$k_{\text{H}}/k_{\text{D}} = 1.13$, a reasonable value for partial breaking of the bond between nitrogen and the carbon at which the deuterium substitution is made. If, on the other hand, deuterium substitution is made in the methyl group (**21**), the $k_{\text{H}}/k_{\text{D}}$ is 0.97 for three deuteriums, or 0.99 per deuterium. These C—H bonds are therefore being altered very little in the rate-determining step, and the conclusion is that the N—CH₃ bond is not breaking. The isotope effect observed when two deuteriums are substituted in **22**, which can produce stabilized benzylic radicals, is $k_{\text{H}}/k_{\text{D}} = 1.27$ (two deuteriums), or 1.13 per deuterium. Therefore here both

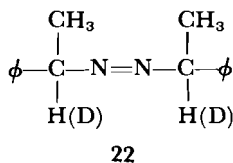

C—N bonds are breaking, and force constants of the C—H bonds on both sides are altered at the transition state.⁶⁹ Pryor and Smith have found independent evidence favoring the single bond cleavage mechanism for unsymmetrical azo compounds.⁷⁰

Decomposition chemistry of the azo compounds is potentially complicated by the existence of *cis* and *trans* isomers (**23** and **24**). The *trans* form is the more

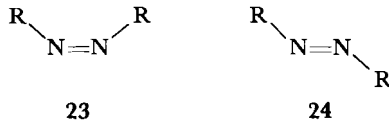

stable; *cis* isomers can be prepared by low-temperature photolysis, but they decompose fairly rapidly at room temperature to yield partly *trans* isomer and

⁶⁶ See Koenig, in *Free Radicals*, J. K. Kochi, Ed., Vol. I, p. 143, for a summary of results.

⁶⁷ R. J. Crawford and K. Takagi, *J. Amer. Chem. Soc.*, **94**, 7406 (1972).

⁶⁸ S. Seltzer and F. T. Dunne, *J. Amer. Chem. Soc.*, **87**, 2628 (1965).

⁶⁹ See note 68.

⁷⁰ W. A. Pryor and K. Smith, *J. Amer. Chem. Soc.*, **92**, 5403 (1970).

partly radical products.⁷¹ The cis isomers are implicated as intermediates in photochemical decompositions starting from trans,⁷² but it is not clear whether they are also involved in thermal decompositions.

Structural Effects

The discussion above has pointed out some of the relationships between structure and concertedness in the decompositions of peroxy compounds and azo alkanes. Other structural variations have been investigated also, such as the effect of electron-donating and -withdrawing substituents and of geometry about carbon atoms at which radical character is developing.

Because radicals are uncharged, one would expect that electron donation and withdrawal would be less important than in ionic reactions. Although this expectation is certainly correct, there is nevertheless ample evidence that transition states of radical reactions do have some polar character. In resonance terminology, one might describe the transition state of a homolysis as a resonance hybrid (25) of covalent, radical, and ionic structures, with importance of the ionic forms subject to influence by substituents in A and B. It should therefore

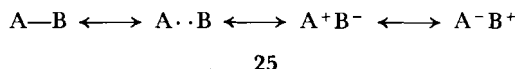

not be surprising to find modest polar effects in radical reactions; indeed, in perester decompositions, for example of 26, a Hammett correlation of rate with σ^+ parameters yields ρ in the neighborhood of -1 , a result that demonstrates significant acceleration by electron donation.⁷³ The result is that expected if in

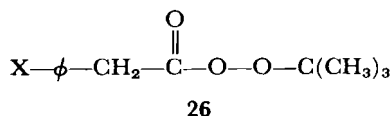

the transition state of a concerted decomposition the breaking C—CO bond is polarized toward the electron-deficient carbonyl carbon, as shown in 27, leaving the benzylic position with some carbocation character. Investigation of alkyl

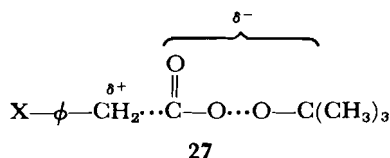

peroxides using the Taft correlation also indicates the polar nature of those transition states.⁷⁴

⁷¹ N. A. Porter and L. J. Marnett, *J. Amer. Chem. Soc.*, **95**, 4361 (1973).

⁷² See note 71.

⁷³ (a) P. D. Bartlett and C. Rüdhardt, *J. Amer. Chem. Soc.*, **82**, 1756 (1960); (b) J. P. Engstrom and J. C. DuBose, *J. Org. Chem.*, **38**, 3817 (1973).

⁷⁴ (a) W. H. Richardson, M. B. Yelvington, A. H. Andrist, E. W. Ertley, R. S. Smith, and T. D. Johnson, *J. Org. Chem.*, **38**, 4219 (1973). The idea that polar effects are important in radical reactions has been challenged by (b) A. A. Zavitsas and J. A. Pinto, *J. Amer. Chem. Soc.*, **94**, 7390 (1972). This work is, however, controversial. See for example (c) W. A. Pryor, W. H. Davis, Jr., and J. P. Stanly, *J. Amer. Chem. Soc.*, **95**, 4754 (1973).

Azo compound decomposition is much less susceptible to polar substituent effects, and so probably has less charge separation in the transition state,⁷⁵ but is more sensitive to geometrical restrictions. Bridgehead azo compounds decompose at rates lower than expected on the basis of their tertiary nature, whereas peresters are much less strongly affected.⁷⁶ The difference can be rationalized by the proposal that the transition state comes farther along the reaction coordinate in azo decomposition, so that the nonplanarity forced on the incipient radical by the ring system is felt more strongly there.

Photochemical Homolysis

A second general method of obtaining radicals is through irradiation, either with light or accelerated particles. The energy transferred to the molecule by the interaction must be of the order of bond dissociation energies or greater to produce homolysis. The energy associated with light quanta in the visible region of the spectrum range from around 40 kcal mole⁻¹ in the red to 70 kcal mole⁻¹ in the blue.⁷⁷ These energies are sufficient for only the weaker bonds, but in the readily accessible ultraviolet, down to 200 nm, the energy rises to a little over 140 kcal mole⁻¹, enough to break most bonds. It should not be concluded that all molecules will homolyze readily upon irradiation with ultraviolet light; in the first place, the light must be absorbed, and many substances are transparent down to 200 nm; second, even when the energy is absorbed, a significant portion of it must be concentrated in vibrational modes leading to dissociation rather than being distributed so as to lead to any of a variety of other pathways open to excited states.

More detailed consideration of light absorption and consequent chemical changes is left to Chapter 13, but it is appropriate here to summarize briefly the types of compounds that are convenient photochemical radical sources. Many of the substances we have been discussing as thermal radical sources absorb light in the visible or ultraviolet and can be decomposed photochemically. The azoalkanes are particularly versatile; they absorb around 350 nm and decompose cleanly to nitrogen and two radicals just as in the thermal reaction. As we have already noted, a preliminary photochemical isomerization to the *cis* isomer precedes the homolysis, which is actually a thermal decomposition of this unstable form.⁷⁸ CIDNP observations confirm a stepwise decomposition pathway, and clarify the various reactions of the radicals produced.⁷⁹

The dialkyl peroxides absorb light below about 300 nm; the quantum energy at this wavelength corresponds to 95 kcal mole⁻¹, and since these compounds have activation energies for thermal homolysis on the order of 35 kcal mole⁻¹ for the dialkyl peroxides and 30 kcal mole⁻¹ for the diacyl peroxides,

⁷⁵ (a) J. R. Shelton, C. K. Liang, and P. Kovacic, *J. Amer. Chem. Soc.*, **90**, 354 (1968); (b) P. Kovacic, R. R. Flynn, J. F. Gormish, A. H. Kappelman, and J. R. Shelton, *J. Org. Chem.*, **34**, 3312 (1969).

⁷⁶ C. Rüchardt, *Angew. Chem. Int. Ed.*, **9**, 830 (1970).

⁷⁷ The quantum energies are put on a per mole basis (energy of Avagadro's number of quanta) for convenient comparison with molar bond dissociation energies. Refer to Section 13.1 for further discussion.

⁷⁸ See note 71, p. 483, (b) N. A. Porter, L. J. Marnett, C. H. Lochmüller, G. L. Closs, and M. Shobataki, *J. Amer. Chem. Soc.*, **94**, 3664 (1972).

⁷⁹ See note 78(b).

there is an excess of at least 60 kcal mole⁻¹. The acyl radicals lose CO₂ rapidly, whereas the alkoxy radicals from dialkyl peroxides, if in the gas phase where they cannot readily dissipate their excess energy by collisions, undergo fragmentation.⁸⁰

Ketones constitute another important class that will yield radicals on irradiation. Nonconjugated ketones absorb weakly in the ultraviolet at 270 nm and decompose with cleavage at the carbonyl group as indicated in Equation 9.31. The carbonyl radical may then fragment further with loss of carbon monoxide according to Equation 9.32. Although this reaction can serve as a source of the

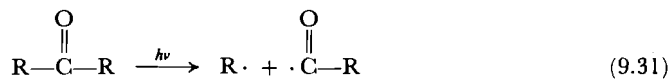

simplest alkyl radicals, there are potential complications from another process when the R groups contain chains of three or more carbons.⁸¹ Similar types of dissociations occur in carboxylic acid derivatives. A number of other functional groups, including aliphatic halides and the hypohalites, ROX, dissociate to radicals on absorption of ultraviolet light.

Termination⁸²

The most important processes that remove radicals are (1) combination of radicals with each other, either by direct bond formation (recombination) or by hydrogen atom transfer from one to the other (disproportionation), and (2) electron transfer between a radical and an oxidizing or reducing agent.

Radical recombination is the simple bond formation between two radicals, for example Equation 9.33; disproportionation is the transfer of a β hydrogen from one radical to the other, shown in Equation 9.34.

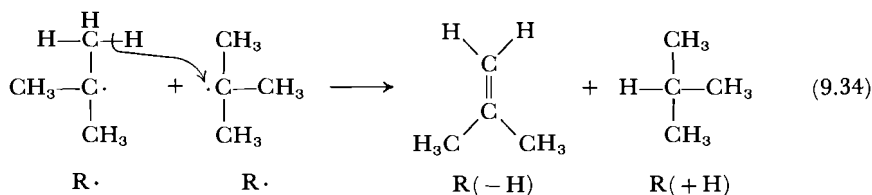
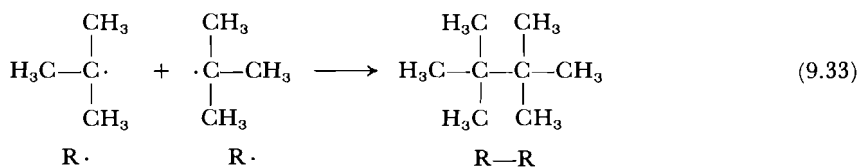

Rates of recombination and disproportionation of simple alkyl radicals are, as we have indicated earlier, very high, and special techniques are required to measure them. These methods measure total termination rate, recombination

⁸⁰ See J. G. Calvert and J. N. Pitts, Jr., *Photochemistry*, Wiley, New York, 1966, chap. 5.

⁸¹ See Section 13.4 for further discussion of ketone photochemistry.

⁸² For a review see M. J. Gibian and R. C. Corley, *Chem. Rev.*, **73**, 441 (1973).

plus disproportionation. Direct measurement is limited to those systems where the radicals themselves can be observed, a requirement that can sometimes be met with flash photolysis or electron resonance. More common are indirect methods, of which one, the *rotating sector* technique, will serve as an example.⁸³

One first selects a chain reaction that can be initiated photochemically and that is terminated by the recombination and disproportionation of interest. An example would be the tin hydride reduction of an alkyl bromide, which proceeds according to Scheme 5. Kinetic analysis (see p. 493) yields a relation between rate

SCHEME 5

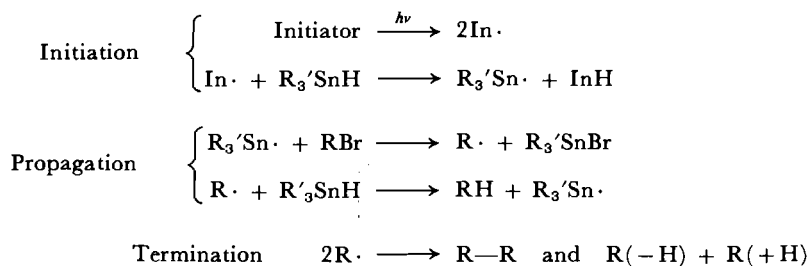

constants of the individual steps and rate of change of some conveniently observed physical property. Initiation rate depends on the square root of light intensity and can be measured directly; the problem is to separate the dependences on propagation and termination. This task is accomplished by observing the response of the system to a periodic interruption of the light source by a rotating screen with a sector cut from it. As the screen stops the light, initiation ceases and the reaction rate falls rapidly, only to increase again when the light is allowed to pass. By measuring the average rate of reaction and the rate of interruption of the light, it is possible to obtain the propagation and termination rate constants. We shall not derive here the equations relating rate constants to the speed of rotation of the sector and to measured reaction rate; they may be found in the literature.⁸⁴

Termination rate constants for alkyl and benzyl radicals in solution range between 10^9 and $10^{10} M^{-1} \text{sec}^{-1}$.⁸⁵ These rates correspond quite closely to that calculated for a diffusion-controlled reaction, about $8 \times 10^9 M^{-1} \text{sec}^{-1}$ for the common solvents at room temperature.⁸⁶ Gas-phase rotating sector results are similar; a newer method, however, shows that in the gas phase the rotating sector technique overestimates termination rates. Recombination is fastest for methyl radicals ($10^{10.5} M^{-1} \text{sec}^{-1}$) and slower for others ($\cdot\text{CF}_3$, $10^{9.7}$ at 146°C ;

⁸³ (a) For a discussion of this and other similar techniques, see: K. U. Ingold, in *Free Radicals*, J. K. Kochi, Ed., Vol. I, p. 40. (b) The rotating sector technique is reviewed by G. M. Burnett and H. W. Melville, in S. L. Friess, E. S. Lewis, and A. Weissberger, Eds., *Technique of Organic Chemistry*, Wiley-Interscience, New York, 1963, Vol. VIII, Part II, p. 1107.

⁸⁴ See note 83(b).

⁸⁵ Termination rates ordinarily quoted are $2k_t$, where k_t is the bimolecular rate constant for the sum of recombination and disproportionation. The factor of 2 appears because two radicals are removed from the system each time the reaction occurs. See K. U. Ingold, in *Free Radicals*, J. K. Kochi, Ed., Vol. I, p. 43, for references to particular alkyl radical results. Rotating sector measurements for allylic radicals have been reported by H. J. Hefter, C. S. Wu, and G. S. Hammond, *J. Amer. Chem. Soc.*, **95**, 851 (1973).

⁸⁶ See K. U. Ingold, in *Free Radicals*, J. K. Kochi, Ed., Vol. I, p. 39.

$C_2H_5\cdot$, $\sim 10^9$ at $142^\circ C$; isopropyl, $10^{8.6}$ at $142^\circ C$; and *t*-butyl, $10^{5.4}$ at $100^\circ C$).⁸⁷ (Disproportionation, which occurs for all except CH_3 and CF_3 , is not included in the figures.) The reason for the discrepancy between solution and gas-phase rates is not entirely clear.⁸⁸

Not all radicals terminate as rapidly as do the simple alkyl radicals. There are, for example, those relatively rare, highly stabilized radicals mentioned in Section 9.1 (p. 463) for which termination rates are comparable to or less than the dissociation rates. There is also a middle ground of radicals that still terminate rapidly enough to preclude obtaining stable solutions, but that nevertheless react with each other more slowly, often by several powers of ten, than the diffusion-controlled rate. Phenoxy radicals with an unsubstituted ortho or para position,

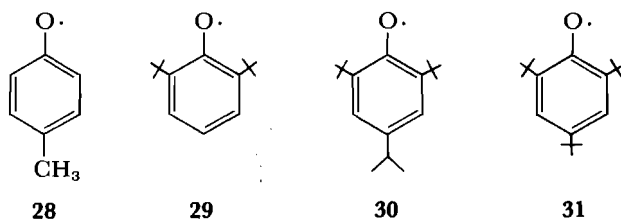

for example **28** and **29**, terminate at rates on the order of 10^6 – $10^9 M^{-1} sec^{-1}$, depending on solvent and substituents.⁸⁹ Substitution at the two ortho and the para positions, with one substituent bearing a benzylic hydrogen, as in **30**, reduces the rate dramatically, to the order of 1 – $5 M^{-1} sec^{-1}$. The reason for the large substituent effect is that the terminations occur through different mechanisms according to the substitution pattern, as indicated in Equations 9.35 and 9.36.⁹⁰

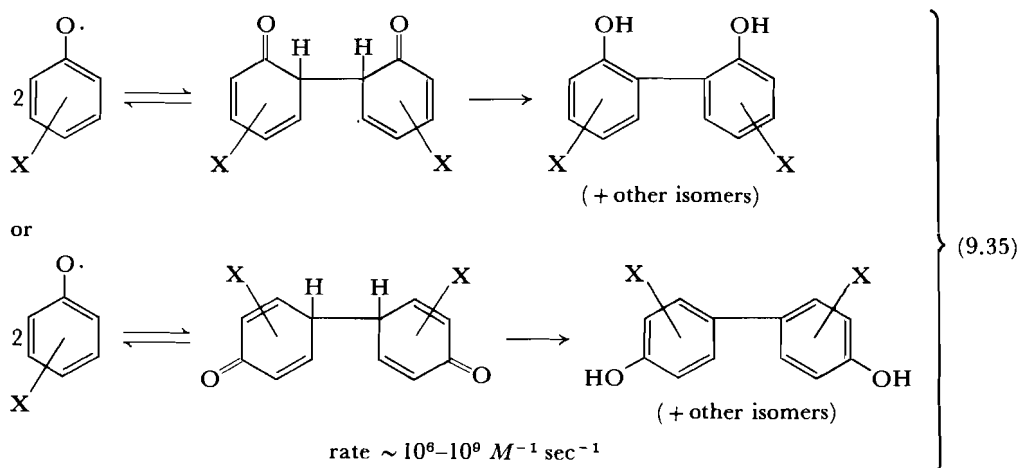

⁸⁷ (a) R. Hiatt and S. W. Benson, *J. Amer. Chem. Soc.*, **94**, 25, 6886 (1972); (b) R. Hiatt and S. W. Benson, *Int. J. Chem. Kinetics*, **4**, 151, 479 (1972); (c) R. Hiatt and S. W. Benson, *Int. J. Chem. Kinetics*, **5**, 385 (1973); (d) $k_t = 10^{9.5}$ for isopropyl between 410 and $535^\circ C$: D. M. Golden, L. W. Piskiewicz, M. J. Perona, and P. C. Beadle, *J. Amer. Chem. Soc.*, **96**, 1645 (1974).

⁸⁸ See note 87(b).

⁸⁹ L. R. Mahoney and S. A. Weiner, *J. Amer. Chem. Soc.*, **94**, 585, 1412 (1972).

⁹⁰ (a) See note 89, (b) C. D. Cook and B. E. Norcross, *J. Amer. Chem. Soc.*, **81**, 1176 (1959); (c) A. Hubele, H. Suhr, and U. Heilmann, *Chem. Ber.*, **95**, 639 (1962).

2,4,6-Tri-*t*-butyl phenoxy radical (31), which can react by neither Equation 9.35 nor Equation 9.36, is stable in solution in the absence of oxygen.

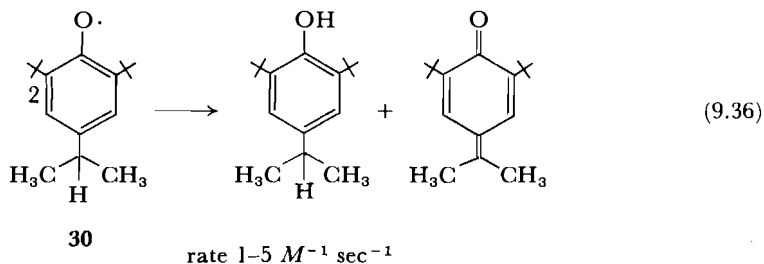

Tertiary peroxy radicals also give slow termination rates (10^3 – $10^4 M^{-1} \text{ sec}^{-1}$)⁹¹ because their dimerization yields an unstable tetroxide that either redissociates or decomposes, partly by a pathway producing new radicals that can continue chains.⁹² The scheme is outlined in Equation 9.37. Primary and

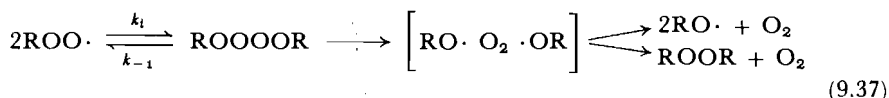

secondary peroxy radicals terminate faster; the tetroxide has available a concerted decomposition path (32), the Russell mechanism, yielding nonradical products.⁹³

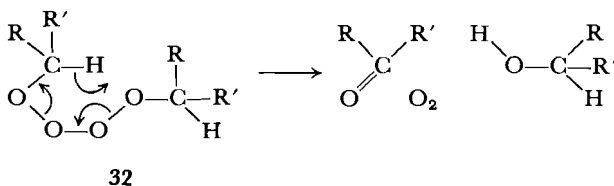

Of the two alternative termination reactions, disproportionation is in alkyl radicals ordinarily somewhat slower than recombination, but frequently still fast enough to compete. Total termination rate can be separated into recombination and disproportionation rates by analyzing the products. The number of hydrogens available for transfer at the β position of a radical will contribute a statistical factor; thus isopropyl radicals, with six β hydrogens, would disproportionate twice as rapidly as ethyl with only three if other factors were equal. For this reason comparisons of disproportionation rates among compounds of different types require rates corrected by dividing by the number n of β hydrogens. Disproportionation becomes more favorable relative to recombination in the series primary, secondary, tertiary, the ratios $k_{\text{dis}}/(n)(k_{\text{comb}})$ being roughly 0.05, 0.2, and 0.8 in this series.⁹⁴ In tertiary radicals stabilized by conjugation, disproportion-

⁹¹ (a) J. A. Howard, in G. H. Williams, Ed., *Advances in Free Radical Chemistry*, Vol. 4, Academic Press, New York, 1972, p. 49; (b) K. U. Ingold, *Accts. Chem. Res.*, **2**, 1 (1969).

⁹² (a) H. S. Blanchard, *J. Amer. Chem. Soc.*, **81**, 4548 (1959); (b) P. D. Bartlett and P. Günther, *J. Amer. Chem. Soc.*, **88**, 3288 (1966); (c) P. D. Bartlett and T. G. Traylor, *J. Amer. Chem. Soc.*, **85**, 2407 (1963); (d) P. D. Bartlett and G. Guaraldi, *J. Amer. Chem. Soc.*, **89**, 4799 (1967).

⁹³ G. A. Russell, *J. Amer. Chem. Soc.*, **79**, 3871 (1957).

⁹⁴ R. A. Sheldon and J. K. Kochi, *J. Amer. Chem. Soc.*, **92**, 4395 (1970). Note that in the *t*-butyl radical, with nine hydrogens, seven times as many radical pairs will disproportionate as combine even though the disproportionation rate per hydrogen is less than k_{comb} .

tionation is slower relative to combination; values of $k_{\text{dis}}/(n)(k_{\text{comb}})$ are typically less than 0.01.⁹⁵ Reasons for the observed ratios are not completely understood.

Cage Effects

Radicals initially formed in solution by a bond homolysis will be held together briefly in a cage of solvent molecules. Because radical recombinations and disproportionations are so fast, they can compete with diffusion of the radicals through the layer of solvent molecules that surround them, with the consequence that some of the radicals formed never become available to initiate other processes in the bulk of the solution.⁹⁶ These recombinations are termed *geminate recombinations*, and the phenomena that arise from this behavior are *cage effects*.

In the simplest type of bond homolysis, where only one bond breaks, as with a dialkyl peroxide, cage recombination simply regenerates the starting compound and hence is the radical analog of internal return in ionizations.⁹⁷ Equation 9.38 illustrates this process; the bar over the radical pair is the symbol for its caged nature. The effect of the internal return is simply to lower the rate of

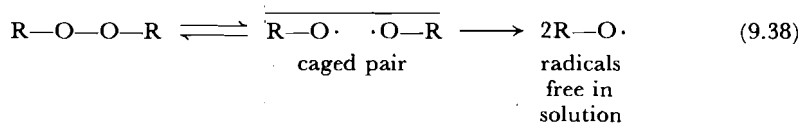

disappearance of substrate from what it would have been without the return. A key to the experimental detection of this phenomenon is the dependence of cage effect on solvent viscosity. The more viscous the solvent, the more difficult it will be for the radicals to move through the walls of the cage and escape; and the longer they remain trapped, the greater the chance that they will recombine with each other. The theoretical relationship between viscosity and internal return has been applied to the determination of the extent of cage recombination.⁹⁸ In other types of structures, such as diacyl peroxides, isotopic labeling may be used as pointed out earlier (p. 478) to detect return; the two methods sometimes agree (acetyl peroxide, for which about 36 percent of radicals formed return in octane⁹⁹) but not always (*t*-butyl perbenzoate¹⁰⁰), and the problem requires more investigation for its satisfactory resolution.

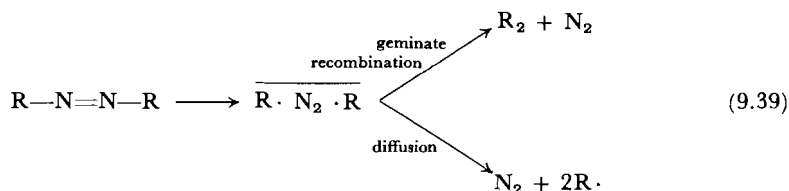

⁹⁵ J. R. Shelton, C. K. Liang, and P. Kovacic, *J. Amer. Chem. Soc.*, **90**, 354 (1968).

⁹⁶ (a) J. Franck and E. Rabinowitch, *Trans. Faraday Soc.*, **30**, 120 (1934); (b) E. Rabinowitch and W. C. Wood, *Trans. Faraday Soc.*, **32**, 1381 (1936); (c) R. M. Noyes, *J. Amer. Chem. Soc.*, **77**, 2042 (1955).

⁹⁷ See Section 5.1, p. 216.

⁹⁸ (a) W. A. Pryor and K. Smith, *J. Amer. Chem. Soc.*, **89**, 1741 (1967); (b) W. A. Pryor and K. Smith, *J. Amer. Chem. Soc.*, **92**, 5403 (1970).

⁹⁹ (a) See note 98(b), (b) J. W. Taylor and J. C. Martin, *J. Amer. Chem. Soc.*, **89**, 6904 (1967).

¹⁰⁰ T. Koenig, M. Deinzer, and J. A. Hoobler, *J. Amer. Chem. Soc.*, **93**, 938 (1971).

When the decomposition in question involves more than one bond in a concerted homolysis, as in an azoalkane (Equation 9.39), the disappearance of substrate is unaffected by recombination, but the number of $R\cdot$ radicals available in the bulk solution to initiate other processes is less than two for each molecule of initiator consumed. Most experimental efforts to determine amount of cage recombination in these instances are of either the crossover or the scavenger type. In a crossover experiment, one decomposes a mixture of $R-N=N-R$ and $R'-N=N-R'$; geminate recombination must yield only $R-R$ and $R'-R'$, whereas the separated radicals will recombine randomly to a statistical mixture of $R-R$, $R'-R'$, and $R-R'$.¹⁰¹

The scavenging approach is to add a substance that reacts very rapidly with radicals. Some typical scavengers are the stabilized free radicals such as galvinoxyl (3, p. 464), the Koelch radical (4, p. 464), and diphenylpicryl hydrazyl (33).¹⁰² These radicals will not undergo self-recombination, but nevertheless

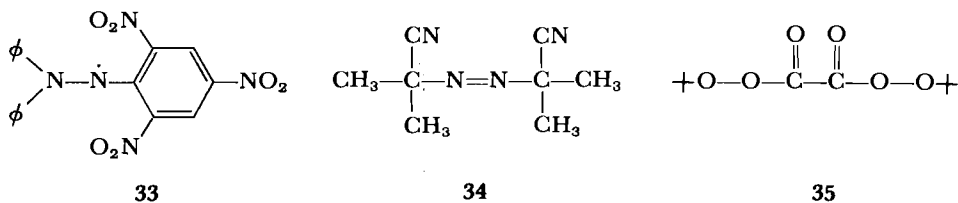

react with less stabilized radicals at high rates. Other possible scavengers are substances with particularly easily abstracted hydrogens, for example, thiols, RSH . The task of the scavenger is to pick up all the radicals that escape from the cage. Experimentally, one measures the rate of disappearance of a low concentration of a colored scavenger radical in the presence of excess decomposing initiator; rates first-order in initiator and independent of scavenger concentration assure that the scavenger is trapping all available radicals.¹⁰³ Results of these experiments show, for example, that azo-isobutyronitrile (34) yields only 65 percent of the potential radicals as free scavengable radicals in solution, whereas with di-*t*-butylperoxyoxalate (35), which produces two *t*-butoxy radicals in a cage separated by two carbon dioxide molecules, all the radicals produced escape from the cage.¹⁰⁴

Finally, recall that geminate processes are detected by the spectroscopic technique of chemically induced nuclear polarization. Because the CIDNP spectrum is directly related to properties of the caged radical pair, as explained in the Appendix to this chapter, much useful information about the nature of caged radicals and their fate can be obtained by this method.

Chain Reactions

We turn now to a more detailed consideration of some of the features of chain reactions. As we have noted earlier, these processes consist of three stages: initiation, propagation, and termination. Each of these classes may include one

¹⁰¹ The results will require a correction for disproportionation if k_{dis}/k_{comb} is different for $R + R$, $R + R'$, and $R' + R'$. See, for example, note 94.

¹⁰² C. E. H. Bawn and S. F. Mellish, *Trans. Faraday Soc.*, **47**, 1216 (1951).

¹⁰³ See, for example: P. D. Bartlett and T. Funahashi, *J. Amer. Chem. Soc.*, **84**, 2596 (1962).

¹⁰⁴ See note 103.

SCHEME 6

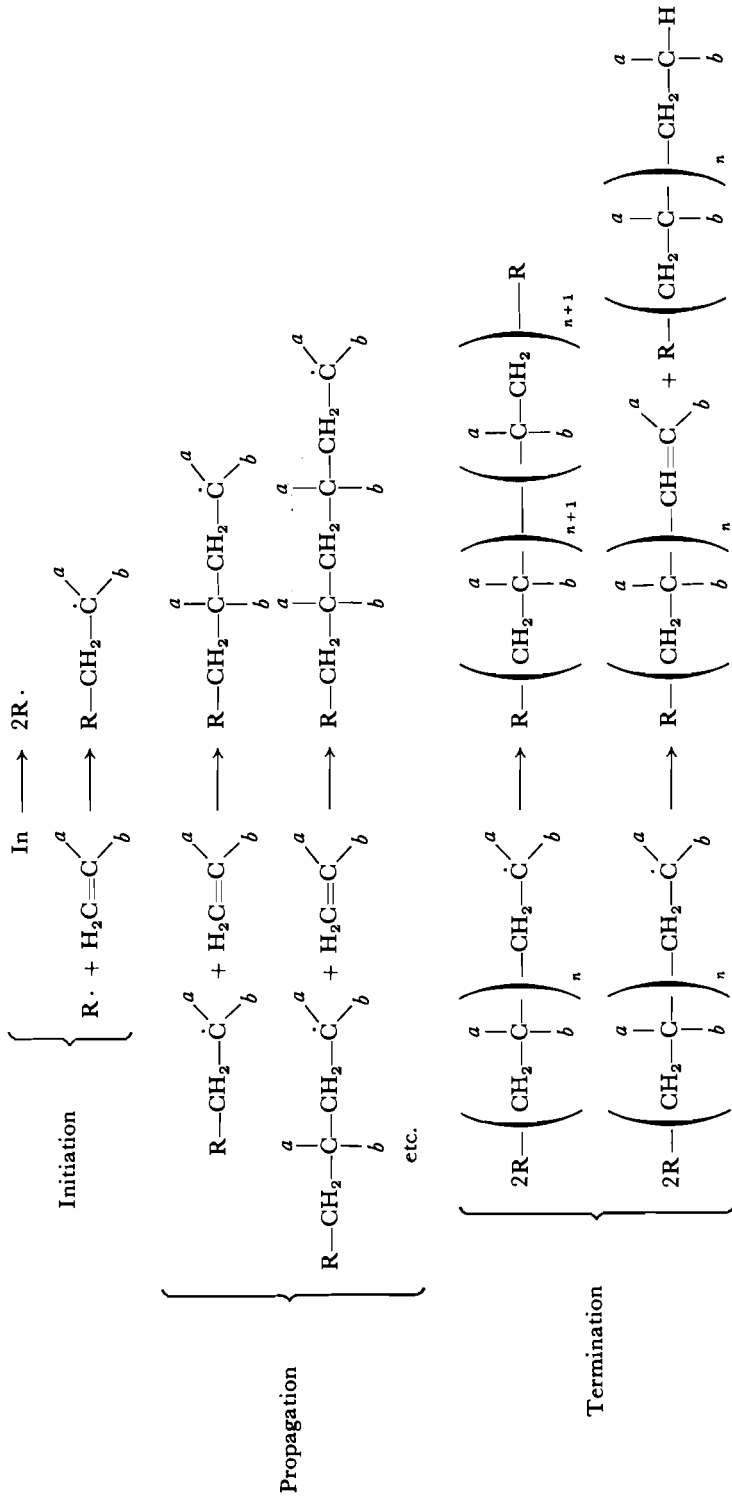

or more individual reactions; reaction schemes can become complex indeed if a number of different radicals are present reacting in a variety of ways, including perhaps with products of the reaction. We shall follow the usual practice of choosing systems for which a small number of steps accounts reasonably well for the observations.

Chain reactions can be divided roughly into two types: polymerization and nonpolymerization. In polymerizations (Scheme 6), an initiating radical ($R\cdot$) adds to a substrate olefin (ordinarily termed the *monomer*), to yield a new radical, which adds to another olefin, and so forth. The kinetic chain, that is, the sequence of events begun by a given $R\cdot$ radical from the initiator, corresponds in this scheme to the actual growth of the polymer molecule, and terminates simultaneously with the growth of the molecular chain as two radicals combine or disproportionate.

A typical nonpolymerization chain reaction (Scheme 7) would be the decomposition (in a solvent without readily abstracted hydrogens) of a tertiary alkyl hypochlorite. Here the kinetic chain may be long without yielding any large molecules, because at each stage a new radical is produced by abstraction

SCHEME 7

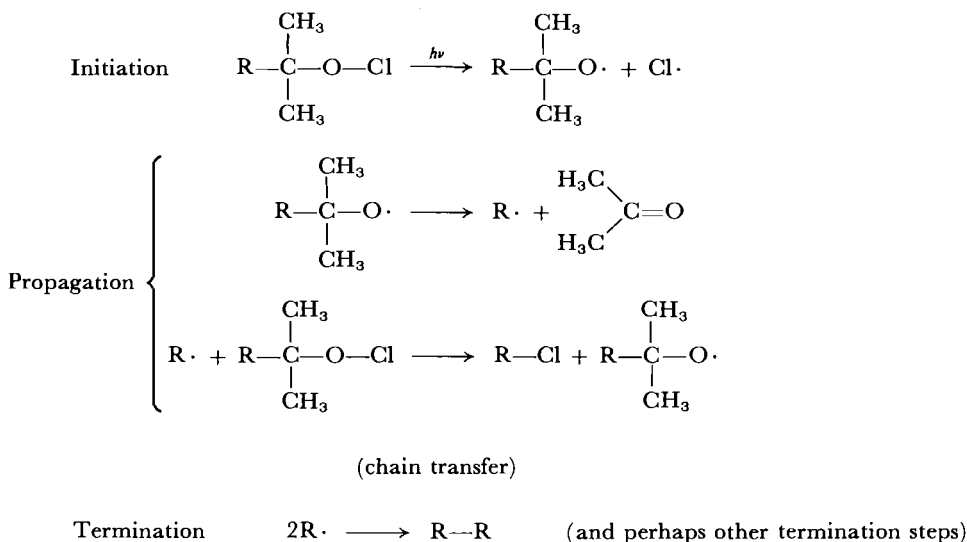

rather than by addition. This process is referred to as *chain transfer*, the terminology signifying that the kinetic chain is continued by transfer to a new molecule rather than by addition of a new monomer unit to the radical.

The reactions in Schemes 6 and 7 are only extremes in a continuous gradation of chain reactions. Suppose, for example, that in the polymerization the growing radical chains occasionally undergo chain transfer by abstracting a hydrogen atom from the solvent. That polymer molecule ceases to grow, but the kinetic chain continues as the solvent-derived radical adds to a monomer and starts a new growing polymer molecule. The ratio of chain transfer rate to addition rate, ranging all the way from zero for the idealized Scheme 6 to infinity for Scheme 7, determines where in the gradation a given reaction falls.

For purposes of a simplified analysis, it is nevertheless convenient and useful to examine the extremes.

In a nonpolymerization, if the kinetic chains are long¹⁰⁵ (they may well be 10^3 or greater), the nature of the reaction products will be determined primarily by the propagation steps. Thus in Scheme 7, the products are almost exclusively those of the propagation steps, namely R—Cl and acetone, and it makes relatively little difference to the products how the chains initiate or terminate. The same remarks apply, though less strongly, to polymerization. Properties of the polymer are little affected by structure of the initiating R·, as it occupies only the end of a chain of many thousand units. But the molecular weight is important, and it is tied closely to kinetic chain length, which is in turn determined by relative rates of initiation, propagation, and termination.

Another characteristic feature of chain reactions is *inhibition*. Interruption of a single chain will prevent the reaction of a large number of substrate molecules; hence any substance that diverts radicals will dramatically reduce reaction rate. Inhibitors may themselves be stable radicals or substances (for example, 2,4,6-tri-*t*-butyl phenol) that can react with radicals to yield stable radicals; the requirement that must be met is that the inhibitor react efficiently with radicals and that neither it nor its products be initiators of new chains.

A kinetic scheme is most easily worked out for the pure polymerization.¹⁰⁶ It is useful first to make certain simplifying approximations and definitions. We replace Scheme 6 by Scheme 8, where In is an initiator producing radicals R·, M is the monomer, $M_n\cdot$ is the growing polymer chain, and M_n-M_m is combination product and $M_n(\pm H)$ are disproportionation products. If all radicals R· produced by the initiator were available to start chains, we could write, from the first two reactions, kinetic Equation 9.40 for rate of change of R· concentration. Because of cage recombination, only some fraction f of the

SCHEME 8

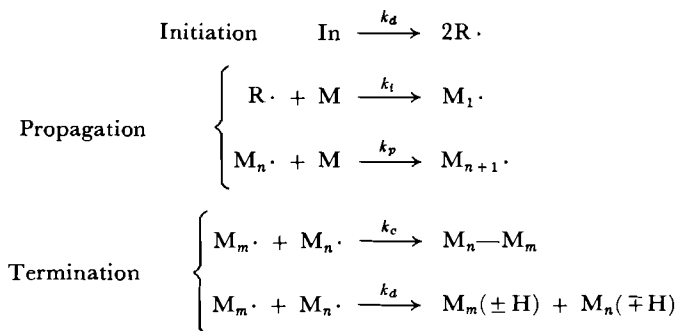

radicals produced will actually be free to start chains, and the equation must be modified accordingly to 9.41. We then assume that when the growing polymer

$$\frac{d[\text{R}\cdot]}{dt} = 2k_d[\text{In}] - k_i[\text{R}\cdot][\text{M}] \quad (9.40)$$

$$\frac{d[\text{R}\cdot]}{dt} = 2fk_d[\text{In}] - k_i[\text{R}\cdot][\text{M}] \quad (9.41)$$

¹⁰⁵ Kinetic chain length is the number of substrate molecules that react during each kinetic chain.

¹⁰⁶ C. Walling, *Free Radicals in Solution*, Wiley, New York, 1957, chap. 3.

chain adds a new unit, it does so at a rate independent of its length; hence even though there are actually many different structures included under the symbol $M_n\cdot$, only one rate constant is needed for each process in which they take part. This assumption is clearly necessary if we are not to be overwhelmed with equations; it is justified on the basis of the principle that reactivity of a functional group (in this case $R-\dot{C}R'R''$) is to a good approximation unaffected by changes made at remote sites in the molecule (here various lengths of the chain R). To simplify matters further, we may put together the two bimolecular termination processes as indicated in Equation 9.42. We can now proceed to establish Equations 9.43 and 9.44 for rates of change of the radical concentrations. Note

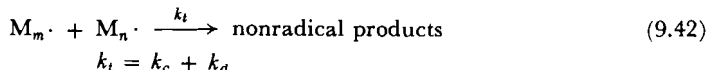

$$\frac{d[M_n\cdot]}{dt} = k_i[R\cdot][M] - k_p[M_n\cdot][M] + k_p[M_n\cdot][M] - 2k_t[M_n\cdot]^2 \quad (9.43)$$

$$= k_i[R\cdot][M] - 2k_t[M_n\cdot]^2 \quad (9.44)$$

that the propagation step makes no net contribution to the concentration of $M\cdot$ radicals; one radical is destroyed but a new one takes its place. We now make the stationary-state assumption for the radicals $R\cdot$ and $M_n\cdot$; since $d[R\cdot]/dt = d[M_n\cdot]/dt = 0$, the initiation rate, $2fk_d[In]$, and termination rate, $2k_t[M_n\cdot]^2$, are equal. This point is intuitively obvious once one assumes the stationary state, that is, that the number of radical chains remains constant. Equations 9.45 and 9.46

$$2fk_d[In] = 2k_t[M_n\cdot]^2 \quad (9.45)$$

$$[M_n\cdot] = \sqrt{\frac{fk_d[In]}{k_t}} \quad (9.46)$$

follow immediately. Equation 9.47 gives the predicted rate of monomer con-

$$-\frac{d[M]}{dt} = k_i[R\cdot][M] + k_p[M\cdot][M] \quad (9.47)$$

$$-\frac{d[M]}{dt} \approx k_p[M\cdot][M] \quad (9.48)$$

$$-\frac{d[M]}{dt} = k_p[M] \sqrt{\frac{fk_d[In]}{k_t}} \quad (9.49)$$

sumption. If chains are long, the second term in Equation 9.47 will be much larger than the first,¹⁰⁷ and the approximation 9.48 will be sufficient; Equation 9.49 follows as the predicted rate equation for the overall reaction. It is often convenient to substitute for the term $2fk_d[In]$, which represents the rate of initiation of chains, a more general notation, r_i , rate of initiation. Equation 9.50

$$-\frac{d[M]}{dt} = k_p[M] \sqrt{\frac{r_i}{2k_t}} \quad (9.50)$$

¹⁰⁷ For example, a chain length of 1000 means that for every M that reacts with $R\cdot$ to start a chain, 1000 react with $M\cdot$ carrying it on; $k_p[M\cdot][M]$ would then be 1000 times $k_i[R\cdot][M]$.

then includes also the possibility of photochemical initiation, where r_i will be proportional to light intensity.

The kinetic treatment of a simple polymerization is readily extended to nonpolymerization chain reactions such as that of Scheme 9. Here we again

SCHEME 9

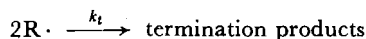
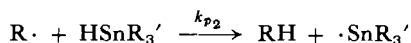
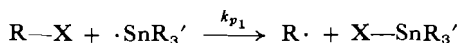
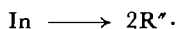

argue that if chains are long, nearly all the $R\cdot$ radicals produced react with tin hydride to continue the chain; therefore the overall rates of the two propagation steps are approximately the same (Equation 9.51). Termination and

$$k_{p1}[R-X][\cdot SnR_3'] \approx k_{p2}[HSnR_3'][R\cdot] \quad (9.51)$$

$$r_i = 2k_t[R\cdot]^2 \quad (9.52)$$

initiation proceed at the same rate in the stationary state, hence Equation 9.52 is also approximately true, and the rate expression predicted for this scheme is found in Equations 9.53–9.55.

$$-\frac{d[RX]}{dt} = k_{p1}[RX][\cdot SnR_3'] \quad (9.53)$$

$$= k_{p2}[HSnR_3'][R\cdot] \quad (9.54)$$

$$= k_{p2}[HSnR_3']\sqrt{\frac{r_i}{2k_t}} \quad (9.55)$$

Note that both 9.50 and 9.55 show the characteristic dependence of reaction rate on first power of substrate concentration and square root of the ratio of initiation rate to termination rate.

Oxidations and Reductions Involving Radicals

An area closely related to ordinary radical chemistry, but on which we can touch only briefly, is that of oxidations and reductions in which radicals are substrates or products.

Under appropriate circumstances a strong reducing or oxidizing agent, or an electrode, can transfer an electron to or from an organic molecule.¹⁰⁸ The substances most susceptible to reduction are those with low-energy vacant orbitals

¹⁰⁸ For discussions of the chemistry of radical ions, see: (a) E. T. Kaiser and L. Kevan, Eds., *Radical Ions*, Wiley-Interscience, New York, 1968; (b) J. F. Garst, in *Free Radicals*, J. K. Kochi, Ed., Vol. I, p. 503; (c) N. L. Holy and J. D. Marcum, *Angew. Chem. Int. Ed.*, **10**, 115 (1971); (d) M. Szwarc, *Prog. Phys. Org. Chem.*, **6**, 323 (1968).

and to oxidation those with high-energy filled orbitals; the molecules most likely to meet these requirements are those with extended π systems. The product of the electron transfer is a radical anion or radical cation, that is, a molecule with an odd number of electrons and a negative or positive charge. Equations 9.56 and 9.57 illustrate typical examples of reaction of aromatic compounds with alkali metals.

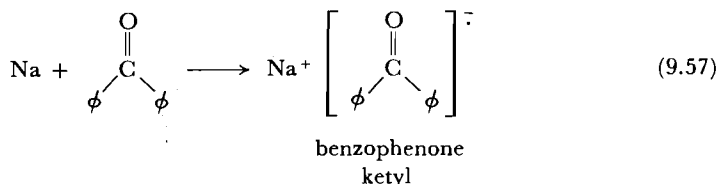
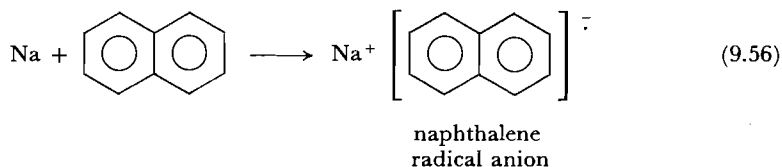

The charge of radical ions modifies their properties considerably from those of ordinary radicals. Because dimerization could form a new bond only at the expense of bringing together two like charges in the same molecule, radical ions are much more stable in solution than radicals, and it is possible to prepare stable solutions of many of them. The radical ions are readily studied spectroscopically, electron resonance being particularly fruitful.

Radical anions are reducing agents and can transfer the extra electron to an alkyl halide. The halide does not remain as a radical ion, but dissociates into a halide ion and an ordinary alkyl radical. If that radical encounters another radical anion, it will be reduced further to alkyl anion.¹⁰⁹ Equations 9.58 and 9.59

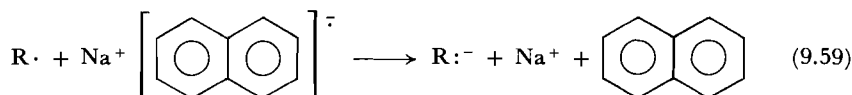
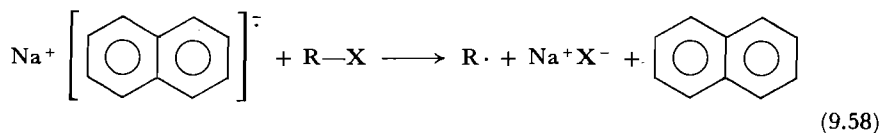

show the sequence. Typical ionic reactions follow, such as protonation of R^- from the solvent, or nucleophilic addition of R^- to the aromatic.

A closely related process is the interaction of organometallics with alkyl halides. Here the electron donor, $\text{RLi} \leftrightarrow \text{R}^- \text{Li}^+$, having an even number of electrons at the start, ends up as a radical (Equation 9.60) after transferring one electron to $\text{R}'\text{X}$. The radicals can now couple or disproportionate (Equation

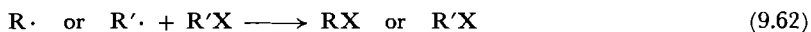
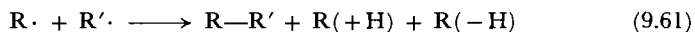
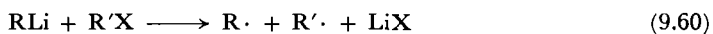

¹⁰⁹ J. F. Garst, *Accts. Chem. Res.*, **4**, 400 (1971).

9.61); the radical nature of the process is confirmed by CIDNP, which shows that some of the radicals abstract halogen from unreacted halide (Equation 9.62).¹¹⁰ The exchange reaction that accompanies this process (Equation 9.63)



may in some instances involve radicals also, but the mechanisms require further clarification.

Radicals themselves are also subject to oxidation and reduction. Radicals interact with oxidizing and reducing transition metal complexes with formation, respectively, of carbocation and carbanion products.^{111, 112}

9.3 FREE-RADICAL SUBSTITUTIONS¹¹³

The term substitution in an unrestricted sense is rather too broad to be useful in classification of radical reactions, since most of them result in replacement of one group by another. We have already seen typical examples of bond homolysis, in which a molecule dissociates to yield two radicals which combine with each other or with another molecule. We are primarily concerned in this section with those elementary reaction steps in which a radical attacks directly an atom of another molecule (Equation 9.64), displacing from the site of attack another group, and with the overall reaction schemes in which these elementary reactions occur.



The direct substitution steps are analogous to the S_N2 or S_E2 displacements of heterolytic chemistry and are termed S_H2 reactions; radical substitutions that are most reasonably formulated as being initiated by addition of a radical to an unsaturated system (Equation 9.65) (analogous to addition-elimination sequences in heterolytic reactions) are considered in Section 9.4.

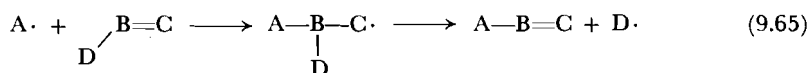

Some Examples of S_H2 Processes

S_H2 substitutions frequently occur in chain reaction sequences, some of which we have already encountered in the earlier discussion. Equations 9.66–9.69 illustrate some reactions; the simple stoichiometric equations serve only to emphasize the overall substitution nature of the process and do not reveal the complexities, often considerable, of the actual pathways followed. We shall not attempt to analyze these processes in detail, but in order to give a better idea of the mechanisms will describe more fully two of them, halogenation and autoxidation.

¹¹⁰ H. R. Ward, R. G. Lawler, and R. A. Cooper, in A. R. Lepley and G. L. Closs, Eds., *Chemically Induced Magnetic Polarization*, Wiley, New York, 1973, p. 281.

¹¹¹ For reviews, see: (a) J. K. Kochi, in *Free Radicals*, J. K. Kochi, Ed., Vol. I, p. 591; (b) J. K. Kochi, *Accts. Chem. Res.*, **7**, 351 (1974).

¹¹² G. Sosnovsky and D. J. Rawlinson, in G. H. Williams, Ed., *Advances in Free Radical Chemistry*, Vol. 4, Academic Press, New York, 1972, p. 203.

¹¹³ For a review, see M. L. Poutsma, in *Free Radicals*, J. K. Kochi, Ed., Wiley, New York, 1973, Vol. II, p. 113.

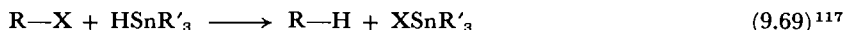
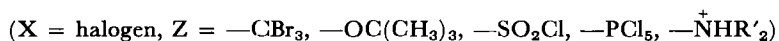
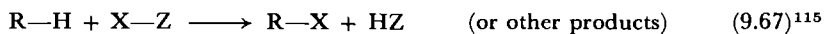

Halogenation¹¹⁸

Free-radical halogenations by the molecular halogens are adequately described by the chain sequence in Scheme 10.

SCHEME 10

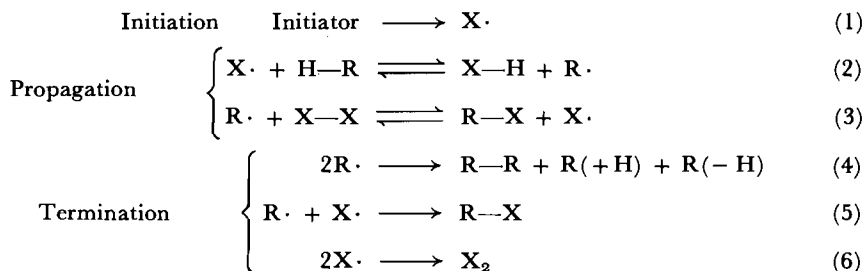

The two propagation steps, 2 and 3, are S_H2 substitutions. Note that the substitutions occur by attack of the radical on a terminal, univalent atom, in one case H, in the other halogen. This feature is characteristic of bimolecular radical substitution steps; attack at multiply bonded sites tends to be by addition (Equation 9.65), and attack at saturated carbon occurs only in highly strained molecules. Thus since terminal singly bonded centers in organic compounds are nearly always hydrogen or halogen, it is at these atoms that most S_H2 substitutions occur.

Halogenations can be initiated in any of the various ways we have discussed earlier; but since the molecular halogens absorb light and dissociate into the free atoms on doing so, initiation is frequently photochemical, in which case it will yield the $\text{X}\cdot$ radical directly. Initiation by some other method, producing a radical $\text{R}'\cdot$, will be rapidly followed by attack of this initiating radical on X_2 to produce again $\text{X}\cdot$. The reaction enthalpies of halogenation (F -101, Cl

¹¹⁴ (a) M. L. Poutsma, in Kochi, *Free Radicals*, Vol. II, p. 159; (b) M. L. Poutsma, in *Methods in Free Radical Chemistry*, Vol. 1, E. S. Huyser, Ed., Marcel Dekker, New York, 1969, p. 79.

¹¹⁵ See note 114.

¹¹⁶ (a) J. A. Howard, in *Free Radicals*, J. K. Kochi, Ed., Vol. II, p. 3; (b) F. R. Mayo, *Accts. Chem. Res.*, **1**, 193 (1968).

¹¹⁷ H. G. Kuivila, *Accts. Chem. Res.*, **1**, 299 (1968).

¹¹⁸ Poutsma [see note 114(a)] reviews the field and gives references to numerous other reviews as well as to experimental papers.

-22, Br -4, and I +16 kcal mole⁻¹)¹¹⁹ reflect the decreasing bond dissociation energies for H—X and C—X bonds in the series F, Cl, Br, I, and the relatively constant $D(X—X)$ (Table 9.4). The highly exothermic fluorination requires no external initiators and occurs violently and uncontrollably on mixing fluorine with a hydrocarbon either in the gas or liquid phase. Chlorination must be initiated, but proceeds readily, whereas bromination frequently requires elevated temperatures. Iodination is rarely successful, and indeed is more likely to occur in the reverse direction as reduction of alkyl iodides by HI.¹²⁰

A prediction of expected kinetic behavior can be made on the basis of the Scheme 10 (Problem 5); experimental observations are in agreement with the radical chain process.¹²¹

Autoxidation¹²²

Autoxidation, oxidation by molecular oxygen, is of great importance and has been the subject of intensive study. Scheme 11 outlines the bare essentials. If the

SCHEME 11

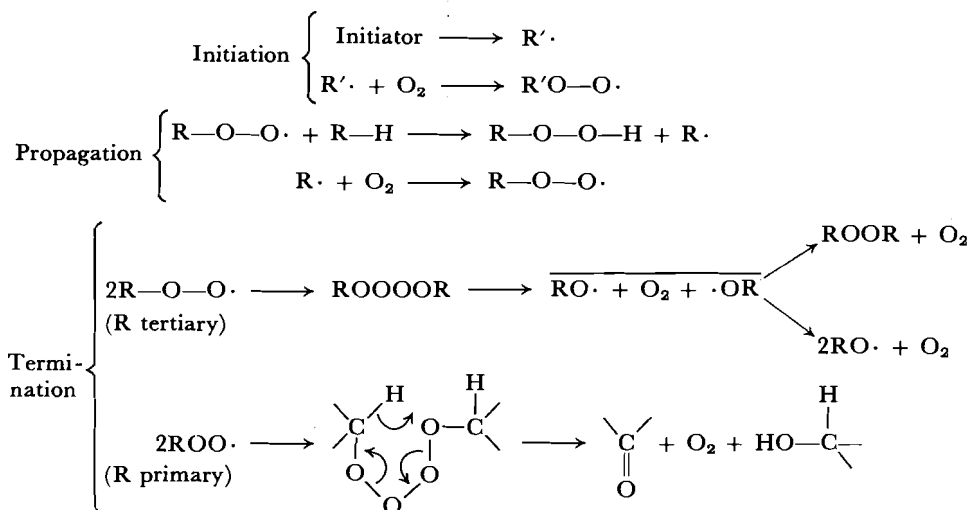

compound being oxidized is an olefin, an addition process involving propagation steps 9.70 and 9.71 can compete and, depending on the structure of the alkene, may occur to the exclusion of Scheme 11.¹²³ Autoxidations are a consequence of

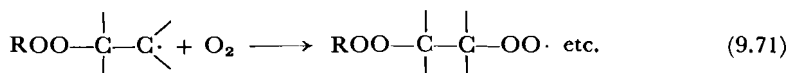
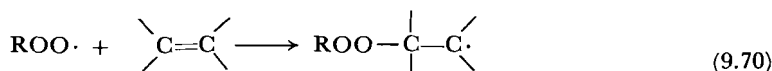

¹¹⁹ Values are for substitution of one hydrogen of CH₄, CH₄ + X₂ → CH₃X + HX. See Poutsma, in Kochi, *Free Radicals*, Vol. II, p. 162.

¹²⁰ See note 114.

¹²¹ (a) G. Chiltz, P. Goldfinger, G. Huybrechts, G. Martens, and G. Verbeke, *Chem. Rev.*, **63**, 355 (1963); (b) S. W. Benson and J. H. Buss, *J. Chem. Phys.*, **28**, 301 (1958).

¹²² See note 116.

¹²³ See note 116(b).

the special nature of O_2 . In its ground state it has two electrons unpaired and so is a triplet-state molecule. Because of this highly unusual feature, oxygen is an efficient trap for radicals.

Termination in autoxidations is rather more complex than in the chain reactions we have considered so far. As we have noted briefly earlier (Section 9.2, p. 488), the peroxy radicals first combine to an unstable tetroxide, $ROOOOR$.¹²⁴ The existence of these compounds when R is tertiary is inferred from isotope tracer studies,¹²⁵ and the equilibrium 9.72 is observable by electron



resonance near $-80^\circ C$.¹²⁶ Another labile compound, the trioxide **36**, also forms



at low temperature, but dissociates above about $-30^\circ C$.¹²⁷ At ambient temperatures and above, combination of peroxy radicals to tetroxide is followed rapidly by its decomposition by the cyclic Russell mechanism shown in Scheme 11, which yields nonradical products and so terminates the chain.¹²⁸ If the original $R\cdot$ was tertiary so that no α hydrogens are available, decomposition occurs by the simple dissociation into oxygen and two alkoxy radicals (Equation 9.74).

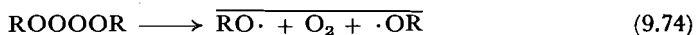

These fragments are produced in a solvent cage; if the two alkoxy radicals

SCHEME 12

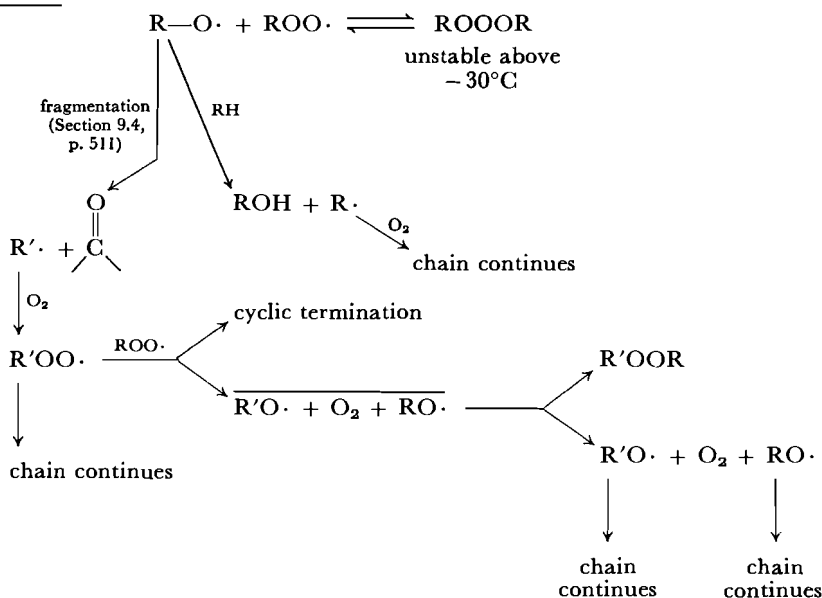

¹²⁴ (a) G. A. Russell, *J. Amer. Chem. Soc.*, **79**, 3871 (1957); (b) H. S. Blanchard, *J. Amer. Chem. Soc.*, **81**, 4548 (1959).

¹²⁵ P. D. Bartlett and T. G. Traylor, *J. Amer. Chem. Soc.*, **85**, 2407 (1963).

¹²⁶ P. D. Bartlett and G. Guaraldi, *J. Amer. Chem. Soc.*, **89**, 4799 (1967).

¹²⁷ P. D. Bartlett and P. Günther, *J. Amer. Chem. Soc.*, **88**, 3288 (1966).

¹²⁸ See note 124(a).

combine in the cage, the chain is terminated and peroxide ROOR results. Some of the alkoxy radicals will escape the cage and initiate the chain of events outlined in Scheme 12.¹²⁹

Further complications can be introduced when interaction of some of the R· radicals with oxygen produces hydrogen transfer from the β carbon of the radical to oxygen (Equation 9.75), a reaction that is in essence a disproportionation with oxygen playing the role of the hydrogen-accepting radical. Yet because oxygen is behaving like a diradical, this process is not a termination like

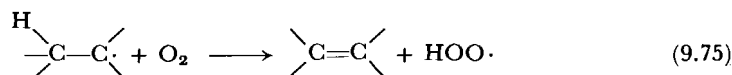

an ordinary disproportionation, but instead yields HOO·, which will continue the chain. The olefin may itself suffer attack by a radical according to the addition oxidation scheme (Equations 9.70 and 9.71).

We shall not continue any further into the labyrinth of autoxidation, but shall merely point out that the complexities we have described are multiplied manifold when one considers the situations that will arise in oxidation of an olefin that reacts by a combination of the addition-polymerization and the abstraction routes, or when the temperature is high enough to homolyze the peroxide products and the reaction is thus producing its own initiator, or when there are several nonequivalent hydrogens in the substrate. Furthermore, the products will themselves be subject to oxidation. Clearly the possibilities are almost without limit.

Because any organic compound is subject to destruction by autoxidation (some, of course, being much more susceptible than others), it is a matter of considerable practical importance to prevent it.¹³⁰ Inhibition is accomplished either by the addition of substances that will break the kinetic chains, or by substances that prevent their initiation. In the former category are compounds such as the hindered phenols, which have in the —OH group a readily abstracted hydrogen but which yield a radical sufficiently unreactive that it will not in turn enter into any processes that will continue the chain. The latter type of inhibitor, particularly useful at higher temperatures where the hindered phenols become ineffective, include substances that destroy peroxide initiators (frequently substances containing unoxidized sulfur), that absorb ultraviolet light without initiating oxidation chains, or that tie up by chelation metal ions that catalyze radical production from peroxides.

Stereochemistry

Since most S_H2 displacements occur at univalent atoms, tests of stereochemistry at the reaction center are ordinarily not possible. Substitutions do nevertheless occur at saturated carbons in highly strained rings.¹³¹ Halogen atoms attack cyclopropane (Equation 9.76) and other strained cyclic compounds,

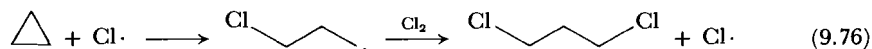

¹²⁹ See note 116(b), p. 498.

¹³⁰ Inhibition is discussed by J. A. Howard, in *Free Radicals*, J. K. Kochi, Ed., Vol. II, p. 3.

¹³¹ (a) K. U. Ingold and B. P. Roberts, *Free-Radical Substitution Reactions*, Wiley-Interscience, New York, 1971, p. 72; (b) Poutsma, in *Free Radicals*, J. K. Kochi, Ed., Vol. II, p. 142.

with ring opening. Opening of *cis*- and *trans*-1,1-dichloro-2,3-dideuteriocyclopropane has been found to occur with inversion in the experiment summarized in Equations 9.77 and 9.78.¹³²

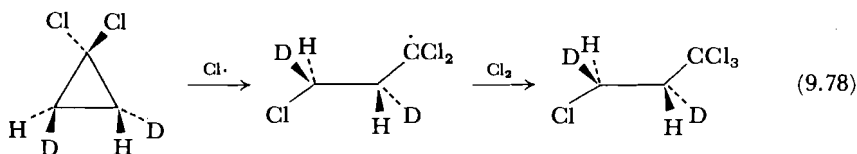
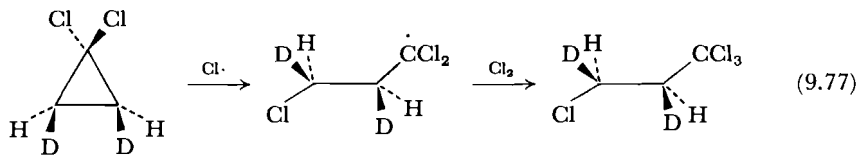

Relative Reactivities

A large amount of information is available on relative reactivities of different kinds of hydrogens toward free radicals and on variations of behavior among different abstracting radicals.¹³³ We must note first that in considering relative reactivities of different kinds of hydrogen, a statistical correction is necessary. Thus in the reaction of chlorine atoms with propane, if primary and secondary hydrogens were of equal reactivity, 1-chloropropane and 2-chloropropane would

Table 9.6 RELATIVE REACTIVITIES OF RADICALS IN ABSTRACTION OF PRIMARY, SECONDARY, AND TERTIARY HYDROGEN ATOMS^a

Radical	Temperature (°C) and Phase	Hydrogen Abstracted			Reference
		H—CH ₂ R	H—CHR ₂	H—CR ₃	
F·	25, Gas	1	1.2	1.4	<i>b</i>
Cl·	25, Gas	1	4	6	<i>b</i>
Br·	40, Liquid	1	200	1.9 × 10 ⁴	<i>c</i>
φ·	60, Liquid	1	9	47	<i>d</i>
CH ₃ ·	110, Liquid	1	4	46	<i>e</i>
CH ₃ ·	182, Gas	1	7	50	<i>e</i>
CF ₃ ·	182, Gas	1	8	24	<i>e</i>
CCl ₃ ·	190, Gas	1	80	2300	<i>e</i>
CH ₃ O·	250, Gas	1	8	27	<i>e</i>
H·	35, Liquid	1	5	40	<i>e</i>

^a Rates for each radical are relative to its reaction with primary C—H.

^b M. L. Poutsma, in *Free Radicals*, J. K. Kochi, Ed., Wiley, New York, 1973, Vol. II, p. 172.

^c G. A. Russell and C. De Boer, *J. Amer. Chem. Soc.*, **85**, 3136 (1963).

^d G. A. Russell, in Ref. *b*, Vol. I, p. 299.

^e J. K. Kochi, in Ref. *b*, Vol. II, p. 690.

¹³² J. H. Incremona and C. J. Upton, *J. Amer. Chem. Soc.*, **94**, 301 (1972).

¹³³ See, for example: (a) Poutsma, in Kochi, *Free Radicals*, Vol. II, pp. 170, 187; (b) G. A. Russell, in *Free Radicals*, J. K. Kochi, Ed., Vol. I, pp. 283, 299; (c) C. Rüchardt, *Angew. Chem. Int. Ed.*, **9**, 830 (1970); (d) A. F. Trotman-Dickenson, in G. H. Williams, Ed., *Advances in Free Radical Chemistry*, Vol. 1, Logos Press and Academic Press, London, 1965, p. 1.

Table 9.7 RELATIVE REACTIVITIES OF RADICALS IN ABSTRACTION OF HYDROGEN FROM PHENYL-SUBSTITUTED CARBON

Radical	Temperature (°C) and Phase	Hydrogen Abstracted				Reference
		H—CH ₂ CH ₃	H—CH ₂ φ	H—CH ₂ φ ₂	H—Cφ ₃	
Cl· ^a	40, Gas	1	1.3 (1 : 6.4 × 10 ⁴)	2.6 (2 : 6.2 × 10 ⁵)	9.5 (7.3 : 1.1 × 10 ⁸)	<i>b</i>
Br· ^a	40, Liquid	1	6.4 × 10 ⁴	6.2 × 10 ⁵	1.1 × 10 ⁸	<i>b</i>
φ· ^a	60, Liquid	1	9 (1 : 7.7)	69 (10 : 7.7)	— (17 : —)	<i>c</i>
Cl ₃ C·	40, Liquid		1	50	160	<i>b</i>

^a Series are given both relative to primary and relative to benzyl.^b G. A. Russell and C. De Boer, *J. Amer. Chem. Soc.*, **85**, 3136 (1963).^c G. A. Russell, in *Free Radicals*, J. K. Kochi, Ed., Wiley, New York, 1973, Vol. I, p. 299.**Table 9.8** SENSITIVITY OF HYDROGEN ABSTRACTION TO POLAR EFFECTS

Radical	Temperature (°C) and Phase	Hydrogen Abstracted			Reference
		H—CHR ₂	H—CHR CH ₂ Cl	H—CHR Cl	
Cl·	35, Gas	1	0.52	0.17	<i>a</i>
Br·	60, Liquid	1	0.47	0.45	<i>a</i>
φ·	60, Liquid	1	1.1	2.3	<i>b</i>
(CH ₃) ₃ CO·	40		1	1.2	<i>c</i>
		H—CHR ₂	H—CHR CH ₂ F	H—CHR F	
Cl·	75	1	0.47	0.25	<i>d</i>
Br·	150	1	0.09	0.1	<i>d</i>
		H—CHR ₂	H—CHR CH ₂ CF ₃	H—CHR CF ₃	
Cl·		1	0.33	0.011	<i>d</i>
Br·		1	0.09	0.01	<i>d</i>

^a M. L. Poutsma, in *Free Radicals*, J. K. Kochi, Ed., Wiley, New York, 1973, Vol. II, p. 188.^b G. A. Russell, in Ref. *a*, Vol. I, p. 299.^c G. A. Russell, in Ref. *a*, Vol. I, p. 307.^d A. F. Trotman-Dickenson, in *Advances in Free Radical Chemistry*, Vol. 1, G. H. Williams, Ed., Logos Press, Academic Press, London, 1965, p. 15.

form in a ratio of 3:1, as there are six methyl protons and only two methylene protons. The actual ratio in the gas phase is only 1.41:1 at 25°C, so on a per-atom basis the secondary hydrogens are more reactive, the ratio primary:secondary being at this temperature 1:2.13.¹³⁴ Since activation energies are different at different positions, the ratios depend on temperature.

Tables 9.6–9.8 illustrate some of the trends observed, and Table 9.9 shows activation parameters for abstraction by halogen atoms of different types of hydrogen. Note that in alkanes, hydrogens become more easily abstracted on

¹³⁴ Data from J. H. Knox and R. L. Nelson, *Trans. Faraday Soc.*, **55**, 937 (1959).

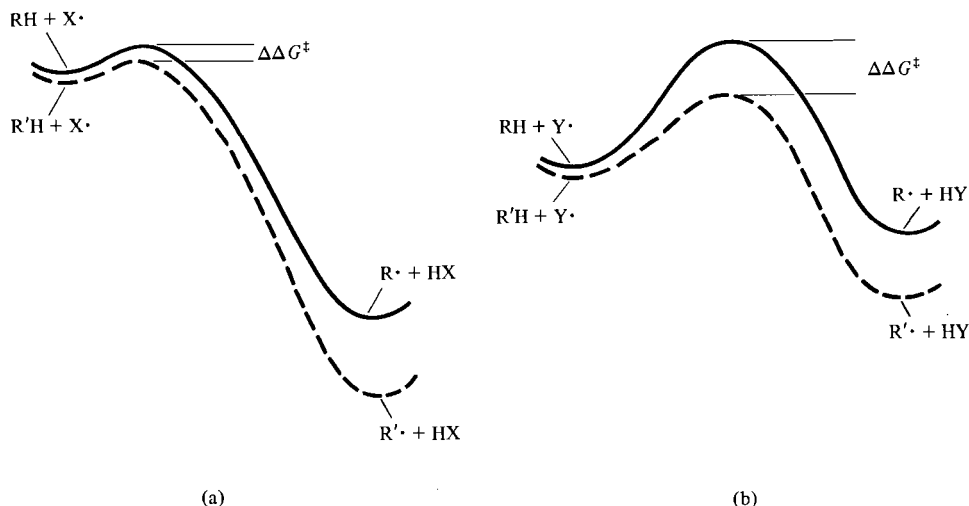

Figure 9.2 Relative reactivities in hydrogen abstraction. (a) In abstraction by a reactive radical the transition state is early and relatively little affected (small $\Delta\Delta G^\ddagger$) by changing the structure of R so as to stabilize the radical being formed. (b) In abstraction by a less reactive radical, with a later transition state, structure change in the product is more strongly felt at the transition state (larger $\Delta\Delta G^\ddagger$).

Table 9.9 ACTIVATION PARAMETERS FOR THE REACTION $R-H + X\cdot \longrightarrow R\cdot + HX^a$

X·	Hydrogen Abstracted					
	H—CH ₂ R		H—CHR ₂		H—CR ₃	
	E_a (kcal mole ⁻¹)	log A	E_a (kcal mole ⁻¹)	log A	E_a (kcal mole ⁻¹)	log A
F·	0	13	0	13	0	13
Cl·	1	13	0.5	13	1	13
Br·	13	13	10	13	7	13

^a Data from A. F. Trotman-Dickenson, in *Advances in Free Radical Chemistry*, Vol. 1, G. H. Williams, Ed., Logos Press, Academic Press, London, 1965, pp. 9, 11.

proceeding along the series primary, secondary, tertiary. The magnitudes of the differences depend on the radical removing the hydrogen, the more reactive ones (F·, Cl·) being less selective and those of lower reactivity (Br·) more selective. Phenyl substitution makes the hydrogens more easily abstracted; again, abstraction by bromine atoms benefits more. The reaction coordinate diagram (Figure 9.2) shows that the consequence of an earlier transition state in abstraction by a more reactive radical should be less sensitivity to stabilization in the product radical. The trend of decreasing selectivity in the series Br· > Cl· > F· parallels the decrease in activation energy illustrated in Table 9.9. Radical selectivity can be modified by the conditions; aromatic solvents, for example, apparently complex with chlorine atoms and increase their selectivity.¹³⁵

¹³⁵ (a) Poutsma, in Kochi, *Free Radicals*, Vol. II, p. 175; (b) J. C. Martin, in *Free Radicals*, J. K. Kochi, Ed., Vol. II, p. 493.

A parameter that should be useful in assessing position of the transition state is the primary hydrogen isotope effect. The isotope effect should be at a maximum for a symmetrical transition state (Section 2.7, p. 108), and smaller for less symmetrical transition states. Russell has tabulated $k_{\text{H}}/k_{\text{D}}$ for hydrogen abstractions from carbon-hydrogen bonds;¹³⁶ although the variety of temperatures makes an evaluation difficult,¹³⁷ there appears to be some confirmation of this expectation, as for example in the observation of $k_{\text{H}}/k_{\text{D}}$ greater (4.9) for the thermoneutral reaction of $\text{Br}\cdot$ with toluene than for the 18 kcal mole⁻¹¹³⁸ exothermic $\text{Cl}\cdot$ with toluene ($k_{\text{H}}/k_{\text{D}}$ 1.3). Pryor and Kneipp have reported isotope effects for hydrogen abstraction from *t*-butyl thiol (Equation 9.79) by various radicals $\text{R}\cdot$ chosen so that the enthalpy change of the reaction ranges

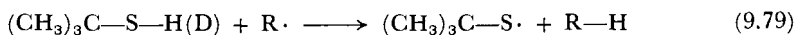

from -24 to +18 kcal mole⁻¹. They found a clearly defined maximum in $k_{\text{H}}/k_{\text{D}}$ when the process is approximately thermoneutral, $\Delta H^\circ \approx 5$ kcal mole⁻¹. For these reactions at least, the expectation of maximum isotope effect for a symmetrical transition state is confirmed.¹³⁹

Because of the unique geometrical constraints of bridgehead positions and because of their importance in carbocation chemistry, there have been several efforts, not always in agreement, to elucidate the reactivity of bridgehead hydrogens toward abstraction.¹⁴⁰ An investigation by Koch and Gleicher of abstraction by trichloromethyl radicals, which on the basis of their high selectivity among primary, secondary, and tertiary hydrogens (Table 9.6) would be expected to reflect quite well differences in reactivity of different types of hydrogen, showed that the more difficult it becomes to flatten the bridgehead, the less reactive is the hydrogen. The difficulty of establishing a radical site at a bridgehead position, however, appears to be considerably less than that of creating a bridgehead cation.¹⁴¹ Because the position of the transition state along the reaction coordinate is uncertain, the precise significance of the results is difficult to assess; they are nevertheless consistent with the conclusion reached in Section 9.1 that radicals prefer the planar geometry.

Table 9.8 illustrates the second main feature of selectivity in abstraction of hydrogen. Polar substituents affect the product distribution, but do so differently for different abstracting radicals.¹⁴² Chlorine atoms attack a hydrogen on a carbon already bearing chlorine less rapidly than on one that does not, whereas phenyl radicals behave in just the opposite way and bromine atoms are intermediate. The explanation is that the chlorine atom is electrophilic and its attack will be hindered by electron withdrawal. In resonance terms, there is an im-

¹³⁶ G. A. Russell, in *Free Radicals*, J. K. Kochi, Ed., Vol. I, p. 312.

¹³⁷ Some isotope effects much in excess of the theoretical maximum for loss of one degree of freedom imply loss of bending modes in addition to loss of C-H stretching.

¹³⁸ Poutsma, in Kochi, *Free Radicals*, Vol. II, p. 163.

¹³⁹ W. A. Pryor and K. G. Kneipp, *J. Amer. Chem. Soc.*, **93**, 5584 (1971).

¹⁴⁰ (a) D. E. Applequist and L. Kaplan, *J. Amer. Chem. Soc.*, **87**, 2194 (1965); (b) J. P. Lorand, S. D. Chodroff, and R. W. Wallace, *J. Amer. Chem. Soc.*, **90**, 5266 (1968); (d) R. C. Fort, Jr., and R. E. Franklin, *J. Amer. Chem. Soc.*, **90**, 5267 (1968); (e) W. H. Chick and S. H. Ong, *Chem. Commun.*, 216 (1969).

¹⁴¹ V. R. Koch and G. J. Gleicher, *J. Amer. Chem. Soc.*, **93**, 1657 (1971).

¹⁴² See note 74(b), (c), p. 483.

portant contribution to the transition state by **37b** and electron withdrawal at the carbon will raise the energy. Bromine atoms are affected similarly and react

less rapidly with $\text{H}-\text{CH}-\text{C}-\text{Cl}$ than with an unchlorinated secondary position,

but because of the later transition state they are more susceptible to the radical stabilizing tendency of an α chlorine and so do not suffer a further decline of activity when the Cl substituent is brought to the α position as do chlorine atoms.

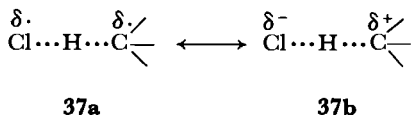

Hammett σ - ρ correlations also point to the influence of polar effects in the abstraction reactions.

Direct radical substitutions can occur at atoms other than hydrogen, halogen, and carbon.¹⁴³

9.4 RADICAL ADDITIONS AND ELIMINATIONS¹⁴⁴

Addition of radicals to carbon-carbon double bonds, ordinarily by a chain process, may lead to the formation of either small molecules or polymers, depending upon the efficiency of chain transfer.

Addition with Chain Transfer¹⁴⁵

Chain reactions of radical addition will follow the familiar sequence of initiation, propagation, and termination. We shall be concerned here primarily with the propagation steps, which determine the nature of the products. Suppose that a chain is initiated by the addition of some radical $\text{X}\cdot$ to an olefin (Equation 9.80).

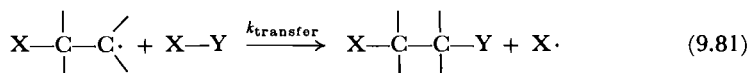
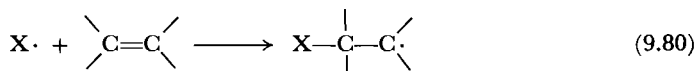

or

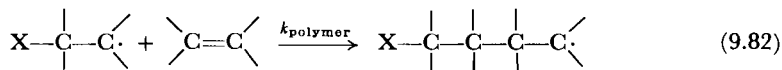

The intermediate alkyl radical produced by the addition has a choice of paths to follow: It may attack $\text{X}-\text{Y}$, abstracting Y and leaving a new $\text{X}\cdot$ to add to another olefin (Equation 9.81), or it may itself add to the next olefin (Equation 9.82). There are also other possibilities, which we shall consider later, such as reversal of the original addition, or some other fragmentation. The nature of the products will depend on the relative rates of processes 9.81 and 9.82. If we

¹⁴³ (a) See note 113, p. 497; (b) note 131, p. 501.

¹⁴⁴ For a review, see: (a) P. I. Abell, in *Free Radicals*, J. K. Kochi, Ed., Wiley, New York, 1973, Vol. II, p. 63. (b) E. S. Huyser, *Free-Radical Chain Reactions*, Wiley-Interscience, New York, 1970.

¹⁴⁵ Chain transfer is discussed by (a) C. Walling, *Free Radicals in Solution*, Wiley, New York, 1957, chap. 6, and by (b) Huyser, *Free-Radical Chain Reactions*, p. 344.

suppose the concentrations of X—Y and the olefin to be comparable, $k_{\text{transfer}} \gg k_{\text{polymer}}$ will produce simple addition of X—Y across the double bond, whereas $k_{\text{transfer}} \ll k_{\text{polymer}}$ will mean that very little of the X—Y will react and the process will produce long polymer chains. If the two rates are about the same, the chances will be good that the first step to follow after Reaction 9.80 will be addition of another olefin, but the chance of adding still another to the same chain will rapidly diminish as the chain grows longer. Under these conditions the product will contain short chains called *telomers*.

If we consider as an example the addition of HCl to ethylene, we find that whereas the propagation step for polymerization will be exothermic by about 30 kcal mole⁻¹,¹⁴⁶ abstraction of H from HCl by the R—CH₂· radical will be endothermic by 5 kcal mole⁻¹. Activation energies for typical polymerization propagation steps are in the range of 6–10 kcal mole⁻¹,¹⁴⁷ and that for abstraction from HCl will have to be greater than the 5 kcal mole⁻¹ endothermicity. These data are at least indicative that radical addition of HCl will not be favorable; experimentally, it is indeed rare, but can be made to occur with excess HCl.¹⁴⁸ With HBr the situation is different. Now the hydrogen abstraction is exothermic by about 10 kcal mole⁻¹ and occurs to the exclusion of telomerization.¹⁴⁹ Hydrogen iodide does not add successfully to olefins because now the initial addition of the iodine atom to the double bond is endothermic.

A number of other substances, for example CCl₄, CCl₃Br, and several other alkyl polyhalides, aldehydes, and thiols, add successfully to olefins.¹⁵⁰ Addition of Cl₂, frequently looked upon as ionic, often occurs as a radical chain reaction, particularly in nonpolar solvents and in the presence of light or peroxides.¹⁵¹

Orientation in addition to unsymmetrical olefins is determined at the addition step, which occurs so as to leave the most stable radical (Equations 9.83

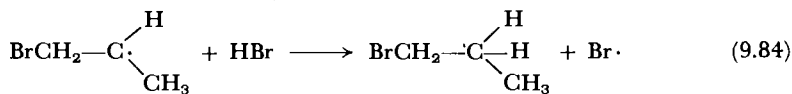
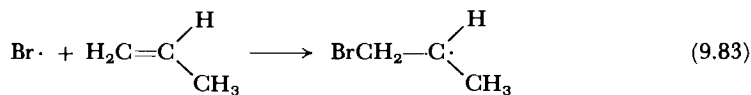

and 9.84). Overall addition is therefore in the sense opposite to that predicted by Markownikoff's rule and to that observed in the polar addition.¹⁵²

Polymerization

Having considered earlier the polymerization reaction pathway and kinetics (p. 493), and the competition between addition and chain transfer, we shall

¹⁴⁶ Estimated by Benson's group additivity scheme as the difference between the heats of formation of ethylene and of two —CH₂—groups. See Table 2.6 p. 75.

¹⁴⁷ K. U. Ingold, in *Free Radicals*, J. K. Kochi, Ed., Vol. I, p. 92.

¹⁴⁸ J. H. Raley, F. F. Rust, and W. E. Vaughan, *J. Amer. Chem. Soc.*, **70**, 2767 (1948).

¹⁴⁹ (a) M. S. Kharasch, H. Engelmann, and F. R. Mayo, *J. Org. Chem.*, **2**, 288 (1937); (b) D. H. Hey and W. A. Waters, *Chem. Rev.*, **21**, 169 (1937); (c) Walling, *Free Radicals in Solution*, pp. 240, 291.

¹⁵⁰ Walling, *Free Radicals in Solution*, chaps. 6 and 7, and Huyser, *Free-Radical Chain Reactions*, chap. 7, give detailed discussions.

¹⁵¹ M. L. Poutsma, in *Free Radicals*, J. K. Kochi, Ed., Vol. II, p. 185.

¹⁵² See notes 149(a), (c).

confine the discussion here to a brief consideration of copolymerization. When two different monomers are present in the reaction mixture undergoing polymerization, the growing chain may have as its terminal unit either of the two monomers, and when it reacts with the next one it has the choice of adding either. There are therefore four propagation steps (Scheme 13) rather than just one as in simple polymerization (Scheme 6, p. 491).

SCHEME 13

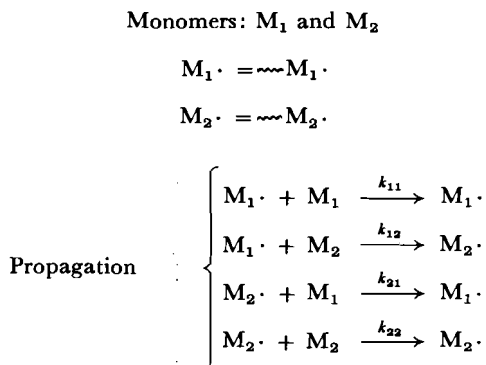

In Scheme 13,¹⁵³ we assume that the reactivity of a growing chain depends only on which unit added last. This assumption allows us to say that there are, for purposes of kinetics, only two kinds of chains, those ending in $\sim M_1 \cdot$ and those ending in $\sim M_2 \cdot$, and that addition of M_1 to either will leave an $\sim M_1 \cdot$ chain whereas addition of M_2 will leave an $\sim M_2 \cdot$ chain. The predictions of this scheme are correct for most, but not all, systems.¹⁵⁴ The matter of interest from the point of view of radical reactivity concerns the effect of structure on the rate constants k_{mn} . In order to bring the data into a more convenient form, it is customary to define the ratios r_1 and r_2 as in Equations 9.85 and 9.86.

$$r_1 = \frac{k_{11}}{k_{12}} \quad (9.85)$$

$$r_2 = \frac{k_{22}}{k_{21}} \quad (9.86)$$

A value of r_1 greater than unity means the chain $\sim M_1 \cdot$ prefers to add another M_1 ; $r_1 = 1$ means that $\sim M_1 \cdot$ adds at random either M_1 or M_2 , and r_1 less than unity means that $\sim M_1 \cdot$ prefers to react with M_2 .¹⁵⁵

The behavior of copolymerizing systems can be deduced from the r values. For example, when M_1 = styrene and M_2 = vinyl acetate, $r_1 = 50$ and r_2 is less than 0.02,¹⁵⁶ then any chain, whether it ends in $\sim M_1 \cdot$ or $\sim M_2 \cdot$, will

¹⁵³ (a) Walling, *Free Radicals in Solution*, p. 100; (b) T. Alfrey, Jr., and G. Goldfinger, *J. Chem. Phys.*, **12**, 205, 322 (1944); (c) F. T. Wall, *J. Amer. Chem. Soc.*, **66**, 2050 (1944); (d) F. R. Mayo and F. M. Lewis, *J. Amer. Chem. Soc.*, **66**, 1594 (1944); (e) E. S. Huyser, *Free-Radical Chain Reactions*, p. 352.

¹⁵⁴ See note 153(a).

¹⁵⁵ Walling, *Free Radicals in Solution*, p. 116 and Huyser, *Free-Radical Chain Reactions*, p. 357, list values.

¹⁵⁶ Walling, *Free Radicals in Solution*, p. 508.

prefer to add M_1 next. Under these circumstances, at the beginning of the reaction essentially only M_1 will be reacting, and poly- M_1 (styrene) will be formed; when nearly all the M_1 is gone, M_2 (vinyl acetate) will polymerize. If r_1 and r_2 are each about unity, as in the case of acrylonitrile and butyl acrylate,¹⁵⁷ chains contain the two monomers in random order. If both r_1 and r_2 are less than unity, as for $M_1 = \text{styrene}$, $M_2 = \text{vinylidene cyanide}$ (1,1-dicyanoethylene), $r_1 = 0.005$, $r_2 = 0.001$, there is a regular alternation and the chains have the structure $\cdots - M_1 - M_2 - M_1 - M_2 - \cdots$.

From the r values one can obtain relative reactivities of each type of radical $R'\cdot$ toward addition to various olefins. In Equation 9.87, rates are greatest for

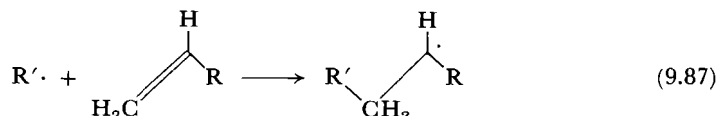

conjugating R groups, such as phenyl or vinyl, and decrease roughly in the order $\text{R} = -\text{COR} > \text{C}\equiv\text{N} > \text{Cl} > \text{COOR} > \text{OR} > \text{CH}_3 > \text{H}$. Thus, for example, the r values for the styrene–vinyl acetate pair show that styrene, $\text{R} = \phi$, is more reactive by a factor of 50 than vinyl acetate, $\text{R} = \text{OAc}$, toward styrene radicals, $\text{R}'\cdot = \phi\dot{\text{C}}\text{H}-\text{C}-$. Styrene is more reactive by a factor of $1/r_2$, more than 50, toward vinyl acetate radicals, $\text{R}'\cdot = \text{AcO}\dot{\text{C}}\text{H}-\text{C}-$. These results must be interpreted as a stabilization by $-\text{R}$ in the order mentioned of the developing radical which exceeds any stabilization that $-\text{R}$ might contribute to the ground-state olefin. Olefins substituted at one end only are more reactive than those with substituents at both ends, an observation that has been explained, perhaps not entirely correctly,¹⁵⁸ on the basis of steric effects.

Reactivities of various radicals toward a given olefin may be obtained by combining relative rate information, from r values, with absolute propagation rate constants for polymerization of various monomers alone.¹⁵⁹ The results show that, as expected, substituents that make olefins reactive by stabilizing the developing radicals make the radicals, once formed, less reactive. The effect is greater on the radicals than on the olefins. Returning again to the styrene–vinyl acetate pair, we find that k_p for styrene at 60°C is $145 M^{-1} \text{sec}^{-1}$ and for vinyl acetate is $3700 M^{-1} \text{sec}^{-1}$.¹⁶⁰ From these data we may derive Table 9.10 by noting that the radical bearing a phenyl substituent prefers styrene over vinyl acetate by a factor of 50 (r_1), and the radical bearing an acetoxy substituent also prefers styrene by a factor of greater than 50 ($1/r_2$). The columns in the table then show that the radical with the acetoxy substituent is more reactive by a factor of over 1000 toward both olefins. It is the interplay between substituent effects on radical reactivity and olefin susceptibility to attack that leads to the curious fact that styrene alone polymerizes more slowly than does vinyl acetate alone, but when mixed the styrene polymerizes first and the vinyl acetate only after the styrene is nearly gone.



¹⁵⁷ See note 155.

¹⁵⁸ P. I. Abell, in *Free Radicals*, J. K. Kochi, Ed., Vol. II, p. 99.

¹⁵⁹ (a) Walling, *Free Radicals in Solution*, p. 123; for rate constants see also (b) K. U. Ingold, in *Free Radicals*, J. K. Kochi, Ed., Vol. I, p. 92.

¹⁶⁰ See note 159(b).

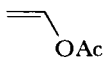
Table 9.10 RATE CONSTANTS IN THE STYRENE-VINYL ACETATE SYSTEM ($M^{-1} \text{ SEC}^{-1}$ AT 60°C)^a

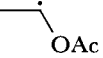
Radical	Olefin	
		
	145	3
	> 160,000	3,700

^a Calculated from data given by C. Walling, *Free Radicals in Solution*, Wiley, New York, 1957, p. 118, and by K. U. Ingold, in *Free Radicals*, J. K. Kochi, Ed., Wiley, New York, 1973, Vol. I, p. 92.

For those monomer pairs that show a strong tendency toward alternation, inconsistencies with the above generalizations appear. With $M_1 =$ styrene, $M_2 =$ maleic anhydride, both r_1 and r_2 are less than 0.05;¹⁶¹ chains ending in styrene units prefer to add to maleic anhydride, but those ending in maleic anhydride prefer to add to styrene. The sequence of stabilization that we have given suggests that styrene should be the more reactive of the two olefins, a conclusion substantiated by the relatively low reactivity of maleic anhydride compared with styrene toward radicals with carboxyl, cyano, or chlorine α substituents. The unusual affinities found in alternating pairs are attributed to the complementary polar character of the groups. If one of the groups R, R'

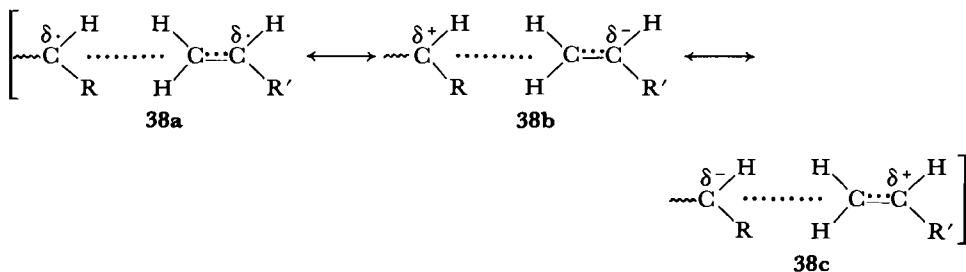

is particularly good for stabilization of positive charge and the other for stabilization of negative charge, then in the transition state either **38b** or **38c** will make a significant contribution and the energy will be lowered. In the styrene-maleic anhydride copolymerization, this criterion is met both for addition of chains ending in a styrene unit to maleic anhydride ($R = \phi$, $R' = \text{COO}-$, **38b** favored) and for addition of chains ending in a maleic anhydride unit to styrene ($R = \text{COO}-$, $R' = \phi$, **38c** favored).

Eliminations

A number of instances are known in which a radical elimination or fragmentation occurs. We have already met some of these, for example in the decomposition of diacyl peroxides, where the second step (Equation 9.89) is an elimination, or in

¹⁶¹ See note 156, p. 508.

fragmentation of alkoxy radicals (Equation 9.90). Perhaps the most obvious elimination is simple reversal of addition of a radical to a carbon-carbon double bond, the back reaction in Equation 9.91. As we noted earlier, this reaction is

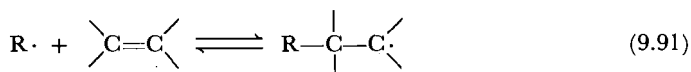
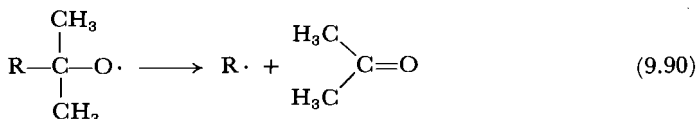
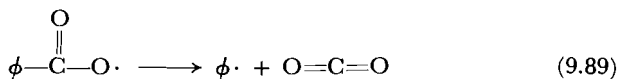
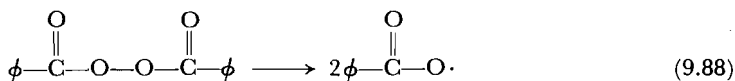

exothermic in the forward direction as written and at moderate temperatures proceeds efficiently to the right; the reverse, having the larger activation energy, nevertheless competes more and more effectively as the temperature is raised. At some critical temperature the rates of polymerization and the reverse (depolymerization) become equal; above the critical temperature polymer chains will come apart to monomer. For styrene the critical temperature is a little over 300°C.¹⁶² Reversibility of addition to olefins is also manifest in the cis-trans isomerization of double bonds by bromine,¹⁶³ iodine,¹⁶⁴ and by thiols¹⁶⁵ under radical conditions. Strain in cyclic compounds can alter the energy relationships so that elimination becomes more favorable relative to addition, as in Equations 9.92 and 9.93.

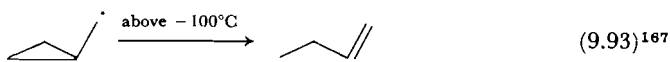
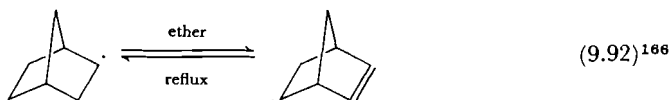

Eliminations in Alkoxy Radicals¹⁶⁸

Elimination of an alkyl radical from an alkoxy radical with formation of a carbonyl group, usually termed β scission (Equation 9.94), is more favorable

¹⁶² F. S. Dainton and K. J. Ivin, *Nature*, **162**, 705 (1948).

¹⁶³ G. A. Oldershaw and R. J. Cvetanović, *J. Chem. Phys.*, **41**, 3639 (1964).

¹⁶⁴ K. W. Egger, *J. Amer. Chem. Soc.*, **89**, 504 (1967).

¹⁶⁵ (a) R. H. Pallen and C. Sivertz, *Can. J. Chem.*, **35**, 723 (1957); see also (b) J. T. Heppinstall, Jr., and J. A. Kampmeier, *J. Amer. Chem. Soc.*, **95**, 1904 (1973); review: (c) K. Griesbaum, *Angew. Chem. Int. Ed.*, **9**, 273 (1970).

¹⁶⁶ J. I. Davies, J. N. Done, and D. H. Hey, *Chem. Commun.*, 725 (1966).

¹⁶⁷ (a) J. K. Kochi, P. J. Krusic, and D. R. Eaton, *J. Amer. Chem. Soc.*, **91**, 1877 (1969); for further examples see (b) J. W. Wilt in *Free Radicals*, J. K. Kochi, Ed., Vol. I, p. 398.

¹⁶⁸ Chemistry of alkoxy radicals is reviewed by J. K. Kochi, in *Free Radicals*, J. K. Kochi, Ed., Vol. II, p. 665.

thermodynamically than is elimination to form an olefin and takes place readily in competition with other processes. Using the data of Benson and co-workers (Tables 2.6, p. 75, and 9.5, p. 474), we can calculate that fragmentation of the

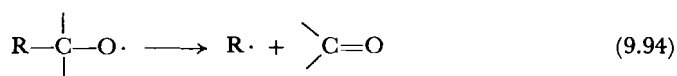

t-butoxy radical (Equation 9.95) is endothermic by 4 kcal mole⁻¹ and elimination of benzyl radical in Equation 9.96 should be exothermic by 12 kcal mole⁻¹. Elimination of hydrogen, on the other hand, is substantially endothermic and rarely occurs.¹⁶⁹ Rates of fragmentation have been measured relative to rate of

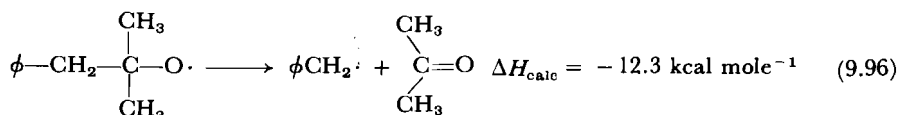
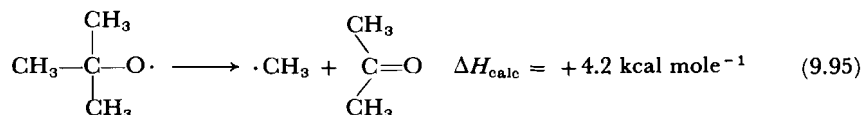
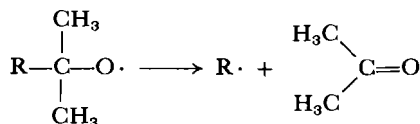

Table 9.11 RELATIVE RATES OF FRAGMENTATION OF ALKOXY RADICALS AT 40°C^a



R·	<i>k</i> _{rel}	Reference
·CH ₃	(1)	<i>b</i>
·CH ₂ Cl	6	<i>b</i>
·C ₂ H ₅	104	<i>b</i>
$\cdot\overset{\text{CH}_3}{\underset{\text{CH}_3}{\text{C}}}-\text{H}$	3,800	<i>b</i>
φCH ₂ ·	12,500	<i>c</i>
$\cdot\overset{\text{CH}_3}{\underset{\text{CH}_3}{\text{C}}}-\text{CH}_3$	> 15,000	<i>b</i>
φ·	24	<i>b</i>

^a Assuming all alkoxy radicals abstract hydrogen from cyclohexane at the same rate, and that there is no interference by chlorine atom chains in the hypochlorite decompositions. See Reference *c*.

^b C. Walling and A. Padwa, *J. Amer. Chem. Soc.*, **85**, 1593 (1963).

^c C. Walling and J. A. McGuinness, *J. Amer. Chem. Soc.*, **91**, 2053 (1969).

¹⁶⁹ (a) P. Gray and A. Williams, *Chem. Rev.*, **59**, 239 (1959); (b) P. Gray, R. Shaw, and J. C. J. Thynne, *Prog. Reaction Kinetics*, **4**, 63 (1967).

abstraction of hydrogen from a hydrocarbon solvent by the alkoxy radical; if one assumes that the abstractions proceed at about the same rate for different alkoxy radicals, the results yield relative rates of fragmentation for different departing R· radicals. Table 9.11 lists relative rate values, which show the increasing rate of fragmentation as the departing radical becomes more highly stabilized.

When there is a choice of more than one group that might cleave, the more stable radical fragments preferentially.¹⁷⁰ A strained bridgehead radical (compare Equations 9.97 and 9.98) is much less susceptible to cleavage than would be expected for an unstrained tertiary radical,¹⁷¹ a result that may reflect difficulty

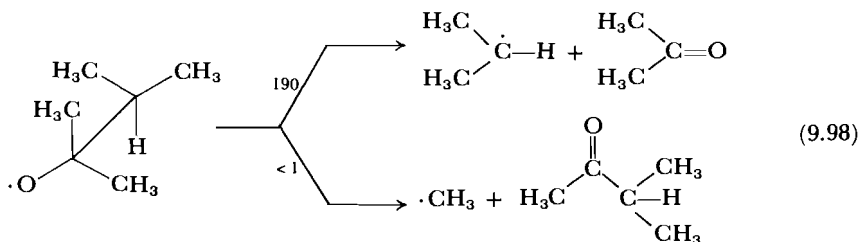
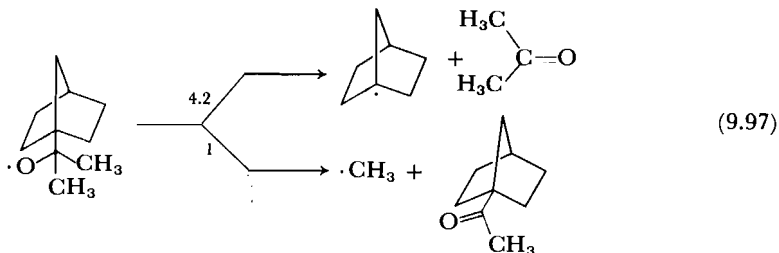

in establishing a radical center at a position that cannot attain planarity. The difficulty of eliminating the norbornyl fragment might, on the other hand, be a consequence of polar contributions to the transition state (**39b**), which would contribute less stabilization if the alkyl fragment is restricted to a nonplanar geometry.¹⁷²

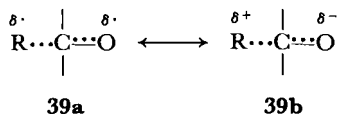

Aromatic Substitution¹⁷³

Radicals react with aromatic rings by substitution in a manner superficially resembling electrophilic or nucleophilic substitution. The reaction proceeds in

¹⁷⁰ F. D. Greene, M. L. Savitz, F. D. Osterholtz, H. H. Lau, W. N. Smith, and P. M. Zanet, *J. Org. Chem.*, **28**, 55 (1963).

¹⁷¹ See note 170.

¹⁷² J. K. Kochi, *Free Radicals*, Vol. II, p. 685.

¹⁷³ For reviews see (a) M. J. Perkins, in *Free Radicals*, J. K. Kochi, Ed., Vol. II, p. 231; (b) D. H. Hey, in *Advances in Free Radical Chemistry*, Vol. 2, G. H. Williams, Ed., Logos Press and Academic Press, London, 1967, p. 47.

steps, as do the heterolytic processes, with initial addition yielding a resonance-stabilized conjugated radical (Equation 9.99). When the radical adding is phenyl, the addition step is for practical purposes not reversible, subsequent steps being much faster than loss of the phenyl radical. Evidence pointing to this conclusion is found in the lack of an isotope effect with deuterated benzene.¹⁷⁴

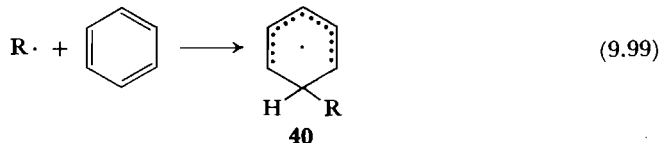

Were reversal of Equation 9.99 to compete with the subsequent removal of a hydrogen atom from **40**, the rate of the hydrogen removal step would enter the overall rate expression; the reaction would then show an isotope effect. (See Section 7.4, p. 385.) In some instances, for example, when the benzoyl radical attacks benzene, the initial addition is apparently reversible,¹⁷⁵ and an isotope effect is found.¹⁷⁶

These features all find counterparts in the heterolytic aromatic substitutions; the rest of the reaction sequence in the radical additions becomes considerably more complex. The first point is that the removal of the hydrogen atom from the carbon that has been attacked in **40** is not spontaneous, but requires interaction with some other radical (Equation 9.100) or oxidizing agent (Equation 9.101). If the abstraction is by another radical (Equation 9.100), the

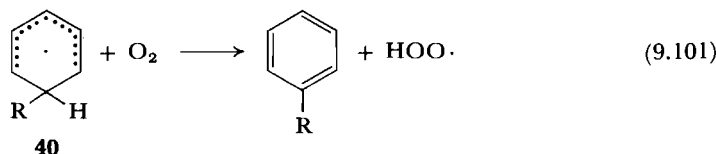
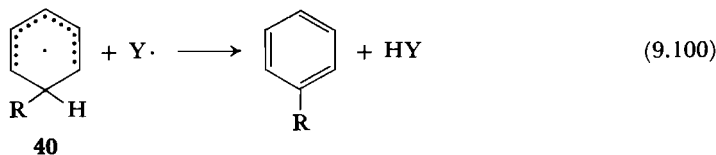

process is a disproportionation that terminates the radical chain. Hence the aromatic substitutions are not ordinarily chain reactions, although side reactions that are chain processes may well accompany them.

The necessity for another radical to complete the substitution sequence opens the way for complications. The cyclohexadienyl radical **40** may well react in some other way. It may dimerize, undergo self-disproportionation, or couple. Furthermore, since the cyclohexadienyl radical has three positions at which it can react, isomeric products are possible in each case.

¹⁷⁴ (a) R. J. Convery and C. C. Price, *J. Amer. Chem. Soc.*, **80**, 4101 (1958); (b) E. L. Eliel, S. Meyerson, Z. Welvert, and S. H. Wilen, *J. Amer. Chem. Soc.*, **82**, 2936 (1960). These authors point out that there may be isotopic selectivity in product formation because of competition at later stages among C—H bond breaking and other kinds of steps. (c) C. Shih, D. H. Hey, and G. H. Williams, *J. Chem. Soc.*, 1871 (1959).

¹⁷⁵ T. Nakata, K. Tokomaru, and O. Simamura, *Tetrahedron Lett.*, 3303 (1967).

¹⁷⁶ J. Saltiel and H. C. Curtis, *J. Amer. Chem. Soc.*, **93**, 2056 (1971).

Isomer Distributions in Aromatic Substitution

Study of isomer distribution in substitution of benzene rings already carrying one substituent presents some potential pitfalls. Inspection of product ratios for ortho, meta, and para substitution, as in investigation of electrophilic substitution (Section 7.4, p. 392), might be expected to give misleading results because of the side reactions that occur in radical substitution. The isomeric substituted cyclohexadienyl radicals first formed by radical attack partition between the simple substitution route and other pathways (Equation 9.102). In order for the

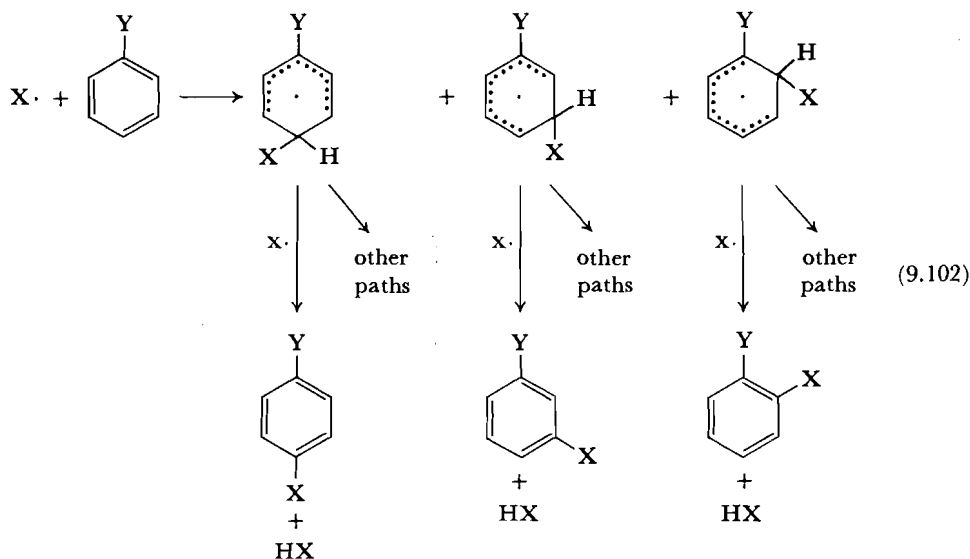

isomer ratios of final simple substitution products to reflect the preference for initial attack at the various positions, the partition between hydrogen abstraction and the other paths must be substantially the same for all three isomers. Careful studies of the effect on product ratios of added oxygen, which diverts more of the intermediate cyclohexadienyl radicals to simple substitution product through Reaction 9.101, reveals that the problem is not in practice a serious one; the product ratios are nearly unchanged.¹⁷⁷

Table 9.12 compares partial rate factors for substitution by phenyl radical with those for electrophilic bromination. Selectivity is clearly much lower for the radical substitution; furthermore, for attacking phenyl radical, nearly all positions in the substituted benzenes are more reactive than in benzene itself, a finding that reflects the tendency for most substituents to stabilize a radical, and thus to lower transition state energy for formation of the cyclohexadienyl intermediate, when compared with hydrogen. The strong polar effects, which cause the familiar pattern of activation and deactivation in the electrophilic substitutions, are absent. One factor that presumably contributes to the low selectivity in radical attack is an early transition state in the addition step, which is exothermic by roughly 20 kcal mole⁻¹.¹⁷⁸

¹⁷⁷ (a) R. T. Morrison, J. Cazes, N. Samkoff, and C. A. Howe, *J. Amer. Chem. Soc.*, **84**, 4152 (1962); (b) D. H. Hey, K. S. Y. Liang, and M. J. Perkins, *Tetrahedron Lett.*, 1477 (1967); (c) D. H. Hey, M. J. Perkins, and G. H. Williams, *Chem. Ind.*, 83 (1963).

¹⁷⁸ Estimated from data of Benson, Table 2.6, p. 75, and Table 9.5, p. 474.

Table 9.12 PARTIAL RATE FACTORS^a FOR RADICAL AND ELECTROPHILIC SUBSTITUTION

Substrate	Attacking Reagent			
	ϕ . ^b	Bromination ^c		
ϕ -CH ₃	f_{ortho}	3.30	600	} <i>d</i>
	f_{meta}	1.09	5.5	
	f_{para}	1.27	2420	
ϕ -NO ₂	f_{ortho}	9.38	—	} <i>e</i>
	f_{meta}	1.16	4.8×10^{-5}	
	f_{para}	9.05	—	
ϕ -OCH ₃	f_{ortho}	3.56	8.7×10^7	} <i>d</i>
	f_{meta}	0.93	2.0	
	f_{para}	1.29	1.1×10^{10}	
ϕ -Cl	f_{ortho}	3.09	—	} <i>f</i>
	f_{meta}	1.01	0.00056	
	f_{para}	1.48	0.145	

^a Rate of substitution at position indicated relative to rate at a single position of benzene. See Section 7.4, p. 392.

^b Data of R. Itô, T. Migita, N. Morikawa, and O. Simamura, *Tetrahedron*, **21**, 955 (1965).

^c Data from compilation of L. M. Stock and H. C. Brown, *Advan. Phys. Org. Chem.*, **1**, 35 (1963).

^d Br₂ in acetic acid-water, 25°C.

^e HOBr in perchloric acid-water, 25°C.

^f Br₂ in acetic acid-nitromethane, 30°C.

Table 9.13 PARTIAL RATE FACTORS FOR SUBSTITUTION BY BENZOYL RADICALS^a

Substrate	Attacking Reagent	
	$\begin{array}{c} \text{O} \\ \\ \phi\text{-C-O}\cdot \end{array}$	
ϕ -CH ₃	f_{ortho}	4.2
	f_{meta}	1.4
	f_{para}	3.7
ϕ -OCH ₃	f_{ortho}	20.6
	f_{meta}	< 0.31
	f_{para}	20.4
ϕ -Cl	f_{ortho}	0.80
	f_{meta}	0.25
	f_{para}	0.98

^a Calculated from data of M. E. Kurz and M. Pellegrini, *J. Org. Chem.*, **35**, 990 (1970).

Not all radical aromatic substitutions are as immune to polar effects as is attack by phenyl. Some radicals reveal marked electrophilic or nucleophilic character. Oxygen-centered radicals, for example, are electrophilic, as would be expected if there is substantial polar contribution to the transition state. Table 9.13 lists partial rate factors for substitution by benzoyl radicals; note that the orientation and activation trends found in typical electrophilic substitutions have begun to appear, but are still modest compared with the dramatic effects shown in Table 9.12 for a true heterolytic substitution.¹⁷⁹

¹⁷⁹ Aromatic substitution patterns have been correlated fairly successfully with activation energies

9.5 REARRANGEMENTS OF RADICALS

Although rearrangements are less prevalent in radical chemistry than in the chemistry of cations, they do occur under various circumstances.¹⁸⁰

1,2-Shifts

Alkyl groups and hydrogen do not undergo the 1,2-shifts so common in carbocations. Orbital theory provides a rationalization for the difference in behavior. The three-center transition state for rearrangement has only one bonding level, which can accommodate the two electrons of a rearranging cation. In a rearranging radical, one electron must go into an antibonding level, and the transition state is destabilized.¹⁸¹ Another point is the relatively small energy differences among primary, secondary, and tertiary radicals; Benson's group additivity method allows an estimate that rearrangement converting primary to secondary and primary to tertiary radicals (Equations 9.103 and 9.104) will be exothermic by only 1.4 and 4.3 kcal mole⁻¹, respectively. The driving forces are thus small;

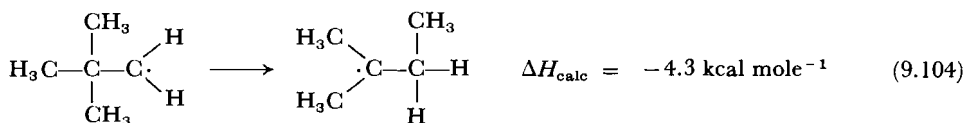
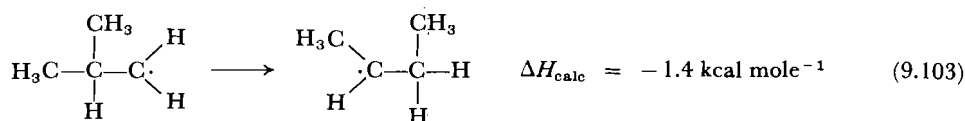

furthermore, there are always in radical systems rapid competing processes that cannot be suppressed by a proper choice of medium.

Rearrangement of phenyl groups and halogen to an adjacent center are more favorable than those of alkyl and hydrogen. 1,2-Shifts of phenyl occur most readily when the rearrangement will yield a more highly stabilized radical, for example, in Equations 9.105 and 9.106. The rearrangement does nevertheless

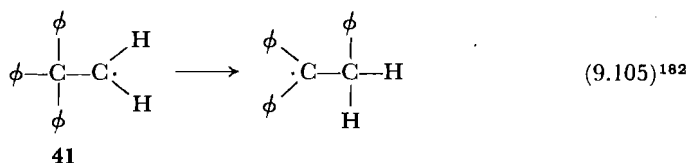

calculated by molecular orbital methods. See (a) M. J. S. Dewar, *The Molecular Orbital Theory of Organic Chemistry*, McGraw-Hill, New York, 1969, p. 299; (b) L. Salem, *Molecular Orbital Theory of Conjugated Systems*, W. A. Benjamin, Menlo Park, Calif., 1966, chap. 6.

¹⁸⁰ (a) A comprehensive review is J. W. Wilt, in *Free Radicals*, J. K. Kochi, Ed., Vol. I, p. 333; see also (b) R. Kh. Friedlina, in *Advances in Free Radical Chemistry*, Vol. 1, G. H. Williams, Ed., Logos Press and Academic Press, London, 1965, p. 211; (c) C. Walling, in *Molecular Rearrangements*, P. DeMayo, Ed., Wiley-Interscience, New York, 1963, Part I, p. 407.

¹⁸¹ (a) H. E. Zimmerman and A. Zweig, *J. Amer. Chem. Soc.*, **83**, 1196 (1961); (b) N. F. Phelan, H. H. Jaffe, and M. Orchin, *J. Chem. Educ.*, **44**, 626 (1967); (c) Wilt, in *Free Radicals*, J. K. Kochi, Ed., p. 335.

¹⁸² (a) D. Y. Curtin and M. J. Hurwitz, *J. Amer. Chem. Soc.*, **74**, 5381 (1952); (b) D. Y. Curtin and J. C. Kauer, *J. Org. Chem.*, **25**, 880 (1960); (c) Wilt, in *Free Radicals*, J. K. Kochi, Ed., p. 351, estimates the activation energy of Equation 9.105 to be about 9 kcal mole⁻¹.

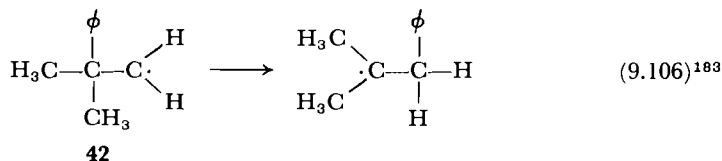

occur even when there are no substituents, as demonstrated by label scrambling

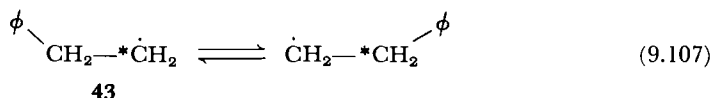

in the β -phenylethyl radical (Equation 9.107).¹⁸⁴ The tendency for **43** to rearrange is less than for **41** or **42**; 2 to 5 percent of radicals **43** rearrange before reacting by hydrogen abstraction (from aldehyde $\phi\text{CH}_2\text{CH}_2\text{CHO}$), whereas **41** rearranges completely and **42** about 50 percent under similar conditions.¹⁸⁵

Because raising the concentrations of substances from which the radicals can abstract hydrogen decreases the amount of rearrangement,¹⁸⁶ it is clear that rearrangement follows the formation of the radical rather than being concerted with it; the half-migrated structure **44**, if an intermediate at all, must be a very

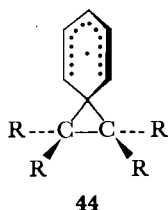

short-lived one. It has not proved possible to detect it by electron spin resonance at low temperature.¹⁸⁷ Vinyl groups also migrate, probably in a manner similar to phenyl.¹⁸⁸

SCHEME 14

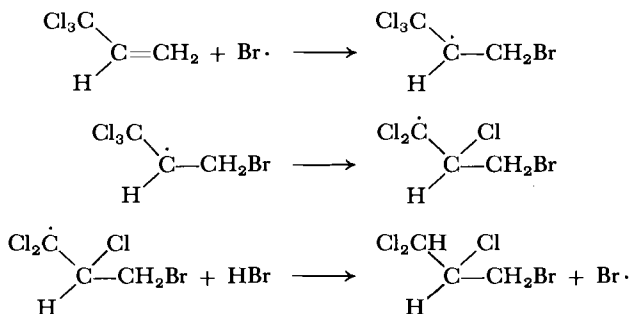

¹⁸³ See note 182(a), (b); (b) E. J. Hamilton, Jr. and H. Fischer, *Helv. Chim. Acta*, **56**, 795 (1973), report $E_a = 10.3 \pm 2$ kcal mole⁻¹ for Equation 9.106.

¹⁸⁴ L. H. Slauch, *J. Amer. Chem. Soc.*, **81**, 2262 (1959).

¹⁸⁵ See note 182(a), p. 517.

¹⁸⁶ See, for example: M. L. Poutsma and P. A. Ibarbia, *Tetrahedron Lett.*, 3309 (1972). Other studies are cited by Wilt, in *Free Radicals*, J. K. Kochi, Ed., pp. 346-347.

¹⁸⁷ J. K. Kochi and P. J. Krusic, *J. Amer. Chem. Soc.*, **91**, 3940 (1969).

¹⁸⁸ See, for example: L. K. Montgomery, J. W. Matt, and J. R. Webster, *J. Amer. Chem. Soc.*, **89**, 923 (1967).

Rearrangements of Halogen

Rearrangement of Cl, Br, or I to an adjacent radical site has been proposed to account for a number of results. Chlorine migration occurs in reaction sequences such as that shown in Scheme 14.¹⁸⁹ Generation of a radical center adjacent to a carbon bearing a bromine substituent has been postulated to be accompanied by bridging of the bromine to form the radical analog of the bromonium ion (Equation 9.108).¹⁹⁰⁻¹⁹³

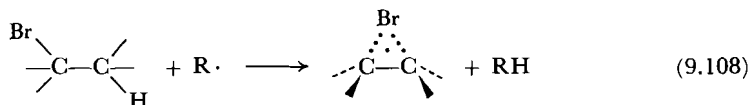

Other Rearrangements

The various radical reactions we have discussed in the earlier sections can occur intramolecularly. When they do, products have rearranged structures.¹⁹⁴ Some of these processes have been exploited for synthetic purposes, but there remains great potential for development of this field.

Rearrangements Involving Aryl Groups

When a radical is formed in a chain four or five carbon atoms removed from an aryl group, rearrangements that amount to intramolecular aromatic substitutions can occur. The initial radical attack will yield a cyclohexadienyl radical intermediate with an attached five- or six-membered ring, as in Equation 9.109.

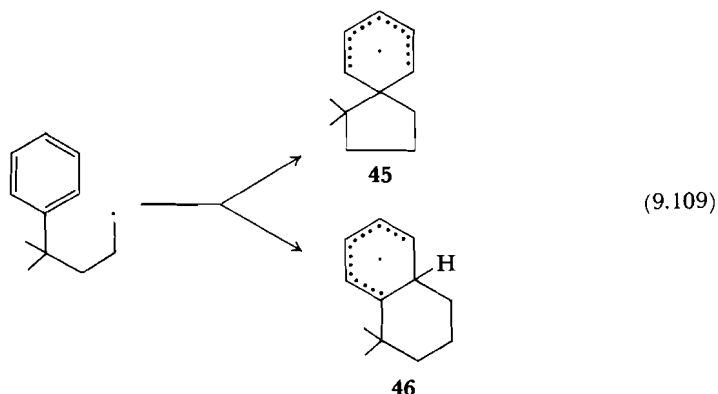

¹⁸⁹ See note 180(a), p. 517.

¹⁹⁰ (a) P. S. Skell and K. J. Shea, in *Free Radicals*, J. K. Kochi, Ed., Vol. II, p. 809; (b) L. Kaplan, *Bridged Free Radicals*, Marcel Dekker, New York, 1972.

¹⁹¹ W. Thaler, *J. Amer. Chem. Soc.*, **85**, 2607 (1963).

¹⁹² P. S. Skell and P. D. Readio, *J. Amer. Chem. Soc.*, **86**, 3334 (1964).

¹⁹³ D. D. Tanner, H. Yabuuchi, and E. V. Blackburn, *J. Amer. Chem. Soc.*, **93**, 4802 (1971); D. D. Tanner, M. W. Mosher, N. C. Das, and E. V. Blackburn, *J. Amer. Chem. Soc.*, **93**, 5846 (1971) have claimed that product ratios supporting the bridging hypothesis are not kinetically controlled but result from subsequent reaction of products with HBr. Others have found this work not reproducible (P. S. Skell and K. S. Shea, *J. Amer. Chem. Soc.*, **94**, 6550 (1972); J. G. Traynham, E. E. Green, Y. Lee, F. Schweinsberg, and C. Low, *J. Amer. Chem. Soc.*, **94**, 6552 (1972)), and have provided further evidence in favor of bridging (P. S. Skell, R. R. Pavlis, D. C. Lewis, and K. J. Shea, *J. Amer. Chem. Soc.*, **95**, 6735 (1973)).

¹⁹⁴ These processes are extensively reviewed by Wilt, in *Free Radicals*, J. K. Kochi, Ed., Vol. I.

If attack was at the point of attachment of the side chain (45), the spirocyclic system will open again (Equation 9.110), and a 1,4-migration of phenyl will have

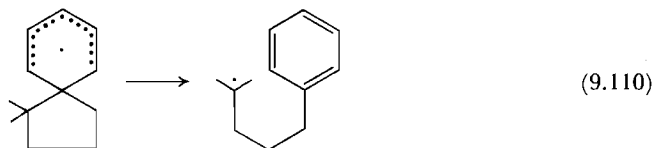

occurred. If the attack was at an ortho position (46), the aromatic substitution will proceed in the ordinary manner to yield a fused ring product (Equation 9.111).¹⁹⁵

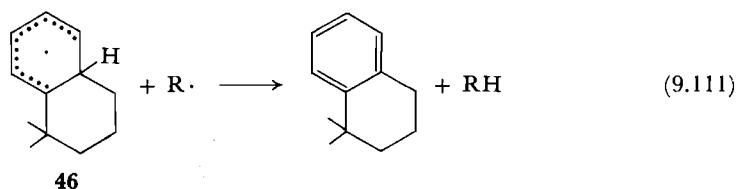

1,5-Hydrogen Migration

An intramolecular S_H2 reaction can occur readily through a six-membered cyclic transition state (47). Migration of a hydrogen over longer distances than

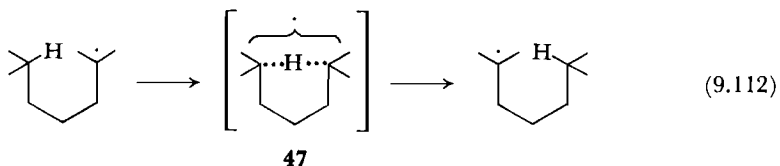

1,5 will become increasingly difficult as the chain lengthens because of the decreasing probability of the proper conformation being present in appreciable concentration. The migration over shorter distances is unfavorable because of the strain that will be introduced in attaining a collinear arrangement of the hydrogen and the two atoms between which it is moving. The 1,5 transfer is therefore by far the most common of the free-radical hydrogen shifts.

Intramolecular hydrogen abstraction is an important synthetic reaction because it provides a method of introducing a functional group at a saturated carbon bonded to only hydrogen and other carbons, a difficult task to accomplish by other means.¹⁹⁶ The abstracting radical need not be carbon; the Barton reaction (Scheme 15) is a standard method in which the abstracting radical is oxygen.¹⁹⁷ This technique has been used extensively for selective introduction of functionality in steroid synthesis.¹⁹⁸

¹⁹⁵ For an example, see: S. Winstein, R. Heck, S. Lapporte, and R. Baird, *Experientia*, **12**, 138 (1956).

¹⁹⁶ For a review of applications, see: K. Heusler and J. Kalvoda, *Angew. Chem. Int. Ed.*, **3**, 525 (1964).

¹⁹⁷ (a) D. H. R. Barton, J. M. Beaton, L. E. Geller, and M. M. Pechet, *J. Amer. Chem. Soc.*, **83**, 4076 (1961); (b) R. H. Hesse, in *Advances in Free Radical Chemistry*, G. H. Williams, Ed., Vol. 3, Academic Press, New York, 1969, p. 83.

¹⁹⁸ See note 196.

SCHEME 15

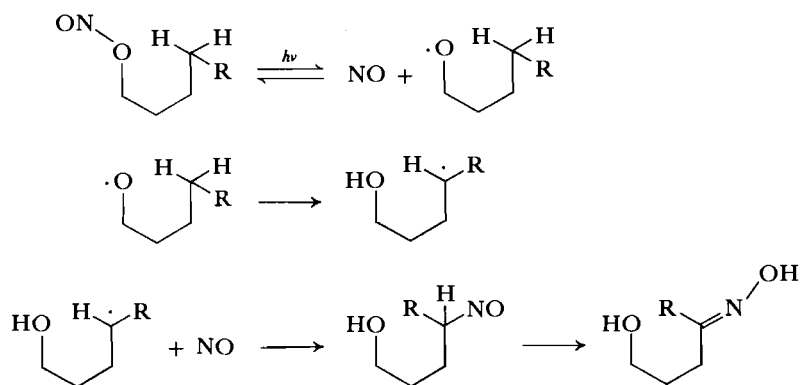

SCHEME 16

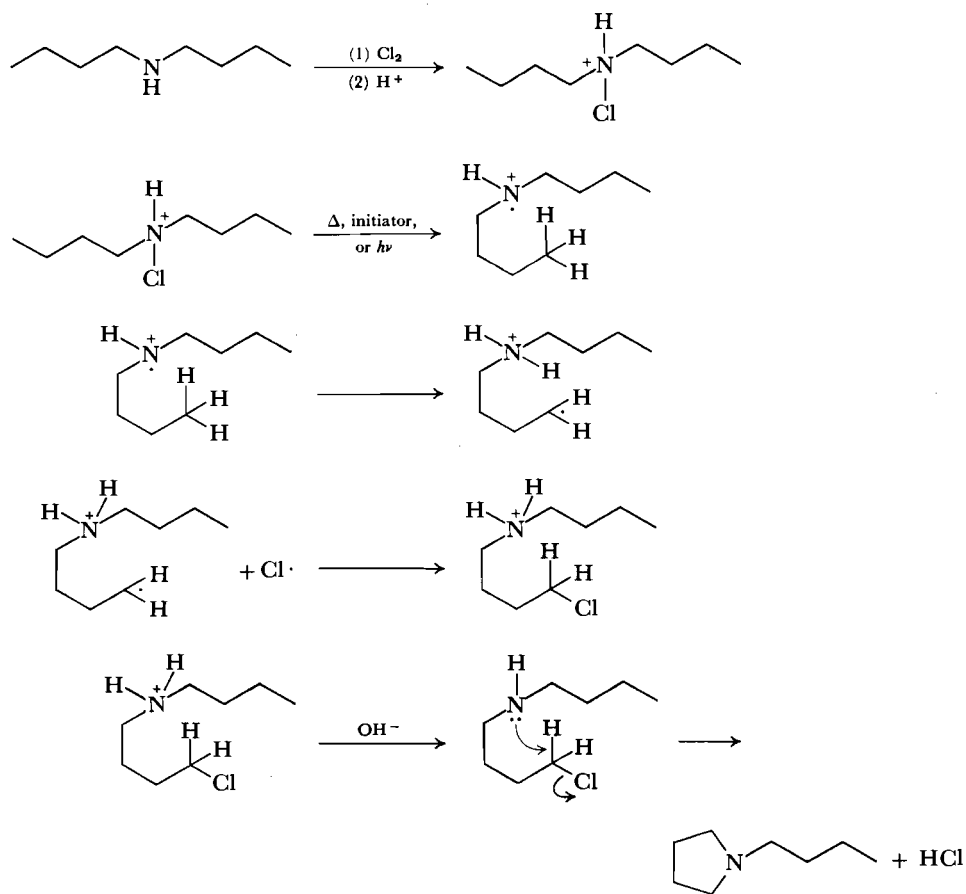

Transannular hydrogen migrations occur readily in medium rings. An example is Equation 9.113.¹⁹⁹

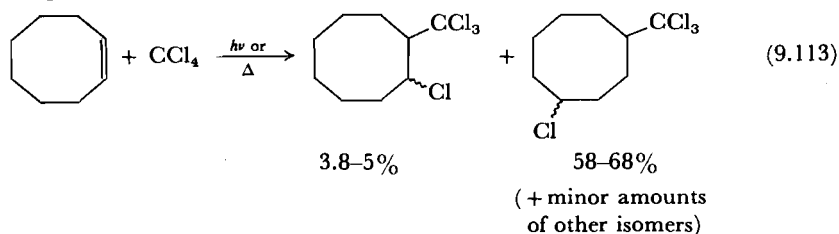

It is sometimes possible to combine a radical reaction with a heterolytic process to achieve a synthetically useful result, as in the Hofmann-Löffler reaction (Scheme 16).²⁰⁰

Intramolecular Additions and Eliminations

Addition of a radical to a carbon-carbon double bond in the same molecule occurs easily if a five- or six-membered ring can form. The most common location of the double bond is at the 5,6-position, as shown in Scheme 17, although

SCHEME 17

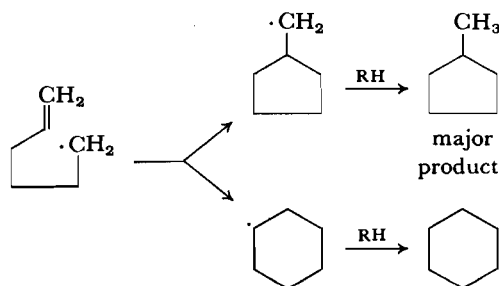

cyclizations will also occur to double bonds one carbon closer or one carbon farther from the radical site. Formation of the five-membered ring is faster than formation of the six-membered ring, but the six-membered radical is thermodynamically more stable. In the presence of good hydrogen-donor solvents, and if the original radical center is not stabilized, the addition does not reverse and

SCHEME 18

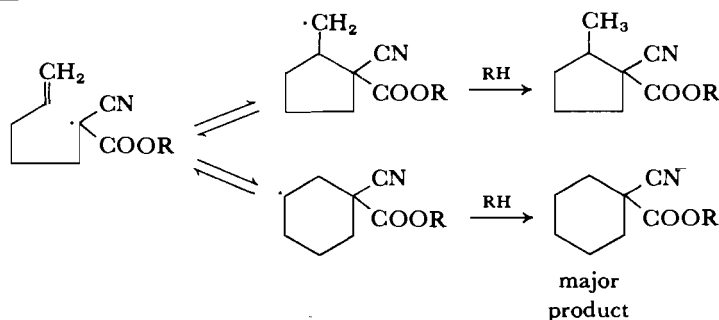

¹⁹⁹ J. G. Traynham and T. M. Couvillon, *J. Amer. Chem. Soc.*, **89**, 3205 (1967).

²⁰⁰ For a review, see: M. E. Wolff, *Chem. Rev.*, **63**, 55 (1963).

the more rapidly formed five-membered ring is trapped by hydrogen abstraction. On the other hand, if the original radical is well stabilized, the cyclization is reversible; then, especially in the absence of particularly good hydrogen donors, the equilibrium will favor the six-membered ring radical, and the cyclohexane product will dominate (Scheme 18).²⁰¹

Some remarkable cyclizations have been accomplished with free radicals; Equation 9.114 gives an example.²⁰²

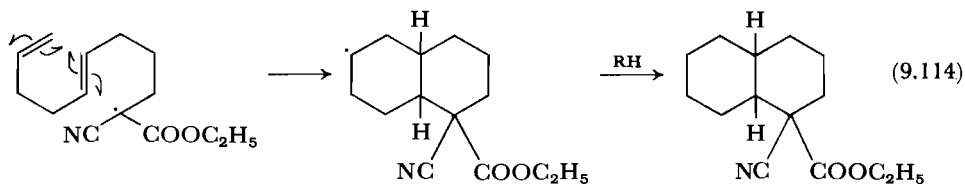

From our discussion of intermolecular additions, we would not expect these cyclizations of carbon radicals to occur in the elimination direction, and indeed cyclic radicals in five-membered or larger rings do not ordinarily open according to Equation 9.115. If the ring is small or highly strained, on the other hand,

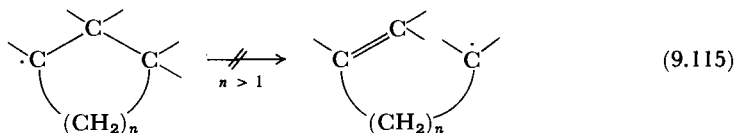

ring opening will occur. An example, Equation 9.116, has been mentioned earlier.²⁰³

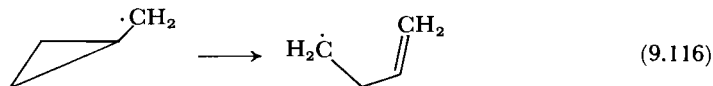

Ring opening with formation of a carbonyl group, β scission, is, as we have seen earlier, thermodynamically more favorable, and ring openings occur, both when the oxygen is originally part of the ring, as in Equation 9.117, and when the oxygen is initially in the form of an alkoxy radical, as in Equation 9.118.

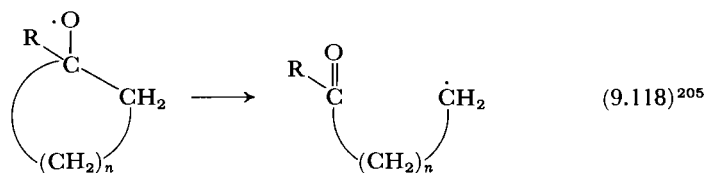
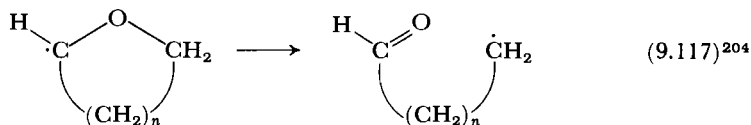

²⁰¹ Wilt, in *Free Radicals*, J. K. Kochi, Ed., Vol. I, p. 432.

²⁰² M. Julia, F. Le Goffic, and L. Katz, *Bull. Soc. Chim. France*, 1122 (1964).

²⁰³ See note 167, p. 511.

²⁰⁴ T. J. Wallace and R. J. Gritter, *J. Org. Chem.*, **26**, 5256 (1961).

²⁰⁵ See, for example: (a) J. W. Wilt and J. W. Hill, *J. Org. Chem.*, **26**, 3523 (1961). (b) F. D. Greene, M. L. Savitz, F. D. Osterholtz, H. H. Lau, W. N. Smith, and P. M. Zanet, *J. Org. Chem.*, **28**, 55 (1963).

Rearrangement of Ylides

There are a number of rearrangements of the type shown in Equation 9.119,



which is the Stevens rearrangement. These processes appear at first sight to be ionic, but some of them give rise to CIDNP spectra and therefore involve radicals. A possible pathway is dissociation to a caged radical pair (**48**), followed by recombination.²⁰⁶

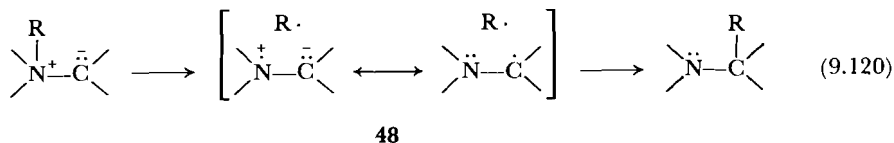

PROBLEMS

- Propose a pathway to account for the formation of epoxides in autoxidation of olefins.
- Explain the following observation:

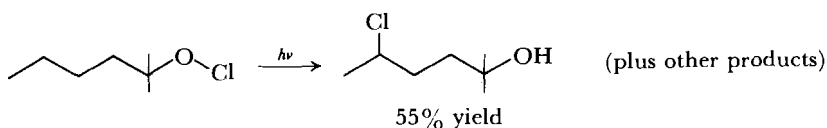

- Account for the differences in proportions of products in the following:

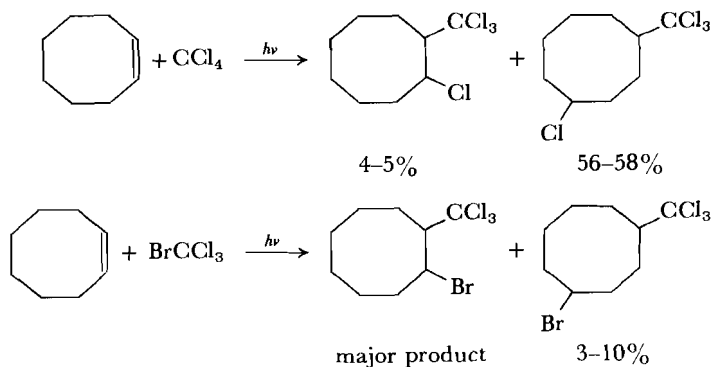

- Propose a pathway to account for the formation of the minor product shown:

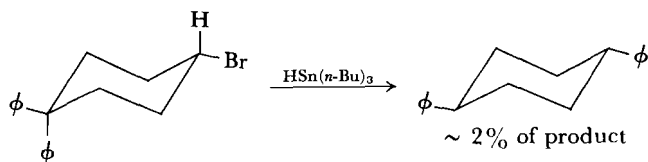

²⁰⁶ A. R. Lepley, in *Chemically Induced Magnetic Polarization*, A. R. Lepley and G. L. Closs, Eds., Wiley, New York, 1973, p. 323.

REFERENCES FOR PROBLEMS

1. M. L. Poutsma, in *Free Radicals*, J. K. Kochi, Ed., Wiley, New York, 1973, Vol. II, p. 134.
2. F. D. Greene, M. L. Savitz, H. H. Lau, F. D. Osterholtz, and W. N. Smith, *J. Amer. Chem. Soc.*, **83**, 2196 (1961). See also E. J. Corey and W. R. Hertler, *J. Amer. Chem. Soc.*, **82**, 1657 (1960).
3. (a) J. G. Traynham and T. M. Couvillon, *J. Amer. Chem. Soc.*, **89**, 3205 (1967); J. G. Traynham, T. M. Couvillon, and N. S. Bhacca, *J. Org. Chem.*, **32**, 529 (1967).
4. J. W. Wilt, R. A. Dabek, and K. C. Welzel, *J. Org. Chem.*, **37**, 425 (1972).
5. M. L. Poutsma, in *Free Radicals*, J. K. Kochi, Ed., Vol. II, p. 165.
6. M. Julia, F. Le Goffic, and L. Katz, *Bull. Soc. Chim. France*, 1122 (1964).
7. K. Heusler and J. Kalvoda, *Tetrahedron Lett.*, 1001 (1963).
8. W. Adam and L. Szendrey, *Chem. Commun.*, 1299 (1971).
9. R. Loven and W. N. Speckamp, *Tetrahedron Lett.*, 1567 (1972).
10. W. H. Urry, D. J. Trecker, and H. D. Hartzler, *J. Org. Chem.*, **29**, 1663 (1964).

Appendix 1

CHEMICALLY INDUCED

DYNAMIC NUCLEAR

POLARIZATION (CIDNP)^a

When two radicals are in close association as a pair surrounded by a cage of solvent molecules, the two odd electrons will interact with one another just as two electrons do within a molecule. The interaction will yield either a singlet state, if the two electrons have spins paired, or a triplet, if the spins are unpaired. If, for example, the caged pair arose by thermal dissociation of an ordinary ground state molecule, in which all electrons would have been paired, the state would initially be a singlet, *S*, whereas if the pair arose in a photochemical reaction from dissociation of an excited molecule in a triplet state, it would be initially a triplet, *T*.

Let us assume that the system is in the magnetic field of the magnetic resonance spectrometer; then a singlet will have only one energy state, but a triplet will have three. During the small fraction of a second that the radicals are held near each other in the solvent cage, they will move about, approaching and receding from each other. As the distance varies, so will the interaction between the electrons. The result is that the energies of the singlet and the three triplet electron spin states will vary, and at certain separations the singlet state and one of the triplet states will come close to each other in energy.^b Ordinarily the transition between a singlet and a triplet state has a low probability; but if the two states are close in energy, the likelihood of a transition is increased.

A simple model will illustrate how the transitions occur. Figure A1.1 shows a schematic diagram of an electron, the spin represented by a vector pointing

^a (a) H. R. Ward, in *Free Radicals*, J. K. Kochi, Ed., Wiley, New York, 1973, Vol. I, p. 241; (b) S. H. Glarum, in *Chemically Induced Magnetic Polarization*, A. R. Lepley and G. L. Closs, Eds., Wiley, New York, 1973, p. 7; (c) S. H. Pine, *J. Chem. Educ.*, **49**, 664 (1972).

^b See note a(b).

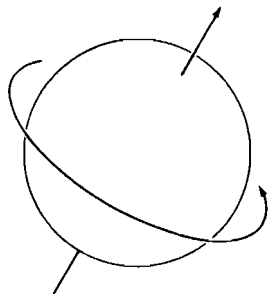

Figure A1.1 A schematic representation of an electron. The spin axis is designated by a vector, which also shows the direction of the magnetic moment.

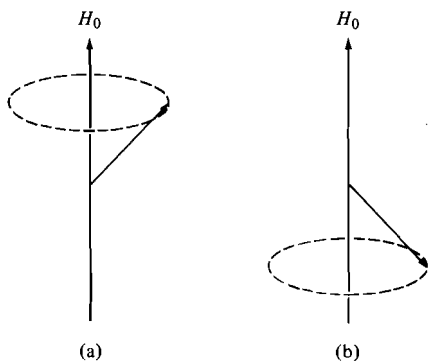

Figure A1.2 The two spin states of an electron in an applied magnetic field H_0 . In (a) there is a component of the magnetic moment vector oriented in the same direction as the applied field, and in (b) there is a component oriented in the direction opposite the applied field. The dotted circles represent the precession of the vectors around the field direction.

along the spin axis. The spinning electron also has a magnetic moment, which is in the same direction as the spin, and is also represented by the vector in Figure A1.1. If the electron is in a magnetic field, it can be in one of two quantized energy states, represented by the two different orientations of the spin vector in Figure A1.2. Because the energy, and therefore the direction of the magnetic moment vector, is quantized, the magnetic moment does not line up with the field direction, even though the field is exerting a twisting force that tries to make it do so. Any spinning object subjected to a force trying to twist the direction of its axis of rotation will respond by precessing at a characteristic rate. This precession is represented in Figure A1.2 by the circular lines, which show the path that the tip of the vector traces out during its precession. The precession frequency depends on the magnetic field strength; for an electron in magnetic fields typically found in magnetic resonance spectrometers, it is of the order of 10^{10} Hz. This precession frequency corresponds to the frequency of radiation that will cause transitions of the electron between the two energy states (Figure A1.2a and A1.2b).

Now suppose that there are two radicals close to each other. The two electron spins can arrange themselves in any one of the four ways shown in Figure A1.3. At the bottom of the figure is the singlet state. In this arrangement,

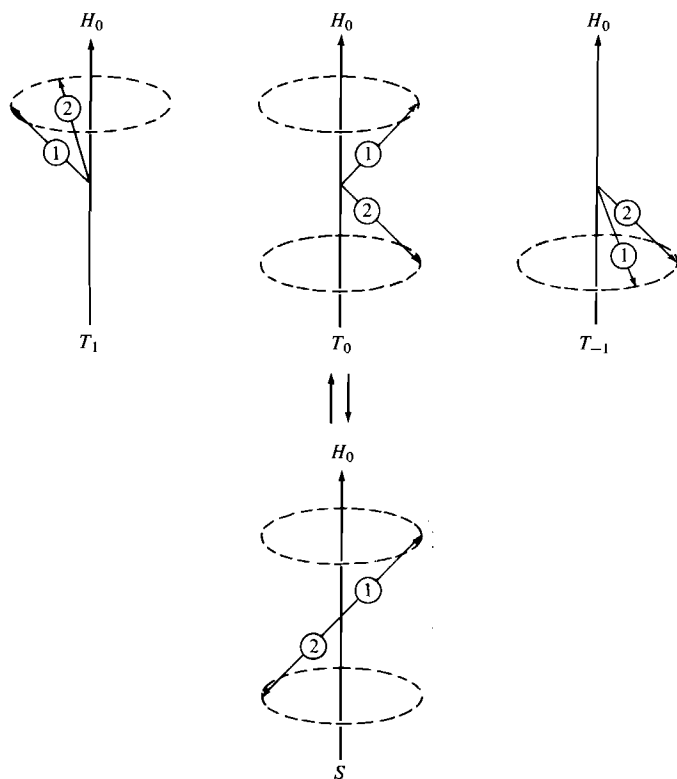

Figure A1.3 Schematic representation of the three triplet states (top) and the singlet state (bottom) for two electrons in an applied magnetic field H_0 . From H. R. Ward, in *Free Radicals*, J. K. Kochi, Ed., Wiley, New York, 1973, Vol. I, p. 242. Copyright © 1973, John Wiley & Sons. Reprinted by permission of John Wiley & Sons, Inc.

the magnetic moments (spins) of the two electrons are pointing in opposite directions. Their vector sum is zero, and there is no magnetic moment. At the top are the three triplet states. On the left, both spins up, there is a net component of magnetic moment in the direction of the applied magnetic field H_0 ; on the right, spins down, there is a component in the direction opposite H_0 . In the center, one spin is up and one is down, but the situation is different from the singlet because the relative orientations are such that the two vectors do not cancel. These three substates of the triplet state are called respectively T_1 , T_{-1} , and T_0 .

If the two radicals were identical, the precession frequency of the two electrons would be precisely the same, and a particular radical pair would remain in whichever of the four states it found itself initially. But if the two radicals are different, the two electrons will have slightly different precession frequencies. The precession frequency of an electron is characterized by a quantity called the *g factor*. If one were to observe just one of the radicals of the pair in an electron paramagnetic resonance spectrometer, the value of its *g factor* would determine the position of the resonance line in the spectrum; *g* of an electron in a radical is thus analogous to chemical shift of a proton.

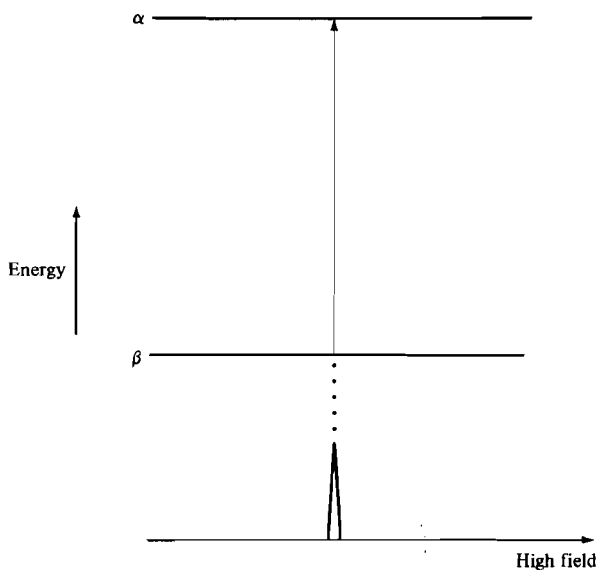
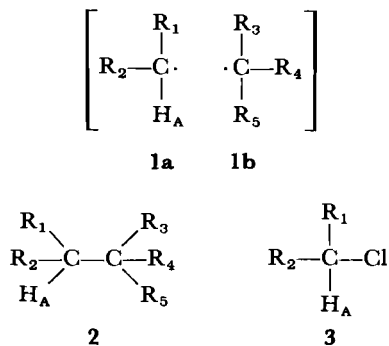

Figure A1.4 Nuclear spin states for a single proton in a magnetic field. At the top the two spin states, α and β , are shown in an energy-level diagram with the transition indicated by an arrow. Below is the single-line spectrum. With normal populations, the number of molecules in the lower state is slightly greater than the number in the higher state; normal net absorption occurs.

The consequence for our radical pair of a difference in g is that the two electrons will precess at very slightly different rates, and so over the course of many revolutions the relative phases of the two will change. One spin will gain on the other, and a pair that started out in state S will change to T_0 , while a pair that started out in T_0 will change to S .

Suppose now that the radical pair, initially in state S , has structure **1**, where one radical, let us say the one with larger g , has a proton H_A that is coupled to the electron. The proton itself experiences the magnetic field, and can be in one of two proton magnetic spin states, α or β . The nuclear magnets provide small magnetic fields which add to or subtract from the applied field. The precession frequency of the electron depends on the total magnetic field strength it feels. The frequency of the electron in radical **1a** will therefore be different depending on whether its proton happens to be in state α or state β , and so the



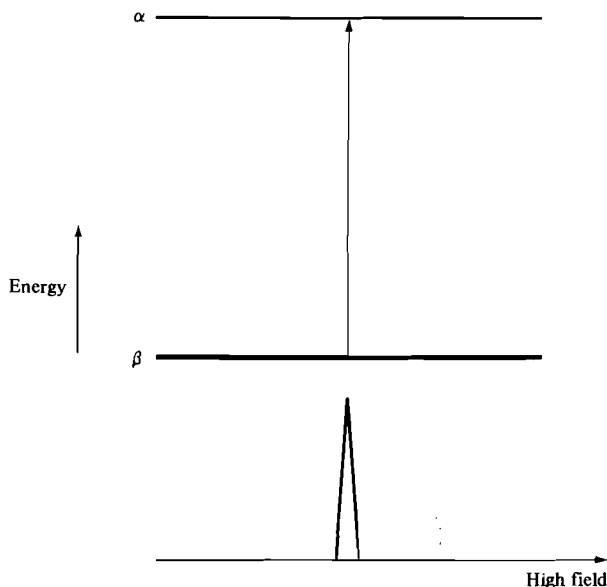

Figure A1.5 Nuclear spin states and spectrum for product 2. The heavy line indicates an enhanced population in state β . The probability of the transition $\beta \rightarrow \alpha$ is increased, and the absorption line is more intense than in Figure A1.4. The spectrum shows enhanced absorption, A. From S. H. Pine, *J. Chem. Educ.*, **49**, 664 (1972). Reproduced by permission of the Division of Chemical Education.

rate at which the two electron spins get out of step with each other will depend on the proton spin state. In this example, the α spin state will cause the pair to go over to triplet state T_0 more rapidly, and the β spin state will cause the pair to go over to T_0 less rapidly, than would have been the case had H_A not been present. Since electron spins must be paired for bond formation to occur, only the singlet pairs can combine with each other to yield 2. (Disproportionation products can also be formed.) Because those radicals in which the nuclear spin state was α are more likely to have gone over to triplets, which could not combine, product 2 will form with an excess population of nuclear spin state β . The radical pairs that were transformed into triplets cannot recombine and so are more likely than the singlet pairs to escape from the cage. Let us suppose that escaped radicals react with a chlorinated solvent to yield chloride 3; this product will have an excess population of the nuclear spin state α .

Now let us look at the nuclear resonance spectra arising from H_A in products 2 and 3. Figure A1.4 shows the relative energies of the two nuclear states α and β when H_A is in the magnetic field. Under ordinary circumstances, the population in the lower state would be slightly greater than in the higher. This population difference is called *polarization*. As the sweeping magnetic field strength reaches the right value for a given transition, the radio frequency field of the spectrometer causes transfer between levels as indicated by the vertical arrow; since the polarization is normal, with slightly more molecules in the lower state than in the higher, there is a net transfer to the higher state and absorption of

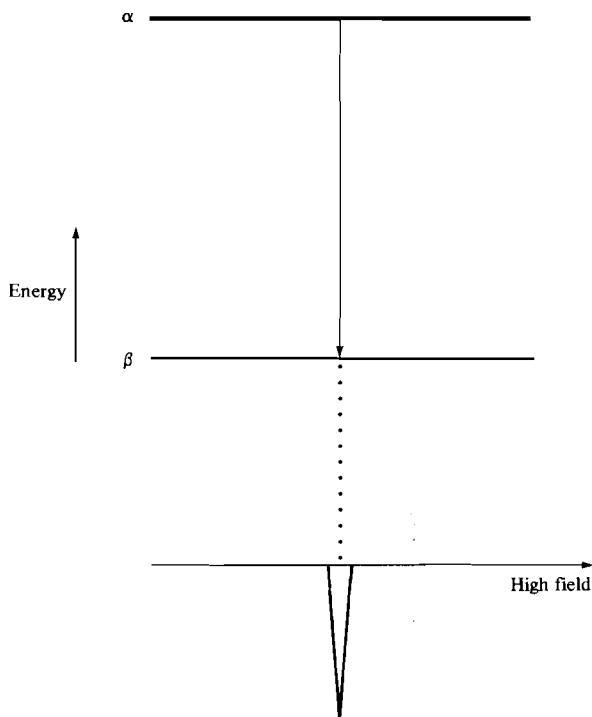

Figure A1.6 Nuclear spin states and spectrum for product 3. The upper spin state, α , has abnormally high population. The probability of the downward transition, $\alpha \rightarrow \beta$, is greater than the probability of the upward transition, and emission occurs. The spectrum shows an inverted emission peak, E . From S. H. Pine, *J. Chem. Educ.*, **49**, 664 (1972). Reproduced by permission of the Division of Chemical Education.

energy by the spin system. The resulting absorption spectrum is shown at the bottom of the figure.

Product 2 is formed with an excess of protons in spin state β . Figure A1.5 shows the result of this alteration in the normal spin polarization. The probability of upward transition is increased since there is a larger excess of molecules in the lower state to absorb, and the spectrum shows an absorption line of enhanced intensity. This overall change of spectrum intensity is called a *net effect*, and in this instance is in the direction of *enhanced absorption*, A .

The product of escape from the cage (3) is formed with an excess population of nuclear spin state α . Figure A1.6 shows the upper state with enhanced population. With this inverted polarization, the spin system will emit energy and a negative peak will be observed. There is a net effect in the direction of *emission*, E .

If the two radicals of the pair are identical, there are still mechanisms for polarization. Consider, for example, the radical pair 4. Now there are four

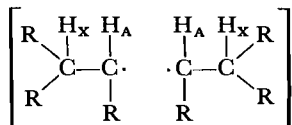

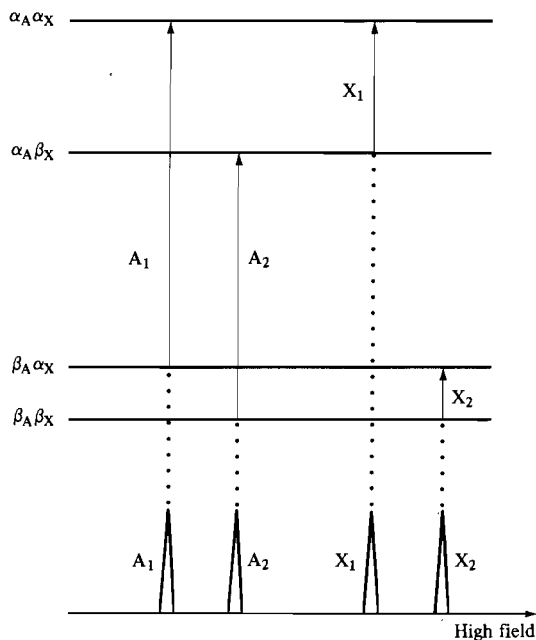
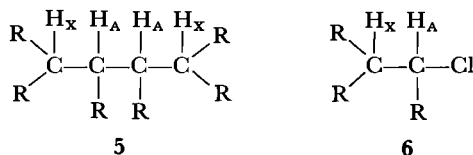

Figure A1.7 Nuclear spin states and normal absorption spectrum for the AX spin system. At the top the four spin states are shown, with the four allowed transitions indicated by arrows. Below is the spectrum, with a line corresponding to each transition. With normal population, the number of molecules in the lower state of each pair is slightly greater than the number in the higher; normal net absorption occurs for each peak in the spectrum. From S. H. Pine, *J. Chem. Educ.*, **49**, 664 (1972). Reproduced by permission of the Division of Chemical Education.

nuclear spin states, $\alpha_A\alpha_X$, $\alpha_A\beta_X$, $\beta_A\alpha_X$, $\beta_A\beta_X$. Figure A1.7 shows the relative energies of these four states in the magnetic field and the transitions that can occur between them.^c With normal populations, the spectrum of this spin system would appear as shown at the bottom in Figure A1.7. Since the two radicals are identical, there is no g factor difference to cause different precession frequencies in the two, but the nuclear spins combined in the various spin states will provide slightly different fields for the two electrons. In this example, the $\alpha_A\beta_X$ and $\beta_A\alpha_X$ nuclear spin states preferentially facilitate the conversion from singlet to triplet. The recombination product (5) will therefore form with excess population of states $\alpha_A\alpha_X$ and $\beta_A\beta_X$. The spectrum will appear as shown in Figure A1.8. This result is called the *multiplet effect*. A multiplet in which the lower field members show emission and the higher field members show absorption is designated E/A .



^c See note a(c), p. 527.

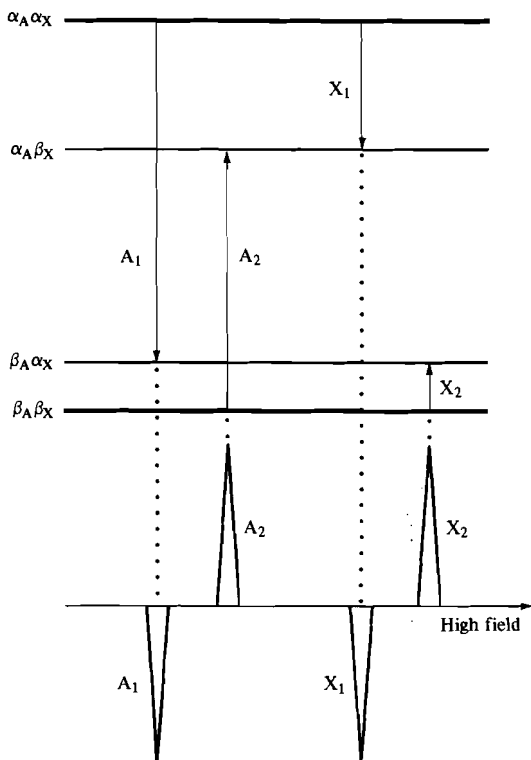

Figure A1.8 Nuclear spin states and spectrum for product 5. At the top the four states are again shown in an energy-level diagram. Heavy lines are the states with enhanced populations. A downward-pointing arrow indicates a net transfer of molecules from an overpopulated higher spin state to a less populated lower one, and corresponds to net emission. The spectrum shows the multiplet effect of type E/A . From S. H. Pine, *J. Chem. Educ.*, **49**, 664 (1972). Reproduced by permission of the Division of Chemical Education.

The product of escape from the cage (6) shows the opposite effect (Figure A1.9). Here the spin states $\alpha_A\beta_X$ and $\beta_A\alpha_X$ have abnormally high populations, and the lower field members of the multiplets exhibit enhanced absorption while the higher field members show emission, A/E .

The net effect and the multiplet effect may occur together. Figure A1.10 shows how excess population in the lowest level of our AX system, and a smaller excess in the highest level, will yield a superposition of a net and a multiplet effect, $A + E/A$.

Kaptein has worked out simple formulae for deciding the type of spectrum that will be obtained in a given set of circumstances.^d Two parameters are defined, Γ_n and Γ_m . Γ_n tells whether there will be a net enhanced absorption, A , or a net emission, E , and Γ_m tells whether the multiplet effect will be of the E/A type or of the A/E type. The calculation of Γ_n and Γ_m and their interpretation are given in Table A1.1.

^d R. Kaptein, *J. Chem. Soc. D.*, 732 (1971). The rules apply to reactions carried out in the strong magnetic field of the nuclear magnetic resonance spectrometer.

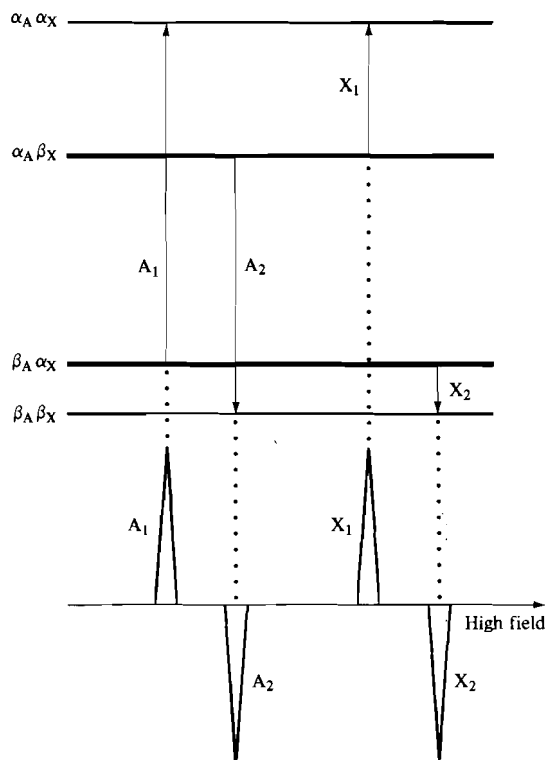

Figure A1.9 Nuclear spin states and spectrum for product **6**. The conventions of the diagram are the same as for Figure A1.7. The spectrum shows the multiplet effect of type *A/E*.

To apply the rule to our first example, product **2** is from a singlet precursor, so μ is negative; and it forms within the cage, so ϵ is positive. We assumed that radical **1a** had the higher g , so Δg is positive. Coupling constant a is negative for $\cdot\text{C}-\text{H}$. We find

$$\begin{aligned} \mu &\epsilon \Delta g a \\ \Gamma_n &= - + + - = + \end{aligned} \quad (\text{A1.1})$$

net absorption. For the product of escape from the cage, **3**,

$$\begin{aligned} \mu &\epsilon \Delta g a \\ \Gamma_n &= - - + - = - \end{aligned} \quad (\text{A1.2})$$

net emission.

For the example **4**, the multiplets arise from coupling of nuclei A and X in the fragment **7**. The precursor of the radical pair is a singlet, so μ is negative; σ_{AX}

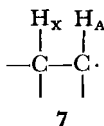

is positive, since nuclei A and X are in the same fragment; $\Delta g = 0$, since the two

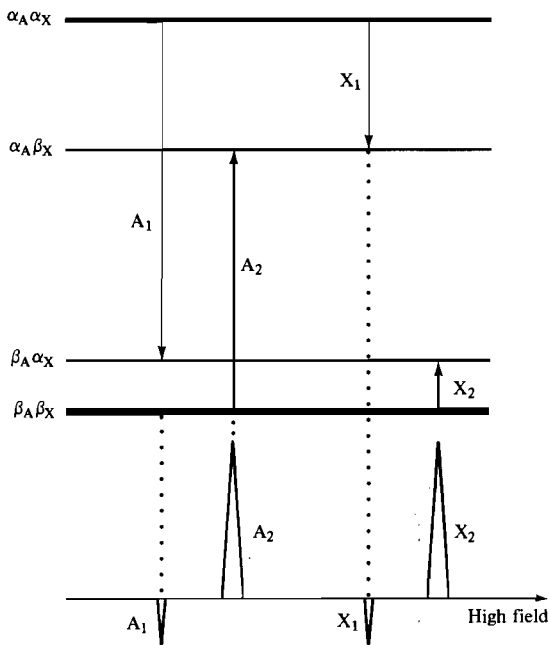

Figure A1.10 The superposition of net enhanced absorption (A) with multiplet emission-absorption (E/A). The lowest level, $\beta_A\beta_X$, has the largest excess population and the highest, $\alpha_A\alpha_X$, a smaller excess. The lines A_2 and X_2 , appearing in absorption, are more intense than the lines A_1 , X_1 , which are in emission. The overall spectrum shows net absorption. From S. H. Pine, *J. Chem. Educ.*, **49**, 664 (1972). Reproduced by permission of the Division of Chemical Education.

radicals of the pair are identical; a is negative for H_A , positive for H_X ; J_{AX} is positive. For the cage product, ϵ is positive. We therefore find:

$$\Gamma_m = \mu \epsilon a_A a_X J_{AX} \sigma = - + - + + + = + \quad (\text{A1.3})$$

$$\Gamma_n = \mu \epsilon \Delta g a = - + 0 (+ \text{ or } -) = 0 \quad (\text{A1.4})$$

There should be an E/A multiplet effect with no net effect, as in Figure A1.8. The product of escape from the cage has ϵ negative and an A/E multiplet effect.

Table A1.1 QUALITATIVE RULES FOR PREDICTING CIDNP EFFECTS^a

Net effect:

$$\Gamma_n = \mu\epsilon \Delta g a_i$$

If Γ_n is +, net absorption, *A*
 If Γ_n is -, net emission, *E*

Multiplet effect:

$$\Gamma_m = \mu\epsilon a_i a_j J_{ij} \sigma_{ij}$$

If Γ_m is +, *E/A*
 If Γ_m is -, *A/E*

Factors:

μ	<ul style="list-style-type: none"> + for a radical pair formed from a triplet precursor; - for a radical pair formed from a singlet precursor.
ϵ	<ul style="list-style-type: none"> + for products of recombination or disproportionation within the original cage; - for products from radicals that escape the cage.
σ_{ij}	<ul style="list-style-type: none"> + if nuclei <i>i</i> and <i>j</i> are originally in the same radical fragment; - if nuclei <i>i</i> and <i>j</i> are originally in different radical fragments.
Δg	the sign of the difference in <i>g</i> value ($g_i - g$), where g_i is the <i>g</i> value of the radical containing the nucleus giving the portion of the spectrum under observation, <i>g</i> is the <i>g</i> value of the other radical. (<i>g</i> is larger for radicals of type $\cdot\text{C}-\text{X}$, $\text{X} = \text{oxygen, halogen, or carbonyl}$; than for radicals containing only C and H. See H. Fischer, in <i>Free Radicals</i> , J. K. Kochi, Ed., Wiley, New York, 1973, Vol. II, p. 453.)
<i>a</i>	The sign of the coupling constant between the electron and the proton giving rise to the portion of the spectrum under observation. (<i>a</i> for $\cdot\text{C}-\text{H}$ is negative; for $\cdot\text{C}-\text{C}-\text{H}$, positive. See Table 9.1.)
J_{ij}	The sign of the nuclear-nuclear coupling constant giving rise to the multiplet. (Usually J_{ij} is negative if protons <i>i</i> and <i>j</i> are separated by an even number of bonds ($\text{H}-\text{C}-\text{H}$; $\text{H}-\text{C}=\text{C}-\text{C}-\text{H}$) and positive if protons <i>i</i> and <i>j</i> are separated by an odd number of bonds ($\text{H}-\text{C}-\text{C}-\text{H}$, $\text{H}-\text{C}=\text{C}-\text{H}$). However, <i>o</i> , <i>m</i> , and <i>p</i> coupling constants in a benzene ring are all positive. See J. W. Emsley, J. Feeney, and L. H. Sutcliffe, <i>High Resolution Nuclear Magnetic Resonance Spectroscopy</i> , Pergamon Press, Oxford, 1966, Vol. 2, p. 681.)

^a R. Kaptein, *J. Chem. Soc. D.*, 732 (1971).

Chapter 10

PERTURBATION THEORY AND SYMMETRY

In this chapter we return to the problem of constructing models for covalent bonding and develop further some of the ideas reviewed in Chapter 1 in order to prepare for the treatment of pericyclic reactions in Chapter 11.

10.1 PERTURBATION THEORY

First we make an extension of the molecular orbital method described in Chapter 1 and introduce some new terminology. In Section 1.2 we described the consequences of interaction of atomic orbitals of two different atoms as the atoms are brought together. Another, very similar way to look at the situation is to say that the atomic orbitals before interacting represent a known starting state, which is going to be disturbed by the interaction. Interactions that disturb a starting state are called *perturbations*, and the method of assessing the consequences of the interactions is *perturbation theory*. Despite its rather formidable name, perturbation theory, particularly on the qualitative level at which we shall be using it, is hardly different, except in nomenclature, from the simple theory of orbital interaction reviewed in Chapter 1.

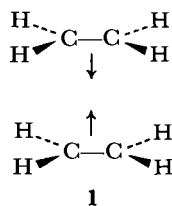

Interactions Between Molecular Orbitals

In Chapter 1 we considered only interactions among atomic orbitals. It would be useful, however, to be able also to deal with interactions between molecular orbitals. For example, suppose that we have two molecules of ethylene, which are approaching each other as shown in **1**, so that the π orbitals of the two molecules come in closer and closer contact. We might ask whether the following reaction will occur:

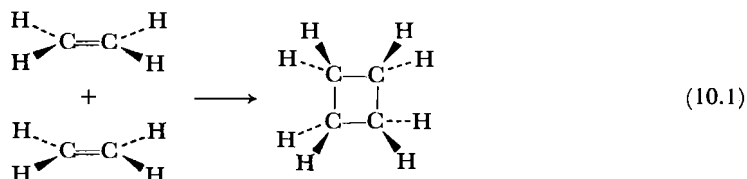

In order to answer this question, we need to be able to tell how the orbital energies of each molecule will be altered by the presence nearby of the orbitals of the other molecule. The situation is thus just the same as in bringing together two hydrogen atoms, except that here we are talking about molecular orbitals instead of atomic orbitals.

Fortunately, the same rules apply to interaction between two molecular orbitals as apply to interaction between two atomic orbitals. We shall be able to make a new model to cover the interacting situation by adding and subtracting the molecular orbital functions that were correct for the separate molecules before the interaction occurred.

From here on, then, everything we say will apply to orbitals in general, be they atomic or molecular.

Basis Orbitals of the Same Energy

If the two interacting orbitals are of the same energy, the situation is just as described in Section 1.2 for the interaction of the two hydrogen $1s$ orbitals to give σ bonding and antibonding MO's. We continue to use the term *basis* for the starting orbitals, which we now identify as the orbitals appropriate to the unperturbed situation. The perturbation (interaction) causes two new orbitals to form, one of lower energy than the original unperturbed orbitals and one of higher energy.

The forms of the two new orbitals (the *perturbed* orbitals) are determined by the following rule:

Rule 1. In the *lower-energy orbital*, the two basis orbitals are added together with the choice of relative signs that makes the result *bonding* in the region where the interaction is taking place. In the *higher-energy orbital*, the two basis orbitals are added together with the choice of relative signs that makes the result *antibonding* in the region where the interaction is taking place.

The reader should apply this rule to the examples in Section 1.2 to convince himself that it is essentially equivalent to the methods used there.

When the unperturbed basis orbitals are of equal energy, each makes an *equal contribution* to the perturbed orbital. In other words, at each point the values

Interactions Between Molecular Orbitals

In Chapter 1 we considered only interactions among atomic orbitals. It would be useful, however, to be able also to deal with interactions between molecular orbitals. For example, suppose that we have two molecules of ethylene, which are approaching each other as shown in **1**, so that the π orbitals of the two molecules come in closer and closer contact. We might ask whether the following reaction will occur:

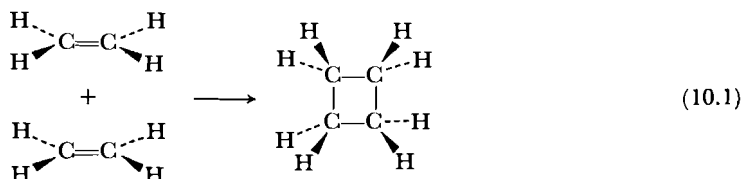

In order to answer this question, we need to be able to tell how the orbital energies of each molecule will be altered by the presence nearby of the orbitals of the other molecule. The situation is thus just the same as in bringing together two hydrogen atoms, except that here we are talking about molecular orbitals instead of atomic orbitals.

Fortunately, the same rules apply to interaction between two molecular orbitals as apply to interaction between two atomic orbitals. We shall be able to make a new model to cover the interacting situation by adding and subtracting the molecular orbital functions that were correct for the separate molecules before the interaction occurred.

From here on, then, everything we say will apply to orbitals in general, be they atomic or molecular.

Basis Orbitals of the Same Energy

If the two interacting orbitals are of the same energy, the situation is just as described in Section 1.2 for the interaction of the two hydrogen 1s orbitals to give σ bonding and antibonding MO's. We continue to use the term *basis* for the starting orbitals, which we now identify as the orbitals appropriate to the unperturbed situation. The perturbation (interaction) causes two new orbitals to form, one of lower energy than the original unperturbed orbitals and one of higher energy.

The forms of the two new orbitals (the *perturbed* orbitals) are determined by the following rule:

Rule 1. In the *lower-energy orbital*, the two basis orbitals are added together with the choice of relative signs that makes the result *bonding* in the region where the interaction is taking place. In the *higher-energy orbital*, the two basis orbitals are added together with the choice of relative signs that makes the result *antibonding* in the region where the interaction is taking place.

The reader should apply this rule to the examples in Section 1.2 to convince himself that it is essentially equivalent to the methods used there.

When the unperturbed basis orbitals are of equal energy, each makes an *equal contribution* to the perturbed orbital. In other words, at each point the values

of the two basis functions are added (or subtracted, according to Rule 1) with equal weights.

The magnitude of the energy lowering for the bonding combination, or raising for the antibonding combination, is greater the greater the overlap between the interacting orbitals. In the simplest theory, the bonding combination is lowered by the same amount as the antibonding is raised. More exact theory shows that the antibonding combination is actually raised by somewhat more than the bonding combination is lowered.

In summary, the case of basis orbitals of the same energy is exactly the one we considered in Section 1.2.

Basis Orbitals of Different Energies

When the unperturbed basis orbitals are initially of unequal energies, the situation is altered only slightly. Again the perturbed orbitals are found by making linear combinations of the basis orbitals. But consider an electron initially in the lower-energy basis orbital. It is already in a relatively favorable situation; not much is to be gained by providing interaction with a second orbital that represents a higher energy state. So the orbital that was initially of lower energy will be altered relatively little. It will be perturbed and pushed to lower energy by adding in a contribution from the other orbital in a bonding way, but the change will be small.

The basis orbital initially of higher energy, conversely, is going to be pushed still higher by an antibonding contribution from the first orbital, but again the contribution will be small.

These ideas are best expressed by writing the orbital functions that result from the perturbation in terms of the basis. In the case of basis orbitals of the *same* energy, the contribution of each basis orbital to each perturbed orbital is the same (Equations 10.2 and 10.3), where ψ_+ is the lower-energy combination,

$$\psi_+ = \varphi_1 + \varphi_2 \quad (10.2)$$

$$\psi_- = \varphi_1 - \varphi_2 \quad (10.3)$$

ψ_- the higher-energy combination, and φ_1 and φ_2 the unperturbed basis orbital functions. When the energies are different, the contributions are unequal (Equations 10.4 and 10.5). Here φ_1 is the basis orbital of lower energy and φ_2

$$\psi_+ = \varphi_1 + \lambda\varphi_2 \quad (10.4)$$

$$\psi_- = \varphi_2 - \lambda\varphi_1 \quad (10.5)$$

the basis orbital of higher energy, and λ is a number between zero and unity. The farther apart φ_1 and φ_2 are in energy, the closer λ is to zero; the closer they are, the closer λ is to unity, until when the energies are the same, Equations 10.4 and 10.5 reduce to Equations 10.2 and 10.3. The changes in the orbitals brought about by adding in to each some portion of the other is sometimes called *mixing*. Figure 10.1 summarizes in an energy-level diagram the interaction between orbitals of different energies.

This discussion leads to the following rules for interactions between orbitals of different energies:¹

¹ For more quantitative statements of these rules, see (a) R. Hoffmann, *Acts. Chem. Res.*, **4**, 1 (1971); (b) L. Libit and R. Hoffmann, *J. Amer. Chem. Soc.*, **96**, 1370 (1974).

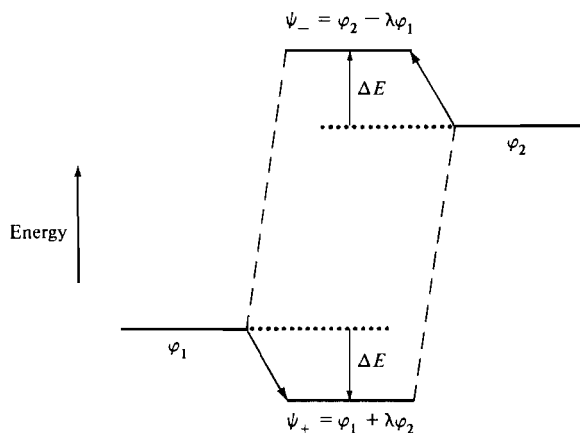

Figure 10.1 Energy changes of two interacting orbitals, φ_1 and φ_2 according to perturbation theory. φ_1 moves down by ΔE and φ_2 moves up by ΔE . The perturbed orbitals, ψ_+ and ψ_- , are linear combinations of φ_1 and φ_2 in which the lower-energy orbital, φ_1 , has been modified by mixing in some of the higher ($\lambda\varphi_2$) in a bonding way and the higher-energy orbital, φ_2 , has been modified by mixing in some of the lower ($-\lambda\varphi_1$) in an antibonding way. The magnitudes of energy change ΔE and of mixing parameter λ are larger the larger the overlap and smaller the larger the initial energy difference. The solid arrows correlate each orbital with its perturbed counterpart, and the dashed lines indicate the sources of mixing that modify the form of each.

Rule 2. When the unperturbed orbitals are initially of different energies, the perturbation causes the one initially lower in energy to be lowered further, and the one initially higher to be raised further. The energy changes are larger the larger the overlap, and smaller the larger the initial energy difference.

Rule 3. The orbital initially of lower energy is altered by adding in (mixing) a portion of the higher one in a bonding way. The orbital initially of higher energy is altered by adding in (mixing) a portion of the lower one in an antibonding way. The mixing in each case is larger the larger the overlap, and smaller the larger the initial energy difference.

10.2 SYMMETRY²

Symmetry plays a fundamental role in orbital theory. As has already been pointed out in Section 1.1, the nuclei provide a field of positive charge in which the electrons move. If the nuclei are arrayed in some symmetrical way, the field

² The application of symmetry to chemical problems is treated in a number of texts on quantum chemistry. An introduction at an elementary level may be found in (a) H. H. Jaffé and M. Orchin, *Symmetry in Chemistry*, Wiley, New York, 1965; a more advanced treatment, including proofs of the important theorems of group theory is (b) M. Tinkham, *Group Theory and Quantum Mechanics*, McGraw-Hill, New York, 1964. See also (c) F. A. Cotton, *Chemical Applications of Group Theory*, 2nd ed., Wiley-Interscience, New York, 1971. An excellent insight into the nature of the quantum theory and its relationship with symmetry may be obtained from (d) R. P. Feynman, R. B. Leighton, and M. Sands, *The Feynman Lectures on Physics*, Vol. III, Addison-Wesley, Reading, Mass., 1965.

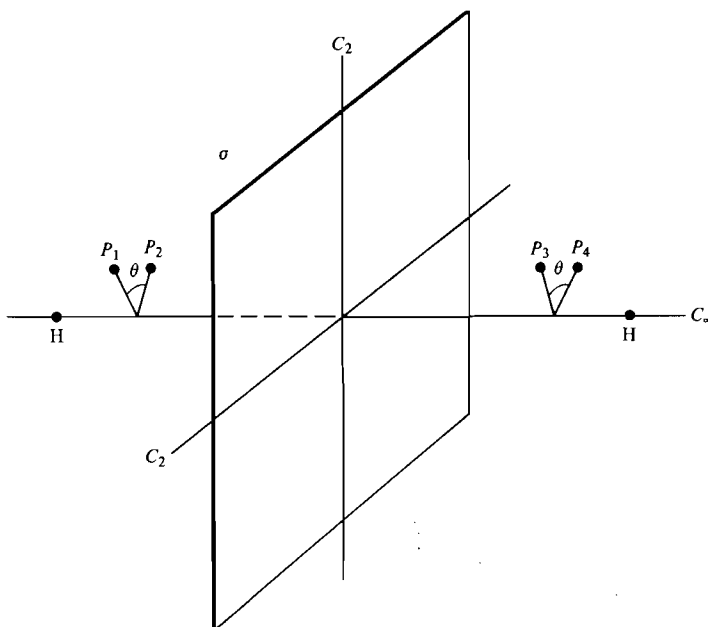

Figure 10.2 Some of the symmetry elements of the H_2 molecule. Illustrated are the infinite-fold rotation axis, the mirror plane perpendicular to it, and two of the twofold rotation axes. There are in addition an infinite number of C_2 axes in the same plane as those shown, an infinite number of mirror planes perpendicular to the one shown, and a point of inversion. P_1 , P_2 , P_3 , and P_4 are symmetry-equivalent points.

of positive charge will have that same symmetry, and the electron distribution, being controlled by the positive charge field, will also have the same symmetry.

It may be useful to illustrate this idea with one or two examples. The H_2 molecule (or any other homonuclear diatomic) has cylindrical symmetry. An electron that finds itself at a particular point off the internuclear axis experiences exactly the same forces as it would at another point obtained from the first by a rotation through any angle about the axis. The internuclear axis is therefore called an axis of symmetry; we have seen in Section 1.2 that such an axis is called an infinite-fold rotation axis, C_∞ . Figure 10.2 illustrates the C_∞ symmetry and also some of the other symmetries, namely reflection in a mirror plane, abbreviated σ , perpendicular to the internuclear axis and equidistant from the nuclei, and rotation of 180° (twofold axis, C_2) about any axis lying in that reflection plane and passing through the internuclear axis. (There are infinitely many of these C_2 axes; only two are shown.) There are, in addition to those elements of symmetry illustrated, others: an infinite number of mirror planes perpendicular to the one illustrated and containing the internuclear axis, and a point of inversion (abbreviated i) on the axis midway between the nuclei.

Each mirror plane, axis, or point of inversion is called a *symmetry element*, and the operations associated with these elements (reflection, rotation through a given angle) that leave the molecule exactly as before are called *symmetry operations*. All the symmetry operations that leave a particular object unchanged

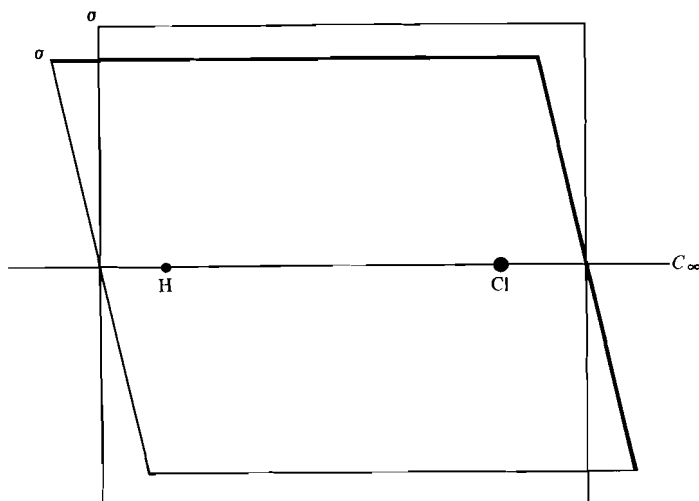

Figure 10.3 The symmetry elements of the HCl molecule are a C_∞ axis coinciding with the internuclear line and all the planes σ that contain the C_∞ axis.

constitute the *symmetry group* of the object; there are only a limited number of these groups, and their properties have been thoroughly studied.³

As an example of a simple molecule with different symmetry, consider HCl. The cylindrical symmetry, characterized by the C_∞ axis, is still present, as are the reflection planes that pass through the nuclei and contain the axis (Figure 10.3). But now the two ends of the molecule are not the same: The plane σ_h of Figure 10.2, the C_2 axes, and the point of inversion are no longer present. An electron still finds the same forces at different points around the axis, but the situation near the chlorine is quite different from that near the hydrogen. The geometrical difference between H_2 and HCl is succinctly expressed by saying that the two belong to different symmetry groups.

The water molecule (Figure 10.4) has only three elements of symmetry rather than the infinite number of the previous examples: two mutually perpendicular reflection planes and a twofold axis.

We may summarize the significance of symmetry for electronic structure of molecules by the following argument. A symmetry operation generates from any arbitrary point in the molecule a new point. If the operation leaves the nuclei unchanged, or interchanges equivalent nuclei so that the physical situation before and after the operation is exactly the same, then the two points are equivalent points, an electron will experience exactly the same forces at the two points, and the probability of finding the electron in the neighborhoods of the two points must be the same. In terms of orbital theory, this conclusion means that the function ψ^2 describing the electron density must be the same at the two points, or, put another way, ψ^2 must have the full symmetry of the molecule. If, then, we are considering a molecule with several elements of symmetry in terms of the molecular orbital model, and if we wish our model to approximate as closely as possible the actual object, then the electron distribution, ψ^2 , of each molecular

³ Refer to the sources cited in note 2(a), (b), (c), p. 541.

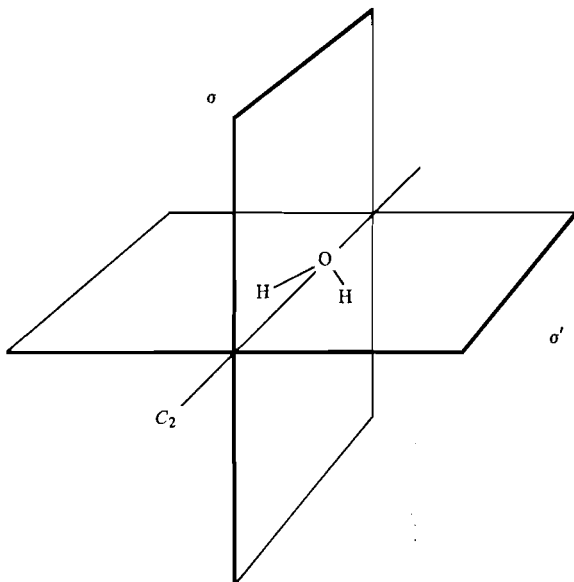

Figure 10.4 Symmetry elements of the H_2O molecule.

orbital must remain unchanged under all the symmetry operations appropriate to the molecule itself.

We may carry the argument one step further. If ψ^2 is to remain unchanged under a given operation, the orbital function may either remain unchanged or may change sign everywhere, but must not change in absolute value. Another way of expressing this idea is to say that the transformation property of ψ must be either symmetric or antisymmetric under each symmetry operation.⁴ An orbital that is symmetric with respect to a given symmetry operation will look exactly the same after that symmetry operation has been carried out as it did before. An orbital that is antisymmetric will have its sign reversed at every point by the operation. An orbital that satisfies one or the other of these criteria is said to be *symmetry correct* with respect to the operation in question. To be completely symmetry correct, an orbital must meet the test for each of the symmetry operations that leaves the molecule unchanged.

The Application of Symmetry to Orbital Interaction

To illustrate the use of symmetry, let us examine a simple example. Consider the possibility of an interaction between the vacant p orbital in a methyl cation and a hydrogen $1s$ orbital. Figure 10.5 shows that a mirror plane is a symmetry element of the molecule. The p orbital is antisymmetric with respect to the mirror plane, since it changes sign on reflection, whereas the s orbital is symmetric because it is unchanged on reflection. Interaction between the s and the p orbitals will be possible only if their overlap is nonzero. Recall from Section 1.2 that the overlap

⁴ It might at first seem inconsistent to allow ψ to change sign under a symmetry operation; it must be remembered, however, that ψ is not itself a physically observable quantity. All that can be required is that the physically meaningful quantity ψ^2 obey the symmetry; this restriction is satisfied equally well for ψ symmetric or antisymmetric.

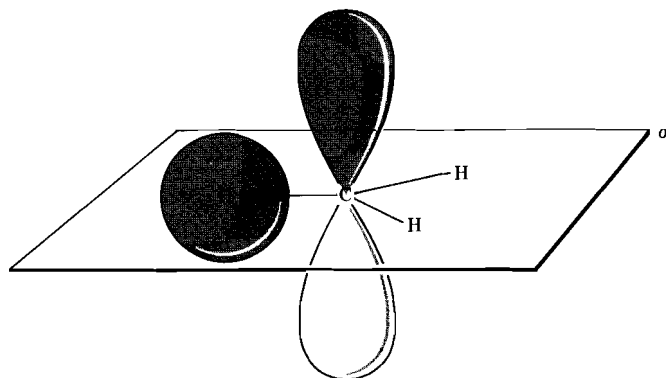

Figure 10.5 Mirror symmetry in a methyl cation. The p orbital is antisymmetric with respect to σ , and the s orbital of hydrogen is symmetric. The two have different symmetries and cannot interact.

is found by evaluating the product of the two orbital functions at each point and summing over all points. It should be clear from Figure 10.5 that every contribution to overlap above the mirror plane will be cancelled by a contribution of the same magnitude but opposite sign below the plane. There is therefore no overlap and no interaction. This situation arises because one of the orbitals changes sign on reflection and the other does not.

The conclusion is general. Whenever two orbitals have opposite symmetry behavior with respect to a symmetry element, their overlap and therefore their interaction will be zero. If there are several symmetry elements, a symmetry mismatch with respect to any one of them will prevent interaction. We can summarize the argument as follows:

Only orbitals of the same symmetry can interact.

Formation of Symmetry Correct Orbitals

In order to take advantage of the symmetry criterion for orbital interaction, it is necessary to have orbitals that are symmetry correct. The molecular orbitals obtained from atomic orbitals by the methods described in Sections 1.2 and 10.1 will sometimes be symmetry correct and sometimes not.

As an example, let us look at a bonding model for the H_2O molecule. The Lewis structure (2) leads to the choice of sp^3 hybridization on the oxygen. We then use two of the hybrids to make σ bonding and antibonding pairs by combi-

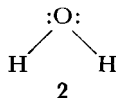

nation with the hydrogens. Let us focus on the two bonding σ orbitals. One of these, ψ_1 , is shown in 3, the other, ψ_2 , in 4. Next we identify the symmetry elements of the molecule. These are two mirror planes and a C_2 rotation axis (Figure 10.4). Inspection of the orbital ψ_1 will show that it is symmetry correct with respect to the reflection σ' , since it is transformed into itself (i.e., is completely unchanged) by this reflection. But it is not symmetry correct with respect



to σ or C_2 . These operations each transform ψ_1 into another orbital of the same shape but in a different location, as illustrated in 5 for the reflection. (The operation C_2 yields the same result.) Since ψ_1 is changed into neither itself nor its negative by these two operations, it is not symmetry correct.

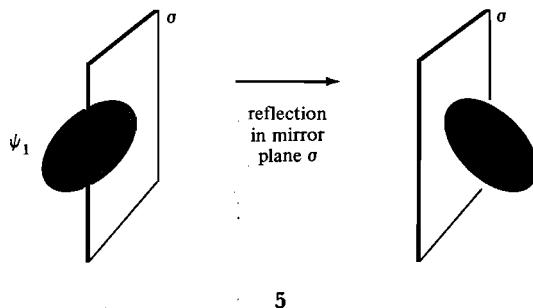

It is evident from a comparison of 5 and 4 that the reflection transforms ψ_1 into ψ_2 . The reader should verify that the σ reflection and the C_2 rotation also transform ψ_2 into ψ_1 , and that ψ_2 is therefore also not symmetry correct. The result we have found will generally hold when molecular orbitals constructed by the LCAO method from hybrid atomic orbitals are subjected to symmetry operations. Each of those orbitals in the set of MO's that is not already symmetry correct will be transformed by a symmetry operation into another orbital of the set.

How can we obtain symmetry correct orbitals to use in place of ψ_1 and ψ_2 ? The procedure is simple, and follows the method we always use in dealing with changes in forms of orbitals. We combine ψ_1 and ψ_2 into a new set of two by adding and subtracting them as follows:

$$\Psi_S = \psi_1 + \psi_2 \quad (10.6)$$

$$\Psi_A = \psi_1 - \psi_2 \quad (10.7)$$

These new orbitals are shown in 6 and 7. The reader should verify that these new orbitals are symmetry correct.



The symmetry correct orbitals can now be classified as to symmetry type. The positive combination (6) is unchanged by reflection in mirror plane σ or by rotation C_2 ; we therefore call it *symmetric* (S). The negative combination (7) changes sign on reflection or on rotation, and is *antisymmetric* (A). It happens in this instance that each of our new orbitals behaves the same way under

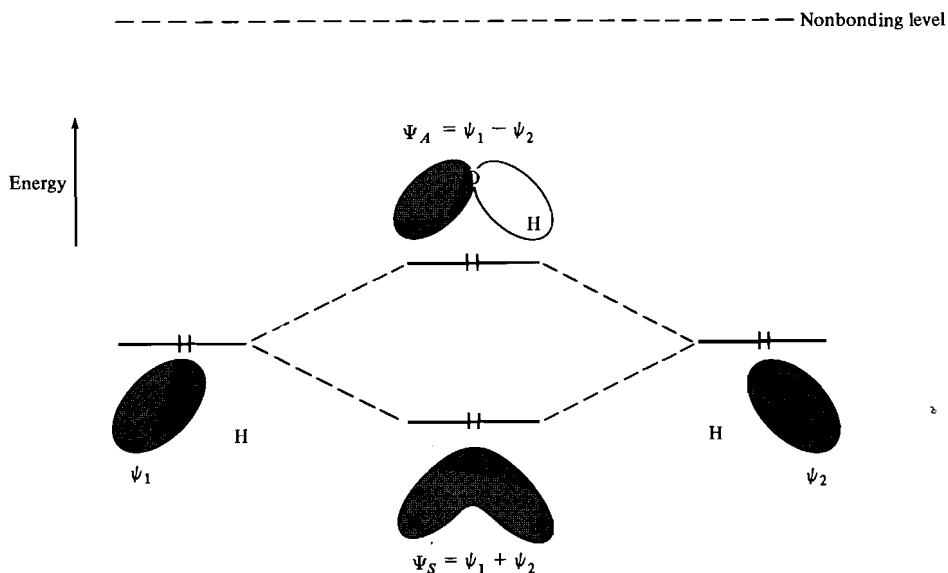

Figure 10.6 Energy changes in the interaction of two O—H bonding σ orbitals ψ_1 and ψ_2 of the water molecule to form the symmetry correct orbitals Ψ_S and Ψ_A .

reflection as it does under rotation; note, however, that Ψ_S and Ψ_A are both symmetric on reflection in mirror plane σ' . In general, a given orbital may be symmetric under some symmetry operations and antisymmetric under others.

The energy changes that accompany the construction of the symmetry correct orbitals are easily obtained qualitatively from our perturbation rules. The combinations represent interactions of ψ_1 and ψ_2 , but the overlap between these two is small. (Remember that the reason we decided to use hybrid orbitals in the first place was precisely so that the overlaps would be confined to a localized bonding region.) The energy of interaction will therefore be small, even though the two interacting orbitals ψ_1 and ψ_2 are of the same energy. Figure 10.6 shows the changes. Note that the conclusion that both of the new orbitals will still be bonding is confirmed by the observation that both orbitals are bonding in the regions between the oxygen and the hydrogens.

Let us summarize the steps to be followed in obtaining symmetry correct orbitals.

1. Construct a bonding model of molecular orbitals from a basis set of atomic orbitals.
2. Identify the symmetry elements of the molecule.
3. Examine each molecular orbital to see whether it is already symmetry correct.
4. For orbitals that are not already symmetry correct, group together orbitals that are transformed into each other by the symmetry operations.
5. Form sums and differences within these symmetry related groups to obtain symmetry correct orbitals. Remember that the total number of orbitals obtained at the end of the process must always equal the total number at the start.

6. It may sometimes happen that not all symmetry elements are needed. Orbitals can be made symmetry correct with respect to selected symmetries, as long as subsequent conclusions are based on these symmetries only.

These procedures will be successful as long as there is no rotational symmetry axis of order higher than two. If there is a threefold or higher axis, some further complications arise. Because of Rule 6, it will often be possible to make symmetry arguments on the basis of other symmetry elements in cases of this kind, and we shall not need to consider this problem further.

Localized and Delocalized Models

An obvious question is, when does one need symmetry correct orbitals? The H_2O example illustrates that the symmetry correct orbitals will usually extend over a larger region of the molecule than did the symmetry incorrect orbitals from which they were made. The symmetry correct model corresponds to a more highly delocalized picture of electron distribution. We believe that electrons are actually able to move over the whole molecule, and in this sense the delocalized symmetry correct pictures are probably more accurate than their localized counterparts. Nevertheless, for most purposes we are able to use the more easily obtained localized model. The reason the localized model works is illustrated in Figure 10.6. The interaction that produced the delocalized symmetry correct orbitals made one electron pair go down in energy and another go up by an approximately equal amount. Thus the *total* energy of all the electrons in the molecule is predicted to be about the same by the localized and by the more correct delocalized model.

The key point here is that both of the orbitals were filled to start with. Delocalization of orbitals already filled will not affect the total energy in the first approximation, whereas delocalization involving orbitals not completely filled, as in the π systems considered in Chapter 1, will lead to significant lowering of the total energy and so must be considered. If we are interested in energies of electrons in *particular* individual orbitals, or if we want to take advantage of the help symmetry can give in evaluating interactions between orbitals within molecules or between orbitals on different molecules, we shall need symmetry correct orbitals. Otherwise, because total energies are reasonably accurately represented by a model in which completely filled levels are localized, we can use the localized model for these filled orbitals even though some of them may not be symmetry correct.

An Application of Perturbation Theory. Interaction of a Methyl Group with an Adjacent Cationic Center

In Chapter 5 we saw that CH_3^+ is strongly stabilized by substituting a hydrogen by methyl. Let us examine this example with the aid of perturbation theory and symmetry.

In CH_3^+ itself (8), we have already seen that the different symmetries of the C—H bonds and the vacant p orbital prevent any interaction. Therefore no electrons from the C—H bonds can be delocalized into the p region to help disperse positive charge toward the hydrogens.

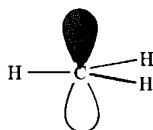

8

Now substitute a CH_3 group for one hydrogen. We must first decide which conformation we want to consider, and we will choose **9**, in which H_c lies in the molecular plane, and H_a and H_b are above and below. Next, we need a bonding model for the CH_3 group. An obvious choice is the set of σ MO's obtained from sp^3 hybrids on C_2 and $1s$ orbitals on H_a , H_b , and H_c . The bonding members of this set are shown in **10**. (For this particular problem we shall not need the

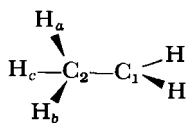

9

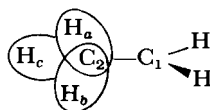

10

antibonding orbitals; their importance in other circumstances will become clear later.) We have already concluded that the $\text{C}_1\text{—H}$ bonds cannot interact with the vacant p orbital, and we need not consider them further. In Figure 10.7 the

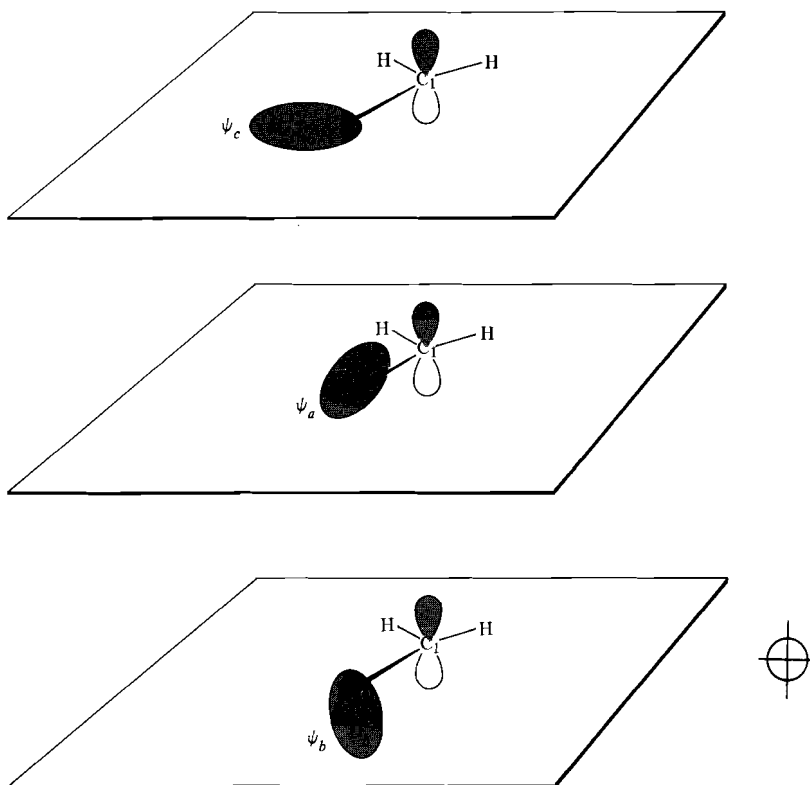

Figure 10.7 The three bonding C—H orbitals of the methyl group in CH_3CH_2^+ . ψ_c is symmetry correct with respect to mirror plane σ , but ψ_a and ψ_b are not.

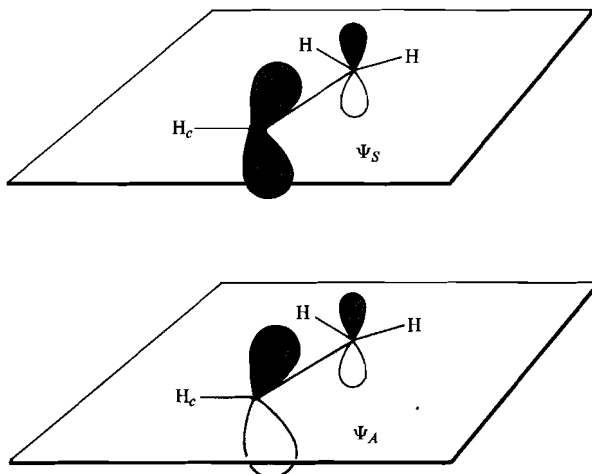

Figure 10.8 The symmetry correct C_2 -H orbitals Ψ_S and Ψ_A .

methyl orbitals are shown individually in order to make clear their symmetry properties with respect to the mirror plane that is the only symmetry element of the methyl substituted ion. Orbital ψ_c is symmetry correct; it is symmetric and therefore of different symmetry from the vacant p orbital on C_1 . The C_2 - H_c bond, like the C_1 -H bonds, cannot interact with the p orbital. We therefore need not consider H_c or ψ_c further.

The orbitals ψ_a and ψ_b are not symmetry correct. They are, however, transformed into each other on reflection, so we can take combinations according to Equations 10.8 and 10.9:

$$\Psi_S = \psi_a + \psi_b \quad (10.8)$$

$$\Psi_A = \psi_a - \psi_b \quad (10.9)$$

We expect Ψ_S to be slightly lower in energy than Ψ_A . Figure 10.8 shows these new symmetry correct orbitals.

Now we are ready to assess the interactions of the electrons in the C- H_a and C- H_b bonds with the vacant p orbital on C_1 . First we notice that of our two new symmetry correct orbitals, only Ψ_A has the same symmetry as the vacant p orbital. Since Ψ_S has different symmetry, it cannot interact and need not be considered further. With the help of the symmetry we have reduced what looked initially like a moderately complicated problem to a simple one. We have only to consider the interaction of two orbitals. In Figure 10.9 we have placed on the left at the nonbonding energy the vacant p orbital. On the right, lower in energy because it is a bonding orbital, is Ψ_A . The two interact according to the perturbation theory rules, as shown at the center. Orbital Ψ_A moves down, carrying with it its electron pair, while the p moves up. Since the p is unoccupied, there is no change in the total energy contributed by its moving up. We conclude that the interaction is stabilizing to the ion as a whole, since one electron pair moves to lower energy.

If we look at the form of the perturbed Ψ_A , we see that it has been altered by mixing in a small contribution of the p orbital of C_1 . This change means that the electron pair that in the unperturbed model was confined to the CH_3 group

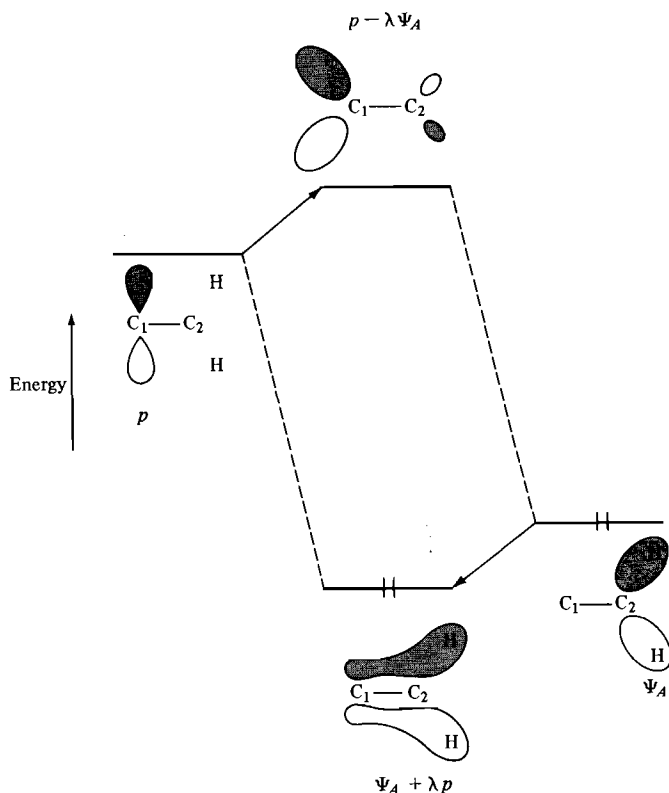
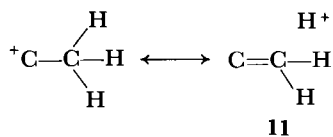

Figure 10.9 Interaction of the methyl group orbital Ψ_A with the p orbital of the cationic carbon. Ψ_A moves down, stabilizing the structure. Its perturbed form shows delocalization of the electron pair into the cation p orbital. Orbital p moves up, but it is unoccupied and so does not alter the energy.

is actually free, according to the perturbed model, to wander into the electron-deficient p orbital. The perturbation has therefore introduced an electron donation by CH_3 to the C^+ .

This delocalization, which would be represented in a Lewis structure model by adding a contribution from resonance structure **11**, is commonly known as *hyperconjugation*. It should be clear from this example that the hyperconjugation



concept arises solely from our particular model-building procedures and is not a real phenomenon at all. When we ask whether hyperconjugation is important in a given situation, we are asking only whether the localized model is adequate for that situation at the particular level of precision we wish to use, or whether the model must be corrected by including some delocalization in order to get a good enough description. In the case of the carbocation problem, we know experimentally that the ion is significantly stabilized by methyl substitution; we therefore say that some delocalization is needed in the model. Note

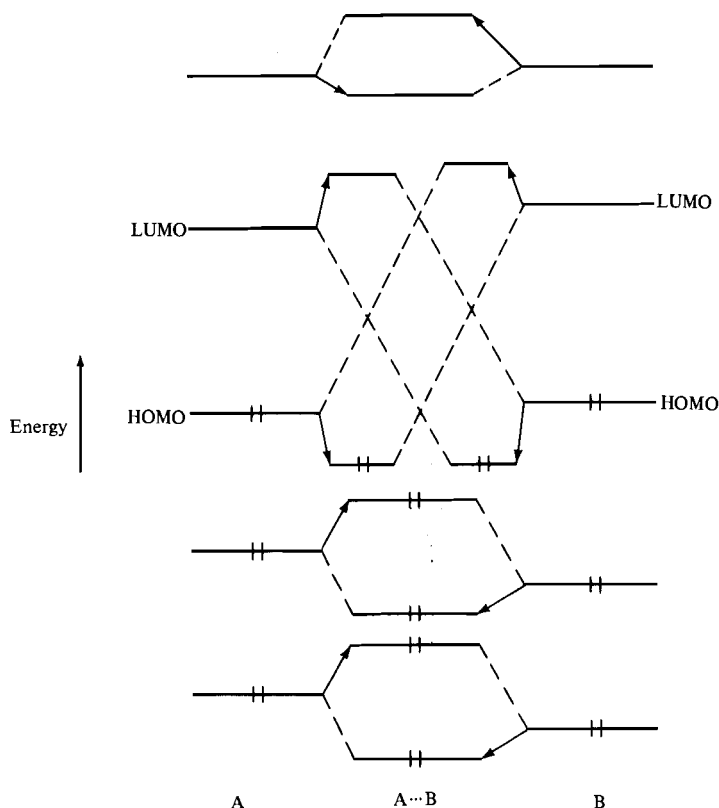

Figure 10.10 Interaction between molecular orbitals of A and B as they approach each other. Perturbations between filled levels have little effect on the total energy. Interaction of HOMO of B with LUMO of A and of HOMO of A with LUMO of B lowers the energy significantly because filled levels move to lower energy while unfilled levels move to higher energy.

that the interaction is not restricted to C—H bonds, as has sometimes been assumed, but should occur with C—C bonds also, a conclusion that is in agreement with experimental results.⁵ The arguments are easily extended to show that with a CH_2X substituent, the preferred conformation should be determined by the electronegativity of X compared with H.⁶ We leave it as an exercise to the reader (Problems 2 and 3) to analyze the interaction between an anion center and an adjacent methyl group, and between a cation center and an adjacent unshared pair.⁷

10.3 INTERACTIONS BETWEEN MOLECULES

One of the most useful applications of the symmetry and perturbation theories is to interactions between molecules.

⁵ R. C. Bingham and P. v. R. Schleyer, *J. Amer. Chem. Soc.*, **93**, 3189 (1971).

⁶ R. Hoffmann, L. Radom, J. A. Pople, P. v. R. Schleyer, W. J. Hehre, and L. Salem, *J. Amer. Chem. Soc.*, **94**, 6221 (1972).

⁷ For further discussion of hyperconjugation, see (a) M. J. S. Dewar, *Hyperconjugation*, Ronald Press, New York, 1962; (b) D. Holtz, *Prog. Phys. Org. Chem.*, **8**, 1 (1971).

HOMO—LUMO Interactions

As long as the molecules whose interaction we want to consider are far apart, each has its own set of molecular orbitals undisturbed by the other. These MO's form the unperturbed basis from which the interaction is to be evaluated. As the molecules approach sufficiently closely that overlap between their orbitals becomes significant, the new interaction constitutes a perturbation that will mix orbitals of each molecule into those of the other. The strongest interactions will be between those orbitals that are close to each other in energy, but interaction between two filled levels will cause little change in the total energy because one orbital moves down nearly as much as the other moves up. The significant interactions are therefore between filled orbitals of one molecule and empty orbitals of the other; furthermore, since the interaction is strongest for orbital pairs that lie closest in energy, the most important interactions are between the highest occupied molecular orbital (HOMO) of one molecule and the lowest unoccupied molecular orbital (LUMO) of the other. These orbitals are sometimes referred to as the *frontier orbitals*. Figure 10.10 illustrates this conclusion for the approach of two molecules that have their HOMO and LUMO levels at comparable energies. If HOMO—LUMO interaction cannot occur, for example because the orbitals are of different symmetry types, this stabilizing interaction is absent, the small energy increase arising from the filled level interactions will dominate, and no reaction will occur.

It is instructive also to look at an example in which the HOMO levels of the two molecules are of different energies. In Figure 10.11 the HOMO and LUMO levels are indicated for molecules D and A, D having its highest filled level substantially higher than that of A. This is a donor—acceptor situation, with D the donor and A the acceptor. Note that the HOMO of D is much closer in energy to the LUMO of A than in the previous example, but the A HOMO is much farther from the D LUMO. Hence the A HOMO will be relatively little affected, and most of the stabilization will occur by lowering the D HOMO. As it is lowered, it will mix in substantial amounts of the A LUMO; charge is

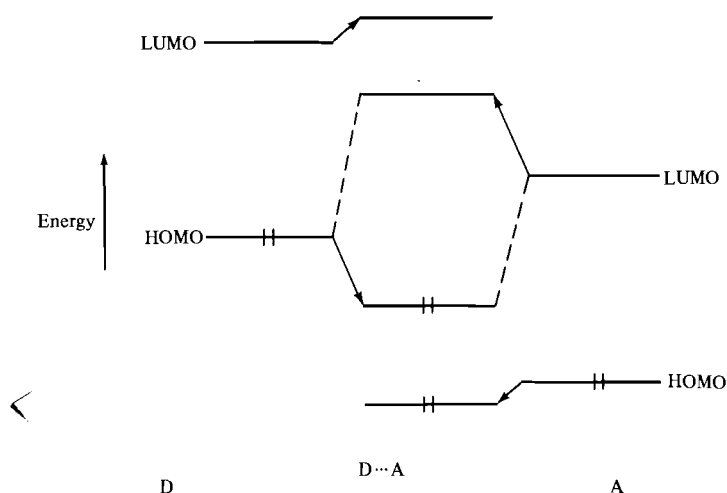

Figure 10.11 HOMO—LUMO interaction of a donor D with an acceptor A.

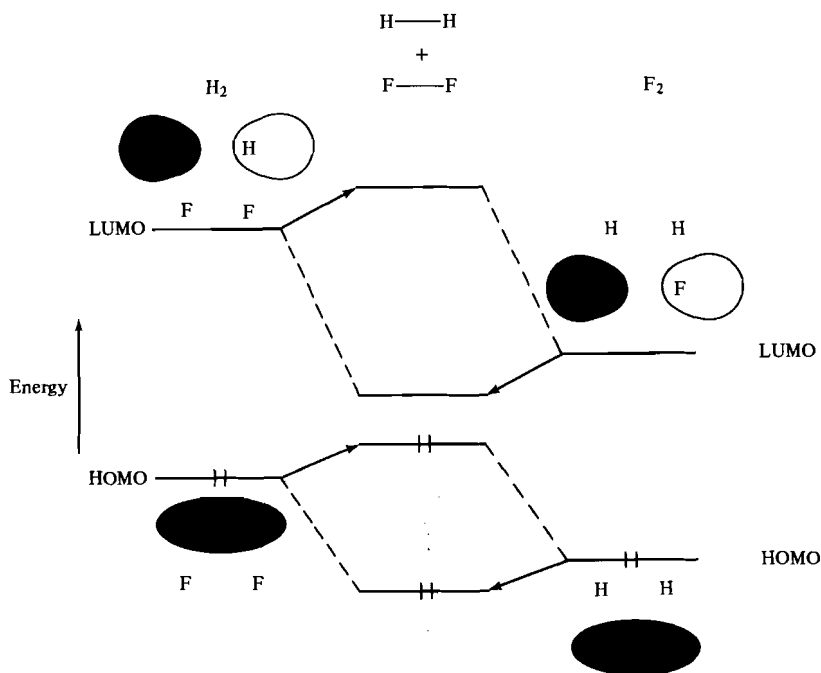

Figure 10.12 In a four-center approach of H_2 and F_2 , symmetry prevents HOMO–LUMO interaction. Only HOMO–HOMO and LUMO–LUMO interactions can occur, and these do not lower the energy.

thereby transferred from D to A. Note that charge transfer occurs primarily to the lowest antibonding acceptor orbital.

Applications of HOMO–LUMO Theory

Qualitative arguments based on the HOMO–LUMO theory are applicable to a variety of chemical processes.⁸ Consider as an example Reaction 10.10. Will this



reaction occur in a single step through a cyclic transition state (Equation 10.11)? Since fluorine is more electronegative than hydrogen, F_2 is the acceptor and

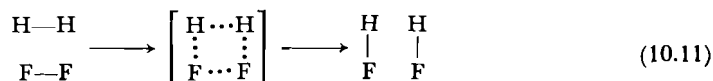

H_2 is the donor. Figure 10.12 shows the LUMO of F_2 and the HOMO of H_2 . If these orbitals are put together in the geometry of the hypothetical transition state (12), it becomes clear that their different symmetries prevent interaction. Hence no stabilization can occur, and we would expect this reaction to have a high energy barrier. HOMO–HOMO and LUMO–LUMO interactions can occur (Figure 10.12), but these do not lower the energy.

⁸ See, for example: (a) R. G. Pearson, *Accts. Chem. Res.*, **4**, 152 (1971); (b) R. G. Pearson, *J. Amer. Chem. Soc.*, **94**, 8287 (1972). Applications of perturbation theory to a variety of chemical processes are discussed by (c) G. Klopman, in *Chemical Reactivity and Reaction Paths*, G. Klopman, Ed., Wiley, New York, 1974, p. 55.

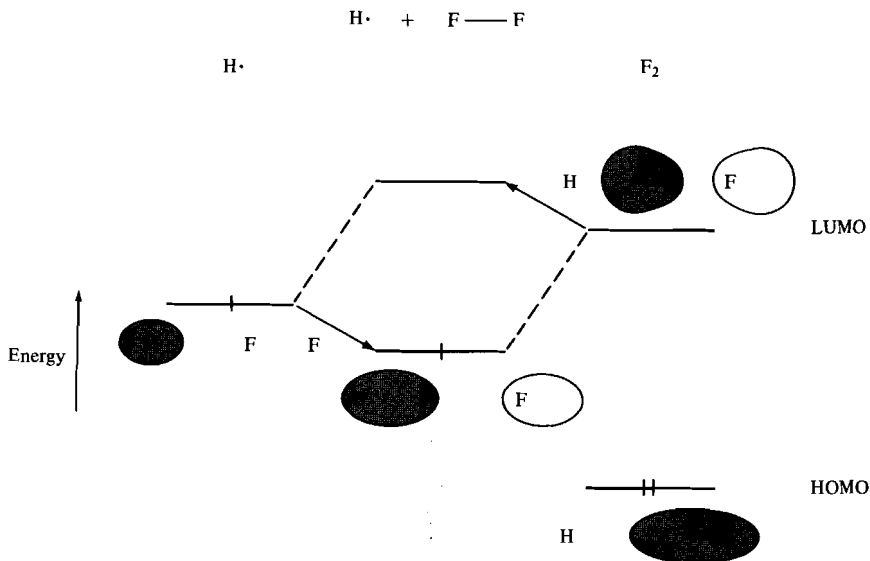

Figure 10.13 In the reaction $\text{H}\cdot + \text{F}_2 \longrightarrow \text{HF} + \text{F}\cdot$, the hydrogen atom HOMO can interact with the F_2 LUMO and stabilization occurs. (There will also be a smaller interaction of the $\text{H}\cdot$ orbital with the F_2 HOMO.)

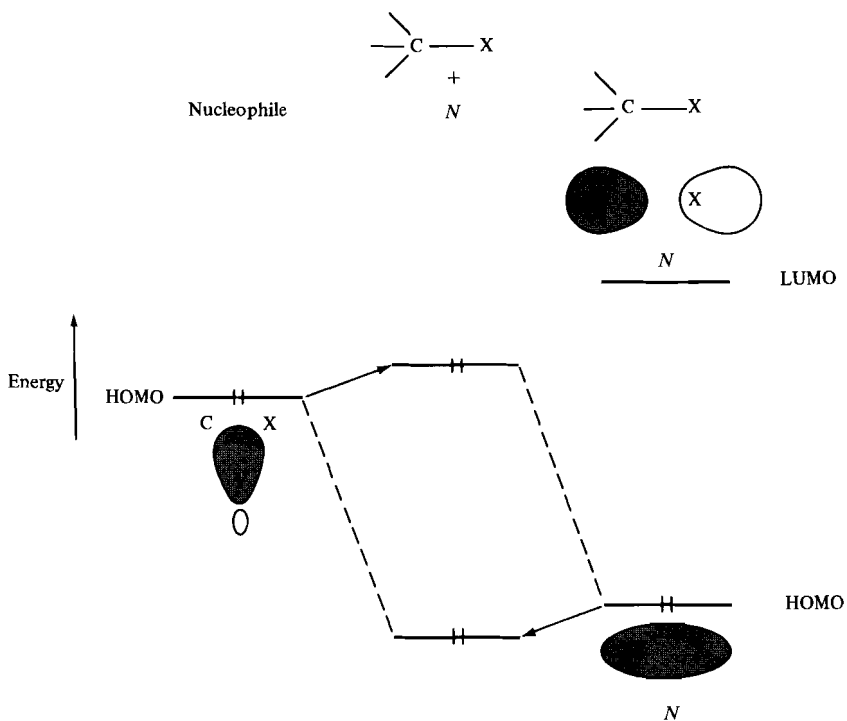

Figure 10.14 Frontside attack of a nucleophile, symbolized by N , on a $\text{C}-\text{X}$ bond. Symmetry prevents HOMO-LUMO interaction; the only interaction is between filled levels. The reaction will not take this path.

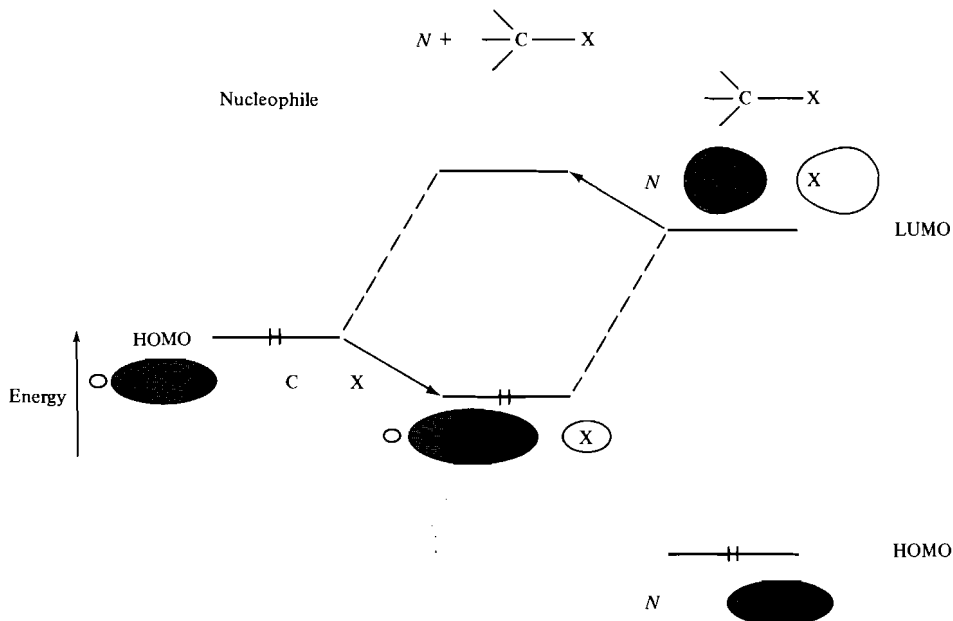
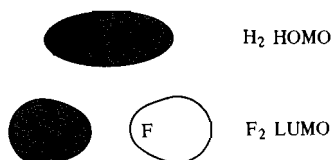

Figure 10.15 Backside attack by a nucleophile. Now HOMO-LUMO interaction is possible, and the transition state is stabilized. (As in the $H \cdot + F_2$ process, Figure 10.13, there will also be a smaller HOMO-HOMO interaction here. Because it is a filled-filled interaction, it will not alter the energy.)

If we try instead a mechanism in which a hydrogen atom attacks the F_2 molecule at an end (Figure 10.13), the symmetry permits HOMO-LUMO interaction, and the perturbed orbital at the center in Figure 10.13 shows that the electron from hydrogen is being transferred to the fluorine.⁹



12

Nucleophilic Substitution

Another application is to bimolecular S_N2 and S_E2 substitutions. Recall from Chapter 4 (pp. 174 and 205) that the nucleophilic reaction prefers backside attack by nucleophile on substrate whereas the electrophilic reaction prefers frontside attack. Figure 10.14 shows the appropriate frontier orbitals for frontside attack by a nucleophile. The nucleophile, symbolized by N , is the donor, and the $C-X$ bond is the acceptor. The symmetries of the nucleophile HOMO and the $C-X$ LUMO do not match (13); therefore only the filled-filled HOMO-

⁹ Pearson [see note 8(a), (b)] has pointed out that the essential feature of a bond-breaking reaction that will occur with a low activation energy is transfer of electron density out of orbitals that are bonding or into orbitals that are antibonding with respect to the bond being broken. Bond formation will be favored by transfer of electron density into orbitals that are bonding or out of orbitals that are antibonding with respect to the bond being formed.

Figure 10.13

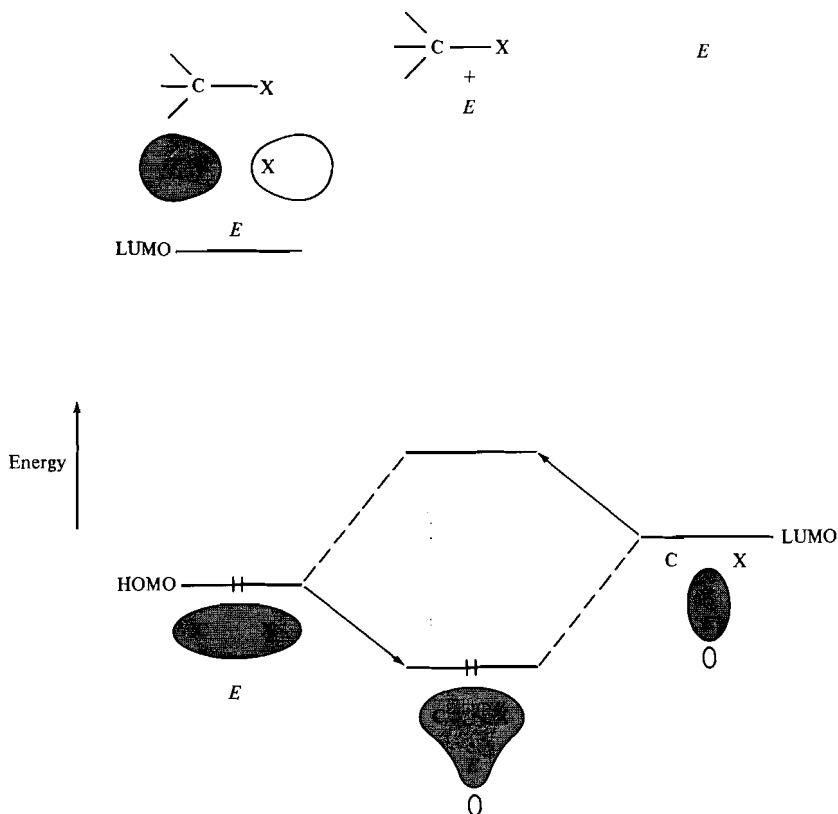
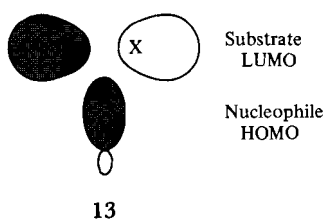
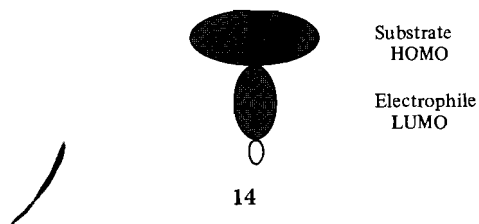

Figure 10.16 The electrophilic bimolecular substitution can occur from the front, because symmetry permits HOMO–LUMO interaction and stabilization.



HOMO interaction is possible and no stabilization can occur. If, on the other hand, the nucleophile approaches at the back (Figure 10.15), stabilization is possible and the reaction can occur.

In electrophilic substitution, the electrophile is the acceptor and the C–X bond the donor. Now frontside attack gives donor HOMO and acceptor LUMO of the same symmetry (**14**), and stabilization can occur (Figure 10.16).



It is possible to be misled by HOMO–LUMO arguments, because they are greatly oversimplified. Unwary acceptance of Figures 10.15 and 10.16, for example, might lead one to suppose that the reactions in question should have no activation energy, since only stabilization occurs. There are obviously other factors that are not shown in diagrams of this kind, in particular, energy increases caused by stretching bonds that will break. Perturbation and symmetry arguments give only a rough guide to the gross features of a reaction, but since they are often successful at picking out the dominant energy changes, they are particularly useful for qualitative understanding.

Hard and Soft Acids and Bases

Klopman has applied HOMO–LUMO arguments to hard–soft Lewis acid–base theory.¹⁰ Although his treatment is a quantitative one, we shall describe only its

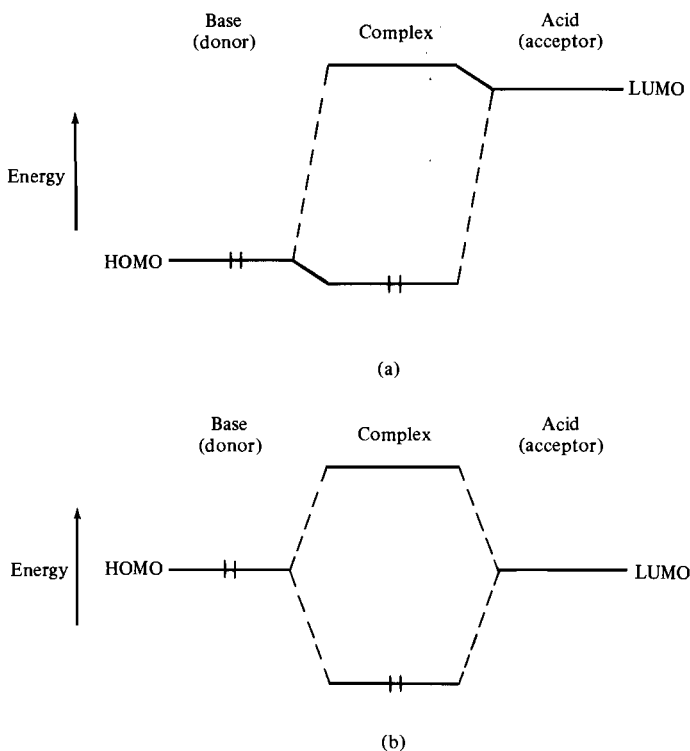

Figure 10.17 HOMO–LUMO interactions in Lewis acid–base processes. (a) In a hard–hard interaction, there is a large energy difference between the donor HOMO (left) and the acceptor LUMO (right). The bonding orbital formed when the two molecules interact (center) is similar to that of the donor both in energy and in form. The electron pair continues to reside mainly on the donor part of the complex, and the bonding has a large degree of ionic character. (b) In a soft–soft interaction, donor and acceptor frontier orbitals are of similar energy; they interact strongly, and the new orbital (center) differs considerably both in energy and in form from either of the original ones. The electron pair is shared, and the bonding is covalent.

¹⁰ G. Klopman, *J. Amer. Chem. Soc.*, **90**, 223 (1968).

qualitative aspects. In this application, it is the energy differences rather than the symmetries that are important in determining the interactions.

Since the Lewis base is the donor and the Lewis acid the acceptor, the HOMO of the base and the LUMO of the acid must be considered. For hard acids and bases, these frontier orbitals are of quite different energy and so do not interact strongly; the result is little distortion of the electron distribution as the acid–base complex is formed, and the bonding is largely ionic (Figure 10.17a). With soft–soft interactions, on the other hand, the frontier orbitals are of similar energy and interact strongly; an orbital is created in which the electron pair is shared in a covalent bond (Figure 10.17b). With a hard–soft pair the situation is intermediate, and the bonding is weaker than for either extreme.

In Klopman's quantitative calculations, the presence of other orbitals close in energy to the frontier orbitals is taken into account in the determination of the reactivity, as is the change in solvation energy on complex formation. On these theoretical grounds, Klopman has been able to classify Lewis acids and bases into hard, soft, and borderline categories; his results closely parallel Pearson's assignments (Section 3.5) made from consideration of chemical properties.

Other Applications

Hoffmann and co-workers have used qualitative perturbation theory to analyze systems in which the properties deduced from a standard localized bond model are substantially modified by consideration of the energy changes that occur when the model is improved by allowing interactions among localized orbitals of the same symmetry.¹¹

10.4 APPLICATION OF PERTURBATION THEORY AND SYMMETRY TO π SYSTEMS

The perturbation and symmetry theories can be used to find molecular orbitals of conjugated chains and to explain the aromaticity $4n + 2$ rule.

Molecular Orbitals of Linear π Systems

Ethylene, the first member of the series, is already familiar. Two adjacent p orbitals interacting will yield a bonding orbital, symmetric with respect to reflection in the mirror plane lying midway between the two carbons and perpendicular to the C—C axis, and an antibonding orbital antisymmetric with respect to that mirror plane. Figure 10.18 illustrates the interaction and the resulting orbitals.

To find the orbitals for a three-carbon chain, we bring up a third p orbital to the end of the ethylene and use the perturbation theory in Figure 10.19 to

¹¹ (a) R. Hoffmann, *Accs. Chem. Res.*, **4**, 1 (1971); (b) W. Stohrer and R. Hoffmann, *J. Amer. Chem. Soc.*, **94**, 779 (1972); (c) R. Hoffmann, R. W. Alder, and C. F. Wilcox, Jr., *J. Amer. Chem. Soc.*, **92**, 4992 (1970); (d) W. Stohrer and R. Hoffmann, *J. Amer. Chem. Soc.*, **94**, 1661 (1972); (e) R. Gleiter, W. Stohrer, and R. Hoffmann, *Helv. Chim. Acta*, **55**, 893 (1972); (f) R. Hoffmann and R. B. Davidson, *J. Amer. Chem. Soc.*, **93**, 5699 (1971); (g) R. Hoffmann, L. Radom, J. A. Pople, P. v. R. Schleyer, W. J. Hehre, and L. Salem, *J. Amer. Chem. Soc.*, **94**, 6221 (1972); (h) D. B. Boyd and R. Hoffmann, *J. Amer. Chem. Soc.*, **93**, 1064 (1971); (i) S. David, O. Eisenstein, W. J. Hehre, L. Salem, and R. Hoffmann, *J. Amer. Chem. Soc.*, **95**, 3806 (1973); (j) R. Hoffmann, C. C. Levin, and R. A. Moss, *J. Amer. Chem. Soc.*, **95**, 629 (1973).

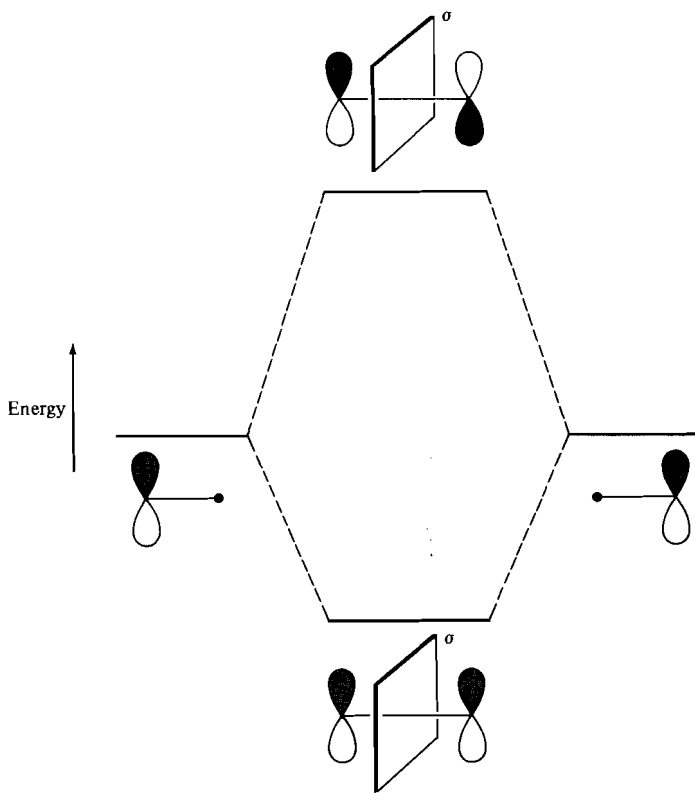
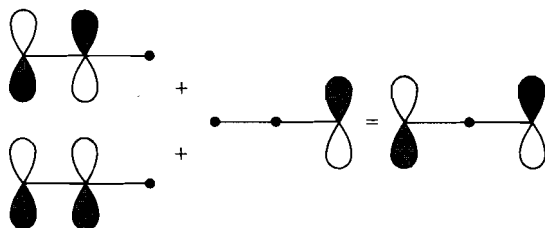

Figure 10.18 Interaction of p orbitals on two adjacent centers yields a bonding orbital, symmetric with respect to the mirror plane σ , and an antibonding orbital, antisymmetric with respect to the mirror plane.

assess the results of the interaction. The ethylene bonding orbital mixes into itself the new orbital in a bonding way, moving down in energy, while the ethylene antibonding orbital mixes into itself the new orbital in an antibonding way and moves up. The added p orbital mixes into itself both the ethylene bonding and antibonding orbitals.

If we follow the perturbation rules, we conclude that this double mixing must occur with the phases arranged as shown in 15, the lower-energy ethylene bonding orbital mixing in an antibonding way to push the single p orbital up,



15

but the ethylene antibonding orbital mixing in a bonding way and pushing it down. Note that there is a reinforcement at the left-hand end of the chain but a cancelling out at the center. If the perturbation is carried to its conclusion, a

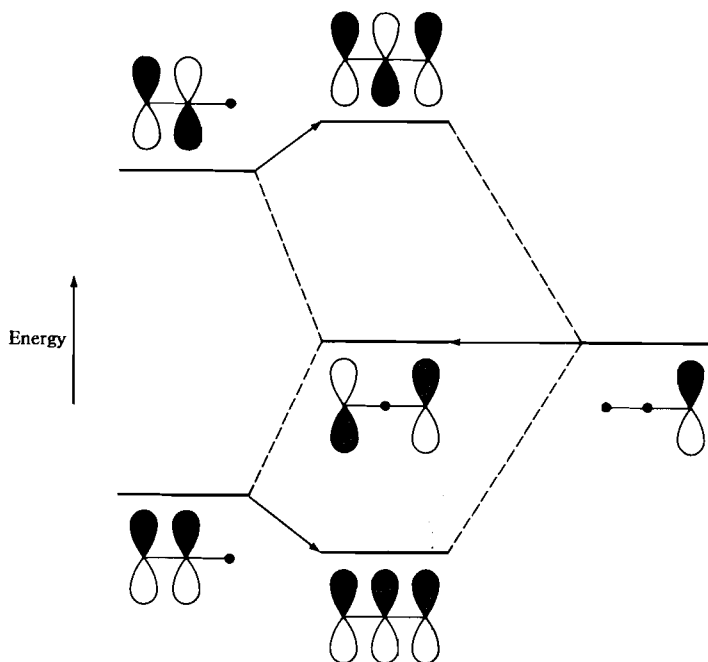

Figure 10.19 Interaction of a p orbital at the end of the ethylene system.

mirror plane again appears in the three-atom chain, this time passing directly through the central atom. Since we know that each of the orbitals we obtain in the end must be either symmetric or antisymmetric with respect to this plane, we can see at once that their forms must be those shown at the center in Figure 10.19. The lowest level is clearly bonding and the highest antibonding; the central level, antisymmetric with respect to the reflection, must necessarily have zero contribution from the central p orbital and is therefore nonbonding.

It is a straightforward task to carry the procedure one step further. In order to find the butadiene orbitals, it is easiest to allow two ethylene units to come together end to end. Figure 10.20 illustrates the results. The important interactions are between orbitals of the same energy; we simply treat the ethylene orbitals as the basis, and combine the bonding pair in the two possible ways and the antibonding pair in the two possible ways.

From these three examples we can already see the pattern that emerges. We summarize it in a simple set of rules, which will allow construction directly by inspection of the molecular orbitals for any length chain.

1. The orbitals alternate in symmetry with respect to the mirror plane passing through the midpoint of the chain, with the lowest-energy orbital always being symmetric.
2. The lowest energy level orbital has no nodes; the number of nodes increases by one in going from one level to the next higher level. The highest level has a node between each adjacent pair. Nodes must always be symmetrically located with respect to the central mirror plane.

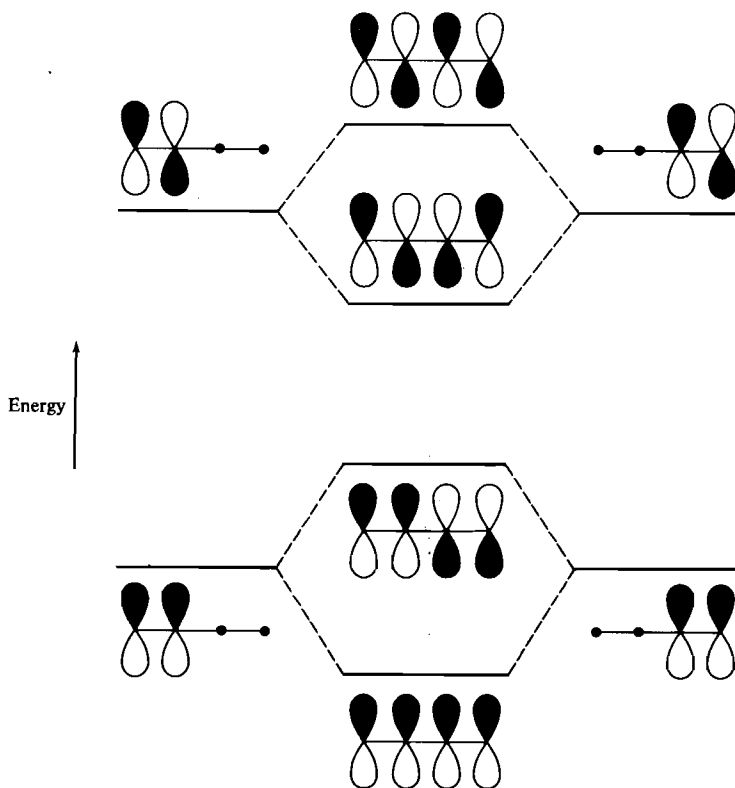

Figure 10.20 Construction of the π orbitals of butadiene by end-to-end interaction of two ethylenes.

- 3. In chains with an odd number of atoms, where the central atom lies in the mirror plane, antisymmetric orbitals must have zero contribution from the central atom. There is a nonbonding level to which alternate p orbitals make zero contribution.**

Figure 10.21 illustrates schematically the forms of the molecular orbitals for chains up to seven atoms in length.

Aromaticity

In order to find out about aromaticity, we want to see how the energy of an open-chain π system will change when it is made into a ring. If the energy goes down, the ring is aromatic; if the energy goes up, it is antiaromatic. Following the treatment of Goldstein and Hoffmann,¹² we note first that in order to make rings by joining two ends of a chain or by bringing two chains together, we shall have to distort the chains so that the central mirror plane may no longer strictly speaking be a symmetry element. But what is really important is the pattern of interaction of the p orbitals; this pattern is established by the linear sequence of p orbitals down the chain and is not disturbed by secondary distortions. Therefore, even if the mirror plane is not a proper symmetry element for the molecule

¹² M. J. Goldstein and R. Hoffmann, *J. Amer. Chem. Soc.*, **93**, 6193 (1971).

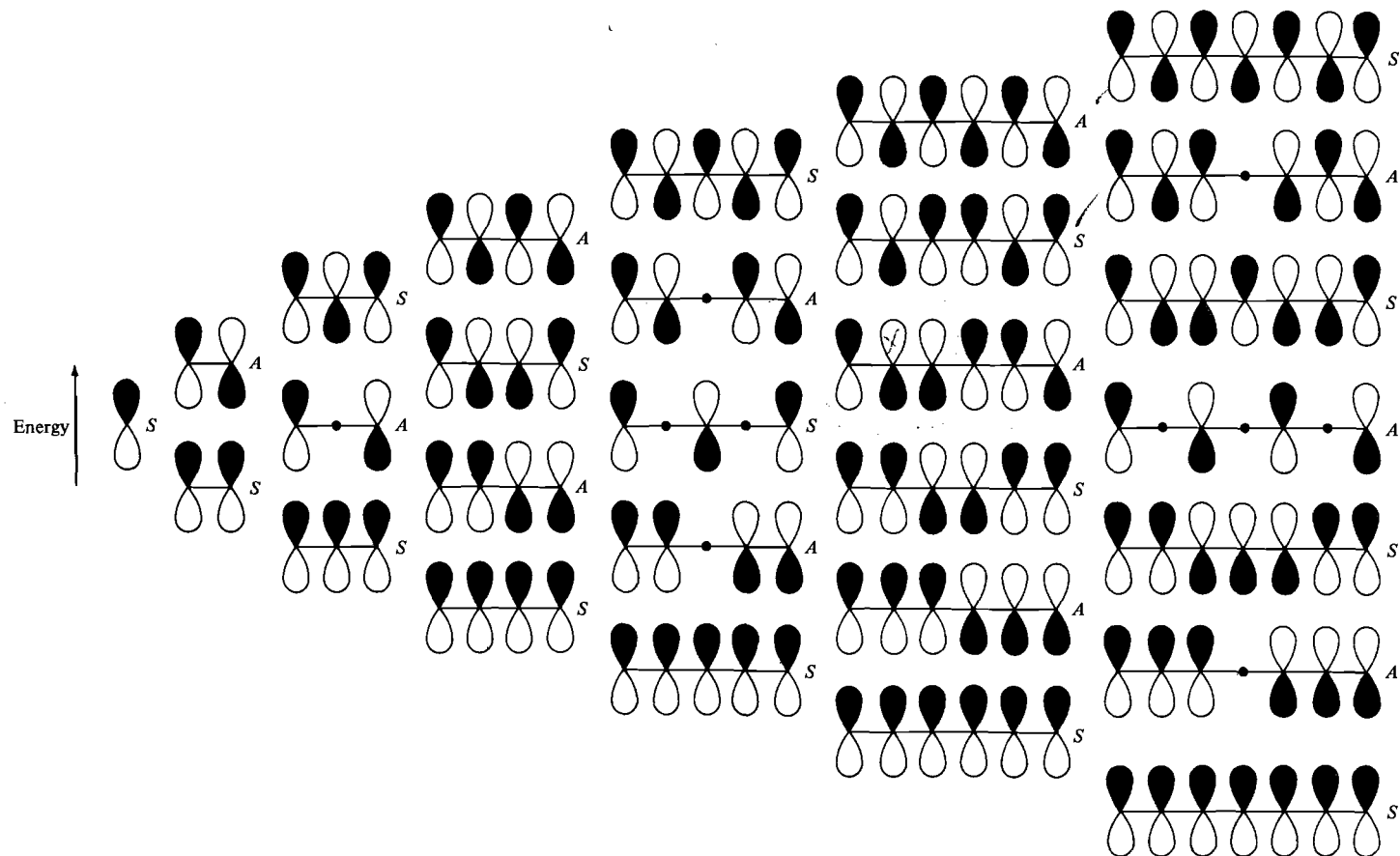

Figure 10.21 Forms of the π molecular orbitals for chains of from one to seven atoms. Symmetry labels (*S*, symmetric; *A*, antisymmetric) refer to symmetry with respect to a perpendicular mirror plane cutting the chain at its midpoint. Reprinted with permission from M. J. Goldstein and R. Hoffman, *J. Amer. Chem. Soc.*, **93**, 6193 (1971). Copyright by the American Chemical Society.

as a whole, it is in effect a local symmetry for the p orbital sequence.¹³ We may bend or otherwise distort linear conjugated chains and still feel confident in the use of the orbital patterns in Figure 10.21 as long as we maintain intact the sequence of interactions among the p orbitals.

Having established that the mirror plane is a proper symmetry element even if the chains are distorted, we look at HOMO–LUMO interactions. If we restrict our attention to chains with even numbers of electrons and focus on the HOMO and the LUMO, we can see that there are only two kinds of chains: those in which the HOMO is symmetric and the LUMO antisymmetric, and those in which the HOMO is antisymmetric and the LUMO symmetric. Goldstein and Hoffmann have named these types respectively Mode 2 and Mode 0.¹⁴ Table 10.1 shows a few examples. Note that anions and cations are covered as well as neutral molecules.

Now consider making a cyclic conjugated ring by joining two fragments at their ends; then stabilization will occur if the HOMO of one chain is of the proper symmetry to interact with the LUMO of the other. Figure 10.22 shows that stabilization occurs when a Mode 2 and a Mode 0 chain interact; we leave it as an exercise (Problem 7) for the reader to show that HOMO–LUMO stabilization will occur neither when two chains of Mode 2 are joined together nor when two chains of Mode 0 are joined together.

Since the lower levels are all filled, there will be to a first approximation no energy change resulting from their interactions. Therefore in the Mode 2 plus Mode 0 union, where HOMO–LUMO interactions are strongly stabilizing, there is an overall stabilization. But with the other two possibilities, Mode 2 plus Mode 2 or Mode 0 plus Mode 0, where HOMO–LUMO interactions are

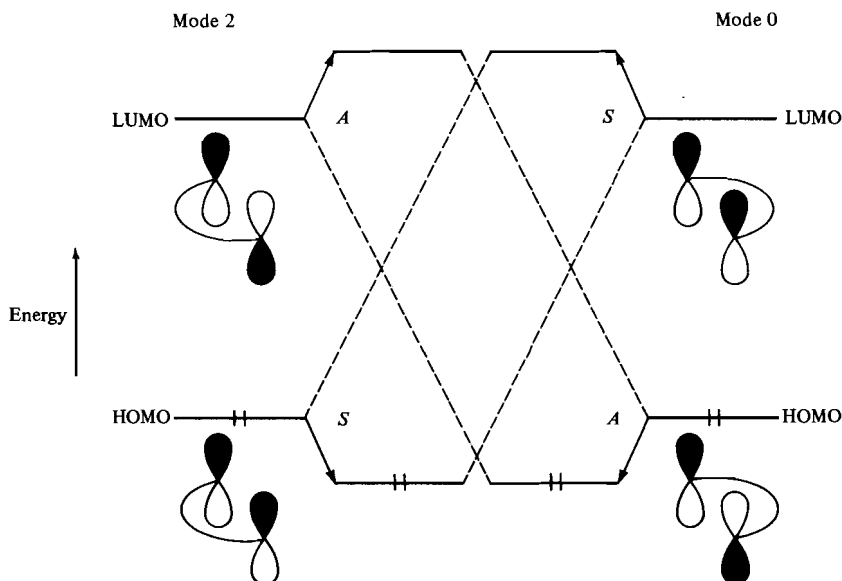
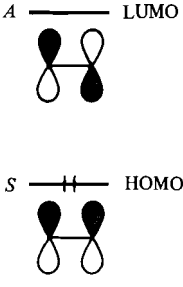
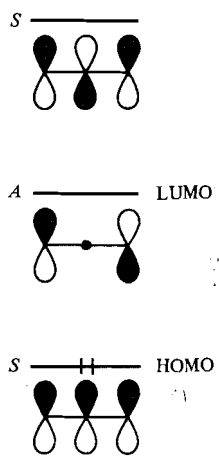

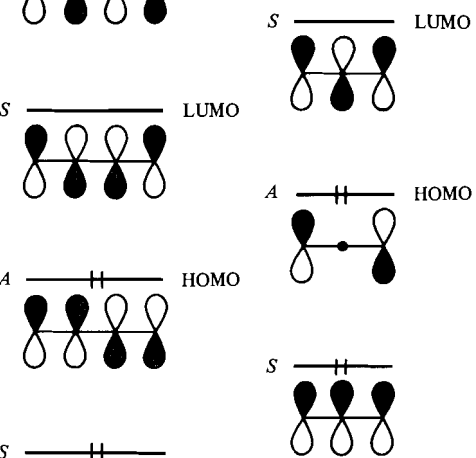
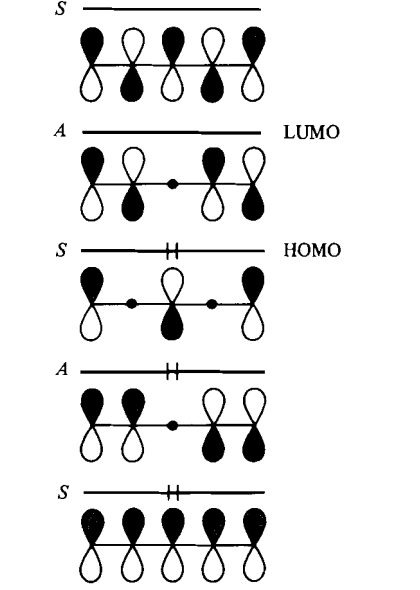
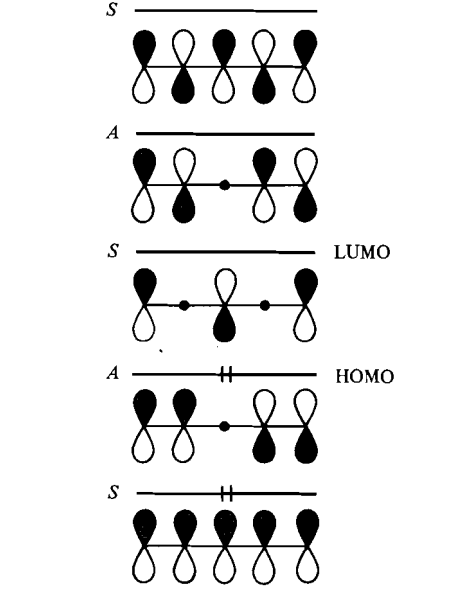

Figure 10.22 Interaction of a Mode 2 with a Mode 0 chain. The HOMO of each chain has the same symmetry as the LUMO of the other, and stabilization occurs.

¹³ Goldstein and Hoffmann (see note 12) refer to the mirror as a *pseudo symmetry* of the π system.

¹⁴ See note 12, p. 562.

Table 10.1 SOME EXAMPLES OF MODE 2 AND MODE 0 CHAINS

Mode 2 LUMO Antisymmetric HOMO Symmetric	Mode 0 LUMO Symmetric HOMO Antisymmetric
 <p style="text-align: center;">Ethylene</p>	 <p style="text-align: center;">Allyl cation</p>
 <p style="text-align: center;">Butadiene</p>	 <p style="text-align: center;">Allyl anion</p>
 <p style="text-align: center;">Pentadienyl anion</p>	 <p style="text-align: center;">Pentadienyl cation</p>

prevented by the symmetry mismatch, we should consider the interactions of the lower filled levels more carefully. Although we have made the approximation that the higher level moves up by the same amount that the lower one moves down, a more exact theory shows that the higher level always moves up more than the lower one moves down, so that interaction of two filled levels is actually somewhat destabilizing. Hence we conclude that union of a Mode 2 chain with a Mode 2, or of a Mode 0 with a Mode 0, will be destabilizing, and the resulting ring will be antiaromatic, whereas union of a Mode 2 with a Mode 0 chain will produce a stabilized, aromatic ring.

The connection can easily be made with number of electrons. The Mode 2 chains have an odd number of pairs ($4n + 2$ electrons), whereas the Mode 0 chains have an even number of pairs ($4n$ electrons). Therefore, joining Mode 2 with Mode 0 will give an odd number of pairs, $4n + 2$ total electrons; but joining Mode 2 with Mode 2, or joining Mode 0 with Mode 0, will give an even number of pairs, $4n$ electrons. Therefore the $4n + 2$ rings should be aromatic, the $4n$ rings antiaromatic.

Goldstein and Hoffmann have extended their arguments to a number of possible geometries of interaction in addition to the simple single ring.¹⁵ Dewar has also presented a perturbation approach to aromaticity that is historically antecedent to that of Goldstein and Hoffmann. We shall return to the topic of aromaticity, and describe Dewar's method, when we discuss pericyclic reactions in Chapter 11.

PROBLEMS

1. Find symmetry correct orbitals in each of the following:

- a. H_2CO
- b. H_2CCH_2
- c. *cis*- and *trans*-1,2-dichloroethylene
- d. allyl cation

2. Analyze the interaction between a filled p orbital of a carbanion and an adjacent methyl group.

3. Analyze the interaction between the vacant p orbital of a carbocation and an unshared electron pair on an adjacent nitrogen. Assume sp^3 hybridization for nitrogen, and the conformation in which the unshared pair has maximum overlap with the carbon p orbital.

4. Consider the model for the transition state for a 1,2-rearrangement of group R as being constructed from π orbitals on C_1 , C_2 , and a hybrid orbital on R. Analyze the HOMO-LUMO interactions (a) for rearrangement in a carbocation, and (b) for rearrangement in a carbanion. How does the argument change if the migrating group is phenyl?



5. Apply Pearson's criteria (see note 9, p. 556) to the examples discussed on pp. 554-558.

6. Draw schematically the π molecular orbitals for linear eight-, nine-, and ten-membered chains.

¹⁵ See note 12, p. 562.

7. Analyze by perturbation theory the energy changes on forming a ring by joining

- a. a Mode 0 and a Mode 0 chain;
- b. a Mode 2 and a Mode 2 chain.

REFERENCES FOR PROBLEMS

- 4. (a) See Chapter 6. (b) N. F. Phelan, H. H. Jaffe, and M. Orchin, *J. Chem. Educ.*, **44**, 626 (1967); H. E. Zimmerman and A. Zweig, *J. Amer. Chem. Soc.*, **83**, 1196 (1961); E. Grovenstein, Jr., and R. E. Williamson, *J. Amer. Chem. Soc.*, **97**, 646 (1975).
- 7. M. J. Goldstein and R. Hoffmann, *J. Amer. Chem. Soc.*, **93**, 6193 (1971).

Chapter 11

THE THEORY

OF PERICYCLIC

REACTIONS

In Chapters 11 and 12 we consider pericyclic reactions, processes characterized by bonding changes taking place through reorganization of electron pairs within a closed loop of interacting orbitals. The bonding changes must be concerted in order for a reaction to fit the pericyclic category; that is, all bonds breaking and forming must do so simultaneously rather than in two or more steps. We shall use the term *stepwise* to imply a nonpericyclic pathway in which one or more bonds form (or break) in a first step to yield an intermediate that subsequently reacts by formation (breakage) of remaining bonds.

The requirement for simultaneous bond formation and cleavage in a pericyclic reaction does not mean that all changes must have taken place to the same extent at all stages along the reaction coordinate. So long as the changes are occurring together, it is possible for bond formation or cleavage at one site to run substantially ahead of bond formation or cleavage at another. A *concerted* reaction is therefore interpreted as simultaneous, but not necessarily synchronous, bond formation and breakage.

Pericyclic reactions represented for many years a difficult mechanistic problem because the apparent absence of intermediates left few concrete features that could be subjected to experimental study. Application of some fundamental principles of orbital theory, initiated in 1965 by Woodward and Hoffmann¹ and since developed extensively by them² and by others,³ have provided new

¹ R. B. Woodward and R. Hoffmann, *J. Amer. Chem. Soc.*, **87**, 395 (1965).

² (a) R. Hoffmann and R. B. Woodward, *J. Amer. Chem. Soc.*, **87**, 2046 (1965); (b) R. B. Woodward and R. Hoffmann, *J. Amer. Chem. Soc.*, **87**, 2511 (1965); (c) R. Hoffmann and R. B. Woodward, *Acts. Chem. Res.*, **1**, 17 (1968); (d) R. B. Woodward and R. Hoffmann, *The Conservation of Orbital*

insight into these reactions and have opened a new field of experimental investigation. This chapter considers the theoretical aspects, and Chapter 12 will take up applications and examples.

11.1 DEFINITIONS

Woodward and Hoffmann⁴ have subdivided pericyclic transformations into five categories: cycloaddition, electrocyclic, sigmatropic, cheletropic, and group transfer reactions. Although one can, from a more generalized point of view, regard all these types as cycloadditions, it is convenient to follow this subdivision for purposes of thinking about both theoretical aspects and particular reactions. In this section we shall define and illustrate each class in order to arrive at an overall view of the kinds of questions with which pericyclic reaction theory is concerned.

Cycloaddition

Cycloaddition is a process in which two or more molecules condense to form a ring by transferring electrons from π bonds to new σ bonds.⁵ Some typical examples, characterized by the number of π electrons in the reacting components, are illustrated in Equations 11.1–11.3.⁶ The bonding changes are sometimes

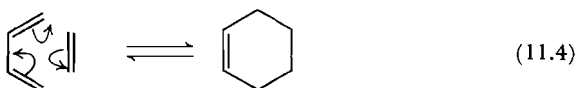
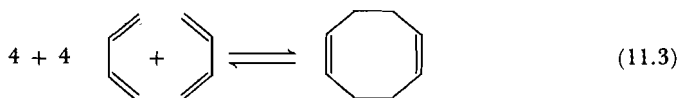
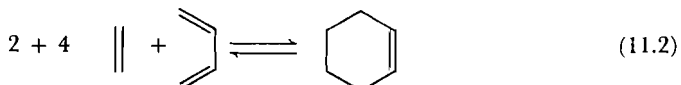
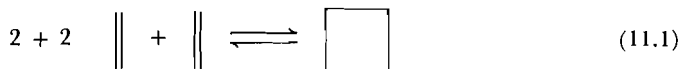

1

Symmetry, Angew. Chem. Int. Ed., **8**, 781 (1969); Verlag Chemie, Weinheim/Bergstr., Germany, and Academic Press, New York, 1970.

³ (a) H. C. Longuet-Higgins and E. W. Abrahamson, *J. Amer. Chem. Soc.*, **87**, 2045 (1965); (b) H. E. Zimmerman, *J. Amer. Chem. Soc.*, **88**, 1564, 1566 (1966); *Accts. Chem. Res.*, **4**, 272 (1971); *Accts. Chem. Res.*, **5**, 393 (1972); (c) M. J. S. Dewar, *Tetrahedron Suppl.*, **8**, 75 (1966); *Angew. Chem. Int. Ed.*, **10**, 761 (1971); (d) K. Fukui, *Accts. Chem. Res.*, **4**, 57 (1971); (e) J. J. C. Mulder and L. J. Oosterhoff, *Chem. Commun.*, 305, 307 (1970); (f) W. J. van der Hart, J. J. C. Mulder, and L. J. Oosterhoff, *J. Amer. Chem. Soc.*, **94**, 5724 (1972); (g) W. A. Goddard, III, *J. Amer. Chem. Soc.*, **94**, 793 (1972); (h) M. J. S. Dewar, S. Kirschner, and H. W. Kollmar, *J. Amer. Chem. Soc.*, **96**, 5240ff. (1974); (i) D. M. Silver, *J. Amer. Chem. Soc.*, **96**, 5959 (1974); (j) for a general treatment, see T. L. Gilchrist and R. C. Storr, *Organic Reactions and Orbital Symmetry*, Cambridge University Press, Cambridge, 1972.

⁴ See note 2(d), p. 568.

⁵ R. Huisgen, *Angew. Chem. Int. Ed.*, **7**, 321 (1968).

⁶ Huisgen (note 5) has proposed a different system of designating the nature of the components.

emphasized by the use of curved arrows, as in Equation 11.4. Although this notation serves as a useful bookkeeping device to record the changes in bonding, one must nevertheless be careful in using it for pericyclic reactions not to attach literal significance to the arrows nor to their direction. As we shall see in more detail later, the bonding changes occur through a set of orbitals interacting on the equivalent of a circular path, but a drawing like **1** must not be taken to imply that particular electron pairs are to be found at particular places on the circle, or that pairs circulate in a particular direction.

The interesting feature of the cycloadditions is that the ease with which they take place depends on the size of the ring. Whereas the 2 + 4 process (Equation 11.2), known as the Diels–Alder reaction, occurs readily with activation enthalpies of roughly 25–35 kcal mole⁻¹, and has been one of the cornerstones of organic chemistry for many years,⁷ the 2 + 2 and 4 + 4 additions are accomplished much less easily. One finds, however, that if one of the reacting molecules is in an electronically excited state, the 2 + 2 and 4 + 4 processes occur more readily than the 2 + 4.⁸

The 1,3-dipolar additions (Equation 11.5), studied extensively by Huisgen and co-workers,⁹ also fit in the cycloaddition category. The 1,3-dipole, which

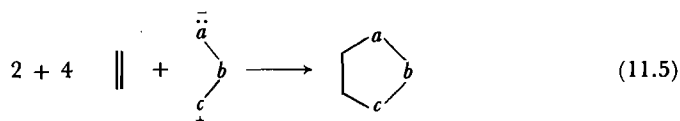

can be any of a variety of stable molecules or reactive intermediates—for example, ozone ($\ddot{\text{O}}=\overset{+}{\text{O}}-\ddot{\text{O}}:\leftrightarrow\overset{+}{\text{O}}-\ddot{\text{O}}-\ddot{\text{O}}:\leftrightarrow\ddot{\text{O}}-\overset{+}{\text{O}}-\ddot{\text{O}}:$), nitro ($\ddot{\text{O}}=\overset{+}{\text{N}}-\ddot{\text{O}}:\leftrightarrow\overset{+}{\text{N}}-\ddot{\text{O}}-\ddot{\text{O}}:$), nitronium ($\overset{+}{\text{O}}-\overset{+}{\text{N}}-\ddot{\text{O}}:\leftrightarrow\overset{+}{\text{O}}-\overset{+}{\text{N}}-\ddot{\text{O}}:$), nitrile oxide ($-\text{C}\equiv\overset{+}{\text{N}}-\ddot{\text{O}}:\leftrightarrow\overset{+}{\text{C}}=\overset{+}{\text{N}}-\ddot{\text{O}}:$)—typically has four π electrons in an orbital system delocalized over three centers. These reactions, like the Diels–Alder, are easily accomplished.

Stereochemistry in Cycloaddition

For a given π electron system, there are two stereochemical alternatives, illustrated for the four-electron fragment of a 2 + 4 addition by Structures **2** and **3**,

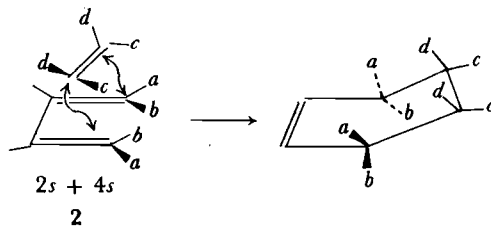

⁷ (a) M. C. Kloetzel, *Org. Reactions*, **4**, 1 (1948); (b) H. L. Holmes, *Org. Reactions*, **4**, 60 (1948); (c) L. W. Butz and A. W. Rytina, *Org. Reactions*, **5**, 136 (1949); (d) J. G. Martin and R. K. Hill, *Chem. Rev.* **61**, 537 (1961); (e) R. Huisgen, R. Grashey, and J. Sauer, in *The Chemistry of Alkenes*, S. Patai, Ed., Wiley-Interscience, London, 1964, p. 739; (f) A. Wassermann, *Diels–Alder Reactions*, Elsevier, Amsterdam, 1965; (g) H. Kwart and K. King, *Chem. Rev.*, **68**, 415 (1968).

⁸ See, for example: W. L. Dilling, *Chem. Rev.* **69**, 845 (1969).

⁹ R. Huisgen, *Angew. Chem. Int. Ed.*, **2**, 565 (1963).

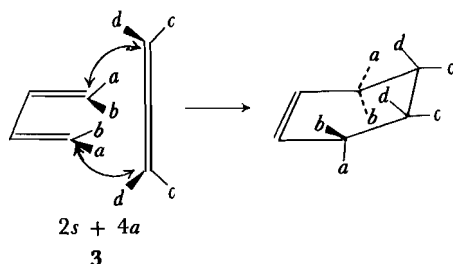

in which the arrows show where the two new σ bonds are forming. In **2**, both bonds form to the same face of the four-electron system; whenever two bonds form on the same face of a unit entering a cycloaddition, that unit is said to enter suprafacially, abbreviated *s*. In **3**, addition occurs on the upper face at one end of the diene and on the lower face at the other; in this instance, the diene is entering antarafacially, *a*. In both structures **2** and **3**, the two-electron component is acting in a suprafacial way; in **2** we would say that the combination is (diene *s*) + (ethylene *s*), and in **3** it is (diene *a*) + (ethylene *s*). Further economy of notation is obtained by indicating only the number of electrons that enter from each unit. The diene is contributing four electrons from its π system and so is designated $4s$ in **2** and $4a$ in **3**. The ethylene is contributing two electrons and so is designated $2s$ in each case. Hence the shorthand notation summarizing number of electrons and stereochemistry is $2s + 4s$ for **2**, and $2s + 4a$ for **3**.

Any of the combinations $s + s$, $s + a$, $a + s$, $a + a$ is conceivable for a cycloaddition of two components. Comparison of *cis-trans* stereochemistry of substituents in product to that in reactants establishes which occurred. In additions of relatively short chains, the antarafacial interaction is difficult for the molecule to attain, but when systems with appropriate geometry are contrived, it is found that reactions in which one component acts in the antarafacial manner exhibit an inverted preference with respect to ring size: The $2 + 2$ additions are now favorable and the $4 + 2$ not.

Electrocyclic Reactions

The second category is that of the electrocyclic reaction, illustrated in Equations 11.6–11.8, characterized by intramolecular opening or closing of a ring by conversion of σ bonds to π bonds or the reverse. Again, a notation with curved

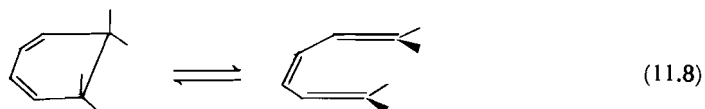
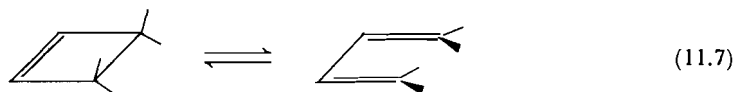

arrows (**4**) is helpful if used with appropriate caution.

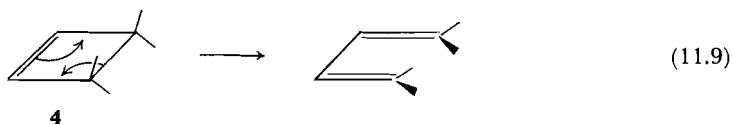

The primary feature of interest here is the stereochemistry of substituents of the σ bond that is broken. These substituents lie above and below the ring plane, and as the bond breaks must rotate in one of the ways illustrated in Equation 11.10. Woodward and Hoffmann introduced the terms *disrotatory* (rotating in opposite directions) and *conrotatory* (rotating in the same direction) to describe these alternatives.¹⁰ (The two disrotatory possibilities shown on the left in Equation 11.10 are fundamentally the same.) Again the preferred path depends on ring size: Electrocyclic ring opening and closing of a ground-state cyclobutene (Equation 11.7) usually follows the conrotatory route, whereas a ground-state cyclohexadiene (Equation 11.8) prefers the disrotatory. The preferences reverse in the photochemical excited-state reactions.

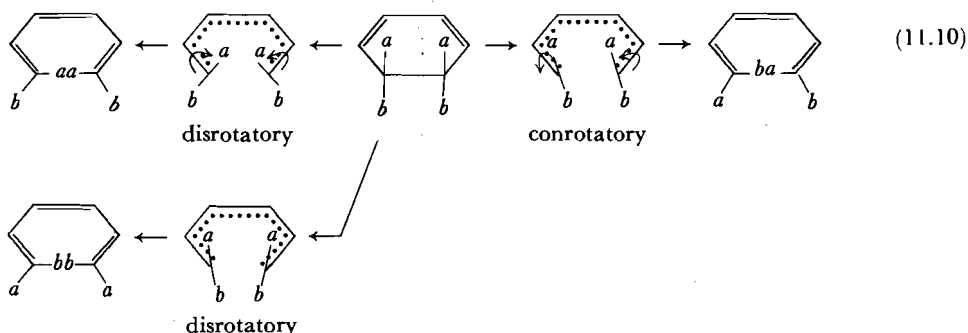

We note that in a more generalized sense the electrocyclic reactions can be regarded also as cycloadditions if one agrees to apply the suprafacial-antarafacial terminology to σ bonds as well as to π bonds in the manner illustrated by 5 and 6.

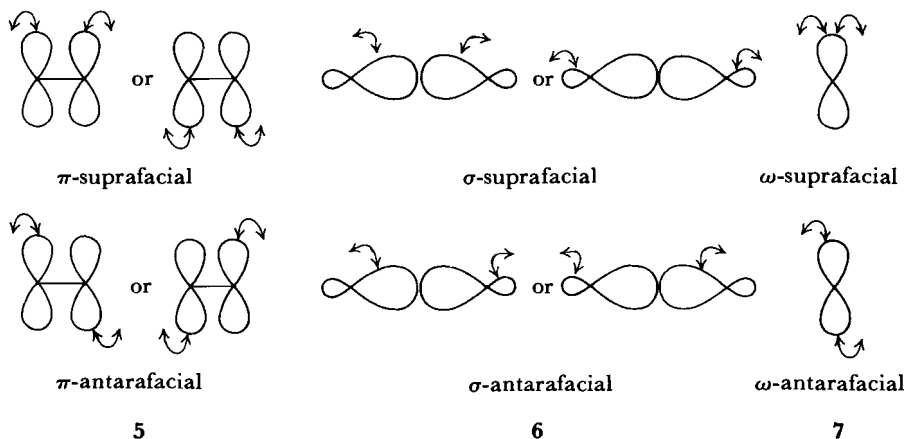

The disrotatory process of Equation 11.10 is then, in the notation of Woodward and Hoffmann, $\sigma 2s + \pi 4s$ (Equation 11.11), and the conrotatory can be con-

¹⁰ See note 1, p. 568.

sidered either $\sigma 2a + \pi 4s$ (Equation 11.12) or $\sigma 2s + \pi 4a$ (Equation 11.13). There are also reactions in which it is convenient to consider a single orbital as

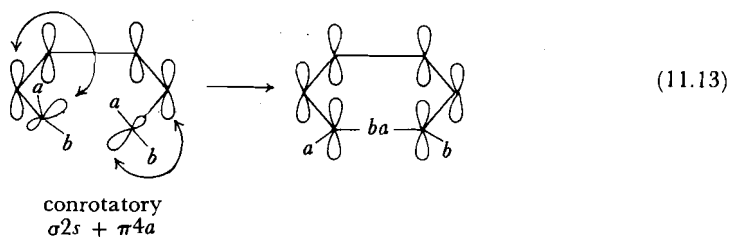
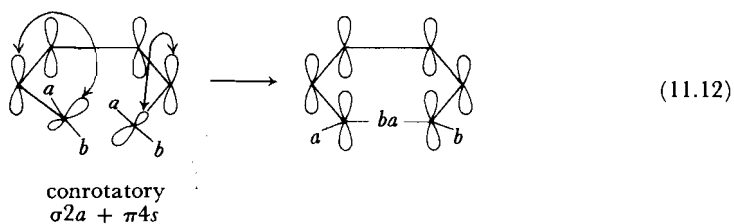
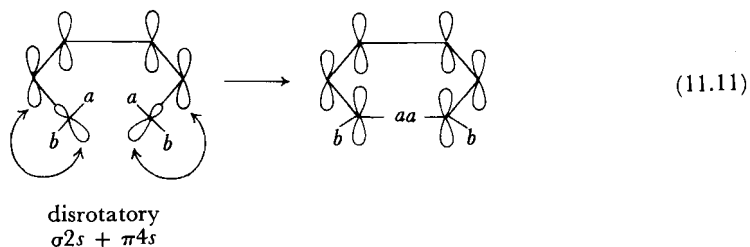

one of the partners in a cycloaddition; we therefore include for completeness the ω -suprafacial and ω -antarafacial interactions (7).

Sigmatropic Reactions

Sigmatropic reactions are those in which a bond migrates over a conjugated system as illustrated in Equations 11.14–11.17, the migrating bond being indicated by a heavy line. The Woodward–Hoffmann nomenclature¹¹ designates with a pair of numbers in square brackets the change (if any) in the position of attachment of the ends of the bond in question. Thus a [1,2] change indicates that one end of the bond remains attached at its original position while the other end moves to an adjacent position; a [3,5] change would mean that one end moves to a 3-position relative to its original point of attachment while the other end moves to a 5-position. Suprafacial and antarafacial possibilities are present here as well; preferred stereochemistry is again determined by the number of electrons in the cyclic array of orbitals. Sigmatropic changes can also be regarded

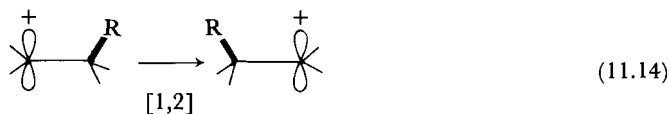

¹¹ See note 2(d), p. 568.

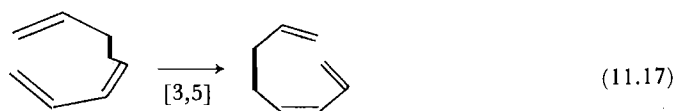
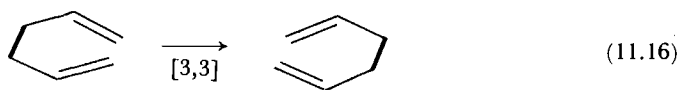
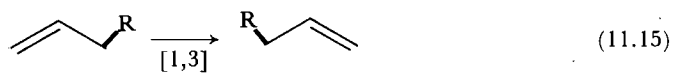

as generalized cycloadditions (Equations 11.18–11.21). Note (Equation 11.20) that when a σ bond enters in an antarafacial way in a $[1,n]$ sigmatropic transformation, an inversion occurs at the center to which the migrating bond remains attached.

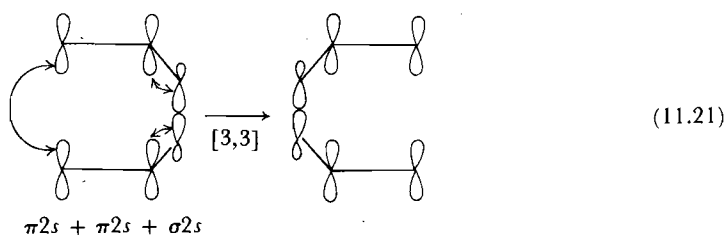
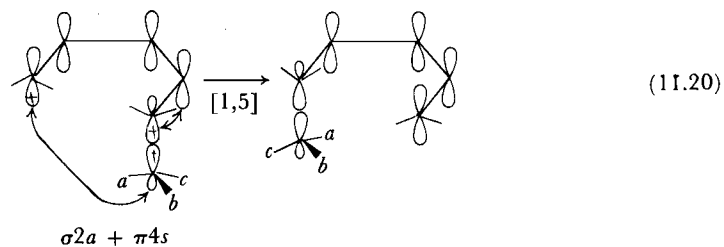
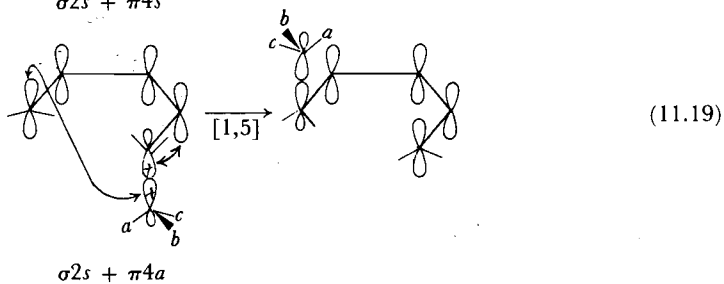
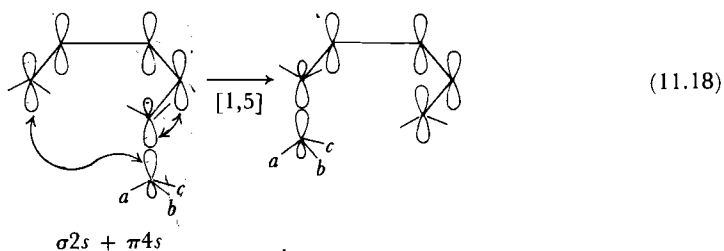

Cheletropic Reactions and Group Transfers

Cheletropic reactions are cycloadditions in which one of the components interacts through a single atom, as in Equation 11.22. Group transfers are character-

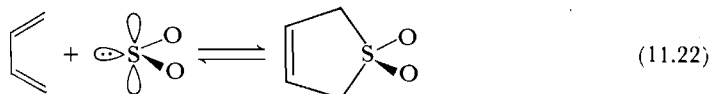

ized by transfer of a group or groups from one molecule to another, as illustrated in Equations 11.23–11.25. Again, one can view these reactions as generalized cycloadditions (Equations 11.26–11.27).

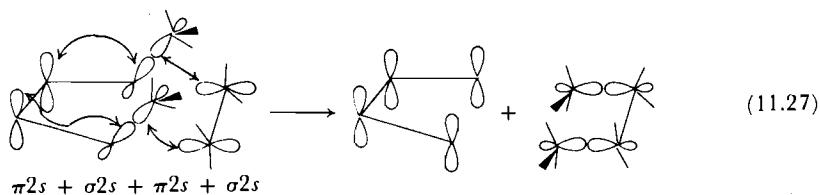
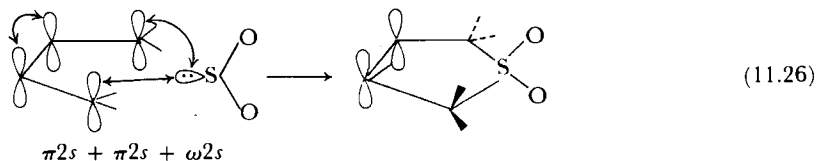
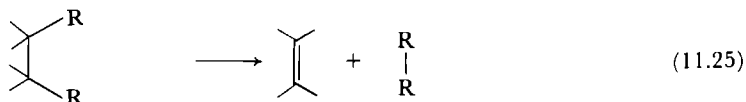
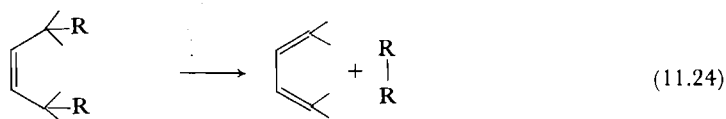
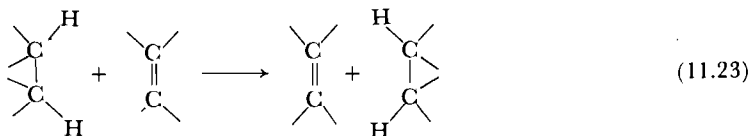

Symmetry in Pericyclic Reactions

An appreciation of the role of symmetry in the construction of orbital models for bonding is essential to the understanding of the theory of pericyclic reactions. The introduction to symmetry presented in Chapter 10 will serve as background for the remainder of this chapter. We summarize its main conclusions here before proceeding.¹²

Symmetric and antisymmetric orbitals The first point is that each symmetry correct molecular orbital may be either unchanged or transformed to

¹² The idea that symmetry properties of orbitals might be important in determining the course of certain reactions apparently originated with L. J. Oosterhoff, quoted by E. Havinga and J. L. M. A. Schlatmann, *Tetrahedron*, **16**, 146 (1961).

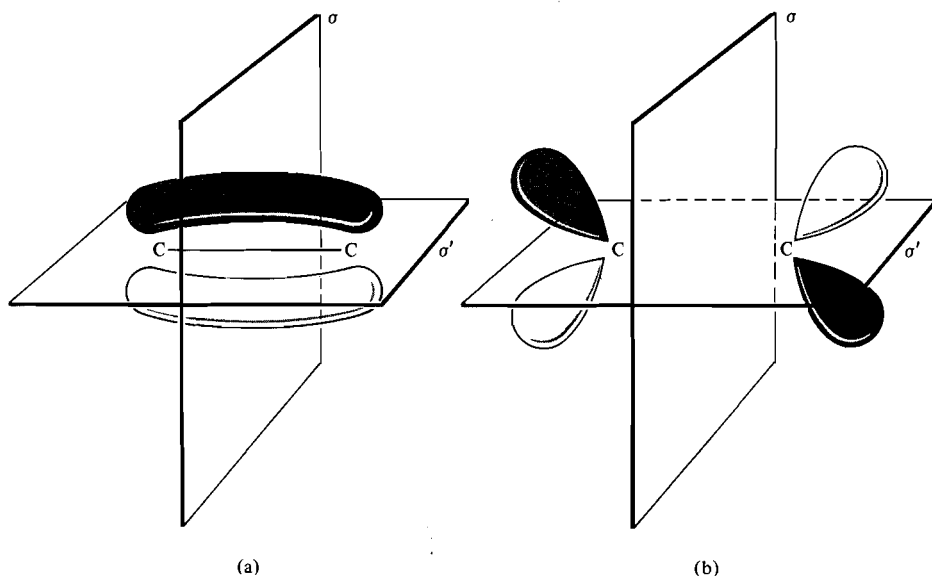

Figure 11.1 (a) The ethylene π bonding orbital is symmetric (S) with respect to reflection in the mirror plane σ , and antisymmetric (A) with respect to reflection in the mirror plane σ' . (b) The ethylene π^* antibonding orbital is antisymmetric (A) with respect to reflection in both σ and σ' .

its negative by each of the symmetry operations of the molecule. An orbital that is unchanged by an operation is said to be *symmetric* (S) with respect to that operation, whereas an orbital that is transformed to its negative is said to be *antisymmetric* (A).¹³ Figure 11.1a shows the π bonding orbital of ethylene together with two of the symmetry elements of the molecule, the mirror planes σ and σ' . This orbital is symmetric (S) with respect to reflection in plane σ , but antisymmetric (A) with respect to reflection in the plane σ' . The π^* orbital (Figure 11.1b) is of a different symmetry type, antisymmetric (A) with respect to both reflections.

Orbital interaction Second, recall that orbitals of the same symmetry can interact, whereas orbitals that have different symmetries with respect to even one symmetry element cannot.

Intrinsic symmetry of reacting orbitals Third, in making bonding models, we noted that it is not always necessary to use all the symmetry elements of the molecule. We may be able to pick out one or more of a number of symmetry elements that will give the desired information. We shall find examples of this procedure in applications of the pericyclic theory. We also need another idea, already introduced in Section 10.4, namely that in some circumstances it is appropriate to use a symmetry element that is not strictly, but rather only approximately, a correct symmetry element of the molecule. The reason we can do this is that in pericyclic reactions we shall focus on those orbitals in the molecule that are actually involved in the bonding changes of interest, which we

¹³ When there are axes of symmetry of threefold or higher, there will be orbitals that transform in more complicated ways. We shall not have occasion to use these higher symmetries in our discussion.

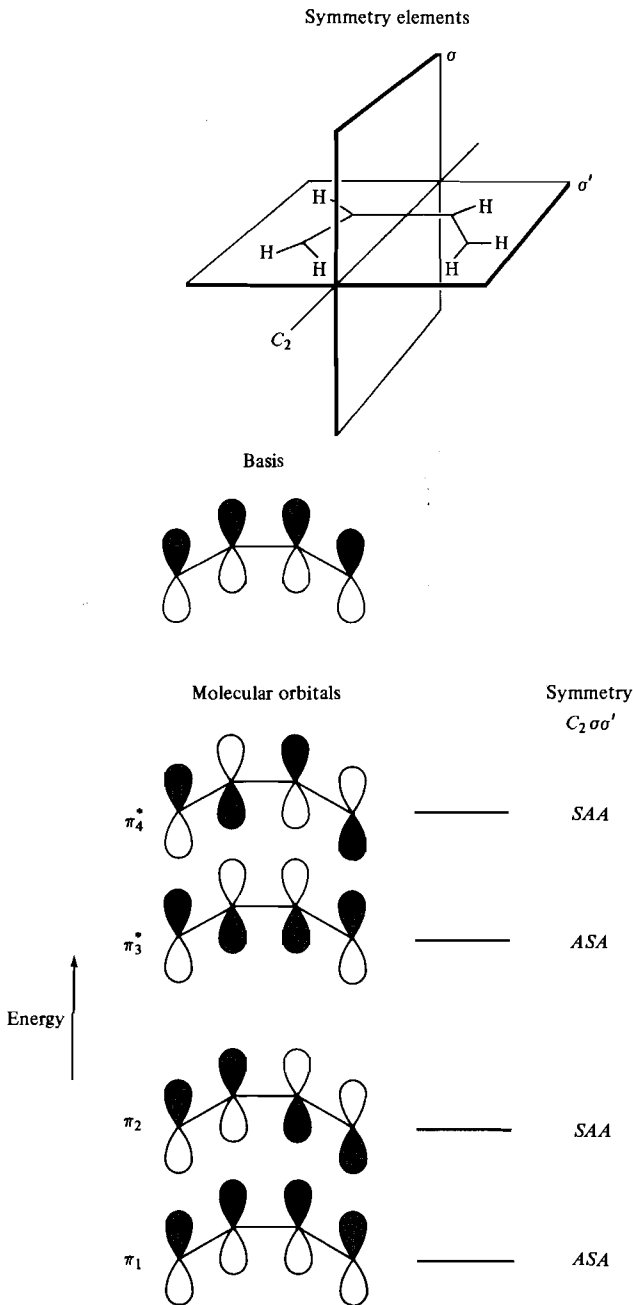

Figure 11.2 The π orbitals of butadiene. At the top are shown the symmetry elements of the molecule, two mirror planes and a C_2 axis, and the basis orbitals to be used in constructing the π molecular orbitals. Below are the four molecular orbitals in an energy-level diagram, with their symmetry behavior under each of the symmetry operations listed at the right.

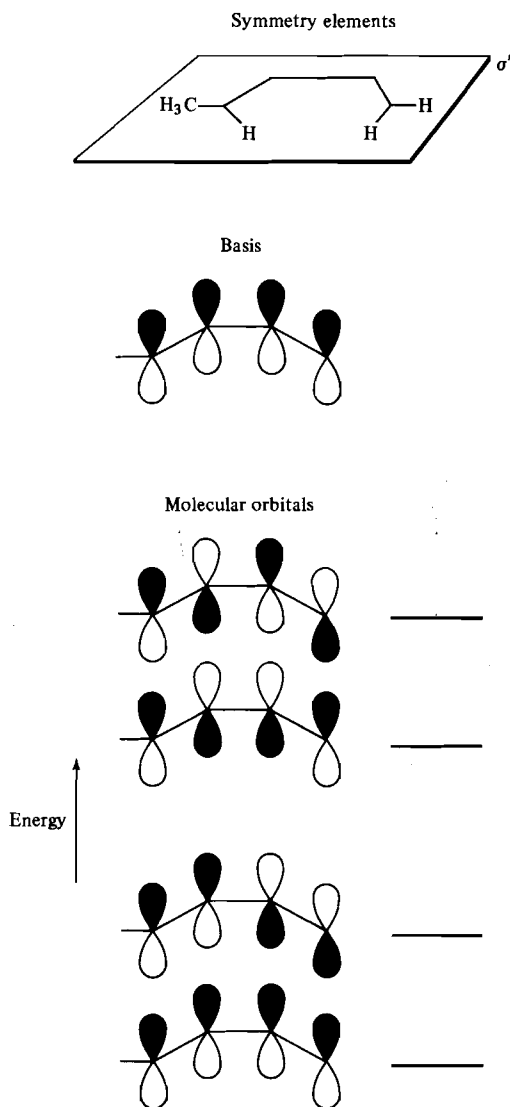

Figure 11.3 The π orbitals for 1-methylbutadiene. Now the correct molecular symmetry consists of only the plane σ' , but the π orbitals are still constructed according to their approximate local symmetry, which remains as shown in Figure 11.2.

shall call the *reacting orbitals*. The system of reacting orbitals may have an intrinsic symmetry that will be appropriate to use, but there may be a substituent in the molecule that, technically speaking, destroys this symmetry. If the substituent does not interact strongly with any of the reacting orbitals, the situation should be the same as if the substituent were not there, and the higher symmetry of the reacting orbitals themselves will be the proper one to use.

Let us suppose, for example, that we wish to know about the interaction of the π orbitals of butadiene with orbitals of some other molecule. If the butadiene is unsubstituted (Figure 11.2), the molecular symmetry and the symmetry needed for the orbital model are the same. The symmetry elements of the mole-

cule in the conformation shown are C_2 , σ , σ' , as given in the figure, and each orbital has been constructed so as to be symmetry correct with respect to each symmetry operation.

Figure 11.2 also introduces the conventions we shall use in the subsequent discussion for showing molecular orbitals. In studying diagrams of orbitals, it is important to differentiate the basis atomic orbital functions from the molecular orbital functions. At the top of Figure 11.2 the orbitals shown designate the basis functions that are to be used as building blocks; the choice of relative signs of the various members of the set is entirely arbitrary, but is usually made in some systematic fashion. The π molecular orbitals obtained from this basis set are depicted in the lower part of the figure. Although the drawings should indicate extended lobes (8 and 9 for π_1 and π_2), the difficulty of making such diagrams, especially



in the more complex structures, clearly dictates a simplified notation in which one merely indicates the relative signs with which the basis functions are combined in each MO. Such simplified diagrams are unambiguous as long as the context clearly specifies whether a basis set or a molecular orbital is meant. The reader should verify the symmetry properties, S or A , of each molecular orbital under each of the symmetry operations.

If we now consider 1-methylbutadiene (Figure 11.3), we find that the introduction of the methyl group has removed two of the symmetry elements. We may nevertheless argue that the methyl group will have only a secondary effect on the π system, the main features of which should be approximately the same as in butadiene itself. For purposes of qualitative arguments, we can therefore ignore the methyl substitution and take the symmetry of the π system itself as the applicable symmetry. The proper symmetry to use in this instance, then, is the same as that of the unsubstituted butadiene (Figure 11.2).

11.2 PERTURBATION THEORY IN PERICYCLIC REACTIONS

There are three ways of looking at pericyclic reactions, all of which give the same results but each of which has its own contribution to make to the understanding of these processes. We shall examine each in turn.

We have discussed in Section 10.3 the application of perturbation theory to processes in which two molecules come together. We saw there that the most important interactions will be between the HOMO of one molecule and the LUMO of the other. This method can serve as a useful guide in deciding whether there will be a stabilization as a pericyclic reaction begins to occur. The HOMO-LUMO approach was the first one that Woodward and Hoffmann used for ana-

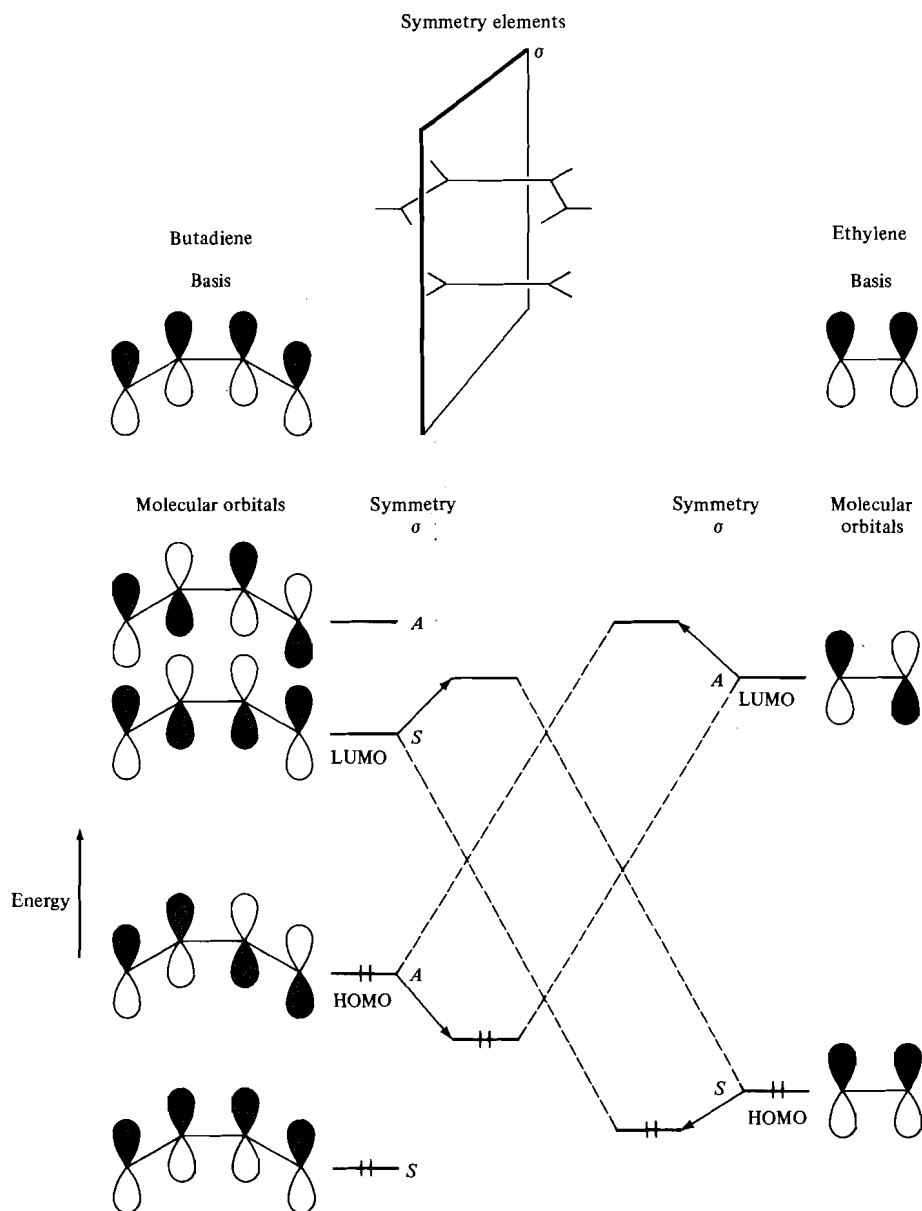

Figure 11.4 HOMO-LUMO interactions in the approach of an ethylene to a butadiene. The symmetry (σ) is shown at top center. At left are the butadiene π MO's, classified according to their symmetry with respect to σ ; at right are the ethylene π MO's, also classified according to σ . The HOMO of each molecule can interact with the LUMO of the other, and a stabilization occurs as they approach one another.

lyzing these processes,¹⁴ and it has been developed in detail by Fukui.¹⁵

Let us consider an ethylene and a butadiene approaching each other in the

¹⁴ R. B. Woodward and R. Hoffmann, *J. Amer. Chem. Soc.*, **87**, 395 (1965).

¹⁵ K. Fukui, *Accts. Chem. Res.*, **4**, 57 (1971).

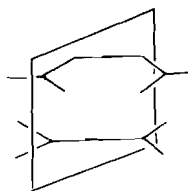

10

manner shown in 10. We wish to consider the interactions of the HOMO of ethylene with the LUMO of butadiene, and of the LUMO of ethylene with the HOMO of butadiene. In order to do this, we identify first the symmetry of the aggregate of the two molecules arranged as in 10; there is one symmetry element, a vertical plane that cuts across the ethylene double bond and the butadiene single bond. In Figure 11.4 we place at the left the π orbitals of butadiene, and at the right the π orbitals of ethylene. The symmetry classification of each orbital is with respect to the mirror plane shown. (Note that the other symmetry elements that would be applicable to butadiene alone or to ethylene alone are not correct symmetry elements for the combination 10 and must not be included.) The interaction of each HOMO with the other LUMO is permitted by symmetry; as we have seen in Section 10.3, this is just the situation that leads to stabilization, and we may expect this cycloaddition to be facile, as indeed it is.

If we now look at the cycloaddition of two butadiene molecules to each other (Figure 11.5), we find that because of the symmetry mismatch between the HOMO of one molecule and the LUMO of the other, there can be no stabilization. The only interaction is between filled levels, which, as we have seen in Section 10.1, p. 540, is destabilizing. Hence this process should not occur readily, a conclusion that is again in agreement with experiment.

11.3 CORRELATION DIAGRAMS AND PERICYCLIC SELECTION RULES

The second method of analysis, developed by Woodward and Hoffmann, traces the molecular orbitals of the starting materials through the entire reaction to the molecular orbitals of the products.¹⁶

Orbital Correlation Diagrams—The Conrotatory Electrocyclic Reaction

We shall consider first the electrocyclic ring closure of butadiene to cyclobutene

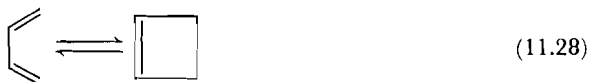

(Equation 11.28).¹⁷ It will be recalled (p. 572) that this process can occur in either of two ways: disrotatory (Equation 11.29) or conrotatory (Equation 11.30) and that it exhibits a marked preference for the conrotatory path.

¹⁶ See note 2, p. 568.

¹⁷ The theory of electrocyclic reactions was first presented in a form that focused on the HOMO by (a) R. B. Woodward and R. Hoffmann, *J. Amer. Chem. Soc.*, **87**, 395 (1965), and later in the form described here: (b) R. Hoffmann and R. B. Woodward, *Accts. Chem. Res.*, **1**, 17 (1968). See also (c) R. B. Woodward and R. Hoffmann, *The Conservation of Orbital Symmetry*, Verlag Chemie, Weinheim/Bergstr., Germany, and Academic Press, New York, 1970.

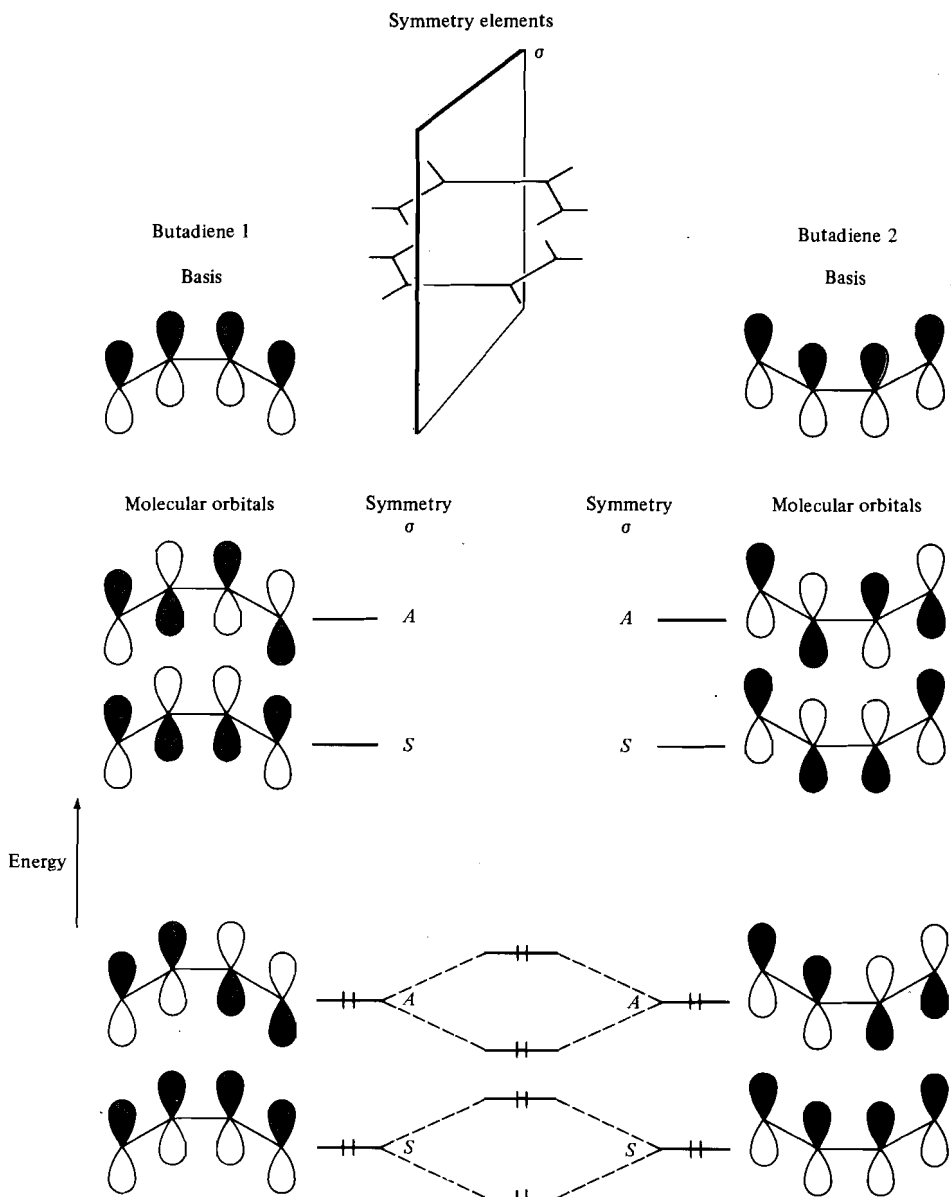
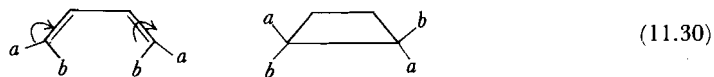
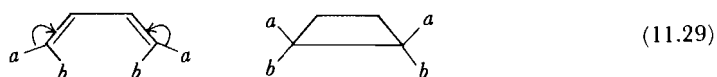

Figure 11.5 The approach of two butadiene molecules. The symmetries do not permit HOMO-LUMO interaction; the interaction between filled levels, permitted by the symmetry, gives no stabilization.

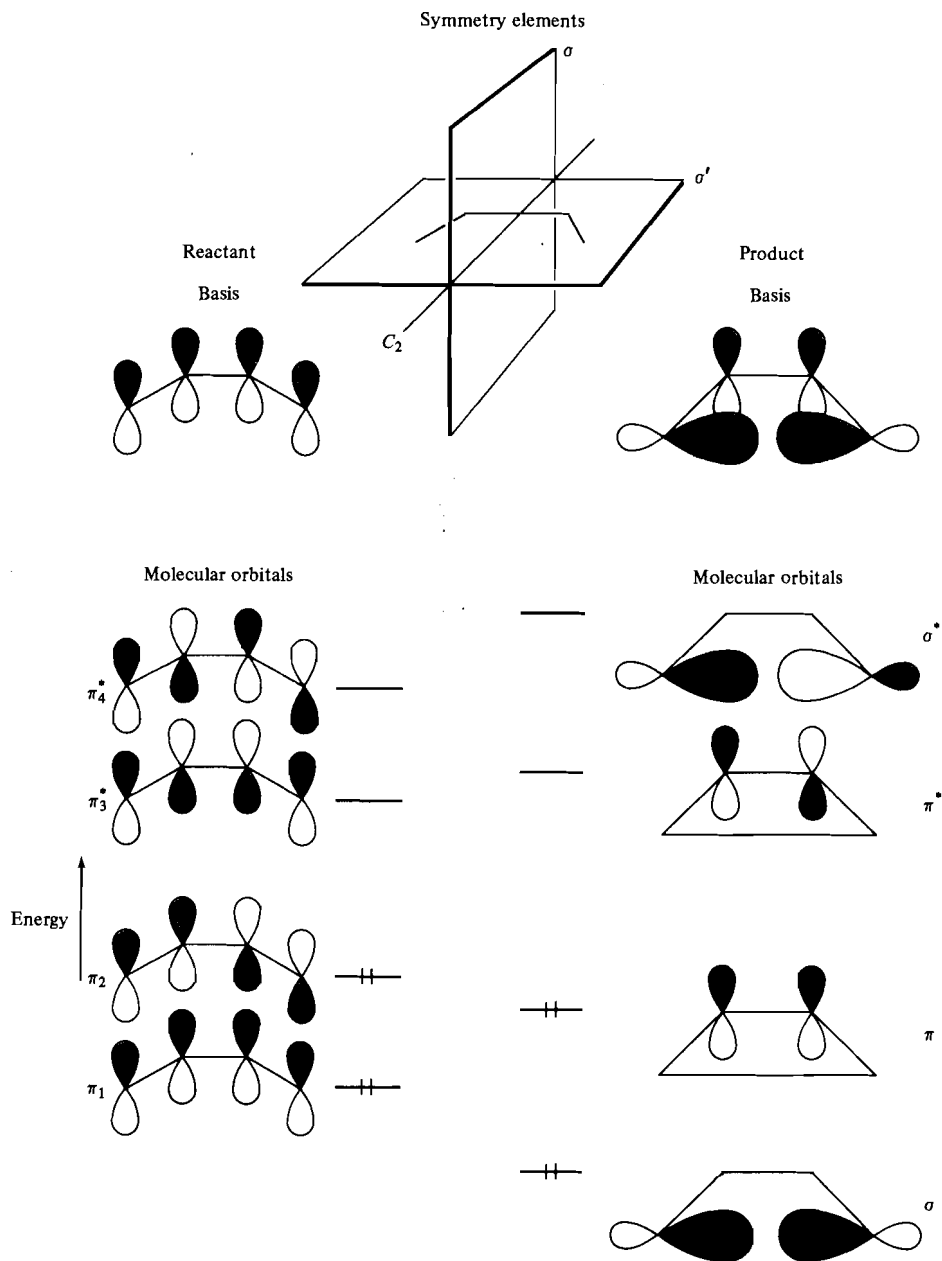

Figure 11.6 The orbitals of reactants and products in electrocyclic ring closure of butadiene.

The reacting orbital system needed to include all the bonds being formed or broken is made up in the reactant from a basis consisting of a p orbital on each of the four carbon atoms, and in the product of p orbitals on each of the two π bonded carbons and a hybrid orbital, approximately sp^3 , on each of the two carbons linked by the newly formed σ bond. Figure 11.6 illustrates the basis functions and the molecular orbitals that arise from them.

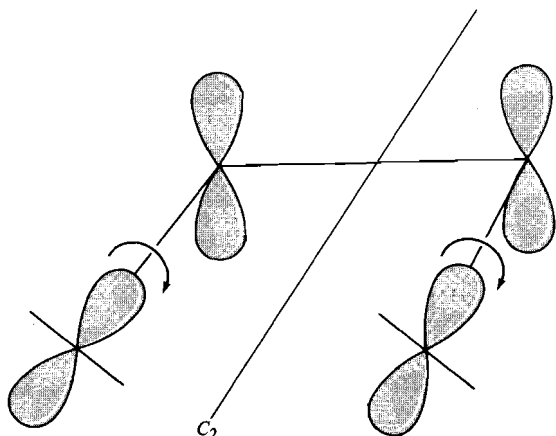

Figure 11.7 Symmetry at an intermediate stage of the conrotatory closure. Only the C_2 axis remains as a symmetry element.

Consider now the changes that will occur when a conrotatory ring closure takes place. Figure 11.7 shows that as soon as the end carbons of the diene begin their rotation, the symmetry of the reacting orbitals changes. The two mirror planes are no longer present, and only the C_2 axis remains. We now wish to follow the molecular orbitals through the transformation using the principle that a molecular orbital *maintains its symmetry* during a bonding reorganization.

Figure 11.8 reproduces the important molecular orbitals and classifies them according to their symmetry with respect to the C_2 axis, the element that defines the local symmetry during the conrotatory process. Orbital π_1 , antisymmetric under C_2 , must change continuously into an orbital of the product in such a way as to remain at all stages antisymmetric under the C_2 operation.

In Figure 11.8, and in subsequent energy-level diagrams we shall construct, the relative energies of reactant and product levels are represented only schematically. One cannot deduce from diagrams of this type the overall thermochemistry of the reaction.

The symmetry conservation principle allows us to reconstruct qualitatively how the orbital π_1 will change.¹⁸ Since it starts out antisymmetric under C_2 , it remains so; it can do this only if it ends up as an antisymmetric orbital of the product, say π (Figure 11.8). As the two end carbons rotate, the contribution of the p orbitals on those end carbons must decrease, finally to disappear altogether. Similarly, in π_2 , the contribution of the two central p orbitals will decrease, leaving only the end two, which will have rotated onto each other to yield the product σ orbital. The changes in the antibonding orbitals may be visualized in a similar way.

The lines joining reactant and product orbitals in Figure 11.8 are referred to as *correlation lines*, and the entire diagram is an *orbital correlation diagram*. It will be noted that since there are two orbitals of each symmetry type on each side, there is an alternative way the correlation might have been made, namely π_1 to σ^* , π_2 to π^* , π_3^* to π , π_4^* to σ . This alternative is eliminated by the non-crossing rule: *Orbitals of the same symmetry do not cross*.

¹⁸ Woodward and Hoffmann, *The Conservation of Orbital Symmetry*, p. 41.

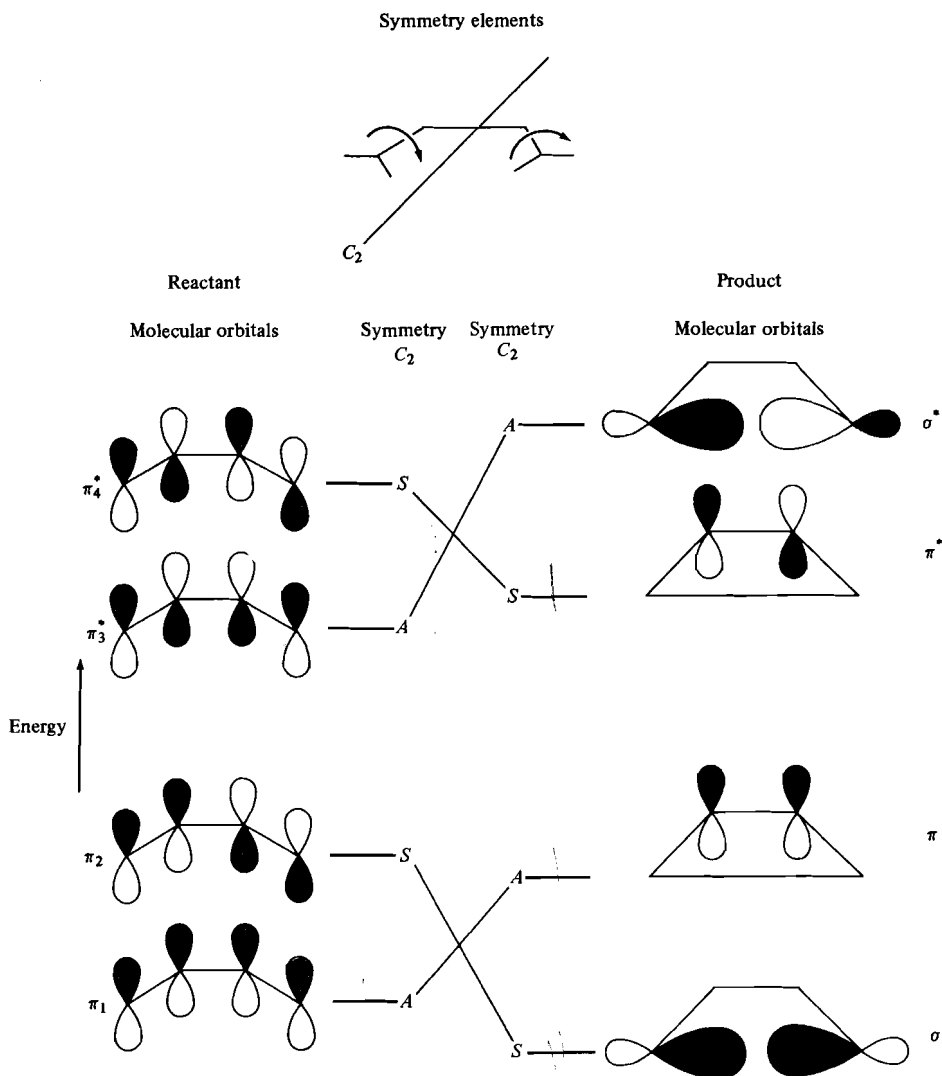

Figure 11.8 Classification of the reacting molecular orbitals of butadiene and cyclobutene for the conrotatory process. Symmetry classifications are with respect to the C_2 axis, S indicating symmetric and A antisymmetric orbitals. The correlation lines are obtained by connecting orbitals of the same symmetry.

Because the noncrossing rule is of fundamental importance to the construction of correlation diagrams, we digress a moment to give a justification for it. We have already seen in Section 10.1 that orbitals of the same symmetry interact in such a way as to push the lower-energy one still lower and the higher-energy one still higher, and that the interaction is stronger the closer the two are in energy. If two orbitals of the same symmetry were to approach each other in energy, the interactions would therefore tend to keep them apart and prevent the lines from crossing. The noncrossing rule does not apply to orbitals of different symmetries, because they do not interact. Hence correlation lines representing orbitals of different symmetry may cross.

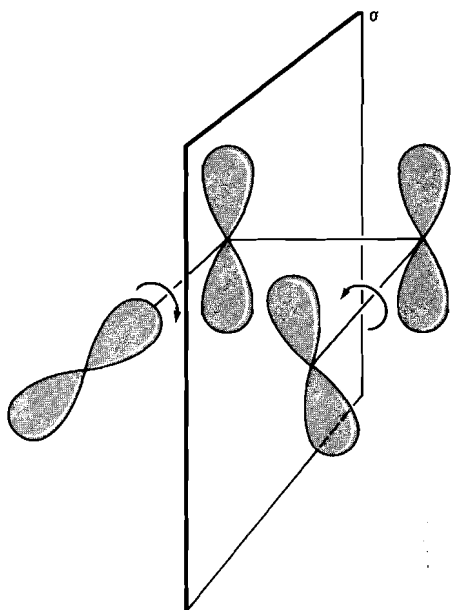

Figure 11.9 Symmetry at an intermediate stage of the disrotatory closure. Only the mirror plane σ remains as a symmetry element.

Although the noncrossing rule may in many instances be relied upon to determine the correlation pattern where alternatives exist, it is not infallible. In order to avoid difficulties in constructing correlation diagrams, Woodward and Hoffmann cite three precautions that should be observed.¹⁹

1. Processes that are inherently independent must be considered separately even if they occur in the same molecule.
2. Each reacting system must be reduced, by removing substituents and distortions, to its highest inherent symmetry.
3. Symmetry elements used in the analysis must bisect bonds made or broken in the reaction.

Having obtained the orbital correlation diagram for the butadiene closure, we can now see that the electron pairs that start out in bonding orbitals of the reactant are transformed without encountering any energy barrier to product bonding orbitals. The process is said to be symmetry *allowed*. This principle lies at the heart of the theory of orbital symmetry control of reaction path: *A reaction is allowed in the ground state only when all reactant bonding electron pairs are transferred without symmetry-imposed barrier to bonding orbitals of the product.*²⁰

The Disrotatory Electrocyclic Reaction

We turn now to the disrotatory closure. The orbitals in reactants and products are the same as before, but this time it is the mirror plane σ (Figure 11.9) that is maintained throughout. Figure 11.10 shows that the symmetry dictates correlation of a bonding to an antibonding orbital; the electron pair in orbital π_2 , if it remained in its original orbital, would end up in the high energy level

¹⁹ Woodward and Hoffmann, *The Conservation of Orbital Symmetry*, p. 31.

²⁰ See note 18, p. 584.

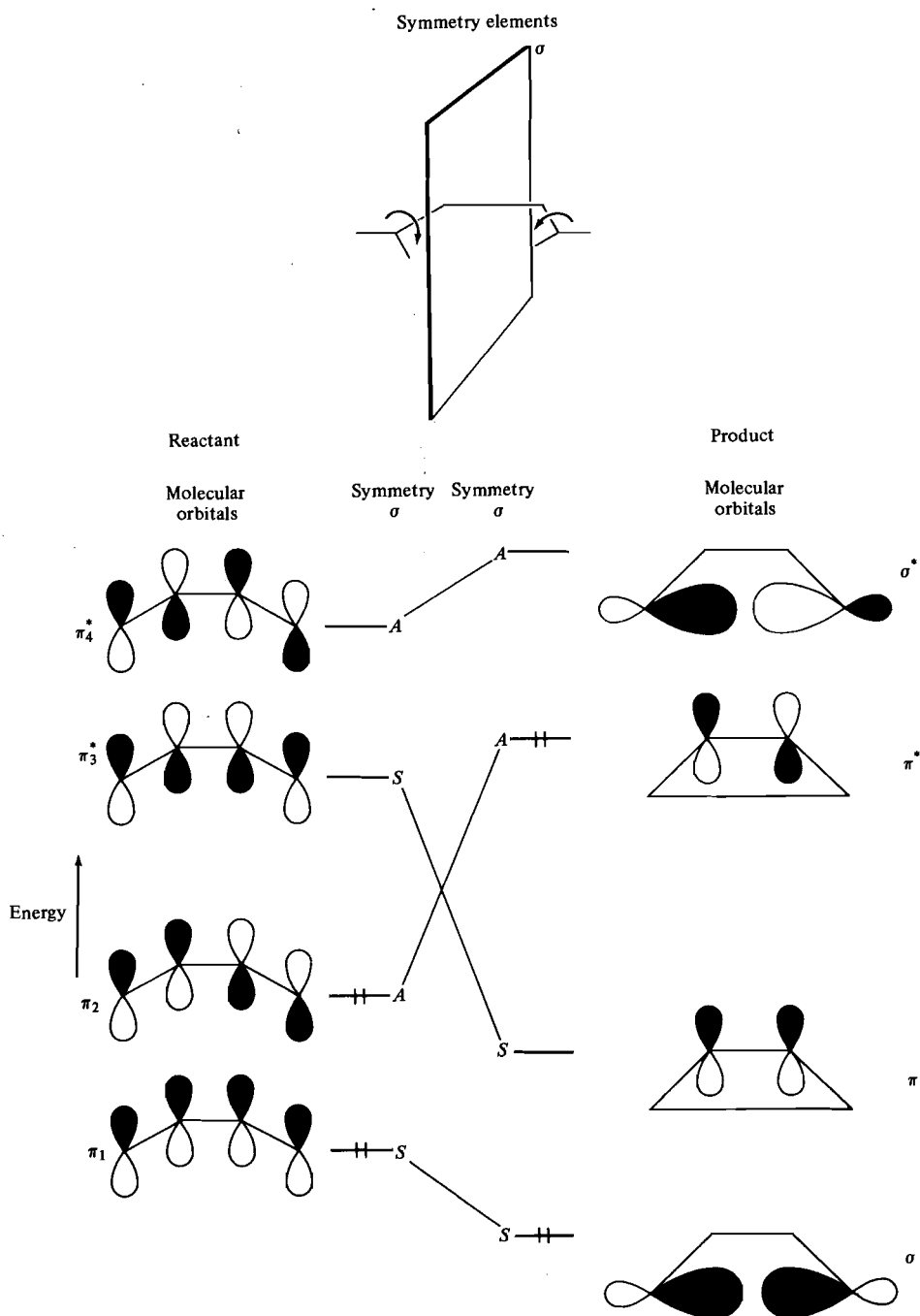

Figure 11.10 Symmetry classification and correlation of orbitals for the disrotatory closure of butadiene. Closure with electron pairs remaining in their original levels would lead to the excited state indicated by the orbital occupancy on the right.

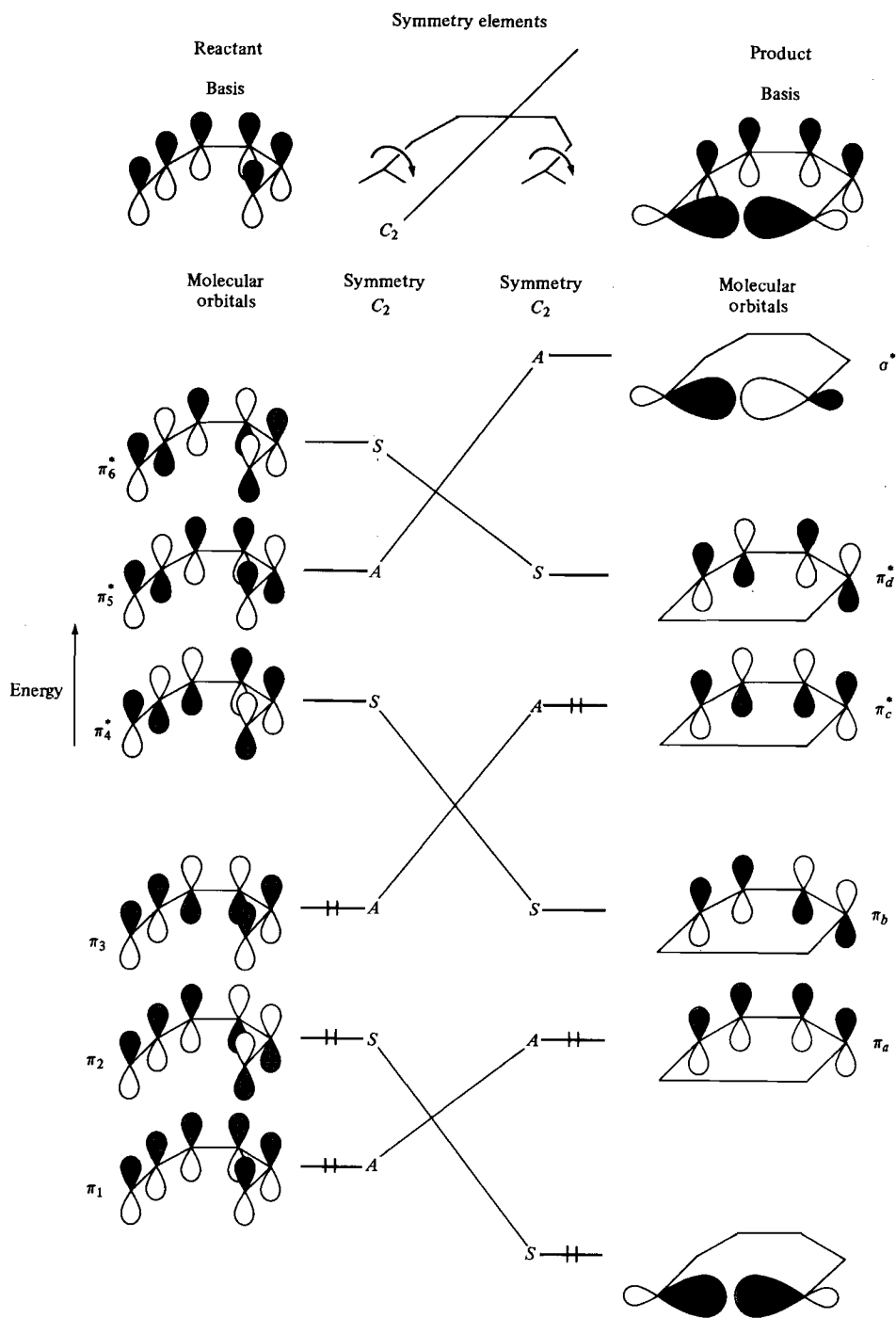

Figure 11.11 Correlation diagram for the forbidden conrotatory closure of hexatriene.

π^* of the product, a process that would require a large energy input. A similar situation would arise in the reverse reaction starting from ground-state cyclobutene, levels σ and π occupied. In this case, then, the symmetry imposes a sizeable barrier, and the reaction is said to be *forbidden*.

There are two aspects of the use of the terms allowed and forbidden in this context that should receive some amplification. First, a symmetry allowed reaction will not necessarily take place with low activation energy. Other requirements, such as ease of approach, favorable overlap of orbitals, and steric interactions, may well combine to impose a substantial activation barrier where none is predicted on the basis of symmetry alone. Moreover, favorable arrangement of orbital energy levels may permit a forbidden reaction to occur more readily than might have been expected. Second, the symmetry rules are based on the assumption that the reactions are concerted. There are always available nonconcerted pathways going through ionic or radical intermediates; a test of the orbital symmetry predictions can be made only if all the bonding changes occur together.

It is instructive now to turn to the correlation diagrams in Figures 11.11 and 11.12 for conrotatory and disrotatory closure of hexatriene, a six π electron system. The disrotatory mode is now allowed, the conrotatory forbidden. If correlation diagrams for larger systems are constructed, it will be found that with each addition of two carbons and an electron pair the predicted selectivity will reverse.

Reactions of Electronic Excited States

The correlation for a forbidden reaction shows a bonding orbital (usually the highest occupied) correlating to an antibonding one (usually the lowest unoccupied). If absorption of a quantum of light of a suitable frequency raises the reactant to its lowest electronic excited state, the orbital occupancy will be as indicated in Figure 11.13. Now as one electron goes up in energy another comes down; correlation (assuming no switching of orbitals by the electrons) is directly to a product state of comparable energy to the starting state and the process should be allowed. Inspection of Figure 11.8 or 11.12 indicates, moreover, that an electronic ground state allowed process should be forbidden in the excited state because the lowest-energy excited state of reactants correlates to a more highly excited state of products. The orbital symmetry rules therefore predict reversal of the allowed or forbidden nature of a given process in the lowest excited state. A word of caution is necessary here. Chemistry of electronic excited states is complex and less well understood than that of ground states. The simple correlation diagrams we have been using are inadequate for describing excited states in detail, and the predictions are less reliable than for ground-state reactions.

Cycloaddition

In Section 11.1 (p. 570) we pointed out that a compound may enter into a cycloaddition in either of two ways, suprafacial or antarafacial. Here we shall construct correlation diagrams for the simple $\pi 2s + \pi 2s$ and $\pi 2s + \pi 4s$ additions.²¹

²¹ R. Hoffmann and R. B. Woodward, *J. Amer. Chem. Soc.*, **87**, 2046 (1965), and Woodward and Hoffmann, *The Conservation of Orbital Symmetry*.

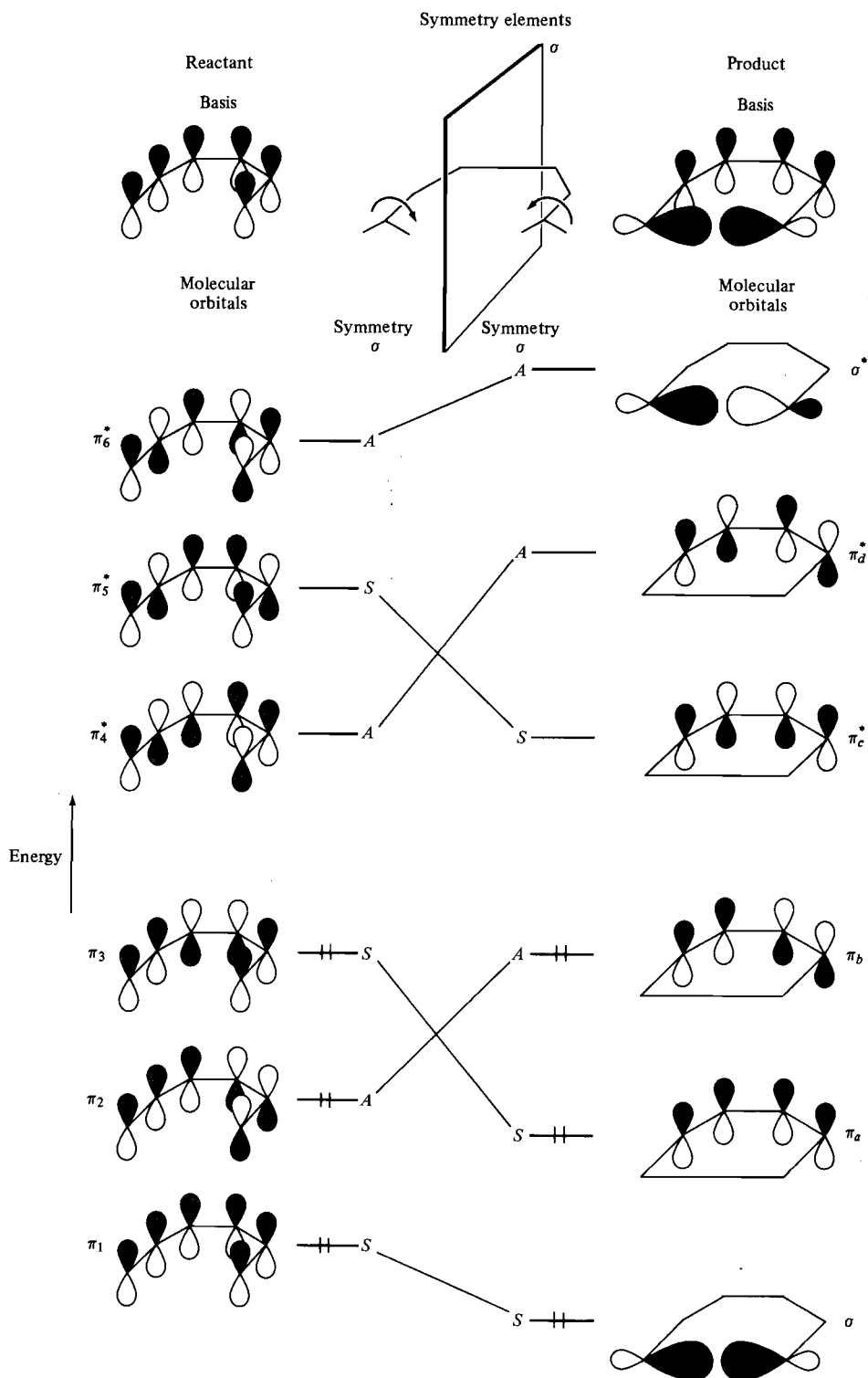

Figure 11.12 Correlation diagram for the allowed disrotatory closure of hexatriene.

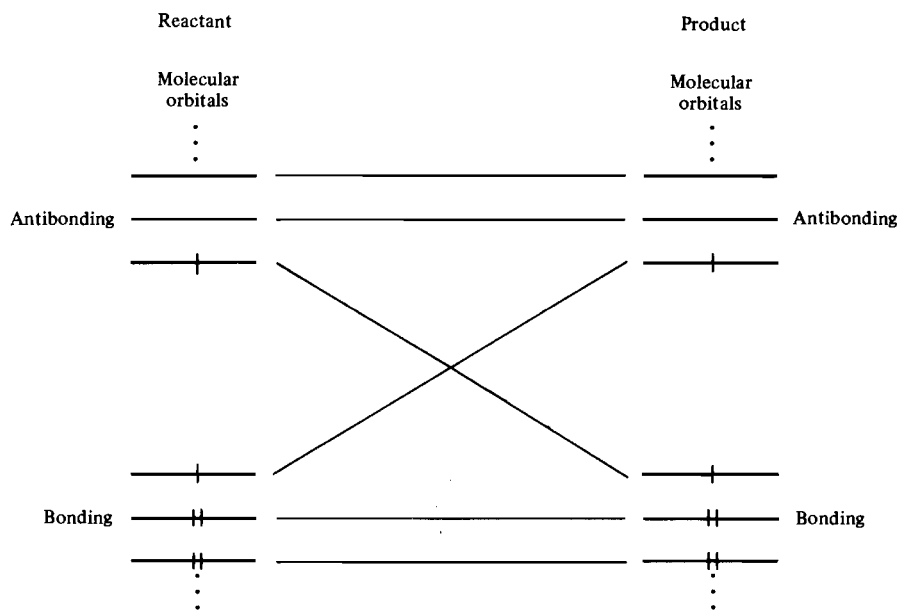

Figure 11.13 Preliminary excitation allows a process forbidden in the ground state.

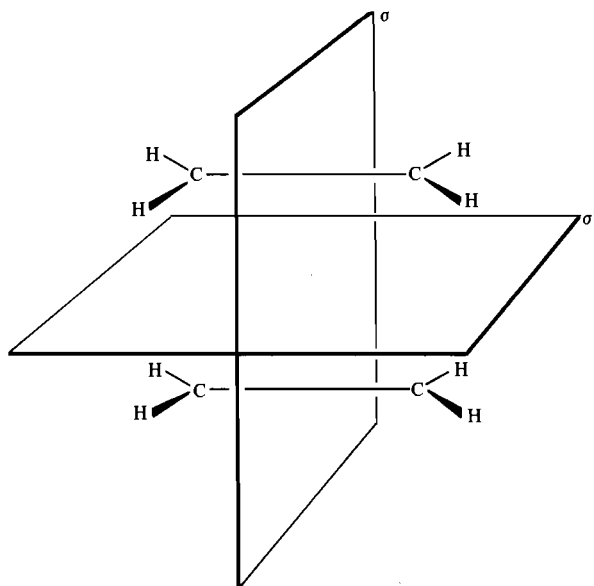

Figure 11.14 Symmetry elements for the suprafacial approach of two ethylene molecules.

Figure 11.14 illustrates the symmetry appropriate to the all-suprafacial approach of two ethylenes. We have followed Rule 3 of p. 586 in singling out for attention the symmetry elements that bisect reacting bonds. We have not included others, such as a C_2 axis passing midway between the two molecules perpendicular to the page, that do not. (These symmetry elements not bisecting reacting bonds could be included without affecting the outcome of the analysis.)

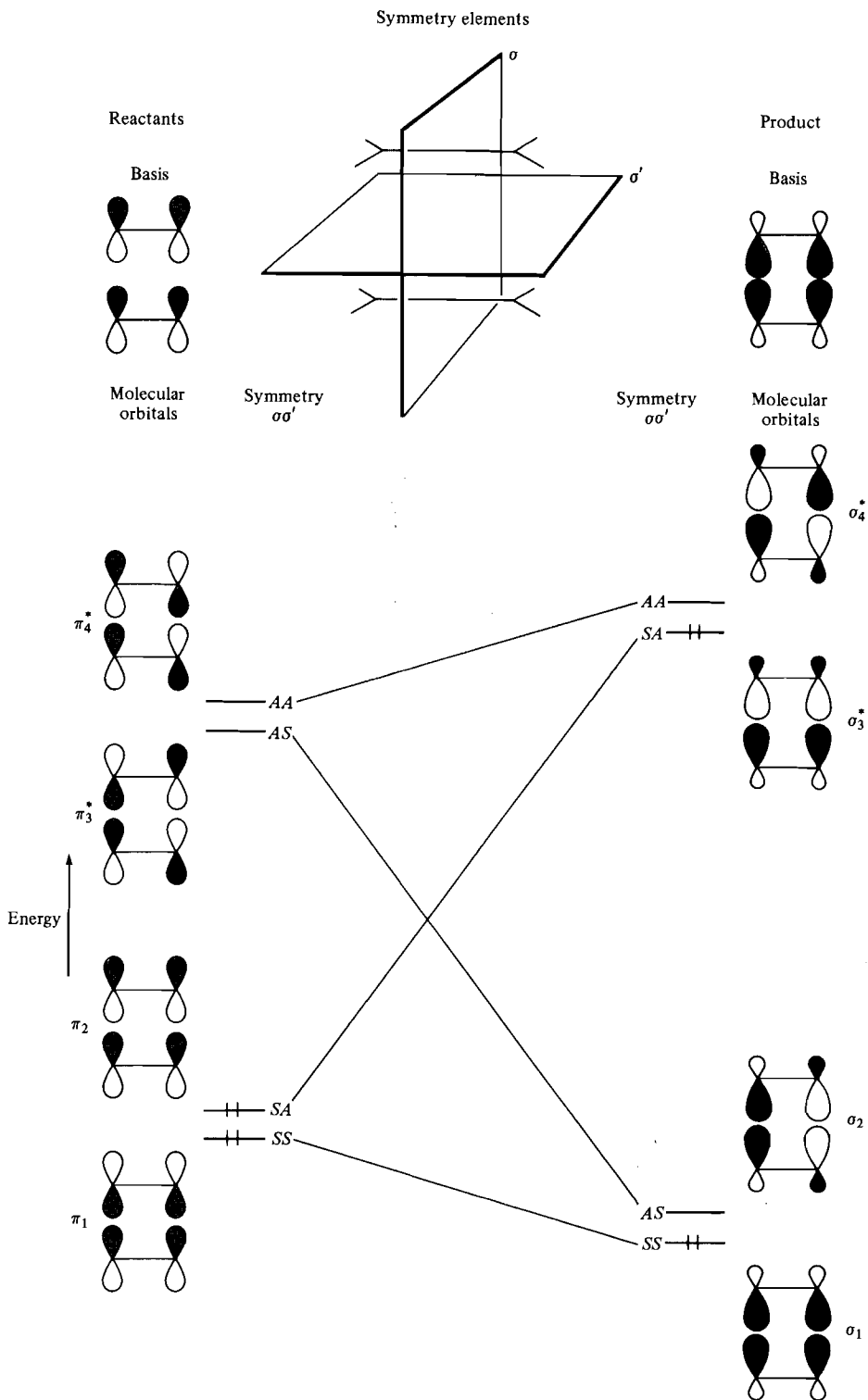

Figure 11.15 Orbitals and orbital correlations for the ground-state $\pi 2s + \pi 2s$ cycloaddition.

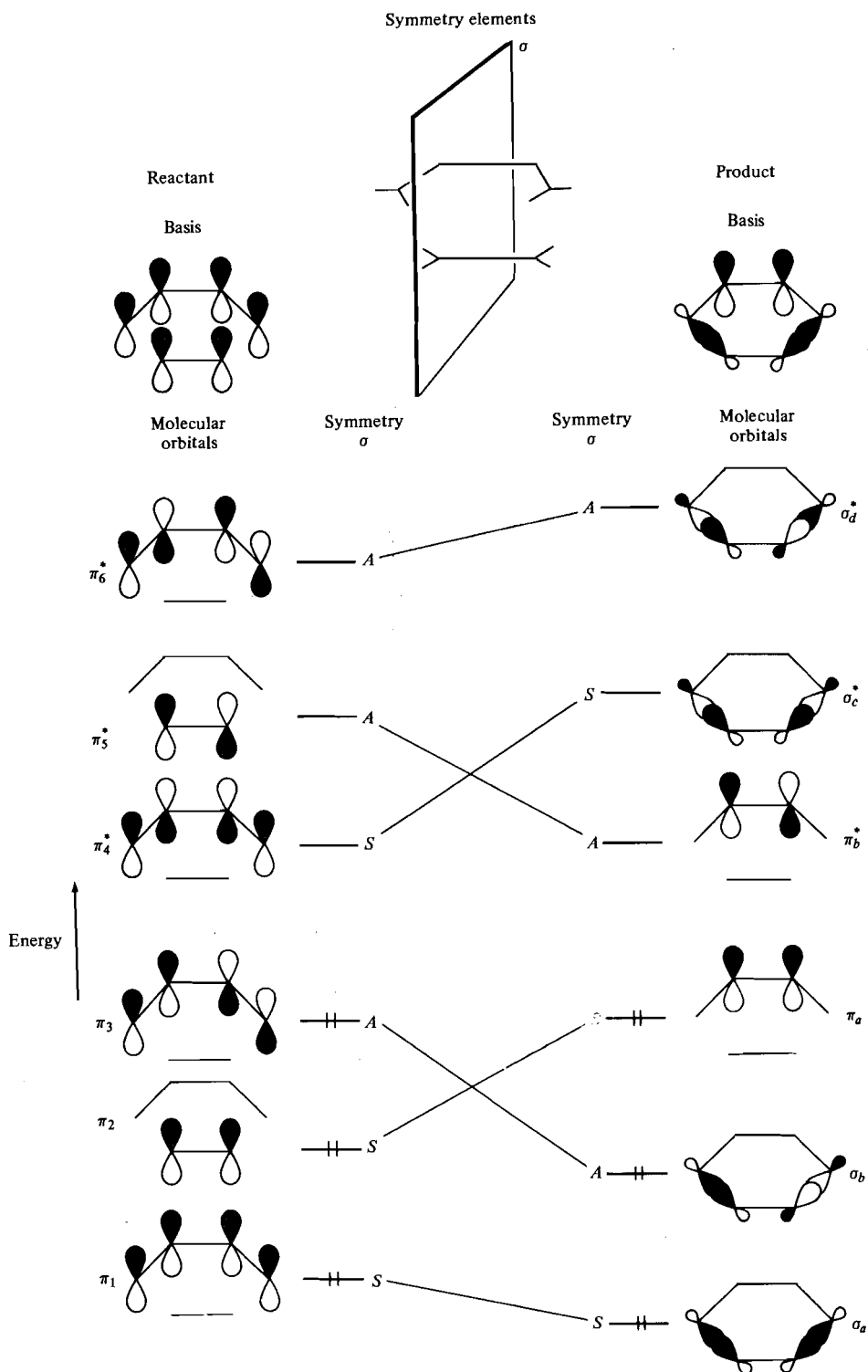

Figure 11.16 Symmetry, basis orbitals, and correlation diagram for the $\pi 2s + \pi 4s$ cycloaddition. Symmetry classifications are with respect to the mirror plane illustrated.

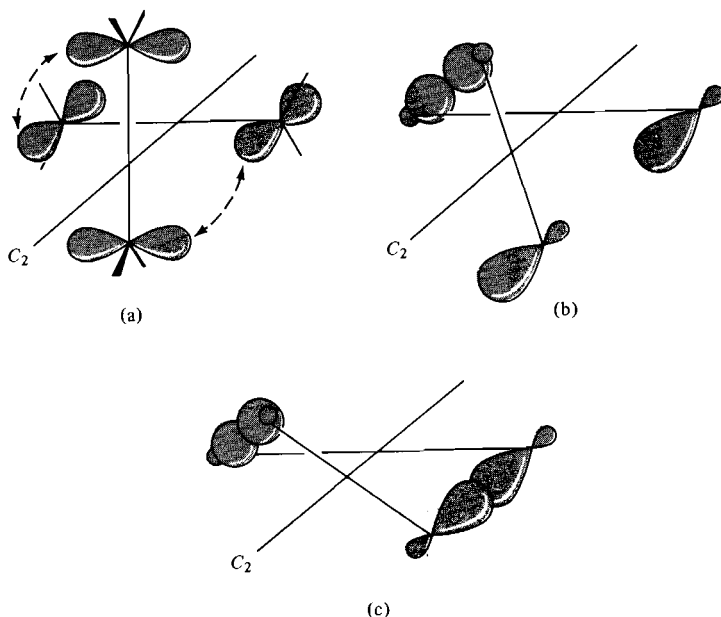

Figure 11.17 The geometry of approach for the $\pi 2s + \pi 2a$ cycloaddition. A C_2 axis of rotation is maintained throughout.

There is danger of error only when such elements are used exclusively.) The atomic orbital basis consists of a p function on each of the four carbon atoms; Figure 11.15 illustrates these orbitals and the derived symmetry correct orbitals. As a result of the reflection plane that carries one ethylene into the other, these molecular orbitals are delocalized over both molecules. Figure 11.15 also shows the orbitals of the product; we consider only the two C—C σ bonds formed and ignore the other two, which were present from the beginning and did not undergo any change.

When the two ethylene molecules are far apart, orbitals π_1 and π_2 are essentially the bonding π orbitals, and will therefore each be occupied by an electron pair if both ethylenes are in their ground states. As the molecules approach, the intermolecular interaction of one of these orbitals is antibonding. One electron pair therefore finds itself in an orbital that is increasing in energy, and would, if it remained in that orbital throughout, end up in one of the σ^* orbitals of the product to yield the excited state indicated on the right in the diagram. The pattern is the one we associate with a ground-state forbidden process.

The situation is reversed for the $\pi 2s + \pi 4s$ addition. Figure 11.16 illustrates this case; now the bonding orbitals all transform directly to bonding orbitals of the product and there is no symmetry-imposed barrier. As with the electrocyclic processes, the correlation diagrams illustrate clearly the reason for the striking difference observed experimentally when the number of electrons is increased from four to six. The reader may verify that the $4s + 4s$ reaction will be forbidden. Each change of the total number of electrons by two reverses the selection rule.

Figure 11.17 shows the geometry for a $\pi 2s + \pi 2a$ addition. The correlation diagram presented in Figure 11.18 shows that the change of one component to the antarafacial mode of addition has caused a change from forbidden to allowed. When both ethylene units enter in the antarafacial manner (Figures 11.19 and

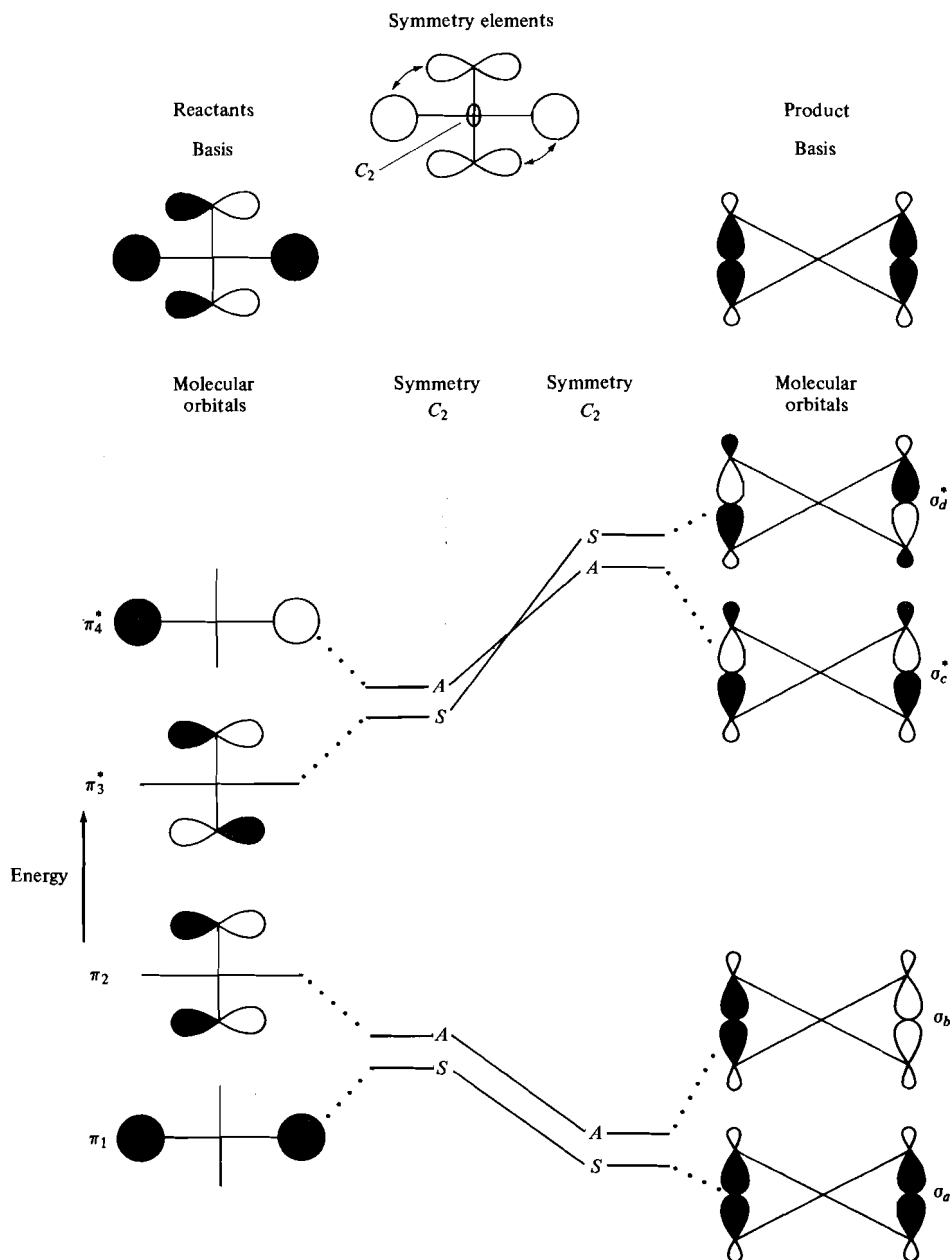

Figure 11.18 Basis orbitals and orbital correlation diagram for the $\pi 2s + \pi 2a$ cycloaddition. Reactants are arranged as in Figure 11.17a, with p orbitals on the nearer ethylene unit seen end-on. The product is in the configuration of Figure 11.17c.

11.20), the reaction is again forbidden. It may be seen that a cycloaddition of two molecules will be allowed in the ground state when the total number of electrons is $4q + 2$, $q = 0, 1, 2, \dots$, if both components are suprafacial or both antarafacial

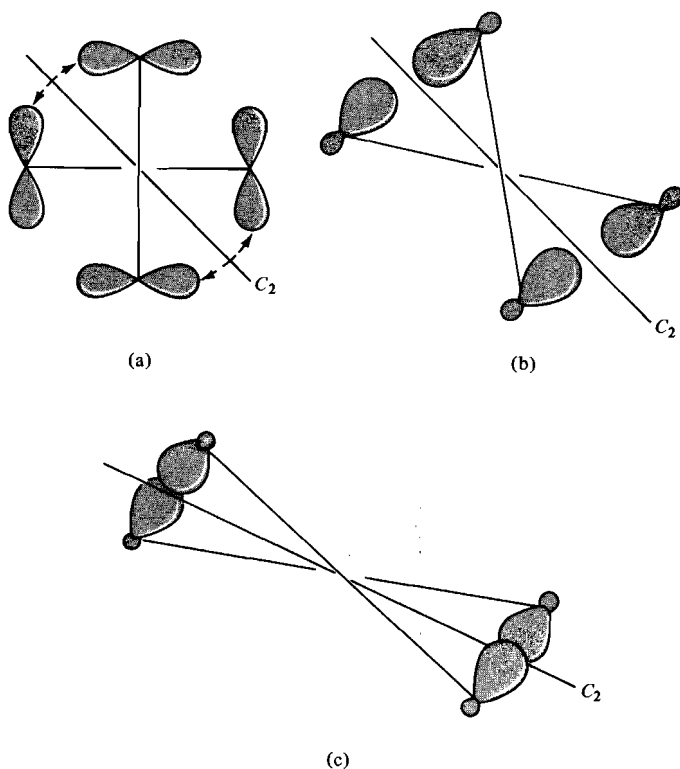

Figure 11.19 The geometry of approach for the $\pi 2a + \pi 2a$ cycloaddition. The C_2 axis is midway between the two molecules.

facial, and when the total number of electrons is $4q$, $q = 0, 1, 2, \dots$, if one component is suprafacial and one antarafacial.

11.4 INTERACTION DIAGRAMS AND THE GENERALIZED WOODWARD-HOFFMANN PERICYCLIC SELECTION RULES

Having described by means of correlation diagrams the nature of forbidden and allowed reactions of two particular pericyclic types, we wish to develop a notation that will permit us to state a generalized *selection rule* summarizing the conclusions of the pericyclic theory.

Local Symmetry and Interaction Topology

We have taken care to emphasize in the discussion that the important symmetry is the local symmetry of the part of the molecule actually involved in the reaction. We have already given in Section 11.1 a justification for this course; another example is appropriate here, now that we have gained an appreciation of the role of orbital symmetry in pericyclic reactions. In Equation 11.31, the substitu-

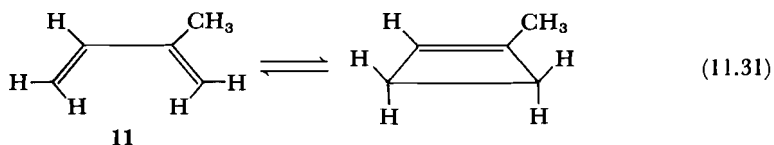

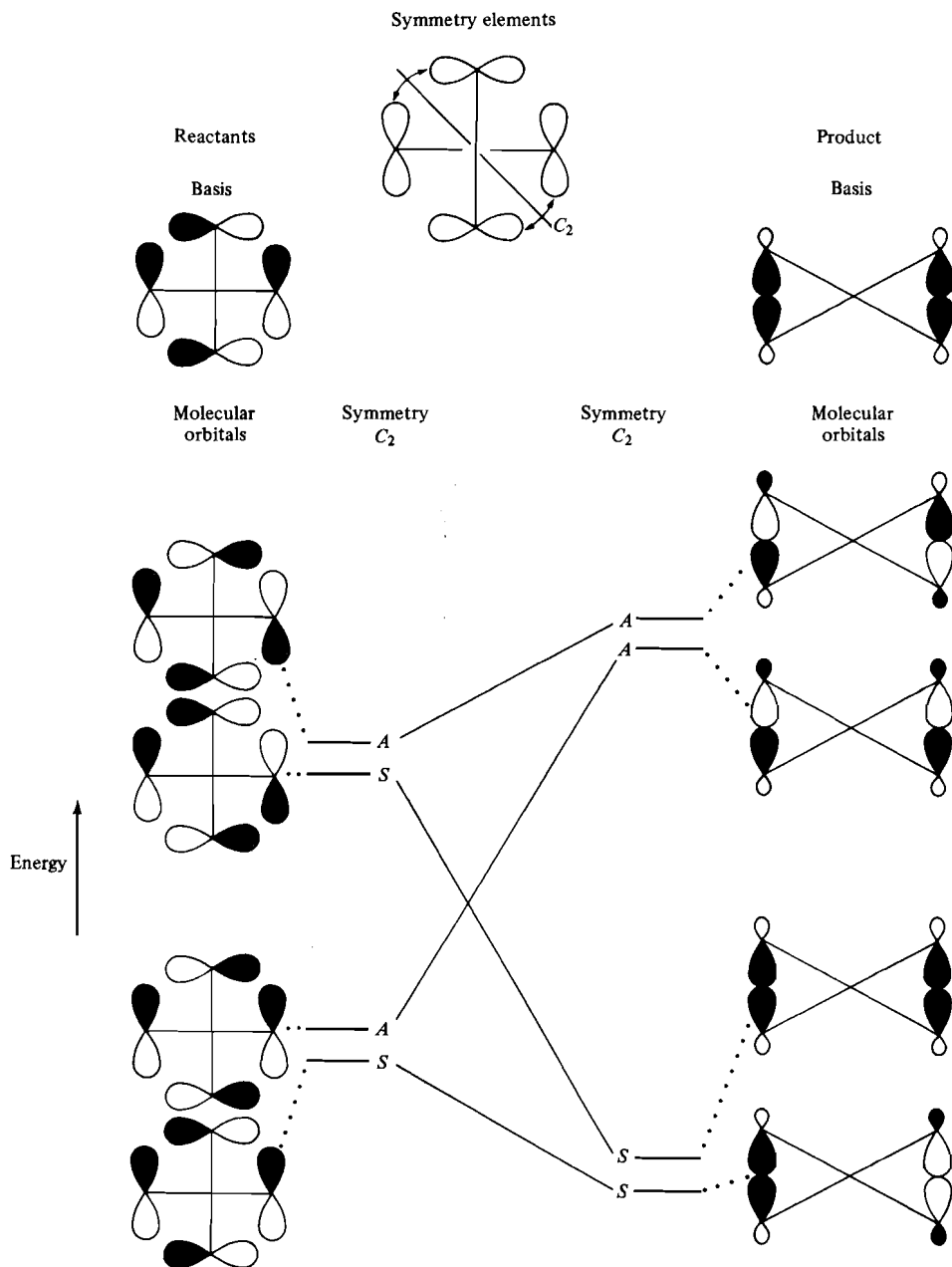

Figure 11.20 Basis orbitals and orbital correlation diagram for the $\pi 2a + \pi 2a$ cycloaddition.

tion of a methyl for one hydrogen on the diene **11** destroys the symmetry. Now a mirror plane reflection (for disrotatory closure) or twofold rotation axis (for conrotatory closure) is no longer a symmetry operation. No symmetry element remains to provide a distinction among different orbitals.²² Yet we know from

²² The identity operation, which is a symmetry operation for any object, is present, but since all orbitals are symmetric with respect to it, it does not distinguish among orbitals.

the success of π electron and localized bonding pictures of molecules that the methyl group should have at most a secondary influence. It is clearly the topology of the interactions among the basis orbital functions that should determine the course of the reaction. The inherent symmetry of this topology, shorn of minor disturbances by substituents or by distortion, is the symmetry with which we need be concerned. The examples we have used to illustrate the ideas of orbital symmetry control serve a useful function because they allow us to visualize that inherent symmetry in terms of the molecule as a whole. But we can as well abstract the essential features of the pattern of orbital interaction by discarding altogether the molecular framework and keeping only the pericyclic reacting orbitals. This argument justifies the Woodward and Hoffmann stipulation (p. 586) that a pericyclic process must be reduced to its highest inherent symmetry for analysis.

Interaction Diagrams

In order to develop this idea further, we adopt an approach similar to that of Dewar²³ and introduce the *orbital interaction diagram* as a topological notation for paths of interaction amongst basis orbitals in pericyclic processes. We depict an orbital system by a schematic drawing of the basis orbitals, and use a short curved line to indicate interaction between two orbitals. When we wish to distinguish interactions present in starting materials from those in products, we use dotted lines for the former and solid lines for the latter; we call such a picture a *directed orbital interaction diagram*, or, more briefly, a *directed diagram*. When the distinction is unimportant, solid lines serve throughout and the result is the *orbital interaction diagram* or, more simply, the *interaction diagram*. A closed loop of interconnected orbitals then symbolizes the pericyclic process. By way of example, Structure **12** shows the ethylene π bond in this convention; **13** would be hexa-

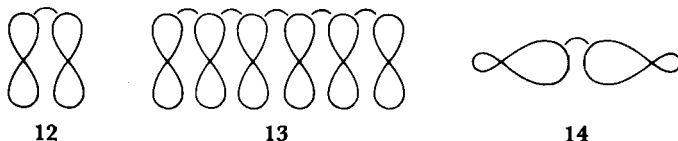

triene; **14** a σ bond between two centers.²⁴ We note first that the arrangement of orbitals and their orientations are unimportant; we assume that we have examined the structures of reactant and product and have determined which basis orbitals to use and what the significant interactions are; thenceforth we need maintain only the topology intact. Thus **15** and **16** are entirely equivalent to **14**;

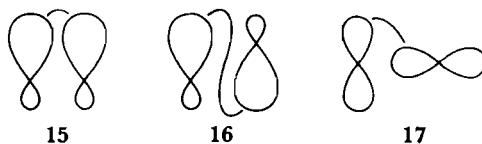

17 is equivalent to **12**. Second, it is clear that for a system of adjacent p orbitals in a π electron system, the interaction at the top lobe is equivalent to that at the bottom; we may therefore choose either for the orbital interaction diagram. For

²³ M. J. S. Dewar, *Angew. Chem. Int. Ed.*, **10**, 761 (1971).

²⁴ Shortly we shall modify the notation by indicating a choice of algebraic sign for the basis functions.

ethylene, we could equally use **18** as **12**; for hexatriene **19** would serve as well as **13**. For convenience, we shall ordinarily choose the connections in such a case

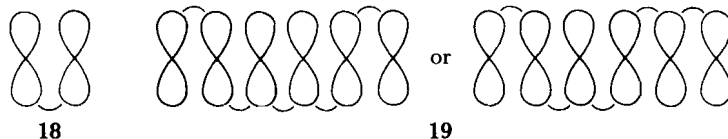

to be all on one face in the diagram. Third, we note that aside from the fact that interaction on the two faces is no longer the same, there is no fundamental topological difference between a π bond and a σ bond; hence the representations



15 and **20** for a σ bond are equivalent, and we may if we wish use the p orbital schematic for both hybrids and true p orbitals. Since at least some of the reacting orbitals ordinarily change from p to hybrid or vice versa, it will often be convenient to do this.²⁵ Before proceeding, it is important to understand that the interaction diagrams show *basis orbitals*, and *not* molecular orbitals. Recall also that the choice of signs of basis orbitals is arbitrary.

It remains to define in our notation the concept of suprafacial and antarafacial modes of addition. We first need to introduce the idea of a component, and a convention for choosing signs of basis orbitals. Recall that in setting up basis orbitals from which to construct molecular orbitals, the sign of each basis orbital function may be chosen independently of the others. Since our orbital interaction diagrams are of basis orbitals and not of molecular orbitals, we are free to attach signs to the orbitals in any way we wish. It is also clear that we are free to consider the conglomerate orbital interaction diagram as being made up of pieces of any size we wish. We therefore define a *component* as a noncyclic fragment that results from any arbitrary subdivision obtained from the interaction diagram by removing one or more of the interactions, and adopt the convention that basis orbital signs are always to be chosen in such a way that *the interaction path within the component connects only lobes of like sign*. We shall restrict this treatment to systems with an even number of electrons; we are therefore free to require that *the number of electrons a component carries is even*. With this definition, we may say that a suprafacial component is one that interacts with its neighbors through lobes at its ends that have the same algebraic sign, whereas an antarafacial component is one that interacts through lobes at its ends that have opposite signs. The topological equivalence of interactions involving orbitals of varying hybridization establishes that there is no fundamental difference among components of the three types, σ , π , and ω .

We are now in a position to designate in a compact way the essential features of pericyclic processes. The directed diagram **21**, for example, represents the $\pi 2s + \pi 4s$ process of Figure 11.16, where dotted and solid lines represent inter-

²⁵ No inconsistencies would arise even were we to put the interaction mark on the wrong face of the system (at the bottom in **15**).

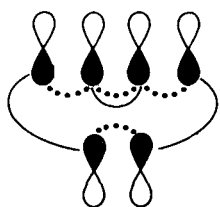

21

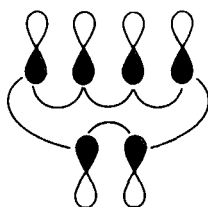

22

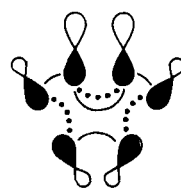

23

actions respectively in the reactants and product. We attach no special significance to a pair of orbitals that interact with each other in both reactant and product; the double interaction is replaced by a single line in the composite picture. The equivalent interaction topology, then, considering all interactions would be the interaction diagram **22**. Had we looked at the process in the other direction, as cleavage of cyclohexene, a $\sigma 2s + \sigma 2s + \pi 2s$ process, we would have arrived at **23**, clearly also equivalent to **22**. In **24**, two $\pi 2$ systems, considered

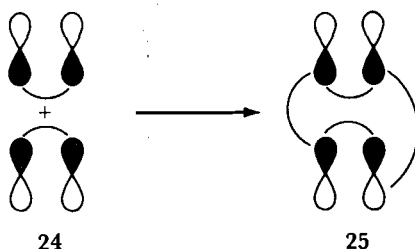

24

25

as components, interact in a suprafacial-antarafacial way to yield the interaction diagram **25** for the $\pi 2s + \pi 2a$ addition.

The interaction diagrams make clear the essential equivalence of the various categories of pericyclic processes discussed in Section 11.1. The $\pi 2s + \pi 2s$ cycloaddition **26** is topologically equivalent to the disrotatory electrocyclic closure of butadiene (**27**); the $\pi 2s + \pi 2a$ addition **28** is equivalent to the con-

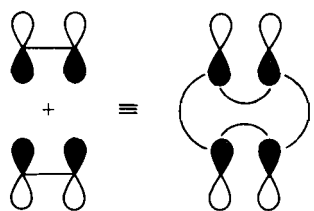

26

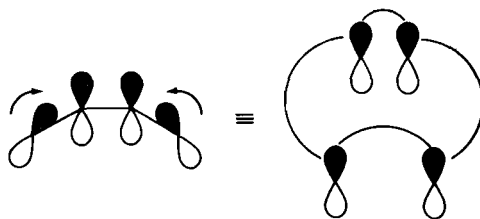

27

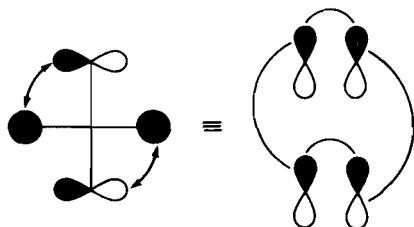

28

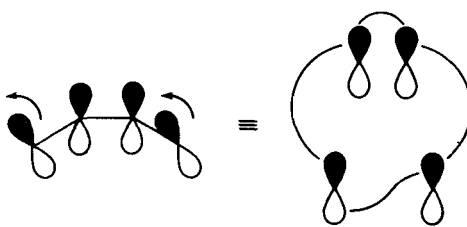

29

rotatory butadiene closure **29**, and to the [1,3] sigmatropic migration with inversion (Equation 11.32 and interaction diagram **30**). A group transfer elimi-

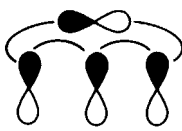
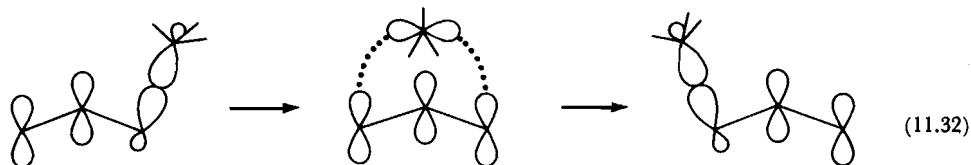

30

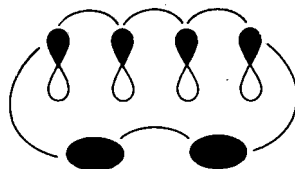

31

nation (Equation 11.33) is readily seen to be topologically equivalent to the $\pi 2s + \pi 4s$ process (**31**) and therefore allowed; the transfer in Equation 11.34 is equivalent to a $\pi 4s + \pi 4s$ cycloaddition (**32**) and therefore forbidden.

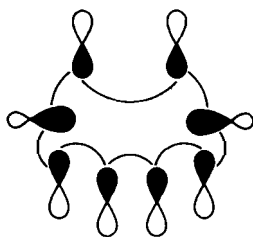
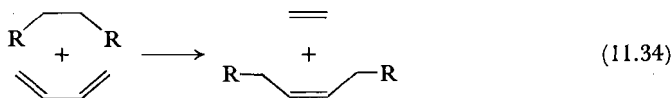

32

The conclusion we may draw from this analysis is that in pericyclic reactions of these kinds we shall always be able to discover the inherent symmetry of the interaction topologically by considering the system as being made up of suitable components, even when there is no actual symmetry maintained in the molecule as a whole. We shall therefore be able to analyze the situation in terms of the

symmetry correlations of the type we have already discussed for cycloadditions and electrocyclic reactions.

The Generalized Woodward–Hoffmann Pericyclic Selection Rules

The forbidden or allowed nature of the reaction will be determined by the suprafacial–antarafacial properties of the components and the number of electrons carried by each. We have seen that each addition of two electrons to the pericyclic ring reverses the selection rule, as does change of the faciality of a component. A generalized rule can thus be formulated in terms of the classification of the components according to two criteria: whether they are supra- or antarafacial, and whether they contain $4q + 2$ or $4r$ electrons, q and r being any integers including zero. Woodward and Hoffmann established in this way a general pericyclic selection rule:²⁶

A pericyclic reaction is allowed in the electronic ground state if the total number of $(4q + 2)s$ and $(4r)a$ components is odd.

A simplified statement of the rule is possible if the interaction diagram is *always* considered to be built from two-electron components, so that there are no components of the $(4r)$ type:

A pericyclic reaction is allowed in the electronic ground state if the number of suprafacial two-electron components is odd.

11.5 AROMATIC AND ANTIAROMATIC TRANSITION STATES

The appearance in the previous section of the $4q + 2$ and $4r$ formulas brings to mind the criteria for aromatic and antiaromatic systems discussed in Chapter 1. Furthermore, the HOMO–LUMO interaction patterns discussed in Section 11.2 are reminiscent of those used in Section 10.4 to analyze aromatic stabilization. In this section, we trace the connection between aromaticity and pericyclic reactions, and show how it leads to a third approach to the pericyclic theory.

The Relationship Between Aromaticity and Pericyclic Reactions

Returning to the interaction diagram for the ground-state allowed $\pi 2s + \pi 4s$ cycloaddition, **33**, we see immediately that it is equivalent to that (**34** or **35**) for

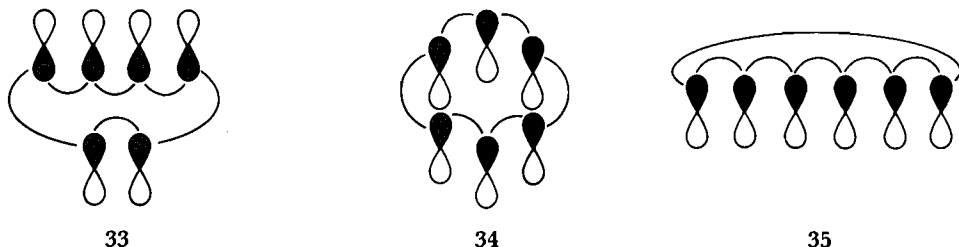

²⁶ Woodward and Hoffmann, *The Conservation of Orbital Symmetry*, p. 169. It is understood that reactions forbidden in the ground state are allowed in the excited state and vice versa.

the aromatic cyclic system of six p orbitals of the benzene π system. The diagram of the ground-state forbidden $\pi 2s + \pi 2s$ addition, **36**, is similarly equivalent to that for the antiaromatic cyclobutadiene (**37** or **38**). When we recall from the

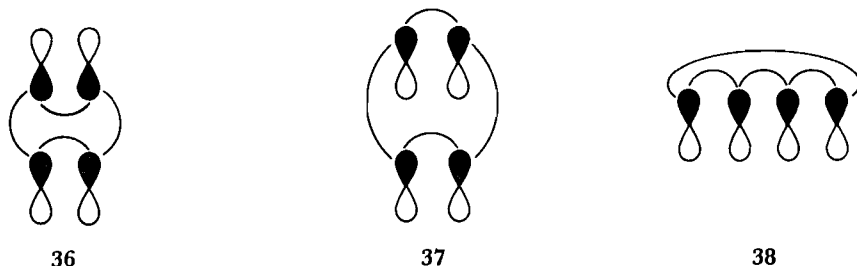

previous section that the allowed two-component suprafacial-suprafacial cycloadditions are those with a total of $4q + 2$ electrons and the forbidden ones are those with $4r$ electrons, it seems likely that there is a connection between the stability of a pericyclic transition state and the aromaticity or antiaromaticity of the topologically equivalent conjugated π electron system.

H. E. Zimmerman in 1966 was the first to apply these ideas to the formulation of pericyclic selection rules.²⁷ Later in the same year, Dewar²⁸ published a somewhat more general analysis, which introduced the topological approach we have adopted with minor variation in the preceding section. Dewar noted that the recognition of the connection between the pericyclic transition state and aromaticity actually originated in 1939 with M. G. Evans, who explicitly pointed out the analogy between the transition state of the Diels-Alder addition of ethylene to butadiene and the ground state of benzene.²⁹ The applicability of this concept to a wide variety of processes was, however, not apparent at that early date, and it was only after the pioneering work of Woodward and Hoffmann, which we have described in Section 11.3, that the full significance of Evans' ideas could be appreciated.

The work of Zimmerman and of Dewar also introduced another important concept, that of the *Möbius*, or *anti-Hückel*, ring. Craig in 1959 showed that the aromatic character of a ring with a given number of π electrons would change if the conjugated system included d orbitals.³⁰ He considered systems with an equal number of d and p orbitals, for example rings composed of alternating phos-

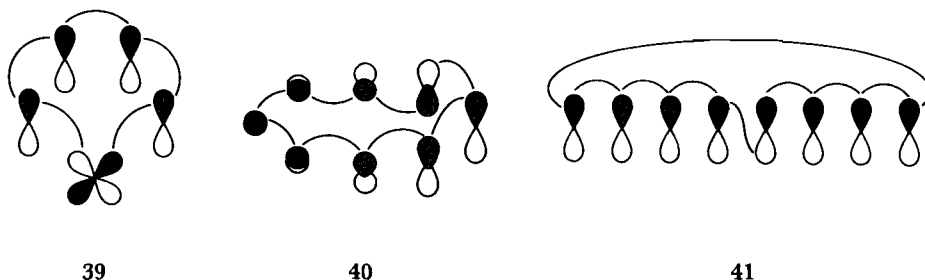

²⁷ (a) H. E. Zimmerman, *J. Amer. Chem. Soc.*, **88**, 1564, 1566 (1966); (b) H. E. Zimmerman, *Accs. Chem. Res.*, **4**, 272 (1971).

²⁸ (a) M. J. S. Dewar, *Tetrahedron Suppl.*, **8**, 75 (1966); (b) M. J. S. Dewar, *Angew. Chem. Int. Ed.*, **10**, 761 (1971).

²⁹ M. G. Evans, *Trans. Faraday Soc.*, **35**, 824 (1939).

³⁰ D. P. Craig, *J. Chem. Soc.*, 997 (1959).

phorus and nitrogen atoms; the point of importance to the present discussion can be illustrated more effectively with just one d orbital, in interaction diagram 39. Given the interaction pattern specified, no matter how the arbitrary phases of the basis orbitals are chosen, there will be somewhere in the ring an interaction between a positive and a negative lobe. Heilbronner pointed out that the same situation occurs in a singly twisted ring (40 or 41) containing only p orbitals.³¹ The topology is that of the Möbius strip, obtained by joining the ends of a strip containing a single twist. For the Möbius systems, if one ignores the loss of stabilization caused by the twisting, the Hückel $4n + 2$ rule is reversed: The twisted rings are aromatic for $4n$ and antiaromatic for $4n + 2$ electrons.³² We adopt Dewar's nomenclature and call the twisted rings *anti-Hückel* systems; rings of the ordinary untwisted variety we designate as *Hückel* systems.³³

The next step in the analysis is to provide an unambiguous method of recognizing systems of the Hückel or anti-Hückel type. We introduce first the idea of a *phase inversion*.³⁴ In the orbital interaction diagram, each interaction joining lobes of opposite sign constitutes a phase inversion. A change of sign *within* an orbital does not constitute a phase inversion. In 42, for example, there



is no phase inversion; in 43 there is one. Since the signs of the basis orbitals are arbitrary, whereas the interaction pattern is fixed by the geometry of the reacting system under consideration, it is clear that the number of phase inversions will depend upon the way in which we choose the basis orbital signs. We may, however, always make a new choice of basis signs if we wish. Suppose that we change the sign of one basis orbital. If there was initially a phase inversion between that orbital and one of its neighbors but none between it and its other neighbor, the phase inversion will merely be moved along the chain (44 \rightarrow 45;

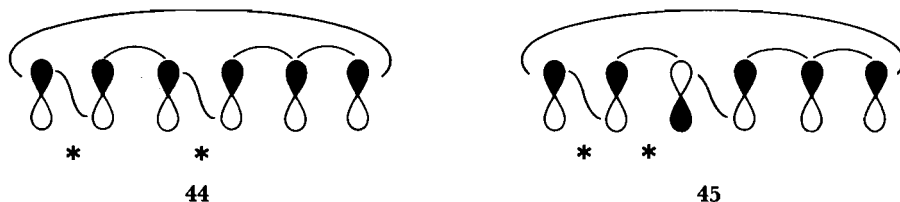

phase inversions marked by *). If there was initially no phase inversion to either neighbor, two new inversions are introduced (44 \rightarrow 46), and if there were initially two phase inversions, one to each neighbor, both will be removed (45 \rightarrow 47). It is thus always possible to make changes in the arbitrary choice of signs in such a way as to bring phase inversions to either side of a single orbital and annihilate them two at a time. Any system with an even number of phase inversions is

³¹ E. Heilbronner, *Tetrahedron Lett.*, 1923 (1964).

³² See note 27, p. 603, and note 28, p. 603.

³³ See note 28(b), p. 603.

³⁴ See note 28, p. 603.

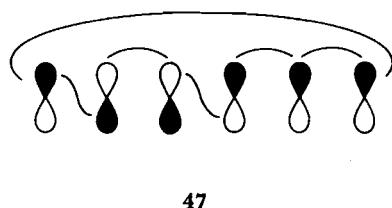
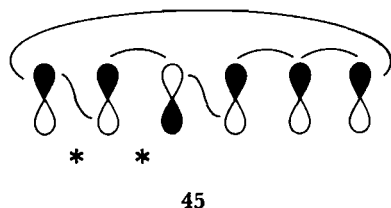
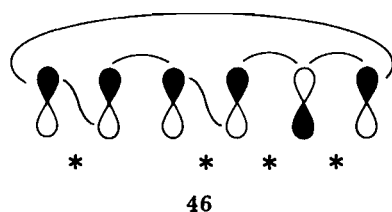
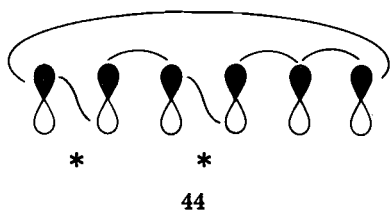

therefore equivalent to a system with none, whereas any system with an odd number of phase inversions is equivalent to a system with one. If we restrict our attention to single rings, there are thus only two types: those with an even number of phase inversions, which we define as Hückel systems, and which can always be formulated with no phase inversions, and those with an odd number of phase inversions, which we define as anti-Hückel systems, and which can always be formulated with one phase inversion.³⁵

We may now state an alternative to the Woodward–Hoffmann pericyclic selection rules. Recalling that an aromatic system is one that is stabilized compared with the open-chain analogue whereas an antiaromatic system is destabilized, we say that a pericyclic reaction will be allowed in the ground state whenever its interaction diagram is topologically equivalent to an aromatic system and forbidden when it is equivalent to an antiaromatic system. The Dewar–Zimmerman pericyclic selection rule follows: Pericyclic reactions proceeding through Hückel transition states are allowed in the electronic ground state when the total number of electrons is $4q + 2$; pericyclic reactions proceeding through anti-Hückel transition states are allowed in the electronic ground state when the total number of electrons is $4q$. Or, more succinctly:

Pericyclic reactions that pass through aromatic transition states are allowed in the ground state; those that pass through antiaromatic transition states are ground-state forbidden.³⁶

A brief comment is in order about the application of the aromatic principle to excited states. The individual orbitals are not as easily followed as they are with the Woodward–Hoffmann approach. Zimmerman has used the Hückel π electron method to trace levels through some representative processes;³⁷ the behavior is essentially the same as that found by Woodward and Hoffmann. The arguments about excited-state reactions that we made in the previous section therefore follow as well from the Dewar–Zimmerman formulation, and

³⁵ See note 28, p. 603.

³⁶ Dewar [note 28(b), p. 603] refers to this rule as the *Evans principle*.

³⁷ See note 27, p. 603.

one may say on the same grounds that Woodward and Hoffmann do that the rules will be reversed for excited states.³⁸

Further Applications of the Perturbation Theory to Pericyclic Reactions³⁹

In the Dewar–Zimmerman approach to the stabilization of pericyclic transition states, the basic criterion for deciding whether a process will be allowed or forbidden is whether the transition state is stabilized or destabilized, respectively, compared with an analogous open-chain system.⁴⁰ This criterion is, as we have noted above, the same as that for aromatic or antiaromatic character of a ground-state system; an important question is how best to apply it to a given situation. Zimmerman has shown stabilization and destabilization of pericyclic transition states by examining the π molecular orbitals in the Hückel approximation for various systems.⁴¹ Dewar has criticized this procedure on the ground that the Hückel method is known to give unreliable orbital energies;⁴² he recommends instead the use of perturbation theory.⁴³

Dewar's perturbation molecular orbital (PMO) method analyzes the interactions that take place on assembling p orbitals in various ways into chains and rings.⁴⁴ It is similar to the methods we have used in Section 10.4 in considering aromaticity, but lends itself better to a semiquantitative treatment. We shall nevertheless be concerned here only with the qualitative aspects of the theory as it applies to pericyclic transition states.

Dewar found that when one imagines a conjugated ring containing an even number of p orbitals to be constructed by joining a single carbon with a p orbital to the ends of a chain with an odd number of p orbitals, the perturbation theory gives a particularly simple result. We have already seen in Section 10.4 that chains with odd numbers of p orbitals have a nonbonding molecular orbital. This nonbonding MO will be at the same energy as the single orbital being added; the largest interaction will therefore be between these two orbitals of the same energy. The forms of the nonbonding orbitals are simple, and the energy change associated with the new interaction between the nonbonding MO and the single p orbital being added can be found easily in the Hückel molecular orbital approximation for union at one end or at both ends. In Dewar's method, the other interactions are neglected, since they are between orbitals of different energies and will therefore be smaller. Use of the approximate Hückel theory here is justified because the perturbation method calculates energy changes directly instead of finding them from differences between large and imprecisely

³⁸ R. C. Dougherty, *J. Amer. Chem. Soc.*, **93**, 7187 (1971) has argued that systems whose ground states are aromatic have antiaromatic excited states and vice versa, and that therefore the universal criterion for allowed pericyclic reactions, both ground and excited-state, is that the transition state be aromatic. The uncertainty of our present knowledge of excited states nevertheless indicates that the more restricted statement given here is to be preferred.

³⁹ For a review, see: W. C. Herndon, *Chem. Rev.*, **72**, 157 (1972).

⁴⁰ See note 28, p. 603.

⁴¹ See note 27, p. 603.

⁴² See note 28(a), p. 603.

⁴³ M. J. S. Dewar, *The Molecular Orbital Theory of Organic Chemistry*, McGraw–Hill, New York, 1969, chap. 6.

⁴⁴ (a) See note 43; (b) M. J. S. Dewar, *J. Amer. Chem. Soc.*, **74**, 3341, 3345 (1952).

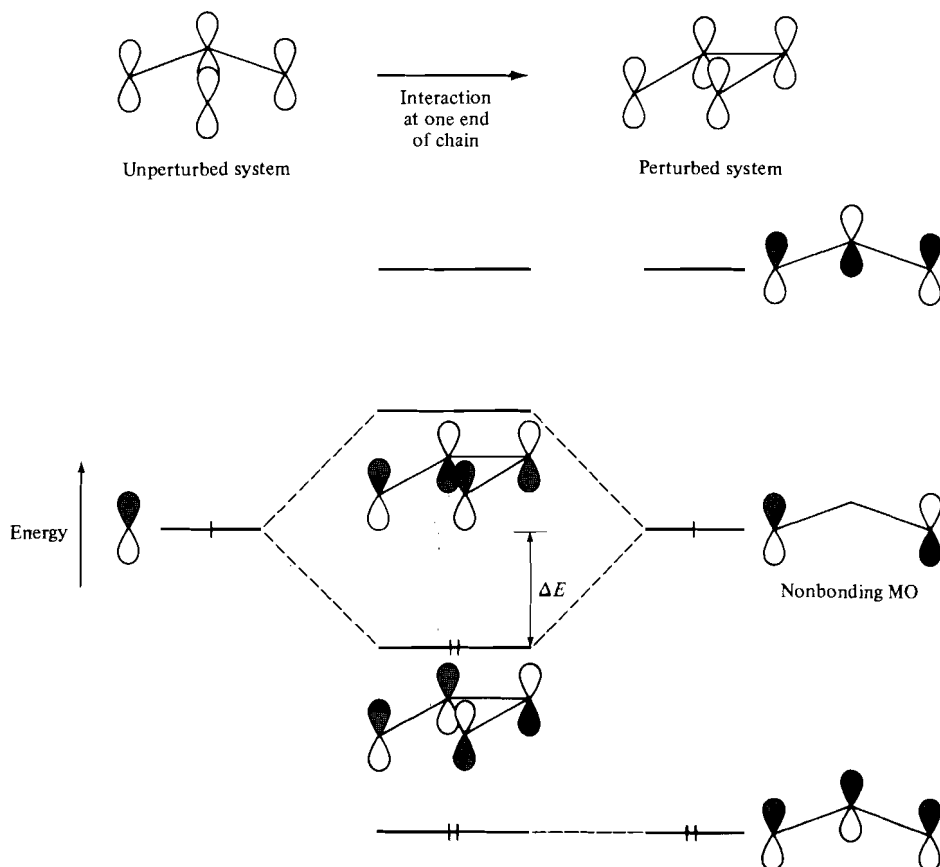

Figure 11.21 Construction of a four-carbon conjugated chain by union of a single carbon with one end of a three-carbon chain. The p orbital being added is at the same energy as the nonbonding orbital. Only the large interaction between orbitals of the same energy is considered; the other, smaller ones are neglected. In the lower-energy combination the interacting orbitals combine in a bonding way and in the higher-energy combination in an antibonding way. The system is stabilized by an amount $2 \Delta E$ (two electrons each decrease in energy by ΔE).

known absolute energies. A much less accurate set of orbital functions therefore suffices to give a reliable result.

Figures 11.21–11.24 show schematically the analysis of the four-carbon and six-carbon cases. Union at one end always produces a stabilization; union at both ends produces either a larger stabilization or no stabilization, depending on whether the symmetries of the nonbonding orbitals and of the single orbital are the same or different. The nonbonding molecular orbitals alternate between being symmetric and antisymmetric with respect to the mirror plane passing through the central atom of the chain as one goes from one odd-membered chain to the next by addition of two carbons; the single p orbital being joined to the ends of the chain is necessarily symmetric with respect to that plane, and so can interact to give cyclic stabilization only if the nonbonding orbital is also symmetric. Since the symmetric nonbonding orbitals occur for chains of 5, 9, 13, . . . members, rings of 6, 10, 14, . . . , $4n + 2$ are stabilized when compared to the

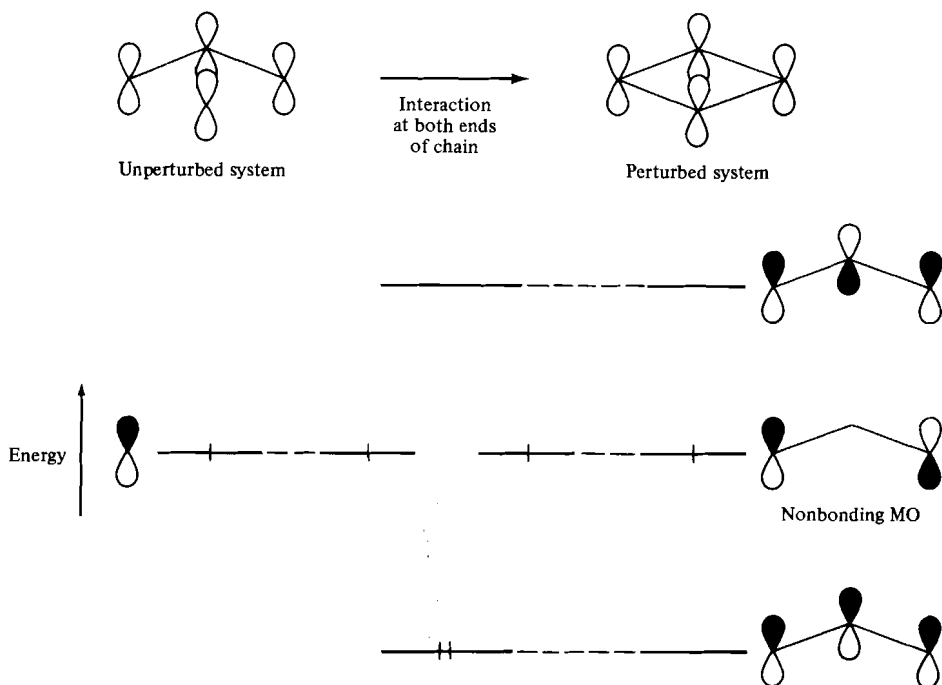

Figure 11.22 Union of a single carbon at both ends of a three-carbon chain. The nonbonding orbital is antisymmetric with respect to the mirror plane bisecting the system and cannot interact with the symmetric p orbital. Alternatively, a bonding interaction at one end is exactly cancelled by an antibonding interaction at the other. No stabilization results; to a first approximation, the cyclic system is less stable than the open chain (Figure 11.21) by $2 \Delta E$ and is therefore antiaromatic.

chain of the same length and so are aromatic, whereas rings of 4, 8, 12, . . . , $4n$ members, derived from the antisymmetric nonbonding orbitals of the chains of 3, 7, 11, . . . members, are destabilized.

Although this analysis applies only to Hückel systems, it is easily extended to cover anti-Hückel rings as well.⁴⁵ Recalling that the basis orbitals of an anti-Hückel ring may be arranged so that a single phase inversion occurs at any convenient point, we may require that the phase inversion occur at one of the points of union. One of the interactions that determines the energy change then reverses sign, and stabilization occurs for those rings that were destabilized before, and destabilization for those that were stabilized.⁴⁶ The Hückel $4n + 2$ rule is therefore reversed for anti-Hückel rings.

The importance of the arguments we have outlined lies in the fact that they provide a theoretical foundation both for aromaticity–antiaromaticity and for pericyclic selection rules. They furthermore demonstrate the relationship between the two: The topological equivalence between an array of p orbitals in a π system of a carbon chain or ring and a pericyclic transition state, composed of an

⁴⁵ See note 28(a), p. 603.

⁴⁶ One reaches the same conclusion if the inversion is within the odd-membered chain. Then the symmetry of the nonbonding molecular orbital is reversed: Cyclic interaction can occur for union with the 3-, 7-, 11-, . . . membered chains and not with the 5-, 9-, 13-, . . . membered chains.

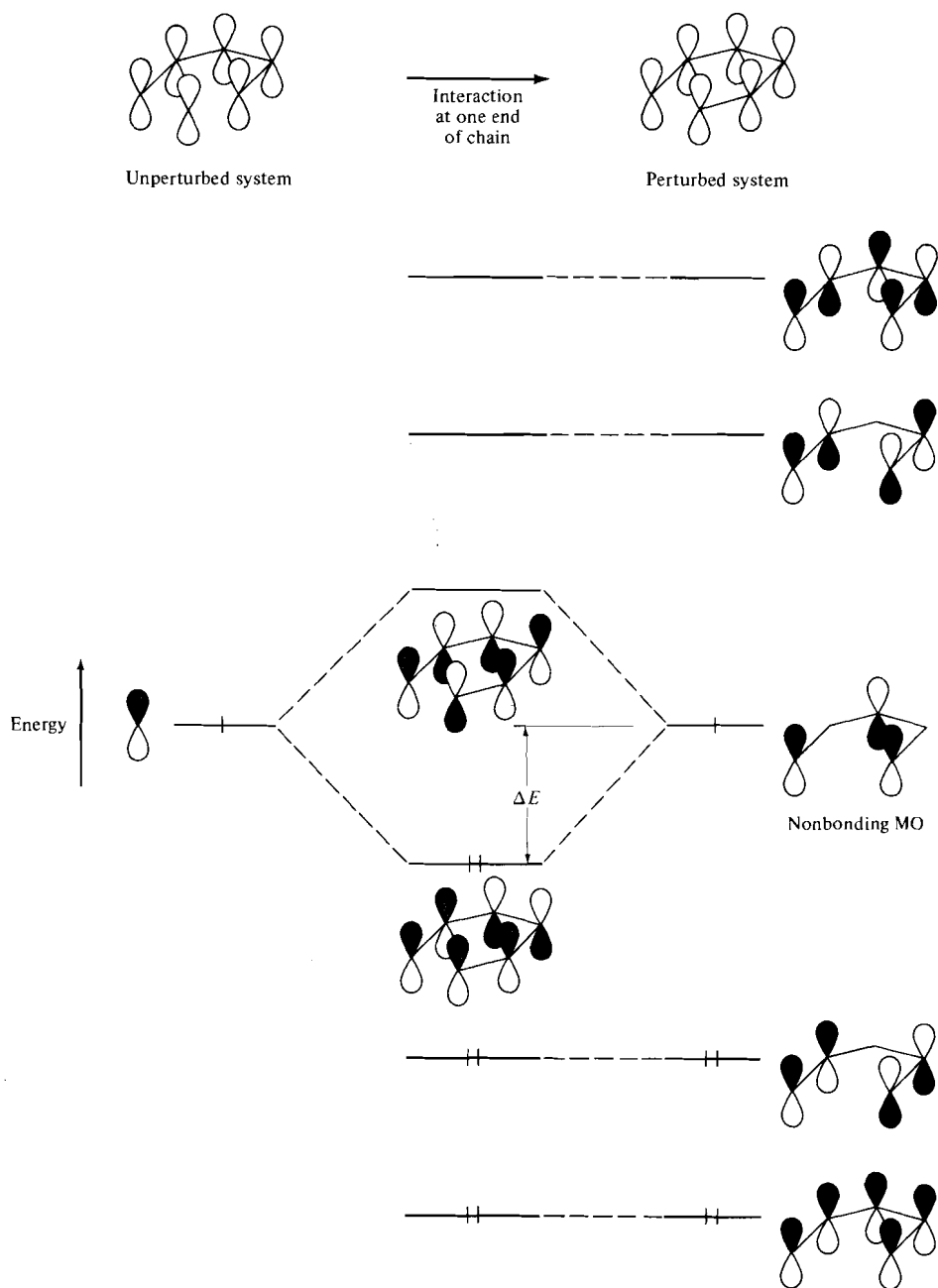

Figure 11.23 Union of a single carbon at one end of a five-carbon chain. Interaction is the same as in Figure 11.21; stabilization is $2 \Delta E$.

array of orbitals of various hybridizations and orientations, assures that the same analysis will apply to both. The pericyclic selection rules then follow immediately from the premise that ground-state allowed reactions are those in which the cyclic transition state is stabilized with respect to an analogous noncyclic one, and

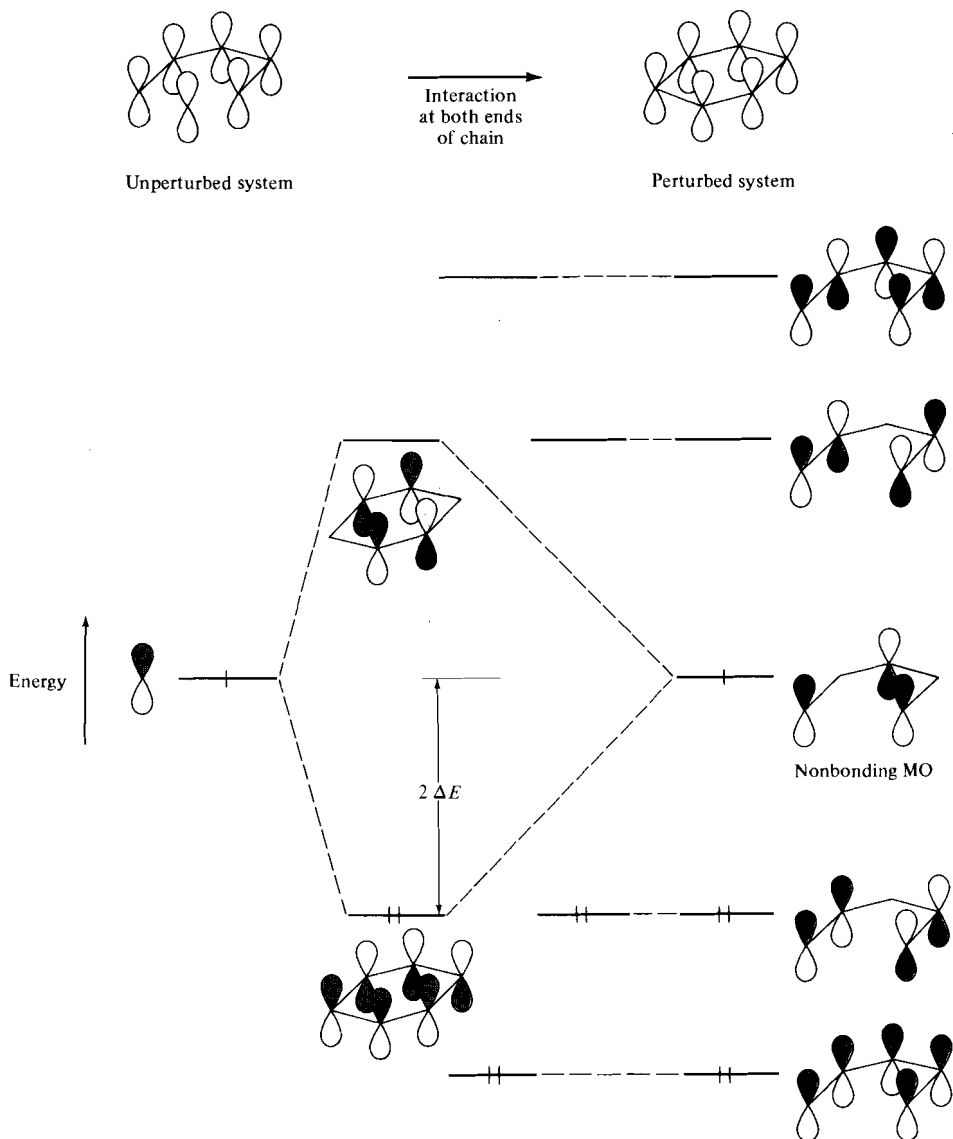

Figure 11.24 Union of a single carbon at both ends of a five-carbon chain. Both orbitals are symmetric, and a bonding interaction occurs at each end. The bonding combination is lowered by $2 \Delta E$, giving a total stabilization for the two electrons of $4 \Delta E$. The ring is more stable than the open chain (Figure 11.23) by $2 \Delta E$ and is therefore aromatic.

ground-state forbidden reactions are those in which the cyclic transition state is destabilized.

The Goldstein-Hoffmann approach to aromaticity, which was discussed in Section 10.4, is also applicable to pericyclic reactions, although the main emphasis in their development was the analysis of alternative geometries for ground-

state aromatic systems.⁴⁷ Salem has presented an analysis of pericyclic reactions based on perturbation theory,⁴⁸ and Oosterhoff and co-workers have used the valence bond method to analyze transition states for aromaticity.⁴⁹

11.6 COMPARISON OF THE WOODWARD-HOFFMANN AND DEWAR-ZIMMERMAN PERICYCLIC SELECTION RULES

In analyzing pericyclic reactions according to the principles of orbital symmetry, we used as the fundamental criterion Woodward and Hoffmann's statement that a transformation is allowed in the ground state if and only if all electrons occupying bonding orbitals of reactants are transformed without symmetry-imposed barriers to bonding orbitals of products. Reasoning by analogy then led to the formulation of the Woodward-Hoffmann selection rule, stated formally in Equation 11.35, where $c(4q + 2)s$ signifies c suprafacial components containing $4q + 2$ electrons and $d(4r)a$ signifies d antarafacial components each containing $4r$ electrons.

$$\begin{array}{ll} \text{Ground-state allowed:} & c(4q + 2)s + d(4r)a = 2n + 1 \\ \text{Ground-state forbidden:} & c(4q + 2)s + d(4r)a = 2n \end{array} \quad (11.35)$$

$q, r, n = 0, 1, 2, \dots$

In the aromatic transition state approach, the basic criterion was that a reaction is allowed in the ground state if and only if there occurs in the transition state aromatic stabilization. This criterion led to the Dewar-Zimmerman selection rule (Equation 11.36), where $p. i. = 0$ signifies an even number of phase inversions, $p. i. = 1$ signifies an odd number of phase inversions, and N is the total number of electrons.

$$\begin{array}{ll} \text{Ground-state allowed:} & p. i. = 0, N = 4q + 2 \\ & p. i. = 1, N = 4q \\ \text{Ground-state forbidden:} & p. i. = 0, N = 4q \\ & p. i. = 1, N = 4q + 2 \end{array} \quad (11.36)$$

$q = 0, 1, 2, \dots$

The two rules are arrived at from rather different perspectives; although consideration of specific examples will readily convince one that they do give the same results for simple systems, it is not obvious that this will always be the case.

A Sufficient Condition for the Equivalence of the Two Pericyclic Selection Rules

All of the systems we have considered to this point are characterized by a single loop of interacting orbitals. Not all pericyclic reactions are of this type; we shall therefore find it useful to have a formal definition of this situation in terms of the interaction diagrams introduced in Section 11.4. We define a *simply connected* pericyclic system as one in which, in the interaction diagram, each basis orbital is connected to exactly two other orbitals. Hence simply connected systems are those that contain a single ring of interaction or possibly two or more independent rings. The case of more than one noninteracting ring is then readily handled by requiring that the process will be allowed only if each ring represents an allowed

⁴⁷ M. J. Goldstein and R. Hoffmann, *J. Amer. Chem. Soc.*, **93**, 6193 (1971).

⁴⁸ L. Salem, *J. Amer. Chem. Soc.*, **90**, 543, 553 (1968).

⁴⁹ (a) J. J. C. Mulder and L. J. Oosterhoff, *Chem. Commun.*, 305, 307 (1970); (b) W. J. van der Hart, J. J. C. Mulder, and L. J. Oosterhoff, *J. Amer. Chem. Soc.*, **94**, 5724 (1972).

transformation.⁵⁰ The analysis that follows is restricted to simply connected systems.

Recall now our definition (p. 599) of a component as a noncyclic chain of interacting basis orbitals with signs chosen so that no internal phase inversions occur. Components may contain either an even or an odd number of basis orbitals, but we are restricting the discussion to systems with an even number of electrons and may therefore require that the number of electrons contributed by a component be even.⁵¹ A component may enter into interaction with other components at its ends in either a suprafacial way, if the signs of the interacting lobes at the two ends are the same, or in an antarafacial way if the signs of the interacting lobes are opposite. There are thus four types of components: $(4q)s$, $(4q)a$, $(4q + 2)s$, and $(4q + 2)a$.

Consider now the formation of an interaction diagram by assembling antarafacial and suprafacial components so as to represent an arbitrary simply connected pericyclic transformation. This task may always be accomplished by joining the components one by one at their ends according to the interaction pattern dictated by the geometry until all are accounted for, and then completing the ring by joining the free end of the last to the free end of the first. Since the sign of every orbital in a component may be changed without violating the rule that no internal phase inversion occur, it is always possible to make all of these connections except the last so as to avoid introducing any phase inversion. If this procedure is followed, the composite acyclic chain obtained after each component is added may itself be regarded as a component; a composite component will be suprafacial or antarafacial if it is made up from an even number or an odd number, respectively, of antarafacial components. The final union that closes the ring is therefore always equivalent to the union of two ends of a single component; if the entire ring contains an even number of antarafacial components the final union will occur without phase inversion, and if the ring contains

⁵⁰ See, for example: R. B. Woodward and R. Hoffmann, *The Conservation of Orbital Symmetry*, Verlag Chemie, Weinheim/Bergstr., Germany, and Academic Press, New York, 1970, p. 32. The reaction cited there,

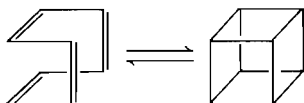

appears to be allowed on superficial examination of the orbital symmetry correlation diagram. This analysis fails because it violates the first precaution (Section 11.3, p. 586), which requires separate analysis of independent processes occurring within the same molecule. The reaction must actually be considered as two independent $\pi 2s + \pi 2s$ cycloadditions. This conclusion follows immediately and unambiguously from the interaction diagram, which consists of two noninteracting simply connected rings:

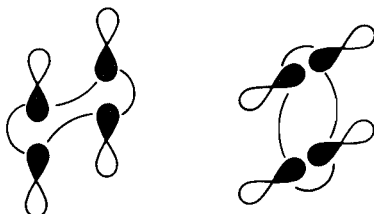

⁵¹ This requirement will, of course, mean that components made up of an odd number of orbitals will represent charged fragments. The entire system will be charged if the total number of components with odd numbers of basis orbitals is odd.

an odd number of antarafacial components the final union will occur with phase inversion.

The example in Scheme 1 illustrates these ideas. Four components, two suprafacial and two antarafacial, are to be joined into a ring. In **48**, the components are defined, with the connections to be made between them indicated by dotted lines. Starting with the component at the upper right and proceeding clockwise, we first change the sign of all orbitals in the next component so that the connection can be made without a phase inversion. We now have on the right in **49** a new composite component that is antarafacial. Then to make the next connection without phase inversion, we must change the sign of the next component, and we obtain in **50** a composite antarafacial component. The same procedure applied once more yields finally a composite suprafacial component,

SCHEME 1

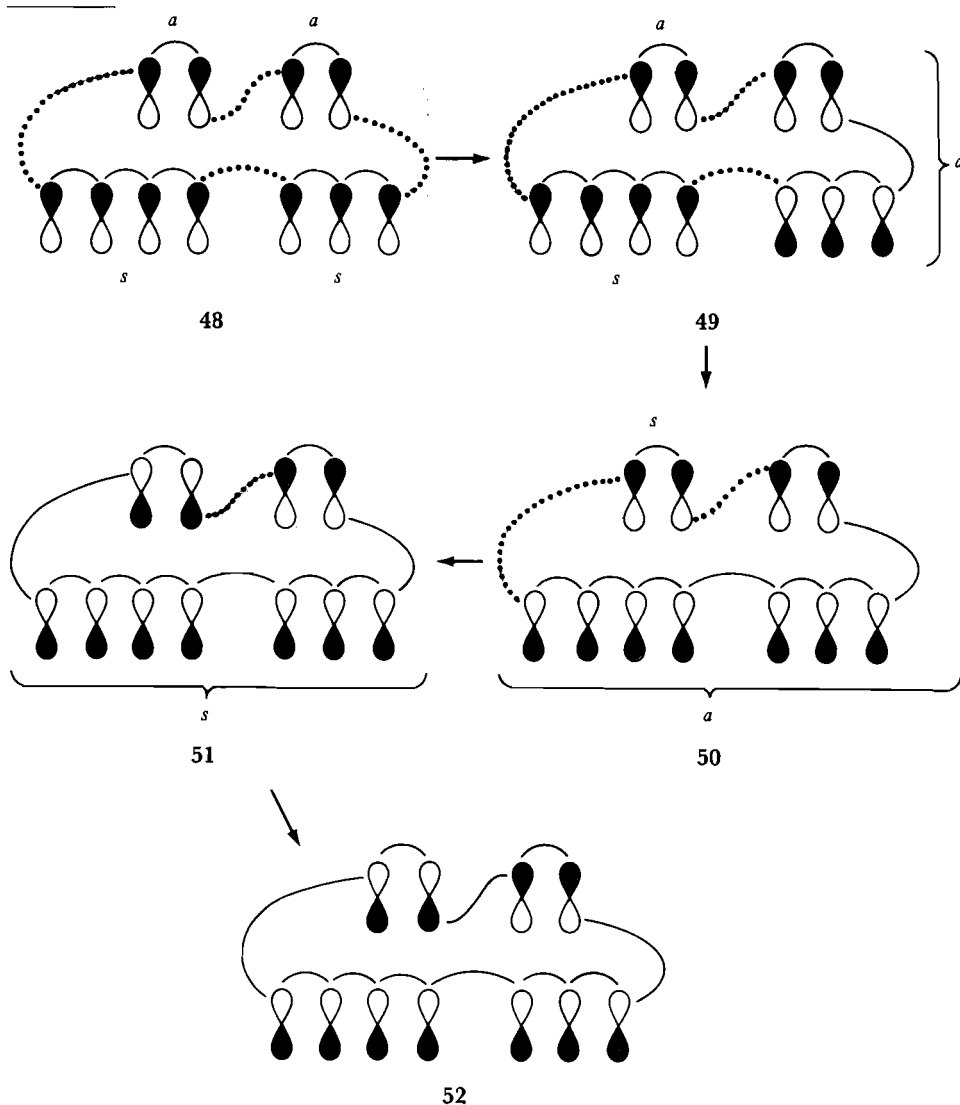

51, which can be joined at the ends to give a ring with no phase inversion, 52.

This argument demonstrates in an entirely general way that the number of phase inversions in the interaction diagram for a simply connected pericyclic transformation is zero if the number of antarafacial components is even and one if the number of antarafacial components is odd. In order to complete the link between the Woodward-Hoffmann and Dewar-Zimmerman points of view, it remains only to find the total number of electrons in the completed ring. A $4q$ system contains an even number of pairs and a $4q + 2$ system an odd number of pairs; therefore any system obtained by joining components will have a total number of electrons satisfying the formula $4q$ (even number of pairs total) if there are an even number of $4q + 2$ components and a total number satisfying $4q + 2$ (odd number of pairs total) if there are an odd number of $4q + 2$ components.

Consider now a pericyclic interaction diagram made up of the four possible kinds of components as follows:

$$m(4q + 2)s + n(4q + 2)a + t(4q)s + u(4q)a$$

The number of phase inversions is then

$$\begin{aligned} p. i. &= 0 && \text{if and only if } n + u \text{ is even} \\ p. i. &= 1 && \text{if and only if } n + u \text{ is odd} \end{aligned}$$

and the total number of electrons is

$$\begin{aligned} N &= 4q && \text{if and only if } m + n \text{ is even} \\ N &= 4q + 2 && \text{if and only if } m + n \text{ is odd} \end{aligned}$$

The Dewar-Zimmerman rule specifies that the reaction is allowed in the ground state if:

$$1. p. i. = 0 \text{ and } N = 4q + 2$$

or if:

$$2. p. i. = 1 \text{ and } N = 4q$$

Condition 1 implies:

$$\begin{aligned} n + u \text{ even and } m + n \text{ odd, or} \\ m + 2n + u \text{ odd, or} \\ m + u \text{ odd} \end{aligned}$$

Condition 2 implies:

$$\begin{aligned} n + u \text{ odd and } m + n \text{ even, or} \\ m + 2n + u \text{ odd, or} \\ m + u \text{ odd} \end{aligned}$$

The Woodward-Hoffmann rule states that the reaction is allowed in the ground state if $m + u$ is odd. The Dewar-Zimmerman rule states that the reaction is forbidden in the ground state if

$$3. p. i. = 0 \text{ and } N = 4q$$

or if:

$$4. p. i. = 1 \text{ and } N = 4q + 2$$

Condition 3 implies:

$$\begin{aligned} n + u \text{ even and } m + n \text{ even, or} \\ m + 2n + u \text{ even, or} \\ m + u \text{ even} \end{aligned}$$

Condition 4 implies:

$$\begin{aligned} n + u \text{ odd and } m + n \text{ odd, or} \\ m + 2n + u \text{ even, or} \\ m + u \text{ even} \end{aligned}$$

The Woodward-Hoffmann rule states that the reaction is forbidden in the ground state if $m + u$ is even.

Since all possibilities have been enumerated, we have demonstrated that for any simply connected pericyclic reaction the two statements of the selection rules are equivalent and must necessarily make the same predictions.

At this point we may summarize the relationships among the various procedures we have explored for analyzing pericyclic processes. The Woodward-Hoffmann method traces the individual molecular orbitals from reactant to product, making use of any symmetry elements that bisect bonds formed or broken as aids to establishing the correlations. The Dewar-Zimmerman approach and the other, essentially equivalent methods of Salem, and of Oosterhoff and co-workers, determine whether the cyclic transition state is stabilized or destabilized compared with the open-chain analog. For simply connected systems, all give the same results; the interaction diagram reveals both the underlying symmetry that effectively determines the orbital correlation and the aromaticity or antiaromaticity of the transition state. The correlation diagram ambiguities that the precautions mentioned in Section 11.3, p. 586, are designed to prevent will not occur in simply connected systems if attention is given to the careful construction of the interaction diagram and to finding from it the fundamental topological symmetry of the pericyclic ring. Non-simply connected systems, on the other hand, will require more thorough individual analysis.

Non-Simply Connected Reactions

There are a number of examples of pericyclic reactions for which the interaction diagram is not simply connected. We define a non-simply connected pericyclic system as one in which in the interaction diagram at least one basis orbital is connected to more than two others. An example is shown with its interaction diagram in Equations 11.37-11.38.

In non-simply connected transformations, it is not possible to construct the interaction diagram by the procedure of simple union of components at their ends. Processes of this type are nevertheless subject to analysis. Orbital correlation diagrams may still be constructed, using the symmetry or, if the symmetry does not offer sufficient guidance, as would be the case if no element bisects bonds being formed or broken, by tracing each individual orbital through the reaction in such a way as to preserve its nodal structure.

Woodward and Hoffmann analyze in detail the benzene—prismane example in Equations 11.37-11.38.⁵² The reaction is formally a $\pi 2s + \pi 2a + \pi 2a$

⁵² Woodward and Hoffmann, *The Conservation of Orbital Symmetry*, p. 107.

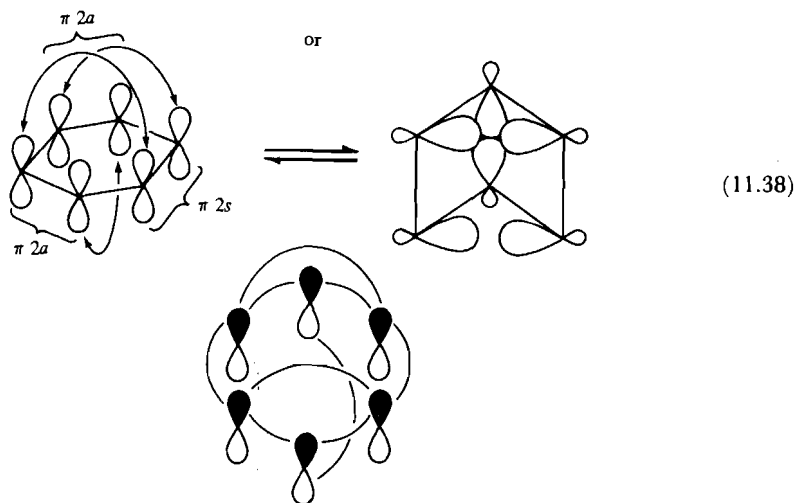
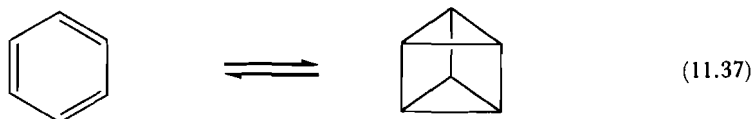

cycloaddition (53), and should be ground-state allowed. The correlation diagram, however, shows that the symmetry imposes a correlation between bonding

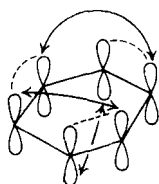

53

and antibonding levels, and so the ground-state reaction is actually forbidden. Experimentally, Oth has found that the isomerization of hexamethylprismane to hexamethylbenzene (Equation 11.39) is exothermic by 91.2 kcal mole⁻¹.⁵³

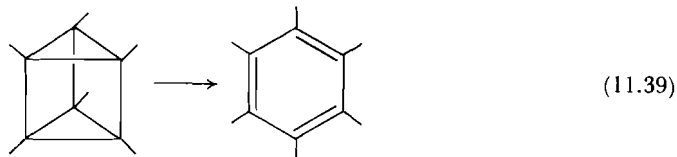

Despite this large favorable energy change, the prismane rearranges by way of intermediate structures (Equation 11.40) with the activation enthalpies indicated. Hence the activation enthalpy for the direct conversion (Equation 11.39) must be greater than 33 kcal mole⁻¹. This barrier is remarkably high for a

⁵³ (a) J. F. M. Oth, *Angew. Chem. Int. Ed.*, **7**, 646 (1968); (b) J. F. M. Oth, *Rec. Trav. Chim.*, **87**, 1185 (1968).

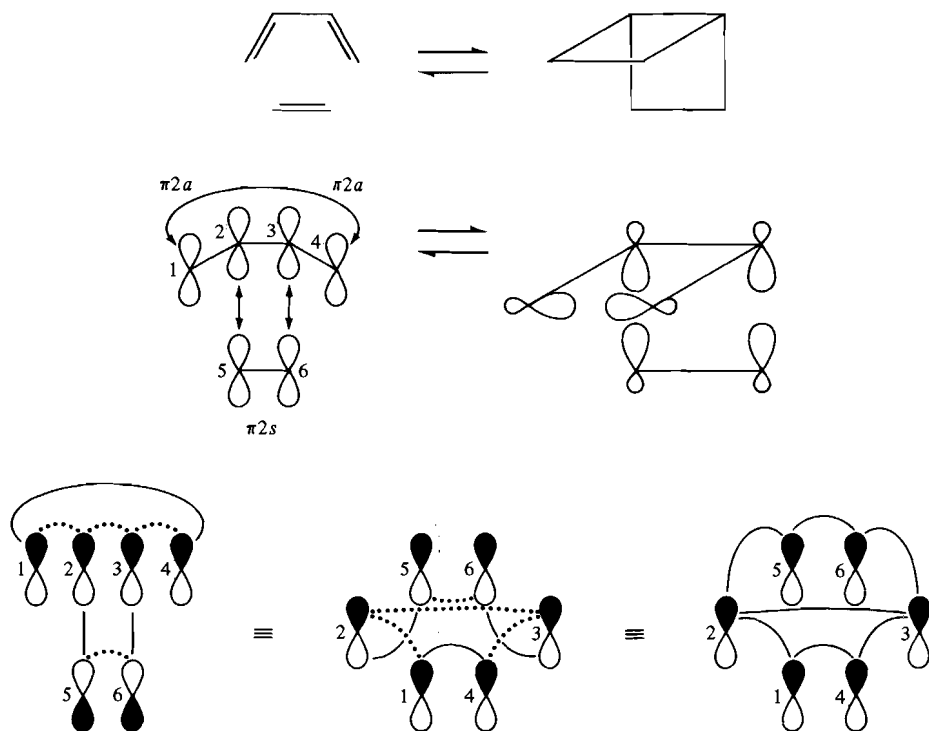

reaction so strongly exothermic; the conclusion that there is a symmetry-imposed barrier seems justified.

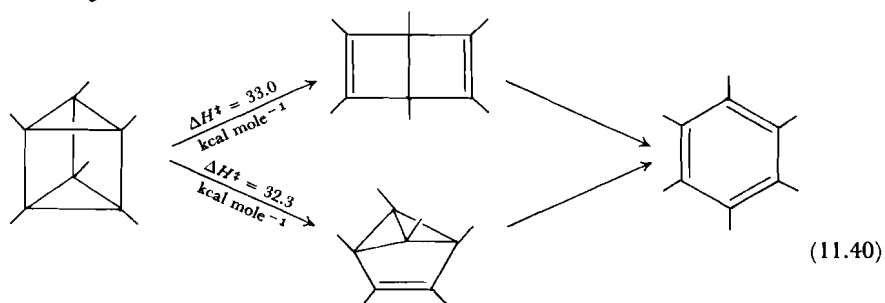

11.7 CORRELATION OF ELECTRONIC STATES

The Woodward-Hoffmann pericyclic reaction theory has generated substantial interest in the pathways of forbidden reactions and of excited state processes, beginning with a paper by Longuet-Higgins and Abrahamson,⁵⁴ which appeared simultaneously with Woodward and Hoffmann's first use of orbital correlation diagrams.⁵⁵ We have noted in Section 11.3, p. 586, that the orbital correlation diagram predicts that if a forbidden process does take place by a concerted pericyclic mechanism,⁵⁶ and if electrons were to remain in their original orbitals, an

⁵⁴ H. C. Longuet-Higgins and E. W. Abrahamson, *J. Amer. Chem. Soc.*, **87**, 2045 (1965)

⁵⁵ R. Hoffmann and R. B. Woodward, *J. Amer. Chem. Soc.*, **87**, 2046 (1965).

⁵⁶ A stepwise pathway, not subject to the same symmetry restrictions, is always possible.

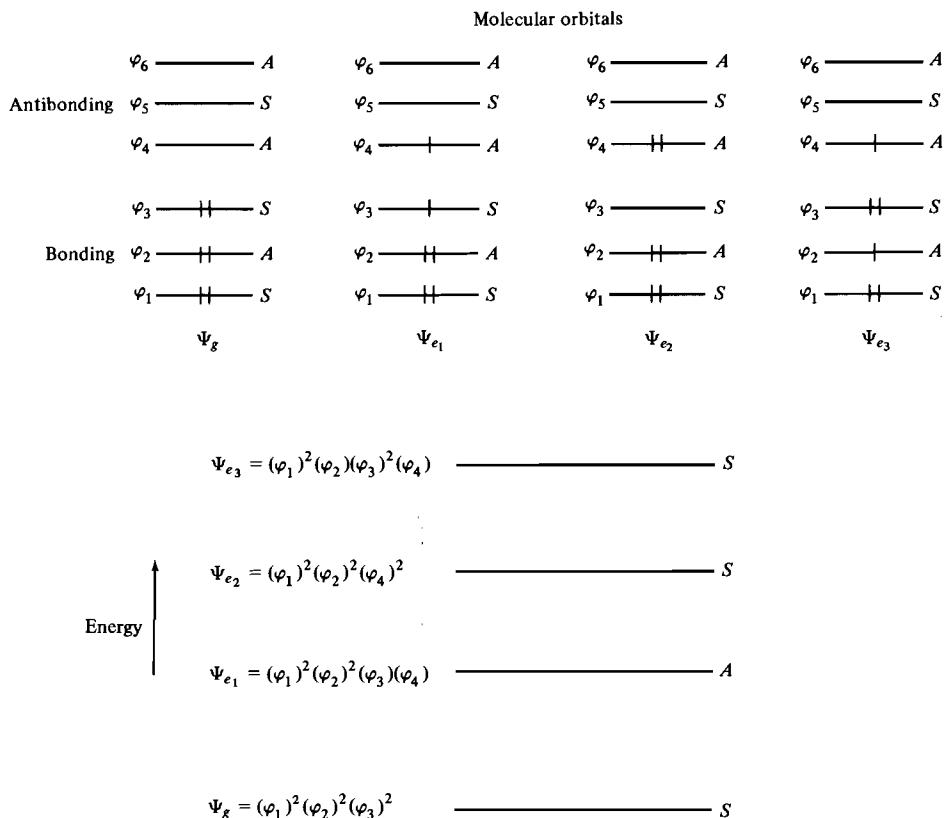

Figure 11.25 The electronic ground state and a few excited states of a hypothetical molecule. Above, orbital energy-level diagrams specify symmetry properties and illustrate orbital occupancies for various states; the molecular orbital set is the same for each state in this approximation. Below, the states are shown on an energy scale. Each state function is a product of orbital functions for the electrons, with state symmetry determined by multiplying the symmetries of the electrons (+1 for *S*, -1 for *A*).

excited state should be produced. Similarly, if reactants start out in a singly excited state (Figure 11.13), the diagrams imply that one electron will decrease in energy and the other increase, the result being a singly excited product state. A number of investigators⁵⁷ have pointed out that under these circumstances the electron pairs are ordinarily not expected to remain in their original orbitals.

In order to understand the reasoning supporting these arguments, it is necessary to appreciate the concept of an *electronic state*. An electronic state is given by the complete specification of the orbital occupancy. Assignment of all electrons to orbitals of the lowest possible energy gives the ground electronic

⁵⁷ (a) See note 54, p. 617. See also, for example: (b) M. J. S. Dewar, *Angew. Chem. Int. Ed.*, **10**, 761 (1971); (c) W. Th. A. M. van der Lugt and L. J. Oosterhoff, *J. Amer. Chem. Soc.*, **91**, 6042 (1969); (d) R. C. Dougherty, *J. Amer. Chem. Soc.*, **93**, 7187 (1971); (e) J. E. Baldwin, A. H. Andrist, and R. K. Pinschmidt, Jr., *Accts. Chem. Res.*, **5**, 402 (1972); (f) R. Hoffmann, S. Swaminathan, B. G. Odell, and R. Gleiter, *J. Amer. Chem. Soc.*, **92**, 7091 (1970); (g) N. D. Epiotis, *J. Amer. Chem. Soc.*, **95**, 1191, 1200, 1206, 1214 (1973).

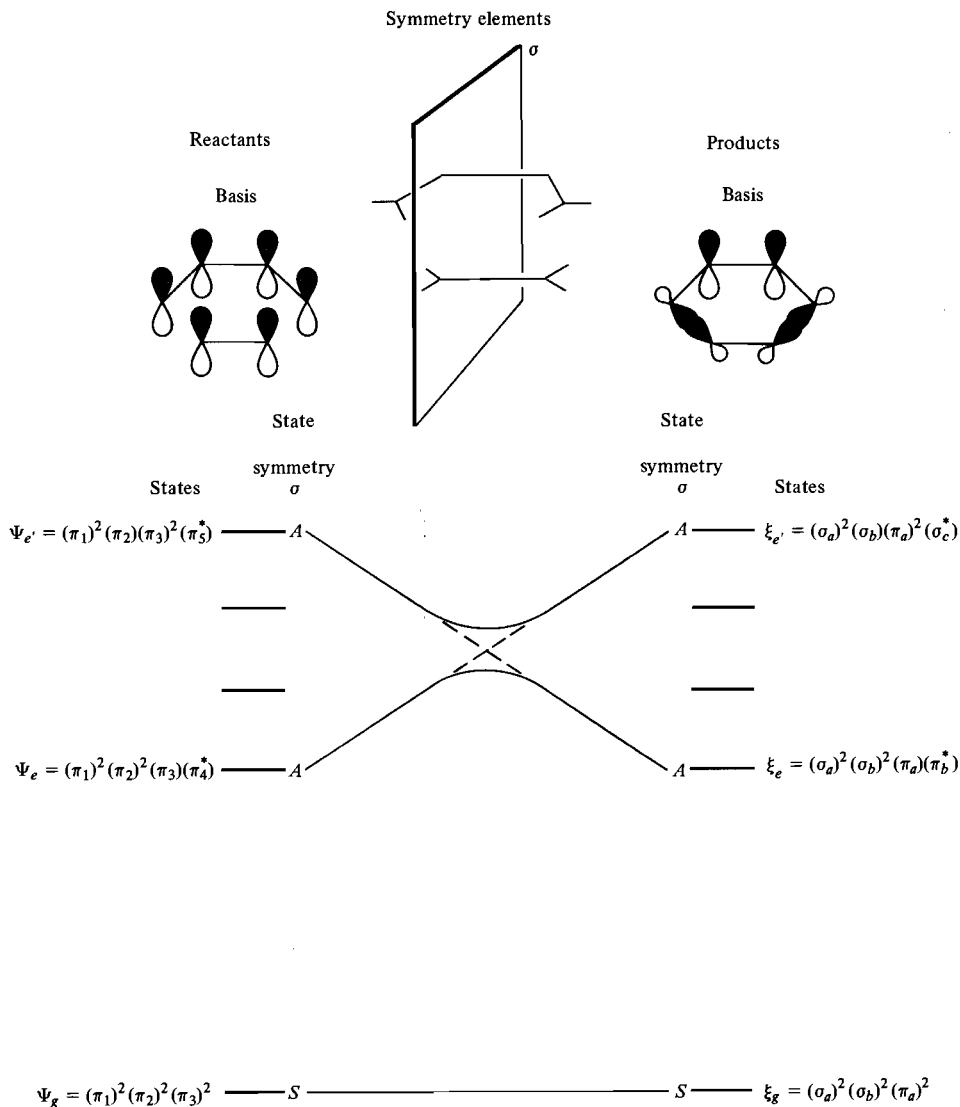

Figure 11.26 State correlation diagram for the allowed $\pi 2s + \pi 4s$ cycloaddition. Refer to Figure 11.16 for the orbital labeling and orbital correlation.

state; alternative arrangements, with some electrons occupying higher-energy orbitals, correspond to excited electronic states. Each electronic state has associated with it a particular symmetry behavior under each symmetry operation of the molecule, found by taking the product of the symmetry behavior (+1 for symmetric, -1 for antisymmetric) of each electron.⁵⁸ Figure 11.25 shows some of the lower electronic states and their symmetries for a hypothetical molecule in which it is supposed that an adequate model is obtained with six molecular

⁵⁸ The discussion is restricted to molecules with axes of rotational symmetry of order no higher than twofold.

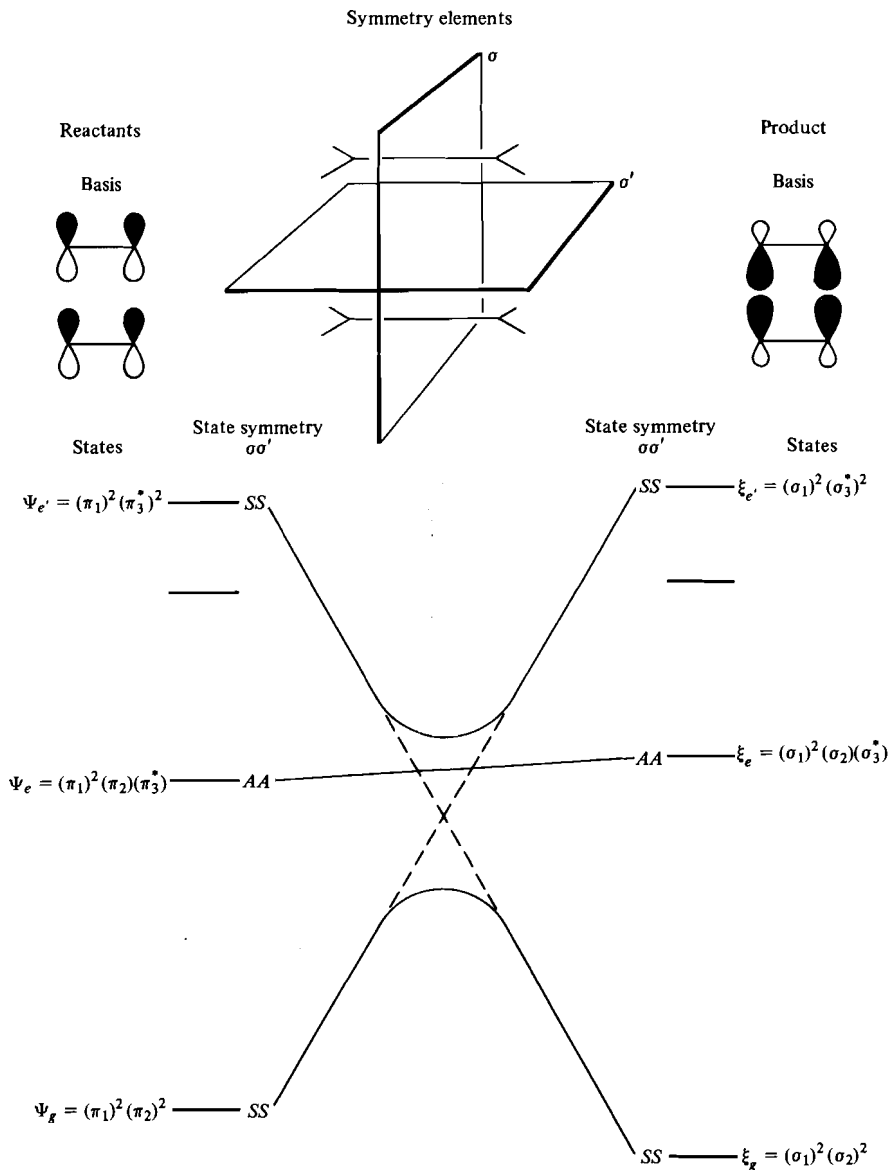

Figure 11.27 State correlation diagram for the forbidden $\pi 2s + \pi 2s$ cycloaddition. The orbital designations are those defined in Figure 11.15. State symmetry designations refer to the mirror planes σ and σ' of Figure 11.15.

orbitals and in which there is one symmetry element. Note that in finding state symmetry, one counts the symmetry of each electron; states with only doubly occupied orbitals will therefore always be symmetric with respect to all symmetry elements.

It is important to realize that whereas in an orbital energy-level diagram each horizontal line represents an orbital and several orbitals will be occupied by electrons, in a state diagram each horizontal line represents a separate state of the entire molecule. Thus the state diagram is a summary of the several different

states in which the molecule might find itself; at any moment it is in only one state.

If we now examine the state correlation diagrams for allowed and forbidden pericyclic reactions, we find patterns like those shown in Figures 11.26 and 11.27. In Figure 11.26 we have used the orbital correlation of Figure 11.16 for the ground-state allowed $\pi 2s + \pi 4s$ cycloaddition. The orbital occupancy shown in Figure 11.16 represents the ground states of reactants and product, Ψ_g and ξ_g . These states correlate directly with no energy increase. If we were to promote an electron in the diene from π_3 to π_4^* (Figure 11.16), we would obtain the state Ψ_e of Figure 11.26. If electrons remained in their original orbitals, this state would transform into the more highly excited state ξ_e . The dotted lines in Figure 11.26 show this correlation, and also reveal that there will be another state of the same symmetry, arising from the excited state Ψ_e (or, in the reverse direction, ξ_e) that will cross. But the noncrossing rule prevents the two states of the same symmetry from crossing.

This situation is called an *intended state crossing*. The perturbation theory provides an explanation for the avoidance of intended state crossings. Two states of different energies will interact if and only if they are of the same symmetry, just as two orbitals do. Because states of different symmetries do not interact, there is no hindrance to their attaining the same energy and crossing. But as two states of the same symmetry approach each other in energy, they interact more and more strongly, interaction always being in such a direction as to push lower the state that is already of lower energy and to push higher the state that is already higher. The two states therefore do not cross. They do nevertheless interact strongly in the region of close approach. This interaction results in strong mixing of the two states, so that near the energy maximum they lose their separate identities, and the molecule can easily undergo a transition from one to the other. In Figure 11.26 the molecule can therefore cross over in the strong mixing region and emerge along the solid line leading to product state ξ_e .⁵⁹ The mixing of two states of the same symmetry is called *configuration interaction*.

Excited-State Allowed Reactions

Figure 11.27 shows the state correlation diagram for the ground-state forbidden, excited-state allowed, $2 + 2$ cycloaddition. We have assumed up to this point that in this situation the first excited state would transfer directly to the first excited state of the product. Indeed, there is no symmetry-imposed barrier to such a transformation, although it may well happen (for example, in the excited-state allowed disrotatory electrocyclic ring closure of butadiene to cyclobutene, Figure 11.10⁶⁰) that a substantial barrier will occur simply because the excited state of the product lies at a significantly higher energy than that of the reactant. It is clear from Figure 11.27, however, that because of the intended correlation of the electronic ground state to a higher excited state, the first electronic excited state comes close in energy to the electronic ground state at some point along the

⁵⁹ For a more rigorous treatment, see W. Kauzmann, *Quantum Chemistry*, Academic Press, New York, 1957, p. 536.

⁶⁰ See note 57(c), p. 618.

reaction coordinate. Had ground and first excited states the same symmetry, we would expect the state mixing described above; in many cases the symmetries will not be the same. More careful analysis nevertheless shows that when two electronic states come close in energy, vibrational motions destroy the symmetry distinctions between them, and the electrons have a means of shifting from the excited state to the ground state.⁶¹ The actual result to be expected, then, is that the molecule starting out in excited state Ψ_e would end up in the product electronic ground state ξ_g instead of in the excited state ξ_e . This is presumably what occurs in the butadiene ring closure;⁶² documented examples have also been described of systems that, by a similar crossing over process but in the reverse sense, yield directly an excited state of a product from the ground state of a high-energy reactant.⁶³

Energy Barriers in Ground-State Forbidden Reactions

If a ground-state forbidden reaction is forced to occur by the provision of sufficient energy, the pathway followed may be stepwise, with initial formation or breakage of one bond to yield a short-lived radical intermediate that will continue on to product in a second step. But, in some instances, the concerted transition state, though forbidden, might still be of lower energy than the stepwise one. In either case, one would like to know approximately what the barrier to the forbidden reaction is. Figure 11.27 provides some insight. As the reaction begins, the ground-state energy surface rises as the unfavorable interactions develop. But somewhere near the center of the reaction coordinate, the ground state, which is headed toward an excited state of the product, encounters a descending state of the same symmetry. The two states interact, and the molecule can follow the solid line to product ground state. Hence, ground state correlates to ground state, but the intended state crossing nevertheless introduces a substantial barrier.

The energy separation between states Ψ_g and Ψ_e for typical unsaturated molecules might range anywhere from 90 to 180 kcal mole⁻¹; if we guess from looking at diagrams like Figure 11.27 that the barrier heights for forbidden reactions might reach the order of $\frac{2}{3}$ the height of Ψ_e , we would conclude that the activation energies for forbidden reactions might range from 60 to 120 kcal mole⁻¹. This estimate is a very crude one, but it is probably of a reasonable order of magnitude. The barriers should certainly be much lower than one would have expected on the basis of a diagram like Figure 11.15, which implies that the product would have to form in a doubly excited state. Furthermore, even allowed reactions have activation energies on the order of 30–35 kcal mole⁻¹. The conclusion is that whereas the difference between allowed and forbidden reaction activation energies will ordinarily be substantial, there may well be circumstances in which it is rather small.⁶⁴

Experimentally, the question of the height of the barrier in a forbidden reaction is difficult to answer in simple systems, because it is not easy to tell

⁶¹ See note 57(b), (d), p. 618.

⁶² See note 57(c), p. 618.

⁶³ (a) P. Lechtken, R. Breslow, A. H. Schmidt, and N. J. Turro, *J. Amer. Chem. Soc.*, **95**, 3025 (1973); (b) N. J. Turro and P. Lechtken, *J. Amer. Chem. Soc.*, **95**, 264 (1973).

⁶⁴ See, for example, W. Schmidt, *Helv. Chim. Acta*, **54**, 862 (1971).

whether or not forbidden processes, when they can be observed at all, are occurring by concerted or nonconcerted paths. Brauman and co-workers have established that the disrotatory (forbidden) opening of a cyclobutene to a butadiene has an activation energy about 15 kcal mole⁻¹ higher than the 33 kcal mole⁻¹ activation energy of the conrotatory (allowed) opening.⁶⁵ This energy difference is just what is estimated for the nonconcerted biradical path. The disrotatory opening therefore may not be concerted, and the barrier to the concerted forbidden reaction may be still higher.⁶⁶ Berson, on the other hand, has argued that, in some cases at least, a concerted forbidden path should be of lower energy than a stepwise radical path. Experimental evidence supporting this view will be discussed in Section 12.3, p. 659.

PROBLEMS

1. Verify that the selection rules found for the two-component cycloadditions (Section 11.3, p. 594) agree with the general pericyclic selection rule. What can be said about all-antara $2 + 2 + 2 + \dots$ cycloadditions? About all-supra $2 + 2 + 2 + \dots$ cycloadditions?

2. Classify as sigmatropic reactions and as cycloadditions each of the following, and predict stereochemistry at the migrating center for the ground-state transformation.

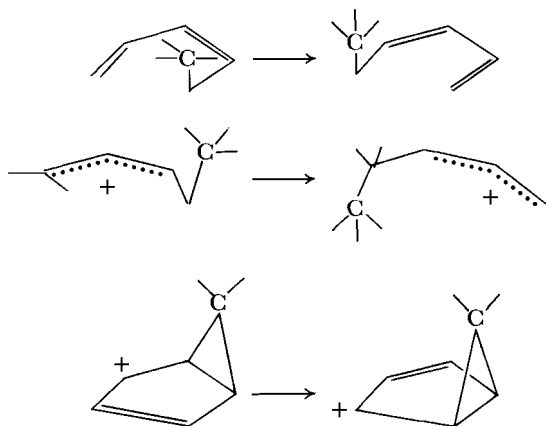

3. Give examples of possible reactions of each of the following types, and determine whether each is forbidden or allowed in the ground state, using both the Woodward-Hoffmann and the Dewar-Zimmerman rules.

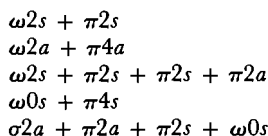

4. Construct correlation diagrams for conrotatory and disrotatory electrocyclic opening of each of the following:

⁶⁵ (a) J. I. Brauman and W. C. Archie, Jr., *J. Amer. Chem. Soc.*, **94**, 4262 (1972); (b) L. M. Stephenson, Jr., and J. I. Brauman, *Accs. Chem. Res.*, **7**, 65 (1974).

⁶⁶ For further discussion see (a) J. E. Baldwin, A. H. Andrist, and R. K. Pinschmidt, Jr., *Accs. Chem. Res.*, **5**, 402 (1972); (b) N. D. Epiotis, *J. Amer. Chem. Soc.*, **95**, 1191, 1200, 1206, 1214 (1973).

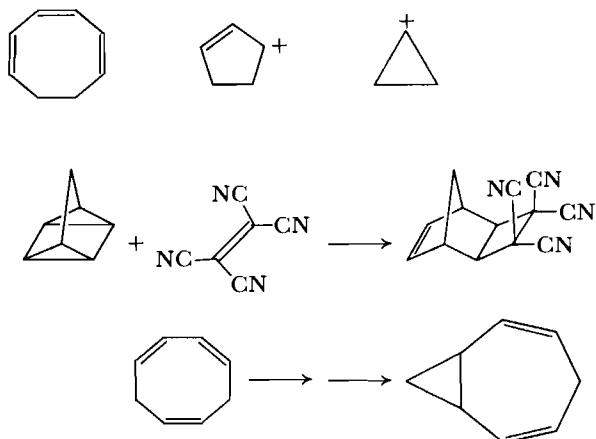

5. Illustrate by orbital drawings at intermediate stages of the reaction the continuous changes that occur in each of the reacting molecular orbitals in the $\pi 2s + \pi 4s$ cycloaddition.

6. Classify each of the following transformations as to type, give the equivalent cycloaddition, and determine whether each will be allowed in ground or excited state.

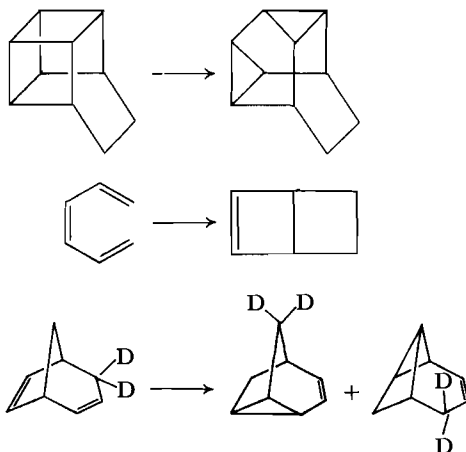

7. Show that the dimerization of sp^2 -hybridized CH_2 is forbidden for approach with the geometry shown below but allowed if the π orbital of one methylene impinges on the unshared pair of the other.

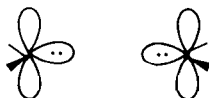

8. Show that a correlation diagram for the $\pi 2s + \pi 2s$ cycloaddition constructed by analysis with respect to either the C_2 axis or the third mirror plane, neither of which bisect bonds made or broken, and by establishing correlations from the noncrossing rule leads to the incorrect conclusion that the reaction is allowed. How is the picture modified if correlation is established by preserving orbital nodal structure rather than by using the noncrossing rule?

9. Construct the correlation diagram for the transformation shown below, in the following steps:

(a) Examine each reacting orbital in the reactant and product and connect those that appear, on the basis of their nodal structure and symmetry, to correlate with each other. Ignore the noncrossing rule at this stage.

(b) Introduce the perturbation interaction which will arise between crossing pairs of orbitals that have the same symmetry with respect to the mirror planes shown. Show how the intended crossings are avoided, leaving an energy barrier to be surmounted during the cyclization.

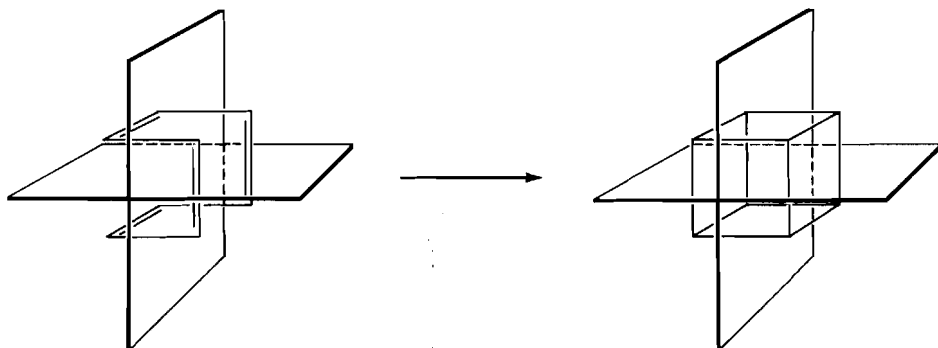

10. Construct an orbital correlation diagram for the non-simply connected transformation shown in Equation 11.38, p. 616. Follow the steps specified in Problem 9.

11. Show that the frontside displacement reactions discussed in Sections 4.2, p. 174, 4.5, p. 205, and 10.3, p. 556, can be considered as cycloadditions, the nucleophilic forbidden and the electrophilic allowed.

REFERENCES FOR PROBLEMS

1. R. B. Woodward and R. Hoffmann, *The Conservation of Orbital Symmetry*, Verlag Chemie, Weinheim/Bergstr., Germany, and Academic Press, New York, 1970, p. 105.
6. K. Shen, *J. Chem. Educ.*, **50**, 238 (1973); Woodward and Hoffmann, *The Conservation of Orbital Symmetry*, pp. 98–99.
7. R. Hoffmann, R. Gleiter, and F. B. Mallory, *J. Amer. Chem. Soc.*, **92**, 1460 (1970).
9. Woodward and Hoffmann, *The Conservation of Orbital Symmetry*, p. 32.
10. Woodward and Hoffmann, *The Conservation of Orbital Symmetry*, p. 109.

Chapter 12

APPLICATIONS

OF THE PERICYCLIC

SELECTION RULES

In this chapter we shall illustrate the application of the selection rules to particular examples of pericyclic reactions. The chemical literature provides a wealth of illustrative examples, many collected in review articles.¹

12.1 CYCLOADDITIONS

Two systems of nomenclature are in use for designating the components of a cycloaddition reaction. One, proposed by Huisgen,² specifies the numbers of atoms in each component; the other, introduced with the pericyclic theory³ and used in Chapter 11, shows the numbers of electrons contributed by each.



¹ Summaries covering all types of pericyclic reactions may be found in: (a) R. B. Woodward and R. Hoffmann, *The Conservation of Orbital Symmetry*, Verlag Chemie, Weinheim/Bergstr., Germany, and Academic Press, New York, 1970; (b) G. B. Gill, *Quart. Rev. (London)*, **22**, 338 (1968); (c) T. L. Gilchrist and R. C. Storr, *Organic Reactions and Orbital Symmetry*, Cambridge University Press, Cambridge, 1972. (d) Activation parameters for a variety of pericyclic reactions are given by R. M. Willcott, R. L. Cargill, and A. B. Sears, *Prog. Phys. Org. Chem.*, **9**, 25 (1972). (e) W. C. Herndon *Chem. Rev.*, **72**, 157 (1972), cites numerous more specialized review articles; reviews covering specific types of pericyclic reactions will be referred to at appropriate points throughout this chapter.

² R. Huisgen, *Angew. Chem. Int. Ed.*, **7**, 321 (1968).

³ See note 1(a).

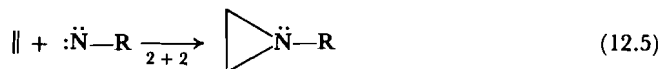

We shall continue to follow the convention that specifies numbers of electrons. Equations 12.1–12.5 show some examples.

2 + 2 Additions Forming Three-Membered Rings⁴

The simplest example of a 2 + 2 addition about which there is substantial information would appear to be the addition of carbenes and nitrenes to olefins (Equations 12.4 and 12.5). Woodward and Hoffmann have designated reactions of this kind, in which one component is a single atom, as *cheletropic*.⁵

Our earlier discussion in Section 5.6 has treated the carbene additions; it remains here to consider the predictions of the pericyclic theory. Recall that the singlet state, with electrons paired in the sp^2 hybrid of the bent structure **1**,

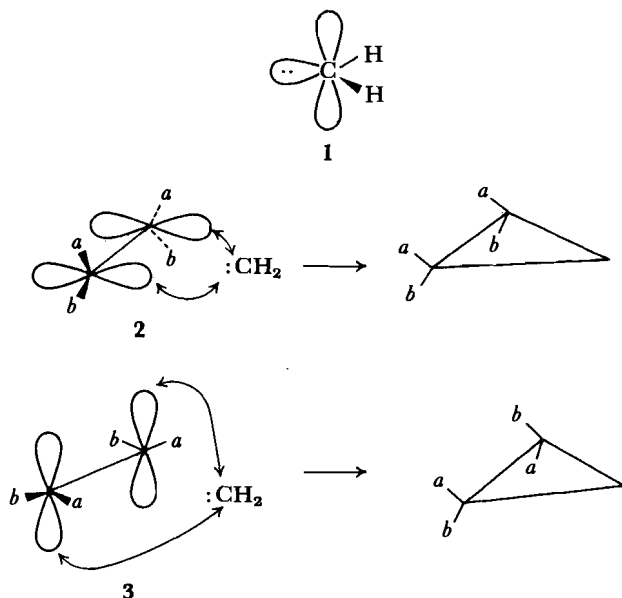

adds concertedly in a *cis* fashion, whereas the triplet gives a mixture of *cis* and *trans* addition and is thought to add stepwise. We are concerned here with the concerted reactions of the singlet. The observed *cis* addition implies that the olefin component enters suprafacially (**2**) rather than antarafacially (**3**). The

⁴ For a review of application of 2 + 2 cycloadditions to preparation of three- and four-membered rings, see L. L. Muller and J. Hamer, *1,2 Cycloaddition Reactions*, Wiley-Interscience, New York, 1967.

⁵ Woodward and Hoffmann, *The Conservation of Orbital Symmetry*, p. 152.

selection rules then specify that in order for the four-electron addition to be thermally allowed, the carbene component must enter antarafacially, as in Structure 4, where for purposes of clarity we have omitted the vacant p orbital.

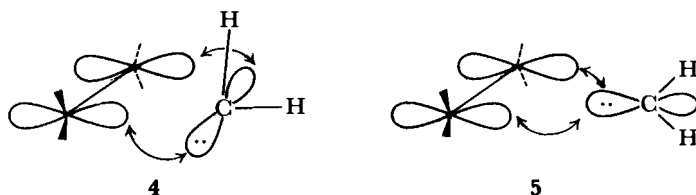

Woodward and Hoffmann refer to this geometry of approach as the *nonlinear*, to distinguish it from the alternative, more symmetrical *linear* approach (5), in which the sp^2 orbital enters suprafacially. Although Hoffmann has reported calculations by the extended Hückel method that are in agreement with the mode of addition 4 predicted by the pericyclic theory,⁶ there is little experimental information.

The reverse of the carbene addition (Equation 12.6) occurs photochemically upon ultraviolet irradiation of cyclopropanes.⁷ Were the extrusion of the carbene

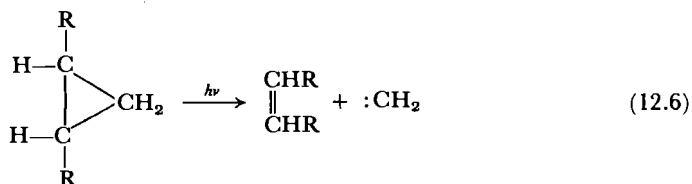

concerted, the pericyclic theory would predict the linear suprafacial-suprafacial path; the observed *cis-trans* isomerization that accompanies the decomposition to a carbene, as in Equation 12.7,⁸ nevertheless implies a stepwise process, with preliminary opening to a diradical (6).

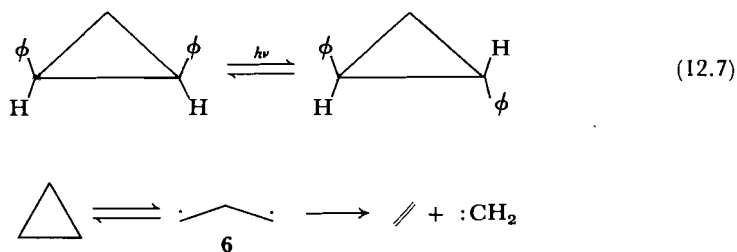

The examples shown in Equations 12.8–12.11 illustrate a few of the other known reverse 2 + 2 cheletropic cycloadditions. Of these reactions, the first two

⁶ R. Hoffmann, *J. Amer. Chem. Soc.*, **90**, 1475 (1968).

⁷ These reactions are reviewed by G. W. Griffin and N. R. Bertoniere, in *Carbenes*, Vol. I, M. Jones, Jr., and R. A. Moss, Eds., Wiley, New York, 1973, p. 305.

⁸ G. W. Griffin, J. Covell, R. C. Petterson, R. M. Dodson, and G. Klose, *J. Amer. Chem. Soc.*, **87**, 1410 (1965).

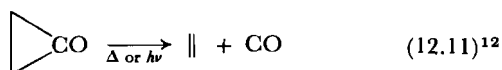
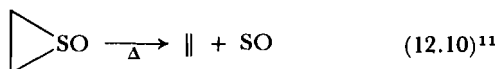
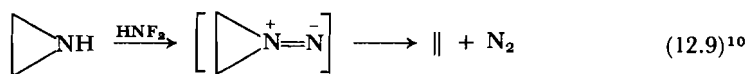
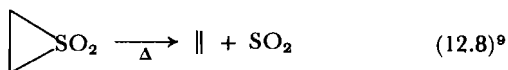

are stereospecific, cis-substituted rings yielding cis olefins and trans yielding trans.¹³ In the third example (Equation 12.10), sulfur monoxide is lost non-stereospecifically; it is possible that biradical or zwitterionic intermediates intervene in both the SO₂ and SO extrusions and the different stereochemical results are a consequence of different rates of bond rotation in the intermediate.¹⁴ Stereochemistry is not known for Reaction 12.11.

2 + 2 Additions Forming Four-Membered Rings¹⁵

The formation of four-membered rings through 2 + 2 cycloaddition is a well-established reaction and the most generally effective synthetic approach to cyclobutanes. Most olefins cannot be induced to undergo this reaction thermally, a finding that is readily rationalized by the forbidden nature of the 2s + 2s addition and the steric difficulties associated with the allowed 2s + 2a pathway. There are nevertheless exceptions. Olefins substituted by two or more fluorine atoms undergo thermal 2 + 2 additions under relatively mild conditions,¹⁶ as do ketenes and allenes.

⁹ (a) L. A. Paquette, *Accs. Chem. Res.*, **1**, 209 (1968). (b) F. G. Bordwell, J. M. Williams, Jr., E. B. Hoyt, Jr., and B. B. Jarvis, *J. Amer. Chem. Soc.*, **90**, 429 (1968), have reported evidence in the case of Equation 12.8 that favors a two-step mechanism with a ring-opened diradical intermediate that loses SO₂ faster than bond rotation can occur.

¹⁰ J. P. Freeman and W. H. Graham, *J. Amer. Chem. Soc.*, **89**, 1761 (1967). Note that in this reference the interpretation of the results as a violation of the Woodward-Hoffmann rules presupposes the linear (suprafacial-suprafacial) path; the idea of the nonlinear path, which brings the results and theory into agreement, developed later [see note 1(a), p. 626].

¹¹ G. E. Hartzell and J. N. Paige, *J. Org. Chem.*, **32**, 459 (1967).

¹² N. J. Turro, P. A. Leermakers, H. R. Wilson, D. C. Neckers, G. W. Byers, and G. F. Vesley, *J. Amer. Chem. Soc.*, **87**, 2613 (1965).

¹³ See note 9(b).

¹⁴ See note 9(b) and note 11.

¹⁵ For reviews, see: (a) R. Huisgen, R. Grashey, and J. Sauer, in *The Chemistry of Alkenes*, S. Patai, Ed., Wiley-Interscience, London, 1964, p. 739; (b) J. D. Roberts and C. M. Sharts, *Org. Reactions*, **12**, 1 (1962). See also note 4, p. 627.

¹⁶ Methylene-cyclopropanes—for example,



behave similarly to the *gem*-difluoroethylenes. P. D. Bartlett and R. C. Wheland, *J. Amer. Chem. Soc.*, **94**, 2145 (1972).

In the case of the fluorinated ethylenes, it is known through work of Bartlett and his collaborators that the reaction is stepwise by way of a biradical intermediate.¹⁷ Much of the evidence supporting this conclusion has been obtained from the study of additions of 1,1-difluoro-2,2-dichloroethylene, abbreviated 1122, to dienes. Scheme 1 outlines six possible general routes, each of which has several potential stereochemical variations, that addition of an olefin to a diene could follow. When 1122 reacts with butadiene and simple substituted butadienes, the products are entirely cyclobutanes; consequently, we may restrict attention

SCHEME 1

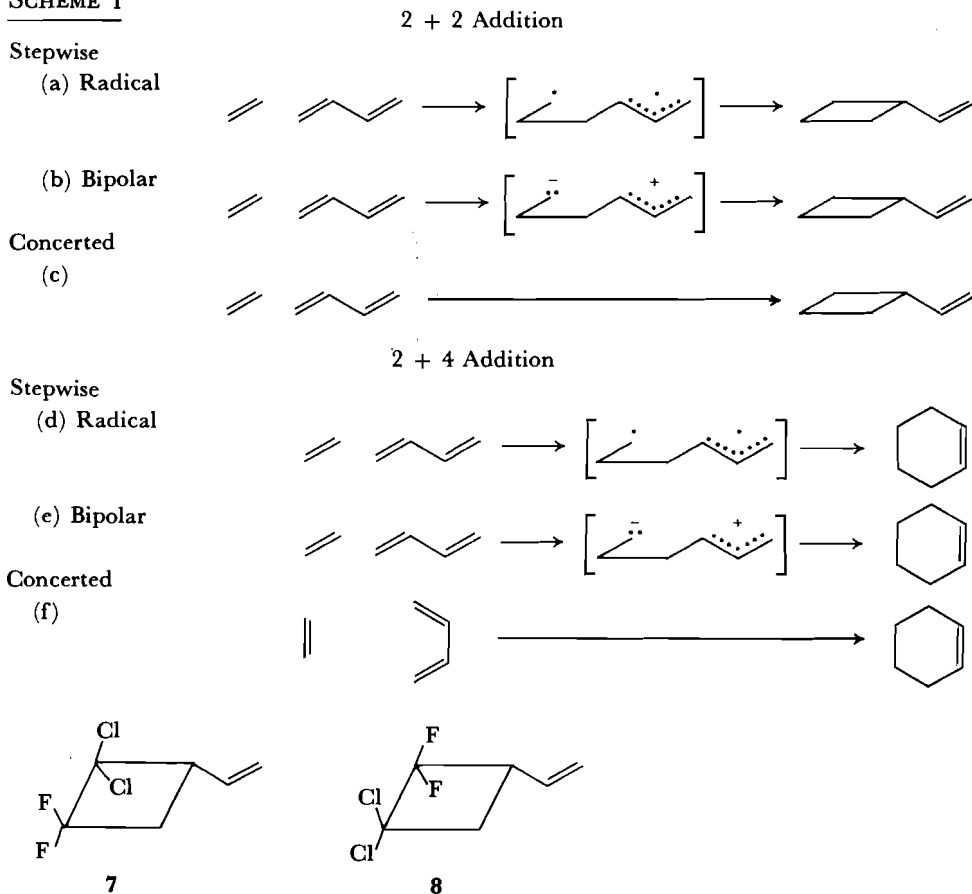

to the first three mechanisms of Scheme 1. Structure determination showed that the products are always of the type **7** rather than the alternative **8**.¹⁸ Because a chlorine substituent is better at stabilizing an adjacent radical center than is fluorine,¹⁹ this result suggests path (a) of Scheme 1. The finding that the stereochemistry about the terminal double bond is retained (Equation 12.12) is

¹⁷ Mechanisms of 2 + 2 additions and the competition between 2 + 2 and 2 + 4 additions are reviewed by (a) P. D. Bartlett, *Quart. Rev. (London)*, **24**, 473 (1970); (b) P. D. Bartlett, *Pure Appl. Chem.*, **27**, 597 (1971); (c) P. D. Bartlett, *Science*, **159**, 833 (1968).

¹⁸ P. D. Bartlett, L. K. Montgomery, and B. Seidel, *J. Amer. Chem. Soc.*, **86**, 616 (1964).

¹⁹ (a) P. D. Bartlett, L. K. Montgomery, and B. Seidel, *J. Amer. Chem. Soc.*, **86**, 616 (1964); (b) P. D. Bartlett and R. R. Hiatt, *J. Amer. Chem. Soc.*, **80**, 1398 (1958).

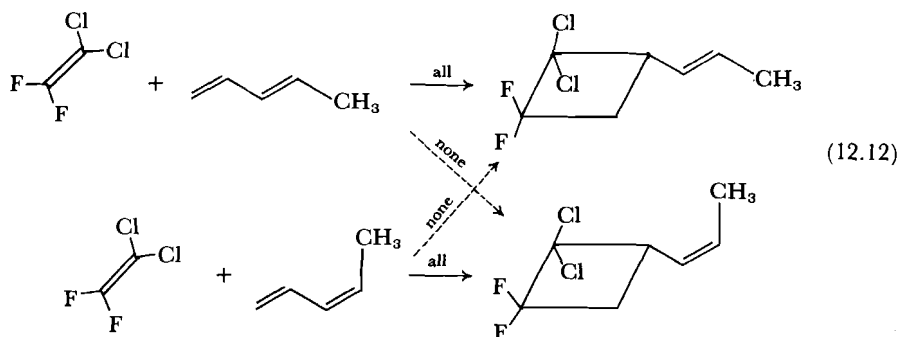

consistent with the known propensity for allylic radicals to resist rotation about the partial double bonds.²⁰ The observation of a rate change by a factor of only three in addition of 1122 to butadiene upon changing solvent from nonpolar ether or hexane to polar nitromethane or methanol effectively eliminates the possibility of the bipolar path (b) of Scheme 1.²¹

The stereochemistry of the reaction of 1122 with each of the three geometrical isomers of 2,4-hexadiene is shown in Scheme 2.²² There are only four products, the trans-trans diene yielding two, the cis-cis diene the other two, and the trans-cis diene all four. The numbers attached to the arrows show the

SCHEME 2

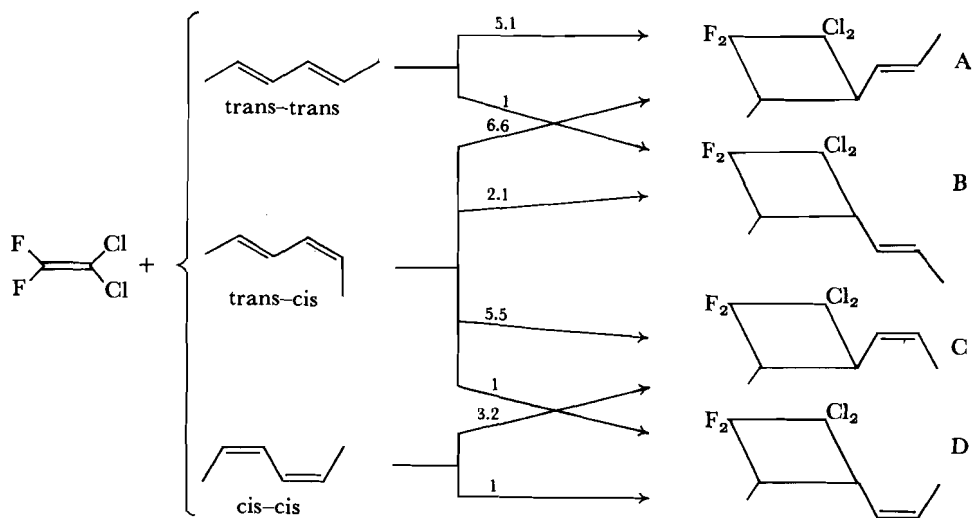

proportions obtained from each. A concerted mechanism would require stereospecific combination of the 1122 with the double bond to which it chooses to add; the trans-trans isomer could then yield only A, the cis-cis isomer only D, and the trans-cis isomer only B and C, predictions clearly inconsistent with the results. The only possible way to account for the observations is to postulate an

²⁰ C. Walling and W. Thaler, *J. Amer. Chem. Soc.*, **83**, 3877 (1961).

²¹ See note 17(a).

²² L. K. Montgomery, K. Schueller, and P. D. Bartlett, *J. Amer. Chem. Soc.*, **86**, 622 (1964).

intermediate (Equation 12.13) in which one bond has formed and in which rotation about the former double bond competes with closure of the ring.²³

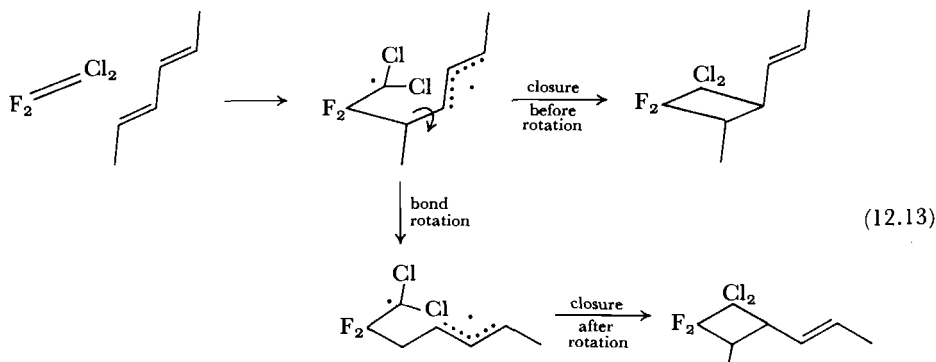

Scheme 3 shows the pathway leading to each product. Arrows with loops designate bond rotation preceding ring closure. The proportions reflect the preference for formation of the trans-substituted cyclobutane and the relative rates of bond rotation and of ring closure. Analysis of the data revealed that bond rotation is ten times faster than closure.²⁴

SCHEME 3²⁵

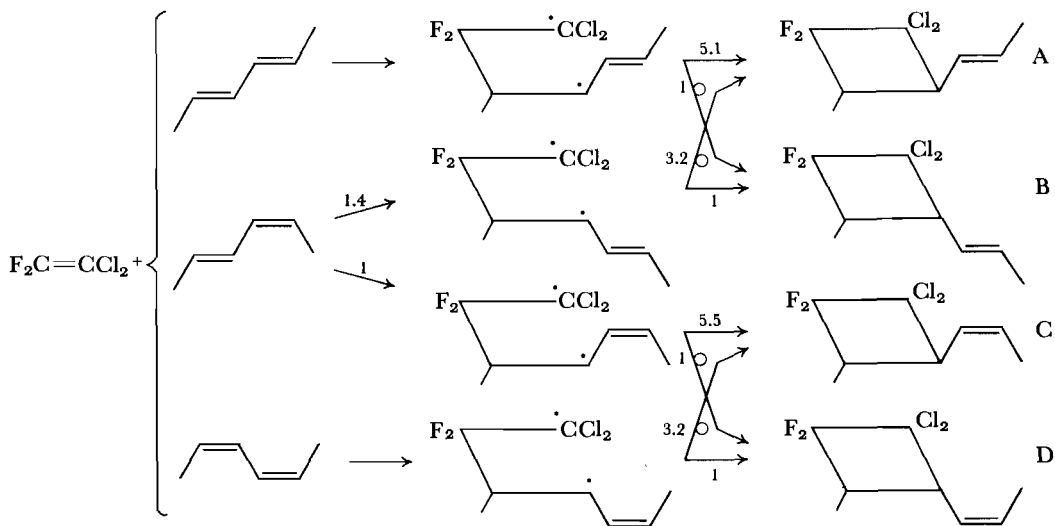

²³ The estimated ΔH for the addition step is sufficiently small that formation of a biradical is plausible. See note 22.

²⁴ (a) See note 22, p. 631. Another characteristic of the biradical cycloadditions, observed particularly at higher temperatures (above 100°C) is reversal of the initial addition step after bond rotation with resulting isomerization of the double bond in recovered diene. See (b) P. D. Bartlett, C. J. Dempster, L. K. Montgomery, K. E. Schueller, and G. E. H. Wallbillich, *J. Amer. Chem. Soc.*, **91**, 405 (1969); (c) P. D. Bartlett and G. E. H. Wallbillich, *J. Amer. Chem. Soc.*, **91**, 409 (1969).

²⁵ Scheme 3 is adapted with permission from Chart I of L. K. Montgomery, K. Schueller, and P. D. Bartlett, *J. Amer. Chem. Soc.*, **86**, 622 (1964). Copyright by the American Chemical Society.

Comparison of results with 1122 and tetrafluoroethylene led Bartlett and co-workers to the conclusion that the important barrier to closure in the intermediate biradical is a conformational one.²⁶ The biradical can be formed in any of a number of conformations, with a stretched-out arrangement (9) likely to be favored. Rotations about the 1,2 and 2,3 bonds are then required to bring

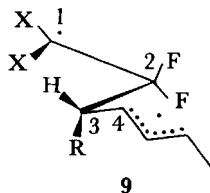

the two radical centers into the proper relative orientation for bonding; meanwhile, there is time for the rotation about 3,4 that determines the stereochemistry of the four-membered ring. Closure occurs with little or no activation energy once the proper conformation is attained. The pattern of loss of stereochemistry is not restricted to addition to dienes, but has been demonstrated also in several 2 + 2 additions to olefins.²⁷

Also known are 2 + 2 cycloadditions proceeding by way of a bipolar ion, path (b) of Scheme 1.²⁸ These reactions occur in situations such as that depicted in Equation 12.14, where the intermediate zwitterion (10) is strongly stabilized. Tetracyanoethylene adds by this mechanism to *p*-methoxyphenyl-,²⁹ alkoxy-,³⁰ and cyclopropyl-³¹ substituted olefins. The additions show large solvent effects.³² Partial loss of stereochemistry occurs as in the biradical cases, but it is much less pronounced.

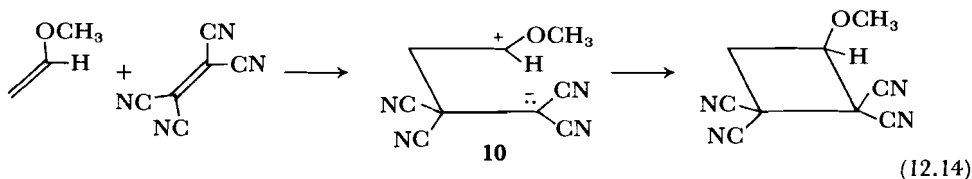

Equation 12.15 illustrates another variation of the 2 + 2 reaction, the $\pi 2 + \sigma 2$ addition of olefins activated by electron-withdrawing groups to highly strained single bonds. (The wavy lines indicate a mixture of stereoisomers.) The lack of stereospecificity shows that these are stepwise reactions.³³

The evidence we have described establishes that in 2 + 2 additions olefins will avoid the forbidden $2s + 2s$ concerted path in favor of a stepwise route.

²⁶ See note 24(b).

²⁷ (a) P. D. Bartlett, K. Hummel, S. P. Elliott, and R. A. Minns, *J. Amer. Chem. Soc.*, **94**, 2898 (1972); (b) P. D. Bartlett, G. M. Cohen, S. P. Elliott, K. Hummel, R. A. Minns, C. M. Sharts, and J. Y. Fukunaga, *J. Amer. Chem. Soc.*, **94**, 2899 (1972); (c) R. Wheland and P. D. Bartlett, *J. Amer. Chem. Soc.*, **95**, 4003 (1973).

²⁸ Review: R. Gompper, *Angew. Chem. Int. Ed.*, **8**, 312 (1969).

²⁹ (a) See note 17(a), p. 630; (b) J. K. Williams, D. W. Wiley, and B. C. McKusick, *J. Amer. Chem. Soc.*, **84**, 2210 (1962).

³⁰ (a) R. Huisgen and G. Steiner, *J. Amer. Chem. Soc.*, **95**, 5054, 5055 (1973); (b) G. Steiner and R. Huisgen, *J. Amer. Chem. Soc.*, **95**, 5056 (1973).

³¹ S. Nishida, I. Moritani, and T. Teraji, *J. Org. Chem.*, **38**, 1878 (1973).

³² See note 30.

³³ P. G. Gassman, *Accts. Chem. Res.*, **4**, 128 (1971).

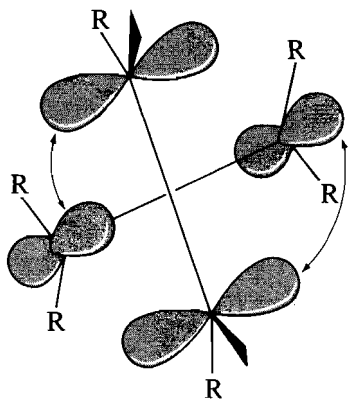
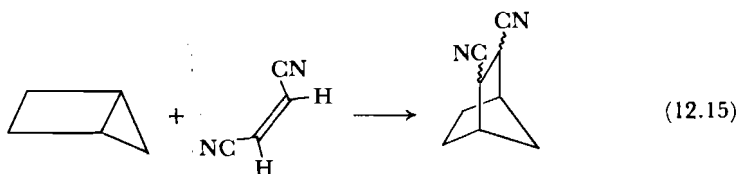
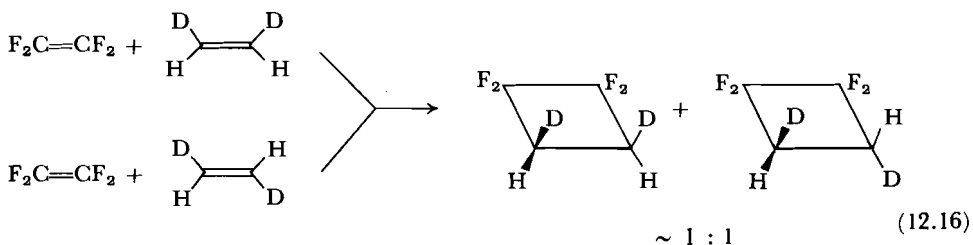

Figure 12.1 Geometry of approach for a $2s + 2a$ cycloaddition.



Thermal additions might nevertheless in some instances follow the allowed $2s + 2a$ process. Figure 12.1 illustrates the approximate geometry required of a $2s + 2a$ transition state; there will be serious hindrance to the approach by the groups R. In a search for this reaction, it will therefore be appropriate to have the groups R as small as possible. Bartlett and his collaborators have examined the stereochemistry of addition of tetrafluoroethylene to *cis*- and *trans*-1,2-dideuterioethylene;³⁴ the results, summarized in Equation 12.16, demonstrate that the reaction is stepwise. Other experiments aimed at detecting the $2s + 2a$ process in olefins have similarly led to negative results.³⁵



A suprafacial-antarafacial path is possible when one of the components has an *sp*-hybridized carbon, as in a ketene, so that one of the interfering R groups is absent. Ketenes add to olefins with retention of the *cis*-*trans* geometry about the olefin component and with the orientation and stereochemistry that yields the sterically most hindered product.³⁶ Thus in additions to cyclopenta-

³⁴ See note 27(b), p. 633.

³⁵ (a) J. E. Baldwin and P. W. Ford, *J. Amer. Chem. Soc.*, **91**, 7192 (1969); (b) A. T. Cocks, H. M. Frey, and I. D. R. Stevens, *Chem. Commun.*, 458 (1969).

³⁶ For a summary of the evidence and references, see: (a) P. D. Bartlett, *Pure Appl. Chem.*, **27**, 597 (1971); review: (b) R. W. Holder, *J. Chem. Educ.*, in press (1976).

diene (Equation 12.17), the larger substituent L assumes the more crowded endo position;³⁷ addition to cis olefins (Equation 12.18) yields the syn product;³⁸ and with 1,1-disubstituted olefins, (Equation 12.19) the product is the vicinal isomer.³⁹ A negative activation entropy, $\Delta S^\ddagger = -20 \text{ cal mole}^{-1} \text{ }^\circ\text{K}^{-1}$,⁴⁰ small solvent effects on rate,⁴¹ and a Hammett ρ of only -0.73 for addition of

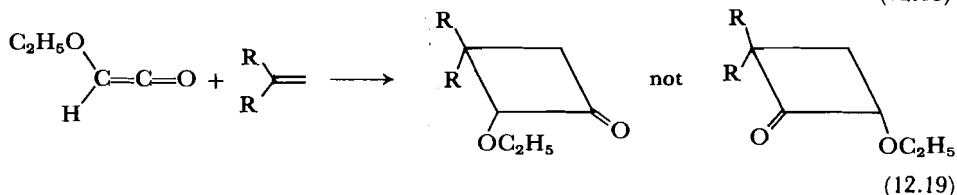
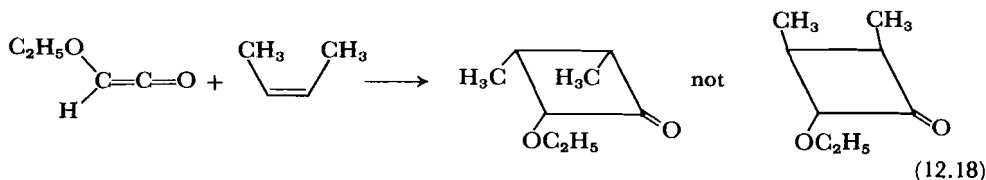
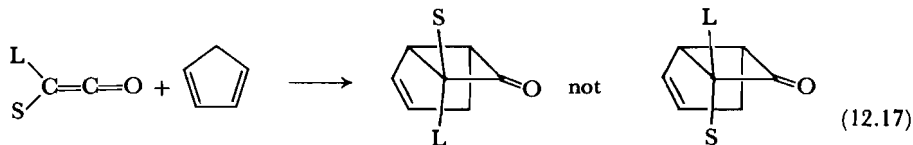

diphenyl ketene to substituted styrenes⁴² point to a transition state characterized by an ordered structure with little charge separation. A secondary isotope effect of $k_{\text{H}}/k_{\text{D}} = 0.91$ per deuterium for the addition of diphenylketene to β,β -deuteriostyrene (Equation 12.20) is consistent with a change from sp^2 toward sp^3 hybridization in the transition state; the result, $k_{\text{H}}/k_{\text{D}} = 1.23$ for Equation 12.21, was considered compatible with a concerted process and not with a stepwise one, although the interpretation remains ambiguous.⁴³ The $2s + 2a$ transition state (11) accounts for the characteristics of the reaction. The least hindered approach of reactants leads inexorably to the most hindered product. The electron-deficient carbon end of the carbonyl π orbital (perpendicular to the page in 11) impinges directly on the olefin π bond in the $s + a$ approach; this interaction is considered to provide a key stabilizing influence.⁴⁴

³⁷ (a) M. Rey, S. Roberts, A. Dieffenbacher, and A. S. Dreiding, *Heiv. Chim. Acta*, **53**, 417 (1970); (b) P. R. Brook, J. M. Harrison, and A. J. Duke, *Chem. Commun.*, 589 (1970); (c) W. T. Brady and E. F. Hoff, Jr., *J. Org. Chem.*, **35**, 3733 (1970); (d) W. T. Brady and R. Roe, Jr., *J. Amer. Chem. Soc.*, **93**, 1662 (1971).

³⁸ T. DoMinh and O. P. Strausz, *J. Amer. Chem. Soc.*, **92**, 1766 (1970).

³⁹ See note 38.

⁴⁰ N. S. Isaacs and P. Stanbury, *J. Chem. Soc., Perkin II*, 166 (1973).

⁴¹ See note 40.

⁴² J. E. Baldwin and J. A. Kapecki, *J. Amer. Chem. Soc.*, **92**, 4868 (1970).

⁴³ J. E. Baldwin and J. A. Kapecki, *J. Amer. Chem. Soc.*, **92**, 4874 (1970).

⁴⁴ (a) Woodward and Hoffmann, *The Conservation of Orbital Symmetry*, p. 163; (b) R. Sustmann, A. Ansmann, and F. Vahrenholt, *J. Amer. Chem. Soc.*, **94**, 8099 (1972). Allenes present a similar steric but different electronic situation. Some investigators have found evidence for a concerted $2s + 2a$ process, but others have interpreted the data in terms of a biradical process. See (c) S. Dai and W. R. Dolbier, Jr., *J. Amer. Chem. Soc.*, **94**, 3946 (1972), and references cited therein; (d) J. J. Gajewski and C. N. Sinh, *J. Amer. Chem. Soc.*, **94**, 1675 (1972).

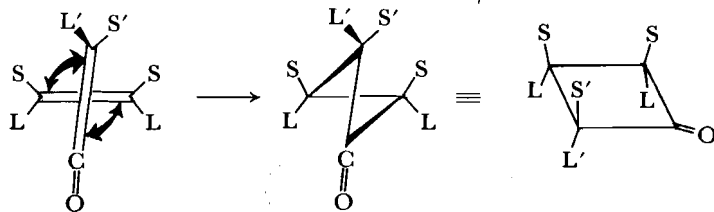
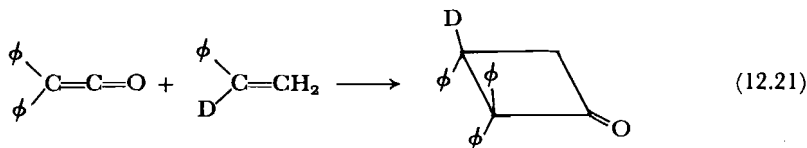
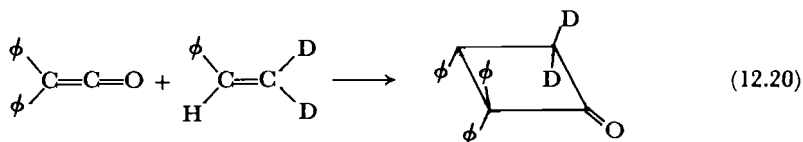

11

Despite the success of the concerted $2s + 2a$ pericyclic pathway in explaining stereochemistry of numerous ketene additions, there are also examples of additions of ketenes that occur by a stepwise path.⁴⁵ A number of other heterocumulenes also undergo $2 + 2$ additions.⁴⁶

The most frequently observed $2 + 2$ additions are photochemical. The excited-state additions, allowed by the pericyclic selection rules, occur readily and have proved extremely useful in synthesis. Examples will be considered in Section 13.4.⁴⁷

2 + 4 Cycloadditions. The Diels-Alder Reaction

Numerous $2 + 4$ cycloadditions have been known since long before the advent of the pericyclic theory; they are among the most powerful of synthetic reactions. The most important of these is the Diels-Alder reaction, of which Equation 12.22 is the prototype. Recognized by Diels and Alder in 1928, it presents a convenient and highly stereospecific route to the ubiquitous six-membered ring.⁴⁸

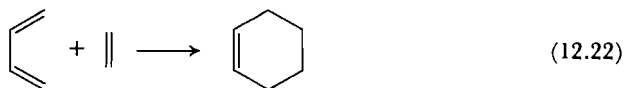

⁴⁵ (a) R. Huisgen and P. Otto, *J. Amer. Chem. Soc.*, **91**, 5922 (1969); (b) W. G. Duncan, W. Weyler, Jr., and H. W. Moore, *Tetrahedron Lett.*, 4391 (1973); (c) note 36(b), p. 634. For a theoretical assessment of conditions under which stepwise additions of ketenes are likely, see (d) K. N. Houk, R. W. Strozier, and J. A. Hall, *Tetrahedron Lett.*, 897 (1974).

⁴⁶ See Gilchrist and Storr, *Organic Reactions and Orbital Symmetry*, p. 167, for some examples.

⁴⁷ Transition metal ions catalyze a number of ground-state forbidden pericyclic reactions. See (a) L. A. Paquette, *Accts. Chem. Res.*, **4**, 280 (1971); (b) F. D. Mango, *Tetrahedron Lett.*, 1509 (1973); (c) C. W. Bird, D. L. Colinese, R. C. Cookson, J. Hudec, and R. O. Williams, *Tetrahedron Lett.*, 373 (1961); (d) P. W. Jolly, F. G. A. Stone, and K. Mackenzie, *J. Chem. Soc.*, 6416 (1965); (e) M. J. S. Dewar, *Angew. Chem. Int. Ed.*, **10**, 761 (1971); (f) W. Th. A. M. van der Lugt, *Tetrahedron Lett.*, 2281 (1970); (g) W. Merk and R. Pettit, *J. Amer. Chem. Soc.*, **89**, 4787, 4788 (1967).

⁴⁸ (a) O. Diels and K. Alder, *Justus Liebigs Ann. Chem.*, **460**, 98 (1928). For references to subsequent work by Diels and Alder and for further discussion the reader is referred to the numerous review

The pericyclic theory, predicting as it does an allowed concerted $2s + 4s$ process, is in agreement with the known facts about the mechanism. We shall review briefly here the salient features.

Although the reaction occurs in the unsubstituted case,⁴⁹ it is most successful when the diene and the olefin (referred to in this context as the *dienophile*) bear substituents of complementary electronic influence. Although these are most commonly an electron-donating group on the diene and an electron-withdrawing group on the dienophile, there are also a number of instances that illustrate *inverse electron demand*, that is, electron-withdrawing groups on the diene and donating groups on the dienophile.

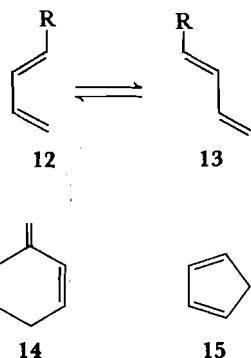

The first important point about the reaction is that the diene must be in the *s-cis* conformation (12) in order to react. Thus dienes with one double bond exocyclic, such as 14, do not give the reaction, whereas endocyclic dienes (15) react rapidly. Reactivity of open-chain dienes, assuming constant substituent R, depends on the equilibrium between the two conformations. A *cis* substituent favors the *s-trans* form (17) and retards the addition, whereas a 2-substituent

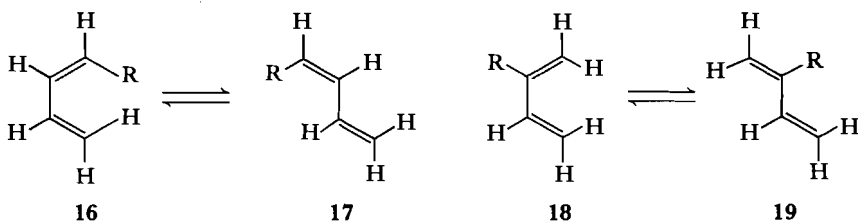

favors the *s-cis* form (18) and enhances the rate. These effects are consistent with the concerted process formulated in Section 11.3 (p. 594), where in the transition state bonding occurs simultaneously at both ends of the diene.

articles that have appeared: (b) J. A. Norton, *Chem. Rev.*, **31**, 319 (1942); (c) M. C. Kloetzel, *Org. Reactions*, **4**, 1 (1948); (d) H. L. Holmes, *Org. Reactions*, **4**, 60 (1948); (e) L. W. Butz and A. W. Rytina, *Org. Reactions*, **5**, 136 (1949); (f) J. Sauer, *Angew. Chem. Int. Ed.*, **5**, 211 (1966); reverse Diels-Alder, (g) H. Kwart and K. King, *Chem. Rev.*, **68**, 415 (1968); components containing hetero atoms, (h) S. B. Needleman and M. C. Chang Kuo, *Chem. Rev.*, **62**, 405 (1962); stereochemistry, (i) J. G. Martin and R. K. Hill, *Chem. Rev.*, **61**, 537 (1961); mechanism (j) A. Wassermann, *Diels-Alder Reactions*, Elsevier, Amsterdam, 1965; (k) J. Sauer, *Angew. Chem. Int. Ed.*, **6**, 16 (1967); general, (l) R. Huisgen, R. Grashey, and J. Sauer, in *The Chemistry of Alkenes*, S. Patai, Ed., Wiley-Interscience, London, 1964, p. 739.

⁴⁹ L. M. Joshel and L. W. Butz, *J. Amer. Chem. Soc.*, **63**, 3350 (1941).

Orientation of addition of a mono-substituted diene and mono-substituted dienophile (Equations 12.23 and 12.24) is difficult to interpret. It might be taken as evidence for a stepwise process, the major products being those expected

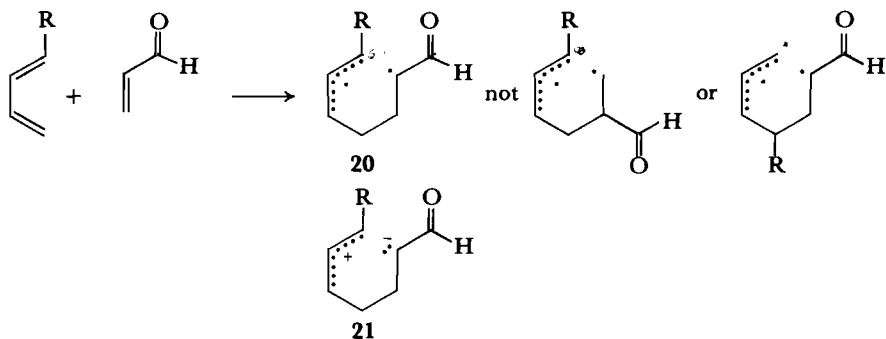
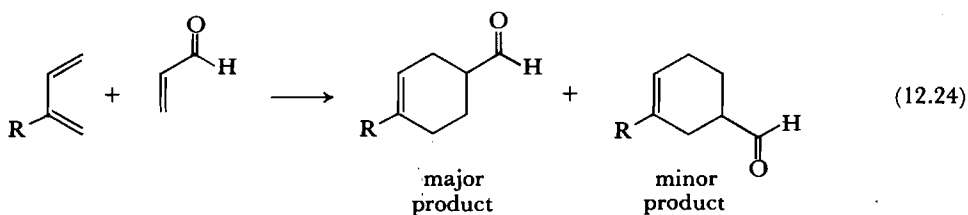
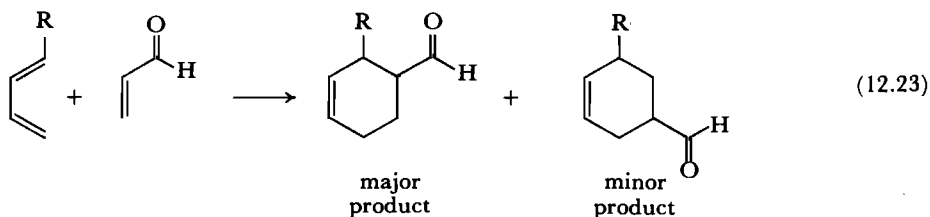

from formation of the most stable intermediate biradical (for example **20**), were it not for the other convincing evidence against such a mechanism. The zwitterion possibility (**21**) is ruled out by lack of solvent effect on rate and by lack of sensitivity of product distribution to the nature of the substituents.⁵⁰

Stereochemistry provides a strong point in favor of a concerted process. The additions are always exclusively *cis*, so that the relative configurations of substituents existing in the components is maintained in the product. Thus a *cis*-substituted dienophile leads to a *cis*-substituted cyclohexene, and *trans* to *trans* (Equation 12.25); *trans*-*trans* dienes yield *cis* substitution, and *cis*-*trans* dienes give *trans* substitution (Equation 12.26).⁵¹ It thus is clear that there is no intermediate of the kind found in 2 + 2 cycloadditions, in which bond rotations leading to mixed stereochemistry can occur.

When both diene and dienophile are substituted, the *endo principle* applies. This rule is illustrated in Equation 12.27;⁵² the more stable transition state (**22**) is that which has the maximum juxtaposition of unsaturated centers. Woodward

⁵⁰ See note 48(k), (l), p. 637.

⁵¹ See note 48(i), p. 637.

⁵² See note 48(i), p. 637.

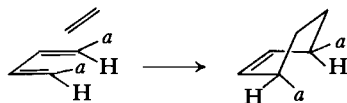
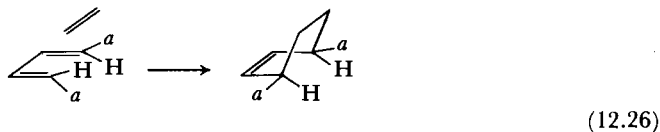
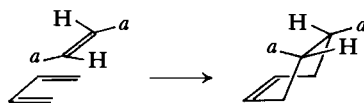
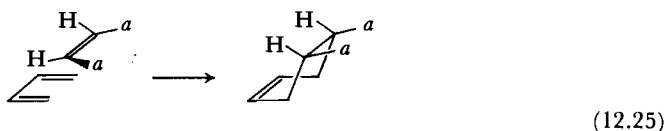

and Hoffmann have attributed the extra stability of **22** to favorable secondary interactions of the HOMO-LUMO type between the centers indicated by *.

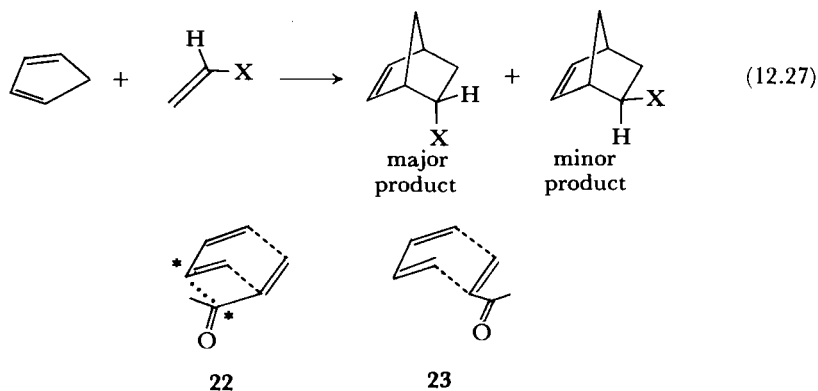

Because these centers are too far apart to interact in the exo alternative **23**, it does not have the benefit of the extra stabilization.⁵³

In addition to the stereochemistry, there is kinetic evidence favoring a concerted process. The highly negative activation entropies (ΔS^\ddagger typically about $-35 \text{ cal mole}^{-1} \text{ }^\circ\text{K}^{-1}$) accompanied by low activation enthalpy (ΔH^\ddagger usually less than $25 \text{ kcal mole}^{-1}$) point to an ordered but energetically favorable transition state. Secondary hydrogen isotope effects have been investigated by various workers; although interpretation is difficult, the observation of small inverse effects ($k_{\text{H}}/k_{\text{D}} < 1$) appears consistent with a concerted process with a small degree of change of hybridization at carbon from sp^2 toward sp^3 in the transition state.⁵⁴

Although the question of whether the addition is concerted or not might still be considered by some to be open to debate,⁵⁵ the weight of evidence favors

⁵³ Woodward and Hoffmann, *The Conservation of Orbital Symmetry*, p. 145.

⁵⁴ See note 48(k).

⁵⁵ N. D. Epiotis, *J. Amer. Chem. Soc.*, **95**, 5624 (1973).

the conclusion that it is concerted. The orientation effects await a convincing explanation.

Bartlett and co-workers have shown that in those rare cases where 2 + 2 and 2 + 4 cycloadditions occur simultaneously between an olefin and a diene, the 2 + 2 addition, as judged by stereochemical criteria, follows the stepwise biradical path whereas the 2 + 4 is stereospecific and concerted.⁵⁶

2 + 4 Reactions. 1,3-Dipolar Additions

A number of reactions are known in which a three-atom chain bearing four electrons in a π system adds to an olefin. These transformations, explored extensively by Huisgen and his collaborators,⁵⁷ are known as 1,3-dipolar additions. The 1,3 dipoles are characterized by a structure for which at least one contributing form is of the dipolar type **24**. Huisgen has identified two types of 1,3



24

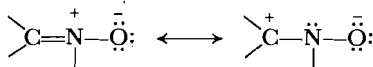

25

nitron

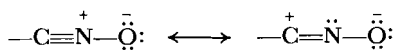

26

nitrile oxide

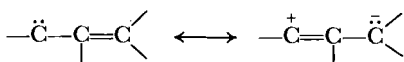

27

vinyl carbene

dipoles, those with *octet stabilization*, for example **25** or **26**, in which the 1,3-dipolar structure is a minor contributor, and those without octet stabilization, such as **27**, which are nonisolable intermediates. A number of 1,3 dipoles containing various combinations of carbon, nitrogen, and oxygen have been investigated; the addition provides an important route to heterocyclic five-membered ring systems.⁵⁸ Evidence similar to that outlined above for the Diels-Alder reaction (stereospecific *cis* addition, highly negative activation entropy) points to concerted

⁵⁶ (a) P. D. Bartlett, A. S. Wingrove, and R. Owyang, *J. Amer. Chem. Soc.*, **90**, 6067 (1968); (b) R. Wheland and P. D. Bartlett, *J. Amer. Chem. Soc.*, **92**, 3822 (1970).

⁵⁷ (a) See note 48(1), p. 637; (b) R. Huisgen, *Angew. Chem. Int. Ed.*, **2**, 565 (1963); (c) R. Huisgen, *Angew. Chem. Int. Ed.*, **2**, 633 (1963).

⁵⁸ An important reaction that may fit into the 1,3-dipolar addition category is the addition of ozone, O₃, to the carbon-carbon double bond. The structure of the initial addition product is, however, still uncertain. See (a) R. W. Murray, *Accts. Chem. Res.*, **1**, 313 (1968); (b) P. R. Story, E. A. Whited, and J. A. Alford, *J. Amer. Chem. Soc.*, **94**, 2143 (1972); (c) C. W. Gilles and R. W. Kuczkowski, *J. Amer. Chem. Soc.*, **94**, 6337 (1972). 1,4-Dipolar additions leading to six-membered rings are also known. See, for example: (d) K. T. Potts and M. Sorm, *J. Org. Chem.*, **36**, 8 (1971).

addition of the 1,3 dipoles to olefinic double bonds and hence supports their treatment as symmetry-allowed pericyclic reactions.

2 + 4 Cheletropic Reactions

The pericyclic theory predicts that cheletropic reactions of four-electron with two-electron components may occur by the linear path (p. 628), that is, suprafacially on the one-atom component, if the diene enters also suprafacially (six-electron interaction diagram **28**). A number of examples are known, most of

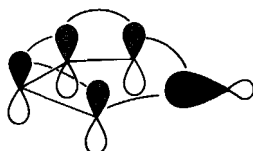

28

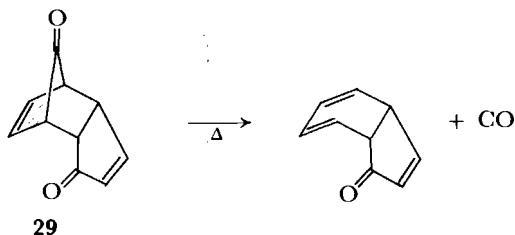

them in the reverse, fragmentation, direction.⁵⁹ Cyclopentenone **29** undergoes fragmentation,⁶⁰ and attempts to prepare norbornadien-7-one (**30**) yield only benzene and carbon monoxide.⁶¹

Equation 12.28, a reaction that also occurs in the addition direction, is stereospecific; because the diene enters suprafacially, the selection rules predict

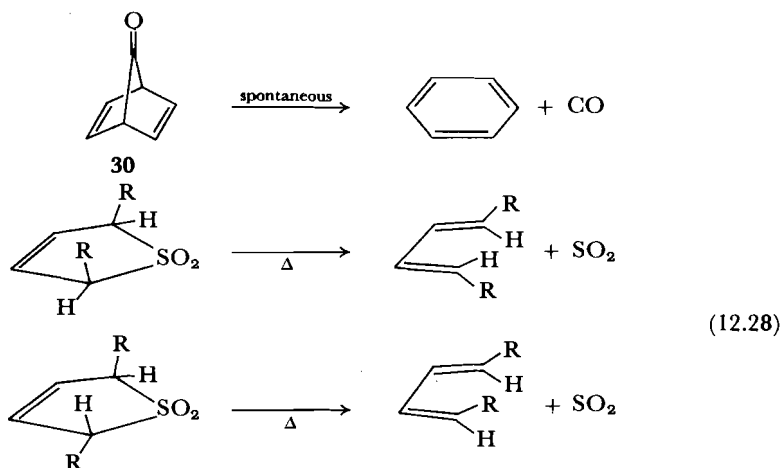

⁵⁹ (a) Woodward and Hoffmann, *The Conservation of Orbital Symmetry*, p. 156; (b) Gilchrist and Storr, *Organic Reactions and Orbital Symmetry*, p. 125.

⁶⁰ J. E. Baldwin, *Can. J. Chem.*, **44**, 2051 (1966).

⁶¹ S. Yankelevich and B. Fuchs, *Tetrahedron Lett.*, 4945 (1967).

that the SO_2 should interact by the linear path.⁶² The analogous reactions involving loss of sulfur monoxide from cyclic sulfoxides, although yielding the expected isomers as major products, are not completely stereospecific. Photolysis, expected on the basis of the pericyclic theory to yield products with reversed selectivity, produces extensive loss of stereochemistry; the photo reactions are probably not concerted.⁶³

Higher Cycloadditions

Examples of cycloadditions with more than six electrons are relatively rare; detailed mechanistic information is in most cases not available. The stereochemistry of the $6 + 2$ cheletropic sulfur dioxide extrusion shown in Equations

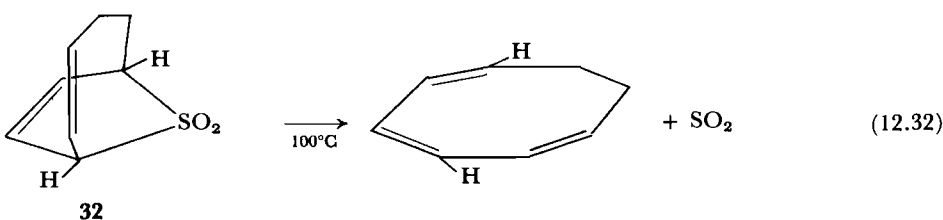
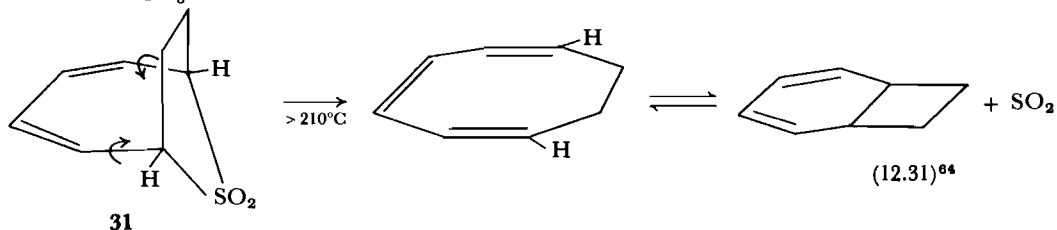
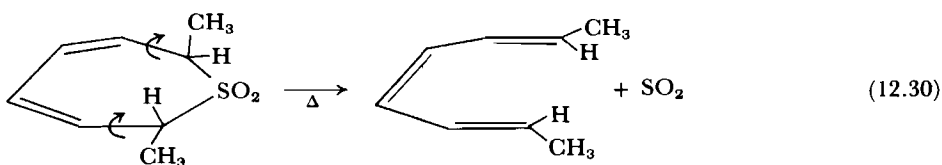
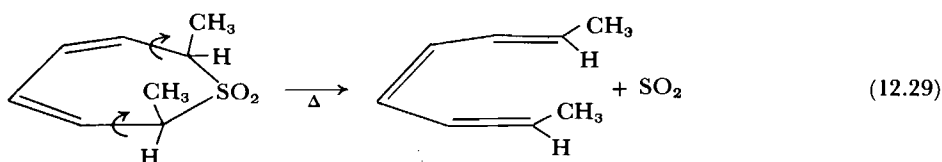

12.29 and 12.30 has been shown to be antarafacial (conrotatory) in the triene component, in accord with expectations for a linear path.⁶⁵ The bicyclic sulfone

⁶² (a) W. L. Mock, *J. Amer. Chem. Soc.*, **88**, 2857 (1966); (b) S. D. McGregor and D. M. Lemal, *J. Amer. Chem. Soc.*, **88**, 2858 (1966); (c) W. L. Prins and R. M. Kellogg, *Tetrahedron Lett.*, 2833 (1973); (d) Review: S. D. Turk and R. L. Cobb, in *1,4 Cycloaddition Reactions*, J. Hamer, Ed., Academic Press, New York, 1967, p. 13; analogous reactions of trivalent phosphorus are reviewed by (e) L. D. Quinn, in *1,4 Cycloaddition Reactions*, J. Hamer, Ed., p. 47.

⁶³ See note 62(c).

⁶⁴ The two C_8H_{10} isomers are in equilibrium at this temperature. See Section 12.2, p. 655.

⁶⁵ W. L. Mock, *J. Amer. Chem. Soc.*, **91**, 5682 (1969).

31, constrained by the ring system to fragment suprafacially on the triene and therefore, according to theory, to open antarafacially (nonlinear path) with respect to the sulfur dioxide, reacts slower by a factor of about 6×10^4 at 180°C than the $4 + 2$ counterpart, **32**, for which the selection rules permit the linear path.⁶⁶ It is not known whether the decomposition 12.31 is concerted.

There are few $6 + 2$ cycloadditions known; an example is given in Equation 12.33.⁶⁷ The selection rules require either that the nitroso group enter

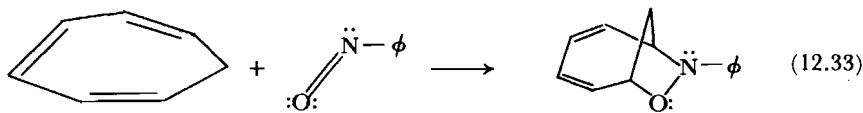

antarafacially (the triene must react suprafacially because of the constraint of the ring) or that the reaction be stepwise. The available evidence does not permit a test of this prediction.

No concerted thermal $4 + 4$ cycloadditions are known; photochemical $4 + 4$ additions are observed, but in most cases probably occur through biradicals.⁶⁸ It should be noted that in the thermal butadiene dimerization (Equation 12.34), the eight-membered ring arises through the allowed $[3,3]$ -sigmatropic isomerization of *cis*-divinylcyclobutane.⁶⁹

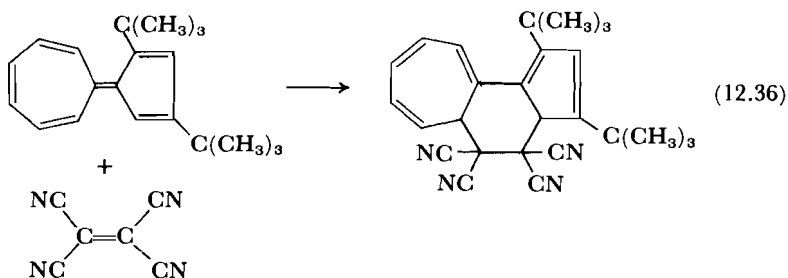
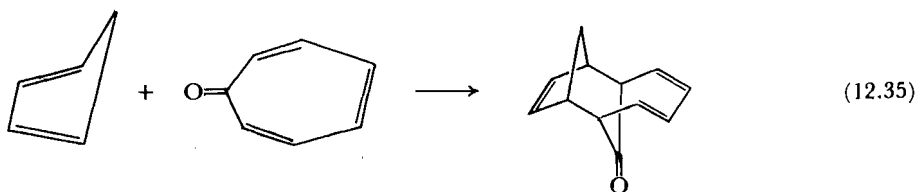
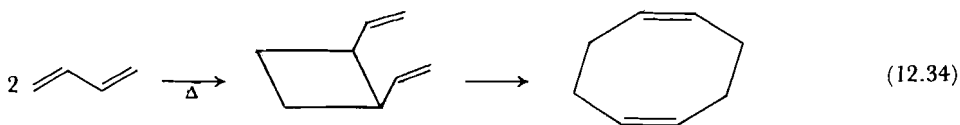

$6 + 4$ Cycloadditions, which should be allowed in the suprafacial-suprafacial mode, are known. An example is the addition of tropone to cyclopentadiene

⁶⁶ W. L. Mock, *J. Amer. Chem. Soc.*, **92**, 3807 (1970).

⁶⁷ (a) J. Hutton and W. A. Waters, *Chem. Commun.*, 634 (1966); (b) P. Burns and W. A. Waters, *J. Chem. Soc. (C)*, 27 (1969); (c) for a similar example, see W. S. Murphy and J. P. McCarthy, *Chem. Commun.*, 1155 (1968).

⁶⁸ (a) W. L. Dilling, *Chem. Rev.*, **69**, 845 (1969); (b) G. Kaupp, *Angew. Chem. Int. Ed.*, **11**, 718 (1972).

⁶⁹ See Section 12.3, p. 671.

(Equation 12.35); a low activation enthalpy and highly negative activation entropy ($\Delta H^\ddagger = 15.3 \text{ kcal mole}^{-1}$, $\Delta S^\ddagger = -35 \text{ cal mole}^{-1} \text{ }^\circ\text{K}^{-1}$) suggest a concerted mechanism similar to that of the Diels-Alder reaction.⁷⁰

Some interesting examples of additions of tetracyanoethylene to fulvalene systems, as in Equation 12.36,⁷¹ formally a 12 + 2 addition, indicate the potential for development in the field of higher-order cycloadditions.

Multicomponent Additions⁷²

Reactions of molecularity higher than two are unlikely because of the low probability of a collision of three or more molecules; multicomponent additions are therefore expected only when several of the components are suitably placed within a single molecule. Equations 12.37–12.40 illustrate some examples; for most reactions of this type, the question of concertedness remains to be answered.

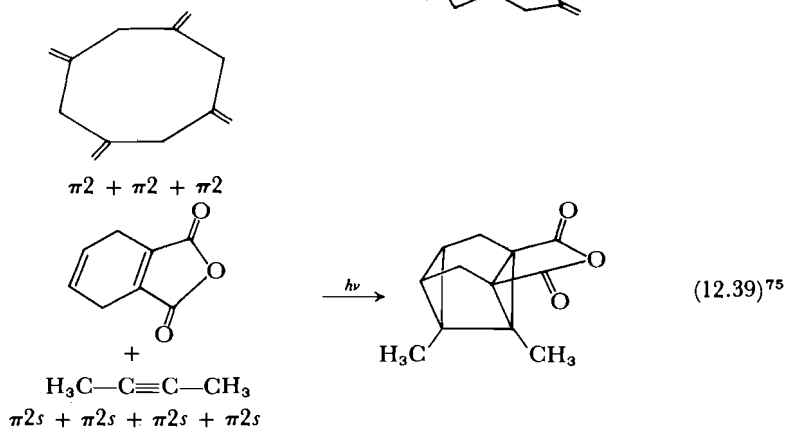
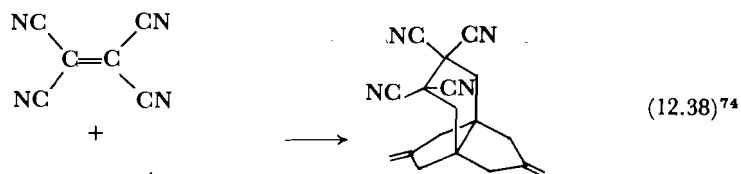
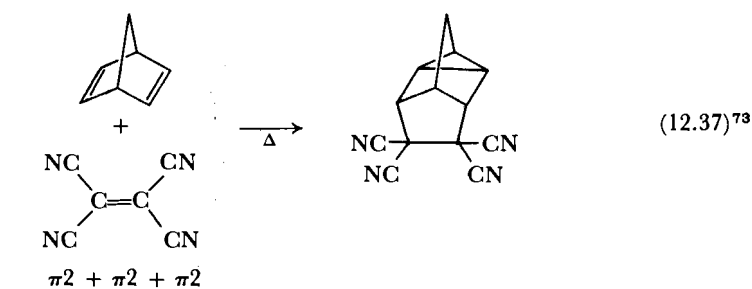

⁷⁰ H. Tanida and H. R. Pfaendler, *Helv. Chim. Acta*, **55**, 3062 (1972).

⁷¹ H. Prinzbach, *Pure Appl. Chem.*, **28**, 281 (1971).

⁷² See note 2, p. 626; and Woodward and Hoffmann, *The Conservation of Orbital Symmetry*, p. 106.

⁷³ (a) A. T. Blomquist and Y. C. Meinwald, *J. Amer. Chem. Soc.*, **81**, 667 (1959); see also (b) H. K. Hall, Jr., *J. Org. Chem.*, **25**, 42 (1960); (c) R. C. Cookson, S. S. H. Gilani, and I. D. R. Stevens, *Tetrahedron Lett.*, 615 (1962).

⁷⁴ J. K. Williams and R. E. Benson, *J. Amer. Chem. Soc.*, **84**, 1257 (1962).

⁷⁵ (a) R. Askani, *Chem. Ber.*, **98**, 3618 (1965); (b) Woodward and Hoffmann, *The Conservation of Orbital Symmetry*, p. 113.

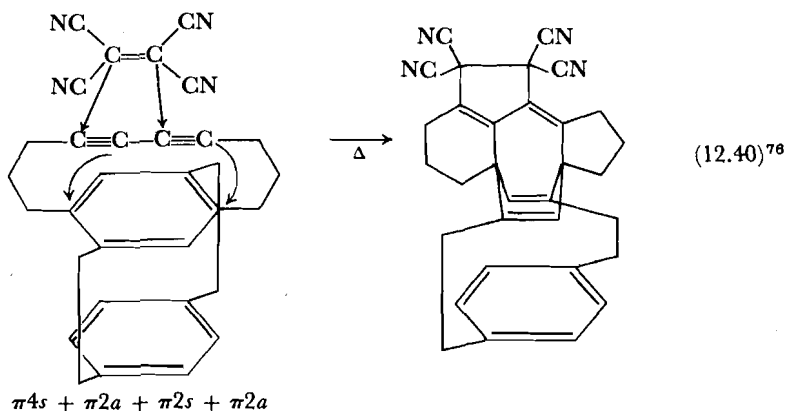

12.2 ELECTROCYCLIC REACTIONS⁷⁷

Electrocyclic reactions, considered in the direction of ring opening, occur in rings composed of two saturated centers joined by a single σ bond and by a π system. There are two general types, depending on whether the π system has an even or an odd number of atoms; the former are neutral closed shell molecules, whereas the latter are cations, anions, or radicals.

Recall from the previous chapter (Section 11.3, p. 581) that ground-state allowed electrocyclic processes are disrotatory (suprafacial, interaction diagram 33) for $4n + 2$ and conrotatory (antarafacial, with one phase inversion, inter-



33



34

action diagram 34) for $4n$ electrons. The ions encountered in odd-membered systems present no difficulty, as they fit readily in the theoretical scheme; radicals are not so easily accommodated. Figure 12.2 shows the correlation diagram for opening of the cyclopropyl ring. It is clear that the cation (lowest level only occupied) should prefer the disrotatory route and the anion (lower two levels doubly occupied) should follow the conrotatory path; in the radical (three π electrons) both require a net increase of energy for one electron. Hence the theory at this level allows no choice to be made. Dewar's first-order perturbation molecular orbital analysis also fails to distinguish the two pathways.⁷⁸ Attempts to settle the ambiguity theoretically have led to contradictory results: Woodward

⁷⁸ T. Kaneda, T. Ogawa, and S. Misumi, *Tetrahedron Lett.*, 3373 (1973).

⁷⁷ (a) R. B. Woodward and R. Hoffmann, *The Conservation of Orbital Symmetry*, Verlag Chemie, Weinheim Bergstr., Germany, and Academic Press, New York, 1970; (b) G. B. Gill, *Quart. Rev. (London)*, **22**, 338 (1968); (c) T. L. Gilchrist and R. C. Storr, *Organic Reactions and Orbital Symmetry*, Cambridge University Press, Cambridge, 1972.

⁷⁸ (a) M. J. S. Dewar and S. Kirschner, *J. Amer. Chem. Soc.*, **93**, 4290 (1971); see also (b) G. Boche and G. Szeimies, *Angew. Chem. Int. Ed.*, **10**, 911 (1971); (c) G. Szeimies and G. Boche, *Angew. Chem. Int. Ed.*, **10**, 912 (1971).

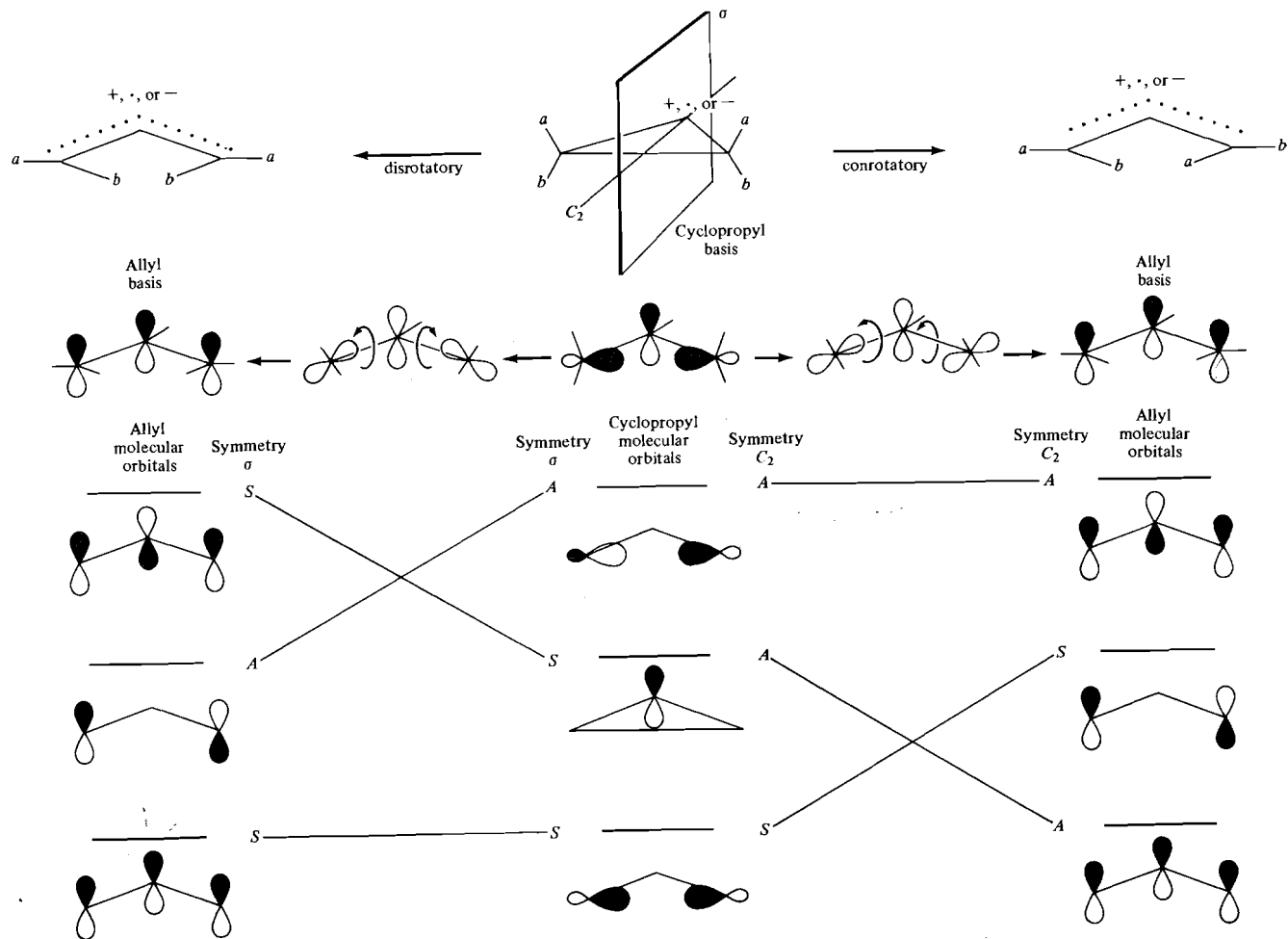

Figure 12.2 Orbital correlation diagram for disrotatory and conrotatory opening of the cyclopropyl system to the allyl system. At the center are the reacting orbitals for the cyclopropyl radical, cation, or anion. Orbitals are the bonding and antibonding σ orbitals and, at the back, the single p orbital that bears the positive or negative charge or unpaired electron. The conrotatory opening is shown at the right, with symmetries given

with respect to the C_2 axis; the disrotatory opening is at the left, with symmetries given with respect to the mirror plane. In the cation, the lowest level is occupied by two electrons, and disrotatory opening should occur; in the anion the two lower levels are each occupied by two electrons, and the conrotatory opening should occur. In the radical, with two electrons in the lowest level and one in the next, no preference is indicated.

and Hoffmann concluded, both on the basis of the idea that the highest occupied molecular orbital should be controlling and from extended Hückel calculation, that radicals should behave like the corresponding anions,⁷⁹ whereas Dewar and Kirschner, using the MINDO self-consistent field method, decided that the radical should behave like the cation.⁸⁰ The latter authors support their conclusion that $4n + 3 \pi$ electron radicals are aromatic by citing experimental evidence of a large stabilization energy in $\cdot\text{C}_7\text{H}_7$.⁸¹ Definitive experimental tests of stereochemistry of radical ring opening or closure are lacking.

Three-Membered Rings

Solvolysis of cyclopropyl derivatives leads directly to the allyl cation; the ring opening is disrotatory as predicted. The most direct demonstration is the transformation of the 2,3-dimethyl-1-chlorocyclopropanes at -100°C in strong acid

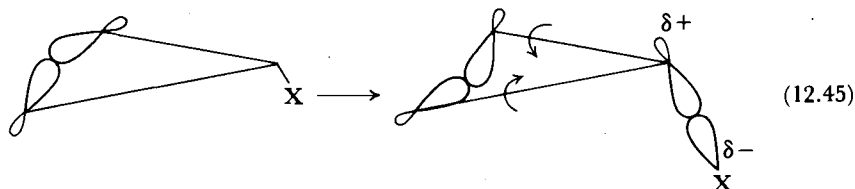
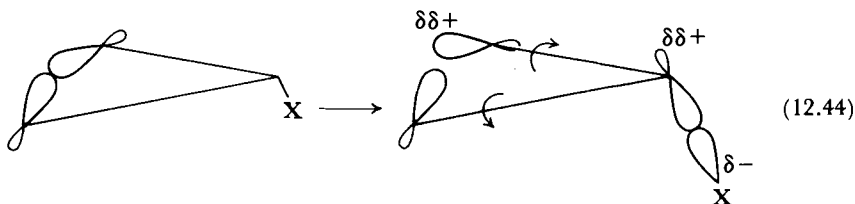
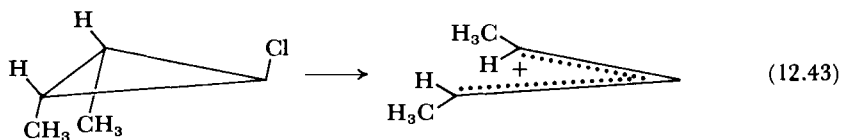
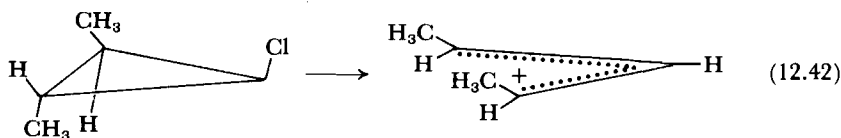
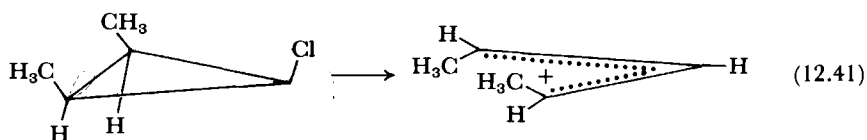

⁷⁹ R. B. Woodward and R. Hoffmann, *J. Amer. Chem. Soc.*, **87**, 395 (1965).

⁸⁰ See note 78, p. 645.

⁸¹ G. Vincow, H. J. Dauben, Jr., F. R. Hunter, and W. V. Volland, *J. Amer. Chem. Soc.*, **91**, 2823 (1969).

medium ($\text{SbF}_5\text{-SO}_2\text{ClF}$) to the isomeric allyl cations (Equations 12.41–12.43), the structures of which were demonstrated by nmr spectroscopy.⁸²

Note that the results shown by Equations 12.41 and 12.43 demonstrate that one of the two possible disrotatory modes of opening is preferred. Woodward and Hoffmann predicted in 1965 that this specificity should occur;⁸³ the reason may be readily understood through the following qualitative argument. Departure of the leaving group will be assisted if the developing positive charge can be delocalized onto the other two carbons of the ring. This stabilization can occur as the $\text{C}_2\text{-C}_3$ bond breaks if it does so in the sense shown in Equation 12.44, with the lobes of the σ bond rotating toward the back of the departing group. The alternative rotation (Equation 12.45) will be less favorable for the same reasons that frontside nucleophilic substitution is unfavorable (Sections 4.2 and 10.3).

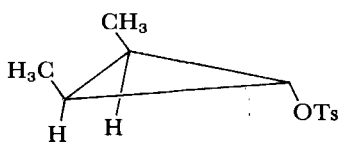

35

Relative solvolysis rate
(acetic acid, 150°C): 4500

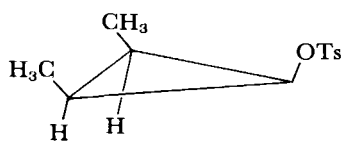

36

1

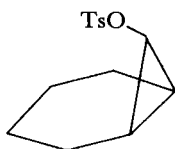

37

Relative solvolysis rate
(acetic acid, 100°C): 11,000

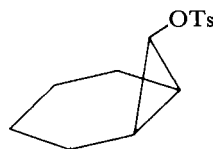

38

1

The concerted nature of the reaction is verified by the finding of substantial assistance to ionization (estimated rate enhancements of $10^4\text{--}10^5$);⁸⁴ its stereospecificity is shown not only by the experiment already cited, but also by the solvolysis rates of **35** and **36** and of bicyclic compounds **37** and **38**.⁸⁵ Compounds **36** and **38** would encounter severe strain in the assisted ionization, which in the first case brings the two methyl groups into contact and in the second is precluded by the constraint of the second ring. Extensive theoretical investigations by sophisticated molecular orbital methods show the cyclopropyl cation to be less stable than allyl by $\Delta\Delta H$ on the order of 39 kcal mole⁻¹; it is thus not surprising that the symmetry-allowed ring opening intervenes in the solvolysis to produce directly the more stable open form.⁸⁶

⁸² P. v. R. Schleyer, T. M. Su, M. Saunders, and J. C. Rosenfeld, *J. Amer. Chem. Soc.*, **91**, 5174 (1969).

⁸³ See note 79, p. 647.

⁸⁴ P. v. R. Schleyer, W. F. Sliwinski, G. W. Van Dine, U. Schöllkopf, J. Paust, and K. Fellenberger, *J. Amer. Chem. Soc.*, **94**, 125 (1972).

⁸⁵ P. v. R. Schleyer, G. W. Van Dine, U. Schöllkopf, and J. Paust, *J. Amer. Chem. Soc.*, **88**, 2868 (1966).

⁸⁶ L. Radom, P. C. Hariharan, J. A. Pople, and P. v. R. Schleyer, *J. Amer. Chem. Soc.*, **95**, 6531 (1973).

SCHEME 4

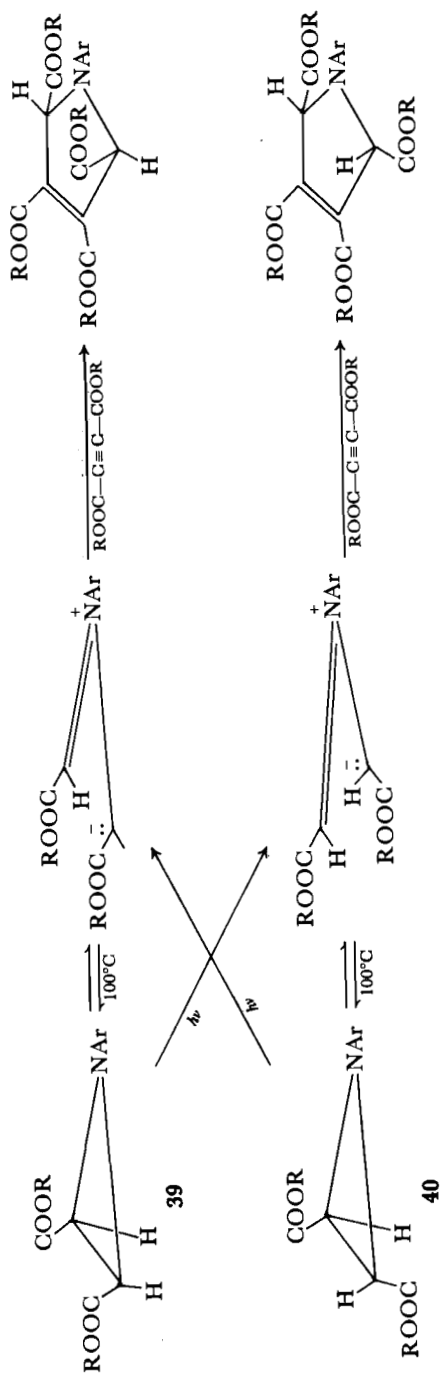

Although the cyclopropyl anion itself does not appear to have been investigated, the isoelectronic aziridines are known to open in the predicted conrotatory sense. Thus heating the *cis* and *trans* isomers **39** and **40** in the presence of dimethylacetylenedicarboxylate leads with high stereospecificity, by way of a 1,3-dipolar addition, to the products indicated in Scheme 4. The stereochemistry is reversed, as predicted, for the excited-state process.⁸⁷

Four-Membered Rings

The stereochemistry of opening of cyclobutenes to butadienes was established some time before the advent of the pericyclic theory.⁸⁸ It is conrotatory, in accord with the theory, as illustrated by the examples shown in Equations 12.46 and 12.47.⁸⁹ Because the equilibrium in the monocyclic case favors the diene, the

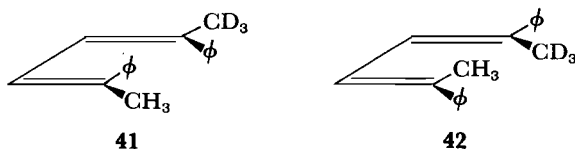
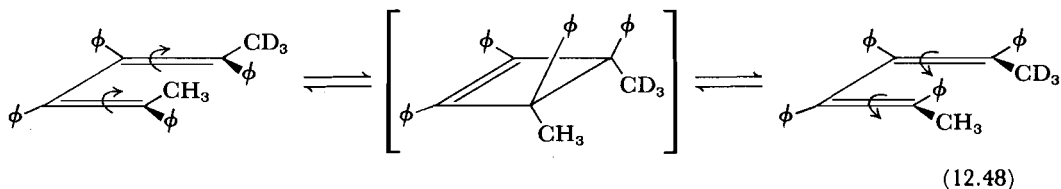
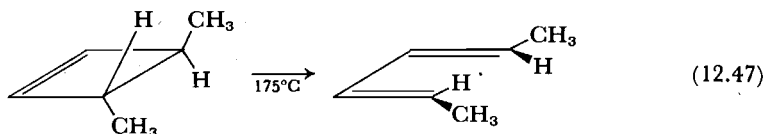
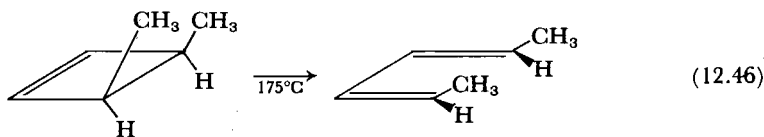

reverse process, closure of an open-chain diene, is not commonly observed. A diene isomerization that presumably takes this route (Equation 12.48) allows an estimate of a lower limit to the energy difference between the allowed conrotatory and forbidden disrotatory paths. In a time (51 days at 124°C) during which over 2×10^6 ring openings occur, none of the disrotatory products **41** and **42** appear, although 1 percent would have been detected; the conrotatory path is therefore favored by at least 7.3 kcal mole⁻¹.⁹⁰ Brauman and Archie found about

⁸⁷ R. Huisgen, W. Scheer, and H. Huber, *J. Amer. Chem. Soc.*, **89**, 1753 (1967).

⁸⁸ (a) E. Vogel, *Justus Liebigs Ann. Chem.*, **615**, 14 (1958); (b) R. Criegee and K. Noll, *Justus Liebigs Ann. Chem.*, **627**, 1 (1959).

⁸⁹ R. E. K. Winter, *Tetrahedron Lett.*, 1207 (1965).

⁹⁰ G. A. Doorakian and H. H. Freedman, *J. Amer. Chem. Soc.*, **90**, 5310, 6896 (1968).

0.005 percent of the forbidden disrotatory product in ring opening of *cis*-3,4-dimethylcyclobutene (Equation 12.49), and estimated, after correcting for steric differences, that the forbidden path was on the order of 15 kcal mole⁻¹ higher in energy than the allowed. The activation energy for the forbidden reaction is close to that estimated for a biradical nonconcerted path.⁹¹

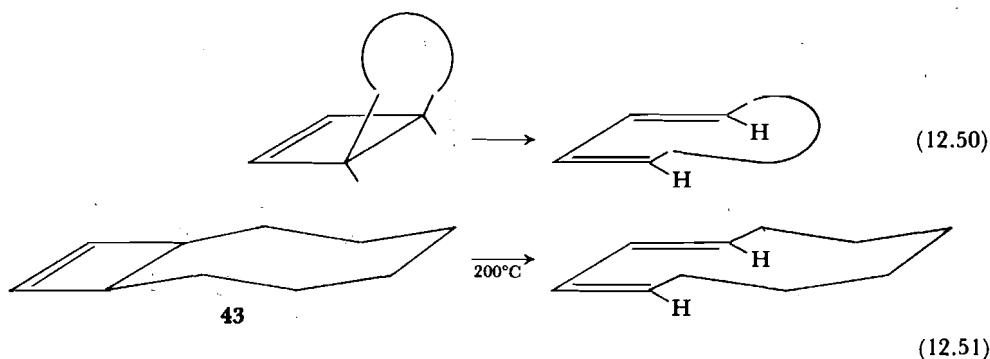
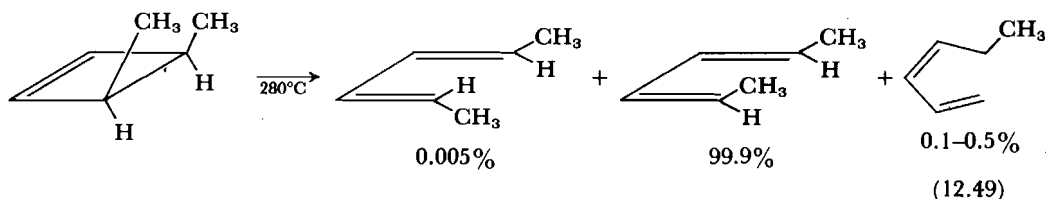

When the two saturated carbons of the cyclobutene ring are joined through a second ring, new constraints appear. The conrotatory opening in such a system (Equation 12.50) leads to a *trans* double bond in the remaining ring. There is no problem if the ring is large enough; thus **43** opens readily at 200°C to *cis-trans*-cyclodecadiene-1,3.⁹² When the bridging ring is five- or six-membered, the reaction is forced into a forbidden or at least nonconcerted biradical path; temperatures required for ring opening in these compounds are typically on the order of 200° higher than those necessary for monocyclic cyclobutenes.⁹³ Bicyclo[3.2.0]heptene (**44**) opens, in violation of the selection rule, to *cis-cis*-

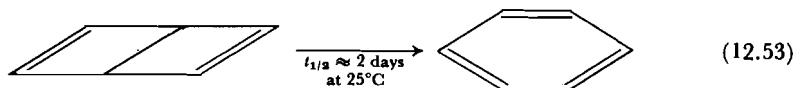
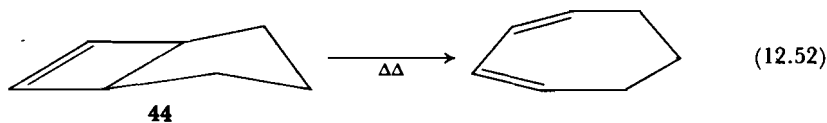

cycloheptadiene (Equation 12.52), but with activation energy 13 kcal mole⁻¹ higher than that for opening of cyclobutene itself.⁹⁴ When the bridging ring

⁹¹ J. I. Brauman and W. C. Archie, Jr., *J. Amer. Chem. Soc.*, **94**, 4262 (1972).

⁹² P. Radlick and W. Fenical, *Tetrahedron Lett.*, 4901 (1967).

⁹³ R. Criegee, D. Seebach, R. E. Winter, B. Börretzen, and H. Brune, *Chem. Ber.*, **98**, 2339 (1965).

⁹⁴ M. R. Willcott and E. Goerland, *Tetrahedron Lett.*, 6341 (1966).

becomes smaller still, the strain energies are large and ring opening is again facile. The Dewar benzene–benzene conversion (Equation 12.53) is similar to the prismane–benzene example referred to earlier in Section 11.6, p. 616; in view of the large exothermicity, it would be difficult to understand why the bicyclic isomer should be observable at all were it not for the orbital symmetry theory.⁹⁵ The hexamethyl derivative is considerably more stable, with a half-life of 105 hr at 120°C; the isomerization to hexamethylbenzene is exothermic by 62 kcal mole⁻¹.⁹⁶

Photochemically, the cyclobutene–diene electrocyclic transformation follows the disrotatory path in agreement with the theory. With the difficulties encountered in bicyclic rings for the thermal conrotatory path thus circumvented, these reactions provide a useful synthetic pathway to various strained ring systems. The cyclic heptadiene **45**, for example, closes as shown in Equation 12.54 in 42 percent yield on irradiation with a mercury arc lamp.⁹⁷ Although the process ought to be reversible, the inability of the remaining olefin function to absorb light at the wavelength available, and the orbital symmetry barrier to thermal reversal, effectively prevent reopening. The ring does reopen on heating; as would be expected from our earlier discussion, the temperature required is 400–420°C.⁹⁸

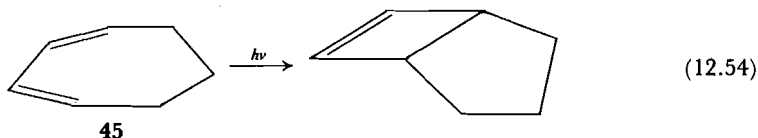

Five-Membered Rings

Electrocyclic closure of both pentadienyl cation and anion have been observed. Cations generated by protonation of dienones close in the predicted conrotatory manner as shown in Equation 12.55.⁹⁹ The pentadienyl anion, a six-electron system, should close in the disrotatory sense; a clear example is the rapid isomerization illustrated in Equation 12.56.¹⁰⁰ Photochemical cyclization of pentadienyl cations has been observed; Equation 12.57 shows an example in a cyclic system.¹⁰¹ The ready thermal reversion, which should be conrotatory and therefore difficult in the bicyclic system, may possibly occur by a stepwise path.¹⁰²

⁹⁵ (a) E. E. van Tamelen, S. P. Pappas, and K. L. Kirk, *J. Amer. Chem. Soc.*, **93**, 6092 (1971); (b) see also Woodward and Hoffmann, *The Conservation of Orbital Symmetry*, p. 174; (c) W. Schäfer, *Angew. Chem. Int. Ed.*, **5**, 669 (1966); (d) W. Schäfer and H. Hellmann, *Angew. Chem. Int. Ed.*, **6**, 518 (1967).

⁹⁶ See note 95(c), (d).

⁹⁷ W. G. Dauben and R. L. Cargill, *Tetrahedron*, **12**, 186 (1961).

⁹⁸ (a) See note 97. See also (b) J. I. Brauman, L. E. Ellis, and E. E. van Tamelen, *J. Amer. Chem. Soc.*, **88**, 846 (1966).

⁹⁹ (a) C. W. Shoppee and B. J. A. Cooke, *J. Chem. Soc., Perkin I*, 2271 (1972); C. W. Shoppee and B. J. A. Cooke, *J. Chem. Soc., Perkin I*, 1026 (1973); (c) see also Woodward and Hoffmann, *The Conservation of Orbital Symmetry*, p. 58.

¹⁰⁰ R. B. Bates and D. A. McCombs, *Tetrahedron Lett.*, 977 (1969).

¹⁰¹ (a) R. F. Childs and B. Parrington, *Chem. Commun.* 1540 (1970); for a review of photoreactions of carbocations, see: (b) P. W. Cabell–Whiting and H. Hogeveen, *Adv. Phys. Org. Chem.*, **10**, 129 (1973).

¹⁰² See note 101(b).

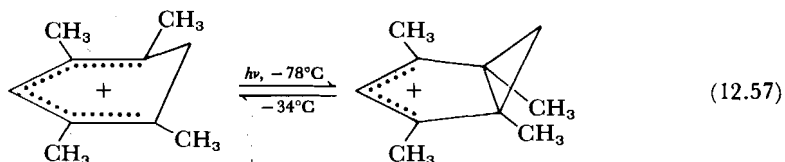
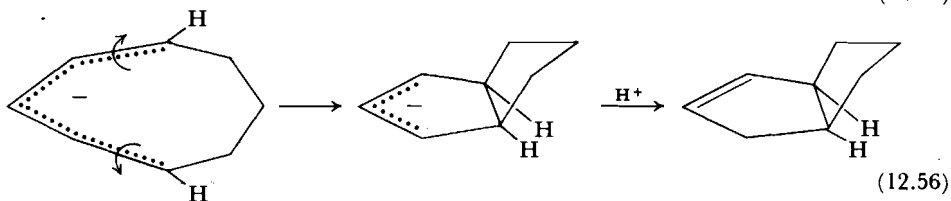
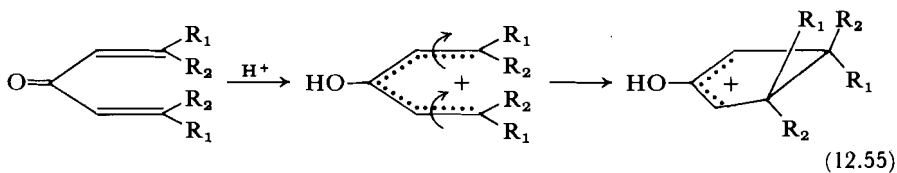

Dienones, which because of the electron deficiency induced at the carbonyl carbon may be regarded as analogs of pentadienyl cations, are known to close photochemically.¹⁰³ These closures occur readily in cyclic systems where the geometry requires the disrotatory mode, but the proposed intermediate product, formally a 1,3 diradical, is ordinarily stabilized through rearrangement.¹⁰⁴ Woodward and co-workers have demonstrated the predicted photochemical

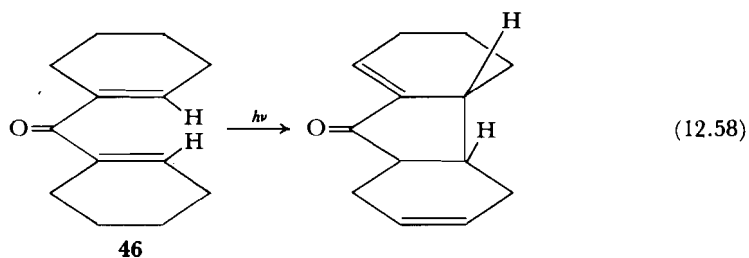

disrotatory cyclization of acyclic dienone **46**, where the hydrogen transfer required to attain the product structure presumably leaves unaltered the initial stereochemistry of ring closure.¹⁰⁵

Six-Membered and Larger Rings

Trans-cis-trans-octatriene (**47**) cyclizes at 130°C in the predicted disrotatory sense to *cis*-5,6-dimethylcyclohexa-1,3-diene.¹⁰⁶ Closure in cyclic trienes also occurs readily according to the generalized structures in Equation 12.60, where

¹⁰³ See, for example: (a) K. Schaffner, *Advan. Photochem.*, **4**, 81 (1966); (b) R. O. Kan, *Organic Photochemistry*, McGraw-Hill, New York, 1966, chap. 4.

¹⁰⁴ See Section 13.4 for further discussion. Some of these processes may be concerted $\sigma_2 + \pi_2$ cycloadditions rather than stepwise processes initiated by electrocyclic ring closure. See Woodward and Hoffmann, *The Conservation of Orbital Symmetry*, p. 89.

¹⁰⁵ See note 99(c).

¹⁰⁶ (a) E. N. Marvell, G. Caple, and B. Schatz, *Tetrahedron Lett.*, 385 (1965); (b) E. Vogel, W. Grimme, and E. Dinné, *Tetrahedron Lett.*, 391 (1965).

the bridging chain indicated by X_n may be made up of carbon or hetero atoms. The simplest example, the cycloheptatriene–norcaradiene interconversion (Equa-

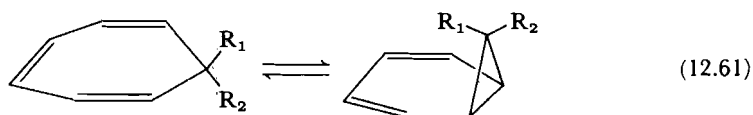
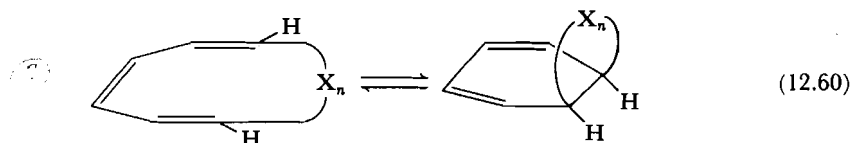
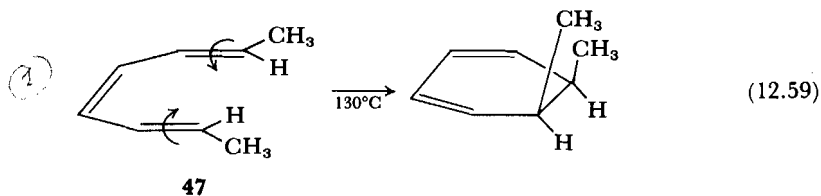

tion 12.61), has received considerable attention.¹⁰⁷ In most instances the equilibrium favors the cycloheptatriene form, but strongly electron-withdrawing substituents R shift the equilibrium toward the bicyclic norcaradiene isomer.¹⁰⁸ Interconversion rates are so great as to preclude isolation of the separate forms; equilibria can be investigated only by nuclear magnetic resonance. Hoffmann has proposed a simple molecular orbital model to account for the stabilization of the bicyclic form by a π electron acceptor.¹⁰⁹ Briefly stated, the argument is that one of the bonding orbitals of the cyclopropane ring has the symmetry depicted in **48**; a π acceptor such as a cyano group can interact with this orbital (**49**) and withdraw electrons from it. The effect is to reduce electron density in

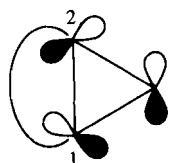

48

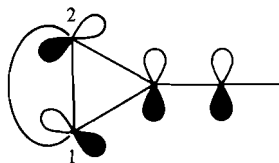

49

this orbital between carbons 1 and 2. Because the orbital is antibonding between positions 1 and 2, this change strengthens the 1–2 bond. This appealingly simple explanation may not suffice to account completely for the observations. Para-substituted phenyl groups at R_1 , R_2 do not appear to affect the equilibrium in a consistent way.¹¹⁰

¹⁰⁷ Review: (a) G. Maier, *Angew. Chem. Int. Ed.*, **6**, 402 (1967); (b) E. Ciganek, *J. Amer. Chem. Soc.*, **89**, 1454 (1967), and references cited therein.

¹⁰⁸ (a) See note 107; (b) G. E. Hall and J. D. Roberts, *J. Amer. Chem. Soc.*, **93**, 2203 (1971); (c) E. Ciganek, *J. Amer. Chem. Soc.*, **93**, 2207 (1971); (d) see also H. Dürr and H. Kober, *Angew. Chem. Int. Ed.*, **10**, 342 (1971).

¹⁰⁹ (a) R. Hoffmann, *Tetrahedron Lett.*, 2907 (1970); (b) for an example, see M. Simonetta, *Accts. Chem. Res.*, **7**, 345 (1974).

¹¹⁰ See note 108(b).

mole⁻¹ °K⁻¹, and a free-energy difference between the two tautomers of 1.5 kcal mole⁻¹.¹¹⁴

All *cis*-cyclononatriene (**53**) cyclizes in the predicted disrotatory manner at measurable rates at 25–50°C to the bicyclic diene **54**.¹¹⁵ The nine-membered ring is large enough to accommodate a *trans* double bond; *trans-cis-cis*-cyclononatriene (**55**), obtained by conrotatory photochemical opening of **54**, cyclizes to the *trans* fused bicyclononadiene **55**.¹¹⁶

The example just cited provides a verification of the prediction that the excited-state reactions should be conrotatory for six-electron systems. The prototype octatriene–cyclohexadiene interconversion (Equation 12.64) shows the same pattern.¹¹⁷ The network of photochemical and thermal electrocyclic reactions connected with the formation of vitamin D provide several further examples.¹¹⁸

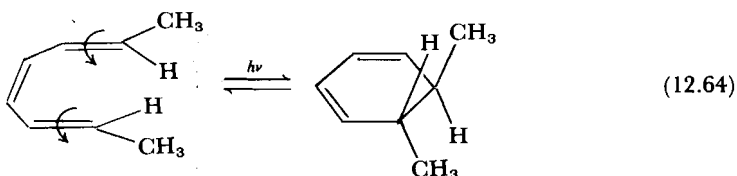

The examples shown in Equations 12.65–12.67 demonstrate the operation of the selection rules in eight-membered rings.

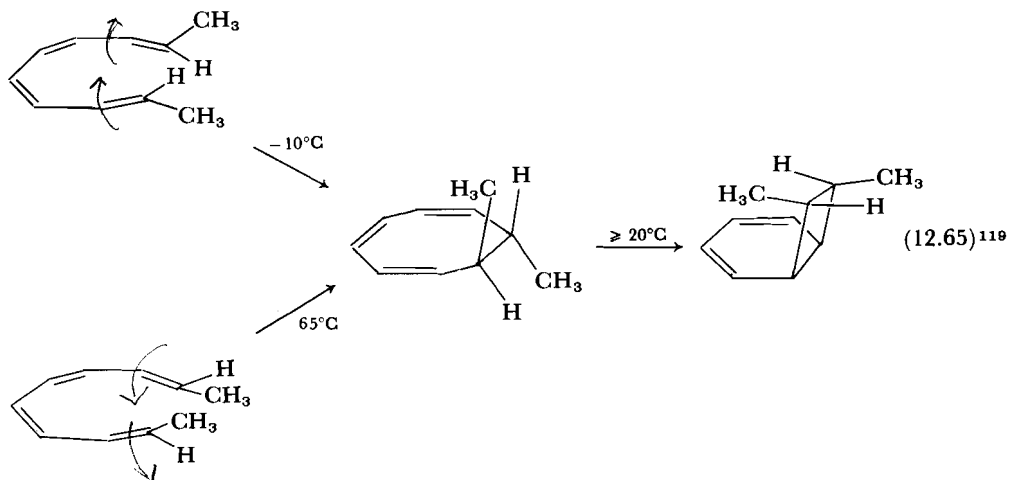

¹¹⁴ (a) R. Huisgen, F. Mietzsch, G. Boche, and H. Seidl, *Organic Reaction Mechanisms, Special Publ. Chem. Soc. (London)*, **19**, 3 (1965); (b) R. Huisgen, G. Boche, A. Dahmen, and W. Hechtel, *Tetrahedron Lett.*, 5215 (1968).

¹¹⁵ D. S. Glass, J. W. H. Watthey, and S. Winstein, *Tetrahedron Lett.*, 377 (1965).

¹¹⁶ See note 106(b), p. 653.

¹¹⁷ G. L. Fonken, *Tetrahedron Lett.*, 549 (1962).

¹¹⁸ (a) Woodward and Hoffmann, *The Conservation of Orbital Symmetry*, p. 52; see also (b) E. Havinga and J. L. M. A. Schlatmann, *Tetrahedron*, **16**, 146 (1961). For further discussion, see Section 13.4.

¹¹⁹ R. Huisgen, A. Dahmen, and H. Huber, *J. Amer. Chem. Soc.*, **89**, 7130 (1967).

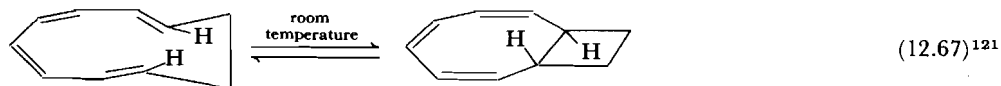
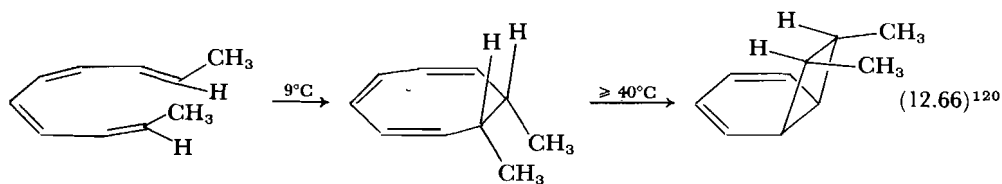

12.3 SIGMATROPIC REACTIONS¹²²

The pericyclic theory has proved enormously fruitful for the field of sigmatropic reactions. In addition to providing a deeper understanding of previously known phenomena, it has led to the discovery of a variety of new rearrangements. Our treatment here, as in the previous sections, is not intended to be comprehensive.

[1,*n*]-Sigmatropic Transformations

The [1,*n*] reactions constitute those instances in which a group migrates to the adjacent atom or to the end of an adjacent π electron system. Equation 12.68

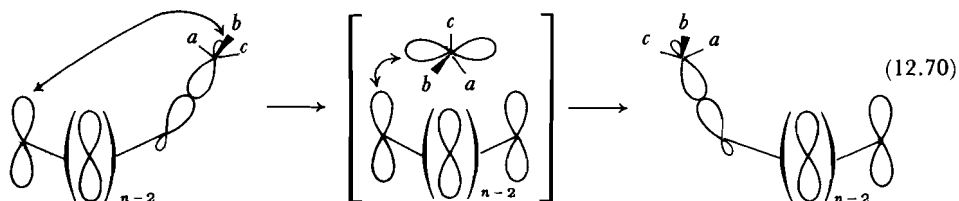
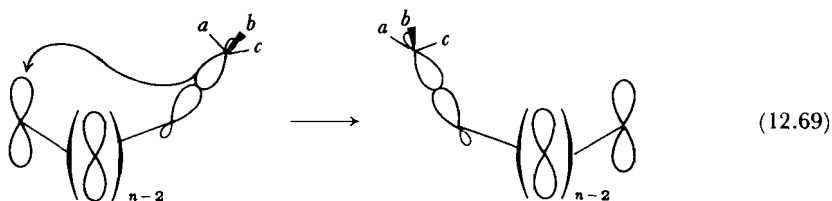
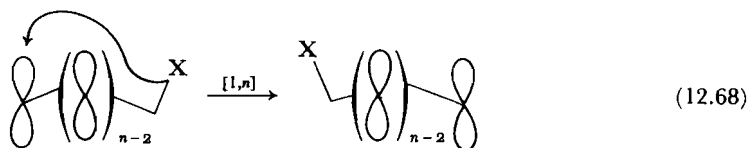

¹²⁰ See note 119.

¹²¹ S. W. Staley and T. J. Henry, *J. Amer. Chem. Soc.*, **92**, 7612 (1970).

¹²² Sigmatropic processes are discussed in detail by (a) R. B. Woodward and R. Hoffmann, *The Conservation of Orbital Symmetry*, Verlag Chemie, Weinheim/Bergstr., Germany, and Academic Press, New York, 1970. Experimental results are reviewed in (b) G. B. Gill, *Quart. Rev. (London)*, **22**, 338 (1968); (c) T. L. Gilchrist and R. C. Storr, *Organic Reactions and Orbital Symmetry*, Cambridge University Press, Cambridge, 1972.

illustrates the generalized process. Recall from our previous discussion (Section 11.1, p. 573) that there is a choice of stereochemistry between suprafacial and antarafacial modes both with respect to the π system and with respect to the migrating group. For short chains, it is expected that a migration antarafacial with respect to the π component will be difficult because it requires the migrating group to reach around to the opposite face of the molecule; antarafacial migration will be easier in longer, more flexible chains. Rearrangements suprafacial with respect to the migrating group will yield retained configuration (Equation 12.69), and those antarafacial will produce inversion (Equation 12.70).¹²³

Two-Electron Systems

Two-electron [1,2]-sigmatropic shifts are the familiar rearrangements commonly observed in carbocations. As these processes have been discussed in detail in Chapter 6, we shall confine our remarks here to noting that the pericyclic rules correctly predict that the rearrangements are suprafacial in both components, with retention of configuration at the migrating group.¹²⁴ It is appropriate also to point out the analogy between the transition state for a [1,2]-sigmatropic shift (57) and that for a frontside substitution (58) (Section 10.3, p. 557), allowed for the two-electron (electrophilic) case. Note that the bridged carbonium ions (Chapter 6) also correspond to 57.



Four-Electron Systems

Four-electron processes can take place in the context of a [1,2]-shift (anionic),

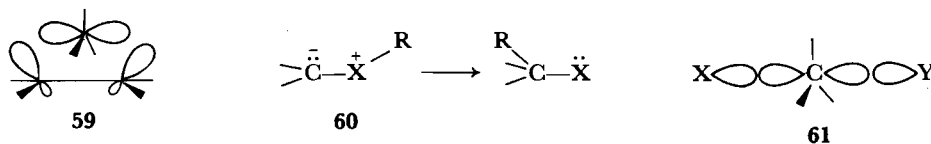

[1,3]-shift (neutral), or [1,4]-shift (cationic); the selection rules now require the reaction to be antarafacial on one of the components. Thus anions would have to undergo [1,2]-rearrangements by way of 59, a geometry that would lead to serious steric difficulties. There is evidence from nuclear resonance spectra (CIDNP, see Section 9.1, p. 470) that anionic [1,2]-rearrangements, which occur, for example, in ylide structures of the type 60, X = N or S, involve a radical dissociation-recombination process.¹²⁵ Steric problems are much less serious in the topologically equivalent transition state 61 for backside substitution.

¹²³ If the migrating group is hydrogen, presumably only the suprafacial mode is possible, the p orbitals needed for the transition state analogous to that in Equation 12.70 being of too high energy.

¹²⁴ (a) T. Shono, K. Fujita, and S. Kumai, *Tetrahedron Lett.*, 3123 (1973); (b) see the discussion in Section 6.1, p. 280.

¹²⁵ (a) U. Schöllkopf, *Angew. Chem. Int. Ed.*, 9, 763 (1970); (b) J. E. Baldwin, W. F. Erickson, R. E. Hackler, and R. M. Scott, *Chem. Commun.*, 576 (1970); (c) A. R. Lepley, P. M. Cook, and G. F. Willard, *J. Amer. Chem. Soc.*, 92, 1101 (1970).

[1,3]-Rearrangements

In neutral systems, [1,3]-shifts of hydrogen should be difficult, since they require transfer to the opposite side of the π system, and indeed these rearrangements are rare. Alkyl groups, on the other hand, can, according to the theory, migrate suprafacially over the π system if they invert configuration (Equation 12.71):

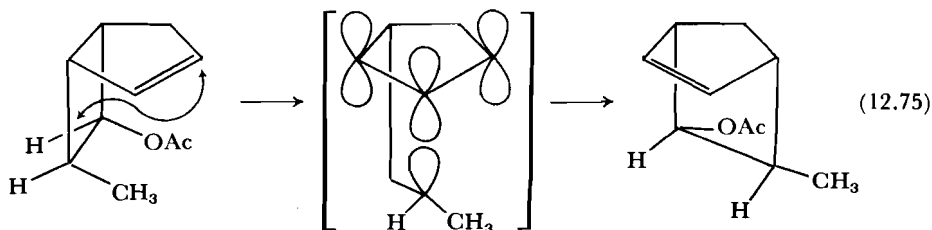
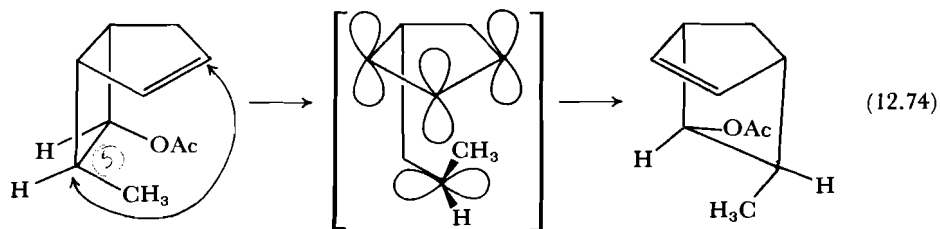
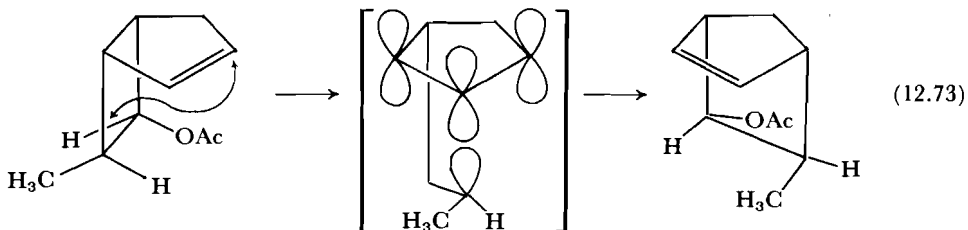
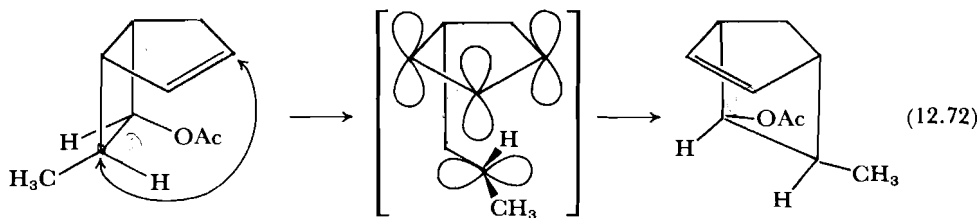
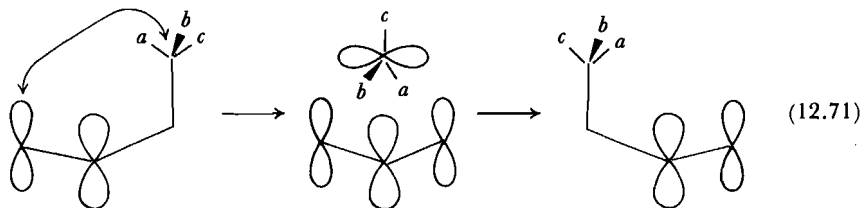

Berson has reported extensive investigations of this rearrangement in the system shown in Equation 12.72.¹²⁶ The reaction prefers the allowed path (Equation

¹²⁶ (a) J. A. Berson, *Accts. Chem. Res.*, **5**, 406 (1972); (b) J. A. Berson and R. W. Holder, *J. Amer. Chem. Soc.*, **95**, 2037 (1973); (c) J. A. Berson and L. Salem, *J. Amer. Chem. Soc.*, **94**, 8917 (1972); (d) W. T. Borden and L. Salem, *J. Amer. Chem. Soc.*, **95**, 932 (1973).

12.72) by a factor of ten over the sterically more favorable forbidden one (Equation 12.73). When the steric difficulties of the allowed reaction are increased by requiring the methyl group rather than hydrogen to pass between the migrating carbon and the ring (Equation 12.74), the forbidden path (Equation 12.75) is preferred by a similar factor. Berson's interpretation is that even the forbidden process in this instance is concerted. If this conclusion is correct, the special steric constraints in this system have raised the activation energy of the allowed reaction above that of the forbidden reaction.

Although rearrangements in these bicyclic systems are concerted, not all observed [1,3]-shifts are; for example, the available evidence favors a stepwise biradical process for Reaction 12.76. Thus both the high activation energy (on the order of 50 kcal mole⁻¹)¹²⁷ and the rapid cis-trans isomerization of **62**

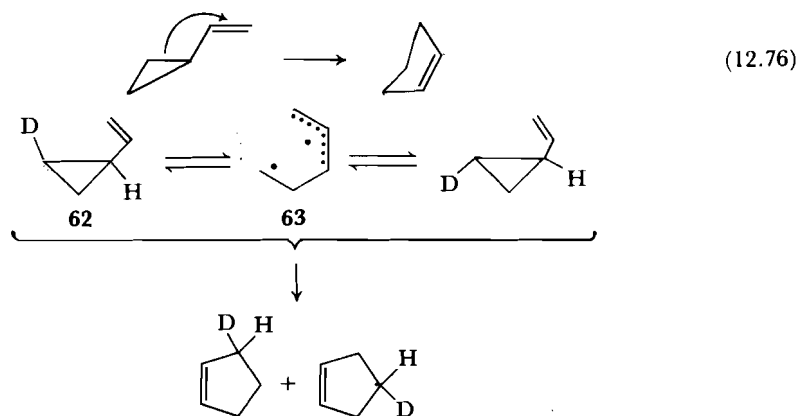

observed to accompany the ring expansion¹²⁸ argue against the concerted mechanism, although they do not exclude it. The situation is ambiguous in the rearrangement 12.77; here secondary deuterium isotope effects in the normal direction ($k_H/k_D > 1$) in **64** were interpreted as being consistent either with a biradical intermediate **65** or with a concerted allowed [1,3]-sigmatropic rearrangement.¹²⁹

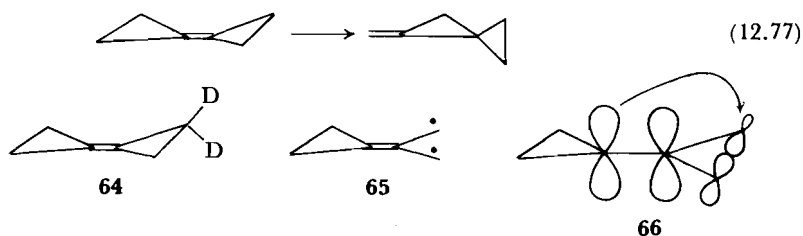

¹²⁷ S. Sarel, J. Yovell, and M. Sarel-Imber, *Angew. Chem. Int. Ed.*, **7**, 577 (1968).

¹²⁸ M. R. Willcott and V. H. Cargle, *J. Amer. Chem. Soc.*, **89**, 723 (1967).

¹²⁹ (a) W. R. Dolbier, Jr., and J. H. Alonso, *J. Amer. Chem. Soc.*, **95**, 4421 (1973). The methylenecyclopropane rearrangement also occurs photochemically; see (b) A. S. Kende, Z. Goldschmidt, and R. F. Smith, *J. Amer. Chem. Soc.*, **92**, 7606 (1970). It should be noted that interpretations that postulate 1,3-biradical structures such as **63** and **65** as intermediates in opening and reclosing of three-membered rings are likely to be misleading. These structures may well represent only extrema in carbon-carbon bond stretching vibrations and will therefore be transition states and not true intermediates, because they do not lie at minima on the potential energy surface. See (c) W. v. E. Doering and K. Sachdev, *J. Amer. Chem. Soc.*, **96**, 1168 (1974).

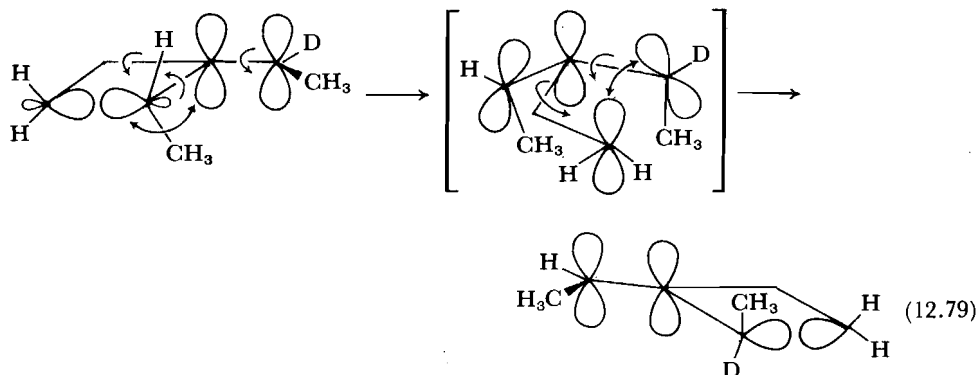
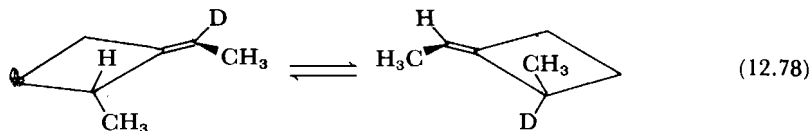

It is also apparently possible, despite what would seem to be considerable steric difficulty, for a [1,3]-reaction to be antarafacial on the π component. Measurements of rates of racemization and of deuterium scrambling show that at least part of the rearrangement in Equation 12.78 proceeds by the path illustrated in Equation 12.79.¹³⁰

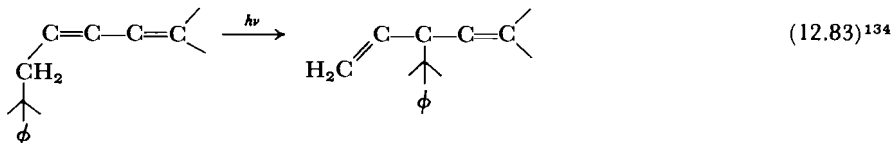
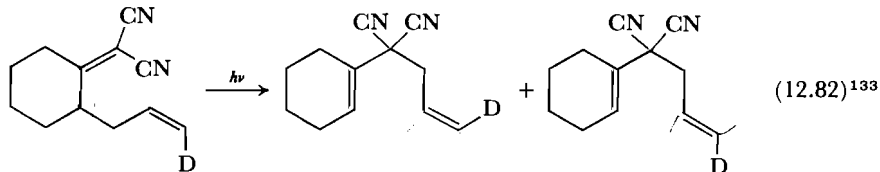
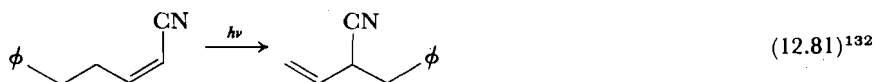
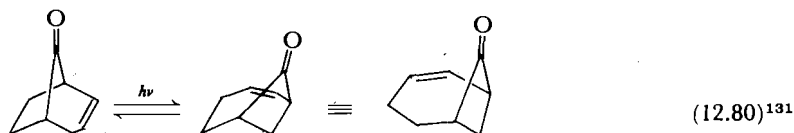

¹³⁰ (a) J. E. Baldwin and R. H. Fleming, *J. Amer. Chem. Soc.*, **94**, 2140 (1972); (b) J. E. Baldwin and R. H. Fleming, *J. Amer. Chem. Soc.*, **95**, 5249, 5256, 5261 (1973).

¹³¹ W. F. Erman and H. C. Kretschmar, *J. Amer. Chem. Soc.*, **89**, 3842 (1967).

¹³² (a) R. C. Cookson, V. N. Gogte, J. Hudec, and N. A. Mirza, *Tetrahedron Lett.*, 3955 (1965);

(b) R. F. C. Brown, R. C. Cookson, and J. Hudec, *Tetrahedron*, **24**, 3955 (1968).

¹³³ See note 132(b).

¹³⁴ E. C. Sanford and G. S. Hammond, *J. Amer. Chem. Soc.*, **92**, 3497 (1970).

Photochemically, the [1,3]-rearrangement is allowed in the sterically easily accessible suprafacial-suprafacial mode. A few of the many examples known are shown in Equations 12.80–12.83.

Cookson and co-workers have established in the experiments outlined in Equations 12.84 and 12.85 that the stereochemistry is as predicted.

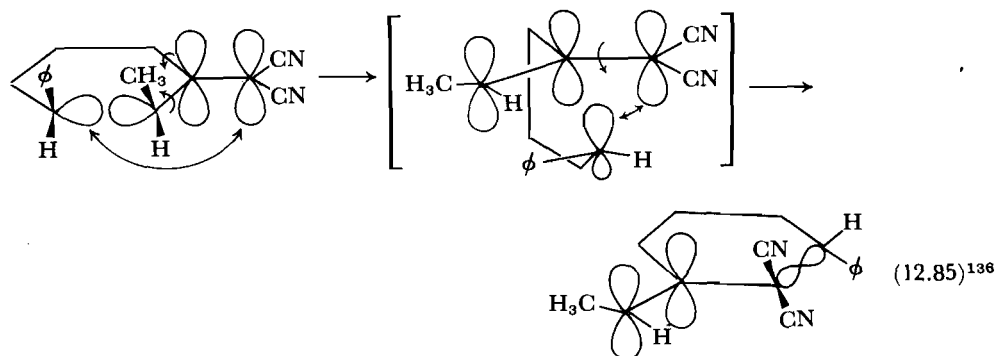
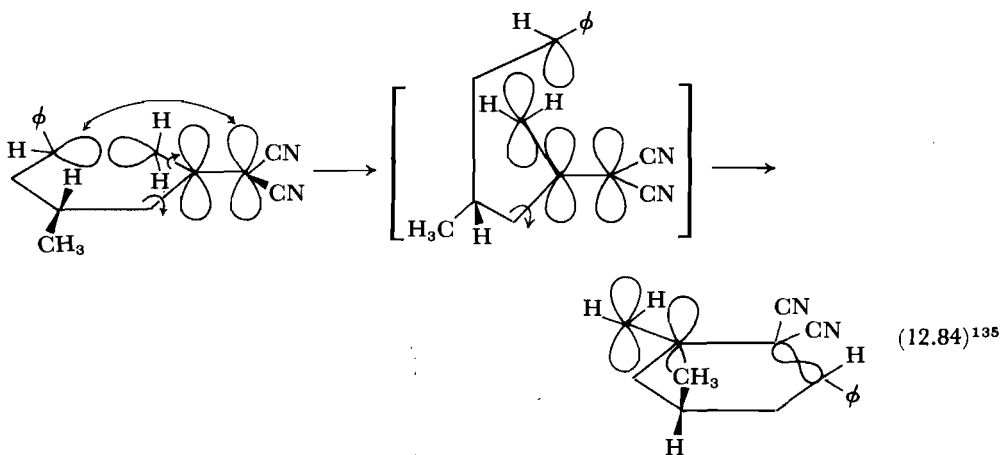

[1,4]-Rearrangements

[1,4]-Shifts should occur in allylic cations; as in the neutral four-electron systems, the rules require the suprafacial-antarafacial mode in the ground state. In the bicyclo[3.1.0]hex-3-en-2-yl cation (**67**), the ring fusion prevents access of

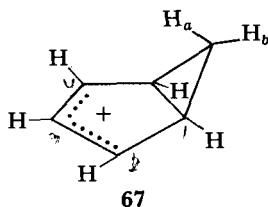

¹³⁵ R. C. Cookson, J. Hudec, and M. Sharma, *Chem. Commun.*, 107 (1971).

¹³⁶ R. C. Cookson, J. Hudec, and M. Sharma, *Chem. Commun.*, 108 (1971).

migrating $-\text{CH}_2-$ to the underside of the allylic ion and assures suprafaciality with respect to the π system; the rearrangement can thus take either of the two courses shown in Equations 12.86 and 12.87. In Equation 12.86, thermally forbidden, suprafacial on the migrating group, the $-\text{CH}_2-$ swings around so that the endo (H_a) and exo (H_b) hydrogens change places, whereas in the allowed Reaction 12.87 the migrating group undergoes inversion and endo and

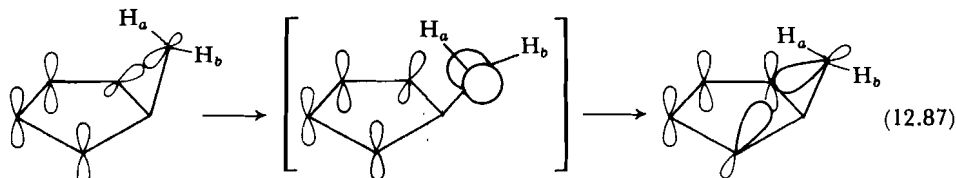
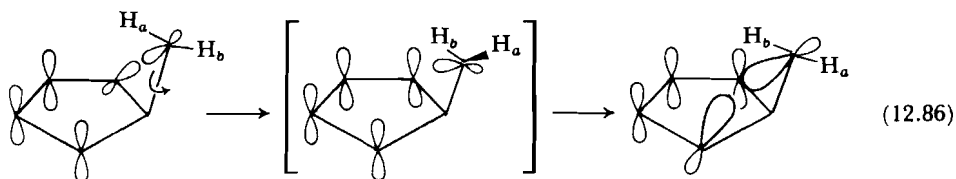

exo positions maintain their integrity. A second rearrangement moves the cyclopropane one position further on the five-membered ring; continuation of the process will walk the three-membered ring all the way around the five. If configuration is retained, the endo and exo substituents interchange at each step; but if configuration is inverted, the endo and exo substituents always remain distinct.¹³⁷ It is found experimentally that, in agreement with predictions, the latter process is the one that occurs. The deuterated cation **68**, prepared by

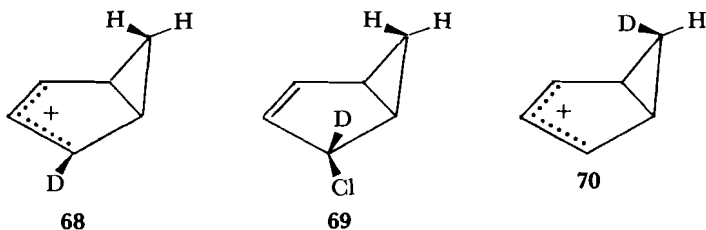

dissolving the chloride **69** in $\text{SbF}_5\text{-SO}_2\text{ClF}$ at low temperature, undergoes a rearrangement, activation free energy $\Delta G^\ddagger = 15 \pm 1 \text{ kcal mole}^{-1}$, which distributes the deuterium equally around the five-membered ring.¹³⁸ Deuterium in the *endo*-7-deuterio ion (**70**) remains endo, the rate of rearrangement being at least 10^4 to 10^6 times the rate of loss of stereochemistry. The authors point out that because the observed process is much easier sterically than the other alternative, this rearrangement is not a particularly revealing test of the sigmatropic selection rules.

¹³⁷ Woodward and Hoffmann give an enlightening discussion of sequential sigmatropic rearrangements in *The Conservation of Orbital Symmetry*, p. 132.

¹³⁸ P. Vogel, M. Saunders, N. M. Hasty, Jr., and J. A. Berson, *J. Amer. Chem. Soc.*, **93**, 1551 (1971). The rearrangement occurs slowly at -90°C . At -20°C , an electrocyclic opening to benzenonium ion takes place; see Equation 12.57.

Six-Electron Systems

A variety of sigmatropic rearrangements through six-electron transition states are known. In contrast to the rare [1,3]-migrations, [1,5]-shifts of hydrogen in dienes, suprafacially allowed, occur readily. The experiment outlined in Equation 12.88 confirms the predicted stereochemistry.¹³⁹ The authors estimated the

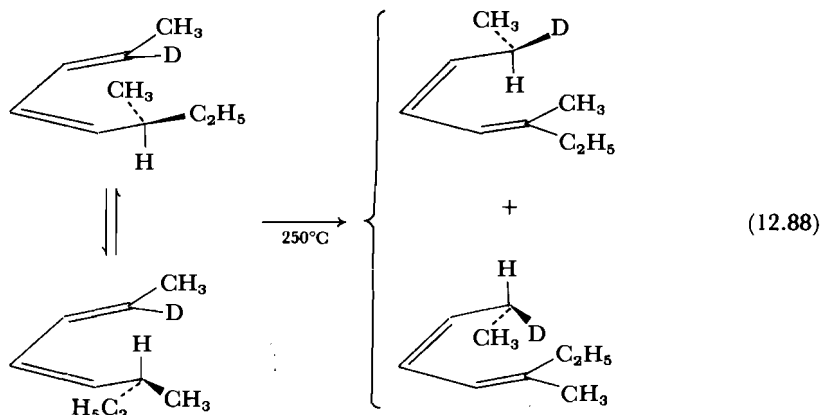

alternative antarafacial rearrangement to be at least 8 kcal mole⁻¹ higher in activation energy. The lack of dependence of rate on phase and on solvent polarity rules out ionic intermediates,¹⁴⁰ and a large primary isotope effect ($k_H/k_D = 12.2$ at 25°C) indicates a symmetrical transition state.¹⁴¹ These points, together with the stereospecificity, support the conclusion that the reaction is concerted. Enthalpies of activation are in the neighborhood of 30 kcal mole⁻¹, and entropies of activation are -5 to -10 cal mole⁻¹ °K⁻¹.¹⁴²

In a bicyclo[4.1.0]heptadiene, there should be a walk-around rearrangement analogous to the one we discussed above in the bicyclic allylic cations.¹⁴³

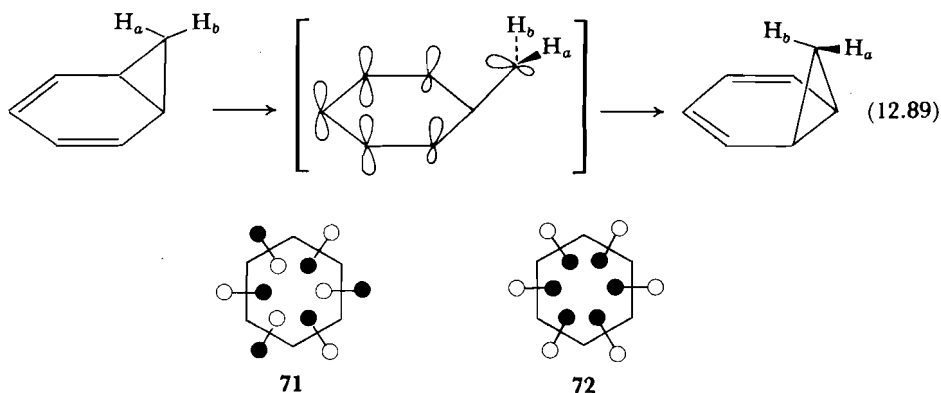

¹³⁹ W. R. Roth, J. König, and K. Stein, *Chem. Ber.*, **103**, 426 (1970).

¹⁴⁰ (a) A. P. ter Borg and H. Kloosterziel, *Rec. Trav. Chim. Pays-Bas*, **82**, 741 (1963); (b) D. S. Glass, R. S. Boikess, and S. Winstein, *Tetrahedron Lett.*, 999 (1966); (c) R. W. Roth, *Justus Liebigs Ann. Chem.*, **671**, 25 (1964).

¹⁴¹ (a) W. R. Roth and J. König, *Justus Liebigs Ann. Chem.*, **699**, 24 (1966); (b) H. Kloosterziel and A. P. ter Borg, *Rec. Trav. Chim. Pays-Bas*, **84**, 1305 (1965).

¹⁴² See note 140.

¹⁴³ Note that these systems also undergo the electrocyclic norcaradiene-cycloheptatriene interconversion (Section 12.2, p. 654).

Here the pericyclic selection rules require the migrating group to move with retention of configuration (Equation 12.89). Woodward and Hoffmann have introduced the abbreviated notation **71** to summarize this process.¹⁴⁴ The view is directly down onto the plane of the six-membered ring, with the substituents at the 7-position (the one-carbon bridge) indicated by filled and open circles. Structure **71** is a composite picture of all six molecules, which would be obtained as the cyclopropane ring moves around the periphery of the cyclohexadiene ring in the manner depicted in Equation 12.89, endo and exo substituents exchanging places with each step. Composite Structure **72** summarizes the alternative (forbidden) possibility; retention of configuration at the migrating center at each step would leave the substituent initially endo (filled circle) always endo. Berson pointed out that a substituent R placed on the six-membered ring, as in **73**, renders the molecule resolvable into enantiomeric forms. Study of the composite **74** will show that the allowed rearrangement never converts a member of the

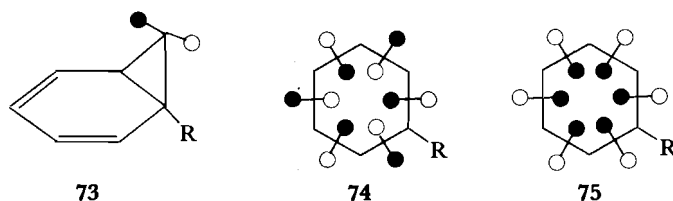

series to its mirror image and so will not lead to loss of optical rotation, whereas the forbidden sequence **75** produces a series of racemic pairs.¹⁴⁵ While the rearrangement has been observed, it has not yet proved possible to carry it out in a system suitably substituted to permit an experimental check of the predictions.¹⁴⁶

Higher-Order Systems

Relatively few higher [1,*n*]-sigmatropic rearrangements are known. The eight-electron [1,7]-shift of hydrogen (Equation 12.90), required to be antarafacial on the π system, ought to be possible since the triene would be sufficiently flexible to attain a favorable conformation for transfer of hydrogen from the top side at one end to the underside at the other. Equation 12.91 illustrates a possible example.¹⁴⁷ Isoelectronic [1,6]-rearrangements in pentadienyl anions are known; they follow the predicted thermally antarafacial and photochemically suprafacial path.¹⁴⁸

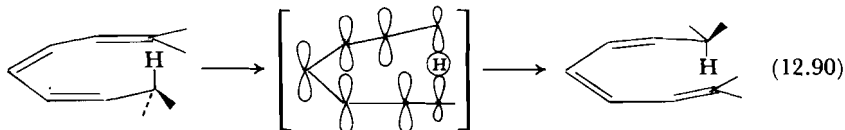

¹⁴⁴ See note 137, p. 663.

¹⁴⁵ J. A. Berson, *Accts. Chem. Res.*, **1**, 152 (1968).

¹⁴⁶ For discussion of the isoelectronic cation in the bicyclo[5.1.0] system, see (a) S. Winstein, C. G. Kreiter, and J. I. Brauman, *J. Amer. Chem. Soc.*, **88**, 2047 (1966); (b) J. A. Berson and J. A. Jenkins, *J. Amer. Chem. Soc.*, **94**, 8907 (1972).

¹⁴⁷ (a) E. Havinga and J. L. M. A. Schlatmann, *Tetrahedron*, **16**, 146 (1961); see also (b) J. L. M. A. Schlatmann, J. Pot, and E. Havinga, *Rec. Trav. Chim. Pays-Bas*, **83**, 1173 (1964).

¹⁴⁸ R. B. Bates, S. Brenner, W. H. Deines, D. A. McCombs, and D. E. Potter, *J. Amer. Chem. Soc.*, **92**, 6345 (1970).

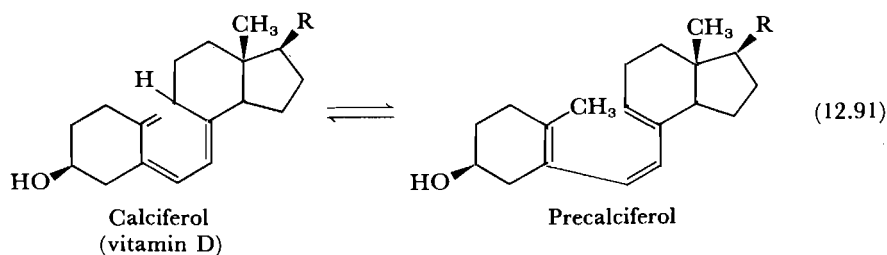

[*m,n*]-Sigmatropic Rearrangements

The majority of known [*m,n*]-rearrangements are six-electron processes, thermally allowed in the suprafacial-suprafacial mode. They take a variety of forms, of which we shall consider only the most important.¹⁴⁹

[2,3]-Rearrangements

A [2,3]-rearrangement occurs in the anion **76**.¹⁵⁰ The analogous process takes place readily in ylides (Equation 12.93), and in various other isoelectronic situations, for example, Equations 12.94 and 12.95. In at least some of these

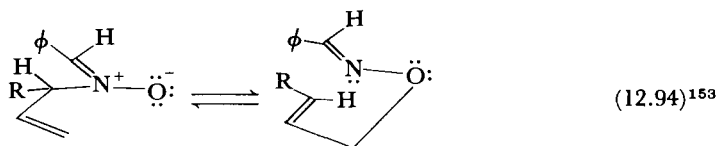
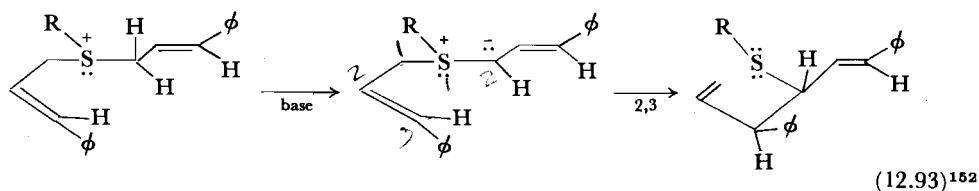
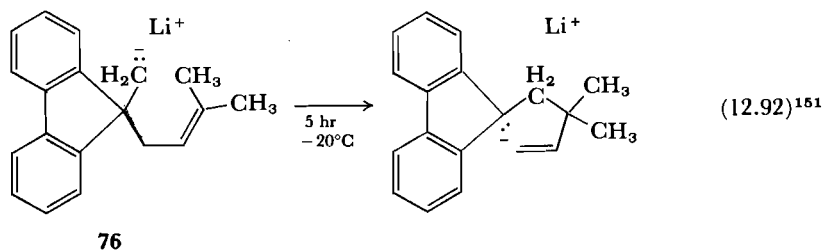

rearrangements, product mixtures (for example, Equation 12.96) show that a biradical dissociation-recombination reaction competes with the [2,3]-re-

¹⁴⁹ For a more complete discussion of examples, see Gilchrist and Storr, *Organic Reactions and Orbital Symmetry*, chap. 7.

¹⁵⁰ J. E. Baldwin and F. J. Urban, *Chem. Commun.*, 165 (1970).

¹⁵¹ See note 150.

¹⁵² J. E. Baldwin, R. E. Hackler, and D. P. Kelly, *Chem. Commun.*, 537, 538 (1968).

¹⁵³ S. Ranganathan, D. Ranganathan, R. S. Sidhu, and A. K. Mehrotra, *Tetrahedron Lett.*, 3577 (1973).

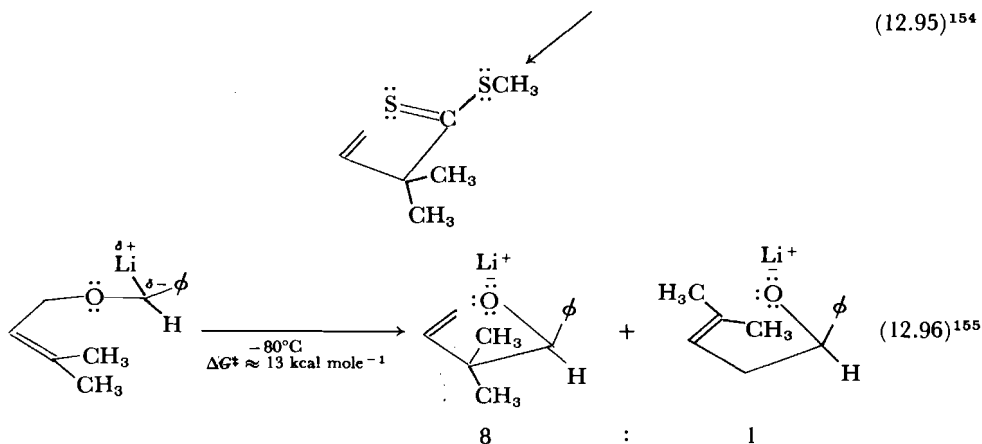
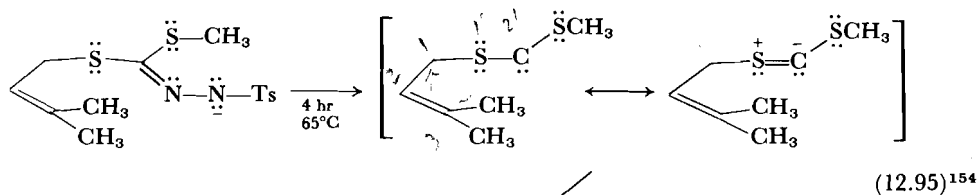

arrangement; the biradical reaction has a higher activation energy and hence is favored by raising the temperature.¹⁵⁶

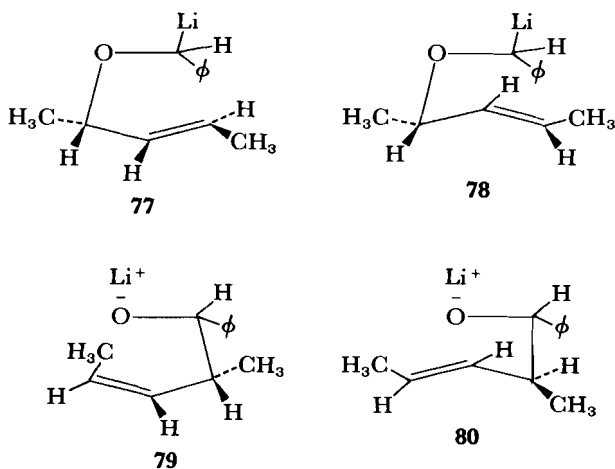
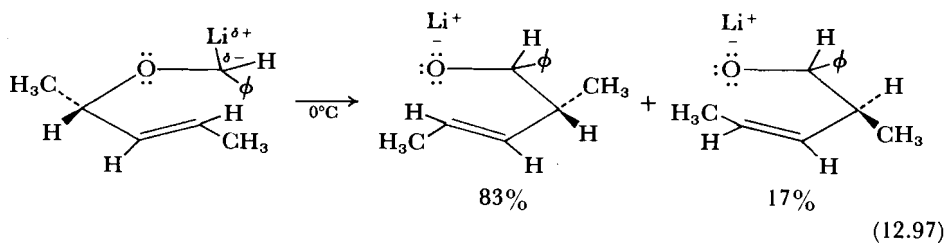

¹⁵⁴ J. E. Baldwin and J. A. Walker, *Chem. Commun.*, 354 (1972).

¹⁵⁵ V. Rautenstrauch, *Chem. Commun.*, 4 (1970).

¹⁵⁶ (a) See note 155; (b) J. E. Baldwin, J. E. Brown, and R. W. Cordell, *Chem. Commun.*, 31 (1970).

Baldwin and Patrick have demonstrated by the experiment outlined in Equation 12.97 that the concerted [2,3]-rearrangement takes the suprafacial path over the allyl group.¹⁵⁷ The two products arise from the two conformations **77** and **78**; antarafacial rearrangement would have yielded **79** and **80**, which were not found.

A transformation closely related to the [2,3]-sigmatropic migration is the elimination illustrated in Equation 12.98. The orbital diagrams **81** for the

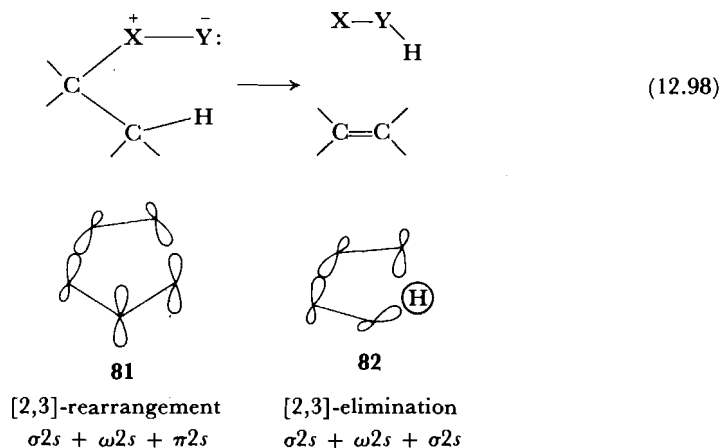

[2,3]-sigmatropic rearrangement and **82** for the [2,3]-elimination show that they differ only in the substitution of a σ for a π electron pair. An important example is the Cope reaction (Equation 12.99), which is a synthetically useful method of introducing unsaturation under mild conditions.¹⁵⁸

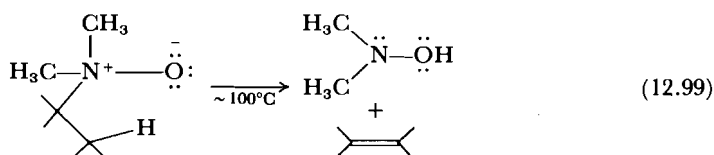

[3,3]-Rearrangements¹⁵⁹

The [3,3]-sigmatropic rearrangements comprise one of the more important classes among the pericyclic reactions. The prototype is the degenerate rearrangement of 1,5-hexadiene shown in Equation 12.100.¹⁶⁰ This process was discovered and studied by Cope and his collaborators during the 1940s and is now known as the Cope rearrangement.¹⁶¹ The reaction is common in both acyclic

¹⁵⁷ J. E. Baldwin and J. E. Patrick, *J. Amer. Chem. Soc.*, **93**, 3556 (1971).

¹⁵⁸ (a) A. C. Cope, T. T. Foster, and P. H. Towle, *J. Amer. Chem. Soc.*, **71**, 3929 (1949); the reaction and some similar ones are reviewed by (b) C. H. DePuy and R. W. King, *Chem. Rev.*, **60**, 431 (1960).

¹⁵⁹ For reviews, see: (a) S. J. Rhoads, in *Molecular Rearrangements*, P. de Mayo, Ed., Wiley-Interscience, New York, 1963, Part I, p. 655; (b) E. Vogel, *Angew. Chem. Int. Ed.*, **2**, 1 (1963); (c) W. v. E. Doering and W. R. Roth, *Angew. Chem. Int. Ed.*, **2**, 115 (1963).

¹⁶⁰ A degenerate rearrangement is one that changes locations of bonds but leaves the structure unchanged.

¹⁶¹ (a) A. C. Cope and E. M. Hardy, *J. Amer. Chem. Soc.*, **62**, 441 (1940); (b) A. C. Cope, C. M. Hoffmann, and E. M. Hardy, *J. Amer. Chem. Soc.*, **63**, 1852 (1941).

and cyclic 1,5-dienes; in the former, most examples occur in molecules bearing an unsaturated substituent in the 3-position. The rearrangement then brings the

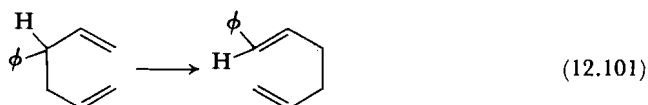

group into conjugation (for example, Equation 12.101); the activation energies are in the range of about 25 to 30 kcal mole⁻¹ with activation entropies around -10 to -15 cal mole⁻¹ °K⁻¹, and the reactions proceed readily between 150 and 200°C.¹⁶² In the absence of the unsaturated substituent, somewhat higher temperatures are required: 3-methylhexa-1,5-diene rearranges at 300°C¹⁶³ and 1,1-dideuteriohexa-1,5-diene at 200–250°C, $\Delta H^\ddagger = 33.5$ kcal mole⁻¹ and $\Delta S^\ddagger = -13.8$ cal mole⁻¹ °K⁻¹.¹⁶⁴ Several lines of argument led to the conclusion that the reaction is concerted. First, the activation energies are in most cases significantly lower than would be required for dissociation into two allyl radicals;¹⁶⁵ second, the negative activation entropy suggests a constrained cyclic structure; and third, the reaction is highly stereospecific.¹⁶⁶

The stereochemistry of the Cope rearrangement has aroused considerable interest. Doering and Roth set out to determine whether a boatlike (**83**) or chairlike (**84**) transition state is preferred. Their experiment, the results of which

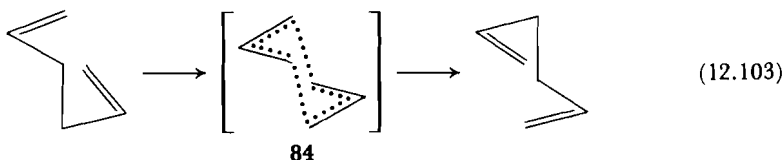
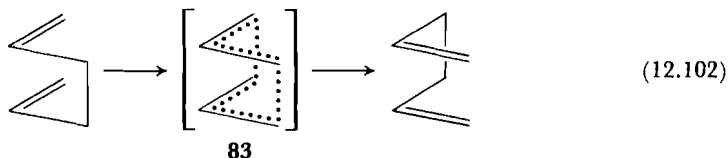

¹⁶² E. G. Foster, A. C. Cope, and F. Daniels, *J. Amer. Chem. Soc.*, **69**, 1893 (1947).

¹⁶³ H. Levy and A. C. Cope, *J. Amer. Chem. Soc.*, **66**, 1684 (1944).

¹⁶⁴ W. v. E. Doering, V. G. Toscano, and G. H. Beasley, *Tetrahedron*, **27**, 5299 (1971).

¹⁶⁵ (a) See note 159(c), p. 668; (b) M. J. Goldstein and M. S. Benzon, *J. Amer. Chem. Soc.*, **94**, 7147 (1972).

¹⁶⁶ Doering has suggested that a biradical (A) could in some cases be an intermediate (see note 164), and Dewar has found some support for this idea in the rearrangement of 2-phenylhexa-1,5-diene and 2,5-diphenylhexa-1,5-diene: M. J. S. Dewar and L. E. Wade, *J. Amer. Chem. Soc.*, **95**, 290 (1973).

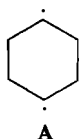

SCHEME 5

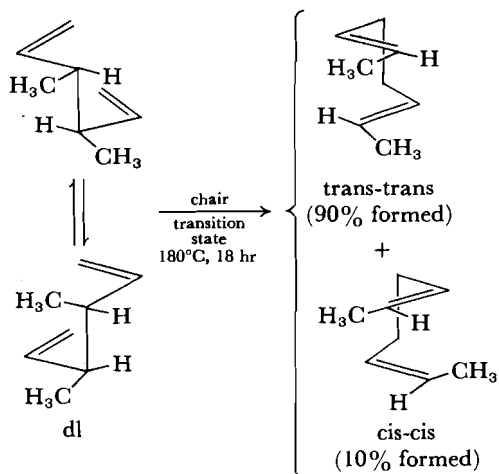
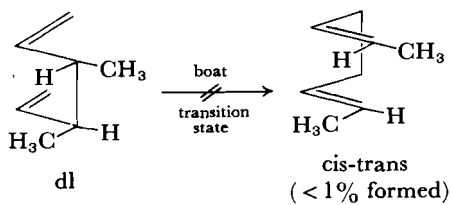
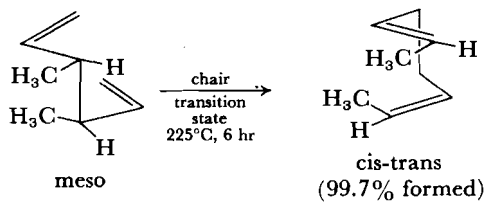
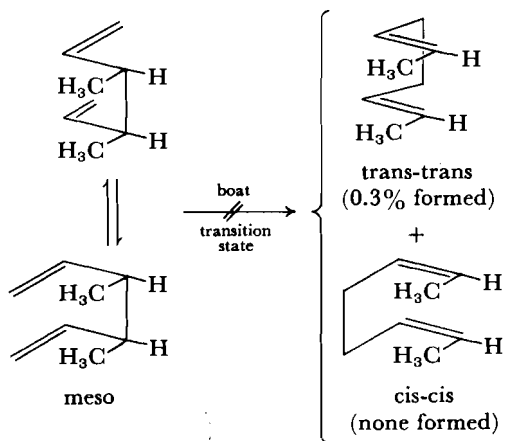
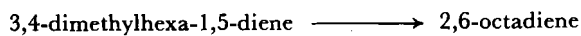

are shown in Scheme 5, demonstrate that the chair route (**84**) is the lower-energy one.¹⁶⁷ Goldstein and Benzon showed that the tetradeuterated diene **85** rearranges through the chair transition state at 230°C, but that the less favorable boat rearrangement begins to compete above 260°C.¹⁶⁸ Their estimate of the difference in free energy of activation, $\Delta\Delta G^\ddagger = 5.8 \text{ kcal mole}^{-1}$, agrees well with Doering and Roth's conclusion of $\Delta\Delta G^\ddagger \geq 5.7 \text{ kcal mole}^{-1}$.¹⁶⁹ Woodward and Hoffmann have rationalized the preference in terms of orbital correlation diagrams.¹⁷⁰

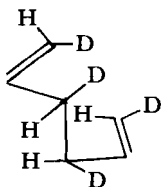
85

The Cope rearrangement produces a number of interesting phenomena in ring systems. Thermal dimerization of butadiene yields as one product 1,5-cyclooctadiene (Equation 12.104). Formally, this dimerization is a 4 + 4 cycloaddition; its actual course (Equation 12.105) is a 2 + 2 addition (presumably biradical) followed by a [3,3]-rearrangement of the *cis*-divinylcyclobutane.¹⁷¹

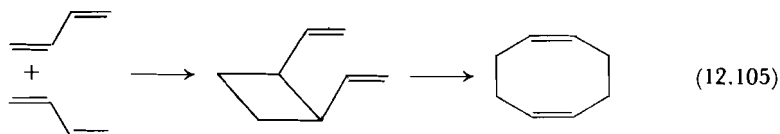

Cis-1,2-divinylcyclopropane also rearranges rapidly (Equation 12.106). The free energy of activation is 20 kcal mole⁻¹, and ΔH^\ddagger is 19.4 kcal mole⁻¹.¹⁷² The *trans* isomer, in contrast, rearranges only at 190°C, presumably the temperature required for its isomerization to the *cis* form.¹⁷³



¹⁶⁷ (a) W. v. E. Doering and W. R. Roth, *Tetrahedron*, **18**, 67 (1962); see also (b) R. K. Hill and N. W. Gilman, *Chem. Commun.*, 619 (1967); (c) R. K. Hill and N. W. Gilman, *Tetrahedron Lett.*, 1421 (1967).

¹⁶⁸ (a) See note 165(b), p. 669. (b) M. J. Goldstein and M. S. Benzon, *J. Amer. Chem. Soc.*, **94**, 7149 (1972), point out that a number of details about the precise stereochemistry of the rearrangement pathway remain to be demonstrated.

¹⁶⁹ See note 167.

¹⁷⁰ Woodward and Hoffmann, *The Conservation of Orbital Symmetry*, p. 149.

¹⁷¹ (a) E. Vogel, *Justus Liebigs Ann. Chem.*, **615**, 1 (1958); (b) C. A. Stewart, Jr., *J. Amer. Chem. Soc.*, **94**, 635 (1972).

¹⁷² J. M. Brown, B. T. Golding, and J. J. Stofko, Jr., *Chem. Commun.*, 319 (1973).

¹⁷³ See note 159(b), p. 668.

Fluotional Molecules¹⁷⁴

Doering and Roth reported in 1963 the preparation of bicyclo[5.1.0]octa-2,5-diene (**86**), which they found to be surprisingly stable.¹⁷⁵ It withstands heating

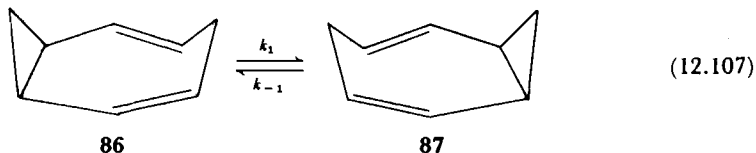

to 305°C without decomposition; the proton magnetic resonance spectrum nevertheless reveals that it is undergoing the degenerate Cope [3,3]-sigmatropic rearrangement indicated in Equation 12.107. The spectrum changes from that expected for **86** alone at -50°C to that of the average of **86** and **87** at 180°C. Rate constants $k_1 = k_{-1}$ estimated from the spectra are on the order of 10^3 sec^{-1} at 180°C and on the order of 1 sec^{-1} at -50°C.¹⁷⁶ An accompanying

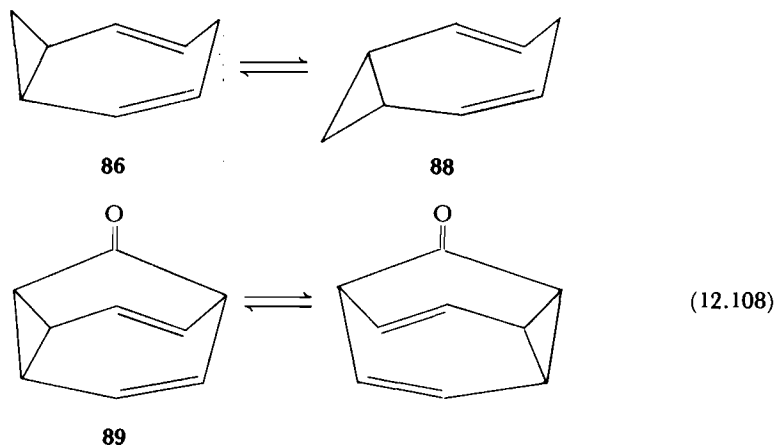

equilibrium, $\mathbf{86} \rightleftharpoons \mathbf{88}$, is avoided in the bridged structure **89**,¹⁷⁷ which rearranges to the identical tautomer rapidly on the proton magnetic resonance time scale down to -90°C. The rate constant is $1.2 \times 10^3 \text{ sec}^{-1}$ at -55°C, and the activation energy E_a is $8.1 \text{ kcal mole}^{-1}$.¹⁷⁸

Doering and Roth, at the time of their first investigations of **86** in 1963, proposed that the structure **90**, which they named bullvalene, should undergo degenerate Cope rearrangements that would make each of the ten CH groups equivalent.¹⁷⁹ Equation 12.109 illustrates just a few of these transformations.¹⁸⁰

¹⁷⁴ For reviews, see: (a) G. Schröder, J. F. M. Oth, and R. Merényi, *Angew. Chem. Int. Ed.*, **4**, 752 (1965); (b) G. Schröder and J. F. M. Oth, *Angew. Chem. Int. Ed.*, **6**, 414 (1967); (c) L. T. Scott and M. Jones, Jr., *Chem. Rev.*, **72**, 181 (1972); (d) L. A. Paquette, *Angew. Chem. Int. Ed.*, **10**, 11 (1971); carbocations, (e) R. E. Leone and P. v. R. Schleyer, *Angew. Chem. Int. Ed.*, **9**, 860 (1970).

¹⁷⁵ See note 159(c), p. 668.

¹⁷⁶ (a) See note 159(c), p. 668; (b) W. v. E. Doering and W. R. Roth, *Tetrahedron*, **19**, 715 (1963).

¹⁷⁷ It is concluded from studies of models that whereas the conformation **88** is the more stable one, it does not undergo the [3,3]-rearrangement as readily as does **86**. See note 159(c), p. 668, and note 176.

¹⁷⁸ J. B. Lambert, *Tetrahedron Lett.*, 1901 (1963).

¹⁷⁹ See note 159(c), p. 668.

¹⁸⁰ The structures are drawn so as to make clear which bonds have shifted; close examination will reveal that all are identical.

If each of the ten CH groups were individually labeled, there would be $10!/3$, or 1,209,600, different ways of arranging them in the Structure **90**.¹⁸¹ Doering and Roth pointed out that observation of a single line in the proton magnetic resonance spectrum would mean that all of these structures were simultaneously present and rapidly interconverting.¹⁸² Later in the same year Schröder announced the synthesis of bullvalene and reported that the proton magnetic

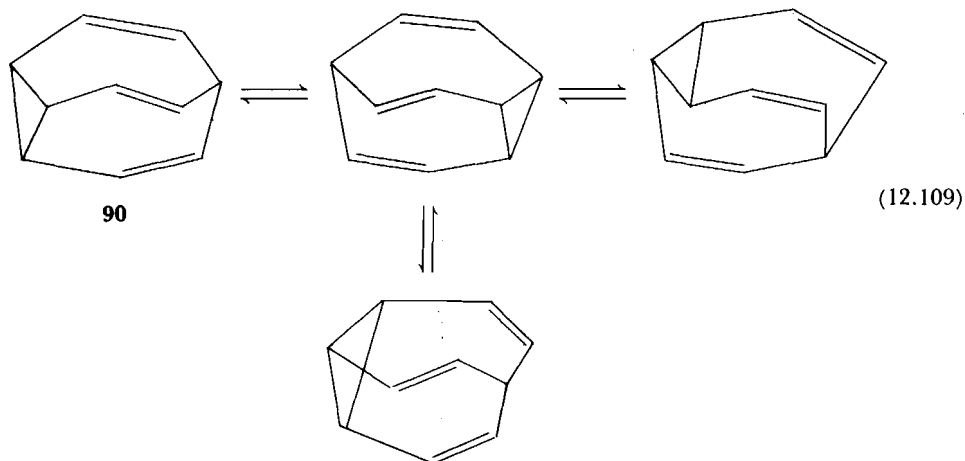

resonance spectrum at 100°C is indeed a single sharp line which broadens on cooling and divides into two bands of area ratio (high field:low field peak) 4:6 at -25°C.¹⁸³ The rate of rearrangement at 0°C is about 800 sec^{-1} , ΔH^\ddagger is 11–12 kcal mole⁻¹, ΔS^\ddagger is -5 cal mole⁻¹ °K⁻¹.¹⁸⁴ When one bridge is saturated (**91**), the rate is faster (about $3 \times 10^5 \text{ sec}^{-1}$ at 0°C), largely because of more favorable activation entropy ($\Delta H^\ddagger \approx 12 \text{ kcal mole}^{-1}$, $\Delta S^\ddagger \approx +11 \text{ cal mole}^{-1} \text{ °K}^{-1}$); decreasing the number of bridging carbons continues to increase the rate, **92** rearranging at $k \approx 3 \times 10^7 \text{ sec}^{-1}$ at 0°C ($E_a \approx 9 \text{ kcal mole}^{-1}$).¹⁸⁵

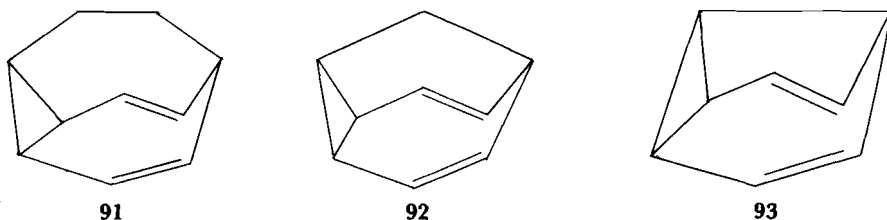

¹⁸¹ Division by the factor of three is required by the threefold symmetry axis. To each arrangement of CH groups there correspond two others, counted as separate elsewhere among the $10!$, which are related by a threefold rotation and so are actually identical.

¹⁸² See note 159(c), p. 668, and note 176(b).

¹⁸³ (a) G. Schröder, *Angew. Chem. Int. Ed.*, **2**, 481 (1963); (b) G. Schröder, *Chem. Ber.*, **97**, 3140 (1964); (c) R. Merényi, J. F. M. Oth, and G. Schröder, *Chem. Ber.*, **97**, 3150 (1964).

¹⁸⁴ (a) See note 174(b); (b) M. Saunders, *Tetrahedron Lett.*, 1699 (1963). Saunders points out that these rates do not correspond to the rate at which a given structure rearranges to any arbitrarily chosen one of the 10^6 possibilities. Change from one structure to some other particular one will in general require a sequence of steps. (c) A. Allerhand and H. S. Gutowsky, *J. Amer. Chem. Soc.*, **87**, 4092 (1965).

¹⁸⁵ (a) See note 174(b), p. 672; (b) W. v. E. Doering, B. M. Ferrier, E. T. Fossel, J. H. Hartenstein, M. Jones, Jr., G. Klumpp, R. M. Rubin, and M. Saunders, *Tetrahedron*, **23**, 3943 (1967).

and **93** even more rapidly, exhibiting no change in proton magnetic resonance spectrum at -110°C .¹⁸⁶

The Claisen Rearrangement¹⁸⁷

A close analog of the Cope is the Claisen rearrangement. Historically, the Claisen, having been known and studied since 1912, is much the older of the two. It is a [3,3]-sigmatropic change (Equation 12.110), with oxygen as one atom of the chain. It is most commonly encountered with unsaturated phenyl ethers of the type illustrated in Equation 12.111, which rearrange to ortho- or para-substi-

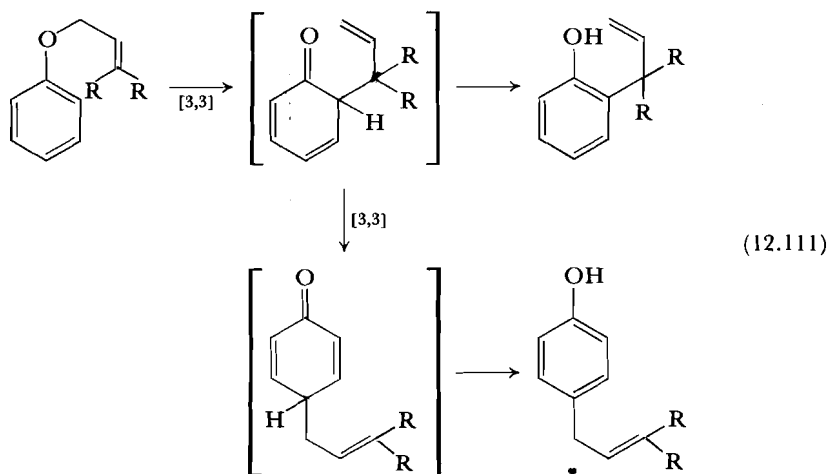

tuted phenols. The end of the chain remote from the oxygen becomes attached to the ortho position of the aromatic ring, inverting the allyl group. A second [3,3]-rearrangement, this one of the Cope type, may follow to leave the carbon originally attached to oxygen bonded to the para position. This para rearrangement is particularly likely to occur if the ortho positions are substituted so that enolization is blocked at the first stage. Negative activation entropies, on the order of $-10 \text{ cal mole}^{-1} \text{ }^{\circ}\text{K}^{-1}$,¹⁸⁸ and the allylic inversion accompanying each step indicate a concerted process. The reaction also occurs in aliphatic systems; experiments modeled after those of Doering and Roth on the Cope rearrangement have shown that the chair transition state is preferred in both aromatic and aliphatic Claisen rearrangements.¹⁸⁹

¹⁸⁶ (a) H. E. Zimmerman and G. J. Grunewald, *J. Amer. Chem. Soc.*, **88**, 183 (1966); (b) R. Hoffmann and W. Stohrer, *J. Amer. Chem. Soc.*, **93**, 6941 (1971), have considered theoretically ways to lower the activation energy still further.

¹⁸⁷ Reviews: (a) D. S. Tarbell, *Chem. Rev.*, **27**, 495 (1940); (b) D. S. Tarbell, *Org. Reactions*, **2**, 1 (1944); (c) A. Jefferson and F. Scheinmann, *Quart. Rev. (London)*, **22**, 391 (1968); (d) see note 159(a), p. 668.

¹⁸⁸ See note 159(a), p. 668.

¹⁸⁹ (a) H. J. Hansen and H. Schmid, *Chem. Brit.*, **5**, 111 (1969); (b) G. Fráter, A. Habich, H. Hansen, and H. Schmid, *Helv. Chim. Acta.*, **52**, 335, 1156 (1969).

The Ene Reaction¹⁹⁰

The process shown in Equation 12.112, in the forward direction termed the *ene reaction* and in the reverse the *retro-ene reaction*, bears the same relationship to the [3,3]-sigmatropic reactions as does the [2,3]-elimination (p. 668) to the [2,3]-sigmatropic shift. It is also closely related to the [1,5]-rearrangement of hydrogen. The reaction can occur either intermolecularly, as in, for example, Equations 12.113 and 12.114, or intramolecularly, as in Equations 12.115 and 12.116.

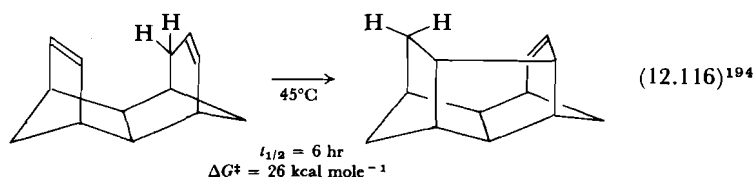
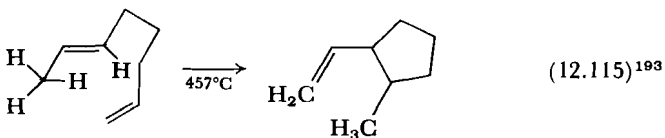
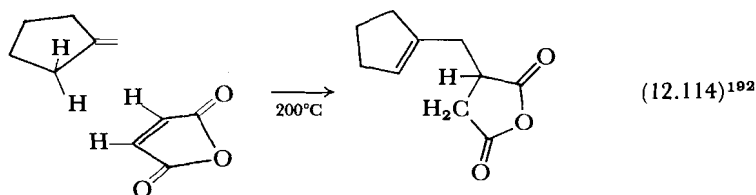
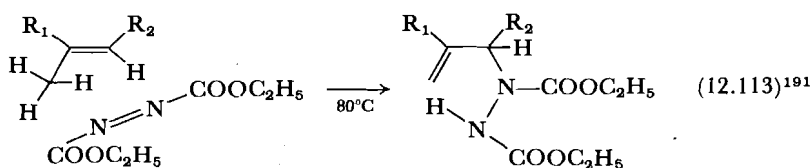
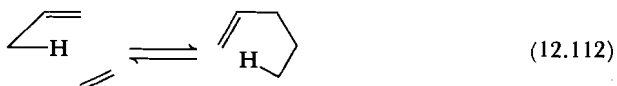

The temperature required varies widely depending upon the substitution pattern. The process is favored by electron-withdrawing substituents on the hydrogen acceptor (*enophile*), by geometrical constraints that hold the components in favorable relative positions (Equation 12.116), and by strain in the double bonds.

The ene reactions exhibit the highly negative entropies of activation (on the order of $-30 \text{ cal mole}^{-1} \text{ }^\circ\text{K}^{-1}$ for intermolecular reaction¹⁹⁵) and cis

¹⁹⁰ Review: H. M. R. Hoffmann, *Angew. Chem. Int. Ed.*, **8**, 556 (1969).

¹⁹¹ W. A. Thaler and B. Franzus, *J. Org. Chem.*, **29**, 2226 (1964).

¹⁹² R. T. Arnold, R. W. Amidon, and R. M. Dodson, *J. Amer. Chem. Soc.*, **72**, 2871 (1950).

¹⁹³ W. D. Huntsman, V. C. Solomon, and D. Eros, *J. Amer. Chem. Soc.*, **80**, 5455 (1958).

¹⁹⁴ J. M. Brown, *J. Chem. Soc. (B)*, 868 (1969).

¹⁹⁵ B. Franzus, *J. Org. Chem.*, **28**, 2954 (1963).

addition to the enophile expected for a concerted process.¹⁹⁶ There are nevertheless indications that a stepwise biradical path may be followed in some cases.¹⁹⁷

Higher-Order $[m,n]$ -Sigmatropic Reactions

Relatively few sigmatropic reactions of order higher than [3,3] have been observed. Examples are shown in Equations 12.117–12.119.

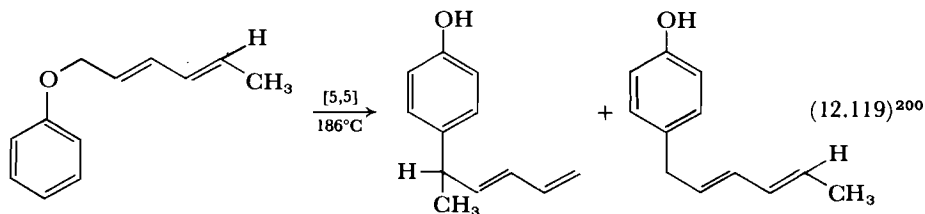
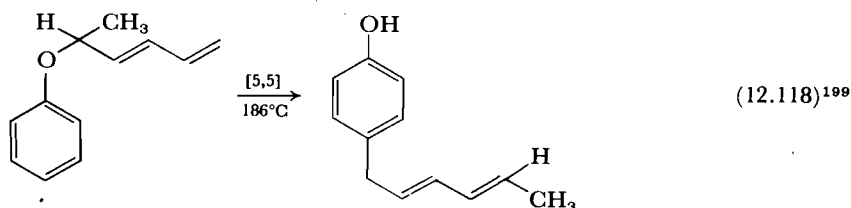
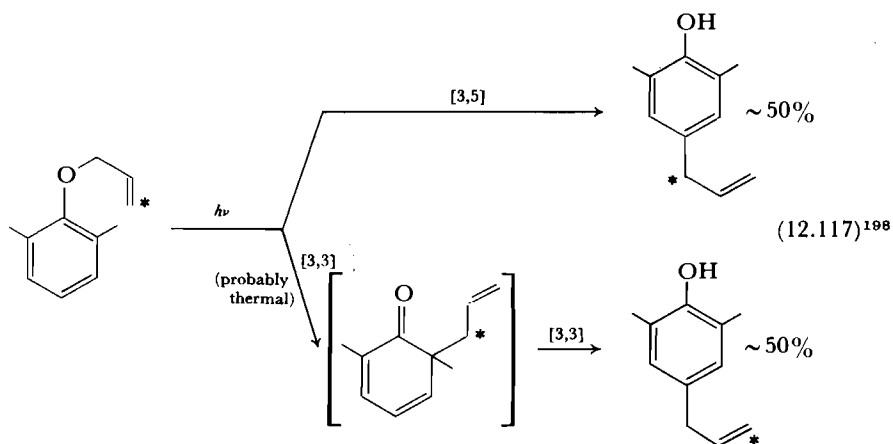

¹⁹⁶ K. Alder and H. von Brachel, *Justus Liebigs Ann. Chem.*, **651**, 141 (1962).

¹⁹⁷ See note 190, p. 675.

¹⁹⁸ K. Schmid and H. Schmid, *Helv. Chim. Acta*, **36**, 687 (1953).

¹⁹⁹ (a) G. Fráter and H. Schmid, *Helv. Chim. Acta*, **51**, 190 (1968); (b) G. Fráter and H. Schmid, *Helv. Chim. Acta*, **53**, 269 (1970).

²⁰⁰ See note 199.

PROBLEMS

1. Propose a pathway for each of the following transformations:

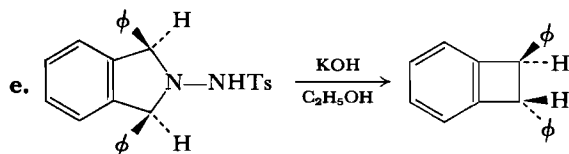
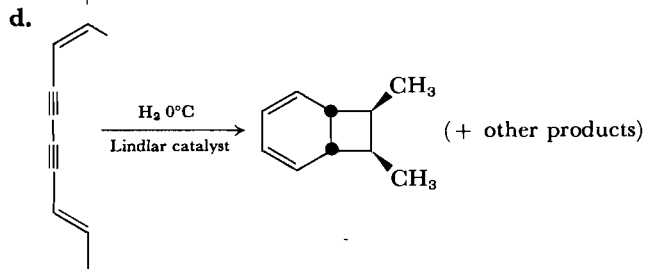
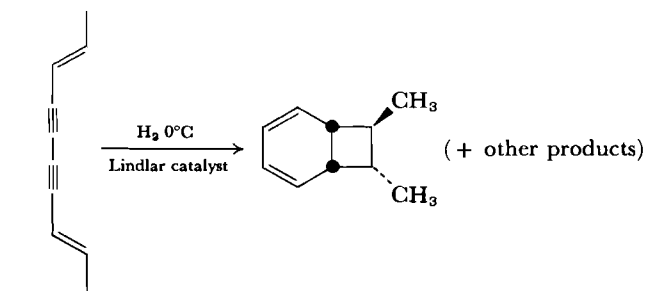
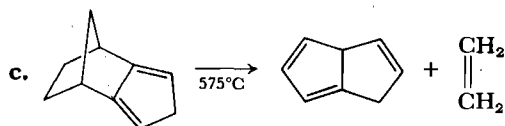
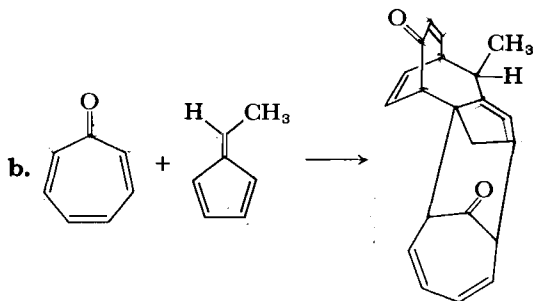
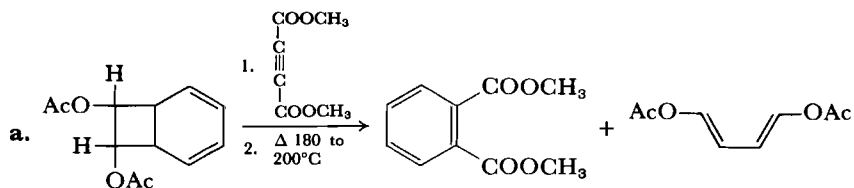

4. Explain why cis olefins add 1,3-dipoles more slowly than trans olefins, despite the fact that the cis ground states are higher in energy.

5. Explain the mechanistic significance of the product distributions shown:

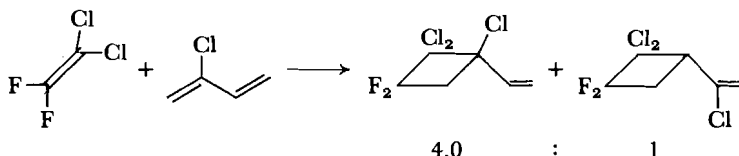
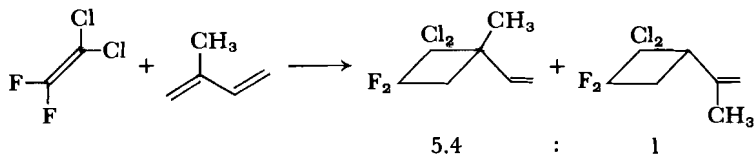

6. Explain the following observation:

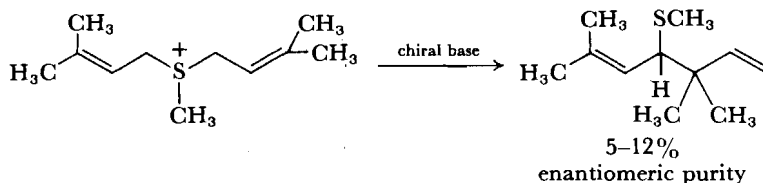

7. Outline the structural and stereochemical consequences of the thermally allowed [1,3]- and [1,5]-sigmatropic shifts of the bridging carbon in each of the following structures:

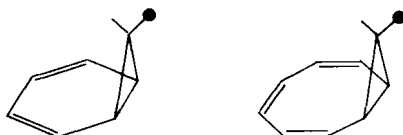

8. Show how the pericyclic theory predicts that the closure of the trimethylene diradical (3) to cyclopropane should be conrotatory.

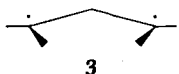

REFERENCES FOR PROBLEMS

- (a) R. Criegee, W. Hörauf, and W. D. Schellenberg, *Chem. Ber.*, **86**, 126 (1953); (b) H. R. Pfaendler and H. Tanida, *Helv. Chim. Acta*, **56**, 543 (1973); (c) T. J. Katz, M. Rosenberger, and R. K. O'Hara, *J. Amer. Chem. Soc.*, **86**, 249 (1964); (d) E. N. Marvell and J. Seubert, *J. Amer. Chem. Soc.*, **89**, 3377 (1967); (e) L. A. Carpino, *Chem. Commun.*, 494 (1966); (f) W. R. Roth and J. König, *Justus Liebigs Ann. Chem.*, **688**, 28 (1965); (g) H. H. Westberg, E. N. Cain, and S. Masamune, *J. Amer. Chem. Soc.*, **91**, 7512 (1969); **92**, 5291 (1970); (h) E. Ciganek, *J. Amer. Chem. Soc.*, **89**, 1458 (1967); (i) J. A. Berson, R. R. Boettcher, and J. J. Vollmer, *J. Amer. Chem. Soc.*, **93**, 1540 (1971); (j) H. E. Zimmerman and G. A. Epling, *J. Amer. Chem. Soc.*, **94**, 3647 (1972); (k) W. v. E. Doering and W. R. Roth, *Angew. Chem. Int. Ed.*, **2**, 115 (1963).
- L. Watts, J. D. Fitzpatrick, and R. Pettit, *J. Amer. Chem. Soc.*, **88**, 623 (1966).

3. A. Nickon and B. R. Aaronoff, *J. Org. Chem.*, **29**, 3014 (1964).
4. R. Huisgen, R. Grashey, and J. Sauer, in *The Chemistry of Alkenes*, S. Patai, Ed., Wiley-Interscience, London, 1964, p. 820.
5. P. D. Bartlett, L. K. Montgomery, and B. Seidel, *J. Amer. Chem. Soc.*, **86**, 616 (1964).
6. B. M. Trost and W. G. Biddlecom, *J. Org. Chem.*, **38**, 3438 (1973).
7. R. B. Woodward and R. Hoffmann, *The Conservation of Orbital Symmetry*, Verlag Chemie, Weinheim/Bergstr., Germany, and Academic Press, New York, 1970, p. 132.
8. R. Hoffmann, *J. Amer. Chem. Soc.*, **90**, 1475 (1968); R. Hoffmann, *Accts. Chem. Res.*, **4**, 1 (1971).

Chapter 13

PHOTOCHEMISTRY¹

In this chapter we shall present a simplified picture of photophysical processes and a glimpse of mechanistic organic photochemistry. More complete accounts of photochemistry, one of the newest and most intensely studied fields of organic chemistry, are found in the books and articles referred to in note 1.

13.1 LIGHT ABSORPTION

A full explanation of the properties of light requires both the wave theory of electromagnetic radiation and the quantum theory. Most photochemical processes are best understood in terms of the quantum theory, which says that light is made up of discrete particles called quanta or photons. Each quantum carries an amount of energy, \mathcal{E} , determined by the wavelength of the light, λ . Equation 13.1, in which h is Planck's constant and c is the speed of light in a vacuum,

$$\mathcal{E} = \frac{hc}{\lambda} \quad (13.1)$$

¹ (a) J. G. Calvert and J. N. Pitts, Jr., *Photochemistry*, Wiley, New York, 1966; (b) R. B. Cundall and A. Gilbert, *Photochemistry*, Thomas Nelson, London, 1970; (c) R. P. Wayne, *Photochemistry*, Butterworths, London, 1970; (d) W. A. Noyes, G. S. Hammond, and J. N. Pitts, Jr., Eds., *Advances in Photochemistry*, Vols. 1—, Wiley-Interscience, New York, 1968—; (e) O. L. Chapman, Ed., *Organic Photochemistry*, Vols. 1—, Marcel Dekker, New York, 1966—; (f) R. S. Becker, *Theory and Interpretation of Fluorescence and Phosphorescence*, Wiley, New York, 1969; (g) D. R. Arnold, N. C. Baird, J. R. Bolton, J. C. D. Brand, P. W. M. Jacobs, P. de Mayo and W. R. Ware, *Photochemistry: An Introduction*, Academic Press, New York, 1974; (h) J. P. Simons, *Photochemistry and Spectroscopy*, Wiley-Interscience, New York, 1971; (i) J. Coxon and B. Halton, *Organic Photochemistry*, Cambridge University Press, New York, 1974.

gives the relationship between energy and wavelength. Equation 13.1 may also be written

$$\mathcal{E} = h\nu \quad (13.2)$$

where ν is the frequency of the light.

A molecule can absorb a quantum if and only if the energy of the quantum is the same as the energy difference between the state the molecule is in and a higher state of the molecule; absorption is accompanied by transition of the molecule to the higher state. According to the law of Stark and Einstein, a molecule absorbs a single quantum to bring about a single transition; thus transition to a first excited state cannot result, for example, from the absorption of two quanta, each of half the required energy. It is important to keep this in mind when considering the effect of light intensity. Increasing it increases the number of molecules that undergo a certain transition, but does not alter the nature of the transition. A few exceptions to the Stark-Einstein law have been observed in which a single molecule (or atom) absorbs two or even three quanta simultaneously. These *bi-* or *triphotonic* absorptions require extraordinarily high light intensities, and are rare even under such conditions.

Depending on the wavelength, radiation may bring about a number of different kinds of molecular transitions. Infrared light can excite a molecule to a higher vibrational or rotational level. Very short wavelength ultraviolet light may actually bring about ionization by removal of an electron from the molecule. Light of intermediate energy (ultraviolet or visible) may promote an electron from the electronic orbital it occupies in the ground state of the molecule to a higher-energy orbital. The molecule is then said to be electronically excited. Henceforth in this chapter, unless we specify otherwise, we shall use the term "excited state" to refer to an electronically excited state only. Photochemistry is the study of the chemical and physical processes the molecule undergoes after electronic excitation.

In line with current practice in the literature, we shall mainly use the nanometer (nm) as the unit of wavelength. One nanometer is equal to 10^{-7} cm. Not long ago the millimicron ($m\mu$) was most frequently used by organic photochemists. One millimicron is exactly equal to one nanometer. Other units often seen are the angstrom (\AA), which is equal to 10^{-8} cm, and the wave number, $\bar{\nu}$, which is equal to $1/\lambda$ (the units of $\bar{\nu}$ therefore depend on the unit of λ). The region of the electromagnetic spectrum that brings about controlled electronic excitation and thus is of interest to photochemists is approximately from 200 to 700 nm (2000 to 7000 \AA).

The energy, E , of 1 mole of quanta (i.e., of one *einstein*) is given by Equation 13.3, where N is Avogadro's number. If one substitutes the appropriate nu-

$$E = \frac{Nhc}{\lambda} \quad (13.3)$$

merical values for N , h , and c , one obtains

$$E = \frac{2.86 \times 10^4}{\lambda} \text{ kcal einstein}^{-1} \quad (13.4)$$

where λ is in nanometers. An einstein of 200-nm light has an energy of 143 kcal, whereas an einstein of 700-nm light has an energy of 40 kcal.

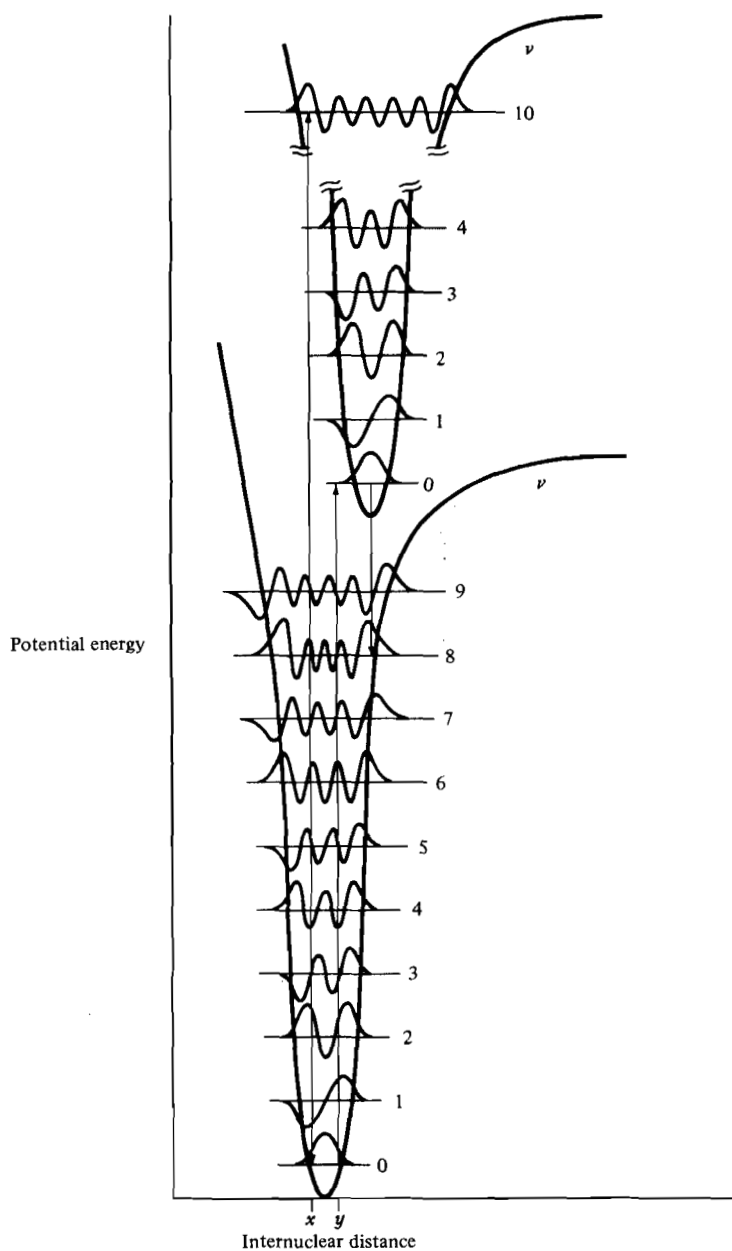

Figure 13.1 Vibrational levels and internuclear distance-probability functions for the ground state and first excited singlet of a diatomic molecule. Absorption and emission according to the Franck-Condon principle are illustrated. Adapted from N. J. Turro, *Molecular Photochemistry*, Addison-Wesley—W. A. Benjamin, Reading, Mass., 1967. Reproduced by permission of Addison-Wesley.

The ultraviolet and visible absorption spectra of single atoms consist of a number of sharp lines, which correspond to the promotion of an electron from one orbital to another. Each atomic orbital has a well-defined energy, and there-

fore only narrow-bandwidth light can be absorbed to effect the transition from one orbital to another. The ultraviolet and visible spectra of molecules are not made up of lines but, instead, of broad bands in which a number of peaks are often discernible. The broader absorption is due to the fact that within the ground state and within each excited state of the molecule there are a number of closely spaced vibrational levels (v), each of different energy, and each of which may be populated. The transition of a molecule from the ground state to a certain excited state may therefore be accomplished by light that has a range of energy.

Figure 13.1 shows potential energy vs. internuclear distance curves for the ground state and first excited state of a diatomic molecule A—B. (Note that the energy minimum for the excited state is at greater internuclear distance than the energy minimum for the ground state. This is often the case. Excited states have antibonding electrons that force the nuclei apart.) The horizontal lines are the vibrational levels, and the curve on each horizontal line is the wave function for that vibrational level. The amplitude squared of the function at any internuclear distance corresponds to the probability that a molecule in that vibrational level of that state will have that internuclear distance. Quantum mechanical treatment shows that: (1) the wave function of the lowest vibrational level of each state has no nodes; (2) each successive vibrational level has a function with one additional node; and (3) in the higher vibrational levels the amplitude of the function is greatest at the turning points.

The excitation of a molecule from one state to another happens much faster than a single molecular vibration (10^{-15} vs. 10^{-12} sec); excitation therefore occurs with almost no change in internuclear distance. The probability that a molecule will undergo a transition from the n th vibrational level of one state to the m th vibrational level of another state is proportional to the overlap of the wave functions of those vibrational levels at the internuclear distance the molecule has at the moment of absorption. For example, as Figure 13.1 shows, in the split second that a molecule of A—B in the lowest (0th) vibrational level of the ground state has internuclear distance x , that molecule cannot absorb a photon to be excited to the 0th vibrational level of the first excited state; the wave function of that excited state vanishes at x , the overlap is zero, and the probability for the transition is also zero. The molecule of A—B can absorb a higher-energy photon and be raised to the 10th vibrational level of the first excited state. Or a split second later, when that molecule has internuclear distance y , there is a small probability that it will be raised to the 0th level of the first excited state. The principle of *vertical transitions* demonstrated in Figure 13.1 was first recognized by Franck and later elaborated by Condon. It is therefore also known as the *Franck-Condon principle*.

Most organic molecules in the ground state at room temperature are in the 0th vibrational level. To which vibrational level of an excited state they are promoted depends on the relative internuclear distances of the ground and excited states. If the ground and excited states have their energy minima at nearly the same internuclear distance, the probability of transition between the 0th level of the ground state and the 0th level of the excited state is high: The 0–0 absorption band will be strong. If the excited state is displaced to larger internuclear distances as in Figure 13.1, the 0–0 absorption will be weak. Organic chemists usually give the wavelength of maximum absorption when giving the

position of an absorption band. It is necessary to keep in mind that this usually does not correspond to 0-0 absorption.

Saturated hydrocarbons do not absorb between 200 and 700 nm. At shorter wavelengths they do absorb to promote an electron from a σ to a σ^* orbital. The excited molecule (with one electron still in the original level) is said to be in a σ, σ^* state. The photochemistry of σ, σ^* states is difficult to study, because all matter absorbs at these wavelengths. Furthermore, it is often not very interesting, since molecules in σ, σ^* states fragment indiscriminately through σ bond cleavage. More interesting chemistry is found in the study of molecules that have multiple bonds and/or heteroatoms with nonbonding electrons.

The promotion of an electron from a π to a π^* orbital in a simple olefin is also a high-energy process, but increasing conjugation greatly decreases the energy of the lowest transition. For example, ethylene has its lowest-energy λ_{\max} at 174 nm, butadiene at 209 nm, and β -carotene (**1**, with 11 conjugated

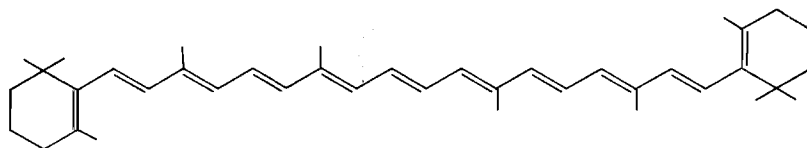

1

double bonds) at 480 nm. Conjugated polyenes, of course, have several possible π, π^* transitions. Carbonyl compounds have two fairly low-energy transitions available to them. The lower, in simple ketones, has λ_{\max} at approximately 280 nm and corresponds to the promotion of a nonbonding electron on oxygen to the lowest unoccupied orbital to give an n, π^* state. The other is promotion of a π electron to give a π, π^* state. In unconjugated ketones a π, π^* transition requires wavelengths less than 200 nm, but again conjugation shifts the lowest-energy π, π^* absorption to longer wavelengths (*red shift*).

The amount of energy required for a certain transition is solvent-dependent. For example, polar solvents cause the n, π^* transition to be shifted to shorter wavelengths. It has been thought that these *blue shifts* are due to solvation of the n electrons in the ground state by the polar solvent, an interaction that would stabilize the ground state. On the other hand, by this hypothesis, the excited state can be only partially stabilized, because the solvent molecules do not have time to reorient themselves during excitation. Thus more energy is required to bring about the transition. More recently, the singlemindedness of this view has been challenged by Haberfield. By measuring heats of solution he has calculated, for example, that in going from hexane to ethanol the ground state of acetone is stabilized, but only by 0.97 kcal mole⁻¹. The excited state, however, is destabilized by 2.49 kcal mole⁻¹. Thus most of the blue shift in this solvent change is caused by an increase in the energy of the excited state. In other solvents—for example, chloroform—the blue shift is due to stabilization of the ground state as previously supposed.² π, π^* transitions often undergo a red shift in polar solvents.³

² P. Haberfield, *J. Amer. Chem. Soc.*, **96**, 6526 (1974).

³ See, for example, R. Rusakowicz, G. W. Byers, and P. A. Leermakers, *J. Amer. Chem. Soc.*, **93**, 3263 (1971) and note 1(f), p. 681.

To specify the occupied orbitals of an excited state does not describe the state fully. We must also specify whether or not all the electron spins in the molecule are paired. In the ground state of most molecules, the bonding orbitals are full and thus all electron spins are paired. After excitation of an electron to an empty orbital, the spins of the two electrons in the half-empty orbitals may be either paired or parallel. If all spins are paired, then the magnetic field generated by one electron is cancelled by its partner and the net interaction with an external magnetic field is zero. Because there is only one way in which the electrons of such a species can interact with a magnetic field they are called singlets, and we say they have a *multiplicity* of one. Singlets are diamagnetic.

If the spins of the two electrons are unpaired, their magnetic fields may interact to: (1) add together to augment an external magnetic field; (2) add together to diminish an external magnetic field; or (3) cancel each other. Such species are called triplets and are said to have a multiplicity of three. Triplets are of lower energy than the corresponding singlets and are paramagnetic.

The multiplicity, S , of a species is given by Equation 13.5, where s is the sum of the spin quantum numbers of all the electrons in the species. For example, if all spins are paired, $s = 0$ and $S = 1$. If all but two electrons are paired,

$$S = 2s + 1 \quad (13.5)$$

$s = 1$ and $S = 3$. To indicate that the electrons in the n and π^* orbitals of an n, π^* state are paired, we write $^1(n, \pi^*)$. To indicate that they are parallel, we write $^3(n, \pi^*)$. The ground-state singlet of a molecule is abbreviated S_0 . The excited singlets are denoted $S_1, S_2, S_3, \dots, S_n$, where the subscripts 1, 2, 3, \dots , n refer to the first, second, third, \dots , n th excited singlets, respectively. Similarly, the first, second, third, \dots , n th excited triplets are denoted $T_1, T_2, T_3, \dots, T_n$. In acetone S_1 is $^1(n, \pi^*)$ and S_2 is $^1(\pi, \pi^*)$. Likewise, T_1 is $^3(n, \pi^*)$.

Not all transitions are equally probable. Improbable transitions are called, dramatically, *forbidden transitions*. Probable ones are called *allowed*. Whether a transition is forbidden or allowed can be predicted on the basis of rules called *selection rules*. The two most important selection rules for the organic photochemist are those that deal with spin-forbidden and space-forbidden transitions.

A transition is spin-forbidden if the multiplicity of the excited state is different from the multiplicity of the ground state. Another way of putting this is to say that during excitation ΔS must equal zero. Thus, on absorption the allowed transitions of a ground-state singlet are to excited singlets and of a ground-state triplet (e.g., O_2) are to excited triplets.

A transition is space-forbidden if the orbitals involved occupy different regions in space. An n, π^* transition is forbidden because the greatest probability of finding an electron in an n orbital is around the nucleus—a region of space that corresponds to a node of a π^* orbital. On the other hand, π and π^* orbitals occupy overlapping regions of space and therefore π, π^* transitions are allowed.

Experimentally, we can determine the probability of a certain transition by measuring its *extinction coefficient*, ϵ . When a beam of monochromatic radiation passes through an absorbing system, the intensity of the transmitted beam, I_t , is given by the Beer-Lambert law (Equation 13.6), where I_0 is the intensity of

$$I_t = I_0 10^{-\epsilon cd} \quad (13.6)$$

the incident light, c is the concentration of the absorbing species, and d is the thickness of the system. The value of ϵ depends, of course, on wavelength, and also on temperature and solvent, but not on concentration. The often-used logarithmic form of the Beer-Lambert law is shown in Equation 13.7, where A is the *absorbance*.

$$\log \frac{I_0}{I_t} = \epsilon cd = A \quad (13.7)$$

The allowed π, π^* transition in acetone has an extinction coefficient of 900, whereas the forbidden n, π^* transition has an ϵ of 15. (Note that forbidden transitions do occur.) The transition to the first excited triplet, $^3(n, \pi^*)$, has not been observed.

Molecules that contain heavy atoms do not obey the spin-forbidden selection rule. For example, neat 1-chloronaphthalene has an extinction coefficient of $\sim 3 \times 10^{-4}$ for the 0-0 band of its $S_0 \rightarrow T_1$ absorption, but 1-iodonaphthalene has an ϵ of 0.6 for the same transition.⁴ The explanation for the *heavy atom effect* is that an actual molecule does not contain pure spin states: A singlet has a certain amount of triplet character and vice versa. Mixing comes about through *spin-orbit coupling*. By the theory of relativity, an electron spinning around a nucleus may also be thought of as a nucleus spinning around an electron. The magnetic field produced by the spinning nucleus applies a torque on the electron and may cause it to "flip" (i.e., to change its spin quantum number from $+\frac{1}{2}$ to $-\frac{1}{2}$ or vice versa). The heavier the nucleus is, the greater is the magnetic field generated by it and therefore the more likely it is to cause an electron to flip. Thus, for a molecule containing a heavy atom, a value cannot be assigned to S of Equation 13.5. Without a value for S , the stipulation that ΔS must equal zero during a transition has no meaning.

The heavy atom effect does not require that the heavy atom be within the molecule undergoing the transition. For example, when the two colorless liquids 1-chloronaphthalene and ethyl iodide are mixed, a yellow color develops. Spectroscopic examination shows that the color is due to an increase in $S_0 \rightarrow T_1$ transitions in chloronaphthalene.⁵ Paramagnetic molecules also increase the probability of $S \rightarrow T$ transitions in neighboring molecules.

13.2 UNIMOLECULAR PHOTOPHYSICAL PROCESSES

Light absorption by a molecule usually produces an excited singlet, S_n , in an upper vibrational level. Normally the following processes follow excitation: Collision with solvent rapidly degrades S_n to its 0th vibrational level, that is, to S_n^0 ; then if n is 2 or higher, this state rapidly undergoes an isoenergetic conversion to the next lowest singlet. The transformation of one excited state into another of the same multiplicity is called *internal conversion* (IC), and is shown schematically in the *Jablonski diagram* of Figure 13.2. (In polyatomic molecules there is no single internuclear distance and therefore we cannot use two-dimensional diagrams such as the one in Figure 13.1 to depict electronic transitions. Instead we use single-coordinate Jablonski diagrams, which simply show the energies

⁴ S. P. McGlynn, R. Sunseri, and N. Christodouleas, *J. Chem. Phys.*, **37**, 1818 (1962).

⁵ M. Kasha, *J. Chem. Phys.*, **20**, 71 (1952).

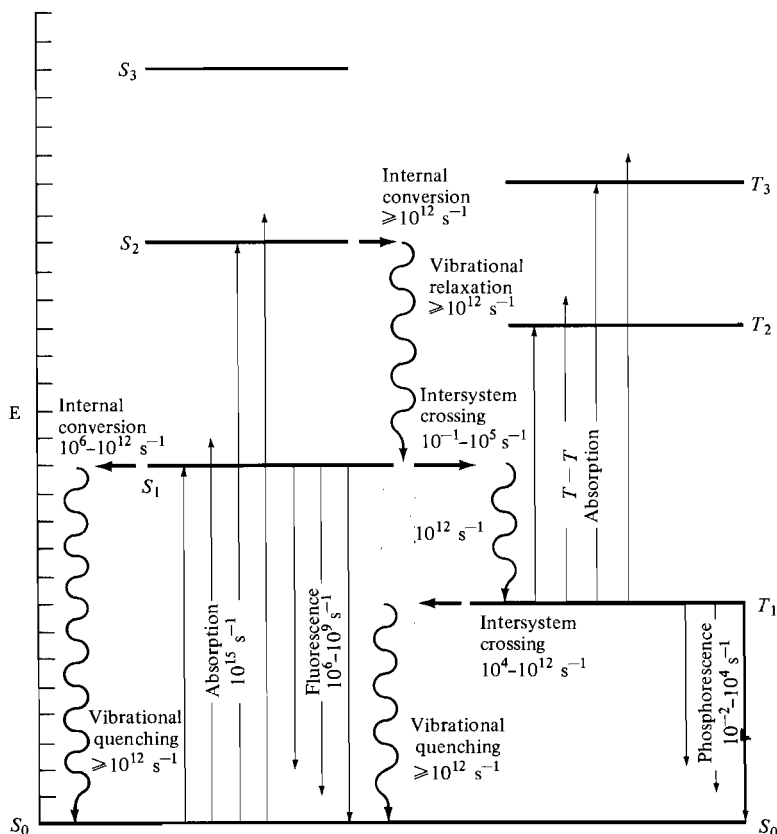

Figure 13.2 Jablonski diagram. Energy levels of excited states of a polyatomic molecule. The lowest vibrational energy levels of a state are indicated by thick horizontal lines; other horizontal lines represent associated vibrational levels. Vertical straight lines represent radiative transitions, wavy lines nonradiative transitions. The orders of magnitude of the first-order rate constants for the various processes are indicated. From R. B. Cundall and A. Gilbert, *Photochemistry*, Thomas Nelson, London, 1970. Reproduced by permission of Thomas Nelson and Sons Limited.

of the different states.) Processes such as *vibrational degradation* and IC that occur without absorption or emission of light are called *radiationless transitions* and are shown on Jablonski diagrams by wavy lines. Radiative transitions are shown by straight lines. The rapidity of IC between two states depends inversely on the energy separation between them. If it is small, isoenergetic conversion of S_n° populates a low vibrational level of S_{n-1} . This is a transition that allows good overlap of the two wave functions. If ΔE is large, a high vibrational level of S_{n-1} must be populated. The oscillatory nature of the higher vibrational wave functions (see Figure 13.1) precludes good overlap of them with a 0th vibrational level wave function. The energy gap between upper singlets is usually small, and therefore S_1° is produced very rapidly after excitation. ΔE between S_1 and S_0 , however, is almost always large, and IC between these states is slower. Thus it is from S_1° that most interesting photochemistry begins.

The three unimolecular physical processes that originate from S_1^0 are internal conversion to S_0 , emission of light, and transformation of S_1 into T_1 . If IC occurs, the net change resulting from electronic excitation is heat transference to the solvent. The other two processes are considerably more interesting.

The first excited singlet may return to the ground state by emitting light: $S_1 \rightarrow S_0 + h\nu$. Light emitted from S_1 is called *fluorescence*. The *natural fluorescent lifetime*, τ_f^0 , is the time required, after the light has been turned off, for the intensity of fluorescence to fall to $1/e$ of its initial value *in the absence of all competing processes*. It depends inversely on the probability of the $S_1 \rightleftharpoons S_0$ radiative transitions (if a transition is probable in one direction it is also probable in the other); a very rough estimate of τ_f^0 can be obtained from Equation 13.8, where ϵ_{\max} is the extinction coefficient of λ_{\max} for the transition $S_0 \rightarrow S_1$.

$$\tau_f^0 = \frac{10^{-4}}{\epsilon_{\max}} \text{ sec} \quad (13.8)$$

A substance with a highly probable $S_0 \rightarrow S_1$ transition ($\epsilon \approx 10^5$) will have τ_f^0 of 10^{-9} sec. A substance whose $S_0 \rightarrow S_1$ transition is space-forbidden ($\epsilon_{\max} \approx 10^{-1}$) will have a τ_f^0 of 10^{-3} sec; such long-lived direct fluorescence is only very rarely observed because competing processes destroy or *quench* S_1 before a quantum can be emitted.

Figure 13.3 shows the absorption and fluorescence spectra of anthracene in ethanol for the $S_0 \rightleftharpoons S_1$ transitions. Since the transitions are allowed, the intensity of light emitted is almost as strong as the intensity of light absorbed. The quantum yield for fluorescence, θ_f , is defined by Equation 13.9.

$$\theta_f = \frac{\text{no. of quanta emitted from } S_1}{\text{no. of quanta absorbed}} \quad (13.9)$$

In the case of anthracene, $\theta_f \approx 1$.

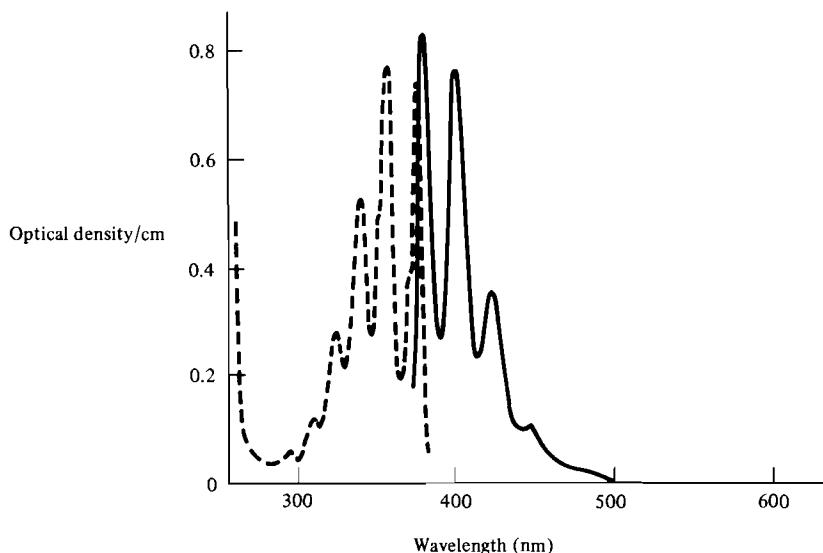

Figure 13.3 Absorption (dashed line; 17.2 $\mu\text{g/ml}$) and fluorescence (solid line; 1.0 $\mu\text{g/ml}$) spectra of anthracene in ethanol. From C. A. Parker and W. T. Rees, *Analyst*, **85**, 587 (1960). Reproduced by permission of *The Analyst* and C. A. Parker.

Note that the absorption and emission spectra of anthracene are not superimposable. Only a single vibrational band overlaps; the rest of the fluorescence spectrum is at longer wavelengths than the absorption spectrum. The reason can be understood by considering Figure 13.1. There is a delay, after absorption, before fluorescence occurs, but the actual process of emission is as rapid as absorption. Therefore the Franck-Condon principle also applies to emission. The shortest-wavelength light that can be emitted, from the 0th vibrational level of S_1 , corresponds to a 0-0 transition. Longer wavelengths are emitted when upper vibrational levels of the ground state are populated. When 0-0 fluorescence has the same wavelength as 0-0 absorption, it is called *resonance fluorescence*. Resonance fluorescence is only sometimes observed. According to the Franck-Condon principle, the initially produced excited molecule must have exactly the same geometry and environment as its ground-state precursor had. If altering either the geometry of the excited molecule or the position of solvent molecules around it reduces the energy of the excited state, and if there is time for these changes to occur before the molecule emits, then 0-0 emission will be of longer wavelength than 0-0 absorption. The shift of emission to longer wavelengths is called a *Stokes shift*. In polar solvents resonance fluorescence of n, π^* transitions is rarely seen. Absorption occurs from a stabilized ground state to an excited state that is not solvated. Before emission can occur, the solvent molecules reorient themselves to stabilize the excited state, but the ground state produced by emission is not stabilized: The emitted light is of longer wavelengths than in nonpolar solvents.

Occasionally absorption occurs from a higher vibrational level of S_0 . This leads to *anti-Stokes* lines, in which the fluorescence is at shorter wavelengths than the exciting radiation.

The distance between peaks in a fluorescence spectrum is a measure of the energy differences between vibrational levels in the ground state; likewise, the peaks in the lowest-energy band of the absorption spectrum give the energy differences between vibrational levels in S_1 . If the spacings are similar, the absorption and emission spectra are mirror images of one another.

Because the excited state first formed on absorption usually relaxes to S_1^0 with high efficiency, the wavelengths and quantum yield of fluorescence normally do not depend on the exciting wavelength. In a few rare instances fluorescence has been observed from S_2 .⁶ Such fluorescence is very weak and requires a sensitive detecting instrument to be observed. The extremely high intensity light and the resulting large number of excited molecules obtained from a laser have made possible the detection of fluorescence from S_2 states not previously observed. In all these cases, of course, the fluorescence spectrum is dependent on the exciting wavelength. S_2 fluorescence can be observed only if S_2 is populated. If the longer-wavelength light required to populate S_1 is used, only S_1 can fluoresce.

Conversion of an excited state in the singlet manifold to one in the triplet manifold is called *intersystem crossing* (ISC).⁷ It is a forbidden process, and in the absence of all spin-orbit coupling would occur very slowly. When heavy atoms

⁶ (a) C. E. Easterly, L. G. Christophorou, R. P. Blaunstien, and J. G. Carter, *Chem. Phys. Lett.* **6**, 579 (1970) and references therein; (b) P. Wannier, P. M. Rentzepis, and J. Jortner, *Chem. Phys. Lett.*, **10**, 102, 193 (1971).

⁷ S. K. Lower and M. A. El-Sayed, *Chem. Rev.*, **66**, 199 (1966).

are present within the molecule or in the solvent, k_{ISC} is greatly increased. The n, π^* state of ketones usually undergoes ISC more rapidly than the π, π^* states of symmetric aromatic compounds.⁸ Intersystem crossing must be isoenergetic; its rate, therefore, also depends on the energy gap between S_1 and T_1 (this gap is called the *singlet-triplet splitting*): A smaller splitting gives a faster rate. The splitting between $^1(n, \pi^*)$ and $^3(n, \pi^*)$ states is usually small, but that between $^1(\pi, \pi^*)$ and $^3(\pi, \pi^*)$ states is usually large.

Once an upper vibrational level of T_1 has been produced, it rapidly undergoes vibrational degradation to T_1^0 . This state has three unimolecular physical processes available to it. It may undergo ISC to S_0 ; it may undergo ISC back to S_1 ; or it may return to S_0 by emitting light called *phosphorescence*. All three processes are spin-forbidden, and therefore at low temperatures the lifetime of T_1^0 is long. Increasing temperature decreases the lifetime of T_1 , mainly by increasing the rate of ISC to S_0 . The reason for the temperature dependence and the exact mechanism of ISC are not well understood.⁹

Since vibrational degradation, $T_1^? \rightsquigarrow T_1^0$ is very fast ($k \approx 10^{12} \text{ sec}^{-1}$)¹⁰ and since T_1^0 is always of lower energy than S_1^0 , ISC from T_1 back to S_1 requires that T_1^0 first be reexcited to a higher vibrational level. That this does occur has been shown by emission studies. For example, Saltiel has found that benzophenone emits, along with its long-wavelength phosphorescence, shorter-wavelength light, the energy of which corresponds to the benzophenone $S_1 \rightarrow S_0$ transition. The lifetime of the shorter-wavelength emission is much longer than usual fluorescence lifetimes. Moreover, the relative intensities of the long- and short-wavelength emissions is temperature-dependent, the intensity of the latter increasing with increasing temperature. These observations are consistent with thermally activated repopulation of S_1 from T_1 and the consequent emission of *delayed fluorescence*.¹¹ (The emission just described is called *E-type* delayed fluorescence. We shall discuss another type of long-lived emission from S_1 , called *P-type* delayed fluorescence, below.)

Because of the forbiddenness of the transition, $T_1 \rightarrow S_0 + h\nu$, the natural phosphorescent lifetime, τ_p^0 , of a triplet state is long—from approximately 10^{-3} sec for an n, π^* triplet to 30 sec for a π, π^* aromatic triplet. At room temperature in solution, phosphorescence is often not observed because ISC of T_1 to S_0 and quenching of T_1 by impurities and molecular O_2 (see below) competes effectively with phosphorescence. Therefore most phosphorescence studies must be carried out at low temperatures in carefully purified, outgassed, rigid media. Under these conditions the quantum yield of phosphorescence, θ_p , defined by Equation 13.10, is often high and approaches 1.0 for some aromatic carbonyls.

$$\theta_p = \frac{\text{no. of quanta emitted from } T_1}{\text{no. of quanta absorbed}} \quad (13.10)$$

⁸ For explanations, see T. Azumi, *Chem. Phys. Lett.*, **17**, 211 (1972) and references therein.

⁹ P. J. Wagner and G. S. Hammond, in *Advances in Photochemistry*, Vol. 5, W. A. Noyes, G. S. Hammond, and J. N. Pitts, Eds., Wiley-Interscience, New York, 1968, p. 21.

¹⁰ See note 1(a), p. 681.

¹¹ J. Saltiel, H. C. Curtis, L. Metts, J. W. Miley, J. Winterle, and M. Wrighton, *J. Amer. Chem. Soc.*, **92**, 410 (1970).

The effect of solvent polarity on the energies of excited states (see p. 685) leads to some interesting phenomena. For example, changing the solvent in which ketone 2 is dissolved from isopentane to ethanol increases the phosphorescence

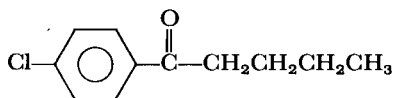

2

lifetime from 4.7×10^{-3} to 4.0×10^{-2} sec, but does not much alter the shape of the phosphorescence spectrum. Apparently, in nonpolar media the ${}^3(n,\pi^*)$ state of phenyl alkyl ketones lies only about 1 kcal below the ${}^3(\pi,\pi^*)$ state. Change to a polar solvent inverts the order: ${}^3(\pi,\pi^*)$ becomes T_1 and the triplet lifetime is lengthened. However, the states are so close in energy that even at 77°K they are in thermal equilibrium, with about 10 percent of the triplets occupying the higher, faster-emitting n,π^* state at any moment. This state is then still the chief phosphorescent species. Analogous results are obtained with other phenyl alkyl ketones.¹² Note that the solvent-induced increase in phosphorescent lifetime is a phenomenon similar to E-type delayed fluorescence. In both cases a longer-lived, lower-energy state acts as an electron reservoir for a higher-energy, faster-emitting state.

Several authors have reported that in polar solvents the overall phosphorescence decay of some phenyl alkyl ketones has a long- and a short-lived component; they attribute this to simultaneous emission from ${}^3(n,\pi^*)$ and ${}^3(\pi,\pi^*)$ states that are not in equilibrium with each other. This interpretation assumes that phosphorescence, a spin-forbidden process, occurs more rapidly than internal conversion from T_2 to T_1 and therefore seems improbable. It is more likely that one of the phosphorescent species is a photochemical product of the original ketone.^{13, 14}

An electronically excited molecule may, under some conditions, absorb another quantum and be raised to a higher excited state. Usually the population of excited species is so low that the probability of this occurrence is very slight. However, in recent years the technique of flash photolysis has been developed, which allows us to investigate the absorption properties of excited states. An extremely high intensity laser, which has approximately one million times the power of a conventional spectroscopic lamp, is turned on for a tiny fraction of a second, and a large population of excited species is produced. Immediately after this *photolysis flash* is turned off, a low-power *spectroscopic flash* may be turned on and the absorption spectrum of the already-excited system determined. By varying the delay between photolysis and spectroscopic flashes, much can be learned about the absorption and lifetime of singlet and triplet excited states.

¹² P. J. Wagner, M. J. May, A. Haug, and D. R. Graber, *J. Amer. Chem. Soc.*, **92**, 5269 (1970).

¹³ N. Y. C. Chu and D. R. Kearns, *J. Amer. Chem. Soc.*, **94**, 2619 (1972) and references therein.

¹⁴ For cases where emission from two different triplet states has been suggested, see: (a) W. Klöpffer, *Chem. Phys. Lett.*, **11**, 482 (1971); (b) P. de Mayo, *Acts. Chem. Res.*, **4**, 41 (1971) and references therein; (c) E. Migirdicyan, *Chem. Phys. Lett.*, **12**, 473 (1972).

13.3 BIMOLECULAR PHOTOPHYSICAL PROCESSES

The intermolecular transfer of electronic excitation energy is a common phenomenon in photochemistry. It is called *photosensitization* and may occur by a number of mechanisms, both radiative and nonradiative. In the radiative process, also called the "trivial" mechanism, the acceptor, A, absorbs a quantum emitted by a donor, D (Equations 13.11 and 13.12).



Nonradiative energy transfer may occur over long or short range. The long-range transfer ($\approx 50 \text{ \AA}$) occurs by coulombic interactions between donor and acceptor. The transfer must be nearly isoenergetic and usually involves transfer of singlet excitation energy. Short-range transfer occurs only when two molecules collide, and it is this type of transfer that, because of its usefulness, is of enormous interest to photochemists.

Collisional Energy Transfer (Exchange Energy Transfer)

When an electronically excited molecule collides with a ground-state molecule that has an excited state of lower energy, the molecules may come out of the encounter with the electronic excitation energy transferred from the donor to the acceptor. The spin states (multiplicities) of the donor and acceptor may change during the encounter, but they do so only according to *Wigner's spin conservation rule*. To understand the implications of the rule, it is simplest to think that during the encounter the spin quantum number of each individual electron is fixed but that one electron can move from donor to acceptor if it is replaced by another electron that moves from acceptor to donor.

Thus, for example, an excited triplet donor (D^*) could *sensitize* a ground-state singlet acceptor (A_0) according to Equation 13.13 or 13.14, depending



on whether the donor is a ground-state singlet or a ground-state triplet. Since most molecules are ground-state singlets, sensitization by a triplet donor usually produces an excited triplet acceptor as in Equation 13.13. This is the process that we spoke of above as being enormously useful.¹⁵ By this method we can produce a vast number of triplets that are not obtainable by ISC from their singlets. Triplet energy transfer was first observed by Terenin and Ermolaev in rigid media at 77°K.¹⁶ They found, for example, that when mixtures of benzophenone and naphthalene are irradiated at wavelengths where only

¹⁵ Energy transfer from an excited singlet may also occur [see, for example, P. S. Engel, L. D. Fogel, and C. Steel, *J. Amer. Chem. Soc.*, **96**, 327 (1974)], but it is less efficient because of the short lifetime of an excited singlet. It is also less useful, since the product resulting from energy transfer is available by direct excitation.

¹⁶ A. Terenin and V. Ermolaev, *Trans. Faraday Soc.*, **52**, 1042 (1956).

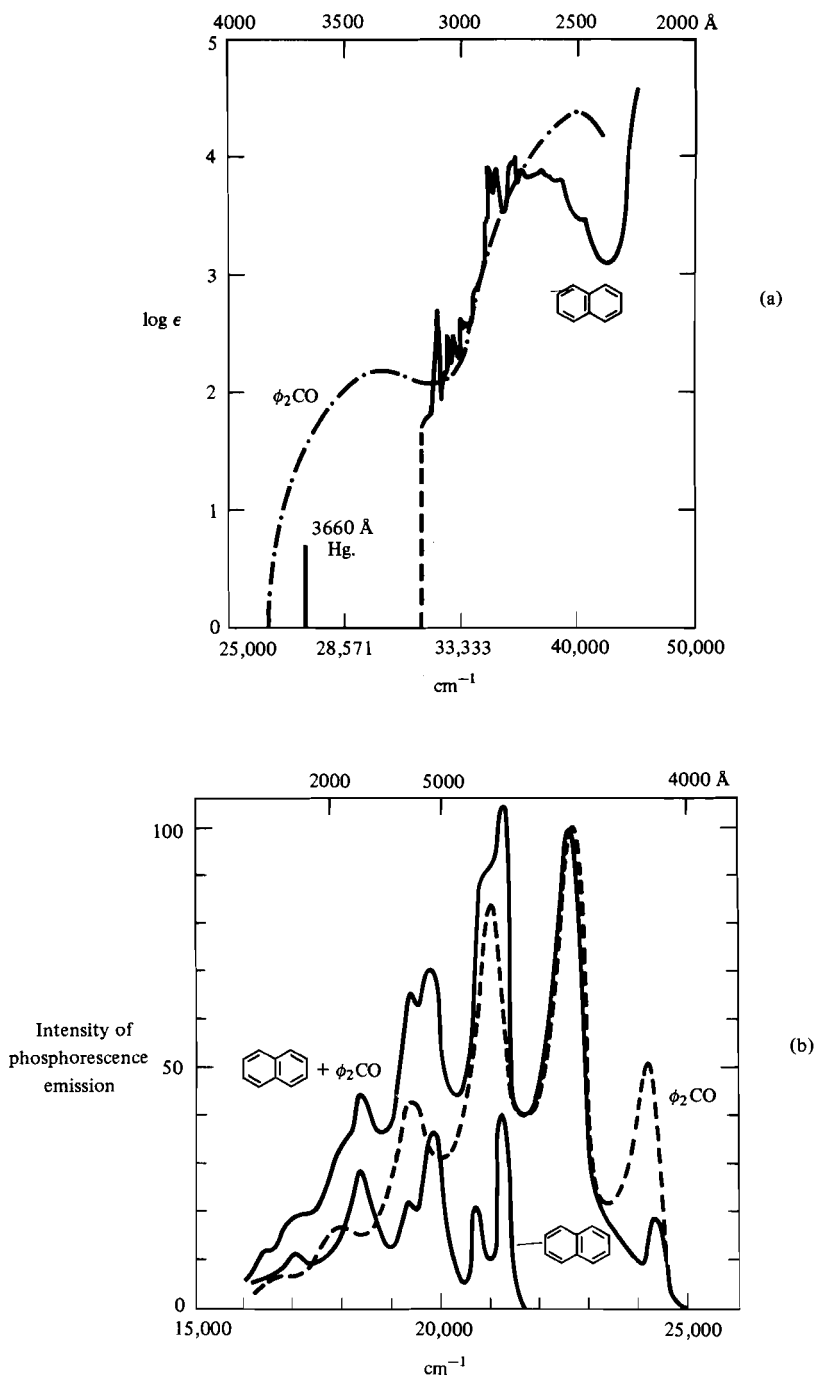

Figure 13.4 (a) Absorption spectra of benzophenone (ethanol, 20°C) and naphthalene (ethanol + methanol, -180°C). (b) Phosphorescence emission spectra at -190°C in ether + ethanol, under steady irradiation at 3660 \AA . Benzophenone, $2 \times 10^{-2} M$; benzophenone + naphthalene, $2 \times 10^{-2} M$ and $3.2 \times 10^{-1} M$, respectively; concentration of pure naphthalene (solid line) not known. From A. Terenin and V. Ermolaev, *Trans. Faraday Soc.*, 52, 1042 (1956). Reproduced by permission of the Faraday Society.

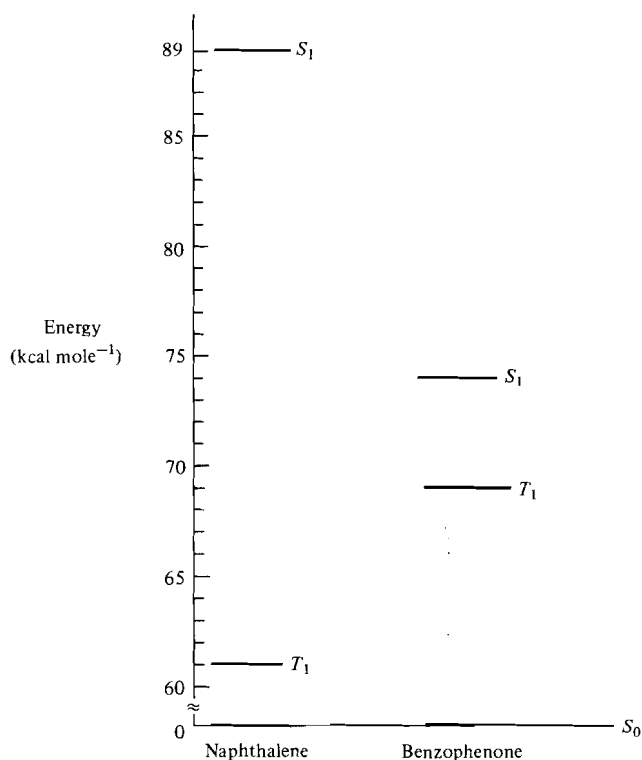

Figure 13.5 Energy levels of the first excited singlets and the first excited triplets of benzophenone and naphthalene.

benzophenone absorbs, the phosphorescence of benzophenone is partially quenched but naphthalene phosphoresces from its T_1 state and does so more strongly than when naphthalene is irradiated directly. The absorption and phosphorescence spectra of the components are shown in Figures 13.4a and 13.4b. As the absorption spectra show, S_1 of naphthalene lies above S_1 of benzophenone; but the T_1 state of naphthalene is lower than the T_1 state of benzophenone. The actual energies are shown in Figure 13.5. Direct irradiation of naphthalene leads to rather inefficient ISC because of the large S_1 - T_1 splitting. When a naphthalene-benzophenone mixture is irradiated with wavelengths too long to excite naphthalene to S_1 but short enough to excite benzophenone to S_1 , a large number of benzophenone triplets are produced (remember that benzophenone has a quantum yield for ISC of approximately 1.0). Once in the T_1 state, benzophenone can transfer its electronic excitation energy to the T_1 state of naphthalene in an exothermic process and does so very efficiently.

Triplet energy transfer also occurs in fluid solution at room temperature. Because most compounds phosphoresce either weakly or not at all under these conditions, energy transfer is often followed by watching the change in reactivity of the acceptor rather than its phosphorescence (see, for example, p. 718). The rate of energy transfer, exothermic by 2 or 3 kcal mole⁻¹ or more, is very fast. Until recent experiments by Turro¹⁷ showed the contrary, it had been

¹⁷ N. J. Turro, N. E. Schore, H.-C. Steinmetzer, and A. Yekta, *J. Amer. Chem. Soc.*, **96**, 1936 (1974).

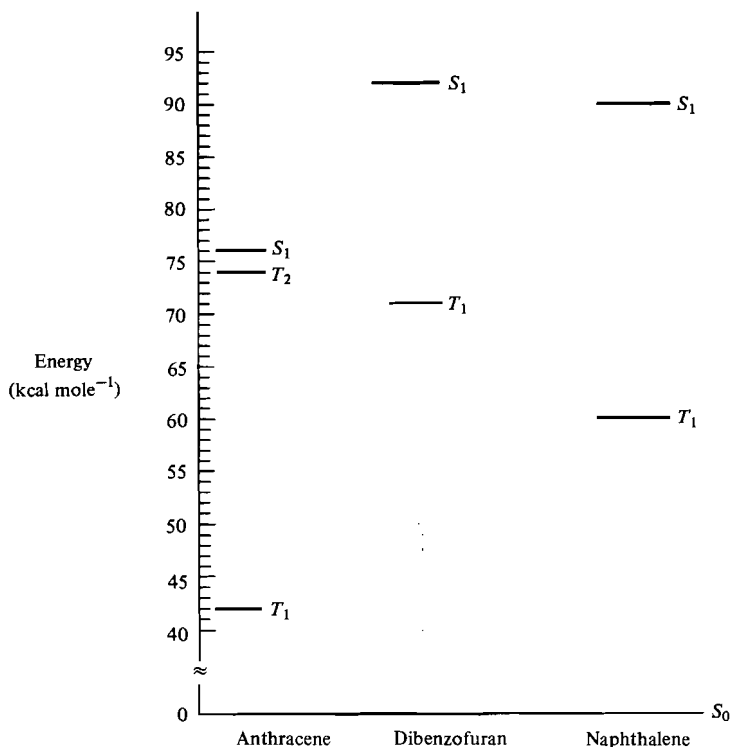

Figure 13.6 Energy levels of the important low-lying states of anthracene, biphenyl, dibenzofuran, and naphthalene d_8 . Reprinted with permission of R. S. H. Liu and R. E. Kellogg, *J. Amer. Chem. Soc.*, **91**, 250 (1969). Copyright by the American Chemical Society.

assumed that in most solvents energy transfer is diffusion-controlled. That assumption is probably true for denser solvents, but cannot be applied, for example, to acetonitrile. In very low density nonviscous solvents such as pentane, the rate is definitely slower than diffusion-controlled. The apparent reason for the dichotomy is that in the more viscous solvents every encounter between donor and acceptor involves a large number of collisions and thus energy transfer, even much less than 100 percent efficient, can take place before the donor and acceptor free themselves from the solvent cage. In nonviscous solvents the donor and acceptor may diffuse apart after only a small number of collisions, before energy transfer has taken place.¹⁸

Sensitization experiments again provide evidence that occasionally a second excited state may undergo a process other than internal conversion. For example, when dibenzofuran crystals, containing 0.1 percent anthracene and 1 percent naphthalene- d_8 impurities, are irradiated with light that only excites anthracene, naphthalene phosphoresces *with 20 times greater intensity* than it does in the absence of dibenzofuran. The relative energies of the relevant excited states are given in Figure 13.6. What apparently happens is that the S_1 state of anthracene under-

¹⁸ P. J. Wagner and I. Kochevar, *J. Amer. Chem. Soc.*, **90**, 2232 (1968).

goes ISC to its T_2 state. A double energy transfer then occurs, first from T_2 of anthracene to T_1 of dibenzofuran and thence to T_1 of naphthalene.¹⁹

The fact that one molecule can quench the excited state of another by energy transfer (or by other means—see below) enables us to calculate the lifetime the quenched excited state has in the absence of quencher.

The simplest excitation–emission–quenching scheme (which does not allow for radiationless decay processes) is given in Equations 13.15–13.17.

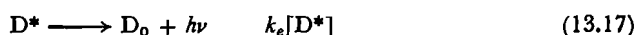
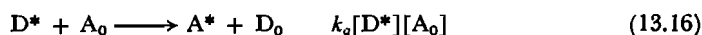

If we assume that $dD^*/dt = 0$, we obtain

$$I_{\text{emitted}} = k_e[D^*] = \frac{k_e I_{\text{abs}}}{k_e + k_q[A]} \quad (13.18)$$

or, by inversion,

$$\frac{1}{I_{\text{emitted}}} = \frac{1}{I_{\text{abs}}} \left(1 + \frac{k_q}{k_e} [A] \right) \quad (13.19)$$

Since the natural lifetime of emission, τ° , is equal to $1/k_e$, Equation 13.19 may be rewritten in the usual form of the *Stern-Volmer equation*:

$$\frac{1}{I_{\text{emitted}}} = \frac{1}{I_{\text{abs}}} (1 + k_q \tau^\circ [A]) \quad (13.20)$$

Thus by plotting $1/I_{\text{emitted}}$ vs. the concentration of A, we obtain a straight line having a slope of $k_q \tau^\circ / I_{\text{abs}}$ and an intercept of $1/I_{\text{abs}}$. From these quantities we can calculate $k_q \tau^\circ$. If k_q can be assumed to be diffusion-controlled (see above), a knowledge of the diffusion-controlled rate constant in the solvent used allows calculation of τ° . (Alternatively, direct measurement or theoretical calculation of τ° allows calculation of k_q .)

If the total excitation–emission quenching scheme is more complicated than shown in Equation 13.15–13.17 in that it also includes radiationless decay processes for D^* , then, instead of Equation 13.19, one obtains Equation 13.21, where $\sum k_u$ is the sum of all the unimolecular decay processes of D^* .

$$\frac{1}{I_{\text{emitted}}} = \frac{1}{I_{\text{abs}}} \left(1 + \frac{k_q}{\sum k_u} [A] \right) \quad (13.21)$$

The analog of Equation 13.20, then, is Equation 13.22, where τ is the actual lifetime (as opposed to natural radiative lifetime) of D^* in the absence of A.

$$\frac{1}{I_{\text{emitted}}} = \frac{1}{I_{\text{abs}}} (1 + k_q \tau [A]) \quad (13.22)$$

¹⁹ R. S. H. Liu and R. E. Kellogg, *J. Amer. Chem. Soc.*, **91**, 250 (1969); see also C. C. Ladwig and R. S. H. Liu, *J. Amer. Chem. Soc.*, **96**, 6210 (1974) and references therein.

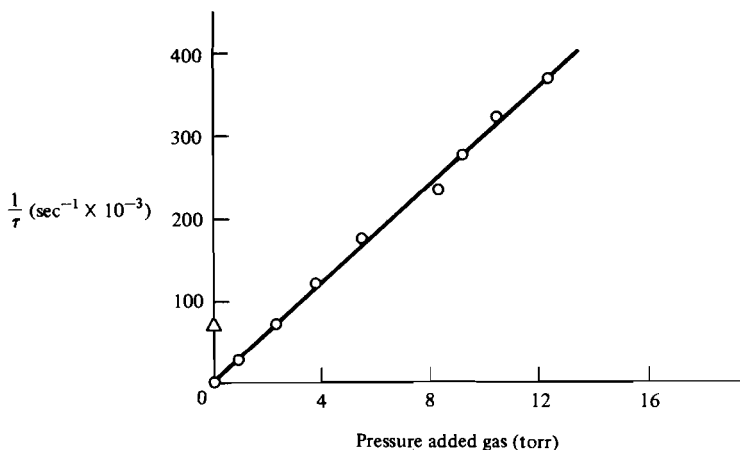

Figure 13.7 Stern-Volmer plot of the reciprocal of biacetyl triplet lifetime vs. the pressure of added oxygen. Reprinted with permission of H. W. Sidebottom, C. C. Badcock, J. G. Calvert, B. R. Rabe, and E. K. Damon, *J. Amer. Chem. Soc.*, **94**, 13 (1972). Copyright by the American Chemical Society.

When quenching of an excited state is detected by lower quantum yields of photoproducts that arise from that state rather than by lower quantum yields of emission, Equation 13.22 becomes

$$\frac{1}{\theta_{pro}} = \frac{1}{\theta_{pro}^0} (1 + k_q \tau [A]) \quad (13.23)$$

where θ_{pro}^0 and θ_{pro} are the quantum yields of the product in the absence and presence, respectively, of the electronic excitation acceptor.

Equations 13.20, 13.22, and 13.23 apply to quenching of either a singlet or a triplet excited state. Figure 13.7, for example, shows a Stern-Volmer plot for the quenching of biacetyl triplet by oxygen. When $1/I_{emitted}$ or $1/\theta_{pro}$ is plotted against A and a straight line is not obtained, then emission or reaction, respectively, is occurring from more than one excited state, usually S_1 and T_1 .

Nonvertical Energy Transfer

Geometrical isomerization of olefins, a reaction that occurs only at high temperatures in the ground state but at room temperature through the first excited triplet, can sometimes be sensitized by triplet donors whose T_1 states are of lower energy than the spectroscopic T_1 state of the olefins. (A *spectroscopic state* of a molecule is that excited state that is formed by direct absorption of a quantum by the ground state and that, therefore, always has the same geometry as the ground state in accordance with the Franck-Condon principle.) The reason proposed for this unexpected energy transfer is that it is *nonvertical*.²⁰ Theoretical calculations indicate that the T_1 state of an olefin is often lower when the molecule is twisted 90° about the π bond than when it is planar. (The difference is

²⁰ (a) G. S. Hammond, J. Saltiel, A. A. Lamola, N. J. Turro, J. S. Bradshaw, D. O. Cowan, R. C. Counsell, V. Vogt, and C. Dalton, *J. Amer. Chem. Soc.*, **86**, 3197 (1964); (b) W. G. Herkstroeter and G. S. Hammond, *J. Amer. Chem. Soc.*, **88**, 4769 (1966).

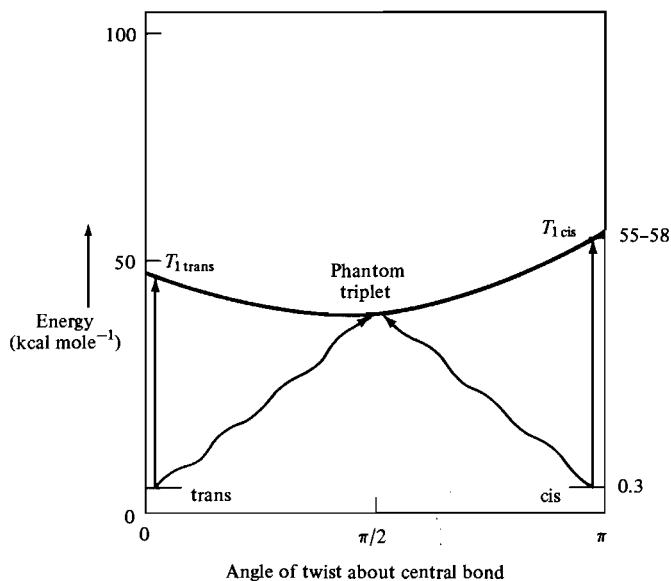

Figure 13.8 Possible potential function for rotation in 1,2-diphenylpropene triplet state. Reprinted with permission of G. S. Hammond, J. Saltiel, A. A. Lamola, N. J. Turro, J. S. Bradshaw, D. O. Cowan, R. C. Counsell, V. Vogt, and C. Dalton, *J. Amer. Chem. Soc.*, **86**, 3197 (1964). Copyright by the American Chemical Society.

approximately 65 kcal mole⁻¹ for ethylene.²¹) Thus, if the olefin rotates about its π bond during transfer, sensitizers having energies lower than the spectroscopic (planar) triplet of the olefin can elevate the olefin to its T_1 state. Figure 13.8 shows the change in potential energy with angle of rotation of the T_1 state of 1,2-diphenylpropene.

An example of the data that has led to postulation of nonvertical energy transfer is shown in Figure 13.9. Rate constants for energy transfer to *cis*- and *trans*-stilbene from a number of triplet sensitizers are plotted against the energy of the sensitizers. The high-energy sensitizers transfer energy to both isomers at approximately the same rate.²² As the sensitizer energy drops below the energy of the T_1 state of *trans*-stilbene (50 kcal), the rate of transfer to the *trans* isomer drops off steeply—as one expects if the energy deficiency has to be supplied by thermal energy. The rate of transfer to *cis*-stilbene by sensitizers of lower energy than its spectroscopic T_1 state (57 kcal) does not fall off nearly as rapidly. Apparently, nonvertical excitation of the *cis* isomer, which has the higher ground-state energy, takes place (but not as efficiently as vertical excitation).

The exact mechanism of nonvertical energy transfer is still unclear. Originally Hammond thought of it as occurring directly, during a prolonged encounter between donor and acceptor.²³ Now, however, isotope effects and other evidence favor the view that the nonspectroscopic, or *phantom*, triplet is formed

²¹ I. E. Kochevar and P. J. Wagner, *J. Amer. Chem. Soc.*, **94**, 3859 (1972) and references therein.

²² D. Valentine, Jr., and G. S. Hammond, *J. Amer. Chem. Soc.*, **94**, 3449 (1972).

²³ See note 20, p. 698.

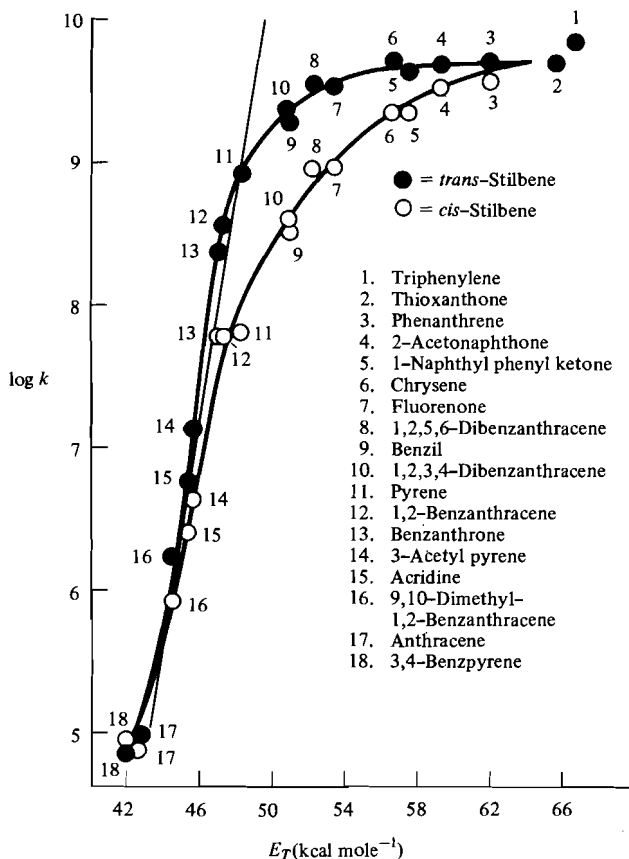
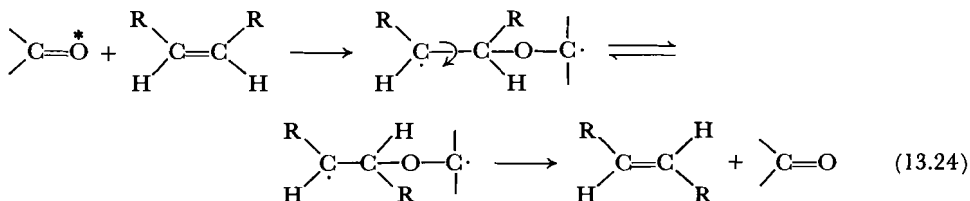

Figure 13.9 Rate constants for energy transfer to *cis*- and *trans*-stilbenes by sensitizers. Reprinted with permission of W. G. Herkstroeter and G. S. Hammond, *J. Amer. Chem. Soc.*, **88**, 4769 (1966). Copyright by the American Chemical Society.

via an intermediate excited-state charge-transfer complex between donor and acceptor (see p. 706).²⁴

Yang proposed an alternative mechanism for sensitized isomerization of olefins by low-energy donors.²⁵ He suggested that sensitizer (a ketone) and olefin form a σ bond to give an intermediate biradical as in Equation 13.24. The intermediate can rotate about the original C—C double bond before decomposing



back to ketone and olefin. This reaction path, however, is unlikely, because **3**

²⁴ R. A. Caldwell, G. W. Sovocool, and R. J. Peresie, *J. Amer. Chem. Soc.*, **95**, 1496 (1973).

²⁵ N. C. Yang, J. I. Cohen, and A. Shani, *J. Amer. Chem. Soc.*, **90**, 3264 (1968).

does not isomerize more slowly than **4** as would be expected from a reaction in which the hybridization of carbon changes from sp^2 to sp^3 .²⁶

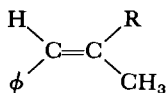

3 R = H

4 R = D

Energy Pooling

Energy transfer may occur when two excited molecules collide. This process, called *energy pooling*, must obey Wigner's rule of spin conservation. Excited singlets are not important in energy pooling, because they usually do not have time to collide with other molecules during their short lifetimes. The most important energy pooling process is collision of two excited triplets to give an excited singlet and a ground-state singlet. This process is called *triplet-triplet annihilation* and is shown in Equation 13.25. The excited singlet A^* , produced in the S_n state, may

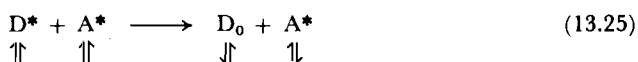

then undergo the same processes it would if formed directly by absorption of light. If it is converted to S_1 and emits, we have what is known as *P-type delayed fluorescence*. It can be distinguished from E-type by the dependence of fluorescence intensity on the intensity of the incident radiation. P-type shows a second-order but E-type a first-order dependence.

Excimers and Exciplexes²⁷

For years it has been known that the quantum yield of fluorescence for a number of aromatic hydrocarbons decreases with increasing concentration, but the cause of this concentration quenching was not well understood. In 1955 it was first noted by Förster that increasing concentration not only quenches the normal fluorescence of pyrene (**5**), but also introduces a new fluorescent component.

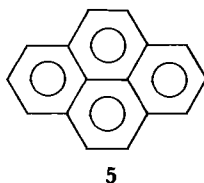

Figure 13.10 shows the fluorescence spectra of solutions of pyrene at various concentrations in *n*-heptane at 20°C. The high concentration band is not due to emission from a photoproduct: Irradiating pyrene for long periods of time does not change the absorption spectrum. Nor is the new band due to aggregates of pyrene that are formed in the ground state and stay together in the excited state,

²⁶ See note 24, p. 700.

²⁷ (a) Th. Förster, *Angew. Chem. Int. Ed.*, **8**, 333 (1969); (b) B. Stevens in, *Advances in Photochemistry*, Vol. 8, W. A. Noyes, G. S. Hammond, and J. N. Pitts, Jr., Eds., 1971, p. 161.

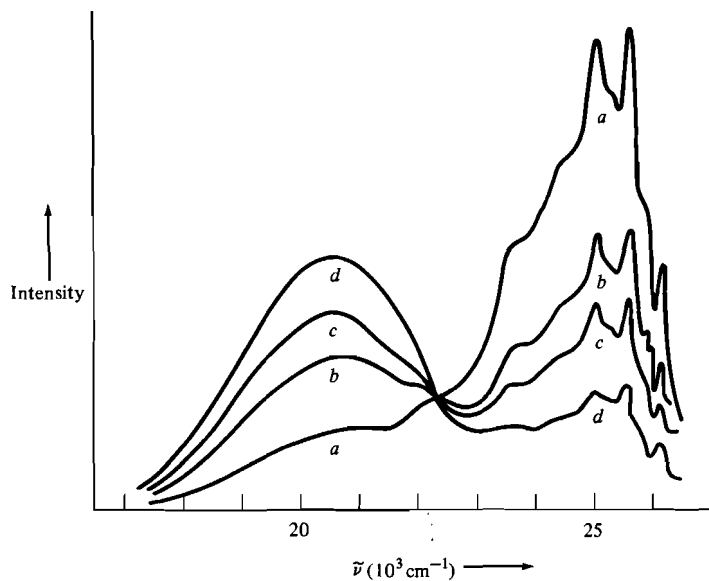

Figure 13.10 Fluorescence spectra of pyrene in *n*-heptane at 20°C; (a) 5×10^{-5} mol/liter; (b) 1.8×10^{-4} mol/liter; (c) 3.1×10^{-4} mol/liter; (d) 7.0×10^{-3} mol/liter. From T. Förster, *Angew. Chem. Int. Ed.*, **8**, 333 (1969). Reproduced by permission of Verlag Chemie, GmbH.

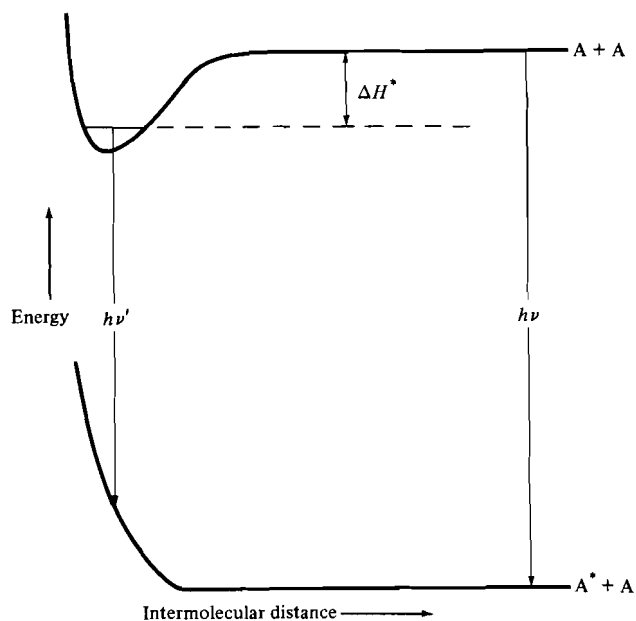

Figure 13.11 Potential energy vs. intermolecular distance for the first excited singlet and the ground state of pyrene excimer. From T. Förster, *Angew. Chem. Int. Ed.*, **8**, 333 (1968). Reproduced by permission of Verlag Chemie, GmbH.

because the absorption spectrum is not concentration-dependent. The fluorescent component must then be formed after electronic excitation and disappear on emission. Kinetic analysis shows that it is a complex of an electronically excited pyrene molecule (in the S_1 state) and a ground-state pyrene molecule.²⁸ The term *excimer* is used to describe associates of this type.

Examination of the spectra in Figure 13.10 shows that emission from the pyrene monomer has vibrational fine structure but that excimer emission is structureless. Structureless emission (or absorption) is characteristic of a transition to an unstable, dissociative state. Figure 13.11, in which potential energy is plotted against internuclear distance, shows why for a diatomic molecule. The lower state, being dissociative, has no vibrational fine structure and therefore emission to it is not quantized.

Since Förster's original work, a large number of aromatic compounds, including benzene, naphthalene, and anthracene, have been found to have concentration-dependent fluorescence spectra under some conditions. Most of these excimers are not as stable as the pyrene prototype, and require lower temperatures or higher concentrations to be observed.²⁹ Some crystals also exhibit excimer emission. Crystalline pyrene, for example, has only a single structureless fluorescence band of the same energy as its excimer emission in solution.³⁰

The geometrical requirements for excimer emission are stringent. In crystals the molecules must be stacked in columns or arranged in pairs with an interplanar distance of less than 3.5 Å.³¹ Chandross and Dempster carried out an elegant investigation of the geometrical requirements for excimer formation in solution. They studied the fluorescence of compounds 6–10 in methylcyclohexane solution and found that only compounds 7 and 9 exhibit strong emission from an intra-

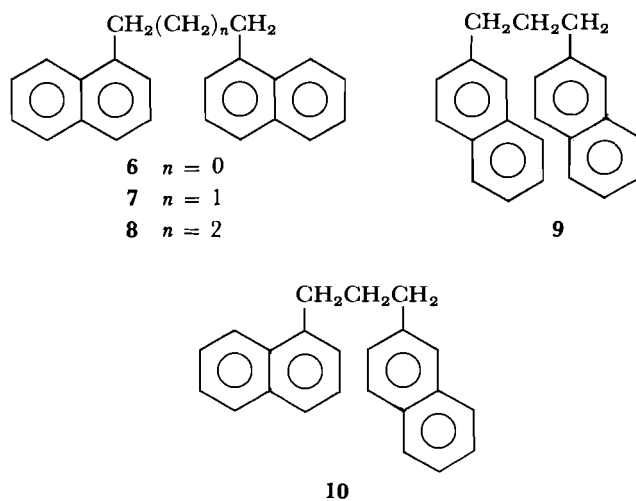

²⁸ Th. Förster and K. Kasper, *Z. Electrochem., Ber. Bunsenges. Phys. Chem.*, **59**, 976 (1955).

²⁹ See note 27, p. 701.

³⁰ J. Ferguson, *J. Chem. Phys.*, **28**, 765 (1958).

³¹ B. Stevens, *Spectrochim. Acta*, **18**, 439 (1962).

molecular excimer. These compounds, and these alone of those studied, allow the two naphthalene rings to be parallel, with one lying directly above the other. In compound **6** the two rings must have a dihedral angle of 45° at their closest approach; compound **10** allows the rings to be parallel, but only with approximately 25 percent overlap; and compound **8** requires appreciable deformation of the hydrocarbon chain for the two rings to come within 3 \AA of each other.³²

What is the nature of the excimer bond? Quantum mechanical calculations of the theoretical position of excimer fluorescence bands give good agreement with experimental positions if excitation resonance and charge resonance are both taken into account—that is, if the structure of the excimer is described by Equation 13.26.³³

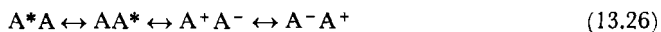

Excimers may undergo processes other than emission. Nonradiative decay apparently occurs more easily from an excimer than from an excited monomer. Photodimerization may also occur.³⁴ Anthracene, for example, gives **11** through an excimer intermediate. It may be that transient photodimerization is, in fact, responsible for all nonradiative decay of excimers.³⁵

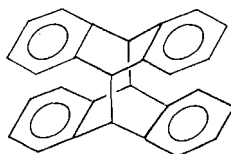
**11**

Excited-state complexes between two dissimilar entities, called *exciplexes*, are also frequently formed. The most thoroughly studied exciplexes are those between an aromatic compound and either an amine or a conjugated olefin or diene. Compound **12**, for example, has an absorption spectrum identical with

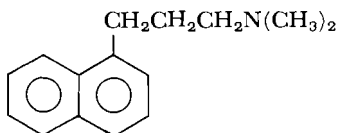
**12**

α -methyl-naphthalene, but its fluorescence is almost entirely structureless and shifted to longer wavelengths than naphthalene fluorescence. An exciplex between the amine nitrogen and the naphthalene ring involving appreciable charge transfer is apparently formed.³⁶

1,4-Dienes quench naphthalene fluorescence although they have no excited state of lower energy than the S_1 state of naphthalene. Apparently, quenching is due to an exciplex that either undergoes radiationless transition to ground-

³² E. A. Chandross and C. J. Dempster, *J. Amer. Chem. Soc.*, **92**, 3586 (1970).

³³ See note 27, p. 701.

³⁴ (a) See note 32; (b) A. S. Cherkasov and T. M. Vember, *Optics and Spectroscopy*, **6**, 319 (1959).

³⁵ See note 27, p. 701, and note 32.

³⁶ E. A. Chandross and H. T. Thomas, *Chem. Phys. Lett.* **9**, 393 (1971).

state naphthalene and diene³⁷ or yields a photoproduct.³⁸ The photoproducts may often go undetected because of their instability but, for example, when naphthalene is excited in the presence of 2,4-dimethylpiperylene with light of longer wavelength than the diene absorbs, the naphthalene fluorescence is quenched and **13** is isolated.³⁹ That cycloaddition definitely can occur via an

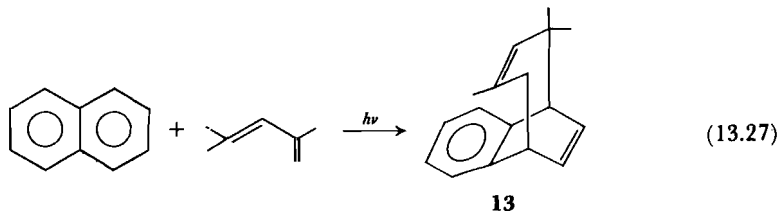

exciplex and is not a separate quenching pathway has been convincingly demonstrated by Caldwell and Smith. Spectroscopic studies show that **14** and **15** form an exciplex, and product studies show that they form the cycloaddition product **16**. When dimethyl acetylenedicarboxylate is added to the reaction system, it

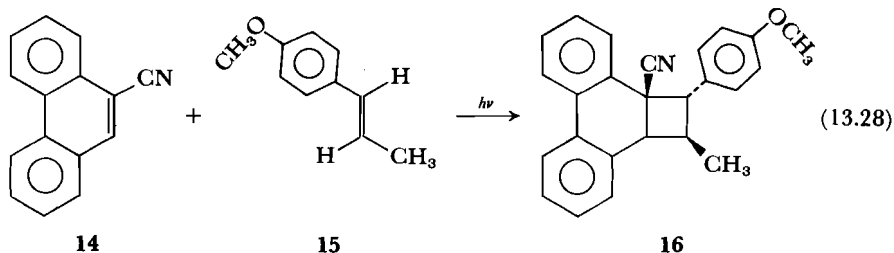

quenches both exciplex emission and product formation and the Stern-Volmer slope, $k_q\tau$, is identical for both quenching processes.⁴⁰

In a systematic study of a number of dienes and substituted naphthalenes, it was found that the quenching efficiency depends on both the ionization potential of the diene and the electron affinity of the excited naphthalene but that the log of the rate of quenching is not a linear function of either parameter. Thus exciplex binding cannot be due to excited-state charge transfer alone.⁴¹ That excitation resonance (see Equation 13.26) accounts for part of exciplex binding has been shown by McDonald and Selinger. They found that exciplexes can be formed by excitation of either component, A or B, and that if the energy levels of the first excited singlets of A and B are not far apart the exciplex can dissociate to produce either excited A or excited B. If the energies are very different, the excited species having the lower energy is produced on dissociation.⁴²

³⁷ (a) D. A. Labianca, G. N. Taylor, and G. S. Hammond, *J. Amer. Chem. Soc.*, **94**, 3679 (1972);

(b) G. N. Taylor and G. S. Hammond, *J. Amer. Chem. Soc.*, **94**, 3684, 3687 (1972).

³⁸ (a) N. C. Yang, J. Libman, and M. F. Savitzky, *J. Amer. Chem. Soc.*, **94**, 9226 (1972); (b) J. Saltiel and D. E. Townsend, *J. Amer. Chem. Soc.*, **95**, 6140 (1973).

³⁹ See note 37(a).

⁴⁰ R. A. Caldwell and L. Smith, *J. Amer. Chem. Soc.*, **96**, 2994 (1974).

⁴¹ (a) See note 37(a). For further evidence for a polar contribution to the exciplex, see (b) R. M. Bowman, T. R. Chamberlain, C.-W. Huang, and J. J. McCullough, *J. Amer. Chem. Soc.*, **96**, 692 (1974);

(c) R. G. Brown and D. Phillips, *J. Amer. Chem. Soc.*, **96**, 4784 (1974).

⁴² R. J. McDonald and B. K. Selinger, *Aust. J. Chem.*, **24**, 1797 (1971).

The geometrical requirements for exciplex formation are not as stringent as those for excimer formation, especially if charge-transfer resonance is an important part of the exciplex binding. For example, Taylor, Chandross, and Schiebel have studied the exciplexes formed from pyrene on the one hand and *N,N*-dimethylaniline or 3,5-di-*t*-butyl-*N,N*-dimethylaniline on the other. In hexane at 23°C these exciplexes have very similar energies (as judged from the wavelength of emission), but that formed from the di-*t*-butyl-substituted aniline is slightly *more* stable. From the small difference in stabilities (0.07 eV), Taylor and co-workers estimate that the excimer formed with *N,N*-dimethylaniline has the sandwich pair Structure 17, but that formed with the di-*t*-butyl-substituted *N,N*-dimethylaniline has the Structure 18.⁴³

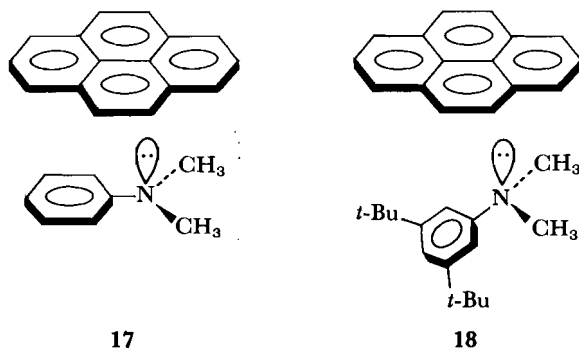

(If both had the sandwich pair structure 17, the exciplex formed with *N,N*-dimethylaniline should be considerably more stable because it would have less steric interference. On the other hand, if both had a structure analogous to 18, 3,5-di-*t*-butyl-*N,N*-dimethylaniline should form the more stable exciplex because of the electron-donating ability of the *t*-butyl groups.)

Singlet excimers and exciplexes have been proposed as intermediates in a number of chemical reactions; we shall encounter them again in this chapter. Triplet excimers and exciplexes seem also to be formed⁴⁴ but are apparently less stable.⁴⁵ They have recently been proposed as the intermediate in non-vertical energy transfer. According to this view, the energy of the donor is stored in the exciplex while the olefin twists about its central bond. On dissociation of the exciplex, the triplet excitation energy is found on the component having the lower triplet excited state—that is, the twisted olefin.⁴⁶

13.4 PHOTOCHEMICAL REACTIONS

A photochemical reaction, a reaction in which one starting material is an electronically excited molecule, may proceed by one of two fundamentally different mechanisms. The starting material may give electronically excited product

⁴³ G. N. Taylor, E. A. Chandross, and A. H. Schiebel, *J. Amer. Chem. Soc.*, **96**, 2693 (1974).

⁴⁴ See, for example: (a) S. G. Cohen and G. Parsons, *J. Amer. Chem. Soc.*, **92**, 7603 (1970); (b) D. I. Schuster and M. D. Goldstein, *J. Amer. Chem. Soc.*, **95**, 986 (1973).

⁴⁵ See note 27, p. 701.

⁴⁶ See note 21, p. 699, and note 24, p. 700.

(Equation 13.29), or it may give ground-state product directly (Equation 13.30).



The mechanism of Equation 13.29 has been suggested for a number of reactions. However, in order to show conclusively that it is operative, the product must undergo some detectable photochemical or photophysical process. Clear-cut examples are rare and usually are reactions that also occur in the ground state. For example, Yang and co-workers have found that when **19** is irradiated, anthracene is obtained, which fluoresces from its first excited singlet state.⁴⁷ In fact,

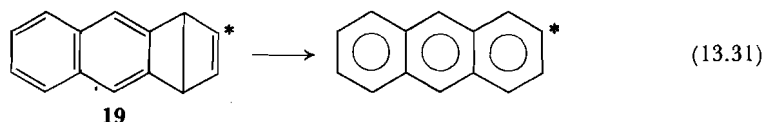

Hammond has suggested that normally A is converted into B by the mechanism of Equation 13.29 at about the same rate as ground-state A is converted into ground-state B and that most photochemical reactions are driven by internal conversion of electronic energy as in Equation 13.30.⁴⁸

Because of the rapidity with which the first-formed excited states are usually converted to the S_1 or T_1 state, most photochemical reactions start from these states. There are exceptions. An obvious one is when an upper dissociative excited state, in which the molecule immediately fragments, is populated.⁴⁹ Other exceptions occur when a molecule contains two different chromophores. For example, **20** reacts analogously to *trans*-stilbene (**21**) from its π, π^* state but also undergoes photoreduction, a process typical of an n, π^* state (see p. 719).⁵⁰

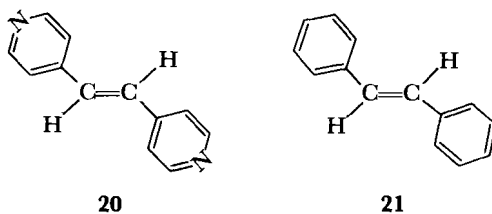

It also, rarely, occurs that the S_2-S_1 splitting is so large that the second excited state is long-lived enough to react chemically.⁵¹

Primary photochemical processes are those events that cause a molecule, excited by irradiation, to be converted to another molecule or back to the ground state. They include nonradiative decay to S_0 , emission, energy transfer, and quenching through exciplex formation.⁵²

⁴⁷ N. C. Yang, R. V. Carr, E. Li, J. K. McVey, and A. S. Rice, *J. Amer. Chem. Soc.*, **96**, 2297 (1974) and references therein.

⁴⁸ (a) G. S. Hammond in *Advances in Photochemistry*, Vol. 7, W. A. Noyes, G. S. Hammond, and J. N. Pitts, Jr., Eds., Wiley-Interscience, New York, 1969, p. 373; see also (b) L. Salem, *J. Amer. Chem. Soc.*, **96**, 3486 (1974).

⁴⁹ See, for example, M. Berger, I. L. Goldblatt, and C. Steel, *J. Amer. Chem. Soc.*, **95**, 1717 (1973).

⁵⁰ D. G. Whitten and Y. J. Lee, *J. Amer. Chem. Soc.*, **94**, 9142 (1972).

⁵¹ See, for example, P. de Mayo and R. Suau, *J. Amer. Chem. Soc.*, **96**, 6807 (1974).

⁵² W. A. Noyes, Jr., G. B. Porter, and J. E. Jolley, *Chem. Rev.*, **56**, 49 (1956).

Formation of photoproducts may involve only primary processes (Equations 13.29 and 13.30) or may occur in reactions subsequent to the primary processes. Equations 13.32 and 13.33 show the mechanism of photochemical formation of HCl from H_2 and Cl_2 . The reaction of Equation 13.32 is a primary process, but the product-forming step, Equation 13.33, is a secondary process. According

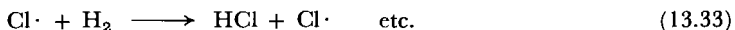

to the law of Stark and Einstein, the sum of the quantum yields of all primary processes is equal to one. Thus if the product is formed entirely in a primary process, the quantum yield of product formation, θ_{pro} , defined by Equation 13.34, cannot be greater than one. If secondary processes are involved, there is no such

$$\theta_{pro} = \frac{\text{no. of molecules of product formed}}{\text{no. of quanta absorbed}} \quad (13.34)$$

limitation. The quantum yield for formation of HCl according to the mechanism of Equations 13.32 and 13.33 may reach 10^6 .

The rest of this chapter will be devoted to a brief glimpse into the mechanisms of some of the more important organic photoreactions.

Cis-Trans Isomerization

The fact that olefins undergo sensitized cis-trans isomerization through their triplet states has already been mentioned in our discussion of nonvertical energy transfer. Most monoolefins absorb at wavelengths too short for facile study of their behavior after direct irradiation. Conjugated olefins, however, have been so studied and do isomerize. Whether these reactions go through singlets or through triplets produced by ISC is still a matter of debate. For example, the excited states responsible for cis-trans isomerization in the stilbenes have the same relative rates of decay to *cis*- and *trans*-stilbene whether the excited states are produced by direct irradiation or by photosensitization.⁵³ This evidence is at least consistent with the triplet being the reactive state in direct isomerization.

More recently, however, Saltiel has shown that direct irradiation of the stilbenes produces isomerizing excited states that are quenched by azulene via singlet-singlet dipole-dipole interactions (see p. 693). Thus it now seems more likely that isomerization of unsubstituted stilbene, following direct excitation, takes place from the S_1 states.⁵⁴ *p*-Bromostilbene, which undergoes ISC more readily than stilbene, isomerizes from both its S_1 and its T_1 states.⁵⁵

When reaction occurs from the triplet manifold, the further problem arises of whether the reactive states are the spectroscopic triplets, $^3cis^*$ and $^3trans^*$, or whether reaction occurs from a single phantom triplet. Direct irradiation of the $S_0 \rightarrow T_1$ absorption bands of *cis*- and *trans*-1,2-dichloroethene gives the same (trans/cis) quantum yield for each isomer, indicating that the phantom

⁵³ See note 20(a), p. 698.

⁵⁴ J. Saltiel and E. D. Megarity, *J. Amer. Chem. Soc.*, **94**, 2742 (1972).

⁵⁵ J. Saltiel, D. W.-L. Chang, and E. D. Megarity, *J. Amer. Chem. Soc.*, **96**, 6521 (1974).

triplet is formed before either ${}^3\text{cis}^*$ or ${}^3\text{trans}^*$ can react.⁵⁶ The generality of the phenomenon is still unclear.⁵⁷

If a system reaches the point where further irradiation under constant conditions causes no further change in composition, it is said to have reached its *photostationary state* (pss). The $(\text{cis}/\text{trans})_{\text{pss}}$ ratio in olefin isomerization depends on the relative extinction coefficients of the cis and trans isomers (i.e., their relative opportunities to isomerize) and on the quantum yields for both directions of the photoisomerization, as shown in Equation 13.35.

$$\left(\frac{\text{cis}}{\text{trans}}\right)_{\text{pss}} = \left(\frac{\epsilon_{\text{trans}}}{\epsilon_{\text{cis}}}\right) \left(\frac{\theta_{\text{trans} \rightarrow \text{cis}}}{\theta_{\text{cis} \rightarrow \text{trans}}}\right) \quad (13.35)$$

The absorption spectra of cis and trans isomers usually overlap strongly, so that it is difficult to irradiate one without also irradiating the other. If, however, the absorptions do not overlap selective irradiation of one converts it completely to the other. An interesting example is the photochemical isomerization of *cis*-cyclooctenone (**22**) to the highly strained, previously unknown isomer, **23**. The cis isomer, which is able to achieve planarity for its conjugated system, has its n, π^* absorption at longer wavelengths than the trans isomer, which cannot be

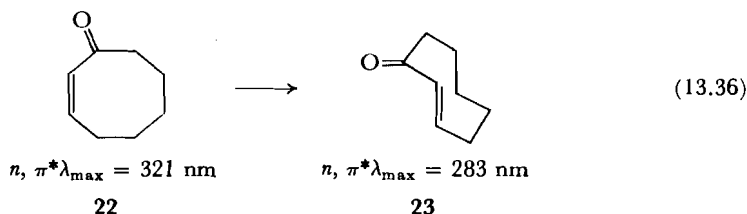

planar. Irradiation with light of wavelength $> 300 \text{ nm}$ gives 80 percent **23**. (The conversion to **23** is not complete because a tail of the trans isomer absorption extends to wavelengths $> 300 \text{ nm}$; irradiation of it gives the back reaction, $\text{23} \rightarrow \text{22}$.⁵⁸)

When excitation is brought about by triplet energy transfer and if isomerization occurs from the phantom triplet, then

$$\left(\frac{\text{cis}}{\text{trans}}\right)_{\text{pss}} = \left(\frac{k_{t \rightarrow p}}{k_{c \rightarrow p}}\right) \left(\frac{k_{p \rightarrow c}}{k_{p \rightarrow t}}\right) \quad (13.37)$$

where $k_{t \rightarrow p}$, $k_{c \rightarrow p}$, $k_{p \rightarrow c}$, and $k_{p \rightarrow t}$ are the rates of Reactions 13.38–13.41, respectively.

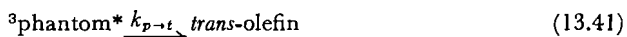
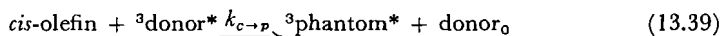
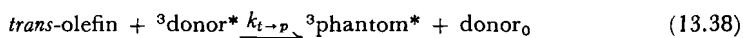

⁵⁶ (a) R. B. Cundall, F. J. Fletcher, and D. G. Milne, *Trans. Faraday Soc.*, **60**, 1146 (1964). For another such case, see (b) J. Saltiel and B. Thomas, *J. Amer. Chem. Soc.*, **96**, 5660 (1974).

⁵⁷ See, for example: J. Saltiel, K. R. Neuberger, and M. Wrighton, *J. Amer. Chem. Soc.*, **91**, 3658 (1969).

⁵⁸ P. E. Eaton and K. Lin, *J. Amer. Chem. Soc.*, **86**, 2087 (1964).

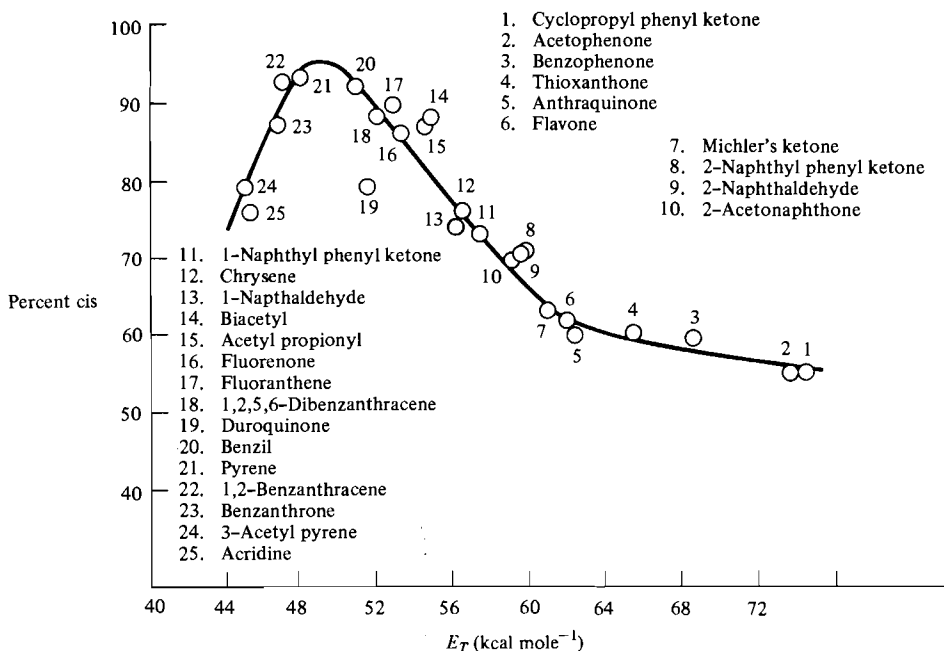

Figure 13.12 Photostationary states for the stilbenes. Reprinted with permission of W. G. Herkstroeter and G. S. Hammond, *J. Amer. Chem. Soc.*, **88**, 4769 (1966). Copyright by the American Chemical Society.

With sensitizers whose triplet energies lie above the triplet energies of both cis and trans isomers, energy transfer to both isomers occurs at almost the same rate (see Figure 13.9).⁵⁹ Then Equation 13.37 simplifies to

$$\left(\frac{\text{cis}}{\text{trans}}\right)_{\text{PSS}} \approx \frac{k_{p \rightarrow c}}{k_{p \rightarrow t}} \quad (13.42)$$

From high-energy sensitizers we can therefore get a direct measure of the relative rates of decay of the phantom triplet to cis and trans isomers. Figure 13.12 shows a plot of percent cis isomer at the photostationary state vs. the energy of the triplet sensitizer in the cis-trans isomerization of stilbene. The high-energy sensitizers all give approximately the same $(\text{cis}/\text{trans})_{\text{PSS}}$ according to Equation 13.42. Then, as energy transfer to the cis isomer becomes less efficient (for the energies of the stilbene triplets see p. 699), the amount of cis in the photostationary state increases. Finally, the amount of cis decreases again when the energy of the sensitizer is so low that only nonvertical energy transfer to the phantom triplet can occur, and the cis isomer, having higher ground-state energy, is more efficiently excited.

Photocycloadditions⁶⁰

One of the possible reactions of an electronically excited monoolefin is dimerization with a ground-state molecule. If the reaction is concerted, the transition

⁵⁹ (a) See note 20(a), p. 698; (b) W. G. Herkstroeter and G. S. Hammond, *J. Amer. Chem. Soc.*, **88**, 4769 (1966); (c) P. Valentine, Jr., and G. S. Hammond, *J. Amer. Chem. Soc.*, **94**, 3449 (1972).

⁶⁰ (a) J. S. Swenton, *J. Chem. Educ.*, **46**, 7 (1969); (b) O. L. Chapman and G. Lenz, in *Organic Photochemistry*, Vol. 1, O. L. Chapman, Ed., Marcel Dekker, New York, 1966, p. 283.

state should be ($\pi 2s + \pi 2s$). Although very few simple olefins have been investigated, from the evidence available it does appear that reaction from the singlet state is concerted. The photodimerization of tetramethylethylene (Equation 13.43) occurs upon irradiation without sensitizer; because the sensitizer-produced triplet state of tetramethylethylene does not dimerize, one may conclude that the dimerization observed on direct irradiation occurs from the singlet.⁶¹ Since tetramethylethylene dimerizes from the singlet state, the 2-butenes probably do also; the results, shown in Equations 13.44 and 13.45, demonstrate that each butene molecule maintains its stereochemistry throughout.⁶²

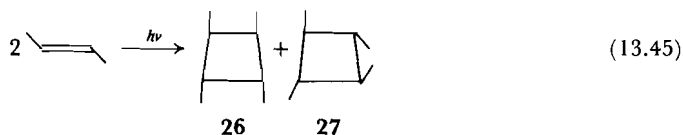
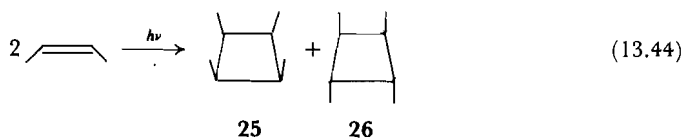
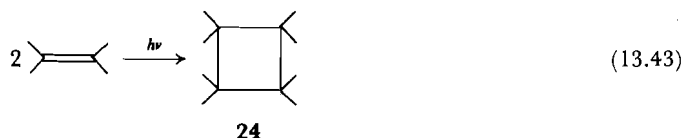

Photochemically induced intramolecular dimerizations are known. For example, when irradiated with 254-nm light, **28** gives the "housane" products **29** and **30** and butadiene gives **31**. Both these reactions apparently proceed through biradical intermediates.⁶³

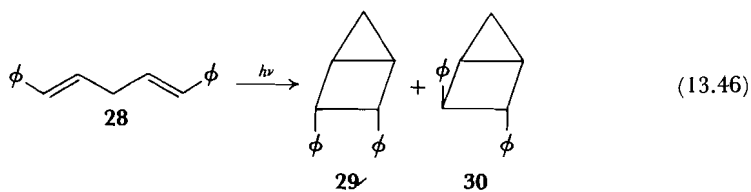

Some olefins conjugated with electron-withdrawing, unsaturated groups dimerize to cyclobutanes as photoproducts, apparently through their triplet states. For example, when acrylonitrile in acetone is irradiated under con-

⁶¹ D. R. Arnold and V. Y. Abraitys, *Chem. Commun.*, 1053 (1967).

⁶² H. Yamazaki and R. J. Cvetanović, *J. Amer. Chem. Soc.*, **91**, 520 (1969).

⁶³ (a) E. Block and H. W. Orf, *J. Amer. Chem. Soc.*, **94**, 8438 (1972); (b) R. Srinivasan, in *Advances in Photochemistry*, Vol. 4, W. A. Noyes, G. S. Hammond, and J. N. Pitts, Jr., Eds., 1966, p. 113; (c) R. Srinivasan, *J. Amer. Chem. Soc.*, **90**, 4498 (1968).

ditions where only acetone absorbs, the dimer **32** is obtained as one of the products. Piperylene, an excellent quencher of triplet energy but a poor singlet

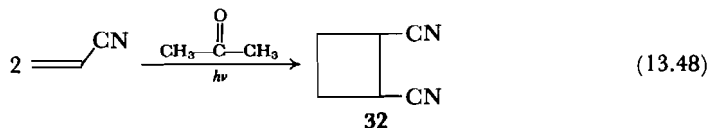

quencher, interferes with the formation of **32** when added to the system. It appears that the T_1 state of acetone is populated by intersystem crossing from S_1 and that the triplet energy is then transferred to acrylonitrile.⁶⁴ Similarly,

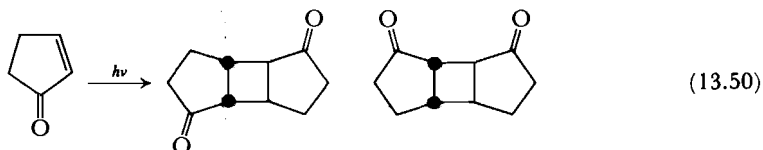
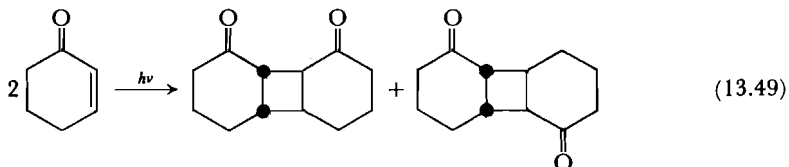

cyclopentenone and cyclohexenone dimerize as shown in Equations 13.49 and 13.50.⁶⁵ These reactions are also quenched by the triplet quencher piperylene. The rate of radiationless decay increases as ease of C—C bond twisting increases. Therefore open-chain α,β -unsaturated ketones do not photodimerize.⁶⁶

Excited cyclic α,β -unsaturated ketones attack simple olefins too in their ground state. For example, Eaton carried out the reaction in Equation 13.51.^{66a} The exact mechanism is not understood, since the characteristics of the reaction vary: With some reactants it is regiospecific and/or stereospecific and with others it is neither.⁶⁷

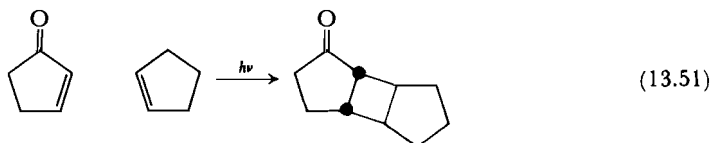

Other examples of two unlike olefins adding together to form a cyclobutane exist. For example, when *trans*-stilbene is selectively excited in the presence of tetramethylethylene, **33** is formed stereoselectively. The quantum yield of

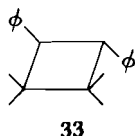

⁶⁴ J. A. Barltrop and H. A. J. Carless, *J. Amer. Chem. Soc.*, **94**, 1951 (1972).

⁶⁵ P. E. Eaton, *Accts. Chem. Res.*, **1**, 50 (1968).

⁶⁶ P. J. Wagner and D. J. Bucheck, *J. Amer. Chem. Soc.*, **91**, 5090 (1969).

^{66a} P. E. Eaton, *J. Amer. Chem. Soc.*, **84**, 2454 (1962).

⁶⁷ P. de Mayo, *Accts. Chem. Res.*, **4**, 41 (1971).

product depends linearly on tetramethylethylene concentration, and therefore the mechanism must involve attack of excited stilbene on tetramethylethylene. That the excited state responsible for addition is the S_1 state of stilbene is shown by the fact that the addition is not sensitized by compounds that do sensitize the *trans*-to-*cis* isomerization of *trans*-stilbene. An exciplex intermediate is implicated because a Stern-Volmer plot of the reciprocal of the quantum yield of stilbene fluorescence vs. concentration of tetramethylethylene is linear despite the fact that tetramethylethylene has a higher singlet energy than stilbene.⁶⁸

The photochemical addition of a carbonyl compound to an olefin to form an oxetane is called the Paterno-Buchi reaction (Equation 13.52) and is one of

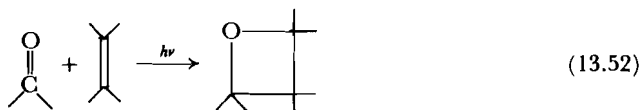

the most common photocyclizations.⁶⁹ It occurs at wavelengths where only the carbonyl compound absorbs and thus involves attack of an excited carbonyl on a ground-state olefin. The stereochemistry of the reaction depends on whether the carbonyl compound is aliphatic or aromatic. Benzaldehyde yields essentially the same mixture of oxetanes with *cis*-2-butene as it does with *trans*-2-butene (Equation 13.53).⁷⁰

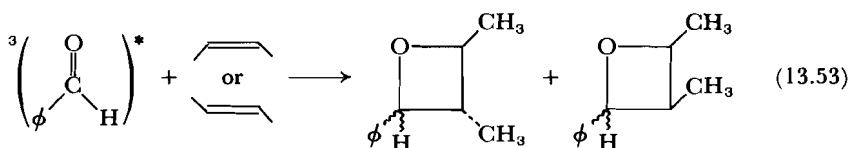

Acetaldehyde, on the other hand, adds stereospecifically to the isomeric 2-butenes (Equations 13.54 and 13.55).⁷¹

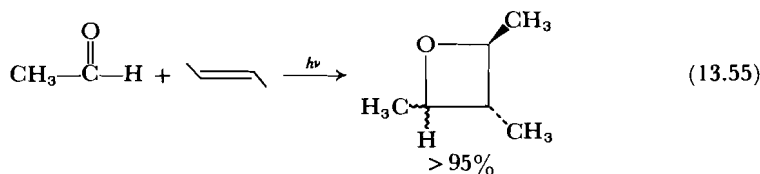
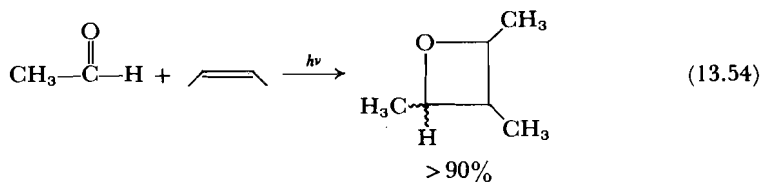

⁶⁸ (a) O. L. Chapman and R. D. Lura, *J. Amer. Chem. Soc.*, **92**, 6352 (1970). For a number of more recent references for cycloadditions that apparently proceed through a singlet exciplex, see (b) D. Creed and R. A. Caldwell, *J. Amer. Chem. Soc.*, **96**, 7369 (1974) and references therein.

⁶⁹ For a review, see: S. Patai, *The Chemistry of the Carbonyl Group*, Wiley-Interscience, New York, 1966, chap. 16.

⁷⁰ D. R. Arnold, R. L. Hinman, and A. H. Glick, *Tetrahedron Lett.*, 1425 (1964).

⁷¹ N. C. Yang and W. Eisenhardt, *J. Amer. Chem. Soc.*, **93**, 1277 (1971).

The reason for the difference in stereochemistry is that, as quenching studies show, the reactive state of the aromatic carbonyls (which undergo ISC rapidly) is T_1 but in aliphatic carbonyls it is S_1 . The intermediate formed from acetaldehyde and *cis*-2-butene, then, is the singlet biradical **34**, whereas the intermediate from benzaldehyde and *cis*-2-butene is the triplet biradical **35**. That the stereo-

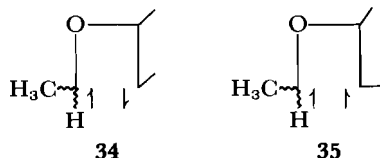

chemistry of ring closure of a 1,4-biradical depends on the multiplicity of the biradical was elegantly shown by Bartlett and Porter. When **36** is irradiated, it decomposes through its singlet state to give the singlet 1,4-biradical **37**, which rapidly forms a bond to give predominantly **38** as shown in Equation 13.56.

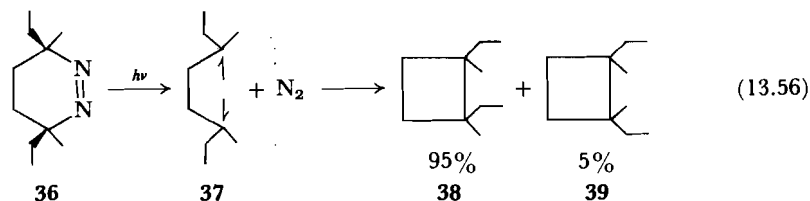

When **36** is photosensitized by a triplet donor, it forms the triplet biradical **40**. Before the slow but necessary process of spin inversion has time to occur, bond rotation in **40** takes place so that a mixture of products rich in **39** is obtained.^{72, 73} The biradical **34** is analogous to **37**, whereas **35** is analogous to **40**.

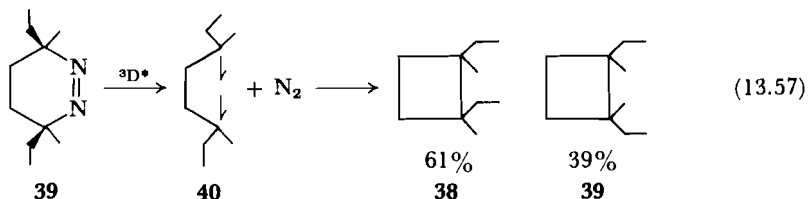

The exact mechanism of the addition of aliphatic aldehydes and ketones to olefins depends on the electron density of the double bond. Electron-rich olefins react via a short-lived biradical or a concerted mechanism, whereas electron-poor olefins form a preliminary charge-transfer complex.⁷⁴

According to pericyclic selection rules, photocyclic addition of a diene to an olefin may be concerted if the transition state has a $\pi 4s + \pi 2a$ configuration.

⁷² P. D. Bartlett and N. A. Porter, *J. Amer. Chem. Soc.*, **90**, 5317 (1968).

⁷³ By the law of spin conservation, the addition of a triplet to a singlet should produce a triplet biradical, which must undergo spin inversion before it can form a second bond. Woodward and Hoffman, however, have suggested that spin inversion may at times be concerted with bond formation so that an intermediate biradical need not always be formed: R. B. Woodward and R. Hoffman, *Angew. Chem. Int. Ed.*, **8**, 781 (1969), Section 6.2. Almost every known example of a triplet adding to a singlet, however, does seem to give an intermediate biradical. For another point of view, see N. D. Epiotis, *J. Amer. Chem. Soc.*, **94**, 1941 (1972).

⁷⁴ (a) See note 69, p. 713; (b) J. A. Barltrop and H. J. A. Carless, *J. Amer. Chem. Soc.*, **94**, 8761 (1972).

Such additions are very rare, apparently because the allowed $\pi 2s + \pi 2s$ process is much more accessible (see Chapter 11.3). Most photo Diels-Alder reactions that have been studied involve attack of a triplet diene on a singlet olefin and thus proceed by an intermediate biradical. Both intramolecular⁷⁵ and intermolecular⁷⁶ concerted Diels-Alder reactions have, however, recently been observed. For example, photolysis of **41**, through a $\pi 4s + \pi 2a$ transition state, stereospecifically forms **42**. Similarly, **43** is converted to **44**. Nevertheless, not all intramolecular Diels-Alder reactions brought about by direct irradiation are stereospecific.⁷⁷

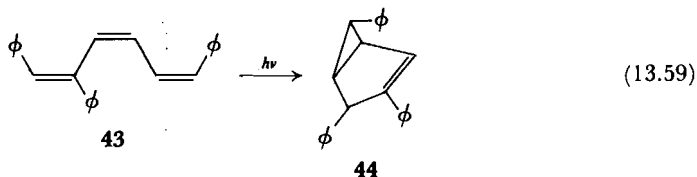
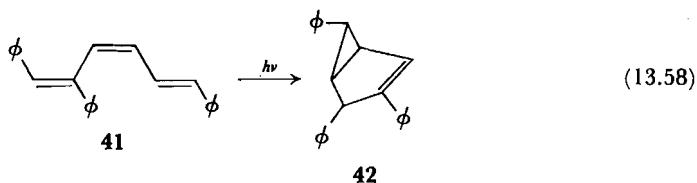

Photosensitized dienes dimerize to give 2 + 2 and 2 + 4 addition products. For example, triplet butadiene yields the three products in Equation 13.60,

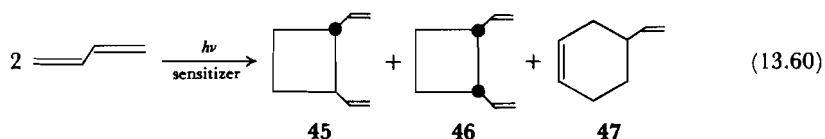

but the composition of the product mixture depends on the energy of the sensitizer. As shown in Table 13.1, high-energy sensitizers all produce approximately the same ratio of products, but when the sensitizer triplet energy (E_T) falls below 60 kcal mole⁻¹, the percentage of vinylcyclohexene begins to increase. Hammond has explained the product distribution on the basis of two distinct stereoisomeric diene T_1 states. In the ground state the highest filled molecular orbital of butadiene is antibonding between C_2 and C_3 . In the first excited state an electron has been promoted from this orbital to one that is bonding between C_2 and C_3 . There is, therefore, a much greater barrier to interconversion of the *s*-cis (**48**) and *s*-trans (**49**) forms in the first excited state than in the ground state. A high-energy sensitizer transfers energy to the first diene molecule it encounters, which is more likely to be in the *s*-trans configuration (>95% of butadiene molecules

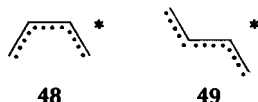

⁷⁵ A. Padwa, L. Brodsky, and S. Clough, *J. Amer. Chem. Soc.*, **94**, 6767 (1972).

⁷⁶ H. Hart, T. Miyashi, D. N. Buchanan, and S. Sasson, *J. Amer. Chem. Soc.*, **96**, 4857 (1974).

⁷⁷ See, for example: D. A. Seeley, *J. Amer. Chem. Soc.*, **94**, 4378, 8647 (1972).

Table 13.1 COMPOSITION OF PRODUCTS FROM PHOTSENSITIZED DIMERIZATION OF BUTADIENE

Sensitizer	Percentage Distribution of Dimers			E_T (kcal mole ⁻¹)
	45	46	47	
Xanthone	78	19	3	74.2
Acetophenone	78	19	3	73.6
Benzaldehyde	80	16	4	71.9
<i>o</i> -Dibenzoylbenzene	76	16	7	68.7
Benzophenone	80	18	2	68.5
2-Acetylfluorenone	78	18	4	62.5
Anthraquinone	77	19	4	62.4
Flavone	75	18	7	62.0
Micheler's ketone	80	17	3	61.0
4-Acetylbiphenyl	77	17	6	60.6
β -Naphthyl phenyl ketone	71	17	12	59.6
β -Naphthaldehyde	71	17	12	59.5
β -Acetonaphthone	76	16	8	59.3
α -Acetonaphthone	63	17	20	56.4
α -Naphthaldehyde	62	15	23	56.3
Biacetyl	52	13	35	54.9
Benzil	44	10	45	53.7
Fluorenone	44	13	43	53.3
Duroquinone	72	16	12	51.0

SOURCE: Reproduced by permission of R. S. H. Liu, N. J. Turro, and G. S. Hammond, *J. Amer. Chem. Soc.*, **87**, 3406 (1965). Copyright by the American Chemical Society.

in the ground state at room temperature are in that configuration because of the lower nonbonding interactions in it than in the *s*-cis form). Once produced, an *s*-trans triplet attacks a ground-state diene molecule, which is again most probably in an *s*-trans configuration, to form either biradical **50** or **51** (see Scheme 1). These biradicals can easily close to divinylcyclobutanes, but can only close to

SCHEME 1

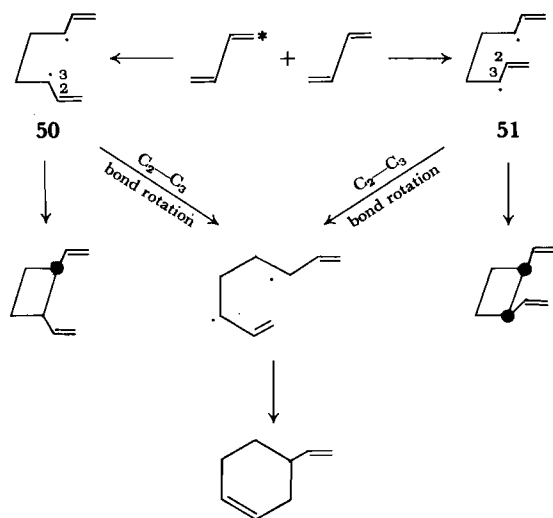

six-membered rings if the C₂-C₃ bond first rotates so that the alkyl groups on it are close to an *s*-cis configuration. This bond rotates slowly because it has appreciable double bond character, and therefore not much vinylcyclohexene is produced.

Sensitizers whose triplet energies are less than 60 kcal mole⁻¹ are of lower energy than the butadiene *s*-trans triplet and they must therefore seek out an *s*-cis diene (triplet energy of *s*-cis butadiene is 53 kcal mole⁻¹) before they can transfer their energy. The biradical produced by attack of an *s*-cis triplet on an *s*-trans ground-state molecule can form a cyclohexene without bond rotation (see Scheme 2), and thus the relative amount of cyclohexene increases. When the

SCHEME 2

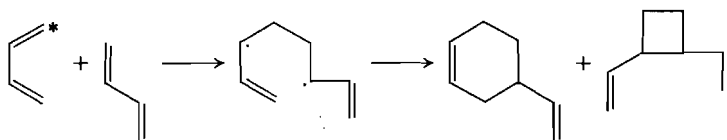

energy of the triplet sensitizer falls below 53 kcal, the relationship between product composition and sensitizer energy becomes complicated because of nonvertical energy transfer.⁷⁸

Photosensitized dienes also add to simple olefins; the relative amount of 2 + 2 and 2 + 4 addition product again depends on the energy of the triplet sensitizer. For example, in the photosensitized addition of butadiene to trifluorethylene (Equation 13.61), the percentage of the 2 + 4 adduct (**52**) increases from 0.5 percent when acetophenone is used as the photosensitizer to 22.5 percent when fluorenone is the photosensitizer.⁷⁹

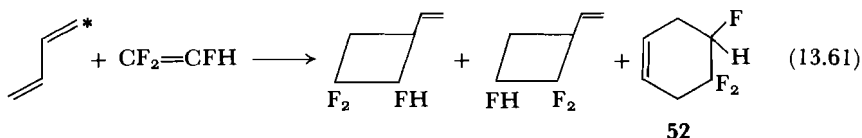

Norrish Type I Reaction⁸⁰

Most aldehydes and ketones in inert solvents or in the gas phase undergo one or two photoreactions, called Norrish Type I and Norrish Type II processes.⁸¹

The Norrish Type I reaction, shown in Equation 13.62, may originate

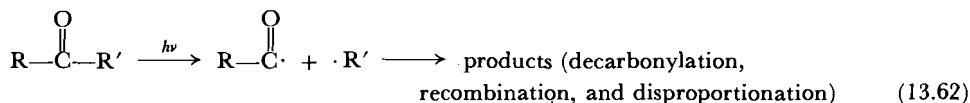

from either the S₁ or T₁ state of the carbonyl compound. For example, Type I

⁷⁸ R. S. H. Liu, N. J. Turro, Jr., and G. S. Hammond, *J. Amer. Chem. Soc.*, **87**, 3406 (1965).

⁷⁹ P. D. Bartlett, B. M. Jacobson, and L. E. Walker, *J. Amer. Chem. Soc.*, **95**, 146 (1973).

⁸⁰ (a) See note 69, p. 713; (b) J. S. Swenton, *J. Chem. Educ.*, **46**, 217 (1969).

⁸¹ Here we discuss only reactions in solution. For an example of Norrish Type I and Norrish Type II reactions in the gas phase, see H. E. O'Neal, R. G. Miller, and E. Gunderson, *J. Amer. Chem. Soc.*, **96**, 3351 (1974).

cleavage of excited cyclohexanone in benzene solution is efficiently quenched by 1,3-dienes, a group of compounds whose S_1 states lie above the carbonyl S_1 states but whose T_1 states are of *lower* energy than the carbonyl T_1 states. A Stern-Volmer plot of $1/\theta_{pro}$ vs. the concentration of the diene is a good straight line over all diene concentrations. Thus all α cleavage occurs from the T_1 excited state.⁸²

A Stern-Volmer plot for diene quenching of the Norrish Type I reaction of methyl *t*-butyl ketone shows that in this compound α cleavage is more complicated. At low concentrations of diene there is an inverse relationship between quantum yield of products and concentration of quencher, but at high diene concentrations the quenching becomes markedly less efficient and the curve decreases in slope.⁸³ Reaction apparently takes place from T_1 and S_1 , although much more efficiently from T_1 . At high diene concentrations, where most of the triplet reaction has already been quenched, inefficient singlet quenching sets in. The ability of a diene to quench the S_1 state of carbonyl compounds has been shown to depend on its ionization potential, and therefore singlet quenching probably occurs via an exciplex.⁸⁴

Norrish Type I reactions occur from T_1 only if the T_1 state is $^3(n,\pi^*)$. Compound **53** has a phosphorescence lifetime of 10^{-3} sec, and there is a mirror-image relationship between its closely spaced phosphorescence and absorption spectra. Compound **54**, however, has a phosphorescence lifetime of 5.5 sec, and there is a large Stokes shift between its dissimilar absorption and phosphorescence spectra. Apparently both compounds have a lowest (n,π^*) singlet,

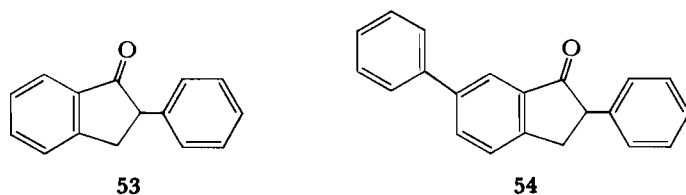

but whereas (n,π^*) is also the lowest triplet of **53**, $^3(\pi,\pi^*)$ is even lower than $^3(n,\pi^*)$ in **54**. The difference in photochemical behavior between the two compounds is striking. Upon irradiation with >320 -nm wavelength light for 9 hr, **53** forms the products in Equation 13.63 in 86 percent yield.

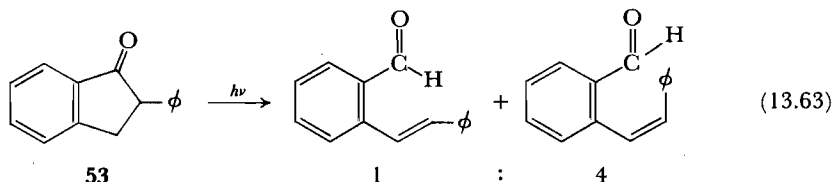

Under the same conditions **54** gives less than 5 percent aldehydic material and is recovered unchanged in 91 percent yield.⁸⁵

⁸² P. J. Wagner and R. W. Spoerke, *J. Amer. Chem. Soc.*, **91**, 4437 (1969).

⁸³ N. C. Yang and E. D. Feit, *J. Amer. Chem. Soc.*, **90**, 504 (1968).

⁸⁴ N. C. Yang, M.-H. Hui, and S. A. Bellard, *J. Amer. Chem. Soc.*, **93**, 4056 (1971).

⁸⁵ A. A. Baum, *J. Amer. Chem. Soc.*, **94**, 6866 (1972).

Which of the two R—C=O bonds cleave in the Norrish Type I reaction of an unsymmetrical ketone depends on the relative stabilities of the two possible R· radicals. Diaryl ketones do not react at all; and **53** cleaves to give a benzyl rather than an aryl radical. From ethyl methyl ketone, an ethyl radical is formed considerably more frequently than a methyl radical.⁸⁶

The fact that the initial cleavage is reversible has been long suspected from the fact that the quantum yield for Norrish Type I products never approaches one, even for very reactive ketones. Positive evidence for the back reaction was provided by Barltrop, who showed that Type I cleavage of *cis*-2,3-dimethylcyclohexanone is accompanied by its isomerization to *trans*-2,3-dimethylcyclohexanone.⁸⁷

Photochemical cleavage of a bond α to a carbonyl group is not unique to aldehydes and ketones. For example, phenyl acetate, from its S_1 state, forms the products in Equation 13.64.⁸⁸

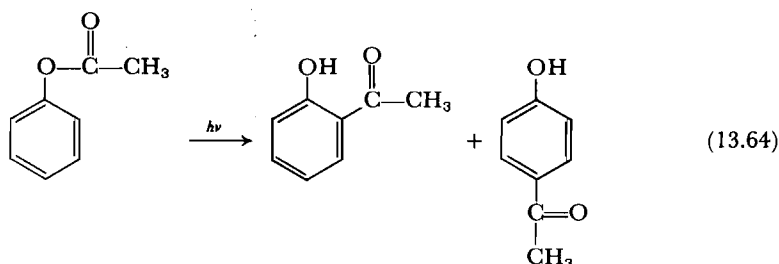

Norrish Type II Reaction⁸⁹

When aldehydes or ketones are irradiated in hydroxylic solvents, they are often reduced to the corresponding alcohol or pinacol. The reduction of benzophenone

SCHEME 3

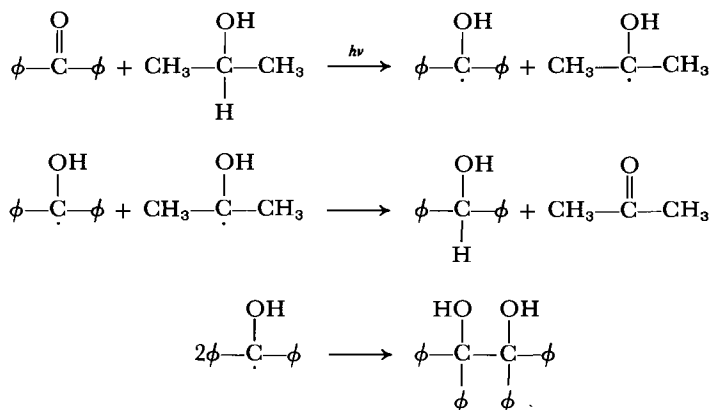

⁸⁶ J. N. Pitts and F. E. Blacet, *J. Amer. Chem. Soc.*, **72**, 2810 (1950).

⁸⁷ J. A. Barltrop and J. D. Coyle, *Chem. Commun.*, 1081 (1969).

⁸⁸ (a) J. W. Meyer and G. S. Hammond, *J. Amer. Chem. Soc.*, **92**, 2187 (1970); (b) F. A. Carroll and G. S. Hammond, *J. Amer. Chem. Soc.*, **94**, 7151 (1972).

⁸⁹ (a) See note 69, p. 713; (b) see note 80(b), p. 717; (c) P. J. Wagner, *Accts. Chem. Res.*, **4**, 168 (1971).

by isopropanol is shown in Scheme 3. Notably unreactive in such photoreductions are most aromatic compounds that have a lowest (π, π^*) rather than a lowest (n, π^*) triplet.

When an excited aldehyde or ketone has a γ hydrogen, intramolecular hydrogen abstraction via a six-membered ring transition state usually occurs. The resulting 1,4-biradical may either cleave or cyclize to give the *Norrish Type II products* of Scheme 4.

SCHEME 4

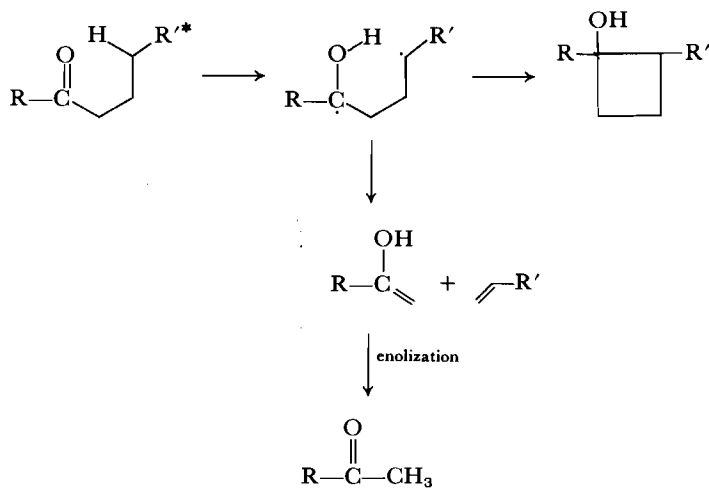

Aliphatic ketones generally undergo Type II reaction from their singlet and triplet states simultaneously, as can be seen from the fact that only part of the reaction can be efficiently quenched by 1,3-dienes. The rates of intersystem crossing for most aliphatic ketones are similar to one another, and therefore the percentage of the singlet reaction depends on how fast it can occur; 5-methyl-2-hexanone (**55**), which has a relatively weak γ -C—H bond, reacts mostly from the singlet state, but 2-pentanone (**56**) reacts mostly from the triplet.⁹⁰

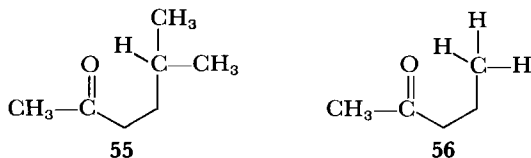

Aromatic ketones, which undergo intersystem crossing with great efficiency, give Type II (and Type I) reactions solely from the triplet state. Like the products of intermolecular hydrogen abstraction, Type II products are largely suppressed if the lowest triplet is π, π^* .⁹¹

That the triplet reaction involves a biradical as shown in Scheme 4 has been convincingly demonstrated. For example, (4*S*)-(+)4-methyl-1-phenyl-1-hexanone (**57**), on irradiation in benzene, gives the products shown in Scheme 5

⁹⁰ N. C. Yang, S. P. Elliott, and B. Kim, *J. Amer. Chem. Soc.*, **91**, 7551 (1969).

⁹¹ P. J. Wagner and A. E. Kemppainen, *J. Amer. Chem. Soc.*, **90**, 5898 (1968).

with a total quantum yield of only 0.2. The optical activity of recovered "unreacted" ketone indicates that photoracemization has also occurred with a quantum yield of 0.78 ± 0.05 . The most reasonable explanation for these observations is that a biradical intermediate is formed with a quantum yield of one, and that the biradical either forms products or returns to racemized starting material.⁹²

SCHEME 5

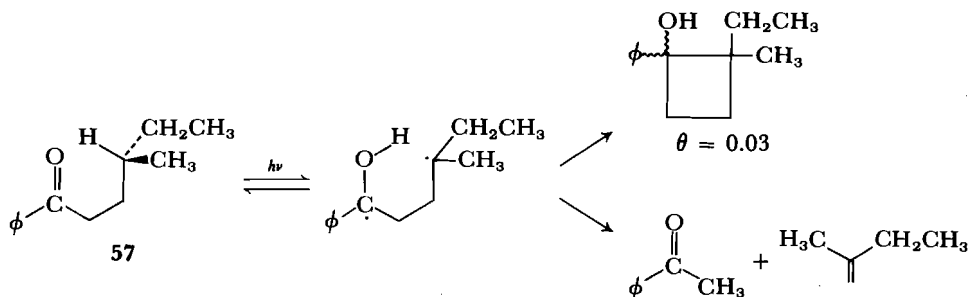

Norrish Type II biradicals have also been trapped. For example, irradiation of a benzene solution of **58**, to which a high concentration of butanethiol-*S-d* has been added, results in quenching of the Norrish Type II reaction and extensive incorporation of deuterium at the γ carbon of recovered **58**. The thiol, a good hydrogen donor, supplies a deuterium to the radical **59** before **59** can give products or return to starting material as shown in Scheme 6.⁹³

SCHEME 6

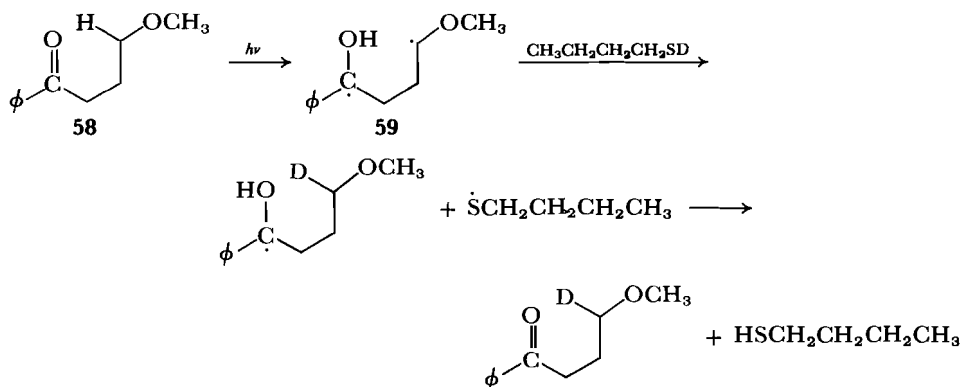

Norrish Type II processes from the triplet state involve a biradical even when concerted reaction would be exothermic. Photolysis of **60** gives the products in Equation 13.65. Concerted reaction with the formation of triplet stilbene (a process corresponding to Equation 13.29) would be exothermic, but triplet stilbene is not formed: The T_1 state of stilbene decays to a 60:40 *cis-trans* mixture, but photolysis of **60** gives 98.6 percent *trans*-stilbene.⁹⁴

⁹² P. J. Wagner, P. A. Kelso, and R. G. Zepp, *J. Amer. Chem. Soc.*, **94**, 7480 (1972).

⁹³ (a) P. J. Wagner and R. G. Zepp, *J. Amer. Chem. Soc.*, **94**, 287 (1972). See also (b) P. J. Wagner and K.-C. Liu, *J. Amer. Chem. Soc.*, **96**, 5952 (1974).

⁹⁴ See note 92.

Until recently, biradical intermediates were not implicated in singlet-state Norrish Type II reactions. Concerted reaction was a possibility: Recovered starting material from photolysis of optically active ketones is not racemized when the photolyses are carried out in the presence of large amounts of 1,3-dienes,

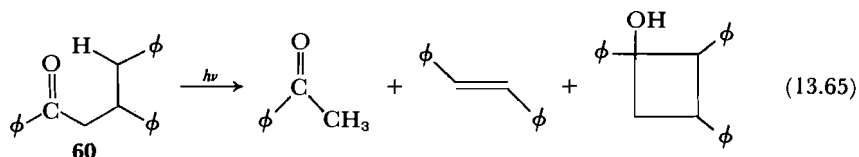

nor has a biradical been trapped or diverted from a singlet Type II reaction. It now appears, however, that singlet Type II reactions also involve a biradical. Photolysis of *threo*-4-methyl-2-hexanone-5-*d*₁ (**61**), in the presence of large amounts of piperylene, yields *cis*- and *trans*-2-butene. If reaction were concerted, transfer of H should form *cis* isomer and transfer of D should form *trans* isomer. Yet transfer of H gives 10 percent *trans*- and 90 percent *cis*-2-butene. Apparently an intermediate singlet biradical (**62**) is formed, which either cleaves to olefin of retained stereochemistry (*cis*) or undergoes bond rotation. The rotated biradical can cleave to the *trans* olefin as shown in Scheme 7. When the photolysis is carried out in the absence of piperylene, triplet-state reaction predominates. Under these conditions the formation of the butenes is much less stereospecific.⁹⁵ The shorter lifetime of the singlet 1,4-biradicals is in agreement with the work of Bartlett and Porter (p. 714).

SCHEME 7

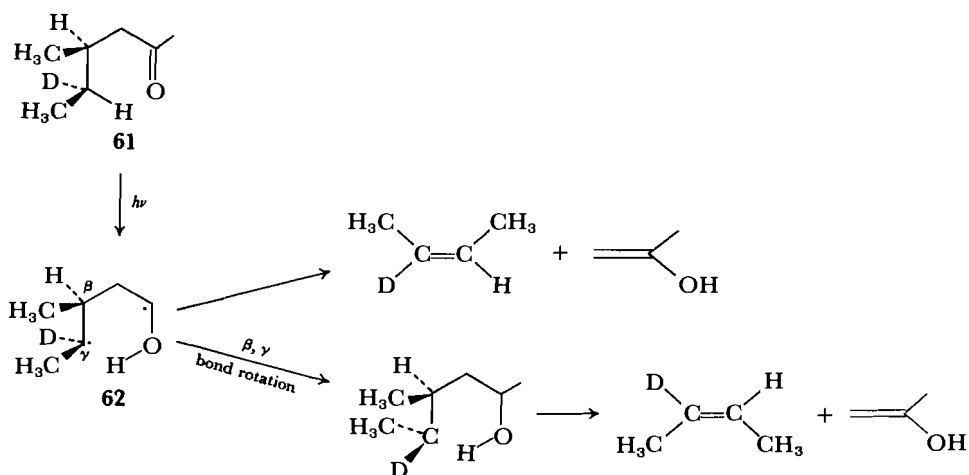

The ratio of Type II fragmentation to Type II cyclization products may depend strongly on the excited state from which reaction occurs. The lowest-energy pathway for fragmentation requires continual orbital overlap between developing *p* bonds. Cyclobutanol formation, however, has less stringent orbital orientation requirements. When the configuration of the ketone is unfavorable

⁹⁵ (a) C. P. Casey and R. A. Boggs, *J. Amer. Chem. Soc.*, **94**, 6457 (1972). See also (b) L. M. Stephenson, P. R. Cavigli, and J. L. Parlett, *J. Amer. Chem. Soc.*, **93**, 1984 (1971).

excited state. Therefore, if formed and stored at low temperatures they are often stable.

It is impossible in this chapter even to scratch the surface of photochemical rearrangements. Examples of electrocyclic and sigmatropic rearrangements have already been cited in Chapter 12.2 and 12.3. Here we shall arbitrarily limit ourselves to electrocyclic rearrangements, the di- π -methane rearrangement and to cyclohexadiene rearrangements; furthermore, our glimpse of these reactions will be fleeting. The reader who is interested in looking further should consult W. A. Noyes, G. S. Hammond, and J. N. Pitts, Jr., Ed., *Advances in Photochemistry* (Wiley-Interscience, New York, 1968 ff.) and O. L. Chapman, Ed., *Organic Photochemistry* (Marcel Dekker, New York, 1966 ff.), and should also consult the current literature because new rearrangements are discovered every day. It should be stressed that one must use care in applying the pericyclic selection rules to photochemical rearrangements, since many rearrangements occur from the T_1 state and are not concerted.

The pericyclic selection rules *are* highly successful in predicting the course of photoinduced electrocyclic reactions. The most highly studied photoinduced electrocyclic reaction is the conversion of *cis*-stilbene into dihydrophenanthrene, which in turn is rapidly oxidized to phenanthrene (Equation 13.68).¹⁰³ Controversy has arisen over whether the reactive state is the first excited singlet or a high vibrational level of the ground state of *cis*-stilbene. If it is S_1 , allowed ring closure should produce the *trans*-dihydrophenanthrene (**66**), as shown in Equation 13.68. The *trans* structure for the dihydrophenanthrene was first suggested

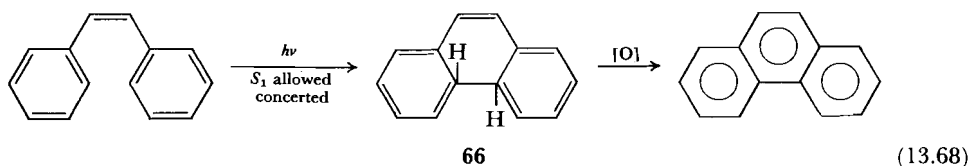

by Mallory on the basis of analogy with the stereochemistry of the 1,3-hexadienes formed photochemically from various 1,3,5-hexatrienes related to vitamin B.¹⁰⁴ More recently, **68** has been isolated from the photoinduced cyclization of **67**, and its *trans* stereochemistry has been chemically proven.¹⁰⁵ (For several other examples, see Section 12.2.)

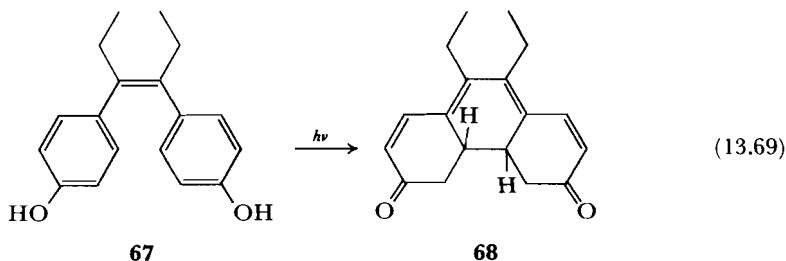

¹⁰³ F. R. Stermitz, in *Organic Photochemistry*, Vol. 1, O. L. Chapman, Ed., Marcel Dekker, New York, 1966, p. 248.

¹⁰⁴ F. B. Mallory, C. S. Wood, and J. T. Gordon, *J. Amer. Chem. Soc.*, **86**, 3094 (1964).

¹⁰⁵ Th. J. H. M. Cuppen and W. H. Laarhoven, *J. Amer. Chem. Soc.*, **94**, 5914 (1972).

Compounds that have a structure such as that shown in **69** upon direct irradiation undergo what is called the *di- π -methane rearrangement* to form **70**. Photosensitized **69** rearranges either inefficiently or not at all, indicating that the reactive state of acyclic systems is S_1 . Apparently the T_1 state of **69** dissipates its energy by free rotation about the unconstrained π bond.¹⁰⁶ In rigidly constrained systems, however, the di- π -methane rearrangement does originate from T_1 .

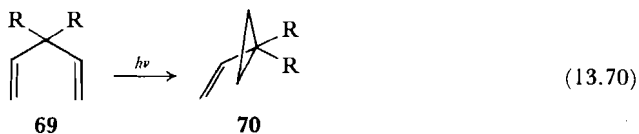

For example, barrelene (**71**), when photosensitized by acetone, rearranges to **72**.¹⁰⁷

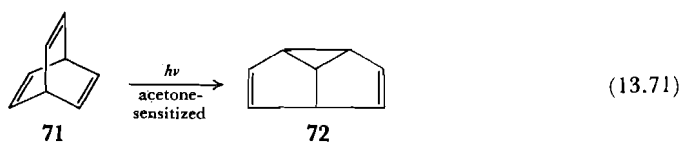

When C_3 of the 1,4-pentadiene is disubstituted as in **69**, the rearrangement is stereospecific at carbons 1 and 5. For example, *cis*-1,1-diphenyl-3,3-dimethyl-1,4-hexadiene (**73**) rearranges to **74**, in which the side chain is *cis*, but *trans*-1,1-diphenyl-3,3-dimethyl-1,4-hexadiene (**75**) rearranges to **76**, in which the side

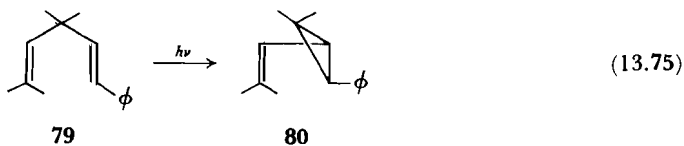
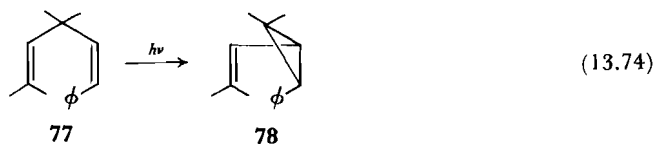
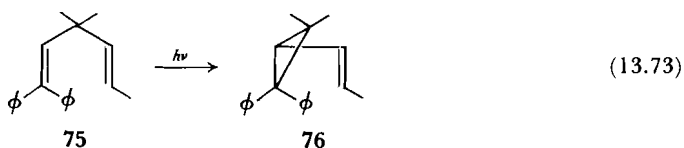
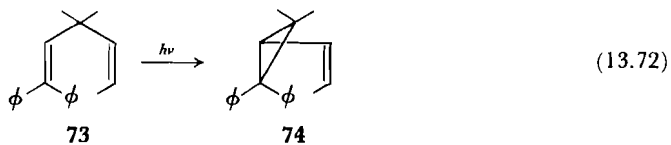

¹⁰⁶ For a review, see: S. S. Hixson, P. S. Mariano and H. E. Zimmerman, *Chem. Rev.*, **73**, 531 (1973).

¹⁰⁷ H. E. Zimmerman and P. S. Mariano, *J. Amer. Chem. Soc.*, **91**, 1718 (1969).

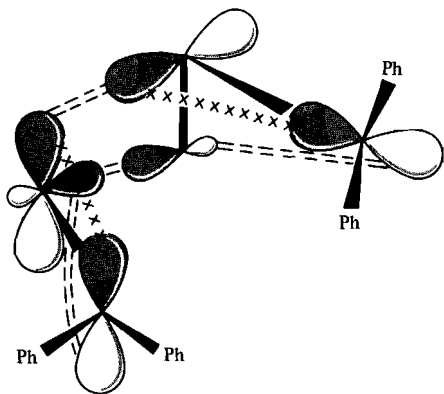
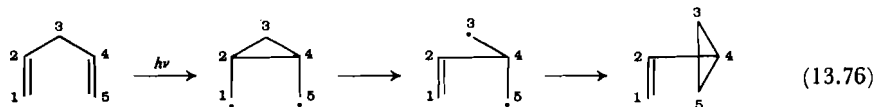

Figure 13.13 $\sigma 2a + \pi 2a + \pi 2a$ transition state for the di- π -methane rearrangement. \blacksquare + lobes in basis set; \square - lobes in basis set; === bonds forming; $\times \times \times$ bonds breaking. Reprinted with permission of H. E. Zimmerman and R. E. Little, *J. Amer. Chem. Soc.*, **94**, 8256 (1972). Copyright by the American Chemical Society.

chain is trans.^{108,109} Similarly, **77** and **89** give predominantly **78** and **80**, respectively.¹¹⁰

The stereospecificity indicates that rearrangement is concerted. Zimmerman has proposed that the mechanism is $\pi 2a + \pi 2a + \sigma 2a$ as shown in Figure 13.13.¹¹¹ This concerted mechanism is broken up into steps in Equation 13.76. At the transition state, bonding between C_5 and C_3 is minimal. This must be so because



of the extraordinary regioselectivity of the reaction.¹¹² Note, for example, that in Reactions 13.72–13.75 it is the phenyl-substituted double bond that always becomes part of the cyclopropane ring. This is readily understood if, at the transition state, there is substantial radical character at C_5 . Phenyl substituents can stabilize a radical better than alkyl substituents, and as a result the carbon bearing the phenyls becomes one of the cyclopropyl ring carbons.¹¹³

When C_3 is unsubstituted, the di- π -methane rearrangement may still take place but, because of the greater difficulty in breaking the C_2 – C_3 bond under these circumstances, a different stepwise mechanism involving hydrogen–radical shifts is followed.¹¹⁴

¹⁰⁸ H. E. Zimmerman and A. C. Pratt, *J. Amer. Chem. Soc.*, **92**, 6267 (1970).

¹⁰⁹ The reaction is also stereospecific (with inversion) at C_3 : H. E. Zimmerman, J. D. Robbins, R. D. McKelvey, C. J. Samuel, and L. R. Sousa, *J. Amer. Chem. Soc.*, **96**, 1974, 4630 (1974).

¹¹⁰ H. E. Zimmerman, P. Baeckstrom, T. Johnson, and D. W. Kurtz, *J. Amer. Chem. Soc.*, **94**, 5504 (1972); **96**, 1459 (1974).

¹¹¹ H. E. Zimmerman and R. D. Little, *J. Amer. Chem. Soc.*, **94**, 8256 (1972).

¹¹² See also H. E. Zimmerman and B. R. Cotter, *J. Amer. Chem. Soc.*, **96**, 7445 (1974).

¹¹³ See note 106, p. 725.

¹¹⁴ (a) See note 63(a), p. 711; (b) H. E. Zimmerman and J. A. Pincock, *J. Amer. Chem. Soc.*, **94**, 6208 (1972).

The photochemical rearrangements of cross-conjugated cyclohexadienones in general, and of 4,4-diphenylcyclohexadienone (**81**) in particular, have been intensively studied.¹¹⁵ When **81** is irradiated in dioxane-water, first 6,6-diphenylbicyclo[3.1.0]hex-3-one-2 (**82**) is obtained which, on further irradiation, forms **83**, **84**, and **85**. The primary photorearrangement product, **82**, can also be obtained by photosensitization of **81**, but not by irradiation of **81** in piperylene. Therefore **82** is formed from the lowest triplet of **81**. The subsequent rearrange-

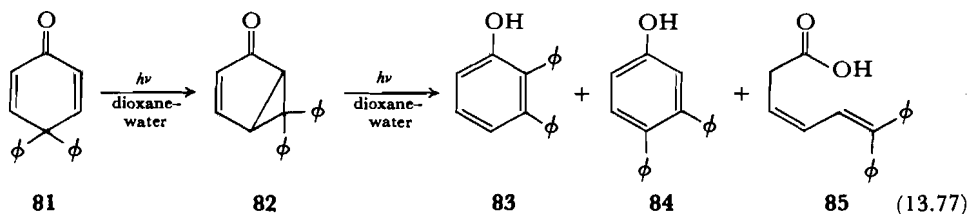

ments of **82** apparently proceed from two different excited states: Formation of the acid (**85**) cannot be entirely quenched by triplet quenchers, whereas formation of the phenols (**83** and **84**) can. Thus **85** is formed partly from S_1 , but **83** and **84** are formed from T_1 .

Zimmerman proposed the mechanisms in Schemes 8 and 9 to account for the rearrangements. The zwitterionic species **86** and **87** were postulated to

SCHEME 8

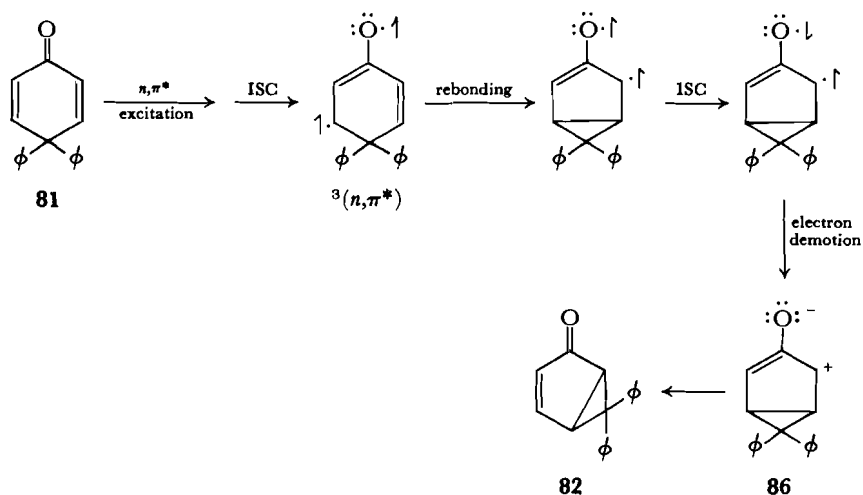

resolve an inconsistency. The rearrangements in the final steps of Scheme 8 and 9 are typical of migrations to electron-deficient carbon. However, n, π^* states usually have electron-rich π systems. Migratory aptitudes are also typical of those to carbocations. For example, although *p*-cyanophenyl is a better migrating

¹¹⁵ For reviews, see: (a) P. J. Kropp, in *Organic Photochemistry*, Vol. 1, O. L. Chapman, Ed., 1967, p. 1; (b) O. L. Chapman, in *Advances in Photochemistry*, Vol. 1, W. A. Noyes, G. S. Hammond, and J. N. Pitts, Jr., Eds., 1963, p. 183; (c) H. E. Zimmerman, in *Advances in Photochemistry*, Vol. 1, 1963, p. 183.

SCHEME 9

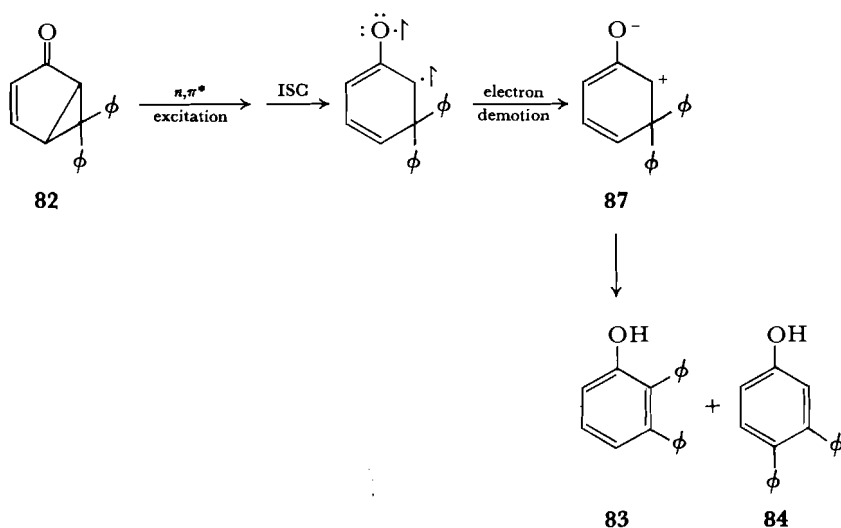

group than phenyl in n, π^* excited states, when **88** is irradiated, only phenyl migrates.

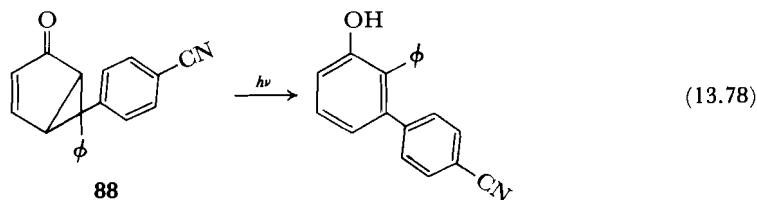

More recently, Zimmerman has independently synthesized the proposed zwitterions **86** and **87** by the attack of potassium *t*-butoxide on **89** and **90**, respectively. **82** is formed from the zwitterion **86** in 74 percent yield.¹¹⁶ Furthermore, **87** yields **83** and **84**, and although the ratio of **83** to **84** is solvent-dependent,

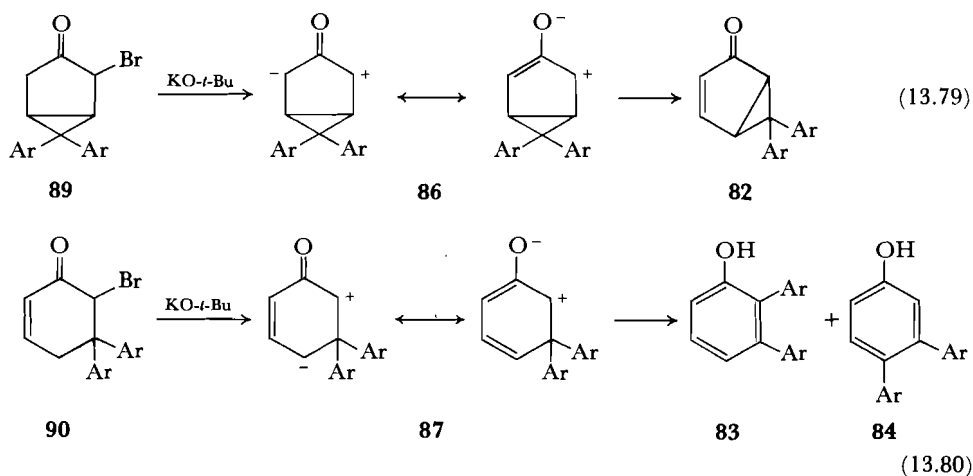

¹¹⁶ H. E. Zimmerman and D. S. Crumrine, *J. Amer. Chem. Soc.*, **90**, 5612 (1968).

it varies in precisely the same way as the ratio of **83** to **84** produced by photo-reaction in different solvents.¹¹⁷

PROBLEMS

1. What is the electronic nature of a doublet.
2. When a mixture of I_2 and O_2 is irradiated with light that only excites I_2 , an excited state of O_2 is produced by collisional energy transfer. What is that excited state likely to be?
3. Which will have the longer τ_p , naphthalene or idonaphthalene?
4. Free radicals readily quench phosphorescence. This phenomenon may be due to a variety of factors. Explain in terms of short-range collisional energy transfer.
5. Although **1a** undergoes the usual anthracene dimerization, **1b** does not. Explain.

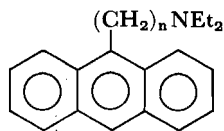

1

a $n = 1$

b $n = 3$

6. Predict the products that will be formed from Reaction 1. Do you expect the product ratio to depend on the sensitizer energy?

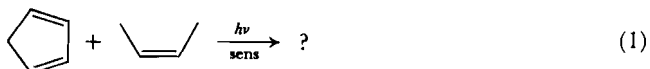

7. Predict the predominant product in the following reaction.

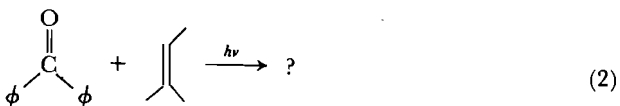

8. Explain why the quantum yield for Norrish Type II product is lower from **2** than from **3**.

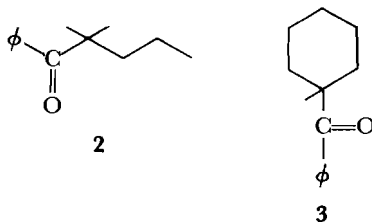

9. On irradiation, **4** gives **5** plus the usual Norrish Type II products. Explain.

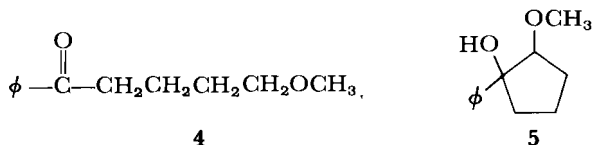

¹¹⁷ H. E. Zimmerman and G. A. Epling, *J. Amer. Chem. Soc.*, **94**, 7806 (1972).

10. What would be the product of the di- π -methane rearrangement of **6**?

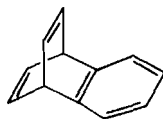

6

11. The quantum yield for dimerization of acenaphthalene (**7**) increases from 0.01 to 0.18 as the concentration of ethyl iodide is increased from 0 to 10 mole percent. Explain.

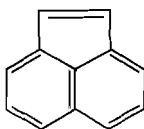

7

REFERENCES FOR PROBLEMS

2. J. Olmsted and G. Karal, *J. Amer. Chem. Soc.*, **94**, 3305 (1972).
3. D. S. McClure, *J. Chem. Phys.*, **17**, 905 (1949).
4. R. E. Schwerzel and R. A. Caldwell, *J. Amer. Chem. Soc.*, **95**, 1382 (1973).
5. D. R. G. Brimage and R. S. Davidson, *Chem. Commun.*, 1385 (1971).
6. B. D. Kramer and P. D. Bartlett, *J. Amer. Chem. Soc.*, **94**, 3934 (1972).
7. D. R. Arnold, R. L. Hinman, and A. H. Glick, *Tetrahedron Letts.*, 1425 (1964).
8. F. D. Lewis and R. W. Johnson, *J. Amer. Chem. Soc.*, **94**, 8914 (1972).
9. P. J. Wagner, P. A. Kelso, A. E. Kemppainen, and R. G. Zepp, *J. Amer. Chem. Soc.*, **94**, 7500 (1972).
10. H. E. Zimmerman, R. S. Givens, and R. M. Pagni, *J. Amer. Chem. Soc.*, **90**, 4191, 6096 (1968).
11. D. O. Cowan and J. C. Koziar, *J. Amer. Chem. Soc.*, **96**, 1229 (1974).

INDEX

Senior authors specifically named in the text are indexed, as are compounds and compound types specifically named.

Symbols: *fig.*, figure; *n.*, note; *pr.*, problem, followed by the problem number; *t.* table.

- A-1 and A-2 mechanisms, 428
Ad₂ mechanism, 340, 343, 345, 350
Ad₃ mechanism, 344, 345, 350
Ab initio molecular orbital theory, 10, 56
Aboderin, A. A., 310
Absorbance, 687
Absorption. *See* Light
Acetaldehyde
 hydration of, 406
 Paterno-Buchi reaction with, 713
Acetaldehyde hydrate, 69
Acetals and ketals, 424-431
Acetic acid, 137, 161
 ω -(4-Aceto-2,6-dinitro)-phenoxyaceto-phenone, 184
Acetone
 acid-base properties of, 126, 163
 enolization of, 453
 light absorption of, 687
 reaction with hydroxylamine, 434
 standard entropy of, 84
Acetophenone, pK_a , 163, 168 (*pr.* 1)
Acetophenones, 330
Acetyl peroxide, 489
Acidity. *See also* Acids and bases
 in different solvents, 137
 gas phase, of selected compounds, 154 *t.*
 intrinsic and practical, 155
 and molecular structure, 152-155
Acidity functions, 130-135
 H_- , 140
 H_R , 381
 H_0 , in acetal and ketal hydrolysis, 430
 and aromatic substitution, 381
 in ester hydrolysis, 446
 and Zucker-Hammett hypothesis, 430
 values of various, 135-136
Acids and bases. *See also* Carboxylic acids
 Brønsted, definitions, 124
 and Lewis, relation between, 164
 catalysis by, 405-416. *See also* General catalysis
 of aromatic substitution, 386, 389-390
 of Baeyer-Villiger oxidation, 331-332
 of Beckmann rearrangement, 319
 of Criegee rearrangement, 329
 of cyanohydrin formation, 418
 of eliminations, 360, 361

- Acids and bases.
 catalysis by,—*cont.*
 of ester hydrolysis, 446
 of hydration, 337–338, 340–341
 of hydrolysis of acid derivatives, 442
 concerted catalysis by, 426, 453
 conjugate, 125, 151
 dissociation of, equilibrium constants,
 126–128
 kinetic acidity, 143–144
 Lewis, 163–168
 as catalysts, 364–375, 379–383
 hard and soft, 165–168, 191, 374–375,
 553, 558
 strength, 126–128, 149–150 *t.*, 188–189 *t.*
 gas phase, 152–155
 and protonation rate, 408
 substituent effects, 149–163
 weak acids, 138–148
 weak bases, 129–138
- Acrylonitrile, 509, 712
- Activated complex. *See* Transition state
- Activation energy, 95
- Active methylene compounds, 454 *t.*, 456
- Activity coefficients, 132
- Acyl halides, 440, 441, 442
- Acylium ions, 234, 440
- Acyloin condensation, 460 (*pr.* 9)
- Adamantyl system
 cation, 271
 solvolysis, 229, 242–243, 265 (*pr.* 4), 266
 (*pr.* 13), 306
- Additions. *See also* Eliminations
 in acid derivatives, 440–443
 1,3-dipolar, 570, 640, 679 (*pr.* 4)
 electrophilic to multiple bonds, 337–355.
See also Halogenation; Hydration;
 Hydrohalogenation
 Markownikoff, 338, 345
 nucleophilic to alkenes, 377–379
 radical, 506–510, 522–523
 of water, *anti*-Markownikoff, 355
- Ahrland, S., 166
- Alcohols
 acidity, solution and gas phase, 152–153
 oxidation of, 420–421
- Aldehyde-ketone rearrangement, 335 (*pr.*
 16)
- Aldehydes. *See also* Carbonyl group
 addition to olefins, 507
 cyanide addition to, 417–418
 decarbonylation of, 467
 hydration of, 403–416
 photochemistry of, 717–723
 sulfite addition to, 418
- Alder, K., 636
- Alkenes. *See also* Additions; Eliminations
cis interactions in, 73
 halogenation of, 345–352
 hydration of, 337–340
 hydroboration of, 353–355
 hydrohalogenation of, 341–345
 photochemical reactions of, 708–714
 radical additions to, 506–510
 reaction with carbenes. *See* Carbenes
 reaction with ketenes, 634–636
 reaction with tetracyanoethylene, 633
 π , π^* transitions of, 685
 T_1 state of, 698
- Alkenium ion, 234
- Alkoxy radicals, 511, 512
- Alkyl substituents
 in bromination of alkenes, 350–351
 charge stabilization by, 154, 161, 227
 in E_2 elimination, 374–376
 in hydration, 338
 polar effect of, 153, 179–180, 229
- Alkynes, 341, 345, 352–353
- Allowed and forbidden reactions, 589
- Allyl acetate, 447
- Allyl system
 bonding in, 27–28, 54–55, 559–561
 cations, from cyclopropyl cations, 648
 sigmatropic rearrangements of, 662
 stability relative to cyclopropyl, 648
 structure of, 235
 and ion pairs, 216–217, 245
 radicals, 631
 solvolysis, 216, 245
 structure, 6
- Allylcarbinol, 295
- Allylcarbinyl tosylate, 293
- α . *See* Brønsted catalysis law
- α -effect, 210 (*pr.* 4)
- Amides, 322, 323, 440–442
- Amines. *See also* Deamination
 acidity of, 155
 addition of, to carbonyl, 432, 436–438
 and ammonium ions, thermochemistry,
 159–161
 catalysis, by, 442
 1-Amino-2-cyclohexylbutane, 284
 1-Amino-2,3-dimethyl-2-pentanol, 280
 1-Amino-2-methylbutanol-1, 283
 6-(Aminomethyl)-2-methyloctane, 284
 1-Amino-1-phenyl-2-*p*-tolyl-2-propanol, 282
 1-Aminopropane-1- ^{14}C , 310–311
 Ammonia, 9, 129, 155, 158
 Ammonium ion, 8, 161
- Anchimeric assistance, 244, 272
 in allylcarbinyl derivatives, 293–300
 in Beckmann rearrangement, 320
 in bicyclooctyl derivatives, 309–310
 in Criegee rearrangement, 328
 in cyclobutyl derivatives, 293–300
 in cyclopropylcarbinyl systems, 293–300

- in cyclopropyl tosylate, 648
 in homoallylic systems, 288–293
 intermediate formation during, 273
 in migrations to oxygen, 319
 in nonstrained compounds, 274
 in norbornyl systems, 300–309
 by oxygen, 332 (*pr.* 2)
 by phenyl, 275–280
 rate acceleration by, 273, 289, 294, 301–303, 305–306
 stereochemical requirements for, 273, 292, 297
 by sulfur, 332 (*pr.* 1)
- Andersen, K. K., 202
 Angstrom, 682
 Anhydrides, 440, 441
 Aniline, 126, 161–162, 398
 Anilines, substituted, 65, 131, 140, 161–162
 3-Anisyl-2-butyl tosylate, 241
 Annulenes, 28–40
 Antarafacial reaction, 571, 573
 Anthracene, 696–697, 689–690, 703, 704
 Antiaromaticity. *See* Aromaticity
 Anti-Hückel ring, 603
 Antimony pentafluoride. *See* Superacids
 Antisymmetrization, 51 *n.*
 Applequist, D. E., 144
 Arnett, E. M., 140, 159, 161, 163, 227
 Aromaticity, 28–40
 and pericyclic reactions, 602–606
 perturbation theory of, 562–566
 Aromatic substitution
 electrophilic, 379–395, 516
 nucleophilic, 395–398
 radical, 513–516
 Arrhenius equation, 94–95
 Atomic orbitals, 10–13, 51. *See also* Hybrid orbitals
 Autoxidation, 499–501
 Azide ion, 214, 215, 222, 243, 244
 Aziridines, 650
 Azoalkanes, 481–483, 484
 Azo-isobutyronitrile, 490
- Bachmann, W. E., 285
 Baeyer, A., 329
 Baeyer-Villiger oxidation, 329–332
 Baldwin, J. E., 668
 Banks, B. E. C., 453
 Bargon, J., 470
 Barltrop, J. A., 719
 Barrelene, 725
 Bartlett, P. D., 184, 228, 291, 470, 630, 634, 640, 714, 722
 Barton reaction, 520
 Bartsch, R. A., 368, 369
 Bases. *See also* Acids and bases
 in E_2 elimination, 365, 367
 weak, strengths of, 129–138
 Basicity. *See also* Acids and bases
 gas-phase, 162 *t.*
 and leaving-group activity, 192
 Basis functions, 17, 51, 539
 Beckmann rearrangement, 319–322
 Beer-Lambert law, 686–687
 Bell, R. P., 426, 453
 Bender, M. L., 441
 Benson, S. W., 71, 72, 83, 261, 473
 Benzaldehyde, 713
 Benzene
 acidity of, 148
 aromaticity of, 29, 34–35, 607
 complex with iodine, 387
 ESCA of, 307
 fluorescence of, 703
 formation from prismane, 615–616
 heat of hydrogenation, 5, 112 (*pr.* 7)
 hexachloro, dication, 38
 nitration of, 381, 393–395
 radical substitution of, 514
 resonance in, 5
 Benzenes, bromination of, 65
 Benzhydryl esters, isotope exchange, 220
 Benzhydryl system, 213–214, 216, 222
 Benzhydryltrimethylammonium hydroxide, 171
 Benzil, 317
 Benzoic acid rearrangement, 317–318
 Benzoic acids, dissociation of, 61
 Benzophenone, as photosensitizer, 695
 Benzophenone diethylketal, 431 *n.*
 Benzoyl peroxide, 478
 Benzoyl radical
 aromatic substitution by, 516
 fragmentation of, 478
 in propionyl benzoyl peroxide decomposition, 480
 Benzpinacol, 719
 Benzyl chloride, 189
 Benzylidene-*t*-butylamine, 435
 Benzyl radical, 486, 512
 Benzynes, 398
 Berson, J. A., 287, 632, 659, 665
- β
 Brønsted. *See* Bronsted catalysis law in molecular orbital theory, 53
 Bicyclobutonium ion, 294–296, 300
 Bicyclo[6.2.0]decene, 651
 Bicyclo[4.1.0]heptadiene system, 664. *See also* Norcaradiene
 Bicyclo[3.2.0]heptene system, 651, 652, 659
 5-Bicyclo[2.2.1]heptenyl halides. *See* 5-Norbornenyl halides
 Bicyclo[2.2.1]heptyl system. *See* Norbornyl
 Bicyclo[2.2.0]hexa-2,5-diene, 652
 Bicyclo[3.1.0]hex-3-en-2-yl cation, 662

- Bicyclo[4.3.0]nonadiene, 655
 Bicyclo[4.2.0]octadiene, 655
 Bicyclo[5.1.0]octa-2,5-diene, 672
 Bicyclo[2.2.2]octa-2,5,7-triene. *See* Barrelene
 Bicyclo[2.2.2]octylmethyl toluenesulfonate, 183
 Bicyclo[2.2.2]octyl system, 229, 309–310
 Biradicals, 714–717, 720–722
 1,3-biradicals, 660 *n.*
 in cycloaddition, 629
 in cyclopropane reactions, 628
 in Diels-Alder reaction, 638
 in sigmatropic rearrangements, 666
 Bisulfite, addition to carbonyl, 418–419
 Blue shift, 685
 Boltzmann distribution, 113–114, 118
 Bond dissociation energies, 152, 471–473
 Bond strength, 337, 471 *n.*
 Borane, 8
 Bordwell, F. G., 358, 413
 Born-Oppenheimer approximation, 50 *n.*
 Boron trimethyl, 69–70, 235
 Brauman, J. I., 154, 623, 650
 Bredt's rule, 8
 Bridgehead radicals, 484, 513
 Bridgehead reactivity, radical, 505
 Bridgehead solvolysis, 225, 228–229, 242–243
 Bridging, in radicals, 519. *See also* Carbocations
 Bromine. *See* Halogen; Halogenation;
 Halogen atoms; Halogen substituents
 N-Bromoamines, 322
 Bromobenzene, 398
 1-Bromo-2-chloroethane, 181–182
 Bromonium ion, 348–351
 Bromopropane, 181–182
 Bromostilbene, 370
p-Bromostilbene, 708
 Bromotrichloromethane, 507
 1-Bromotriptycene, 176
 Brønsted, J. N., 409
 Brønsted acids and bases. *See* Acids and bases
 Brønsted catalysis law, 141–143, 406
 α and β , anomalous values, 413
 in carbonyl additions, 415–416
 and MSAD scale, 145
 in mutarotation, 426
 and transition state location, 410–413
 variation with acid strength, 408
 and nucleophilic catalysis, 443
 Brosylate, definition, 223 *t.*
 Brown, H. C., 226, 277, 279, 304, 355, 368, 371, 392
 Bruice, T. C., 453
 Buffers, and general catalysis, 406
 Bullvalene, 672–673
 Bunnett, J. F., 397, 430, 446
 Bunton, C. A., 200
 Burwell, R. L., 144
 1,3-Butadiene
 bonding in, 28
 s-cis and *s*-trans, 716–717
 dimerization, 581, 643, 671, 716–717
 electrocyclic ring closure of, 581, 586–589, 621
 from electrocyclic ring opening, 650
 energy levels of, 41 (*pr.* 12)
 intramolecular photocycloaddition, 711
 molecular orbitals, theory of, 561
 π, π^* absorption in, 685
 reaction with ethylene, theory, 580–581, 594
 structure of, 7
 symmetry of, 578
 1-Butanol, dehydration of, 269
 2-Butene
 bromination of, 59, 347
 from E_1 reaction, 357
 hydration of, 338
 Paterno-Buchi reaction with, 713
 reaction with carbon atoms, 266 (*pr.* 9)
t-Butoxy radical, fragmentation, 512
t-Butyl acetate, hydrolysis, 449
 Butyl acrylate, copolymerization, 509
n-Butyl bromide, 178
s-Butyl cation, 312
t-Butyl cation, 235, 307
n-Butyl chloride, 184
t-Butyl chloride, solvolysis, 242–243
 4-*t*-Butylcyclohexene, bromination, 347
t-Butylethylene, 341–342, 344
t-Butyl hydroperoxide, 477
s-Butylmagnesium bromide, 205
s-Butylmercuric bromide, 205–207
t-Butyl perbenzoate, cage effect, 489
t-Butyl radical, 467, 487
 2-Butyl radical, thermochemistry, 475
t-Butyl solvolysis, elimination and substitution in, 216 *t.*
t-Butyl thiol, 505
erythro-3-*d*₁-2-Butyl tosylate, 357
 C-alkylation, of enolates, 454
 Cage effects, 471, 479, 489–490, 500
 Caldwell, R. A., 705
 Carbanions, 250–255. *See also* Michael condensation
 in aromatic substitution, 384 *n.*
 in E_1cB eliminations, 358–362
 rearrangements in, theory of, 566 (*pr.* 4)
 Carbenes, 256
 formation of, 256–258
 reactions of, 257 *t.*, 259–265, 627–628
 structure of, 258–259
 vinyl, as 1,3-dipoles, 640

- Carbenium ions. *See* carbocations
 Carbenoids, 257
 Carbinolamines, 432
 Carbocations, 233–238
 in acetals and ketals, 425, 431
 carbenium, 233, 288
 carbonium, 233, 237, 288–314
 carbynum, 236–237
 classical, 234, 288
 in ester hydrolysis, 444
 formation of, heat of reaction, 227
 homoallylic, 288–293
 hot, 282, 286
 and ion pairs, 216
 nonclassical, 234, 288
 primary, 269 *n.*
 rearrangements of, 268–316
 as sigmatropic reactions, 658
 theory, 566 (*pr.* 4)
 in S_N1 reaction, 215
 stabilization of, 227
 Carbon acids. *See* Acids and bases, strength,
 weak acids
 Carbonium ions. *See* Carbocations
 Carbon leaving groups, 254–255
 Carbon tetrachloride, 507
 Carbonyl group
 acetals and ketals, 424–432
 affinity of nucleophiles for, 423–424
 carboxylic acid derivatives, 439–449
 condensation reactions of, 454–455 *t.*,
 458–459 *t.*
 cyanide addition to, 416–417
 hydration, 403–411, 413–416
 and nitrogen nucleophiles, 432–439
 organometallic addition to, 419–420
 oxidation and reduction of, 420–421
 stereochemistry of addition, 421–423
 sulfite addition to, 418–419
 Carboxylic acids
 acidity, 6, 69, 156–158
 catalysis by, concerted, 427
 in carbonyl additions, 411
 derivatives of, 439–449
 Carbynum ions. *See* Carbocations
 β -Carotene, π, π^* absorption in, 685
 Catalysis, acid base. *See* Acids and bases
 Chain length, 492–493
 Chain reactions, 463, 490–495
 Chain transfer, 492, 506–507
 Chandross, E. A., 703, 706
 Charge transfer, 553–554
 Charman, H. B., 207
 Cheletropic reaction, 575, 627, 641–642
 Chemically-induced dynamic nuclear
 polarization. *See* CIDNP
 CH_5^+ ion, 207
 $C_3H_7^+$ ions, 312
 Chirality, 58
 in ion pairs, 217–218
 α -Chloracetone, 184
 α -Chloroacetonitrile, 184
 Chlorine. *See* Halogen; Halogenation;
 Halogen atoms; Halogen substituents
 p -Chlorobenzhydryl chloride, 218
 p -Chlorobenzyl chloride, 182
 1-Chloronaphthalene, 687
 Chloronium ion, 352
 3- β -Cholesteryl chloride, solvolysis, 288
 Chromic acid, 421
 CIDNP, 470–471, 527–537
 in azoalkane decomposition, 484
 in diacyl peroxide decomposition, 479
 in radical ion-alkyl halide reaction, 497
 in ylide rearrangements, 524
 Ciuffarin, E., 202
 Claisen rearrangement, 674
 Classical ions. *See* Carbocations
 Closed shell, definition, 32
 Closs, G. L., 471
 CNDO, 56, 298
 Collins, C. J., 288
 Common ion effect, 214, 215, 219, 221
 Complexes
 cation-base, 361, 371–372
 π , and σ , 386–389, 394–395
 Components, pericyclic, 599, 612
 Concerted catalysis, 426
 Concerted radical decomposition, 478,
 481–483
 Concerted reaction, definition, 568
 Configuration interaction, 621
 Conformation
 of dienes, 637, 715–716
 of radicals, 466
 Conjugate acids and bases. *See* Acids and
 bases
 Conjugation
 and S_N1 reaction, 227
 and S_N2 reaction, 184–185
 Conrotatory reaction, 572, 581
 Cope, A. C., 315, 655, 668
 Cope reaction, 668
 Cope rearrangement, 668, 672, 674
 Copolymerization, 508
 Correlation diagrams
 of cycloaddition, 589–596
 of electrocyclic reactions, 581–589
 of excited state reactions, 621
 Coupling, electron-nuclear
 and CIDNP, 471, 533
 and radical structure, 465
 Craig, D. P., 603
 Cram, D. J., 144, 199, 252, 254, 275, 421
 Cram's rules, 421
 Crawford, R. J., 482

- Criegee, R., 327, 329
 Criegee rearrangement, 327–329
 Crown ethers, 371, 372
 Cryoscopic measurements, 130, 234, 380–381
 Cumene, 148, 382
t-Cumyl chloride, solvolysis of, 65
 Curtius rearrangement, 335 (*pr.* 18)
 Cyanide, addition to carbonyl, 417–418
 Cyanohydrins, 111 (*pr.* 1), 417
 Cyclization, of radicals, 522
 Cycloaddition, 569
 examples, 626–645
 orbital correlation theory, 589–596
 photochemical, 710–717
 stereochemistry of, 570–571
 Cyclobutadiene, 30
 antiaromaticity of, 35, 607
 dimerization of, 678 (*pr.* 2)
 energy levels, 41 (*pr.* 12)
 tetramethyl, dication, 37
 tetraphenyl, dication, 37
 Cyclobutanes, methylene, 661
 Cyclobutanol, 295, 298
 Cyclobutene, electrocyclic reaction of, 572, 581, 586, 621, 623, 650, 652
 Cyclobutylamine, deamination, 293
 Cyclobutyl methanesulfonate, 298
cis-trans-Cyclodecadiene-1,3, 651
 Cyclodecyl cation, 316
 Cycloheptadiene-1,3, 651, 652
 Cycloheptatriene
 electrocyclic ring closure of, 654
 ions, 39, 40
 Cycloheptatrienone. *See* Tropone
 Cycloheptatrienyl radical, 647
 Cyclohexadiene, ring opening of, 572
 Cyclohexadienones, photochemistry, 727–729
 Cyclohexadienyl radicals, 514, 515
 Cyclohexane, acidity, 145
 Cyclohexanone, photochemistry, 718
 Cyclohexanone enol, 452
 Cyclohexanones, addition to, 422
 Cyclohexene, hydrochlorination, 342–344
 Cyclohexenone, photochemistry of, 712
 Cyclohexyl acetate, 342
 Cyclohexylamine
 acidity, 155
 as solvent, 129, 139
 2-Cyclohexylbutan-2-ol, 284
 Cyclohexyl chloride, 342
 Cyclohexyl tosylate, 365
 Cyclohexyl-2,6-*d*₂ tosylate, 313
 Cyclononatriene, 656
 1,5-Cyclooctadiene, 671
 Cyclooctan-*cis*-1,4-diol, 315
 Cyclooctatetraene, 31, 35–36
 dianion, 37–38
 tetramethyl, dianion, 38
 1,3,5-Cyclooctatriene, 655
 Cyclooctene, 315–316, 340
 5,6-*d*₂-Cyclooctene oxide, 315
 Cyclooctenols, 315
 Cyclopentadiene
 anion, 39, 40
 reaction with tropone, 643
 Cyclopentadienone, 39
 Cyclopentane, acidity, 145
 Cyclopentenone, photodimerization, 712
 Cyclopentenones, 641
 Cyclopropane
 bond angles, 169 (*pr.* 5)
 cyclopropylidene, 660
 protonated, 310–313
 from trimethylene diradicals, 679 (*pr.* 8)
 vinyl, rearrangements of, 660
 Cyclopropanes
 from carbenes, 261
 photochemistry, 628
 reaction with radicals, 501–502
 ring opening of, 647–650
 Cyclopropanone, 40, 629
 Cyclopropenes, ions 40
 Cyclopropenone, 40
 Cyclopropyl ions, 254, 648
 Cyclopropylcarbinol, 295, 298
 Cyclopropylcarbinyl amine, 293, 294
 Cyclopropylcarbinyl methanesulfonate, 298
 Cyclopropylcarbinyl system, 293–300
 Cyclopropyl chlorides, solvolysis, 235

 Dauben, W. G., 422
 Dawson, H. M., 453
 Deamination, 225–226
 in cyclopropylcarbinyl system, 293–294
 and memory effects, 287
 and protonated cyclopropanes, 310–311
 and semipinacol rearrangements, 280, 282–284, 286
 Debye-Hückel theory, 127, 132
 9-Decalylcarbinyl hypochlorite, 468 *t.*
 9-Decalyl radical, 468
 Decarbonylation, of aldehydes, 467
 Decarboxylation, 255
 2,4,6,8-Decatetraene, 656
 5-Decen-1-yl *p*-nitrobenzoate, 292
 Degenerate rearrangement, 668 *n.*
 Degenerate systems, distortion in, 38 *n.*
 Dehydration, 69, 269, 435
 Dehydroannulenes, 41 (*pr.* 6)
 Delocalization, 6, 27–31, 548
 Dempster, C. J., 703
 Denney, D. B., 327
 Depolymerization, 511
 Depovere, P., 286
 Deprotonation, heat of, 140

- Dessey, R. E., 144
 Dewar, M. J. S., 566, 598, 603, 606, 647
 Dewar benzene, 652
 Diamagnetism, 686
 Diastereomers, 58
 Diazo compounds, decomposition of, 258
 Diazomethane, photolysis, 259
 Diazonium ions
 in aromatic substitution, electrophilic, 383, 386, 389–390
 nucleophilic, 398
 pericyclic reactions of, 629
 Diazotization. *See* Deamination
 Dibenzofuran, as photosensitizer, 696
 Diborane, 353
 2,3-Dibromobutane, 59, 347
 1,2-Dibromo-1-phenylpropane, 348
 3,5-Di-*t*-butyl-*N,N*-dimethylaniline, 706
 Di-*s*-butylmercury, 205–207
 Dichloroacetone, hydration, 406
 1,2-Dichloroethene, 708–709
 Dichloromethylene, 256
 1,1-Dicyanoethene, 509
 Dideuterioethene, 634
 1,1-Dideuteriohexa-1,5-diene, 669
 Diebler, H., 436
 Dielectric constant, 84–85, 86–87 *t*.
 Diels, O., 636
 Diels-Alder reaction, 570, 636–640
 isotope effect on rate of, 110
 photochemical, 715–717
 1,3-Dienes, 636–638
 s-cis and *s*-trans forms, 637, 715–716
 photocycloadditions of, 714–717
 as quenchers, 704–705, 712, 718, 720
 1,5-Dienes, rearrangements of, 669
 Dienolate ions, 456
 Dienones, protonated, 652–653
 Dienophile, definition, 637
 Diethyl ether, basicity, 168 (*pr.* 1)
 Diffusion control
 of energy transfer, 696
 of proton transfer, 406, 408
 in radical reactions, 463, 486
 1,1-Difluoro-2,2-dichloroethylene, 630–632, 679 (*pr.* 5)
 Difluoromethylene, 259
 Dihedral angle, 270
 Dihydrophenanthrene, 724
 β -Diketones, enol content, 450
 Di- π -methane rearrangement, 725–726
 Dimethylallyl chloride, solvolysis, 220
N,N-Dimethylaniline, exciplex of, 706
 1,2-Dimethylbenzene, 73
 2,3-Dimethylbutane, 72
 2,3-Dimethyl-1-butene, 73
 2,3-Dimethyl-2-butene, 340
 2,3-Dimethyl-1-chlorocyclopropanes, 647
 5,6-Dimethylcyclohexa-1,3-diene, 653, 656
 1,4-Dimethylcyclohexane, 74
cis-2,3-Dimethylcyclohexanone, 719
 1,2-Dimethylcyclohexene, 345
 4,4-Dimethylcyclopropylcarbonyl cation, 300
 Dimethylformamide, 190
 7,7-Dimethylnorbornyl-1-*p*-toluenesulfonate, 176
 2,6-Dimethyloctan-6-ol, 284
 2,4-Dimethylpiperylene, 705
 Dimethylsulfoxide
 acid-base reactions in, 129, 140
 carbanion reactions in, 252–253
 dipolar properties, 86
 heat of deprotonation in, 140
 S_N2 reactions in, 191
 Dimroth, K., 233
 4,4'-Dinitrobenzophenone, pK_a , 168 (*pr.* 1)
 7,5-Dinitro-3-coumaranone, 184
 Diphenylamine, basicity, 161–162
 1,1-Diphenyl-2-amino-1-propanol, 282
 4,4-Diphenylcyclohexadienone, 727–729
 1,2-Diphenylpropene, T_1 state of, 699
 1,3-Dipolar additions. *See* Additions
 Dipole moment, 85–86, 86–87 *t*.
 Disproportionation of radicals, 485, 488
 Disrotatory reaction, 298, 572, 581
 Dissociation, acid-base *See* Acids and Bases
cis-Divinylcyclobutane, 643, 671
 1,2 Divinylcyclopropane, 671
 DMF. *See* Dimethylformamide
 D_3O^+ , acidity of, 112 (*pr.* 11)
 Doering, W. v. E., 259, 330, 669, 671, 672, 673
 Donor-acceptor interactions. *See* Acids and bases, Lewis
 Dvoretzky, I., 259
 E_s , steric substituent constant, 67, 68 *t*., 70
 E_1 mechanism, 355–358, 363, 364
 E_1cB mechanism, 355, 358–362, 364, 373
 E_2 mechanism, 356, 362–377
 E_2C and E_2H mechanisms, 364–376
 Eaton, P. E., 712
 Edwards, J. O., 190, 191
 Edwards equation, 191
 Eigen, M., 406, 408
 Einstein, 682
 Electrocyclic reaction
 definition, 571
 examples, 645–657
 orbital correlation theory, 581–589
 Electromagnetic spectrum, 682
 Electron density, definition, 12
 Electron paramagnetic resonance
 of carbenes, 258
 of radicals and radical ions, 464–467
 Electron spin resonance. *See* Electron

- Electron spin resonance.—*cont.*
 paramagnetic resonance
- Electronegativity
 and acid strength, 151
 of hybrid orbitals, 25
 of selected elements, 151 *t.*
- Electronic energy, 117, 682
- Electronic state. *See* State, electronic
- Electrophilic aliphatic substitution. *See*
 S_N1 reaction; S_N2 reaction; S_N2
 reaction
- Electrophilic catalysis, 443
- Element effect, 396
- Eliel, E. L., 423
- Eliminations. *See also* Additions
 alpha, 257
 in carbonyl reactions, 424–432
 1,2, 355–377
 competition with substitution, 216, 375
 in dipolar aprotic solvents, 89
 in radicals, 510–513
 [2,3]-sigmatropic, 668
- Enamines, 434, 456
- Enantiomers, 57
- Endo principle, in Diels-Alder, 638–639
- Ene reaction, 675
- Enolate ions, 449–458
- Enolization, in carbonyl additions of
 organometallics, 419–420
- Enols and enolate ions, 254, 449–458
- Enophile, 675
- Enthalpy. *See* Heat
- Entropy
 of activation, 100
 standard, 71, 75–84 *t.*
 units, 101 *t.*
- EPR. *See* Electron paramagnetic resonance
- Equilibrium constant, 114, 115
- ESCA. *See* X-Ray photoelectron
 spectroscopy
- ESR. *See* Electron paramagnetic resonance
- Esters, 440
 hydrolysis of, 67, 68, 443–449
 oxygen isotope exchange in, 219–220, 441
 pyrolysis of, 376–377
- Ethane, heat of formation of, 72
- Ethylbenzene, nitration of, 381
- Ethylene
 basicity of, 163
 bonding in, 25–27, 559
 dimerization, theory, 591
 π, π^* absorption in, 685
 reaction with butadiene, theory, 580–581,
 594
 T_1 state of, 699
- Ethyl iodide, S_N2 reaction of, 178
- Ethyl radical, recombination rate, 487
- Ethyl trifluoroacetate, 446
- Evans, M. G., 603
- Exchange, isotopic. *See* Isotope exchange
- Excimer, 701–704
- Exciplex, 704–706, 713, 718
- Excited state. *See* State, electronic
- Extended Hückel method, 56
- External ion pair, 221
- External return, 221
- Extinction coefficient, 686–687
- Eyring, H., 100
- Eyring equation, 100
- Fahey, R. C., 343, 345
- Favorskii rearrangement, 460 (*pr.* 11)
- Field effect, 179 *n.*
- Fischer, H., 470
- Flash photolysis, 464, 692
- Fluorobenzene, 398
- Fluoromethylene, 259
- Fluoronium ion, 352
- Fluorosulfuric acid, 138. *See also* Superacids
- Forbidden reaction, definition, 589
- Force constants, 105–111, 122
- Formal charge, 3
- Formaldehyde hydration, 406
- Formic acid, isotope effect, 112 (*pr.* 12)
- Förster, Th., 701
- $4n + 2$ rule. *See* Hückel
- Fragmentation. *See* Elimination
- Franck-Condon principle. *See* Transition,
 electronic
- Free energy, 61–62, 71
 of activation, definition, 100
 and Brønsted catalysis law, 141, 142
 and partition function, 115
- Free radicals. *See* Radicals
- Freezing point depression. *See* Cryoscopic
 measurements
- Friedel-Crafts reaction, 382–383
- Frontier orbitals. *See* HOMO-LUMO
 interactions
- Fukui, K., 580
- Fulvalenes, 644
- g*-Factor, 480, 529
- Galvinoxyl, 478, 490
- Gas-phase acidity, 152–155
- Gassman, P. G., 292, 324, 325
- Gauche interactions, 72, 73
- Geminate recombination. *See* Cage effects

- General catalysis, 405–416. *See also* Acids and bases
 in acetal and ketal reactions, 425, 431
 of amine addition to carbonyl, 438
 of carbinolamine dehydration, 435
 of eliminations, 361
 of enolization, 451
 of hydration, 340
 of hydrolysis, 442, 446
 of mutarotation, 426
 of thiol addition to carbonyl, 431
- Geneste, P., 423
- Geometry, molecular, 8
- Gleicher, G. J., 505
- Glucose, 425
- Goering, H. L., 219, 220, 310
- Goldstein, M. J., 479, 562, 566, 610, 671
- Greene, F. D., 468
- Grignard reagents, 252
- Ground state. *See* State, electronic
- Group transfer reactions, 575
- Grunwald, E., 232
- Grunwald-Winstein Y scale, 90, 232–233, 243, 245
- H_A . *See* Acidity functions
- H_C . *See* Acidity functions
- H_I . *See* Acidity functions
- H_{-} . *See* Acidity functions
- H_O . *See* Acidity functions, Hammett
- H^* . *See* Acidity functions
- H_R . *See* Acidity functions
- Haberfeld, P., 685
- Halide ions, as Lewis bases, 165
- Halides
 bond dissociation energies of, 473 *t.*
 photolysis of, 485
 reaction with organometallics, 496
 reaction with radical ions, 496
 solvolysis rates, 226 *t.*
- Haloforms, α -elimination in, 256–257
- Halogen, rearrangement of, 519
- Halogenation
 of alkenes, 59, 345–352
 of alkynes, 352–353
 of aromatics, 65–66, 379–380, 389
 radicals, 498–499, 525 (*pr.* 5)
- Halogen atoms, 502–506
- Halogen substituents
 effect on S_N1 rates, 227
 stabilization of radical by, 630
- α -Halosulfone rearrangement, 460 (*pr.* 11)
- Hamiltonian, 50–51, 52
- Hammett, L. P., 60, 130, 217
- Hammett acidity function. *See* Acidity functions
- Hammett equation, 62. *See also* ρ ; σ
 in acetal and ketal hydrolysis, 430
 in additions of ketenes to olefins, 635
 in additions to multiple bonds, 338, 341, 351
 in Baeyer-Villiger oxidation, 331
 in Beckman rearrangement, 320–321
 in Criegee rearrangement, 329
 in eliminations, 362
 and polar effect in radicals, 506
 in radical reactions, peresters, 483
 in solvolysis, 229, 279, 292
- Hammett indicators. *See* Acidity functions, Hammett
- Hammond, G. S., 103, 707, 715
- Hammond postulate, 102–103
 and acid-base catalysis, 408
 and Brønsted catalysis law, 143
 and cation selectivity, 231
 and elimination, 358
 and proton transfer, 411
 and reacting bond rules, 246
 and solvolysis mechanisms, 225, 226
- Hard-soft acid base theory. *See* Acids and bases, Lewis
- Hartree-Fock, 51
- Hassner, A., 323
- Heat
 of activation, 100
 of formation, standard, 71–84
 of radicals, 471–475
 of protonation, 138, 161
 of reaction, 71
- Heavy atom effect, 325–326, 687
- Heilbronner, E., 604
- Hemiacetals and hemiketals, 424
- Hemithioacetals and hemithioketals, 431
- Herzberg, G., 258, 464
- 2,4-Hexadiene, 631–632
- 1,5-Hexadienes, rearrangements of, 668
- Hexafluoro-2-propanol, 243
- Hexamethyl Dewar benzene, 652
- Hexatriene, electrocyclic reactions, 589
- 1-Hexene, hydroboration of, 353
- 3-Hexene, from E_2 elimination, 372
- 3-*n*-Hexyltrimethylammonium iodide, 372–373
- 3-Hexyne, hydrochlorination of, 345
- Hine, J., 256, 317
- Hoffmann, H. M. R., 223
- Hoffmann, R., 261, 559, 562, 566, 610, 628, 654. *See also* Woodward, R. B., and Hoffmann, R.
- Hofmann, A. W., 322
- Hofmann degradation. *See* Hofmann rearrangement
- Hofmann elimination, 357–358
- Hofmann-Löffler reaction, 522
- Hofmann rearrangement, 322–323
- Holtz, H. O., 183

- Homoaromaticity, 34
HOMO-LUMO interactions. *See also*
 Perturbation theory
 in aromatic systems, 564
 in Diels-Alder reaction, 639
 in pericyclic reactions, 579
 theory of, 552-559
Homolysis, thermal, 476
HSAB. *See* Acids and bases, Lewis, hard and soft
Hückel, E., 31
Hückel $4n + 2$ rule, 31-33
Hückel π electron theory, 10, 27, 53-55
Hückel ring, 604
Hughes, E. D., 171, 174, 178, 207, 214
Huisgen, R., 286, 570, 626, 640, 655
Hunter, D. H., 361
Hybrid orbitals, 20-27
 construction of, 43-49
 overlap between, 547
Hybridization
 and acidity of carbon acids, 155-156
 change of, isotope effect and, 110
 in ethylene, 25-26
 index, 46, 48
 in methane, 20
 in radicals, 467
Hydration
 of aldehydes and ketones, 403-416
 of alkenes and alkynes, 337-341
 of C=N, 435
Hydrazones, 433
Hydride, addition of, to carbonyl, 420
Hydride shift. *See* Hydrogen, rearrangement of
Hydrides of the elements
 acid-base properties, 151-152, 158-159
 bond dissociation energies, 152 *t.*
Hydroboration, of alkenes, 353-355
Hydrobromination, 345, 507
Hydrocarbons, acidities of, 146-147 *t.*
Hydrochlorination, 341-345, 507
Hydrofluoric acid, 234-235
Hydrogen, rearrangement of
 in carbocations, 270-275, 304, 310-316
 in radicals, 520-522
 sigmatropic, 664, 665
Hydrogen abstraction, 497-506
Hydrogen azide, 323
Hydrogen bonding, 88-89, 161, 407, 450
Hydrogen cyanide, 417
Hydrogen fluoride, 554
Hydrogen iodide, acidity, 152
Hydrogen molecule, 15, 542
Hydrogen sulfide, 431
 α -Hydroxy acid, 417

p-Hydroxybenzaldehyde, 331
Hydroxylamine, 434, 437
Hyperconjugation
 in carbocations, 229, 273, 551
 in radicals, 466
Hypohalites, decomposition of, 485, 492
Imines, 432, 435, 439
INDO, 56
Induced common ion effect, 221, 222
Induced decomposition, 477
Inductive effects. *See* Polar effects
Infrared spectroscopy, of cations, 235
Ingold, C. K., 171, 172, 178, 207, 214, 317, 443
Inhibition, 493, 501
Initiation, 463, 476, 498
Insertion of carbenes, 259-261
Interaction diagrams, 598-606, 613, 616-617
Interactions of molecules. *See* HOMO-LUMO interactions
Internal assistance to ionization. *See* Anchimeric assistance
Internal conversion. *See* Radiationless transitions
Internal return, 221
Intersystem crossing, 690-691
Intimate ion pair, 221
Iodine. *See* Halogen; Halogenation; Halogen atoms; Halogen substituents
1-Iodonaphthalene, light absorption, 687
Iodonium ion, 352
Ion pairs, 216-222
 and acid-base dissociation, 139
 in deamination, 226
 in eliminations, 356-357, 360
 in hydrochlorination, 341
 with phenonium ion, 276
 in S_N2 reaction, 173 *n.*
 in solvolysis, 239, 244-245, 250, 266-267 (*pr.* 15), 304
Ionic bonding, in Lewis complexes, 168
Ionization, isotope effect on, 110
Ionizing power, of solvents, 243
Ipso position, 379
Isobutene, hydration of, 338
Isomerization of alkenes
 photochemical, 708-710
 radical, 511
Isopropyl radical, 487
Isopropyl solvolysis, 243, 265 (*pr.* 4)
Isotope effects, 105-111, 120-123
 in aromatic substitution, 385, 386, 389-390
 in azoalkane decomposition, 482
 in Baeyer-Villiger oxidation, 330, 332
 in benzyne reactions, 398
 in E_2 reaction, 362, 364
 in E_2C reaction, 365
 in hydride migration, 315

- in hydrochlorination, 342
- in ketene addition to alkenes, 635
- in proton transfer, 413
- in radical substitution, 505, 514
- in S_N1 reactions, 230
- in S_N2 reactions, 210 (*pr.* 3)
- in sigmatropic hydrogen migrations, 664
- solvent, 339, 430
- Isotope exchange
 - hydrogen, 451. *See also* Acids and bases; Kinetic acidity
 - oxygen, in acid derivatives, 441
 - in carbonyl hydration, 404
 - in S_N1 reactions, 218–219
- Isotope labeling
 - in additions to alkenes, 338–339, 341, 343, 352
 - in benzyne reactions, 398
 - in carbocation rearrangements, 282, 293–295, 298, 304, 310–312, 315
 - in Norrish Type II reaction, 721–722
 - in peroxide decomposition, 478
 - in rearrangements to oxygen, 317, 321–322, 327, 330
- Jablonski diagram, 687–688
- Jena, A., 317
- Jencks, W. P., 246, 434
- Jensen, F. R., 208
- Kaptein, R., 471
- Ketals. *See* Acetals and Ketals
- Ketenes, reactions with alkenes, 634–636
- Keto tautomer. *See* Enols and enolate ions
- β -Ketoesters, enol content, 450
- Ketones. *See also* Carbonyl group
 - acid-base properties of, 138
 - cyanide addition to, 417–418
 - enol content of, 450
 - halogenation of, 451
 - hydration of, 403–416
 - intersystem crossing of, 691
 - isotope exchange in, 451
 - light absorption of, 685
 - photochemical reactions of, 485, 717–723
 - racemization of, 451
 - sulfite addition to, 418
- Kice, J. L., 201
- Kinetic acidity. *See* Acids and bases
- Kinetic chain, 492–493
- Kinetics, 90–94
- Kirmse, W., 275, 280
- Klopman, G., 558
- Koch, V. R., 505
- Koelch radical, 490
- Kosower, E. M., 233
- Kosower, Z scale, 90, 233
- Kresge, A. J., 340
- Lactic acid, 57–58
- Lamaty, G., 423
- Langford, C. H., 144
- Lapworth, A., 417
- Lasers, 690, 692
- Lawler, R. G., 470
- LCAO, 13, 51–52
- Leaving groups
 - in E_2 reactions, 364, 367–369, 374–375
 - in S_NAr reactions, 396–397
 - in S_N1 reactions, 223–226
 - in S_N2 reactions, 192–194
 - solvent effect on activity of, 193–194
- Leffler-Grunwald operator, 104 *n.*
- Leveling effect, 128–129
- Lewis, G. N., 163
- Lewis acids and bases. *See* Acids and bases
- Lewis structures, 2–9
- Liebig, J., 317
- Light absorption, 681–686, 692
- Limiting unimolecular mechanism, 215
- Linear combination of atomic orbitals. *See* LCAO
- Linear free energy relationships, 60–71
 - in aromatic substitution, 392–393
 - Brønsted catalysis law, 143
 - nucleophilicity scales, 186, 188
- Linear path, of cycloaddition, 628
- Lithium aluminum hydride, 420
- Lithium perchlorate, 221
- Local symmetry, 596–598
- Longuet-Higgins, H. C., 617
- Lossen rearrangement, 335 (*pr.* 17)
- LUMO. *See* HOMO-LUMO interactions
- Lysozyme, 431
- McConnell relation, 465
- McDonald, R. J., 705
- McEwen, W. K., 138, 145
- Majerski, Z., 298
- Maleic anhydride, copolymerization, 510
- Mallory, F. B., 724
- Mechanism, nature of, 174
- Meerwein-Ponndorf-Verley reduction, 420–421
- Meisenheimer, J., 396
- Meisenheimer complexes, 396–397
- Melander, L., 385
- Memory effects, 287–288
- Mercury exchange reactions, 204–209
- Merritt, R. F., 352
- Meso molecule, 58
- Methane, 8, 20, 152, 163
- Methanol, 253
- 1-Methoxycyclohexane, 452
- p*-Methoxyphenyl acetate, 449
- Methyl anion, 251
- Methyl azide, 9

- Methyl bromide, 186
 1-Methylbutadiene, symmetry of, 579
 2-Methylbutanal, 275, 283
 (S)-2-Methylbutan-1,2-diol, 275
 2-Methylbutene-1, 339
 2-Methylbutene-2, 353
bis-3-Methyl-2-butylborane, 353
 Methyl *t*-butyl ketone, 718
 Methyl cation, 8, 544, 548–551
 1-Methylcyclobutyl cation, 300
 2-Methylcyclohexanone, 457 (*pr.* 1)
trans-2-Methylcyclopentanol, 355
 2-Methylcyclopentanone, 455
 1-Methyl-2,2-diphenylethyl triflate, 269
 Methylene, 258–259, 624 (*pr.* 7)
 Methyl ethyl ketone, photochemistry, 719
 3-Methylhexa-1,5-diene, 669
 5-Methyl-2-hexanone, photochemistry, 720
 threo-4-Methyl-2-hexanone-5-*d*₁, 722
 Methyl iodide, 190
 Methyl nitrite, 395
 2-Methylnorbornyl cation, ESCA of, 308
 4-Methyl-1-phenyl-1-hexanone, 720–721
 Methyl radical, 464, 486
 Methyl substitution, in solvolysis, 226
 Methyl tosylate, solvolysis, 245
 Michael condensation, 378
 Microscopic reversibility, 92, 208 *n.*
 Migration. *See* Rearrangements
 Migratory aptitude, 284
 Millimicron, 682
 MINDO, 56
 Mislow, K., 198
 Möbius. *See* Anti-Hückel
 Mode, of π chains, 564, 565 *t.*
 Molecular orbitals, 9–20
 degenerate, 32
 interactions of, 539–541, 545, 548, 553
 localized and delocalized, 548
 nonbonding, 28, 606
 π , 19, 27–31, 561
 reacting, 576–579
 σ , 19
 symmetric and antisymmetric, 544, 546, 575
 symmetry, correct, 544–548
 theory, 50–56
 of CH_5^+ , 207
 of C_3H_7^+ , 312
 of cyclopropylcarbinyl cation, 300
 and radical aromatic substitution, 516 *n.*
 of radical rearrangements, 517
 Molecularity, definition, 91
 Molecules, geometry of. *See* Geometry
 Monomer, 492
 More O'Ferrall, R. A., 246
 MSAD acidity scale, 144–148
 Multiplet effect, CIDNP, 533
 Multiplicity, electronic, 686, 693
 Mustard cation, 189
 Mutarotation, 425–426

n. *See* Nucleophilic constants
*n*_{CH₃T}. *See* Nucleophilic constants
*n*_{PT}. *See* Nucleophilic constants
 Nanometer, 682
 Naphthalene
 fluorescence of, 703
 phosphorescence of, 695, 696
 photoadduct of, 705
 radical ion of, 496
 Neighboring group participation. *See*
 Anchimeric assistance
 Neopentane, ESCA of, 307
 Neopentyl iodide, 269
 Net effect, CIDNP, 532
 Nitration, of aromatics, 380–381, 393–395
 Nitrenes, 256, 627
 Nitrenium ion, 324–326
 Nitrile oxide, as 1,3-dipole, 570, 640
 Nitro group, as 1,3-dipole, 570
 Nitrogen bases, 158–162
 Nitron, as 1,3-dipole, 640
 Nitronium ion, 381, 393–395
p-Nitrophenol, anion of, 64
 Node, 12
 Nonclassical carbonium ions. *See* Carbo-
 cations
 Noncrossing rule, 584, 621
 Nonlinear path, of cycloaddition, 628
 Nonvertical energy transfer. *See* Photo-
 sensitization
 Norbornadien-7-one, 641
 Norbornene, 371
 Norbornenium ion, 303, 307
 Norbornenyl-7-carbinyl amines, 287
 5-Norbornenyl halides, 290
anti-7-Norbornenyl tosylate, 291
 Norbornonium ion, 300–309
 2-Norbornyl arenesulfonates, 237, 301–
 309
 Norbornyl cation. *See* Norbornenium ion;
 Norbornonium ion
 2-Norbornyl fluoride, 307
 Norcaradiene, 654. *See also* Bicyclo[4.1.0]
 heptadiene
 Nordlander, J. E., 306
 Normalization, 43, 51
 Normal modes of vibration, 96, 120–123
 Norrish Type I and Type II reactions,
 717–723
 Noyce, D. S., 341
 Nuclear magnetic resonance
 of carbocations, 70, 227, 235, 236, 299, 308,
 312, 351, 387–388

- and cycloheptatriene-norcaradiene inter-conversion, 654
- of ethylfluoride—boron trifluoride complex, 387
- of radical reaction products. *See* CIDNP in sigmatropic rearrangement, 672
- Nucleophiles, 170
 - affinity of, for carbonyl, 423–424
 - ambident, 211 (*pr.* 8)
 - intramolecular, 271
 - nitrogen addition to carbonyl, 432–439
 - selectivity of cations toward, 230–232
- Nucleophilic catalysis, 439, 442, 446
- Nucleophilic constants
 - n , 186 *t.*
 - $n_{\text{CH}_3\text{I}}$, 187–188 *t.*, 188–189
 - n_{Pt} , 187–188 *t.*, 191
- Nucleophilic substitution, and reacting bond rules, 246–250. *See also* $\text{S}_{\text{N}}1$; $\text{S}_{\text{N}}2$
- Nucleophilicity
 - in $\text{S}_{\text{N}}\text{Ar}$ reaction, 396
 - $\text{S}_{\text{N}}2$ reaction, 185–192
 - of solvents, 243, 245
- O-alkylation, of enolates, 454
- Octatrienes, 653, 656
- s*-Octyl iodide, 174
- 2-Octyl methanesulfonate, 244
- Ogata, Y., 332
- Olah, G. A., 209, 235, 288, 308, 351, 394–395
- O'Neal, H. E., 473
- Oesterhoff, L. J., 471, 575 *n.*, 611, 615
- Open shell, 33
- Oppenauer oxidation, 421
- Orbitals
 - approximation, 51
 - atomic. *See* Atomic orbital
 - hybrid. *See* Hybrid orbital
 - interaction energy of, 16
 - molecular. *See* Molecular orbital
 - overlap, 17
 - π . *See* Molecular orbitals
 - σ . *See* Molecular orbitals
- Order, kinetic, 91
- Organomercurials, 204–209, 252
- Organometallic compounds
 - in acidity measurements, 138, 144
 - addition to carbonyl, 419–420
 - and carbanions, 252
 - carbenoids, 257
 - reaction with alkyl halides, 496
- Ortho effect, 61 *n.*, 392
- Orthogonality, 43
- Oth, J. F. M., 616
- Overlap, in perturbation theory, 540
- Overlap integral, 52
- Oxetanes, 713
- Oxidation
 - of alcohols, 420–421
 - Baeyer-Villiger, 329–332
 - peroxyformic acid, of alkenes, 315
 - in radical aromatic substitution, 514
- Oximes, 433. *See also* Beckmann rearrangement
- Oxygen bases, 161–163
- Ozone, as 1,3-dipole, 570
- Ozonolysis, 640 *n.*
- Paramagnetism, 686
- Parker, A. J., 364
- Partial rate factor, 392–393
- Partition functions, 114–117, 121
- Partitioning effect, 385
- Paterno-Buchi reaction, 713
- Pearson, R. G., 144, 166, 190, 191, 559
- Pentadienyl system
 - anion, 652, 665
 - bonding in, 28
 - cation, 652
 - energy levels, 41 (*pr.* 12)
- Perbenzoic acid, 331
- Pericyclic reactions
 - aromaticity theory of, 602–606
 - cycloaddition, examples, 626–644
 - in cyclobutyl solvolysis, 298–299
 - definitions, 569–575
 - electrocyclic, examples, 645–656
 - excited state, 617–622
 - forbidden, energy barriers in, 622–623, 650
 - non-simply connected, 615–617
 - orbital correlation theory of, 581–596, 617–622
 - perturbation theory of, 579–581
 - in photochemical reactions, 714–715, 724, 726
 - selection rules, 602, 605
 - sigmatropic, examples, 657–676
 - simply connected, 611
 - symmetry and, 575–579
- Periplanar, syn and anti, 270
- Peroxides
 - concerted decomposition of, 478
 - heterolytic reactions of, 319, 329
 - photochemical decomposition of, 484–485
 - rearrangements of, 476–477, 479
- Peroxy radicals, 488
- Peroxyesters. *See also* Criegee rearrangement
 - decomposition of, 319
 - concerted, 480 *n.*
- Peroxyformic acid, 315–316
- Perrin, C. L., 379
- Perturbation theory, 538–541. *See also* HOMO-LUMO interactions
 - of aromatic transition states, 606–610

- Perturbation theory,—*cont.*
 and noncrossing rule, 585, 621
 in pericyclic reactions, 579–581
 of π systems, 559–566
- Phase inversion, 604, 612
- Phenols, 65, 161–162, 450–451, 501
- Phenonium ion, 275–280
- Phenoxy radicals, 487–488
- Phenyl acetate, 449
- Phenylacetic acids, dissociation, 61–63
- Phenyl benzoate, 330
- 3-Phenyl-2-butyl tosylate, 275–280
- 1-Phenylcyclobutyl cation, 299
- Phenyl ethers, 674
- β -Phenylethyl radical, 518
- 1-Phenylethyl system, 176, 220, 245
- 9-Phenylfluorene, 139, 144, 148 *n.*
- Phenyl group, rearrangement, in radicals, 517–518, 519–520
- Phenyl 1-phenylethyl ketone, 270
- Phenylpropene, halogenation of, 348, 352
- 3-Phenylpropionaldehyde, 518
- Phenylpropionic acids, 63
- α -Phenylpropiophenone, 282
- 1-Phenylpropyne, hydrochlorination, 345
- Phenyl radicals, 505, 515
- Phenyl substitution, in solvolysis, 226 *t.*
- Phosphorescence, 691–692, 697
- Phosphorus bases, 158–159
- Photochemical homolysis, 484–485
- Photosensitization, 693–706, 708, 716–717
- Photostationary state, 709–710
- π -Complex. *See* Complexes
- π -Orbitals. *See* Molecular orbitals
- π -Route, 334 (*pr.* 9, 10)
- Pinacol, 268, 274
- Pinacol rearrangement, 269, 274, 275, 285
- Pinacolone, 274
- Pincock, J. A., 353
- Piperazine, 436
- pK_a , definition, 128 *n.*
- Polar effects
 in additions to carbonyl, 403, 417, 418, 438
 of alkyl groups, 153, 179–180, 229
 in aromatic substitution, 390
 in hydroboration of alkenes, 354
 inductive and field, 179 *n.*
 in radicals, 483, 503, 505, 510, 516
 in S_N1 reaction, 227
 in S_N2 reaction, 181–184
- Polarizability, 86–87 *t.*, 88
- Polarization, magnetic, 531
- Polymerization, 507–510
 and chain transfer, 506–507
 kinetics and mechanism of, 491–494
- Pople, J. A., 312
- Potential energy and internuclear distance, 683–684
- Potential energy surfaces, 95–96, 105
- Precession, nuclear moments, 528
- Pre-exponential factor, 95
- Preliminary equilibrium, 94
- Primary alkyl systems, solvolysis, 244
- Primary processes, photochemical, 707–708
- Prismane, 615–616
- Product development control, 422
- Propagation, 463, 506, 508
- Propane, 72, 502
- Propene
 basicity of, 163
 halogenation of, 351, 352
 hydration of, 338
- Propiolactone, 189
- Propionyl benzoyl peroxide, 479–480
- n*-Propylbenzene, 382
- Proton. *See also* Acids and bases
 leaving group, S_N1 reaction, 251–254
 solvation of, 124–125
- Proton affinity, 163
- Proton transfer
 in carbon acids, 413
 concerted, 407–411
 extent of, at transition state, 411
 intramolecular, 436
 rate of, 406, 408
 rate determining, 405, 409, 439
- Protonation
 of acid derivatives, 442
 of enols, 452
 heat of. *See* Heat of protonation
- Pryor, W. A., 482, 505
- Pseudo first-order kinetics, 92
- Pyrene, fluorescence of, 701, 703
- Pyridine, catalysis by, 446
- Pyridine-4-aldehyde, 436
- 2-Pyridone, 426–427
- Quantum numbers, spin, 686–687
- Quantum yield, 689, 690, 691, 708
- Quenching, 689, 691, 697–698, 704–706
- r*-Value, for copolymerization, 508
- Racemic mixture, 58
- Racemization, in solvolysis, 217, 219
- Radiationless transitions, 687, 688, 712
- Radical ions, 465, 496
- Radicals
 additions, 506–510
 aromatic substitution by, 513–516
 bridged, 519
 characteristics of, 462–475
 eliminations in, 510–513
 intermediate, in pericyclic reactions, 622
 pericyclic reactions of, 645
 reactions of, 475–497

- rearrangements of, 517-524
 structure and spectroscopy of, 463-470
 substitutions by, 497-506
 thermochemistry of, 471-475
 Radiolysis, pulse, 464
 Raman spectroscopy, of carbocations, 235
 Rate acceleration. *See* Anchimeric assistance
 Rate constants
 microscopic, 90
 observed, 91
 ratios of, and activation parameter differences, 101 *t.*
 in solvolysis processes, 218 *t.*
 transition state theory of, 95-100, 113-119
 Reacting bond rules, 103-105
 in E₂ eliminations, 364
 in proton transfer, 410
 in S_N1 reactions, 246-250
 Reacting orbitals, 578, 583
 Reaction coordinate, 97-99
 Reaction coordinate diagrams
 for nucleophilic substitution, 172, 173, 246-250
 for solvolysis mechanisms, 239-241, 303
 Rearrangements
 to carbonyl carbon, 316-318
 effect of migrating group on rates of, 327 *t.*
 to electron deficient carbon, 268-318
 to electron deficient nitrogen, 319-326
 to electron deficient oxygen, 327-332
 HOMO-LUMO theory of, 566 (*pr.* 4)
 photochemical, 723-729
 of radicals, 517-524
 sigmatropic, 657-676
 stereochemistry of, 281-284
 Recombination, radical, 485, 488. *See also*
 Cage effects
 Red shift, 685
 Reduced mass, 105-106 *n.*
 Reduction
 of carbonyl group, 420-421
 photochemical, 719
 Regiospecific reaction, 338 *n.*
 Resonance, 4-8
 and aromatic substitution, 391-392
 and aromaticity, 29-31
 energy, 33, 41 (*pr.* 13)
 through, 64
 Retro-ene reaction, 675
p., 61, 63 *t.*, 64 *t.*, 66
 Richardson, D. B., 259
 Ring current, 33-34, 37
 Ring opening, of radicals, 523
 Ring strain, 74, 228
 Roberts, I., 317, 348
 Roberts, J. D., 290, 293, 294, 304, 398
 Roothaan. *See* Hartree-Fock
 Roque, J.-P., 423
 Rotating sector, 486
 Rotation, partition function for, 116
 Russell, G. A., 505
 Russell mechanism, 488, 500
s, Substrate constant, 188, 189 *t.*
 S_Bi reaction, 204, 205, 207-209
 S_B1 reaction, 203, 250
 S_B2 reaction, 203, 205, 207, 431, 556
 S_H2 reaction, 497-498
 S_NAr reaction, 395-397
 S_Ni reaction, 266 (*pr.* 14)
 S_N1 reaction
 kinetics and stereochemistry, 213-222
 leaving groups in, 223-226
 nucleophiles in, 230-232
 reacting bond rules and, 246-250
 rearrangements in. *See* Rearrangements
 and S_N2, 171, 237-245
 substrate structure in, 226-230
 S_N2 reaction
 on carbon, 171-194
 and E₂ reaction, 375
 ion pairs in, 173*n.*, 244, 250
 on oxygen, 211 (*pr.* 7)
 relationship to E₂C elimination, 365
 on silicon, 210 (*pr.* 5), 211 (*pr.* 6)
 on sulfur, 194-203
 Sabol, M. A., 202
 Salem, L., 611, 615
 Salt effects, 220-221, 245
 Salties, J., 691, 708
 Sargent, G. D., 305, 306
 Saunders, W. H., 373
 Saytzeff elimination, 357-358
 Scavengers, radical, 478 *n.*, 490
 Schiff bases, 433
 Schleyer, P. v. R., 225, 226, 240, 245, 277, 279, 297, 306, 312
 Schmidt rearrangements, 323-324
 Schofield, K., 319, 394
 Schröder, G., 673
 Schrödinger equation, 10, 50
 Schubert, W. M., 338
 β-Scission, 511, 523
 Secondary systems, solvolysis, 243-244
 Secular equation, 52-53
 Selection rules. *See also* Transition, electronic
 Dewar-Zimmerman, 605
 Woodward-Hoffmann, 602
 pericyclic, comparison of, 611-615
 Selectivity factor, 393
 Self-consistent field. *See* Hartree-Fock
 Seltzer, S., 482
 Semicarbazide, 438
 Semicarbazones, 433

- Semipinacol rearrangement, 280 *n.*
 Shiner, V. J., Jr., 245
 Shoppee, C. W., 288
 Shubin, V. G., 286
 σ , 62 *t.*, 61–62, 279, 331
 σ^+ , 62 *t.*, 64–65, 70, 292, 320, 329, 338, 341, 351
 σ^- , 62, *t.* 64–65
 σ^o , 67 *t.*
 σ^* , 67–70, 68 *t.*, 351
 σ^n , 66–67, 67 *t.*
 σ_i , 67
 σ_R , 67
 σ -Complex. *See* Complexes
 σ Orbital. *See* Molecular orbitals
 Sigmatropic reactions, 573, 657–676
 Simmons, M. C., 259
 Singlet state. *See* State, electronic
 Skell, P. S., 263, 357
 Sneen, R. A., 244, 250
 Sodium borohydride, 420
 Softness. *See* Acids and bases, Lewis
 Solvation. *See* Solvents
 Solvent effects
 on alcohol acidity, 154
 on bromination, 348–349, 350 *t.*, 353
 on carbanion stereochemistry, 252–253
 on cycloaddition, 631
 on E₁ reaction, 357
 on E₂ reaction, 366
 on leaving group activity, 193–194
 on light absorption, 685
 on nucleophilicity, 190–191
 on phosphorescence, 692
 on radical selectivity, 504
 on S_N1 reactions, 215, 232–233
 on S_N2 reactions, 177
 on substitution-elimination competition, 356
 Solvent-separated ion pair, 221
 Solvents, 84–90
 ionizing power of, 232–233, 243
 nonaqueous, acidity measurements in, 135–138
 nucleophilicity of, 243, 245
 participation in solvolysis, 239–250, 278–280
 viscosity, and radical recombination, 489
 Solvolysis. *See also* individual compounds
 of alkyl systems, 216, 226 *t.*, 243–244
 of allyl system, 220, 245
 of benzhydryl system, 213–214, 216
 of bridgehead systems. *See* Bridgehead solvolysis
 definition, 213
 mechanism of, 239–250
 Special salt effect, 220–221
 Specific catalysis, 340, 405–416. *See also*
 Acids and bases; General catalysis
 in acetal and ketal hydrolysis, 428
 in amine addition to carbonyl, 438
 and general catalysis, 407, 413–416
 in thiol addition to carbonyl, 431
 Spin density, 465
 Spin-orbit coupling, 687, 690
 Spiro [cyclopropane-1,2'-adamantyl]
 chloride, 297
 Spivey, E., 453
 Stark and Einstein law, 682, 708
 State, electronic
 in caged radical pairs, 471, 527
 of carbenes, 258, 627
 correlation of, 617–622
 definition, 13, 618
 electron paramagnetic resonance and, 467
 excited
 formation and photophysical processes
 of, 681–706
 pericyclic reactions of, 589, 605
 reactions of, 706–729
 intended crossing of, 621
 of nitrenium ion, 325–326
 symmetry of, 619
 Stationary state approximation, 93, 214, 494
 Stepwise reaction, 568
 Stereochemistry, 57–60. *See also* individual reactions
 of anchimeric assistance, 270–271, 273, 292, 297
 of carbanions, 251–252
 of carbocations, 235–236
 of rearrangements, 281–284
 of substitution transition states, 199–200
 Stereoelectronic effects, 60
 Stereoisomers, 57
 Stereoselective reaction, 58
 Stereospecific reaction, 59
 Steric approach control, 422
 Steric effects
 in cyclohexanone additions, 423
 in hydration, 403
 in ketene addition to olefins, 635
 in nucleophilic catalysis, 443
 in radical additions of olefins, 509
 on S_N2 reactions, 180
 in sigmatropic reactions, 660
 Stern-Volmer equation, 697–698, 713, 718
 Stevens rearrangement, 524
 Stilbene dibromide, elimination, 370
 Stilbenes, photochemistry of, 699, 708, 712, 724
 Stobbe condensation, 457 (*pr.* 3)
 Stokes shift, 690
 Streitwieser, A., 110, 139–148, 155, 181
 Styrene
 copolymerization of, 508, 510

- halogenation of, 351, 352
- hydration of, 339, 340
- Substituent constants. *See* E_s ; σ
- Substitution
 - bimolecular, 170-209
 - in dipolar aprotic solvents, 89
 - and elimination, 216 *t.*
 - radical, 497-506
 - unimolecular, 213-255
- Sugars, 425
- Sulfite, addition to carbonyl, 418-419
- Sulfonation, of aromatics, 381-382
- Sulfones, pericyclic reactions, 629, 642
- Sulfonium ions, 399 (*pr.* 2, 3)
- Sulfoxides, pericyclic reactions, 629, 642
- Sulfur bases, 161-163
- Sulfur, S_N2 reactions on, 194-203
- Sulfur trioxide, 134, 382
- Sulfuric acid, 134, 234, 382
- Superacids, 134
 - acidity functions in, 136 *fig.*
 - cations in, 234-235, 280, 307-309, 312, 351, 387
 - electrophilic substitution in, 209
 - migratory aptitudes in, 286
 - rearrangements in, 270
- Suprafacial reactions, 571, 573
- Swain, C. G., 185, 190, 244, 245, 426, 453
- Swain-Scott equation, 185-189
- Symmetry, 541-552
 - and aromatic rings, theory of, 564
 - of electronic states, 619
 - element, definition, 18
 - and HOMO-LUMO theory, 554-557
 - operation, definition, 19
 - and pericyclic reactions, 575-602
 - in π systems, 559-566
 - rotational, 83-84
- Syn-anti dichotomy, 372-373

- Taft, R. W., 67-70, 340
- Taft equation, 67-70
 - in acetal and ketal hydrolysis, 430
 - in carbonyl additions, 403
 - in radical reactions of peroxides, 483
 - in S_N1 solvolysis, 229
 - in sulfite addition to carbonyl, 418
- Taylor, G. N., 706
- Telomer, 507
- Terenin, A., 693
- Termination, radical chain, 463, 485-489
- Tertiary alkyl systems, solvolysis, 216
- Tetracyanoethylene, 633
- Tetrafluoroethylene, 634
- 1, 2, 3, 5-Tetramethylbenzene, 389
- Tetramethylethylene, 711, 712
- Tetramethylglucose, 426
- Tetrazoles, 323

- Tetroxides, 488, 500
- Thallium, as aromatic substituent, 383
- Thermochemistry, 71-84
 - of radicals, 471-475
- Thioacetals and thioketals, 431-432
- Thiol ester hydrolysis, 443
- Thiols
 - additions of, 431, 507
 - as radical scavengers, 490
- Thorneley, R. N. F., 436
- Thornton, E. R., 103, 246
- Tin hydrides, 495
- Toluene
 - acidity, MSAD scale, 145
 - bromination of, 392
 - nitration of, 381, 393-395
- Toluenesulfonic acid, 59
- Tosylate, definition, 223 *t.*
- Tosylate-to-bromide rate ratio, 192-193, 223-225
- Transannular reactions, 292, 314-316, 522
- Transition, electronic, 684-692
- Transition state
 - in addition to cyclohexanones, 422
 - in bimolecular substitution, 172, 174-175, 180, 181, 198-199
 - Brønsted α and β and, 411-413
 - in E_2C reaction, 366
 - in E_2 elimination, 362-365
 - equation for rate constant, 100
 - in ester pyrolysis, 377
 - in hydroboration, 354 *n.*
 - isotope effect and, 108-109, 230
 - partition function for, 117-119
 - pericyclic, theory of, 606-610
 - in radical substitution, 505
 - reacting bond rules and, 104, 246-250
 - in S_Ni reaction, 208-209
 - in solvolysis, 225, 226, 239-250
 - theory of, 95-105, 113-119
- Translation, partition function, 116
- Transmission coefficient, 119
- Triarylmethyl cations, 234, 236
- Triarylmethyl system, solvolysis, 215-216
- 2, 4, 6-Tri-*t*-butyl phenol, 493
- 2, 4, 6-Tri-*t*-butylphenoxy radical, 488
- Trichloromethyl radical, 505
- Triethyl amine, 178
- Trifluoroacetic acid, 243, 306
- Trifluoroethanol, 243
- Trifluoromethanesulfonate, 223 *t.*, 236
- Trifluoromethyl radical, 467, 486
- Trifluoroperoxyacetic acid, 331
- 2, 3, 3-Trimethylbutyl cation, 270
- Trimethyl-*n*-decylammonium hydroxide, 171
- Trimethylene diradical, 679 (*pr.* 8)
- Trimethylsulfonium ion, 178
- Trioxides, 500

- Triphenylamine, basicity of, 161-162
Triphenylcarbinol, 234
Triphenylmethyl cation, 236
Triphenylmethyl chloride, 65, 244
Triphenylmethyl perchlorate, 236
Triplet state. *See* State, electronic
Tropone, 39, 643
Tropone diethylacetal, 460 (*pr.* 7)
Tunnelling, 119
Turro, N. J., 695
- Urey, H. C., 317
- Valence-shell occupancy, 2
Variation principle, 51
Vibrations
 and isotope effect, 105-111
 partition function for, 117
 and potential energy surfaces, 95-96
 reacting bond rules and, 104
Villiger, V., 329
Vinyl acetate, 447-449, 508
Vinyl alcohols, 341
Vinyl anions, 254
Vinyl cations, 236-237, 341, 345
Vinyl group, radical rearrangement, 518
Vitamin D, 656
- Wagner-Meerwein rearrangements, 268,
 286, 338, 345
Walborsky, H. M., 310
Walden, P., 174
Walden inversion, 174
Wallis, F. S., 322
Ward, H. R., 470
Wasserman, E., 258
Water
 in acid-catalyzed reactions, 431
 addition of. *See* Hydration
 gas phase acidity of, 155
 ionization constant of, 127-128
 mixtures with strong acids, 129
Water molecule, symmetry of, 543, 545-547
Wave function, 10
 of vibrational levels, 684, 688
Wave number, 682
Westheimer, F. H., 199
Wigner's spin conservation rule, 693
Windshield wiper effect, 277
Winstein, S., 218, 220, 232, 237, 273, 289,
 291, 297, 301, 302, 306, 328, 364
Wolff rearrangement, 334 (*pr.* 14)
Woodward, R. B., 653. *See also* Woodward,
 R. B., and Hoffmann, R.
Woodward, R. B., and Hoffmann, R., 568,
 569, 572, 579, 586, 598, 602, 603,
 611, 615, 617, 627, 628, 638-639,
 645, 648, 665, 671
- Xanthate esters, 376-377
X-Ray photoelectron spectroscopy, 235,
 307-308
- Y.** *See* Grunwald-Winstein **Y** scale
Yang, N. C., 700, 707
Yates, K., 349, 353, 446
Ylides, rearrangements of, 524, 658, 666
Young, W. G., 220
- Z.** *See* Kosower **Z** scale
Zero-point energy, 106-111, 117, 120
Zimmerman, H. E., 58, 603, 606, 726, 727,
 728
Zollinger, H., 386
Zucker-Hammett hypothesis, 430
Zwitterions, 633, 638