

Osamu Suzuki  
Kanakano Watanabe  
*Editors*

# Drugs and Poisons in Humans

A Handbook  
of Practical  
Analysis



**Drugs and Poisons in Humans**  
A Handbook of Practical Analysis

Osamu Suzuki and Kanako Watanabe

# Drugs and Poisons in Humans

**A Handbook of Practical Analysis**

With 236 Figures and 90 Tables

**Prof. Osamu Suzuki**

Assoc. Prof. Kanako Watanabe  
Department of Legal Medicine  
Hamamatsu University School of Medicine  
Hamamatsu City 431-3192  
Japan

This is a translation of "Yaku-Doku Butsu Bunseki Jissen Handobukku" originally published in Japanese in 2002 by Jiho, Inc. 2-6-3, Hitotsubashi, Chiyoda-ku, Tokyo 101-8421 Japan

**ISBN 3-540-22277-4 Springer-Verlag Berlin Heidelberg New York**

Library of Congress Control Number: 2005921910

This work is subject to copyright. All rights are reserved, whether the whole or part of the material is concerned, specifically the rights of translation, reprinting, reuse of illustrations, recitation, broadcasting, reproduction on microfilm or in any other way, and storage in data banks. Duplication of this publication or parts thereof is permitted only under the provisions of the German Copyright Law of September 9, 1965, in its current version, and permission for use must always be obtained from Springer. Violations are liable to prosecution under the German Copyright Law.

**Springer is a part of Springer Science+Business Media**

springeronline.com

© Springer-Verlag Berlin Heidelberg 2005  
Printed in the European Union

The use of registered names, trademarks, etc. in this publication does not imply, even in the absence of a specific statement, that such names are exempt from the relevant protective laws and regulations and therefore free for general use.

Product liability: The publishers cannot guarantee the accuracy of any information about the application of operative techniques and medications contained in this book. In every individual case the user must check such information by consulting the relevant literature.

Editor: Thomas Mager, Heidelberg  
Development Editor: Andrew Spencer, Heidelberg  
Production Editor: Frank Krabbes, Heidelberg  
Typesetting: Fotosatz-Service Köhler GmbH, Würzburg  
Cover design: Martina Winkler, Heidelberg



# Foreword

It was with great pleasure that I accepted the invitation to write the foreword for *Drugs and Poisons in Humans. A Handbook of Practical Analysis*. Dr. Osamu Suzuki and Dr. Mikio Yashiki, two outstanding Japanese scientists, first published the Handbook in Japanese in 2002. Specialists throughout Japan contributed analytical methods for a wide variety of therapeutic and illicit drugs, pesticides, and natural toxins and alkaloids. In fact, rarely has such a wide spectrum of analytes and metabolites been addressed within a single reference manual.

At the beginning of the book, general topics are addressed, including instructions on handling biological materials, measurement of drugs in alternative specimens, and guidance on resolving analytical problems that may occur. There are discussions of extraction modalities and detection methodologies and how to select these appropriately based on the physiochemical characteristics of the drug. Analysis of specific classes of drugs and relevant metabolites are covered in subsequent chapters. Clinical, analytical and forensic toxicology and clinical chemistry laboratories will find the volume informative and useful. Toxicologists are often faced with developing methods for new drugs and metabolites with little information available in the literature. This book provides a great starting point for method development providing procedures that have been utilized in real life situations. In addition, toxicologists developing new methodologies may use this volume as a guide to selecting the most appropriate instrumentation to handle the breadth of their analytical workload.

One of the most valuable aspects of the Handbook is the inclusion of specific case studies. Useful also are the discussions on suggested analyte concentration ranges and troubleshooting tips. The 2002 version of the Handbook in Japanese was judged to be highly valuable and led to the production of an English version. This Handbook also has been updated to include additional methods and procedures for this edition.

Despite the value of these methodologies, it is essential for laboratorians to validate fully a method within their own laboratory. Differences in instrumentation, sample size, extraction procedures (such as different solid-phase extraction columns) and experience level of personnel may vary markedly between laboratories. Therefore, these methods provide help and guidance in initiating a new analysis, but do not take the place of independently determining limits of detection, quantification and linearity, and the selectivity and precision of the assay in their own hands. Internal standardization is always the preferred approach, although use of external standard addition may be necessary with difficult matrices, such as decomposed postmortem specimens. Quality assurance and quality control procedures are essential components of accurate and reliable methods and should be included in the analysis of each batch of specimens. Quality control samples should span the linear range of the assay. The issue of method validation cannot be emphasized too strongly and is necessary for the accurate application of these diverse analytical methods.

Dr. Suzuki and Dr. Watanabe have gathered an extensive array of methods for the measurement of xenobiotics and metabolites in biological matrices. *Drugs and Poisons in Humans. A Handbook of Practical Analysis* will be a well-used reference for toxicology laboratorians and will help guide assay development.

Marilyn A. Huestis, Ph.D.

Acting Chief, Chemistry and Drug Metabolism

Intramural Research Program, National Institute on Drug Abuse

National Institutes of Health, Washington, D.C., USA

and

President, The International Association of Forensic Toxicologists (TIAFT)

# Preface

The readers of this book will immediately realize that all authors are Japanese scientists; this is the English translation of a book which was published in Japanese by Jiho, Inc., Tokyo in 2002. Upon translation, the Editors added five new chapters to the previous 67 chapters in view of international occurrences of poisoning by drugs and poisons.

The most important aim of this book is to provide the most reliable and reproducible methods for analysis of drugs and poisons; therefore, the newest methods and ones requiring skills have not been adopted. Each chapter has been written by at least one expert currently engaged in the quantitative analysis of each toxin. This book is arranged so precisely that any fresh analytical chemist can start analytical experiments on a drug or a poison in a crude biological matrix, even if the analyst has no experience of analyzing the compound. Special care has been given to clarify the origins (manufacturers) or synthetic methods for chemicals to be used in reproducing the experiments, and also to present detailed procedures for the extraction of a drug or a poison from complicated matrices such as whole blood, tissues and urine.

Compounds causing cases of poisoning will increase and vary according to events in the world; the technology of analytical instruments is also advancing very rapidly. The Editors do not claim that this book covers all compounds to be analyzed and are well aware of the limitations of the book. The Editors hope that this book will be revised according to feedback received in the near future; some groups of drugs and poisons will then be added in a later edition.

The Editors also hope that this book will be widely distributed in the world and be useful for many analysts affiliated to forensic, environmental, clinical and doping control institutions.

The Editors wish to thank the following people for helping to make the present publication of this book possible: Dr. T. Mager and Mr. A. Spencer, Springer-Verlag, Heidelberg, for undertaking the laborious work of the publication; Messrs. T. Araki, D. Kobayashi and S. Hattori, Jiho, Inc., Tokyo, for kindly encouraging us to translate the original Japanese version; Mr. and Mrs. Kouichi Watanabe, the parents of one of the Editors, for typing extensive pages of manuscripts for the translation.

Osamu Suzuki  
Kanakano Watanabe  
Editors

# Notes on the use of this book

## Contents

---

This book is composed of 9 chapters of general nature and 63 chapters of specific toxins. In the latter chapters, compounds with high poisoning frequency have been chosen; detailed procedures of analyses have been presented for each compound or each group. The methods mentioned are relatively new and easily reproducible in every chemical laboratory equipped with the standard analytical instruments. In this book, preliminary tests such as color and immunological reactions are almost omitted; most of them are chromatographic ones.

Each chapter on specific toxin is composed of: 1 Introduction; 2 Reagents and their preparation; 3 Instrumental conditions; 4 Procedure; 5 Assessment of the method; 6 Poisoning cases, toxic and fated concentrations; 7 Notes; and 8 References.

Especially, protocols for experimental procedure are headed by small letters of Roman numerals.

For notes, small alphabets are shown on the right shoulder of a corresponding word in the text. For references, Arabic numerals in brackets are shown in the text.

## Symbols, units and expressions

---

Length:  $10^{-9}$  m has been expressed as nm (not  $m\mu$ ); volume:  $10^{-6}$  m<sup>3</sup> expressed as mL (not cc); concentration: mol in 1 L volume expressed as M (not mol/L); NMR shift:  $\delta$  values (not  $\gamma$  values); fraction: for example g/mL (not g mL<sup>-1</sup>).

In GC analysis, when the initial oven temperature is 50 °C with 1-min hold, followed by its elevation at 5 °C/min up to 150 °C; after 5-min hold at the latter temperature, it is again elevated at 20 °C/min up to 280 °C. These steps of the procedure are simply described as follows.

50 °C (1 min) → 5 °C/min → 150 °C (5 min) → 20 °C/min → 280 °C.

## Abbreviations

---

There are a number of abbreviated words being commonly used in the field of analytical toxicology. The following abbreviated words can be used in the text of this book without explanation.

CI:	chemical ionization
CID:	collision-induced dissociation
EI:	electron impact ionization
FID:	flame ionization detector
GC:	gas chromatography or its instrument
GC/MS:	gas chromatography/mass spectrometry or its instrument
GC/MS/MS:	gas chromatography/tandem mass spectrometry or its instrument
HPLC:	high-performance liquid chromatography or its instrument
IS:	internal standard
LC:	liquid chromatography = HPLC or its instrument
LC/MS:	liquid chromatography/mass spectrometry or its instrument
LC/MS/MS:	liquid chromatography/tandem mass spectrometry or its instrument
NPD:	nitrogen-phosphorus detector
SIM:	selected ion monitoring
TIC:	total ion chromatogram or total ion current
TLC:	thin-layer chromatography
UV:	ultraviolet (detection)

# Contents

## I. Chapters of general nature

1) How to handle biological specimens . . . . .	1
2) Alternative specimens . . . . .	9
3) Pitfalls and cautions in analysis of drugs and poisons. . . . .	17
4) Pretreatments of human specimens . . . . .	25
5) Detection methods . . . . .	33
6) A computer system for diagnosis of causative drugs and poisons developed by the Japan Poison Information Center (Tokyo) . . . . .	45
7) Practical use of the poison-net developed by the Japan Poison Information Network (Hiroshima) . . . . .	51
8) Problems in toxin analysis in emergency medicine . . . . .	59
9) Analyses of chemical warfare agents and their related compounds. . . . .	69

## II. Chapters on specific toxins

<i>1. Volatile compounds</i>	
1) Carbon monoxide . . . . .	91
2) Hydrogen sulfide and its metabolite. . . . .	101
3) Cyanide. . . . .	113
4) Methanol and formic acid . . . . .	123
5) Ethanol . . . . .	135
6) Chloroform and dichloromethane. . . . .	143
7) Toluene, benzene, xylene and styrene . . . . .	149
8) Alkyl nitrites . . . . .	153
9) Components of gasoline and kerosene . . . . .	159
<i>2. Controlled drugs</i>	
1) Amphetamines and their metabolites . . . . .	171
2) Cannabinoids and their metabolites. . . . .	187
3) Morphine and its analogues . . . . .	195
4) Cocaine and its metabolites . . . . .	207
5) Pentazocine . . . . .	219
6) Lysergic acid diethylamide (LSD) . . . . .	225

7) 3,4-Methylenedioxyamphetamines . . . . .	229
8) Phencyclidine . . . . .	241
9) $\gamma$ -Hydroxybutyric acid . . . . .	247
 3. <i>Psychopharmaceuticals and hypnotics</i>	
1) Phenothiazines . . . . .	255
2) Butyrophenones . . . . .	263
3) Tricyclic and tetracyclic antidepressants . . . . .	271
4) Benzodiazepines . . . . .	283
5) Bromisovalum . . . . .	293
6) Barbiturates . . . . .	301
 4. <i>General drugs</i>	
1) Diphenylmethane antihistaminics . . . . .	315
2) Propionic acid derivative analgesic-antipyretics . . . . .	325
3) Acetaminophen (paracetamol) . . . . .	335
4) Acetylsalicylic acid . . . . .	343
5) Antiepileptics . . . . .	351
6) Muscle relaxants . . . . .	359
7) $\beta$ -Blockers . . . . .	369
8) Local anaesthetics . . . . .	377
9) Salicylic acid . . . . .	391
10) $\beta$ -Lactam antibiotics . . . . .	395
 5. <i>Chemicals of daily necessities</i>	
1) Hypochlorite . . . . .	403
2) Benzalkonium chlorides . . . . .	407
3) Hair dyes . . . . .	415
4) Permethrin . . . . .	425
5) Boric acid . . . . .	431
6) Naphthalene . . . . .	437
7) <i>p</i> -Dichlorobenzene . . . . .	443
8) Ethylene glycol . . . . .	449
 6. <i>Natural toxins and alkaloids</i>	
1) Aconite toxins . . . . .	455
2) Mushroom toxins . . . . .	469
3) Tetrodotoxin . . . . .	481
4) Methylxanthine derivatives . . . . .	491
5) Nicotine and cotinine . . . . .	499
6) Tropane alkaloids . . . . .	509
7) Oleander toxins . . . . .	519
 7. <i>Pesticides</i>	
1) Simultaneous analysis of pesticides by GC/MS . . . . .	527
2) Organophosphorus pesticides . . . . .	535

3) Glufosinate and glyphosate . . . . .	545
4) Carbamate pesticides . . . . .	559
5) Paraquat and diquat . . . . .	571
6) Cresol . . . . .	581
7) Diazine and triazine herbicides . . . . .	591
8) Coumarin rodenticides . . . . .	599
<i>8. Miscellaneous</i>	
1) Sarin and its decomposition products . . . . .	609
2) VX and its decomposition products . . . . .	619
3) Sodium azide . . . . .	629
4) Arsenic compounds and other inorganic poisons . . . . .	637
5) Nitrate and nitrite compounds . . . . .	649
6) Methemoglobin . . . . .	655
Subject index . . . . .	659



# List of Contributors

**Kiyoshi AMENO**

Department of Forensic Medicine,  
Faculty of Medicine, Kagawa University, Kagawa

**Hiroaki ANDO**

Criminal Investigation Laboratory,  
Metropolitan Police Department, Tokyo

**Tomonori ARAO**

Department of Legal Medicine,  
School of Medicine, University of Ryukyus,  
Okinawa

**Manami FUJISAWA**

Department of Hospital Pharmacy,  
Niigata City General Hospital, Niigata

**Chiaki FUKE**

Department of Legal Medicine,  
School of Medicine, University of Ryukyus,  
Okinawa

**Mariko FUKUMOTO**

Division of Toxicology, Center for Clinical  
Pharmacy and Clinical Sciences,  
School of Pharmaceutical Sciences,  
Kitasato University, Tokyo

**Sunao FUKUSHIMA**

Forensic Science Laboratory, Fukuoka  
Prefectural Police Headquarters, Fukuoka

**Kunio GONMORI**

Department of Legal Medicine, Hamamatsu  
University School of Medicine, Hamamatsu

**Shigeyuki HANAOKA**

Chemicals Evaluation and Research Institute,  
Japan, Tokyo Laboratory, Saitama

**Hideki HATTORI**

Department of Legal Medicine,  
Aichi Medical University School of Medicine,  
Aichi

**Kazuichi HAYAKAWA**

Graduate School of Natural Science and  
Technology, Kanazawa University, Kanazawa

**Yoko HIEDA**

Department of Legal Medicine,  
Shimane University School of Medicine,  
Shimane

**Yasushi HORI**

Department of Hospital Pharmacy,  
Niigata City General Hospital, Niigata

**Kazuo IGARASHI**

Kobe Gakuin University,  
Faculty of Pharmaceutical Sciences, Kobe

**Noriaki IKEDA**

Department of Forensic Pathology and Sciences,  
Graduate School of Medical Sciences,  
Kyushu University, Fukuoka

**Akira ISHII**

Department of Legal Medicine,  
Fujita Health University School of Medicine,  
Aichi

**Kitae ITO**

Department of Pharmacy,  
Haramachi City Hospital, Fukushima

**Yuko ITO**

Aichi Prefectural Institute of Public Health,  
Nagoya

**Shigetoshi KAGE**

Forensic Science Laboratory,  
Fukuoka Prefectural Police Headquarters,  
Fukuoka

**Shinji KAGEYAMA**

Mitsubishi Kagaku Bio-Clinical Laboratories, Inc.,  
Tokyo

**Munehiro KATAGI**

Forensic Science Laboratory,  
Osaka Prefectural Police Headquarters, Osaka

**Yoshinao KATSUMATA**

Department of Legal Medicine and Bioethics,  
Nagoya University Graduate School of Medicine,  
Nagoya

**Takaaki KIKUNO**

Emergency and Critical Care Service,  
National Tokyo Medical Center, Tokyo

**Kojiro KIMURA**

Department of Legal Medicine,  
Graduate School of Biomedical Sciences,  
Hiroshima University, Hiroshima

**Toshikazu KONDO**

Department of Legal Medicine,  
Wakayama Medical University, Wakayama

**Kazuhiro KOYAMA**

Department of Pharmacy,  
National Tokyo Medical Center, Tokyo

**Keiko KUDO**

Department of Forensic Pathology and Sciences,  
Graduate School of Medical Sciences, Kyushu  
University, Fukuoka

**Xiao-Pen LEE**

Department of Legal Medicine,  
Showa University School of Medicine, Tokyo

**Naoto MATSUMOTO**

Department of Pharmacy,  
National Defense Medical College Hospital,  
Saitama

**Akihiro MIKI**

Forensic Science Laboratory,  
Osaka Prefectural Police Headquarters, Osaka

**Yoshihiko MIYATA**

Criminal Investigation Laboratory,  
Metropolitan Police Department, Tokyo

**Michinao MIZUGAKI**

Tohoku Pharmaceutical University, Sendai

**Fumio MORIYA**

Department of Legal Medicine,  
Kochi University Medical School, Kochi

**Rika NAKAJIMA**

Department of Legal Medicine,  
School of Medicine, Keio University, Tokyo

**Akira NAMERA**

Department of Legal Medicine,  
Graduate School of Biomedical Sciences,  
Hiroshima University, Hiroshima

**Makoto NIHIRA**

Department of Legal Medicine,  
Nippon Medical School, Tokyo

**Manami NISHIDA**

Department of Legal Medicine,  
Graduate School of Biomedical Sciences,  
Hiroshima University, Hiroshima

**Mayumi NISHIKAWA**

Forensic Science Laboratory,  
Osaka Prefectural Police Headquarters, Osaka

**Kazuta OGURI**

School of Pharmaceutical Sciences,  
Kyushu University of Health and Welfare,  
Miyazaki

**Yukio OHTSUKA**

Department of Forensic Pathology and Sciences,  
Graduate School of Medical Sciences,  
Kyushu University, Fukuoka

**Hisao OKA**

Aichi Prefectural Institute of Public Health,  
Nagoya

**Takeshi SAITO**

Department of Forensic Medicine,  
Tokai University School of Medicine, Kanagawa

**Masakatsu SAKATA**

Department of Clinical Toxicology and  
Metabolism, Faculty of Pharmaceutical Sciences,  
Health Sciences University of Hokkaido,  
Ishikari, Hokkaido

**Keizo SATO**

Department of Legal Medicine,  
Showa University School of Medicine, Tokyo

**Shouichi SATO**

Department of Clinical Laboratory,  
Chiba Cardiovascular Center, Chiba

**Hiroshi SENO**

Department of Legal Medicine,  
Aichi Medical University School of Medicine,  
Aichi

**Yasuo SETO**

National Research Institute of Police Science,  
Chiba

**Yoko SHIMAZU**

Department of Pharmacy,  
National Tokyo Medical Center, Tokyo

**Tatsuo SHINOZUKA**

Department of Legal Medicine,  
School of Medicine, Keio University, Tokyo

**Osamu SUZUKI**

Department of Legal Medicine,  
Hamamatsu University School of Medicine,  
Hamamatsu

**Shinichi SUZUKI**

National Research Institute of Police Science,  
Chiba

**Yasuhiro SUZUKI**

National Research Institute of Police Science,  
Chiba

**Nariaki TAKAYAMA**

Forensic Science Laboratory,  
Ishikawa Prefectural Police Headquarters,  
Kanazawa

**Tatsunori TAKAYASU**

Forensic and Social Environmental Medicine,  
Graduate School of Medical Science,  
Kanazawa University, Kanazawa

**Sanae TAKEICHI**

Department of Forensic Medicine,  
School of Medicine, Tokai University, Kanagawa

**Kenichi TAKEKAWA**

Forensic Science Laboratory,  
Yamanashi Prefectural Police Headquarters,  
Yamanashi

**Einosuke TANAKA**

Department of Legal Medicine,  
Institute of Community Medicine,  
University of Tsukuba, Tsukuba

**Masaru TERADA**

Department of Legal Medicine,  
School of Medicine, Toho University, Tokyo

**Hitoshi TSUCHIHASHI**

Forensic Science Laboratory,  
Osaka Prefectural Police Headquarters, Osaka

**Makoto UEKI**

Mitsubishi Kagaku Bio-Clinical Laboratories, Inc.,  
Tokyo

**Kanako WATANABE**

Department of Legal Medicine,  
Hamamatsu University School of Medicine,  
Hamamatsu

**Kazuhiro WATANABE**

Department of Hygienic Chemistry,  
Faculty of Pharmaceutical Sciences,  
Hokuriku University, Kanazawa

**Ritsuko WATANABE**

Department of Legal Medicine,  
Osaka University Graduate School of Medicine,  
Osaka

**Hideyuki YAMADA**

Graduate School of Pharmaceutical Sciences,  
Kyushu University, Fukuoka

**Mikio YASHIKI**

Department of Legal Medicine,  
Graduate School of Biomedical Sciences,  
Hiroshima University, Hiroshima

**Naofumi YOSHIOKA**

Department of Forensic Medicine,  
Akita University School of Medicine, Akita

**Toshiharu YOSHIOKA**

Department of Emergency Medicine,  
Osaka Prefectural General Hospital, Osaka

# **I. Chapters of general nature**

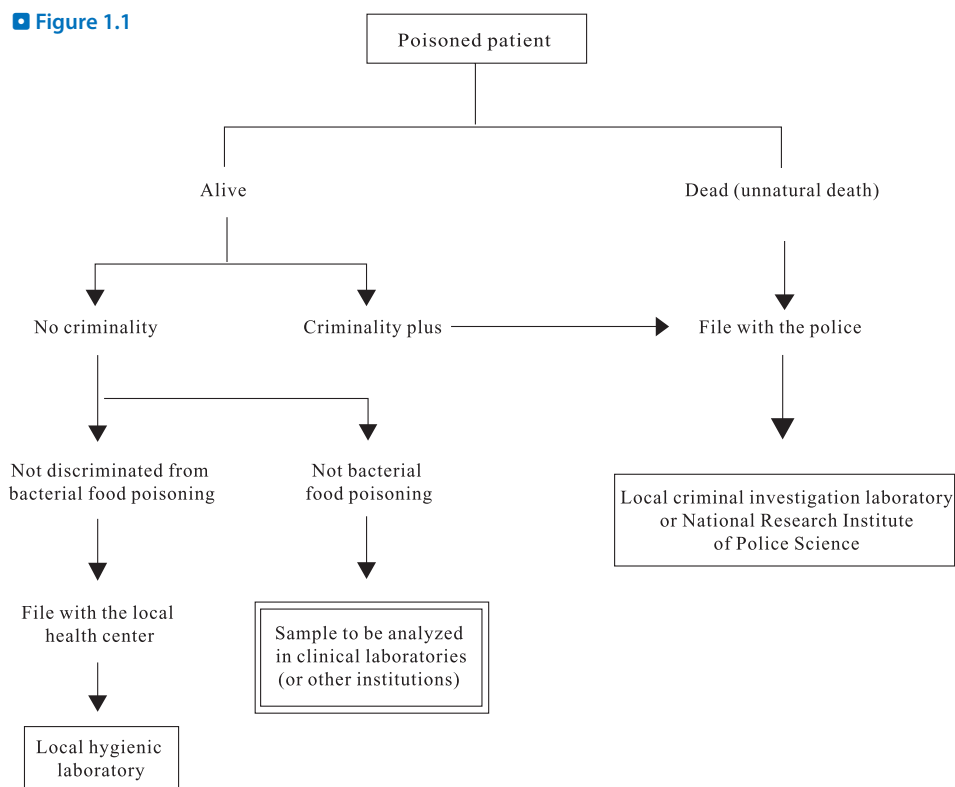
# I.1 How to handle biological specimens

By Osamu Suzuki

## Some knowledge to be required before handling specimens

The flowchart for how to handle specimens obtained from poisoned patients is shown in [▶ Figure 1.1](#). When a poisoning incident takes place and a patient is sent to hospital, medical doctors and co-medical staffs should concentrate their efforts on the intensive care of the patient. However, at this point, the discrimination whether it is a poisoning case or not is, of course, very important. If the patient dies and the death is judged due to poisoning, the responsible doctor should file the death with the police located at the district within 24 h according to a law in Japan.

■ **Figure 1.1**



**Flowchart for how to handle specimens obtained from poisoned patients.**

The death due to bacterial food poisoning should be classified into intrinsic one (disease death), and be discriminated from the death due to drugs or poisons (extrinsic death); it is not necessary to file with the police, but it should be filed with a local health center. Irrespective of being dead or alive of the patient, both bacterial food poisoning and drug poisoning should be filed with a local health center. It should be mentioned here that deaths due to ingestion of puffer fish and mushrooms are classified as extrinsic ones.

After the police accepts the file of an unnatural death, the analysis of a causative toxin is made, according to the need, at a local criminal investigation laboratory of police headquarters in each prefecture in Japan. When the analysis at the local laboratory is difficult, the specimens are sent for analysis to the National Research Institute of Police Science in Kashiwa City, Chiba Prefecture. When a cadaver of unnatural death is subjected to judicial autopsy at a department of legal medicine of a medical school, the toxin specimens obtained from the cadaver is analyzed at the department in case that the department is capable to analyze it.

When a patient survives and criminality is suspected in a poisoning case, it should be filed with the police immediately; in such a case, the police is absolutely responsible for the toxin analysis.

Only when a poisoning patient is alive with no criminality, and also no discrimination between poisonings by bacterial food and by drugs/poisons can be made, a request addressed to a local hygienic laboratory for toxin analysis is possible *via* a health center. The main duties of the hygienic laboratory are bacterial tests on foods and analysis of environmental pollutants; the laboratory is usually equipped with expensive analytical instruments such as mass spectrometers, and seems to sufficiently meet the analysis of drugs and poisons. However, at the present time in Japan, such request is usually rejected by the laboratory after the possibility of being bacterial food poisoning is excluded. Therefore, a problem arises concerning which institution undertakes the analysis of specimens collected from a poisoning patient admitting at a hospital, who survives and shows no criminality (suicide trial or accident). The best way is that the clinical laboratory of the same hospital undertakes the analysis of the specimens; however the analysis of drugs and poisons is almost impossible at a local hospital, because it is usually not easy, and requires a skill of analysts. Unfortunately, in Japan, the so-called poison control centers for undertaking the toxin analysis are not available; while in the US and Europe the poison control centers are active for analysis of such specimens. Our problem is not due to the scientific delay in analytical chemistry in our country, but is due to the delay in measures to be taken by Japanese Government. To overcome the above problem, much efforts are being made at non-governmental levels [1]; one of the efforts is presented in Chapter I.7.

## Sampling of specimens on a clinical scene

---

### Blood

Blood specimens are now being collected from the vein using vacuum sampling tubes; EDTA, citrate or heparin is usually contained in the tube as an anticoagulant. Some tubes contain sodium fluoride as a preservative. The analysts should be aware of the presence of such additives.

Larger amounts of blood are preferable to be sampled for toxin analysis; however, in view of the stress to patients, 5–10 mL of blood is to be sampled. If a situation permits, multiple samplings at different intervals are desirable. The time-course analysis is very useful for deciding the therapeutic policy in poisoning cases. When plasma is required, the supernatant fraction is obtained by centrifuging the tubes containing whole blood at 2,000–3,000 rpm.

## Urine

Also for urine, larger amounts are preferable to be sampled. When urine is obtained by catheterization from a patient, it should be taken into mind that a jelly containing a local anaesthetic had been applied to the catheter; urine is usually contaminated by such a drug. Also for urine, the samplings according to time intervals are preferable. According to the need, sodium fluoride or sodium azide is added to urine samples at a concentration of 1 mg/mL as a preservative.

According to the kinds of drugs and poisons, large amounts of metabolites are sometimes excreted into urine. Before analysis, some knowledge on the metabolism and excretion for a possible toxin is needed; a useful dictionary was published for such a purpose [2].

## Vomitus and gastrolavage fluid

After oral ingestion of a drug or a poison, there is a possibility that gastric contents contain a high level of an unchanged toxin. The vomitus and gastrolavage fluid should be stored in amounts as large as possible; their volumes should be strictly recorded. Also according to the need, sodium fluoride or sodium azide can be added as a preservative.

## Hair and nails

When chronic intoxication by a drug or a poison (especially heavy metals and basic drugs) is suspected, after getting the consent from the patient, several pieces of long hair are sampled by cutting off at their roots, put in a dry polyethylene bag with a fastener and kept at room temperature or 4° C.

Nails are also good materials for detection of a drug or a poison which was ingested in the past, and can be an alternative specimen, especially when the scalp hair is too short or not available. They can be kept also at room temperature or 4° C.

## Collection of informations on a possible drug or a poison administered or ingested

Inquiries on a drug or a poison to the patient and his/her family are essential. Efforts should be made to find a cup or a bottle left on a poisoning spot, because there is a possibility that pure or clean solution of a toxic compound is contained in it. It is a good method to ask members of the emergency services to look for such items on the spot.



## Sampling from cadavers

---

### Observation on the spot of poisoning

When a medical doctor is requested to make postmortem inspection, he/she should arrive at the spot of poisoning to achieve the duty. Before the inspection of a cadaver, the doctor should observe the surrounding situations as carefully as possible, and also should sniff the air. There are many fatal cases of organophosphorous pesticide and cresol poisonings, in which a strong aromatic smell is given from the vomitus and from the mouth of a cadaver. When no finding of vomiting is observed, it is sometime useful for the doctor to try to sniff the smell by keeping doctor's nose closer to the nose and mouth of the cadaver and by pushing its chest slowly. Many of cadavers due to poisoning show dirty mucous fluids, froth or degeneration of the lip or around the mouth. It is also essential to look for a bottle or a cup containing a toxic compound. When they are found, they should be carefully stored until analysis. The packages and plastic cases for tablets and capsules should be looked for especially in a trash can or other places in the room. If vacant packages or cases are found in the trash can, they should be carefully lined up according to upper-to-lower layers. In case of failure to find out them inside the room, such search should be extended to nearby places, where trash is gathered outdoors.

When it is disclosed that the victim has visited a clinic or a hospital, detailed informations can be obtained on the kinds of drugs and their amounts prescribed; informations on the diagnosis of diseases and the time of the last visit can be also obtained by making inquiries to the responsible doctor. On every package or case for tablets or capsules, code numbers or special marks are usually shown; it is easy to identify a drug by the code numbers or marks using a drug-list book [3]. In most cases of poisoning, victims usually ingest multiple kinds and large amounts of drugs to commit suicide. The final judgement whether a death is due to drug poisoning should be made by counting the number of drugs and by considering the toxicity of each drug ingested.

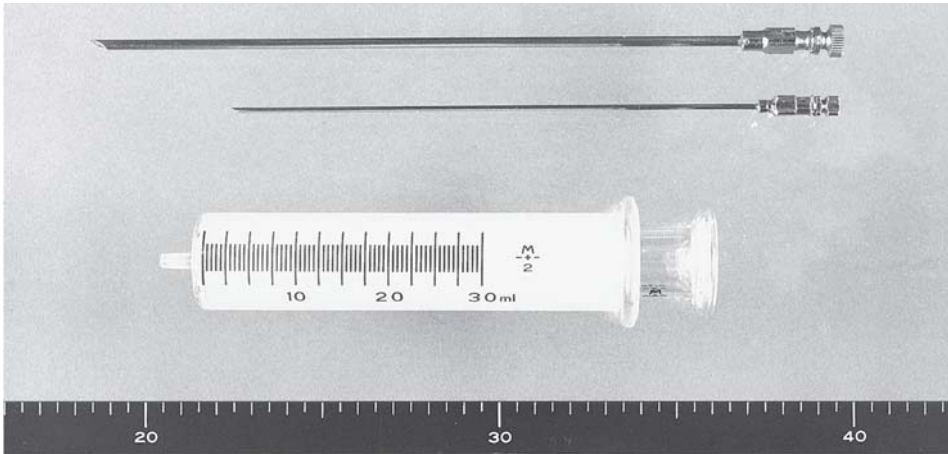
### Sampling at postmortem inspection

When vomitus and gastrolavage fluid are available, it is preferable to keep all of them. Since the froth or saliva fluids attached to the lips or their surrounding skin may contain high concentrations of a drug or a poison, they should be sampled by wiping them carefully with gauze and be kept in a sealed case at room temperature or 4° C.

The author et al. usually sample about 10 mL blood at every postmortem inspection, even if the cause of death is strongly suggested to be only disease; we keep it at -80° C for at least 1 year. This is because any unpredictable matters may be disclosed by further investigation of the police. Especially in rural areas without a medical examiner system (this system is active only in some big cities in Japan), the cadavers, which are considered not involved in criminality, are usually not autopsied, but subjected only to postmortem inspection. Therefore, the storage of a blood sample for a long time seems very important, because there is a possibility that the sample will serve as an effective evidence in the future.

Since the punctures for samplings are based on the request of a judicial police officer, they are not illegal; but it is preferable to get the consent of family members upon samplings.

■ Figure 1.2



**Needles and a glass syringe for punctures. The upper big needle is used for stomach puncture; the smaller one for cardiac, suboccipital and urinary bladder punctures.**

The needle usually used for lumbar puncture can be used at postmortem inspection. However, we are using so-called “a contrast medium needle”, which is thicker and longer than that for lumbar puncture (▶ Figure 1.2); it is about 16 cm long and its internal diameter is about 1 mm; it is useful for cardiac, urinary bladder and suboccipital punctures. For stomach puncture, we are using even thicker and longer needles (20 cm long and 1.5 mm internal diameter) (▶ Figure 1.2), because the stomach usually contains solid contents. The marking with an oil-based marker pen at the sites of 5 and 10 cm from the tip of a needle is useful to estimate the depth of puncture. A conventional glass syringe of a 10–30 mL volume is recommendable rather than a plastic disposable syringe, because the glass syringe easily gives subtle touch sense to be transmitted to the finger upon drawing blood.

For cardiac puncture, the needle should be stuck rapidly at the depth of about 10 cm on the following location of the chest; on the straight line combining both nipples, on an intercostal space and at the left margin of the sternum. After removing the inner needle, the glass syringe is connected to the needle; together with pulling the plunger, the needle position is moved back and forth slowly. When blood is present in the heart, it is easily withdrawn into the syringe; at least 5 mL blood is sampled and stored.

For urine sampling, the pubic symphysis is palpated, and the needle is stuck into the urinary bladder at the upper margin of the pubic bone at an angle of about 45 degree against the abdominal skin surface. When a large amount of urine is present in the bladder, it is easily withdrawn into a syringe. Of course, the sampling of urine by catheterization *via* the urethra is possible like in the case of a living patient. Larger amounts of urine are preferable for the case in which poisoning is suspected.

For sampling of stomach contents, the above large needle is rapidly stabbed toward the stomach at the inner margin of the left costal cartilages. When a large amount of stomach contents is present, it is easily obtainable. However, it is not easy when their amount is small; it is difficult to inject the needle through the stomach wall, because the latter is too movable in the absence of a large amount of stomach contents.

According to the need, cerebrospinal fluid (CSF), hair and nails are sampled. CSF is sampled by suboccipital puncture as follows. The neck is bent forward, and the needle is stuck from the backside at the level between the foramen magnum and the first jugular vertebra to reach the cisterna magna; more than 10 mL of CSF can be obtained by such puncture. As stated before, there are many cases in which basic drugs or poisons are relatively stably retained in hair or nails for a long time; hair and nails sometimes become good alternative specimens for analysis of drugs and poisons in putrefied cadavers, and may be also useful for detection of toxins which had been taken or administered in the past. The utility of hair and nails is presented in Chapter I.2 entitled "Alternative specimens" of this book.

Puncture needles should be kept clean; after their use, blood attached to the needles should be immediately removed by washing with tap water by moving the inner needles back and forth. The bloody needles should not be left to dryness after use.

## Sampling at autopsy

When death by poisoning is suspected, stomach contents, right and left heart blood and urine are collected as much as possible (10–100 mL) and stored. More than 20 g of each tissue of the brain, lung, heart, liver, kidney and spleen should be sampled. In case of a putrefied cadaver, the skeletal muscle in the thigh may become a useful specimen for analysis, because the tissue of this part is most resistant to putrefaction and contains levels of drugs and poisons almost equal to those in blood. The tissues from different organs should not be put in the same container or polyethylene bag; they should be kept separately. Special care should be taken for the stomach contents, because it may contain a very large amount of a drug or a poison, which can contaminate other specimens.

When subcutaneous or intramuscular injection of toxins is suspected, the probable injection site is incised, and the skin is carefully removed to sample the corresponding subcutaneous adipose tissue or muscle, which may contain high levels of unchanged drugs or poisons.

## Storage of samples

---

Blood or urine obtained from a living patient or a cadaver is kept in a glass vial (or tube) with a Teflon screw cap; the vial should be sealed completely. When a polyethylene or plastic tube is used, the contamination of the sample by a plasticizer and other compounds should be taken into mind. Solid samples (organs and tissues) are separately put in small polyethylene bags with fasteners to prevent them from drying. It is preferable that every sample is prepared in duplicate; one is kept at 4° C for analysis within a few days and the other kept at –80° C for a long storage. When glass tubes are kept at temperatures below 0° C, the rupture of glassware due to expansion of frozen fluids should be avoided by leaning or laying the tubes.

## References

- Suzuki O, Watanabe-Suzuki K, Seno H (2000) Current situation and perspectives of clinical laboratory investigation. *J Med Technol* 44:1480–1486 (in Japanese)
- Yamamoto I (1995) *Yamamoto's Dictionary of Drug Metabolism*. Hirokawa Publishing Co., Tokyo (in Japanese)
- Japan Pharmaceutical Information Center (2001) *Drug in Japan*, 24th edn. Jiho Inc., Tokyo (in Japanese)

## 1.2 Alternative specimens

By *Fumio Moriya*

### Introduction

Blood, urine and stomach contents (including gastric lavage fluid and vomitus) are usually used as specimens for analysis of drugs and poisons for living subjects. A blood concentration of a toxin can be an indicator for estimation of intoxication degree. Urine sometimes contains large amounts of metabolites and/or an unchanged form of a toxin; it contains low levels of proteins, which usually interfere with analysis, and thus is suitable for screening tests using immunoassays without tedious pretreatments. Stomach contents can be a useful specimen for identification of a toxin, only when the time after ingestion is short; it contains a large amount of an unchanged form of a compound ingested. However, there are many cases, in which neither blood, urine nor stomach contents can be obtained, because of various reasons. Even with urine, illegal drugs become undetectable several days after their administration. Recently, according to marked development of analytical technologies, possibilities are being extended to ultra-sensitive analysis of toxins in hair, nails, saliva and sweat; these specimens are proving to be useful for toxin analysis, because many toxins are excreted into these specimens [1].

The use of non-therapeutic drugs, by pregnant women is now a problem, because of their bad effects on the fetus. To assess the effects of maternal use of drugs on the fetus, data obtained from a newborn baby together with the mother sometimes become necessary. In that case, blood and urine are, of course, usually used. Recently, however, meconium to be excreted by a newborn baby has become an object of interest [2].

At autopsy, any body fluid and tissue can be used for analysis; blood, urine, bile, stomach contents and the liver are being well used. For assessment of intoxication degree, the blood levels of drugs and poisons are usually used; however, we occasionally encounter the cases, in which sufficient amounts of blood cannot be collected, because of exsanguination. In place of blood samples, pericardiac fluid, cerebrospinal fluid, vitreous humor and skeletal muscle can be used [3, 4].

### Hair

---

Hair consists of its shaft and root; the cross section shows the cuticle, cortex and medulla. The cortex part consists of keratine and melanin, and the part counts 80–90% of the whole weight. At the hair bulb, there is the hair papilla with a bundle of capillary vessel, where drugs and poisons are transported from blood to hair cells. The cells are keratinized during their growth. Through this procedure, drugs and poisons are incorporated into hair, resulting in their stable storage in it. The growth rate of hair is dependent to some extent on age, sex, race and health conditions; the rates are about 10 mm and 6 mm per month for scalp and pubic hair, respectively [5].

Hair had been used for detecting its exposure to heavy metals by chemical analysis from the 1950s [6]. The first use of hair for drug analysis is not so old; Baumgartner et al. [7] were

■ **Table 2.1**

**Segmental analysis of methamphetamine in hair and nails, obtained from a habitual abuser at autopsy, by mass spectrometry in the CI mode\***

Specimen	Length from the root (cm)	Methamphetamine concentration (ng /10 mg)
Scalp hair (parietal region)	0–0.2	10.8
	0.2–1.0	1.38
	1.0–2.0	2.19
	2.0–3.0	0.68
Pubic hair	0–0.2	25.2
	0.2–2.0	0.76
	2.0–5.0	0.08
Finger nail (left thumb)	0–0.5	0.83
	0.5–1.0	0.76
	1.0–1.5	0.38
	1.5–2.0	0.08
Toe nail (left big toe)	0–0.5	1.51
	0.5–1.0	0.60
	1.0–1.5	0.23
	1.5–2.0	0.23

\* Cited from reference [9]; methamphetamine could not be detected from any body fluid or organ.

first to detect opiate from hair of a heroin abuser by radioimmunoassays in 1979. Thereafter, many kinds of drugs were reported to accumulate in hair. Nowadays, hair analysis is recognized to be a useful tool for detection of drugs use or abuse. It is possible to detect drug use history of several months by making segmental analysis of hair, when it is sufficiently long [8]. For example, the authors et al. [9] could detect repeated abuse of methamphetamine until the time 3–5 days before his death by segmental analysis of both hair and nails obtained at autopsy (▶ *Table 2.1*); in this case, methamphetamine could not be detected from blood, urine and organs.

For samplings of hair, the scalp hair at the posterior part of parietal region is said to be best, because of its constant growth rate [10]. Prior to analysis, it is necessary to remove environmental (exogenous) compounds attached to the surface of hair. Some surfactants, 0.05–1% sodium laurylsulfate, organic solvents such as n-hexane, dichloromethane, methanol, ethanol and acetone, and 0.01–0.1 M HCl are used for washing the hair surface. To enhance the washing efficiency, an ultrasonic cleaner is often used. To extract a target compound from hair, the sample is put in methanol, 0.1 M HCl or 0.1 M NaOH and incubated at 40–60° C. There are also methods employing digestion with 2.5 M NaOH or proteinase K. These extracts are subjected to liquid-liquid extraction or solid-phase extraction to purify target compounds; the final analysis is usually made by immunoassays, HPLC, GC or GC/MS [1, 11].

On the basis of extensive data of hair analysis, the cutoff values when measured by GC/MS were presumed to be 1.0 pg/10 mg hair for marijuana metabolites, 5 ng/10 mg hair for cocaine, opiate and methamphetamine, and 3 ng/10 mg hair for phencyclidine [12].

Hair is a good specimen for long-term detection of drugs and poisons; it is possible to analyze a compound many days later. However, we should keep it in mind that the drug use within 3 days cannot be detected by hair analysis.

## Nails

---

The nail consists of nail body (plate) and root; its growth takes place at the nail root and the Malpighian layer of the nail bed. The nail contains hard keratin and its growth process is similar to that of the hair cortex. Drugs are considered to be transported from blood to nail matrix cells at capillary vessels located around the nail root. Drugs incorporated into nails are very stable like in hair. Growth rates of nails were reported to be 3–5 mm [13] and 1.1 mm [14] per month for the fingers and toes, respectively, although they differ to some extent according to seasons. In spite of the fact that similar mechanisms do exist in nails for transportation and accumulation of drugs to those in hair, the reports on nail analysis are not many. In 1984, Suzuki et al. [15] first reported detection of amphetamines from the nails of methamphetamine abusers. Since then only a few reports on methamphetamine detection from nails were reported [9, 16].

The analytical procedure for nails can be similar to that for hair. Before extraction, nails should be washed with methanol and water to avoid exogenous contamination. The extraction can be made after dissolution in 2.5 M NaOH with heating or after crushing in 0.6 HCl. Although the reports on nail analysis are not many, its usefulness seems comparable to that of hair analysis, in view of identification ability of a drug previously administered and estimation of both amount and time (period) of administration [9]. Nails seem worth considering as a good alternative specimen for both antemortem and postmortem subjects.

## Saliva

---

It was in the middle of 1950s when drugs were reported movable from blood to saliva [1]. Since then many researchers examined the usefulness of saliva analysis, and clarified that drug concentrations in saliva reflected those in blood, showed close relationship with the pharmacological effects and could be used for calculation in pharmacokinetics. Recently, saliva is being tried for therapeutic drug monitoring and for detection of the driving under the influence of a drug in the world. Drugs are usually excreted into saliva in their unchanged forms. The concentration ratio of saliva to blood tends to be less than 1 for acid and neutral drugs, and more than 1 for basic drugs; the ratio is also dependent on pH values of saliva [17]. The ratio for alcohol is about 1.1 and not influenced by pH of saliva [18].

Saliva can be easily sampled by directly spitting to a tube; a small cotton ball, which had been weighed, can be placed just under the tongue and kept there for a while for absorption of saliva into the cotton. These are all noninvasive. It is possible to enhance saliva secretion by biting a Teflon plate or rubber bands; citric acid is also useful for stimulating the secretion. However, it should be kept in mind that during the change in the secretion rate, the amount of a drug excreted into saliva may change according to changes in its pH [17].

A close relationship between drug concentrations in blood and in saliva can be found only under strictly controlled conditions. This means that it is difficult to determine blood drug concentrations from the results of saliva analysis in actual cases. However, the drug analysis using saliva is qualitatively useful for proving drug use, when contamination is excluded.

## Sweat

---

Sweat is a fluid excreted from the sweat glands (eccrine and apocrine types). The eccrine glands are widely distributed at the surface of the whole body. The apocrine glands are located in the axillary, mammary, genital and perianal regions. The glands are under the control of sympathetic nerves; but a majority of the glands is cholinergic and a small part is adrenergic. The maximal excretion volume was reported to be about 2 L/day in healthy subjects and about 4 L/day in trained sport athletes; but the volumes and components are greatly different according to individuals, types of the gland and various stresses (emotional, physical and thermal) [19].

The sweat analysis started in about 1970, and showed that various drugs can be detected from sweat [19]. Johnson and Malbach [20] reported that there was close relationship between  $pK_a$  of a drug and its amount of excretion into sweat, and also between drug concentrations in sweat and in plasma. However, the sampling of sweat is a problem; it is difficult to collect it quantitatively. In actual cases, the sweat components are collected by wiping the skin surface with cotton, gauze or towel; PharmChek™ sweat patch (PharmChem Lab. Inc, Menlo Park, CA, USA) is commercially available for absorbing sweat components [19]. Underwears, which absorbed sweat components, were used for detection of amphetamines [21]. The components absorbed could be eluted with water, followed by extraction of drugs before instrumental analysis.

The sweat is not suitable for quantitative analysis of drugs, because of its problem for samplings. However, only advantage of the use of sweat is the longer periods of drug excretion into sweat; drugs could be detected from sweat even 1–4 weeks after single administration [1].

## Meconium

---

Meconium is dark-greenish/green-black and muddy, but does not smell unlike feces of children and adults. It contains meconium vesicles, downs, squamous cells, lipid droplets and cholesterol crystals. It begins to accumulate in the large intestine at week 16 of pregnancy, and is not excreted before birth; it is excreted 1–3 days after birth [22]. Ostrea et al. [23] first reported that meconium was suitable as a specimen for drug analysis in newborn babies. A drug, which has been administered to a pregnant woman, passes through the placenta, reaches the fetus, and is metabolized in the fetal liver. The drug together with its metabolites is partly excreted into bile and finally stored in meconium [24]. Amniotic fluid, which may contain a maternal drug and its metabolites, is swallowed by the fetus, also resulting in the accumulation of compounds in meconium [25].

The samplings of meconium is easy; meconium excreted in diapers is put to a container. The volume of meconium to be analyzed is usually 0.5–1 g. Liquid-liquid extraction and/or solid-phase extraction are employed [2]. The author et al. [26] made drug analysis for meconium and urine of 50 newborn babies delivered from mothers, who had been suspected for their drug abuse, at University of Southern California Medical Center; as results benzoylcegonine could be detected in 12 cases; 5 cases positive for both meconium and urine, 3 cases positive only for meconium and 4 cases positive only for urine. Opiate was also detected in 7 cases; 3 cases positive for both meconium and urine, 2 cases positive only for meconium and 2 cases positive only for urine. In addition, phencyclidine was detected from meconium in one case [26].



The author et al. [27] divided the large intestine containing meconium into 5 parts of a still birth baby delivered from a woman, who had been habitually abusing cocaine during pregnancy, and measured benzoylecgonine levels in each part; but we obtained similar levels (1.86–2.24 ng/g) of the metabolite in each part.

Meconium cannot be used for detection of drug use by a mother on a few days before delivery; but it is useful for the use during an earlier period. The merit of the use of meconium is that drug concentration is usually high when a drug was habitually used by a mother and that the amount of meconium obtainable is large enough. It seems to be a better alternative specimen for living newborn babies than hair and nails.

## Pericardial fluid

---

Pericardial fluid exists in the pericardial space; 5–10 mL or more of it can be obtained, if a cadaver is relatively fresh. The fluid can be easily sampled with a syringe after opening the pericardium.

Pericardial fluid has not drawn attention as a specimen for drug analysis until now. However, the author et al. [3] have clarified its usefulness in forensic toxicology by examining autopsy cases. The concentrations ( $x$ ) of acid, neutral and basic drugs in pericardial fluid were compared with those ( $y$ ) in blood of the femoral vein using fresh cadavers almost without postmortem changes [4]; there were good correlation between the two body fluids ( $y=1.03x-0.034$ ,  $r=0.994$ ,  $n=16$ ), suggesting that drug concentrations in pericardial fluid is useful for estimation of intoxication degree. The ratio of drug concentration in pericardial fluid to that in blood of the femoral vein was  $1.33\pm 0.55$  [4]. Other merits are that sufficient amounts of pericardial fluid can be obtained even from a completely exsanguinated body and that the clean fluid can be directly used for drug screening with an immunoassay kit such as Triage™ without any pretreatment. In addition, the author et al. [4] reported that an average value of drug concentrations in pericardial fluid and in cerebrospinal fluid gave more accurate value for estimation of blood drug concentration than the value of pericardial fluid only.

Care should be taken against that pericardial fluid is easily contaminated by postmortem diffusion, when a large amount of a drug is present in the stomach. The mechanism by which a drug is transported from blood to pericardial fluid antemortem is considered to be passive diffusion. The drug concentrations in pericardial fluid seem to change almost in parallel with those in blood; but more precise data on the pharmacodynamic relationship between the interval from the intake of a drug to death and its pericardial fluid concentration are required.

## Cerebrospinal fluid (CSF)

---

CSF is slightly yellowish fluid secreted from the choroids plexus of the ventricle, and fills the ventricles and subarachnoid spaces; its protein contents is as low as about 0.02%. About 400 mL of CSF is produced per day, and transported to the sinus; the total amount of CSF in a adult human is 100–150 mL [28]. CSF can be sampled by lumbar or suboccipital puncture at post-mortem inspection, or by introducing a thin vinyl tube into the ventricles after removal of some parts of the brain at autopsy.

There are almost no reports dealing with the relationship between drug concentrations in CSF and in blood except for alcohol. The authors et al. [4] compared the concentrations ( $x$ ) of acid, neutral and basic drugs in CSF with those ( $y$ ) in blood of the femoral vein; the equation and correlation coefficient were:  $y=1.28x-0.055$  and  $r=0.991$  ( $n=16$ ). The ratio of drug concentration in CSF to that in blood of the femoral vein was  $0.55\pm 0.29$ . Though the value was far less than 1.0, the data of drug concentrations in CSF can be a supporting evidence for judging whether a death is due to poisoning.

## Vitreous humor

---

Vitreous humor is a clear gel-like fluid filling the vitreous body of the eyeball. A 1–2 mL volume of the fluid can be obtained from one eyeball by puncture. Vitreous humor was first used for alcohol analysis in 1966 [29]. Since then, many researchers tried analysis of various abused and therapeutic drugs in vitreous humor, and studied the relationship between drug concentrations in vitreous humor and in blood [30]. The author et al. [4] also made similar experiments; it was disclosed that drug concentrations in vitreous humor were sometimes helpful for assessment of intoxication degree, like those in pericardial fluid and CSF. However, it seemed difficult to estimate a blood drug concentration only with the concentration in vitreous humor. The volume of vitreous humor is limited, and thus it is not suitable for extensive analysis for many drugs.

## Skeletal muscle

---

Garriott [31] and the author et al. [3] clarified that drug concentrations in the skeletal muscle well reflected those in blood. In the case of alcohol, the skeletal muscle-to-blood ratio of alcohol concentration usually show a value of about 1.0. Therefore, when blood cannot be sampled or contamination of blood is suspected, alcohol concentrations in the skeletal muscle can be an indicator for intoxication degree and estimation of the quantity ingested [18, 32]. Although the concentration equality observed for alcohol in the skeletal muscle is not the case for other drugs [33], the drug concentration in the muscle seems very helpful for judgement of poisoning and its degree. In addition, the skeletal muscle is obtainable in large quantities; the specimen is useful in cases in which any body fluid cannot be sampled, and even in cases of mutilated and dismembered bodies.

## References

- 1) Inoue T, Seta S, Goldberger BA (1995) Analysis of drugs in unconventional samples. In: Liu RH, Goldberger BA (eds) Handbook of Workplace Drug Testing. AACCC Press, Washington DC, pp 131–158
- 2) Kadehjian L (1996) Drug testing of meconium: determination of prenatal drug exposure. In: Wong SHY, Sunshine I (eds) Handbook of Analytical Therapeutic Drug Monitoring and Toxicology. CRC Press, Boca Raton, pp 265–279
- 3) Moriya F, Hashimoto Y (1999) Pericardial fluid as an alternative specimen to blood for postmortem toxicological analyses. *Legal Med* 1:86–94
- 4) Moriya F, Hashimoto Y (2000) Criteria for judging whether postmortem blood drug concentrations can be used for toxicologic evaluation. *Legal Med* 2:143–151

- 5) Japan Permanent Wave Fluid Kogyo Kumiai (ed) (1980) Hair and Permanent Wave. Shin-biyo-shuppan, Tokyo, (in Japanese)
- 6) Maugh TH 2nd (1978) Hair: a diagnostic tool to complement blood serum and urine. *Science* 202:1271–1273
- 7) Baumgartner AM, Jones PF, Baumgartner WA et al. (1979) Radioimmunoassay of hair for determining opiate abuse histories. *J Nucl Med* 20:749–752
- 8) Sachs H (1996) Forensic applications of hair analysis. In: Kintz P (ed) *Drug Testing in Hair*. CRC Press, Boca Raton, pp 211–222.
- 9) Moriya F, Miyaishi S, Ishizu H (1992) Presumption of a history of methamphetamine abuse by postmortem analyses of hair and nails: a case report. *Jpn J Alcohol Drug Dependence* 27:152–158
- 10) Harkey MR, Henderson GL (1989) Hair analysis for drugs of abuse. In: Baselt RC (ed) *Advances in Analytical Toxicology, Vol 2*. Year Book Medical Publishers, Chicago, pp 298–329
- 11) Moeller MR, Eser HP (1996) The analytical tools for hair testing. In: Kintz P (ed) *Drug Testing in Hair*. CRC Press, Boca Raton, pp 85–120
- 12) Cairns T, Kippenberger DJ, Gordon AM (1996) Hair analysis for detection of drugs of abuse. In: Wong SHY, Sunshine I (eds) *Handbook of Analytical Therapeutic Drug Monitoring and Toxicology*. CRC Press, Boca Raton, pp 237–251
- 13) Hamilton JB, Terada H, Mestler GE (1955) Studies of growth throughout the lifespan in Japanese: growth and size of nails and their relationship to age, sex, heredity, and other factors. *J Gerontol* 100:401–415
- 14) Bean WB (1953) A note for fingernail growth. *J Invest Dermatol* 20:27–31
- 15) Suzuki O, Hattori H, Asano M (1984) Nails as useful materials for detection of methamphetamine or amphetamine abuse. *Forensic Sci Int* 24:9–16
- 16) Suzuki S, Inoue T, Hori H et al. (1989) Analysis of methamphetamine in hair, nail, sweat, and saliva by mass fragmentography. *J Anal Toxicol* 13:176–178
- 17) Cone EJ, Jenkins AJ (1996) Saliva drug analysis. In: Wong SHY, Sunshine I (eds) *Handbook of Analytical Therapeutic Drug Monitoring and Toxicology*. CRC Press, Boca Raton, pp 303–333
- 18) Caplan YH (1996) Blood, urine, and other fluid and tissue specimens for alcohol analysis. In: Garriott JC (ed) *Medicolegal Aspects of Alcohol*, 3rd edn. Lawyers & Judges Publishing, Tucson, pp 137–150
- 19) Sunshine I, Sutliff JP (1996) Sweat it out. In: Wong SHY, Sunshine I (eds) *Handbook of Analytical Therapeutic Drug Monitoring and Toxicology*. CRC Press, Boca Raton, pp 253–264
- 20) Johnson HL, Malbach HI (1971) Drug excretion in human eccrine sweat. *J Invest Dermatol* 56:182–186
- 21) Nakashima K, Al-Dirbashi O, Ikeda K et al. (2000) Determination of methamphetamine and amphetamine in abusers' underwear by HPLC with UV and fluorescence detection. *Jpn J Forensic Toxicol* 18:148–149 (in Japanese with an English abstract)
- 22) Behrman RE, Vaughan VC (eds) (1987) *Nelson Textbook of Pediatrics*, 13th edn. Saunders, Philadelphia, p 7
- 23) Ostrea EM, Parles PM, Brady MJ (1988) Rapid isolation and detection of drugs in meconium of infants of drug-dependent. *Clin Chem* 34:2372–2373
- 24) Krauer B, Dayer P (1991) Fetal drug metabolism and its possible clinical implications. *Clin Pharmacokinet* 21:70–80
- 25) Garcia DC, Romero A, Garcia GC et al. (1996) Gastric fluid analysis for determining gestational cocaine exposure. *Pediatr* 98:291–293
- 26) Moriya F, Chan K-M, Noguchi TT et al. (1994) Testing for drugs of abuse in meconium of newborn infants. *J Anal Toxicol*;18:41–45
- 27) Moriya F, Chan K-M, Noguchi TT et al. (1995) Detection of drugs-of-abuse in meconium of a stillborn baby and in stool of a deceased 41-day-old infant. *J Forensic Sci*; 40:505–508
- 28) Fujimori B, Itoh S, Nagai T et al. (eds) (1974) *Physiology*, 7th edn. Nanzando, Tokyo, (in Japanese)
- 29) Sturner WQ, Coumbis MS (1966) The quantitation of ethyl alcohol in vitreous humor and blood by gas chromatography. *Am J Clin Pathol* 46:349–351
- 30) Bost RO (1996) Analytical toxicology of vitreous humor. In: Wong SHY, Sunshine I (eds) *Handbook of Analytical Therapeutic Drug Monitoring and Toxicology*. CRC Press, Boca Raton, pp 281–302
- 31) Garriott JC (1991) Skeletal muscle as an alternative specimen for alcohol and drug analysis. *J Forensic Sci* 36: 60–69
- 32) Ito A, Moriya F, Ishizu H (1998) Estimating the time between drinking and death from tissue distribution patterns of ethanol. *Acta Med Okayama* 52:1–8
- 33) Langford AM, Taylor KK, Pounder DJ (1998) Drug concentration in skeletal muscles. *J Forensic Sci* 43:22–27

## I.3 Pitfalls and cautions in analysis of drugs and poisons

By Fumio Moriya

### Introduction

Blood and urine are the common specimens for drug analysis in both antemortem and postmortem cases. Usually, urine is used for drug screening using immunoassays at the first step; secondly, the drug detected is chromatographically quantitated with blood. The data obtained are carefully assessed with taking the values reported in references into consideration together with clinical and postmortem findings; the judgement of poisoning and its degree is made comprehensively.

The periods between samplings and analysis and the storage conditions of samples are very important for assessment of analytical results for human specimens, especially for postmortem specimens; the postmortem intervals and the degree of putrefaction should be always taken into consideration. Even in a vial (*in vitro*) after sampling and also inside the whole body postmortem, drugs may be metabolized by coexisting enzymes [1, 2]; postmortem production [3, 4] and decomposition [5] can take place by the action of bacterial growth. In the autopsy cases, the source of blood sampled should be recorded exactly; the high concentrations of drugs present in the lung, heart and liver can diffuse into the surrounding tissues, resulting in higher drug concentrations in blood there [6]. When a large amount of a drug is present in the stomach, it diffuses into the surrounding tissues and blood postmortem [7, 8]. The urinary bladder sometimes contains a large amount of urine with a high drug concentration; in such a case, diffusion of a drug from the bladder into blood of the femoral vein can take place postmortem [9]. When vomitus containing a high concentration of a drug is aspirated into the trachea or bronchus, or local anaesthetic jelly is applied to the trachea upon intubation, the concentration of the drug in heart blood may be enhanced postmortem [10, 11]. Even if analytical instruments are excellent, correct diagnosis of poisoning is impossible without considering the above phenomena. In analysis of drugs and poisons, there are many subtle points to be considered; in this chapter, pitfalls and cautions are presented for correct analysis in poisoning.

### Metabolism of drugs by coexisting enzymes

Ester compounds, such as local anaesthetics, are susceptible to their metabolism by coexisting enzymes; they are easily metabolized postmortem by plasma cholinesterase in a cadaver and even *in vitro* after antemortem samplings [1, 2]. The cholinesterase activity in blood does almost not decline 3 weeks after its storage at room temperature [12]. Cocaine, one of the local anaesthetics and most popular abused drugs, is largely converted to benzoylecgonine by chemical reaction in antemortem blood at pH 7.4, and a minor part of the drug is metabolized by plasma cholinesterase to yield ecgonine methyl ester [13]. The latter is further decomposed to ecgonine by chemical hydrolysis very rapidly and thus not accumulates in blood of living sub-

jects [13]. In the case of postmortem blood, the pH value of blood rapidly declines due to anaerobic glycolysis postmortem, resulting in no chemical hydrolysis of cocaine into benzoylecgonine but in accumulation of ecgonine methyl ester by the action of the coexisting cholinesterase [13]. Therefore, the cocaine concentration in blood at the point of death was reported to be exactly estimated by summing up the concentrations of cocaine and ecgonine methyl ester [14].

To prevent ester compounds from their decomposition in blood, the addition of NaF, a cholinesterase inhibitor, at the concentration of about 1% is being recommended. Cocaine seems stable in blood for 2–3 weeks in the presence of NaF in a refrigerator [2]. However, in the case of tetracaine, the addition of neostigmine is necessary in place of NaF to suppress the *in vitro* metabolism completely. It should be mentioned that dichlorvos, an ester-type organophosphorus pesticide, is decomposed more easily in the presence of NaF [15].


Heroin is more susceptible to decomposition by plasma cholinesterase than cocaine; the half-life of the reaction in living subjects is only several minutes [13]. Therefore, it was difficult to detect heroin from blood of a cadaver, who had received intravenous injection only several minutes before [16]; but 6-monoacetylmorphine, the main metabolite of heroin, is relatively stable in blood and detectable postmortem [16].

## Postmortem production and decomposition of compounds by putrefactive bacteria

Various kinds of compounds are postmortem produced by growing bacteria in human specimens; especially alcoholic and amine compounds should be noted in toxicological analysis. Ethanol is most commonly produced by fermentation. The *in vitro* production of ethanol in blood and urine is much less than its production inside a cadaver, and usually give no problems under storage at 4° C for a week. However, when a large amount of glucose and marked contamination by bacteria are present, non-negligible amounts of ethanol can be produced in specimens collected. To discriminate ethanol produced postmortem from the antemortem one, n-propanol can be used as an indicator, because it is produced by bacteria concomitantly [3]. The concentration of n-propanol is not lower than 5% of a postmortem ethanol concentration [3].

The most typical amine produced during putrefaction is  $\beta$ -phenylethylamine. Its structure is similar to those of amphetamines. The similarity of the amine sometimes gives false positive results during screening by immunoassays [17, 18].

In analysis of drugs in specimens collected from cadavers killed especially by severe injuries, followed by intensive medical treatments, a special caution is needed. In such cadavers, non-negligible amounts of ethanol and  $\beta$ -phenylethylamine are sometimes produced by the action of bacterial translocation [19,21].

The metabolic reactions for drugs by bacteria are essentially reductive; nitro, *N*-oxide, oxime, thiono, sulfur-containing heterocyclic and aminophenolic compounds are known to be decomposed rapidly [5]. Robertson and Drummer [22] reported that nitrobenzodiazepine drugs were metabolized to 7-amino reduced forms by enteric bacteria and that such reducing reaction could not be suppressed by adding NaF. The author et al. collected the cerebral cortex, diencephalons, cerebellum of a nitrazepam user at autopsy, and measured nitrazepam and 7-amino-nitrazepam both immediately and 10 days (at 4° C) after autopsy as shown in  Table 3.1.

■ **Table 3.1**

**Postmortem changes in the level ( $\mu\text{g/g}$ ) of nitrazepam and 7-aminonitrazepam during *in vitro* storage of specimens obtained from a nitrazepam user at autopsy**

Specimen	Immediately after autopsy		10 days after autopsy*	
	Nitrazepam	7-Aminonitrazepam	Nitrazepam	7-Aminonitrazepam
Cerebral cortex	3.49	2.55	0.626	5.11
Diencephalon	6.22	2.49	4.61	3.82
Cerebellum	2.17	5.11	0.545	6.55

\* Stored at 4° C.

The reductive reaction for nitrazepam proceeds upon storage of specimens at 4° C, but such reaction can be completely suppressed at -20° C [22].

Clozapine, an antipsychotic drug, is easily metabolized antemortem to an *N*-oxide form, which accumulates in blood of living subjects; the metabolite can be conversely reduced to form the precursor clozapine in a cadaver and in blood stored in a vial by the action of bacteria.

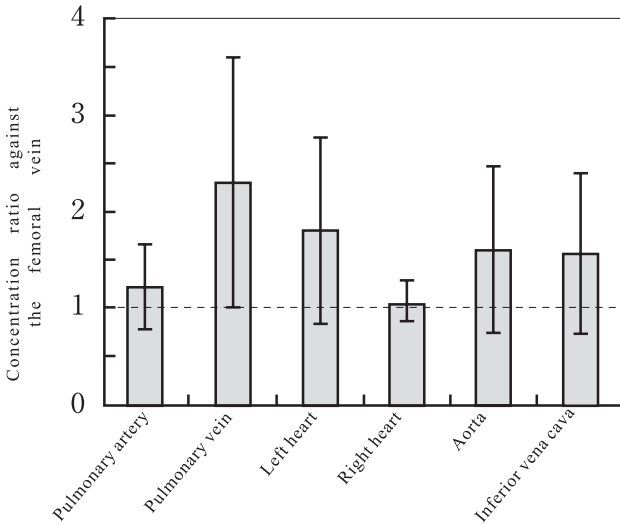
The concentration ratios of each free form to each glucuronate-conjugated form of opiates in blood are known to be helpful to estimate intervals after their administration; but the conjugated forms can be hydrolyzed to form free opiates by metabolism of bacteria, when bacteria growth is marked [23].

## Postmortem redistribution of drugs

Postmortem redistribution is more common for basic drugs, which have high affinities to the lung, heart muscle and liver and show wide distribution areas [6]. These drugs are partly liberated from tissues with high contents, penetrate vessel walls and diffuse into blood, resulting in higher concentrations of the drugs in surrounding tissues than true concentrations at the time of death. After death, the supply of oxygen and ATP, and the  $\text{Na}^+/\text{K}^+$  pumping function of cell membranes stop; then cell membranes and organelles are damaged. In the cells, energy-requiring bindings of proteins with drugs are inhibited, and pH is lowered as a result of accumulation of lactic acid produced by anaerobic glycolysis. These conditions of cells cause basic drugs to diffuse outside the cells more easily.

Holt and Benstead [24] first demonstrated the increase of blood drug concentration post-mortem as a result of redistribution; they found a higher concentration of digoxin in blood of the heart than in blood of the femoral vein in an autopsy case of a digoxin-user. Jones and Pounder [25] reported analytical results of imipramine and its metabolite desipramine in blood and various organs of a victim, who had died by ingesting imipramine and acetaminophen together with alcohol (postmortem interval: 12 h); when the concentration of imipramine (2.3  $\mu\text{g/mL}$ ) and desipramine (1.5  $\mu\text{g/mL}$ ) in peripheral blood is assumed as 1.0, the relative values were 2.3 and 2.2 in blood of the thoracic aorta, 2.1 and 1.4 in blood of the inferior vena cava, 3.5 and 3.4 in blood of the pulmonary artery, 7.0 and 7.1 in blood of the pulmonary vein, 70 and 115 in the lung, and 78 and 52 in the liver, respectively. The above data show that imipramine concentrations in blood of the pulmonary artery and vein are higher than those in blood of the inferior vena cava, although imipramine concentration in the lung was almost equal to that in the liver, suggesting that the diffusion of the drug into blood is more marked

■ **Figure 3.1**



**Variation in drug concentration in blood obtained from different locations of each cadaver. Blood specimens were obtained from fresh cadavers, which had ingested various drugs, with almost no postmortem changes. Each value was expressed as a ratio of the concentration in blood of a target location to that in blood of the femoral vein for each victim and for each drug. All values obtained from blood of each location were averaged irrespective of the kinds of drugs. The bars show means  $\pm$ SD ( $n=11-16$ ). The drugs detected were: phenobarbital, phenytoin, ephedrine, diazepam, nordiazepam, lidocaine, methamphetamine, codeine, barbital, zotepine, amitriptyline and nortriptyline.**

for the lung than for the liver. Hilberg et al. [26] reported, using rats, that the concentrations of amitriptyline and its metabolite nortriptyline in blood of the heart increased within 2 h after death, and those in blood of the inferior vena cava increased more than 5 h after death. The author et al. [27, 28] also clarified that basic drugs distributed in the lung tissue at high concentrations diffuse postmortem, through thin walls of the pulmonary vein, into blood of the vein and are further redistributed into blood of the left atrium of the heart; this is the mechanism of the higher concentrations of basic drugs in heart blood. The increase in drug levels in blood of the right heart is less than in blood of the left heart. In many of autopsy cases, drug concentrations in blood of the right heart are similar to those in peripheral blood (in the femoral vein) (➤ *Figure 3.1*). Therefore, blood of the right heart together with peripheral blood seems to be good specimens for determination of the correct blood drug level, when a cadaver is relatively fresh [29]. Cautions are needed against that the posture movements of a body at postmortem inspection and during its transportation can cause a flow of blood in the vessels and thus enhance such redistribution of drugs.

## Postmortem diffusion of drugs from the stomach and urinary bladder

---

Ethanol is best studied for its postmortem diffusion from the stomach. Pounder and Smith [7] reported that the body fluids most influenced by the diffusion of the stomach ethanol were pericardial fluid, followed by blood of the left pulmonary vein, aorta, left heart, pulmonary artery, superior vena cava, inferior vena cava, right heart and right pulmonary vein; the blood in the femoral vein was almost not affected. The postmortem diffusion of ethanol from the stomach is dependent upon the residual amounts of ethanol in the stomach, physique and postmortem intervals. In actual cases, such diffusion is a problem, when more than 100 g contents containing more than several percent of ethanol are present in the stomach and the post-mortem interval is longer than one day.

Not many basic studies have not been reported on the postmortem diffusion of general drugs from the stomach. A drug can diffuse from the stomach postmortem into the surrounding tissues and body fluids in the presence of a large amount (more than several ten mg) of the drug in the stomach with a long postmortem interval. However, the blood of the femoral and subclavian veins is almost not affected about 2 days after death [8].

Although the postmortem diffusion of a drug from the urinary bladder is rare, it can take place in the presence of a large amount of urine containing a high content of a drug. The author et al. [9] experienced an autopsy case of a drug abuser, in which diphenhydramine and dihydrocodeine diffused from the urinary bladder, resulting in the remarkable increase in their concentrations in the femoral vein; although the postmortem interval was 9 days, the putrefaction was not so marked because of the winter season. The amount of urine in this case was as large as 600 mL, and diphenhydramine and dihydrocodeine concentrations in it were 22.6 and 37.6  $\mu\text{g}/\text{mL}$ , respectively; their concentrations in the femoral vein were 1.89 and 3.27  $\mu\text{g}/\text{mL}$ , which were much higher than those (0.204–0.883 and 0.173–1.01  $\mu\text{g}/\text{mL}$ ) obtained from other parts of circulation, respectively. Although it is unequivocally accepted by forensic chemists that blood of the femoral vein is most suitable for postmortem analysis of drugs, it seems dangerous to use only femoral vein blood for drug analysis because of our above experience.

## Postmortem diffusion of drugs from the trachea into heart blood

---

In the autopsy cases, in which vomitus containing a large amount of a drug is aspirated into the trachea, postmortem diffusion of a drug into the surrounding tissues of the trachea, especially into heart blood, should be taken into consideration [10]. In forensic science practice, ethanol is the case for such diffusion from the trachea [10]. In the ethanol-aspirated case, the story becomes complicated, because both diffusions from the trachea and from the stomach take place concomitantly. There are not many reports dealing with comparison of the diffusion from the trachea with that from the stomach. The postmortem diffusion velocity of toluene from the trachea was reported to be faster than that from the stomach, after thinner solvent had been injected into both trachea and stomach of a human cadaver [30]. According to the experiments, in which ethanol, paracetamol and dextropropoxyphene were introduced into the trachea, the drugs diffused into blood of the pulmonary vein and artery most rapidly, followed by blood of the heart, superior vena cava and aorta [31].



■ **Table 3.2**

**Lidocaine concentrations in various body fluids and organs obtained from 4 victims who did not regain heart beats after resuscitation treatments\***

Specimen	Lidocaine concentration ( $\mu\text{g}/\text{mL}$ or $\mu\text{g}/\text{g}$ )			
	Case 1	Case 2	Case 3	Case 4
Pulmonary artery blood	–	–	–	2.04
Pulmonary vein blood	–	–	–	2.29
Left heart blood	0.349	1.02	–	1.55
Right heart blood	0.102	0.209	–	0.699
Aorta blood	–	–	0.642	–
Superior vena cava blood	–	–	0.746	–
Inferior vena cava blood	0.195	0.163	0.133	0.491
Iliac vein blood	–	0.074	0.057	0.152
Femoral vein blood	–	0.015	ND	ND
Cerebrospinal fluid	ND	–	–	0.191
Vitreous humor	–	–	–	0.007
Pericardial fluid	0.193	0.097	0.171	0.489
Bile	–	–	–	ND
Urine	–	–	–	ND
Cerebrum	ND	ND	ND	0.044
Left lung	–	10.9	1.37	9.33
Right lung	–	2.65	1.41	2.60
Heart muscle	–	–	–	0.186
Liver	ND	ND	ND	0.183
Right kidney	–	ND	ND	0.020
Right femoral muscle	ND	ND	ND	ND

\* Xylocaine™ jelly was used at intubation. ND: not detected.

Case 1: 3.5 month female, resuscitation 5 min, postmortem interval about 20 h.

Case 2: 44 year male, resuscitation 5 min, postmortem interval about 20 h.

Case 3: 38 year male, resuscitation 60 min, postmortem interval about 20 h.

Case 4: 60 year female, resuscitation 20 min, postmortem interval about 12 h.

In Japan, Xylocaine™ jelly is usually used at endotracheal intubation in emergency medicine; we frequently experience the detection of lidocaine from blood due to such intubation in cadavers, which had received the cardiopulmonary resuscitation [32]. Although many victims without regaining heart beat were included in such resuscitation cases, relatively high concentrations of lidocaine could be detected from their heart blood [11]. The distribution of lidocaine, which had been used at endotracheal intubation, in body fluids and organs of 4 victims, who did not regain the heart beat, is shown in ▶ *Table 3.2*. The postmortem intervals were as short as 12~20 h, but rapid postmortem diffusion of the drug from the trachea into heart blood (especially left heart blood) was observed; there was no influence on the femoral vein blood. The lidocaine level was remarkably increased in the left heart blood, probably because lidocaine in the trachea diffused through the thin walls of the pulmonary vein into blood and then moved to the left atrium of the heart. Lidocaine in the trachea seems to diffuse into blood of the pulmonary artery. However, the diffusion velocity is slow because of thick walls of the

artery; the blood of the pulmonary artery hardly flows backward to the right ventricle of the heart. These seem to be reasons why the concentration of lidocaine is higher in the left heart blood than in the right heart blood. The postmortem diffusion of lidocaine from the trachea was also confirmed by experiments with rabbits [11]. Analytical chemists should be always aware of such a phenomenon for victims who had received emergency medical treatments.

## Countermeasures

As stated above, when the handling of specimens is careless, it may cause serious variations of drug concentrations depending on the kinds of drugs upon their analysis. The temporary storage of specimens can be made at 4° C in a refrigerator; but they should be kept at -20° C or preferably at -80° C until analysis, when the intervals between samplings and analysis are more than one week. When ester and nitro compounds are analyzed, the addition of a suitable preservative (usually NaF and/or NaN<sub>3</sub>) should be considered.

In autopsy cases, blood specimens should be collected from the atrium/ventricle of both sides, and also from the femoral vein; the analytical data from different locations should be assessed. For the victims, who had received medical treatments, the analysts should be aware of the details of the treatments and clinical process.

## References

- 1) Kalow W (1952) Hydrolysis of local anesthetics by human serum cholinesterase. *J Pharmacol Exp Ther* 104: 122–134
- 2) Baselt RC (1983) Stability of cocaine in biological fluids. *J Chromatogr* 268:502–505
- 3) Nanikawa R (1977) *Legal Medicine*. Nippon-iji-shinpo-sha, Tokyo, pp 239–260 (in Japanese)
- 4) Oliver JS, Smith H, Williams DJ (1977) The detection, identification and measurement of indole, tryptamine and 2-phenethylamine in putrefying human tissue. *Forensic Sci* 9:195–203
- 5) Stevens HM (1984) The stability of some drugs and poisons in putrefying human liver tissues. *J Forensic Sci Soc* 24:577–589
- 6) Anderson WH, Prouty RW (1989) Postmortem redistribution of drugs. In: Baselt RC (ed) *Advances in Analytical Toxicology, Vol 2*. Year Book Medical Publishers, Chicago, pp 70–102
- 7) Pounder DJ, Smith DRW (1995) Postmortem diffusion of alcohol from the stomach. *Am J Forensic Med Pathol* 16:89–96
- 8) Pounder DJ, Fuke C, Cox DE et al. (1996) Postmortem diffusion of drugs from gastric residue: an experimental study. *Am J Forensic Med Pathol* 17:1–7
- 9) Moriya F, Hashimoto Y (2001) Postmortem diffusion of drugs from the bladder into femoral venous blood. *Forensic Sci Int* 123:248–253
- 10) Marraccini JV, Carroll T, Grant S et al. (1990) Differences between multisite postmortem ethanol concentrations as related to agonal events. *J Forensic Sci* 35:1360–1366
- 11) Moriya F, Hashimoto Y (1997) Postmortem diffusion of tracheal lidocaine into heart blood following intubation for cardiopulmonary resuscitation. *J Forensic Sci* 42:296–299
- 12) Coe JI (1993) Postmortem chemistry update: emphasis on forensic application. *Am J Forensic Med Pathol* 14:91–117
- 13) Karch SB (1996) *The Pathology of Drug Abuse*, 2nd edn. CRC Press, Boca Raton
- 14) Isenschmid DS, Levine BS, Caplan YH (1992) The role of ecgonine methyl ester in the interpretation of cocaine concentrations in postmortem blood. *J Anal Toxicol* 16:319–324
- 15) Moriya F, Hashimoto Y, Kuo T-L (1999) Pitfalls when determining tissue distributions of organophosphorus chemicals: sodium fluoride accelerates chemical degradation. *J Anal Toxicol* 23:210–215

- 16) Goldberger BA, Cone EJ, Grant TM et al. (1994) Disposition of heroin and its metabolites in heroin-related deaths. *J Anal Toxicol* 18:22–28
- 17) Kintz P, Tracqui A, Mangin P et al. (1988) Specificity of the Abbott TDx assay for amphetamine in post-mortem urine samples. *Clin Chem* 34:2374–2375
- 18) Moriya F, Hashimoto Y (1997) Evaluation of Triage™ screening for drugs of abuse in postmortem blood and urine samples. *Jpn J Legal Med* 51:214–219
- 19) Carrico CJ, Meakins JL, Marshall JC et al. (1986) Multiple-organ-failure syndrome. *Arch Surg* 121:196–208
- 20) Border JR, Hassett J, LaDuca J et al. (1987) Gut origin septic states in blunt multiple trauma (ISS=40) in the ICU. *Ann Surg* 206:427–446
- 21) Moriya F, Hashimoto Y (1996) Endogenous ethanol production in trauma victims associated with medical treatment. *Jpn J Legal Med* 50:263–267
- 22) Robertson MD, Drummer OH (1995) Postmortem drug metabolism by bacteria. *J Forensic Sci* 40:382–386
- 23) Moriya F, Hashimoto Y (1997) Distribution of free and conjugated morphine in body fluids and tissues in a fatal heroin overdose: is conjugated morphine stable in postmortem specimens? *J Forensic Sci* 42:734–738
- 24) Holt WD, Benstead JG (1975) Postmortem assay of digoxin by radioimmunoassay. *J Clin Pathol* 28:483–486
- 25) Jones GR, Pounder DJ (1987) Site dependence of drug concentrations in postmortem blood—a case study. *J Anal Toxicol* 11:186–190
- 26) Hilberg T, Bugge A, Beylich K-M et al. (1993) An animal model of postmortem amitriptyline redistribution. *J Forensic Sci* 38:81–90
- 27) Moriya F, Hashimoto Y (1999) Redistribution of basic drugs into cardiac blood from surrounding tissues during early-stages postmortem. *J Forensic Sci* 44:10–16
- 28) Moriya F, Hashimoto Y (2000) Redistribution of methamphetamine in the early postmortem period. *J Anal Toxicol* 24:153–154
- 29) Moriya F, Hashimoto Y (2000) Criteria for judging whether postmortem blood drug concentrations can be used for toxicologic evaluation. *Legal Med* 2:143–151
- 30) Fuke C, Berry CL, Pounder DJ (1996) Postmortem diffusion of ingested and aspirated paint thinner. *Forensic Sci Int* 78:199–207
- 31) Pounder DJ, Yonemitsu K (1991) Postmortem absorption of drugs and ethanol from aspirated vomitus: an experimental model. *Forensic Sci Int* 51:189–195
- 32) Moriya F, Hashimoto Y (1998) Absorption of intubation-related lidocaine from the trachea during prolonged cardiopulmonary resuscitation. *J Forensic Sci* 43:718–722

# I.4 Pretreatments of human specimens

*By Akira Namera and Mikio Yashiki*

## Introduction

Small amount of drugs and poisons incorporated into human bodies are hidden among large amounts of biological components, such as proteins, lipids, nucleic acids and membranes. It is not easy to detect only a target compound from such complicated matrices. Before instrumental analysis, extraction procedure is usually essential and very important. Extraction methods are used for removal of such proteins and lipids existing in large amounts in biological matrices, for removal of impurity compounds interfering with chromatographic separation, for condensation of a target compound, and for removal of compounds causing troubles (such as obstruction of chromatographic columns and contamination of a detector) in instrumental analysis. There are numerous methods of extraction, according to target compounds. In this chapter, the authors briefly present some pretreatment methods including extraction and derivatization usually being used in biomedical analysis. Many reviews and books on the details of extractions are available [1–5].

## Extraction methods

---

According to the advancement of analytical instruments, there are some reports on the analysis of compounds using crude biological samples without any tedious extraction procedure (or with dilution with water only); this is solely dependent upon the high capability of an instrument. However, in view of the stability and tool life, it is desirable to make suitable pretreatments. In emergency medicine, where a long time for analysis is not permitted, a rapid extraction method with the minimal purification step is chosen to meet such demand.

For extraction of polar or ionic compounds, a biological specimen can be acidified with tartaric acid, followed by addition of acetone or ethanol, shaking of the mixture and centrifugation. To extract metals, organic compounds in a biological specimen should be completely destroyed; dry or wet incineration methods are employed. For the details of the procedure, the readers can refer to the books [3, 6]. The authors describe some extraction methods only for organic compounds as follows.

## Deproteinization methods

In analysis of drugs and poisons in human specimens, the main interfering compounds are protein and lipids components. To remove these molecules, the following methods are being used.

### i. Ultrafiltration

Ultrafiltration is a separation method according to molecular sizes of compounds, and is also used for removal of macromolecules. Many type of filters with various pore sizes for passage of macromolecules (30,000, 10,000 and 5,000 daltons) are commercially available (Millipore, Advantec or Whatman). The advantages of this method is the simplicity of handling and small volumes (<0.5 mL) of fluid samples to be required. However, it is impossible to separate drugs or poisons from the endogeneous medium- and small-sized compounds by this method.

### ii. Sedimentation

By adding acids or organic solvents to specimens, proteins can be denatured to form insoluble aggregates, which can be easily removed by centrifugation. The reagents being widely used for sedimentation are: methanol or acetonitrile, trichloroacetic acid or other acids, and ammonium sulfate or tungstate. This type of methods is simple, relatively rapid and thus suitable for use in the emergency medicine. Analysts, however, should be cautious of the serious loss of target compounds, because of their incorporation into the aggregated and sedimented macromolecules.

### iii. Dialysis

Semipermeable membranes of tubular types are usually used for extraction of low-molecular compounds by dialysis. Typically, a volume of crude specimen fluid is packed in a membrane tube, which is then put in a large volume of an organic solvent in a beaker with stirring of a Teflon-coated magnet bar. Since the movement of a drug stops, when an equilibrium is attained between the inner and outer solutions, complete recovery cannot be achieved by a single extraction. Although the handling procedure itself is very simple, it takes a long time to reach the equilibrium according to the kind of a target compound; this method is not suitable for treatments of many specimens.

## Headspace method

A specimen is put in a vial with a Teflon septum cap, and warmed (or heated) in a water bath or on a block heater. After a suitable time of warming, a needle of a syringe is inserted through the septum to draw the headspace gas containing a target compound. This method is very suitable for gas chromatographic analysis. The headspace method is widely used for analysis of volatile compounds, but is not suitable for thermolabile compounds. It is being used for analysis of ethanol and toluene [5]; and also used for semi-volatile compound such as amphetamines [7].

## Liquid-liquid extraction method


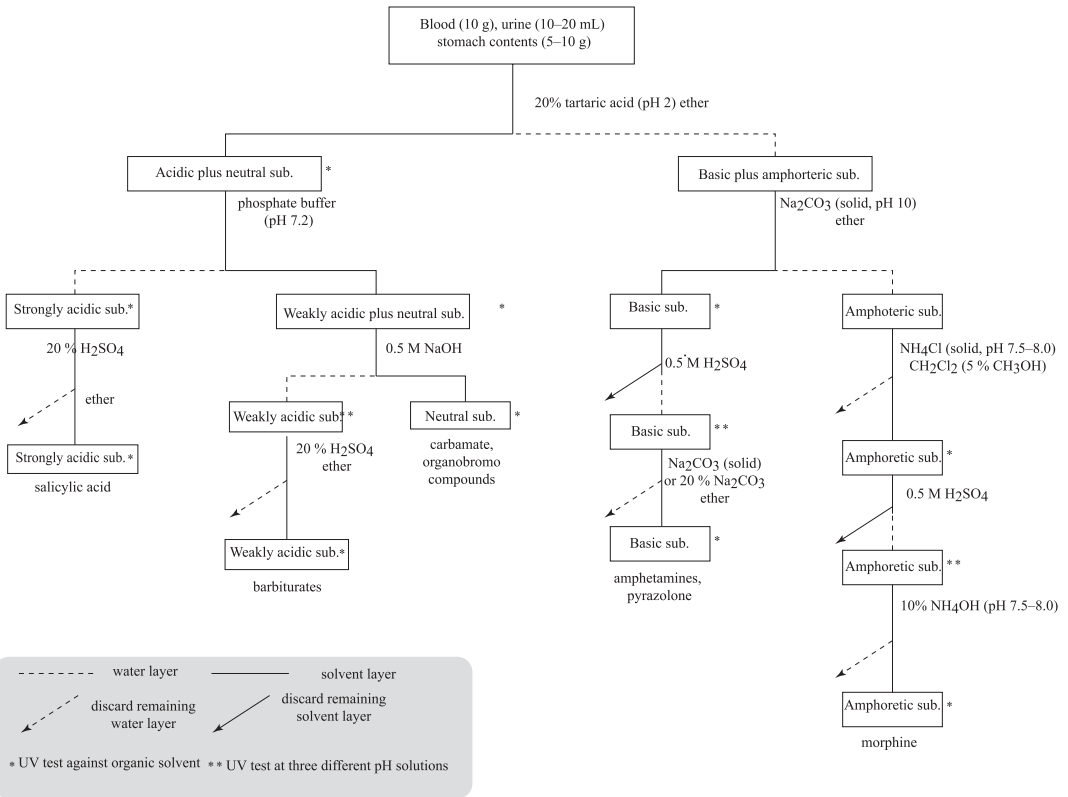
Many of drugs or poisons show hydrophobic properties, though their degree of hydrophobicity is different in different compounds. By utilizing the solubility in organic solvent (difference in partition coefficients), drugs and poisons can be extracted from an aqueous specimen into an organic solvent by shaking them. Various modified methods of the liquid-liquid extraction were reported; each method has its advantage and disadvantage. An example of the methods is shown in  *Figure 4.1*.

Fig. 4.1

Biological material



### An example of separation of drugs by liquid-liquid extraction (cited from reference 2).

This method allows selective extraction of drugs according to the properties of the compounds (acidity or basicity). The mode of transfer of a drug from a phase to another phase is well known empirically and can be estimated physicochemically; this is very useful for analysis of an unknown compound. However, during extraction from specimens with high protein and lipid contents by this method, emulsion formation sometimes appears and makes it difficult to separate the two liquid phases clearly.

Extrelut<sup>®</sup> is a diatomite with a porous structure, and can adsorb and maintain a water phase on its surface. A crude aqueous specimen can be directly applied onto an Extrelut<sup>®</sup> column; then an organic solvent, which is not miscible with water, is used for elution of a drug. Although the procedure is very similar to that of solid-phase extraction, the principle for Extrelut<sup>®</sup> is essentially liquid-liquid extraction, which takes place between aqueous and organic phases on the surface of the diatomite. A merit of the use of an Extrelut<sup>®</sup> column is that emulsion is not formed even for whole blood specimens.

■ **Table 4.1**

**Kinds and characteristics of various packing materials for solid-phase extraction**

Packing material	Characteristic
Octadecyl (C <sub>18</sub> ) group	Reversed phase: highly hydrophobic
Graphite carbon	Reversed phase: highly hydrophobic
Octyl (C <sub>8</sub> ) group	Reversed phase: hydrophobic
Silica	Normal phase: polar and neutral
Florisil	Normal phase: polar and weakly basic
Alumina A	Normal phase: polar and acidic
Cation exchanger	Cation exchange
Anion exchanger	Anion exchange
Mixed mode	Reversed phase (C <sub>8</sub> ) plus cation exchanger
Aminopropyl (NH <sub>2</sub> ) group	Normal phase, reversed phase or weak cation exchanger
Cyanopropyl (CN) group	Normal phase or reversed phase
Diol (OH) group	Normal phase or reversed phase

## Solid-phase extraction

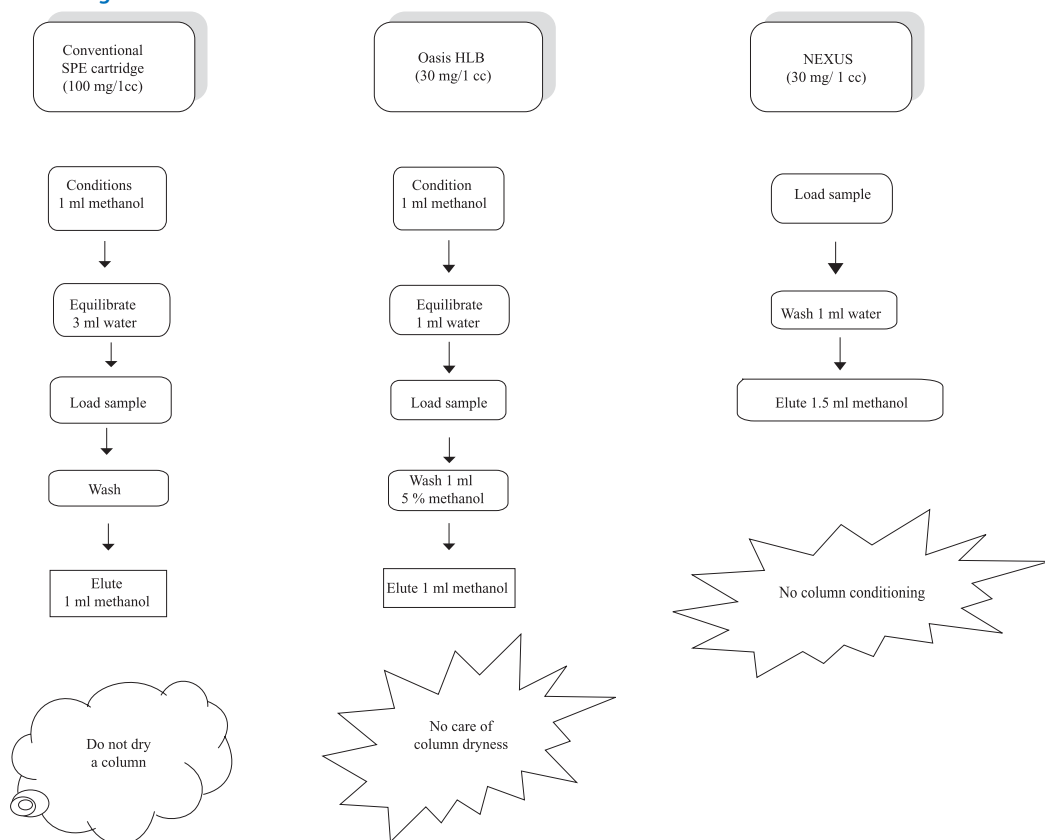
Solid-phase extraction is used for separation of a drug from biological components by utilizing their different affinities to packing materials (stationary phase) [8]. Originally, natural materials such as silica gel was used; but recently, many kinds of packing materials, to which various functional groups and polymer materials had been bound (▶ *Table 4.1*), have been developed and have become commercially available. Therefore, the range of their selection has been extensively increased. For the original types of solid-phase columns (cartridge), activation of the packing materials before use was required and the materials could not be dried throughout the procedure. As shown in ▶ *Figure 4.2*, however, new items for solid-phase extraction without need for such activation (absolut™ NEXUS, Varian) and without need for cares not to dry up the column (Oasis®, Waters) have been developed. To realize a high throughput for extraction, a plate for simultaneous extraction of as many as 96 samples is now commercially available.

Condensation is required for a large volume of eluted solution after solid-phase extraction. This procedure takes a long time, when the volume of an eluent is large and the volatility of the eluent is relatively low. Recently, a thin disk (Empore Disk®, 3M), which enables the efficient adsorption of drugs and their efficient elution only with a small amount of a solvent, has been developed.

## Solid-phase microextraction

Solid-phase microextraction is a method employing adsorption of drugs to a stationary phase coated on a fiber attached to a microsyringe [9, 10]. Drugs adsorbed are desorbed inside an injection port of a GC instrument at high temperatures, inside an interface of an HPLC instrument or inside a capillary of CE, to introduce drugs into each analytical instrument. To adsorb drugs, both headspace and direct immersion methods are being used. Recently, a special stirrer magnet coated with a stationary phase has become commercially available (Twister™, Gerstel).

Fig. 4.2



Handling procedures of solid-phase extraction.

## Derivatization

Derivatization of a compound is usually used for volatilization and stabilization of a non-volatile or thermolabile compound, for modification into a suitable form to be detected by a specific detector (for example, pentafluorobenzoylation for ECD of GC and dansylation for fluorescence detection by HPLC) and for detecting a high-molecular fragment peak in mass spectrometry. In addition, a polar (ionic) compound is occasionally converted to a non-polar compound by binding a hydrophobic group to it for efficient extraction of the derivatized product into an organic solvent.

The authors briefly mention some methods of derivatization being widely used in biomedical analysis as follows. For details on reagents and procedures, the readers can refer to the books [11] or instruction leaflets attached to each derivatization reagent.



## Alkylation

One of the most popular derivatization methods is alkylation; alkyl groups, such as methyl or propyl moieties, can be bound to acid or amino compounds using tetrabutyl ammonium (TBA) or pentafluorobenzyl bromide (PFB-Br). Organic acids, salicylic acid and barbituric acids are frequently alkylated for GC analysis.

## Acylation

Acylation is also widely used for derivatization of amino, hydroxyl and thiol groups, and it improves chromatographic separation by suppressing non-specific adsorption to gas chromatographic columns; trifluoroacetyl chloride (TFA-Cl) and *p*-nitrobenzoyl chloride are used as reagents for acylation. Anhydrous conditions are necessary for the reaction according to the kinds of derivatization reagents.

For the analysis of amphetamines, trifluoroacetylation is widely employed to prevent them from their adsorption to an injection port and to detect fragment ions in higher mass ranges. However, the trifluoroacetyl derivatives suffer from their instability and loss due to evaporation.

## Silylation

This is a reaction for converting non-volatile compounds due to the dipole action of a hydrogen donor group such as hydroxyl, phenol, carboxylic acid and amino groups into volatile ones. The characteristic fragmentation patterns make structure analysis easier.

The silylation derivatization is usually used for analysis of morphine and codeine. Although these compounds can be analyzed by GC(/MS) in undelivatized forms, the derivatization gives much improvement of peak shapes and enhanced sensitivity.

## Esterification

Acidic drugs containing a carboxylic acid group are highly polar, show tailing caused by interaction between the drugs and a GC column, and are usually involatile due to association among the molecules. To solve these problems, the esterification is made on the carboxylic acid compounds using hydrochloric acid-containing alcohol or diazomethane. The latter reagent is considered to be the best compound for esterification, but shows danger of carcinogenesis and explosion; in place of the diazomethane, trimethylsilyldiazomethane dissolved in hexane is now commercially available, because of its safety.

## Other derivatizations

Derivatizations are also used for purposes to add visible or ultra violet absorptivity, fluorescence and optical activity to compounds to be analyzed. For such derivatizations, reagents reacting with amino, carboxyl and hydroxyl groups are available. The details are described in the book [11].

## Automated pretreatments

---

In parallel with the increase of the number of poisoning incidents, the number of human specimens to be analyzed is increasing. Trace analysis is required in many cases of analysis of drugs and poisons; this means that a relatively long time is required for pretreatment of each sample. It is difficult for the limited number of workers to treat many samples simultaneously. The use of automated pretreatment instrument is labor-saving, decrease artificial mistakes and increase reproducibility and reliability of data. When hazardous compounds are handled, such instrument makes workers free from dangerous situation and increases safety.

The automatic pretreatment instruments have been constructed for both liquid-liquid extraction and solid-phase extraction. AASP (advanced automated sample processors) are being sold by Gilson and Varian; PROSPECT from GL Sciences, Tokyo.

## References

- 1) Muller RK (ed) (1991) *Toxicological Analysis*. Verlag Gesundheit GmbH, Berlin pp 52–90
- 2) Brandenberger H (1974) *Clinical Biochemistry. Principles and Methods*. Walter de Gruyter, Berlin, pp 1425–1467
- 3) Pharmaceutical Society of Japan (ed) (1992) *Standard Methods of Chemical Analysis in Poisoning – With Commentary*. 4th edn. Nanzando, Tokyo, pp 27–38 (in Japanese)
- 4) Mcdowall, RD (1989) Sample preparation for biological analysis. *J Chromatogr* 492:2–58
- 5) Seto Y (1994) Determination of volatile substances in biological samples by headspace gas chromatography. *J Chromatogr A* 674:25–62
- 6) Pharmaceutical Society of Japan (ed) (2000) *Methods of Analysis in Hearth Science*. Kanehara-shuppan, Tokyo, pp 372–382
- 7) Tsuchihashi H, Nakajima K, Nishikawa M et al. (1991) Determination of methamphetamine and amphetamine in urine by headspace gas chromatography/mass spectrometry. *Anal Sci* 7:19–22
- 8) Thurman EM, Mills MS (1998) *Solid-Phase Extraction-Principles and Practice*. John Wiley & Sons, New York
- 9) Pawliszyn J (1997) *Solid Phase Microextraction-Theory and Practice*. Wiley-VCH, New York
- 10) Pawliszyn J (ed) (1999) *Applications of Solid Phase Microextraction*. The Royal Society of Chemistry, Cambridge
- 11) Blau K, Halket JM (eds) (1993) *Handbook of Derivatives for Chromatography*, 2nd edn. John Wiley & Sons, Chichester

# 1.5 Detection methods

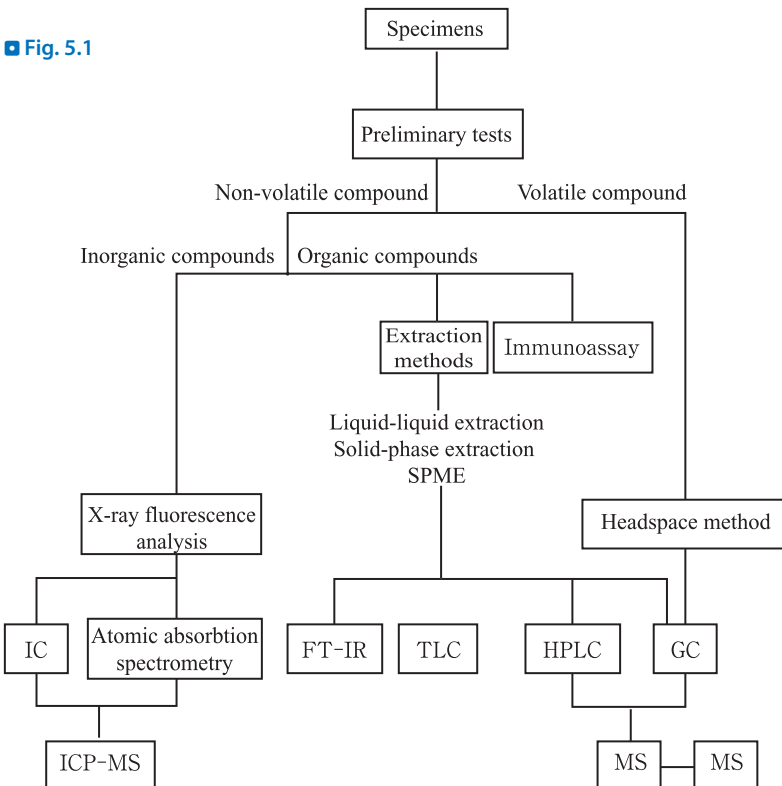
By Osamu Suzuki

## Introduction

The advancement of technologies was marvelous during the past half century; new analytical instruments have been being invented and improved. About 30 years ago, thin-layer chromatography (TLC) was being used most widely for detection and identification of drugs and poisons. Around that time, the use of GC/MS started in the field of medicine. Therefore, an ideal procedure for analysis of drugs and poisons was considered to be the screening by TLC, followed by the final identification and quantitation by GC/MS.

However, recently, various enzyme immunoassays for drugs without need of pretreatments have appeared, and some disposable drug screening kits have become available, resulting in a great change of analytical procedure for unknown toxins in human samples. [▶ Figure 5.1](#) shows a flowchart of the current analytical procedure for human specimens. For the details of

■ Fig. 5.1



Flowchart of analytical methods for drugs and poisons.

preliminary spot or color tests, the readers can refer to a new book [1], which has been published very recently.

## Thin-layer chromatography (TLC)

---

TLC is a method of chromatography in which a thin-layer made of silica gel, alumina, florisil or cellulose is coated on glass or aluminum plates. Numerous types of TLC ready for use without the need of pretreatments are commercially available.

An extract fluids is spotted onto a bottom area of a plate. After drying the spot, the plate is developed with a mobile phase consisting of various ratios of organic solvents, acids and/or water. During the development with a mobile phase, a compound spotted moves at a certain speed towards the top. The movement of a compound to be analyzed is usually expressed by  $R_f$  values (distance which a compound travels from the origin/distance which a solvent front travels from the origin).

This method requires no expensive instruments and is very simple. Since relatively many samples can be analyzed by this method in several hours, it is widely used as a simple method for detection and tentative identification of drugs. For detecting each spot, a reagent solution specially prepared can be sprayed on the plate to detect a compound specifically. The details of the TLC method are well described in many books of forensic and analytical chemistry [2, 3]; the specific reagents to be sprayed are also described [4, 5].

The spots separated and detected by TLC can be quantitated to some extent (semiquantitatively) by a densitometer; the detection limits are several ten ng to several  $\mu\text{g}$  on a plate.

Recently, TLC plates coated by stationary phases with small and uniform particles (4.5–5  $\mu\text{m}$  diameter) have become commercially available [6]; these plates are superior in separation ability and requires shorter times for development. They are being called “high-performance TLC (HPTLC)”.

## Spectrophotometric and fluorescence analysis

---

A spectrophotometer and a fluorophotometer (spectrofluorophotometer) are very common analytical instruments equipped at almost every chemical or biochemical laboratory. With spectrophotometers, the absorption of ultraviolet and/or visible light can be measured. The detection limits are usually several  $\mu\text{g}/\text{mL}$  by spectrophotometry and about several ten  $\text{ng}/\text{mL}$  by fluorophotometry. Each spectrum of compounds can be recorded for tentative identification by both methods, but only with the spectra of compounds, the final identification cannot be achieved.

The spectrophotometer and fluorophotometer are also useful as detectors in high-performance liquid chromatography (HPLC); in these cases, the detectors are simplified and downsized.

## Infrared absorption spectroscopy

---

When a molecule is irradiated by an infrared light beam, a certain rotation or vibration takes place depending on the nature of a molecule. Infrared absorption occurs only when a change

in dipole moment takes place. The conventional dispersive type of the spectrometer gives low sensitivity and requires several ten  $\mu\text{g}$  to several mg of a pure compound for measurements. By comparing the absorption spectra, the confirmation of identity can be achieved for a known compound; estimation of particular bonds and functional groups may be possible for an unknown compound.

The conventional dispersive type of the instrument was high-powered by changing optic structures and by using a computer system to construct the Fourier transform infrared spectrophotometer (FT-IR). The instrument is as expensive as a mass spectrometer. By increasing the scan number and by shortening the scan time, FT-IR can be connected with GC and HPLC. However, in toxicological analysis, FT-IR does not seem superior to mass spectrometry.

## Radio- and enzyme-immunoassays and fluoroimmunoassays

---

Radioimmunoassays (RIA) are based on the competition of a drug in a specimen with its radiolabelled one for binding sites of a specific antibody, which had been prepared previously. The sensitivity of RIA is usually very high with detection limits of pg to ng levels.

The basic principle of the enzyme-immunoassays (ELISA) is the same as that of RIA. ELISA employs an enzyme linked to a drug as a marker in place of radioisotopes. The tests can be performed at any laboratory without any licence for radioactive compounds. The recent products of ELISA have sensitivity and specificity comparable to those of RIA. In the sandwich ELISA method, the primary antibody fixed to a plate and the secondary antibody labeled with an enzyme marker are employed. The antigen (drugs or poisons) is bound between the two antibodies.

One of the fluoroimmunoassays is based on the difference in polarization between the bound and free forms of a fluorophore-labelled drug observable during the antigen-antibody reaction. Although this method is simple, the sensitivity is not so high.

In all of the above immunoassays, antibodies specific to drugs or poisons should be prepared in advance. There is a disadvantage of cross reactions among drugs of similar structures. However, when once the method is established for a drug as a kit, a crude biological specimen can be analyzed without any extraction or purification; it is quite useful for screening or as a preliminary test.

Now, immunoassay kits are commercially available from manufacturers in U.S.A. and Europe for amphetamines, antiepileptics, antiarrhythmics, cardiac glycosides, antibiotics, bronchodilating agents, anticarcinogens, antipyretic-analgesics and immuno-suppressives.

Recently, a disposable kit Triage<sup>®</sup> is being widely used to screen drugs of abuse and their metabolites in urine; this kit is also based on an immunoassay using gold colloid particles. It can qualitatively detect benzodiazepines, cocaine metabolites, amphetamines, a cannabinoid metabolite, opiates, phencyclidine and tricyclic antidepressants in only about 10 min. Some similar kits are being sold in U.S.A. and Europe. The situation of widely used or abused drugs is different according to countries. Abusing cases with phencyclidine are very rare in Japan, while the cases with phenothiazines, bromisovalum and acetaminophen are very common. The development of an immunoassay screening kit covering the above drugs widely used in Japan is being awaited.

## Gas chromatography (GC)

---

GC was previously called “gas-liquid chromatography”. It is based on separation by partition between gaseous and liquid phases for vaporized compounds flowing together with a carrier gas ( $N_2$  or He) inside a GC column at relatively high temperatures. Therefore, GC is not suitable for analysis of non-volatile or thermolabile compounds, but is superior in separation ability, because of the high number of theoretical plates; the reproducibility of the method is excellent, because of the simple structure of the instrument. GC is now being indispensable for drug analysis.

### GC columns

The conventional packed column is prepared by introducing a packing material into a glass column with internal diameter of 2–3 mm and with length of several meters. The packing material is prepared by well mixing an inert granular support with an oily liquid phase. The kinds of both supports and liquid phases are numerous; the most suitable ones can be chosen from many.

Recently, fused silica capillary columns are far more popular than the packed columns. The former columns are open-tubular and several ten meters long; carrier gas can flow fast through them. A liquid phase of 0.1–2.0  $\mu\text{m}$  thickness is coated on the inside-surface of each column. There are three types of capillary columns according to the size of their internal diameter; narrow-bore columns for 0.1–0.18 mm, medium-bore columns for 0.25–0.32 mm and wide-bore columns for 0.53–0.72 mm.

The capillary columns give better separation and less adsorption of analytes than the packed columns, resulting in the appearance of sharp and symmetrical peaks with high sensitivity. As liquid phases, non-polar dimethylsilicone, slightly polar 5% phenylsilicone/95% dimethylsilicone, intermediately polar 50% phenylsilicone/50% dimethylsilicone and highly polar polyethylene glycol are being used. Even for compounds, which give no peaks with packed columns, their peaks can be detected with capillary columns in many cases.

The wide-bore capillary column is useful, when a relatively large amount of gas has to be injected without splitting; it can be used for alcohol analysis in combination with the head-space method. Since the gas flow inside the wide-bore column is fast, and thus the time for exposure to heat is short, the column is sometimes suitable for analysis of relatively thermolabile compounds such as benzodiazepines.

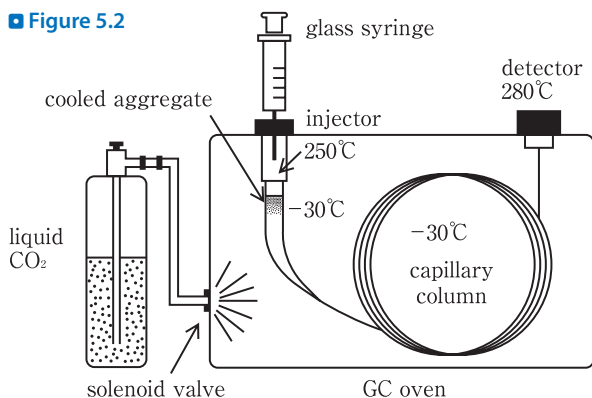
Since the gas flow rate for a medium-bore capillary column is usually several mL/min, 1–2  $\mu\text{L}$  of an organic solvent extract to be injected should be split prior to its introduction into the column; this means that only less than 10% of the entire sample volume injected is detected, resulting in lowered sensitivity. However, about ten years ago, an automatic switching device between the splitless and split modes became very popular for new types of GC instruments. The device made it possible to introduce an entire amount of a compound to be analyzed into a medium-bore capillary column in the splitless mode at a relatively low column temperature to completely trap the compound inside a front part of the column; after changing to the split mode, the oven temperature is elevated gradually, until a large peak due to the entire amount of the analyte appears.

## Cryogenic oven trapping GC

A microcomputer controlling cryogenic oven temperatures below  $0^{\circ}\text{C}$  became widely available for modern types of GC instruments. It had been originally designed for rapid cooling of an oven to reduce analysis time. The authors et al. [7, 8] used it to trap volatile organic compounds (VOCs) contained in gas samples, and named it “cryogenic oven trapping (COT)”. By use of this method, a large volume of headspace vapor (5 mL or more) can be introduced, in the splitless mode, into a medium-bore capillary column at low oven temperatures. The procedure results in trapping of VOCs inside a narrow zone of the inlet end of a cooled column without any loss of analytes in the splitless mode (▶ *Figure 5.2*). Therefore, very sharp and big peaks and good separation can be achieved by this method. In spite of the use of the conventional flame ionization detector, the sensitivity obtained by GC-COT is 10–50 times higher than that of the usual headspace GC. The author et al. [7] first applied this method to sensitive analysis of chloroform and dichloromethane and established the details of the procedure. After this study, we extended this line of experiments to other VOCs and got good results.

The cost of the COT device is low, and the handling of the device is so simple that no special procedure is required during GC analysis. One disadvantage of COT with liquid  $\text{CO}_2$  is the possibility of  $\text{CO}_2$  poisoning. Air containing more than 3%  $\text{CO}_2$  was reported to be hazardous to humans; 6–10%  $\text{CO}_2$  is very dangerous. Such danger should be kept in mind, and laboratories should be ventilated during such experiments. The consumption of the liquid  $\text{CO}_2$  is rapid especially for COT at very low temperatures; this means that more cost for liquid  $\text{CO}_2$  is needed for lower oven temperatures.

■ **Figure 5.2**



**Structural schema of cryogenic oven trapping (COT) GC.** Liquid nitrogen is vaporized in the GC oven for cooling under the control of a microcomputer. After injection of 5 mL volume of headspace gas, the entire amount of a target compound is trapped inside a front part of the capillary column.

## GC detectors

The flame ionization detector (FID) is most common for GC analysis. Every compound having a C-H bond can be detected with the FID. At the outlet of GC flow, hydrogen gas and air are mixed with the carrier gas and burnt in the presence of voltage; ion current due to ionized carbon is measured. The detection limits of an FID is 1–10 ng in an injected volume.

The flame photometric detector (FPD) is partly similar to the above FID in that a target compound is burnt with hydrogen gas and air; however in this method, the changes in color of the hydrogen flame are optically detected. It is sensitive and specific for compounds containing sulfur and phosphorus.

The electron capture detector (ECD) utilizes  $\beta$ -ray irradiated from  $^{63}\text{Ni}$  to detect compounds containing halogen and nitro groups in their structures. The detection limits obtained with an ECD are several pg to several ng in an injected volume.

The flame thermionic detector (FTD) is the same as the nitrogen phosphorus detector (NPD), and responds to nitrogen- and phosphorus-containing compounds with high sensitivity. Its detection limits are several ten pg to several ng; the sensitivity with an FTD is about ten times lower than that with an ECD.

The surface ionization detector (SID) was developed in Japan. It is highly sensitive and specific for tertiary amino compounds. Good results were obtained for analysis of tricyclic antidepressants and diphenylmethane antihistaminics.

## High-performance liquid chromatography (HPLC)

Many years ago, more than nine million compounds were registered in the Chemical Abstracts; among them the number of compounds analyzable by GC was said to be only 130,000 (1.4%). It shows that the great majority (more than 98%) of the compounds are highly polar, non-volatile or thermolabile. Therefore, it seems correct that to analyze unknown compounds, HPLC is more suitable than GC. In fact, the use of HPLC is increasing.

In an HPLC column, a fine particle packing material (stationary phase) is packed; after loading purified sample solution onto the column, a mixture of organic solvents and/or a buffer solution is sent to the column. The target compound can be separated from other compounds during passage through the column according to the difference in flow rate for different compounds. The separation ability of HPLC is much inferior to that of capillary GC. HPLC columns can be classified into three groups, *viz.* normal phase, reversed phase and ion exchanger columns. Among them, reversed phase columns are being used most popularly; as packing materials,  $\text{C}_{18}$  and CN groups covalently bound to support materials are being well used. As a mobile phase, a mixture of water and methanol (or acetonitrile) is commonly used. When octanesulfonate or heptanesulfonate is added to the mobile phase, the ion-exchanging effects can be added to the reversed phase HPLC, resulting in the better resolution ability of the column. This is called “ion-pairing reversed phase HPLC” and is becoming more popular also in analysis of drugs and poisons.

As one of the trends in HPLC, miniturization of separation columns and the related systems can be mentioned. In addition to the standard-bore columns of 3–6 mm internal diameter, so-called micro-bore columns of 1.0–2.1 mm internal diameter have become used popularly. Capillary HPLC columns of 0.3–0.5 mm internal diameter are also commercially availa-



ble. This kind of minituarization makes the volume to be injected smaller, which is eventually related to enhancement of sensitivity, and makes the resolution ability better.

Before introduction to a separation column, a switching system consisting of a condensation column and a switching valve can be attached to an HPLC instrument. By this system, as large as 500  $\mu\text{L}$  of sample solution can be injected and sent to the separation column without any loss of a target compound, resulting in much higher sensitivity.

As detectors for HPLC, a UV plus visible spectrophotometer and a fluorophotometer are most common. With the latter detector, several ten pg to several hundred pg of compounds can be determined under the best instrumental conditions. Catecholamines can be detected with an electrochemical detector of HPLC with very high sensitivity.

The HPLC sometimes suffers from shifts in retention time during repeated assays and most seriously from the obstruction of the column. More efforts for maintenance is required for HPLC than for GC.

## Ion chromatography (IC)

---

IC is a specialized type of HPLC; it is exclusively adapted for analysis of ionic compounds including inorganic and metal compounds. The arsenic poisoning incident which took place in Wakayama, 1998, and the following incidents with sodium azide poisoning reminded us the importance of analysis of inorganic compounds. To analyze inorganic ions with high sensitivity, IC is now the most useful tool. However, the costs for IC instruments are much higher than that of a usual HPLC. An IC system consists of a pump, an ion-exchange separation column, a suppressor, a conductivity detector and a workstation for integration and data processing. For analysis of inorganic anions and cations, anion and cation exchanger columns are used, respectively.

Since the change in electric conductivity caused by a target inorganic ion is measured by IC, high baselines and interfering peaks caused by ions being mixed in the mobile phase become serious problems. Therefore, the suppressor is essential to lower the baseline and to stabilize it to detect a peak of the target compound with high sensitivity; it should be, of course, located before the detector. The detection limits are several ng to several  $\mu\text{g}$  on-column depending on the kinds of compounds to be analyzed.

Various combinations of a mobile phase with a separation column, almost every inorganic ion (anions and cations) can be detected and quantitated. IC for inorganic ions is comparable to HPLC for organic compounds; thus the final identification cannot be achieved only by IC. For the identification of inorganic ions, ICP-MS is required.

## Mass spectrometry (MS)

---

In the positive ion electron impact (EI) mode of MS, a target molecule is strongly collided by electron to yield many/some fragment ions. The positive fragment ions are accelerated in an electric field, introduced into a lens of an electric or magnetic field or into an electric field of a quadrupole for separation according to the mass numbers of fragment ions, and finally detected. A characteristic mass spectrum is obtained with the mass number on the horizontal axis and bars of various intensities on the vertical axis. The EI mass spectrum shows a stereo-

typed pattern according to each compound under similar MS conditions; it is widely accepted that MS is the most reliable identification method. When the profile of an EI mass spectrum obtained from a compound in a specimen coincides with that obtained from the authentic compound, it can be almost concluded that the two compounds are identical. In the selected ion monitoring (SIM) mode of MS, ultra-sensitive quantitation can be realized at pg or fg levels on-column. The magnetic sector mass spectrometer is relatively large in size and expensive. To obtain exact mass numbers with four decimal places, high resolution mass spectrometry using a double-focusing magnetic sector mass spectrometer is necessary. The functions of recent MS instruments have been markedly improved; even with a low resolution mass spectrometer, good measurements can be achieved without shifts in a mass unit. Therefore, for analysis of drugs and poisons, bench-top type quadrupole mass spectrometers, which are relatively cheap and easy to be handled, are being used widely.

## GC/MS

A mass spectrum can be obtained by the direct inlet method; in this method, an almost pure compound should be used. When a crude extract from a human specimen is analyzed, a target compound should be separated by chromatography before application to MS. Therefore, on-line GC/MS is usually used in such cases.

There are 3 types of ionization in GC/MS; positive ion EI, positive ion chemical ionization (CI) and negative ion CI modes. The positive ion EI mode is most common, standardized and suitable for measurements of mass spectra. However, there are many cases in which molecular ions ( $M^+$ ) cannot be obtained; the molecular weight cannot be estimated in such cases.

The positive ion CI mode is a much softer ionization method than the EI mode; the collision of electrons ionizes the reagent gas, and the ionized gas interacts with a target compound largely to yield an intense  $[M+1]^+$  protonated-molecular ion, which is useful for estimation of its molecular weight.

In the negative ion CI mode, the reaction mechanisms are similar to the above positive one; but only negative ions produced are detected. This method gives various characteristic advantages; by this method, halogen group- and nitro group-containing compounds can be detected with high sensitivity, and these groups can be easily identified by the presence of characteristic peaks of halogens liberated. The method also gives characteristic base peaks for organophosphorus pesticides, which is very useful for both screening and sensitive quantitation by SIM.

## LC/MS

The reason why on-line GC/MS was first realized is that the connection between GC and MS is very easy; with use of a medium-bore capillary GC column, the sample gas can be directly introduced into an ionization chamber without use of a separator, because of its low flow-rate. However, there were many difficulties for connecting LC (HPLC) with MS until recently. Nowadays, these problems have been overcome, and many types of on-line LC/MS instruments are commercially available. Many reports are being published on analysis of drugs and poisons by LC/MS. The connection device between LC and MS is called "interface". As interfaces, thermospray, frit-fast atom bombardment, atmospheric chemical ionization (APCI) and electrospray

ionization (ESI) modes can be mentioned. Among them, ESI and APCI are being used best, because of their high sensitivity and good quantitiveness.

LC/MS instruments have become widespread very rapidly. Many drugs and poisons in biological specimens can be identified and quantitated without any derivatization by this method. The sensitivity of LC/MS has been improved and is now comparable to that of GC/MS.

## MS/MS (tandem MS)

Two MS instruments are combined; the first MS is used for separation of compounds like GC, and the second one is used for selective detection. Relatively crude samples with many impurities can be injected into the first MS by the direct inlet method, and a single ion produced is selected and introduced into the second one to collide with neutral molecules (inert gas), resulting in product ion formation. The latter process is called “collision induced dissociation (CID)” and useful for identification and quantitation using the product ions.

GC or LC (HPLC) can be connected with MS/MS; GC/MS/MS or LC/MS/MS gives clean product ion mass spectra without impurity peaks, and enables sensitive quantitation by selected reaction monitoring (SRM) with very high specificity. GC/MS/MS and LC/MS/MS are now the most powerful tools for drug and poison analysis.

As described above, the tandem type with two MS instruments is called “tandem-in-space mode”, and is relatively expensive. Another tandem type is MS of ion trap mode; it does not need two instruments. One MS instrument can fulfill the tandem function with a different principle and with regulation by a computer; this type is called “tandem-in-time mode”, and less expensive than the tandem-in-space MS type. Although the tandem-in-time type does not allow the simultaneous scanning of both precursor and product ions, the sensitivity is very high. It is said that quantitiveness of the ion trap MS is low; to achieve accurate quantitation, the use of a stable isotopic internal standard is necessary.

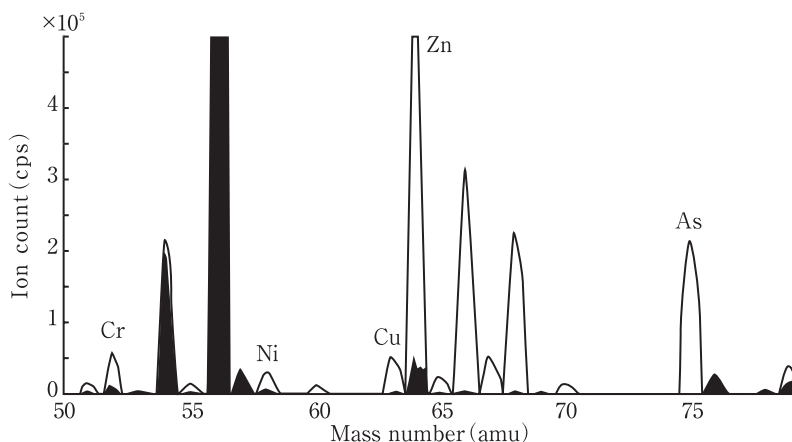
## Inductively coupled plasma-MS (ICP-MS)

“Plasma” is electrically neutral but ionized gas, in which atoms moving randomly, ions and electrons are coexisting. ICP is argon plasma, which has been excited by high frequency induction [9].

A copper wire is coiled around a discharge tube made of quartz glass, which is called “torch”; and an electric field is produced inside the torch by turning on the electricity through the coil. When argon gas is introduced into the torch, the argon atoms are accelerated in the electric field to yield argon plasma after repeated collisions. The temperature of the resulting ICP is as high as 6,000–8,000 K. When a nebulized specimen is introduced into the torch together with carrier gas of argon, atoms in the specimen are excited and emit each spectrum beam, which is specific to an element; a part of the atoms is ionized simultaneously.

ICP emission spectrometry is a method for detecting the beam emitted by the ICP spectrophotometrically; ICP-MS is a method for detecting the ions by MS. In ICP-MS, a quadrupole MS instrument is usually used; many elements can be simultaneously detected with high sensitivity at pg/mL levels within a short time. These ICP methods are suitable for elemental analysis of inorganic compounds and metals rather than organic compounds.

**Figure 5.3**



ICP mass spectrum for arsenic and other metals. Human nails were used for analysis. The peak at  $m/z$  75 is due to arsenic. The shadow peaks were obtained from a blank sample.

The mass spectrum of ICP-MS is different from that of usual MS for organic compounds. It is an elemental analysis and does not show the structure of a molecule. To estimate a structure of an inorganic ion, it is recommendable to connect ion chromatography (IC) with the ICP-MS. **►** Figure 5.3 shows a characteristic ICP-mass spectrum; the horizontal axis shows the mass number and the vertical axis the intensity of each ion of elements [10]. In the mass spectrum for arsenic, it should be kept in mind that Ar being used as plasma gas is easily bound with Cl to form argride ( $\text{ArCl}^+$ ,  $m/z$  75), which give the same mass number as that of  $\text{As}^+$ . Quantitative analysis can be also made by ICP-MS.

The cost for ICP-MS is as high as that of the magnetic sector mass spectrometer. IC/ICP-MS is very useful for identification and quantitation of inorganic molecule, but the cost is even higher. The IC/ICP-MS is comparable to the LC/MS for organic compounds.

## X-ray fluorescence analysis

In the X-ray fluorescence analysis, the word “fluorescence” is used. However, it does not mean the use of actual fluorescence light. In the usual fluorescence spectrophotometry, when an aromatic molecule having a conjugated double bond is irradiated by a light with a shorter wavelength (higher energy), the molecule absorbs the light energy to be enhanced to an excited state and emits a light with a longer wavelength (lower energy) as fluorescence. A similar phenomenon can be observed for other radiations; when an atom is irradiated by an X-ray,  $\gamma$  beam or electron beam, an X-ray characteristic of the atom is emitted. Therefore, the emitted X-ray is called “fluorescence X-ray”.

In the X-ray fluorescence analysis, elements having molecular weights not smaller than that of Na can be easily analyzed qualitatively and quantitatively; the method is very suitable for elemental analysis of inorganic and metal compounds. The advantage of this method is the ability of analysis without any damage to a specimen; it is noninvasive, and the specimen, which

had been used for the X-ray fluorescence analysis can be again used for another analysis. Therefore, this method is especially useful for screening of inorganic compounds (see [▶ Figure 5.1](#)), and the final analysis can be made by IC or ICP-MS. In the curry poisoning incident in Wakayama, arsenic could be identified from curry by these methods [10].

The sensitivity of the X-ray fluorescence method is at  $\mu\text{g/g}$  levels, and the cost for the instrument is relatively high.

## Atomic absorption spectrometry

When NaCl crystals are introduced into a flame of gas burner, the blue color of the flame immediately changes to an orange color. By utilizing such a phenomenon, various inorganic and metal compounds can be analyzed spectrophotometrically by burning specimens [12]. It is especially suitable for analysis of cation metals; however, each lamp, which emits a light showing a specific wavelength, is necessary for each element to be analyzed.

Recently, so-called flameless atomic absorption spectrometry is being used; it does not use flame burning, but uses a furnace of high temperature. The advantages of the flameless method are smaller volume of specimens required and higher sensitivity.

The detection limits of atomic absorption spectrometry with flame burning are at several  $\mu\text{g/g}$  levels. The pretreatments for this method are generally simple.

The method has a long history; the readers can find the details of the method in many books [12].

## References

- 1) Jeffrey W (2004) Colour tests. In: Moffat AC, Osselton MD, Widdop B (eds) *Clarke's Analysis of Drugs and Poisons*, 3rd edn. Pharmaceutical Press, London
- 2) Yamamoto I (ed) (1998) *Legal Medicine and Forensic Chemistry*, 3rd edn. Hirokawa Publishing Co., Tokyo, pp 121–205 (in Japanese)
- 3) Pharmaceutical Society of Japan (ed) (1992) *Standard Method of Chemical Analysis in Poisoning – With Commentary*. Nanzando, Tokyo, pp 1–462 (in Japanese)
- 4) Dawson RMC, Elliott DC, Elliott WH et al. (1986) *Data for Biochemical Research*, 3rd edn. Clarendon Press, Oxford, pp 453–501
- 5) Stevens HM (1986) Colour tests. In: Moffat AC, Jackson JV, Moss MS et al. (eds) *Clarke's Isolation and Identification of Drugs*. The Pharmaceutical Press, London, pp 128–147
- 6) Shinozuka T, Terada M, Ogamo A et al. (1996) Data on high-performance thin-layer chromatography of analgesic and antipyretic drugs. *Jpn J Forensic Toxicol* 14:246–252
- 7) Watanabe K, Seno H, Ishii A et al. (1997) Capillary gas chromatography with cryogenic oven temperature for headspace samples: analysis of chloroform or methylene chloride in whole blood. *Anal Chem* 69:5178–5181
- 8) Watanabe-Suzuki K, Ishii A, Lee X-P et al. (2000) Analysis of volatile organic compounds by cryogenic oven trapping gas chromatography. *Jpn J Forensic Toxicol* 18:201–209 (in Japanese with an English abstract)
- 9) Osumi Y (1996) ICP (including ICP-MS). In: Izumi Y, Ogawa M, Kato S et al. (eds) *Manual of Instrumental Analysis*, 2nd edn., vol 3. Kagakudojin, Kyoto, pp 43–51 (in Japanese)
- 10) Suzuki S (2001) Analysis of poisonous materials focused on arsenous acid. *Jpn J Forensic Toxicol* 19:1–10 (in Japanese with an English abstract)
- 11) Toda K (1996) X-ray fluorescence analysis. In: Izumi Y, Ogawa M, Kato S et al. (eds) *Manual of Instrumental Analysis*, 2nd edn., vol 3. Kagakudojin, Kyoto, pp 55–72 (in Japanese)
- 12) Hirashima Y (1996) Atomic absorption spectrometry. In: Izumi Y, Ogawa M, Kato S et al. (eds) *Manual of Instrumental Analysis*, 2nd edn., vol 3. Kagakudojin, Kyoto, pp 19–32 (in Japanese)

## I.6 A computer system for diagnosis of causative drugs and poisons developed by the Japan Poison Information Center (Tokyo)

by Toshiharu Yoshioka

### Introduction

In addition to the well known Tokyo Sarin Incident in 1995, the arsenic-adulteration incident in Wakayama and the cyanide-adulteration incident in Nagano both in 1998 seem to have triggered several ten poisoning cases, which took place in 1998–1999. An explosion incident of a chemical factory, a turnover incident of a chemical tank truck and a poisoning murder incident for insurance have also occurred recently. Such poisoning-related incidents are becoming more serious social problems also in Japan.

In the arsenic-adulteration incident of Wakayama, the identification of the causative poison was delayed for some time; the serious incident itself together with the criticism upon the delay made the Japanese Government reconsider the crisis-management system of Japan. Since the incident, the Japan Poison Information Center has also studied how to narrow toxin candidates to a single causative one, by methods other than actual analysis of toxins.

As a result of such efforts, the author et al. [1] have constructed a database for estimation of a causative toxin (assisting system for diagnosis of a causative toxin) according to clinical symptoms and a computer system for searching a toxin, which had been used previously, on the basis of poisoning situations. In additions, by registering experts for each toxin, which was targeted in the above systems, information exchange between a clinical doctor treating a poisoned patient and the expert of a poison has become possible [2].

The setting up of a detailed procedure of pretreatments and of conditions for instrumental analysis is usually difficult without any estimation of a target compound. It seems very important for clinical doctors and analysts to narrow causative toxins by means other than instrumental analysis.

## Database according to poisoning symptoms (assisting system for diagnosis of a causative toxin)

### Drugs and poisons to be targeted

To enhance the probability for estimation of a causative toxin, all of the numerous existing compounds should not be dealt with, but a limited number of toxic compounds should be picked up. Thus, compounds with high general toxicity, which had been used in the previous incidents, were chosen. Specific antidotes are available for some toxins; they were added to the toxins list. However, volatile poisons and corrosive compounds, which can be easily diagnosed by clinical doctors from the circumstances and symptoms, were excluded from the list. As a result, 488 compounds in 75 groups were chosen as shown in [Table 6.1](#).

**Table 6.1.**

**Target compounds for the database according to poisoning symptoms (the final poison groups classified)**

Industrial item	Agricultural item
1 Cyanide and its derivatives	1 Organophosphorus pesticides
2 Toluene/xylene	2 Carbamate pesticides
3 Ethylene glycol	3 Organochlorine insecticides
4 Methanol	4 Cartap
5 Carbon tetrachloride	5 Blastocidin S
6 Sulfur-containing compounds	6 Nicotine products
7 Hydrogen sulfide	7 Paraquat/diquat
8 Arsenic and its derivatives	8 Glyphosate
9 Cadmium and its derivatives	9 Glufosinate
10 Mercuric compounds/mercuric chloride	10 Urea herbicides
–	–
–	–
–	–
75 toxin groups	

### Listing of keywords for searching and their weighting

In poisoning cases, nausea and vomiting are usually observed in common; contradictory symptoms, such as respiratory acceleration and suppression, sometimes appear in poisoning by the same compound according to its severity. These complicated problems embarrassed us much. Much time and efforts were required for classifying clinical symptoms as keywords and for their weighting. More than 500 words describing poisoning symptoms were carefully checked in view of each pathology and grouped using our massive data being filed according to the kinds of causative toxins. As many as 120 words of clinical symptoms were finally chosen

as keywords for computer research; abnormal values of clinical tests were also classified into 50 through the similar examinations and efforts. The weighting using scores of 0–9 was given to each word according to its rapid appearance of a characteristic symptom, but it seems somewhat dogmatic and groundless. For example, the severe diarrhea characteristically appearing in arsenic poisoning was scored 9; while the diarrhea due to cyanide poisoning 3. Conversely, the acidosis caused by arsenic poisoning is scored 1; while that by cyanide poisoning 9.

## Construction of the system

After inputting the basic data of the names of toxic compounds and the scored keywords of symptoms into a computer, a system for estimating a causative toxin from a total score of symptoms appearing was constructed. In this system, Visual Basic 6.0 of Microsoft is being used, and it works well by installing it in a computer not powerless than the Windows 98.

In an upper part of the screen of CRT, the names of organs, such as digestive, respiratory and circulatory ones, are shown; when a responsible organ is clicked, the keywords (poisoning symptoms) for the organ appear. When each button on the left side of each keyword is clicked, “Not clear” is changed to “Observable”. After answering to all items of symptoms, the next organ should be clicked to undergo the same procedure; after completion for all organs, toxic compounds together with each total score appear being lined up according to the score number. The order of the candidate compounds is not important, but the difference in the score between the top and the second compounds is useful for the final judgment of a causative toxin.

Another characteristic of this system is the addition of a repeated questionnaire for some clinical symptoms, which is useful for evaluation (weighting) of candidate compounds listed in a high rank. The operator of the computer confirms the presence of symptoms by communicating with the responsible clinical doctor according to the questionnaire; this process can further enhance the probability of a causative toxin. To monitor if a bias in items to be input is present, the numbers of input for each organ and clinical test are shown on the screen at real-time as “item navigator”. When one of the causative toxin candidate is double-clicked, a detailed data file for the toxin can be opened. The 500 keywords of clinical (poisoning) symptoms, which had been chosen at the initial step of this study, are always stored in the computer, and any of the symptoms can be automatically added to the 120 keywords by clicking according to the need.

Although it is a quite different from the above system, the author et al. are developing a new system for estimating a causative compounds by using complex research of up to 14 keywords. In this system, the symptoms observable in common to various poisonings, such as vomiting, diarrhea, convulsion and tachycardia, are not useful for narrow down causative toxins; the symptoms with relatively high selectivity, such as miosis, hyperventilation and hypotension, and also the informations about a toxin, such as the color of solution or powder, smell, the form of a tablet or a capsule, the kind of a container, purpose, the name of manufacturer, solubility and melting point, are used as keywords for narrowing down toxins.



## A computer system for estimating a causative toxin, which had been used previously, using the outline of an incident (retrospective diagnostic system)

A place of incident, a matrix of poison, severity of poisoning, the number of victims, described in news reports, were chosen and patterned, using poisoning incidents in which causative toxins had been specified, by searching newspaper database of the past 15 years. The above items chosen were grouped as follows, respectively; nine groups of places, *viz.* store, vending machine, station/underground passage, toilet, nursery school/kindergarten, elementary school/junior high school/senior high school, hospital/laboratory, other indoor or outdoor place, and place not clarified; eleven groups of the matrices in which poisons were mixed, *viz.* drink in a glass bottle, drink in a can, drink in a paper package, drink in a plastic bottle, drink in an unknown container, tea in a pot, tea in a water supply device, seasonings, foods, confectionaries, and others; four groups of severity of poisoning, *viz.* strange smell only, digestive symptom only, hospitalization, and very severe or fatal case; four groups of the number of victims, *viz.* only one, a few, more than ten, and more than several ten.

If a case, in which one person falls into a severe state after taking a drink in a bottle found near a vending machine, is assumed, paraquat and cyanide are shown as causative candidate toxins together with their probability data; when either of the toxins is double-clicked, the details of incidents which took place in the past appear; by this method, detailed informations about a causative toxin can be also obtained.

This kind of research system should have been fundamentally constructed by the police, because the informations obtainable only from the database of newspaper by the author et al. are limited. There were many incidents in which causative poisons could not be identified only from the database; these cases had to be deleted. Veterans of forensic science laboratory of the police might have been able to get more informations about a causative poison or estimate it with high accuracy using so-called “the sixth sense” in the above cases. These informations and estimation by the police on causative toxins and details of incidents seem very useful to construct a more powerful research system.

## Database of experts for each causative toxin

The information exchange between an expert of a toxin and a clinical doctor treating a patient can, of course, enhance the probability of identification of a toxin. Therefore, the author et al. decided to register experts for causative toxins in the 75 groups, which had been stored in the present assisting system for diagnosis.

The selection of the registrants was made by literature research using each toxin as keyword and by recommendation by scientists belonging to toxicology-related societies. For complete inclusion of experts, the letters for requesting the recommendation were sent to chairpersons of toxicology laboratories of universities.

➤ *Table 6.2* shows the contents of registration for the database of experts for each toxin. Fifty nine experts from the basic science fields, and 22 clinical doctors have been registered. A majority of them belongs to medical schools/medical colleges and pharmaceutical schools/pharmaceutical colleges; others to national institutes of hygiene and health science, laboratories for food and drug safety and agricultural/fishery schools. ➤ *Table 6.3* shows examples

■ **Table 6.2**

**Contents for registration of experts for each causative toxin**

1	Causative compound
2	Name and affiliation
3	Special field of study/research subject
4	Communication methods
5	Representative publication of the registrant

■ **Table 6.3**

**Research subjects of the experts registered in basic sciences**

➤	Molecular toxicology of arsenic, heavy metals and semiconductor materials
➤	Studies on the Minamata disease
➤	Effects of silicon compounds on immune cells
➤	Biomedical influence of trace element
➤	Biochemical studies on mechanisms of poisoning by drugs and poisons at cellular levels
➤	Studies on metabolic disorders of lipids induced by drugs
➤	Studies on anticoagulant and antithrombotic effects of annexin (Ca <sup>++</sup> -dependent and membrane-bound protein)
➤	On the metabolism and toxicity of fluorine compounds (especially hydrogen fluoride)
➤	Mechanisms of induction of cytochrome p-450 caused by drugs and poisons
➤	Studies on neurotoxicity of chemicals
➤	Mechanisms of induction of behavioral abnormality caused by nitrile compounds
➤	Mechanisms of acute poisoning by paraquat; cellular toxicity of furanonaphthoquinone; medicine of active oxygen
➤	Delayed neurotoxicity of organophosphorus compounds
➤	Biomedical influence of organic solvents and their metabolites
➤	Studies on detection methods for volatile compounds and their pharmacodynamics
➤	Studies on quality control and authentication of natural remedies and on the origin of the traditional folk medicine
➤	Analysis of marine toxins and toxicogenic mechanisms in fish and shellfish
➤	Basic studies on signal transduction and gene expression for environmental chemicals
➤	Chemical and toxicological changes of organic compounds by chlorine treatments, and production mechanisms of dioxins
➤	Sensitive analysis of trace drugs and poisons by LC/MS and GC/MS
➤	Immunoassay methods
➤	Studies on analysis on drugs and poisons by mass spectrometry
➤	Hair analysis / mechanisms of transportation of drugs to hair
➤	Natural toxins (especially on the analytical methods of plant toxins)
➤	Detection of poisoning by hydrogen sulfide, hydrogen cyanide, carbon monoxide and other gases

of subjects of studies being conducted by the experts registered in basic sciences. Among the 488 compounds in 75 groups, there are 15 compounds for which no experts were found, but 47 toxic compounds were newly added by suggestion of the experts.

## Conclusion

When a patient is brought to an emergency room, the medical and co-medical staffs should doubt poisoning first. When the possibility of poisoning is high, they should communicate with the Japan Poison Information Center on the clinical symptoms and on the results of clinical tests [3]. When estimation of a poison is made only by clinical symptoms and abnormal data, the reliability of such informations is most important. The information exchange should be made between a doctor directly treating the patient and a staff of the Japan Poison Information Center being well aware of the structure of the database according to poisoning symptoms. In their conversation, both of them should clarify clinical symptoms as many as possible; according to a case, additional clinical tests may be necessary. When a causative poison is estimated, the talks are extended to an expert of the poison using the expert database. Using our computer systems, the fairly exact narrowing down of poisons can be achieved.

The database according to poisoning symptoms presented in this chapter was targeted only at compounds, which caused severe damages or even death; such poisoning cases may be not many. For the volatile poisons and corrosive compounds, which had been excluded, a similar diagnostic system should be also constructed. There are many compounds to be added as causative toxins. Efforts should be made for the enhancement of completeness of the diagnostic system; the upgrade of each system is necessary.

## References

- 1) Yoshioka T, Ikeuchi N, Endo Y et al. (1999) Estimation of a causative compound using poisoning systems. *Clinic All-Round* 48:2499–2502 (in Japanese)
- 2) Yoshioka T, Hirota T, Endo Y (2000) Toxicologists and specialists in related fields of poisoning on the management of Japan Poison Information Center. *Jpn J Toxicol* 13:279–286 (in Japanese)
- 3) Yoshioka T, Oda J, Ikeuchi N et al. (2000) Practical use of Japan Poison Information Center. *J Med Technol* 44:1498–1500 (in Japanese)

## I.7 Practical use of the poison-net developed by the Japan Information Network (Hiroshima)

*By Mikio Yashiki and Manami Nishida*

### Introduction

Forensic autopsy is an important task for proving crimes medically; unfortunately, every department of legal medicine of Japanese universities is suffering from insufficient staffs and budget. About 30 years ago, one of the authors started the analysis of drugs and poisons at the Department of Legal Medicine, Hiroshima University School of Medicine. At that time, the author did not have much knowledge about poison analysis; but it is a good memory that many good friends of toxicological societies gave the author many useful suggestions on analytical methods. Therefore, the author felt that nationwide non-governmental activities for communication about poisoning informations were essential among forensic (analytical) chemists, clinical doctors and other people being involved in poisoning. The authors started creating a communication network first with letters, followed by telephone calls, facsimile, personal computer communication and the mailing list using the Internet; according to the current of times, the communication methods have changed and the number of registrants has increased in our network. At the Department of Legal Medicine, Hiroshima University, a home page (HP) was set up to enable the members to take a look into it subject to passwords. The HP includes the contents of talks, which had been made for information exchange in the network, and many other informations related to poisoning. In this chapter, the authors briefly present the practical use of the network.

### What is “poison-net”?

---

The authors designated the activities of the Japan Poison Information Network as “poison-net”, comprehensively. It includes “poisoning mailing list”, “analysis mailing list”, supply of informations of poisoning on Web, requests for analysis of a causative toxin, trials of toxin analysis and hosting a short course of training for preliminary spot tests of drugs and poisons.

### Poisoning mailing list (ml-poison)

---

The ml-poison (ml-poison@hiroshima-u.ac.jp) was started in about 1994, when the Internet was introduced into Hiroshima University School of Medicine. The members of the poison-net were composed of clinical doctors of emergency rooms, clinical technologists and experts of

toxicology; to protect human rights of patients, the press men and the general public were not allowed to join the ml-poison. The good communication quality is being maintained to be able to cope with the sudden outburst of a poisoning incident or accident; the complementary talks are being refrained as possible. The mailing list is convenient for rapid response to an incident or accident and for getting the newest informations, but caution should be taken against informations obtained through the mailing list, because they are occasionally not reliable. The number of the registrants counted about 700 at the time point of August, 2001. A password is given to each registrant to enable looking into the poisoning information part of HP of the poison-net.

## Analysis mailing list (ml-anal)

---

In 1998, the Ministry of Health and Welfare of Japan distributed analytical instruments for toxins to the 8 advanced critical care medical centers and the 65 critical care medical centers. Each of the latter centers was equipped with an HPLC instrument and an X-ray fluorescence spectrometer, which costed twenty million yen; and the advanced critical care medical centers were equipped with an HPLC, an X-ray fluorescence spectrometer, GC/MS and other instruments with the cost of eighty million yen. However, only with the introduction of such expensive analytical instruments, they do not work in the absence of a sufficient number of experts, who can operate them. Many correspondences and questions about the instrumental analysis were sent to our laboratory through the ml-poison. Therefore, in 1999, the authors decided to separately create ml-anal (ml-anal@hiroshima-u.ac.jp) to support toxin analysis in such critical care medical centers and other hospitals. The registrants of the ml-anal were composed of the members of ml-poison who were interested in the analysis, engineers of manufacturers of analytical instruments and attendees of the short course of the preliminary color tests; the number of the registrants counted more than 300 in August, 2001. At the beginning, both analysts and engineers of manufactures got embarrassed saying, “Which kind of drugs or poisons can be analyzed by HPLC?” and, “Which kind of drugs or poisons do the analysts want to analyze?”, respectively. Later, after the instruments have become to work well, the qualities of the questions became much higher.

## Supply of information by the web

---

The URL of HP of the poison-net is <http://maple-www2.med.hiroshima-u.ac.jp>; this is expected to be changed in the near future according to servers to be used.

## Storage of contents of talks made in the mailing lists (ml-poison plus ml-anal)

The contents of talks made in both ml-poison and ml-anal were rearranged according to causative toxins, and shown in the “poisoning-talking salon” of HP of the poison-net (subject to a password given to each registrant). The causative toxins are composed of daily necessities, drugs (including over-the-counter drugs), pesticides, natural toxins, industrial materials and others.

Many cases of poisoning and informations on analysis are shown in the HP. If talk contents are opened to the public, the permission by each talker becomes necessary; the authors thus refrain from introducing the contents in this chapter. However, the headlines of the “poisoning-talking salon” are being demonstrated in the top page of HP, which can be accessed without any password.

## Databases (DBs) in wide areas of poisoning

Various kinds of DBs related to poisoning are available in HP of the poison-net as shown below.

### i. DB for analytical methods

The papers describing analytical methods for drugs and poisons in human specimens were searched by the Medline. The papers were selected by the eleven scientists, who were the members of a joint study project supported by a Grant-in-Aid for Scientific Research (B) from the Ministry of Education, Science and Culture of Japan. Chemical compounds listed were: natural toxins, organic solvent/toxic gases, anaesthetics (local anaesthetics, inhalation anaesthetics, intravenous-injection anaesthetics and muscle relaxants), neuroleptics/anti-depressants (psychopharmaceuticals, antiepileptics and antiparkinsonian drugs), amphetamines/narcotics, hypnotics/tranquilizers, pesticide and others. On the basis of extensive informations collected from 900 papers, the most suitable analytical method can be rapidly found by searching with a combination of a specimen name, an analytical method and a chemical name (target) to be analyzed. Each specimen (urine, blood, authentic, serum/plasma, tissues or others) and each method (TLC, HPLC, UV-VIS, GC/MS, GC, immunoassay, MS, LC/MS or others) are chosen using the pulldown menu, and a chemical name (subject) is input. When the search is made with a dubious name of a chemical, there is a possibility not to be able to reach a corresponding analytical method; in this case, the chemical name can be reexamined with a list of “chemical names stored in the DB of analytical methods”. The analytical methods included in the DB are reliable, because the scientists who selected them are experts of forensic toxicology. When any question on an analytical method is sent to our Network by the ml-anal, a good answer will be returned by the responsible scientist.

### ii. DB for blood concentrations of causative toxins

In forensic cases in which drugs are involved, the assessment of blood drug concentration is necessary. Also in clinical cases, the blood drug levels obtained by analysis should be rapidly classified into therapeutic, toxic and fatal ones to serve for deciding the policy of treatment. The blood levels and symptoms, reported by Mayer and by Winek both in 1994, and other data in actual cases were input into the DB. The items for our input into the DB were: a name of a drug, a name(s) of coexisting drug(s) (single, multiple and not clear), blood levels in the literature, institution number (forensic or analysis numbers), dead or alive, age, sex, interval after ingestion, outline of an incident, clinical or autopsy findings, analytical method, levels of the target drug obtained from blood and other specimens by analysis, unit of the values, the presence of other drugs in blood, cause of death/diagnosis, comments and address for correspondence of a user. Care was taken for enabling an expert to directly correspond to the user about

more details of an actual case. By comparing the analytical results with the data in the DB, it is possible to estimate the antemortem conditions of a deceased and the symptom levels of a living patient.

### iii. DB for poisoning-related journals and toxicology society journals

The DB was mainly created by Prof. Shirakawa of Ehime University Hospital, Emergency Units, and covers the contents of domestic journals and abstracts related to poisoning, which are not included in international literature DB. When a user inputs a chemical for research together with “OR” or “AND”, a list of journal name, society name, year, volume, page and title appears. By clicking the title, the details of contents (abstract, authors and affiliation) can be obtained. Even in poisoning cases which had been only presented at a meeting and not been submitted to a journal, good ideas for medical treatments may be included. When a poisoning incident takes place with a chemical which is included in the DB, it may give useful informations on treatments and analysis in the poisoning.

### iv. DB for contents of talks in the ml-poison

The contents of talks in the ml-poison can be obtained by the method as described in section 1; they are stored in a DB to make keyword research possible.

## Other articles about poisoning appearing in HP of the poison-net

### i. Simple color test methods for drugs and poisons (ver 2)

Screening or preliminary tests for drugs and poisons are essential before their instrumental analysis to narrow probable compounds for poisoning. The article was abstracted from the book [Department of Legal Medicine, Hiroshima University School of Medicine (ed) (2001) Simple Detection Methods for Drugs and Poisons: The Color Tests. Jiho Inc., Tokyo]. It includes cyanide compounds, carbon monoxide, organophosphorus pesticides, paraquat, bromisovalum, acetaminophen, barbiturates, tricyclic antidepressants, boric acid, amphetamines, screening methods using spot tests and some comments on analytical instruments.

### ii. Manual for analysis of drugs and poisons (the first draft)

A manual for analysis of drugs and poisons was first created on our Web site. “Manual for Forensic Toxicology Analysis” was then published by the Forensic Toxicology Working Group of the Japanese Society of Legal Medicine in a printed form, on the basis of this article (the first draft) on the Web. The original draft on the Web contains more detailed description on toxin analysis. It seems desirable to use both printed and Web ones for getting more detailed informations on analysis.

### iii. Cautions in analysis of human specimens

In this article, pitfalls in analysis are being discussed. The contents are: the procedure of bio-medical analysis, human specimens (sampling methods and cautions upon sampling and storage), preliminary tests (cyanide compounds, arsenic compounds, azide, organophosphorus pesticides, paraquat, glufosinate, controlled drugs, bromisovalum and acetaminophen), pre-treatments of specimens (the methods and cautions), confirmatory analysis (analytical instruments, methods and cautions), substantiation of drug standard collection and critical assess-

ment of analytical results. In every item, only basic problems are being discussed; but it is emphasized that the carelessness causes serious mistake.

## Mediating service for the request of analysis of causative toxins using the network

---

It is essential to analyze a causative toxin for making an effective treatment. It is preferable to analyze it at a local laboratory; however, unfortunately, institutions undertaking such analysis are not many in Japan. Private clinical laboratory companies undertake analysis of the limited number of toxic compounds. Therefore, the authors established a system for receiving a request of toxin analysis in the HP of the poison-net to respond to it at any time. When the request form revealed in the HP is filled, it is automatically mailed to a manager who checks the contents of the form; after removal of undesirable parts of the contents, which may violate human rights, it is mailed through the ml-poison to the members. When an analyst is found, direct communication is made between the requester and the analyst. The analytical results are reported to the ml-poison. If the requested analysis is regarded as a joint study between them, the analysis is made free of charge for the requester; in principle, it should be presented at a meeting or published in a journal. When no analyst is found, it is requested to a private clinical laboratory company with a charge. In Japan, many experts are available for analysis of toxic compounds; their results of analysis and maintenance of their analytical instruments are reliable. The above requesting system using the ml-poison can be regarded as a “virtual poison control center” for analysis. In USA and Europe, many poison control centers dealing with toxin analysis are present and well utilized; while, in Japan, the situation is much delayed and no official institutions for toxin analysis are available at the present time. However, thanks to the spread of activities of private express transportation companies, the cooled or frozen specimens can reach any part of Japan within two days. With the intellectual and substantial cooperation of the experts of toxin analysis distributed throughout Japan, similar activities to those of poison control centers can be realized without an enormous cost using the Internet and the above express transportation services. Until now, the authors experienced many cases of analysis requests through the system. For example, in the cresol-poisoning incident which took place in Aomori, cresols in plasma and urine (free and conjugated forms with glucuronide and sulfate) were repeatedly analyzed in Okinawa for specimens sampled from patients at various intervals after ingestion; the results were reported to the ml-poison one week later. A part of list of the analysis requests is shown on the Web ([http://maple-www2.med.hiroshima-u.ac.jp/analysis\\_2.html](http://maple-www2.med.hiroshima-u.ac.jp/analysis_2.html)). As explained above, the mediating service through ml-poison is useful for settlement of a poisoning incident. However, some problems should be mentioned; it sometimes takes a long time for analysis, resulting in no contribution to clinical treatments; when neither presentation at a meeting nor publication in a journal is realized after laborious analysis, the principle of being a joint study collapses, causing a trouble between the analyst and requester on the cost. The authors feel that, even in a joint project, the cost for analysis should be paid by a requester for continuation of the mediating service system for a long time.



## Trial for quality of analysis of drugs and poisons

---

Actual training of analysis is essential rather than collecting informations on analytical methods to make accurate identification and quantitation of a causative toxin. Even with an identical specimen, the discrepancies of analytical results can appear in different institutions, probably due to different levels of skillfulness of analysts or different capability of instruments being used; such discrepancies should be avoided by quality control. For this purpose, the authors are hosting the trial for quality of analysis every year.

In the first trial, a poisoning case was assumed in which a guest staying at a hotel did not come out of his room for checkout; a bellboy discovered the guest collapsing and sent him to a hospital. Together with paper describing fictitious situations and comments by a clinical doctor, each serum specimen, to which a fixed amount of pentobarbital had been added, was sent to 42 analysts who had wished the trial. The second trial (66 participants) was held on pesticide poisoning with addition of an emulsion product of DCPA and NAC. For both trials, answers were collected from the participants after a while; about a half of them could achieve both qualitative and quantitative analyses successfully, and a few could neither make qualitative nor quantitative analysis for both trial. After the collection, the model answers and the summaries of the results given by all participants were returned to them. By examining the report, the self-assessment of each participant could be made; it seemed useful for intensifying a sense of quality self-control. For correspondence and questions to the participants, the trial ML (ml-trial) was used. In U.S.A. and Europe, such trials for analysis in poisoning are very common; while no trials have been made in Japan except ours. Since the trials were made being supported by a Grant-in-Aid from the Ministry of Health and Welfare of Japan, the participants were free of charge. The authors are continuing the trials for improvement of analytical techniques of participants. At the present time, however, they are being made without any financial support; the authors do hope that the national organization or official societies will undertake the quality assurance of analysis of drugs and poisons.

## Short course of training for simple preliminary tests of drugs and poisons

---

As stated before, upon occurrence of a poisoning incident, preliminary tests are required to narrow causative toxin candidates before accurate analysis by instruments of high performance. Although the number of chemicals being analyzable by kits commercially available is limited, it is very easy to handle them. Because of such easiness and simplicity, the authors hosted a short course, in which clinical doctors were trained for simple poison analysis with the kits; they will be able to analyze poisons at bedside by themselves before sending the specimens to analytical experts. The short training course is being held under the auspices of the Committee on Analysis of Japanese Society for Clinical Toxicology on the day before the Annual Meeting of the Society. In the first course, the participants were trained for tests of glufosinate in urine (Basta qualitative kit), TLC for drugs (Toxi-Lab®), organophosphorus pesticides in urine, controlled drugs by an immunoassay (Triage®), acetaminophen in serum and cyanide ion in blood; the number of participants of this course held at Hiroshima University was 80. In the second course held at Azabu University in the next year, the participants were trained for some of the same tests as described above, but two tests were newly added, *viz.* tests for toxic gases and

boric acid in serum; but the participants counted 38 only. The cause of the decrease of participants might be due to that the tests were almost the same as those of the previous year and that some participants wished instrumental analysis. In the next course, the authors are planning to use some instruments.

## Perspectives

---

The poison-net has been supporting people in the field of clinical toxicology, especially in the analysis of drugs and poisons using various methods described above. The authors do hope that more lives suffering from poisoning will be saved with the assistance of the informations obtained from the poison-net. The maintenance of this kind of system by a single institution is too hard; it should be changed to be supported by a governmental organization or scientific societies. The network is based on the mutual trusting relationship of members; it does not exist only for receiving informations, but does exist to supply reliable informations to members positively. The latter will make the network more developed and upgraded.

It seems convenient for readers to take a look into HP and URL describing informations on poisoning. However, the contents and URL will be changed during a long period of time. If the readers can not access our network, please communicate to Hiroshima University Graduate School of Medicine by other means.

# I.8 Problems in toxin analysis in emergency medicine

By Makoto Nihira

## Introduction

The identification of a causative toxin is one of the most important tasks in emergency medicine; it requires both rapidness and accuracy. In the Japan-shaking poisoning incidents taking place in 1998, such as curry (arsenous acid) poisoning in Wakayama, sodium azide poisoning in Niigata and cyanide poisoning in Nagano, the importance of a rapid and accurate analysis system for poisons was well recognized by Japanese people and government. Since then, the importance of toxin analysis (clinical analytical toxicology) on the spots of clinical treatments of poisoned patients (clinical toxicology) was also confirmed. The Ministry of Health and Welfare of Japan decided to distribute an X-ray fluorescence spectrometer to be used for metal analysis together with an HPLC instrument with a photodiode array detector to be used for drug analysis to the 65 critical care medical centers; the above two instruments plus some mass spectrometric instruments for the final identification and quantitation to the 8 advanced critical care medical centers. Such analytical instruments were introduced also to our Advanced Critical Care Medical Center of Nippon Medical School. Upon introduction of the state-of-the-art analytical instruments, all staffs of both Department of Legal Medicine and Advanced Critical Care Medical Center discussed together on the selection of each type of instruments, which had been proposed by various manufacturers, for strengthening the toxin analysis system in emergency medicine at our College Hospital.

At Nippon Medical School, the Department of Legal Medicine and the Advanced Critical Care Medical Center have been cooperating for practical analysis and studies on new analytical methodologies of drugs and poisons in specimens sampled from poisoned patients for more than 20 years since 1980 [1–8]. Screening tests are being made at bedside, *viz.* inside the Advanced Critical Care Medical Center and complicated analysis for identification and quantitation is being made at laboratories of the Department of Legal Medicine. The analytical system has been also improved to become responsible for the 15 toxic compounds, which were proposed by the Committee on Analysis of Japanese Society for Clinical Toxicology [9]. The poisonings taking place in the midst of the metropolitan area, where our College is located, are largely due to drugs; they are so-called “urban-type poisonings” [1, 6, 10] caused by illicit drugs of abuse and therapeutic ones. Therefore, our system for analysis should mainly cover these drugs. In this chapter, the author presents some of our analytical system and discusses on problems arising during maintaining the system.

## Analytical system at Nippon Medical School

---

### Screening tests at the emergency rooms

1. Volatile compounds
  - Alcohol: a simple kit for alcohol measurements (alcohol dehydrogenase method)
  - Cyanide: capillary electrophoresis (CE)
  - Azide: CE
  - Carbon monoxide (CO): oxymeter
2. Drugs
  - Psychopharmaceuticals and illicit drugs: Triage (immunoassay)
3. Metals
  - Arsenic, thallium, mercury and others: X-ray fluorescence spectrometer
4. Pesticides
  - Bipyridinium pesticides (paraquat and diquat): color tests

### Confirmation and quantitation at the laboratories of the Department of Legal Medicine

1. Volatile compounds
  - Alcohol: GC [headspace method, flame ionization detector (FID)]
  - Toluene: GC (headspace method, FID)
  - Cyanide: GC (headspace method, nitrogen- phosphorus detector)
2. Drugs
  - Illicit drugs
    - a. Amphetamines (methamphetamine, amphetamine and others): GC/MS
    - b. Opiates (morphine, heroin and others): GC/MS
    - c. Cannabinoids (tetrahydrocannabinol and others): GC/MS
3. Other drugs
  - a. Barbituric acids: GC/MS
  - b. Phenothiazines: GC/MS
  - c. Tricyclic antidepressants: GC/MS
  - d. Bromisovalum: GC/MS
  - e. Benzodiazepines: LC/MS
  - f. Sildenafil citrate (Viagra): LC/MS
4. Pesticides
  - Bipyridinium pesticides (paraquat and diquat): HPLC
  - Amino acid type herbicides (glyphosate and glufosinate): HPLC
  - Organophosphorus pesticides (MEP, DDVP, malathion and others): GC/MS
5. Metals
  - Atomic absorption spectrometry (in cooperation with the Department of Public Health)

## Screening tests at the emergency rooms

---

It is, of course, necessary to estimate a toxin by careful monitoring of symptoms of a patient, such as miosis in case of organophosphorus pesticide poisoning; but actual screening tests at the emergency rooms for causative toxins are also very useful. It seems important to simply detect alcohol and carbon monoxide, at a clinical scene for rapid and suitable treatments, because their poisoning is most frequent. The screening kit Triage is useful for detection of eight groups of drugs; an important information can be obtained by this method especially for an illicit drug, although a confirmatory test is required. The Triage kit utilizes an immunoassay for detecting drugs in urine and is widely distributed in U.S.A. The items of drugs detectable by the kit are not fit well for the situation in Japan. As shown in [▶ Table 8.1](#), the cutoff values are established for each drug in the kit; positive results can be obtained at levels higher than the cutoff values. It does not require any pretreatment and enables tentative bedside diagnosis of the presence of a drug. Although it is very useful at emergency rooms, it suffers from the inability of detecting bromisovalum, phenothiazines and acetaminophen, which are very common in poisoning cases in Japan; the simple kits using immunoassays for the above drugs are being eagerly awaited.

Especially for pesticide poisonings, their prognosis is markedly affected by a method of treatment to be made at the early stage of poisoning; an suitable treatment is necessary as soon as possible. The screening tests for discrimination among pesticides of bipyridinium, organophosphorus and amino acid type herbicide groups are very important, because of the above reason. The bipyridinium pesticides can be easily screened by a color reaction with hydrosulfite. For organophosphorus pesticides, the clinical findings, such as miosis and lowered levels of serum cholinesterase activity, are useful as indicators of their poisoning; a simple color tests using 4-(4-nitrobenzyl)pyridine and tetraethylenepentamine is also available for the pesticides. For amino acid type herbicides, a TLC method with a ninhydrin color spot test can be used; its procedure is relatively complicated and a simpler test is being awaited.

## Confirmatory tests and quantitation at the laboratories of Department of Legal Medicine

---

The result obtained by the preliminary Triage test should be reexamined using a confirmatory test, because immunoassays sometimes give false positive results for similar compounds. In addition, the cross reaction usually takes place among compounds of the same group. When the Triage kit shows a positive result for OPI, discrimination among heroin, morphine, codeine and dihydrocodeine is impossible by the kit. The specification of an opiate is very important, because dihydrocodeine is usually contained in over-the-counter drugs of antitussives and cold medicines and is not illicit. 6-Acetylmorphine is considered to be an indicator of heroin use; but there is a possibility that morphine has been prescribed for treating pain of a cancer patient at a late stage. The confirmatory tests are useful in both therapeutic and legal points of view.

After detecting a drug (group) by the Triage kit, mass spectral measurements are most useful to identify a compound [11]. The author presents some details of confirmatory tests using GC/MS and LC/MS in this section.

## GC/MS

The compounds with an amino group and a hydroxyl group are trifluoroacetylated and trimethylsilylated, respectively, for GC/MS analysis [11]. The primary informations by Triage screening are useful for selection of a derivatization method most suitable. Most drugs can be confirmed by GC/MS after derivatization; GC/MS is indispensable for analysis of illicit opiates and amphetamines.

The author experienced a case in which 3,4-methylenedioxymethamphetamine (MDMA) and 3,4-methylenedioxyamphetamine (MDA) were identified by GC/MS in a urine specimen (▶ Fig. 8.1), which had shown a positive result for amphetamine by Triage [12]. The retention times and mass spectra of the peaks coincided well with those of MDMA and MDA; however, methamphetamine and amphetamine could not be identified. In this case, it was fortunate that the Triage test was positive, which enabled us to identify these compounds, because the reactivity of Triage with MDMA is relatively low; the reaction color can be observed only at more than 3,500 ng/mL of MDMA levels. If the Triage test was negative, MDMA and MDA had been overlooked.

Secondly, the author mentions another case of phencyclidine (PCP) poisoning [12]. According to the allegation of a poisoned patient, she had ingested a large amount of Tylenol (main component, acetaminophen). Therefore, the Triage test was not made at her bedside. However, at the laboratories of Department of Legal Medicine, acetaminophen could not be detected, but PCP could (▶ Fig. 8.2); the allegation of the patient was found not true. When illicit drugs are involved, the allegation of patients is usually not trustworthy; the medical team should be cautious about it and act at their own discretion.

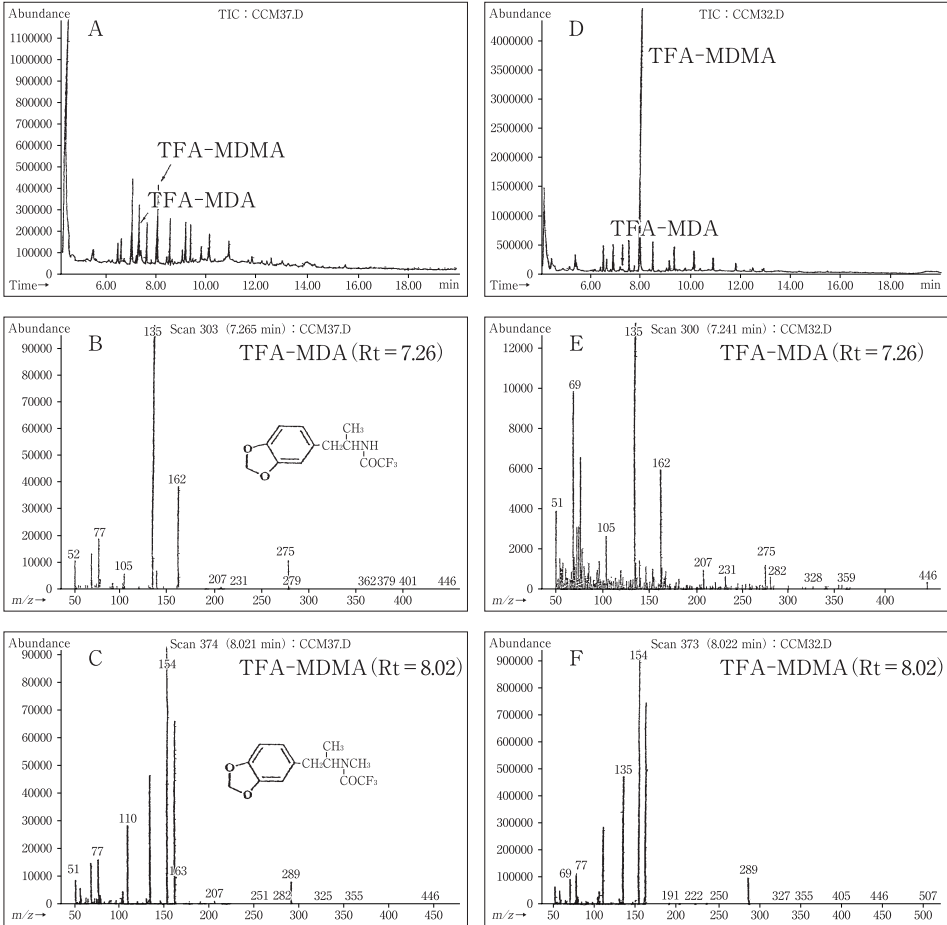
## LC/MS

LC/MS is suitable for analysis of thermolabile and non-volatile compounds. The author et al. are using LC/MS for benzodiazepines and sildenafil citrate (Viagra). Screening of benzodiazepines by Triage is a problem, because the cutoff level of the drug group is as high as 300 ng/mL; the lower levels of the drugs are overlooked. The urinary levels of a benzodiazepine are low in a short time after its intake, resulting in a negative result is the Triage test.

The author et al. [13] experienced a curious case of homicide using benzodiazepines, which forced us to make a hard work for analysis. In this case, the Triage test was negative; thus a tedious procedure of urinary screening by GC/MS [14] was adopted, but it gave negative results. Finally, the blood of the victim was analyzed by LC/MS; surprisingly high concentrations of triazolam, brotizolam and 1-OH-triazolam could be detected and identified, and their blood levels were almost fatal [15, 16]. The discrepancy between their levels in urine and blood was probably due to a short interval between the ingestion and death. The author felt the need for a new sensitive screening method, which can detect low levels especially of benzodiazepines.

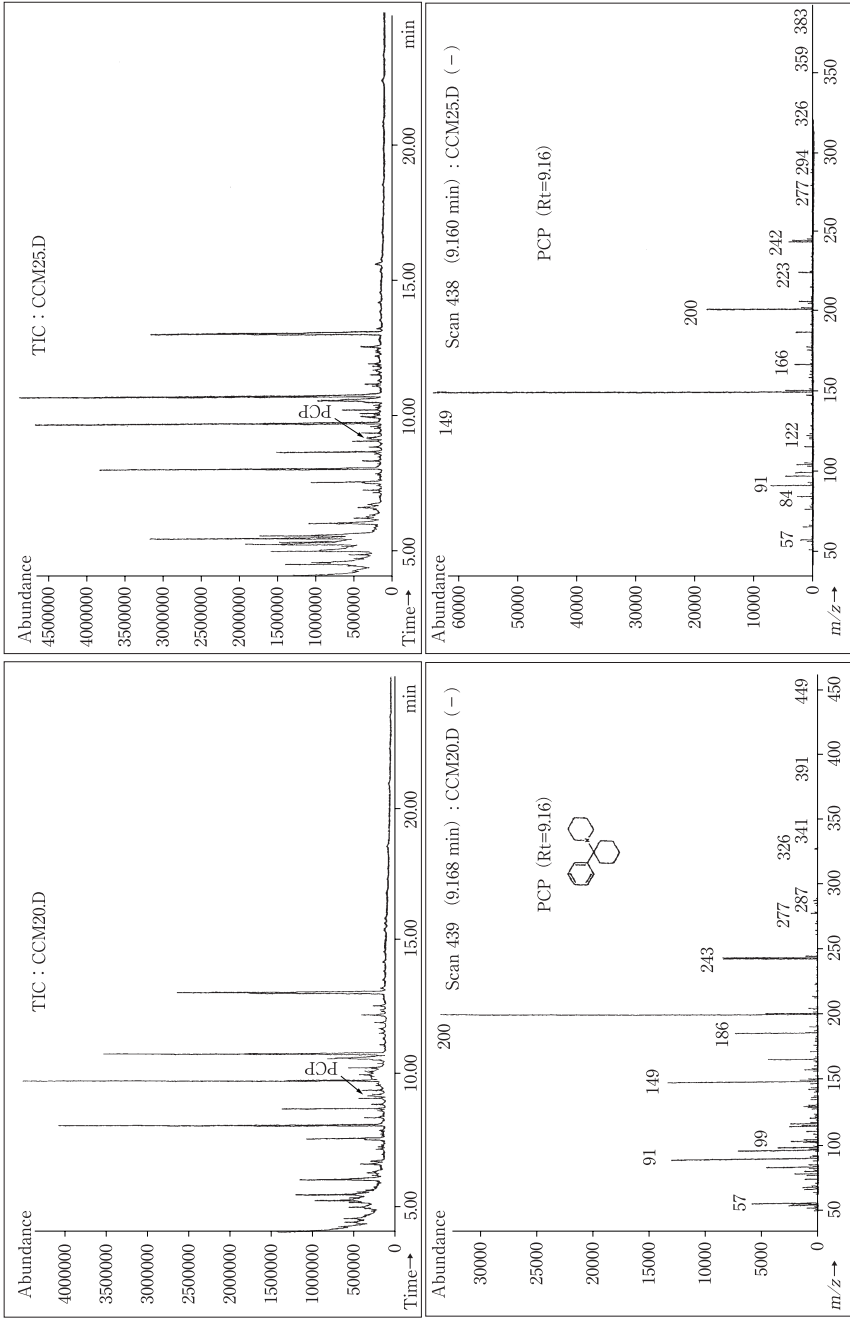
In the confirmatory tests of paraquat, the survival curve proposed by Proudfoot et al. [17] is still being valid; it is useful for estimation of prognosis of the poisoning. It is possible to detect paraquat from hair by LC/MS [18]. The hair analysis for paraquat sometime becomes useful for poison diagnosis, especially when a poisoned patient survives for more than a week, and paraquat cannot be detected from blood or urine. The history of the patient's exposure to paraquat can be known by hair analysis.

**Figure 8.1**



TICs and mass spectra of TFA derivatives of 3,4-methylenedioxymethamphetamine (MDMA) and 3,4-methylenedioxyamphetamine (MDA) obtained from urine of a patient and from the respective standard compounds. Right panels: TIC and mass spectra obtained from the urine extract of a patient; left panels: those obtained from the authentic standards. The identities of MDMA and MDA were confirmed by the coincidence of the retention times and by the same mass spectral profiles.

**Figure 8.2**



**TICs and mass spectra of phencyclidine (PCP) obtained from urine of a patient and from its standard compound. Right panels: TIC and a mass spectrum obtained from the urine extract of a patient; left panels: those obtained from the authentic standard.**



In this chapter, the author has mainly dealt with poisoning by drugs and mentioned some problems encountered in our actual activities of toxin analysis. Recently, various kinds of drugs have become obtainable using the Internet; the consolidation of our analytical system is required to be able to cope with such new compounds.

## Perspectives

### Securing of the standard compounds for analysis in poisoning

For the final identification and quantitation of toxic compounds, their standard (authentic) compounds of high purities are absolutely necessary; without them, reliable analysis cannot be achieved. When the target to be analyzed is a substance controlled by our Government, the import of its pure compound is limited too severely in Japan. The severe control is being extended even to its stable-isotopic compound to be used as internal standard upon analysis. There are many foreigners working or studying in Japan; there is a possibility of occurrence of poisoning incidents using drugs or poisons which had been brought to Japan by foreigners. When the pure compound of such a target to be analyzed is not available in Japan and also the compound is included in the list of controlled substances, such a problem arises for difficulty in getting the standard compound. In U.S.A. and Europe, small amounts of controlled substance standards are being freely transported for analytical purpose; easing of import of controlled substance standards should be realized for analysts and researchers as soon as possible in Japan.

### Checking of the reliability of analytical methods

In the Triage test, cutoff values are being presented as stated before (▶ *Table 8.1*); such setting of the values seems sometimes inadequate. For example, even in a suicidal case with a tricyclic antidepressant, the Triage test was negative for the drug in urine; however high concentrations of a tricyclic anti depressant were proven in blood by GC/MS. This is also true for benzodiazepine poisoning. Such limitation of the Triage test should be kept in mind.

In Japan, any third-party institution is unfortunately not available for quality assurance of analysis of toxic compounds or for assessment of analytical data [19]; the third-party institu-

■ **Table 8.1**

Cutoff values (ng/mL) of the Triage® kit

PCP	Phencyclidine	25
BZO	Benzodiazepines	300
COC	Cocaine (benzoylecgonine)	300
AMP	Amphetamines	1,000
THC	THC (11-non- $\Delta^9$ -carboxylic acid)	50
OPI	Opiates (morphine)	300
BAR	Barbiturates	300
TCA	Tricyclic antidepressants	1,000

tion or a specialized committee of a scientific society dealing with quality control of the analysis should be established as soon as possible.

## Support and management of the analytical system

Apart from analytical methods and techniques, the author wants to mention the financial aspects for the support and management of the analytical system. Many of analytical instruments are very expensive; the maintenance of various components of instruments, such as vacuum pumps and nitrogen gas generators, together with that of the main bodies of instruments, is also expensive. Financial support is also required for keeping 24-hour analysis; for the purpose, a sufficient number of analysts should be secured.

The good education for analysts is also important to maintain a high quality of their analytical skill; the establishment of educational institutions special to toxin analysis is awaited.

Only after solving all of the above problems, the genuine analytical system for drugs and poisons will be established in Japan.

## References

- 1) Hayashida M (1983) Analysis of acute poisoning patients admitted to Critical Care Medical Center, Nippon Medical School during the past 7 years. *Jpn J Legal Med* 37:227–235 (in Japanese with an English abstract)
- 2) Hayashida M, Nihira M, Watanabe T (1990) Application of a computer-assisted high-performance liquid chromatographic multi-wavelength ultraviolet detection system to simultaneous toxicological drug analyses. *J Chromatogr* 506:133–143
- 3) Nihira M, Hirakawa K, Hayashida M et al. (1990) Rapid analysis of organophosphorus pesticides using  $^{31}\text{P}$  Fourier transform nuclear magnetic resonance spectroscopy (FT-NMR). *Jpn J Legal Med* 3:57–62 (in Japanese with an English abstract)
- 4) Hayashida M, Nihira M, Moriya N et al. (1992) An evaluation and standardization of TOXI-LAB<sup>®</sup> test for emergency drug screening. *Jpn J Toxicol* 5:251–265 (in Japanese with an English abstract)
- 5) Hayashida M, Ohno Y, Nihira M et al. (1996) Severity index in traffic accident trauma and blood alcohol concentration. *Res Prect Forensic Med* 39:307–316 (in Japanese)
- 6) Inuzuka S, Hayashida M, Nihira M (1997) Study on the situation of drug use and usefulness of rapid drug screening at the critical care medical center. *J Nippon Med Sch* 64:344–352 (in Japanese with an English abstract)
- 7) Nihira M, Hayashida M, Ohno Y et al. (1997) Evaluation of the use of Triage<sup>®</sup>, a simple screening kit for drugs in urine, for emergency patients. *Rinshokensa-kiki. Shiyaku* 20:519–525 (in Japanese)
- 8) Nihira M (1998) Drug abuse and toxicological scene in Japan. *J Toxicol Sci* 23(Suppl II):201–204
- 9) Yoshioka T, Kohriyama K, Ueki M et al. (1999) A proposal on a guideline for analysis of toxic substances. *Jpn J Toxicol* 12:437–441 (in Japanese)
- 10) Nihira M, Hayashida M, Ohno Y et al. (1998) Urinalysis of body packers in Japan. *J Anal Toxicol* 22:61–65
- 11) General study group on analysis of drugs in biological specimens (Ministry of Health and Welfare of Japan) (1995) *Forum on Analysis of Drugs in Biological Specimens 1994*. Tokyo, p 113 (in Japanese)
- 12) Nihira M, Hayakawa M, Yamada T et al. (2002) Analysis of MDMA and PCP by GC-MS from patients admitted to the critical care medical center. *Jpn J Toxicol* 15:47–52 (in Japanese with an English abstract)
- 13) Nihira M, Hayashida M, Ohno Y (2001) Toxicological analysis for samples obtained at the Advanced Critical Care Medical Center of Nippon Medical School. *Jpn J Forensic Toxicol* 19:195–205 (in Japanese with an English abstract)
- 14) Japanese Society of Legal Medicine (ed) (1999) *Manual for Forensic Toxicology Analysis of the Japanese Society of Legal Medicine*. Tokyo, pp 14–15 (in Japanese)
- 15) Baselt RC, Cravey RH (eds) (2000) *Disposition of Toxic Drugs and Chemicals in Man*, 5th edn. Chemical Toxicology Institute, Foster City, pp 851–854

- 16) Saito T, Takeichi Y, Yukawa N et al. (1997) A case of homicidal poisoning involving several drugs. *J Anal Toxicol* 21:584–586
- 17) Proudfoot AT, Stewart MS, Levitt T et al. (1979) Paraquat poisoning: significance of plasma-paraquat concentrations. *Lancet* 2:330–332
- 18) Scientific study group of Ministry of Health and Welfare of Japan (2000) Studies on Hair Analysis for Prevention and Clarification of Causes of Drug Poisoning. Harms by Medicines and Pesticide Poisoning. Tokyo, pp 147–172 (in Japanese)
- 19) Akahori F (2000) Toxicologists authorized by the Japanese Society of Toxicology. *Jpn J Toxicol* 13:275–278 (in Japanese)

# I.9 Analysis of chemical warfare agents and their related compounds

By Shigeyuki Hanaoka

## Introduction

The chemical warfare agents well known count only about 30 kinds of compounds, such as sarin, soman, tabun, VX, mustard gas, lewisite and others. When unknown toxic substances should be analyzed upon the occurrence of chemical terrorism, much more kinds of poisons and related compounds become the objects of analysis. In the Chemical Weapons Convention (CWC)<sup>a</sup>, 120 thousand compounds<sup>b</sup>, including typical chemical warfare agents, their related compounds, precursors and decomposition products, are being listed to be controlled. In the CWC, the on-site inspection and chemical analysis to be made by the Organisation for the Prohibition of Chemical Weapons (OPCW) are also being defined to verify the presence of a chemical agent; the latter itself or their related compounds should be analyzed rapidly and accurately. The analytical methods can be also applied to other poisons and drugs.

In this chapter, various analytical methods of chemical warfare agents and related compounds based on the verification defined in the CWC [1] are presented.

The classification of chemical agents is shown in ▶ [Table 9.1](#). The scheduled chemicals defined in the CWC are listed in ▶ [Table 9.2](#); the chemical agents not listed in the scheduled chemicals of CWC, such as riot control agents and others, are shown in ▶ [Table 9.3](#).

■ **Table 9.1**

### Classification of representative chemical agents

Nerve agents	G agents : sarin (GB), soman (GD), tabun (GA), V agents : VX
Blister agents	sulfur mustard (HD), nitrogen mustard (HN), lewisite (L)
Incapacitant	3-quinuclidinyl benzilate (BZ)
Emetics (sternutators)	adamsite (DM), diphenylchloroarsine (DA), diphenylcyanoarsine (DC)
Lacrimators	2-chlorobenzylidenemalononitrile (CS), 2-chloroacetophenone (CN)
Suffocating agents	phosgene (CG), PFIB, chloropicrin
Blood agents	cyanogen chloride (CK), hydrogen cyanide (AC)

Table 9.2

Scheduled chemicals listed by the Chemical Weapons Convention (CWC)

Schedule 1
<b>A. Toxic chemicals</b>
1. O-alkyl ( $\leq C_{10}$ , incl. cycloalkyl) alkyl ( $\leq C_3$ )-phosphonofluoridates, e.g. sarin, soman
2. O-alkyl ( $\leq C_{10}$ , incl. cycloalkyl)-N, N-dialkyl ( $\leq C_3$ )-phosphoramidocyanidates, e.g. tabun (GA)
3. O-alkyl (H or $\leq C_{10}$ , incl. cycloalkyl)-S-dialkyl ( $\leq C_3$ )-aminoethyl alkyl ( $\leq C_3$ )-phosphonothiolates and corresponding alkylated or protonated salts, e.g. VX, VE, VM, VMM, VP, VS
4. sulfur mustards (9 chemicals), e.g. mustard gas (yperite), sesquimustard, O-mustard
5. lewisites (3 chemicals), e.g. 2-chlorovinyl dichloroarsine (lewisite 1)
6. nitrogen mustards (3 chemicals), e.g. bis(2-chloroethyl)ethylamine (HN1)
7. saxitoxin
8. ricin
<b>B. Precursors</b>
9. alkyl ( $\leq C_3$ )-phosphonyldifluorides
10. O-alkyl (H or $\leq C_{10}$ , incl. cycloalkyl)-O-2-dialkyl ( $\leq C_3$ )-aminoethylalkyl ( $\leq C_3$ )-phosphonites and corresponding alkylated or protonated salts
11. chlorosarin
12. chlorosoman
Schedule 2
<b>A. Toxic chemicals</b>
1. amiton
2. PFIB
3. BZ
<b>B. Precursors</b>
4. chemicals, except for those listed in Schedule 1, containing a phosphorus atom to which is bonded one methyl, ethyl or propyl group but not further carbon atoms, e.g. methylphosphonyl dichloride, dimethyl methylphosphonate
5. N, N-dialkyl ( $\leq C_3$ ) phosphoramidic dihalides
6. dialkyl ( $\leq C_3$ )-N, N-dialkyl ( $\leq C_3$ )-phosphoramidates
7. arsenic trichloride
8. benzoic acid
9. quinuclidin-3-ol
10. N, N-dialkyl ( $\leq C_3$ )-aminoethyl-2-chlorides and corresponding protonated salts
11. N, N-dialkyl ( $\leq C_3$ )-aminoethane-2-ols and corresponding protonated salts (exemptions: N, N-dimethyl and N, N-diethylaminoethanol and corresponding protonated salts)
12. N, N-dialkyl ( $\leq C_3$ )-aminoethane-2-thiols and corresponding protonated salts
13. thiodiglycol
14. pinacolyl alcohol

Table 9.2 (Continued)

Schedule 3	
<b>A. Toxic chemicals</b>	
1.	phosgene
2.	cyanogen chloride
3.	hydrogen cyanide
<b>B. Precursors</b>	
4.	chloropicrin
5.	phosphorus oxychloride
6.	phosphorus trichloride
7.	phosphorus pentachloride
8.	trimethyl phosphite
9.	triethyl phosphite
10.	dimethyl phosphite
11.	diethyl phosphite
12.	sulfur monochloride
13.	sulfur dichloride
14.	thionyl chloride
15.	ethyldiethanolamine
16.	methyldiethanolamine
17.	triethanolamine

Mustard mixtures : mustard HT (60% H+ 40% T), HS ( H+ 15% carbon tetrachloride), HQ (75% H+ 25% Q), HL (50% H+ 50% L).

Table 9.3

Other chemical agents not included in the list of CWC (including riot control agents)


Blister agents	methyldichloroarsine (MD), ethyldichloroarsine (ED), phenyldichloroarsine (PD/PFIFFIKUS), phosgene oxime (CX), arsine oil*
Emetics (sternutators)	diphenylchloroarsine (Clark I/DA), diphenylcyanoarsine (Clark II/DC), 10-chloro-5,10-dihydrophenarsazine (adamsite/DM)
Lacrimators	$\alpha$ -bromobenzyl cyanide (CA), 2-chloroacetophenone (CN), 2-chlorobenzylidenemalononitrile (CS), dibenzo-1,4-oxazepine (CR), benzyl bromide, cyanobenzyl bromide, methylbenzyl bromide, bromoethyl acetate, iodoethyl acetate, vanillylamine pelargonate
Suffocating agents	diphosgene, triphosgene, chlorine
Blood agents	hydrogen cyanide (AC), cyanogen chloride (CK)

\* The mixture of 5% arsenic trichloride, 50% PFIFFIKUS, 5% Clark and 5% triphenylarsine.

## Verification analysis for the Chemical Weapons Convention (CWC)

---

### Outline of verification methods

To detect traces of the use or production of a chemical weapon, screening tests for nerve agents, blister agents and their related compounds (chemicals with low molecular weights, such as phosgene and cyanide, not covered sufficiently), followed by qualitative (identification) analysis, are conducted for environmental specimens sampled, such as water and soil. For the screening, gas chromatographs with selective detectors are usually used to narrow down the toxin candidates by retention index (RI) together with informations on specific elements (P, S, As, *etc.*). The qualitative analysis is made by GC/MS, GC/ FTIR and NMR; it is preferable to get spectra by more than two different methods. Usually, GC/MS in the electron impact (EI) ionization mode is most popular to identify the chemicals; the mass spectral data obtained from specimens are compared with those of the authentic compounds. When the authentic compounds or reference data are not available, careful analysis of the spectra is made for identification on the basis of the data of analogous compounds. A flowchart for the verification analysis is shown in  *Figure 9.1*.

### Forms of specimens

**Environmental specimens:** Water (waste water, environmental water, decontaminant fluids), soil, organic solvents, waste fluids, environmental atmosphere, exhaust gas, solid specimens (rubber, macromolecular materials, paint, clothes and others)<sup>c</sup> and wipes (oily adherents, dust, residues and others).

**Human specimens:** Blood, urine, skin and hair.

### Targets for analysis

Chemical warfare agents, their decomposition products, precursors, synthetic intermediates, reaction products, polymeric forms, impurities, derivatives, synthetic by-products, binary chemical weapons<sup>d</sup> and others.

### Pretreatment methods<sup>e, f</sup>

---


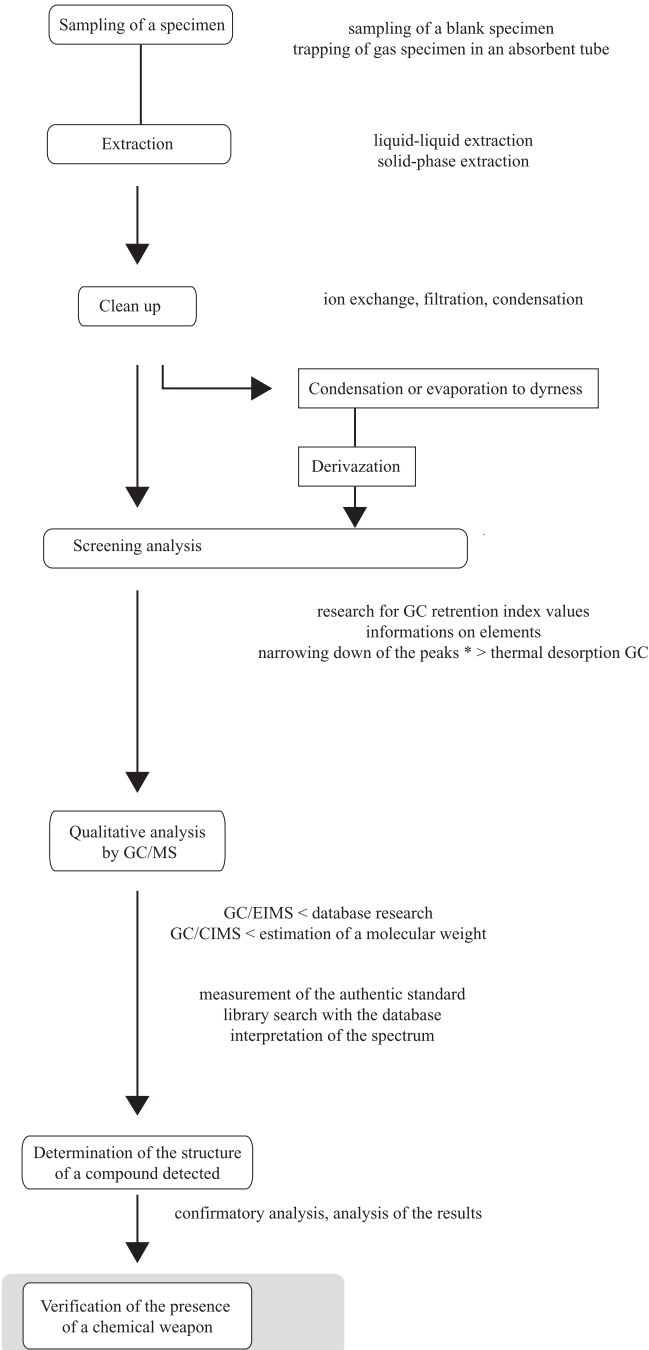
The liquid-liquid and solid-phase extractions are used for the scheduled chemicals in crude specimens; after clean-up, the extracts are subjected to instrumental analysis. A usual diagram for analysis of environmental specimens is shown in  *Figure 9.2*.

Figure 9.1



Flowchart for the procedure of the verification analysis of chemical warfare agents and their related compounds in environmental specimens.



Figure 9.2

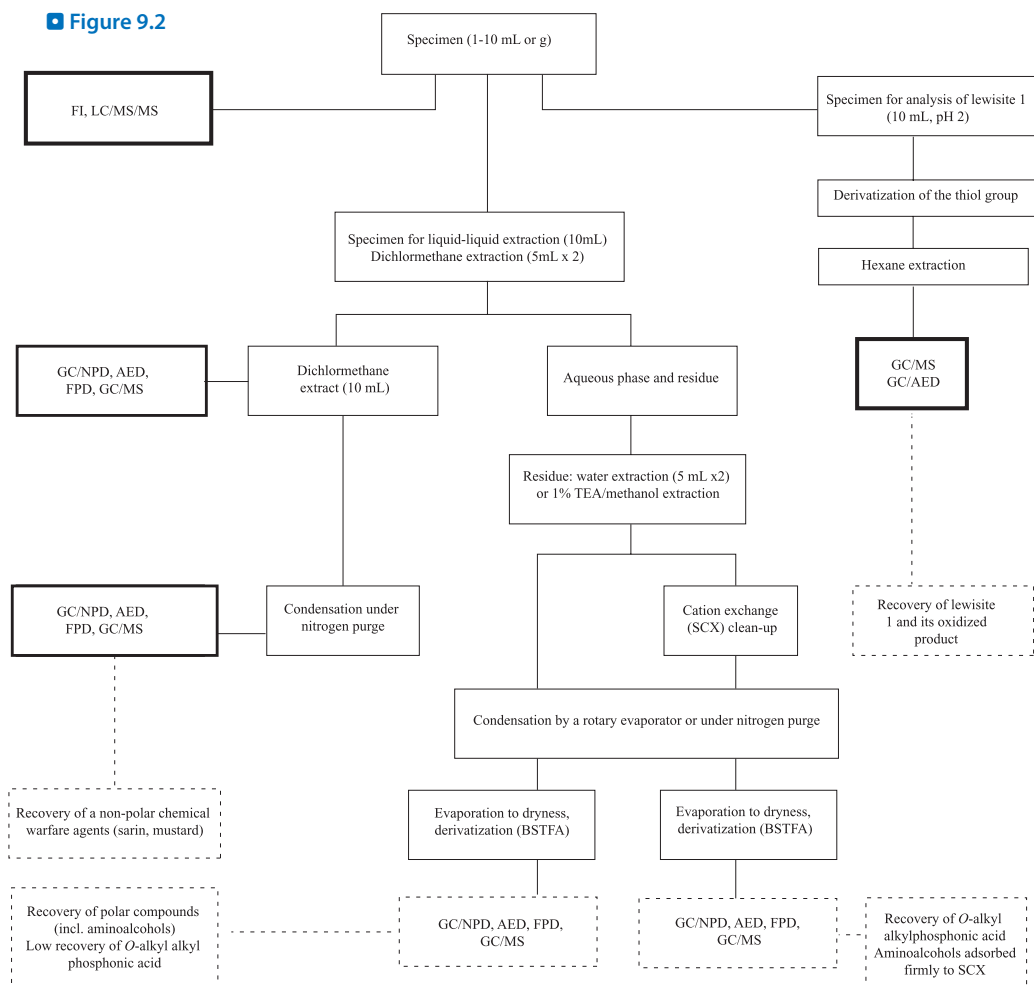


Diagram for analysis of chemical warfare agents in environmental specimens.

## Liquid-liquid extraction

For specimens of an unknown chemical, a suitable volume of dichloromethane<sup>g</sup> (1–2 volumes for a solid specimen and  $\frac{1}{2}$  volume for an aqueous specimen) is added to each specimen, followed by extracting two times with shaking<sup>h</sup>, dehydration with anhydrous sodium sulfate, filtration if necessary, centrifugation (2,000 g, 3 min), condensation<sup>i</sup> and finally the analysis by GC.

For aqueous specimens, the pH should be checked and neutralized with ammonium hydroxide or dilute hydrochloric acid solution before extraction. Although chemical warfare agents and their non-polar related compounds are easily extracted into the dichloromethane phase, polar decomposition products cannot be extracted into the phase efficiently. Therefore untreated solid specimens or their residues after extraction with dichloromethane are extracted

with pure water<sup>l</sup> twice, followed by filtration with a 0.45  $\mu\text{m}$  cellulose membrane filter; the final analysis is made by LC with or without the condensation of the extracts or by GC after derivatization. Also for the aqueous specimens, the residual aqueous phase is directly subjected to LC analysis or is evaporated to dryness by pressure-adjustable rotary evaporator followed by GC analysis after derivatization.

## Solid-phase extraction

For neutral aqueous specimens, solid-phase extraction can be used in place of the liquid-liquid extraction for analysis of chemical weapons, because of its simplicity and high capability; usually  $\text{C}_{18}$  or  $\text{C}_8$  cartridges with a packing material volume of 100 or 200 mg are being used<sup>k</sup>. However, the recovery rates are low for some of the dialkyl aminoethyl compounds derived from the V series of chemicals by the solid-phase extraction.

## Clean-up

For decontaminant fluid specimens, cations should be excluded<sup>k, l</sup> with cation exchange cartridges (SCX, 100 or 200 mg) to avoid formations of organic alkali salts or organic acid salts, before condensation or evaporation.

Many of chemical warfare agents are easily hydrolyzed; in the practical analysis, their decomposition products, impurity compounds remaining and some reaction products are usually analyzed.

## Derivatization

---

For derivatization of decomposition products of nerve agents and mustards, methylation with diazomethane and silylation with *N,O*-bis-(trimethylsilyl)trifluoroacetamide (BSTFA) or *N*-methyl-*N*-(*tert*-butyldimethylsilyl)trifluoroacetamide (MTBSTFA) are most common<sup>m</sup>. The low concentrations of organic arsenic chemical agents cannot be directly analyzed by GC, because the bond of arsenic with chlorine or a hydroxyl group is fragile. For GC analysis of such arsenic compounds, derivatization methods utilizing a stable arsenic-sulfur bond are being employed. Lewisite 1 and its decomposition product can be derivatized with 1,2-ethanedithiol (EDT) [2] or 3,4-dimercaptotoluene (DMT); diphenylcyanoarsine and its decomposition product with thioglycol acid methyl ester (TGM) [3] or alkylmonothiol as derivatization reagent<sup>n</sup>.


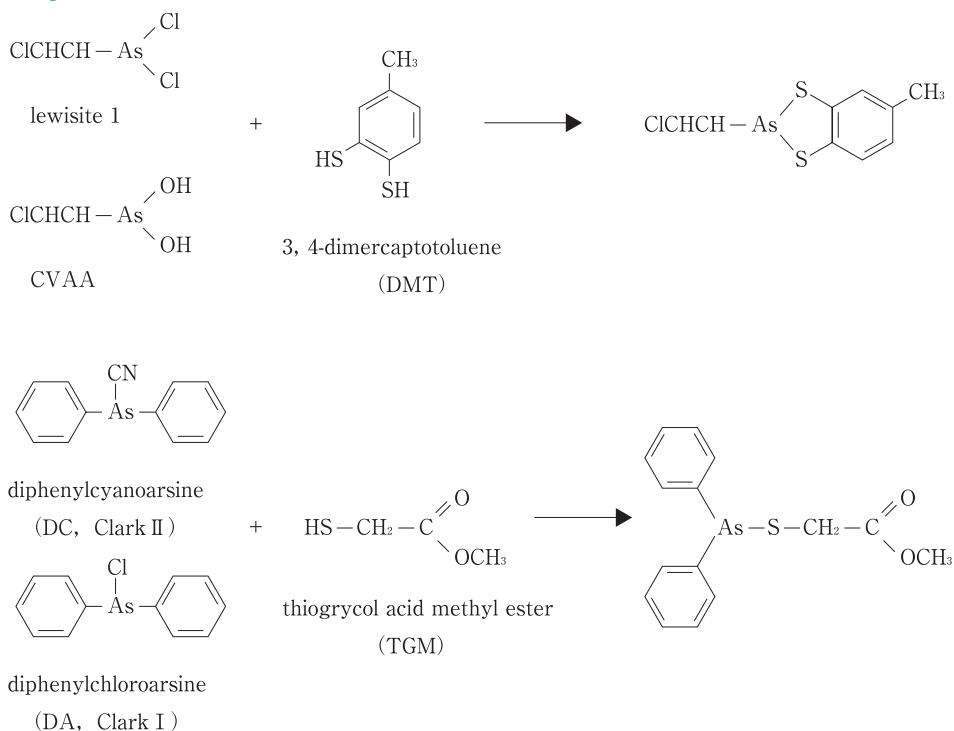
As stated above, the most suitable derivatization method should be chosen according to a target compound. The examples of derivatization reactions for organic arsenic chemical agents are shown in  Figure 9.3.

Figure 9.3



Derivatization reactions for organoarsenic chemical agents.

## Instrumental analysis

### Screening analysis

GC analysis with a selective detector is useful for screening of chemical agents in unknown specimens without any information. When many interfering impurity peaks appear, it is difficult to narrow toxin candidates at low concentrations only by GC/MS. The selective detectors for GC to be used for analysis of the scheduled chemicals are shown in [Table 9.4](#); FID, NPD, FPD and AED are well used<sup>9</sup>.

An example of the standard GC conditions for screening of the scheduled chemicals is shown as follows.

#### i. GC conditions

For verification analysis, slightly polar fused silica capillary columns, such as DB-5 (5% phenylmethyl polysiloxane), are well used. Intermediately polar capillary columns such as DB-1701 (14% cyanopropylphenyl methyl polysiloxane) are also effective. In the practical analysis, at least two capillary GC columns with different polarity should be used simultaneously. For analysis of decomposition products, highly polar CW-20M or DB-WAX columns are applica-

■ **Table 9.4**

**GC selective detectors to be used for analysis of chemical warfare agents**

GC detector	Application	Target compound
Flame ionisation detector (FID)	It is the most common GC detector, and shows good linearity in a wide concentration range. Although the sensitivity is low especially for phosgene and hydrogen cyanide, it is useful for most of chemical agents.	Chemical agents and their related compounds in general.
Photoionization detector (PID)	It responds to general compounds, but sometimes show high sensitivity and specificity to certain compounds. The response is dependent on the ionization efficiency of a compound to be analyzed. The detector shows a wide range of linearity. It shows higher sensitivity than an FID for sulfur-containing compounds, such as mustard gas, and for compounds having double bonds, such as tabun and lewisite. It does not need detector gases, and can be used on-site. However, since it shows high sensitivity for aromatic compounds, the specificity becomes questionable in many cases of environmental specimens.	Chemical agents and their related compounds in general.
Nitrogen-phosphorus detector (NPD) or flame thermionic detector (FTD)	It is highly selective and sensitive to compounds having phosphorus and nitrogen in their structures. Although arsenic compounds, such as lewisite can be detected with this detector, the sensitivity is inferior to that of an FID. It is especially effective for analysis of nerve agents, nitrogen mustard, BZ and other agents.	Compounds having phosphorus and nitrogen, nerve agents and their decomposition products, nitrogen mustard, BZ and amino chemicals.
Flame photometric detector (FPD)	It is widely used for sulfur-containing compounds, and also responds to nitrogen-containing compounds. It can be used for analysis of nerve agents and sulfur mustard. However, for sulfur-containing compounds, good linearity cannot be obtained; quenching can occur, when they are eluted with hydrocarbons. Simultaneous detection of both sulfur- and-nitrogen containing compounds can be made on two channels.	Phosphorus- and sulfur-containing compounds, nerve agents, their decomposition products, phosphates, sulfur mustard and its related compounds.
Sulfur chemiluminescence detector (SCD)	It is effective to detect sulfur-containing compounds. It detects sulfur oxides produced by chemiluminescence reaction of the compounds with ozone in the reducing flame. Its sensitivity is one order of magnitude higher than that of an FPD. It shows high selectivity and good linearity, and does not suffer from quenching.	Sulfur mustard and its related compounds.

Table 9.4 (Continued)

GC detector	Application	Target compound
Electron capture detector (ECD)	It is applicable to compounds producing negative ions by reaction with thermo-electron. The chlorine-containing compounds such as erosive gases can be detected with this detector, but the decomposition products not containing halogens cannot be detected. The sensitivity is dependent upon the affinity of a compound to electron, and is sometimes very low for certain compounds. Sufficient sensitivity can be obtained for many compounds, but sufficient selectivity cannot be obtained. Especially for environmental specimens, the detection of a compound to be monitored is markedly interfered with, because they contain a lot of compounds, which is sensitive to an ECD.	Chemical agents containing chlorine and their intermediates.
Atomic emission detector (AED)	It is the most effective detector for screening of chemical weapons and their related compounds. It can detect a selected element with high sensitivity and specificity. It enables the estimation of a compositional formula of an unknown compound. Elements, such as carbon, phosphorus, sulfur, nitrogen, chlorine and arsenic, can be analyzed simultaneously; chromatograms for each element can be obtained. However, since its sensitivity to nitrogen is low, nitrogen mustards and BZ should be detected with the NPD.	Chemical agents, their related compounds in general, nerve agents, their related compounds, sulfur mustard, its related compounds and organo-arsenic compounds like lewisite.

ble. For general screening of wide ranges of the chemical agents, capillary columns with internal diameter of 0.2–0.3 mm, with length of 20–30 m and film thickness of 0.25–0.33  $\mu\text{m}$  are used.

#### ii. Simple qualitative analysis using the retention index

In GC analysis, *n*-alkane ( $\text{C}_6$ – $\text{C}_{30}$ ) standards together with a target compounds are simultaneously detected to obtain its retention index (RI) value. The simple estimation of a compound can be made by comparing the obtained RI value with that of a known compound. It is necessary to use the same column and the same GC conditions for exact comparison of RI values<sup>f</sup>. The RI values of the main scheduled chemicals are listed in [▶ Table 9.5](#). Elemental chromatograms by GC/AED for a mixture of some chemical agents and their related compounds are shown according to each element in [▶ Figure 9.4](#).

### Identification analysis

When a peak suggesting a chemical weapon-related compound appears, the mass spectrum of the peak is recorded by GC/MS; the spectrum is subjected to library research to identify a compound. The EI mass spectra for the main chemical weapons and their decomposition

■ **Table 9.5**

**Retention index values of typical chemical weapons and their related compounds**

Compound name (chemical weapon)	RI		Remarks
	DB-5*	DB1701**	
sarin	820	953	1
soman	1044/1048	1183/1189	1
tabun	1133	1342	1
VX	1713	1882	1
<i>O</i> -ethyl <i>S</i> -dimethylaminomethyl methylphosphono thiolate (VMM)	1442	1621	1
<i>O</i> -ethyl <i>S</i> -diethylaminoethyl methylphosphono thiolate (VM)	1594	1768	1, 2
<i>O</i> -ethyl <i>S</i> -diethylaminoethyl ethylphosphonothiolate (VE)	1671	1832	1, 2
<i>O</i> -ethyl <i>S</i> -diisopropylaminoethyl ethylphosphonothiolate (VS)	1786		
<i>O</i> -ethyl <i>S</i> -diisopropylaminoethyl methylphosphonothiolate (VP)			
mustard gas (HD)	1178	1337	1
sesquimustard (Q)	1703	1945	1
<i>O</i> -mustard (T)	1990	2263	1
nitrogen mustard 1 (HN-1)	1156	1274	1
nitrogen mustard 2 (HN-2)	1087	1204	1
nitrogen mustard 3 (HN-3)	1411	1612	1
lewisite 1 (L1)	1083		1
lewisite 2 (L2)	1290		1
lewisite 3 (L3)	1465	1614	1
BZ	2658		2
diphenylchloroarsine (DA)	1812		3
diphenylcyanoarsine (DC)	1866		3
2-chloroacetophenone (CN)	1301		3
<i>O</i> -chlorobenzylidenemalononitrile (CS)	1564	1824	1
dibenzo-1,4-oxazepine (CR)	1811	2017	1
methylphosphonodifluoride (DF)	488***		2
chlorosarin	977 (973)		1, (3)
chlorosoman	1203 (1199)		1, (3)
<i>O</i> -ethyl- <i>O</i> -diisopropylaminoethyl methylphosphonate (QL)	1354		1

Table 9.5 (Continued)

Compound name (decomposition product · derivative)	RI		Remarks
	DB-5*	DB1701**	
dimethyl methylphosphonate (DMMP)	881 (884)	(1048)	1, (3)
<i>O</i> -ethyl- <i>O</i> -methyl methylphosphonate (EMMP)	952	1112	1
<i>O</i> -isopropyl- <i>O</i> -methyl methylphosphonate (IMMP)	989	1137	1
<i>O</i> -ethyl methylphonic acid (EMPA)-TMS	1082		2
<i>O</i> -isopropyl methylphosphonic acid (IMPA)-TMS	1108		2
methylphosphonic acid-(TMS) <sub>2</sub>	1148 (1145)	1270	1, (3)
EMPA- <i>t</i> -BDMS	1300		2
IMPA- <i>t</i> -BDMS	1327		2
methylphosphonic acid-( <i>t</i> -BDMS) <sub>2</sub>	1569		2
1,4-dithiane	1068	1169	1
thiodiglycol	1184	1468	1
thiodiglycol-TMS	1423		3
mustard sulfone	1433	1783	1
quinuclidin-3-ol (3-Q)-TMS	1267		2
benzilic acid-TMS	1098		2
BZ-TMS	2633		2
<i>N,N</i> -diisopropylaminoethanol	1057		2
<i>N,N</i> -diisopropylaminoethanethiol	1120		3
<i>N,N</i> -diisopropylaminoethanol-TMS	1171		2
LI-EDT	1578		3
LI-DMT	2044		3
diphenylarsine-SG	2319		3

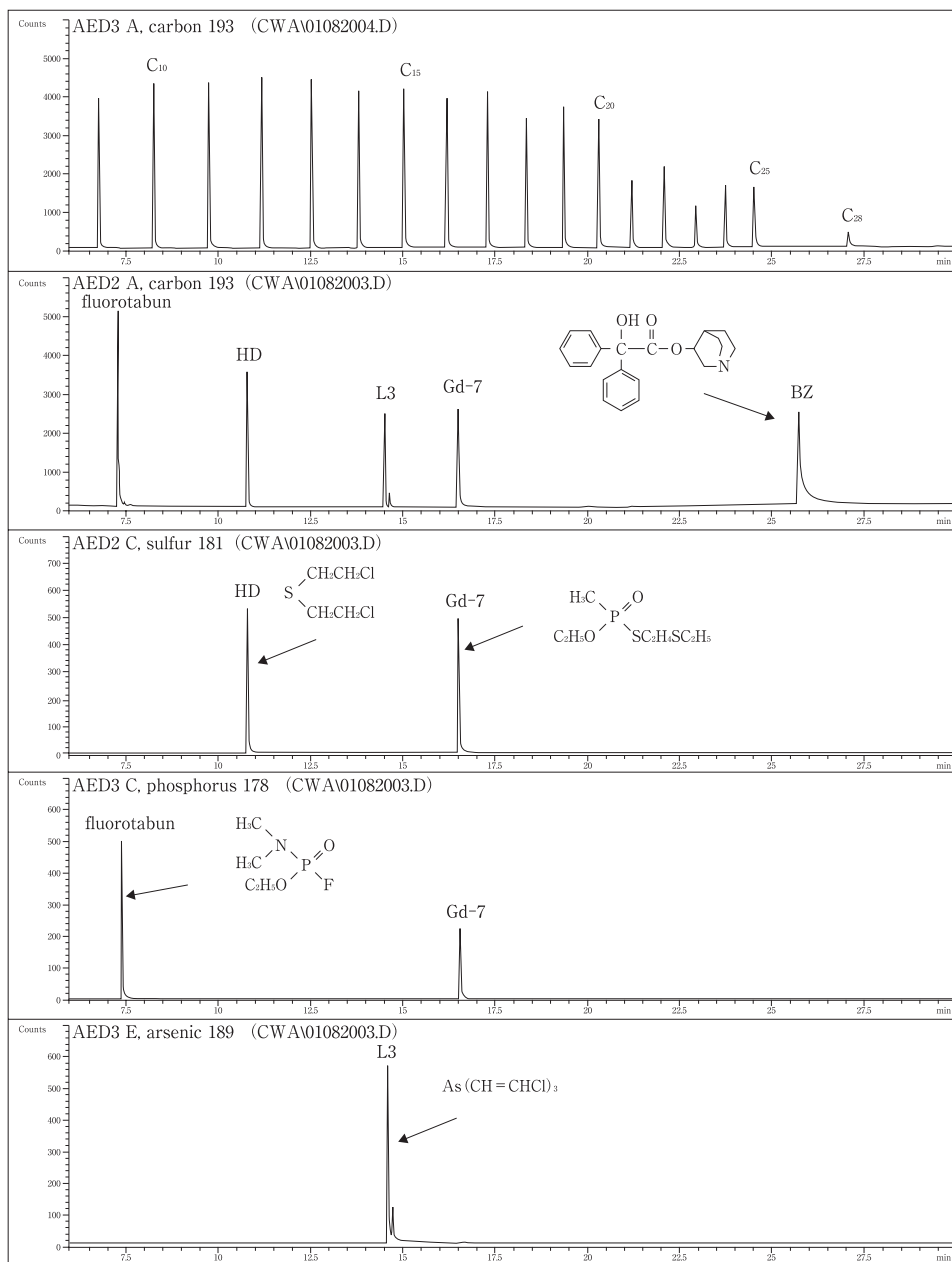
\* DB-5: 5% phenylmethylpolysiloxane (SE-54, DB-5ms, CPSi18, etc.).

\*\* DB-1701: 14% (cyanopropyl-phenyl)-methylpolysiloxane (OV-1701, etc.).

\*\*\* extrapolated value.

1. ROPs [see reference 1] : SE-54, OV- 1701.
2. OPCW : DB -5, DB-5ms etc.
3. Chemicals Evaluation and Research Institute, Japan: DB-5, DB-1701.

Figure 9.4



GC/AED elemental chromatograms for a mixture of chemical agent-related compounds.

Standard mixture: fluorotaban, mustard gas, lewisite 3, Gd-7 and BZ. GC conditions: DB-5 (30 m × 0.32 mm, film thickness 0.25 μm); column temperature: 40° C (1 min) → 10° C / min → 280° C (5 min).



products are usually included in the standard databases (such as NIST library and others) and their library research is possible. Some compounds, such as sulfur mustards, can be easily identified only by EI mass spectra using the database research. If the EI mass spectral measurements do not give the final identification, corroboration with other data is necessary. Mass spectral measurements in the chemical ionization (CI) mode<sup>s</sup> are useful for estimation of molecular weights; the estimated compound should not be contradictory to the result of elemental analysis and the RI value both obtained by GC.

Although GC/MS is the main tool for identification, confirmation by GC/FTIR or NMR is useful to achieve higher reliability. For identification of decomposition products in aqueous (liquid) specimens, LC/MS/MS<sup>t</sup> with electrospray ionization (ESI) or with atmospheric chemical ionization (APCI) is effective. When quantitation with high specificity and sensitivity is required, selected ion monitoring (SIM) can be used. Analysis by high resolution GC/MS or GC/MS/MS gives identification or quantitation with high sensitivity and selectivity.

The standard GC/MS conditions are shown below.

Instrument	HP5973 MSD (Agilent Technologies)
Column	DB-5 (30 m × 0.32 mm, film thickness 0.25 μm, J&W)
Column temperature	40° C (6 min) → 10° C/min → 280° C (5 min)
Injection temperature	250° C
Injection mode	Splitless (purge-on-time 1.0 min)
Carrier gas	He (1.5 mL/min, constant flow mode)
Ion source temperature	250° C
Ionization methods	EI and CI
Ionization voltage	70 eV
Scanning methods	Scan (EI range: <i>m/z</i> 25–600, speed: 0.5 s); (CI range: <i>m/z</i> 60–600, speed: 0.5 s)
CI reagent gas	Ammonia or isobutane

Also for estimating peaks appearing in the total ion chromatograms (TIC) using each RI value, the same GC conditions and the *n*-alkane standards are adopted for the GC/MS analysis.

## Analysis of chemical warfare agents by thermal desorption GC

A gas-adsorbed sample<sup>u</sup> obtained with a Tenax adsorbent tube is introduced into GC through a thermal desorption device (ATD 400, PerkinElmer, Wellesley, MA, USA). This method is effective for use, when analytical results are rapidly needed or the concentration of a target compound in the atmosphere is low. It is applicable to analysis of volatile compounds in solid specimens, such as soil and clothes. The thermal desorption conditions for GC are: desorption temperature, 250° C (10 min)<sup>v</sup>; desorption flow rate, 10 mL/min; and cold trap temperature: -90° C (in the case of capillary columns).

## Identification of compounds and analytical database

---

### Analytical database

The identification of a compound in a specimen can be made by comparing the mass spectrum and the retention index value of a target compound with those of the authentic compound; if they match well, the final identification can be achieved. However, actually, the authentic compounds of chemical agents and many of their related compounds cannot be obtained except commercial reagents. The library search for typical (major) chemical weapons or other related compounds being widely used also for non-military purposes is possible using a database commercially available. However, when a compound to be analyzed is one of the family compounds of a chemical agent, such search is impossible, because of the absence of their data in the database. Also when a compound is derivatized for analysis by GC/MS, the search also becomes impossible in the absence of the data on the derivatized compounds. Substantiation of the database of RI values may give rapid and reliable informations, but actually the RI database is much less than the mass spectral data. In addition, such RI data are useless, if analytical conditions are different. To identify a compound without the authentic one and without its RI data usable, an analogous mass spectrum is looked for in the database, and if found, the mass spectrum of the unknown target compound is carefully compared with that of the analogous compound in the database. Analogous compounds of chemical agents usually contain the same group in their structures in common; in their mass spectra, characteristic fragment peaks usually appear. This kind of information is quite useful for analysis of a mass spectrum of an unknown compound for estimation of its structure. The relationship among a chemical agent itself, its decomposition product, a reaction product and a derivative, together with other chemical informations, is also useful for such structural analysis.

### Relationship of a chemical agent with its precursor, by-products and decomposition products


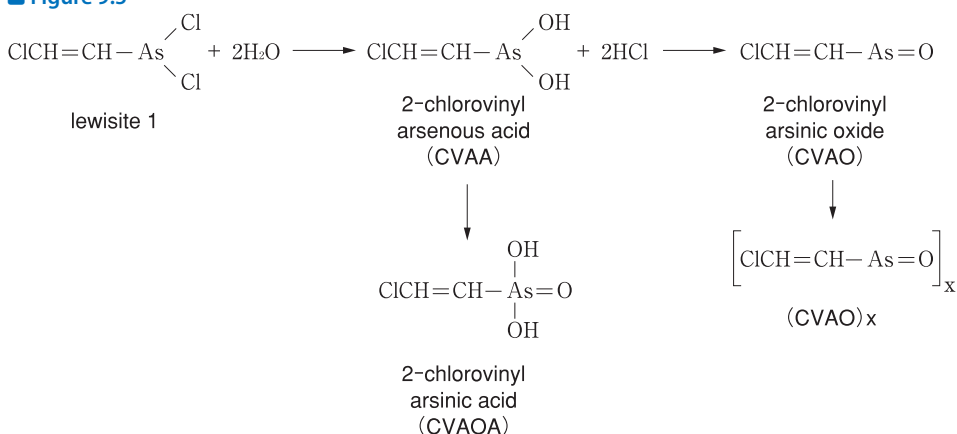
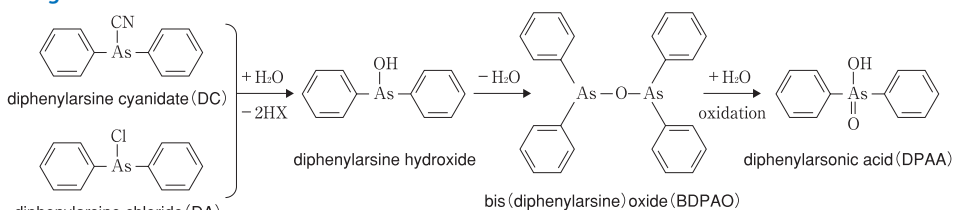
The decomposition of chemical agents is usually rapid and the intact compounds cannot be detected in most cases. In analysis of a chemical agent, the mechanisms of its decomposition and chemical reaction should be well understood. When the purity of an agent is low, stable impurities coexisting, precursor(s) and by-product(s) can be used for specifying a chemical agent. For example, even when mustard gas is decomposed or disappears, it is possible that 1,4-dithiane, sesquimustard or *O*-mustard with lower volatility is detected. Since the organic arsenic chemical agents are easily oxidized and hydrolyzed, the main decomposition products should be analyzed simultaneously. The decomposition processes of lewisite 1 and diphenylarsinic compounds are shown in  *Figures 9.5 and 9.6*, respectively. CVAA, CVAO and CVAOA, the decomposition products of lewisite 1, are known to be equally erosive like lewisite 1 [4]; it is important to detect such decomposition products especially for environmental and human specimens.

Figure 9.5



Decomposition process of lewisite 1.

Figure 9.6



Decomposition process of diphenylarsinic compounds (DA and DC).

## Analysis of chemical warfare agents in human specimens

In the analysis of human specimens, the kinds of chemical agent products detectable are usually different in different human specimens according to the modes of metabolism and excretion. Recently, analytical methods for detection of bio-markers of chemical warfare agents have been developed. In this section, the author presents some of them for nerve agents, sulfur mustards and lewisite in human specimens.

### Nerve agents

The measurements of acetylcholinesterase activity in blood by the DTNB methods are usually made after exposure of humans to a nerve agent, because of its simplicity and rapidness; by this method, it is impossible to specify a causative nerve agent. There is a possibility that a G agent *per se*, such as sarin, is detected within several hours and VX within 12 h after exposure from tissues and blood by GC/MS. Most of nerve agents, however, are rapidly metabolized to the respective *O*-alkylmethylphosphonic acid and trace amounts of phosphonic acid. It seems easy to analyze these products in blood and urine obtained from a poisoned patient by GC/MS [5, 6]

or LC/MS/MS [7]. However, the period suitable for analysis is limited, because these products are rapidly excreted within a few days.

An analytical method for phosphorylbutylcholinesterase was developed [8]. This method allows separation and semi-quantitative analysis of a phosphonofluoridate, giving the information on the identity of a causative toxin and also the estimation of its level with high sensitivity. However, the method suffers from limitations due to the spontaneous regeneration and aging of the phosphorylated enzyme and the natural life-span of the enzyme. Another method for GC/MS analysis of the phosphorylated moiety separated from the inhibited cholinesterase after derivatization was reported [9]. Since the nerve agents are easily bound with tyrosine residues of plasma albumin, the phosphorylated serum albumin is considered to be a bio-marker of exposure to soman [10].

## Sulfur mustard

Sulfur mustard is rapidly bound with nucleophilic atoms under physiological conditions. The reaction products of the sulfur mustard with nucleophilic atoms of glutathione in body fluids, of amino acids included in proteins and of DNA can be bio-markers of sulfur mustard poisoning.

The sulfur mustard metabolites produced in a short period after the exposure are excreted into urine in the presence of water and glutathione. Thiodiglycol sulfoxide, mustard sulfoxide and mono-/bis-conjugates of mustard sulfone were reported as the metabolites of sulfur mustard [11]. The metabolites produced by  $\beta$ -lyase,  $O_2S(CH_2CH_2SOCH_3)_2$  and  $CH_3SOCH_2CH_2SO_2CH_2CH_2SCH_3$ , were also analyzed by LC/MS/MS [11]. Thiodiglycol, thiodiglycol sulfoxide and the  $\beta$ -lyase metabolites<sup>w</sup> in urine of a victims, who had been exposed to sulfur mustard, were analyzed by GC/MS/MS with high sensitivity (detection limit, 0.1 ng/mL) [12].

Sulfur mustard easily reacts with nucleophilic moieties, such as the COOH groups of aspartic acid and glutamic acid, the imidazole NH group of histidine, the  $NH_2$  group of *N*-terminal amino acid valine of  $\alpha$ - and  $\beta$ -chains of hemoglobin and the SH group of cysteine; such alkylated adducts were detected and identified by LC-ES/MS/MS after protease digestion [13]. The *N*-alkyl valine at *N*-terminal of hemoglobin obtained from victims of sulfur mustard poisoning was analyzed by negative ion GC/MS/MS with high sensitivity after derivatization [14]. Sulfur mustard also reacts with cysteine residues of human serum albumin; the alkylated cysteine fragment could be detected and identified by micro LC/MS/MS with high sensitivity after trypsin digestion of the albumin [15]. These alkylated adducts detected from hemoglobin and albumin can be regarded as bio-markers of sulfur mustard poisoning in blood specimens.

Sulfur mustard shows carcinogenicity by alkylation of nitrogen in the 7-position of guanine; the alkylated product  $N^7$ -2-[(hydroxyethyl)thio]-ethyl guanine could be analyzed for the skin, blood and urine of animals, which had been exposed to sulfur mustard, by GC/MS/MS after derivatization, and by LC-ES/MS/MS without derivatization for a blood specimen sampled more than 20 days after exposure to sulfur mustard [16]. Such alkylated DNAs are considered to exist in various tissues, blood and urine. There is also a possibility that the unchanged sulfur mustard can remain in adipose tissues and hair.

The main route of excretion of sulfur mustard is *via* urine; less parts are retained in the skin. Only a trace amount of the agent exists in blood. Its levels in urine and the skin decrease

rapidly within a few days, while the agent remains for as long as 6 weeks being bound with hemoglobin in erythrocytes in blood [17]; the hemoglobin-bound form of sulfur mustard can be a bio-marker of a relatively long period in its poisoning.

## Lewisite

Lewisite is rapidly hydrolyzed to CVAA in aqueous environments such as blood plasma (▶ *Figure 9.5*); the CVAA should be practically measured for detection of lewisite. CVAA can be extracted by adding 1,2-ethanedithiol to a specimen, and separated from plasma or urine for analysis by GC/MS [18]. However, its excretion into urine is rapid; it is difficult to detect the metabolite from urine obtained more than 12 h after exposure. Lewisite together with CVAA is estimated to be bound with cysteine residues of proteins, because of high affinity between arsenic and thiol groups. As high as 20–50% of lewisite is known to be bound with globin after its exposure to blood. After reaction of CVAA with 2,3-dimercaptopropanol (BAL), the adduct with L-BAL was extracted (separated) from globin for sensitive GC/MS analysis. The amounts of the BAL adduct separable from blood specimens decreased according to intervals after exposure to lewisite; about 10% was reported to be found in blood specimens sampled 10 days after exposure.

In actual cases, specimens are usually sampled a long time after exposure; this means that trace levels (sub-ppb order) of derivatives of chemical agents should be analyzed qualitatively and quantitatively. The urinary metabolites of sulfur mustard can be targeted as biomarkers up to 2 week after exposure; and the adduct with DNA or proteins up to 3 weeks. For such analyses, GC/MS/MS in the CI mode or LC/MS/MS with an ESI interface can be used as powerful tools.

## Notes

- a) The international treaty “The Convention on the Prohibition of the Development, Production, Stockpiling and Use of Chemical Weapons and on their Destruction (The Chemical Weapons Convention, CWC)” had entered into force on April 29, 1997. A Japanese law (The Law for Banning Chemical Weapons) was promulgated on April 5, 1995 to realize the above treaty accurately.
- b) In the CWC, toxic compounds to be used with high probability as chemical weapons and their precursors are defined as Schedule 1 chemicals; toxic compounds and their precursors other than the above typical chemical weapons defined as the Schedule 2 chemicals; toxic compounds and their precursors, which are mainly used for non-military purposes, defined as Schedule 3 chemicals (▶ *Table 9.2*). The “specified substances” defined by the Japanese law correspond to the Schedule 1 chemicals; the “designated substances” correspond to the Schedule 2 and 3 chemicals. The family compounds are those with similar fundamental skeletons. For example, VE, VM, VMM, VP and VS are the family compounds of VX; all of them had been developed as chemical weapons.
- c) There was a special case in which sarin *per se* could be detected 4 years after exposure from a painted metal debris specimen [19]; sarin had been adsorbed into the paint material and protected from decomposition by water.

- d) Two intermediate reagents are separately packed in each cell of an artillery shell and mixed to produce a chemical weapon just before landing. With this system, the handling of chemical weapons becomes very easy, because of its safety. The DF of the G agents and the QL of the V agents are equipped with the binary system.
- e) The handling methods differ according to the kinds of chemical agents. To avoid secondary exposure, all handlings of a specimen, which is suspected to contain a chemical warfare agent, should be done inside a fume hood or a glove box equipped with an activated charcoal chamber or alkali scrubber. It is essential to wear gloves not to expose the skin. The gloves with butyl materials are good for non-permeability, but suffer from their bad operability; those with nitrile materials seem best. The glove for surgical operation made of polyethylene and latex being widely used in laboratories are weak especially for erosives; the latter chemicals permeate through such gloves in about 5 min after their contact. When these gloves have to be used, they should be worn doubly; the outer one is immediately removed upon such contact of the agents. It is important to understand physicochemical properties of each chemical agent to be handled for effective protection.
- f) The glassware used is put in a decontaminant fluid and kept there for several weeks until complete detoxification. For blister agents, 5% solution of bleaching powder or sodium hypochlorite is used; for nerve agents, 5–10% aqueous solution of sodium hydroxide is also effective for decontamination. For the mustard gas, aqueous solution of nitric acid is effective. The contents of the DS2 being well known as a decontaminant of chemical warfare agents are 70% diethylenetriamine and 28% ethylene glycol monomethyl ester solutions.
- g) The chemical warfare agents usually react with alcohols to yield products; the chlorine or fluorine group of an agent is easily replaced by an alkyl ester group. Especially, organoarsenic chemicals such as lewisite 1 rapidly react with water to form decomposition products; thus upon extraction with an organic solvent, the contamination by water should be avoided. As extraction solvents, non-polar toluene and hexane are preferable. In dichloromethane (ultra-pure grade), 0.2–0.5% methanol is sometimes being added as a stabilizing agent; the solvent should not be used for extraction of organoarsenic chemicals.
- h) Usually, ultrasonic and shaking extractions are used for solid and liquid specimens, respectively. When ultrasonic extraction is made for soil specimens, a matrix inside the clay may be eluted and give negative influences on the analysis; more moderate tumbling extraction is recommended for soil specimens. The times for extraction for solid and liquid specimens are about 10 and 2–5 min, respectively.
- i) Since simultaneous analysis of various compounds with different physicochemical properties, including volatile chemical weapons such as sarin, is required, drastic evaporation to dryness and rapid condensation should be avoided not to lose them during the treatments; the condensation should be made under a gentle stream of nitrogen very carefully.
- j) The nitrogen-containing compounds, such as V agents, are sometimes difficult to be efficiently extracted from soil specimens owing to their adsorption to silicon hydroxide. In such cases, the soil specimens are extracted with 1% triethanolamine / methanol or 0.5 M potassium hydroxide / methanol for good recovery. Care should be taken against that these compounds are easily adsorbed to glassware.
- k) The cartridges should be pre-conditioned by passing methanol and water according to an explanatory leaflet of each manufacturer.

- l) The eluate should not be evaporated to dryness. Some compounds, such as cyclohexylsalin and hydrolyzed products of soman, cannot be eluted or recovered from the cartridge due to their strong adsorption to the resin.
- m) The methylation is lower in reactivity than silylation, and thus is not suitable for derivatization of thiodiglycol, a decomposition product of sulfur mustard, and the alkyl amino compounds formed by the mustard. For silylation, a dried extract residue of a specimen is dissolved in 0.5 mL of acetonitrile or THF and 0.5 mL of a silylating reagent, sealed with a screw cap, sonicated and heated at 60° C for 30 min for derivatization. The silylation is generally useful for derivatization of most of decomposition products of chemical warfare agents, because of its high reactivity; the *t*-BDMS reagent is generally more reactive than the TMS reagent.
- n) These derivatization reactions are rapidly completed at room temperature in 10–20 min after addition of each derivatization reagent to a specimen solution. The hydrolysates co-existing are also derivatized in many cases. 2,3-Dimercaptopropanol (BAL: British Anti Lewisite) being used as an antidote can be used as a derivatization reagent. For the monoalkylthiol, the use of an alkyl group of a different length can give a different retention time of GC to avoid interfering impurity peaks.
- o) The selective detectors for GC, such as NPD and FPD, are effective for analysis of chemical agents containing phosphorus, nitrogen and sulfur; however, these detectors result in overlooking other chemicals not containing the above atoms. For example, pinacolyl alcohol for soman and benzoic acid for BZ cannot be detected by the selective detectors. When a selective detector is used, an FID should be simultaneously used not to overlook other compounds; the FID is also useful, because the FID chromatogram can be compared with a TIC in mass spectrometry.
- p) In the splitless mode, caution is needed against the memory effect due to adsorption of a compound in the injection port. For compounds which are thermolabile and highly absorptive, such as organoarsenic chemical agents, the on-column derivatization method is effective; in such cases, an inactivated retention gap (about 50 cm in length) is connected with a separation column to protect it from degradation.
- q) To confirm the absence of contamination by the memory effect of the injection port and by solvent effect, solvent blank should be analyzed periodically. The memory effect is notable especially for organoarsenic compounds.
- r) Even under the same conditions with the same kind of a column, variations can be found to some extent. Usually, under the same condition, an RI value being deviated by only less than 10 units from that of the authentic is effective. Tentative qualitative analysis by RI is one of the useful tools, because it is simple and rapid. However, the coincidence in RI does not mean that both compounds are identical. Further evidence is required for the final identification by other analytical methods.
- s) In the EI mass spectra of the V agents, many peaks due to fragmentation of the alkylaminoethyl moiety appear; only with the mass spectra, the final identification of each agent is not possible. In the CI mode, the protonated molecular ion appears and is useful for identification of the compound. For sulfur mustard, the CI mass spectrum does not give such a distinct protonated molecular ion. Methane, ammonia or isobutane is being usually used as reagent gas in the CI mode; isobutane is most recommendable to obtain a protonated molecular ion, because it gives the softest ionization.
- t) LC/MS/MS is useful, because decomposition products in environmental and biomedical specimens can be analyzed without any derivatization. However, the database for mass



spectra of LC/MS(/MS) is not available; for identification by this method, the simultaneous determination of mass spectra using the authentic standard is required. Flow injection MS/MS is useful for screening of compounds; in this case, a blank specimen should be analyzed simultaneously.

- u) An atmospheric gas specimen is practically aspirated into a Tenax TA tube to trap a target compound; the Tenax TA tube should be cleaned before use.
- v) For analysis of mustards adsorbed to polymer materials, such as rubber and paint, the desorption temperature should be set at 120–150° C to avoid interference with GC analysis by impurities being contained in the polymers.
- w) Since thiodiglycol sulfoxide endogenously exists in urine of normal subjects at low concentrations (10 ng/mL), it cannot be a definitive marker of sulfur mustard poisoning. The  $\beta$ -lyase metabolites could be detected from urine sampled 13 days after exposure; the  $\beta$ -lyase metabolites together with the DNA adduct with sulfur mustard in urine can be definitive bio-markers for mustard poisoning.

## References

- 1) The Ministry for Foreign Affairs of Finland (1994) Recommended Operating Procedures for Sampling and Analysis in the Verification of Chemical Disarmament (ROPs), Helsinki (ISBN 951-724-008-2)
- 2) Fowler WK, Stewart DC, Weinberg DS et al. (1991) Gas chromatographic determination of the lewisite hydrolytate, 2-chlorovinylarsenous acid, after derivatization with 1,2-ethanedithiol. *J Chromatogr* 558:235–246
- 3) Schoene K, Steinhilber J, Bruckert H-J et al. (1992) Speciation of arsenic-containing chemical warfare agents by gas chromatographic analysis after derivatization with thiodiglycolic acid methyl ester. *J Chromatogr* 605:257–262
- 4) Bossle PC (1989) Determination of lewisite contamination in environmental waters by high performance liquid chromatography. CRDEC-TR-042, U.S. Army Chemical Research, Development and Engineering Center AD-A 206000, Maryland
- 5) Fredriksson S-A, Hammarström L-G, Henriksson L et al. (1995) Trace determination of alkyl-methylphosphonic acids in environmental and biological samples using gas chromatography/negative-ion chemical ionization mass spectrometry and tandem mass spectrometry. *J Mass Spectrom* 30:1133–1143
- 6) Tsuchihashi H, Katagi M, Nishikawa M et al. (1998) Identification of metabolites of nerve agent VX in serum collected from a victim. *J Anal Toxicol* 22:383–388
- 7) Noort D, Hulst AG, Platenburg DHJM et al. (1998) Quantitative analysis of O-isopropyl methyl-phosphonic acid in serum samples of Japanese citizens allegedly exposed to sarin: estimation of internal dosage. *Arch Toxicol* 72:671–675
- 8) Polhuijs M, Langenberg JP, Benschop HP (1997) New method for retrospective detection of exposure to organophosphorus anticholinesterases: application to alleged sarin victims of Japanese terrorist. *Toxicol Appl Pharmacol* 146:156–161
- 9) Matsuda Y, Nagano M, Takatori T et al. (1998) Detection of sarin hydrolysis product in formalin-fixed brain tissues of victims of the Tokyo subway terrorist attack. *Toxicol Appl Pharmacol* 150:310–320
- 10) Black RM, Harrison JM, Read RW (1999) The interaction of sarin and soman with plasma proteins: the identification of a novel phosphorylation site. *Arch Toxicol* 73:123–126
- 11) Black RM, Brewster K, Clarke RJ et al. (1992) Biological fate of sulfur mustard, 1,1'-thiobis (2-chloroethane): isolation and identification of urinary metabolites following intraperitoneal administration to rat. *Xenobiotica* 22:405–418
- 12) Black RM, Read RW (1995) Biological fate of sulfur mustard, 1,1'-thiobis (2-chloroethane): identification of  $\beta$ -lyase metabolites and hydrolysis products in human urine. *Xenobiotica* 25:167–173
- 13) Black RM, Clarke RJ, Harrison JM et al. (1997) Biological fate of sulfur mustard: identification of valine and histidine adducts in hemoglobin from casualties of sulfur mustard poisoning. *Xenobiotica* 27:499–512
- 14) Benschop HP, Van der Schans GP, Noort D et al. (1997) Verification of exposure to sulfur mustard in two casualties of the Iran-Iraq conflict. *J Anal Toxicol* 21:249–251



- 15) Noort D, Hulst AG, De Jong LPA et al. (1999) Alkylation of human serum albumin by sulfur mustard in vitro and in vivo: mass spectrometric analysis of a cysteine adduct as a sensitive biomarker of exposure. *Chem Res Toxicol* 12:715–721
- 16) Fidder A, Noort D, De Jong AL et al. (1996) Monitoring of in vitro and in vivo exposure to sulfur mustard by GC/MS determination of the N-terminal valin adduct in hemoglobin after a modified Edman degradation. *Chem Res Toxicol* 9:788–792
- 17) Hambrook JL, Howells DJ, Schock C (1993) Biological fate of sulfur mustard (1,1'-thiobis (2-chloroethane)): uptake, distribution and retention of 35S in skin and in blood after cutaneous application of 35S-sulfur mustard in rat and comparison with human blood in vitro. *Xenobiotica* 23:537–561
- 18) Logan TP, Smith JR, Jakubowski EM et al. (1996) Verification of lewisite exposure by the analysis of 2-chlorovinylarsenous acid in urine. *Proceedings 1996 Medical Defense Bioscience Review Vol. II. The Drug Assessment Division of the U.S. Army Medical Research Institute of Chemical Defense, Aberdeen Proving Ground, MD, USA*, pp 923–934
- 19) Black RM, Clarke RJ, Read RW et al. (1994) Application of gas chromatography-mass spectrometry and gas chromatography-tandem mass spectrometry to the analysis of chemical warfare samples, found to contain residues of the nerve agent sarin, sulfur mustard and their degradation products. *J Chromatogr A* 662:301–321

## **II. Chapters on specific toxins**

## II.1.1 Carbon monoxide

*By Keizo Sato*

### Introduction

The incidence of carbon monoxide (CO) poisoning is highest among those of various poisonings in forensic science practice; about 2/3 of the total accidental poisoning deaths is due to CO poisoning in Japan [1]. Previously, suicides, homicides and accidental deaths frequently took place using city gas containing about 9% CO. However, during recent years, city gas is being replaced by natural gas containing no CO, resulting in drastic decrease of the number of CO poisoning cases. Nevertheless, many incidents of CO poisoning are occurring due to imperfect combustion, fire, exhaust gas of automobiles and other causes. For a victim found at the scene of a fire, the saturation ratio of carboxyhemoglobin (COHb) can be an indicator<sup>a</sup> for judging whether the victim has died in a fire or had been already killed before the fire.

For measurements of COHb saturation ratios in blood, spectrophotometric and GC methods are available. Since methemoglobin (Met-Hb) is contained in many of blood specimens in forensic science practice for measurements of COHb saturation [2], it is important to use a method<sup>b</sup>, which is not influenced by the presence of Met-Hb. In this chapter, simple and reliable spectrophotometric [3] and GC [4] methods for measurements of COHb saturation not to be influenced by Met-Hb are presented.

### Spectrophotometric method

---

See [3].

### Reagents and their preparation

- 0.1% Na<sub>2</sub>CO<sub>3</sub> solution: 0.1 g Na<sub>2</sub>CO<sub>3</sub> is dissolved in distilled water to prepare 100 mL solution.
- 5 M NaOH solution: 20 g NaOH is dissolved in distilled water to prepare 100 mL solution.
- Sodium hydrosulfite (sodium dithionite) obtainable from Yoneyama Yakuin Kogyo Co., Osaka and other manufacturers.

### Analytical instrument

A Hitachi 557 dual-wavelength spectrophotometer (Hitachi, Ltd., Tokyo, Japan)

## Procedure

- i. Two 3-ml volume cuvettes of the same type are cleaned well by washing with distilled water.
- ii. A 2.5-mL volume of 0.1%  $\text{Na}_2\text{CO}_3$  aqueous solution is placed in a cuvette.
- iii. About 2 mg of solid sodium hydrosulfite is added to the above cuvette and mixed well.
- iv. A 10- $\mu\text{L}$  volume of whole blood and 0.2 ml of 5 M NaOH solution are added to the mixture and mixed well.
- v. After standing for 5 min, the absorbances at 532 and 558 nm ( $A_{532}$  and  $A_{558}$ ) are read against distilled water in another cuvette as a blank.
- vi. The percentage of HbCO can be calculated by the following equation:  

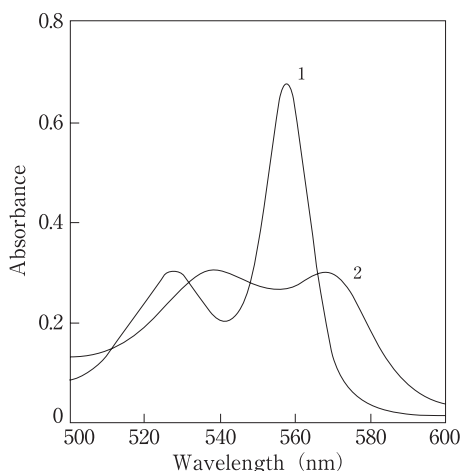
$$\text{COHb \%} = (2.44 - A_{558}/A_{532}) \times 67$$

## Assessment and some comments on the method

The above spectrophotometric assay for HbCO saturation ratio well meets the needs in forensic science practice. To perform accurate measurements of low ranges of COHb by this method, the following modification of the method is recommended.

About 20–30 specimens of fresh blood obtained from healthy subjects is analyzed according to the above procedure. A specimen with the lowest COHb value is taken as 0%, which can be used as the blank test. When the blood specimen with the lowest COHb value is processed through 1–4 described in the above procedure, the absorbance spectrum 1 due to reduced Hb can be obtained as shown in [▶ Figure 1.1](#); when CO gas is then bubbled in the same cuvette, the absorbance spectrum 2 shown in the same figure can be obtained. In the spectrum 1, the isobestic point around 532 nm and the absorbance maximum around 558 nm appear; the exact wavelengths are re-examined for both points and small shifts of their wavelengths according to instrumental conditions can be corrected. Even when the absorptions at corrected wavelengths

■ **Figure 1.1**



**Absorption spectra of reduced Hb (1) and COHb (2) in the presence of NaOH.**

are used, it is not necessary to change the coefficient values in the above equation. The method using a blank test of a healthy and fresh blood and using corrected wavelengths enables the accurate measurements of COHb contents less than 10% [3, 5].

For measurements of COHb in bloody fluids in the thoracic and abdominal cavities, a special care should be taken. Kojima et al. [6] reported that 2.3–44.1% of COHb could be detected from bloody fluids in the thoracic cavities of 7 victims without any fire or CO exposure, while COHb contents in the hearts were only 0.3–6.0%. The high COHb contents found in the thoracic fluids are considered due to postmortem production of COHb; the latter may be produced by decomposition of Hb and myoglobin during putrefaction [6, 7]. The postmortem production of COHb is said to be most marked for bloody thoracic fluids of cadavers, which have died of drowning [6, 8]. Putrefied blood also contains sulfurated hemoglobin (Sulf-Hb), which does not react with hydrosulfite, together with the postmortem COHb; the hemolyzed solution to be analyzed becomes composed of reduced Hb, COHb and Sulf-Hb, and thus is not suitable for measurements of COHb by the spectrophotometry.

As one of the factors which influence the COHb values, smoking should be mentioned. The COHb saturation percentages in blood of nonsmokers in metropolitan areas are less than 1%, while those of smokers consuming more than 15 cigarettes per day in the same areas are 3–5%. In view of such smoking effect and the above postmortem production, it seems reasonable to set up a cutoff value of COHb in heart blood to be 10%; when a cadaver shows a COHb value not greater than 10% and also tendency of putrefaction, the CO exposure can be assumed to be absent.

For fire victims, there are many cases in which only coagulated blood by the action of heat can be obtained. In such a case, 8-mL of saline solution is added to 2 g of the coagulated blood and gently homogenized with a Teflon homogenizer<sup>c</sup>. However, it should be cautioned that the values obtained from the coagulated blood are much less reliable than those obtained from the fluidal blood.

## Storage of specimens

Care should be taken also for the storage of specimens until analysis. By the action of strong light, CO can be liberated from COHb; the shading of specimens from light is preferable. For long storage, the specimens should be frozen [9, 10]. At 3° C of storage, a slight liberation of CO can occur [10]; at –30° C, slight production of Met-Hb is obtained, but no changes in values of COHb and the total Hb for at least 60 days. At –80° C, no production of Met-Hb and no changes in COHb and total Hb can be achieved; the storage with shading at –80 is most desirable.

## GC analysis

---

See [4].

## Reagents and their preparation

- Solution of saponin and potassium ferricyanide: 500 mg of saponin (obtainable from many manufacturers) and 2 g of potassium ferricyanide are dissolved in distilled water to make 10 mL solution.




- Plastic disposable syringes (5 mL, Terumo, Tokyo, Japan or any other manufacturer)
- CO standard gas: 50 L (GL Sciences, Tokyo, Japan).
- Cyanmethemoglobin reagent: Hemoglobin Test Wako (Wako Pure Chemical Industries, Ltd., Osaka, Japan).
- Cyanmethemoglobin reagent (by Sato et al. [11]): 20 g of potassium ferricyanide is dissolved in 500 mL of 1/15 M phosphate buffer solution (pH 7.1), followed by the addition of 50 mg potassium cyanide and 100 mL of 1% Triton X-100 (obtainable from every manufacturer) with gentle mixing. The mixture is made to 1 L by adding distilled water. The final pH of this reagent is about 7.2.

## GC conditions

Column: Molecular Sieve 5A (60–80 mesh, 2 m × 3 mm i.d., Shimadzu Corp., Kyoto, Japan)

GC condition: a common GC instrument for packed columns with an FID is used. Carrier gas is hydrogen at a flow-rate of 40 mL/min; the column temperature is 80° C. The above separation column (Molecular sieve 5A) is connected with a stainless steel column (40 cm × 3 mm i.d.) packed with a nickel catalyst (Shimalite-Ni, Shimadzu). The stainless column is heated at 650° C in a reaction furnace (RAF-1A, Shimadzu Corp.), in which CO is converted into methane to be detected with an FID. The temperature of the injection port and detector is 150° C.

## Procedure

- The plunger of a plastic disposable syringe (5 mL, Terumo) is drawn to make a 3-mL space as shown in  *Figure 1.2*.
- The tip of the syringe is capped with a silicone rubber plug (the detailed structure also shown in  *Figure 1.2*).
- A 25- $\mu$ L volume of whole blood is injected into the space of the above disposable syringe using a microsyringe.
- A 15- $\mu$ L volume of the 5% saponin plus 20% potassium ferricyanide solution<sup>d</sup> is also injected using a microsyringe.
- The disposable syringe containing the above mixture is shaken well and left at room temperature for 30 min.
- A needle of a gas-tight syringe is inserted into the disposable syringe, and 200  $\mu$ L of the headspace gas is drawn into the gas-tight syringe together with pushing the plunger of the plastic disposable syringe. The gas in the gas-tight syringe is injected into GC.
- When another injection into GC is required, the above procedure can be repeated.
- To prepare CO standard gases at various concentrations (50–2,000 ppm), various volumes of pure CO are placed in a 1,000 mL glass container, which has been filled with air. A 200- $\mu$ L volume of each CO standard gas is drawn into a gas-tight syringe and injected into GC to make an external calibration curve ( *Figure 1.3*).
- Measurement of a total Hb concentration in the test blood: the cyanmethemoglobin method [11, 12] is employed. The stock solution of the kit (Hemoglobin Test Wako, Wako Pure

Chemical Industries, Ltd.) is diluted 10-fold. The whole blood to be analyzed should be vortex-mixed before use; 20  $\mu\text{L}$  of whole blood is added to 5 mL of the diluted solution and mixed. After standing for 150 min, the absorbance at 540 nm is measured against distilled water as blank test. The total Hb concentration of the test blood is easily calculated by comparing the absorbance of the test blood with that of the standard solution of cyanmethemoglobin included in the kit.

COHb is very stable and it takes as long as 150 min to convert COHb into cyanmethemoglobin completely using the reagent solution of the commercial kit [11]. To shorten the analysis time, a hand-made reagent of Sato et al. [11] containing a larger amount (20 g/L) of potassium ferricyanide is recommendable to be used. To 5 ml of the Sato's solution (without dilution), 20  $\mu\text{L}$  of the test whole blood is added, mixed well and left only for 5 min; the following procedure is the same as described above.

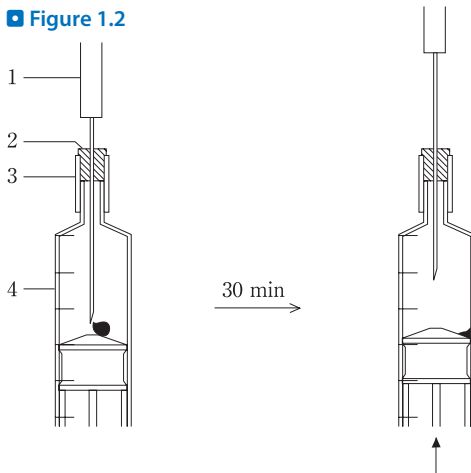
- x. On the basis of the fact that 1.36 mL of CO can be bound with 1 g of hemoglobin, the COHb saturation percentage is calculated by the following equation:

$$\text{COHb \%} = \frac{\text{Amount of CO bound with Hb in the test blood}}{\text{Amount of CO combinable with total Hb in the test blood}} \times 100$$

$$= \frac{\frac{A \times 3.08^e}{10^6}}{\frac{B \times 25 \times 1.36}{10^5}} \times 100 = 0.906 \times \frac{A}{B}$$

where A is the CO concentration (ppm) measured by the GC method; B the total Hb concentration (g/dL).

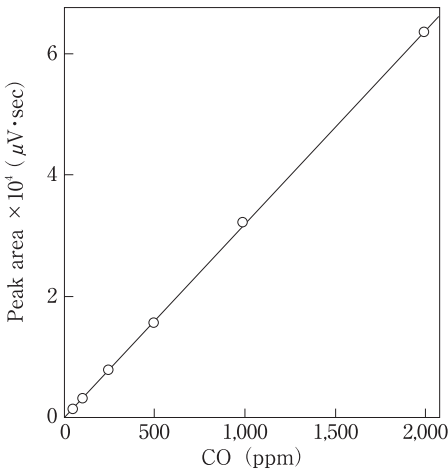
Figure 1.2



Handling procedure for liberating CO from a blood specimen.

1: microsyringe; 2: silicone rubber plug; 3: silicone rubber tube; 4: plastic disposable syringe.

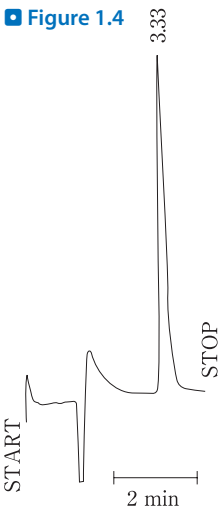
■ **Figure 1.3**



Calibration curve for CO measurements by GC using the authentic standard gas.

## Assessment and some comments on the method

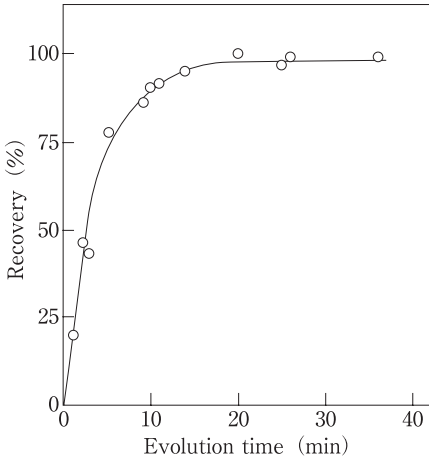
► *Figure 1.4* shows a typical gas chromatogram for the authentic CO gas. Usually a single peak due to CO appears, but when  $\text{CO}_2$  or methane coexists, multiple peaks are detected. Both CO and  $\text{CO}_2$  are converted into methane by nickel catalysis to be detected by an FID, but CO is neither contaminated by  $\text{CO}_2$  nor methane, because they are well separated by the Molecular Sieve 5A column before their conversion into methane. Since hydrogen at a constant flow rate of 40 mL/min is used in this method, care should be taken for sufficient ventilation of the laboratory.



Gas chromatogram for CO. A 200- $\mu\text{L}$  volume of 500 ppm CO was injected into GC.

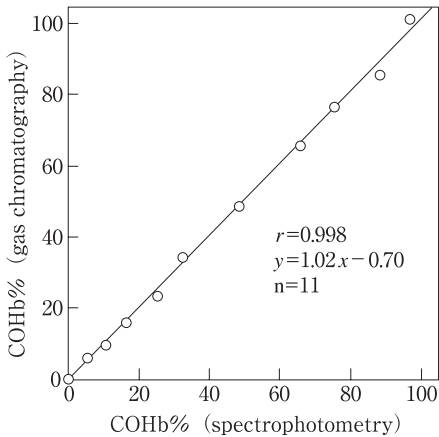


■ **Figure 1.5**



**Liberation of CO from a blood specimen as a function of incubation time at room temperature.**

■ **Figure 1.6**



**Correlation between the spectrophotometric method [3] and the GC method [4] for measurements of blood CO.**

The time-course of CO liberation from a test blood by the action of the saponin plus potassium ferricyanide inside the plastic disposable syringe is shown in [▶ Figure 1.5](#). The liberation reaction was over in about 20 min; in this method, 30 min of incubation at room temperature was adopted.

The relationship between the present GC [4] and spectrophotometric [8] methods is shown in [▶ Figure 1.6](#); the correlation coefficient ( $r$ ) was 0.998.

The postmortem production of COHb should be kept in mind. The appearance of Sulf-Hb in putrefied blood is also a problem for measurement of the total Hb concentration. However, since the extinction coefficient of Sulf-Hb is fortunately similar to that of cyanmethemoglobin

at 540 nm, the error of the total Hb concentration may be small, when putrefaction is slight. When the denaturation of blood is marked, the measurement of total Hb concentration becomes impossible. In this case, a method employing the analysis of iron should be used for estimation of total Hb concentration [13]. CO in the coagulated blood cannot be analyzed by the GC method.

## Toxic and fatal concentrations

Since the affinity of CO to Hb is 250–300 fold higher than that of O<sub>2</sub> to Hb, CO interferes with the transportation of O<sub>2</sub> by Hb in human body. CO does not only cause hypoxia in tissues, but also causes inhibition of enzymes, such as cytochrome oxidase [1]. The poisoning symptoms as a function of blood COHb percentage are shown in [Table 1.1](#). However, the toxicity of CO depends upon both CO concentration in the air and duration of CO inhalation. The table shows only an outline of its toxicity; 50% or more of COHb in blood is an indicator of fatality.

■ **Table 1.1**

COHb saturation percentages in blood and symptoms in CO poisoning [1]

COHb in blood (%)	Poisoning symptom
0–10	No symptoms
10–20	Tense feeling of the forehead, slight headache
20–30	Headache, pulse feeling in the temporal region
30–40	Severe headache, general fatigue, dizziness, impairment of visual acuity, vomiting
40–50	Hyperventilation, coma with convulsion, Cheyne-Stokes breathing
60–70	Coma with convulsion, cardiac disfunction
70–80	Death

## Notes

- When the percentage of COHb in heart blood is more than 10%, it is probable that the victim has died in the fire.
- A spectrophotometric method for COHb using separate measurements of COHb and O<sub>2</sub>Hb [14] and a GC method using a ratio of CO peak areas before and after complete saturation with CO [15] are influenced by the presence of Met-Hb, while the spectrophotometric [3, 5, 16] and GC [4, 17] methods presented in this chapter are not.
- The amount of the homogenate should be increased to 40–50  $\mu$ L.
- The saponin serves to hemolyze erythrocytes, while the potassium ferricyanide converts COHb into Met-Hb to liberate CO.
- The accurate volume of the plastic disposable syringe (Terumo) at the mark of 3 mL was 3.08 mL [4].

## References

- 1) Yamamoto I (ed) (1998) *Legal Medicine and Forensic Chemistry*, 3rd edn. Hirokawa Publishing Co., Tokyo, pp 132–135 (in Japanese)
- 2) Katsumata Y, Aoki M, Oya M et al. (1980) Simultaneous determination of carboxyhemo-globin and methemoglobin in victims of carbon monoxide poisoning. *J Forensic Sci* 25:546–549
- 3) Katsumata Y, Aoki M, Sato K et al. (1982) A simple spectrophotometry for determination of carboxyhemoglobin in blood. *J Forensic Sci* 27:928–934
- 4) Katsumata Y, Sato K, Yada S (1985) A simple and high-sensitive method for determination of carbon monoxide in blood by gas chromato-graphy. *Acta Crim Jap* 51:139–144
- 5) Ramieri A Jr, Jatlow P, Seligson D (1974) New method for rapid determination of carboxyhemo-globin by use of double wavelength spectro-photometer. *Clin Chem* 20:278–281
- 6) Kojima T, Nishiyama Y, Yashiki M et al. (1982) Postmortem formation of carbon monoxide. *Forensic Sci Int* 19:243–248
- 7) Markiewicz J (1967) Investigation on endogenous carboxyhemoglobin. *J Forensic Med* 14:16–21
- 8) Kojima T, Yashiki M, Une I (1983) Experimental study on postmortem formation of carbon monoxide. *Forensic Sci Int* 22:131–135
- 9) Hessel DW, Modglin FR (1967) The determination of carbon monoxide in blood by gas-solid chromatography. *J Forensic Sci* 12:123–131
- 10) Sato K, Tamaki K, Hattori H et al. (1990) Determination of total hemoglobin in forensic blood samples with special reference to carboxyhemoglobin analysis. *Forensic Sci Int* 48:89–96
- 11) Sato K, Katsumata Y, Aoki M et al. (1983) A new reagent for the rapid determination of total hemoglobin as hemoglobincyanide in blood containing carboxyhemoglobin. *Biochem Med* 30:78–88
- 12) Van Kampen EJ, Zijlstra WG (1961) Standardization of hemoglobinometry. II. The hemoglobincyanide method. *Clin Chim Acta* 6:538–544
- 13) Katsumata Y, Sato K, Aoki M et al. (1982) A simple and accurate method for measurement of the hemoglobin content in blood by colorimetric iron determination. *Z Rechtsmed* 88:27–30
- 14) Kozuka H, Niwase K, Taniguchi T (1969) Spectrophotometric determination of carboxyhemoglobin. *Eisei Kagaku* 15:342–345 (in Japanese with an English abstract)
- 15) Takahashi S, Kumabe Y, Ito N et al. (1980) Gas chromatographic analysis of carbon monoxide in blood with the use of ultrasonic irradiation. *Jpn J Legal Med* 34:556–562
- 16) Fukui M, Kumaoka K, Ito H et al. (1971) *Forensic Chemistry*. Hirokawa Publishing Co., Tokyo, pp 244–245 (in Japanese)
- 17) Kojima T, Nishiyama Y, Yashiki M et al. (1981) Determination of carboxyhemoglobin saturation in blood and body cavity fluids by carbon monoxide and total hemoglobin concentrations. *Jpn J Legal Med* 35:305–311 (in Japanese with an English abstract)

## II.1.2 Hydrogen sulfide and its metabolite

By Shigetoshi Kage

### Introduction

Hydrogen sulfide ( $\text{H}_2\text{S}$ ) is a colorless gas with the smell of putrid eggs; it can exist in both non-ionic and ionic forms in aqueous solution. The ratio of the nonionic form to the total ionized one is influenced by concentration of hydrogen ion in the solution. Under acidic conditions,  $\text{H}_2\text{S}$  does not ionize and evaporates from water; under alkaline conditions it is easily ionized and retained in the solution.

As toxic effects of  $\text{H}_2\text{S}$ , it (at higher than 700 ppm) acts on the central nervous system causing generalized poisoning, and also shows localized inflammatory effects on the wet mucous membranes of the eye and respiratory organs.  $\text{H}_2\text{S}$  poisoning together with oxygen deficiency is most frequent in industries; the former is also occurring at sewers, sewage treatment institutions, petroleum refineries, sodium sulfide factories, and zones of volcanos and spas. The poisoning can also occur by ingesting a pesticide of the lime-sulfur mixture or bath salts including sulfur.

It is necessary to analyze  $\text{H}_2\text{S}$  in blood of a poisoned patient to verify its poisoning. The analytical methods for  $\text{H}_2\text{S}$  can be classified into two groups; methods for detecting nonionic  $\text{H}_2\text{S}$  under acidic conditions and those for detecting an ionized form of  $\text{H}_2\text{S}$  under alkaline conditions. In this chapter, a method of GC with a flame photometric detector (FPD) for analysis of the nonionic  $\text{H}_2\text{S}$  and a method of GC/MS for the ionized form with derivatization are presented.

$\text{H}_2\text{S}$  is easily oxidized to thiosulfate and sulfate in a human body [1–3]. The levels of sulfate in blood and urine of non-poisoned subjects are relatively high, making sulfate difficult to be used as an indicator of  $\text{H}_2\text{S}$  poisoning. However, thiosulfate can be used as the indicator of the poisoning [4–9], because its endogenous levels in human blood and urine are usually low<sup>a</sup>. Therefore, a method for detecting this metabolite is also presented.

### GC analysis of Hydrogen sulfide ( $\text{H}_2\text{S}$ ) in blood

See [10].

#### Preparation of the standard stock solution of $\text{H}_2\text{S}$

- i. One gram of sodium sulfide nonahydrate ( $\text{Na}_2\text{S} \cdot 9\text{H}_2\text{O}$ , Wako Pure Chemical Industries, Ltd., Osaka, Japan and many other manufacturers) is placed in a volumetric flask (100 mL) and dissolved in purified water<sup>b</sup>, which had been degassed by bubbling with nitrogen, to make 100 mL solution.
- ii. A 25-mL volume of iodine solution [0.1 N (=0.05 M) standard solution available from Wako Pure Chemical Industries, and other manufacturers] is placed in an Erlenmeyer flask, fol-

lowed by addition of 1 mL of concentrated HCl and 10.0 mL of the above  $\text{Na}_2\text{S} \cdot 9\text{H}_2\text{O}$  solution, and left at room temperature for 10 min.

- iii. The iodine in the above solution is titrated using the titer(f)-known sodium thiosulfate solution [0.1 N=0.1 M, standard solution available from many manufacturers] in the presence of the starch color reactant (1 g of starch is mixed with 10 ml water, which is put in 100 mL hot water with stirring, boiled for 1 min and cooled) using a biuret titrator.
- iv. A volume of the sodium thiosulfate solution (0.1 M) to be required for the above titration is assumed to be (a) mL; separately, at the step ii), 10 ml of distilled water is added in place of 10 ml of the  $\text{Na}_2\text{S} \cdot 9\text{H}_2\text{O}$  solution as a blank test and the following titration procedure is exactly the same as described above. A volume of the sodium thiosulfate solution (0.1 M) to be required for the titration of the blank test is assumed to be (b) mL.
- v. The volume of  $\text{Na}_2\text{S} \cdot 9\text{H}_2\text{O}$  solution prepared at the first step to be used for making the final standard solution of  $\text{H}_2\text{S}$  is:  $[89.3/(b-a)f]$  mL. This volume of the solution is placed in a 100-mL volume volumetric flask, followed by dilution with the purified water degassed with nitrogen to make the final 100 mL solution; this standard stock solution contains 152  $\mu\text{g}/\text{mL}$  of  $\text{H}_2\text{S}$ .

## GC conditions

GC: an instrument with a flame photometric detector (FPD) and with a filter for sulfur; column: a glass packed column (3 m  $\times$  3 mm i.d.); packing material: diatomite treated with acid and silane (60–80 mesh) and coated with 25% 1,2,3-tris(2-cyanoethoxy)propane (TCEP)<sup>c</sup>; column temperature: 70 °C; injection temperature: 150 °C; carrier gas: nitrogen; its flow rate: 50 mL/min.

## Procedure

- i. One milliliter of whole blood is placed in a 10-mL volume glass centrifuge tube with a ground-in stopper.
- ii. Five milliliters of cold acetone and 0.5 ml of 20% HCl solution are added to the above centrifuge tube and mixed well.
- iii. The tube is centrifuged at 3,000 rpm for 5 min to remove sediment at low temperature; the supernatant fraction is decanted to another glass tube.
- iv. The supernatant fraction is diluted 5–20 fold with acetone. A 1–3  $\mu\text{L}$  aliquot of it is injected into GC.
- v. Using a double-logarithmic graph, a external calibration curve is drawn with  $\text{H}_2\text{S}$  concentration (0.05–2.0  $\mu\text{g}/\text{mL}$ ) on the horizontal axis and with peak height (cm) on the vertical axis in advance. The concentration ( $\mu\text{g}/\text{mL}$ ) of  $\text{H}_2\text{S}$  in a test sample is calculated using the calibration curve.

## Assessment of the method

When  $\text{H}_2\text{S}$  in a blood specimen is extracted by the headspace method, the  $\text{H}_2\text{S}$  gas in the headspace is decomposed according to heating temperature and time, resulting in variation in data obtained. However,  $\text{H}_2\text{S}$  is relatively stable in the acetone solution acidified with HCl. The  $\text{H}_2\text{S}$

concentration in blood was measured in an H<sub>2</sub>S poisoning case by this method [11]. The detection limit is 0.1 µg/mL; the sensitivity is satisfactory. However, the retention time of H<sub>2</sub>S is as short as 0.7 min; it overlaps peaks of pentane and hexane. The retention time of acetone is 3.8 min.

## GC/MS analysis

See [8, 12–14].

### Reagents and their preparation

- H<sub>2</sub>S standard stock solution: its preparation is the same as described in the above GC analysis section.
- 5 mM Tetradecyldimethylbenzylammonium chloride (TDMBA, Tokyo Kasei Kogyo Co., Ltd., Tokyo, Japan)<sup>d</sup> / borax-saturated aqueous solution: 36.8 mg of TDMBA is dissolved in 20 mL of purified water, which has been degassed with nitrogen and saturated with sodium tetraborate.
- 20 mM Pentafluorobenzyl bromide (PFBBr, GL Sciences, Tokyo, Japan and other manufacturers) solution: 104 mg of PFBBr is dissolved in 20 mL toluene.
- 10 µM 1,3,5-Tribromobenzene (TBB, Wako Pure Chemical Industries and others) solution (internal standard, IS): 31.5 mg TBB is dissolved in 100 mL ethyl acetate; the solution is diluted 100-fold with ethyl acetate.

### GC/MS conditions

See [8].

Column: HP-5 (30 m × 0.32 mm i.d., film thickness 0.25 µm, Agilent Technologies, Palo Alto, CA, USA); column temperature: 100° C (2 min) → 10° C/min → 220° C (5 min); injection temperature: 220° C; ion source temperature: 210° C; carrier gas: He; its flow rate: 2 mL/min; injection mode: splitless; ionization mode: EI; electron energy: 70 eV; ionization current: 300 µA.

### Procedure

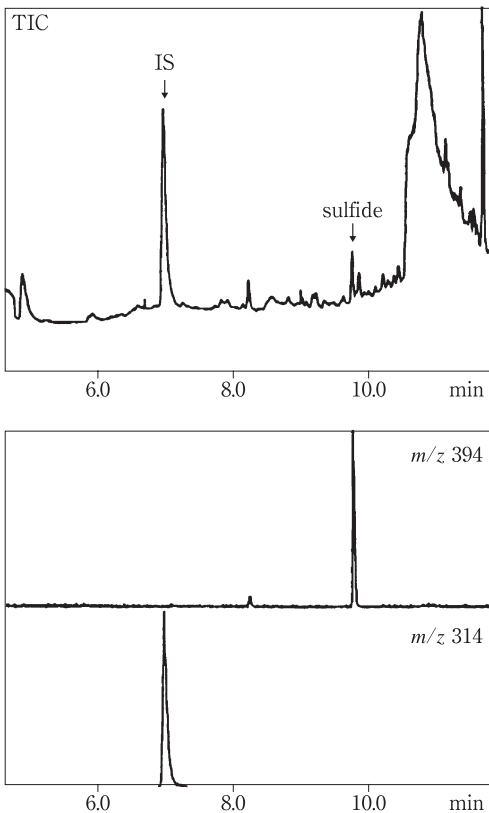
- A 0.8-mL volume of 5 mM TDMBA aqueous solution, 0.5 mL of 20 mM PFBBr toluene solution and 2.0 mL of 10 µM TBB ethyl acetate solution are placed in a 10-mL volume glass centrifuge tube with a ground-in stopper.
- A 0.2-mL volume of blood is added to the above mixture and vortex-mixed for 1 min.
- A 0.1-g aliquot of solid potassium dihydrogenphosphate is added to the mixture <sup>e</sup> and vortex-mixed for 10 s.
- The tube is centrifuged at 2,500 rpm for 5 min; the supernatant fraction is transferred to a small vial with a screw cap to serve as test solution.

- v. A 1- $\mu\text{L}$  aliquot of the solution is injected into GC/MS.
- vi. A calibration curve is constructed with sulfide concentration ( $\mu\text{g}/\text{mL}$ ) on the horizontal axis and with the area ratio of the peak at  $m/z$  394 (the derivative of sulfide) to that at  $m/z$  314 (IS) on the vertical axis. The concentration of sulfide ( $\mu\text{g}/\text{mL}$ ) in a specimen is calculated with this curve.

## Assessment of the method

► Figure 2.1 shows a total ion chromatogram (TIC) and mass chromatograms for the sulfide derivative (retention time 9.8 min) and IS (7.0 min) [8]. In the present GC/MS analysis for the derivative of sulfide<sup>f</sup> using PFBBR as a derivatization reagent, it is not necessary to extract sulfide from blood beforehand; the method is highly sensitive, allows the final identification of the compound and thus is useful to verify its poisoning. Since  $\text{H}_2\text{S}$  is produced in putrefied blood and also by decomposition of cysteine [15, 16], it is necessary to construct a calibration curve by adding sulfide to blood obtained from healthy subjects<sup>g</sup>. The detection limit is 0.2  $\mu\text{g}/\text{mL}$  in

■ Figure 2.1



TIC and mass chromatograms of a derivative of sulfide obtained from blood of a victim who died of hydrogen sulfide poisoning.  $m/z$  394: the derivative of sulfide;  $m/z$  314: IS.

the scan mode and 0.02 µg/mL in the SIM mode. Using the present GC/MS method, the changes in sulfide concentration in blood during storage in a refrigerator or a freezer were reported [14, 15]; sulfide poisoning cases were also reported [7–9, 17–19].

## Toxic concentrations

In the survived cases, blood should be sampled from patients as soon as possible after exposure to H<sub>2</sub>S gas, because H<sub>2</sub>S is rapidly metabolized in a human body. In the experience of the author et al., sulfide could not be detected from blood specimens sampled from six survived patients 4–15 h after exposure [7, 9].

► *Table 2.1* summarizes H<sub>2</sub>S concentrations in blood of fatal poisoning cases. Ikebuchi et al. [11] detected 0.31 µg/mL of H<sub>2</sub>S from blood obtained at autopsy from a victim, who had died of poisoning by H<sub>2</sub>S gas evaporated from polluted water at an industrial waste disposal facility. Kimura et al. [17] autopsied 3 of 4 victims, who had died of poisoning by H<sub>2</sub>S developed from dark slime accumulated in a seawater-introducing pipe at a flatfish farm, and detected 0.08–0.5 µg/mL of sulfide from their blood obtained. The author et al. also experienced cases, in which one subject had died by exposure to H<sub>2</sub>S gas developed from slime in an underground waste water tank of a hospital [7], in which one subject had died of H<sub>2</sub>S added for conversion of glutathione copper into glutathione at a glutathione-refinery factory [9], and in which one subject had died of poisoning by volcano gas flowing backward into an oil-separating tank at a geothermal power plant [8]; the blood concentrations of sulfide detected from these victims were 0.13–0.45 µg/mL. In addition, the author et al. [15] made animal experiments, in which rats were exposed to 550–650 ppm of H<sub>2</sub>S gas; the mean blood concentration of H<sub>2</sub>S in the rats (n=5) killed by H<sub>2</sub>S poisoning was 0.38 µg/mL.

The fatal blood concentrations of sulfide were also measured for humans and rats after oral ingestion of sulfide or polysulfide<sup>h</sup>; as shown in ► *Table 2.2*, the concentrations of sulfide after oral ingestion were more than 20 times higher than those after exposure to H<sub>2</sub>S gas [18, 19].

► **Table 2.1**

**Blood concentrations of hydrogen sulfide (H<sub>2</sub>S) in fatal poisoning cases after exposure to its vapor**

No.	Place of incident	Concentration (µg/mL)	Ref.
1	Industrial waste disposal facility	0.31	[11]
2	Flatfish farm	0.08–0.50 (3 victims)	[17]
3	Underground waste water tank of a hospital	0.22	[7]
4	Glutathione-refinery factory	0.13	[9]
5	Geothermal power plant	0.45	[8]
Rat experiments (exposed to 550–650 ppm H <sub>2</sub> S)		0.38	[15]



■ **Table 2.2**

**Blood concentrations of sulfide in fatal poisoning cases after oral ingestion of sulfide or polysulfide**

No.	Poison ingested	Concentration ( $\mu\text{g/mL}$ )	Ref.
1	Sulfide	30.4	[19]
2	Polysulfide	32.0	[18]
3	Polysulfide	131	[18]
Rat experiments			
	Sulfide	10.2	[19]
Rat experiments			
	Polysulfide	16.6	[18]

## GC/MS analysis of thiosulfate (a metabolite of hydrogen sulfide) in blood and urine

See [5, 8].

### Reagents and their preparation

- Standard solution of sodium thiosulfate: its 0.1 M solution is commercially available (Wako Pure Chemical Industries and other manufacturers), or it can be easily prepared in a laboratory.
- 200 mM Ascorbic acid solution: 352 mg of ascorbic acid is dissolved in purified water to prepare 10 mL solution.
- 5% NaCl solution: 500 mg NaCl is dissolved in purified water to prepare 10 mL solution.
- 20 mM Pentafluorobenzyl bromide (PFBBr) solution: 104 mg of PFBBr is dissolved in acetone to prepare 20 mL solution.
- 25 mM Iodine solution: 317 mg of iodine is dissolved in ethyl acetate to prepare 100 mL solution.
- 40  $\mu\text{M}$  1,3,5-Tribromobenzene (TBB) solution (IS): 31.5 mg of TBB is dissolved in 100 mL ethyl acetate; 4 ml of the solution is diluted 25-fold with ethyl acetate to prepare 100 mL solution.

### GC/MS conditions

Column: HP-5 (30 m  $\times$  0.32 mm i.d., film thickness 0.25  $\mu\text{m}$ , Agilent Technologies); column temperature: 100° C (2 min)  $\rightarrow$  10° C/min  $\rightarrow$  220° C (5 min); injection temperature: 220° C; ion source temperature: 210° C; carrier gas: He; its flow rate: 2 mL/min; injection mode: splitless; ionization mode: EI; electron energy: 70 eV; ionization current: 300  $\mu\text{A}$ .

## Procedure

- i. A 0.05-mL volume of 200 mM ascorbic acid, 0.05 mL of 5% NaCl aqueous solution and 0.5 mL of 20 mM PFBBr acetone solution are placed in a 10-mL volume glass centrifuge tube with a ground-in stopper.
- ii. A 0.2-mL volume of blood or urine<sup>i</sup> is added to the above mixture and vortex-mixed for 1 min.
- iii. A 2.0 mL volume of 25 mM iodine ethyl acetate solution and 0.5 mL of 40  $\mu\text{M}$  TBB ethyl acetate solution are also added to the mixture and vortex-mixed for 30 s.
- iv. The tube is centrifuged at 2,500 rpm for 5 min; and left at room temperature for 1 h. Then, the supernatant fraction is transferred to a small vial with a screw cap to serve as test solution.
- v. A 1- $\mu\text{L}$  aliquot of the solution is injected into GC/MS.
- vi. A calibration curve is drawn with thiosulfate concentration ( $\mu\text{mol}/\text{mL}$ ) on the horizontal axis and with the area ratio of the peak at  $m/z$  426 (the derivative of thiosulfate) to that at  $m/z$  314 (IS) on the vertical axis. The concentration of thiosulfate ( $\mu\text{mol}/\text{mL}$ ) in a test specimen is calculated with this curve.

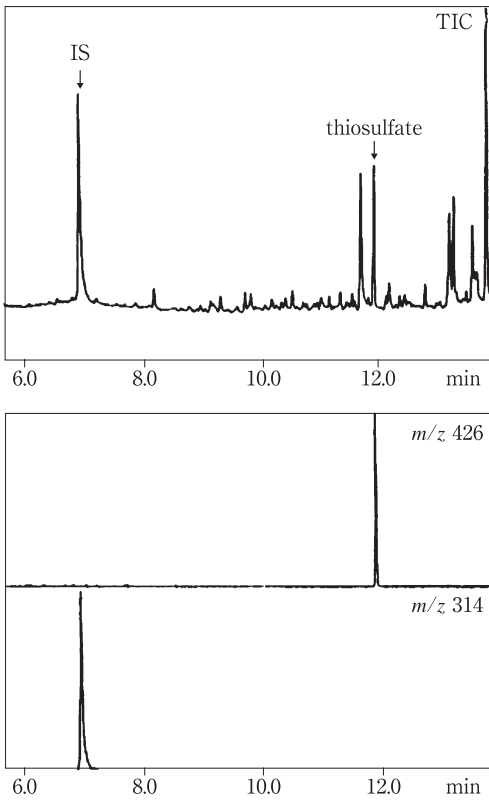
## Assessment of the method

► *Figure 2.2* shows a TIC and mass chromatograms for the thiosulfate derivative<sup>j</sup> (retention time 11.9 min) and IS (7.0 min) [8]. This method does not require any special pretreatment, and sensitive identification and quantitation can be achieved like in the case of GC/MS assays of sulfide described before. The detection limit was 0.02  $\mu\text{mol}/\text{mL}$  in the scan mode, and 0.002  $\mu\text{mol}/\text{mL}$  in the SIM mode. Using the present GC/MS method, the changes in thiosulfate concentration in blood and urine during storage in a refrigerator were reported [14];  $\text{H}_2\text{S}$  poisoning cases were also reported [7–9].

## Toxic concentrations

As shown in ► *Table 2.3*, the author et al. [7] could not detect thiosulfate from blood of four survived patients after exposure to  $\text{H}_2\text{S}$  gas at a recycled paper manufacturing factory; the blood specimens had been sampled 6–15 h after the exposure. However, 0.12–0.43  $\mu\text{mol}/\text{mL}$  of thiosulfate could be detected from urine in 3 of the 4 patients. In a case in which 2 subjects were exposed to  $\text{H}_2\text{S}$  gas during working in a close position to an instrument for excluding acidic gas at an ammonia- manufacturing factory, thiosulfate could not be detected from blood of both patients sampled 4–5 h after the exposure, but 0.18 and 0.50  $\mu\text{mol}/\text{mL}$  thiosulfate could be detected from their urine [9]. In the survived cases of animal experiments in which rabbits were exposed to 100–200 ppm  $\text{H}_2\text{S}$  gas, 0.061  $\mu\text{mol}/\text{mL}$  of thiosulfate could be detected from blood sampled just after the exposure, followed by a trace amount of the metabolite 2 h after the exposure; while in urine of rabbits, about 1  $\mu\text{mol}/\text{mL}$  of thiosulfate could be detected 1–2 h after the exposure, followed by 0.51  $\mu\text{mol}/\text{mL}$  4 h after the exposure and further decrease according to time, but a small but higher peak of thiosulfate than the control peak could be detected even after 24 h [6]. These data show that the measure-

■ **Figure 2.2**



TIC and mass chromatograms of a derivative of thiosulfate obtained from blood of a victim who died of hydrogen sulfide poisoning. *m/z* 426: the derivative of thiosulfate; *m/z* 314: IS.

■ **Table 2.3**

Concentrations of thiosulfate in urine of survivors after exposure to H<sub>2</sub>S

No.	Place of incident (interval between exposure and sampling)	Concentration (μmol/mL)	Ref.
1	Recycled paper manufacturing factory (6–15 h)	0.12–0.43 (3 victims)	[7]
2	Ammonia-manufacturing factory (4–5 h)	0.18, 0.50 (2 victims)	[9]
Rabbit experiments (exposed to 100–200 ppm H <sub>2</sub> S for 60 min) (exposure-to-sampling interval: 4 h)		0.51 (5 animals)	[6]

■ **Table 2.4**

**Concentrations of thiosulfate in blood after death by H<sub>2</sub>S poisoning**

No.	Place of incident	Concentration (μmol/mL)	Ref.
1	Underground waste water tank of a hospital	0.025	[7]
2	Glutathione-refinery factory	0.058	[9]
3	Geothermal power plant	0.143	[8]
	Rabbit experiments (exposed to 500–1,000 ppm H <sub>2</sub> S)	0.080	[6]

ments of thiosulfate in urine are more effective than those in blood especially in survived cases.

▶ *Table 2.4* shows the thiosulfate contents in blood of fatal victims exposed to H<sub>2</sub>S gas. The three cases are the same as those shown in ▶ *Table 2.1* [7–9]. Their blood concentrations of thiosulfate were 0.025, 0.058 and 0.143 μmol/mL, respectively. As animal experiments, rabbits were exposed to 500–1,000 ppm H<sub>2</sub>S gas until death. The mean blood concentration of thiosulfate in the poisoned rabbits was 0.080 μmol/mL [6]. However, thiosulfate could not be detected from rabbit urine, probably because of their sudden death due to exposure to H<sub>2</sub>S. It can be thus concluded that the measurements of thiosulfate in blood are more effective than those in urine for such sudden death cases.

## Notes

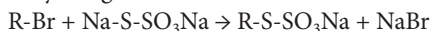
- Kawanishi et al. [20] analyzed thiosulfate in urine and plasma of 5 healthy subjects; thiosulfate concentrations in urine and plasma were 31.2 μmol/24 h (0.0288 μmol/mL) and 0.00268 μmol/mL, respectively. The author et al. [5] also detected 0.007 μmol/mL (mean value) of thiosulfate from urine of 12 healthy subjects; while the level in blood was below the detection limit (0.003 μmol/mL).
- Since H<sub>2</sub>S can be decomposed by oxygen dissolved in water, the purified water degassed with nitrogen gas is used. The purified water after boiling, followed by cooling to room temperature, can be also used.
- A similar packing material can be purchased from GL Sciences, Tokyo, Japan.
- The reagent is a quaternary ammonium compound to be used as a phase-transfer-catalyst. Another group reported a polymer-bound tributylmethylphosphonium chloride for such a type of catalysis [13].
- Under alkaline conditions, sulfur-containing compounds, such as cysteine and glutathione, in blood decompose to produce sulfide. To suppress these reactions, the pH of the mixture is made acidic.
- The derivatization reaction of sulfide is:  

$$2R-Br + Na_2S \rightarrow R-S-R + 2NaBr$$
R = pentafluorobenzyl
- McAnalley et al. [21] analyzed blood sulfide for 100 subjects without any exposure to H<sub>2</sub>S; the results were not greater than 0.05 μg/mL. The author et al. [15] found that the blood sulfide levels were markedly influenced by postmortem intervals and by temperatures of specimens

for storage. When blood specimens are sampled within 24 h after death and stored at not higher than 20° C, the postmortem production of H<sub>2</sub>S can be suppressed; the sulfide concentration in blank blood was not greater than 0.01 µg/mL. When the specimens are stored in a refrigerator or in a freezer, the postmortem production of H<sub>2</sub>S due to putrefaction could be suppressed even for the blood specimens sampled from a cadaver with a postmortem interval of more than 24 h.

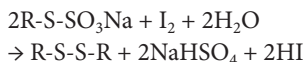
- h) When polysulfide is ingested orally, the unchanged compound can be detected from blood [18].
- i) Blood is the suitable specimen for fatal poisoning cases; while urine is suitable for survived cases after poisoning.
- j) The derivatization reaction for thiosulfate is shown as follows. It consists of two-step reactions; the first one is alkylating reaction and the second one oxidation reaction.

Alkylating reaction:



R = pentafluorobenzyl

Oxidation reaction:



## References

- 1) Curtis CG, Bartholomew TC, Rose FA et al. (1972) Detoxication of sodium 35 S-sulphide in the rat. *Biochem Pharmacol* 21:2313–2321
- 2) Bartholomew TC, Powell GM, Dodgson KS et al. (1980) Oxidation of sodium sulphide by rat liver, lungs and kidney. *Biochem Pharmacol* 29:2431–2437
- 3) Beauchamp RO, Bus JS, Popp JA et al. (1984) A critical review of the literature on hydrogen sulfide toxicity. *Crit Rev Toxicol* 13:25–97
- 4) Kangas J, Savolainen H (1987) Urinary thiosulfate as an indicator of exposure to hydrogen sulphide vapour. *Clin Chem Acta* 164:7–10
- 5) Kage S, Nagata T, Kudo K (1991) Determination of thiosulfate in body fluids by GC and GC/MS. *J Anal Toxicol* 15:148–150
- 6) Kage S, Nagata T, Kimura K et al. (1992) Usefulness of thiosulfate as an indicator of hydrogen sulfide poisoning in forensic toxicological examination: a study with animal experiments. *Jpn J Forensic Toxicol* 10:223–227
- 7) Kage S, Takekawa K, Kurosaki K et al. (1997) The usefulness of thiosulfate as an indicator of hydrogen sulfide poisoning: three cases. *Int J Legal Med* 110:220–222
- 8) Kage S, Ito S, Kishida T et al. (1998) A fatal case of hydrogen sulfide poisoning in a geothermal power plant. *J Forensic Sci* 43:908–910
- 9) Kage S, Kudo K, Ikeda N (1998) Determination of sulfide, thiosulfate and polysulfides in biological materials for diagnosis of sulfide poisoning. *Jpn J Forensic Toxicol* 16:179–189 (in Japanese with an English abstract)
- 10) Tanaka E, Nakamura T, Terada M et al. (1987) Determination of hydrogen sulfide in fluid and organ specimens by gas chromatography with a flame photometric detector. *Eisei Kagaku* 33:149–152 (in Japanese with an English abstract)
- 11) Ikebuchi J, Yamamoto Y, Nishi K et al. (1993) Toxicological findings in a death involving hydrogen sulfide. *Jpn J Legal Med* 47:406–409 (in Japanese with an English abstract)
- 12) Kage S, Nagata T, Kimura K et al. (1988) Extractive alkylation and gas chromatographic analysis of sulfide. *J Forensic Sci* 33:217–222
- 13) Miki A, Tsuchihashi H (1999) Determination of hydrogen sulfide in blood by gas chromatography/mass spectrometry after liquid-liquid-solid phase-transfer-catalyzed pentafluorobenzoylation. *Jpn J Forensic Toxicol* 17: 14–21

- 14) Tsuge K, Kataoka M, Seto Y (2000) Changes of sulfide and thiosulfate in blood and urine during storage in a refrigerator. *Jpn J Sci Tech Iden* 4:83–90 (in Japanese with an English abstract)
- 15) Nagata T, Kage S, Kimura K et al. (1990) Sulfide concentrations in postmortem mammalian tissues. *J Forensic Sci* 35:706–712
- 16) Abe K, Kimura H (1996) The possible role of hydro-gen sulfide as an endogenous neuromodulator. *J Neurosci* 16:1066–1071
- 17) Kimura K, Hasegawa M, Matsubara K et al. (1994) A fatal disaster case based on exposure to hydrogen sulfide – an estimation of the hydrogen sulfide concentration at the scene. *Forensic Sci Int* 66:111–116
- 18) Nagata T, Kage S, Kimura K et al. (1994) How to diagnose polysulphide poisoning from tissue samples. *Int J Leg Med* 106:288–290
- 19) Imamura T, Kage S, Kudo K et al. (1996) A case of drowning linked to ingested sulfides – a report with animal experiments. *Int J Legal Med* 109:42–44
- 20) Kawanishi T, Togawa T, Ishigami A et al. (1984) Determination of thiosulfate in human urine and plasma by high performance liquid chromatography with a dual electrochemical detector. *Bunseki Kagaku* 33:E295–E300
- 21) McAnalley BH, Lowry WT, Oliver RD et al. (1979) Determination of inorganic sulfide and cyanide in blood using specific ion electrodes: application to the investigation of hydrogen sulfide and cyanide poisoning. *J Anal Toxicol* 3:111–114

## II.1.3 Cyanide

by Yasuo Seto

### Introduction

Hydrogen cyanide (HCN) is volatile (boiling point: 25.7°C) and weakly acidic (pK<sub>a</sub>: 9.2). It is bound with cytochrome oxidase to inhibit its activity and induce cellular anoxia; it shows an immediate toxic effects. The fatal dose of HCN is about 100 mg. Cyanide has been being involved in various incidents of suicides, homicides and accidents. It is relatively easy to obtain cyanide, because it is being widely used in metallurgy, metal-plating and other chemical industries. It is a typical poison to be analyzed with high priority. Cyanide is also included in some plants, such as some beans and Japanese plums, in the forms of its glycosides; by ingesting such plants, HCN is sometimes released from the glycosides in the stomach. In the tropical areas, it is also contained in cassaba; its poisoning by ingesting a large amount of cassaba is being a problem for health. HCN can be produced during imperfect combustion of nitrogen-containing compounds; it is also included in cigarette smoke and gases produced in a fire.

There are many kinds of qualitative and quantitative methods for analysis of cyanide in wide fields, reflecting the great needs of its analysis. The Japanese Industrial Standard (JIS) standardized a method of cyanide analysis for factory waste water [1]. Nonomura [2] published a review for analytical methods of cyanide in water specimens. In two books [3, 4] both edited by the Pharmaceutical Society of Japan, the analytical methods for cyanide are also presented. In the field of forensic toxicology, the review on cyanide analysis written by Maseda and Fukui [5] seems useful. Many years ago, Bark et al. [6] and Guatelli [7] presented reviews on fundamental tests for cyanide, such as color tests. Very recently, preliminary tests or simplified qualitative tests for cyanide have been described in a book [8] edited by the Department of Legal Medicine Hiroshima University School of Medicine. In this chapter, the methods using microdiffusion plus pyridine-pyrazolone reaction and using headspace gas chromatography (HS-GC) are presented for analysis of cyanide in human blood, which is useful in forensic toxicology.

### Determination of blood cyanide by the microdiffusion/pyridine-pyrazolone method

---

#### Reagents and their preparation

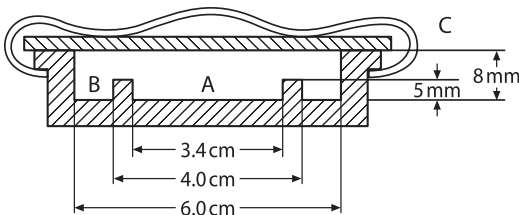
- A-20 mg aliquot of chloramine T (sodium *p*-toluenesulfonchloramide trihydrate, to be stored in a refrigerator, Wako Pure Chemical Industries, Ltd., Osaka, Japan and other manufacturers) is dissolved in distilled water to prepare 10 mL solution (2 mg/mL) just before use. A 15.6 g aliquot of sodium dihydrogenphosphate dihydrate is dissolved in distilled water to prepare 100 mL solution (1 M, preservable in a refrigerator). A 5 mL volume of the chloramine T solution is mixed well with 15 mL of the phosphate buffer and kept cooled in ice (0 °C) until use (the mixture to be prepared freshly just before use).

- A 0.1 g aliquot of 1-phenyl-3-methyl-5-pyrazolone (Wako Pure Chemical Industries, Ltd., and other manufacturers)<sup>a</sup> is dissolved in distilled water to prepare 100 mL solution (1 mg/mL, to be prepared freshly just before use). When it is not easily dissolved, the mixture solution can be warmed and stirred to obtain clear solution. A 20 mg aliquot of bis (1-phenyl-3-methyl-5-pyrazolone) (Wako Pure Chemical Industries, Ltd., and other manufacturers) is dissolved in 20 mL pyridine (1 mg/mL, to be prepared freshly). The above two solutions are combined just before use.
- Concentrated sulfuric acid is mixed slowly with a larger volume of distilled water to obtain 10-fold diluted solution (preservable at room temperature).
- A 1.76 g aliquot of *L*-ascorbic acid is dissolved in distilled water to prepare 10 mL solution (1 M, preservable in a refrigerator).
- One gram of NaOH is dissolved in distilled water to prepare 250 mL solution (0.1 M, preservable at room temperature in an airtight state).
- A 25.1 mg of potassium cyanide<sup>b</sup> (Wako Pure Chemical Industries, Ltd., and other manufacturers, analytical grade, designated as a poisonous substance by the Poisonous and Deleterious Substances Control Law) is dissolved in distilled water to prepare 10 mL solution (cyanide ion 1 mg/mL, preservable for a week in a refrigerator). The cyanide solution is diluted 500-fold with 0.1 M NaOH solution to prepare cyanide standard solution (2 µg/mL, to be freshly prepared).

## Procedure

- A specimen (1 mL blood and 0.03 mL of 1 M ascorbic acid solution) are placed in the outer groove (B) of a Conway microdiffusion cell (▶ *Figure 3.1*) (outer groove: wall height 8 mm, outer diameter 6 cm, inner diameter 4 cm; central round basin: wall height 5 mm, diameter 3.4 cm, Shibata Kagaku, Tokyo, Japan); 2 mL of 0.1 M NaOH solution for absorbing HCN gas is placed in the central round basin (A) and sealed airtightly with a glass plate cover smeared with glycerin at the joint part. By sliding the glass plate, a part of the roof of the outer groove (B) is opened; 0.5 mL of 10 % sulfuric acid is rapidly added to the blood specimen plus ascorbic acid, and the cell is again sealed immediately and fixed with a metal stopper. The Conway cell is gently swirled to well mix sulfuric acid and the specimen.

■ **Figure 3.1**



Schematic diagram of a cross section of the Conway microdiffusion cell. The bottom of the cell is compartmented by a circular wall of 5-mm height into an outer donut-shaped groove (B) and a central round basin (A). The glass plate cover is fixed with a metal stopper (C).



- ii. The Conway cell is left at room temperature for 2 h (diffusion)<sup>c</sup>.
- iii. One milliliter of the inner basin solution (0.1 M NaOH) is transferred to a glass tube and cooled with ice.
- iv. A 0.2 mL volume of the chloramine T/phosphate buffer solution, which has been cooled with ice, is added to the above solution and cooled for 2 min (chlorocyanogen production).
- v. A 3 mL volume of the pyridine-pyrazolone solution is added to the above mixture and left at room temperature for 40 min (coloration procedure)<sup>d</sup>.
- vi. The absorbance of the test solution is measured at 630 nm.
- vii. Calculation: the external calibration method is employed; various concentrations of cyanide in 0.1 M NaOH are prepared, and 1 mL each is subjected to coloration and measurement procedures [procedure iv) to vi)] to construct a calibration curve (cyanide concentration *vs.* absorbance). Using the curve, a concentration value for a test specimen is calculated and doubled<sup>e</sup> to obtain a concentration in the blood specimen. When the absorbance obtained for a specimen is beyond the concentration range of the calibration curve, the inner basin solution is diluted appropriately and the same procedure is repeated.

## Assessment and some comments on the method

The present pyridine-pyrazolone method is based on the König's reaction. The cyanide reacts with chloramine T<sup>f</sup> to produce chlorocyanogen, which opens the pyridine ring. The resulting aldehyde condenses with pyrazolone molecules to yield a blue compound<sup>g</sup>, as shown in [▶ Figure 3.2](#). At the beginning of the color development, it becomes pink and then bleaches, followed by appearance of a blue color, which is intensified according to time intervals, reaches a stable stage for 2–3 h and then bleaches; therefore, the measurements of the absorbance should be made during the stable stage.

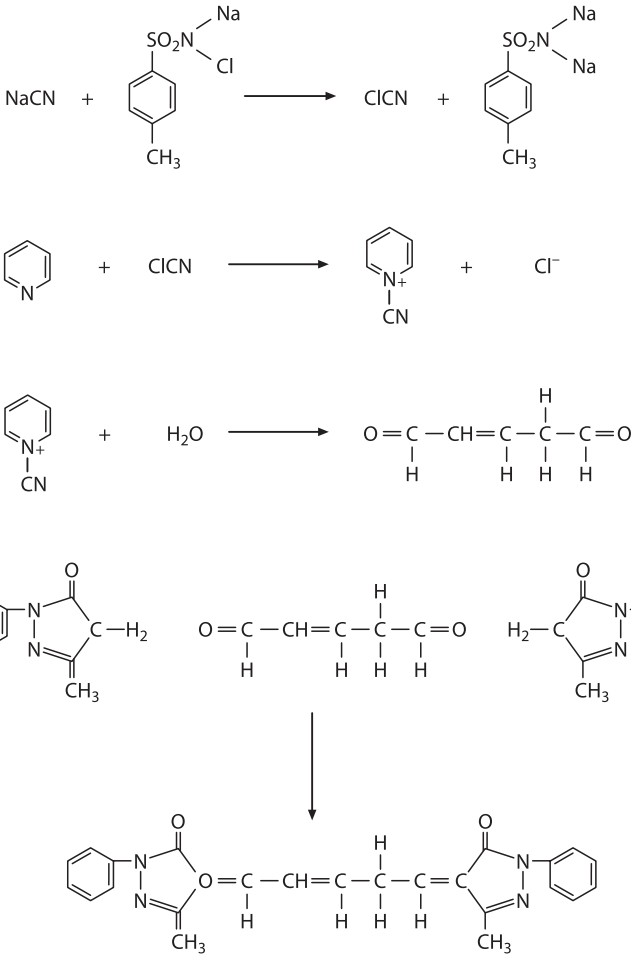
[▶ Figure 3.3](#) shows a calibration curve for cyanide. It is linear up to 1 µg/mL, but shows a minor trend of saturation above 2 µg/mL. Although the slope coefficient ( $A_{630}/\mu\text{g/mL}$ ) of the curve varies according to a method of preparing reagents, room temperature and other analytical conditions, the variation is not greater than 1.5 %. The detection limit is about 10 ng/mL.

As shown in [▶ Table 3.1](#) [9], cyanide can be detected from blood of healthy subjects. The endogenous levels are close to the detection limit of the present method.

The König's coloration method seems specific for cyanide, but thiocyanic acid (HSCN) markedly interferes with the above color development [10]. Thiocyanic acid also reacts with chloramine T to produce chlorocyanogen, which is not negligible. When a specimen containing thiocyanic acid is directly color-developed by the pyridine-pyrazolone method without extraction, it suffers from overestimated values of cyanide due to the false-positive reaction. Blood and serum contain much higher concentrations of thiocyanic acid than that of cyanide ([▶ Table 3.1](#)); in saliva, its concentrations are even higher. The concentrations of thiocyanic acid in blood and saliva of smokers are significantly higher than those of non-smokers; therefore, thiocyanic acid levels are being used as an indicator of smoking. To avoid such false-positive reaction, pretreatments of specimens, such as distillation, purging and diffusion, are essential to extract cyanide from the matrix. Thiocyanic acid is not volatile under acidic conditions, which enables the separation between thiocyanic acid and cyanide.

There is great variation in the level of cyanide in blood of healthy subjects [11]; the values are 3–75 ng/mL in non-smokers, and 9–180 ng/mL in smokers. However, the variation is not

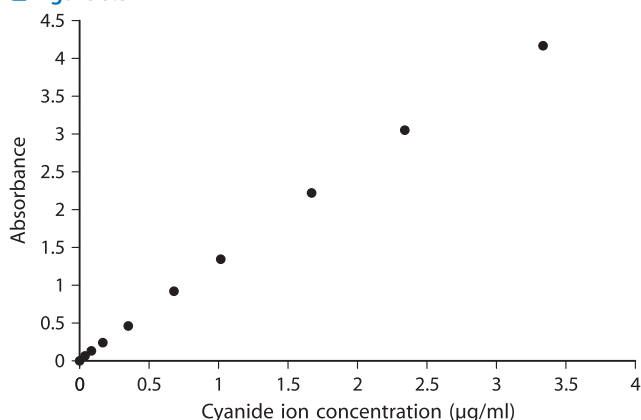
Figure 3.2



Color reaction mechanism for cyanide by the pyridine-pyrazolone method.

due to the individual difference, but due to different methods of analysis used. In every analytical method for cyanide in blood, a pretreatment of blood with relatively strong acid to denature hemoglobin to liberate HCN is included, prior to any type of detection. During the acid-treatment process, the oxygenated hemoglobin present in large amounts in blood (12–16 %) is rapidly denatured to produce large amounts of superoxide anion radical ( $\text{O}_2^-$ ), which causes non-specific oxidation of compounds including thiocyanic acid [12]; thiocyanic acid is attacked by  $\text{O}_2$  or its conjugated acid perhydroxyl radical ( $\text{HOO}\cdot$ ), resulting in liberation of cyanide from thiocyanic acid. Although the situation is different according to the concentrations of oxygenated hemoglobin, the kind of acid, its concentration and other pretreatment conditions, about 2.4% of total thiocyanic acid is usually converted to cyanide. By considering high concentrations of thiocyanic acid present in blood, it is easily concluded that a major part of cyanide detected from blood of a healthy subject is due to artificial production of cyanide by

■ Figure 3.3



Calibration curve for cyanide ion by the pyridine-pyrazolone method.

■ Table 3.1

Concentrations of cyanide and thiocyanic acid in blood and saliva of healthy human subjects\*

Analyte	Concentration (ng/mL)		
	Total	Non-smoker	Smoker
The number of Specimen	40	20	20
Cyanide in blood**	$5.7 \pm 2.1$	$4.4 \pm 1.1$	$7.0 \pm 1.8$
Thiocyanic acid in plasma	$4,200 \pm 4,490$	$1,940 \pm 1,470$	$6,450 \pm 5,340$
Cyanide in saliva**	$13.5 \pm 10.9$	$9.9 \pm 6.8$	$17.2 \pm 13.5$
Thiocyanic acid in saliva	$63,700 \pm 50,000$	$31,400 \pm 23,500$	$96,000 \pm 48,800$

\* The data were cited from reference [9] with slight modification.

\*\* The cyanide concentrations are express as those in the form of cyanide ion.

oxidation of thiocyanic acid [11]. The high blood cyanide levels often observed in the literature seems to reflect such artifacts produced during pretreatments. For blood specimens of individuals (heavy smokers and tobacco amblyopia) containing high concentrations of thiocyanic acid, high concentrations of cyanide can be detected; this may cause misdiagnosis of cyanide poisoning. The artificial production of cyanide from thiocyanic acid can be suppressed by adding ascorbic acid to blood; ascorbic acid removes active oxygen and suppress the false positive reaction to give true cyanide levels in blood [11].

Cyanide in blood is relatively stable under storage in a refrigerator. After sampling blood specimens, the methemoglobin-reducing enzyme system in erythrocytes is gradually inactivated, causing gradual increase in methemoglobin concentrations. In blood specimens, high concentrations of cyanide can stably exist in the trapped form by methemoglobin. However, there is a report dealing with changes in blood cyanide concentration under storage in a refrigerator [13]. In a frozen state, blood cyanide seems very stable. Under storage at room temperature, cyanmethemoglobin is decomposed by the actions of denaturation, dissolution and putrefaction; therefore, there is a possibility of change in cyanide level in blood. The cyanide production by putrefaction should be also considered. The *in vitro* production

of cyanide can be observed, though it is not so marked; care should be taken for such phenomena.

As postmortem change of cyanide, spontaneous production of cyanide through denaturation blood by heat was reported in a fire death case; the produced level is below the fatal one and does not cause misdiagnosis for cyanide poisoning. When the cyanide-containing blood is heated strongly, the cyanide level is decreased [14].

The present method is applicable to any specimen other than blood, such as body fluids and organs (after homogenization). It is also applicable to non-biological specimens, such as drinks and foods in adulteration incidents. In such cases, care should be taken for the presence of nitrous acid in the specimen; nitrous acid can react with organic compounds in specimens to produce cyanide non-specifically. In the presence of an oxidant, such as hydrogen peroxide, thiocyanic acid contained in drinks or foods can be oxidized to yield cyanide. When a large amount of oxidant is present in them, it is difficult to suppress oxidative production of cyanide by adding ascorbic acid; it gives false-positive results for cyanide [12]. When the effects of an oxidant are suspected, 1 M sodium acetate buffer (pH 5) should be used in place of sulfuric acid in the microdiffusion procedure to avoid artificial production of cyanide.

## Determination of blood cyanide by headspace-GC

---

### Reagents and their preparation

- Concentrated phosphoric acid (85 %, w/v) is diluted 1.7-fold with distilled water (50 %, w/v, preservable at room temperature).
- A 1.76 g aliquot of *L*-ascorbic acid is dissolved in distilled water to prepare 10 mL solution (1 M, preservable in a refrigerator).
- A 25.1 mg aliquot of potassium cyanide (analytical grade, designated by the Poisonous and Deleterious Substances Control Law) is dissolved in distilled water to prepare 10 mL solution (cyanide ion 1 mg/mL, preservable for a week in a refrigerator). The cyanide solution is diluted 200-fold with distilled water just before use (5 µg/mL).

### GC conditions

GC column<sup>h</sup>: a porous polymer-type fused silica wide-bore capillary column (HP PLOT Q, 30 m × 0.53 mm i. d., film thickness 0.25 µm, Agilent Technologies, Palo Alto, CA, USA).

GC conditions: an HP 6890 Series gas chromatograph (Agilent Technologies): injection mode: split; split ratio: 5; injection temperature: 200°C; detector: NPD; detector temperature: 250°C; carrier gas: He; its flow rate: 5 mL/min; column temperature: 120°C

### Procedure

- i. A 0.5 mL volume of a specimen (blood), 0.03 mL of 1 M ascorbic acid solution and 0.27 mL distilled water are placed in a glass vial with a screw cap (8 mL volume, external diameter

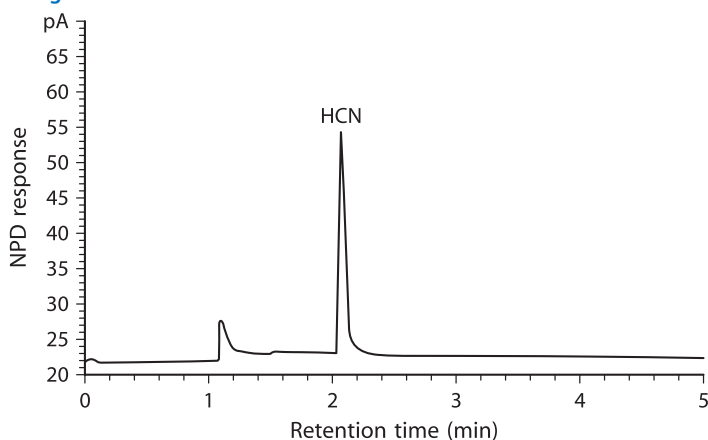
- 17 mm, height 6 cm, GL Sciences, Tokyo, Japan or other manufacturers) and capped airtightly using a Tuf-Bond™ disc (PTFE/silicone septum)<sup>l</sup>.
- ii. A 0.2 mL volume of 50 % phosphoric acid solution is drawn into a tuberculin glass syringe attached with a 25 G × 1" needle (0.50 × 25 mm, Terumo, Tokyo, Japan), injected into the vial and heated at 50° C for 30 min for headspace extraction of cyanide. In this case, the vial is put on an aluminum block (type D) heater (Reacti-Therm, GL Sciences), and the top of the vial is covered with cotton<sup>l</sup> upon heating.
  - iii. A 0.5 mL volume of the headspace vapor is drawn into a clean tuberculin glass syringe attached with a 25 G × 1" needle<sup>k,l</sup> (0.50 × 25 mm, Terumo) and injected into GC immediately.
  - iv. Calculation: the external calibration method is employed; each of various concentrations of cyanide together with 0.5 ml each of blank blood, ascorbic acid solution and distilled water is placed in a vial, and the following procedure is same as described above. A calibration curve is constructed with cyanide concentration on the horizontal axis and peak area on the vertical axis<sup>m</sup>. The final volume of the solution mixture in the vial is 1.0 mL. Since a low level of endogenous cyanide is detected in the blank test, the cyanide peak areas obtained after subtracting the blank area are used for constructing the calibration curve. The cyanide concentration in a specimen can be easily calculated using the curve.

## Assessment and some comments on the method

► *Figure 3.4* shows a GC chromatogram obtained from blood containing 200 ng/mL cyanide ion. Except the big peak of HCN (retention time, 2.1 min), small peaks due to alkyl nitrile compounds, such as acetonitrile (retention time, 5.7 min) can be detected. The detection limit is about 1 ng/mL with low split ratios, enabling measurements of endogenous cyanide in blood.

Darr et al. [15] first reported analysis of cyanide in blood by headspace GC using a column packed with a porous polymer packing material Porapak Q and an FTD ( flame thermionic

■ **Figure 3.4**



GC chromatogram for HCN extracted from a blood specimen containing 200 ng/mL of cyanide by the headspace method [20].

detector, the same as an NPD) with a detection limit of 50 ng/mL. In GC with such a packed column, the resolution ability is frequently lowered by interference of volatile components contained in biomedical specimens; to solve this problem, tedious aging of the packed column at a high temperature is required after each measurement. A fused-silica capillary column with a similar porous polymer is resistant to degradation and enable repeated measurements without aging of the column. As headspace-GC analysis for HCN, the methods using a chlorination pre-column and an ECD [16] and using SPME [17] were reported. In addition, a sensitive headspace-GC method using a cryogenic oven trapping device was also reported [18]. The partition coefficient for HCN between aqueous and gas phases (at 50° C) is 76 [19], showing relatively low concentrations of HCN detectable in the headspace vapor. The toxic and fatal concentrations of cyanide in blood are several  $\mu\text{g}/\text{mL}$  or less. Therefore, a sensitive detector is required for analysis of cyanide in biomedical specimens [20]. Although toxic levels of cyanide in blood can be detected by GC with an FID, the test peak is usually interfered with by acetaldehyde [19]; the use of an NPD, an ECD (after halogenation) and mass spectrometry gives satisfactory results.

## Toxic and fatal concentrations

---

The fatal concentrations of cyanide in blood were reported to be not lower than 3 [21] to 5  $\mu\text{g}/\text{mL}$  [22]. In the acute poisoning by cyanide, the absorbed cyanide exists in blood plasma and is transported to vital organs (such as the respiratory center of the central nervous system) to exert its toxicity. According to time intervals, cyanide in plasma passes through erythrocyte membranes to be bound with methemoglobin and stays there in a relatively stable form. The hemoglobin concentration in blood is as high as 12–16%. Even if only one percent of the total hemoglobin is assumed to be present in the oxidized form (methemoglobin), entire amounts of cyanide present in blood at fatal levels can be trapped by methemoglobin. In blood plasma, cyanide is relatively unstable and disappears by absorption into erythrocytes or by being bound with proteins irreversibly. Theoretically, cyanide existing in blood plasma is directly related with its toxicity. However, a majority of cyanide being measured by the present methods does exist in a bound form with methemoglobin; further consideration about the relationship between blood cyanide concentration and its toxicity seems to be required.

The toxic concentrations in blood cyanide was reported to be 0.1–0.2  $\mu\text{g}/\text{mL}$  [22]. However, in this report, the interference by thiocyanic acid cannot be excluded; the values should be reexamined.

## Notes

- a) A reagent mixture Cyanoline Blue<sup>®</sup> is commercially available from Dojindo Laboratories (Kumamoto, Japan). The pyridine-pyrazolone reagent can be simply prepared only by dissolving 0.27 g of the above mixture in 20 mL pyridine, followed by addition of 100 mL distilled water.
- b) The extra-pure reagent contains almost 100 % potassium cyanide; however, it degrades during a long storage (*e.g.*, absorption of carbonic acid). When such a possibility arises, the potassium cyanide solution prepared should be titrated with silver nitrate aqueous solution using *p*-dimethylaminobenzylidenerhodanine as an indicator [1, 3].

- c) In an emergent case, the diffusion procedure can be done in an incubator at 37° C. A quantitative extraction of cyanide from the acidic specimen into the alkaline absorbent solution can be achieved only in 15 min [23].
- d) Also in an emergent case, the coloration procedure can be also shortened by incubating the reaction mixture at 37° C in an incubator for only 15 min [23].
- e) Since a 1 mL aliquot of 2 mL alkaline absorbent solution is used, the value obtained using the external calibration curve should be doubled.
- f) As a halogenating reagent, hypochlorite and bromine solution can be used except chloramine T.
- g) Except the pyridine-pyrazolone reagent, pyridine-barbituric acid and 4-pyridinecarboxylic acid-pyrazolone reagents were developed as coloration reagents and are being practically used.
- h) The porous polymer-type fused silica capillary columns are suitable for analysis of HCN. Except the HP PLOT Q column, the GS-Q column (wide-bore, J&W) is also being used [19].
- i) Cyanide gas does not usually adsorb to the surfaces of glassware and rubber strongly. Although lipophilic volatile compounds are sometimes absorbed to the septa made of butyl rubber, the cyanide gas gives no problems even with such rubber septa.
- j) During heating the vial at 50° C, the water vapor is aggregated on the septum surface to form water droplets, because of lower temperature on the top of the vial; cyanide gas can be absorbed into the water droplets, resulting in high concentration of cyanide in them, because the partition coefficient of cyanide between gas and aqueous phases is as high as 76 [19]. If the needle of a syringe touches the water droplets containing high concentrations of cyanide, serious contamination of the syringe by cyanide can occur. To avoid the formation of water droplets, the top of the vial should not be cooled, but heated at the same temperature by covering it with cotton.
- k) The diameter of syringe needle is smaller the better, because the damage is less with a smaller needle diameter. With use of a larger-diameter needle of a gastight syringe, the septum is damaged, resulting in leakage of gas after injection several times only.
- l) The glass syringe can be also heated by putting it on the aluminum block heater together with the glass vials to avoid the adsorption of water vapor together with cyanide gas to the syringe.
- m) The calibration curve shows linearity from the detection limit up to about 100 µg/mL. The concentration in a specimen should be within the concentration range of the calibration curve. Usually, a calibration curve with a concentration range of 0–5 µg/mL is prepared for blood specimens.

## References

- 1) Japanese Industrial Standards (1999): 38. Cyanide compounds (JIS K 0102–1998), The test methods for factory waste water. JIS Handbook for Environmental Analysis. Japanese Industrial Standards, Tokyo, pp 1189–1195 (in Japanese)
- 2) Nonomura M (1992) Advance in quantitative methods of cyanide in water. *Kogyoyosui* 401:12–25 (in Japanese)
- 3) The Pharmaceutical Society of Japan (ed) (2000) Cyanide compounds. *Methods of Analysis in Health Science 2000*. Kanehara Shuppan, Tokyo, pp 241–245, 719–720, 853–856, 1062–1063 (in Japanese)

- 4) The Pharmaceutical Society of Japan (ed) (1992) *Standard Methods of Chemical Analysis in Poisoning*, 4th edn. Nanzando, Tokyo, pp 75–83 (in Japanese)
- 5) Maseda C, Fukui Y (1992) Forensic aspects of cyanide analysis. *Jpn J Forensic Toxicol* 10:2–8 (in Japanese with an English abstract)
- 6) Bark LS, Higson HG (1963) A review of the methods available for the detection and determination of small amounts of cyanide. *Analyst* 88:751–760
- 7) Guatelli MA (1964) The toxicology of cyanides. In: Curry AS (ed) *Methods of Forensic Science*, Vol. 3. Interscience Publications, London, pp 233–265
- 8) Department of Legal Medicine, Hiroshima University School of Medicine (ed) (2001) *Cyanide compounds. Simple Analytical Methods for Drugs and Poison – Color Reaction Tests*. Jiho Inc., Tokyo, pp 3–20 (in Japanese)
- 9) Tsuge K, Kataoka M, Seto Y (2000) Cyanide and thiocyanate levels in blood and saliva on healthy adult volunteers. *J Health Sci* 46:343–350
- 10) Epstein J (1947) Estimation of microquantities of cyanide. *Anal Chem*. 19:272–274
- 11) Seto Y (1996) Determination of physiological levels of blood cyanide without interference by thiocyanate. *Jpn J Toxicol Environ Health* 42:319–325
- 12) Seto Y (1995) Oxidative conversion of thiocyanate to cyanide by oxyhemoglobin during acid denaturation. *Arch Biochem Biophys* 321:245–254
- 13) Ballantine B (1976) Changes in blood cyanide as a function of storage time and temperature. *J Forensic Sci Soc* 16:305–310
- 14) Seto Y (1996) Stability and spontaneous production of blood cyanide during heating. *J Forensic Sci* 41, 465–468
- 15) Darr RW, Capson TL, Hileman FD (1980) Determination of hydrogen cyanide in blood using gas chromatography with alkaline thermionic detection. *Anal Chem* 52, 1379–1381
- 16) Maseda C, Matsubara K, Shiono H (1989) Improved gas chromatography with electron-capture detection using reaction pre-column for the determination of blood cyanide: an higher content in the left ventricle of fire victims. *J Chromatogr* 490:319–327
- 17) Takekawa K, Oya M, Kido A et al. (1998) Analysis of cyanide in blood by headspace solid-phase microextraction. SPME and capillary gas chromatography. *Chromatographia* 47:209–214
- 18) Ishii A, Seno H, Watanabe-Suzuki K et al. (1998) Determination of cyanide in whole blood by capillary gas chromatography with cryogenic oven trapping. *Anal Chem* 70:4873–4876
- 19) Seto Y, Tsunoda N, Ohta H et al. (1993) Determination of blood cyanide by headspace gas chromatography with nitrogen-phosphorus detection and using a megabore capillary column. *Anal Chim Acta* 276:247–259
- 20) Seto Y, Kataoka M (2001) Dependence of detection sensitivity of volatile substances on physicochemical properties and analytical conditions in headspace gas chromatography. *Jpn J Forensic Toxicol* 19:218–227
- 21) Kaplan HL, Grand AF, Hartzell GE (1984) Toxicity and the smoke problem. *Fire Safety J* 7:11–23
- 22) Stead AH, Moffat AC (1983) A collection of therapeutic, toxic and fatal blood drug concentrations in man. *Hum Toxicol* 3:437–464
- 23) Tsuge K, Kataoka M, Seto Y (2001) Rapid determination of cyanide and azide in beverages by microdiffusion spectrophotometric method. *J Anal Toxicol* 25:228–236



## II.1.4 Methanol and formic acid

by Xiao-Pen Lee and Keizo Sato

### Introduction

Methanol (methyl alcohol) poisoning accidents take place most frequently by drinking it in mistake for ethanol. Methanol poisoning is not due to the effect of methanol itself, but due to toxicity of its metabolites. Methanol is rapidly absorbed into human body through the airway mucous membranes, digestive tract mucous membranes or the skin; it is metabolized into formaldehyde (formalin, HCHO) and then formic acid (HCOOH) by the actions of alcohol dehydrogenase and aldehyde dehydrogenase, respectively. Formic acid inhibits cytochrome oxidase in the optic nerves, and causes visual disturbances followed by the loss of eyesight. The accumulation of formic acid in the body provokes severe acidosis, which is characteristic for methanol poisoning. The metabolic (oxidation) velocity for methanol is about 5–10 times slower than that for ethanol. This is the reason why the poisoning symptoms do not appear soon after its ingestion, but appear after a while. Formic acid can be detected from urine for about one week after methanol ingestion. It is possible to diagnose methanol poisoning by detecting methanol and/or formic acid from blood and urine specimens.

For analysis of methanol and formic acid, GC methods with packed columns were employed [1–5]. In this chapter, GC methods for analysis of them in blood and urine using a wide-bore capillary column and using solid-phase microextraction (SPME) [6–9] are presented.

### Analysis of methanol

---

#### Reagents and their preparation (in common with both wide-bore capillary GC and headspace SPME-GC)

- Methanol standard solution: a 0.127 mL volume of methanol of special grade is dissolved in 100 mL distilled water to prepare 1 mg/mL solution.
- Internal standard (IS) solution: a 0.128 mL volume of acetonitrile of special grade is dissolved in 100 mL distilled water to prepare 1 mg/mL solution.

#### Conditions for wide-bore capillary GC

Column: an Rtx-BAC2 wide-bore capillary column (30 m × 0.53 mm i.d., film thickness 2.0 μm, Restek, Bellefonte, PA, USA).

GC conditions: a Shimadzu GC-14B gas chromatograph (Shimadzu Corp., Kyoto, Japan) with an FID was used. Column (oven) temperature: 30°C (1 min) → 20°C/min → 210°C; injection and detector temperature: 240°C; carrier gas: He; its flow rate: 5.0 mL/min.

## Procedure for wide-bore capillary GC

- i. A 0.5 mL volume of whole blood, 80  $\mu\text{L}$  of IS solution, 0.5 mL of distilled water and 0.6 g of solid ammonium sulfate<sup>a</sup> are placed in a 4 mL volume glass vial, capped with a silicon-septum cap and mixed well.
- ii. The vial is heated at 60°C on an aluminum block heater with stirring with a small Teflon-coated magnetic bar<sup>b</sup>. After 15 min of heating, about 0.6 mL volume of the headspace vapor is drawn into a gas-tight syringe<sup>c</sup>. Just after the vapor volume in the syringe is adjusted to 0.3 mL<sup>d</sup> by pushing the plunger slowly, it is rapidly injected into GC.
- iii. Quantitation: various concentrations of methanol and 80  $\mu\text{L}$  of IS solution are spiked to vials containing 0.5 mL blank whole blood, 0.5 mL distilled water and 0.6 g ammonium sulfate each, followed by the above procedure, to make a calibration curve with methanol concentration on the horizontal axis and with peak areas ratio of methanol to IS on the vertical axis. Using the calibration curve, methanol concentrations in specimens can be calculated<sup>e</sup>.

## Conditions for headspace SPME-GC

Column: a Supelcowax 10 medium-bore capillary column (30 m  $\times$  0.25 mm i.d., film thickness 0.25  $\mu\text{m}$ , Supelco, Bellefonte, PA, USA)

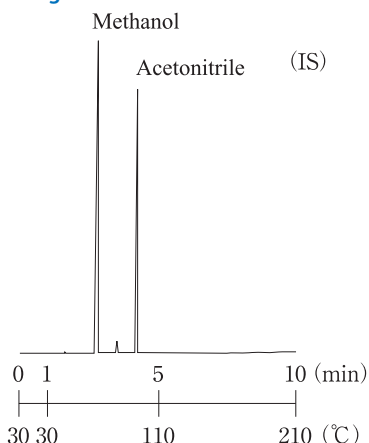
SPME devices and fibers<sup>f</sup>: 75  $\mu\text{m}$  Carboxen/polydimethylsiloxane fibers (both from Supelco)

GC conditions [9]: the same GC instrument with an FID as above was used. Column (oven) temperature: 35°C (6 min)  $\rightarrow$  20°C/min  $\rightarrow$  135°C; injection port<sup>g</sup> and detector temperature: 280°C; carrier gas: He; its flow rate: 0.7 mL/min. Injection is made in the splitless mode upon inserting the SPME fiber<sup>h</sup>; it is changed to the split mode after 90 s.

## Procedure for headspace SPME-GC

- i. A 0.5 mL volume of whole blood or urine, 2  $\mu\text{L}$  of IS solution, 0.5 mL of distilled water and 0.6 g of ammonium sulfate are placed in a 4 mL volume glass vial, capped with a silicone-septum cap and mixed well.
- ii. The vial is heated at 60°C on an aluminum block heater with stirring with a small Teflon-coated magnetic bar. After 5 min of heating, the holder needle of SPME is inserted into the vial through the septum, and the SPME fiber is exposed to the headspace vapor and kept there with stirring and heating at 60°C for 10 min.
- iii. After the exposure, the fiber is withdrawn into the needle, and the needle of the syringe is taken out of the vial and immediately injected into the GC port to expose the fiber in it.
- iv. Quantitation: to vials containing the above components each, one of various amounts of methanol and 2  $\mu\text{L}$  of IS were added and processed as above to construct a calibration curve for quantitation<sup>i</sup>.

Figure 4.1



Detection of methanol from human blood by wide-bore capillary GC. To 0.5 mL blank blood, 400  $\mu\text{g}$  methanol and 80  $\mu\text{g}$  IS had been added.

## Assessment of both methods

Figure 4.1 shows a wide-bore capillary gas chromatogram obtained from 0.5 mL whole blood, to which 400  $\mu\text{g}$  methanol and 80  $\mu\text{g}$  acetoneitrile (IS) had been added. Excellent peaks of methanol and IS appeared at different retention times within 5 min; a few small background impurity peaks appeared. The extraction efficiency (recovery) of methanol spiked was 0.29%. Good linearity was found in the range of 50–500  $\mu\text{g}/0.5$  mL. The detection limit was about 10  $\mu\text{g}/0.5$  mL.

Figure 4.2 shows a headspace SPME-gas chromatogram obtained for 0.5 mL whole blood, to which 200  $\mu\text{g}$  methanol and 2  $\mu\text{g}$  of IS had been added. Both peaks were separated well and appeared within 10 min. The extraction efficiencies (recoveries)<sup>j</sup> were 0.25 % for whole blood and 0.38 % for urine. The calibration curve showed good linearity in the range of 1.56–800  $\mu\text{g}/0.5$  mL for both whole blood and urine specimens. The detection limits were 0.5  $\mu\text{g}/0.5$  mL for whole blood and 0.1  $\mu\text{g}/0.5$  mL for urine.

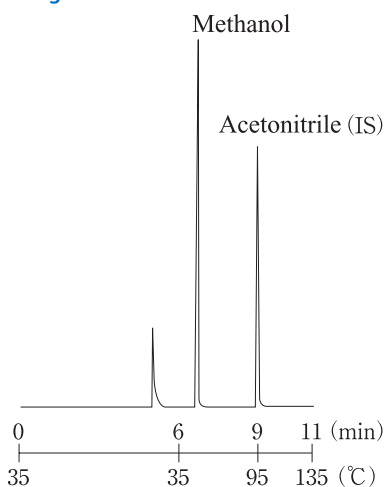
## Analysis of formic acid

Formic acid cannot be analyzed by GC in its underivatized form; it should be esterified [10] prior to the analysis. Usually, formic acid is methylated to be detected as formic acid methyl ester.

### Reagents and their preparation (in common with both methods)

- IS: a 0.128 mL volume of acetonitrile of special grade is dissolved in 100 mL distilled water to prepare 1 mg/mL solution.

■ Figure 4.2



**Detection of methanol from human blood by headspace SPME-GC.** To 0.5 mL blank blood, 200  $\mu\text{g}$  methanol and 2  $\mu\text{g}$  IS had been added.

- Methanol: reagent of special grade.
- Sodium formate: 10 mg of sodium formate of special grade is dissolved in 10 mL water to prepare 1 mg/mL solution.
- Concentrated sulfuric acid: reagent of special grade containing 98 % of the compound.

### Conditions for wide-bore capillary GC

Column: the same column as used in the methanol analysis (Rtx-BAC2 wide-bore capillary column).

GC conditions: the same GC instrument with an FID was used. Column (oven) temperature: 30°C (2 min)  $\rightarrow$  5°C/min  $\rightarrow$  100°C; injection and detector temperature: 240°C; carrier gas: He; its flow rate: 5.0 mL/min.

### Procedure for wide-bore capillary GC

- A 0.5 mL volume of whole blood and 500  $\mu\text{L}$  IS solution are placed in a 7.5 mL volume glass vial; to the mixture, 0.3 mL of concentrated sulfuric acid is gradually added and mixed well under cooling with ice<sup>k</sup>. After cooling the vial with ice, 25  $\mu\text{L}$  (corresponding to 20 mg) of methanol and 0.2 mL distilled water are added to the above mixture, rapidly capped with a silicone-septum cap and mixed well.
- The vial is incubated at 35°C for 15 min with mixing gently several times. After the incubation, about 0.6 mL of the headspace vapor is drawn into a gastight syringe and the volume is adjusted to 0.3 mL, which is rapidly injected into GC for analysis.

- iii. Quantitation: to vials containing 0.5 mL of blank whole blood and 500  $\mu\text{L}$  of IS solution each, various amounts of sodium formate<sup>1</sup> were added, followed by the procedure described above to construct a calibration curve with peak area ratio of formic acid to IS on the vertical axis for quantitation.

## Conditions for headspace SPME-GC

Column: the same Supelcowax 10 medium-bore capillary column as used in the methanol analysis.

SPME devices and fibers: the same ones as used for methanol analysis.

GC conditions [9]: the same GC instrument with an FID as used above was used. Column (oven) temperature: 30°C (3 min)  $\rightarrow$  25°C/min  $\rightarrow$  105°C  $\rightarrow$  10°C/min  $\rightarrow$  145°C; injection and detector temperature: 280°C; carrier gas: He; its flow rate: 0.7 mL/min. The SPME fiber is injected into GC in the splitless mode and the splitter is opened after 90 s.

## Procedure for headspace SPME-GC

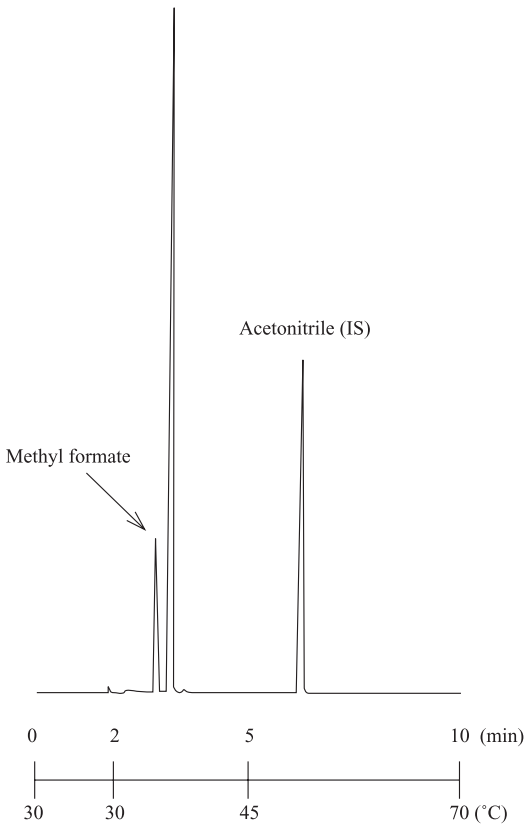
- i. A 0.5 mL volume of whole blood or urine and 20  $\mu\text{L}$  of IS solution are placed in a 7.5 mL volume glass vial; to the mixture, 0.3 mL of concentrated sulfuric acid is gradually added and mixed well under cooling with ice. After cooling the vial, 25  $\mu\text{L}$  (corresponding to 20 mg) of methanol<sup>m</sup> and 0.2 mL distilled water are added to the above mixture, capped with a silicone-septum cap and mixed well.
- ii. The vial is incubated at 35°C for 5 min on an aluminum block heater. Then, the needle of the SPME holder is inserted into the vial through the septum, and the SPME fiber is exposed to the headspace vapor and kept there with stirring and warming at 35°C for 10 min.
- iii. After the exposure, the fiber is withdrawn into the needle and taken out of the vial; it is immediately injected into GC to expose the fiber to the carrier gas at high temperature for GC analysis. The quantitation is made in the same manner as described above.

## Assessment of both methods

► *Figure 4.3* shows a wide-bore capillary gas chromatogram obtained from 0.5 mL of blank whole blood, to which 400  $\mu\text{g}$  formic acid and 500  $\mu\text{g}$  acetonitrile (IS) had been added, using an Rtx-BAC2 wide-bore column. Excellent peaks of methyl formate and IS appeared; however the former peak was close to but separable from the big methanol peak, which had been used for esterification. The background was clean except for the methanol peak. The extraction efficiency (recovery) of formic acid spiked was 0.33 %. The calibration curve showed good linearity in the range of 50–500  $\mu\text{g}$  (in the form of free formic acid)/0.5 mL. The detection limit was 15  $\mu\text{g}$ /0.5 mL.

► *Figure 4.4* shows a headspace SPME-gas chromatogram obtained from 0.5 mL blank whole blood, to which 54  $\mu\text{g}$  of formic acid and 20  $\mu\text{g}$  of acetonitrile (IS) had been added, using a Supelcowax 10 medium-bore capillary column. The peaks of methyl formate and IS appeared as big peaks; but some impurity peaks were observed in the background. The extraction effi-

■ Figure 4.3



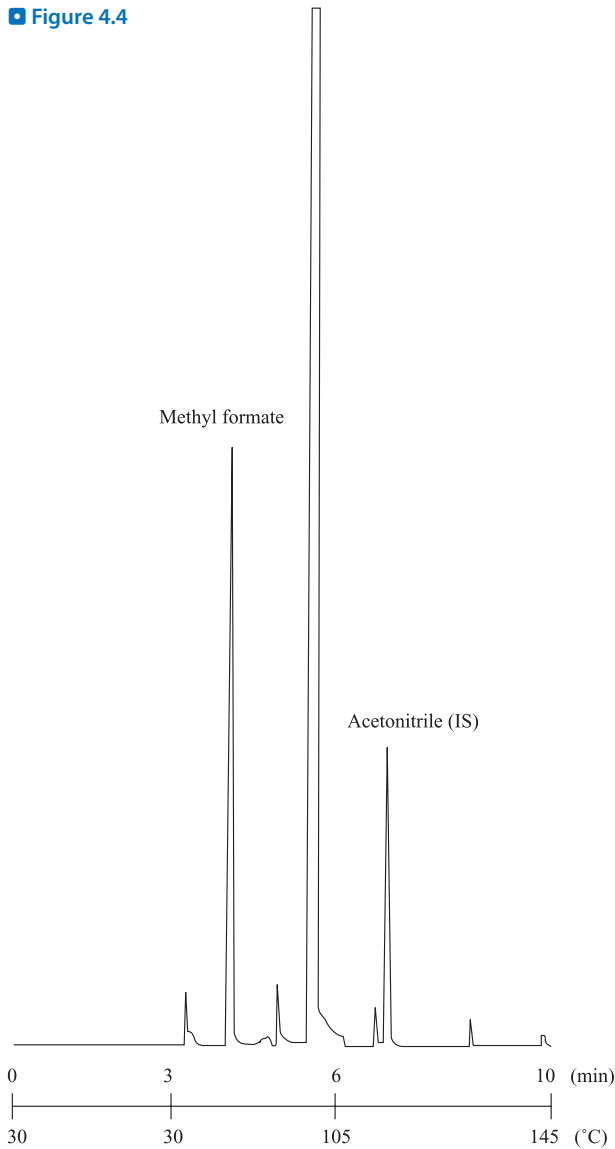
**Detection of formic acid from human blood by wide-bore capillary GC.** To 0.5 mL blank blood, 600  $\mu\text{g}$  sodium formate (equal to 400  $\mu\text{g}$  formic acid) and 500  $\mu\text{g}$  IS had been added. The big peak appearing at 3.2 min of retention time is due to methanol, which had been added for methylation reaction of formic acid.

iciencies (recoveries) of formic acid were 1.55 % for whole blood and 1.24 % for urine. The calibration curve showed good linearity in the range of 1.56–500  $\mu\text{g}$  (in the form of free formic acid)/0.5 mL for both whole blood and urine specimens. The detection limit was 0.6  $\mu\text{g}/0.5$  mL for both specimens.

## Poisoning cases, and toxic and fatal concentrations

Poisoning doses of methanol varies markedly according to different individuals. However, it is considered that the intake of 10–20 mL methanol causes severe visual disturbance or the loss of eyesight; the fatal dose is 30–100 mL [11]. Blood methanol concentrations of surviving poisoned patients were reported to be not lower than 100  $\mu\text{g}/\text{mL}$  [11]; those in fatal poisoning cases 200–3,200  $\mu\text{g}/\text{mL}$  [4, 11, 12]. When blood concentration is more than 4 mg/mL, the victim dies of anaesthetic paralysis.

■ Figure 4.4



**Detection of formic acid from human blood by headspace SPME-GC. To 0.5 mL blank blood, 80 µg sodium formate (equal to 54 µg formic acid) and 20 µg IS had been added. The big peak appearing at 5.7 min is due to methanol, which had been used for methylation of formic acid.**

The acute methanol poisoning symptoms are vertigo, debility feeling, headache, nausea, vomiting and others; in rare cases, visual disturbance appears at an early stage. These symptoms usually appear 12–24 h after the ingestion, but in severe cases they can appear in about 1 h after the intake. The symptoms of its chronic poisoning are considered to appear by inhalation of methanol gas for a long time, extensive contact of the skin with methanol or continuous in-

gestion of its small amounts; they are disturbances of the central nervous system, liver and eyes.

In the Vodka (disclosed to be the mixture of methanol and water later) Smuggling Incident taking place in Iran, 1975, fifty seven people fell into methanol poisoning; among them, two lost their eyesight and 17 died. The methanol concentrations in heart blood obtained at autopsies were 230–2,680  $\mu\text{g}/\text{mL}$  (average 1,205  $\mu\text{g}/\text{mL}$ ) [12]. In Japan, 8 correspondences about methanol poisoning were received by Japan Poison Information Center in 2000.

The toxicity of formic acid, a metabolite of methanol, is very high and induces blindness and acidosis. The concentration of formic acid in blood in methanol poisoning cases were reported to be 90–2,270  $\mu\text{g}/\text{mL}$  [13, 14].

## Notes

- a) The addition of ammonium sulfate to the mixture is effective to increase the extraction efficiency by the salting-out effect.
- b) The use of a stirrer is effective for shortening the time of the headspace extraction; heating at 60 °C is also effective to enhance the extraction efficiency.
- c) The septum of a vial made of silicone/Teflon sometimes causes leakage of headspace gas, when a usual needle of a gastight syringe is inserted into the vial through the septum. To prevent such leakage, the authors are using 23 G needles with a 90 cut at their tips. When the needle of the syringe is pulled out of the vial, care should be taken not to aspirate atmospheric air into the syringe.
- d) The internal standard calibration method is employed. At least 5–6 concentrations of methanol are plotted to confirm the linearity of the curve.
- e) The SPME method is a new extraction technique developed by Pawliszyn et al. [15] of Waterloo University of Canada in 1990. It has been being used mainly for analysis of environmental pollutants in water; it is also being applied in the field of forensic toxicology nowadays [6–8, 16–21]. The advantages of SPME are that it does not require any organic solvent and that the extraction, condensation and injection into GC can be achieved with one-step procedure. Especially in the headspace SPME, the impurity peaks appearing in a GC chromatogram is very few. Therefore, SPME seems very useful for analysis of drugs and poisons in forensic toxicology.
- f) On the surface of an SPME fiber, a liquid phase or an adsorbent material of 7–100  $\mu\text{m}$  thickness is coated. A drug or a poison is extracted into the coating. The polarity and retention capacity is dependent on the material of a coating and its thickness. [▶ Table 4.1](#) summarizes SPME fibers now commercially available. The most suitable fiber should be selected empirically and theoretically for each compound to be analyzed.
- g) The SPME fibers should be pre-conditioned (aging at a high temperature for a certain interval) for new fibers or ones, which were not used for a long period. To protect a fiber from contamination, the needle tip of SPME should be capped by sticking it into a GC port septum.
- h) When a needle of SPME is injected into an injection port of GC to expose the fiber, it does not produce a large volume of gas and thus does not need a large space of injection chamber; this is quite different from usual GC analysis with an organic solvent injection. Especially for volatile compounds extracted by SPME, a large space of an injection chamber



**Table 4.1**  
Various kinds of SPME fibers commercially available and their characteristics\*

Fiber	Use	Film thickness	Liquid phase	Adsorbent coexisting	Polarity	Analyte example(s)
PDMS	GC, HPLC	7 µm, 30 µm, 100 µm	O	-	Low	Hydrophobic compounds
DVB/PDMS	GC, HPLC	65 µm (GC), 60 µm (LC)	-	Porous polymer	Intermediate/low	Amines with short chains
StableFlex DVB/PDMS	GC	65 µm	-	Porous polymer	Intermediate/low	Low molecules Intermediately to highly polar compounds
Polyacrylate	GC, HPLC	85 µm	O	-	Intermediate	Polar compounds with intermediate boiling points
Carboxen/PDMS	GC	75 µm	-	Carbon type	Low/low	Gas Compounds with low boiling points
StableFlex DVB/Carboxen/PDMS	GC	50/30 µm	-	Carbon type/polymer	Low/intermediate/low	Nasty smell of water
Carbowax/DVB	GC	65 µm	-	Porous polymer	High/intermediate	Organic solvents with intermediate boiling points
Carbowax/TPR	HPLC	50 µm	-	Porous polymer	High/high	Surfactants

PDMS: polydimethylsiloxane; DVB: divinylbenzene; TPR, template resin.

\* Cited with modification from a catalog book of Supelco entitled "2001 Chromatography Products: Sample Handling".

is not desirable, because it causes broadening of peaks in GC chromatograms. Therefore, when the SPME method is used, a glass insert liner tube with a small internal diameter (0.5–0.8 mm) should be used to get a sharp peak of a target compound; this results in the better S/N ratio, sensitivity and quantitiveness.

- i) The SPME is very suitable for splitless injection, because it does not produce a large volume of gas; the analyte is rapidly desorbed from the fiber and introduced into a capillary column.
- j) The internal standard calibration method is also employed for the SPME-GC analysis. The linearity of the calibration curve should be confirmed using at least 5–6 plots at different concentrations of methanol. On this occasion, a single fiber should be repeatedly used (including the construction of a calibration curve) in a set of experiments to avoid the variation of data due to a different lot of a fiber.
- k) Although the extraction efficiency (recovery) of the headspace SPME is usually low, the entire amounts of methanol and IS adsorbed to the fiber can be introduced into a column. This results in relatively high sensitivity of the SPME-GC analysis.
- l) For esterification of formic acid, the action of concentrated sulfuric acid is required. Upon addition of the acid to an aqueous mixture, heat is produced. Therefore, the gradual mixing of sulfuric acid should be made under cooling with ice.

Formic acid exists in a liquid form, which is relatively inconvenient for handling. Therefore, solid sodium formate can be used in place of free formic acid. Upon quantitation, the values should be calculated to those of the free formic acid.

- m) To achieve esterification of formic acid completely, an excess amount of methanol should be added for the reaction. However, the addition of a large amount methanol can badly affect the partition coefficient of methyl formate on the surface of the SPME fiber. Therefore, the minimal amount of methanol meeting the complete reaction should be used. In these experiments, 25  $\mu\text{L}$  (20 mg) methanol was optimal for the present concentration range of formic acid (1.56–500  $\mu\text{g}/0.5\text{ mL}$ ).

In the putrefied blood, in which ethanol has been produced postmortem, ethyl formate can be also produced by the esterification reaction.

## References

- 1) Anthony RM, Sutheimer CA, Sunshine I (1980) Acetaldehyde, methanol, and ethanol analysis by headspace gas chromatography. *J Anal Toxicol* 4:43–45
- 2) Henderson MH (1982) Determination of formic acid in aqueous fermentation broth by head-space gas chromatography. *J Chromatogr* 236:503–507
- 3) Kuo T-L (1982) The effects of ethanol and methanol intoxication I. A simple headspace gas chromatography for the determination of blood formic acid. *Jpn J Legal Med* 36:669–675
- 4) Pla A, Hernandez AF, Gil F et al. (1991) A fatal case of oral ingestion of methanol. Distribution in postmortem tissues and fluids including pericardial fluid and vitreous humor. *Forensic Sci Int* 49:193–196
- 5) Osterloh JD, D'Alessandro A, Chuwers P et al. (1996) Serum concentrations of methanol after inhalation at 200 ppm. *J Occup Environ Med* 38:571–576
- 6) Hall BJ, Brodbelt JS (1997) Determination of barbiturates by solid-phase microextraction – SPME and ion trap gas chromatography-spectrometry. *J Chromatogr A* 777:275–280
- 7) Kumazawa T, Seno H, Lee X-P et al. (1999) Extraction of methylxanthines from human body fluids by solid-phase microextraction. *Anal Chim Acta* 387:53–60
- 8) Kumazawa T, Seno H, Watanabe-Suzuki K et al. (2000) Determination of phenothiazines in human body fluids by solid-phase microextraction and liquid chromatography/tandem mass spectrometry. *J Mass Spectrom* 35:1091–1099

- 9) Lee X-P, Kumazawa T, Kondo K et al. (1999) Analysis of methanol or formic acid in body fluids by headspace solid-phase microextraction and capillary gas chromatography. *J Chromatogr B* 734:155–162
- 10) Abolin C, McRae JD, Tozer TN et al. (1980) Gas chromatographic head-space assay of formic acid as methyl formate in biologic fluids: potential application to methanol poisoning. *Biochem Med* 23:209–218
- 11) Moffat AC, Jackson JV, Moss MS et al. (eds) (1986) *Clark's Isolation and Identification of Drugs*, 2nd edn. Pharmaceutical Press, London, pp 744–745
- 12) Tonkabony SHE (1975) Post-mortem blood concentration of methanol in 17 cases of fatal poisoning from contraband vodka. *Forensic Sci* 6:1–3
- 13) Fraser AD, MacNeil W (1989) Gas chromatographic analysis of methyl formate and application in methanol poisoning cases. *J Anal Toxicol* 13:73–76
- 14) Tanaka E, Honda K, Horiguchi H et al. (1991) Postmortem determination of the biological distribution of formic acid in methanol intoxication. *J Forensic Sci* 36:936–938
- 15) Arthur CL, Pawliszyn W (1990) Solid phase microextraction with thermal desorption using fused silica optical fibers. *Anal Chem* 62:2145–2148
- 16) Kumazawa T, Watanabe K, Sato K et al. (1995) Detection of cocaine in human urine by solid-phase microextraction and capillary gas chromatography with nitrogen-phosphorus detection. *Jpn J Forensic Toxicol* 13:207–210
- 17) Seno H, Kumazawa T, Ishii A et al. (1995) Detection of meperidine (pethidine) in human blood and urine by headspace solid phase microextraction and gas chromatography. *Jpn J Forensic Toxicol* 13:211–215
- 18) Lee X-P, Kumazawa T, Sato K et al. (1996) Detection of organophosphate pesticides in human body fluids by headspace solid-phase microextraction-SPME and capillary gas chromatography with nitrogen-phosphorus detection. *Chromatographia* 42:135–140
- 19) Kumazawa T, Lee X-P, Seno H et al. (1996) Extraction of local anaesthetics in human blood by direct immersion-solid phase micro extraction-SPME. *Chromatographia* 43:59–62
- 20) Lee X-P, Kumazawa T, Sato K et al. (1997) Detection of tricyclic antidepressants in whole blood by headspace solid-phase microextraction and capillary gas chromatography. *J Chromatogr Sci* 35:302–307
- 21) Lord HL, Pawliszyn J (1997) Method optimization for the analysis of amphetamines in urine by solid-phase microextraction. *Anal Chem* 69:3899–3906

## II.1.5 Ethanol

by Kanako Watanabe

### Introduction

Alcohol usually means ethanol/ethyl alcohol. It has a long history for the human being, and gives euphoric effects and sometimes improves the human relationship. In contrast, there are many cases of violence, injuries, homicides and traffic accidents with drinking; close relation can be observed between ethanol and crimes/accidents. When forensic autopsies are performed, ethanol concentrations in blood and urine are routinely measured.

GC analysis of ethanol using the conventional packed columns is described in many of literature [1, 2]. In this chapter, a quantitative method is presented for GC analysis of ethanol in blood and urine using headspace extraction and wide-bore capillary columns; an ultra-sensitive analysis of breath ethanol is also given.

### Determination of ethanol in blood and urine

---

#### Reagents and their preparation

- 10  $\mu\text{L}$  of ethanol is dissolved in 10 mL distilled water (0.1 %, v/v).
- 10  $\mu\text{L}$  of *n*-propanol<sup>a</sup> is dissolved in 10 mL of distilled water (0.1 %, v/v).
- 10  $\mu\text{L}$  of *tert*-butanol (internal standard, IS)<sup>b</sup> is dissolved in 10 mL of distilled water (0.1 %, v/v). All above chemicals can be of reagent grade.

#### GC conditions

GC columns: a DB-1 fused silica wide-bore capillary column (30 m  $\times$  0.53 mm i. d., film thickness 5  $\mu\text{m}$ , J&W Scientific, Folsom, CA, USA), and a Rtx-BAC2 fused silica wide-bore capillary column (30 m  $\times$  0.53 mm i. d., film thickness 2.0  $\mu\text{m}$ , Restek: Bellefonte, PA, USA).

GC conditions [3]: an HP6890 Series gas chromatograph<sup>c</sup> (Agilent Technologies: Palo Alto, CA, USA) equipped with FID.

Conditions for the DB-1 column are:

Column (oven) temperature: 40  $^{\circ}\text{C}$  (isothermal); injection port and detector temperature: 170  $^{\circ}\text{C}$ ; carrier gas: helium; its flow rate: 20 mL/min.

Conditions for the Rtx-BAC2 column are:

Column (oven) temperature: 40  $^{\circ}\text{C}$   $\rightarrow$  5  $^{\circ}\text{C}/\text{min}$   $\rightarrow$  70  $^{\circ}\text{C}$  (5 min)  $\rightarrow$  20  $^{\circ}\text{C}/\text{min}$   $\rightarrow$  280  $^{\circ}\text{C}$ ; injection port and detector temperature: 170  $^{\circ}\text{C}$ ; carrier gas: helium; its flow rate: 5 mL/min.

## Procedure

- i. 0.5 mL of a specimen (whole blood or urine) is placed in a 4 mL volume test tube<sup>d</sup> with a rubber cap, followed by the addition of 0.2 mL IS solution and 0.2 mL distilled water, and sealed with the rubber cap.
- ii. In another test tube (standard solution), 0.5 ml of 0.1 % ethanol, 0.2 mL of IS solution and 0.2 mL of 0.1 % *n*-propanol are placed, and sealed with the rubber cap.
- iii. Both test tubes are heated at 55 °C for 15 min on an aluminum block heater or in a water bath. During the above heating, a glass syringe to be used is also put on the heater to heat it simultaneously; the syringe is a 1 mL volume gas-tight grass syringe with a 23 G needle<sup>e</sup>. After heating, 0.1 mL of the headspace vapor is withdrawn into the syringe and injected to GC swiftly.

Calculation:

$$\text{Ethanol (\%)}^f = 0.1 \times \frac{P(\text{ethanol})_s}{P(\text{IS})_s} \times \frac{P(\text{IS})_{ss}}{P(\text{ethanol})_{ss}}$$

$P(\text{ethanol})_s$  : peak area of ethanol in the specimen

$P(\text{IS})_s$  : peak area of IS in the specimen

$P(\text{ethanol})_{ss}$  : peak area of ethanol in the standard solution

$P(\text{IS})_{ss}$  : peak area of IS in the standard solution.

## Assessment and some comments on the method

► *Figure 5.1* shows gas chromatogram for a whole blood specimen containing 0.1 % ethanol. With the DB-1 column [3], peaks of ethanol and IS appeared at short retention times at 40 °C; the Rtx-BAC2 column [4] had been developed for analysis of ethanol, and gives good shapes of the peak and high sensitivity. The detection limits of the method are 20–50 µg/mL whole blood with the DB-1 wide-bore capillary column, and about 10 µg/mL whole blood with the Rtx-BAC2 wide-bore capillary column. For actual measurements of blood ethanol after drinking, the GC method is sufficiently sensitive with either of the capillary columns, because blood ethanol concentrations in blood after drinking is usually 0.3–0.4 mg/mL.

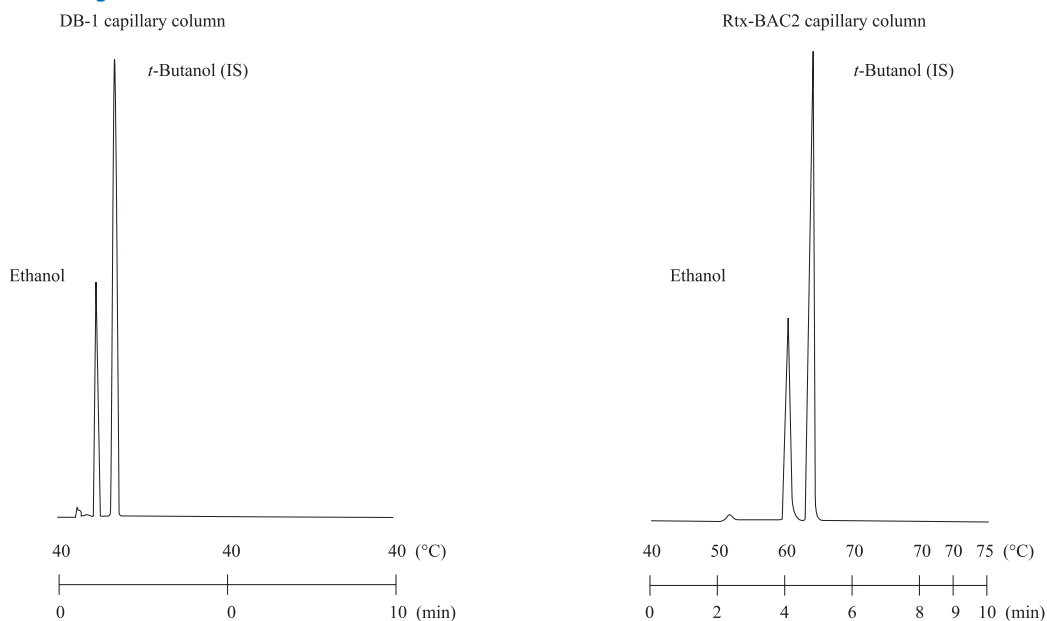
The headspace method for GC analysis of ethanol gives clean background and almost no interfering peaks.

The postmortem production of ethanol<sup>a</sup> due to putrefaction should be kept in mind in case of non-fresh specimens; in such cases the appearance of *n*-propanol is an indicator of the concomitant postmortem production of ethanol. Even without drinking, so-called “endogenous ethanol” is present, which is probably due to food and enteric bacteria; its level was reported to be as low as  $0.180 \pm 0.117$  µg/mL [5], and thus does not interfere with the ethanol determination after drinking.

After fresh blood is sampled into a test tube and sealed with a cap, it can be stored at 4 °C for 1–2 weeks without any change of ethanol levels.

The author et al. set the cutoff level of blood ethanol to be 0.1 mg/mL, considering the postmortem production of ethanol.

Figure 5.1



Detection of blood ethanol by wide-bore capillary GC.

## Toxic and lethal concentrations






















Figure 5.2 shows symptoms of Japanese subjects caused by ethanol according to its blood concentrations [6]. The symptoms shown in the figure only show typical ones; there exist exceptional individuals, who show blood levels of as high as 4 mg/mL, but are not drunk heavily. About 10 % of Japanese population is of homotype of ALD-type 2 for the isozymes of aldehyde dehydrogenase, and thus very weak to ethanol showing various intoxication symptoms even at low blood ethanol levels.

## Determination of breath ethanol

A close relationship exists in ethanol concentration between breath and blood ; the breath concentration is as low as about 2,000 times less than that in blood. Because of its extremely low concentrations, it cannot be measured by the usual capillary GC method described before. When the breath ethanol is measured by the conventional GC with FID, more than 500 mL of the vapor should be passed through a column packed with an adsorbent to collect and concentrate breath ethanol before introducing to GC or GC/MS [7–9]. The apparatus for the above pretreatment is relatively complicated and its handling also requires some training.

A microcomputer controlling cryogenic oven temperature below 0 °C has become widely available for modern types of GC instruments. It was originally designed for rapid cooling of an oven to reduce analysis time. We have used it to trap volatile organic compounds contained in

Figure 5.2

	Stage 0	Stage I	Stage II	Stage III	Stage IV	Stage V
						
(mg/mL)						
BEC	0~0.5	0.5~1.0	1.0~1.5	1.5~2.5	2.5~3.5	3.5~
Sake						
Beer						
Whisky						
Symptoms	Almost no symptoms, slight feverish feeling or slightly lowered senses of taste and smell	Very weakly intoxicated: slight feverish face, relief from suppression of mind, decrease in anxiety and tension, cheerfulness, slight euphoria, delayed reaction	Slightly intoxicated: cheerfulness, talkativeness, boldness, slight paralysis of sense, but normal personality	Intermediately intoxicated: drowsiness, disturbance of sense of equilibrium (stagger), slurred speech, decrease in understanding and judgement ability	Markedly intoxicated: paralysis, inability to walk, pale face, cold sweat, nausea, vomiting, clouding of consciousness	Comatose state and finally death due to paralysis of the respiratory center

### Correlation between blood ethanol concentration and intoxication rate.

gas samples, and named it “cryogenic oven trapping (COT)” [10, 11]. Since the COT system can be attached easily and cheaply (about 1,000 US dollars) to any modern type of GC instruments, we present a sensitive method for determination of breath ethanol by GC using the system.

## Materials and their preparation

- Quantification is made by the external standard calibration method. Each aliquot of ethanol, viz. 3.17, 6.34, 9.51 and 12.7  $\mu\text{L}$ , is added to 10 mL methanol to prepare standard solutions of ethanol. Using a plunger-in-needle syringe<sup>g</sup>, each 0.1  $\mu\text{L}$  aliquot of the standard solutions is injected into GC. The peak areas obtained at 4 concentrations of ethanol are plotted against the amount of ethanol to make a calibration curve; the final amounts of ethanol injected are 25, 50, 75 and 100 ng, respectively.
- Breath ethanol polyethylene bags (about 1 L volume, Komyo-Rikagaku-Kogyo, Tokyo, Japan)<sup>h</sup>

## GC conditions

GC column: an Rtx-BAC2 fused silica wide-bore capillary column (30 m  $\times$  0.53 mm i. d., film thickness 2.0  $\mu\text{m}$ , Restek · Bellefonte, PA, USA)<sup>i</sup>.

COT [11]: a liquid carbon dioxide ( $\text{CO}_2$ ) tank with a siphon steel tube which enables direct introduction of liquid  $\text{CO}_2$  into a GC oven to cool it. An electrically operated solenoid valve

(Agilent Technologies · Palo Alto, CA, USA) controlled by a microcomputer introduces liquid CO<sub>2</sub> at a rate appropriate for cooling of the oven to a temperature desired.

GC conditions: an HP 6890 Series gas chromatograph equipped with FID. Column (oven) temperature: -60 °C (1 min) → 10 °C/min → 40 °C (10 min) → 20 °C/min → 240 °C; injection temperature: 200 °C; detector temperature: 240 °C; carrier gas: helium; its flow rate: 3 mL/min. The breath gas is injected into GC at -60 °C of column (oven) temperature in the splitless mode within 5 seconds, and the splitter is opened after 1 min.

## Procedure

- i. The mouth of a subject is washed well with tap water.
- ii. The breath gas is expired into the above polyethylene bag<sup>h</sup>, and its introduction tube is rapidly sealed with Parafilm.
- iii. A needle<sup>j</sup> of a glass syringe (5 mL volume) is stabbed to the polyethylene bag, and 5 mL gas is withdrawn into the syringe. All of the volume is injected into GC at -60 °C of column (oven) temperature in the splitless mode, and analyzed as above.
- iv. Using the external standard calibration curve, the concentrations expressed as per mL of breath ethanol are easily calculated dividing the value obtained by 5.

## Assessment of the method

► Figure 5.3 shows gas chromatograms of breath gas sampled at 30 and 60 min after drinking 200 mL of common beer [12]. The big peaks of ethanol appear with low background and a few small impurity peaks. After 10 volunteers of both sexes drank 200 mL beer each, the concentration of breath ethanol were  $30.0 \pm 18.1$  ng/mL gas at 30 min and  $15.8 \pm 6.72$  ng/mL gas at 60 min (► Table 5.1). The detection limit of this method is about 1 ng/mL gas.

■ Table 5.1

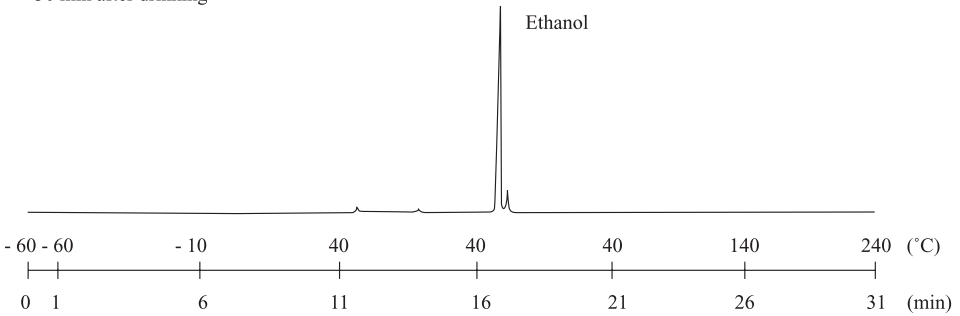
Concentrations of breath ethanol 30 and 60 min after drinking 200 ml beer

Subject (sex, age)	Breath ethanol concentration (ng/mL)	
	30 min	60 min
No. 1 (F, 29)	30.8	19.6
No. 2 (M, 23)	9.62	6.23
No. 3 (F, 23)	73.5	18.0
No. 4 (F, 24)	24.8	13.0
No. 5 (F, 20)	34.0	29.0
No. 6 (M, 24)	18.5	8.94
No. 7 (M, 35)	20.2	10.4
No. 8 (F, 22)	45.2	21.8
No. 9 (M, 23)	19.9	16.3
No. 10 (M, 36)	23.9	14.9
Mean ± SD	$30.0 \pm 18.1$	$15.8 \pm 6.72$

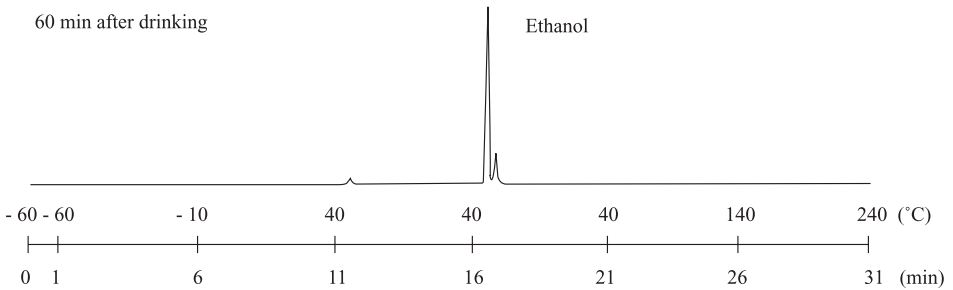


■ **Figure 5.3**

30 min after drinking



60 min after drinking



**Detection of breath ethanol by GC with cryogenic oven trapping. The volunteer drank 200 mL of common beer**

## Notes

- In putrefying specimens, ethanol can be easily produced by the action of bacteria [13]. Together with the postmortem production of ethanol during putrefaction, *n*-propanol is always produced concomitantly. Since *n*-propanol is usually not detectable in fresh human specimens, the presence of *n*-propanol becomes indicative of the postmortem production of ethanol. Therefore the standard solution contains *n*-propanol for reference. The concentration ratio of *n*-propanol to ethanol in putrefied specimens was reported to be about 0.05; the postmortem ethanol concentration may be 20 times as much as that of *n*-propanol. The following equation, therefore, can be postulated.  
Antemortem blood ethanol concentration = postmortem ethanol concentration – *n*-propanol concentration × 20.
- Various alkyl alcohols were used in the literature as IS. *n*-Propanol is produced postmortem; isobutanol coexists with ethanol in many alcoholic beverages, though its concentrations are much lower [14]. *tert*-Butanol seems best as IS, because it does not usually exist in biological specimens.

- c) Every type of gas chromatographs, to which capillary columns can be attached, can be used.
- d) A 5–7 mL screw vial with a Teflon septum cap can be also used. The authors are using cheap test tubes with rubber caps; they give no impurity peaks due to plasticizers.
- e) The syringe needle is cut obliquely; the edges of the tip is very sharp. When this type of needles is used for the headspace extraction, it is often experienced that the needle is obstructed with the septum debris. The authors are using special conical needles, which can be ordered to a manufacturer (Kurita Syringe Needle Manufacturing Co., 5-25-7 Hongo, Bunkyo-ku, Tokyo, Japan). Using this type of needles, the obstruction of the needle and contamination of the injection chamber with the septum debris became not so serious.
- f) The concentrations of ethanol can be expressed as % (percent, v/v), and also as ‰ (permil); 0.1 % = 1 ‰. When it should be expressed as mg/mL, 0.1 % is equal to 0.789 mg/mL, because specific gravity of ethanol at 20 °C is 0.789.
- g) The plunger-in-needle syringe is designed to be used for injecting as small as 0.1 µL of sample solution with high precision. The authors are using the syringe (code No. 0.5BNR-5) obtained from SGE International (Ringwood, Victoria, Australia); the shape of the needle tip is conical.
- h) When the special breath ethanol bags are not available, a usual polyethylene bag can be used instead. The breath is expired into the bag which is knotted immediately, and the following procedure is the same as described before. Since there is possibility of contamination of the air inside by volatile plasticizers leaked from the usual polyethylene bag, it should be checked by GC beforehand.
- i) For cryogenic oven trapping (COT), it is not necessary to use a wide-bore capillary column; medium-bore capillary columns seem more suitable for COT-GC because they give sharper peaks and thus higher sensitivity. At the moment of making the present experiments, only the Rtx-BAC2 wide-bore capillary columns are commercially available; however, very recently, the Rtx-BAC2 medium-bore capillary columns have become available from the same manufacturer. Thus, now the latter column can be recommended for use because of higher sensitivity.
- j) The size of the syringe needle should be 23–24 G and the tip shape of the needle is preferably conical as stated in e).

## References

- 1) Nanikawa R (1977) Legal Medicine. Nippon-Iji-Shinposha, Tokyo, pp 239–260 (in Japanese)
- 2) Pharmaceutical Society of Japan (ed) (1992) Standard Methods of Chemical Analysis in Poisoning, 4th edn. Nanzando, Tokyo, pp 108–116 (in Japanese)
- 3) Hara K, Kageura M, Hieda Y et al. (1991) Quantitative analysis of ethanol in postmortem specimens using wide-bore capillary gas chromatography. *Jpn J Forensic Toxicol* 9:94–95 (in Japanese with an English abstract)
- 4) O'Neal CL, Wolf CE, Levine B et al. (1996) Gas chromatographic procedures for determination of ethanol in postmortem blood using t-butanol and methyl ethyl ketone as internal standards. *Forensic Sci Int* 83:31–38
- 5) Watanabe-Suzuki K, Seno H, Isii A et al. (1999) Ultra-sensitive method for determination of ethanol in whole blood by headspace capillary gas chromatography with cryogenic oven trapping. *J Chromatogr B* 727:89–94
- 6) Kashimura S (2001) Drink joyfully. Farewell to tossing off. To prevent death from acute alcoholism. *Jpn J Legal Med* 55:42–45 (in Japanese)
- 7) Jones AW (1985) Excretion of low-molecular weight volatile substances in human breath, focus on endogenous ethanol. *J Anal Toxicol* 9:246–250

- 8) Phillips M, Greenberg J (1987) Detection of endogenous ethanol and other compounds in the breath by gas chromatography with on-column concentration of sample. *Anal Biochem* 163:165–169
- 9) Ghooos Y, Hiele M, Rutgeerts P et al. (1989) Porous-layer open-tubular gas chromatography in combination with an ion trap detector to assess volatile metabolites in human breath. *Biomed Environ Mass Spectrom* 18: 613–616
- 10) Watanabe K, Seno H, Ishii A et al. (1997) Capillary gas chromatography with cryogenic oven temperature for headspace samples. Analysis of chloroform or methylene chloride in whole blood. *Anal Chem* 69:5178–5181
- 11) Watanabe-Suzuki K, Ishii A, Lee X-P et al. (2000) Analysis of volatile organic compounds by cryogenic oven trapping gas chromatography. *Jpn J Forensic Toxicol* 18:201–209 (in Japanese with an English abstract)
- 12) Watanabe-Suzuki K, Seno H, Ishii A et al. (1999) Sensitive detection of ethanol in human breath by headspace capillary gas chromatography with cryogenic oven trapping. *Jpn J Forensic Toxicol* 17:61–65
- 13) Watanabe-Suzuki K, Ishii A, Seno H et al. (2000) Stability of ethyl acetate in whole blood during storage under various conditions. *Jpn J Forensic Toxicol* 18:237–243
- 14) Hosogai Y, Nakazawa H, Nishijima M (eds) (1998) *Chemical Compound Date Book for Food Hygiene*. Chuohouki, Tokyo, p 580 (in Japanese)

## II.1.6 Chloroform and dichloromethane

by Kanako Watanabe

### Introduction

Chloroform exerts a suppressing effect on the central nervous system. It had been used as a general anaesthetic since the 19th century, but it disappeared, because of its hepatotoxicity and arrhythmia-inducing effects. It is now being used for industrial purposes, such as a solvent, extracting reagent, refrigerant and chemical material. Chloroform poisoning can be seen in accidental, suicidal [1] and homicidal cases.

Dichloromethane (methylene dichloride, methylene chloride) is also being widely used in industries as a solvent and refrigerant like chloroform, and causing many poisoning cases due to accidents and suicides [2]. Recently, dichloromethane has become of interest as a substitute of chlorofluorocarbon, because the latter was found to accelerate the depletion of the ozone layer and is in the line of being abolished completely.

Since both chloroform and dichloromethane are volatile compounds, their analysis is usually made by the headspace extraction and GC detection. In this chapter, a simple headspace GC method, using dichloromethane as internal standard (IS) for assays of chloroform and *vice versa*, is presented [3].

### Reagent and their preparation

#### i. Reagents

Chloroform, dichloromethane and methanol of special grade can be purchased from Wako Pure Chemical Industries, Ltd., Osaka, Japan and many other manufacturers.

#### ii. Preparation

A 337- $\mu\text{L}$  volume of chloroform and a 377- $\mu\text{L}$  volume of dichloromethane are separately dissolved in methanol to prepare each 100 mL solution as stock solutions. Each solution is diluted 5-fold with methanol; a 10- $\mu\text{L}$  volume containing 10  $\mu\text{g}$  of each compound is added to 0.5 mL whole blood as IS and mixed well.

## GC Conditions<sup>a</sup>

GC column<sup>b</sup>: a DB-1 fused silica wide-bore capillary column (30 m × 0.53 mm i. d., film thickness 5 μm, J&W Scientific, Folsom, CA, USA).

GC conditions: an HP 5890 Series gas chromatograph (Agilent Technologies, Palo Alto, CA, USA)<sup>c</sup>; detector: FID; column (oven) temperature: 50 °C (10 min) → 20 °C/min → 280 °C; injection temperature: 250 °C; detector temperature: 280 °C; carrier gas: He; its flow rate: 10 mL/min; injection mode: splitless.

## Procedure

- i. A 0.5-mL volume of whole blood<sup>d</sup>, 10 μL of dichloromethane solution (IS, containing 10 μg) for measurement of chloroform and 0.5-mL of distilled water are placed in a 7-mL volume glass vial with a Teflon-septum screw cap, immediately capped and mixed gently.
- ii. The vial containing the mixture is heated at 55 °C for 20 min on a heat block or in a water bath. A 0.5-mL volume gas-tight syringe to be used can be simultaneously heated on the same heat block.
- iii. A needle<sup>e</sup> of 23 G is used for the syringe. After heating, a 0.5-mL volume of the headspace vapor is drawn into the syringe and injected into GC immediately.
- iv. More than 4 vials are prepared to construct a calibration curve; to each vial, a 0.5-mL volume of whole blood obtained from a healthy subject, 10 μL of IS (10 μg of dichloromethane) and one of the various concentrations of chloroform are added, and the following procedure is exactly the same as described above. The calibration curve is composed of chloroform concentration on the horizontal axis and the peak area ratio of chloroform to dichloromethane (IS) to enable the calculation of chloroform concentration in a test specimen.
- v. In case of the analysis of dichloromethane, chloroform is used as IS, conversely, and the procedure is exactly the same as above.

## Assessment of the method

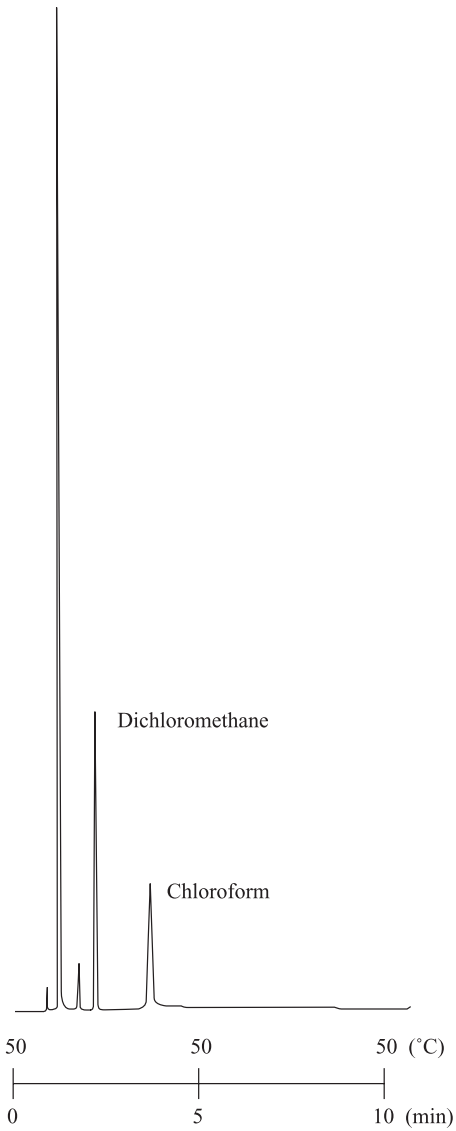
▶ *Figure 6.1* shows a gas chromatogram obtained from human whole blood (0.5-mL) containing both chloroform and dichloromethane. With the DB-1 column, the peaks of chloroform and dichloromethane appeared separated well, and were not interfered with by any impurity peak. The methanol used as vehicle appeared around 1 min of retention time as a big peak, but did not interfere with that of dichloromethane.

The efficiencies for extraction of chloroform and dichloromethane from the aqueous phase containing 0.5 mL whole blood were 12–20 % by the present headspace method.

The detection limit of this method is about 1 μg/mL whole blood for both compounds.

Dichloromethane is known to be converted into carbon monoxide (CO) *in vivo* [4], and thus in poisoning with dichloromethane, both carboxyhemoglobin (COHb) and dichloromethane concentrations were sometimes measured simultaneously [5]. However, the concentration of COHb is usually only around 10 %; it seems impossible to be killed only by CO poisoning after oral ingestion or inhalation of dichloromethane.

■ Figure 6.1



Detection of chloroform and dichloromethane from whole blood by wide-bore capillary GC (DB-1 column). The amount of chloroform and dichloromethane added to 0.5 mL of whole blood was equally 10  $\mu$ g. The big peak appearing at an early stage is that of methanol used as vehicle.

## Poisoning cases, and toxic and fatal concentrations

---

### A chloroform-poisoning case [6]

A 27-year-old male was found in an unconscious state; it was estimated that he had ingested 4 ounces (114 mL) of chloroform orally. On arrival at a hospital, he was comatose, snoring and cyanotic. His physical conditions were: the pupils: dilated and not responsive to light; heart beat: 70/min; blood pressure: 140/90 mmHg; and respiration rate: 40/min. He was intubated and subjected to oxygen inhalation, and his stomach was lavaged. The gastric lavage solution gave a strong smell of chloroform. One hour after admission, the arterial blood showed pH at 7.29 and PaCO<sub>2</sub> at 50 mmHg. Therefore, 4.3 % glucose in saline and 0.9 % saline, 500 mL of each, were injected by intravenous drop infusion; 50 mL of 5 % NaHCO<sub>3</sub> was also injected to treat the metabolic acidosis. His electrocardiogram occasionally showed extrasystoles and slight lowering of ST within several hours after admission. Eleven hours after admission, the patient became responsive to a call and the intratracheal tube was removed. He complained of his chest pain upon swallowing and epigastric discomfort; he did not show any retrograde amnesia and remembered that he had ingested 4 ounces of chloroform. Twelve hours after admission, the clinical tests showed arterial blood at pH 7.4, PaCO<sub>2</sub> at 40 mmHg and bicarbonate ion at 21 mEq/L. Three days after admission, slight icterus and swelling of the liver appeared. On day 4, the symptoms of the liver disturbance were aggravated even more and he repeated vomiting. Such a serious state lasted for 2 days and the symptoms were gradually alleviated thereafter in about 10 days. He was discharged from the hospital on day 28. In this patient, almost no abnormality in electrolytes even during the acute stage was observed; while urea and bilirubin in his blood increased during 2–3 days of acute stage and decreased to normal values soon. The AST (GOT) reflecting liver function showed very high values during the acute stage, but gradually decreased until his discharge.

### A dichloromethane-poisoning case [2]

A 63-year-old male was drying a big pump, after finishing unloading dichloromethane from a tanker; the hold of the tanker was filled with dichloromethane gas, which caused a collapse of his colleague working there. To rescue his colleague, he entered the hold, lost his consciousness for a short time by inhaling the same gas and was sent to an emergency room of a hospital. Upon arrival at the hospital, the level of his consciousness was JCS 1, and about 2 cm-sized contusion wound was found in the frontal region of his head. He complained of slight headache, but general conditions were stable without any abnormality in light reaction and in eye movement. As slight headache continued, COHb concentration was measured; it was 16.5 % 12 h after the exposure, followed by 7.6 % at 16 h and 2.3 % at 36 h. About 20 h after the exposure, the symptom was improved; he was discharged, about 40 h after exposure.

### Toxic and fatal concentrations

After a single oral dose of 500 mg chloroform to 2 subjects, peak blood concentrations of about 1 and 5 µg/mL were attained in 1 h, respectively [7]. The fatal oral dose of chloroform is about

10 mL and the maximum permissible atmospheric concentration is 10 ppm. In fatal chloroform poisoning cases, its concentrations were 10–48  $\mu\text{g/mL}$  in blood, 50.4–156  $\mu\text{g/g}$  in the brain, 16–27  $\mu\text{g/g}$  in the kidney, 6–86.2  $\mu\text{g/g}$  in the liver and 0–60  $\mu\text{g/mL}$  in urine [7].

Dichloromethane is very similar to chloroform in its structure; the toxic effects of the former is also considered similar to those of the latter. However, the anaesthetic effect of dichloromethane is much lower than that of chloroform. The maximum permissible atmospheric concentration of dichloromethane is 200 ppm. In a fatal dichloromethane poisoning case, its concentrations were 252  $\mu\text{g/mL}$  in blood, 125  $\mu\text{g/g}$  in the brain, 130  $\mu\text{g/g}$  in the liver and 10  $\mu\text{g/mL}$  in urine [8].

## Notes

- a) In this chapter, a usual headspace GC method using a fused silica wide-bore capillary column is described. If more sensitive detection of the compounds is necessary, a cryogenic oven trapping GC method using a medium-bore capillary column [3] is recommendable, because it gives the sensitivity 10–100 times higher.
- b) Any wide-bore capillary column of a similar type can be used, regardless of its manufacturer.
- c) Any GC instrument for a capillary column can be used for analysis.
- d) Urine can be probably analyzed through the same procedure, because it is a much simpler matrix than whole blood.
- e) As described in the chapter of ethanol, the author is using a 23 G needle of the gas-tight syringe with a 90° cut at its tip or with a conical cut to avoid the obstruction of the needle by a debris of a septum.

## References

- 1) Ryall JE (1990) Suicide by chloroform inhalation. *Bull Int Assoc Forensic Toxicol* 20 (3):28–29
- 2) Nishi S, Yabe M, Shindoh M et al. (1996) Pharmacokinetic aspect for methylene chloride intoxication. *Jpn J Toxicol* 9:81–87 (in Japanese with an English abstract)
- 3) Watanabe K, Seno H, Ishii A et al. (1997) Capillary gas chromatography with cryogenic oven temperature for headspace samples: analysis of chloroform or methylene chloride in whole blood. *Anal Chem* 69:5178–5181
- 4) Ratney RS, Wegman DH, Elkins HB et al. (1974) In vivo conversion of methylene chloride to carbon monoxide. *Arch Environ Health* 28:223–226
- 5) Forrest ARW, Marsh I, Usher A (1990) Poisoning with methylene chloride (dichloromethane) without concomitant carboxyhaemoglobinaemia. *Bull Int Assoc Forensic Toxicol* 20 (3):26–27
- 6) Schroeder HG (1965) Acute and delayed chloroform poisoning. *Br J Anaesth* 37:972–975
- 7) Moffat AC, Jackson JV, Moss MS et al. (eds) (1986) *Clarke's Isolation and Identification of Drugs*, 2nd edn. The Pharmaceutical Press, London, pp 450–451
- 8) Moffat AC, Jackson JV, Moss MS et al. (eds) (1986) *Clarke's Isolation and Identification of Drugs*, 2nd edn. The Pharmaceutical Press, London, p 766



## II.1.7 Toluene, benzene, xylene and styrene

by Xiao-Pen Lee and Keizo Sato

### Introduction

Toluene, benzene, xylene and styrene are being widely used for chemical product materials, solvents and constituents of adhesives and paints, and thus sometimes cause poisoning incidents by inhaling their gas at chemical product-manufacturing factories. The abuse of thinner solvents, containing toluene, benzene and xylene, is now a social problem especially for young people. There are many crimes and poisoning incidents involving the thinner solvent abuse. Recently, styrene leaking from new building materials is an object of interest, because it causes the sick house syndrome.

The above four solvents are rapidly absorbed into human body by inhalation, *per os* and percutaneously to cause various disturbances, such as suppression of the central nervous system. In addition, benzene and styrene are being regarded as carcinogenic compounds.

For analysis of toluene, benzene, xylene and styrene, the conventional GC methods with packed columns are being used [1–10]. In this chapter, a method of their analysis for human blood using headspace wide-bore capillary GC is presented.

### Reagents and their preparation

- Standard solutions: toluene, benzene or each isomer<sup>a</sup> of xylene of special grade is dissolved in methanol to prepare each 1 mg/mL solution.
- Internal standard (IS) solution: aniline of special grade is dissolved in methanol to give 10 mg/mL solution.

### GC conditions

Column: an Rtx-BAC2 wide-bore capillary column (30 m × 0.53 mm i. d., film thickness 2.0 μm, Restek, Bellefonte, PA, USA).

GC conditions; instrument: a Shimadzu GC-14B gas chromatograph (Shimadzu Corp., Kyoto, Japan); detector: FID; column (oven) temperature: 30 °C (1 min) → 15 °C/min → 240 °C injection and detector temperature: 240 °C; carrier gas: He; its flow rate: 5.0 mL/min.

## Procedure

- i. A 0.5 mL volume of whole blood, 20  $\mu\text{L}$  (200  $\mu\text{g}$ ) of IS solution, 1.5 mL of distilled water and 0.6 g of solid NaCl<sup>b</sup> are placed in a 7.5 mL volume vial, stoppered with a silicone-septum cap and mixed well.
- ii. The vial is heated at 100 °C with stirring<sup>c</sup> on an aluminum block heater. After 15 min of heating, about 0.6 mL of the headspace vapor is drawn into a gas-tight syringe<sup>d</sup> and the volume of the vapor is reduced to 0.3 mL<sup>e</sup> by pushing the plunger. It is immediately injected into GC for analysis.
- iii. Quantitation: to each 0.5 mL of blank whole blood, one of the known amounts of each solvent and 200  $\mu\text{g}$  of IS are added to construct a calibration curve<sup>f</sup>, consisting of concentration of a solvent on the horizontal axis and peak area ratio of a solvent to IS on the vertical axis for enabling calculation of a concentration of a test compound in whole blood.

## Assessment of the method

► Figure 7.1 shows a headspace wide-bore capillary gas chromatogram obtained from 0.5 mL whole blood, to which toluene, benzene, 3 kinds of xylene isomers and styrene, 3  $\mu\text{L}$  (3  $\mu\text{g}$ ) of each, together with 20  $\mu\text{L}$  (200  $\mu\text{g}$ ) of IS solution, had been added. Every peak was separated well from each other except for *m*- and *p*-xylenes. The background was clean with few impurity peaks. The extraction efficiencies (recoveries) for each organic solvent are 3.1–5.2 %. Good linearity of the calibration curve can be obtained in the range of 0.5–5.0  $\mu\text{g}/0.5\text{ mL}$  for each compound; the detection limit is equally about 0.2  $\mu\text{g}/0.5\text{ mL}$ .

It is impossible to separate *m*-xylene from *p*-xylene with the present Rtx-BAC2 wide-bore capillary column. To separate such isomers, the use of a packed column with Bentone-34 or a chiral capillary column, such as an  $\alpha$ -DEX 120 capillary column (Supelco, Bellefonte, PA, USA), is recommendable.

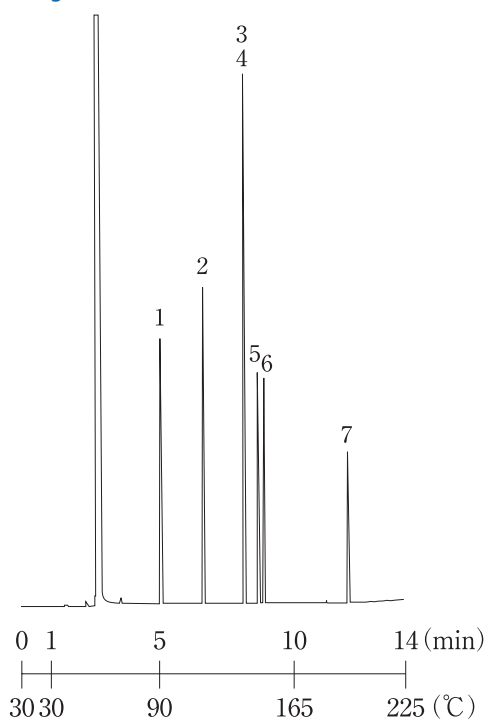
## Toxic and fatal concentrations and poisoning symptoms

Although the poisoning effects of toluene and benzene vary according to different individuals, the oral ingestion of 15–20 mL toluene generally causes serious toxicity. The fatal dose of benzene is estimated to be about 100 mL; but there was a case in which a subject died after oral ingestion of only 15 mL benzene. The atmospheric concentration of toluene at 2,000 ppm is dangerous for humans [11]. There is a possibility of death after single inhalation of 10,000 ppm gas of benzene [11]. The maximum permissible atmospheric concentrations of toluene and benzene are 50 and 0.5 ppm, respectively, according to the Japanese Society of Industrial Hygiene. In fatal thinner poisoning cases, the blood concentrations of toluene were reported to be 6–110  $\mu\text{g}/\text{mL}$  [3]; in fatal benzene poisoning cases, blood benzene concentrations to be 0.94–38  $\mu\text{g}/\text{mL}$  [12].

As symptoms of acute poisoning by exposure to toluene or benzene, immediate headache, vertigo and coma appear, according to severity of poisoning, followed by death finally.

As symptoms of chronic poisoning by toluene or benzene, hematological disorders, such as aplastic anemia and acute leukemia, together with the symptoms of the central nervous system, can take place.

Figure 7.1



**Detection of toluene, benzene, xylene isomers and styrene from whole blood by headspace capillary GC. 1: benzene; 2: toluene; 3: *p*-xylene; 4: *m*-xylene; 5: *o*-xylene 6: styrene; 7: aniline (IS). Three micrograms each of the above 6 compounds and 200  $\mu\text{g}$  of aniline (IS) were added to 0.5 mL whole blood.**

The toxicity of xylene is lower than that of toluene or benzene, but it also causes acute and chronic poisoning. The fatal atmospheric concentration of xylene is about 19,000 ppm [13]. Its maximum permissible atmospheric concentration is 100 ppm according to the same society. In autopsy cases of self-ignition using gasoline, the blood concentrations of the three xylene isomers were reported to be 46.5–250  $\mu\text{g}/\text{mL}$  [14].

As symptoms by styrene poisoning, the disturbances of the central nervous system appear. At 200–400 ppm of atmospheric concentrations of styrene, stimulation of the eye and the respiratory organs can occur; by inhalation of 1 % vapor of styrene, a victim can fall into a comatose state in a few minutes [15]. After chronic exposure to styrene, the side chain of styrene is epoxidized and causes carcinogenicity. The maximum permissible atmospheric concentration of the compound defined by the same society is 50 ppm. In the survived cases of styrene poisoning, the blood concentrations were reported to be 0.01–1.0  $\mu\text{g}/\text{mL}$  [16, 17].

## Notes

- a) There are 3 isomers of xylene, *viz.* *o*-, *m*- and *p*-xylene.
- b) To improve extraction efficiency (recovery), the addition of NaCl is effective, because of its salting-out effect.
- c) By using a stirrer, the time for extraction can be shortened; the recovery rate is also increased also by heating, due to enhanced mobility of molecules.
- d) When a vial septum made of silicone/Teflon is used, a 90°cut needle at its tip for the gas-tight syringe is effective to prevent the leakage of gas upon piercing through the septum.
- e) This procedure of reducing the volume is effective for expelling atmospheric air, which has been aspirated into the syringe just after taking the needle out of the vial, because of the negative pressure.
- f) For drawing a calibration curve, 5–6 concentrations of a compound should be plotted to confirm its linearity.

## References

- 1) Wampler TP, Bowe WA, Levy EJ (1985) Dynamic headspace analyses of residual volatiles in pharmaceuticals. *J Chromatogr Sci* 23:64–67
- 2) Zahlens K, Rygnestad T, Nilsen OG (1985) Oral intake of a toluene-containing thinner. Effects and headspace gas chromatographic analytical diagnosis. *Arch Toxicol Suppl* 8:412–415
- 3) Takeichi S, Yamada T, Shikata I (1986) Acute toluene poisoning during painting. *Forensic Sci Int* 32:109–115
- 4) Morinaga M, Hara K, Kageura M et al. (1990) A simple, rapid and simultaneous analysis of complex volatile hydrocarbon mixtures in blood using gas chromatography/mass spectrometry with a wide-bore capillary column. *Z Rechtsmed* 103:567–572
- 5) Kato K, Nagata T, Kimura K et al. (1990) Demonstration of ingested thinner. *Jpn J Legal Med* 44:223–226
- 6) Ghittori S, Fiorentino ML, Maestri L et al. (1993) Urinary excretion of unmetabolized benzene as an indicator of benzene exposure. *J Toxicol Environ Health* 38:233–243
- 7) Kessels H, Hoogerwrf W, Lips J (1992) The determination of volatile organic compounds from EPA method 524.2 using purge and trap capillary gas chromatography, ECD and FID. *J Chromatogr Sci* 30:247–255
- 8) Otson R, Kumarathanan P (1995) An automated head space analysis method for xylenes and ethylbenzene in blood and water. *Chemosphere* 30:1109–1123
- 9) Pantarotto C, Fanelli R, Belletti I et al. (1980) Determination of styrene in biological specimens by gas chromatography selected ion monitoring distribution in mice. *Anal Biochem* 105:340–347
- 10) Varner SL, Breder CV, Fazio T (1983) Determination of styrene migration from food-contact polymers into margarine, using azeotropic distillation and headspace gas chromatography. *J Assoc Off Anal Chem* 66:1067–1073
- 11) Olson KR (ed) (1994) *Poisoning & Drug Overdose*, 2nd edn. Appleton & Lange, Norwalk, CT, pp 298–300
- 12) Moffat AC, Jackson JV, Moss MS et al. (eds) (1986) *Clark's Isolation and Identification of Drugs*, 2nd edn. Pharmaceutical Press, London, p 380
- 13) Ishibashi H (1967) *Guide to Organic Solvents*. Maki-shoten, Tokyo, p 128 (in Japanese)
- 14) Hattori H, Iwai M, Kurono S et al. (1998) Sensitive determination of xylenes in whole blood by capillary gas chromatography with cryogenic trapping. *J Chromatogr B* 718:285–289
- 15) Patty FA (ed) (1967) *Industrial Hygiene and Toxicology*, 2nd edn. Wiley, New York, p 1222
- 16) Cherry N, Waldron HA, Wells GG et al. (1980) An investigation of the acute behavioral effects of styrene on factory workers. *Br J Ind Med* 37:234–240
- 17) Klaassen CD (ed) (1996) *Casarett and Doull's Toxicology*, 5th edn. McGraw-Hill, New York, p 999

## 11.1.8 Alkyl nitrites

by Yasuo Seto

### Introduction

Alkyl nitrites are highly volatile organic solvents of aliphatic alcohol esters of nitrites [1]. Amyl nitrite<sup>a</sup>, butyl nitrite and isobutyl nitrite are the representative alkyl nitrites; their boiling points are 98, 78 and 67 °C, respectively. Amyl nitrite is being widely used as a detoxicant for cyanide poisoning, because alkyl nitrites oxidize hemoglobin in erythrocytes to yield methemoglobin, which is bound with cyanide to inactivate it [1]. Alkyl nitrites also show a coronary artery-dilating effect, and had been, therefore, used for the treatment of angina pectoris many years ago [2]; the pharmacological effect of the dilation of the coronary arteries was found due to the action of nitrogen monoxide produced by decomposition of alkyl nitrites [3]. They are being mainly used as materials for manufacturing drugs or as reagents for synthesis in industries; they are also used as aromatics. Because of their pharmacological effect, alkyl nitrites are being abused as uncontrolled inhalant drugs and causing a social problem [4]. Although there are many reports on toxic and fatal cases due to alkyl nitrites [5], reports on their fatal doses are few; it is estimated that oral ingestion of 10–15 mL of each alkyl nitrite causes serious methemoglobinemia [6]. The LD<sub>50</sub> value for an alkyl nitrite is reported to be 205 mg/kg. There are not many cases of analysis of alkyl nitrites in the field of forensic toxicology. In this chapter, the methods for analysis of the compounds by headspace (HS)-gas chromatography (GC) and liquid-liquid extraction-GC are presented.

### Determination of isobutyl nitrite in aqueous solution by headspace-GC

---

#### Reagents and their preparation

- A 115- $\mu$ L volume (100 mg) of isobutyl nitrite (Tokyo Kasei Kogyo Co., Ltd., Tokyo, Japan and other manufacturers) is dissolved in acetone to prepare 10 mL stock solution (10 mg/mL, preservable for a week in a refrigerator)<sup>b</sup>. The stock solution is diluted 2,000-fold with acetone to prepare standard solution (5  $\mu$ g/mL).
- A 124- $\mu$ L volume (100 mg) of isobutyl alcohol (obtainable from many manufacturers) is dissolved in acetone to prepare 10 mL stock solution (10 mg/mL, preservable in an airtight container at room temperature). The stock solution is diluted 2,000-fold with acetone to prepare standard solution (5  $\mu$ g/mL).

## GC conditions

GC column: a polar fused silica capillary column (HP-Wax, 30 m × 0.25 mm i. d., film thickness 0.25 μm, Agilent Technologies, Palo Alto, CA, USA).

GC conditions<sup>c</sup>: an HP 6890 Series gas chromatograph (Agilent Technologies); injection mode: split with its ratio 30; injection temperature: 200 °C; detector: FID; detector temperature: 220 °C; carrier gas: He; its flow rate: 0.67 mL/min; column (oven) temperature: 40 °C (3 min) → 15 °C/min → 115 °C.

MS conditions: transfer line temperature: 280 °C; ion source temperature: 200 °C; ionization mode: EI; electron energy: 70 eV; ionization current: 60 μA.

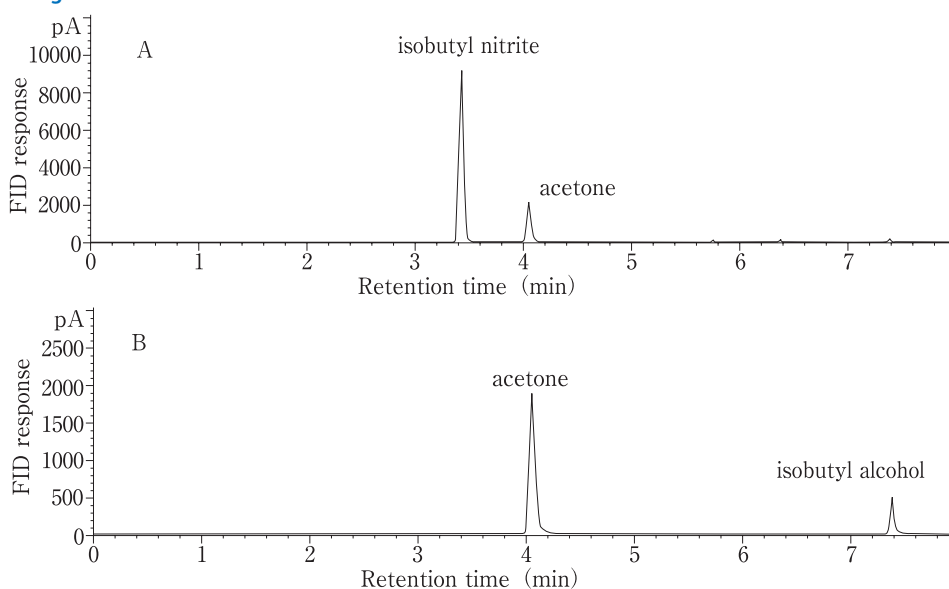
## Procedure

- i. A 0.25-mL volume of a specimen<sup>d</sup>, 0.5 mL of 1 M phosphate buffer solution (pH 7), 0.2 mL distilled water and 0.05 mL acetone are placed in a glass vial with a septum screw cap (8 mL volume, external diameter 17 mm, height 6 cm, GL Sciences, Tokyo, Japan) and airtightly stoppered with a cap with a Tuf-Bond<sup>TM</sup> disc (PTFE/silicone septum).
- ii. The vial is incubated at 30 °C for 10 min on a Type-D aluminum block heater (Reacti-Therm<sup>TM</sup>, Pierce, Rockford, IL, USA) to gain an equilibrium.
- iii. A 0.5-mL volume of the headspace vapor in the vial is drawn into a glass tuberculin syringe with a 25 G × 1" needle (0.50 × 25 mm, Terumo, Tokyo, Japan and other manufacturers) and rapidly injected into GC.
- iv. Quantitation: a 0.25 mL of the same matrix<sup>e</sup> (without an analyte), 0.5 mL of the phosphate buffer, 0.05 mL of isobutyl nitrite or isobutyl alcohol standard solution at various concentrations and 0.2 mL distilled water are placed in the vial and mixed. The following procedure is exactly the same as described above. The 5–6 vials containing different concentrations of the analyte are prepared to construct each external calibration curve, consisting of the concentration of an alkyl nitrite on the horizontal axis and peak area on the vertical axis. The concentration of the analyte in a specimen is calculated using the calibration curve.

## Assessment and some comments on the method

➤ *Figure 8.1* shows gas chromatograms of isobutyl nitrite (injected amount 5 μg) and isobutyl alcohol (injected amount 10 μg); they appeared at 3.4 and 7.4 min of retention times, respectively. The solvent acetone appeared at about 4 min. The detection limits of isobutyl nitrite and isobutyl alcohol in liquid specimens were 62 ng and 1.9 μg/mL, respectively [7]. ➤ *Figure 8.2* shows EI mass spectra of isobutyl nitrite (A) and isobutyl alcohol (B).

Alkyl nitrites are easily hydrolyzed in aqueous solutions to yield each alkyl alcohol and inorganic nitrite; the hydrolytic reaction is even more rapid in blood [8,9]. The hydrolysis proceeds not only during storage of specimens, but also during the headspace analysis. As shown in ➤ *Fig. 8.1A*, the decomposition product isobutyl alcohol is detected even in headspace GC analysis of the standard isobutyl nitrite solution in acetone. Under acidic conditions, the esterification of inorganic nitrite, the opposite reaction, also takes place to reach an equilibri-

**Figure 8.1****Gas chromatograms for isobutyl nitrite (A) and isobutyl alcohol (B).**

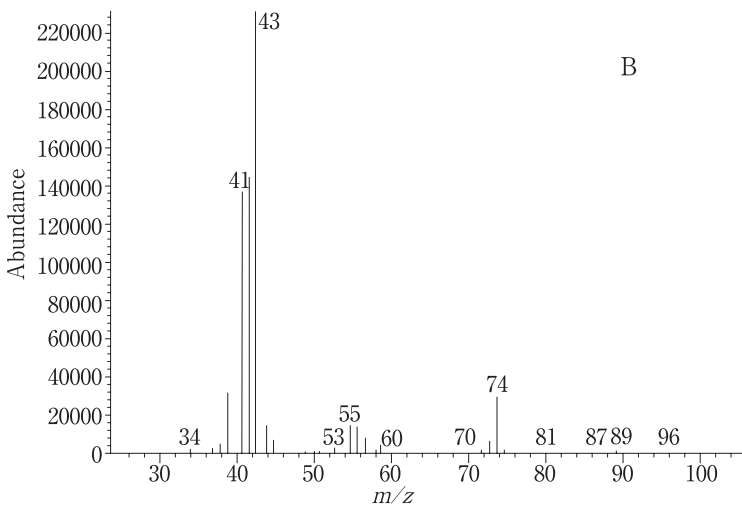
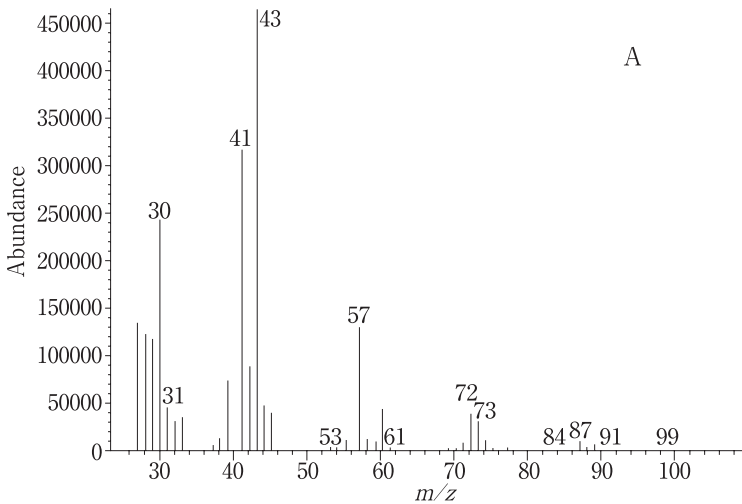
um between the hydrolysis and esterification [7]. Under the present HS conditions, the decomposition of alkyl nitrites by hydrolysis is minimized, and the esterification reaction is completely suppressed; it seems to be the best conditions for the headspace analysis of alkyl nitrites. Under these conditions, the peak of isobutyl alcohol, the decomposition product, becomes relatively low.

## Determination of isobutyl nitrite in blood by GC with liquid-liquid extraction

### Reagents and their preparation

- A 11.5- $\mu\text{L}$  volume (10 mg) of isobutyl nitrite is dissolved in 5 mL pentane in a glass vial with a Teflon-septum screw cap to serve as a stock solution (2 mg/mL), and kept airtightly in a refrigerator. A 5- $\mu\text{L}$  volume of the above solution is placed using a microsyringe in a glass vial containing 1 mL of dimethyl sulfoxide (DMSO), capped airtightly and mixed well to prepare the standard isobutyl nitrite solution (10  $\mu\text{g}/\text{mL}$ ).
- A 10- $\mu\text{L}$  volume (10 mg) of n-propyl nitrate (Aldrich, Milwaukee, WI, USA) is dissolved in 5 mL pentane in a glass vial with a Teflon-septum screw cap to serve as a stock solution (2 mg/mL) to be stored airtightly in a refrigerator. A 5- $\mu\text{L}$  volume of the above solution is dissolved in 1.0 mL DMSO in another vial; then 0.05 mL of the solution is dissolved in 4.95 mL pentane to give 100 ng/mL solution (IS-containing pentane for extraction).

■ **Figure 8.2**



**EI mass spectra of isobutyl nitrite (A) and isobutyl alcohol (B).**

## GC conditions

GC column: a non-polar fused silica capillary column (DB-1, 30 m × 0.32 mm i. d., film thickness 1 μm, J & W Scientific, Folsom, CA, USA).

GC conditions; instrument: an HP 6890 Series gas chromatograph (Agilent Technologies); injection: split mode with its ratio of 30; injection temperature: 45 °C; detector: ECD; detector temperature: 195 °C; carrier gas: N<sub>2</sub>; its flow rate: 1 mL/min; column (oven) temperature: 30 °C (9.5 min) → 60 °C/min → 45 °C (8.5 min).



## Procedure

- i. A blood specimen is directly sampled through a heparinized cannula into a 0.5-mL volume glass vial, which has been cooled with ice, capped airtightly and stored in a refrigerator.
- ii. A 0.4-mL volume of the blood specimen is rapidly mixed with 0.4 mL of the IS-containing pentane solution in a glass vial with a Teflon septum screw cap, which has been cooled with ice, and vortex-mixed for 5 s.
- iii. A 3- $\mu$ L aliquot of the upper organic phase is rapidly injected into GC.
- iv. Quantitation: the internal calibration method is used; a volume (0.5–20  $\mu$ L) of the cooled standard solution of isobutyl nitrite (10  $\mu$ g/mL) is added to the mixture of 0.4 mL of blank blood and 0.4 mL of IS- containing pentane solution in a glass vial with a Teflon-septum screw cap, which has been cooled with ice, and vortex-mixed for 5 s; a 3- $\mu$ L aliquot of the organic layer is injected into GC. At least 5 vials with different volume of the standard isobutyl nitrite solution should be prepared to construct a calibration curve with isobutyl nitrite concentration on the horizontal axis and peak area ratio of isobutyl nitrite to IS on the vertical axis. The concentration of isobutyl nitrite in a test blood specimen is calculated using the calibration curve.

## Assessment and some comments on the method

The present method is based on a report of analysis developed for studying the pharmacodynamics of isobutyl nitrite [10, 11]. In this method, every care is being taken to suppress the decomposition and evaporation of isobutyl nitrite throughout the procedure (from the sampling until injection to GC, and from the standard solution to a test specimen). In principle, the sampling, extraction and GC analysis should be made at low temperature, in a gastight state and in a short time. This method is applicable to other biomedical specimens and drinks/foods in forensic chemistry. It should be pointed out that the concentration of isobutyl nitrite detected by analysis only shows one at the time point of the injection into GC and does not reflect the *in vivo* level. Under the present GC conditions, the peak of isobutyl nitrite appears at 7.6 min and that of n-propyl nitrate (IS) at 15.9 min. The recovery of isobutyl nitrite from blood is 86 % [11].

## Toxic and fatal concentrations

It is impossible to obtain fatal concentrations of alkyl nitrites in blood, because they are easily hydrolyzed in it. The inorganic nitrite, a decomposition product, is responsible for their toxicity; but it is further decomposed in a short time, after reaction with hemoglobin in erythrocytes. Therefore, the measurements of inorganic nitrite in blood seem useless for assessment of toxicity of alkyl nitrites. The most useful indicator of alkyl nitrite poisoning is methemoglobin concentrations in blood; about 20 % of methemoglobin concentration is toxic, and more than 70 % fatal [12].

## Notes

- a) So-called “amyl nitrite” is a mixture of pentyl nitrite isomers containing isoamyl nitrite as a main component.
- b) In the commercial products of an alkyl nitrite, small amounts of corresponding alkyl alcohol, the decomposition product, are contained. Since the decomposition of an alkyl nitrite proceeds even in a polar organic solvent, such as acetone, the stock solution should be stored in a refrigerator and be used within a week.
- c) There is a possibility of decomposition of alkyl nitrites in the injection chamber, column and detector, because they are very unstable. To avoid such decomposition, the temperatures of the injection port and detector were lowered in some analytical cases; however, the contamination of the injection port due to low temperature is concerned. The author tested the possibility of decomposition of the compounds in the injection chamber at various temperatures; the results showed almost no decomposition up to 200 °C. Therefore, we adopted 200 °C of injection temperature.
- d) As specimens, refreshing drinks are being assumed, but this method is applicable to body fluid specimens.
- e) Since a fluid matrix markedly affects the equilibration of a compound in the analysis by headspace GC [13], the same or very similar matrix should be used for constructing a calibration curve.

## References

- 1) Haley TJ (1980) Review of the physiological effects of amyl, butyl, and isobutyl nitrites. *J Toxicol Clin Toxicol* 16:317–329
- 2) Haverkos HW, Kopstein AN, Wilson H et al. (1994) Nitrite inhalants: history, epidemiology, and possible links to AIDS. *Environ Health Perspect* 102:858–861
- 3) Kowaluk EA, Chung SJ, Fung HL (1993) Nitrite ion is not an active intermediate in the vascular metabolism of organic nitrates and organic nitrites to nitric oxide. *Drug Metab Dispos* 21:967–968
- 4) Kojima T, Kamimura H, Doi K et al. (2000) Unregulated drugs containing nitrite esters. *Jpn J Toxicol* 13:85–86 (in Japanese)
- 5) Bradberry SM, Whittington RM, Parry DA et al. (1994) Fatal methemoglobinemia due to inhalation of isobutyl nitrite. *J Toxicol Clin Toxicol* 32:179–184
- 6) Osterloh J, Olson K (1986) Toxicities of alkyl nitrites. *Ann Int Med* 104:727
- 7) Seto Y, Kataoka M, Tsuge K et al. (2000) Pitfalls in the toxicological analysis of an isobutyl nitrite-adulterated coffee drink. *Anal Chem* 72:5187–5192
- 8) Osterloh JD, Goldfield D (1984) Butyl nitrite transformation in vitro, chemical nitrosation reactions, and mutagenesis. *J Anal Toxicol* 8:164–169
- 9) Osterloh JD, Goldfield D (1985) Uptake of inhaled n-butyl nitrite and in vivo transformation in rats. *J Pharm Sci* 74:780–782
- 10) Kielbasa WB, Bauer JA, Fung HL (1999) Analysis of isobutyl nitrite inhalant in rat and human blood: application for pharmacokinetic investigations. *J Chromatogr B* 734:83–89
- 11) Kielbasa W, Fung HL (2000) Pharmacokinetics of a model organic nitrite inhalant and its alcohol metabolite in rats. *Drug Metab Dispos* 28:386–391
- 12) Seger DL (1992) Methemoglobin-forming chemicals. In: Sullivan JB Jr, Krieger GR (eds) *Hazardous Materials Toxicology – Clinical Principles of Environmental Health* -. Williams & Wilkins, Baltimore, pp 800–806
- 13) Seto Y (1994) Head-space gas chromatography in forensic toxicology. *Jpn J Forensic Toxicol* 12:175–191 (in Japanese with an English abstract)

## II.1.9 Components of gasoline and kerosene

by *Tatsunori Takayasu and Toshikazu Kondo*

### Introduction

The petroleum fuels are a group of hydrocarbons refined and modified from the crude oil, and include more than 100 kinds of aliphatic and aromatic hydrocarbons. They are roughly classified into petroleum gas, gasoline, kerosene, light oil, heavy oil and others [1]. This chapter deals with analysis of hydrocarbons of  $C_3$ – $C_{16}$  being included in automobile gasoline, purified kerosene (No.1 kerosene), automobile light oil for a diesel engine and liquefied petroleum (LP) gas.

The petroleum oils, such as gasoline and kerosene, are frequently detected from specimens in fire cases. The detection of petroleum components from human specimens is especially important in legal medicine as a proof of vital reaction [2, 3]. In the field of police science, the discrimination analysis among gasoline, kerosene and other products is being made for specimens of a fire and of environmental pollution; the detection of each component serves as an objective and important evidence for an accident or an incident [4]. Although such specimens can be grouped into biological ones and non-biological ones such as fire debris and polluted materials, the methods to be presented in this chapter are usable for both groups of specimens.

Since the petroleum components are generally volatile with the exception of some fluids such as heavy oil, the methods of headspace extraction [2–8], liquid-liquid extraction using hexane [9], purge-and-trap extraction [10, 11], dynamic headspace extraction [12] and solid-phase microextraction (SPME) [13–18] are being employed as pretreatments; their analysis is being made by GC with FID or GC/MS.

As medicolegal application, a GC/MS method for discrimination among LP gas, gasoline and kerosene is also presented for a gas sample obtained from the trachea of a cadaver [19].

### Reagents and their preparation

Reagents are of analytical grade obtainable from many manufacturers. The organic solvents to be used for extraction should be of ultra-pure grade. Toluene- $d_6$  can be purchased from Merck (Darmstadt, Germany) and other companies. The 0.001 % *n*-butylbenzene solution is prepared by dissolving 1.0  $\mu$ L *n*-butylbenzene in 100 mL distilled water.

## Instrumental conditions

### i. GC (/MS) conditions-1 [8, 19]

Column: a DB-1 fused silica wide-bore capillary column (30 m × 0.53 mm i. d., film thickness 1.5 μm or 5.0 μm, J&W, Scientific, Folsom, CA, USA)<sup>a</sup>, DB-17 (15 m × 0.53 mm i. d., film thickness 1.0 μm, J&W, Scientific)<sup>a</sup>; column temperature: 40 °C (1 min) → 16 °C/min → 250 °C (10 min); injection temperature: 250 °C; splitless mode: 60 s; carrier gas<sup>b</sup> (flow rate): N<sub>2</sub> (1 mL/min), He (15 mL/min); FID conditions<sup>b</sup>: H<sub>2</sub> (35 mL/min), air (400 mL/min); detector temperature: 300 °C; MS conditions<sup>c</sup>: positive ion EI; accelerating voltage: 3 kV; electron energy: 70 eV; ionization current: 0.3 mA; interface temperature: 250 °C.

### ii. GC conditions-2

Column: 1.5 % GE SE-30 Chromosorb W (2 m × 2.6 mm i. d., glass column, GL Sciences, Tokyo, Japan, and similar columns obtainable from other manufacturers); column temperature: 60 °C (2 min) → 2 °C/min → 120 °C (5 min); carrier gas<sup>b</sup> (flow rate): N<sub>2</sub> (40 mL/min), He (40 mL/min); detector temperature: 140 °C

### iii. GC/MS conditions-3 (cold trap)

Instrument: a QP-5000 GC/MS instrument equipped a cryogenic oven trapping system with liquefied carbon dioxide (Shimadzu Corp., Kyoto, Japan); column: an XTI-5 fused silica capillary column (30 m × 0.25 mm i. d., film thickness 0.25 μm, Restek, Bellefonte, PA, USA); column temperature: 40 °C (1 min) → 30 °C/min → 290 °C (5 min); carrier gas (flow rate): helium (2.1 mL/min); MS conditions: positive ion EI; electron energy: 70 eV; interface temperature: 260 °C; scan range: *m/z* 33–200, 0.35 s/cycle.

## Procedures

### i. Headspace method [2–8, 19]

- i. Liquid samples, such as blood and urine, are directly subjected to analysis. Organ specimens, after being frozen, are rapidly minced into small pieces with a scalpel or a knife, or emulsified with a closed-type homogenizer.
- ii. A fixed amount (0.5–2 mL or g) of a specimen is placed in a glass vial<sup>d</sup> containing an internal standard (IS)<sup>e</sup> solution, if necessary, capped airtightly and heated<sup>f</sup> at a temperature (55–65 °C) for a period (15–30 min).
- iii. A volume (0.5–1.0 mL) of the headspace vapor is drawn into a gastight syringe (or a glass syringe), which has been also heated at the same temperature (55–65 °C), and injected into GC<sup>f</sup> [GC(/MS) conditions-1].

### ii. Liquid-liquid extraction method [9]

- i. A 5 mL volume of blood and IS solution (0.001 % *n*-butylbenzene, 0.2 mL<sup>g</sup> are placed in a glass centrifuge tube with a ground-in stopper.
- ii. A 7 mL volume of *n*-pentane is added to the mixture, shaken vigorously and centrifuged at 3,000 rpm for 5 min.
- iii. The upper organic layer is carefully transferred to a vial and condensed into about 200 μL<sup>h</sup>. A 3–5 μL aliquot of it is injected into GC (GC conditions-2).

### iii. Headspace SPME method

- i. A human blood or other specimen (0.2–2 mL or g) is placed in a 10–15 mL volume vial with a screw cap<sup>d</sup> containing IS solution, if necessary (toluene-*d*<sub>8</sub><sup>g</sup>, in case of GC/MS analysis).
- ii. An SPME device (100 μm polydimethylsiloxane, Supelco, Bellefonte, PA, USA) is injected into the vial for exposure of a fiber, heated at 55 °C for 15 min and then cooled at 5 °C for 15 min.
- iii. The device is pulled out of the vial and injected into GC port [GC (/MS) conditions-1].

### iv. Headspace SPME-cold trap method [18]

- i. A human blood or other specimen (0.2 g), IS solution (toluene-*d*<sub>8</sub>, 0.2 or 1 μg) and 0.8 mL distilled water are placed in a 12 mL volume screw-cap vial and capped with a Teflon-coated silicone rubber septum.
- ii. A 100 μm polydimethylsilicone fiber (Supelco) is exposed in the headspace of the vial at 5 °C for 30 min for adsorption of target compounds.
- iii. The SPME device is pulled out of the vial, injected into GC/MS and left there for 3 min (1 min for sampling and 2 min for purging) (GC/MS conditions-3).

### v. Analysis of intratracheal gas (direct injection method) [19]

- i. The front skin of the neck of a cadaver is incised to expose the trachea; a needle of a 2 mL volume glass syringe is inserted into the trachea to obtain the intratracheal gas.
- ii. The tip of the needle is capped with the septum of GC injection; it is injected into a GC port as soon as possible [GC (/MS) conditions-1].

## Assessment of the methods

The gasoline/kerosene analysis is frequently made for the purpose of discrimination between them. The most common method for such analysis is the one by liquid-liquid extraction. However, it is somewhat complicated, tedious and occasionally suffers from interference by compounds with low boiling points being contaminated in an organic solvent used. It is also a problem that some compounds with low boiling points to be analyzed may be lost during the condensation step.

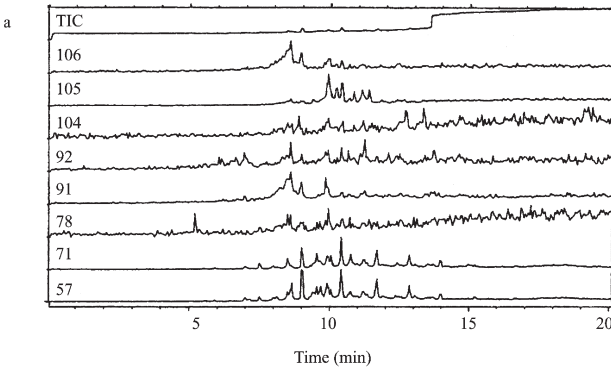
Therefore, the headspace method, without the need of an organic solvent for extraction, is widely used; it is very suitable for analysis of volatile compounds, such as LP and butane gas [2–8]. However, this method is not suitable for compounds with relatively high boiling points (larger than C<sub>10</sub>) and not useful for discrimination between kerosene and light oil.

Since the static headspace method is based on the equilibrium of a compound between gas and aqueous phases, its sensitivity is sometimes not sensitive enough. To overcome this problem, the dynamic headspace and purge-and-trap<sup>i</sup> methods have been developed in recent years. The volatile compounds are purged from a specimen to be trapped by activated charcoal or a column of Tenax<sup>j</sup>, followed by desorption of the compounds by (pulse) heating and introduction into GC (/MS) for analysis. However, these methods require special instrumental devices; and they also suffer from adsorption of water to the activated charcoal, or from difficulty in desorption of compounds with relatively high boiling points from the Tenax column.

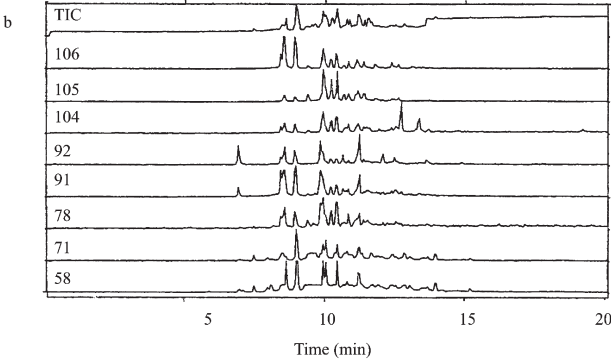
Recently, the headspace SPME method [method (3)] and the combined method [method (4)] have been developed as useful methods for analysis of volatile compounds.

**Figure 9.1**

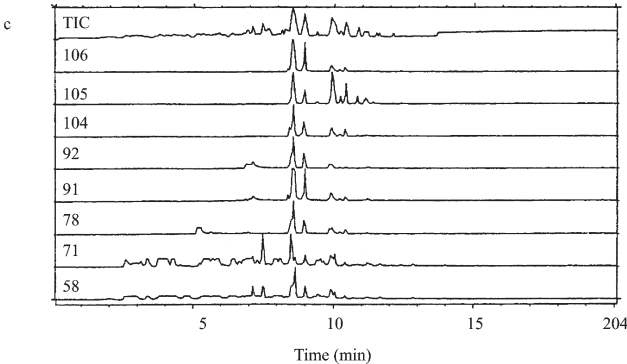
Intra-tracheal gas



Kerosene under long storage



Gasoline under long storage



GC/MS analysis of intratracheal gas in an actual case. TICs and mass chromatograms for each ion are shown. The data on kerosene and gasoline are shown for comparison; the profiles showed that the intratracheal gas contained kerosene. The GC/MS conditions-1 described in the text with a column of DB-1 (30 m × 0.53 mm i. d., film thickness 5 μm) were used. For the panels b and c, each headspace gas was injected into GC/MS. TIC: total ion chromatogram; the numbers shown at the left corners of each panel are mass numbers of ions ( $m/z$ ) used for mass chromatography.

As an application to an actual forensic case, the analysis of intratracheal gas was performed (➤ *Fig. 9.1*, in which kerosene could be detected); it is possible to discriminate among LP gas, gasoline, kerosene and others by the simple direct gas analysis<sup>k</sup> [19], and the presence of such components in the trachea can be regarded as an indicator of vital reaction.

➤ *Figure 9.2* shows the results of GC/MS analysis of gasoline, kerosene and light oil commercially available by the methods of headspace [method (1)], headspace SPME [method (3)] and direct injection. By the headspace method, the discrimination among LP gas, gasoline and kerosene could be achieved [19], but that between kerosene and light oil was somewhat difficult. By the headspace SPME method, the discrimination among gasoline, kerosene and light oil was possible; but there was a trend of low recoveries of compounds with low boiling points. Therefore, by combining the headspace methods with the headspace SPME method, the discrimination of almost all petroleum gas and liquids is possible and applicable to forensic science practice<sup>l</sup>.

In conclusion, for screening of petroleum fuels, such as gasoline, kerosene and others, the headspace GC-FID should be used first. When the peaks are too small by the headspace method to discriminate the petroleum fuels, the GC patterns obtained after liquid-liquid extraction seem useful. In the near future, the automated analysis by the headspace SPME/GC (/MS) will be probably used widely for components of gasoline and kerosene.

## Toxic and fatal concentrations

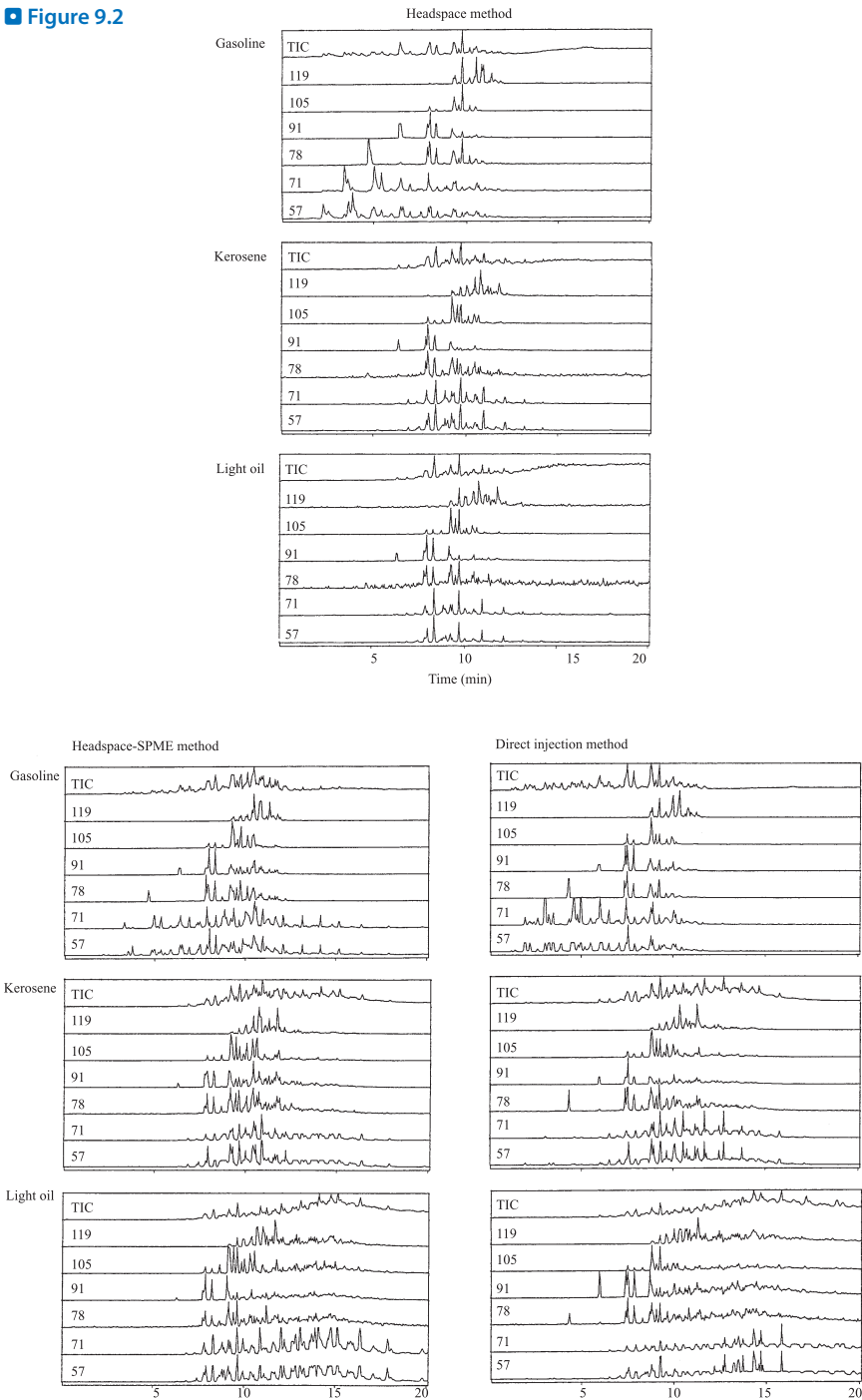
The poisoning cases with gasoline or kerosene are not rare. The most frequent acute poisoning is caused by their oral ingestion [20]. The acute poisoning symptoms by the oral ingestion are causalgia of the oral cavity and the stomach, nausea, vomiting, cyanosis, aspiration pneumonia and lung edema [21]. In the case of aspiration of petroleum fluids into the lung, the symptoms are said to be severer than those caused by the oral ingestion [20]; severe causalgia of the chest, respiratory disturbance, bronchitis and pneumonia appear [21].

Although the toxic concentrations of gasoline in human blood could be hardly found in the literature, the minimum fatal oral dose of gasoline was reported to be 10–50 mL; and that by aspiration not more than several mL [21].

Gasoline and kerosene are composed of many toxic compounds, which are somewhat different according to their brands and even to their lots. Therefore, it seems not desirable to express the toxic and fatal concentrations simply as the amounts of gasoline or kerosene itself. However, toluene and xylene, the most toxic components of gasoline and kerosene can be indicators for their toxicity. In ➤ *Fig. 9.3*, the analytical results by GC for a 28-year-old male, who died by inhalation of gasoline gas inside a automobile trunk with suicidal intent, are shown [8]; each peak appearing in the TICs was identified by GC/MS. The analytical results of this victim are shown in ➤ *Table 9.1* together with those appearing in some reports [5, 6, 8, 22].

Carnevale et al. [5] reported that the gasoline concentration in blood of a 25-year-old male, who had died of gasoline poisoning, was 52 µg/mL (ppm). Matsumoto et al. [7] reported a case, in which a male had been discovered alive in an automobile filled with gasoline vapor; he died 9 days later. They measured gasoline concentrations in his blood at 39 and 63 h after the exposure, and estimated the initial gasoline concentration in blood to be 247 µg/mL. In the above case [8], the blood concentrations of toluene and xylene were 7.66 and 12.6 µg/mL, respectively, which were almost fatal.

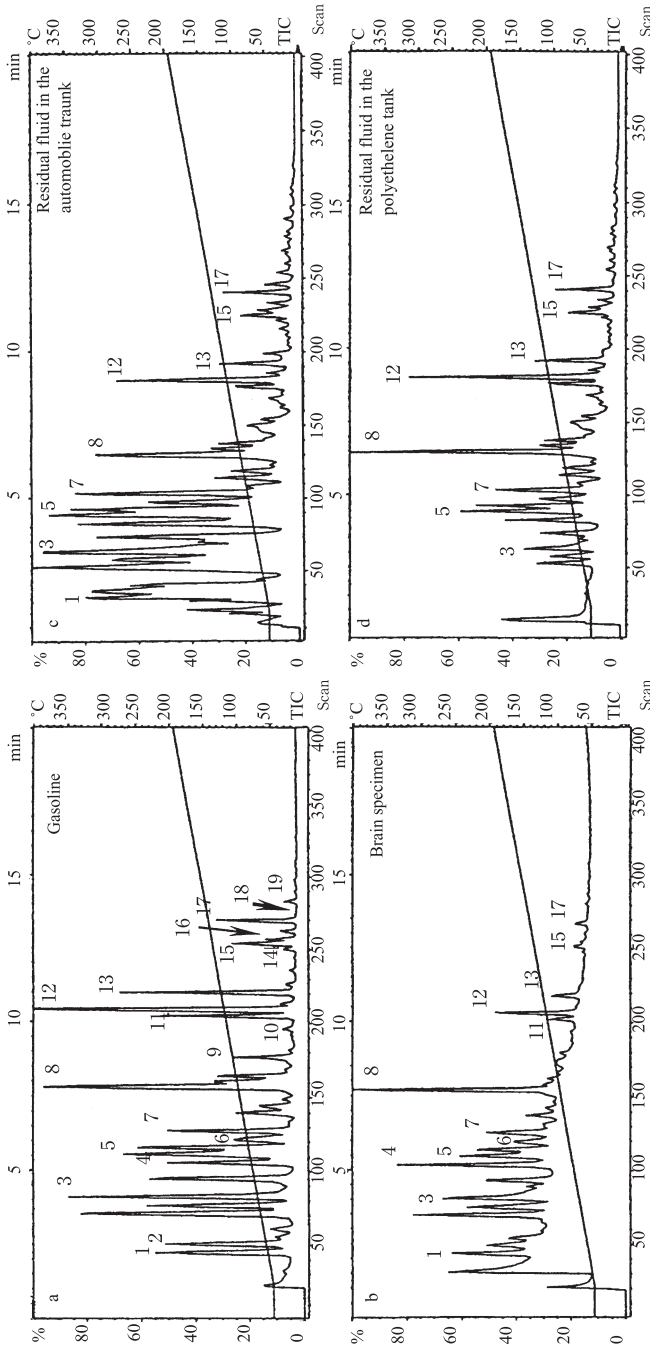
Figure 9.2



GC/MS analysis of gasoline, kerosene and light oil commercially available by the methods of headspace extraction, headspace-SPME and direct injection. The GC/MS conditions-1 described in the text were used with the same column as specified in [Fig. 9.1](#).



Figure 9.3



TICs obtained by headspace GC/MS for specimens collected from an actual case of gasoline poisoning. The GC/MS conditions-1 described in the text were used with the same column as specified in Fig. 9.1. Each peak was identified by measurements of mass spectra as follows. 1: isopentane, 2: *n*-pentane, 3: *n*-hexane, 4: benzene, 5: 2,4-dimethylpentane, 6: 1-heptene, 7: *n*-heptane, 8: toluene, 9: *n*-octane, 10: 2-octane, 11: *o*-xylene, 12: *m,p*-xylene, 13: ethylbenzene, 14: *n*-propylbenzene, 15: 4-ethyltoluene, 16: 1,3,5-trimethylbenzene, 17: 1,2,4-trimethylbenzene, 18: *n*-decane, 19: 1,2,3-trimethylbenzene (from reference [8] with permission).

**Table 9.1**  
Concentrations of gasoline and its components in blood and organs in fatal cases of gasoline poisoning

Case	Age	Sex	Compound identified	Concentration ( $\mu\text{g}/\text{mL}$ or g)							Ref		
				Blood	Brain	Lung	Liver	Kidney	Sceretal muscle	Adipose tissue		Oil used	
1	18	M	Gasoline (a peak, RT 1 min)	-	300-400	-	-	-	-	-	-	Gasoline	[22]
2	18	M	Gasoline (a peak, RT 1 min)	+	+	400	700	+	-	-	-	Gasoline	[22]
3	25	M	Gasoline (2-methyl pentane)	51.5	44.2	457	663	51.5	-	-	-	Gasoline	[5]
4	44	M	Isopentane <i>n</i> -Pentane 2-Methyl-2-butene 2-Methylpentane 3-Methylpentane <i>n</i> -Hexane Ethanol	0.051 0.241 0.284 0.186 0.222 0.447 2.21 (mg/mL)	-	-	-	-	-	-	-	Gasoline	[6]
5	28	M	Toluene Xylene	7.66 12.6	40.8 40.7	5.34 14.6	27.9 23.1	5.38 7.49	14.8 12.9	15.3 12.2	-	Gasoline	[8]

Nelm et al. [22] dared to use the values in terms of gasoline in the cases of gasoline poisoning (▶ *Table 9.1*), but the analysis of each component is, of course, desirable to assess the toxicity.

For poisoning with kerosene, the symptoms were reported almost the same as those for gasoline [21]; the fatal oral dose in humans was estimated to be 90–120 g [21]. The analytical data of kerosene and its components in human specimens are not found, but are estimated to be similar to those of gasoline.

## Notes

- a) Retention times of petroleum components are, of course, different with different DB-17 and DB-1 columns and with different film thickness, which should be confirmed by each analyst. The retention times with an HP-17 column probably differ from those with the DB-17 column in spite of the same material, size and film thickness; this is also true between HP-1 and DB-1. By the use of GS-Q column (30 m × 0.53 mm i. d., J&W, Scientific), the discrimination among LP gas, gasoline and kerosene can be also made [19, 23].
- b) The conditions are different in different types of instruments and are required for careful readjustment.
- c) The MS conditions in the EI mode, which is most common, are shown. The positive EI mode gives the most reproducible, sensitive and stable results for both qualitative and quantitative analysis.
- d) For headspace extraction, a vial cap with a septum made of materials containing rubber (including Teflon and silicon rubber) is to be avoided, if possible. The safest one is the vial with a screw cap with a cork disk coated with aluminum foil on the inside surface (Nichidenrika Glass, Tokyo, Japan and any other manufacturer). In this case, it is necessary to drill a hole through the central part of each plastic cap (not trough the cork disk) beforehand.
- e) The petroleum fluids contain too many compounds to be quantitated by GC-FID with use of an IS. However, by GC/MS, the accurate quantitation of the components becomes possible with stable isotopic ISs, such as toluene- $d_8$  (at about 10 µg/mL, 10 ppm),  $C_{10}D_{22}$ ,  $C_{11}D_{24}$ ,  $C_{12}D_{26}$ ,  $C_{13}D_{28}$ ,  $C_{14}D_{30}$  or  $C_{15}D_{32}$  (Cambridge Isotope Lab., Woburn, MA, USA) [also see the below g)].
- f) With use of an autosampler for headspace extraction, accurate determination can be made even with caps with Teflon or silicone rubber septa, because highly reproducible measurements can be achieved with a fixed time and temperature for heating; however, butyl rubber septa cause too many impurity peaks and thus should not be used.
- g) In GC/MS, 1–10 µg/mL of toluene- $d_8$  or  $C_{10}D_{22}$  dissolved in 10 % (v/v) Tween-20 (polyoxyethylene sorbitan monooleate, Nacalai Tesque, Kyoto, Japan and other manufacturers) aqueous solution can be used as IS [also see the above e)].
- h) The condensation is made under the stream of nitrogen without warming. Care should be taken not to dry or condense too much.
- i) The examples of the purge-and-trap instruments are: Tekmar 3000J/4000J, CP 4020 PTI/TCT (GL Sciences) and Curie point headspace sampler (JHS-100, Nihon Bunseki Kogyo, Tokyo, Japan).

- j) It is activated by heating at 260 °C for 30 min before use.
- k) There are also reports dealing with the usefulness of intratracheal contents (not air) [24, 25].
- l) The specimens obtained at the scene of a fire usually give profiles of peaks different from those of an oil actually used for ignition, because of the evaporation of low-boiling point components during burning and intervals after the fire; such changes should be taken into consideration upon each judgement. For identification of environmental pollutants, care should be taken for the possibility of the presence of multiple oils and of denaturation due to a long storage or use.

## References

- 1) Japanese Society of Chemistry (ed) (1995) *Chemistry Handbook*, 5th edn. Applied Chemistry. Maruzen, Tokyo, pp 735–774 (in Japanese)
- 2) Nagata T, Kagaura M, Hara K et al. (1977) Gas chromatography-mass spectrometric termination of gasoline in blood. *Jpn J Legal Med* 31:136–139 (in Japanese with an English abstract)
- 3) Kimura K, Nagata T, Hara K et al. (1988) Gasoline and kerosene components in blood-A forensic analysis. *Hum Toxicol* 7:299–305
- 4) American Society for Testing and Materials ASTM (2001) *Annual Book of ASTM Standards*. West Conshohocken, PA
- 5) Carnevale A, Chiarotti M, De Giovanni N (1983) Accidental death by gasoline ingestion. Case report and toxicological study. *Am J Forensic Med Pathol* 4:153–157
- 6) Ikebuti J, Kotoku S, Yashiki M et al. (1986) Gas chromatographic and gas chromatographic-mass spectrometric determination of gasoline in a case of gasoline vapor and alcohol poisoning. *Am J Forensic Med Pathol* 7:146–150
- 7) Matsumoto T, Koga M, Sata T et al. (1992) The change of gasoline components in blood in a case of gasoline intoxication. *J Toxicol Clin Toxicol* 30:653–662
- 8) Nishigami J, Ohshima T, Kondo T et al. (1994) A suicidal case due to inhalation of gasoline vapor in the trunk of a car. *Jpn J Forensic Toxicol* 12:33–39
- 9) Shiono H, Matsubara K, Akane A et al. (1989) Immolation after drinking kerosene. *Am J Forensic Med Pathol* 10:229–231
- 10) Twibell JD, Home JM (1977) Novel method for direct analysis of hydrocarbons in crime investigation and air pollution studies. *Nature* 268:711–713
- 11) Ojanpera I, Pihlainen K, Vuori E (1998) Identification limits for volatile organic compounds in the blood by purge-and-trap GC-FTIR. *J Anal Toxicol* 22:290–295
- 12) Kärkkäinen M, Seppälä I, Himberg K (1994) Detection of trace levels of gasoline in arson cases by gas chromatography-mass spectrometry with an automatic on-line thermal desorber. *J Forensic Sci* 39:186–193
- 13) Lee XP, Kumazawa T, Sato K (1995) A simple analysis of 5 thinner components in human body fluids by headspace solid-phase microextraction(SPME) *Int J Legal Med* 107:310–313
- 14) Iwasaki Y, Yashiki M, Nagasawa N et al. (1995) Analysis of inflammable substances in blood using headspace-solid phase microextraction and chemical ionization selected ion monitoring. *Jpn J Forensic Toxicol* 13:189–194
- 15) Almirall JR, Bruna J, Furton KG (1996) The recovery of accelerants in aqueous samples from fire debris using solid-phase microextraction. SPME. *Sci Justice* 36 :283–287
- 16) Furton KG, Almirall JR, Bruna JC (1996) A novel method for the analysis of gasoline from fire debris using headspace solid-phase microextraction. *J Forensic Sci* 41:12–22
- 17) Namera A, Yashiki M, Kojima T et al. (1998) Solid phase microextraction in forensic toxicology. *Jpn J Forensic Toxicol* 16:1–15 (in Japanese with an English abstract)
- 18) Liu J, Hara K, Kashimura S et al. (2000) Headspace solid-phase microextraction and gas chromatographic-mass spectrometric screening for volatile hydrocarbons in blood. *J Chromatogr B* 748:401–406
- 19) Takayasu T, Ohshima T, Kondo T et al. (2001) Intratracheal gas analysis for volatile substances by gas chromatography/mass spectrometry-Application to forensic autopsies. *J Forensic Sci* 46:98–104


- 20) Naito H (2001) Poisoning of Industrial products, Gases, Pesticides, Drugs, and Natural Toxins. Cases, Pathogenesis and its Treatment, 2nd edn. Nankodo, Tokyo, pp 2–7 ( in Japanese)
- 21) Yoshimura S, Hayata M, Yamazaki F et al. (1996) Acute Poisoning Information File, 3rd edn. Hirokawa Publishing Co, Tokyo, p 341, 343 (in Japanese)
- 22) Nelms RJ Jr, Davis L, Bond J (1970) Verification of fatal gasoline intoxication in confined spaces utilizing gas-liquid chromatography. *Am J Clin Pathol* 53:641–646
- 23) Takayasu T, Ohshima T, Nishigami J et al. (1995) Screening of volatile substances and determination of toluene (a thinner component) in the blood and urine in emergency medical care and autopsy cases by the pulse heating method. *J Clin Forensic Med* 2:65–72
- 24) Takatori T (1980) Gas chromatographic determination of kerosene components from cadaveric hypopharyngeal contents. *Hokkaido J Med Sci* 55:471–473
- 25) Yoshida M, Watabiki T, Tokiyasu T et al. (1994) Case of death by fire with kerosene – analysis of contents of trachea and stomach. *Jpn J Legal Med* 48:96–104 (in Japanese with an English abstract)

## II.2.1 Amphetamines and their metabolites

By Nariaki Takayama and Kazuichi Hayakawa

### Introduction

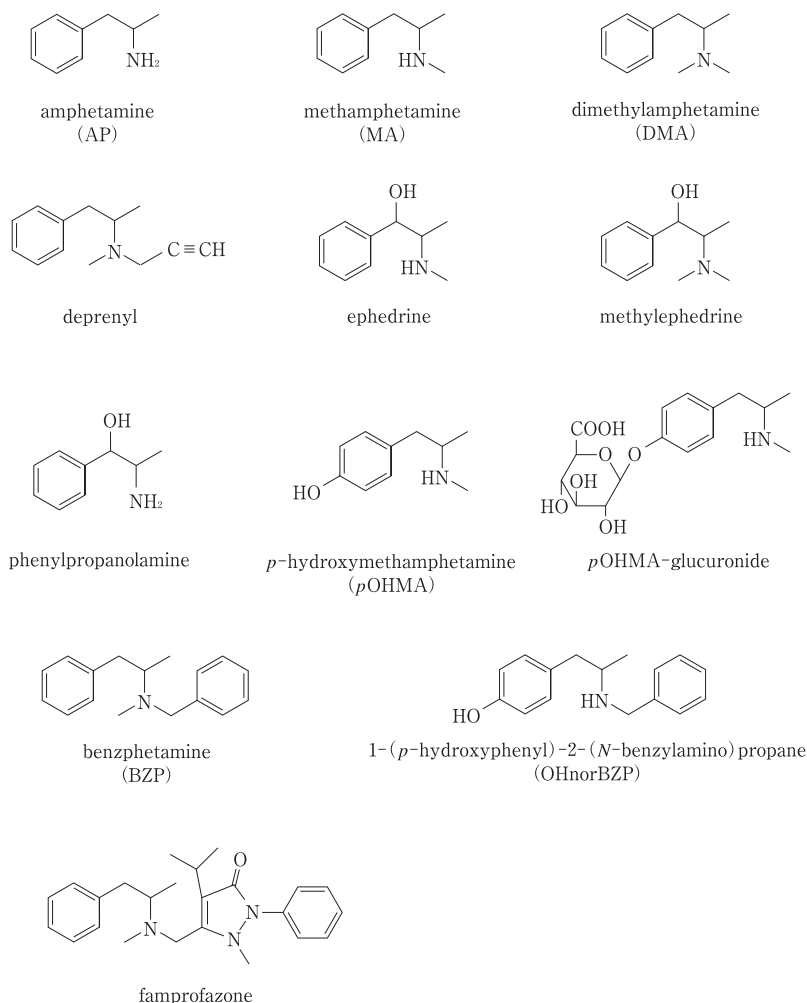
Amphetamines are a group of drugs stimulating the central nervous system; they act on the cerebral cortex to enhance psychic activities, resulting in the removal of general fatigue and drowsiness and thus in the transient improvement of working efficiency. Their abuse causes dependence, hallucination, delusion and changes in personality. Because of such harmfulness of the drugs, their use and possession are prohibited by the Stimulant Drugs Control Law in Japan [1]. The recent methamphetamine (MA) abuse is characteristically involving young generation, and causing a serious social problem; it is regarded as the 3rd peak period of MA abuse [2]. The drug is being smuggled from China, Korea Peninsula and the so-called “Golden Triangular Zone” [3], where borders of Myanmar, Thailand and Laos are intercrossing.

The stimulant drugs include amphetamine (AP, 1-phenyl-2-aminopropane), MA (1-phenyl-2-methylaminopropane) and their salts. As an ethical drug for treatment of depression, only MA hydrochloride (commercial name: Philopon) is available from Dainippon Pharmaceutical Co., Ltd., Osaka in Japan. Most of MA being abused is the one smuggled from abroad. In the Stimulant Drugs Control Law, dimethylamphetamine (DMA, 1-phenyl-2-dimethylaminopropane), deprenyl (*N*- $\alpha$ -dimethyl-*N*-2-propynylphenethylamine), ephedrine, phenylpropanolamine (racemic norephedrine), methylephedrine, chloroephedrine, chloromethylephedrine, phenylacetic acid, phenylacetoacetonitrile, phenylacetone are also being controlled as materials for producing MA or AP ( Figure 1.1).

Unchanged MA, its metabolite AP and *p*-hydroxymethamphetamine (*p*OHMA)<sup>a</sup> are usually detected from urine of MA abusers. Recently, the abuse of DMA, a material for producing amphetamines, has been reported; DMA is partly metabolized into MA, AP and *p*OHMA, which are excreted into urine together with unchanged DMA [4, 5]. Therefore, it is now essential to test the presence of DMA<sup>b</sup> for urine of abusers in order to discriminate between DMA and MA abusers. Benzphetamine (BZP) is commercially available in USA as a slimming drug (Didrex); a major part of the drug is metabolized into 1-(*p*-hydroxyphenyl)-2-(*N*-benzylamino)propane (OHnorBZP), and a minor part of it into MA, which are both excreted into urine. Thus, the detection of OHnorBZP has also become required for urine specimens of MA abusers [6, 7].

The optical isomers of MA exist, because of the presence of asymmetric carbon in the MA structure. The medical drug Philopon is the *d*-isomer of MA. MA being abused is largely its *d*-form, but the *l*-form has occasionally become detectable from specimens of abusers [8]. However, according to the Control Law in Japan, the optical isomers are not discriminated; both *d*- and *l*-forms are the objects of legal control. The effective ingredient of a nasal decongestant Vicks Inhaler, being sold in U.S.A., is *l*-MA. Selegiline (*l*-deprenyl, FP®, Fujimoto Pharmaceutical, Osaka, Japan) started to be used for treatment of Parkinson's disease from

Figure 1.1



**Chemical structures of amphetamines and their related compounds to be dealt with in this chapter.**

December, 1998 in Japan; it is metabolized into *l*-MA followed by *l*-AP to be excreted into urine [9]<sup>b</sup>. Famprofazone (➔ Figure 1.1), an effective ingredient of an analgesic Gewodin® being sold in Germany, is also metabolized into racemic MA to be excreted into urine. Nowadays, chiral analysis of amphetamines has become necessary, because of the above reasons.

For the final identification of a trace drug or poison in human specimens, the measurements of mass spectra are essential. Many methods for detection and determination of MA, AP and related compounds were reported using GC, HPLC, GC/MS and LC/MS. In this chapter, GC and HPLC are first presented as usual methods for analysis of MA, AP and related compounds; the methods by GC/MS and LC/MS are also described as the final confirmatory tests. In addition, a new capillary electrophoresis (CE) method for the compounds is also introduced.

## Reagents and their preparation

---

- *d*-MA hydrochloride is obtainable from Dainippon Pharmaceutical Co., Ltd., Osaka, Japan or Sigma, St. Louis, MO, USA with a proper legal procedure; *d*-AP sulfate: it can be synthesized by the method of Blackburn and Burghard [10] also with a legal procedure; *dl*-AP sulfate (previous commercial name: Zedrin®) was obtained from Takeda Chem. Ind. Ltd., Osaka, Japan; *l*-MA hydrochloride and *l*-AP sulfate donated from the Ministry of Health, Labor and Welfare of Japan; *p*OHMA from Sigma; trifluoroacetic anhydride (TFAA) obtainable from Wako Pure Chemical Industries, Ltd., Osaka, Japan and other manufacturers; OHnorBZP was synthesized by the method of Niwaguchi et al. [11].
- A 30-mL volume of chloroform is mixed with 10 mL isopropanol to prepare a solvent (3:1, v/v) to be used for extracting MA and metabolites from urine.
- A 10-mg aliquot of diphenylmethane (DPM, Nacalai Tesque, Kyoto, Japan and other manufacturers) is dissolved in 100 mL ethyl acetate to prepare stock solution (100 µg/mL). The solution is diluted 100-fold with ethyl acetate to prepare internal standard (IS) solution (1 µg/mL).
- A 10-mg aliquot of 2-phenylethylamine hydrochloride (PEA, Tokyo Kasei Kogyo Co., Ltd., Tokyo, Japan and other manufacturers) and 10 mg of 1-amino-4-phenylbutane hydrochloride (APB, Tokyo Kasei Kogyo and other manufacturers) are dissolved in 100 mL of ultra-pure water to be used as IS mixture solution (100 µg/mL each) for CE analysis.
- A 5.8-mL volume of phosphoric acid is mixed with ultra-pure water to prepare 10 mL of stock solution (8.5 M). A 0.1-mL volume of the stock solution is dissolved in ultra-pure water to prepare 300 mL solution (2.8 mM) as a mobile phase for the pretreatment-HPLC analysis.
- A 7.7-g aliquot of ammonium acetate is dissolved in 100 mL ultra-pure water to prepare stock solution (1 M). The stock solution is diluted 50-fold and 100-fold with ultra-pure water to prepare a mobile phase (20 mM) for the Simon's reaction-HPLC and a mobile phase (10 mM) for the LC/MS analysis, respectively.
- A 0.91-g aliquot of Tris(hydroxymethyl)aminomethane (Tris, Wako Pure Chemical Industries and other manufacturers) is dissolved in 100 mL ultra-pure water, and the pH of the solution is adjusted to 2.5 by adding 20% phosphoric acid solution. A 1.3-g aliquot of 2,6-di-*O*-methyl-β-cyclodextrin (DM-β-CD, Wako Pure Chemical Industries and other manufacturers) and 0.34 g of β-cyclodextrin (β-CD, many manufacturers) are dissolved in the above solution to prepare an electrolyte (75 mM Tris/10 mM DM-β-CD/3 mM β-CD) for the CE analysis.
- A 9-mL volume of chloroform is mixed with 1 mL methanol and 0.1 mL of 25% ammonia solution to prepare a developing solvent (90:10:1, v/v) for TLC (the volume of the development container, 380 mL).
- A 5-mL volume of 20% sodium carbonate aqueous solution is mixed with 5 mL of 1% sodium nitroprusside (Wako Pure Chemical Industries and other manufacturers) aqueous solution just before use as the Simon's reagent.
- Pure acetaldehyde solution (Wako Pure Chemical Industries and other manufacturers) is placed in a airtight container to obtain acetaldehyde gas to be used for color development of a TLC plate.



## Instrumental conditions

---

### GC analysis

Column: a DB-5 fused silica capillary column (30 m × 0.25 mm i.d., film thickness 0.25 μm, Agilent Technologies, Folsom, CA, USA).

GC conditions; instrument: an Agilent 5890 Series II gas chromatograph (Agilent Technologies, Palo Alto, CA, USA); detectors: an FID and a nitrogen-phosphorus detector (NPD); column temperature: 40° C (1 min) → 60° C/min → 100° C (1 min) → 20° C/min → 250° C (5 min); injection temperature: 200° C; detector temperature: 250° C; injection volume: 1 μL (splitless injection); carrier gas: He; its flow rate: 1.2 mL/min.

### GC/MS analysis

#### i. Usual GC/MS conditions

Column: a DB-5MS fused silica capillary column (30 m × 0.25 mm i.d., film thickness 0.25 μm, Agilent Technologies); instrument: a QP-5050A GC/MS instrument (Shimadzu Corp., Kyoto, Japan); column temperature: 80° C (3 min) → 10° C/min → 200° C (5 min); injection temperature: 200° C; interface temperature: 250° C; injection volume: 1 μL (splitless injection); carrier gas: He; its flow rate: 1.5 mL/min; ionization mode (electron energy): EI (70 eV); detector voltage: 1.5 kV; scan range:  $m/z$  60–250

#### ii. Chiral GC/MS conditions

Column: a β-DEX225 fused silica capillary column coated with cyclodextrin on its inside surface (30 m × 0.25 mm i.d., film thickness 0.25 μm, Supelco, Bellefonte, PA, USA); instrument: an Agilent 5973N GC/MS instrument (Agilent Technologies); column temperature: 60° C (1 min) → 6° C/min → 120° C → 2° C/min → 150° C → 5° C/min → 180° C (3 min); injection temperature: 210° C; interface temperature: 210° C; injection volume: 1 μL (splitless injection); carrier gas: He; its flow rate: 1.0 mL/min; ionization mode (electron energy): EI (70 eV); electron multiplier voltage: 1,094 V; scan range:  $m/z$  35–350

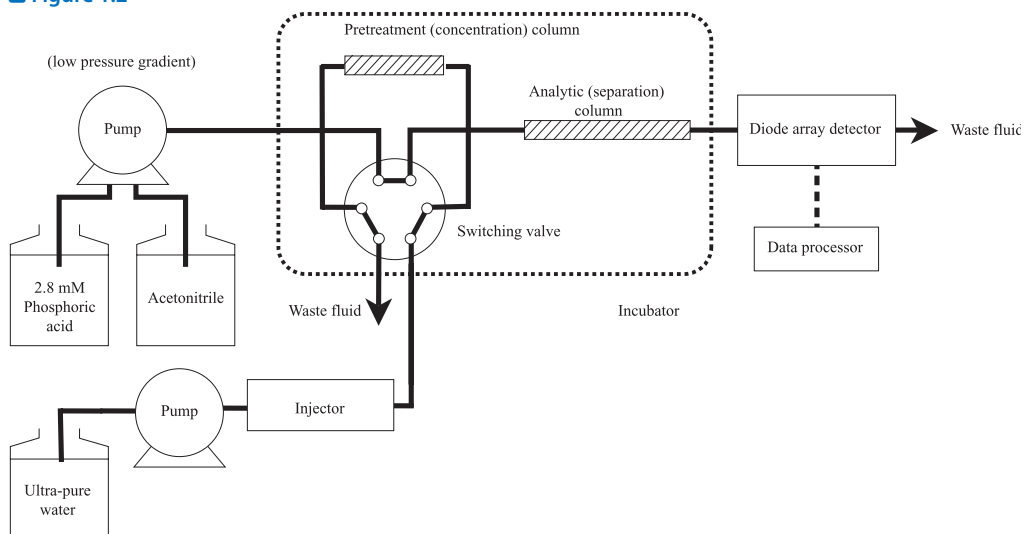
### HPLC analysis

#### i. Usual pretreatment-HPLC conditions

Column: a silica-based ODS column, Develosil ODS-UG-5 (250 × 4.6 mm i.d., Nomura Kagaku, Aichi, Japan); instrument: LC-10Avp (Shimadzu Corp.); mobile phase (gradient elution conditions): acetonitrile/2.8 mM phosphate buffer solution (gradient from 10:90, v/v, to 50:50 for 10 min and hold at 50:50 for 20 min); flow rate: 1.0 mL/min; column temperature: 50° C; injection volume: 10 μL; detector: a diode array detector (DAD, detection wavelength 205–350 nm); pretreatment column: a polyvinyl alcohol resin column, Shim-pack SPC-RP3 (30 × 4.0 mm i.d., Shimadzu GLC Center, Tokyo, Japan)

The specimen solution and ultra-pure water are introduced into the pretreatment column at a flow rate of 1.0 mL/min for 2 min to trap a target compound in the column; by

Figure 1.2



### Outline of the system for the usual pretreatment-HPLC.

switching the valve, the mobile phase is poured in the opposite direction through the pretreatment column to bring the target compound to the separation (analytical) column. The outline of the system is shown in [Figure 1.2](#)

### ii. Simon's reaction-HPLC conditions

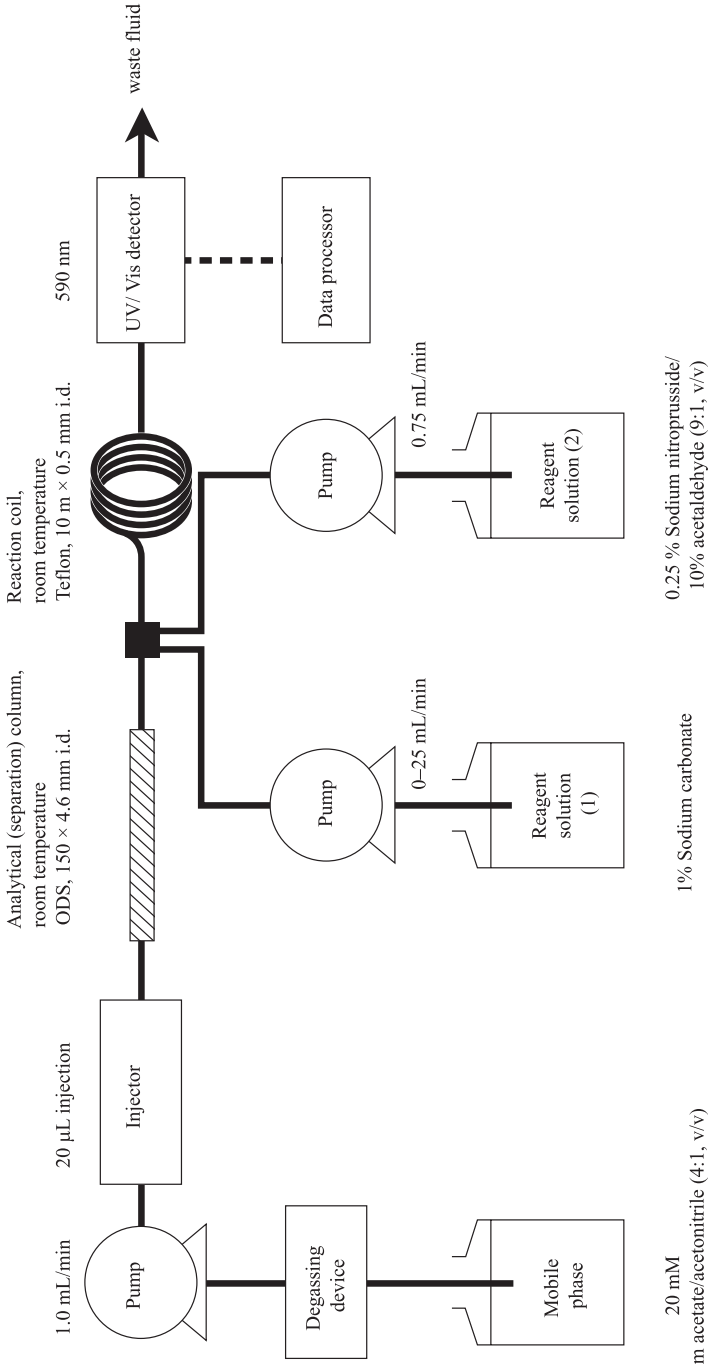
The Simon's reaction is made in the post-column mode; the two kinds of reagents are mixed with the post-column mobile phase. The outline of the system is shown in [Figure 1.3](#). Column: a silica-based ODS column, L-column ODS (150 × 4.6 mm i.d., Chemicals Evaluation and Research Institute, Tokyo, Japan); instrument: LC-10A (Shimadzu Corp.); mobile phase (isocratic elution mode): acetonitrile/20 mM ammonium acetate solution (20:80, v/v); flow rate: 1.0 mL/min; reaction solution (1): 1% sodium carbonate aqueous solution, 0.25 mL/min; reaction solution (2): 0.25% sodium nitroprusside aqueous solution/10% acetaldehyde aqueous solution (90:10, v/v), 0.75 mL/min; reaction coil: 10 m × 0.5 mm i.d.; injection volume: 20 μL; detector: a UV-visible detector (detection wavelength 590 nm); column and reaction coil temperature: room temperature

## LC/MS analysis

### i. Usual LC/MS conditions

Column: L-column ODS (150 × 2.1 mm i.d., Chemicals Evaluation and Research Institute); instrument: M-8000 LC/MS (Hitachi, Tokyo, Japan); mobile phase (isocratic elution mode): methanol/10 mM ammonium acetate solution (15:85, v/v); flow rate: 0.2 mL/min; column temperature: 40° C; injection volume: 10 μL; ionization mode: sonic spray ionization (SSI); polarity: positive electric charge mode; drift and focus voltage: 30 V; chamber voltage: 1.2 kV; assisting gas: nitrogen, 2.4 kg/cm<sup>2</sup>; target gas: He; scan range: *m/z* 70–250

Figure 1.3



Outline of the system of the Simon's reaction-HPLC and its analytical conditions.

## ii. Chiral LC/MS conditions

Column: a silica-based ODS column bound with cyclodextrin, Chiral Drug Column (150 × 2.0 mm i.d., Shiseido, Tokyo, Japan); instrument: an Alliance LC/MS instrument attached with ZMD (Waters, Milford, MA, USA); mobile phase (isocratic elution mode): methanol/acetonitrile/10 mM ammonium acetate solution (30:10:60, v/v); flow rate: 0.25 mL/min; column temperature: 40° C; injection volume: 10 µL; ionization mode: electrospray ionization (ESI); polarity: positive electric charge mode; capillary voltage: 3.5 kV; cone voltage: 30 V; sheath gas: nitrogen (400° C, 400 L/h); scan range:  $m/z$  80–350

## CE analysis

Capillary: 80.5 cm (effective length 72 cm) × 75 µm i.d. fused silica bubble cell (Agilent Technologies, Waldbronn, Germany)

CE conditions; instrument: an Agilent CE system (Agilent Technologies); capillary temperature: 25° C; impressed voltage: +30 kV; sample injection: 50 mbar × 3 s; detection wavelength: 195 nm; electrolyte: aqueous solution containing 75 mM Tris/10 mM DM-β-CD/3 mM β-CD

## Specimens and procedures

### Specimens

Urine specimens obtained from abusers of MA and DMA and from selegiline users were used. The mean concentration of MA in urine of MA abusers was reported to be 66 µg/mL (mean of 68 subjects) [12].

### Procedures

- i. A 10-mL volume of urine is alkalinized by adding 1 mL of 15% sodium carbonate solution, and extracted with 10 mL of chloroform/isopropanol three times. For urine of CE analysis, 100 µL of the mixture solution of PEA and APB (100 µg/mL each) is added beforehand.
- ii. The combined organic layer is dehydrated by adding about 1 g of anhydrous sodium sulfate and filtrated through a filter paper. A small amount of the organic filtrate is subjected to GC analysis (➤ *Figure 1.4*, an analysis example for urine of a DMA abuser).
- iii. The organic filtrate is evaporated to dryness after adding 1–2 drops of 10% hydrochloric acid solution, under a stream of nitrogen or with a rotary evaporator.
- iv. The resulting residue is dissolved in 0.5 mL ultra-pure water to serve as specimens of analysis [13]. Parts of the aqueous solution can be directly subjected to the usual pretreatment-HPLC (➤ *Figure 1.5*, an analysis example for urine of a DMA abuser), the Simon's reaction-HPLC (➤ *Figure 1.6*, an analysis example for urine of an MA abuser to which OHnorBZP had been spiked), the usual LC/MS (➤ *Figure 1.7*, an analysis example for urine of a DMA abuser), the chiral LC/MS (➤ *Figure 1.8*, an analysis example for urine of

an MA abuser) and the CE (▶ *Figure 1.9*, an analysis examples for urine specimens of an MA abuser and a selegiline user).

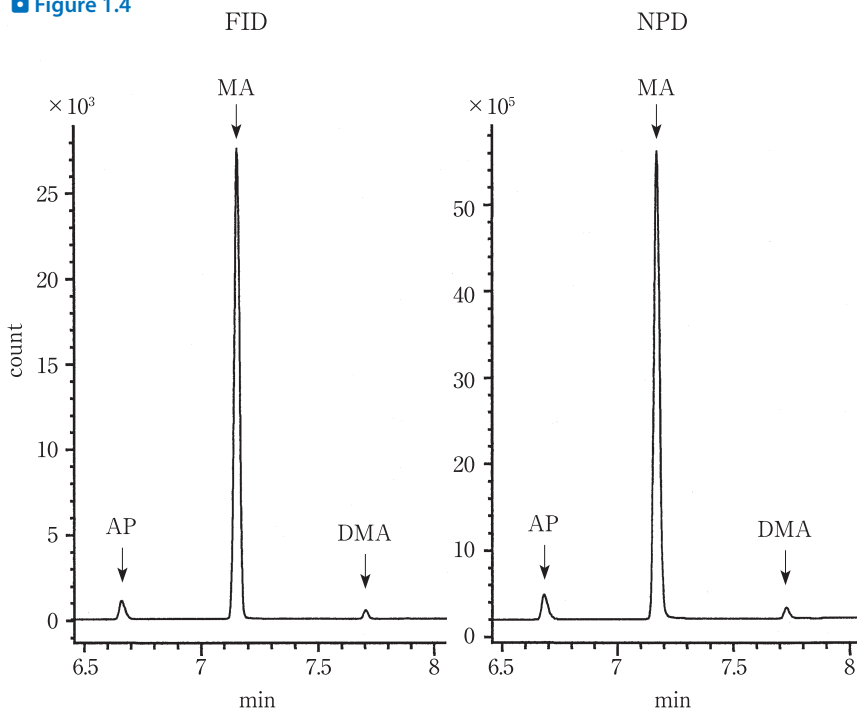
- v. For analysis requiring derivatization, the following procedure is used. A 0.1-mL volume of the above aqueous solution is evaporated to dryness under a stream of nitrogen in a screw cap vial; ethyl acetate and TFAA, 0.2 mL each, are added to the residue, capped airtightly and vortex-mixed.
- vi. The vial is heated at 55° C for 15 min; the content is evaporated to dryness under a gentle stream of nitrogen, dissolved in 0.5 mL of the IS solution containing 1 µg/mL DPM and subjected to the usual GC/MS [13] (▶ *Figure 1.10*, an analysis example for urine of an MA abuser) and to the chiral GC/MS (▶ *Figure 1.11*, an analysis example for urine of an MA abuser).

## Assessment and some comments on the methods

### Characteristics and cautions for each method

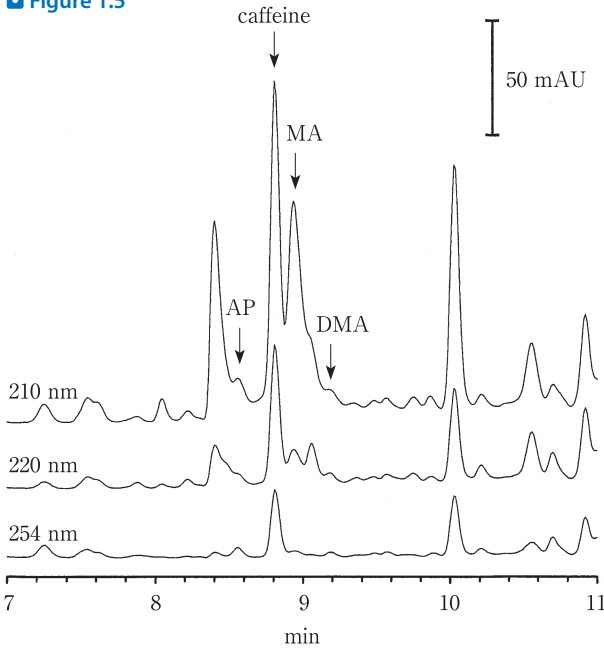
Free base of amphetamines can be analyzed by GC with an FID and an NPD without any derivatization (▶ *Figure 1.4*); the organic extract can be directly injected into GC.

■ **Figure 1.4**



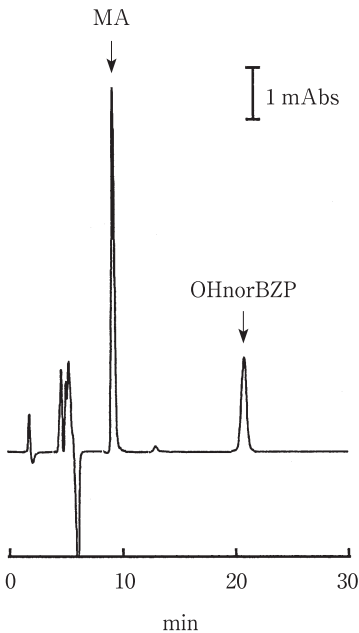
**Detection of methamphetamine (MA), amphetamine (AP) and dimethylamphetamine (DMA) from urine of a DMA abuser by GC-FID and GC-NPD. The drugs were not derivatized.**

Figure 1.5



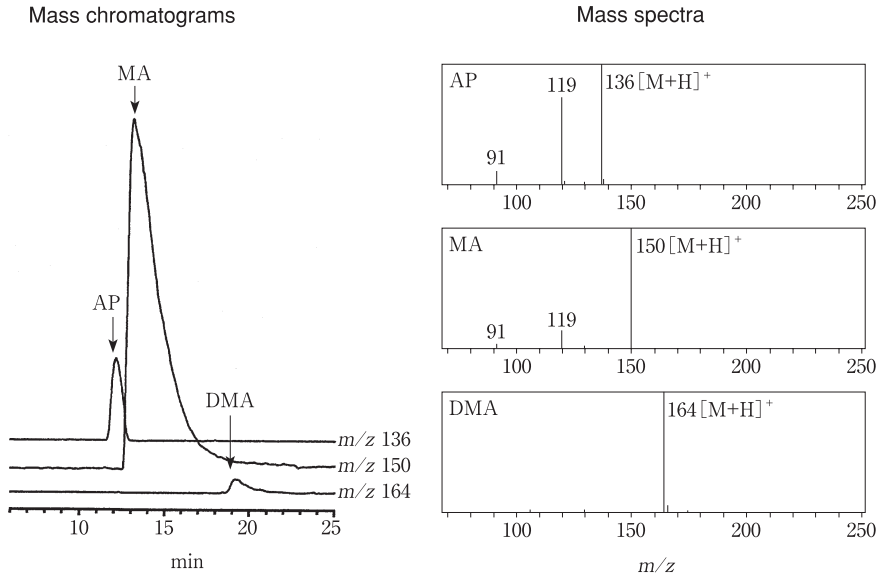
Detection of MA, AP and DMA from urine of a DMA abuser by the usual pretreatment-HPLC.

Figure 1.6



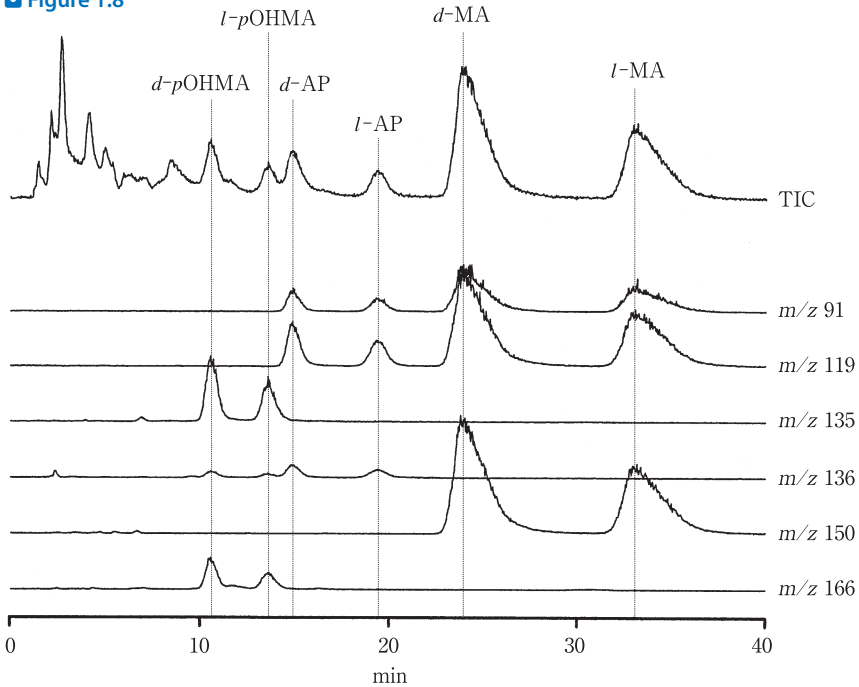
Detection of MA and spiked OHnorBZP (a metabolite of benzphetamine) from urine of an MA abuser by the Simon's reaction-HPLC. The concentration of OHnorBZP spiked was 4 µg/mL.

Figure 1.7



Detection of MA, AP and DMA from urine of a DMA abuser by the usual LC/MS.

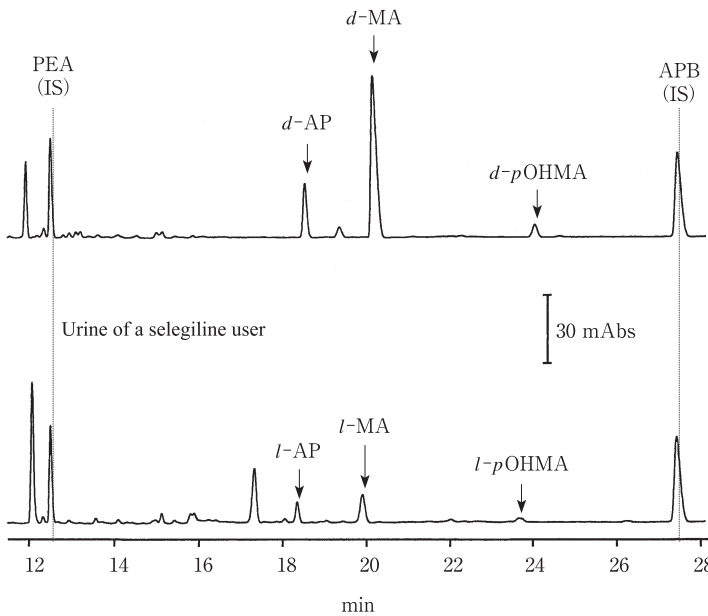
Figure 1.8



Chiral analysis of *d-l*-isomers of MA, AP and *p*-hydroxymethamphetamine (*p*OHMA) in urine of an MA abuser by chiral LC/MS.

■ **Figure 1.9**

Urine of a methamphetamine abuser

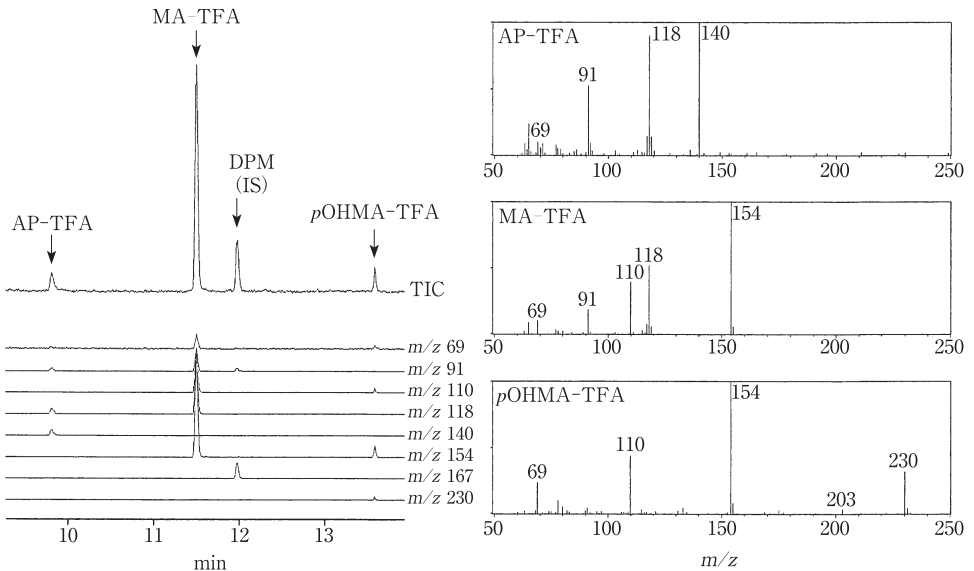


Chiral analysis of *d*-/*l*-isomers of MA, AP and pOHMA in urine of an MA abuser and a selegiline user by capillary electrophoresis (CE).

■ **Figure 1.10**

TIC and mass chromatograms

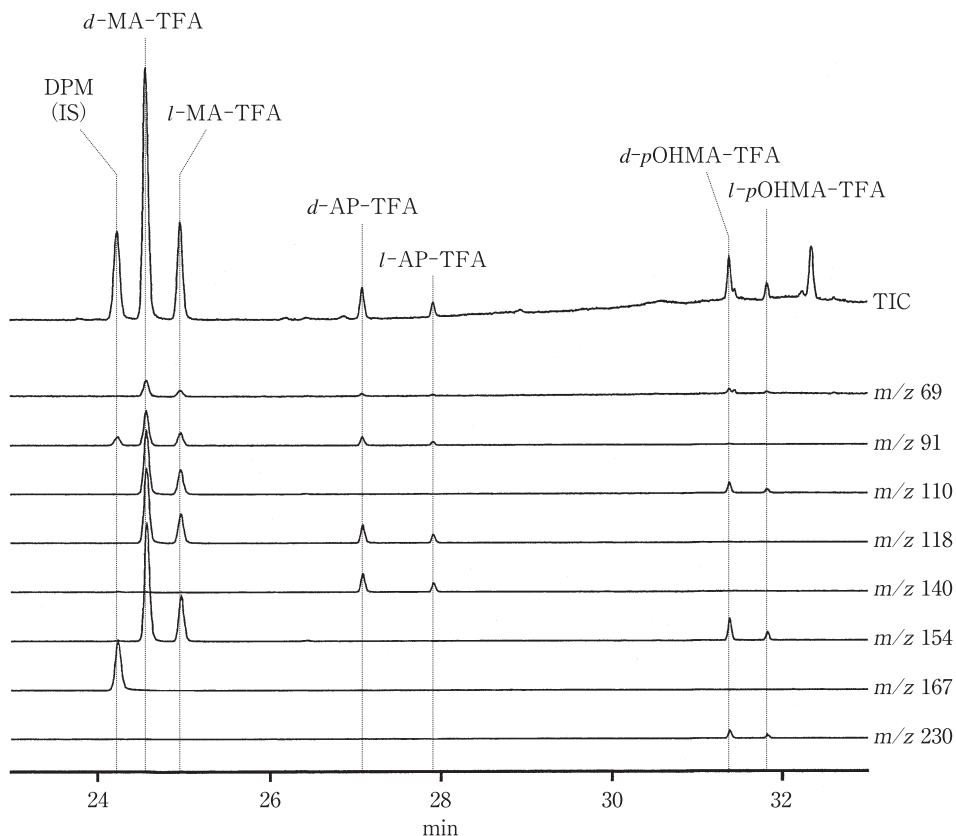
Mass spectra



Detection of TFA-derivatives of MA, AP and pOHMA in urine of an MA abuser by the usual GC/MS.



■ **Figure 1.11**



**Chiral analysis of the TFA- derivatives of *d*-/*l*-isomers of MA, AP and *p*OHMA in urine of an MA abuser by chiral GC/MS.**

The analysis of amphetamines by GC/MS after TFA derivatization (▶ *Figure 1.10*) is used most commonly and shows high reliability.

The chiral GC/MS analysis of amphetamines (▶ *Figure 1.11*) suffers from its instability of the chiral column especially caused by the coexistence of water; care should be taken to dehydrate the organic extract completely.

The usual pretreatment-HPLC analysis (▶ *Figure 1.5*) was made using the same type of HPLC as the one, which had been distributed to every critical care medical center by the Ministry of Health, Labor and Welfare of Japan in 1998.

The Simon's reaction-HPLC analysis (▶ *Figure 1.6*) gives the sensitivity about 100 times higher than that of TLC<sup>c</sup>, although the system of the former is complicated.

Although the instrument to be used for the chiral LC/MS analysis and the corresponding column are expensive, it is advantageous in that no derivatization is required before analysis. There is a possibility of leakage of cyclodextrin from the packing material of the analytical (separation) column, resulting in contamination of the ion source and thus rapid decrease in sensitivity of the instrument.

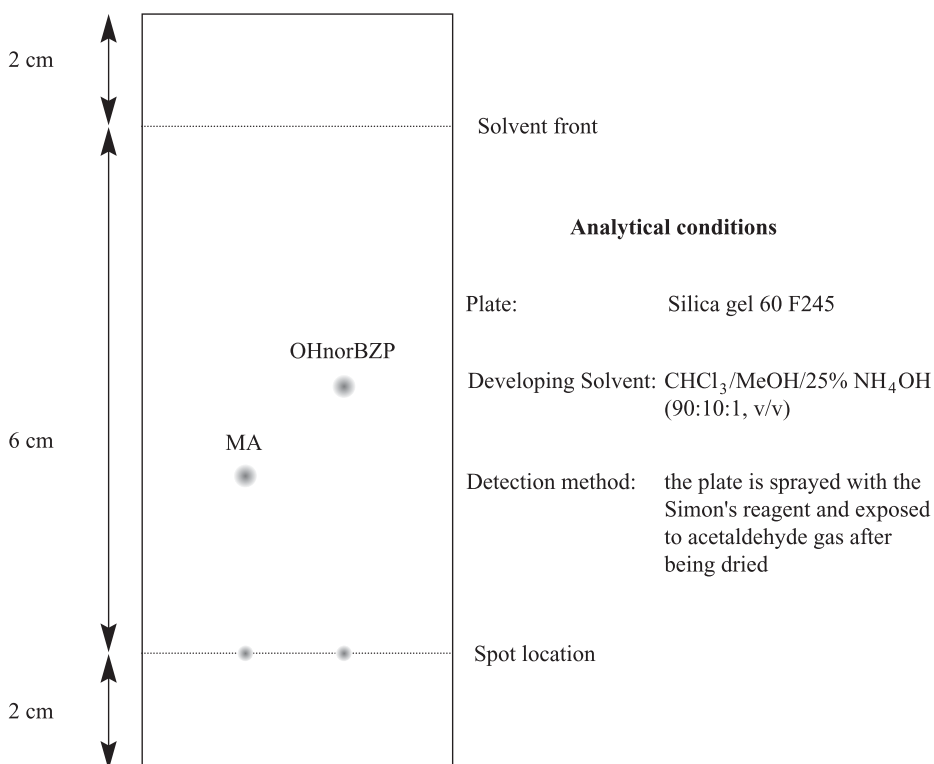
The chiral analysis by CE (➤ *Figure 1.9*) does also not need derivatization. This is the newest instrument; there is no concern about contamination due to carry-over (a phenomenon of contamination by a residual compound which had been used in the previous measurement) with this instrument.

### Detection limits<sup>d</sup> of MA obtained by various methods

GC analysis with an FID and NPD (➤ *Figure 1.4*): 0.5 and 0.05 ng/1  $\mu\text{L}$ , respectively; the usual GC/MS analysis (➤ *Figure 1.10*): 0.05 ng/1  $\mu\text{L}$ ; the chiral GC/MS analysis (➤ *Figure 1.11*): 0.01 ng/1  $\mu\text{L}$ ; the usual pretreatment-HPLC analysis (➤ *Figure 1.5*): 5 ng/10  $\mu\text{L}$ ; the Simon's reaction-HPLC analysis (➤ *Figure 1.6*): 1 ng/20  $\mu\text{L}$ ; the usual LC/MS analysis (➤ *Figure 1.7*): 1 ng/10  $\mu\text{L}$ ; the chiral LC/MS analysis (➤ *Figure 1.8*): 0.5 ng/10  $\mu\text{L}$ ; the CE analysis (➤ *Figure 1.9*): 100 ng/mL; the Simon's reaction TLC (➤ *Figure 1.12*): 100 ng/spot.

■ **Figure 1.12**

TLC plate




Detection of MA and OHnorBZP by the Simon's reaction TLC.

## Toxic and fatal concentrations

Although there are no reports dealing with the relationship between urinary concentrations of MA and poisoning symptoms (toxic and fatal), those between the blood MA concentrations and the symptoms were reported as follows [14–16]: 30–40  $\mu\text{g}$  (all values expressed as not in the salt form but in the free form)/mL, fatal; 5–7  $\mu\text{g}/\text{mL}$ , severe (poisoning death possible); about 1.5  $\mu\text{g}/\text{mL}$ , highly symptomatic (abnormal excitement and high derangement); about 0.8  $\mu\text{g}/\text{mL}$ , intermediately symptomatic (excitement, hallucination and strange behavior); about 0.15  $\mu\text{g}/\text{mL}$ , slightly symptomatic (the levels of habituais); less than 0.15  $\mu\text{g}/\text{mL}$ , no symptoms (therapeutic levels). There is also a report insisting no relationship between blood MA concentrations and psychic symptoms [17].

## Notes

- Since the metabolite of MA, *p*OHMA, is largely excreted into urine in the form of the glucuronate conjugate (*p*OHMA-glucuronide), it is occasionally not detected without any hydrolytic treatment of urine with  $\beta$ -glucuronidase or acid.
- The material compounds for chemical synthesis of MA or AP are neither metabolized into MA, AP nor *p*OHMA, except DMA and deprenyl.
- The data of the Simon's reaction TLC using a fluorescent plate (Merck, Darmstadt, Germany) with silica gel thickness of 0.25 mm are shown in  *Figure 1.12* (an example of analysis of the authentic MA and OHnorBZP). Under the conditions, the  $R_f$  values were 0.35 and 0.50, respectively.
- All detection limits obtained using MS are those measured in the scan mode. When selected ion monitoring (SIM) is used for quantitation, the sensitivity 10–100 times higher can be achieved.

## References

- The Pharmaceutical Society of Japan (ed) (1992) Standard Methods of Chemical Analysis in Poisoning – With Commentary. Nanzando, Tokyo, pp 283–329 (in Japanese)
- The National Police Agency (ed) (2000) Police White Paper 2000, Department of Printing of the Ministry of Finance, Tokyo, p 38 (in Japanese)
- The National Police Agency (ed) (2000) DRUG 2000. Public Relations Department of the National Police Agency, Tokyo, p 15 (in Japanese)
- Inoue T, Suzuki S (1986) Studies on metabolism of methamphetamine analogs 6. Analysis of dimethylamphetamine and its metabolites. Rep Natl Res Inst Police Sci 39:228–234 (in Japanese with an English abstract)
- Inoue T, Suzuki S (1987) The metabolism of dimethylamphetamine in rat and man. Xenobiotica 17:965–971
- Inoue T, Suzuki S (1986) The metabolism of benzphetamine and furfenorex in man. Xenobiotica 16:691–698
- Chinaka S, Tanaka S, Takayama N et al. (2000) Determination of methamphetamine in human urine by HPLC using post-column Simon's reaction. J Health Sci 46:16–20
- Nagai To, Matsushima K, Nagai Ta et al. (2000) Interpretation and enantiomer analysis of methamphetamine abusers, urine and illegally brewed methamphetamine. J Anal Toxicol 24:140–145
- Hasegawa M, Matsubara K, Fukushima S et al. (1999) Stereoselective analyses of selegiline metabolites. Forensic Sci Int 101:95–106
- Blackburn D, Burghard G (1965) Radiosynthesis of dextramphetamine-C14 sulfate. J Pharm Sci 54:1586–1588


- 11) Niwaguchi T, Inoue T, Suzuki S (1982) The metabolism of 1-phenyl-2-(N-methyl-N-benzylamino)propane (benzphetamine) in vivo in the rat. *Xenobiotica* 12:617–625
- 12) Amemiya M, Nagai T (2000) Study on the screening test for urine of stimulant abusers using Triage®. *Jpn J Sci Tech Iden* 4:95–98 (in Japanese with an English abstract)
- 13) Inoue T, Niwaguchi T (1981) Effect of diuretic furosemide on the excretion of methamphetamine and its metabolite into rat urine. *Rep Natl Res Inst Police Sci* 34:142–146 (in Japanese with an English abstract)
- 14) Nagata T, Hara K, Kageura M et al. (1980) Significance of blood and tissue levels of methamphetamine. *Jpn J Legal Med* 34:354 (in Japanese)
- 15) Nagata T (1986) Toxicological examination from the medico-legal aspects. *Jpn J Legal Med* 40:455–464 (in Japanese with an English abstract)
- 16) Inoue T, Tanaka K (1999) Stimulants Q&A: A Chemical Guide for Investigators. Reibunsha, Tokyo, pp 21–22 (in Japanese)
- 17) Miyazaki T (1986) Relationship between methamphetamine and amphetamine concentrations in the blood and symptoms in methamphetamine abusers. *Jpn J Legal Med* 40:132–139 (in Japanese with an English abstract)

## II.2.2 Cannabinoids and their metabolites

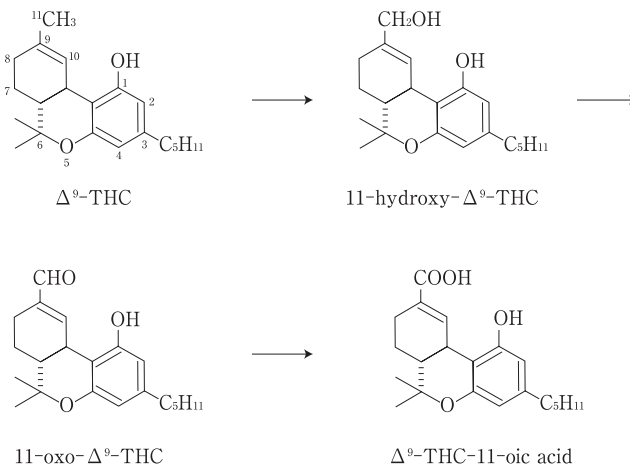
by Kazuhito Watanabe

### Introduction

The plant *Cannabis sativa* L. has a long history for human being since about BC 2000 for its use as fiber material, food and folk medicine; cannabis (hemp, marijuana) means the whole plant itself and its dried products except for its stem and seeds. The word “hashish” is mainly used for the resin of the cannabis plant. Since the main component of cannabis,  $\Delta^9$ -tetrahydrocannabinol ( $\Delta^9$ -THC), has various psychopharmacological effects including hallucination, the cannabis and its components are being controlled under the Cannabis Control Law and the Narcotics Control Law in Japan. For such legal control, analysis of cannabis components and their metabolites is required for plant specimens and human specimens.

The cannabis contains more than 60 analogous components with a  $C_{21}$  skeleton; they are comprehensively called “cannabinoids.” The main cannabinoids are  $\Delta^9$ -THC, cannabidiol (CBD) and cannabinol (CBN). The major metabolic pathway of  $\Delta^9$ -THC is shown in  Fig. 2.1; the methyl group in the 11-position is oxidized to produce  $\Delta^9$ -THC-11-oic acid to be excreted into urine [1, 2]. To diagnose the abuse of cannabis or its component, the analysis of  $\Delta^9$ -THC-11-oic acid in urine is essential. In this chapter, a GC method for analysis of cannabis components in plant specimens and a GC/MS method for  $\Delta^9$ -THC-11-oic acid in urine are presented.

 **Figure 2.1**



**Major metabolic pathway of  $\Delta^9$ -THC.**

## GC analysis of cannabinoids in plant specimens<sup>a</sup>

### Reagents and their preparation

- Extraction and purification of cannabinoids [3]:  
*Cannabis sativa* L. is being grown at Hokuriku University, Faculty of Pharmaceutical Sciences with permission from the Government. The dried plant is minced and immersed in 20 volumes of methanol for 2 days for extraction; this procedure is repeated once. The combined methanolic extracts are evaporated to dryness. The residue is decarboxylated by heating at 140 °C for 20 min. The treated residue is applied to a 20 volumes (against the weight of the plant) of florisil and eluted with benzene for partial purification to remove chlorophyll. Finally, column chromatography with 50 volumes of silica gel is performed using benzene/*n*-hexane/diethylamine (25:10:1, v/v) as eluting solvent for getting each cannabinoid standard.
- $\Delta^9$ -THC, CBD and CBN are separately dissolved in ethanol to prepare 0.05–0.5 mg/mL standard solution for each compound<sup>b</sup>.
- 5 $\alpha$ -Cholestane (Sigma, St. Louis, MO, USA) is dissolved in ethanol to prepare a 0.5 mg/mL solution for use as internal standard (IS).

### GC conditions

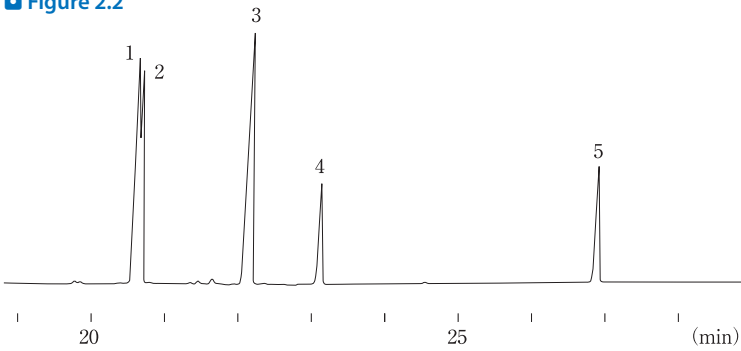
GC column [4]: a fused silica capillary column (slightly polar), HP-5MS (30 m  $\times$  0.25 mm i. d., film thickness 0.25  $\mu$ m, Agilent Technologies, Palo Alto, CA, USA); MDN-5S (30 m  $\times$  0.25 mm i. d., film thickness 0.25  $\mu$ m, Supelco, Bellefonte, PA, USA).

GC conditions; an Autosystem XL (Perkin Elmer, Wellesley, MA, USA) and an FID were used. Column (oven) temperature: 50 °C (2 min)  $\rightarrow$  20 °C/min  $\rightarrow$  200 °C (0.5 min)  $\rightarrow$  5 °C/min  $\rightarrow$  300 °C (5 min); injection temperature: 250 °C; carrier gas (flow rate): He (1 mL/min); FID gas (flow rate): air (400 mL/min) and H<sub>2</sub> (40 mL/min); make-up gas (flow rate): N<sub>2</sub> (30 mL/min); injection volume: 1  $\mu$ L (split ratio 1/50).

### Procedure

- i. A dried specimen is minced and extracted with 10 volumes of methanol with stirring for 10 min at room temperature.
- ii. The above methanol extract is condensed or diluted to an appropriate amount and mixed with a fixed amount of 5 $\alpha$ -cholestane (IS).
- iii. A 1- $\mu$ L aliquot of the above extract is injected into GC for qualitative analysis and for quantitation using the below calibration curve.
- iv. Construction of a calibration curve: the standard solutions at 0.05–0.5 mg/mL mixed with a fixed amount of IS each are prepared for each cannabinoid, and a 1- $\mu$ L aliquot of each solution is injected into GC to construct a calibration curve with cannabinoid concentration on the horizontal axis and with peak area ratio of a cannabinoid to IS on the vertical axis.

Figure 2.2



Gas chromatogram for cannabinoids. 1: CBD; 2: CBC; 3:  $\Delta^9$ -THC; 4: CBN; 5:  $5\alpha$ -cholestane (IS).

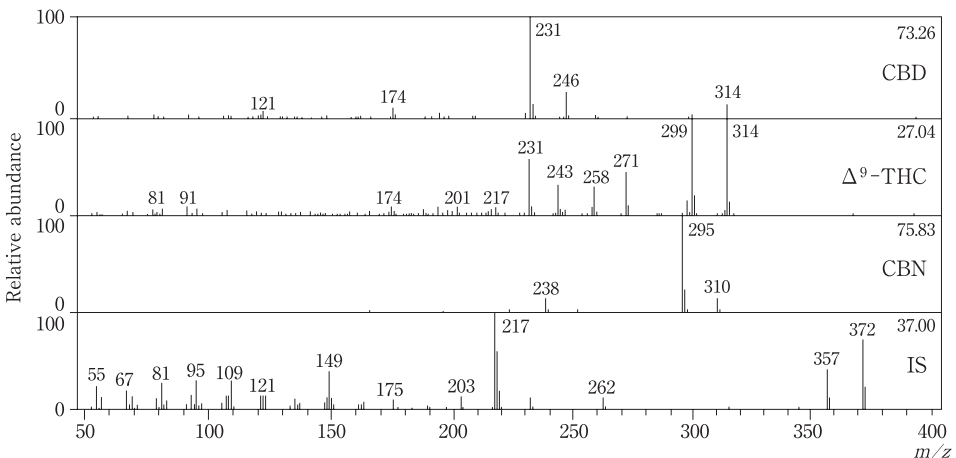
## Assessment and some comments on the method

Figure 2.2 shows a gas chromatogram for  $\Delta^9$ -THC, CBD, CBN and cannabichromene (CBC) obtained under the GC conditions. The peaks of  $\Delta^9$ -THC (22.2 min), CBD (20.6 min) and CBN (23.2 min) are separated well; but the peak of CBC may overlap that of CBD.

When the dried cannabis is analyzed, the peaks of cannabinoids are not interfered with by impurity peaks in background, because the total concentration of cannabinoids in the dry specimen is as high as 0.5 %. For the specimen which had been stored for a long time,  $\Delta^9$ -THC and CBD are converted into CBN by oxidation reaction, resulting in relatively high concentrations of CBN [5]. For discrimination of seeds, a GC method for cannabinoids with benzene extraction was reported [6].

The confirmatory test for cannabinoids should be made by GC/MS. For this purpose, the mass spectra of  $\Delta^9$ -THC, CBD, CBN and  $5\alpha$ -cholestane (IS) are shown in Figure 2.3.

Figure 2.3



EI mass spectra of  $\Delta^9$ -THC, CBD, CBN and  $5\alpha$ -cholestane.

## GC/MS analysis of $\Delta^9$ -THC-11-oic acid in urine<sup>d</sup>

### Reagents and their preparation

- $\Delta^9$ -THC-11-oic acid can be synthesized by the method of Pitt et al. [7]. The author et al. are using the compound supplied by the National Institute on Drug Abuse in USA. The authentic compound is dissolved in ethanol to prepare 0.1 mg/mL solution. IR,  $\gamma^{\text{CHCl}_3}$  1,680  $\text{cm}^{-1}$ ; NMR ( $\text{CD}_3\text{COCD}_3$ )  $\delta$ : 1.08, 1.39 (s, 3H  $\times$  2, gem- $\text{CH}_3$ ), 3.38 (d,  $\text{C}_{10\text{a}}$ -H), 6.15, 6.30 (s, 1H  $\times$  2, aromatic-H), 8.10 (m, 1H,  $\text{C}_{10}$ -H); MS,  $m/z$  344 ( $\text{M}^+$ ).
- 5'-Nor- $\Delta^8$ -THC-4'-oic acid was synthesized by the method of Ohlsson et al. [8]. The compound is dissolved in ethanol to prepare 0.1 mg/mL solution. IR,  $\gamma^{\text{CHCl}_3}$  1,710  $\text{cm}^{-1}$ ; NMR ( $\text{CDCl}_3$ )  $\delta$ : 1.10, 1.38 (s, 3H  $\times$  2, gem- $\text{CH}_3$ ), 1.70 (s, 3H,  $\text{C}_9$ - $\text{CH}_3$ ), 3.22 (dd, 1H  $\text{C}_{10\text{a}}$ -H), 5.42 (m, 1H,  $\text{C}_8$ -H), 6.07, 6.24 (s, 1H  $\times$  2, aromatic-H); MS,  $m/z$  330 ( $\text{M}^+$ ).
- The solution of 5 $\alpha$ -cholestane (IS) is also prepared with the same procedure as those of the above two compounds.

### GC/MS conditions

Analysis with a packed column [9]; column: 5 % SE-30 (2 m  $\times$  2 mm i. d.); GC/MS: a JEOL GCG-06 gas chromatograph connected with a JEOL JMS-DX300 mass spectrometer (JEOL, Tokyo, Japan); column (oven) temperature: 250  $^\circ\text{C}$ ; injection temperature: 270  $^\circ\text{C}$ ; carrier gas: He; its flow rate: 40 mL/min; electron energy: 70 eV.

Analysis with a capillary column [10]; column: DB-5 or DB-1 (30 m  $\times$  0.25 mm i. d., J & W Scientific, Folsom, CA, USA); GC/MS: a Varian Model 3500 gas chromatograph (Varian, Harbor City, CA, USA) connected with a Finnigan MAT ITS 40 GC/MS system (Thermo-Finnigan, San Jose, CA, USA); column temperature: 180  $^\circ\text{C}$   $\rightarrow$  20  $^\circ\text{C}/\text{min}$   $\rightarrow$  280  $^\circ\text{C}$ ; injection temperature: 300  $^\circ\text{C}$ ; carrier gas: He; its flow rate: 1 mL/min; electron energy: 70 eV.

### Procedures

#### i. Liquid-liquid extraction

- A 10-mL volume of urine and 10 mL of 10 M NaOH solution are placed in a glass centrifuge tube with a ground-in stopper<sup>e</sup> and heated at 50  $^\circ\text{C}$  for 15 min in a water bath for hydrolysis<sup>f</sup>.
- After cooling to room temperature, 2 mL of 1 M potassium dihydrogen- phosphate solution is added to the mixture and its pH is adjusted to 2–3 by adding hydrochloric acid.
- A 20-mL volume of *n*-hexane/ethyl acetate (7:1) is added to the mixture, shaken for 10 min and centrifuged [9].
- The organic phase is carefully transferred to another centrifuge tube of the same type, mixed with 5 mL of 0.5 M NaOH solution, shaken for 10 min and centrifuged at 3,000 rpm for 5 min.
- The organic phase is discarded by aspiration; 2 mL of 1 M potassium dihydrogenphosphate solution is added to the aqueous phase and its pH is adjusted to 2–3 with hydrochloric acid.



A 20-mL volume of *n*-hexane/ethyl acetate (7:1) is added to the above solution to extract  $\Delta^9$ -THC-11-oic acid again<sup>8</sup>.

- vi. The organic phase is dehydrated with anhydrous sodium sulfate, passed through filter paper and evaporated to dryness.

#### ii. Solid-phase extraction [10]

- i. A 2-mL volume of the hydrolyzed urine obtained after step i) of the above procedure is mixed with a fixed amount of IS<sup>b</sup>, and poured into a Bond Elut Certify II column (Varian, Harbor City, CA, USA), which has been activated by passing 2 mL methanol and 2 mL water, at a flow rate of about 1 mL/min [10].
- ii. The column is washed with 9 mL of 50 mM phosphoric acid solution and 3 mL of 50 mM phosphoric acid solution/methanol (4:1).
- iii. After drying the column under reduced pressure, the target compound and IS are eluted with 2 mL of *n*-hexane/ethyl acetate (4:1) containing 1 % acetic acid and evaporated to dryness under a stream of nitrogen.

#### iii. Derivatization-1

One of the above dry residues is dissolved in 10  $\mu$ L acetonitrile, 15  $\mu$ L of *N,O*-bis(trimethylsilyl)trifluoroacetamide (BSTFA) and 5  $\mu$ L trimethylchlorosilane (TMCS), and heated at 60 °C for 20 min. After cooling, a 1- $\mu$ L aliquot of it is injected into GC/MS.

#### iv. Derivatization-2

One of the above dry residues is dissolved in 2 mL of solution of diazomethane in ethyl ether<sup>i</sup>, left at room temperature for 30 min and evaporated to dryness. The residue is then subjected to the above Derivatization-1 for trimethylsilylation to obtain methyl ester plus TMS derivatives. A 1- $\mu$ L of the solution is subjected to the GC/MS analysis.

#### v. Quantitation

By using various amounts of  $\Delta^9$ -THC-11-oic acid and an fixed amount each of IS, which had both been spiked into blank urine, a calibration curve is constructed for quantitation of the acid in a test urine specimen.

## Assessment and some comments on the method

Jones et al. [11] reported that  $\Delta^9$ -THC-11-oic acid was stable during storage at -18 °C for 2 months. The author et al. confirmed that the compound did not change at -20 °C for at least 2 months.

$\Delta^9$ -THC-11-oic acid is known to be decarboxylated at high temperatures; it, therefore, is necessary to be derivatized for GC/MS analysis. Baker et al. [12] examined various derivatizations and reported that the methyl ester plus TMS derivative of the acid gave the highest sensitivity, although the two-step derivatization procedure is required.

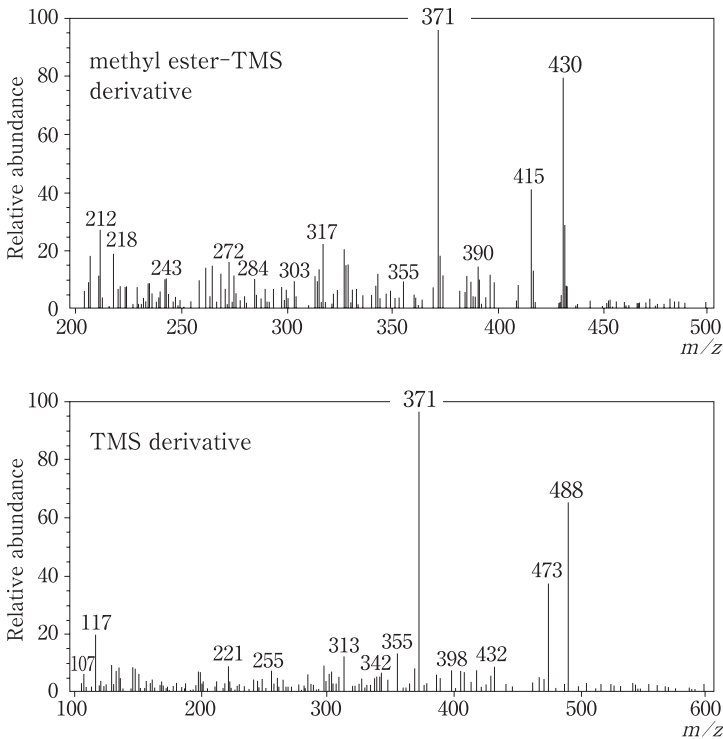
➤ Table 2.1 shows major ions of mass spectra for  $\Delta^9$ -THC-11-oic acid, 5 $\alpha$ -cholestane and 5'-nor- $\Delta^8$ -THC-4'-oic acid obtained by both derivatization methods. For the  $\Delta^9$ -THC-11-oic acid, the base peak appeared at *m/z* 371 and is most suitable for quantitation by SIM. ➤ Figure 2.4 shows mass spectra of  $\Delta^9$ -THC-11-oic acid after the TMS and methyl ester-TMS derivatizations.

■ **Table 2.1**

**Diagnostic ions in mass spectra of  $\Delta^9$ -THC-11-oic acid, 5 $\alpha$ -cholestane and 5'-nor- $\Delta^8$ -THC-4'-oic acid with different derivatizations**

	Diagnostic ion ( <i>m/z</i> )		
	$\Delta^9$ -THC-11-oic acid	5 $\alpha$ -cholestane	5'-nor- $\Delta^8$ -THC-4'-oic acid
Derivatization-1	488, 473, 371	372	474
Derivatization-2	430, 415, 371	372	416, 333

■ **Figure 2.4**



**Mass spectra of the methyl ester plus TMS and TMS derivatives of  $\Delta^9$ -THC-11-oic acid.**

The Substance Abuse and Mental Service Administration (SAMSA) in USA set the cutoff value of  $\Delta^9$ -THC-11-oic acid in urine at 50 ng/mL by immunoassay and the identifiable value of the acid by mass spectral measurements at 15 ng/mL.

## Cases of analysis [13]

**Case 1:** A 22-year-old male was killed by a mysterious accident during driving a truck. Because of the high severity of injuries, blood specimens could not be obtained; the analysis was made

with urine and the liver tissue. Urine showed a positive result for the cannabinoid metabolite by screening with EMIT. The concentrations of  $\Delta^9$ -THC-11-oic acid measured by GC/MS were 22 ng/mL in urine and 0.6 ng/g in the liver.

**Case 2:** A paper factory worker was killed by being caught in a machine during working with it. The concentrations of  $\Delta^9$ -THC-11-oic acid measured by GC/MS were 78 and 12 ng/mL in urine and blood, respectively; 0.7 ng/mL of  $\Delta^9$ -THC was also detected from blood.

**Case 3:** A male died of gunshot injury. His death was estimated to be suicidal or accidental under the influence of a drug.  $\Delta^9$ -THC at 0.4 ng/mL and  $\Delta^9$ -THC-11-oic acid at 40 ng/mL were detected from his blood.

**Case 4:** The author et al. [9] also analyzed a urine specimen of a subject, who had been suspected of cannabis smoking, and found 60 ng/mL of  $\Delta^9$ -THC-11-oic acid in it.

## Notes

- a) For the cannabis plant and its resin, established methods are available for their chemical diagnosis [14].
- b) The cannabinoids dissolved in ethanol are very stable at  $-20\text{ }^\circ\text{C}$ , and a long storage is possible under the conditions.
- c) In a fresh cannabis plant, cannabinoids exist in the carboxylated form. They are easily decarboxylated at  $250\text{ }^\circ\text{C}$ .
- d) There are reviews dealing with GC/MS analysis of  $\Delta^9$ -THC-11-oic acid in human urine [15, 16].
- e) A method of silylation of glassware to be done before analysis was reported [17]; such treatment suppresses the adsorption of cannabinoids to the surface and enhances reproducibility of analysis.
- f) Since  $\Delta^9$ -THC-11-oic acid is excreted into human urine in the form of its glucuronide, it should be hydrolyzed before extraction. A hydrolysis procedure using  $\beta$ -glucuronidase can be used; but the hydrolysis with NaOH is simple and sufficient to be used.
- g) By the repeated extraction, the background levels are lowered and interfering impurity peaks become much less; clean and distinct mass spectra can be obtained after the treatments. Since  $5\alpha$ -cholestane cannot be recovered with this extraction procedure; it cannot be used as IS; the external calibration method should be used for quantitation.
- h) As ISs for quantitation by SIM, stable isotopic compounds of  $\Delta^9$ -THC-11-oic acid are most preferable; usually  $d_3$ - and  $d_{10}$ - substitution products of the acid are used. When  $\Delta^9$ -THC-11-oic acid- $d_3$  is used, the mass spectrum shows ions at  $m/z$  433, 418 and 374 with the Derivatization-2, and at  $m/z$  491, 476 and 374 with the Derivatization-1. Since the stable isotopic IS interferes with the non-isotopic  $\Delta^9$ -THC-11-oic acid in mass spectral measurements, the ISs such as  $5\alpha$ -cholestane and  $5'$ -nor- $\Delta^8$ -THC- $4'$ -oic acid become useful.
- i) The solution of diazomethane in ethyl ether can be prepared from 1-methyl-3-nitro-1-nitrosoguanidine using the Diazald kit (Aldrich, Milwaukee, WI, USA).

## References

- 1) Wall ME, Sadler BM, Brine D et al. (1983) Metabolism, disposition, and kinetics of delta-9-tetrahydrocannabinol in men and women. *Clin Pharmacol Ther* 34:352–363
- 2) Agurell S, Halldin M, Lindgren J-E et al. (1986) Pharmacokinetics and metabolism of  $\Delta^1$ -tetrahydrocannabinol and other cannabinoids with emphasis on man. *Pharmacol Rev* 38:21–43
- 3) Aramaki H, Tomiyasu N, Yoshimura H et al. (1968) Forensic chemical study on marihuana. I. A detection method of the principal constituents by thin-layer and gas chromatographies. *Chem Pharm Bull* 16:822–826
- 4) Yokoyama M, Okada Y, Suzuki K (1992) Determination of cannabinoids in cannabis oil by capillary gas chromatography. *Eisei Kagaku* 38:471–475 (in Japanese with an English abstract)
- 5) Watanabe K, Yamaki E, Yamamoto I et al. (1979) A colorimetric method for the determination of cannabinoids with Fast Blue BB salt. *Eisei Kagaku* 25:321–326
- 6) Matsunaga T, Nagatomo H, Narimatsu S et al. (1993) Studies on identification of cannabis seeds. I: Qualitative and quantitative analysis of cannabinoids in cannabis seeds. *Jpn J Forensic Toxicol* 11:158–165 (in Japanese with an English abstract)
- 7) Pitt CG, Fowler MS, Sathe S et al. (1975) Synthesis of metabolites of  $\Delta^9$ -tetrahydrocannabinol. *J Am Chem Soc* 97:3798–3802
- 8) Ohlsson A, Agurell S, Leander K et al. (1979) Synthesis and psychotropic activity of side-chain hydroxylated  $\Delta^6$ -tetrahydrocannabinol metabolites. *Acta Pharm Suec* 16:21–33
- 9) Yamamoto I, Watanabe K, Narimatsu S et al. (1990) A GC-MS method for determination of  $\Delta^9$ -tetrahydrocannabinol-11-oic acid in human urine. *Eisei Kagaku* 36:149–152 (in Japanese with an English abstract)
- 10) Dixit V, Dixit VM (1991) Solid-phase extraction of 11-nor-delta-9-tetrahydrocannabinol-9-carboxylic acid from human urine with gas chromatographic-mass spectrometric confirmation. *J Chromatogr* 567:81–91
- 11) Jones AB, ElSohly HN, Arafat ES et al. (1984) Analysis of the major metabolite of  $\Delta^9$ -tetrahydrocannabinol in urine. VI. A comparison of five methods. *J Anal Toxicol* 8:249–251
- 12) Baker TS, Harry JV, Russell JW et al. (1984) Rapid method for the GC/MS confirmation of 11-nor-9-carboxy- $\Delta^9$ -tetrahydrocannabinol in urine. *J Anal Toxicol* 8:255–259
- 13) Foltz RL, McGinnis KM, Chinn DM (1983) Quantitative measurement of  $\Delta^9$ -tetrahydrocannabinol and two major metabolites in physiological specimens using capillary column gas chromatography negative ion chemical ionization mass spectrometry. *Biomed Mass Spectrom* 10:316–323
- 14) Yamamoto I (1992) Methods for analysis of cannabis and its components. In: The Pharmaceutical Society of Japan (ed) *Standard Methods of Chemical Analysis in Poisoning – With Commentaries*, 4th edn., Nanzando, Tokyo, pp 247–263 (in Japanese)
- 15) Bronner WE, Xu AS (1992) Gas chromatographic-mass spectrometric methods of analysis for detection of 11-nor- $\Delta^9$ -tetrahydrocannabinol-9-carboxylic acid in biological matrices. *J Chromatogr* 580:63–75
- 16) Goldberger BA, Cone EJ (1994) Confirmatory tests for drugs in the workplace by gas chromatography-mass spectrometry. *J Chromatogr* 674:73–86
- 17) Fenimore DC, Davis CM, Whitford JH et al. (1976) Vapor phase silylation of laboratory glassware. *Anal Chem* 48:2289–2290

## II.2.3 Morphine and its analogues

by Hideyuki Yamada and Kazuta Oguri

### Introduction

There are a number of compounds, such as morphine and codeine, which are classified into the opium alkaloids (opiates). They are being used as ethical drugs of narcotic analgesics and antitussives; 1 % powder of codeine or dihydrocodeine is commonly included in over-the-counter drugs of antitussives.

▶ *Figure 3.1* shows metabolic pathways of morphine, heroin and codeine. Since morphine and codeine are finally excreted into urine in the conjugated forms with glucuronic acid [1–3], it is necessary to hydrolyze the conjugated forms of these compounds before GC/MS analysis. Heroin is rapidly deacetylated and finally excreted into urine as morphine glucuronides. Therefore, it is not easy to discriminate the heroin use from morphine use [4, 5]. The detection of 6-acetylmorphine is recommendable for diagnosis of heroin use, because of its relatively long half-life in the body [4].

For accurate diagnosis of a cause of death in an opiate poisoning case, the ratio of a free form to a conjugated form becomes important (see section 4 of this chapter). In such a case, an opiate before (free form) and after (a total amount) hydrolysis should be analyzed. The amount of a conjugated form can be calculated by subtracting the amount of a free form from the total amount. By HPLC, the simultaneous analysis of free and conjugated forms is possible without any hydrolysis; in the near future, LC/MS may become a main tool for analysis of opiates and their metabolites. However, at the present time, GC/MS is being widely used for opiate analysis.

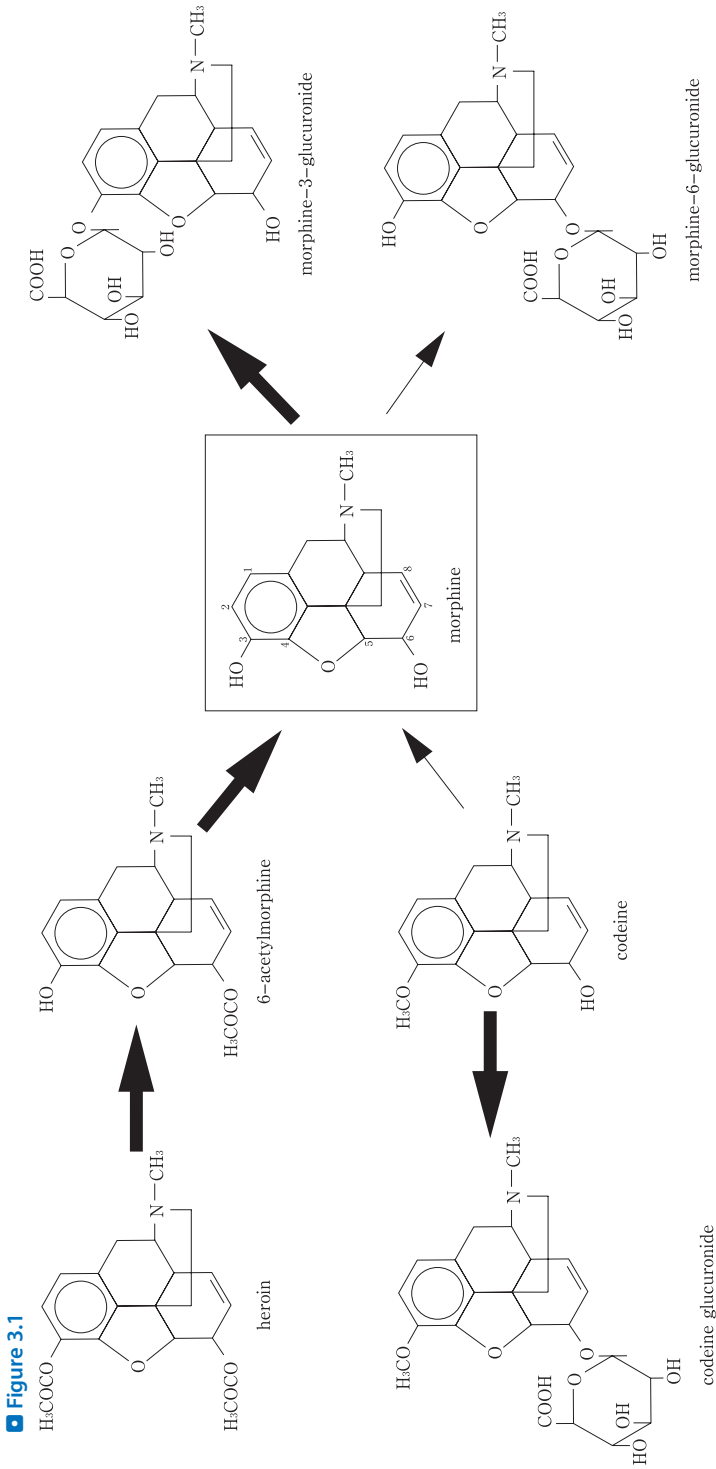
For HPLC analysis of the conjugated forms of opiates, the authentic standards of morphine-3-glucuronide (M-3-G) and morphine-6-glucuronide (M-6-G) are necessary. In U.S.A. and Europe, it is easy to obtain these authentic compounds from commercial sources, but the import of these compounds to Japan is strictly controlled; easing of import of such compounds should be realized.

### GC and GC/MS analysis

---

#### Reagents and their preparation

- Ethylmorphine (internal standard, IS)<sup>a</sup> solution: a 1-mg aliquot of ethylmorphine hydrochloride (Sankyo Co., Ltd., Tokyo, Japan) is dissolved in purified water to prepare 1 mg/mL solution. A 0.1-mL aliquot of this solution is mixed with 1.9 mL of purified water for 20-fold dilution (the final concentration in the form of the hydrochloride salt: 50 µg/mL), which is stored at –20 °C.



**Main metabolic pathways of morphine, heroin and codeine. The thick and thin arrows show the main and minor metabolic pathways, respectively.**

- Standard solutions of morphine for a calibration curve (2, 6 and 20  $\mu\text{g/mL}$ ): a 1-mg aliquot of morphine hydrochloride (Shionogi & Co, Ltd., Osaka, Japan and other manufacturers) is dissolved in purified water to prepare 1 mg/mL solution; 0.1 mL of this solution is mixed with 4.9 mL purified water for 50-fold dilution (20  $\mu\text{g/mL}$ ). The latter solution is diluted 3.33-fold and 10-fold to prepare 6 and 2  $\mu\text{g/mL}$  solutions, respectively, which are also stored at  $-20\text{ }^\circ\text{C}$ . For preparing the standard solutions to be used for a calibration curve of 6-acetylmorphine hydrochloride or codeine phosphate (Shionogi & Co.), the same dilution procedure is followed. 6-Acetylmorphine hydrochloride can be synthesized by the method previously reported [6].
- 5 M NaOH solution (100 mL): a 20-g aliquot of NaOH is dissolved in about 70 mL purified water in a 100-mL volume glass beaker with stirring in an ice bath. After the temperature of the solution is cooled to room temperature, it is transferred to a 100 mL-volume volumetric flask together with the water solution which has been used for washing the above glass beaker, and the volume is adjusted to 100 mL exactly. The solution is kept at room temperature; it is essential to seal the flask airtightly, because  $\text{CO}_2$  in atmospheric air can be absorbed into the NaOH solution to yield  $\text{NaHCO}_3$ , resulting in the decrease of titer of the solution.
- 5 M  $\text{NH}_4\text{Cl}/\text{NH}_3$  buffer solution (pH 9, about 200 mL): a 23.7-mL volume of 28 % ammonia water solution is dissolved in purified water to prepare 250 mL solution (5 M  $\text{NH}_3$  solution). A 13.4-g aliquot of  $\text{NH}_4\text{Cl}$  is dissolved in purified water to prepare 50 mL solution (5 M  $\text{NH}_4\text{Cl}$  solution). An appropriate amount of 5 M  $\text{NH}_3$  solution is mixed with the 5 M  $\text{NH}_4\text{Cl}$  solution to adjust the pH to 9.0. The buffer can be stored at room temperature.
- 10 M KOH solution saturated with  $\text{KHCO}_3$  (100 mL): a 56-g aliquot of KOH is dissolved in about 70 mL purified water in a 100-mL volume glass beaker with stirring in an ice bath. The volume of the solution is adjusted to about 85 mL with purified water and left until being cooled to room temperature. The  $\text{KHCO}_3$  powder is added to the NaOH solution until its saturation with stirring (about 30 g necessary). Upon saturation, the volume of the solution becomes to be about 100 mL. This can be used for experiments and is preservable at room temperature.
- Pretreatment of a solid-phase extraction cartridge (Bond Elut Certify)<sup>b</sup>: a 2-mL volume of methanol and 2 mL purified water are passed through a Bond Elut Certify cartridge (Varian, Harbor City, CA, USA) just before use. For a new cartridge, each solution can flow by natural pressure through it without any aspiration. When the flow stops, it is aspirated for a moment; then the methanol or water can flow through it only by gravity. The purified water should not be passed through the cartridge completely; the cartridge should not be dried. The water flow should be stopped, when the water volume in the reservoir becomes small.

## Analytical conditions

GC column: DB-1 (15 m  $\times$  0.25 mm i. d., film thickness 0.25  $\mu\text{m}$ , J & W Scientific, Folsom, CA, USA).

GC/MS conditions; instrument: an HP5890 GC-HP 5989A MS Engine (Agilent Technologies, Palo Alto, CA, USA); column (oven) temperature:  $200\text{ }^\circ\text{C}$  (0.5 min)  $\rightarrow 5\text{ }^\circ\text{C}/\text{min} \rightarrow 260\text{ }^\circ\text{C}$  (3 min); injection temperature:  $200\text{ }^\circ\text{C}$ ; injection volume: 1  $\mu\text{L}$  (splitless mode); carrier gas: He; flow pressure: 6 psi; ionization mode: EI; electron energy: 70 eV.

## Procedures

Two extraction methods, the liquid-liquid extraction and the solid-phase extraction, are available; the latter gives cleaner extracts for GC and GC/MS analysis.

### i. Liquid-liquid extraction

- i. A 2-mL volume of urine<sup>c</sup> and 1.5 mL of concentrated hydrochloric acid are placed in a 50-mL volume glass centrifuge tube with a ground-in stopper, and heated at 100 °C for 30 min in a water bath to hydrolyze the conjugated forms of a target compound. The water level of the water bath should be slightly above the surface level of the hydrolysis solution in the tube. As a blank test, 2 mL urine obtained from a healthy subject is also treated as above. For quantitative experiments, in addition, a 0.1-mL volume each of solutions at three concentrations of an opiate (2.6 and 20 µg/mL) is added to 2 mL each of the blank urine; these samples are also processed in the same way as above.
- ii. After cooling to room temperature, 0.1 mL of the IS solution is added to the hydrolyzed solution. A 3-mL volume of 5 M NaOH is added to the solution for neutralization, followed by the addition of 4 mL of 5 M NH<sub>4</sub>Cl/NH<sub>3</sub> buffer solution (pH 9). The final pH of the solution should be checked with a test paper (Whatman, type CF); if the pH of the solution shifts from 9, it should be readjusted to pH 9.0 by adding the above ammonium buffer solution.
- iii. The above solution is extracted with 15 mL of chloroform/ isopropanol (9:1, v/v) by shaking.
- iv. After centrifugation at 3,000 rpm for 5 min, the organic (lower) layer is carefully transferred to another 50-mL volume glass centrifuge tube of the same type with a pipette, followed by the addition of a sufficient amount of anhydrous sodium sulfate (2–3 g), and mixed well.
- v. The organic solution is passed through folded filter paper to remove the dehydrator and collected in a 10-mL volume glass centrifuge tube<sup>d</sup> with a ground-in stopper (the shape of the tube bottom preferably to be conical). The solution is evaporated to dryness under a stream of nitrogen with warming the tube at 30–40 °C.
- vi. The residue in the tube is mixed with 50 µL of *N,O*-bis(trimethylsilyl)acetamide (BSA) reagent<sup>e</sup>, capped airtightly and heated at 80 °C for 20 min; a 1-µL aliquot of the derivatized solution is injected into GC or GC/MS.
- vii. For the unconjugated (free) forms of morphine, codeine and 6-acetylmorphine, the extraction is made as follows<sup>f</sup>. A 2-mL volume of urine is diluted 2-fold with purified water and mixed with 0.1 mL of the IS solution and 0.2 mL of 5 M NH<sub>4</sub>Cl/NH<sub>3</sub> buffer solution (pH 9). The pH of the solution is confirmed to be 9 with a pH test paper; if not, an appropriate amount of the ammonium buffer solution is added to it. The solution is extracted with 10 mL of chloroform/ isopropanol (9:1, v/v), and the following procedure is performed according to the above iv–vi steps. The blank urine and calibration samples are also processed in the same way.

### ii. Solid-phase extraction

- i. The hydrolysis of urine is made according to the step i of the above section.
- ii. The hydrolyzed solution is mixed with IS solution<sup>a</sup>, followed by a careful and gradual addition of 1.5 mL of 10 M KOH solution saturated with KHCO<sub>3</sub> (bubbling appears), mixed with 3 mL of 2 M Tris-HCl buffer solution (pH 8.1) and stirred well. The pH of the final solution is confirmed to be 8–9 with a test paper. If not, the pH of the solution is adjusted to 8–9 using the 10 M KOH solution saturated with KHCO<sub>3</sub> or 1 M HCl solution.

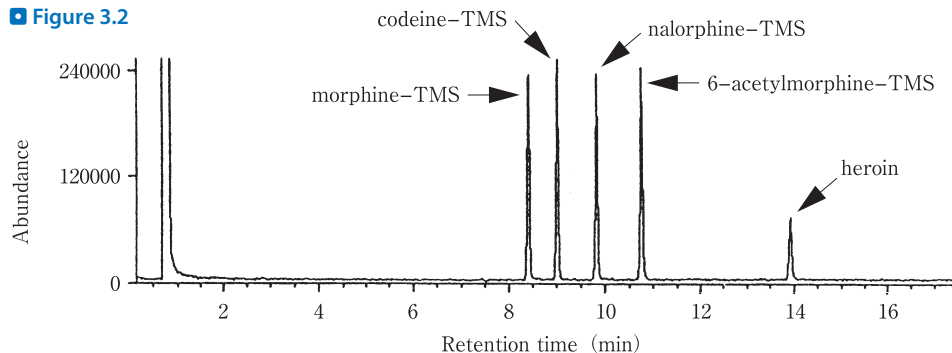


- iii. The solution is poured into a Bond Elut Certify Cartridge to let the solution flow inside the cartridge slowly taking more than 2 min to adsorb an opiate.
- iv. The cartridge is washed with 2 mL each of purified water, 0.1 M acetate buffer solution (pH 4) and methanol, and dried for 2 min by aspiration with a vacuum manifold, followed by washing with 3 mL methanol and drying for 5 min again.
- v. The target opiate is eluted, by passing 2 mL of dichloromethane/isopropanol/ammonia water (80:20:2, v/v) through the cartridge, into a 10-mL volume glass centrifuge tube with a ground-in stopper (the shape of the tube bottom preferably to be conical). The eluate is evaporated to dryness under a stream of nitrogen with warming at 30–40 °C.
- vi. The derivatization and injection into GC or GC/MS are made exactly in the same way as that described in the step vi) of the above liquid-liquid extraction section.
- vii. For the unconjugated (free) forms of morphine, codeine and 6-acetylmorphine, the extraction is made as follows. A 2-mL volume of urine is diluted 2-fold with purified water and mixed with 0.1 mL of the IS solution and 0.2 mL of 2 M Tris-HCl buffer solution (pH 8.1). The pH of the solution is confirmed to be 8–9; if not, an appropriate amount of the above buffer solution is added to it. The blank urine and calibration samples are processed in the same way. These samples are equally treated according to the above steps iii–vi.

## Assessment and some comments on the methods

Qualitative analysis is performed by finding a peak appearing at the same retention time as that of the authentic standard after trimethylsilyl (TMS) derivatization; it is also important to confirm the absence of the corresponding peak in the blank specimen. The final identification is made by comparing a mass spectrum obtained from a test specimen with that obtained from the authentic standard. A total ion chromatogram (TIC) of the authentic compounds is shown in [▶ Fig. 3.2](#); the mass spectra of the derivatized compounds are shown in [▶ Fig. 3.3](#). Quantitation is performed by selected ion monitoring (SIM) using the peak height or area ratio of a test compound to IS; the ratio is applied to a calibration curve, which has been prepared in advance, to calculate the concentration of the test compound in a speci-

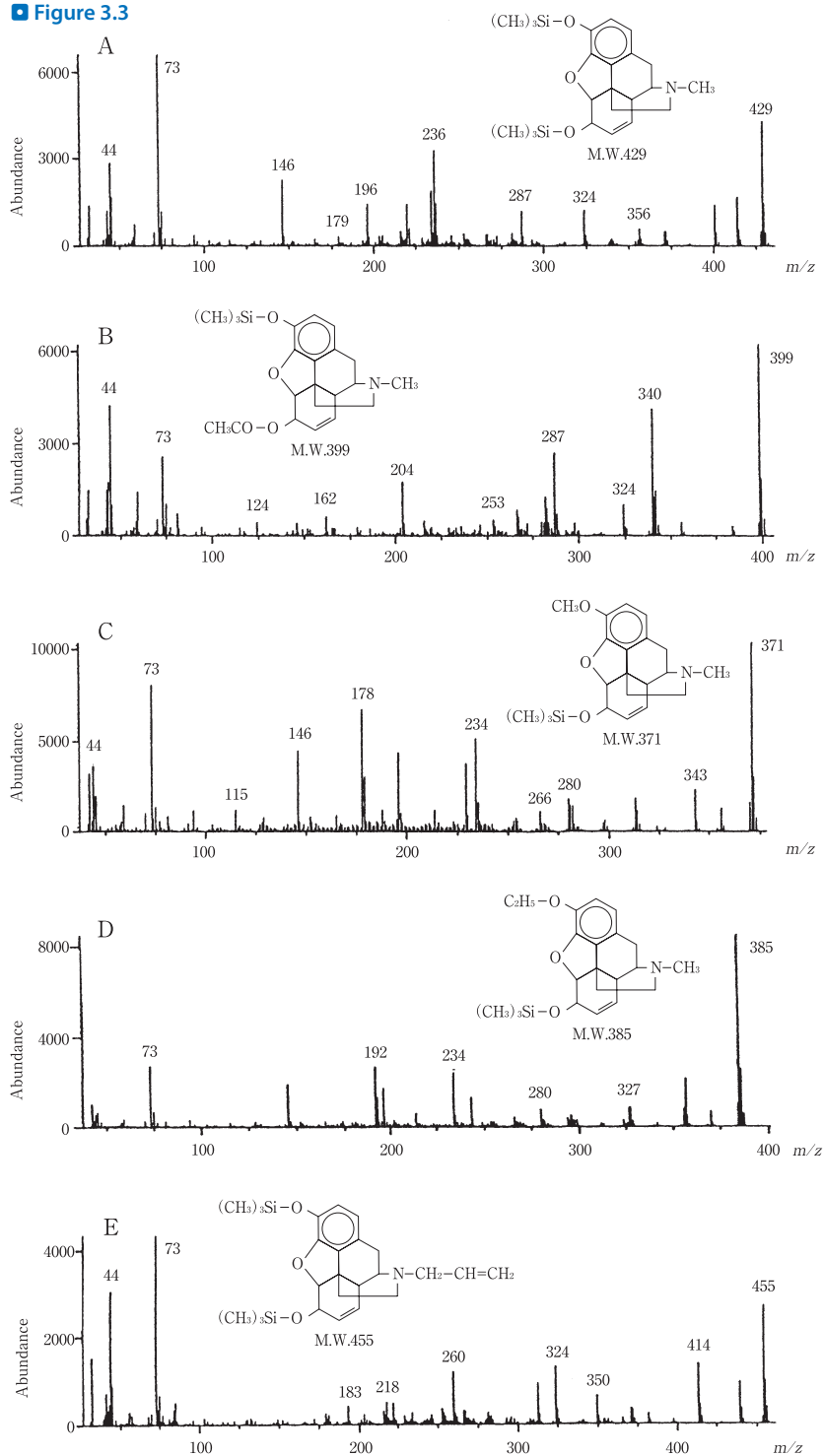
■ **Figure 3.2**



**TIC of TMS derivatives of morphine and its analogues by GC/MS. Heroin is not derivatized.**

**The peak of the TMS derivative of ethylmorphine is not included in this chromatogram; but it is eluted at 9.4 min under the same conditions.**

Figure 3.3



men. The peaks to be detected are as follows (the mass numbers underlined to be used for quantitation).

morphine-TMS:  $m/z$  429 ( $M^+$ ), 414, 401, 287

6-acetylmorphine-TMS:  $m/z$  399 ( $M^+$ ), 340, 287, 204

codeine-TMS:  $m/z$  371 ( $M^+$ ), 343, 234, 178

ethylmorphine-TMS:  $m/z$  385 ( $M^+$ )

nalmorphine-TMS:  $m/z$  455 ( $M^+$ )

By SIM of GC/MS, a low level of morphine less than 100 ng/mL can be detected and quantitated; however, when a low level of morphine is detected, special care should be taken, because of the following reasons. Low levels (0.1–25 pmol/g tissue) of morphine exist in various animals including humans as an endogenous compound; the levels are significantly increased by various stresses [7]. Therefore, the detection of low levels of morphine starting from a large amount of a specimen cannot be a proof of the intake of the drug. The level of morphine in urine of healthy subjects determined by GC/MS was reported to be about 1 ng/mL [8]. The poppy seeds are being used for various foods; when the foods including the seeds are eaten, an appreciable amounts of morphine (including its conjugates) are reported to be excreted into urine [9]. Because of these reasons, it seems reasonable to set a cutoff value of morphine in urine to be 300 ng/mL. However, caution is needed, because a morphine concentration higher than the cutoff level can be detected in some urine samples of subjects who have eaten a food containing poppy seeds [9]. It should be noted that an amount of codeine comparable to that of morphine are also included in the poppy seed- containing foods [10].

The half-life of heroin disappearance in human body was reported to be only about 2 min. It is, therefore, impossible to detect heroin itself from urine to prove its abuse. 6-Acetylmorphine is alternatively being analyzed as an indicator of heroin abuse; however, even with this metabolite, its half-life is only about 40 min, which is much shorter than that of unconjugated morphine (3.7 h) [4]. Even if the cutoff value of 6-acetylmorphine is set to be as low as 0.8 ng/mL, it is being considered necessary to analyze a urine specimen sampled not later than 5 h after the heroin intake [4].

## HPLC analysis

### Reagents and their preparation

- Standard solutions of morphine for a calibration curve (2, 6 and 20  $\mu\text{g/mL}$ ): see “Reagents and their preparation”, above of GC and GC/MS analysis section.
- 0.5 M Ammonium sulfate solution (pH 9.4, 100 mL): a 6.6-g aliquot of ammonium sulfate is dissolved in about 80 mL purified water, followed by the adjustment of its pH to 9.4 with dilute ammonia solution. The volume is adjusted to 100 mL using a volumetric flask and stored at room temperature.

◀ **Mass spectra of TMS derivatives of the authentic morphine and its analogues. A: morphine-TMS; B: 6-acetylmorphine-TMS; C: codeine-TMS; D: ethylmorphine-TMS; E: nalmorphine-TMS. A 50- $\mu\text{L}$  volume of BSA is added to 20  $\mu\text{g}$  each of opiates for derivatization [see the section 2-3)-(1)-vi]; a 0.4- $\mu\text{L}$  aliquot each is injected into GC/MS.**

- 5 mM Ammonium sulfate solution (pH 9.4): a 66-mg aliquot of ammonium sulfate is subjected to the above procedure, and stored at room temperature.
- 0.5 M Phosphate buffer solution (pH 2.1, 500 mL): a 24.5-g aliquot of phosphoric acid is dissolved in about 400 mL purified water, followed by adjustment of its pH to 2.1 using several percent NaOH solution. The final volume of the solution is adjusted to 500 mL by adding purified water, and stored at room temperature.
- 50 mM Phosphate buffer solution (pH 2.1, 100 mL): a 0.5-g aliquot of phosphoric acid is dissolved in about 80 mL of purified water, followed by adjustment of its pH to 2.1 using dilute NaOH solution. The final volume of the solution is adjusted to 100 mL by adding purified water, and stored at room temperature.
- 0.2 M Sodium dodecyl sulfate (SDS) solution (100 mL): a 5.8-g aliquot of SDS is dissolved in about 70 mL purified water in a volumetric flask, and left overnight to dissipate bubbles. Purified water is gently added to the above solution to prepare 100 mL solution, mixed well and stored at room temperature.
- Mobile phase, 5 mM-SDS containing 100 mM phosphate buffer solution (pH 2.1)/acetonitrile (76:24, v/v, 1 L): a 152-mL volume of 0.5 M phosphate buffer solution and 19 mL of the above 0.2 M SDS solution are placed in a 1-L volume glass graduated cylinder; the final volume of the solution is adjusted to 760 mL by adding purified water, well mixed and transferred to a 1-L volume Erlenmeyer flask. A 240-mL volume of acetonitrile of HPLC grade is measured with the above empty graduated cylinder, and added to the solution in the Erlenmeyer flask. After mixing, the mobile phase solution is passed through a filter (Millicup-HV, Millipore, Bedford, MA, USA)<sup>g</sup> under reduced pressure. The filtrate is stored in a clean glass container with a stopper at room temperature. A required amount of the above solution is transferred to another glass container, and degassed by immersing the container in an ultrasonic cleaner for 10 min just before use.
- 10 mM Phosphate buffer solution (pH 2.1)–10 % acetonitrile (100 mL): a 20-mL volume of 50 mM phosphate buffer solution (pH 2.1) and 10 mL acetonitrile are placed in a graduated cylinder, and the volume of the solution is adjusted with purified water to 100 mL and mixed well.
- Pretreatment of a Sep-Pak C<sub>18</sub> cartridge<sup>b</sup>: a 5 mL of methanol, 3 mL of 10 mM phosphate buffer (pH 2.1)–10 % acetonitrile and 5 mL purified water are successively passed through a Sep-Pak C<sub>18</sub> cartridge (Waters, Milford, MA, USA) to activate the cartridge just before use. For the handling method, see “Reagents and their preparation”, of the GC and GC/MS analysis section of this chapter.

## Analytical conditions

HPLC column; many analytical methods using reversed phase C<sub>18</sub> columns were reported; an example is: a Nova-Pak C<sub>18</sub> cartridge column equipped with an RCM × 10 pressurized module; precolumn: Nova-Pak C<sub>18</sub> Guard-pak Insert.


HPLC conditions; instrument: a Hitachi 655 HPLC instrument (Hitachi Ltd., Tokyo, Japan) equipped a wavelength-variable UV monitor (Hitachi 655A); mobile phase: 5 mM-SDS containing 100 mM phosphate buffer (pH 2.1)/acetonitrile (76:24, v/v); flow rate: 1.2 mL/min; detection wavelength: 220 nm.

## Procedure

A modification of the method developed by Svensson et al. [11] is shown below.

- i. A 5-mL volume of 0.5 M ammonium sulfate solution (pH 9.4) is added to 2 mL blood plasma or 4 mL of 2-fold diluted urine. When required, the mixture solution is passed through a filter (Cellulose Acetate 0.45  $\mu\text{m}$ , Advantec, Tokyo, Japan). A blank urine specimen obtained from a healthy subject and the urine specimens spiked with 0.1 mL each of the standard solutions (2, 6 and 20  $\mu\text{g/mL}$ ) are also handled in the same way as above.
- ii. Each of the above solution is passed through a pretreated Sep-Pak C<sub>18</sub> cartridge.
- iii. The cartridge is washed with 20 mL of 5 mM ammonium sulfate solution (pH 9.4) and 0.5 mL purified water.
- iv. Opiate compounds (free and conjugated forms) trapped in the cartridge are eluted with 1.2 mL methanol.
- v. The eluate is evaporated to dryness under a stream of nitrogen with warming at 40 °C. The residue is dissolved in 200  $\mu\text{L}$  of the HPLC mobile phase; a 20- $\mu\text{L}$  aliquot of it is injected into HPLC.

## Assessment and some comments on the method

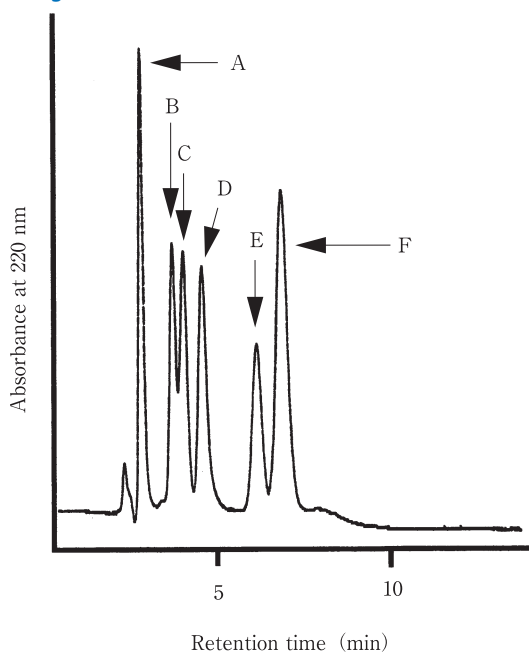
Qualitative analysis is made by the comparison of the retention time of a peak of a specimen with that of the authentic standard and also by the confirmation of the absence of such a peak in a blank specimen. An HPLC chromatogram for the authentic compounds is shown in  Fig. 3.4. For quantitation, the peak area or height of a test compound in a specimen is applied to an external calibration curve to calculate its concentration. The use of IS is preferable to make accurate quantitation, but the authors have not studied on it. Ethylmorphine may be usable as IS like in the case of GC/MS analysis. With a UV detector, the good linearity of morphine could be confirmed in a range not lower than 20 ng/mL; the detection limit was reported to be 5 ng/mL [11]. With an electrochemical detector, the analysis of opiates is reported to be achievable with even higher sensitivity (detection limit less than about 1 ng/mL) [12]. However, since the electrochemical detection is based on the oxidoreductive potential of the hydroxyl group of the phenol moiety, it is not suitable for analysis codeine or M-3-G. For cautions and cutoff values upon detection of trace levels of morphine, the readers can see the 2-4) section of this chapter.

By LC/MS, morphine and 6-acetylmorphine give the base peaks of  $[\text{M}+\text{H}]^+$  ions; M-3-G and M-6-G also give  $[\text{M}+\text{H}]^+$  ions (with major fragment ions due to subtraction of glucuronic acid from the molecules) [13, 14]. The quantitiveness in the SIM mode was confirmed; the linearity could be obtained in a range over 30 ng/mL, and the detection limit was 1–3 ng/mL [13].

## Toxic and fatal concentrations

Fatal doses of morphine and heroin (in the form of their hydrogen chloride salts, *per os*) were reported to be 70–500 mg and 10–600 mg, respectively [15], with great variation according to individuals. As one of the reasons for the increase in fatal doses, the resistance to an opiate acquired by its repeated use can be mentioned. In a chronic opiate-dependent patient, several grams of an opiate do occasionally not cause death.

■ **Figure 3.4**



**HPLC chromatogram (detected at 220 nm) of the authentic morphine and its related compounds. A: morphine-6-sulfate; B: normorphine-3-glucuronide; C: morphine-3-glucuronide; D: morphine-6-glucuronide; E: codeine glucuronide; F: morphine. The opiates and their conjugated forms, 10  $\mu\text{g}$  each, were dissolved in 4 mL purified solution, and analyzed according to the procedure described in the section 3-3).**

As a result of analysis of 203 fatal cases with morphine and heroin, three parameters were reported to be related to the fatality; they are a blood concentration of free morphine (not lower than 0.24  $\mu\text{g}/\text{mL}$ ), a ratio of the free form to the total morphine (free plus conjugated forms) in blood (not lower than 37 %) and a total morphine concentration in the brain (not lower than 0.08  $\mu\text{g}/\text{g}$  and/or higher than the concentration of the free form in blood) [16]. In sudden deaths taking place within 3 h after morphine intake, a phenomenon that the ratio of free morphine to its total amount in blood is not lower than 44 % is said to be characteristically observed [16].

## Notes

- Nalorphine at the same concentration can be also used as IS. In the authors' experience, it is less stable and its solution should be prepared just before use. If a deuterium-labeled morphine is available for use, it is most desirable for MS analysis.
- Convenient thick glass-made devices for assisting elution of extraction cartridges are commercially available (GL-SPE Vacuum Manifold, GL Sciences, Tokyo, Japan and some manufacturers in USA); it enables the attachment of 12 cartridges, and the simultaneous washing, elution and drying of the cartridges can be made under reduced pressure.

- c) When the specimen is blood plasma (1.5 mL), the same volume of 20 % trichloroacetic acid is added, mixed well and centrifuged at 3,000 rpm for 5 min; the resulting supernatant fraction is subjected to be same procedure as that for urine [17, 18]. A solid organ tissue (1 g) is homogenized with the same volume of purified water; the homogenate is deproteinized as in the case of the above blood plasma and processed in the same way [18]. The main metabolite M-3-G is not easily hydrolyzed; it requires heating at 100 °C for 30 min in the presence of 15 % hydrochloric acid. The free morphine is relatively unstable and sensitive to oxidative decomposition. To protect free morphine from its decomposition, 0.1 mL of 40 % sodium hydrosulfite can be added at the hydrolysis [17, 18].
- d) Since in the next derivatization step the reaction is made in a smaller volume, the organic phase filtrate is collected in a 10-mL volume glass centrifuge tube with a ground-in stopper. In this case, the filtration step is divided into several times; about 5 mL of the first filtrate in the 10-mL volume centrifuge tube is subjected to evaporation to reduce its volume, followed by the addition of the next filtrate. This procedure is repeated several times. Upon repeated filtration, it is not necessary to change the paper filter.
- e) Any BSA reagent commercially available can be used. *N,O*-Bis(trimethylsilyl)trifluoroacetamide (BSTFA)/trimethylchlorosilane (TMCS) (99:1) can be also used, but no difference in reactivity from the use of BSA can be found. Trifluoroacetic anhydride or propionic anhydride can be used for acylation of opiates. However, the acylating reaction sometimes gives the mixture of monoacyl and diacyl derivatives.
- f) Since codeine contains a methylated hydroxyl group in the 3-position and thus is not a phenolic base, it is extractable from strongly basic solution. Utilizing this property, it is possible to remove codeine from an extract [17, 19]. Concretely, an organic solvent extract, containing opiates such as morphine and codeine, is back-extracted with 1 M HCl solution; after the pH of the aqueous phase is brought to 12, the phase is extracted with chloroform, resulting in the extraction of codeine only.
- g) The filtrate can be collected in a Erlenmeyer flask or a cleaned recycled gallon bottle. When a Erlenmeyer flask is used, the diameter of the mouth of the flask should not be close to that of Millicup-HV, because there is a possibility of destruction of the glassware due to remarkably reduced pressure.

## References

- 1) Fujimoto JM, Way EL (1957) Isolation and crystallization of "blood" morphine from urine of human addicts. *J Pharmacol Exp Ther* 121:340–346
- 2) Yoshimura H, Tsukamoto H, Oguri K (1969) Metabolism of drugs-LXII. Isolation and identification of morphine glucuronides in urine and bile of rabbits. *Biochem Pharmacol* 18:279–286
- 3) Yoshimura H, Mori M, Oguri K et al. (1970) Metabolism of drugs-LXV. Studies on the urinary conjugated metabolites of codeine. *Biochem Pharmacol* 19:2353–2360
- 4) Cone EJ, Welch P, Mitchell JM et al. (1991) Forensic drug testing for opiates: I. Detection of 6-acetylmorphine in urine as an indicator of recent heroin exposure, drug and assay considerations and detection times. *J Anal Toxicol* 15:1–7
- 5) Ohshita T (1993) Determination of diacetylmorphine in human urine using capillary gas chromatography/mass spectrometry. *Eisei Kagaku* 39:431–436 (in Japanese with an English abstract)
- 6) Fehn J, Megges G (1985) Detection of O6-monoacetylmorphine in urine samples by GC/MS as evidence for heroin use. *J Anal Toxicol* 9:134–138
- 7) Stefano GB, Goumon Y, Casares F et al. (2000) Endogenous morphine. *Trends Neurosci* 23:436–442

- 8) Matsubara K, Fukushima S, Akane A et al. (1992) Increased urinary morphine, codeine and tetrahydropapaveroline in Parkinsonian patient undergoing L-3,4-dihydroxyphenylalanine therapy: a possible biosynthetic pathway of morphine from L-3,4-dihydroxyphenylalanine in humans. *J Pharmacol Exp Ther* 260:974–978
- 9) ElSohly HN, ElSohly MA, Stanford DF (1990) Poppy seed ingestion and opiates urinalysis: a closer look. *J Anal Toxicol* 14:308–310
- 10) Hasegawa M, Maseda C, Kagawa M et al. (1992) Morphine and codeine being contained in poppy seeds and poppy seed-containing foods. *Eisei Kagaku* 38:192–195 (in Japanese with an English abstract)
- 11) Svensson J-O, Rane A, Säwe J et al. (1982) Determination of morphine, morphine-3-glucuronide and (tentatively) morphine-6-glucuronide in plasma and urine using ion-pair high-performance liquid chromatography. *J Chromatogr* 230:427–432
- 12) Mason JL, Ashmore SP, Aitkenhead AR (1991) Simple method for the determination of morphine and its active glucuronide metabolite in human plasma by high-performance liquid chromatography with electrochemical detection. *J Chromatogr* 570:191–197
- 13) Nishikawa M, Nakajima K, Igarashi K et al. (1992) Analysis of morphine-3-glucuronide in urine by LC/APCI-MS. *Eisei Kagaku* 38:121–126 (in Japanese with an English abstract)
- 14) Tatsuno M, Nishikawa M, Katagi M et al. (1996) Simultaneous determination of illicit drugs in human urine by liquid chromatography-mass spectrometry. *J Anal Toxicol* 20:281–286
- 15) Nagano T, Wakasugi C (eds) (1995) *Modern Legal Medicine*, 3rd edn. Kanehara-shuppan, Tokyo, pp 181–183 (in Japanese)
- 16) Spiehler VR (1998) Computer-assisted interpretation in forensic toxicology: morphine-involved deaths. *J Forensic Sci* 34:1104–1115
- 17) Yoshimura H (ed) (1991) *Forensic Chemistry*, 2nd edn. Nanzando, Tokyo, pp 155–159 (in Japanese)
- 18) Spiehler V, Brown R (1987) Unconjugated morphine in blood by radioimmunoassay and gas chromatography/mass spectrometry. *J Forensic Sci* 32:906–916
- 19) The Pharmaceutical Society of Japan (ed) (1992) *Standard Methods of Chemical Analysis in Poisoning – With Commentary –*, 4th edn. Nanzando, Tokyo, pp 230–234 (in Japanese)



## II.2.4 Cocaine and its metabolites

by Kenichi Takekawa

### Introduction

Cocaine is an alkaloid being contained in the leaves of *Erythroxylon coca* Lam. or *Erythroxylon novogranatense* (Morris) Hieronymus of Erythroxylaceae plants. The compound is being used as a local anaesthetic. It also shows stimulating action on the central nervous system; when it is used continuously, psychic dependence on its use appears, resulting in its chronic toxicosis [1]. Cocaine is being abused worldwide; its abuse is most serious in the north and south American continents. Fortunately, in Japan, its abuse is not so many; but it cannot be overlooked.

In this chapter, the methods of extraction<sup>a</sup> and GC/MS analysis for cocaine and its main metabolites, such as ecgonine methyl ester (EME) and benzoylecgonine (BE), in urine and blood, are presented; a fatal cocaine poisoning case, which the author experienced, is also demonstrated.

### Chemical synthesis of the metabolite standards [2]

- Cocaine hydrochloride (Shionogi & Co., Ltd., Osaka, Japan; Takeda Chem. Ind. Ltd., Osaka, Japan; or Sigma, St. Louis, MO, USA) is dissolved in 0.2 M hydrochloric acid aqueous solution and heated at 90 °C with refluxing (gentle mixing) for 24 h to produce ecgonine. The solution is extracted with ethyl ether to remove benzoic acid. The dried residue of ecgonine hydrochloride is dissolved in 10 % hydrochloric acid methanolic solution for its methylation to synthesize EME [2].
- Aqueous solution of cocaine hydrochloride is carefully adjusted to pH 7 by repeated addition of 0.1 M NaOH solution with refluxing for 3 days; precipitated BE can be obtained. For more details of procedure, see reference [2].

### Reagents and their preparation

- Bond Elut Certify<sup>®</sup> LRC<sup>b</sup> (Varian, Harbor City, CA, USA)
- Extrelut<sup>®c</sup> (Merck, Darmstadt, Germany)
- 0.1 M Phosphate buffer solution (pH 6): 13.6 g of potassium dihydrogenphosphate is dissolved in 900 mL distilled water and its pH is adjusted to 6.0 ( $\pm 0.1$ ) by adding 0.1 M potassium hydroxide solution; the final volume is brought to 1,000 mL by adding distilled water.
- 0.1 M Hydrochloric acid solution: an 833- $\mu$ L aliquot of concentrated hydrochloric acid is added to distilled water to prepare 100 mL solution.
- Eluent-1: dichloromethane/isopropanol/28% ammonia water (80:20:2, v/v) Eluent-2: chloroform/isopropanol (9:1, v/v)

- Standard stock solutions: 11.2 mg of cocaine hydrochloride (10 mg of the free form) is dissolved in dilute hydrochloric acid solution (0.1 mM, pH 4.0) to prepare 100 mL solution; EME and BE, 10 mg each, are dissolved in 100 mL methanol respectively. These stock solutions are appropriately diluted just before use to serve for standard solutions.
- As internal standard (IS)<sup>d</sup>, 3 mg of scopolamine hydrobromide (Kanto Chemicals, Tokyo, Japan and any other manufacturer) is dissolved in 100 mL distilled water to prepare 30 µg/mL solution.
- Derivatization reagents<sup>e</sup>: pentafluoropropionic anhydride (PFPA, Tokyo Kasei Kogyo Co., Ltd., Tokyo, Japan and other manufacturers); trifluoroacetic anhydride (TFAA, manufacturers the same as above); hexafluoroisopropanol (HFIP, Kanto Chemicals, Tokyo, Japan and other manufacturers).

### Storage of specimens<sup>f</sup> [3–5]

Cocaine is rapidly metabolized<sup>g</sup> by enzymes such as cholinesterase and by chemical reaction after its absorption into bodies; these reactions continue postmortem. Therefore, the analysis of cocaine in an unchanged form in biomedical specimens depends on how to stop the metabolism and decomposition of cocaine in a matrix and how to keep its concentrations at the point of analysis. For these purposes, the following treatments should be made as soon as possible after sampling specimens:

- Addition of cholinesterase inhibitors (sodium fluoride, eserine, organophosphorus compounds and others)
- Adjustment of pH to 5.0 for specimens by adding acidic solutions
- Storage in a refrigerator or in a frozen state.

### GC/MS conditions<sup>h</sup>

Gas chromatograph/mass spectrometer: Finnigan Polaris Q (Thermoquest, Austin, TX, USA); column: Rtx-5MS (30 m × 0.25 mm i. d., film thickness 0.25 µm, Restek, Bellefonte, PA, USA); column temperature: 50 °C → 25 °C/min → 150 °C (3 min) → 10 °C/min → 300 °C; injector temperature: 250 °C; transfer line temperature: 300 °C; carrier gas: He; its flow rate: 0.9 mL/min; injection mode: splitless; measurement: scan mode.

### Procedures

Since cocaine in biomedical specimens is rapidly hydrolyzed, the specimens<sup>i</sup> should be treated for its preservation immediately after sampling, and processed for extraction and derivatization procedure. Good recoveries of cocaine and its metabolites can be obtained with a mixed type extraction column (Bond Elut Certify<sup>®</sup>) and a diatomite column (Extrelut<sup>®</sup>). The extraction with the diatomite column is somewhat inferior in purification ability, but gives good recoveries with simple procedure and thus is useful in forensic toxicology.

## a) Procedure I (Bond Elut Certify®) [6–8]

### i. Extraction from urine and derivatization

- i. A 5-mL volume of urine is mixed with 5 mL of 0.1 M phosphate buffer (pH 6) and 100  $\mu$ L IS solution.
- ii. The column is activated by passing 3 mL methanol and then 3 mL of 0.1 M phosphate buffer solution (pH 6) through it<sup>l</sup>.
- iii. The above urine mixture is poured into the column to let it flow slowly (about 1 mL/min)<sup>k</sup>.
- iv. The column is washed with 5 mL distilled water, 3 mL of 0.1 M hydrochloric acid solution<sup>l</sup> and 9 mL methanol, and aspirated with reduced pressure for more than 5 min to dry the column<sup>m</sup>.
- v. Cocaine and its metabolites are eluted with 3 mL of the Eluent-1.
- vi. The eluate is evaporated to dryness under a stream of nitrogen<sup>n</sup> with warming at 50 °C. The residue is dissolved in a small amount of methanol<sup>o</sup> and transferred to a reaction vial. The solution is again evaporated to dryness under a stream of nitrogen, mixed with 100  $\mu$ L PFPA and 50  $\mu$ L HFIP, capped airtightly, and heated at 70 °C for 30 min for derivatization.
- vii. After the reaction, the solvent is removed under a gentle stream of nitrogen; the residue is dissolved in 100  $\mu$ L ethyl acetate to be subjected to GC/MS analysis.

### ii. Extraction from blood and derivatization

- i. A 1-mL volume of blood (plasma) is mixed with 100  $\mu$ L IS solution and 5 mL methanol, vortex-mixed for 1 min and centrifuged to separate a supernatant fraction. Another 3-mL methanol is added to the sediment in the centrifuge tube, vortex-mixed and centrifuged in the same way.
- ii. The supernatant fractions are combined and concentrated (under a stream of nitrogen or in a rotary evaporator) to not larger than 1 mL, mixed with 5 mL of 0.1 M phosphate buffer solution (pH 6) and centrifuged. The supernatant fraction is poured into the Bond Elut Certify column.
- iii. The following procedure is exactly the same as described above for the urine specimen.

## b) Procedure II (Extrelut®) [5]

- i. A 1-mL volume of blood (plasma) is mixed with 4 mL distilled water; in the case of urine, 5 mL is used without any dilution. The 5 mL specimen is mixed with 100  $\mu$ L IS solution and its pH is adjusted to 8–9<sup>p</sup> with 10 % ammonia water.
- ii. The above solution is poured into the Extrelut® column and left for 20 min.
- iii. Cocaine and its metabolites are eluted from the column with 30 mL of the Eluent-2.
- iv. The eluate is evaporated to dryness under reduced pressure with warming at 50 °C. The residue is dissolved in 100  $\mu$ L PFPA and 50  $\mu$ L HFIP, capped airtightly and heated at 70 °C for 30 min for derivatization. A 1–2  $\mu$ L aliquot of it is subjected to GC/MS analysis.

### c) Construction of calibration curves<sup>a</sup>

- i. To each blank blood (1 mL) and urine (5 mL), are added 100  $\mu$ L IS solution, cocaine (100–1,000 ng/mL), EME (100–1,000 ng/mL) and BE (200–1,000 ng/mL).
- ii. The specimens are subjected to either Procedure I or Procedure II.
- iii. For each calibration curve, peak area ratio of a compound to IS is used for the vertical axis. Monitor ions used are ; EME-PFP:  $m/z$  82; BE-HFIP:  $m/z$  318; cocaine:  $m/z$  82; scopolamine-PFP (IS):  $m/z$  138.

### Assessment and some comments on the methods

It is not easy to simultaneously extract cocaine, EME and BE by liquid-liquid extraction due to the high polarity of BE. However, the three compounds can be simultaneously extracted with the Bond Elut Certify<sup>®</sup> and Extrelut<sup>®</sup> columns with high efficiency. The recovery rates were not lower than 86 % for the three compounds with the Bond Elut Certify<sup>®</sup> column [7,8] and not lower than 81 % with the Extrelut<sup>®</sup> column [5].

► *Figure 4.1* shows a TIC and mass chromatograms (MCs) of cocaine (100 ng), EME (100 ng), BE (200 ng) and IS, which had been spiked into 1 mL blood before extraction with a Bond Elut Certify<sup>®</sup> column and PFP-HFIP derivatization. In the TIC, many big impurity peaks appeared; the test peaks were small. Each mass spectrum contained some impurity peaks, but by subtracting background impurity peaks from the test mass spectrum, a clean spectrum can be obtained, which is almost identical to that of the authentic standard. By mass chromatography, quantitative analysis can be achieved without any interference by impurities. ► *Figure 4.2* shows mass spectra of the authentic cocaine, EME and BE after derivatization.

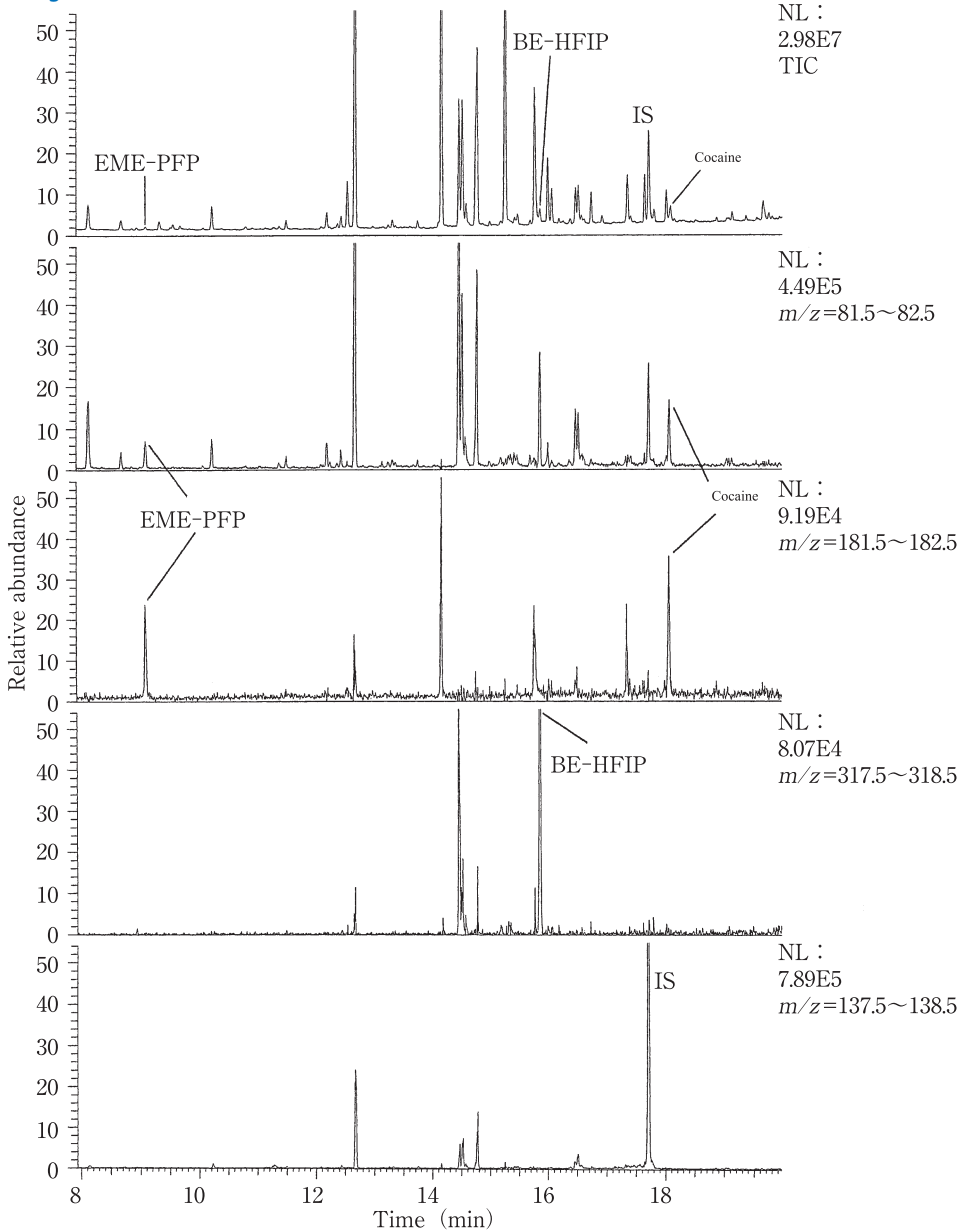
Setting up of cutoff values are very common in USA and Europe as a part of QC (quality control) and QA (quality assurance) system; the idea is useful to suppress the discrepancies of results among testing institutions and to secure the accuracy of each analysis. The cutoff values [9] of BE in urine for cocaine abuse being established in U.S.A. are 300 ng/mL for the primary judgement by immunoassays, and 150 ng/mL for the secondary judgement by GC/MS. However, in Japan, such criteria set by official institutions are not available for drugs of abuse. Upon judgements of analytical data, the idea of cutoff values should be adopted with reference to the values established in USA or Europe. When BE in urine is analyzed by GC/MS in the full scan mode for both mass spectral measurements and quantitation by mass chromatography, the most suitable cutoff value seems to be 300 ng/mL.

### Poisoning case

Numerous fatal cocaine poisoning cases were reported in USA, but in Japan the number of such cases is limited. The author et al. experienced a fatal cocaine poisoning case and measured concentrations of cocaine and its metabolites in body fluids and various organs.

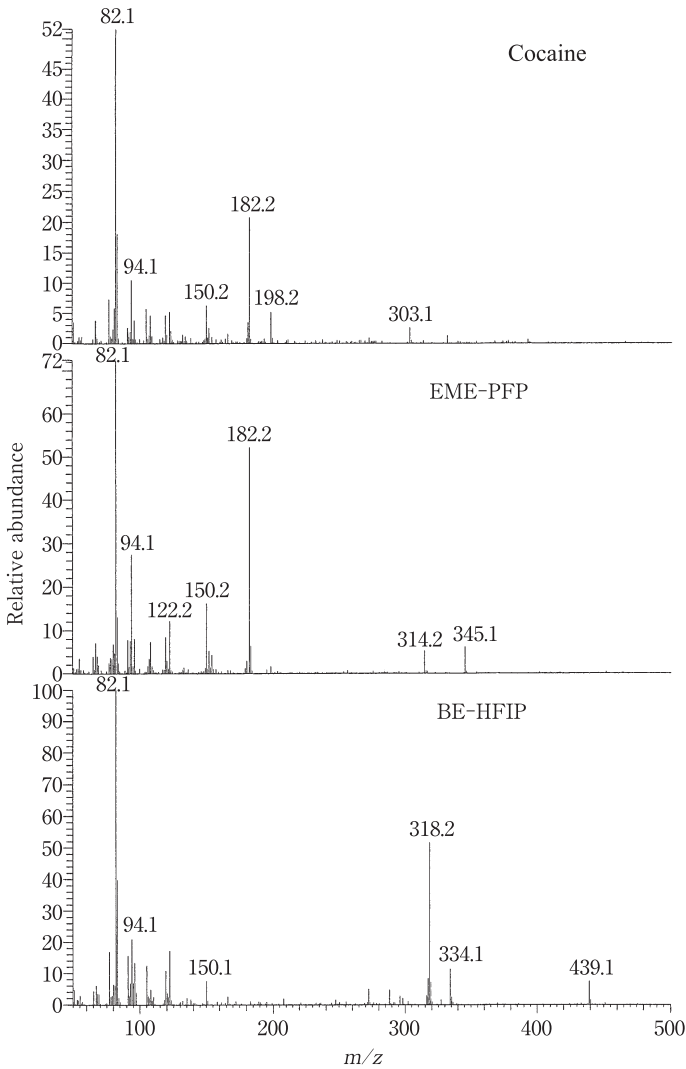
A 41-year-old male was found dead in a hotel room. The clothes on the corpse were not disordered; no external wounds could not be found. However, the skin around both nostrils was reddened erosively. In his room, nine small empty polyethylene bags, to which small amounts of cocaine powder adhered were found; methamphetamine powder, cannabis resin

Figure 4.1



Total ion chromatogram (TIC) and mass chromatograms for the PFP-HFIP derivatives of the extract of 1 mL blood, to which 100 ng cocaine, 100 ng EME and 200 ng BE had been added.

■ **Figure 4.2**



**Mass spectra of the authentic cocaine and its metabolites.**

and tablets of 3,4-methylenedioxymethamphetamine (MDMA) were also discovered. The cadaver was subjected to forensic autopsy with suspicion of drug poisoning.

The analytical results are summarized in [Table 4.1](#); the TIC and mass spectra for heart blood of this victim are shown in [Fig. 4.3](#). The level of cocaine found in heart blood (19.4  $\mu\text{g/mL}$ ) was considered to be in the fatal range, because those reported in the previous fatal cases were largely not higher than 20  $\mu\text{g/mL}$  [10–13]. Because of the presence of red skin around the nostrils, inhalation of cocaine was suspected; but its level in the lung was not higher than those in other organs. The cocaine levels in stomach contents and the stomach wall were especially high, while the levels of its metabolites EME and BE were low in both speci-

Table 4.1

Concentrations of cocaine, EME and BE in the autopsy specimens\*

Specimen	Cocaine	EME	BE	Total cocaine**
Heart blood	19.4 (0.06)	30.9 (0.16)	28.5 (0.01)	96.5 (0.32)
Urine	81.5 (0.27)	242 (1.22)	487 (1.69)	962 (3.17)
Stomach contents	764 (2.52)	66 (0.33)	155 (0.54)	1,027 (3.39)
Bile	82.4 (0.27)	47 (0.24)	20.3 (0.07)	175 (0.58)
Brain	41.1 (0.14)	2.9 (0.02)	5.8 (0.02)	51.6 (0.17)
Lung	103 (0.34)	28.5 (0.14)	41.5 (0.14)	190 (0.63)
Heart	44 (0.15)	6.1 (0.03)	5.1 (0.02)	58.9 (0.19)
Pancreas	148 (0.49)	32.4 (0.16)	23.0 (0.08)	222 (0.73)
Liver	171 (0.56)	41.5 (0.21)	160 (0.55)	403 (1.33)
Spleen	109 (0.36)	51.1 (0.26)	46.3 (0.16)	235 (0.78)
Kidney	71.3 (0.24)	25.9 (0.13)	15.8 (0.06)	127 (0.42)
Stomach wall	655 (2.16)	30.7 (0.15)	27.4 (0.10)	730 (2.41)

\* Unit:  $\mu\text{g/mL}$  or  $\text{g}$  and  $\mu\text{mol/mL}$  or  $\text{g}$  in parentheses

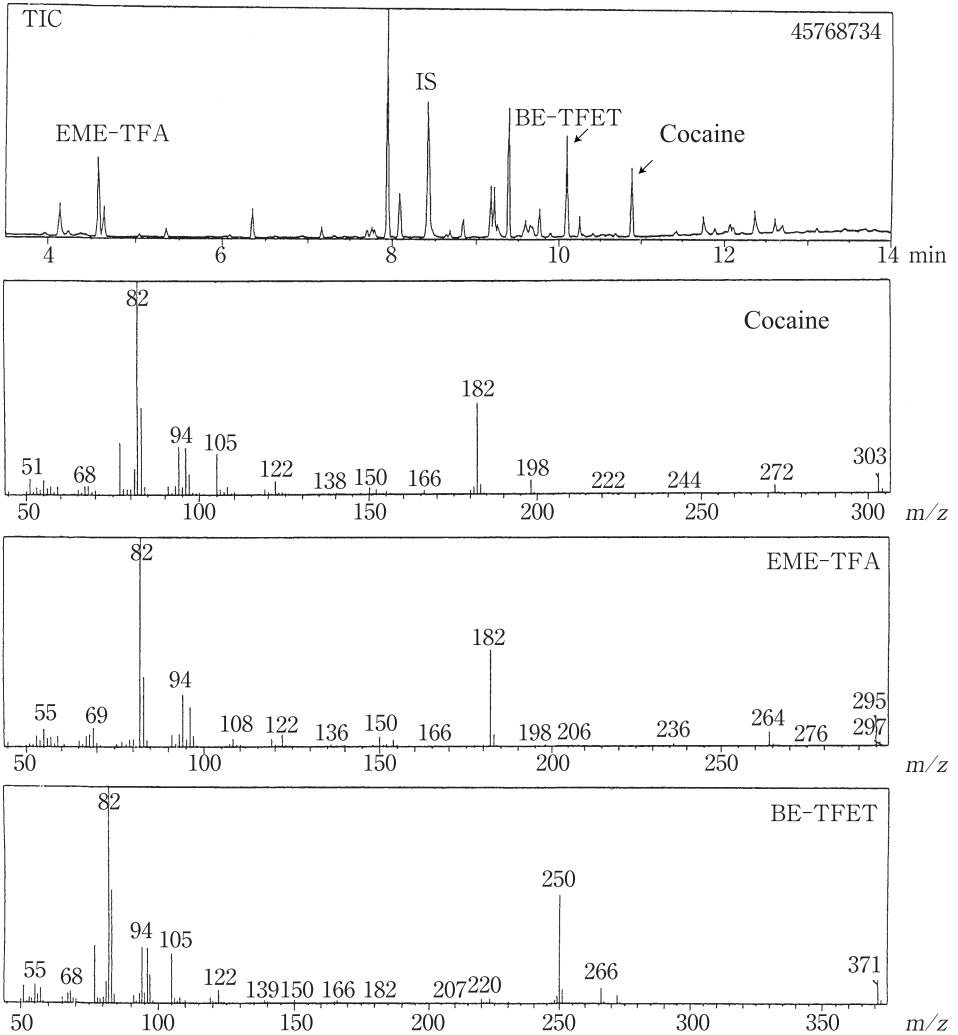
\*\* The total cocaine concentration was calculated after conversion of amounts of EME and BE into those of cocaine

mens. This means that the victim had died relatively shortly after ingestion of cocaine; this idea seems to be also supported by the result that the ratio of unchanged cocaine in urine was as much as 8.5 % (➔ Table 4.1).

According to human experiments, the urinary ratio of BE to cocaine was reported to be 5.9 on average for urine sampled 0–1 h after cocaine inhalation; the ratio was 10.6 on average for urine sampled 0–8 h after the inhalation. The ratios increased according to the increase in time interval between the inhalation and samplings [13–15]. In the present case, the ratio counted 6.3, suggesting a relatively short period between the times of his ingestion and death. In addition, the ratios of cocaine to BE in blood and in the brain, and the brain-to-blood ratios of cocaine and BE were compared with those described in literature [11]; such comparison also suggested his death to have taken place 1–3 h after cocaine ingestion<sup>f</sup>.

Neither amphetamines, cannabis metabolite, MDMA nor ethanol were detected from the present specimens; only cocaine and its metabolites could be detected. Since neither injuries nor diseases could be found, the cause of his death was diagnosed to be cocaine poisoning. Considering the size of nine empty polyethylene bags attached by cocaine powder, the whole

■ **Figure 4.3**



TIC and mass spectra for the extract of heart blood in an actual poisoning case. The extraction was made with an Extrelut® column. The derivatization was made with the combination of trifluoroacetic anhydride and trifluoroethanol.

content of cocaine hydrochloride was estimated to be about 1.5 g, which corresponds to the oral fatal dose of cocaine hydrochloride.

## Toxic and fatal concentrations [16]

Since cocaine in human specimens is rapidly hydrolyzed into EME by enzymatic reaction, and into BE by chemical reaction, the cocaine concentrations detected neither reflect those at the



time of death nor those at the time of samplings. Therefore, there are great variation in the fatal levels of cocaine in literature probably due to the above factors. The fatal doses are, of course, different according to administration routes. Usually, the oral fatal dose for humans is said to be about 1.2 g; but there was a fatal case, in which only 30 mg of cocaine had been applied to mucous membrane of a hypersensitive subject. Among habitual abusers of cocaine, there are cases in which as much as 5 g is used daily. Toxic blood concentrations of cocaine is 0.25–5 µg/mL; there were fatal cases, in which blood cocaine concentration was 1 µg/mL or more.

## Notes

- a) Cocaine is a basic compound (pK<sub>a</sub> 8.6) and thus extractable with chloroform under weakly alkaline conditions. BE, however, is highly polar and thus difficult to be extracted with the solvent; to extract BE by liquid-liquid extraction, a polar solvent mixture of chloroform and isopropanol or ethanol should be used. The simultaneous analysis can be made using chloroform/isopropanol (9:1) or (3:1), and using columns of Bond Elut Certify® and Extrelut®.
- b) The Bond Elut Certify® column is composed of a mixture of non-polar phase and a cation exchanger phase; the mechanisms are reversed-phase extraction plus cation-exchanging action. The LRC reservoir is advantageous, because as much as 10 mL of sample solution can be applied to it. As extraction columns of a similar type, Oasis® MCX and a disc-type SPEC · PLUS™ · DAU are commercially available.
- c) The extraction mode for the Extrelut® column is sometimes classified as solid-phase extraction; but this is not true. It is essentially liquid-liquid extraction; it is not based on molecular interaction between the stationary phase and the mobile phase, which is just the principle of the solid-phase extraction. The essential nature of the Extrelut® column is the partition of a molecule between the water phase adsorbed to the support material and an organic solvent phase, which can be classified as liquid-liquid extraction. The Extrelut® is being sold as packed mini-columns or powder for repacking. The powder is convenient in that the volume of the packing material can be changed according to the volume of a sample solution to be poured. However, the Extrelut® column is inferior to solid-phase extraction columns in view of cleanup ability. When a trace compound is extracted with the Extrelut® column to identify the compound by mass spectral measurements, there are sometimes cases in which a satisfactory mass spectrum cannot be obtained because of contamination by impurity peaks. In the SIM, the possibility of such contamination is much lower and highly sensitive analysis can probably be achieved even with the use of the Extrelut® column.
- d) As an IS, the use of a deuterated compound is ideal, because its physicochemical behavior is almost identical to that of a target compound. In USA, many deuterium-labeled compounds are being commercially available. In Japan, the situation is more inconvenient; therefore, a non-labeled IS was used in these experiments. In forensic judgement, the confirmation of a target compound is usually achieved by agreement of its mass spectrum with that of the authentic standard. Since, with simultaneous use of a deuterated IS, a mass spectrum of a target compound is interfered with by the IS, another mass spectral measurement is required without IS. Scopolamine tends to yield a peak due to dehydration of the compound in its mass spectrum, but can be used as IS. The author tried ketamine and an-

tipyrine as ISs for cocaine; ketamine suffered from variation of its peak height and antipyrine showed tailing. Both compounds showed similar problems in reproducibility.


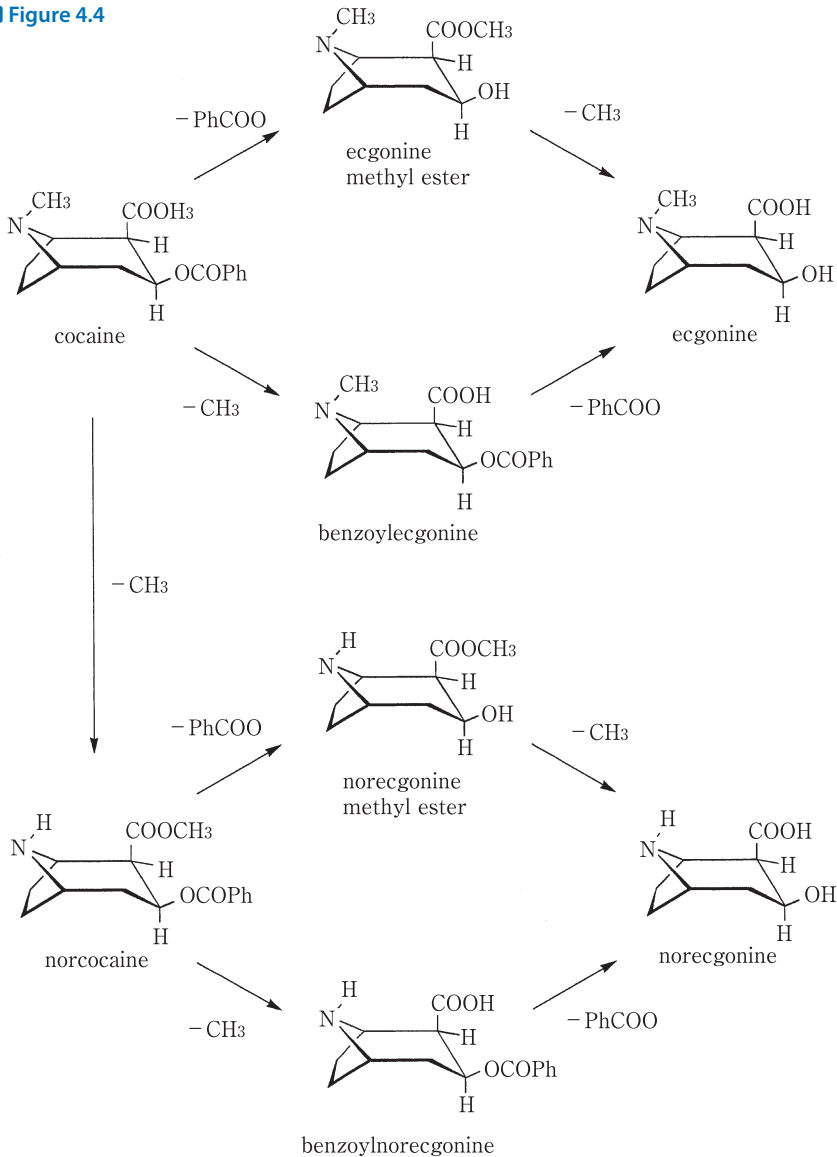
- e) The hydroxyl group of EME is acylated and the carboxyl group of BE is esterified for derivatizations simultaneously. As an acylating reagent, pentafluoropropionic anhydride, trifluoroacetic anhydride or heptafluorobutyric anhydride can be used. For estrification, hexafluoroisopropanol (HFIP) or trifluoroethanol (TFET) can be used. The combination of TFAA with TFET can also give good results for derivatizations.
- f) For body fluid specimens, such as blood, urine, stomach content fluid and bile, sodium fluoride is added to each fluid at 10 mg/mL and the pH of the fluid is adjusted to 5, before storage in a refrigerator or in a frozen state. For solid specimens such as organs, the tissue are homogenized with a buffer solution (pH 5) containing sodium fluoride at 10 mg/mL, and centrifuged. The supernatant fraction is decanted and stored in a refrigerator or in a frozen state. Care should be taken to shorten the time between the sampling and the above pretreatments for storage.
- g) Cocaine is largely metabolized into EME by cholinesterase present in blood and the liver after its rapid absorption into the body, and is also chemically hydrolyzed into BE; they are excreted into urine [17] ( Fig. 4.4). With human experiments, it was reported that cocaine, EME and BE disappeared from urine in 8–16 h, 24–48 h and 48–72 h, respectively [15]. Although the amounts of the compounds excreted into urine is dependent on the methods of administration, the relative amounts of unchanged cocaine, EME and BE excreted into urine are 1–14 %, 12–60 % and 14–55 % of total amount of cocaine administered, respectively [16, 18, 19]. Because of the basicity of cocaine, its amounts to be excreted into urine are dependent upon pH of urine; its amount for excretion increases for acidic urine [16]. However, it is difficult to detect unchanged form of cocaine from urine more than 24 h after its use. In such cases, EME and BE should be analyzed as target compounds.
- h) The optimal conditions are different according to each analytical instrument and separation column to be used. Various conditions including column temperature should be reexamined according to situations. Both recording of full mass spectra and quantitation can be simultaneously made in the scan mode.
- i) The concentration of cocaine in blood is very low, and it is rapidly metabolized by cholinesterase; therefore, urine is a better specimen for analysis of cocaine and its metabolites.
- j) When the column is dried, it causes the decrease of recovery rate; the column should be kept in a wet state with the buffer solution.
- k) When the flow trough the column is rapid, the target compounds are not held in the column sufficiently; the flow rate should be as slow as 1 mL/min.
- l) A majority of basic drugs is adsorbed to the cation exchanger phase, and a minor part is adsorbed to the non-polar phase. The latter part is desorbed and adsorbed again to the cation exchanger by washing the column with acidic solution. In place of the 0.1 M hydrochloric acid solution, 0.1 M acetic acid solution can be used.
- m) It is important to dry the column to secure a high recovery rate and efficient derivatization.
- n) In place of nitrogen, air can be used for evaporation using an air pump.
- o) After evaporation to dryness, the residue is dissolved in methanol; this step is useful for removal of insoluble components and thus contributes to enhance the cleanup.
- p) Since cocaine is easily hydrolyzed under the alkaline conditions above pH 9, care should be taken to keep the pH of the solution in the range of pH 8–9.

Figure 4.4



**Metabolic pathways of cocaine.**

- q) Cocaine, EME and BE generally showed linear calibration curves in the range of 100–1,000 ng/mL. EME-PFP showed variation in a low range (around 100 ng/mL) and in a high range (around 1,000 ng/mL) to some extent. For the extract from blood containing 100 ng/mL of BE, characteristic peaks of the BE-HFIP derivative can be observed in the mass spectrum. However, the mass spectrum obtained from the extract is sometimes interfered with by background impurity peaks, resulting in the difficulty to obtain a clean mass spectrum; while at 200 ng/mL of BE in blood, a satisfactory mass spectrum can be obtained. For BE,

- therefore, the calibration curve should be constructed in the range of 200–1,000 ng/mL. When very high concentrations of a target compound can be expected in advance, the mode of injection can be changed from the splitless mode to the split one to obtain good linearity.
- r) For autopsy specimens, the postmortem interval (period between death and autopsy) and the *in vitro* interval (period between sampling and analysis) are variable; the hydrolytic rate of cocaine shows great variation. Usually, the metabolism, metabolite accumulation and excretion for cocaine habituals are quite different from those for non-habituals. Therefore, it is difficult to accurately estimate the cause of death, time of death and time after drug use, using the ratio of cocaine to BE and the brain-to-blood ratios of cocaine and BE. The ratios only give rough estimation of them.

## References

- 1) Editorial Committee of the Manual of the Japanese Pharmacopoeia (ed) (1996) Manual of Japanese Pharmacopoeia, 13th edn. Hirokawa Publishing Co., Tokyo, pp C556–C559 (in Japanese)
- 2) Hawks RL, Kopin IJ, Colburn RW et al. (1974) A pharmacologically active metabolite of cocaine found in brain. *Life Sci* 15:2189–2195
- 3) Baselt RC (1983) Stability of cocaine in biological fluids. *J Chromatogr* 268:502–505
- 4) Isenschmid DS, Levine BS, Caplan YH (1989) A comprehensive study of the stability of cocaine and its metabolites. *J Anal Toxicol* 13:250–256
- 5) Matsubara K, Maseda C, Fukui Y (1984) Quantitation of cocaine, benzoylecgonine and ecgonine methyl ester by GC-MS after Extrelut extraction. *Forensic Sci Int* 26:181–192
- 6) Varian's Bond Elut Certify Instruction Manual. Harbor City, CA, USA
- 7) Abusada GM, Abukhalaf IK, Alford DD et al. (1993) Solid-phase extraction and GC/MS quantitation of cocaine, ecgonine methyl ester, benzoyl-ecgonine, and cocaethylene from meconium, whole blood, and plasma. *J Anal Toxicol* 17:353–358
- 8) Crouch DJ, Alburges ME, Spanbauer AC et al. (1995) Analysis of cocaine and its metabolites from biological specimens using solid-phase extraction and positive ion chemical ionization mass spectrometry. *J Anal Toxicol* 19:352–358
- 9) Ueki M (1999) Significance and problems of doping tests and toxin analysis. *Nipponrinsho* 57:361–363 (in Japanese)
- 10) Sander R, Ryser MA, Lamoreaux TC et al. (1985) An epidemic of cocaine associated deaths in Utah. *J Forensic Sci* 30:478–484
- 11) Spiehler VR, Reed D (1985) Brain concentrations of cocaine and benzoylecgonine in fatal cases. *J Forensic Sci* 30:1003–1011
- 12) Karch SB, Stephens B, Ho C-H (1998) Relating cocaine blood concentrations to toxicity—an autopsy study of 99 cases. *J Forensic Sci* 43:41–45
- 13) Jenkins AJ, Levine B, Titus J et al. (1999) The interpretation of cocaine and benzoylecgonine concentrations in postmortem cases. *Forensic Sci Int* 101:17–25
- 14) Hamilton HE, Wallace JE, Shimek EL et al. (1977) Cocaine and benzoylecgonine excretion in humans. *J Forensic Sci* 22:697–707
- 15) Amber J (1985) The urinary excretion of cocaine and metabolites in humans: a kinetic analysis of published data. *J Anal Toxicol* 9:241–245
- 16) Moffat AC, Jackson JV, Moss MS et al. (eds) (1986) Clark's Isolation and Identification of Drugs, 2nd edn. The Pharmaceutical Press, London, pp 489–490
- 17) Vitti TG, Boni RL (1985) Metabolism of cocaine. In: Barnett G, Chiang CN (eds) *Pharmacokinetics and Pharmacodynamics of Psychoactive Drugs*. Biomedical Publications, Foster City, CA, pp 427–440
- 18) Amber J, Fischman M, Ruo T-I (1984) Urinary excretion of ecgonine methyl ester, a major metabolite of cocaine in humans. *J Anal Toxicol* 8:23–25
- 19) Amber J, Ruo TI, Nelson J et al. (1988) Urinary excretion of cocaine, benzoylecgonine, and ecgonine methyl ester in humans. *J Anal Toxicol* 12:301–306

## II.2.5 Pentazocine

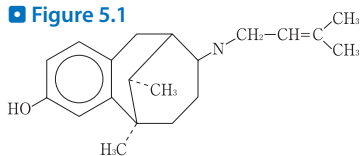
by Osamu Suzuki

### Introduction

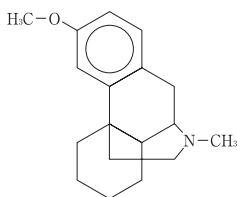
Pentazocine (▶ Fig. 5.1) is a non-narcotic analgesic, but shows mild dependence; there are many cases of pentazocine abuse especially for medical and co-medical workers. The drug is being regulated as a subclass compound of narcotics (DEA class: IV).

Pentazocine in both antemortem and postmortem specimens is being analyzed by GC [1–4], HPLC [5–7] and GC/MS [8]. In this chapter, a simple method for GC/MS analysis of pentazocine in human whole blood and urine is presented.

■ Figure 5.1



pentazocine



dextromethorphan (IS)

**Structures of pentazocine and dextromethorphan (IS).**

### Reagents and their preparation

#### i. Reagents

Ampoules for pentazocine injection were purchased from Yamanouchi Pharmaceutical Co., Ltd., Tokyo, Japan. Each ampoule (1 mL) contains 15 mg of free pentazocine. The solution is transferred to a small glass centrifuge tube with a ground-in stopper, followed by addition of several mg of solid  $K_2CO_3$  and 3 mL of chloroform. The tube is vortex-mixed well and centrifuged at 3,000 rpm for 5 min. The upper aqueous phase is carefully removed with a Pasteur pipette, and the lower organic phase is evaporated to dryness with a centrifugal freeze drier to obtain free pentazocine. However, at the present time, pure pentazocine is commercially available from Sigma (St. Louis, MO, USA). Dextromethorphan-HBr to be used as internal standard (IS) was purchased from Sigma; Sep-Pak  $C_{18}$  cartridges (classic type) from Waters

(Milford, MA, USA). Other common chemicals were of the highest purity commercially available.

## ii. Preparation

- Pentazocine and dextromethorphan solutions: the drugs are separately dissolved in appropriate amount of methanol; a 10–20  $\mu\text{L}$  aliquot was added to 1 mL of whole blood or urine.
- 1 M  $\text{NaHCO}_3$ : a 8.4-g aliquot of  $\text{NaHCO}_3$  is dissolved in distilled water to prepare 100 mL solution.
- Chloroform/ethanol (9:1, v/v): a 100-mL volume of the mixture is prepared.

## GC/MS conditions [8]

GC column<sup>a</sup>: a DB-17 fused silica capillary column (30 m  $\times$  0.32 mm i. d., film thickness 0.25  $\mu\text{m}$ , J&W Scientific, Folsom, CA, USA).

GC conditions: a GC-17A gas chromatograph (Shimadzu Corp., Kyoto, Japan); column (oven) temperature: 150  $^\circ\text{C}$  (1 min)  $\rightarrow$  20  $^\circ\text{C}/\text{min}$   $\rightarrow$  280  $^\circ\text{C}$ ; injection temperature: 280  $^\circ\text{C}$ ; carrier gas: He; its flow rate: 3 mL/min; injection: splitless mode for 1 min, followed by the split mode.

MS conditions; instrument: a Shimadzu QP-5050A quadrupole mass spectrometer<sup>b</sup> connected with the above GC; ionization: positive ion EI; electron energy: 70 eV; emission current: 60  $\mu\text{A}$ ; ion source temperature: 280  $^\circ\text{C}$ ; accelerating voltage: 1.5 kV.

## Procedure

- To 1-mL of whole blood or urine, containing pentazocine, are added 50 ng dextromethorphan (IS, methanolic solution) and 6 mL distilled water, followed by mixing well. For a whole blood specimen, it is necessary to confirm the complete hemolysis. A 3-mL volume of 1 M  $\text{NaHCO}_3$  solution is added to the above mixture to bring its pH to about 8.
- A 10-mL volume of ethanol and 10 mL distilled water are passed through a Sep-Pak  $\text{C}_{18}$  cartridge using a 10-mL volume glass syringe to activate the cartridge at a flow rate not faster than 5 mL/min.
- The cartridge is washed with 10 mL distilled water twice; pentazocine and IS are slowly eluted with 3 mL of chloroform/ethanol (9:1) into a glass vial.
- A small amount of upper aqueous layer is carefully removed by aspiration with a Pasteur pipette. The organic layer (chloroform) is evaporated to dryness under a stream of nitrogen. The residue is dissolved in 100  $\mu\text{L}$  methanol; a 1- $\mu\text{L}$  aliquot of it is injected into GC/MS being operated in the selected ion monitoring (SIM) mode.
- Ions at  $m/z$  271 plus 214 are analyzed for the IS from 3 to 7 min, and those at  $m/z$  285 plus 217 for pentazocine from 7 to 8 min by SIM<sup>c</sup>.
- A calibration curve is constructed by adding 50 ng IS and one of various concentrations of pentazocine to each vial containing 1 mL of blank whole blood or urine and 6 mL distilled water, followed by the above procedure. The number of different concentrations of pentazocine should be not smaller than 4 for the calibration curve, which is composed of pen-

tazocine concentration in the horizontal axis and peak area ratio of pentazocine to IS in the vertical axis. The peak area ratio of a test specimen is applied to the calibration curve to obtain its pentazocine concentration.

## Assessment of the method

► *Table 5.1* shows EI mass spectra of pentazocine and IS. The base peaks unfortunately appeared in a low mass range at  $m/z$  70 and 59, respectively. Therefore, the author et al. [8] used the combined SIM mode as shown in Figure 5.2. Ions at  $m/z$  271 ( $M^+$ ) plus 214 and at  $m/z$  285 ( $M^+$ ) plus 217 were used for detection of IS and pentazocine, respectively. When SIM with a single ion is made, ions at  $m/z$  217 and 271 ( $M^+$ ) should be used for pentazocine and IS, respectively.

The detection limits<sup>d</sup> ( $S/N=3$ ) in the SIM mode were 20–30 ng/mL for pentazocine and 5–10 ng/mL for IS. The therapeutic concentrations of pentazocine in blood was reported to be 50–200 ng/mL; the acute toxic blood level more than 1 µg/mL [9]. Therefore, the present method can be used for detection and quantitation of both therapeutic and toxic levels of pentazocine in blood.

The recovery of pentazocine using the Sep-Pak  $C_{18}$  cartridge was close to 100 % for both whole blood and urine [8].

In this method, dextromethorphan is used as IS; the drug is being widely used as an anti-tussive and a fatal case, suggesting dextromethorphan poisoning, was reported [10]. To measure dextromethorphan, the same method can be used with pentazocine as IS conversely.

■ **Table 5.1**

**EI mass spectra of pentazocine and dextromethorphan (IS)**

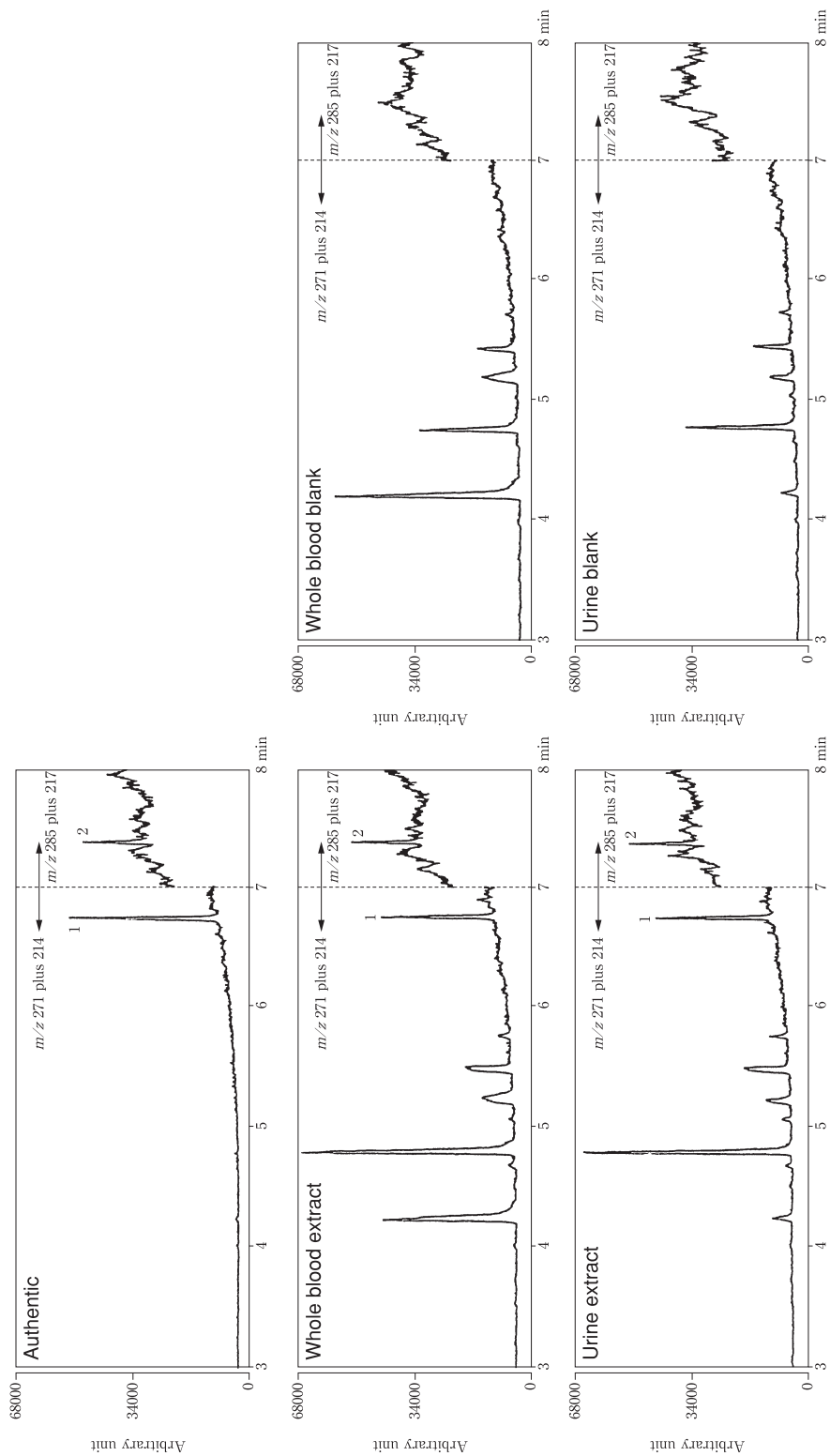
Compound	$m/z$ (% peak intensity)				
Pentazocine	70 (100)	110 (39)	217 (45)	270 (9)	285 (9)
IS	59 (100)	150 (17)	214 (9)	271 (17)	

## Poisoning case, and toxic and fatal concentrations

A 17-year-old female [11] ingested about 100 tablets of pentazocine (total amount estimated, 2.5 g) and fell into unconsciousness with convulsion like grand mal. She was sent to an emergency room, but still showed general cyanosis, convulsions and severe tachycardia. Because of her irregular spontaneous respiration, endotracheal intubation was accomplished and oxygen supply started. Since she showed severe acidosis, 100 mg of sodium bicarbonate, 1.6 mg of naloxone and diazepam (anticonvulsant) were administered to her. Her recovery was smooth, and she got free of the artificial respiration device after 3 h; her consciousness became clear.

A 45-mg aliquot each of pentazocine was administered to 8 subjects intramuscularly. The maximum blood concentrations were obtained 1 h after the administration; they were 0.11–0.24 µg/mL (average 0.14 µg/mL). A 75 mg aliquot each of pentazocine was orally administered to 5 subjects; the maximum blood concentrations (0.11–0.30 µg/mL; average 0.16 µg/mL) were obtained 1–3 h after the administration [12].

**Figure 5.2**



**SIM chromatograms for pentazocine (peak 2) and dextromethorphan (IS, peak 1) extracted from whole blood and urine. In this system, ions at  $m/z$  271 plus 214 (IS) and at  $m/z$  285 plus 217 (pentazocine) were used at the retention times of 3–7 min and 7–8 min, respectively. The amount of pentazocine and IS spiked into 1 mL of blank whole blood or urine was equally 50 ng.**



In two autopsy cases of pentazocine poisoning, its concentrations were 9.2 and 3.3  $\mu\text{g}/\text{mL}$  in blood, 43 and 34  $\mu\text{g}/\text{g}$  in the liver, and not detectable and 4.5  $\mu\text{g}/\text{mL}$  in urine, respectively [12].

The blood concentrations of dextromethorphan, which has been used as IS in this chapter, were reported to be 100–950 ng/mL (average 380 ng/mL) in its poisoning fatal cases of infants [10].

## Notes

- a) Any capillary column of a 50 % phenylsilicone/50 % dimethylsilicone stationary phase (intermediately polar) can be used, regardless of manufacturers.
- b) Any type of GC/MS instruments, to which a capillary column can be attached, can be used.
- c) With a computer system unable to perform such combined SIM detection, the usual SIM using a single ion can be made by the method described below.
- d) In view of sensitivity only, GC-NPD was reported to give similar sensitivity to that of the present GC/MS for pentazocine [1–3].

## References

- 1) Mackell MA, Poklis A (1982) Determination of pentazocine and tripeleminamine in blood of T<sub>s</sub> and Blue addicts by gas-liquid chromatography with a nitrogen detector. *J Chromatogr* 235:445–452
- 2) Schaffer MI, Lin RL, Wu-Chen NB et al. (1983) Spontaneous live birth with a maternal history of intravenous use of pentazocine and tripeleminamine, T<sub>s</sub> and Blues. *J Forensic Sci* 28:489–495
- 3) Kintz P, Tracqui A, Lugnier AJ et al. (1990) Simultaneous screening and quantification of several nonopioid narcotic analgesics and phencyclidine in human plasma using capillary gas chromatography. *Method Find Exp Clin Pharmacol* 12:193–196
- 4) Hattori H, Suzuki O, Seno H et al. (1993) Sensitive determination of pentazocine in whole blood and urine by gas chromatography with surface ionization detection. *Jpn J Forensic Toxicol* 11:31–36
- 5) Shibasaki S, Imamura Y, Itoh T et al. (1987) Application of high-performance liquid chromatography with electrochemical detection for monitoring the concentration of pentazocine in human blood. *J Chromatogr* 421:425–429
- 6) Hackett LP, Dusci LJ, Ilett KF (1987) The analysis of several nonopioid narcotic analgesics and cocaine in serum using high-performance liquid chromatography. *J Anal Toxicol* 11:269–271
- 7) Misztal G, Przyborowski L (1991) Determination of pentazocine in human plasma by high performance liquid chromatography. *Pharmazie* 46:464–465
- 8) Seno H, Kumazawa T, Ishii A et al. (2000) Determination of pentazocine in human whole blood and urine by gas chromatography/surface ionization organic mass spectrometry. *J Mass Spectrom* 35:33–38
- 9) Uges DRA (1997) Blood level data. In: Brandenberger H, Maes RAA (eds) *Analytical Toxicology for Clinical, Forensic and Pharmaceutical Chemists*. Walter de Gruyter, Berlin, pp 707–718
- 10) Association of Medical Examiners, NAME, Pediatric Toxicology Registry, USA (1994) Dextromethorphan blood concentrations in infants. *Bull Int Assoc Forensic Toxicol* 24 (1):38–39
- 11) Yamazaki F, Mori H (eds) (2000) *Guide to Acute Poisonings by Medical Drugs*. Van Nostrand Reinhold, Tokyo, p 222 (in Japanese)
- 12) Moffat AC, Jackson JV, Moss MS et al. (eds) (1986) *Clarke's Isolation and Identification of Drugs*, 2nd edn. The Pharmaceutical Press, London, pp 860–861

## II.2.6 Lysergic acid diethylamide (LSD)

by Shinichi Suzuki

### Introduction

Lysergic acid diethylamide (LSD, lysergide) is known as one of the most powerful hallucinogenic drugs of abuse. LSD was explosively abused in U.S.A. in the latter half of the 1960s. In Japan, the amount of seizure of LSD is much smaller than that of methamphetamine. However, in recent years, it has been increasing markedly; 3,500 tablets of LSD were seized in 1996, while 53,043 tablets in 2000 (about 15-fold increase), arousing a serious concern about the phenomenon.

LSD is a compound chemically modified from ergot alkaloid produced by a bacterium *Claviceps purpurea*. LSD is one of the compounds synthesized by the reactions of lysergic acid isolated from the ergot with various amines at the Rockefeller Institute in the 1930s; LSD was synthesized as the 25th compound and thus called LSD-25. The strong hallucinogenic activity of LSD was confirmed by Albert Hofmann who did synthesize the compound; the pharmacological activity can be obtained by oral administration of as small as 20–75 µg of LSD. The absorption of LSD from the digestive tract is rapid and distinct visual hallucination takes place 45 min–1 h after oral intake of about 20 µg of LSD [1]. The hallucination becomes most marked 2–3 h after the intake and lasts for 8–12 h.

In this chapter, a detection method by TLC and confirmatory analysis by GC/MS for LSD are presented.

### Reagents and their preparation

- LSD can be obtained from each local bureau of drug enforcement officers under an official transfer process.
- *p*-Dimethylbenzaldehyde reagent: a 0.125-g aliquot of *p*-dimethylaminobenzaldehyde (Wako Pure Chemical Industries, Ltd., Osaka, Japan and other manufacturers) is dissolved in 100 mL of 65 % sulfuric acid solution, followed by the addition of 0.1 mL of 5 % ferric chloride aqueous solution.
- Dragendorff reagent [2]: there are various modifications of its preparation; the most typical method is described here. A 0.85-g aliquot of bismuth subnitrate is dissolved in a mixture of 40 mL distilled water and 10 mL acetic acid to prepare “A” solution. A 8-g aliquot of potassium iodide is dissolved in 20 mL distilled water to prepare “B” solution. Then, a mixture of A/B/acetic acid/distilled water (1:1:4:20, v/v) is prepared.
- Iodoplatinate reagent [2]: A 1-mL aliquot of 10 % platinum chloride solution is mixed with 25 mL of 4 % potassium iodide solution and 24 mL distilled water.

## Pretreatments

LSD is seized in the forms of tablets, capsules and paper sheets. The latter is most popular; a paper sheet which had absorbed LSD can be cut into pieces along perforation lines. One of the pieces is put in the mouth and sucked.

LSD shows strong bluish fluorescence; therefore, LSD can be easily located on a TLC plate, and the LSD fraction can be obtained for purification by LC under an ultraviolet light.

For a piece of paper, which is suspected to contain LSD, the drug is extracted by adding 1 % tartaric acid aqueous solution and by shaking it for 5 min. This procedure is repeated six times and the tartarate extract solutions are combined. After the pH of the solution is adjusted to 8.5, the solution is extracted with an appropriate amount of chloroform four times. The combined chloroform extract is evaporated to dryness; the residue is dissolved in a small amount of methanol to be subjected to further analysis.

## TLC analysis

---

### Analytical conditions

TLC plate: a usual silica gel plate, for example, Kieselgel (0.25  $\mu\text{m}$  thickness, Merck, Darmstadt, Germany and other manufacturers).

Developing solvents: (A) acetone/chloroform (4:1, v/v); (B) chloroform/methanol/*n*-hexane (4:2:1, v/v).

### Assessment of the method

The  $R_f$  values of LSD were 0.29 with the (A) solvent system and 0.55 with the (B) system. The colors of the spot of LSD are blue-purple with the *p*-dimethylaminobenzaldehyde reagent, orange with the Dragendorff reagent and purple with the iodoplatinate reagent.

## MS by the direct inlet method

---

Under the ultraviolet light at 365 nm, the fraction showing strong fluorescence is obtained by TLC or LC, and extracted with chloroform. The resulting residue is subjected to analysis by the direct inlet method of EI-MS.

### Analytical conditions

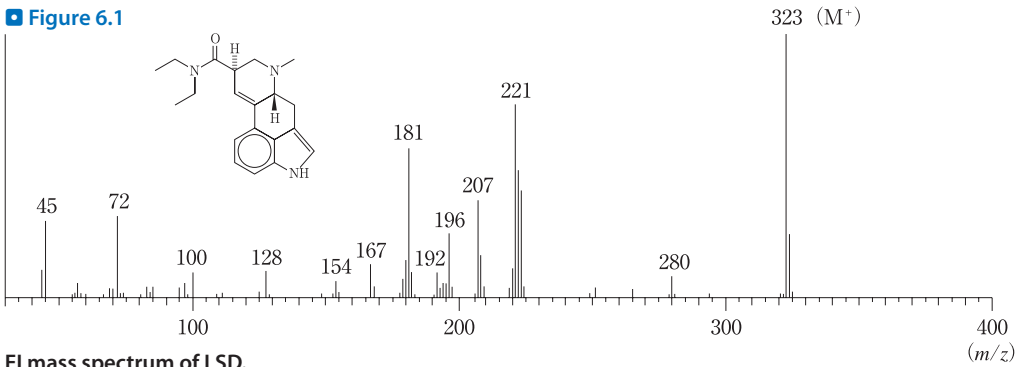
Any type of an MS instrument can be used; electron energy: 20 eV; ionization current: 110  $\mu\text{A}$ ; measurements: full-scan mode.

## Assessment and some comments on the method

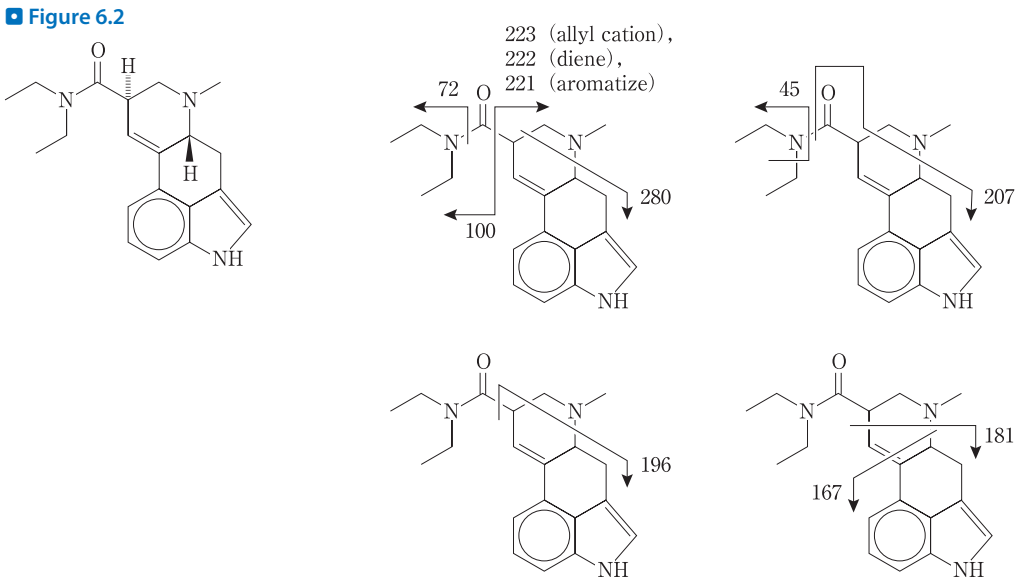
An EI mass spectrum of LSD is shown in [▶ Fig. 6.1](#). The molecular ion appears as the base peak. Fragment peaks can be observed at  $m/z$  221, 207, 181 and 167. The fragmentation pathways are shown in [▶ Fig. 6.2](#). The confirmation of LSD should be made with each mass spectrum.

LSD is easily decomposed by light; all procedure is preferably made under shading from light.

■ **Figure 6.1**



■ **Figure 6.2**



■ **Fragmentation pathways for ions observable in the EI mass spectrum of LSD.**

## Toxicity, and concentrations in blood and urine

---

The acute toxicity of LSD is generally low; it does almost not cause death.

In this chapter, detection and identification methods have been described for seized items, and not for human specimens. It is actually not easy to detect LSD from blood and urine, because its amount to be ingested is as small as about 10 µg and LSD is rapidly metabolized in human bodies. As metabolites of LSD, 2-oxo-LSD, 3-, 13- and 14-hydroxy-LSDs and an *N*-de-ethyl-LSD are known [3]. After oral ingestion of 160 µg LSD, the maximum blood concentration of LSD was 9 ng/mL and its half-life is said to be about 2 h. The concentrations of LSD of LSD-abusing patients, who had been brought to a critical care medical center were 0.5–1.9 ng/mL in blood and 0.2–7.7 ng/mL in urine [4].

## References

- 1) Tu AT (1999) Principle of Toxicology – Science of Poisons –. Jiho Inc., Tokyo, pp 108–109 (in Japanese)
- 2) The Pharmaceutical Society of Japan (ed) (1992) Standard Methods of Chemical Analysis in Poisoning – With Commentary –. Nanzando, Tokyo, p 43 and p 151 (in Japanese)
- 3) Cody JT (2000) Hallucinogens. In: Bogusz MJ (ed) Handbook of Analytical Separations, Vol. 2, Forensic Science. Elsevier, Amsterdam, pp 143–162
- 4) Karch SB (1996) The Pathology of Drug Abuse, 2nd edn. CRC Press, Boca Raton, pp 267–270

## II.2.7 3,4-Methylenedioxyamphetamines

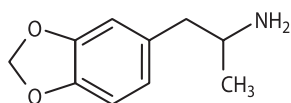
by Munehiro Katagi and Hitoshi Tsuchihashi

### Introduction

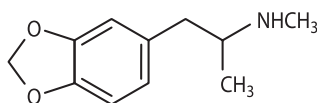
3,4-Methylenedioxyamphetamines (MDAs), which were described as a new drug class “entactogens”<sup>a</sup> by Nichols [1], are being abused to enhance mutual understanding, communicativeness and empathy together with their hallucinogenic effects [1–3]. They are known as a group of designer drugs, and include 3,4-methylenedioxyamphetamine (MDA), 3,4-methylenedioxyamphetamine (MDMA), 3,4-methylenedioxyethylamphetamine (MDEA) and *N*-methyl-1-(3,4-methylenedioxyphenyl)-2-butanamine (MBDB) (▶ Fig. 7.1). Of the MDAs, MDA, MDMA and MDEA are strictly controlled by laws<sup>b</sup>.

These drugs are being usually sold in tablet forms in black markets. The tablets are often imprinted with various kinds of graphic designs and commercial logos, including the 3-diamond (“Mitsubishi” mark), birds, animals and other characters on their faces. Some GC/MS and LC/MS studies have revealed that they contain various amounts of MDAs (in most cases ranging from 50 to 150 mg per tablet) as the primary ingredient, sometimes smaller amounts of amphetamines and/or other pharmaceutical agents, such as caffeine and ketamine [4, 5].

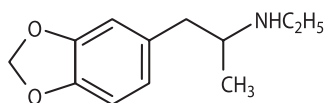
■ Figure 7.1



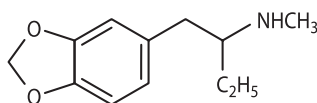
3,4-methylenedioxyamphetamine  
(MDA)



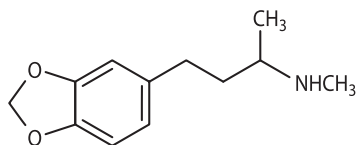
3,4-methylenedioxyamphetamine  
(MDMA)



3,4-methylenedioxyethylamphetamine  
(MDEA)



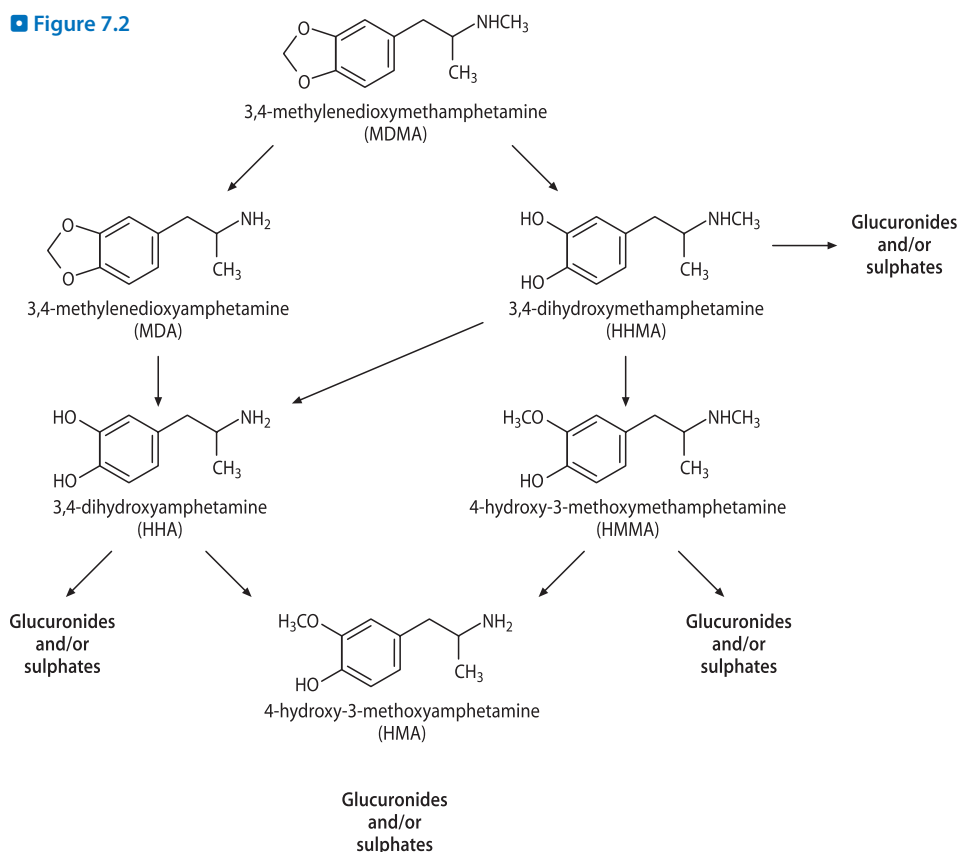
*N*-methyl-1-(3,4-methylenedioxyphenyl)-  
2-butanamine (MBDB)



*N*-methyl-1-(3,4-methylenedioxyphenyl)-  
3-butanamine (HMDMA)

Structures of MDA and its analogues.

Figure 7.2



### Metabolic pathways for MDMA and MDA.

MDMA, which is well known by the street name of “Ecstasy”, is now the most popular recreational drug in the world. It emerged in Europe in the 1980s and has generally been being used at all night techno dance parties (Raves). It is also becoming more popular in the United States and even in Japan.

Several studies have shown that MDMA is metabolized mainly by demethylenation, *O*-methylation, *N*-demethylation and conjugation as shown in [Fig. 7.2](#) [6–10]. For the proof of MDMA use, detection of MDMA and its metabolite MDA is being generally performed for urine specimens.

In this chapter, the procedures for GC/MS and LC/MS analyses of MDAs in the forms of tablets and those for GC/MS analysis of MDAs and their main metabolites 4-hydroxy-3-methoxymethamphetamine (HMMA) and 4-hydroxy-3-methoxyamphetamine (HMA) in urine specimens are presented.

## Reagents and their preparation

- MDA, MDMA and MDEA can be purchased from Sigma (St. Louis, MO, USA) with appropriate legal procedures. They can be also synthesized by reductive amination of piperonyl methyl ketone (Tokyo Kasei Kogyo Co., Ltd., Tokyo, Japan) using ammonium acetate or appropriate amines (Sigma and other manufacturers) and sodium cyanoborohydride (Aldrich, Milwaukee, WI, USA); every synthesized standard compound is purified as their hydrochloride. The standard stock solutions are prepared in distilled water (1 mg/mL), and diluted to appropriate concentrations with drug-free urine.
- Acetonitrile is of HPLC grade, and other chemicals used are of analytical grade.
- Samprep-LCR unit, a 0.2  $\mu\text{m}$  plastic membrane filter, is purchased from Millipore (Bedford, MA, USA).
- HMMA is synthesized by the reaction of methylamine hydrochloride and sodium cyanoborohydride with 4-hydroxy-3-methoxyphenylacetone (Aldrich) [11]. HMA is synthesized by the reduction of 4-hydroxy-3-methoxyphenyl-2-nitropropene, which has been prepared by reaction of 4-hydroxy-3-methoxybenzaldehyde (Aldrich) with nitroethane (Aldrich) [11]. Every synthesized standard was purified as each hydrochloride. The standard stock solutions are prepared with distilled water (1 mg/mL), and diluted to appropriate concentrations with drug-free urine.
- Diphenylmethane (DPM, obtainable from many manufacturers) solution is prepared by dissolving 1 mg DPM in 100 mL ethyl acetate, and used as internal standard (IS) solution for quantitation.
- Carbonate buffer solution (pH 10) is prepared by dissolving 2.1 g of  $\text{NaHCO}_3$  and 7.9 g of anhydrous  $\text{Na}_2\text{CO}_3$  in 100 mL distilled water.
- $\beta$ -Glucuronidase (from *E. coli*, type IX-A) used for hydrolysis is purchased from Sigma.
- Bond Elut SCX (100 mg) cation-exchange cartridges used for solid-phase extraction are purchased from Varian (Harbor City, CA, USA).

## Instrumental conditions

### a) GC/MS

Instrument: Shimadzu GCMS-QP2010 (Shimadzu, Kyoto, Japan); columns: DB-1 and DB-17 MS fused-silica medium-bore capillary columns (both 30 m  $\times$  0.32 mm i. d., film thickness 0.25  $\mu\text{m}$ , J&W Scientific, Folsom, CA, USA); injection mode: splitless; injection temperature: 250  $^{\circ}\text{C}$ ; column temperature: 70  $^{\circ}\text{C}$  (1 min) $\rightarrow$ 15  $^{\circ}\text{C}/\text{min}$  $\rightarrow$ 300  $^{\circ}\text{C}$  (5 min); temperatures of the interface and the ion source: 250 and 200  $^{\circ}\text{C}$ , respectively; carrier gas: He; its flow rate: 3 mL/min; EI electron energy: 70 eV; multiplier gain, 1.2; scan range:  $m/z$  40–400; scan rate: 0.5 s/scan.

### b) LC/MS

Instrument: Shimadzu LCMS-QP2010; column: CAPCELL PAK SCX (150  $\times$  1.5 mm i. d., Shiseido, Tokyo, Japan)<sup>c</sup>; mobile phase: acetonitrile/10 mM ammonium acetate (70:30, v/v, pH 5.5); flow rate: 150  $\mu\text{L}/\text{min}$ ; interface: electrospray ionization (ESI); capillary voltage:



+ 3.5 kV; probe voltage: 2.5 kV; CDL voltage: -20 V; CDL temperature: 230 °C; deflector voltage: 40 V; multiplier voltage: 650 V; quantitative analysis: by the absolute calibration curve method employing the protonated molecule of each analyte in the selected ion monitoring (SIM) mode<sup>d</sup>.

## Procedures

### a) Tablet specimens

#### i. For GC/MS analysis

- i. A sample tablet is ground into fine powder. A 10-mg aliquot of it is dissolved in 10 mL of distilled water.
- ii. The solution is extracted with 20 mL of ethyl acetate under ammonia-alkaline conditions (pH 9).
- iii. The organic layer is dried with anhydrous sodium sulfate, and evaporated to dryness under a stream of nitrogen after adding 10  $\mu$ L of 2.5 M HCl solution.
- iv. To the residue is added 0.2 mL of trifluoroacetic anhydride and 0.2 mL of ethyl acetate, and the mixture is heated at 60 °C for 30 min<sup>e</sup>.
- v. The reaction mixture is evaporated to dryness under a gentle stream of nitrogen and reconstituted in 100  $\mu$ L of DPM (IS) solution. A 1- $\mu$ L aliquot of it is injected into GC/MS.

#### ii. For LC/MS analysis

- i. A sample tablet is ground and dissolved in distilled water as described above.
- ii. The aqueous solution is further diluted to appropriate concentrations with distilled water. The resulting sample aqueous solution is passed through a Samprep-LCR unit, a 0.2  $\mu$ m plastic membrane filter<sup>f</sup>.
- iii. A 5- $\mu$ L aliquot of the filtrate is injected into LC/MS.

### b) Urine specimens for MDAs and their metabolites

#### i. Hydrolysis

Enzymatic hydrolysis:

To 2 mL of urine is added 0.4 mL of 75 mM phosphate buffer (pH 6.8), containing 2000 Fishman units/mL urine of  $\beta$ -glucuronidase<sup>g</sup>. The mixture is incubated at 37 °C for 3 h. After centrifugation, the supernatant solution is subjected to the below extraction procedure.

Acid hydrolysis<sup>h</sup>:

To 2 mL of urine is added 0.5 mL of conc. HCl, and the mixture is heated at 100 °C for 1 h. After cooling to room temperature, the mixture is neutralized with solid Na<sub>2</sub>CO<sub>3</sub>. The solution is subjected to the below extraction procedure.

#### ii. Extraction

Liquid-liquid extraction:

- i. The above hydrolyzed solution is mixed with 2 mL of carbonate buffer solution (pH 10)<sup>i</sup> and extracted with 5 mL of chloroform/isopropanol (3:1, v/v).

- ii. After centrifugation, the organic layer is separated and dried with anhydrous sodium sulfate.
- iii. It is transferred to a screw-capped Pyrex tube and evaporated to dryness under a stream of nitrogen after adding 10  $\mu\text{L}$  of 2.5 M HCl solution. The residue is subjected to the below trifluoroacetyl (TFA)-derivatization.


Solid-phase extraction [6]:



- i. A Bond Elut SCX cartridge is successively preconditioned with 2 mL of methanol, 1 mL of distilled water and 1 mL of 25 mM  $\text{KH}_2\text{PO}_4$  solution.
- ii. The hydrolyzed urine sample is mixed with 1 mL of 75 mM  $\text{KH}_2\text{PO}_4$  solution and loaded on the preconditioned cartridge.
- iii. The cartridge is washed with 1.5 mL of 25 mM  $\text{KH}_2\text{PO}_4$  and then 1 mL of methanol.
- iv. Target compounds are eluted with 2 mL of methanol/2.5 M HCl solution (97.5:2.5, v/v).
- v. The eluate is transferred to a screw-capped Pyrex tube and evaporated to dryness under a stream of nitrogen. The residue is subjected to the below TFA-derivatization.


### iii. Derivatization



- i. To the extract residue are added 0.2 mL of trifluoroacetic anhydride<sup>j</sup> (TFAA) and 0.2 mL of ethyl acetate, and the mixture is heated at 60 °C for 30 min.
- ii. The reaction mixture is evaporated to dryness under a gentle stream of nitrogen and reconstituted in 0.1 mL of DPM (IS) solution. A 1- $\mu\text{L}$  aliquot of it is injected into the GC/MS system with a DB-17MS system<sup>k</sup>.

## Assessment of the methods

EI mass spectra of TFA derivatives<sup>l</sup> of MDA, MDMA and MDEA, obtained from clandestine tablets, are shown in  Fig. 7.3. The MDAs produce EI mass spectra characterized by intense ions resulting from the  $\alpha$ -cleavage of the amines and some less intense fragment ions.

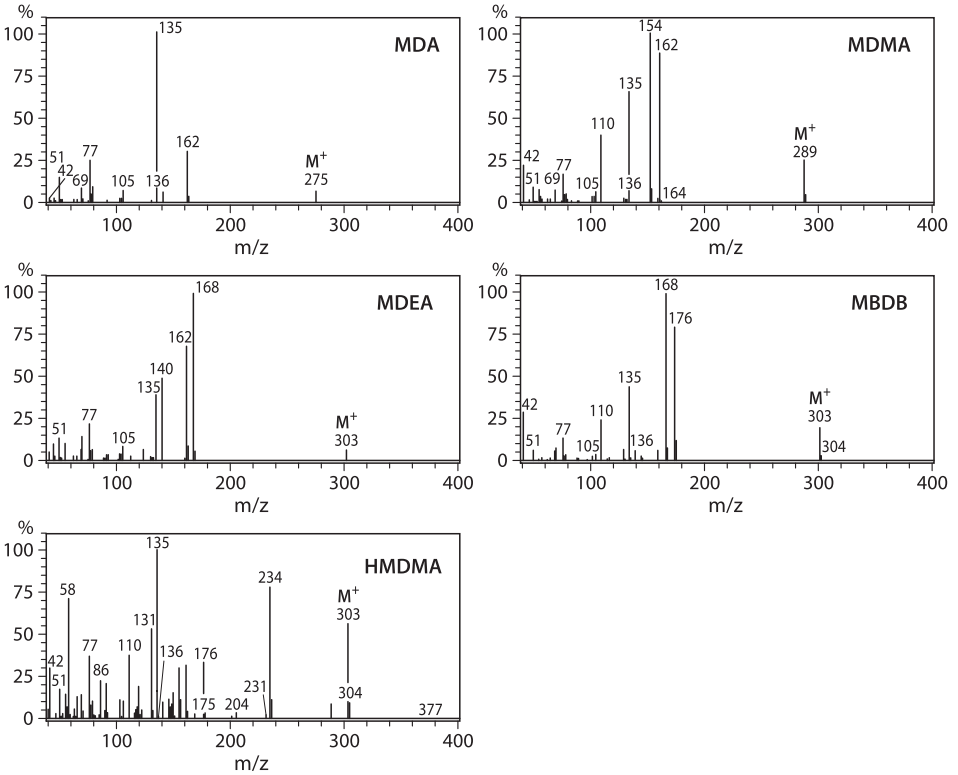
Recently, MBDB and an MDMA homologue, *N*-methyl-1-(3,4-methylenedioxyphenyl)-3-butanamine (HMDMA) ( Fig. 7.1), have appeared as components of clandestine drug samples even in Japan. MBDB and HMDMA are regioisomers of MDEA [9]; MBDB yields a very similar EI mass spectrum to that of MDEA. The discrimination of these isomers can be accomplished by proton nuclear magnetic resonance spectrometry, but it is useless for small amounts of the compounds in a tablet mixture. As an alternative technique for such isomer discrimination, TFA derivatization followed by GC/MS is applicable ( Fig. 7.3).

The quantitative analysis data for MDAs in many kinds of clandestine tablets encountered in Japan are summarized in  Table 7.1 [4, 5]. For simple and rapid quantitation, the LC/MS technique without any derivatization would be more recommendable.

A total ion chromatogram and mass chromatograms obtained from an MDMA addict's urine by the GC/MS technique after the liquid-liquid extraction are shown in  Fig. 7.4. Not only MDMA and its metabolite MDA, but also their metabolites with open methylenedioxy rings, HMMA and HMA, were detected in the urine sample (HHMA not monitored). The mass spectra of TFA derivatives of MDMA and its three metabolites obtained from the urine specimen are shown in  Fig. 7.5.

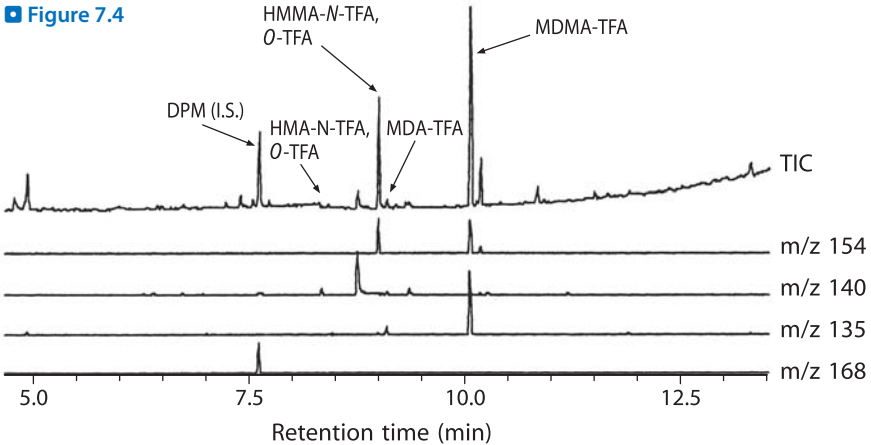
For the proof of the use of MDMA, detection of MDA along with MDMA itself is being usually performed [12–14]. However, the main metabolic pathway of MDMA in humans is the

Figure 7.3



Mass spectra of TFA derivatives of MDA, MDMA, MDEA, MBDB and HMDMA obtained by GC/MS.

Figure 7.4



Total ion chromatogram and mass chromatograms for TFA derivatives obtained from an MDMA addict's urine. Detailed GC/MS conditions are described in the text.

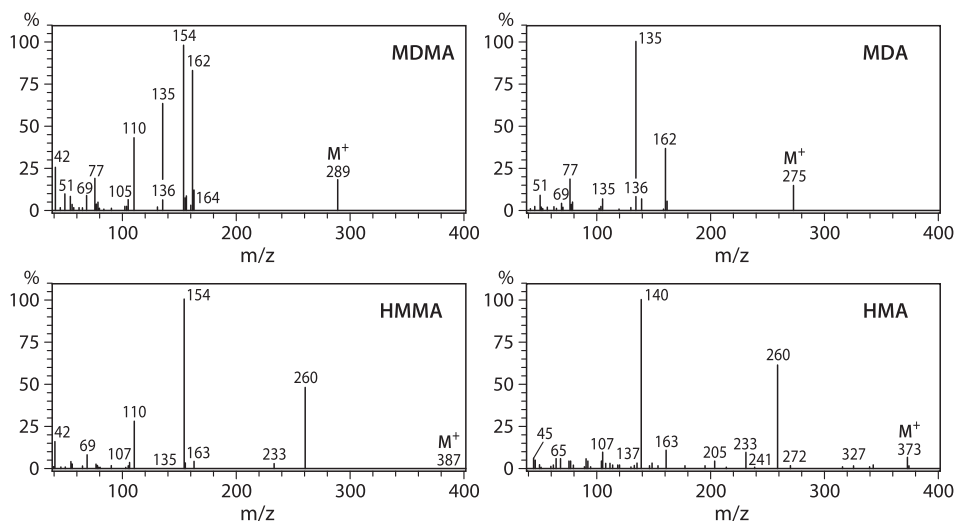
■ **Table 7.1**

**Clandestine MDMA or MDA tablets encountered in Osaka**

Logo	Color	Diameter (mm)	Weight (mg)	Active ingredients (mg)*
Y2K	off white	9.2	290	MDMA 73, AP 4.4
Y2K	light green, blue mottled	9.2	230	MDMA 87, MA 30
RN	off-white	8.4	250	MDMA 83, AP 9.3
RN	light green	9.2	300	MDMA 120
JB	light blue and purple mottled	8.4	290	MDMA 62
[smiling sun]	off-white	9.3	290	MDMA 160
SKY	green mottled	8.1	310	MDMA 100
["KAPPA" logo]	light green	9.3	320	MDMA 81
[pac man]	light yellow	8.2	350	MDMA 120, caffeine
[fort]	yellow	8.2	330	MDMA 180, caffeine
[none]	light brown mottled	8.4	320	MDMA 120
[none]	off-white	7.2	290	MDMA 88
[none]	red mottled	6.9	140	MDMA 64
[none]	light green, blue, yellow mottled	8.1	300	MDMA 95, MA 25, ketamine
[none]	blue mottled	8.4	330	MDMA 110, MA 1.7, ketamine
["Mitsubishi" logo]	off-white	9.1	340	MDMA 130
["Mitsubishi" logo]	off-white	8.1	340	MDMA 65
["Mitsubishi" logo]	off-white	8.2	340	MDMA 98
["Mitsubishi" logo]	red mottled	9.1	300	MDMA 160
O	off-white	8.2	270	MDMA 93
O	light green mottled	8.2	270	MDMA 90
M3	yellow	8.1	310	MDMA 130
B	yellow	7.1	200	MDMA 140
B	bluish purple	7.3	160	MDMA 52
["Channel" logo]	pink	8.2	250	MDMA 89, MA 1.0, AP 6.9, ketamine, caffeine
[Ying Yang]	off-white	8.1	270	MDMA 60
[crown]	off-white	8.2	270	MDMA 98
[sparrow]	off-white	9.1	270	MDMA 28, MDEA 49
[monster face]/ ["Mitsubishi" logo]	off-white	8.3	250	MDA 86
[diamond]	orange	8.1	190	MDA 110
["Mitsubishi" logo]/[lips]	light brown mottled	8.2	250	MDA 94
["Mitsubishi" logo] (both sides)	light brown mottled	8.3	250	MDA 100

\* The values were calculated as the free base; MDMA=3,4-methylenedioxymethamphetamine; MDA=3,4-methylenedioxyamphetamine; MDEA=3,4-methylenedioxyethylamphetamine; MA=methamphetamine; AP=amphetamine.

■ **Figure 7.5**



**Mass spectra of TFA-derivatives of MDMA, MDA, HMMA and HMA extracted from an MDMA addict's urine. Detailed GC/MS conditions are described in the text.**

cleavage of the methylenedioxy bridge by *O*-dealkylation, followed by *O*-methylation and conjugation; HMMA is the major urinary metabolite of MDMA [6–9]. For more reliable and effective proof of the use of MDAs, their metabolites with the cleavage of methylenedioxy rings, such as HMMA, HMA and 4-hydroxy-3-methoxyethylamphetamine, are more useful than the unchanged drugs<sup>m</sup>.

HMMA and HMA are excreted mainly as conjugates (glucuronides and/or sulfates) into urine [6, 7]; the hydrolysis of urine is, therefore, essential prior to extraction.

The confirmatory cutoff level for urinary MDAs recommended by the Substance Abuse and Mental Health Services Administration (SAMHSA) is 250 ng/mL.

## Symptoms, and toxic and fatal concentrations

MDMA causes increased catecholamine (including serotonin) release and blockade of reuptake resulting in cardiac and central nervous system effects [15]. The effects of MDMA vary depending on its doses, frequency and duration of use; not only acute effects but also chronic (long-term) effects have been studied [16]. Acute and chronic symptoms provoked by MDMA are summarized in [▶ Table 7.2](#) [15]. The effects of chronic MDMA use have not been well studied, but appear to include both toxic hepatitis and damages of the serotonergic neural pathways [17, 18]. The acute MDMA toxicities are similar to those noted with other amphetamines; they are tachycardia, hypertension, seizures, hyperthermia, rhabdomyolysis, acute renal failure, disseminated intravascular coagulation and death [19, 20]. A detailed review by Kalant [16] revealed that 87 MDAs-related fatalities were associated with hyperpyrexia, rhabdomyolysis, intravascular coagulopathy, hepatic necrosis, cardiac arrhythmias, cerebrovascular disorders, and drug-related accidents or suicides. The effects of other MDAs are similar to those of MDMA.

■ **Table 7.2**

**Acute and chronic effects of MDMA**

Acute effect	Chronic effect
bruxism/trismus	memory impairment
nausea/vomiting	depression
irregular eye movements	sleep problems
tachydysrhythmias	anxiety
hypertension	paranoia
intracranial bleeding	liver disease
altered mental status	
alteration in muscle tone/activity	
automatic instability	
hyperthermia	
diarrhea	
hyponatremia	
seizures	
rhabdomyolysis	
acute renal failure	
disseminated intravascular coagulation	
death	

The typical dose range of MDMA for “recreational” use varies from 50 to 150 mg, but its amount per tablet is different according to tablets [4, 5] as summarized in Table 7.1. MDMA is readily absorbed from the intestinal tract and reaches its peak concentration in plasma about 2 h after oral administration [21, 22]. The doses of 50, 75 and 125 mg in the usual “recreational” range for healthy human volunteers produced peak blood concentration of 106, 131 and 236 ng/mL, respectively. According to the review by Kalant [16], most of the cases with serious toxicity or fatality gave blood levels ranging from 0.5 to 10 µg/mL, which are up to 40 times higher than the usual recreational levels. However, some serious cases showed levels as low as 0.11–0.55 µg/mL, which overlap the “normal” range or a little above it. From such data, Kalant [16] mentioned that seriousness of its effects may be dependent also on environmental factors other than the blood drug concentrations.

## Notes

- The created word “entactogen” is derived from the Greek and Latin origins; “en”, “gen” and “tactus” mean “within”, “produce” and “touch”, respectively. Therefore, the word means “to produce a touching within” [1].
- MDA, MDMA and MDEA are all classified as Schedule I drugs in the US, and as Class A drugs in the UK. However, MBDB is currently uncontrolled in both countries, as well as in Japan.
- An ODS-type column is also applicable. However, the SCX column allows to use a much less polar mobile phase, leading to highly sensitive ESI-MS determination.
- For the quantitation by LC/ESI-MS, no IS is required. In the SIM mode, the ions at  $m/z$  180, 194 and 208 should be selected for MDA, MDMA and MDEA, respectively.

- e) For the TFA-derivatization, *N*-methylbis(trifluoroacetamide) (MBTFA) is also applicable as an on-column derivatization reagent [23, 24]; MBTFA is injected immediately after the sample injection. Upon applying to a high concentration of a sample, a part of the injected analytes, however, may be underivatized.
- f) The filtration will avoid clogging and deterioration of the analytical column.
- g) For the hydrolysis of conjugates,  $\beta$ -glucuronidases from several sources, such as *Helix pomatia*, *Escherichia coli* (*E. coli*), bovine liver and abalone entrails, are commercially available. The enzymatic activities greatly change depending on the properties of enzymes and substrates. Shima et al. [25] have shown that  $\beta$ -glucuronidase from *E. coli* is most preferable for the enzymatic hydrolysis of conjugates of the metabolites after cleavage of the methylenedioxy rings (HMMA and HMA).
- h) The hydrolysis with hydrochloric acid is faster and more efficient than with  $\beta$ -glucuronidase [6, 23]. However, the hydrolysate with the acid, containing a large amount of  $\text{Na}_2\text{CO}_3$ , cannot be applied to the SCX cartridge directly.
- i) A mixture at pH value higher than 10 gives lower recoveries of HMMA and HMA.
- j) For derivatization, pentafluoropropionic anhydride (PFPA) and heptafluorobutylic anhydride (HFBA) are also applicable. However, for the TFA-derivatization of HMMA and HMA, on-column derivatization with MBTFA is not suitable.
- k) The non-polar column, DB-1, does not give sufficient separation of MDA-TFA from HMMA-*N,O*-diTFA.
- l) For the derivatization of MDAs, PFPA [10] and HFBA [6, 14] are also applicable.
- m) In controlled experiments with six volunteers performed by Pizarro et al. [9], 44.7 % of the total dose was found to be eliminated into urine as MDMA (23.9 %), MDA (1.8 %), HMMA (17.1 %) and HMA (1.9 %) during the first 24 h after the administration of 100 mg MDMA.
- n) Another study with 3 volunteers by Ensslin et al. [26] revealed that 19 % of the MDEA dose was eliminated into urine as an unchanged form, 31.6 % as 4-hydroxy-3-methoxyethylamphetamine and 2.8 % as MDA within 32 h after oral administration of 140 mg MDEA.

## References

- 1) Nichols DE (1986) Differences between the mechanism of action of MDMA, MBDB, and the classic hallucinogens. Identification of a new therapeutic class: entactogens. *J Psychoactive Drugs* 18:305–313
- 2) Nichols DE, Hoffman AJ, Oberlender RA et al. (1986) Derivatives of 1-(1,3-benzodioxol-5-yl)-2-butanamines: representatives of a novel therapeutic class. *J Med Chem* 29:2009–2015
- 3) Gouzoulis E, Steiger A, Ensslin HK et al. (1992) Sleep EEG effects of 3,4-methylenedioxyethylamphetamine (MDE, "Eve") in healthy volunteers. *Biol Psychiat* 32:1108–1117
- 4) Katagi M, Tsutsumi H, Miki A et al. (2002) Analyses of clandestine tablets of amphetamines and their related designer drugs encountered in recent Japan. *Jpn J Forensic Toxicol* 20:303–319
- 5) Katagi M, Tsuchihashi H (2002) Update on clandestine amphetamines and their analogues recently seen in Japan. *J Health Sci* 48: 14–21
- 6) Helmlin H-J, Bracher K, Bourquin D et al. (1996) Analysis of 3,4-methylenedioxymethamphetamine (MDMA) and its metabolites in plasma and urine by HPLC-DAD and GC-MS. *J Anal Toxicol* 20:432–440
- 7) Ortuño J, Pizarro N, Farré M et al. (1999) Quantification of 3,4-methylenedioxymethamphetamine and its metabolites in plasma and urine by gas chromatography with nitrogen-phosphorus detection. *J Chromatogr B* 723:221–232
- 8) Kreth K-P, Kovar K-A, Schwab M et al. (2000) Identification of the human cytochromes P450 involved in the oxidative metabolism of "Ecstasy" related designer drugs. *Biochem Pharmacol* 59:1563–1571

- 9) Pizarro N, Ortuño J, Farré M et al. (2002) Determination of MDMA and its metabolites in blood and urine by gas chromatography-mass spectrometry and analysis of enantiomers by capillary electrophoresis. *J Anal Toxicol* 26:157–165
- 10) Clark CR, DeRuiter J, Noggle FT (1996) Chromatographic and mass spectrometric methods for the differentiation of N-methyl-1-(3,4-methylenedioxyphenyl)-2-butanamine from regioisomeric derivatives. *J Chromatogr Sci* 34:230–237
- 11) Morgan PH, Beckett AH (1975) Synthesis of some N-oxygenated products of 3,4-methylenedioxyamphetamine and its N-alkyl derivatives. *Tetrahedron* 31:2595–2601
- 12) Zhao H, Brenneisen R, Scholer A et al. (2001) Profiles of urine samples taken from Ecstasy users at Rave parties: analysis by immunoassays, HPLC, and GC-MS. *J Anal Toxicol* 25:258–269
- 13) Letter EAD, Clauwaert KM, Lambert WE et al. (2002) Distribution study of 3,4-methylenedioxymethamphetamine and 3,4-methylenedioxyamphetamine in a fatal overdose. *J Anal Toxicol* 26:113–118
- 14) Stout PR, Horn CK, Klette KL (2002) Rapid simultaneous determination of amphetamine, methamphetamine, 3,4-methylenedioxyamphetamine, 3,4-methylenedioxymethamphetamine, and 3,4-methylenedioxyethylamphetamine in urine by solid-phase extraction and GC-MS: a method optimized for high-volume laboratories. *J Anal Toxicol* 26:253–261
- 15) Gill JR, Hayes JA, deSouza IS et al. (2002) Ecstasy (MDMA) deaths in New York City: a case series and review of the literature. *J Forensic Sci* 47:121–126
- 16) Kalant H (2001) The pharmacology and toxicology of “ecstasy” (MDMA) and related drugs. *Can Med Assoc J* 165:917–928
- 17) Kelly PA (2000) Does recreational ecstasy use cause long-term cognitive problem? *West J Med* 173:129–130
- 18) Mathias R (2000) “Ecstasy” damages the brain and impairs memory in humans. *NIDA Notes* 14
- 19) Weinmann W, Bohnert M (1998) Lethal monointoxication by overdosage of MDEA. *Forensic Sci Int* 91:91–101
- 20) Lora-Tamayo C, Tena T, Rodriguez A (1997) Amphetamine derivative related deaths. *Forensic Sci Int* 85:149–157
- 21) Verebey K, Alrazi J, Jaffe JH (1988) The complications of “ecstasy” (MDMA). *JAMA* 259:1649–1650
- 22) Mas M, Farré, de la Torre R et al. (1999) Cardiovascular and neuroendocrine effects and pharmacokinetics of 3,4-methylenedioxymethamphetamine in humans. *J Pharmacol Exp Ther* 290:136–145
- 23) Tsuchihashi H, Nakajima K, Nishikawa M et al. (1989) Headspace gas chromatography of stimulants in urine by in-column trifluoroacetyl derivatization method. *J Chromatogr* 467:227–235
- 24) Tsuchihashi H, Nakajima K, Nishikawa M et al. (1991) Determination of methamphetamine and amphetamine in urine by headspace gas chromatography/mass spectrometry. *Anal Sci* 7:19–22
- 25) Shima N, Kamata T, Nishikawa M et al. Examination of the hydrolysis conditions of drug glucuronides in urine. In preparation
- 26) Ensslin HK, Maurer HH, Gouzoulis E et al. (1996) Metabolism of racemic 3,4-methylenedioxyethylamphetamine in humans. Isolation, identification, quantification, and synthesis of urinary metabolites. *Drug Metab Dispos* 24:813–820



## II.2.8 Phencyclidine

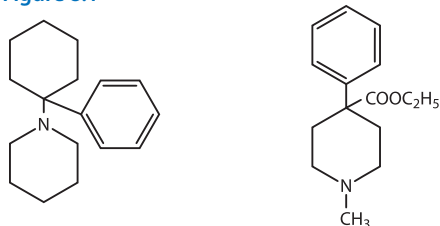
by Akira Ishii and Yoshinao Katsumata

### Introduction

Phencyclidine (PCP) (▶ Fig. 8.1), a synthetic arylcyclohexylamine hallucinogen, had been first applied as an anaesthetic to animals and then to humans for a short period. PCP is known by street names of “angel dust” and “crystal”. Illicit use of PCP first appeared during mid-1960s along the West Coast, and then peaked in the United States in 1979; illicit PCP use declined by 1992. However, daily use of PCP has remained stable among young school seniors over the past decade; PCP is thus being an important drug of abuse [1–3]. It is being regulated as a subclass compound of narcotics and stimulants (DEA Class II).

PCP in both antemortem and postmortem specimens is being analyzed by immunoassays [4–9], GC [10–13], GC/MS [14–18], GC/MS/MS [19, 20], HPLC [21] and CE [22]. In this chapter, a detailed procedure for simple GC/MS analysis of PCP in blood and urine is presented.

■ Figure 8.1



Phencyclidine (PCP)

Pethidine (IS)

Structures of PCP and pethidine (IS).

### Reagents and their preparation

#### i. Reagents

PCP hydrochloride and pethidine (meperidine) hydrochloride (internal standard, IS) can be purchased from Sigma (St. Louis, MO, USA) with suitable legal documentation. Bond Elut Glass columns are obtained from Varian (Harbor City, CA, USA). Other chemicals to be used are of analytical grade.

## ii. Preparation

- PCP and pethidine solutions: the compounds are separately dissolved in appropriate amounts of methanol; a 10–20  $\mu\text{L}$  aliquot is spiked into 1 mL of a whole blood or urine specimen.
- 1 M  $\text{NaHCO}_3$  solution: 8.4 g of  $\text{NaHCO}_3$  is dissolved in distilled water to prepare 100 mL solution.
- Chloroform/methanol (9:1, v/v): a 100-mL volume of the mixture is prepared.

## GC/MS conditions

GC column<sup>a</sup>: a FactorFour VF-5ms fused-silica capillary column (30 m  $\times$  0.25 mm i. d., film thickness 0.25  $\mu\text{m}$ , Varian, Harbor City, CA, USA).

GC conditions; instrument: a Varian CP-3800 gas chromatograph with a split-splitless injector (Walnut Creek, CA, USA); column (oven) temperature: 100  $^\circ\text{C}$  (1 min) $\rightarrow$  20  $^\circ\text{C}/\text{min}\rightarrow$  300  $^\circ\text{C}$ ; injection temperature: 250  $^\circ\text{C}$ ; carrier gas: He; its flow rate: 1.0 mL/min; injection: splitless mode for 1 min, followed by the split mode (split ratio: 50).

MS conditions; instrument: a Varian Saturn 2000 ion-trap tandem mass spectrometer<sup>b</sup> connected with the above GC; ionization: positive ion EI; electron energy: 70 eV; emission current: 10 A; multiplier offset: 230 V; detector voltage: 1.6 kV; scan time: 0.6 s; transfer temperature: 240  $^\circ\text{C}$ ; manifold temperature: 45  $^\circ\text{C}$ ; trap temperature: 210  $^\circ\text{C}$ .

## Procedure [18]

- To 1 mL of whole blood or urine specimen containing PCP, are added 100 ng of pethidine (IS, methanolic solution) and 8 mL distilled water, followed by mixing well. For a whole blood specimen, it is necessary to confirm the complete hemolysis. A 1-mL volume of 1 M  $\text{NaHCO}_3$  solution is added to the above mixture to bring its pH to about 8.
- A 10-mL volume of methanol and 10 mL distilled water are passed through a Bond Elut Glass column to activate it. This procedure is repeated at least twice.
- The above mixture is loaded onto the column, and the column is washed with 20 mL distilled water.
- PCP and IS are slowly eluted with 3 mL of chloroform/methanol (9:1) into a glass vial.
- A small amount of upper aqueous layer is carefully removed by aspiration with a Pasteur pipette. The organic layer (chloroform) is evaporated to dryness under a stream of nitrogen. The residue is dissolved in 50  $\mu\text{L}$  methanol; a 2- $\mu\text{L}$  aliquot of it is injected into GC/MS being operated in the mass chromatographic mode.
- Combined ions at  $m/z$  242 plus 200 are analyzed for PCP and those at  $m/z$  246 plus 232 plus 218 are analyzed for IS from 4 to 12 min of retention time.
- A calibration curve is constructed by adding various concentrations of PCP and 100 ng IS to the vials containing 1 mL of blank whole blood or urine and 8 mL distilled water each, followed by the above procedure. The number of different concentrations of PCP should not be smaller than 4. The calibration curve is composed of PCP concentration on the horizontal axis and peak area ratio of PCP to IS on the vertical axis. The peak area ratio of a test specimen is applied to the calibration curve to calculate its concentration.

Table 8.1

El mass spectra of PCP and pethidine (IS)

Compound	<i>m/z</i> (% peak intensity)				
PCP	200 (100)	242 (84)	84 (24)	91 (18)	186 (13)
IS	246 (100)	71 (98)	172 (84)	232 (63)	218 (46)

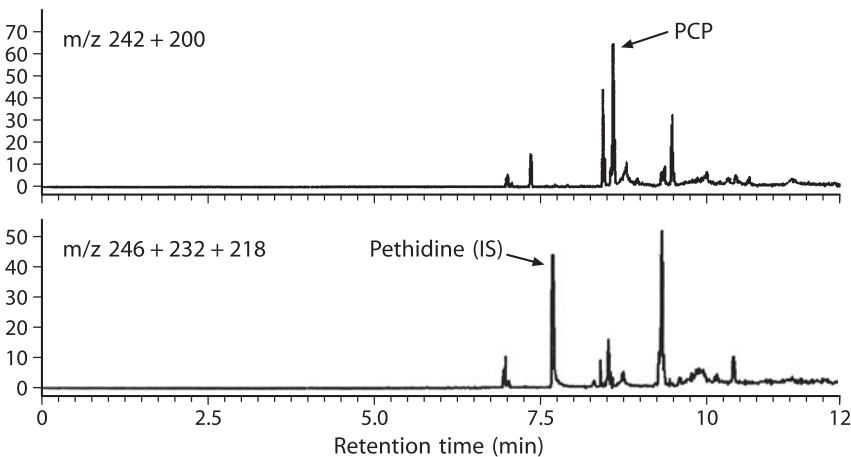
## Assessment of the method

Table 8.1 shows EI mass spectra of PCP and IS. In this method, combined ions at *m/z* 242 ( $[M-1]^+$ ) plus 200 and those at *m/z* 246 ( $[M-1]^+$ ) plus 232 plus 218 are used for PCP and IS, respectively. The mass chromatograms of PCP and IS are shown Fig. 8.2.

The detection limit ( $S/N = 3$ ) was about 5 ng/mL for PCP. According to NIDA guidelines, the cutoff level of PCP in urine samples is 25 ng/mL. The toxic concentrations of PCP in blood were reported to be 7–240 ng/mL; the fatal blood levels were 1–5  $\mu\text{g/mL}$  [23]. Thus, the present method can be sufficiently applicable for detection and quantitation of toxic levels of PCP in blood.

The recovery of PCP using the Bond Elut Glass column was about 100 % for whole blood [18].

Figure 8.2



Mass chromatograms for PCP and pethidine (IS) extracted from whole blood. In this system, ions at *m/z* 200 plus 242 (PCP) and at *m/z* 246 plus 232 plus 218 (IS) were used at the retention time of 4–12 min. The amounts of PCP and IS spiked into 1 mL blank whole blood were 25 and 100 ng, respectively.

## Poisoning case, and toxic and fatal concentrations

A 28-year-old white man [24], who had had a history of drug abuse, exhibited bizarre behavior on an airline flight; he was transferred to the University of California, San Diego Medical

Center. At admission, he stared straight ahead, following commands but not responding verbally; the levels of serum creatin kinase and aspartate aminotransferase were more than 100-times the normal limits. On hospital day 2, he became rigid, diaphoretic and had a temperature reaching 39.2 °C; he was treated for neuroleptic malignant syndrome. On day 4, the serum PCP concentration reached 1,879 ng/mL, the highest level during the course. On day 8, he required intubation due to respiratory failure; his temperature increased to 41.4 °C. On day 11 (13 days after ingestion), he was found to pass two plastic bags through his rectum; one bag had been ruptured. He had probably swallowed the two plastic bags containing PCP powder, one of which had been ruptured to cause the PCP poisoning. On hospital day 12, he made a rapid neurologic recovery; he was discharged with clear consciousness on day 24.

A similar case of protracted coma, caused by an intestinal deposit containing PCP, was also reported; the highest PCP concentration in serum reached 1,690 ng/mL [25].

A fatal PCP poisoning case associated with hypertensive crisis [26], and two sudden death cases during arrest associated with PCP poisoning [27] were reported.

Three death cases, resulting from the PCP use, were reported in Los Angeles County, 1976; PCP concentrations in blood and the liver ranged from 2.0 to 19.0 µg/mL and from 1.7 to 32.7 µg/g, respectively [28].

Cravey et al. reported nine PCP-related deaths; the concentrations in blood and the livers ranged from 0.3 to 12 µg/mL (average: 2.4 µg/mL) and from 0.9 to 80 µg/g (average: 20.1 µg/g), respectively [29].

## Notes

- a) Any capillary column of 5 % phenylsiloxane/95 % dimethylsiloxane stationary phase can be used, regardless of manufacturers; but GC/MS grade columns are recommendable.
- b) Any modern type of GC/MS instruments can be used. The present instrument can be used as a GC/MS/MS system; the better selectivity can be obtained in the tandem mode.

## References

- 1) Zukin SR, Sloboda Z, Javitt DC (1997) Phencyclidine (PCP) In: Lowinson JH, Ruiz P, Millman RB (eds) Substance Abuse: A Comprehensive Textbook, 3rd edn. Williams & Wilkins, Baltimore, pp 238–246
- 2) Gorelick DA, Balster RL (1996) Phencyclidine (PCP). In: Bloom FE, Kupfer DJ (eds) Psychopharmacology: The Forth Generation of Progress. Raven Press, New York, pp 1767–1776
- 3) Schneider S, Kuffer P, Wennig R (1998) Determination of lysergide (LSD) and phencyclidine in biosamples. *J Chromatogr B* 713:189–200
- 4) ElSohly MA, Stanford DF (1990) Cutoff of 25 ng/mL for the EMIT d.a.u. phencyclidine assay. *J Anal Toxicol* 14:192–193
- 5) Armbruster DA, Krolak JM (1992) Screening for drugs of abuse with Roche ONTRAK assays. *J Anal Toxicol* 16:172–175
- 6) Asselin WM, Leslie JM (1992) Modification of EMIT assay reagents for improved sensitivity and cost effectiveness in the analysis of hemolyzed whole blood. *J Anal Toxicol* 16: 381–388
- 7) Sneath TC, Jain NC (1992) Evaluation of phencyclidine by EMIT® d.a.u.™ utilizing the ETS® analyzer and a 25-ng/mL cutoff. *J Anal Toxicol* 16:107–108
- 8) Diosi DT, Harvey DC (1993) Analysis of whole blood for drugs of abuse using EMIT d.a.u. reagents and a Monarch 1000 chemistry analyzer. *J Anal Toxicol* 17:133–137


- 9) Parsons RG, Kowal R, LeBlond D et al. (1993) Multianalyte assay system developed for drugs of abuse. *Clin Chem* 39:1899–1903
- 10) Kandiko CT, Browning S, Cooper T et al. (1990) Detection of low nanogram quantities of phencyclidine extracted from human urine preparation of an acetylated column packing material for use in gas chromatography with nitrogen-phosphorus detection. *J Chromatogr* 528:208–213
- 11) Werner M, Hertzman M, Pauley CJ (1986) Gas-liquid chromatography of phencyclidine in serum, with nitrogen-phosphorus detection. *Clin Chem* 32:1921–1924
- 12) Ishii A, Seno H, Kumazawa T et al. (1996) Simple and sensitive detection of phencyclidine in body fluids by gas chromatography with surface ionization detection. *Int J Legal Med* 108:244–247
- 13) Ishii A, Seno H, Kumazawa T et al. (1996) Simple extraction of phencyclidine from human body fluids by head-space solid-phase microextraction (SPME). *Chromatographia* 43:331–333
- 14) Nakahara Y, Takahashi K, Sakamoto T et al. (1997) Hair analysis for drugs of abuse X VII. Simultaneous detection of PCP, PCHP, and PCPdiol in human hair for confirmation of PCP use. *J Anal Toxicol* 21:356–362
- 15) ElSohly MA, Little TL Jr, Mitchell JM et al. (1988) GC/MS analysis of phencyclidine acid metabolite in human urine. *J Anal Toxicol* 12:180–182
- 16) Slawson MH, Wilkins DG, Foltz RL et al. (1996) Quantitative determination of phencyclidine in pigmented and nonpigmented hair by ion-trap mass spectrometry. *J Anal Toxicol* 20:350–354
- 17) Stevenson CC, Cibull DL, Platoff GE et al. (1992) Solid phase extraction of phencyclidine from urine followed by capillary gas chromatography/mass spectrometry. *J Anal Toxicol* 16:337–339
- 18) Ishii A, Seno H, Watanabe-Suzuki K et al. (2000) Ultrasensitive determination of phencyclidine in body fluids by surface ionization organic mass spectrometry. *Anal Chem* 72:404–407
- 19) Kidwell DA (1993) Analysis of phencyclidine and cocaine in human hair by tandem mass spectrometry. *J Forensic Sci* 38:272–284
- 20) Moore CM, Lewis DE, Leikin JB (1996) The determination of phencyclidine in meconium using ion trap mass spectrometry. *J Forensic Sci* 41:1057–1059
- 21) Cook CE, Brine DR, Jeffcoat AR et al. (1982) Phencyclidine disposition after intravenous and oral doses. *Clin Pharmacol Ther* 31:625–634
- 22) Chen F-TA, Evangelista RA (1994) Feasibility studies for simultaneous immunochemical multianalyte drug assay by capillary electrophoresis with laser-induced fluorescence. *Clin Chem* 40:1819–1822
- 23) Schulz M, Schmoldt A (2003) Therapeutic and toxic blood concentrations of more than 800 drugs and other xenobiotics. *Pharmazie* 58:447–474
- 24) Jackson JE (1989) Phencyclidine pharmacokinetics after a massive overdose. *Ann Intern Med* 111:613–615
- 25) Young JD, Crapo LM (1992) Protracted phencyclidine coma from an intestinal deposit. *Arch Intern Med* 152:859–860
- 26) Eastman JW, Cohen SN (1975) Hypertensive crisis and death associated with phencyclidine poisoning. *JAMA* 231:1270–1271
- 27) Pestaner JP, Southall PE (2003) Sudden death during arrest and phencyclidine intoxication. *Am J Forensic Med Pathol* 24:119–122
- 28) Noguchi TT, Nakamura GR (1978) Phencyclidine-related deaths in Los Angeles County, 1976. *J Forensic Sci* 23:503–507
- 29) Cravey RH, Reed D, Ragle JL (1979) Phencyclidine-related deaths: a report of nine fatal cases. *J Anal Toxicol* 3:199–201

## II.2.9 $\gamma$ -Hydroxybutyric acid

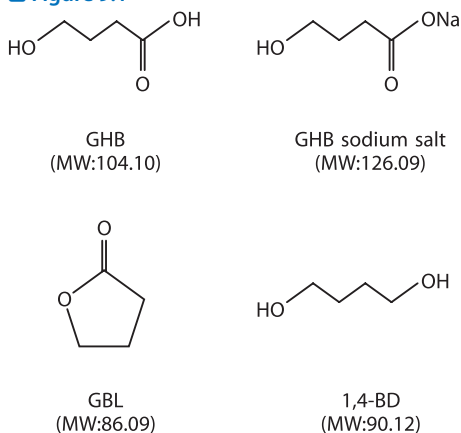
by Fumio Moriya

### Introduction

$\gamma$ -Hydroxybutyric acid (GHB) is an endogenous compound present in the central nervous system (CNS) and peripheral tissues [1]. It is a minor metabolite and precursor of  $\gamma$ -aminobutyric acid (GABA), and also a potent inhibitory neurotransmitter [2]. GHB has a distinct pre-synaptic receptor in the brain [3], and is an agonist of GABA<sub>B</sub> receptors [4–8]. GHB was first synthesized in 1960 and used as an anaesthetic adjuvant or induction agent [9]. This application is still in use in Europe. In the United States, GHB has been being evaluated for the treatments of narcolepsy and alcohol or opiate withdrawal since the 1970s. Recently, Xyrem<sup>®</sup>, the first medically formulated GHB, has been approved by the FDA.

The sodium salt of GHB is an odorless white powder miscible with water and alcohol beverages. It is rapidly absorbed from the gastrointestinal tracts, and strongly depresses the CNS, depending on its doses [2]. Because of its unique pharmacological actions on the CNS, GHB has become one of many popular “club drugs” [2]. GHB has a strong amnesiac action and is being implicated in a number of drug-facilitated sexual assaults [10]. Since it also has growth hormone releasing effects [11], many of body builders are using it as a steroid alternative; but its effects on muscle growth are questionable [12]. Because of the popularity of GHB, it became a federally controlled Schedule I substance in the United States in March, 2000. In Japan, the use of GHB has been strictly regulated by the Narcotics and Psychotropic Substances Control Law since October, 2001. In addition to GHB, abuse of  $\gamma$ -butyrolactone (GBL) and 1,4-butanediol (1,4-BD) is on the rise, because both are rapidly biotransformed to GHB [2]. Structures of these substances are shown in  Fig. 9.1.

**Figure 9.1**



Structures and molecular weights of GHB, GHB sodium salt, GBL and 1,4-BD.

GHB rapidly disappears from blood with non-linear kinetics. Its half-life depends on doses, but usually ranges from 0.3 to 1.0 h [13]. As a result, GHB is undetectable within 12 h even after a large dose [13]. It is difficult to determine if GHB comes from an exogenous or endogenous source, when small amounts are found in blood and urine.

In this chapter, a simple and reliable headspace gas chromatographic (GC) method for detecting GHB from body fluids is described <sup>a</sup>.

## Reagents and their preparation

Sodium salt of GHB can be purchased from Sigma (St. Louis, MO, USA) with suitable legal documentation. A 100-mg aliquot of the compound is accurately weighed and dissolved in 100 mL methanol to prepare 1 mg/mL standard solution <sup>b</sup> in a volumetric flask.

A 100-mg aliquot of  $\alpha$ -methylene- $\gamma$ -butyrolactone (AMGBL, Aldrich, Milwaukee, WI, USA) is accurately weighed and dissolved in 100 mL methanol to prepare its 1 mg/mL solution (internal standard, IS) <sup>b</sup>.

## GC analysis

GC column <sup>c</sup>: DB-624 (30 m  $\times$  0.545 mm i. d., film thickness 3  $\mu$ m, J&W Scientific, Folsom, CA, USA).

GC conditions; instrument: GC-14B (Shimadzu Corp., Kyoto, Japan); detector: flame ionization detector (FID); column (oven) temperature: 50  $^{\circ}$ C (3 min)  $\rightarrow$  20 $^{\circ}$ C/min  $\rightarrow$  150  $^{\circ}$ C (2 min); temperature of the injection port and detector: 150  $^{\circ}$ C; carrier gas: N<sub>2</sub> (100 kPa)

## Procedures <sup>d</sup>

### i. Body fluids

- i. A 1-mL volume of each fluid is mixed with 1 mL distilled water and 100  $\mu$ L IS solution in a test tube with a screw cap.
- ii. A 300- $\mu$ L volume of concentrated sulfuric acid is added to the mixture little by little on a Vortex mixer to convert GHB into its cyclized form (cyclized GHB) <sup>e</sup>.
- iii. The acidified mixture is left at room temperature until it becomes cool (approximately 15 min) and then extracted by vigorous shaking with 6 mL of dichloromethane for 15 min using a mechanical shaker.
- iv. The upper aqueous phase is discarded by aspiration and the lower organic phase is transferred to a new disposable test tube <sup>f</sup>.
- v. The organic phase is evaporated to 50–100  $\mu$ L at 35 $^{\circ}$ C under a gentle stream of nitrogen and transferred to a 15-mL glass vial <sup>g</sup>.
- vi. The vial is capped with a Teflon-coated silicone rubber stopper and sealed with an aluminum cap.
- vii. The vial is heated at 100  $^{\circ}$ C for 15 min on a heating block and 1 mL of the headspace gas is injected into GC.

## ii. Calibrators

- i. Various volumes (10–100  $\mu\text{L}$ ) of the standard solution of sodium salt of GHB are placed in test tubes with screw caps, and evaporated to dryness under gentle streams of nitrogen at room temperature.
- ii. A 1-mL volume of blank blood or distilled water is added to each test tube and mixed on the vortex mixer<sup>h</sup>.
- iii. Each mixture is then processed according to the procedure for body fluids mentioned above.

## Assessment of the method

### i. Advantages of the method

The analytical procedure is simple.

No interfering peaks appear even for body fluids obtained from corpses with moderate decomposition<sup>i</sup>.


The GC injection port and column are kept clean by introducing headspace gas to the GC.

### ii. Disadvantages of the method

Harmful concentrated sulfuric acid is used.

A caution must be taken not to evaporate dichloromethane containing cyclized GHB to dryness, when it is concentrated.

### iii. Sensitivity and accuracy of the method

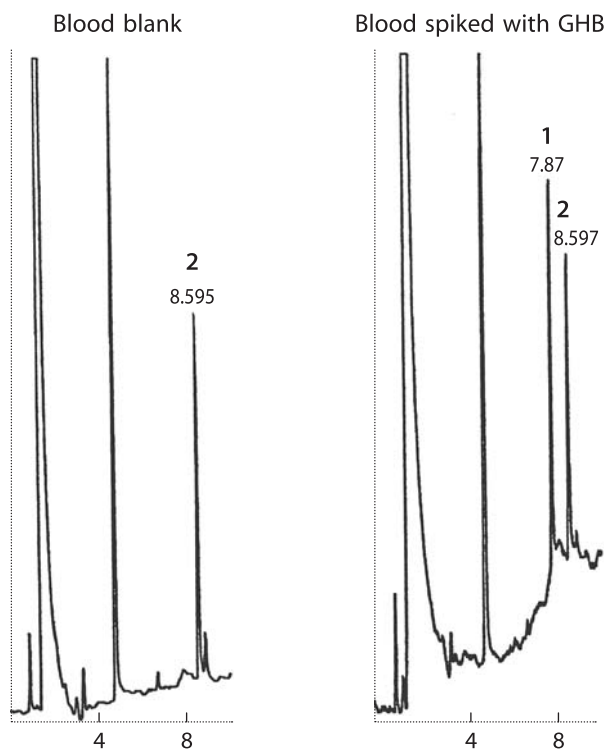
A minimum limit of detection ( $S/N = 3$ ) for GHB was about 0.5  $\mu\text{g}/\text{mL}$ . Calibration curves prepared by plotting GHB concentrations *versus* peak height ratios of GHB to IS were linear in the range of 0–83  $\mu\text{g}/\text{mL}$ . The regression equations were  $y = 69.4x - 1.28$  ( $r = 0.9996$ ) for blood, and  $y = 115x + 1.80$  ( $r = 0.9990$ ) for distilled water. The coefficients of variation for blood and distilled water were in the ranges of 6.46–7.38 % and 4.54–6.59 %, respectively. Gas chromatograms for blank blood and blood spiked with 83  $\mu\text{g}/\text{mL}$  GHB are shown in  Fig. 9.2.

## Poisoning cases, and toxic and fatal concentrations<sup>j</sup>

In a series of study with sixteen adult patients, Helrich et al. [14] found that blood GHB levels at 244–395  $\mu\text{g}/\text{mL}$  were associated with deep sleep; those at 151–293  $\mu\text{g}/\text{mL}$  with medium sleep; those at 63–265  $\mu\text{g}/\text{mL}$  with light sleep; and those at less than 100  $\mu\text{g}/\text{mL}$  with wakefulness. Sporer et al. [15] analyzed serum and urine specimens of fifteen GHB overdose patients, who had been transferred to a hospital with a Glasgow Coma Scale score of 8 or even lower. Serum GHB levels were in the range of 45–295  $\mu\text{g}/\text{mL}$  (average: 180  $\mu\text{g}/\text{mL}$ ) at the time of admission. Eleven patients, who showed a Glasgow Coma Scale score of 3, had peak serum GHB levels at 72–300  $\mu\text{g}/\text{mL}$  (average: 193  $\mu\text{g}/\text{mL}$ ). The time required for awakening ranged from 30 to 190 min (average: 120 min). Serum GHB levels did not correlate with the degree of coma or the time until awakening. GHB levels in urine collected within 30 min after arrival were in the range of 432–2,410  $\mu\text{g}/\text{mL}$  (average: 1,260  $\mu\text{g}/\text{mL}$ ). In a male patient who lost consciousness for several hours after ingesting GBL, serum GHB concentration was 133  $\mu\text{g}/\text{mL}$  [13].



■ **Figure 9.2**




**Gas chromatograms for blank blood and blood spiked with GHB at a concentration of 83  $\mu\text{g}/\text{mL}$ . 1: cyclized GHB; 2: IS (AMGBL).**

In six fatal GHB overdose cases, postmortem blood GHB concentrations were in the range of 27–1,030  $\mu\text{g}/\text{mL}$  (average: 228  $\mu\text{g}/\text{mL}$ ) [13]. In a male subject who had committed suicide by ingesting GBL, postmortem blood GHB concentration was 538  $\mu\text{g}/\text{mL}$  [13]. In two fatalities after consuming 1,4-BD, GHB was detected from postmortem blood at concentrations of 280 and 432  $\mu\text{g}/\text{mL}$  [13].

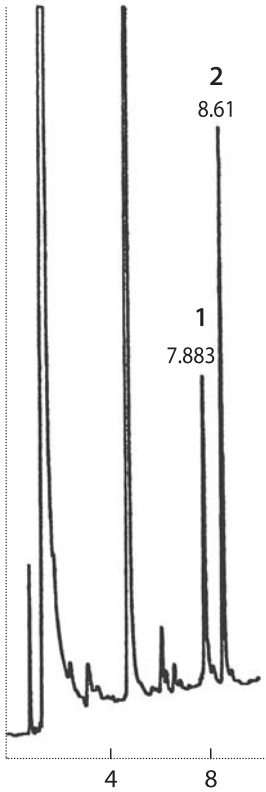
## Notes

- GHB determination was also accomplished by GC/MS methods using GHB- $d_6$  as IS [16–21]. GHB was either converted to its cyclized form or derivatized with *N,O*-bis-(trimethylsilyl)trifluoroacetamide (BSTFA) containing 0.1 % trimethylchlorosilane (TMCS). These methods employ liquid-liquid extraction, solid-phase extraction or solid-phase microextraction. HPLC is not in routine use for GHB analysis.
- These standard solutions are stable in capped brown glass bottles at room temperature for a long period.
- A TC-1 capillary column (dimethylsilicone, 15 m  $\times$  0.53 mm i. d., film thickness 1.5  $\mu\text{m}$ , GL Sciences Inc., Tokyo, Japan) can be also used for identifying cyclized GHB by GC/MS [22].

- d) The analytical method described by LeBeau et al. [16] has been modified.
- e) The use of a liquid dispenser for adding concentrated sulfuric acid is convenient. To prevent a blood sample from coagulation, concentrated sulfuric acid should be dispensed while the test tube is vortexed. The cyclized GHB is identical with GBL. If the intake of GBL is suspected, two specimens should be prepared for detecting the total GBL (unchanged GBL plus GHB biotransformed from GBL) and unchanged GBL. For unchanged GBL, the cyclization step with sulfuric acid for GHB is skipped. The concentration of GHB biotransformed from GBL can be calculated by subtracting unchanged GBL concentration from the total GBL concentration.
- f) For blood samples, denatured proteins cannot be removed by aspiration completely. The clear organic phase is drawn through the layer of denatured proteins. A 3.5-mL polyethylene disposable pipette with a 15-cm length (ELKAY LIQUIPETTE™, Tyco Healthcare Group LP, Mansfield, MA, USA) is convenient for the manipulation.
- g) If the remaining volume of dichloromethane containing cyclized GHB is more than 100  $\mu$ L in the vial, the proportion of dichloromethane gas, being contained in the headspace vapor to be injected after heating, becomes too high; this results in much less sensitivity for detecting cyclized GHB. However, the organic phase should not be evaporated to dryness, because there is a significant loss of cyclized GHB and IS under such conditions.
- h) Since liquid-liquid extraction of cyclized GHB and IS is moderately affected by matrix effects, calibration curves should be prepared using blank blood and distilled water for determining GHB levels in blood and other fluid specimens, respectively.
- i) When putrefaction advances, interfering peaks appear.
- j) Endogenous GHB levels in blood of healthy humans are usually very low [22–24]. Elian [24] detected 0.17–1.51  $\mu$ g/mL (average: 0.74  $\mu$ g/mL) of endogenous GHB from blood specimens of 240 subjects; 0.34–5.75  $\mu$ g/mL (average: 3.08  $\mu$ g/mL) of GHB from urine specimens of 670 subjects. Similar results were reported for urine of antemortem subjects by LeBeau et al. [25], and Yeatman and Reid [26]. GHB levels at 5  $\mu$ g/mL in blood and 10  $\mu$ g/mL in urine obtained from antemortem subjects have been proposed as the cutoff limits for judging exogenous use of GHB, GBL or 1,4-BD.

When antemortem citrate-buffered blood specimens were stored at  $-20\text{ }^{\circ}\text{C}$  for 6–32 months, GHB was produced *de novo* at levels of 4–12  $\mu$ g/mL (average: 9  $\mu$ g/mL). However, such *de novo* production of GHB in blood could not be observed in the presence of EDTA as anticoagulant during storage at the same temperature [27]; citrate should not be used as anticoagulant for blood samples for GHB analysis. Postmortem blood often contains higher levels of endogenous GHB [28–30]. Substantial amounts of GHB are produced in blood inside a corpse as early as several hours after death [30]. Sometimes, postmortem blood GHB concentrations reach therapeutic levels at 24–88  $\mu$ g/mL. A gas chromatogram of blood obtained from a deceased, who was not a user of GHB, is shown in  Fig. 9.3. Postmortem enzymatic conversion of succinic acid or putrescine into GHB is suspected [2]. A large portion of endogenous GHB in postmortem blood may be produced during the interval between death and autopsy (sample collection), rather than during storage of blood at  $4\text{ }^{\circ}\text{C}$  until analysis [30]. The author has found that postmortem production of GHB is slower in cerebrospinal fluid, vitreous humor and urine than in blood. Villain et al. [21] and Elliott [31] have tentatively set positive cutoff limits of GHB at 50 and 30  $\mu$ g/mL for postmortem blood, and 10 and 20  $\mu$ g/mL for postmortem urine, respectively.

■ Figure 9.3



Gas chromatogram for a postmortem blood specimen, in which endogenous GHB was detected at a concentration of 36.6  $\mu\text{g/mL}$ . Postmortem interval was 108 h. 1: cyclized GHB; 2: IS (AMGBL).

## References

- 1) Vayer P, Mander P, Maitre M (1987) Gamma-hydroxybutyrate, a possible neurotransmitter. *Life Sci* 41:1547–1557
- 2) Marinetti LM (2001)  $\gamma$ -Hydroxybutyric acid and its analogs,  $\gamma$ -butyrolactone and 1,4-butanediol. In: Salomone SJ ed. *Benzodiazepines and GHB: Detection and Pharmacology*. Humana Press, Totowa, pp 95–126
- 3) Snead OC 3rd (2000) Evidence for a G-protein-coupled gamma-hydroxybutyric acid receptor. *J Neurochem* 75:1986–1996
- 4) Snead OC 3rd, Liu CC (1984) Gamma-hydroxybutyric acid binding sites in rat and human brain synaptosomal membranes. *Biochem Pharmacol* 33:2587–2590
- 5) Maitre M, Hechler V, Vayer P et al. (1990) A specific  $\gamma$ -hydroxybutyrate receptor ligand possesses both antagonistic and anticonvulsant properties. *J Pharmacol Exp Ther* 255:657–663
- 6) Snead OC 3rd (1996) Relation of the [ $^3\text{H}$ ]  $\gamma$ -hydroxybutyric acid (GHB) binding site to the  $\gamma$ -aminobutyric acid<sub>B</sub> (GABA<sub>B</sub>) receptor in rat brain. *Biochem Pharmacol* 52:1235–1243
- 7) Cash CD, Gobaille S, Kemmel V et al. (1999)  $\gamma$ -Hydroxybutyrate receptor function studied by the modulation of nitric oxide synthase activity in rat frontal cortex punches. *Biochem Pharmacol* 58:1815–1819
- 8) Lingenhoebl K, Brom R, Heid J et al. (1999)  $\gamma$ -Hydroxybutyrate is a weak agonist at recombinant GABA<sub>B</sub> receptors. *Neuropharmacology* 38:1667–1673
- 9) Blumenfeld M, Suntay RG, Harmel MH (1962) Sodium gamma-hydroxybutyric acid: a new anesthetic adjuvant. *Anesth Analg* 41:721–726

- 10) ElSohly MA, Lee LF, Halzauer LB et al. (2001) Analysis of urine samples in cases of alleged sexual assault: case history. In: Salamore SJ (ed) *Benzodiazepines and GHB: Detection and Pharmacology*. Humana Press, Totowa, pp 127–144
- 11) Takahara J, Yunoki S, Yakushiji W et al. (1977) Stimulatory effects of gamma-hydroxybutyric acid on growth hormone and prolactin release in humans. *J Clin Endocrinol Metab* 44:1014–1017
- 12) Addolorato G, Caoristo E, Gessa GL et al. (1999) Long-term administration of GHB does not affect muscular mass in alcoholics. *Life Sci* 65:191–196
- 13) Baselt RC (2002) *Disposition of Toxic Drugs and Chemicals in Man*, 6th edn. Biomedical Publications, Foster City, pp 472–475
- 14) Helrich M, McAslan TC, Skolniks S et al. (1964) Correlation of blood levels of 4-hydroxybutyrate with state of consciousness. *Anesthesiology* 25:771–775
- 15) Sporer KA, Chin RL, Dyer JE et al. (2003) Gamma-hydroxybutyrate serum levels and clinical syndrome after severe overdose. *Ann Emerg Med* 42:3–8
- 16) LeBeau MA, Montgomery MA, Miller ML et al. (2000) Analysis of biofluids for gamma-hydroxybutyrate (GHB) and gamma-butyrolactone (GBL) by headspace GC-FID and GC-MS. *J Anal Toxicol* 24:421–428
- 17) Couper FJ, Logan BK (2000) Determination of gamma-hydroxybutyrate (GHB) in biological specimens by gas chromatography-mass spectrometry. *J Anal Toxicol* 24:1–7
- 18) Elian AA (2001) GC-MS determination of gamma-hydroxybutyric acid (GHB) in blood. *Forensic Sci Int* 122: 43–47
- 19) Frison G, Tedeschi L, Maietti S et al. (2000) Determination of gamma-hydroxybutyric acid (GHB) in plasma and urine by headspace solid-phase microextraction and gas chromatography/positive ion chemical ionization mass spectrometry. *Rapid Commun Mass Spectrom* 14:2401–2407
- 20) Kalasinsky KS, Dixon MM, Schmunk GA et al. (2001) Blood, brain, and hair GHB concentrations following fatal ingestion. *J Forensic Sci* 46:728–730
- 21) Villain M, Cirimele V, Ludes B et al. (2003) Ultra-rapid procedure to test for gamma-hydroxybutyric acid in blood and urine by gas chromatography-mass spectrometry. *J Chromatogr B* 792:83–87
- 22) Moriya F, Hashimoto Y (2003) Postmortem formation of  $\gamma$ -hydroxybutyric acid in blood. *Jpn J Forensic Toxicol* 21:262–269
- 23) Snead OC 3rd, Brown GB, Morawetz RB (1981) Concentration of gamma-hydroxybutyric acid in ventricular and lumbar cerebrospinal fluids. *N Engl J Med* 304:93–95
- 24) Elian AA (2002) Determination of endogenous gamma-hydroxybutyric acid (GHB) levels in antemortem urine and blood. *Forensic Sci Int* 128:120–122
- 25) LeBeau MC, Christenson RH, Levine B et al. (2002) Intra- and interindividual variations in urinary concentrations of endogenous gamma-hydroxybutyrate. *J Anal Toxicol* 26:340–346
- 26) Yeatman DT, Reid K (2003) A study of urinary endogenous gamma-hydroxybutyrate (GHB) levels. *J Anal Toxicol* 27:40–42
- 27) LeBeau MC, Montgomery MA, Jufer RA et al. (2000) Elevated GHB in citrate-buffered blood. *J Anal Toxicol* 24:383–384
- 28) Fieler EL, Coleman DE, Baselt RC (1998)  $\gamma$ -Hydroxybutyrate concentrations in pre- and postmortem blood and urine. *Clin Chem* 44:692
- 29) Stephens BG, Coleman DE, Baselt RC (1999) In vitro stability of endogenous gamma-hydroxybutyrate in post-mortem blood. *J Forensic Sci* 44:231
- 30) Moriya F, Hashimoto Y (2004) Endogenous  $\gamma$ -hydroxybutyric acid levels in postmortem blood. *Legal Med* 6: 47–51
- 31) Elliott SP (2004) Further evidence for the presence of GHB in postmortem biological fluid: implications for the interpretation of findings. *J Anal Toxicol* 28:20–26

## II.3.1 Phenothiazines

by Akira Ishii and Yoshinao Katsumata

### Introduction

Phenothiazine drugs, including chlorpromazine and levomepromazine, have been being widely used as neuroleptics (major tranquilizers), antiparkinsonian drugs and antihistaminics for a long time [1]. ▶ *Table 1.1* shows chemical structures of representative phenothiazines. These drugs show blocking action on D<sub>2</sub> receptors of dopaminergic neurons; there is close relationship between the receptor blocking and tranquilizing actions. The dopamine D<sub>2</sub> receptor-blocking actions provoke extrapyramidal symptoms, such as muscular stiffness, tremor and ptialism. Orthostatic hypotension, arrhythmia and icterus are occasionally found after administration of phenothiazines as side effects.

The number of phenothiazine poisoning cases is relatively small, as compared with the extensive use of this group of drugs [2]. However, until now, many phenothiazine poisoning cases, including fatal ones [3, 4], were reported.

Phenothiazines were analyzed by various methods, such as GC, GC/MS, HPLC and LC/MS. The methods by GC and GC/MS are relatively simple, but most of the methods reported used packed columns or wide-bore capillary columns [5, 6], which did not give high sensitivity.

Hattori et al. [7] reported a highly sensitive method for detecting phenothiazine in body fluids using GC-surface ionization detection (SID)<sup>a</sup>. Although the SID detector has an advantage in that each compound having a tertiary amino group can be analyzed with high sensitivity and specificity, it is not a detector commonly available. In this chapter, the methods of qualitative and quantitative analysis of phenothiazines in human body fluids using useful GC/MS and LC/MS are presented.

### GC/MS analysis

---

### Reagents and their preparation

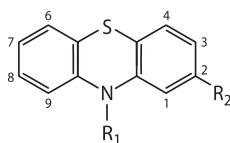
#### i. Reagents










Chlorpromazine, triflupromazine, promethazine and thioridazine can be purchased from Sigma (St. Louis, MO, USA). Pure powder of levomepromazine was donated by Mitsubishi Welpharma, Osaka, Japan.

Other common chemicals were of the highest purity commercially available.

■ **Table 1.1**

**Structures of phenothiazine drugs**



Compound	M.W.	R <sub>1</sub>	R <sub>3</sub>	Misc.
promazine	284	—CH <sub>2</sub> CH <sub>2</sub> CH <sub>2</sub> N(CH <sub>3</sub> ) <sub>2</sub>	H	—
chlorpromazine	318	—CH <sub>2</sub> CH <sub>2</sub> CH <sub>2</sub> N(CH <sub>3</sub> ) <sub>2</sub>	Cl	—
triflupromazine	352	—CH <sub>2</sub> CH <sub>2</sub> CH <sub>2</sub> N(CH <sub>3</sub> ) <sub>2</sub>	CF <sub>3</sub>	—
promethazine	284	—CH <sub>2</sub> CH(CH <sub>3</sub> )N(CH <sub>3</sub> ) <sub>2</sub>	H	—
isothipendyl	285	—CH <sub>2</sub> CH(CH <sub>3</sub> )N(CH <sub>3</sub> ) <sub>2</sub>	H	1:N
ethopropazine	312	—CH <sub>2</sub> CH(CH <sub>3</sub> )N(CH <sub>2</sub> CH <sub>3</sub> ) <sub>2</sub>	H	—
trimeprazine	298	—CH <sub>2</sub> CH(CH <sub>3</sub> )CH <sub>2</sub> N(CH <sub>3</sub> ) <sub>2</sub>	H	—
levomepromazine	328	—CH <sub>2</sub> CH(CH <sub>3</sub> )CH <sub>2</sub> N(CH <sub>3</sub> ) <sub>2</sub>	OCH <sub>3</sub>	—
perazine	339	—CH <sub>2</sub> CH <sub>2</sub> CH <sub>2</sub> N  NCH <sub>3</sub>	H	—
prochlorperazine	373	—CH <sub>2</sub> CH <sub>2</sub> CH <sub>2</sub> N  NCH <sub>3</sub>	Cl	—
trifluoperazine	407	—CH <sub>2</sub> CH <sub>2</sub> CH <sub>2</sub> N  NCH <sub>3</sub>	CF <sub>3</sub>	—
thiethylperazine	399	—CH <sub>2</sub> CH <sub>2</sub> CH <sub>2</sub> N  NCH <sub>3</sub>	SCH <sub>2</sub> CH <sub>3</sub>	—
thiopropazine	446	—CH <sub>2</sub> CH <sub>2</sub> CH <sub>2</sub> N  NCH <sub>3</sub>	SO <sub>2</sub> N(CH <sub>3</sub> ) <sub>2</sub>	—
perphenazine	403	—CH <sub>2</sub> CH <sub>2</sub> CH <sub>2</sub> N  NCH <sub>2</sub> CH <sub>2</sub> OH	Cl	—
fluphenazine	437	—CH <sub>2</sub> CH <sub>2</sub> CH <sub>2</sub> N  NCH <sub>2</sub> CH <sub>2</sub> OH	CF <sub>3</sub>	—
propericiazine	365	—CH <sub>2</sub> CH <sub>2</sub> CH <sub>2</sub> N  CHOH	CN	—
thioridazine	370	—CH <sub>2</sub> CH <sub>2</sub> —  N(CH <sub>3</sub> )	SCH <sub>3</sub>	—

TIC and mass chromatograms (MCs) for 5 phenothiazines. 1: triflupromazine; 2: promethazine; 3: chlorpromazine; 4: levomepromazine; 5: thioridazine. For the authentic sample, the mixture of 4 ng each of the compounds was directly injected into GC/MS. A 200-ng aliquot each of 5 compounds had been spiked into 1 mL whole blood or urine and extracted with a Sep-Pak C<sub>18</sub> cartridge; the residue was dissolved in 100 µL methanol and a 2- µL of it was injected into GC/MS.

## ii. Preparation

Each drug is dissolved in methanol to prepare 1 mg/mL solution<sup>b</sup>. Many of the phenothiazine drugs are in the forms of hydrochloride salt. For example, to prepare 1 mg/mL solution of the free form of chlorpromazine, the amount of chlorpromazine hydrochloride to be dissolved in 1 mL methanol is calculated as follows.

$$1 \text{ mg (MW of the free form 318.9 MW of the salt form 355.4)} = 1.11 \text{ mg}$$

The 1 mg/mL solution of each phenothiazine drug is diluted with methanol appropriately, according to need.

## GC/MS conditions

GC column: an Rtx-1 fused silica capillary column (30 m × 0.32 mm i.d., film thickness 0.25 μm, Restek, Bellefonte, PA, USA)<sup>c</sup>

GC conditions; instrument: a Shimadzu GC-17A gas chromatograph connected to MS (Shimadzu Corp., Kyoto, Japan)<sup>d</sup>; column (oven) temperature: 150 °C (1 min) → 15 °C/min<sup>e</sup> → 290 °C (10 min); injection temperature: 270 °C; interface temperature; 270 °C; carrier gas: He; its flow rate: about 1.5 mL/min; injection: splitless mode for 1 min followed by the split mode.

MS conditions; instrument: a Shimadzu QP-5050A quadrupole mass spectrometer<sup>f</sup>; measurement: scan mode; ionization: positive ion EI; ionization current: 60 μA; electron energy: 70 eV; scan range: *m/z* 50–400; scan speed: 1,000 amu/s.

## Procedure

- i. A 10-mL volume of methanol and 10 mL distilled water are passed through a Sep-Pak C<sub>18</sub> cartridge; this procedure is repeated twice (in total 3 times) to activate the cartridge<sup>g</sup>.
- ii. To 1 mL of whole blood or urine, are added 8 mL distilled water<sup>h</sup>, internal standard (IS) solution and 1 mL of 1 M sodium bicarbonate solution. For IS, a non-target phenothiazine drug (200 ng)<sup>i</sup> is selected for use.
- iii. The mixture solution is poured into the cartridge, followed by washing with 10 mL distilled water twice and by elution with 3 mL of chloroform/acetonitrile (8:2).
- iv. The upper aqueous layer of the eluate is removed with a Pasteur pipette; the organic phase is evaporated to dryness under a stream of nitrogen. The residue is dissolved in 100 μL of methanol and a 2-μL of it is injected into GC/MS.
- v. For each target compound, a suitable ion (*m/z*) is selected; a peak area ratio of the target compound to IS is obtained.
- vi. For quantitation with mass chromatograms (MCs), a fixed amount of IS and various concentrations of a target compound are added to 1 mL each of blank whole blood or urine, and processed as above. At least 4 vials containing different concentrations of the compound are prepared to construct a calibration curve, consisting of drug concentration on the horizontal axis and of peak area ratio of a drug to IS on the vertical axis. The above peak area ratio obtained from a specimen is applied to the calibration curve to obtain its concentration.

## Assessment of the method

➤ *Figure 1.1* shows a TIC and MCs for 5 phenothiazine drugs obtained by GC/MS. Panels A and B show a TIC and an MC for the authentic compounds, respectively; panels C and D those for extracts of human whole blood and urine, respectively. In the TIC, small peaks of 5 compounds could be discernible for the authentic sample, but could not for the extracts of whole blood or urine spiked with 200 ng each/mL of phenothiazines due to the appearance of big impurity peaks (data not shown). In MCs, every compound could be detected. The detection limits<sup>j</sup> obtained by mass chromatography were 25–200 ng/mL depending on the kinds of phenothiazines. Since the toxic concentrations of phenothiazines are several hundred ng–1 µg/mL, the sensitivity of the present method is sufficient to detect the toxic levels. The recovery rate was not lower than 80 %; in some experiments, it apparently exceeded 100 %<sup>k</sup>.

The GC/MS analysis for phenothiazines shows some disadvantages as follows. ① Phenothiazines with long side chains are not suitable for GC/MS analysis; especially, those with long piperazinyl or hydroxyl side chains cannot be detected by either GC or GC/MS. ② Promethazine, isothipendyl and ethopropazine do not give molecular ions, but give big fragment peaks at  $m/z$  58 or 72 only, which are not useful for identification of the compounds. For analysis of such compounds, the following LC/MS becomes very useful.

## LC/MS analysis [8]

---

See [8].

## Reagents and their preparation

### i. Reagents

Prochlorperazine, trifluoperazine, perphenazine, fluphenazine, propericiazine and thioridazine can be purchased from Sigma (St. Louis, MO, USA). Pure powder of perazine and clospirazine was donated by Mitsubishi Welpharma, Osaka, Japan; that of flupentixol by Takeda Chem. Ind. Ltd., Osaka, Japan; that of thioproperazine by Shionogi & Co., Ltd., Osaka, Japan; that of thiethylperazine by Sandoz, Basel, Switzerland.

### ii. Preparation

The above compounds are all in the salt forms; 1 mg free base/mL methanolic solution is prepared for each compound.

## LC/MS conditions

LC column: a Capcell Pak C<sub>18</sub> UG-80 capillary column (S-5 µm, 250 × 1.0 mm i.d., Shiseido, Tokyo, Japan).

LC conditions; instrument<sup>l</sup>: an HP-1100 Series LC chromatograph (Agilent Technologies, Palo Alto, CA, USA); mobile phase A: distilled water containing 0.1 % formic acid and 10 mM



ammonium acetate; mobile phase B: 100 % acetonitrile. A gradient elution with solutions A and B was performed; the initial composition of 70 % A plus 30 % B was linearly changed to the final composition of 10 % A plus 90 % B during 40 min; the flow rate was 50  $\mu\text{L}/\text{min}$ .

MS conditions; instrument: an MAT LCQ ion-trap MS instrument (ThermoFinnigan, San Jose, CA, USA); interface: electrospray ionization (ESI) in the positive mode; capillary temperature: 230  $^{\circ}\text{C}$ ; spray needle voltage: + 5.5 kV; sheath gas pressure: 80 units; assisted gas pressure: 15 units; detection: mass chromatography in the full scan mode

## Procedure

- i. To 1 mL whole blood, are added an appropriate amount of IS, 3 mL distilled water and 0.5 mL of 1 M sodium bicarbonate solution. After well mixing, the mixture is centrifuged at 3,000 rpm for 10 min. For IS, one of other phenothiazine drugs is selected.
- ii. A 1-mL volume of methanol and 1 mL distilled water are passed through an Oasis HLB 3 cc cartridge (Waters, Milford, MA, USA) to activate it.
- iii. The above supernatant fraction obtained at the step i) is poured into the cartridge at a flow rate not greater than 2 mL/min.
- iv. The cartridge is washed with 2 mL distilled water, and the target compound and IS are eluted with 2 mL acetonitrile.
- v. The eluate is evaporated to dryness under a stream of nitrogen.
- vi. The residue is dissolved in 50  $\mu\text{L}$  methanol, followed by addition of 100  $\mu\text{L}$  distilled water with mixing. A 100- $\mu\text{L}$  aliquot of it is injected into LC/MS.
- vii. Using a specific ion of each target compound, a peak area ratio of the compound to IS is obtained.
- viii. The method for construction of a calibration curve for a target compound by LC/MS is essentially similar to that for GC/MS. At least 4 vials containing various concentrations of a target compound are prepared for a calibration curve.

## Assessment of the method

All eleven kinds of phenothiazine drugs gave the base peaks of protonated molecular ions. Under the present conditions, many phenothiazines could be extracted from whole blood with high efficiencies; 2 ng (on-column) of many compounds could be detected as distinct peaks. However, peaks of perazine, prochlorperazine, thiethylperazine and perphenazine were small and also interfered with by impurity peaks; low concentrations of these compounds in human whole blood and urine cannot be analyzed by LC/MS. To overcome this difficulty, detection using LC/tandem MS seems useful. For the details of the tandem MS for phenothiazines, the readers can refer to the reference [8]. According to the reference, every phenothiazine with a long side chain can be specifically detected with a high S/N ratio. A report dealing with the combination of LC/MS/MS with solid-phase microextraction (SPME) for phenothiazines was also published [9].

## Toxic and fatal concentrations

---

Serum concentrations of chlorpromazine, the most typical phenothiazine, were reported to be 0.05–0.5 µg/mL as therapeutic levels and 0.5–1 µg/mL as toxic ones [10]. Blood concentrations of chlorpromazine were reported to be 0.5–2 µg/mL as toxic levels and not lower than 2 µg/mL as fatal ones [11]. Blood concentrations of other phenothiazines; perazine: therapeutic levels 0.025–0.1 µg/mL and toxic level 0.5 µg/mL; perphenazine: therapeutic levels 0.0004–0.03 µg/mL and toxic level 0.05 µg/mL; promazine: therapeutic levels 0.1–0.4 µg/mL and toxic levels 2–3 µg/mL; thioridazine: therapeutic levels 0.2–1 µg/mL and toxic level 2 µg/mL [10]. The therapeutic and toxic concentrations are markedly different according to different kinds of phenothiazines. Thioridazine was reported to show higher cardiotoxicity than other phenothiazines [12].

### Notes

- a) The GC-SID is commercially available from Shimadzu Corp., Kyoto, Japan; the detector can be attached to a GC-14 type of instruments. The detector specifically responds to compounds with a tertiary amino group. For biomedical specimens, such as blood and urine, containing large amounts of amino compounds, the GC-SID can detect compounds with a tertiary amino group with much higher specificity and sensitivity than GC-NPD.
- b) The methanolic standard solution at 1 mg/mL is stable for at least 2–3 weeks at 4 °C.
- c) This column corresponds to the DB-1 (J&W); any capillary column with 100 % dimethylpolysiloxane can be used, regardless of its manufacturer. However, when many impurity peaks appear in background upon analysis by GC/MS, so-called “low bleed MS column” can be tried. When satisfactory separation of compounds cannot be achieved with such non-polar columns, slightly and intermediately polar columns (DB-5 and DB-17) are worth trying.
- d) Any type of gas chromatographs, to which a capillary column can be attached, can be used.
- e) The temperature program conditions also affect the separation ability for compounds, together with the type of a column to be used. According to Hattori et al. [7], the temperature-elevating program was 6 °C/min.
- f) The quadrupole type mass spectrometer is generally cheaper and relatively easy to be handled. Any type of GC/MS, such as the sector and ion-trap types, can be used. GC/MS/MS can be also used to perform even more specific detection; this was omitted, because it is beyond the policy of this book.
- g) According to the original method by Suzuki et al. [13] reported in 1989, the cartridge had been activated by passing 10 mL each of chloroform/methanol (9:1), methanol and water; the procedure had been repeated 2–3 times. However, for the recent lots of the same type of cartridges, the above procedures oppositely cause the appearance of many impurity peaks. The activation should be mildly made with methanol and water only to get good results.
- h) The first addition of distilled water is aimed to completely hemolyze the blood specimen. According to the original method, 16 mL distilled water had been added to 1 mL whole blood, followed by addition of 3 mL of 1 M sodium bicarbonate solution. In the experience of the authors, only with half the amount of distilled water (8 mL), almost the same results could be obtained without any problem.

- i) In the report of Hattori et al. [7], 100 pmol each (about 30–40 ng) of phenothiazines had been added.
- j) If the selected ion monitoring mode is used, the sensitivity is increased 10–100 fold.
- k) As probable reasons of such a phenomenon, the slight thermal decomposition of the authentic standard during the step of GC, and/or protection of the target phenothiazine from its thermal decomposition or from adsorption to the column by certain compound(s) being contained in specimen extracts, can be mentioned.
- l) Any LC instrument, to which a capillary LC column can be attached and which enables a low flow rate of 50–200  $\mu\text{L}/\text{min}$ , can be used, regardless of its manufacturer.

## References

- 1) Baldessarini RJ, Tarazi FI (2001) Drugs and the treatment of psychiatric disorders. In: Goodman Gilman A, Hardman JG, Limbard LE (eds) *Goodman & Gilman's The Pharmacological Basis of Therapeutics*, 10th edn. McGraw-Hill, New York, pp 485–520
- 2) Meredith TJ, Vale JA (1985) Poisoning due to psychotropic agents. *Adverse Drug React Acute Poisoning Rev* 4:83–126
- 3) Geraut A, Kintz P, Traqui A et al. (1994) Toxicological findings in a fatality involving chlorpromazine. *Bull Int Assoc Forensic Toxicol* 24 (2):27–30
- 4) Kintz P, Berthault F, Traqui A et al. (1995) A fatal case of alimemazine poisoning. *J Anal Toxicol* 19:591–594
- 5) Ishikawa Y, Suzuki O, Hattori H (1990) Positive- and negative-ion mass spectrometry and rapid clean-up of 19 phenothiazines. *Forensic Sci Int* 44:93–105
- 6) The Pharmaceutical Society of Japan (ed) (1992) *Standard Methods of Chemical Analysis in Poisoning – With Commentary*, 4th edn. Nanzando, Tokyo, pp 150–158 (in Japanese)
- 7) Hattori H, Yamamoto S, Iwata M et al. (1992) Sensitive determination of phenothiazines in body fluids by gas chromatography with surface ionization detection. *J Chromatogr* 579:247–252
- 8) Seno H, Hattori H, Ishii A et al. (1999) High performance liquid chromatography/electrospray tandem mass spectrometry for phenothiazines with heavy side chains in whole blood. *Rapid Commun Mass Spectrom* 13:2394–2398
- 9) Kumazawa T, Seno H, Watanabe-Suzuki K et al. (2000) Determination of phenothiazines in human body fluids by solid-phase microextraction and liquid chromatography/tandem mass spectrometry. *J Mass Spectrom* 35:1091–1099
- 10) Uges DRA (1997) Blood level data. In: Brandenberger H, Maes RAA (eds) *Analytical Toxicology for Clinical, Forensic and Pharmaceutical Chemists*. Walter de Gruyter, Berlin, pp 707–718
- 11) Moffat AC, Jackson JV, Moss MS et al. (eds) (1986) *Clarke's Isolation and Identification of Drugs*. The Pharmaceutical Press, London, pp 460–461
- 12) Buckley NA, Whyte IM, Dawson AH (1995) Cardio-toxicity more common in thioridazine overdose than with other neuroleptics. *J Toxicol Clin Toxicol* 33:199–204
- 13) Suzuki O, Kumazawa T, Seno H et al. (1989) Rapid isolation with Sep-Pak  $\text{C}_{18}$  cartridges and wide-bore capillary gas chromatography of some barbiturates. *Med Sci Law* 29:242–248

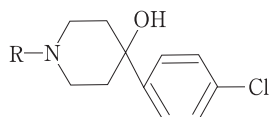
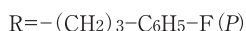
## II.3.2 Butyrophenones

by Kazuo Igarashi

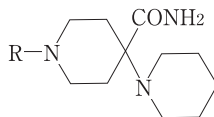
### Introduction

Butyrophenone drugs including haloperidol are being widely used in the field of psychiatry. The acute butyrophenone poisoning incidents sometimes take place; in such cases, the analysis of a butyrophenone becomes necessary in forensic toxicology or clinical toxicology. Their analysis is being made by GC [1–4], GC/MS [5–6], HPLC [7–15] and LC/MS [16,17]. Six butyrophenones are now available as ethical drugs in Japan (▶ Fig. 2.1); the most typical ones are haloperidol and bromperidol, which most frequently cause poisoning incidents among butyrophenones. These drugs are rapidly metabolized in human bodies into reduced haloperidol and reduced bromperidol, respectively. In this chapter, the methods of GC/MS, HPLC and LC/MS<sup>a</sup> are presented for analysis of haloperidol, bromperidol and their reduced forms.

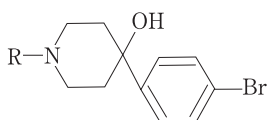
■ Figure 2.1



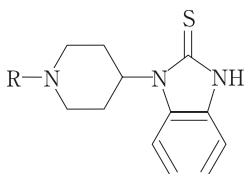
haloperidol



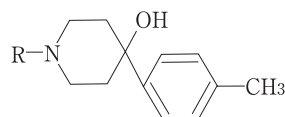
floropipamide



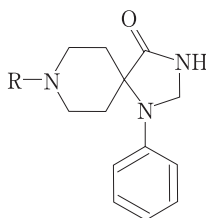
bromperidol



timiperone



moperone



spiperone

Structures of butyrophenones.

## GC/MS analysis

---

### Reagents and their preparation

- Haloperidol can be purchased from Sigma (St. Louis, MO, USA) and other manufacturers; bromperidol, reduced haloperidol and reduced bromperidol from Research Biochemical International (Natick, MA, USA).
- A 4-g aliquot of NaOH and 6 g NaCl are dissolved in distilled water to prepare 100 mL solution (1 M NaOH solution)<sup>b</sup>.
- n-Hexane/isopropanol (95:5, v/v) mixture solution
- 0.1 M Hydrochloric acid solution
- As internal standard (IS)<sup>c</sup>, bromperidol (500 ng/mL in 0.1 M hydrochloric acid solution) is used for analysis of haloperidol, and *vice versa*.
- Preparation of standard solutions: haloperidol or bromperidol solutions at 2–50 ng/mL in 0.01 M hydrochloric acid are prepared, and each 2-mL aliquot is placed in a 15-mL volume glass centrifuge tube with a ground-in stopper.

### GC/MS conditions

Instrument: an Agilent 5890 GC instrument (Agilent Technologies, Palo Alto, CA, USA) connected with a JEOL Automass quadrupole mass spectrometer (JEOL, Tokyo, Japan).

GC column: an HP-5 fused silica capillary column (30 m × 0.32 mm i. d., film thickness 0.25 μm, Agilent Technologies); column (oven) temperature: 100 °C (1 min) → 30 °C/min → 270 °C (30 s) → 5 °C/min → 290 °C (5 min); injection temperature: 260 °C; separator temperature: 280 °C; carrier gas: He; its flow rate: 1.5 mL/min; MS ionization mode: EI; electron energy: 70 eV; detector voltage: 750 V; ion source temperature: 280 °C.

### Procedure<sup>d</sup>

- i. A 2-mL volume of urine or blood, 0.05 mL IS and 0.5 mL of 1 M NaOH are placed in a 15-mL volume glass centrifuge tube with a ground-in stopper and mixed well, followed by addition of 6 mL of the mixture of n-hexane/isopropanol and its shaking for 20 min.
- ii. After centrifugation at 600 g for 5 min, 5.5 mL of the upper organic layer is transferred to another 15-mL volume glass centrifuge tube, followed by the addition of 1.5 mL of 0.1 M hydrochloric acid solution and vigorous shaking for 20 min.
- iii. After centrifugation at 600 g for 5 min, the upper organic layer is discarded; the aqueous phase is again washed with 1 mL of the mixture of n-hexane/isopropanol by shaking it for 30 s.
- iv. After centrifugation at 600 g for 5 min, 1.2 mL of the lower aqueous phase is transferred to a 10-mL volume glass centrifuge tube with a ground-in stopper, followed by addition of 0.2 mL of 1 M NaOH and 1 mL of the n-hexane/isopropanol mixture, and vigorous shaking for 30 s.
- v. After centrifugation at 600 g for 5 min, the upper organic layer is transferred to a small glass test tube and evaporated to dryness.
- vi. The residue are dissolved in 20 μL ethanol.

vii. For quantitation, the selected ion monitoring (SIM) mode of GC/MS is employed using ions at  $m/z$  224 for haloperidol and  $m/z$  268 for bromperidol; peak area ratios of haloperidol or bromperidol to IS are plotted against various concentrations of the test compound spiked to blank blood or urine to draw a calibration curve. A peak area ratio of a test specimen is applied to the calibration curve to calculate its concentration.

## Assessment of the method

The butyrophenone drugs analyzable by GC or GC/MS in the underivatized forms are haloperidol, bromperidol, moperone and flopropamide; but for timiperone and spiperone, satisfactory peaks cannot be obtained.

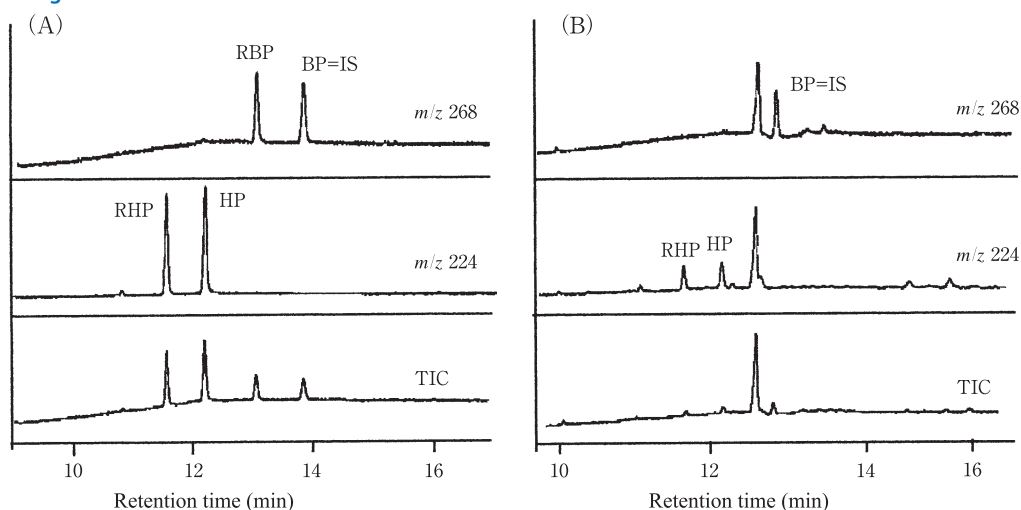
TICs and SIM chromatograms of haloperidol, bromperidol and their reduced forms are shown in [▶ Fig. 2.2](#). The detection limit was about 10 pg in an injected volume for both haloperidol and bromperidol; the recoveries were also excellent. The separation ability of GC or GC/MS is much superior to that of HPLC or LC/MS.

## HPLC and LC/MS analysis

### Reagents and their preparation

The sources for acquisition of haloperidol, bromperidol and their reduced forms is the same as described in the GC/MS section.

■ **Figure 2.2**



TICs and SIM chromatograms by GC/MS for the authentic standards of butyrophenone drugs (100 ng/mL each) (A) and for a serum extract from a poisoned patient (B).  $m/z$  224: haloperidol (HP) and reduced haloperidol (RHP);  $m/z$  268: bromperidol (BP, IS) and reduced bromperidol (RBP).

## HPLC analysis

Instrument: an SPD-M10A photodiode array detector (DAD), a CTO-10A column oven, an SIL-10A autosampler and an LC-10AD pump system (all from Shimadzu Corp., Kyoto, Japan).

HPLC conditions; column: Cosmosil 5CN-MS (150 × 4.6 mm i. d., particle diameter 5 μm, Nacalai Tesque, Kyoto, Japan; mobile phase: acetonitrile/methanol/20 mM ammonium acetate aqueous solution/triethylamine (20:25:55:0.1, v/v, to be adjusted to pH 4.7 with phosphoric acid); flow rate: 1.0 mL/min; column (oven) temperature: 40 °C; detection wavelength: 220 nm.

## LC/MS analysis

Instrument: a 2690 Alliance HPLC pump system (Waters, Milford, MA, USA) connected with a Micromass Quattro Ultima desktop quadrupole MS-MS instrument (Micromass, Manchester, UK)

LC/MS conditions; column: Cosmosil 5CN-MS (150 × 4.6 mm i. d., particle diameter 5 μm, Nacalai Tesque); mobile phase: methanol/20 mM ammonium formate aqueous solution (60:40, v/v); flow rate: 0.6 mL/min; column (oven) temperature: 40 °C; interface: electrospray ionization (ESI); ion source temperature: 120 °C; temperature for removing solvent: 350 °C; gas for removing solvent: 600 L/h; spray (cone) voltage: 35 eV.

## Procedure

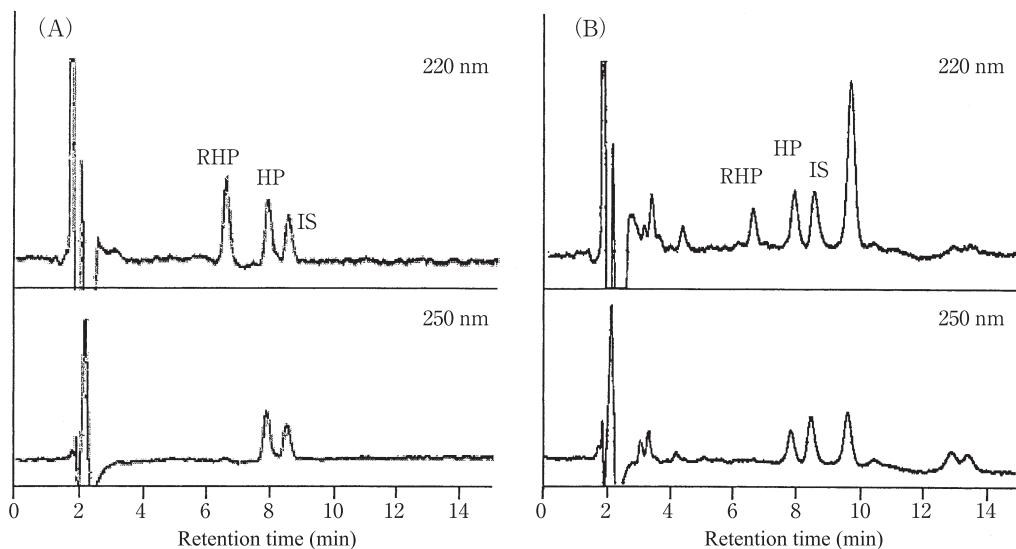
- i. The procedure i–v described in the GC/MS analysis section is followed for a urine or blood specimen to obtain a residue containing butyrophenones. The residue is dissolved in 0.1 mL of the mobile phase of HPLC or LC/MS.
- ii. For HPLC-DAD and LC/MS, 50 and 20 μL of the above solution are injected, respectively.
- iii. For the SIM of LC/MS, the ions at  $m/z$  376, 378 and 422 are used for detection of haloperidol, reduced haloperidol and bromperidol, respectively.
- iv. For both HPLC and LC/MS, bromperidol is used as IS for quantitation of haloperidol, and *vice versa*.
- v. For both HPLC and LC/MS, the peak area ratio of a test compound to IS obtained from a test specimen is applied to a calibration curve constructed in advance to calculate the concentration of the test compound.

## Assessment of the methods

▶ *Figure 2.3* shows chromatograms for haloperidol, reduced haloperidol and bromperidol (IS) obtained by HPLC-DAD. The optimum detection wavelength was 220 nm; when measured at 250 nm, reduced haloperidol could not be detected. The detection limit obtained by HPLC-DAD was about 5 ng in an injected volume for all compounds.

HPLC-DAD is advantageous over HPLC-UV in that the sensitivity can be enhanced by measuring a target compound at the wavelength of its absorbance maximum, or by shifting the

**Figure 2.3**



**HPLC-DAD chromatograms for the authentic haloperidol (HP) and reduced haloperidol (RHP) (100 ng/mL each) (A) and for a serum extract from a poisoned patient (B).**

wavelength from its maximum to avoid impurity peaks. Also by measuring an absorbance spectrum of a compound, it is possible to make tentative identification.

By LC/MS analysis, the sensitivity and specificity are much higher. Distinct peaks of all compounds appear (➔ Fig. 2.4); the detection limit by LC/MS was about 2 pg in an injected volume.

For sensitive analysis of timiperone and spiperone with relatively high molecular weights, LC/MS may be most suitable.

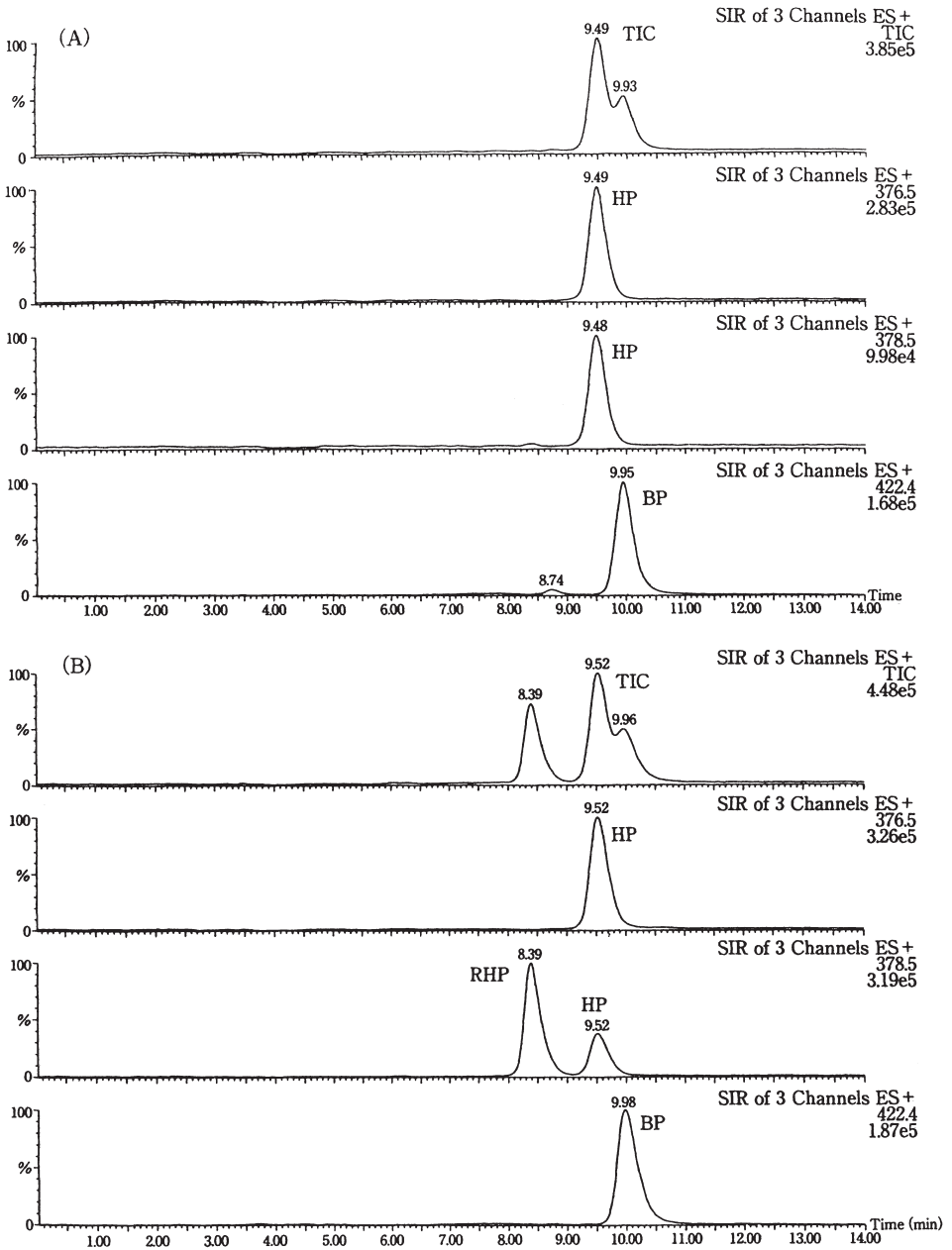
## Poisoning cases, and toxic and fatal concentrations

A 2-year plus 5 month-old female and an 11-month-old male [18] had ingested 265 mg haloperidol in total (combined amount for both children); both were brought to a hospital in the comatose state and showed bradycardia, hypotension and sinus arrhythmia. Mannitol was injected into the female child intravenously; though the consciousness was gradually recovered 24 h after admission, neurological symptoms, such as tremor, muscle stiffness and dyskinesia of the face, appeared. Thus, diphenhydramine was injected into her intravenously; she recovered 4 days after admission. For the male baby, similar treatments, such as intravenous injection of mannitol and diphenhydramine, were carried out, but the neurological symptoms were not improved easily; it took as long as 7 days for his recovery.

Therapeutic and toxic blood levels of haloperidol were reported to be 5–40 and 50–100 ng/mL, respectively; therapeutic blood levels of bromperidol 2–20 ng/mL [19]. Therapeutic and toxic blood levels of floropipamide were reported to be 0.1–0.4 and 0.5–0.6 ng/mL, respectively [20].



■ Figure 2.4



SIM chromatograms by LC/MS for the authentic haloperidol (HP) and bromperidol (BP) (100 ng/mL each) (A) and for a serum extract from a poisoned patient (B).  $m/z$  376.5: HP;  $m/z$  378.5: HP and RHP;  $m/z$  422.4: BP=IS.

## Notes

- a) When GC/MS, HPLC and LC/MS are compared for analysis of haloperidol and bromperidol, the LC/MS seems of the best choice for their trace analysis. The HPLC method enables highly sensitive detection (ng/mL) of the compounds with an electrochemical detector (ECD). Since, in this chapter, poisoning cases with ingestion of large amounts of drugs are assumed, HPLC analysis with a photodiode array detector can be realized for several ten ng/mL of the drugs. GC/MS is unexpectedly not so highly sensitive; it requires a condensation step.
- b) NaCl was added to the 1 M NaOH solution, because it increases extraction efficiency due to its salting-out effect.
- c) There is a report using a haloperidol analog as IS, in which chlorine is substituted for the fluorine; but this compound is usually difficult to be obtained. Therefore, bromperidol was used as IS for analysis of haloperidol and *vice versa*. This is because both drugs are not simultaneously administered in most cases.
- d) All glasswares, including glass centrifuge tubes with ground-in stoppers, are preferably treated for inactivation with dimethylsilyl coating, because trace amounts of drugs are easily adsorbed to their surfaces, causing variation of results.

## References

- 1) Seno H, Suzuki O, Kumazawa T et al. (1989) Rapid isolation with Sep-Pak C<sub>18</sub> cartridges and wide-bore capillary gas chromatography of some butyrophenones. *Z Rechtsmed* 102:127–132
- 2) Tyndale RF, Inaba T (1990) Simultaneous determination of haloperidol and reduced haloperidol by gas chromatography using a megabore column with electron capture detection: application to microsomal oxidation of reduced haloperidol. *J Chromatogr* 529:182–188
- 3) Ulrich S, Meyer FP, Neuhof S et al. (1995) Megabore capillary gas-liquid chromatographic method with nitrogen-phosphorus selective detection for the assay of haloperidol and reduced haloperidol in serum: results of therapeutic drug-monitoring during acute therapy of eight schizophrenics. *J Chromatogr B* 663:289–296
- 4) Tokunaga H, Kudo K, Imamura T (1996) Screening of antipsychotic drugs by wide-bore capillary gas chromatography with nitrogen phosphorus detection. *Jpn J Legal Med* 50:196–202
- 5) Hattori H, Suzuki O, Brandenberger H (1986) Positive- and negative-ion mass spectrometry of butyrophenones. *J Chromatogr* 382:135–145
- 6) Couper FJ, McIntyre IM, Drummer OH (1995) Detection of antidepressant and antipsychotic drugs in postmortem human scalp hair. *J Forensic Sci* 40:87–90
- 7) Nilsson LB (1988) Reversed-phase ion pair liquid chromatographic method for the determination of low concentrations of haloperidol in plasma. *J Chromatogr* 431:113–122
- 8) Hariharan M, Kindt EK, Van Noord T et al. (1989) An improved sensitive assay for simultaneous determination of plasma haloperidol and reduced haloperidol levels by liquid chromatography using a coulometric detector. *Ther Drug Monit* 11:701–707
- 9) Park KH, Lee MH, Lee MG (1991) Simultaneous determination of haloperidol and its metabolite, reduced haloperidol, in plasma, blood, urine and tissue homogenates by high-performance liquid chromatography. *J Chromatogr* 572:259–267
- 10) Eyles DE, Whiteford HA, Stedman TJ et al. (1992) Determination of haloperidol and reduced haloperidol in the plasma and blood of patients on depot haloperidol. *Psychopharmacology* 106:268–274
- 11) Fang J, Gorrod JW (1993) High-performance liquid chromatographic method for the detection and quantitation of haloperidol and seven of its metabolites in microsomal preparations. *J Chromatogr B* 614:267–273
- 12) Aravagiri M, Marder SR, Van Putten T et al. (1994) Simultaneous determination of plasma haloperidol and its metabolite reduced haloperidol by liquid chromatography with electrochemical detection: plasma levels in schizophrenic patients treated with oral or intramuscular depot haloperidol. *J Chromatogr B* 656:373–381

- 13) Igarashi K, Kasuya F, Abe T et al. (1995) Simultaneous determination of haloperidol and its neurotoxic metabolite in plasma and brain tissue from schizophrenic patients treated with haloperidol using HPLC and solid-phase extraction. *Jpn J Forensic Toxicol* 13:31–38
- 14) Pan L, Rosseel MT, Belpaire FM (1998) Comparison of two high-performance liquid chromatographic methods for monitoring plasma concentrations of haloperidol and reduced haloperidol. *Ther Drug Monit* 20:224–230
- 15) Walter S, Bauer S, Roots I et al. (1998) Quantification of the antipsychotics flupentixol and haloperidol in human serum by high-performance liquid chromatography with ultraviolet detection. *J Chromatogr B* 720:231–237
- 16) Igarashi K, Shigee Y, Kasuya F et al. (1997) Analysis of haloperidol and its neurotoxic pyridinium metabolite in biological samples by liquid chromatography/mass spectrometry. *Jpn J Forensic Toxicol* 15:44–54
- 17) Hoja H, Marquet P, Verneuil B et al. (1997) Determination of haloperidol and its reduced metabolite in human plasma by liquid chromatography-mass spectrometry with electrospray ionization. *J Chromatogr B* 688:275–280
- 18) Yamazaki F, Mori H (eds) (2000) *Guide to Acute Poisonings by Medical Drugs*. Van Medical, Tokyo, p 56 (in Japanese)
- 19) Uges DRA (1997) Blood level data. In: Brandenberger H, Maes RAA (eds) *Analytical Toxicology for Clinical, Forensic and Pharmaceutical Chemists*. Walter de Gruyter, Berlin, pp 707–718
- 20) Uges DRA, Conemans JMH (2000) Antidepressants and antipsychotics. In: Bogusz MJ (ed) *Handbook of Analytical Separations Vol.2, Forensic Science*. Elsevier, Amsterdam, pp 229–257

## 11.3.3 Tricyclic and tetracyclic antidepressants

by Akira Namera and Mikio Yashiki

### Introduction

Many of antidepressants exert their effects by inhibiting the reuptake of norepinephrine and serotonin and by accelerating the release of them at synaptic terminals of neurons in the brain. As characteristic structures of such drugs showing antidepressive effects, many of them have tricyclic or tetracyclic nuclei; this is the reason why they are called “tricyclic antidepressants or tetracyclic antidepressants”.

There are many cases of suicides using the antidepressants; their massive intake sometimes causes death. About 10 kinds of tricyclic and tetracyclic antidepressants are now being used in Japan (▶ *Figure 3.1*); among them, amitriptyline is best distributed [1, 2]. Recently, the use of tetracyclic antidepressants is increasing, because of their mild side effects and their high effectiveness with their small doses; the increase of their use is causing the increase of their poisoning cases. Although carbamazepine does not belong to the antidepressant group, its structure is very similar to those of tricyclic antidepressants; therefore, the drug is also included in this chapter.

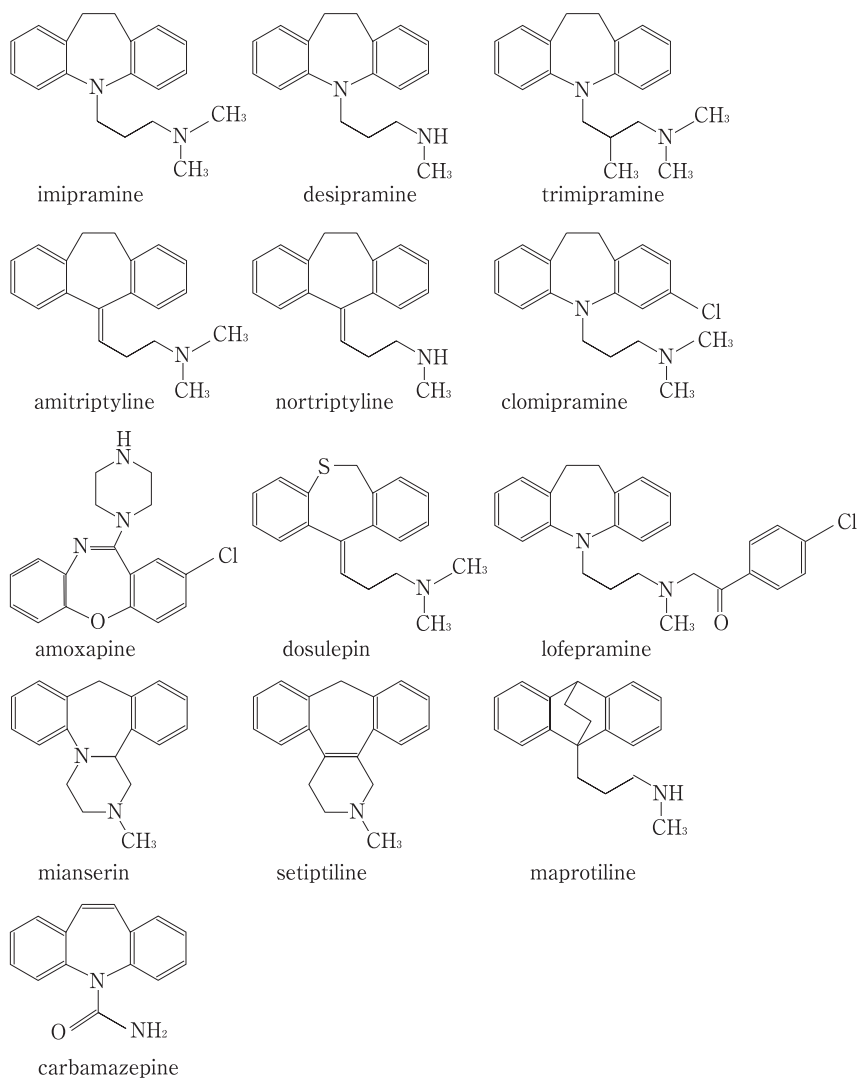
### GC/MS analysis

---

#### Reagents and their preparation

- Amitriptyline, carbamazepine, clomipramine, desipramine, imipramine, maprotiline, mianserin, nortriptyline and trimipramine can be purchased from Sigma (St. Louis, MO, USA); pure powder of the following drugs was donated by each manufacturer: amoxapine by Takeda Chem. Ind. Ltd., Osaka, Japan; dosulepin by Kaken Pharmaceutical Co., Ltd., Tokyo, Japan; lofepramine by Daiichi Pharmaceutical Co., Ltd., Tokyo, Japan; and setipitiline by Mochida Pharmaceutical Co., Ltd., Tokyo, Japan.
- A 20-g aliquot of sodium carbonate is dissolved in distilled water to prepare 100 mL solution (20 %, w/v).
- A 9.85-mL volume of hexane is mixed well with 0.15 mL isoamyl alcohol to prepare an extraction solvent.
- A 1-mg aliquot of promethazine (Sigma) is dissolved in 10 mL acetonitrile to prepare internal standard solution (0.1 mg/mL).

■ **Figure 3.1**



**Structures of tricyclic and tetracyclic antidepressants and carbamazepine.**

## GC conditions

GC column: an HP-5MS fused silica capillary column (30 m × 0.25 mm i. d., film thickness 0.25 μm, Agilent Technologies, Palo Alto, CA, USA).

GC/MS conditions; instrument: an HP 5890 Series II gas chromatograph (Agilent Technologies) connected with a mass spectrometer (HP-5971A MSD, Agilent Technologies); column (oven) temperature: 170 °C (1 min) → 5 °C/min → 280 °C (4 min); injection temperature: 250 °C; detection temperature: 280 °C; carrier gas: He (100 kPa); mass scan range:  $m/z$  50–500.

## Procedure

- i. A 0.5-g (mL) aliquot of a specimen<sup>a</sup>, 0.5 mL dissolved water, 0.2 mL of 20 % sodium carbonate solution and 25  $\mu$ L of promethazine solution (0.1 mg/mL, IS<sup>b</sup>) are placed in a 10-mL volume glass centrifuge tube with a ground-in stopper and mixed well<sup>c</sup>.
- ii. A 3-mL volume of hexane/isoamyl alcohol<sup>d</sup> (98.5:1.5, v/v) is added to the mixture and shaken vigorously for 2 min.
- iii. The tube is centrifuged at 3,000 rpm for 3 min.
- iv. A 2.5-mL volume of the upper organic phase is transferred to a 8-mL volume glass vial and evaporated to dryness under a stream of nitrogen.
- v. The residue is dissolved in 0.5 mL hexane and a 1- $\mu$ L aliquot of it is injected into GC/MS.

## Assessment of the method

▶ *Figure 3.2* shows total ion chromatograms (TICs) obtained by GC/MS for tricyclic and tetracyclic antidepressants (5  $\mu$ g/mL) spiked into human whole blood. Using the slightly polar capillary column (HP-5MS), the peak top of trimipramine could be separated from that of imipramine, but they were not separated at the bottom completely. With non-polar columns, many drugs could not be separated from each other; such a type of columns seems not suitable for analysis of a specimen, which may contain multiple antidepressant drugs. The intermediately polar columns may be useful for drugs, which are not separable with non-polar or slightly polar columns, but in these experiments, only the conditions using a slightly polar capillary column are presented, because of its wide applicability to various drugs. Using the present TIC, the detection limit was about 0.01  $\mu$ g/g (mL); this means that toxic and fatal levels of the drugs can be detected by this method.

Many of tricyclic antidepressants are demethylated and/or hydroxylated to be converted into active metabolite(s)<sup>e</sup>. Therefore, to assess a blood concentration of an antidepressant, the combined concentration of the drug itself plus active metabolite(s) should be considered.

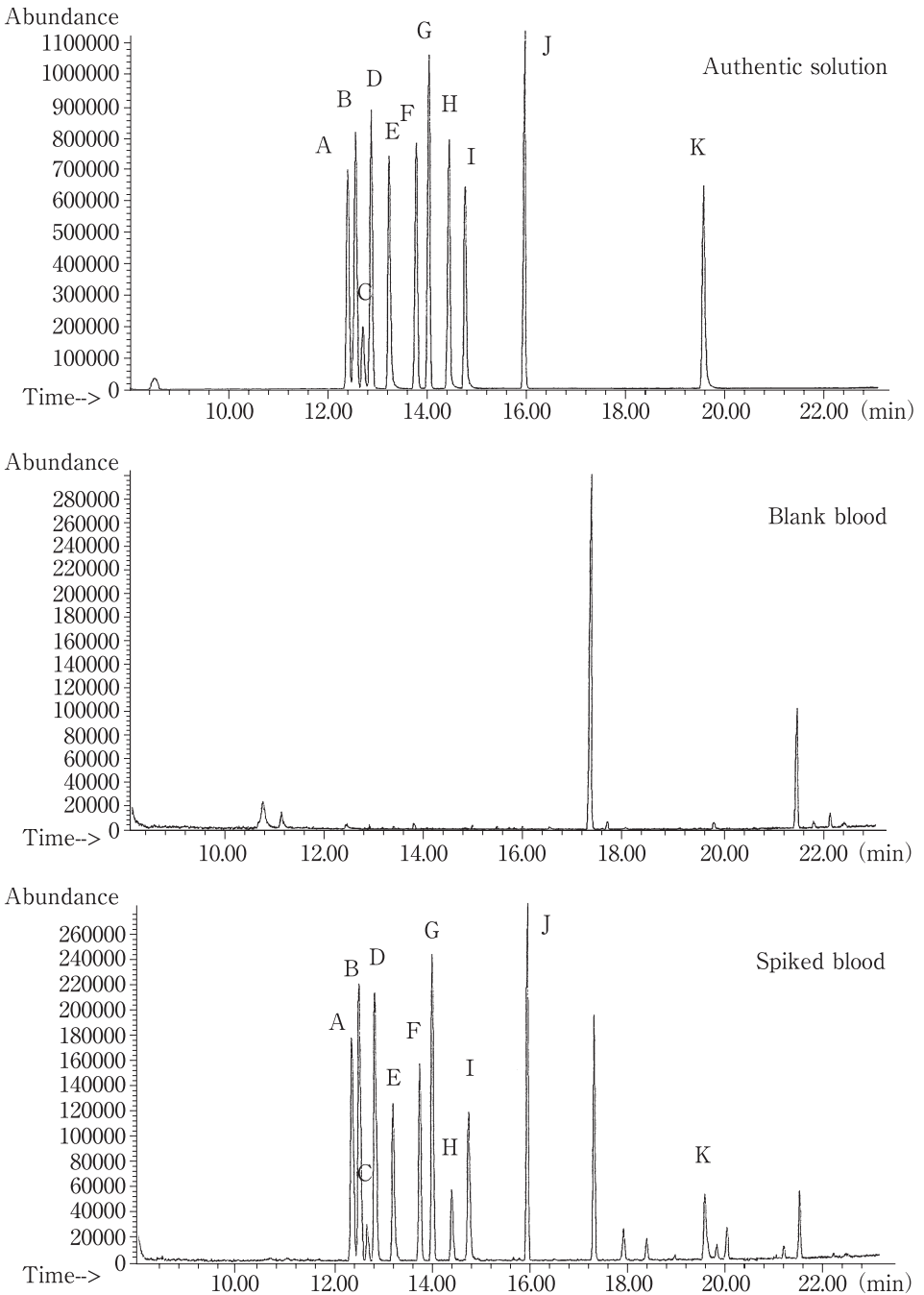
## HPLC analysis

---

### Reagents and their preparation

- Phosphoric acid used is of the special grade commercially available.
- An Oasis HLB<sup>f</sup> column (30 mg/cc, Waters, Milford, MA, USA) is activated by passing 1 mL methanol and 1 mL distilled water.
- A 0.5-mL volume of methanol is mixed with 9.5 mL distilled water to prepare 5 % methanol solution (v/v).
- A 2-g aliquot of phosphoric acid is dissolved in 1,000 mL of Milli Q water<sup>g</sup>; the pH of the solution is adjusted to 3.0 by adding NaOH aqueous solution.
- A 1.22-g aliquot of sodium dihydrogenphosphate (dihydrate,  $\text{NaH}_2\text{PO}_4 \cdot 2\text{H}_2\text{O}$ ) and 1.73 g disodium hydrogenphosphate are dissolved in 1,000 mL of Milli Q water; the pH of the

**Figure 3.2**



**TICs for tricyclic and tetracyclic antidepressants and carbamazepine obtained by GC/MS. A:** amitriptyline, **B:** mianserin, **C:** nortriptyline, **D:** imipramine, **E:** desipramine, **F:** promethazine (IS), **G:** setipitiline, **H:** carbamazepine, **I:** maprotiline, **J:** clomipramine, **K:** amoxapine.

solution is adjusted to 6.5 by adding either NaOH aqueous solution or phosphoric acid to prepare 20 mM phosphate buffer solution (pH 6.5).

- Mobile phase (A): 50 mL acetonitrile is well mixed with 450 mL of 0.2 % phosphoric acid. After degassing<sup>h</sup>, the solution is passed through a filter (0.45  $\mu\text{m}$ ) to be used as a mobile phase.
- Mobile phase (B): 300 mL acetonitrile is well mixed with 200 mL of 20 mM phosphate buffer solution (pH 6.5). After degassing, the solution is passed through a filter (0.45  $\mu\text{m}$ ) to be used as a mobile phase.

## HPLC conditions

HPLC column<sup>i</sup>: an Eclipse XDB-C<sub>8</sub> octyl group bonded silica column (250  $\times$  4.6 mm i. d., particle size 5  $\mu\text{m}$ , Agilent Technologies).

HPLC conditions: an LC-10A high-performance liquid chromatograph (Shimadzu Corp., Kyoto, Japan); detectors: a UV-VIS detector (UV-VIS, Shimadzu Corp.) and a photodiode array detector (PDA, Shimadzu Corp.)

### i. Conditions for acidic mobile phase (A)

Mobile phase: acetonitrile/phosphoric acid solution (0.2 %, pH 3.0) (1:9, v/v); column (oven) temperature: 40 °C; flow rate: 1.0 mL/min; detection wavelength: 215 nm.

### ii. Conditions for neutral mobile phase (B)

Mobile phase: acetonitrile/phosphate buffer solution (20 mM, pH 6.5) (6:4, v/v); other conditions are the same as described above.

## Procedure

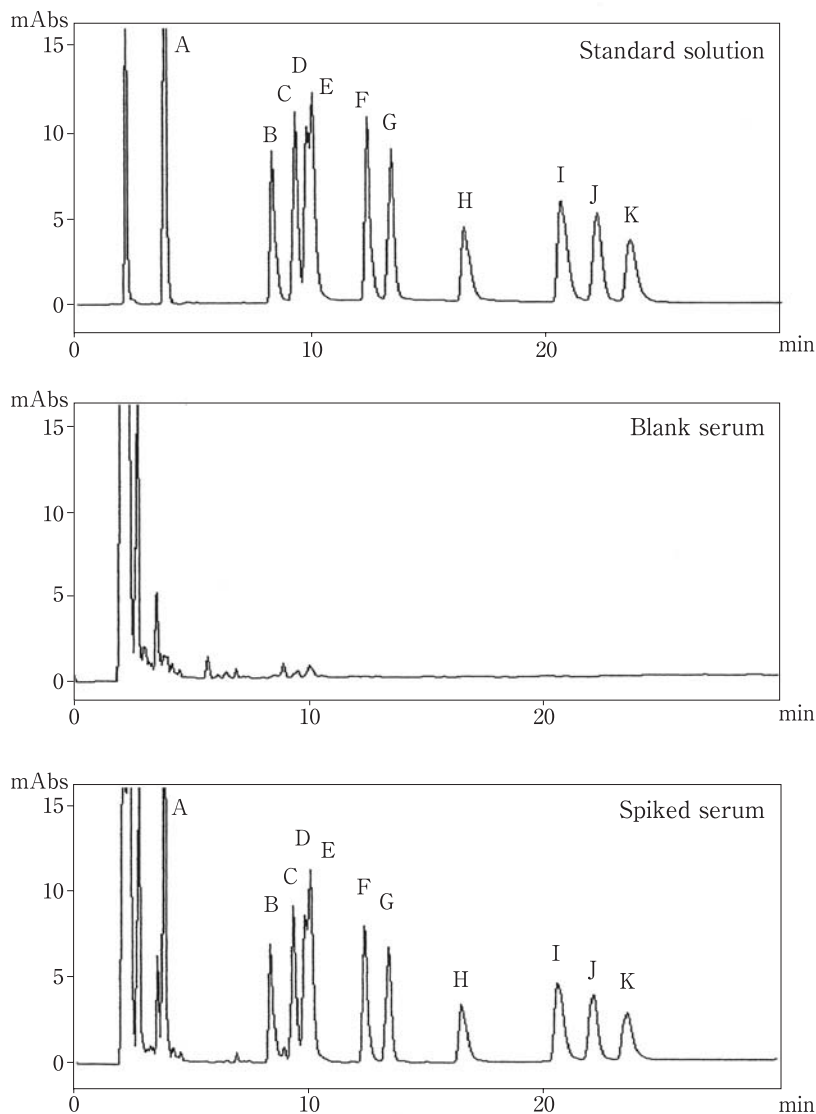
- A 0.5-g (mL) aliquot of a specimen is mixed with 10  $\mu\text{L}$  phosphoric acid in a test tube and mixed well.
- The mixture solution is poured into an activated Oasis HLB column<sup>j</sup>.
- The column is washed with 1 mL of 5 % methanol aqueous solution<sup>k</sup>.
- A target compound is eluted with 1 mL methanol into a glass vial; the eluate is evaporated to dryness under a stream of nitrogen.
- The residue is dissolved in 0.5 mL of each mobile phase; a 5- $\mu\text{L}$  aliquot of it is injected into HPLC for analysis.

## Assessment of the method

► Figure 3.3 shows HPLC chromatograms for tricyclic and tetracyclic antidepressants (5  $\mu\text{g}/\text{mL}$ ) spiked into human serum using the mobile phase (B). With the use of the Eclipse XDB-C<sub>8</sub> column, the peak top of nortriptyline (D) could be separated from that of amoxapine (E), but major parts of their peaks could not be separated. When the acidic mobile phase (A) was used, the 7 kinds of tricyclic antidepressants could be separated; but mianserin and setipitiline could



■ **Figure 3.3**




**Chromatograms for tricyclic and tetracyclic antidepressants and carbamazepine obtained by HPLC-UV. A: carbamazepine, B: desipramine, C: maprotiline, D: nortriptyline, E: amoxapine, F: setipitiline, G: mianserin, H: imipramine, I: amitriptyline, J: trimipramine, K: clomipramine.**

not be separated from amoxapine. However, the three compounds could be separated using the neutral mobile phase (B) (➔ Figure 3.3). Therefore, both mobile phases (A) and (B) should be used according to needs. For tentative identification of drugs, a UV absorbance spectrum can be measured together with the confirmation of coincidence of retention time of a test peak with that of an authentic compound. Although an analytical case using TSK gel Super-Octyl

(particle diameter 2  $\mu\text{m}$ ) was reported [3], the separation among desipramine, maprotiline and amoxapine could not be achieved. It is generally difficult to make simultaneous detection of many drugs using a UV detector. In addition, peaks of benzodiazepines sometimes overlap those of the antidepressants. When a UV detector is used, at least two different conditions using different mobile phases or columns should be used. When a mass spectrometer is used as a detector, the reliable identification of a compound is possible without complete separation of two peaks. The detection limit of each antidepressant measured by the present HPLC-UV is about 0.01  $\mu\text{g/g}$  (mL); the toxic and fatal levels of antidepressants can be measured.

The retention time for lofepramine is long; it cannot be eluted under the present HPLC conditions. The ratio of methanol or acetonitrile in a mobile phase should be much higher to enable detection of the peak of lofepramine.

## Poisoning cases, and toxic and fatal concentrations

In  *Table 3.1*, the therapeutic and toxic blood concentrations of each compound are shown [4]. For all drugs, the toxic levels were in the order of  $\mu\text{g/mL}$ . Two examples of poisoning cases are shown below.

**Case 1 [5]:** A 35-year-old female was found collapsed in the morning at her house by her family member. Although she was sent to a doctor by an ambulance car, she had been dead already. Many empty packages for tablets were discovered in her room; the death due to drug poisoning was suspected. As her past history, hypotension, depression and insomnia were disclosed; antidepressants and anti-anxiety drugs had been prescribed by a doctor. Among the empty packages, the number of them was largest for Tecipul (setiptiline maleate); as many as 200 tablets of Tecipul were found missing. As results of GC/MS analysis, setiptiline was

 **Table 3.1**

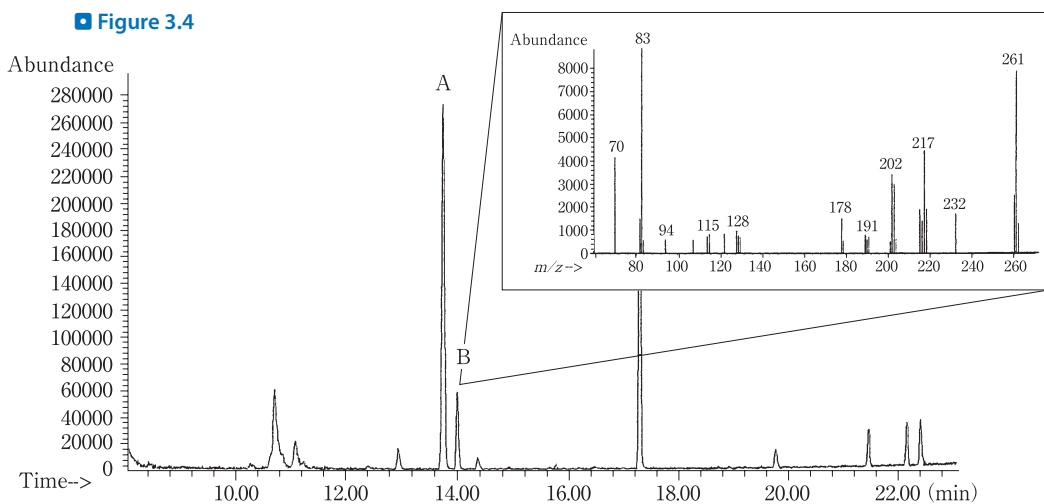
**Blood concentrations of tricyclic and tetracyclic antidepressants**

Compound	Therapeutic level* ( $\mu\text{g/mL}$ )	Toxic level ( $\mu\text{g/mL}$ )
amitriptyline	0.038–0.162	0.6–15
amoxapine	0.017–0.093	0.9–20
carbamazepine	1.4–12	12–77
clomipramine	0.10–0.48	0.4–0.54
desipramine	0.016–0.567	0.5–7.8
dosulepin	0.03–0.07	0.3–4.5
imipramine	0.008–0.105	0.3–30
lofepramine	0.04–0.14	–
maprotiline	0.168–0.718	1.3–13
mianserin	0.015–0.070	2.3
nortriptyline	0.022–0.242	0.5–8.4
setiptiline	0.001–0.003	>0.02
trimipramine**	0.008–0.241	0.4–12

\* Largely concentrations in blood plasma.

\*\* Now not available for ethical use in Japan.

Figure 3.4



TIC and a mass spectrum obtained from the blood extract of a victim in fatal setiptiline poisoning. A: promethazine (IS); B: setiptiline.

detected from her stomach contents, whole blood and urine; its blood concentrations were 0.78–1.77  $\mu\text{g/mL}$ . In [Figure 3.4](#), a TIC and a mass spectrum obtained from blood of this victim are shown.

**Case 2 [6]:** A 26-year-old female ingested a massive dose of drugs, which had been prescribed by a psychiatrist, in the evening. After about 30 min, ataxia appeared and she fell into sleep; at this time point, she was discovered by her family member. About 2 h after the ingestion, she was sent to an emergency room of a hospital. Her physical conditions at admission were: consciousness level, 300 (Japan Coma Scale, JCS); pupil diameter, 4 mm; light reaction, prompt; heart rate, 100/min with the sinus rhythm. Although gastric lavage and administration of a purgative and activated charcoal were performed after admission, no improvement of her consciousness could be achieved. Next morning, her mother brought empty packages of carbamazepine tablets; she was diagnosed as carbamazepine poisoning. Hemodialysis was performed with careful control of her respiration and circulation, but she died in spite of the intensive care on the second day. The analysis of blood sampled about 15 h after ingestion showed 71.3  $\mu\text{g/mL}$  of carbamazepine, which was a fatal level.

## Notes

- As specimens for analysis, body fluids, such as whole blood, serum (plasma) and urine, can be used. Tablets can be destroyed into powder using a mortar to be extracted with an organic solvent before analysis. For the specimens containing solid particles, such as stomach contents, the liquid-liquid extraction is suitable.
- As IS, deuterium-labeled compounds, such as imipramine- $d_3$  (Sigma), are most desirable; but there are problems for easiness of getting them or for their high costs. When a deuterium-labeled compound cannot be used, one of other tricyclic or tetracyclic antidepressants can

■ **Table 3.2**

**RI values and mass spectra of tricyclic and tetracyclic antidepressants**

Name	MW	RI**	Mass fragmentation ions (m/z)***				
amitriptyline	227.18	2205 (2196)	<u>58</u>	202	215	91	277
amoxapine	313.10		<u>245</u>	257	193	228	313
carbamazepine	236.10	2285 (2290)	<u>193</u>	236	165		
clomipramine	314.15	2455 (2406)	<u>58</u>	269	85	314	227
desipramine	226.18	2225 (2242)	<u>195</u>	235	208	71	266
dosulepin	295.14	2385 (2380)	<u>58</u>	221	202	295	234
imipramine	280.19	2215 (2223)	<u>58</u>	85	234	193	280
lofepramine [9]	418.18		<u>58</u>	235	193	418	208
maprotiline	277.18	2390 (2356)	<u>59</u>	70	277	203	191
mianserin	264.16	2210 (2211)	<u>193</u>	72	264	165	178
nortriptyline	263.17		<u>202</u>	220	189	91	263
setiptiline [5]	261.15	2255 (2210)	<u>83</u>	261	70	202	217
trimipramine	294.21	2225 ( 2201)	<u>58</u>	249	193	99	294


\*: molecular weight.

\*\*: retention index [7] (from the TIAFT Bulletin [8]).

\*\*\*: typical mass fragmentation ions [7,9] (underline; base peak ion).

be used as IS, after confirmation of the absence of the compound in the specimen. For such a purpose, retention indexes and mass spectral data are presented in [Table 3.2](#).

- c) Upon the extraction step, the pH of the aqueous phase should be higher than 11, because extraction efficiencies are markedly decreased below pH 11. Such a phenomenon is observed especially for desipramine, nortriptyline, maprotiline and amoxapine, which have imino groups in their side chain structures. There is also a possibility of low recoveries due to adsorption of drugs to glasswares; this problem can be overcome by siliconizing the glasswares or by adding carriers such as triethylamine.
- d) Various reports including liquid-liquid extraction of antidepressants using various organic solvents, such as hexane, ethyl acetate and diethyl ether, were reported. The best solvent can be chosen according to the kind of a target drug.
- e) Imipramine and amitriptyline are metabolized into desipramine and nortriptyline, respectively, in a human body. Both metabolites show comparable or even more active pharmacological effects. Therefore, to discuss the relationship between toxicity and the concentration of an antidepressant drug, the combined concentration of the drug itself and its active metabolite should be assessed. For example, when imipramine is ingested, the combined concentration at 1 µg/mL of imipramine plus desipramine is being regarded as the toxic level.
- f) The Oasis HLB is a new mixed-type column for solid-phase extraction being sold by Waters. This column has overcome problems of the conventional silica-based packing materials; it uses a porous polymer packing material, and can simultaneously hold both polar and non-polar compounds with high efficiencies. Similar columns are also commercially available from different manufacturers and usable in these experiments. However, if free silanol groups remain in the packing material, the drugs adsorb to the material too firmly, resulting in low recoveries of drugs. The mixed-type solid-phase extraction column with minimal residual free silanol groups should be used.

- g) The Milli Q water is the one, which had been passed through a Millipore filter with a special ion-exchanging system, and is being widely used in laboratories. This water is usable for a mobile phase of HPLC in place of distilled water.
- h) A mobile phase solution, after suitable mixing with a polar organic solvent, is usually degassed under reduced pressure using an aspirator together with sonication. The glass container should thus be pressure-resistant. The solution should not be left under reduced pressure for a long time, because methanol or acetonitrile is evaporated resulting in changes of composition ratio of the mobile phase.
- i) According to the kinds of columns used (manufacturer, type, internal diameter and length), the turn of drugs to be eluted and also the retention time become different.  Table 3.3

■ Table 3.3

Differences in retention times according to different HPLC columns

Mobile phase A	p <i>K<sub>a</sub></i>	i	ii	iii	iv
amitriptyline	9.4	1.16	1.16	1.18	1.16
amoxapine	*	0.60	0.60	0.57	0.58
clomipramine	9.5	1.71	1.78	1.89	1.83
desipramine	9.5	0.91	0.92	0.91	0.89
imipramine	9.5	1.00 (11.322 min)	1.00 (11.983 min)	1.00 (17.259 min)	1.00 (17.399 min)
maprotiline	10.5	1.11	1.11	1.11	1.06
mianserin	7.1	0.60	0.61	0.55	0.58
nortriptyline	9.7	1.05	1.06	1.07	1.05
setiptiline	7.8	0.57	0.59	0.54	0.57
trimipramine	7.7	1.30	1.30	1.35	1.31

\* No data available

Mobile phase B	p <i>K<sub>a</sub></i>	i	ii	iii	v	vi	vii
amitriptyline	9.4	1.24	1.20	1.32	1.35	1.22	1.24
amoxapine	*	0.60	0.49	0.45	0.45	0.41	0.66
clomipramine	9.5	1.38	1.38	1.92	1.60	1.45	1.45
desipramine	9.5	0.49	0.53	0.52	0.56	0.41	0.53
imipramine	9.5	1.00 (15.195 min)	1.00 (24.237 min)	1.00 (14.003 min)	1.00 (38.997 min)	1.00 (18.687 min)	1.00 (8.869 min)
maprotiline	10.5	0.53	0.60	0.45	0.56	0.41	0.53
mianserin	7.1	0.80	0.78	1.27	0.49	0.64	0.96
nortriptyline	9.7	0.58	0.62	0.62	0.67	0.51	0.59
setiptiline	7.8	0.75	0.70	1.06	0.49	0.59	0.86
trimipramine	7.7	1.34	1.28	1.60	1.20	1.20	1.49

Column i) Eclipse XDB-C<sub>8</sub> (250 × 4.6 mm i. d.)

Column ii) Inertsil ODS-2 (250 × 4.6 mm i. d.)

Column iii) Develosil UG-5 (250 × 4.6 mm i. d.)

Column iv) TSK gel OSD-80T<sub>M</sub> (250 × 4.6 mm i. d.)

Column v) TSK gel OSD-80T<sub>M</sub> (150 × 4.6 mm i. d.)

Column vi) TS Kgel OSD-80T<sub>S</sub> (150 × 4.6 mm i. d.)

Column vii) Discovery C<sub>18</sub> (150 × 4.6 mm i. d.)

The relative retention time values were calculated by assuming that of imipramine as 1.00.

shows the results on relative retention times for ten antidepressant drugs using different types of HPLC columns. Especially, the residual silanol groups remaining in the column cause longer retention times and broadening of the peak width. To overcome these problems, the ratio of methanol or acetonitrile in the mobile phase is increased; the addition of 10–20 mM counter ions, such as triethylamine, is also effective to some extent.

- j) The flow rate for the solid-phase column upon adsorption, washing and elution should be 1–2 mL/min. Upon washing the column, too slow flow rate causes the elution of a target drug. It should be cautioned that the column should not be dried up just after its activation; however, just before elution of a target drug, the column should be dried up. The analysts should be careful not to make a mistake on the above matter. In this section the most common procedure is presented, but a different washing and elution procedure using a different solvent can be used.
- k) The column washing should be sufficient. If not, protein components cannot be removed; upon elution with 100 % methanol, proteins appear together with a drug in the eluate. In such a case, the removal of proteins by filtration becomes necessary.

## References

- 1) Nakayama K (ed) (1994) *Science of Antidepressant Drugs – Basic and Clinical Verification* – Seiwashoten, Tokyo (in Japanese)
- 2) Kiuchi Y, Oguchi E, Oguchi K (1994) Action mechanisms and pharmacodynamics of drugs in the human body. *Nipponrinsho* 52:1190–1195 (in Japanese)
- 3) Tanaka E, Terada M, Nakamura T et al. (1997) Forensic analysis of eleven cyclic antidepressants in human biological samples using a new reversed-phase chromatographic column of 2 mm porous microspherical silica gel. *J Chromatogr B* 692:405–412
- 4) Baselt RC, Cravey RH (1995) *Disposition of Toxic Drugs and Chemicals in Man*, 4th edn., Chemical Toxicology Institute, Foster City, CA
- 5) Namera A, Watanabe T, Yashiki M et al. (1998) Simple analysis of tetracyclic antidepressants in blood using headspace-solid phase microextraction and GC/MS. *J Anal Toxicol* 22:396–400
- 6) Okada K, Kimura T (1999) A fatal case of carbamazepine poisoning. *Jpn J Toxicol* 12:65–68 (in Japanese with an English abstract)
- 7) Pflieger K, Maurer HH, Weber A (1992) *Mass Spectral and GC Data of Drugs, Poisons, Pesticides, Pollutants and Their Metabolites*, 2nd edn. VCH, Weinheim
- 8) DFG, TIAFT (1985) *Gas Chromatographic Retention Indices of Toxicologically Relevant Substances on SE-30 and OV-1*, 2nd edn. VCH, Weinheim
- 9) Suzuki O, Hattori H, Asano M et al. (1986) Positive and negative ion mass spectrometry of tricyclic antidepressants. *Z Rechtsmed* 97:239–250

## 11.3.4 Benzodiazepines

by Hiroshi Seno and Hideki Hattori

### Introduction

Benzodiazepines show antianxiety, hypnotic, anticonvulsant and muscle-relaxant effects. This group of drugs has wide safety dose ranges; it means that the ratio of the LD<sub>50</sub> to the ED<sub>50</sub> (therapeutic index) is high. Because of its safety, benzodiazepines are being widely used in the world. Some of benzodiazepines are also being abused or used for so-called “drug facilitated sexual assault”, and thus they are under the control of the Narcotics and Psychotropics Control Law; in Japan, triazolam abuse has become one of the serious social problems. In this chapter, a GC/MS method for simultaneous analysis of 22 kinds of benzodiazepines listed in [▶ Table 4.1](#) is described. In addition, the LC/MS analysis of triazolam, and its metabolites 4-hydroxytriazolam and  $\alpha$ -hydroxytriazolam is also presented.

### GC/MS analysis of benzodiazepines in blood and urine

---

#### Reagents and their preparation

- The pure powder of the 22 kinds of benzodiazepines was donated by each pharmaceutical manufacturers according to the authors' request<sup>a</sup> (some of benzodiazepines now obtainable from Sigma, St. Louis, MO, USA).
- 1 M Sodium bicarbonate solution: a 8.4-g aliquot of sodium bicarbonate is dissolved in distilled water to prepare 100 mL solution.
- 2 M Sodium acetate solution: a 27.5-g aliquot of sodium acetate is dissolved in distilled water to prepare 100 mL solution.

#### GC/MS conditions

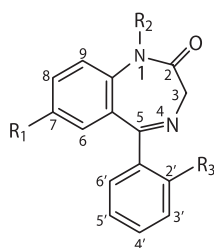
Column: a DB-5 fused silica capillary column (30 m × 0.25 mm i.d., film thickness 0.25  $\mu$ m, J & W Scientific, Folsom, CA, USA).

GC conditions; instrument: a GC-17A gas chromatograph (Shimadzu Corp., Kyoto, Japan); column (oven) temperature: 150 °C (1 min) → 20 °C/min → 300 °C (6.5 min); injection temperature: 250 °C; carrier gas: He; its flow rate: 0.9 mL/min; sample injection: splitless mode for 1 min, followed by the split mode.

MS conditions: a QP-5050A mass spectrometer (Shimadzu Corp.); ionization: EI; electron energy 70 eV; interface temperature: 250 °C.

■ **Table 4.1**

**Chemical structures of benzodiazepines**



Compound	R <sub>1</sub>	R <sub>2</sub>	R <sub>3</sub>	R <sub>4</sub>
diazepam	Cl	CH <sub>3</sub>	H	–
fludiazepam	Cl	CH <sub>3</sub>	F	–
flurazepam	Cl	(CH <sub>2</sub> ) <sub>2</sub> N <div style="display: inline-block; vertical-align: middle; margin-left: 10px;"> <math>\begin{array}{l} \diagup \text{C}_2\text{H}_5 \\ \diagdown \text{C}_2\text{H}_5 \end{array}</math> </div>	F	–
prazepam	Cl	CH <sub>2</sub> — ◁	H	–
flutoprazepam	Cl	CH <sub>2</sub> — ◁	F	–
dipotassium clorazepate	Cl	H	H	3: CHCOOK
medazepam	Cl	CH <sub>3</sub>	H	2: CH <sub>2</sub>
clordiazepoxide	Cl	–	H	2: CNHCH <sub>3</sub> ; 4: N→O
nitrazepam	NO <sub>2</sub>	H	H	–
nimetazepam	NO <sub>2</sub>	CH <sub>3</sub>	H	–
clonazepam	NO <sub>2</sub>	H	Cl	–
flunitrazepam	NO <sub>2</sub>	CH <sub>3</sub>	F	–
bromazepam	Br	H	–	5: C-pyridine
tofisopam	CH <sub>3</sub> CO	–	H	1: CHC <sub>2</sub> H <sub>5</sub> ; 2: C–CH <sub>3</sub> ; 3: N; 3': –OCH <sub>3</sub> ; 4': –OCH <sub>3</sub> ; 8: –COCH <sub>3</sub>
oxazolam	Cl	H	H	4, 5: 2-methyloxazolo
mexazolam	Cl	H	Cl	4, 5: 3-methyloxazolo
estazolam	Cl	–	H	1, 2: triazolo
alprazolam	Cl	–	H	1, 2: 1-methyltriazolo
triazolam	Cl	–	Cl	1, 2: 1-methyltriazolo
midazolam	Cl	–	F	1, 2: 1-methyltriazolo
etizolam	–	–	Cl	1, 2: 1-methyltriazolo; 1, 5: 7-ethylthieno
brotizolam	–	–	Cl	1, 2: 1-methyltriazolo; 1, 5: 7-bromothieno



## Procedure

- i. A 1-mL volume of whole blood or urine is mixed well with 8.5 mL distilled water<sup>b</sup> in a 15-mL volume glass centrifuge tube with a ground-in stopper, followed by addition of 0.5 mL of 1 M sodium bicarbonate solution.
- ii. After it is vortex-mixed, it is centrifuged at 3,000 rpm for 10 min to obtain a supernatant fraction.
- iii. An Oasis HLB 3cc solid-phase extraction cartridge (Waters, Milford, MA, USA) is set on a vacuum manifold, and 3 mL methanol and 3 mL water are passed through the cartridge for conditioning<sup>c</sup>.
- iv. The supernatant fraction prepared at the step ii) is loaded on the Oasis HLB cartridge<sup>c</sup>.
- v. The cartridge is washed with 3 mL distilled water<sup>d</sup>.
- vi. A target drug is eluted with 3 mL chloroform<sup>c</sup> into a 5-mL volume glass tube with a conical bottom.
- vii. The chloroform layer (lower phase) is carefully transferred to a 4-mL volume glass vial using a Pasteur pipette.
- viii. The organic layer is evaporated to dryness under a stream of nitrogen.
- ix. The residue is dissolved in 50  $\mu$ L methanol and a 2- $\mu$ L aliquot is injected into GC/MS<sup>e</sup>.

## Assessment and some comments on the method


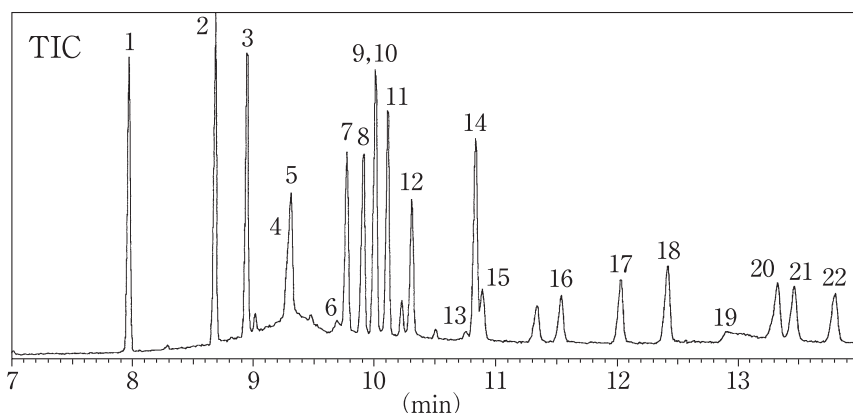
The recovery rates of the drugs from blood and urine were not less than 60 %.  Figure 4.1 shows a total ion chromatogram (TIC) for the authentic standards of benzodiazepines dissolved in methanol. In this chromatogram, separation between dipotassium clorazepate and

 Figure 4.1



TIC for the authentic standards of 22 benzodiazepines.

1: medazepam, 2: fludiazepam, 3: diazepam, 4: dipotassium clorazepate, 5: chlordiazepoxide, 6: oxazolam, 7: midazolam, 8: flunitrazepam, 9: flutoprazepam, 10: bromazepam, 11: prazepam, 12: nimetazepam, 13: mexazolam, 14: flurazepam, 15: nitrazepam, 16: clonazepam, 17: estazolam, 18: alprazolam, 19: tofisopam, 20: etizolam, 21: triazolam, 22: brotizolam.

chlordiazepoxide, between flutoprazepam and bromazepam and between flurazepam and nitrazepam could not be achieved; the peak of tofisopam showed tailing. The separation of other drugs was relatively good. The retention times, molecular weights and principal mass spectral ions of benzodiazepines are shown in [Table 4.2](#).

The quantitation<sup>e</sup> of the drugs was made by selected ion monitoring (SIM). Excellent quantitative-ness could be confirmed in the range of 10–1,000 ng/mL of diazepam, fludiazepam, flurazepam, prazepam, flutoprazepam, dipotassium clorazepate, medazepam, chlordiazepoxide, flunitrazepam, alprazolam, midazolam, etizolam and brotizolam for both blood and urine. The detection limits of these 13 drugs were 1–5 ng/mL. For nitrazepam, mexazolam, nimetazepam, clonazepam, bromazepam, tofisopam, estazolam and triazolam, quantitative-ness could be observed in the range of 50–1,000 ng/mL with detection limits of 10–20 ng/mL, and for oxazolam it could be observed in the range of 200–1,000 ng/mL with detection limits of 50 ng/mL in urine and 100 ng/mL in blood.

**Table 4.2**

Retention times and principal mass spectral ions of benzodiazepines measured by GC/MS

Compound	Retention time (min)	Molecular weight	Principal ions <i>m/z</i> (% intensity)
medazepam	7.97	270	207 (100), <b>242</b> (91), 244 (30), 270 (20), 165 (15)
fludiazepam	8.68	302	274 (100), 301 (96), <b>302</b> (92), 109 (43), 283 (37)
diazepam	8.94	284	283 (100), 256 (94), <b>284</b> (88), 221 (36), 110 (31)
dipotassium clorazepate	9.28	409	<b>242</b> (100), 270 (69), 103 (34), 89 (33), 76 (30)
chlordiazepoxide	9.31	299	<b>282</b> (100), 124 (20), 247 (16), 220 (14), 89 (11)
oxazolam	9.72	328	<b>251</b> (100), 253 (30), 70 (30), 105 (13), 77 (12)
midazolam	9.78	325	<b>310</b> (100), 312 (30), 325 (20), 163 (12), 111 (12)
flunitrazepam	9.91	313	285 (100), 312 (99), <b>313</b> (95), 266 (58), 238 (37)
flutoprazepam	10.00	342	55 (100), <b>313</b> (67), 109 (61), 287 (42), 259 (37), 342 (29)
bromazepam	10.01	315	90 (100), 326 (92), <b>315</b> (91), 77 (91), 317 (86)
prazepam	10.10	324	55 (100), 91 (91), 269 (75), 295 (68), <b>324</b> (46) 241 (36)
nimetazepam	10.30	295	267 (100), 294 (77), 248 (63), <b>295</b> (62), 220 (34)
mexazolam	10.75	363	<b>251</b> (100), 253 (30), 70 (22), 139 (11), 236 (9)
flurazepam	10.83	387	86 (100), 99 (7), 58 (6), <b>387</b> (2)
nitrazepam	10.91	281	<b>280</b> (100), 253 (95), 234 (80), 264 (61), 206 (58)
clonazepam	11.56	315	280 (100), 314 (87), <b>315</b> (68), 288 (54), 89 (52)
estazolam	12.03	294	259 (100), 293 (65), <b>294</b> (64), 205 (59), 89 (50)
alprazolam	12.42	308	279 (100), 273 (90), <b>308</b> (88), 204 (84), 102 (82)
tofisopam	12.97	382	<b>382</b> (100), 326 (87), 341 (63), 353 (33), 156 (31)
etizolam	13.32	342	<b>342</b> (100), 344 (47), 313 (37), 266 (31), 125 (24)
triazolam	13.50	342	<b>313</b> (100), 315 (76), 238 (71), 75 (62), 342 (52)
brotizolam	13.82	392	<b>394</b> (100), 392 (77), 245 (43), 118 (38), 123 (27)

\* The ions used for SIM are shown in boldfaces.

In the analysis of benzodiazepines by GC and GC/MS, the decomposition of drugs due to heat frequently takes place. The decomposition is marked especially for oxazolam, cloxazolam, mexazolam, flutazolam and haloxazolam having oxazolo rings in their structures [1]. In such cases, the relatively low injection temperature and the use of a wide-bore capillary column with short length (15 m) can protect the drugs from their heat decomposition to some extent.

For nitro-group containing drugs, such as nitrazepam, nimetazepam, clonazepam and flunitrazepam, the nitro group is rapidly metabolized into an amino group (in the 7-position) after being absorbed into human body [2].

The above GC/MS method deals with detection and identification of unchanged benzodiazepines. To detect benzodiazepine metabolites from urine specimens, it is necessary to hydrolyze the glucuronate conjugates of the drugs using  $\beta$ -glucuronidase; the resulting free forms with hydroxyl groups should be derivatized before GC (/MS) analysis.

When benzodiazepines are treated in strong acid, they are hydrolyzed into benzophenones, which are very stable against heat; the benzophenones can be also obtained from the hydroxylated metabolites and their conjugates together with unchanged forms of benzodiazepines [3–5]. Using the benzophenone, detection and identification of a benzodiazepine or its metabolites can be achieved by GC or GC/MS without any derivatization. However, it should be noted that an unchanged benzodiazepine, its hydroxylated metabolite and its glucuronide metabolite all give the same benzophenone; also there are many cases in which different benzodiazepines give the same benzophenone. Therefore, by the benzophenone method, it is impossible to discriminate among unchanged, hydroxylated and conjugated forms, and also among similar types of benzodiazepines.

## LC/MS analysis of triazolam and its metabolites

---

To analyze drugs in human specimens with high protein contents, such as blood and plasma, the deproteinization procedure is generally essential. Recently, special column packing materials are being developed from some manufacturers, which enable direct application of a crude specimen without any prior deproteinization process. “Internal surface reversed phase column” is one of the columns of this type. In this section, a method of LC/MS analysis of triazolam and its metabolites (4-hydroxytriazolam and  $\alpha$ -hydroxytriazolam) using the above new column without the need of deproteinization is presented.

### Reagent and their preparation

- Triazolam can be purchased from Sigma (St. Louis, MO, USA). 4-Hydroxytriazolam and  $\alpha$ -hydroxytriazolam were purchased from Funakoshi, Tokyo, Japan<sup>f</sup>.
- 0.05 % Formic acid-containing 7.5 mM ammonium acetate solution (solution A): 578 mg ammonium acetate and 0.5 mL formic acid are dissolved in distilled water to prepare 1,000 mL solution.
- 2 M Sodium acetate solution: 27.5 g of sodium acetate is dissolved in distilled water to prepare 100 mL solution.

## LC/MS conditions

Column: Wakopak WS GP-N6 (150 × 4.6 mm i. d., Wako Pure Chemical Industries, Ltd., Osaka, Japan)<sup>g, h</sup>

LC conditions: an LC 1100 Series high-performance liquid chromatograph (Agilent Technologies, Palo Alto, PA, USA); mobile phases (isocratic mode): 100 % solution A for the initial 5 min (the eluate not introduced into MS)<sup>i</sup>, followed by solution A/acetonitrile (75:25, v/v) to be introduced into MS; flow rate: 0.3 mL/min.

MS conditions: an LCQ ion trap mass spectrometer (ThermoFinnigan Corp., San Jose, CA, USA); ionization: electrospray ionization (ESI); capillary temperature: 230 °C; sheath gas (flow rate): N<sub>2</sub> (80 units).

## Procedures

### i. Blood plasma specimen

A 1-mL volume of plasma is mixed with 1 mL of solution A in a 4.5-mL volume glass vial; 20 μL of it is injected into LC/MS<sup>j</sup>.

### ii. Urine specimen

- i. A 1-mL volume of urine is mixed with 50 μL of 2 M sodium acetate solution and 40 μL of β-glucuronidase solution<sup>k</sup> in a 4.5-mL volume glass vial, and incubated at 56 °C for 2 h.
- ii. After cooling to room temperature, 1 mL of solution A is mixed with the above mixture, and a 20-μL aliquot of the solution is injected into LC/MS<sup>j</sup>.

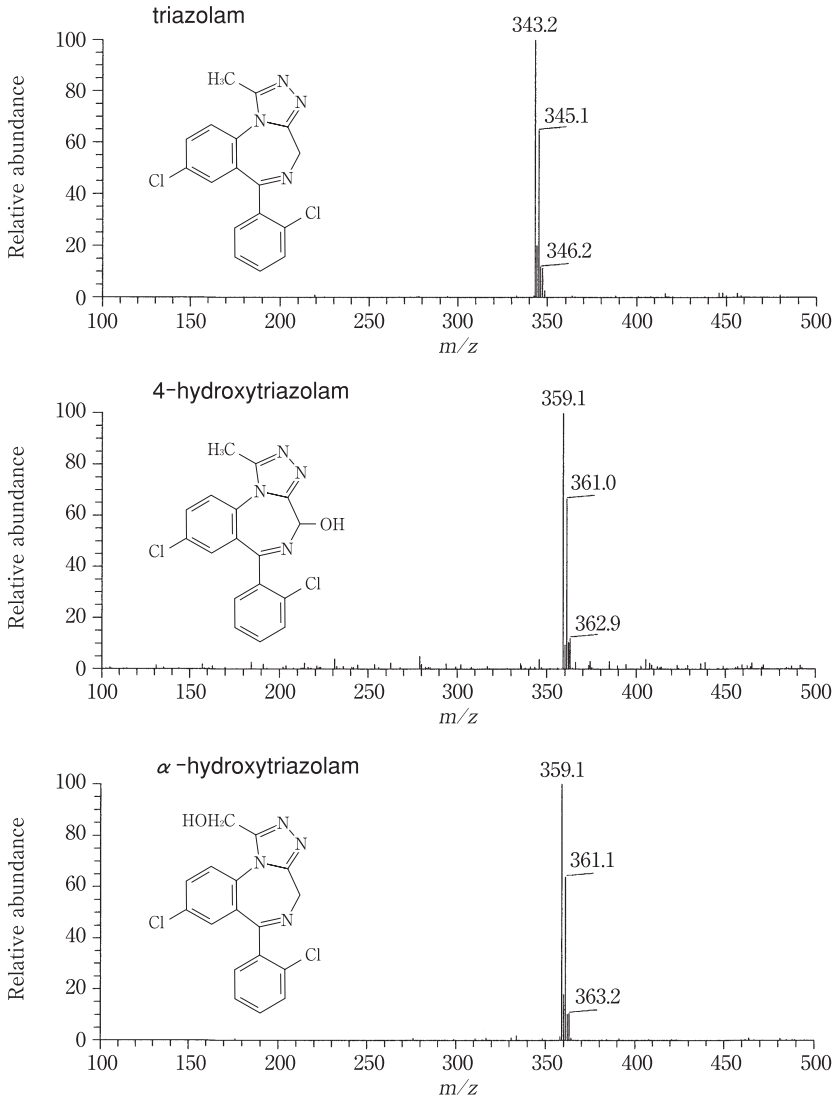
## Assessment of the method

▶ *Figure 4.2* shows ESI mass spectra of triazolam, 4-hydroxytriazolam and α-hydroxytriazolam. The recoveries of triazolam and 4-hydroxytriazolam from plasma and urine were not less than 80 %; those of α-hydroxytriazolam 60–70 %. ▶ *Figure 4.3* shows mass chromatograms for triazolam, 4-hydroxytriazolam, α-hydroxytriazolam and alprazolam (IS). Under the present conditions, the separation of peaks of triazolam, 4-hydroxytriazolam and α-hydroxytriazolam was good. The detection limits obtained by mass chromatography were 20 ng/mL for triazolam and 40 ng/mL for both 4-hydroxytriazolam and α-hydroxytriazolam in plasma and urine. The quantitiveness could be observed in the range of 50–400 ng/mL for all compounds in both plasma and urine.

## Toxic and fatal concentrations

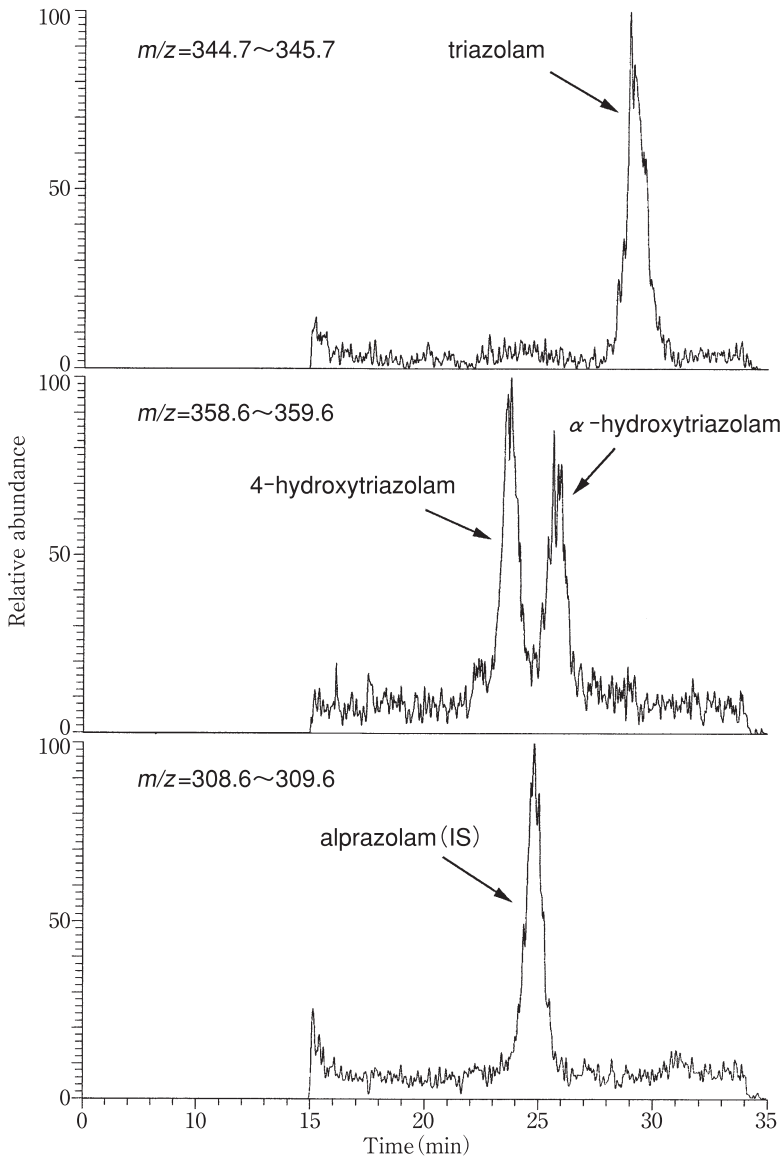
Benzodiazepines generally show low toxicities and the fatal doses are not clear for many drugs. However, toxic blood levels were reported to be 5–20 μg/mL for diazepam, dipotassium clorazepate and chlordiazepoxide; not lower than 2 μg/mL for oxazepam, and not lower than 0.2–0.3 μg/mL for flurazepam, lorazepam and nitrazepam. The fatal blood concentrations were reported to be not lower than 20 μg/mL for diazepam and chlordiazepoxide, and

Figure 4.2



ESI mass spectra of triazolam, 4-hydroxytriazolam and α-hydroxytriazolam.

■ Figure 4.3



Mass chromatograms of triazolam, 4-hydroxytriazolam,  $\alpha$ -hydroxytriazolam and alprazolam (IS). A 100-ng aliquot each of triazolam, 4-hydroxytriazolam and  $\alpha$ -hydroxytriazolam and 50 ng of alprazolam were added to 1 mL blood plasma.

0.5–17 µg/mL for flurazepam [6–8]. Deaths by benzodiazepine poisoning only are rare; simultaneous ingestion of other hypnotics or alcohol enhance the sedative and respiration-suppressing effects of benzodiazepines, resulting in deaths occasionally.

## Notes

- a) The conventional Narcotics Control Law was changed into the Narcotics and Psychotropics Control Law in 1990 in Japan, and benzodiazepines have become included in the drug list to be controlled. Therefore, at the present time, it is not easy to obtain them from each pharmaceutical manufacturer.
- b) By adding distilled water to whole blood, the erythrocytes are hemolyzed completely.
- c) The flow rate should not be higher than 1 mL/min especially under reduced pressure. It is usually not necessary to use a pump; without aspiration, the solution flows inside the cartridge only by natural gravity slowly.
- d) Since the polymer used for the Oasis HLB cartridge has high water retentivity, the drying of the cartridge during its manipulation does not affect recovery rates and reproducibility. After a cartridge is washed with distilled water and its droplets by the action of natural gravity stop coming out, the cartridge is aspirated using a pump to remove water as much as possible; this results in the least contamination of the organic eluate by water.
- e) For quantitative analysis, one of other benzodiazepines can be chosen as IS.
- f) 4-Hydroxytriazolam and  $\alpha$ -hydroxytriazolam had been able to be purchased from Funakoshi, Tokyo, Japan; however, they are not included in the list of their catalogue book 2001–2002. In the catalogue book 2002–2003 of Sigma,  $\alpha$ -hydroxytriazolam (H2529) is listed as an uncontrolled substance and thus easily obtainable.
- g) The Wakopak WS GP-N6 packing material (Wakosil GP-N6) is made of silica gel support, into which a single modification group with hydrophilic and hydrophobic properties is introduced. Large molecules, such as protein, pass through the column; while drugs are retained in the column because of the hydrophobic interaction. This column enables direct analysis of a crude specimen without any complicated pretreatment. For triazolam, 4-hydroxytriazolam and  $\alpha$ -hydroxytriazolam, the separation of each peak was satisfactory with this column. With Wakopak WS GP-N6, analysis can be achieved without a column switching device.
- h) A pre-column line filter is preferably connected with the column to prevent it from clogging. It is possible to analyze without the filter, but the column pressure is increased after 10–20 time use.
- i) Since proteins are usually eluted within 5 min, the eluate is not introduced into MS, but drained outside during this period. After this time, the valve is switched to introduce clean eluate into MS not to contaminate MS with impurities.
- j) When the sample solution is turbid, the clear supernatant fraction after centrifugation is injected into LC/MS.
- k) As  $\beta$ -glucuronidase solution, type HP-2 (from *Helix promatia*), 132,500 units/mL (Sigma, St. Louis, MO, USA) was used.

## References

- 1) Hattori H, Suzuki O, Sato K et al. (1987) Positive and negative ion mass spectrometry of 24 benzodiazepines. *Forensic Sci Int* 35:165–179
- 2) Yamamoto I (1995) *Yamamoto's Dictionary of Drug Metabolism*. Hirokawa Publishing Co., Tokyo, pp 301–302 (in Japanese)
- 3) Suzuki O, Hattori H, Asano M et al. (1987) Positive and negative ion mass spectrometry of benzophenones, the acid-hydrolysis products of benzodiazepines. *Z Rechtsmed* 98:1–10
- 4) Seno H, Suzuki O, Kumazawa T et al. (1991) Rapid isolation with Sep-Pak C<sub>18</sub> cartridges and wide-bore capillary gas chromatography of benzophenones, the acid-hydrolysis products of benzodiazepines. *J Anal Toxicol* 15:21–24
- 5) Guan F, Seno H, Ishii A et al. (1999) Solid-phase microextraction and GC-ECD of benzophenones for detection of benzodiazepines in urine. *J Anal Toxicol* 23:54–61
- 6) Schonwald S (2001) *Medical Toxicology. A Synopsis and Study Guide*. Lippincot Williams & Wilkins, Philadelphia, USA, pp 345–347
- 7) Moffat AC, Jackson JV, Moss MS et al. (eds) (1986) *Clarke's Isolation and Identification of Drugs*, 2nd edn. The Pharmaceutical Press, London
- 8) Winek CL (1989) *Drug and Chemical Blood-Level Data 1988*. Fisher Scientific, Pittsburgh, PA



## 11.3.5 Bromisovalum

by Keiko Kudo and Noriaki Ikeda

### Introduction

Bromisovalum ( $\alpha$ -bromoisovalerylurea, bromovalerylurea, Brovarin) (▶ *Figure 5.1*) has long been being used as a hypnotics or sedative since many years ago. It is not only prescribed as an ethical drug, but also contained in some analgesic- antipyretics and hypnotics being sold as over-the-counter drugs. Because of the easiness of getting it, bromisovalum is one of the most important drugs in poisoning in Japan.

The analysis of bromisovalum is being made by GC [1, 2], GC/MS [3], HPLC [4, 5] and LC/MS [6–8]. Because of its thermolability, HPLC or LC/MS is more recommendable than GC or GC/MS to obtain good reproducibility. In this chapter, three kinds of methods for extraction of bromisovalum from blood and urine and its HPLC analysis are presented.

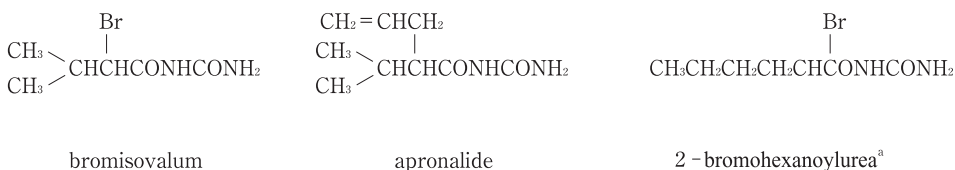
### Reagents and their preparation

- Bromisovalum (Nippon Shinyaku Co., Ltd., Kyoto, Japan, Wako Pure Chemical Industries, Ltd., Osaka, Japan and other manufacturers) is dissolved in methanol to prepare 1 mg/mL standard solution.
- Phenytoin (internal standard, IS<sup>a</sup>, Wako Pure Chemical Industries and other manufacturers) is dissolved in methanol to prepare 1 mg/mL standard solution.

### HPLC conditions

Column: a reversed-phase column (CAPCELL-PAK C<sub>18</sub> MG<sup>b</sup>, 250 × 3 mm i. d., particle diameter 5 μm, Shiseido, Tokyo, Japan); mobile phase: acetonitrile/8 mM KH<sub>2</sub>PO<sub>4</sub> solution (35:65, v/v)<sup>c</sup>; detection wavelength: 210 nm; flow rate: 0.8 mL/min; column temperature: 40 °C.

■ **Figure 5.1**



### Bromisovalum and its related compounds.

## Procedures

### i. Extraction with an Extrelut column [9]

- i. A 1-mL (or g) aliquot of a specimen (whole blood, serum or urine) is mixed with 5  $\mu$ L phenytoin solution (IS, 1 mg/mL) and 1 mL of 0.1 M hydrochloric acid solution<sup>d</sup> in a centrifuge tube.
- ii. The mixture is vortex-mixed for 10 s.
- iii. It is centrifuged (4 °C, 2,500 rpm, 15 min) to obtain a supernatant fraction.
- iv. A 2.5-g aliquot of Extrelut<sup>e</sup> (Merck, Darmstadt, Germany) is packed in a glass column (about 15 cm  $\times$  15 mm i. d.).
- v. The above supernatant fraction is poured into the column and left for 20 min.
- vi. Bromisovalum and IS are eluted with 7 mL ethyl acetate; the eluate is evaporated to dryness under a stream of nitrogen.
- vii. The residue is dissolved in 100  $\mu$ L of the mobile phase; a 10- $\mu$ L aliquot of it is injected into HPLC.

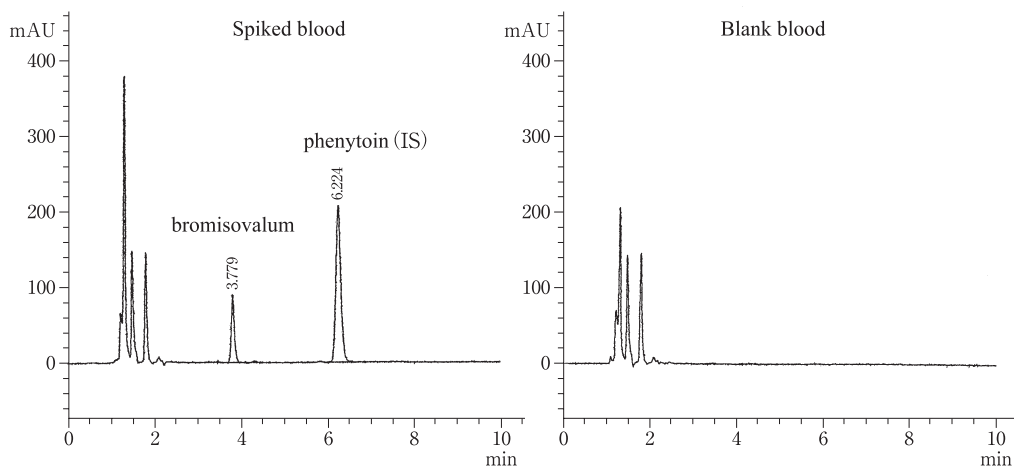
### ii. Extraction with a Sep-Pak C<sub>18</sub> cartridge [1]

- i. A 1-mL (or g) aliquot of a specimen is mixed with distilled water (9 mL for a whole blood specimen; 4 mL for serum and urine specimens) and 5  $\mu$ L phenytoin solution (IS, 1 mg/mL) in a centrifuge tube.
- ii. The mixture is vortex-mixed for 10 s.
- iii. It is centrifuged (4 °C, 2,500 rpm, 15 min) to obtain a supernatant fraction.
- iv. A Sep-Pak C<sub>18</sub> cartridge (Waters, Milford, MA, USA) is activated by passing 5 mL of dichloromethane/methanol (9:1), 5 mL acetonitrile and 10 mL distilled water.
- v. The above supernatant fraction is poured into the Sep-Pak cartridge, washed with 10 mL distilled water and eluted with 3 mL of dichloromethane/methanol (9:1).
- vi. After removal of a small amount of the upper layer (aqueous phase) of eluate with a Pasteur pipette, the organic eluate is evaporated to dryness under a stream of nitrogen.
- vii. The residue is dissolved in 100  $\mu$ L of the mobile phase, and a 10- $\mu$ L aliquot is injected into HPLC.

### iii. Liquid-liquid extraction [5]

- i. A 1-mL (or g) aliquot of a specimen (whole blood, serum or urine) is mixed with 5  $\mu$ L of phenytoin solution (IS, 1 mg/mL) and 1 mL of 0.1 M hydrochloric acid solution in a centrifuge tube.
- ii. A 3-mL volume of *tert*-butyl methyl ether<sup>f</sup> (Tokyo Kasei Kogyo Co., Ltd., Tokyo, Japan and other manufacturers) is added to the above mixture and vortex-mixed for 2 min.
- iii. It is centrifuged (4 °C, 2,500 rpm, 15 min).
- iv. The organic phase is transferred to a glass vial, and evaporated to dryness under a stream of nitrogen.
- v. The residue is dissolved in 100  $\mu$ L of the mobile phase, and a 10- $\mu$ L aliquot is injected into HPLC.

Figure 5.2



HPLC chromatograms for blood extracts in the presence and absence of bromisovalum and IS. The concentration of bromisovalum spiked into whole blood was 5  $\mu\text{g/mL}$ .

## Assessment and some comments on the methods

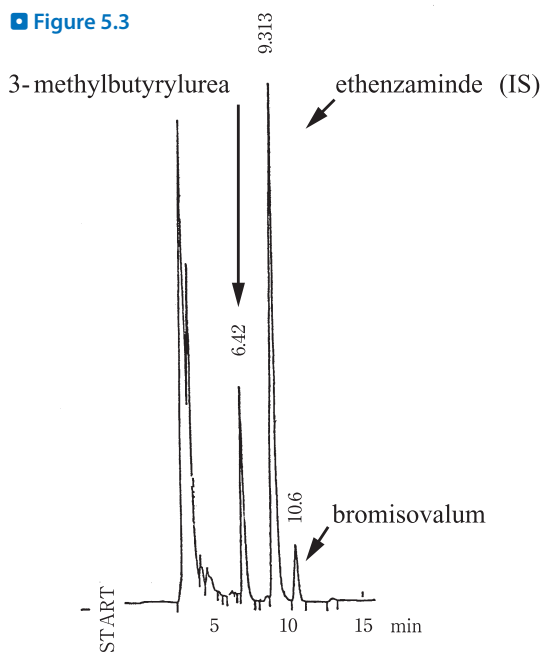
Figure 5.2 shows HPLC chromatograms for whole blood specimens, which had been extracted with an Extrelut column. The peaks of bromisovalum and IS appeared at 3.77 and 6.22 min, respectively, without any interfering peak. The calibration curve showed excellent linearity in the range of 0.1–10  $\mu\text{g/mL}$ ; recovery rates were 60–80%. When ethenzamide is used as IS, it appears before bromisovalum; when 2-bromohexanoylurea is used as IS, it appears after phenytoin. By extraction with Extrelut or Sep-Pak  $\text{C}_{18}$ , there is occasionally a case in which bromisovalum is not separated from other basic drugs, when they are ingested simultaneously. By the liquid-liquid extraction, the basic drugs can be removed efficiently; but coloration of the organic phase takes place to some extent, when whole blood is analyzed.

Figure 5.3 shows an HPLC chromatogram of the extract of rat plasma obtained 2 h after intraperitoneal administration of bromisovalum (30 mg/kg) [5]. Because of the different HPLC conditions, the retention times were somewhat different; but a de-bromo-metabolite (3-methyl butyrylurea) appeared before ethenzamide.

As over-the-counter drugs containing bromisovalum, Rislon (100 mg bromisovalum per tablet, Sato Pharmaceutical, Tokyo, Japan) and Wutt (83 mg bromisovalum, 50 mg apronalide and 8.3 mg diphenhydramine hydrochloride per tablet, Itami Pharmaceutical, Shiga, Japan) can be mentioned. Apronalide (Figure 5.1) contained in Wutt appears at 5.07 min under the present HPLC conditions and thus can be an indicator of ingestion of Wutt.

In some analgesic-antipyretics, bromisovalum is also contained together with acetaminophen and ethenzamide. Therefore, when bromisovalum is detected, various possibilities of concomitant ingestion of other drugs should be taken into consideration.

■ **Figure 5.3**



HPLC chromatogram for the extract of rat serum obtained 2 h after intraperitoneal injection of bromisovalum (30 mg/kg). HPLC conditions; column: Symmetry Shield RP<sub>18</sub>, 15 cm × 4.6 mm i. d., particle diameter 3.5 μm, Waters; mobile phase: acetonitrile/8 mM KH<sub>2</sub>PO<sub>4</sub> solution (35:65, v/v); detection wavelength: 210 nm; flow rate: 0.4 mL/min.

## Toxic and fatal concentrations

Fatal blood bromisovalum concentrations in poisoning with bromisovalum only were reported to be 44.0–93.8 μg/mL by Hishida [10], 67–134 μg/mL by Maguchi [11] and 114 μg/mL by Kojima et al. [12]. In the fatal cases of multiple drug ingestion, blood bromisovalum concentrations were reported to be 37 μg/mL by Terada et al. [13], 23.6 μg/mL by Matsubara et al. [14], and 31.5 and 40.8 μg/mL by Yashiki et al. [15].

## Poisoning cases

Many cases of poisoning by bromisovalum were reported. In this section, representative clinical and medicolegal cases are presented.

### a) Cases in clinical toxicology [16]

**Case 1:** a 26-year-old male ingested more than 3 g bromisovalum and his consciousness level was 300 (Japan Coma Scale) on arrival at a hospital. His clinical blood tests were: the maxi-

mum blood bromisovalum concentration, 235  $\mu\text{g/mL}$ ; bromide (Br) 1.4 mEq/L (on day 2 of admission) and chloride (Cl), 151 mEq/L<sup>g</sup>. The half-life of bromisovalum was 12.6 h; that of bromide 92.7 h. The consciousness levels were in good parallel with blood concentrations of bromisovalum.

**Case 2:** a 29-year-old female ingested 20.4 g of bromisovalum. The maximum blood bromisovalum concentration was 117.3  $\mu\text{g/mL}$  on arrival at a hospital; the concentration of chloride was 119 mEq/L. Her consciousness levels were improved according to the decrease in the bromisovalum levels. The chloride levels did not correlate with the consciousness levels.

**Case 3:** a 57-year-old female fell into cardiopulmonary arrest due to asphyxia, but was resuscitated by a rescue squad, and brought to a hospital. A 0.4-g aliquot of bromisovalum had been prescribed for her to sleep. Her blood bromisovalum concentration was 10.1  $\mu\text{g/mL}$  on her arrival to the hospital; chloride concentration 177 mEq/L. Bromide concentrations decreased with a half-life of 58.3 h.

## b) Medicolegal cases

**Case 1 [12]:** a 43-year-old housewife was missing. After 4 days, she was found dead in a shed located in a rice field. Her autopsy findings were: height, 151 cm; weight, 49 kg; mild subcutaneous hemorrhages observable in the chest, abdomen and extremities; and lung edema (left lung 460 g, right lung 440 g). Except these findings, neither severe injuries nor diseases were found. The stomach contents consisted of 14 g of white clayey substance and about 350 mL of aqueous solution. About 350 mL urine was present in her urinary bladder.

Analytical results: 3 g of bromisovalum was detected from the above white clayey substance; about 1 g of the same drug detected from the aqueous solution. Bromisovalum concentrations were 114, 140, 123 and 55  $\mu\text{g/mL}$  or g in blood, the brain, liver and urine, respectively. It was diagnosed that the cause of her death was bromisovalum poisoning.

**Case 2 [17]:** human skeletal remains were discovered in a bush located in a suburban area of a big city. Next to the remains, three empty bottles, to which labels describing 100 tablets of bromisovalum had been attached, five unopened bottles containing the same tablets and a 1.5-L volume plastic bottle containing about a half volume of water were found. By dental findings, the remains were found to be a 46-year-old male who had been missing for 7 months. Using the femoral bone marrow, the analysis of bromisovalum was conducted by GC/MS and LC/MS. The drug was identified by the methods; its concentrations measured by LC/MS were 93.8 and 26.0  $\mu\text{g/g}$  in the right and left femoral bones, respectively.

## Notes

- a) As an IS, ethenzamide can be used. For LC/MS analysis of bromisovalum, 2-bromohexanoylurea, showing very similar physicochemical properties, is most suitable as IS [7, 18, 19]. This compound can be easily synthesized with 2-bromohexanoyl bromide and urea: 5 g of 2-bromohexanoyl bromide (Aldrich, Milwaukee, WI, USA) and an equimolar amount of urea are placed in a 100 mL volume eggplant-shaped glass flask and warmed in a water bath to form a soft clay. After warm distilled water is added to the clay, solid sodium bicarbonate is gradually added to the mixture until the solution becomes alkaline with warming; this

procedure results in formation of white crystal powder, which is collected by filtration, and recrystallized in ethanol. The crystals thus obtained show a melting point at 133–135 °C. Kokatsu et al. [3] used 2-bromoisobutyrylurea as IS for analysis of bromisovalum by GC/CI-MS. 2-Bromoisobutyrylurea can be also synthesized by a similar method.

- b) The column can be replaced by other reversed phase columns.
- c) The pH of this solution is 4.75. When bromisovalum is analyzed by LC/MS, ammonium acetate buffer solution (10 mM ammonium acetate solution adjusted to pH 3.5 with formic acid) should be used as a volatile mobile phase [6].
- d) For an old blood specimen, it may clot with strongly acidic solution. In such cases, 10 mM hydrochloric acid solution should be used.
- e) The Extrelut powder should be well washed with ethyl ether and dried before use. Without such pretreatment, there is possibility that interfering impurity peaks appear in trace analysis of drugs. As a column for the Extrelut packing, a glass syringe can be used.
- f) *tert*-Butyl methyl ether has a boiling point higher than that of diethyl ether, and does not contain peroxide compounds; it is thus suitable as a solvent for extraction.
- g) When chloride is measured by the ion selective electrode (ISE) method, chloride may be overestimated in the presence of a high concentration of bromide [20].

## References

- 1) Kumazawa T, Seno H, Suzuki O (1992) Rapid isolation with Sep-Pak C<sub>18</sub> cartridges and wide-bore capillary gas chromatography of bromisovalum. *J Anal Toxicol* 16:163–165
- 2) Okada H, Ohashi K (1998) Highly sensitive determination of bromvalerylurea in human blood by gas chromatography after derivatization. *Jpn J Forensic Toxicol* 16:25–33
- 3) Kokatsu J, Yomoda R, Suwa T (1992) Selected ion monitoring for the determination of bromvalerylurea in human plasma. *Chem Pharm Bull* 40:1517–1519
- 4) Miyauchi H, Ameno K, Fuke C et al. (1991) Simultaneous determination of bromvalerylurea, bromodiethyl-acetylurea, and allylisopropylacetylurea in serum and urine by high-performance liquid chromatography with a multiwavelength UV detector and thin-layer chromatography. *J Anal Toxicol* 15:123–125
- 5) Tanaka E, Nakamura T, Nagashima A et al. (2001) Determination of plasma bromvalerylurea and its main metabolite by a simple high-performance liquid chromatographic method and quantitation of bromide by energy dispersive X-ray spectrometry in carbon tetrachloride-intoxicated rats. *J Chromatogr B* 759:361–366
- 6) Tsuchihashi H, Nishikawa M, Igarashi K et al. (1998) Determination of bromvalerylurea and its metabolites in biological samples by frit-fast atom bombardment liquid chromatography-mass spectrometry. *J Anal Toxicol* 22:591–595
- 7) Nagata T, Kudo K, Imamura T et al. (1995) Sensitive and selective determination of bromisovalum by high-performance liquid chromatography/particle beam mass spectrometry. *Forensic Sci Int* 74:205–211
- 8) Higuchi T, Kogawa H, Satoh M et al. (1996) Application of high-performance liquid chromatography/mass spectrometry to drug screening. *Am J Forensic Med Pathol* 17:21–23
- 9) Okamoto I, Chikasue F, Miyazaki T et al. (1985) Extrelut<sup>®</sup> column extraction for screening of drugs in biological materials by gas chromatography and gas chromatography-mass spectrometry. A fatal poisoning by ingestion of a drug containing acetaminophen, ethenzamide and bromvalerylurea. *Jpn J Legal Med* 39:386–391 (in Japanese with an English abstract)
- 10) Hishida S (1968) Studies on the separation and quantitative determination of hypnotics by gas chromatography in forensic toxicology. *Jpn J Legal Med* 22:577–617 (in Japanese with an English abstract)
- 11) Maguchi T (1961) Experimental and clinical studies on the concentrations of bromvalerylurea in body fluids in its acute poisoning. *Hokkaido J Med Sci* 36:43–51 (in Japanese with an English abstract)
- 12) Kojima T, Yashiki M, Takeoka T (1976) Quantitative determination of bromvalerylurea in tissue. A fundamental study and tissue concentrations in two cadavers taking bromvalerylurea. *Jpn J Legal Med* 30:365–367 (in Japanese with an English abstract)

- 13) Terada M, Yoshimura S, Yamamoto T et al. (1981) A case report on the detection of amobarbital, bromvalerylurea and levomepromazine from the postmortally burnt body. *Jpn J Legal Med* 35:456–461 (in Japanese with an English abstract)
- 14) Matsubara K, Maseda C, Fukushima M et al. (1986) A rapid method for determination of bromvalerylurea in human specimens by high-performance liquid chromatography. *Eisei Kagaku* 32:368–372 (in Japanese with an English abstract)
- 15) Yashiki M, Miyazaki T, Chikasue F et al. (1987) Determination of bromvalerylurea in biological fluids by chemical ionization-selected ion monitoring – A case of bromvalerylurea intoxication –. *Jpn J Legal Med* 41:452–456 (in Japanese with an English abstract)
- 16) Kiyota K, Maekawa K, Nishihara K et al. (1997) Significance of bromvalerylurea and bromide ion in blood in bromvalerylurea poisoning. *Jpn J Toxicol* 10:228 (in Japanese)
- 17) Maeda H, Oritani S, Nagai K et al. (1997) Detection of bromisovalum from the bone marrow of skeletonized human remains: a case report with a comparison between gas chromatography/mass spectrometry (GC/MS) and high-performance liquid chromatography/mass spectrometry (LC/MS). *Med Sci Law* 37:248–253
- 18) Kudo K On the synthesis of an internal standard for bromisovalum. ml-poison 228 (<http://maple-www2.med.hiroshima-u.ac.jp/Poison/bromvar/index.html>) (in Japanese)
- 19) Nakano M On the internal standard for Brovarin. ml-poison 01175 (see above) (in Japanese)
- 20) Kan K, Satowa S, Takeuchi I et al. (1984) Three cases of Br poisoning apparently showing abnormal values of serum chloride caused by Sedes A tablet abuse. *J Jpn Soc Intern Med* 9:85–89 (in Japanese)

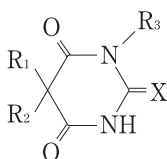
## II.3.6 Barbiturates





by Masaru Terada and Ritsuko Watanabe

### Introduction

Barbiturates are being widely used as antiepileptics, hypnotics and anaesthetics (▶ Figure 6.1 and ▶ Table 6.1). The incidence of barbiturate poisoning cases tends to increase in Japan (▶ Figure 6.2) [1]. A majority of the barbiturate drugs is being controlled by the Narcotics

▶ Figure 6.1

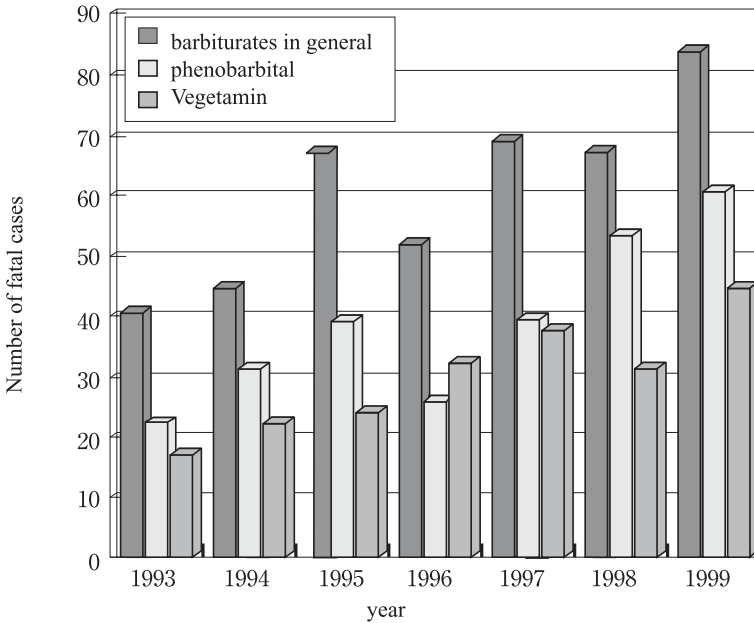


Compound	R <sub>1</sub>	R <sub>2</sub>	R <sub>3</sub>	X
barbital	C <sub>2</sub> H <sub>5</sub> -	C <sub>2</sub> H <sub>5</sub> -	H	O
phenobarbital		C <sub>2</sub> H <sub>5</sub> -	H	O
mephobarbital		C <sub>2</sub> H <sub>5</sub> -	CH <sub>3</sub>	O
metharbital	C <sub>2</sub> H <sub>5</sub> -	C <sub>2</sub> H <sub>5</sub> -	CH <sub>3</sub>	O
cyclobarbital		C <sub>2</sub> H <sub>5</sub> -	H	O
allobarbital	CH <sub>2</sub> CHCH <sub>2</sub> -	CH <sub>2</sub> CHCH <sub>2</sub> -	H	O
amobarbital	(CH <sub>3</sub> ) <sub>2</sub> CH(CH <sub>2</sub> ) -	C <sub>2</sub> H <sub>5</sub> -	H	O
pentobarbital	CH <sub>3</sub> (CH <sub>2</sub> ) <sub>2</sub> CH <sub>3</sub> CH-	C <sub>2</sub> H <sub>5</sub> -	H	O
secobarbital	CH <sub>3</sub> (CH <sub>2</sub> ) <sub>2</sub> CH <sub>3</sub> CH-	CH <sub>2</sub> CHCH <sub>2</sub> -	H	O
hexobarbital		CH <sub>3</sub> -	CH <sub>3</sub>	O
thiopental	CH <sub>3</sub> (CH <sub>2</sub> ) <sub>2</sub> CH <sub>3</sub> CH-	C <sub>2</sub> H <sub>5</sub> -	H	S
thiamylal	CH <sub>3</sub> (CH <sub>2</sub> ) <sub>2</sub> CH <sub>3</sub> CH-	CH <sub>2</sub> CHCH <sub>2</sub> -	H	S

Structures of barbiturates.



■ **Figure 6.2**



**Incidence of fatal barbiturate poisoning cases. Since fatal cases due to Vegetamin® tablets containing phenobarbital are many, its incidence rate is also shown in this figure.**

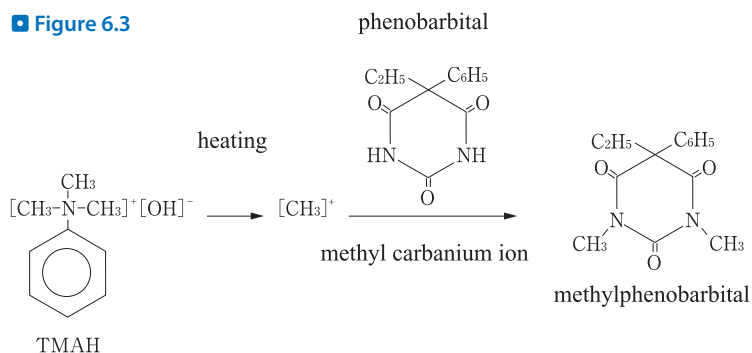
and Psychotropics Control Law in Japan; thus they are also important drugs in view of forensic toxicology. The analysis of barbiturates in human specimens is being made by GC [2–6], GC/MS [3, 6, 7–9], HPLC [10–13], LC/MS/MS [14], capillary electrophoresis [15] and immunoassays [16, 17]. In this chapter, usual methods for analysis of barbiturates by GC and HPLC are presented.

■ **Table 6.1**

**Properties and doses of barbiturates**

Action type	Compound	Route	Therapeutic dose (g)	Maximum dose (g)
long-acting	barbital	oral	0.3	0.5
	phenobarbital	oral	0.03–0.2	0.25
	phenobarbital sodium	suppository	0.015–0.03	0.2
	metharbital	oral	0.1	
Intermediate acting	amobarbital	oral	0.1–0.3	0.5
	amobarbital sodium	i.v./i.m.	0.25–0.5	
short-acting	pentobarbital calcium	oral	0.05–0.1	0.5
	pentobarbital sodium	i.v.	0.1	0.5
	secobarbital sodium	i.v.	0.1–0.2	
	hexobarbital	oral	0.1–0.4	0.5
ultrashort-acting (anaesthetic)	thiopental sodium	i.v.	0.3–0.5	
	thiamylal sodium	i.v.	0.3–0.5	1.0

Figure 6.3



Methylation reaction of phenobarbital with TMAH.

## GC analysis [3, 6]

### Reagents and their preparation

- Barbitol, phenobarbital sodium, amobarbital sodium, pentobarbital sodium, secobarbital sodium, hexobarbital, thiopental sodium and thiamylal can be purchased from Sigma (St. Louis, MO, USA); pure powder of metharbital was donated by Dainippon Pharmaceutical Co., Ltd., Osaka, Japan.
- Each barbiturate is dissolved in methanol to prepare 1 mg/mL stock standard solution and stored at  $-20^\circ\text{C}$ .
- An on-column methylation reagent, 0.2 M trimethylanilium hydroxide (TMAH) (Pierce, Rockford, IL, USA), is diluted with methanol to prepare 4 mM TMAH or 0.4 mM TMAH solution to be used as an on-column methylation reagent (▶ Figure 6.3)<sup>a</sup>.
- Diethyl ether<sup>b</sup> used is of a special grade as pure as that used for analysis of the autoxidation value (AV) and peroxide value (POV) (Dojin Laboratories, Kumamoto, Japan). Other organic solvents are of the highest purity commercially available.
- For calibration curves, various concentrations (4–200 ng/mL) of each barbiturate are prepared by diluting each 1 mg/mL solution with methanol, and a 10- $\mu\text{L}$  each is evaporated to dryness under a stream of nitrogen, followed by addition of 0.2 mL serum.


### GC conditions

Instrument: a Shimadzu GC-14A gas chromatograph (Shimadzu Corp., Kyoto, Japan).

Column: a methylsilicone fused silica wide-bore capillary column<sup>c</sup> (DB-1, 15 m  $\times$  0.53 mm i. d., film thickness 1  $\mu\text{m}$ , J & W Scientific, Folsom, CA, USA).

Column temperature:  $60^\circ\text{C} \rightarrow 8^\circ\text{C}/\text{min} \rightarrow 250^\circ\text{C}$ ; injection temperature:  $250^\circ\text{C}$ <sup>d</sup>; carrier gas (flow rate): He (15 mL/min); make-up gas (flow rate): He (30 mL/min); detectors: an FID and a nitrogen-phosphorus detector (NPD).

## Procedure

- i. A 0.2-mL volume of serum<sup>c</sup>, 1.3 mL distilled water, 1.0 mL of 0.2 M sodium acetate/acetic acid buffer solution (pH 6.0) and 6.0 mL of ethyl acetate/diethyl ether (1:1, v/v)<sup>f</sup> are placed in a glass centrifuge tube with a ground-in stopper.
- ii. The tube is shaken vigorously for 5 min.
- iii. It is centrifuged at 800 g for 5 min, and the organic layer is transferred to a glass vial with a conical bottom.
- iv. The organic extract is evaporated to dryness under a stream of nitrogen with warming at 40 °C; the residue is dissolved in 0.4 mL of 0.4 mM TMAH methanolic solution.
- v. A 1–2 µL aliquot of it is injected into GC; in this method, external calibration method is used. An external calibration curve<sup>g</sup> is constructed by spiking various concentrations of a barbiturate into serum. The peak area of a peak obtained from a test specimen is applied to the calibration curve to obtain its concentration in a specimen. For identification by GC/MS, mass spectra are presented in  Table 6.2.

■ Table 6.2

### Mass spectra of free forms and methyl derivatives of barbiturates

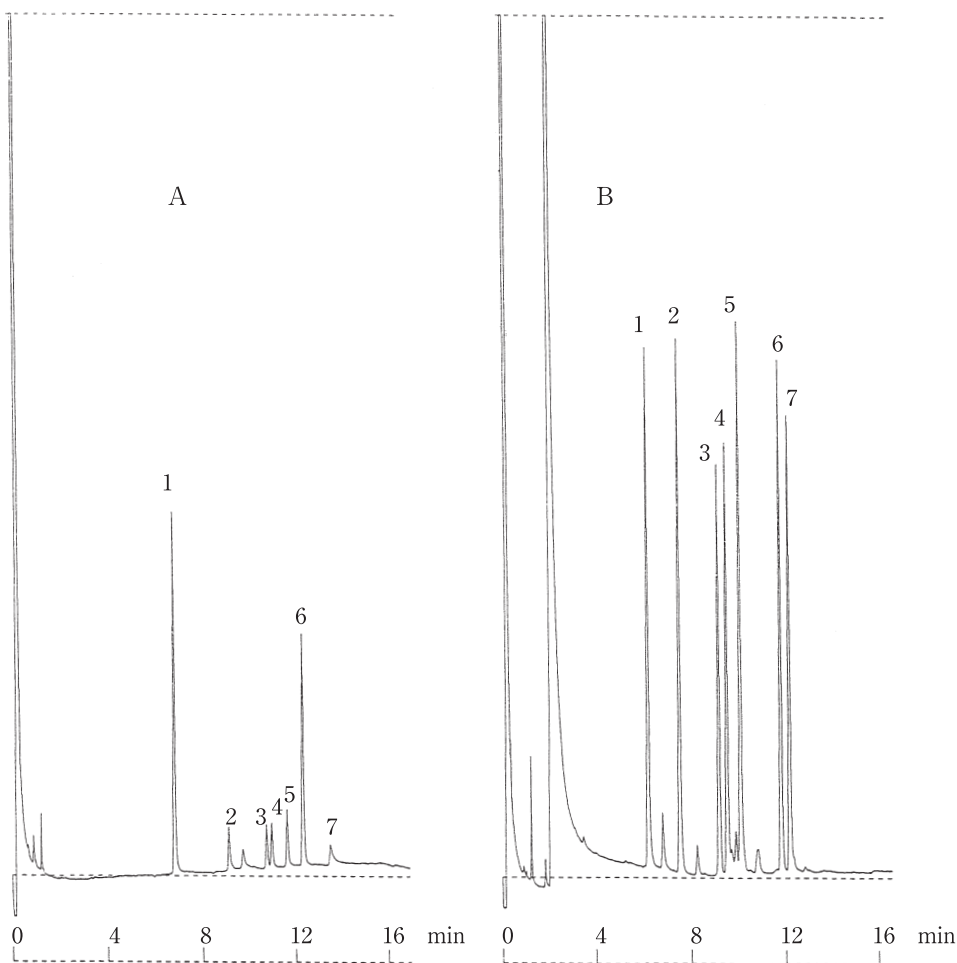
Compound	M. W.	CI mode (isobutane) MH <sup>+</sup>	El mode base peak	Other fragment ions
metharbital	198		155	170, 112, 169
methylmetharbital	212	213	169	184, 126, 112
allobarbital	208		167	124, 80, 141, 106, 53
methylallobarbital	236	237	195	138, 194, 110, 221
amobarbital	226		156	141, 157, 55, 98
methylamobarbital	254	255	169	184, 112, 126
pentobarbital	226		141	156, 157, 55, 98
methylpentobarbital	254	255	169	184, 112, 126
secobarbital	238		167	168, 97, 124, 55
methylsecobarbital	266	267	196	195, 181, 138, 223
hexobarbital	236		221	81, 157, 80, 79, 155, 108, 53
methylhexobarbital	250	251	235	81, 79, 169
mephobarbital	246		218	117, 118, 146, 103
methylmephobarbital	260	261	232	117, 146, 175, 77
phenobarbital	232		204	117, 146, 161, 77, 115
methylphenobarbital	260	261	232	117, 146, 175, 77
cyclobarbital	236		207	141, 81, 79, 67
methylcyclobarbital	264	265	235	169, 79
thiamylal	254		184	168, 167
thiopental	242		172	157, 173, 97, 69

Instrument: a Shimadzu QP-1000EX GC/MS instrument; column: DB-1 (15 m × 0.25 mm i.d., film thickness 0.25 µm); column temperature: 60° C (3 min) → 8° C/min → 290° C; injection temperature: 250° C; carrier gas (flow rate): He (1 mL/min); electron energy: 70 eV (EI), 200 eV (CI); reagent gas: isobutane.

## Assessment and some comments on the method

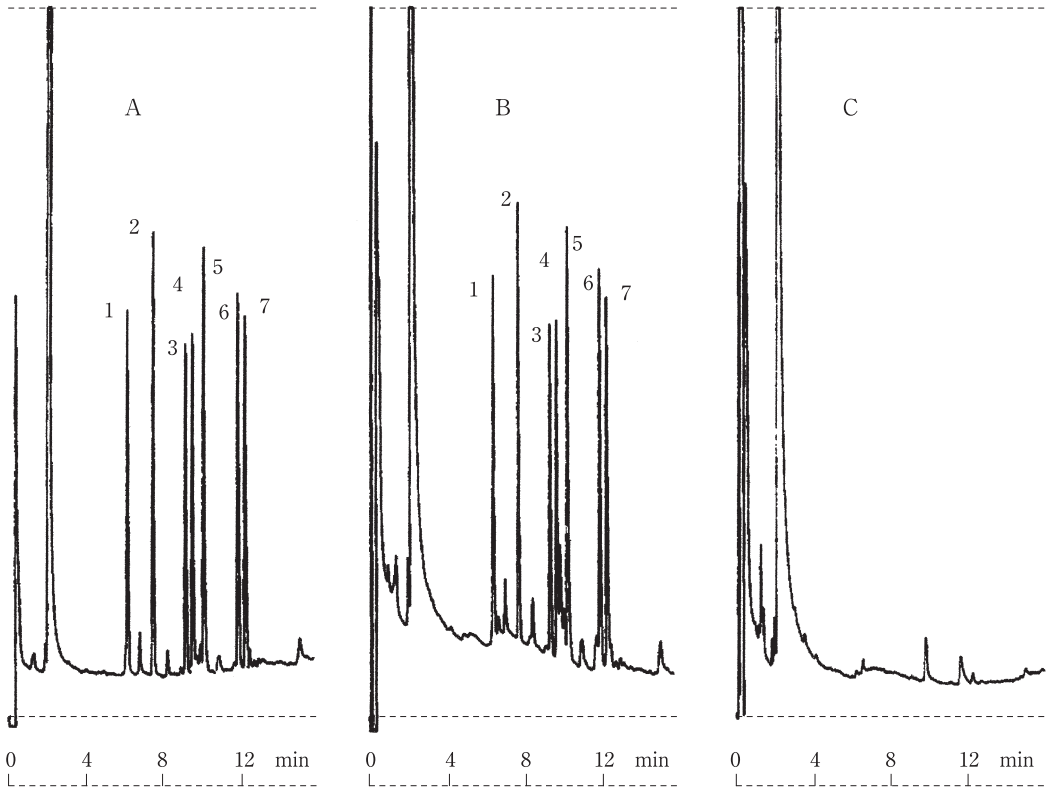
The GC analysis of barbiturates without any derivatization gives very low sensitivities, even if a non-polar fused silica wide-bore capillary column (DB-1) is used, except for metharbital and hexobarbital. The sensitivities of most barbiturates are enhanced several-fold to several ten-fold by the methyl-derivatization (▶ Figs. 6.4 and 6.5, and ▶ Table 6.3). The on-column methylation is very rapid and simple. The detection limits of the methyl-derivatives of barbiturates were 60–90 pg on-column with an NPD and 14–19 ng on-column with an FID. Methylmephobarbital is identical with methylphenobarbital; this means that discrimination

■ Figure 6.4



Gas chromatograms of free forms (A) and methyl-derivatives (B) of barbiturates using an NPD. Amounts of barbiturates used for the free and derivatized forms were 2 and 1 ng on-column, respectively. 1: metharbital; 2: allobarbital; 3: amobarbital; 4: pentobarbital; 5: secobarbital; 6: hexobarbital; 7: phenobarbital.

■ **Figure 6.5**



Gas chromatograms for methyl derivatives of barbiturates spiked into distilled water (A) and human serum (B), and for blank human serum (C) using an NPD. The amount of each barbiturate spiked into distilled water or 0.2 mL plasma was 0.5  $\mu\text{g}$ . The peak numbers are the same as specified in [▶ Figure 6.4](#).

between mephobarbital and phenobarbital becomes impossible after methylation of these compounds. It should be cautioned that the peak of thiopental overlaps that of methylcyclo-barbital.

## HPLC analysis [10]

### Reagents and their preparation

- Each barbiturate is dissolved in methanol to prepare 10  $\mu\text{g}/\text{mL}$  standard solution and stored at  $-20\text{ }^\circ\text{C}$ .
- As internal standard (IS) solution, 5-(4-methylphenyl)-5-phenylhydantoin (Sigma) is dissolved in methanol to prepare 10  $\mu\text{g}/\text{mL}$  solution.

■ **Table 6.3**

**Retention times and detection limits for main barbiturates and their methyl derivatives measured by GC-NPD**

Compound	Retention time (min)	Detection limit (pg/on-column)
metharbital	6.86	139
methylmetharbital	6.30	52
allobarbital	9.13	667
methylallobarbital	7.61	46
amobarbital	10.7	667
methylamobarbital	9.27	61
pentobarbital	11.0	667
methylpentobarbital	9.61	60
secobarbital	11.6	435
methylsecobarbital	10.2	48
hexobarbital	12.3	169
methylhexobarbital	11.9	52
mephobarbital	12.8	306
methylmephobarbital	12.2	57
phenobarbital	13.5	1,670
methylphenobarbital	12.2	57
cyclobarbital	13.7	1,360
methylcyclobarbital	12.4	89
thiopental	12.4	80

- Calibration curves: 10, 25, 50, 100, 500 and 1,000  $\mu\text{L}$  of the standard solution of each barbiturate were separately placed in glass centrifuge tubes together with 50  $\mu\text{L}$  of IS solution, and evaporated to dryness under a stream of nitrogen, followed by addition of 0.5 mL serum each.

## HPLC conditions

Column: a reversed phase column<sup>b</sup> (ODS-80 Ts, 10 cm  $\times$  4.6 mm i.d., particle diameter 2  $\mu\text{m}$ , Toso, Tokyo, Japan).

Mobile phase: 8 mM phosphoric acid solution/acetonitrile (3:7, v/v).

Detection wavelength: 215 nm; flow rate: 0.4 mL/min; temperature: room temperature.

## Procedure

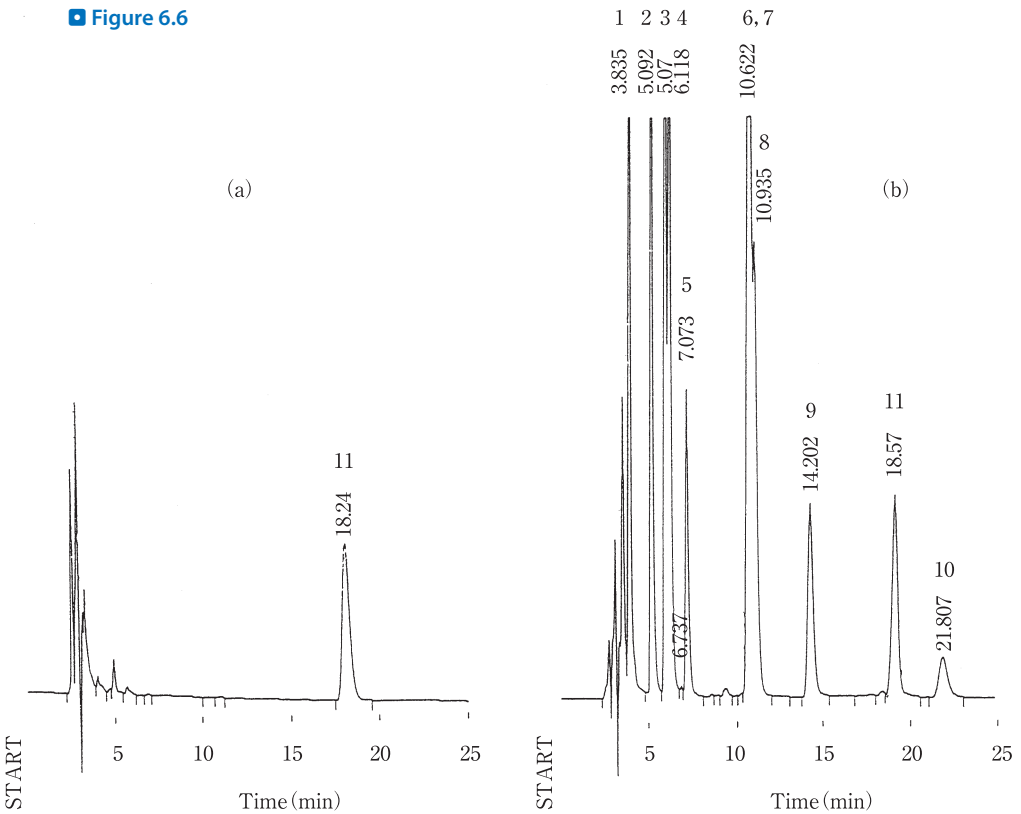
- A 0.5-mL volume of blood (urine)<sup>i</sup>, 50  $\mu\text{L}$  IS solution, 0.5 mL distilled water, 0.1 mL of 0.2 acetic acid/sodium acetate buffer solution (pH 6.0) and 3 mL of ethyl acetate/diethyl ether (1:1, v/v) are placed in a 10-mL volume glass centrifuge tube with a ground-in stopper.

- ii. The tube is well vortex-mixed or shaken for 2 min.
- iii. It is centrifuged at 800 g for 5 min, and the organic layer is transferred to a glass vial with a conical bottom.
- iv. The organic extract is evaporated to dryness under a stream of nitrogen with warming at 40 °C. The residue is dissolved in 100  $\mu\text{L}$  of the mobile phase.
- v. A 10- $\mu\text{L}$  aliquot of the above solution is injected into HPLC. The peak area ratio obtained from a test specimen is applied to the calibration curve<sup>j</sup> to calculate its concentration, which had been constructed with the spiked serum according to the above procedure.

## Assessment and some comments on the method

In this method, the authors used an HPLC column with a particle diameter of 2  $\mu\text{m}$  in place of 5  $\mu\text{m}$ ; the smaller diameter gives various advantages, such as higher sensitivity, rapid analysis and a smaller amount of the flow of mobile phase. The detection limit for most barbiturates

Figure 6.6



HPLC chromatograms for blood extracts in the presence (b) and absence (a) of barbiturates. The concentration of each barbiturate spiked into blood was 0.1  $\mu\text{g}/\text{mL}$ . 1: barbital; 2: allobarbital; 3: metharbital; 4: phenobarbital; 5: cyclobarbital; 6: pentobarbital; 7: hexobarbital; 8: amobarbital; 9: secobarbital; 10: thiopental; 11: IS [5-(4-methylphenyl)-5-phenylhydantoin].

■ **Table 6.4**

**Retention times and detection limits for main barbiturates measured by HPLC**

Compound	Retention time (min)	Detection limit (µg/mL)
barbital	3.8	0.05
allobarbital	5.1	0.05
metharbital	5.9	0.05
phenobarbital	6.1	0.05
cyclobarbital	7.1	0.05
pentobarbital	10.6	0.05
hexobarbital	10.6	0.05
amobarbital	10.9	0.05
secobarbital	14.2	0.05
thiopental	21.8	0.5

was about 0.05 µg/mL except for thiopental (0.5 µg/mL) (▶ [Table 6.4](#)). The peak of pentobarbital overlaps that of hexobarbital; the peak of amobarbital appears very close to these peaks (▶ [Figure 6.6](#)).

## Toxic and fatal concentrations

Therapeutic, toxic and fatal blood concentrations of some barbiturates are shown in ▶ [Table 6.5](#) [18, 19]. Every concentration shows a wide variation according to individuals. By single administration, the dose (route), peak blood concentration and its time are: phenobarbital 50 mg (oral), 1.9 µg/mL after 3 h [6]; amobarbital 120 mg (oral), 1.8 µg/mL after 2 h [20]; pentobarbital 100 mg (oral), 1.2–3.1 µg/mL after 0.5–2 h [21]; thiopental 400 mg (intravenous), 28 µg/mL after 2 min, 7 µg/mL after 15 min, and 3 µg/mL after 90 min [22]. The minimum fatal doses are: amobarbital, about 1.5 g; pentobarbital, about 1 g; phenobarbital, about 1.5 g; and thiopental, about 1 g [19].

■ **Table 6.5**

**Blood concentrations of main barbiturates (µg/mL)**

Compound	Therapeutic conc.	Toxic conc.	Fatal conc.	Reference
amobarbital	1–5	10–30	13–96	[18]
	2–12	>9	9–72	[19]
pentobarbital	1–3	>5	10–169	[18]
	1–10	>8	8–73	[19]
phenobarbital	10–40	40–60	>80	[18]
	2–30	4–90	4–120	[19]
thiopental	1–42	>7	10–400	[18]
	4.2–134		6–392	[19]



## Survived and fatal poisoning cases

---

### Survived phenobarbital poisoning case [23]

A 26-year-old male ingested 2–3 g of phenobarbital plus phenytoin. Upon arrival at a hospital, blood phenobarbital concentration was as high as 107 µg/mL. As emergency treatments, 30 g of activated charcoal and 30 g of sodium sulfate were administered orally. The concentration of blood phenobarbital decreased to 72 µg/mL after 24 h; he thereafter recovered without any complication.

### Fatal thiopental poisoning cases

**Case 1** [24]: a 21-year-old female received intravenous administration of 17 mL of Thiobal (thiopental sodium solution) for artificial abortion at a women's clinic, and fell into a shock state 20 min after. Although various emergency treatments were made, she died 2 h after. The blood concentration of thiopental of this victim was 8.2 µg/mL.

**Case 2** [25]: a 26-year-old male (son) and a 54-year-old female (mother). At their wit's end due to domestic violence by the son, his father intended to commit triple-suicide. He injected about 12 mL (about 1.75 g thiopental) and about 15 mL (about 1.5 g thiopental) of thiopental solution into his son and wife intravenously, respectively; both of them were killed. He introduced car exhaust into his car room and also tried to inject the same solution intravenously by himself to commit suicide, but his trials were abortive. The blood thiopental concentrations of his son and wife were 6.9 and 4.4 µg/mL, respectively.

**Case 3** [25]: a 25-year-old female was found dead in her room; she had committed suicide by injecting an alate needle into a vein of the right dorsum pedis for drop infusion of thiopental (its amount infused not clear). The concentration of thiopental in her heart blood was 6.3 µg/mL; the amount administered was estimated to be about 1.5 g.

### Fatal pentobarbital poisoning case [26]

A 3.2-year-old male. A doctor directed a nurse to inject 50 mg pentobarbital into the child intramuscularly; but the nurse misunderstood the direction. She began intravenous injection of 50 mL pentobarbital solution to the child. After injection of the 15 mL solution, he fell into a shock state. In spite of efforts with various emergency treatments, he died 22 h later. The pentobarbital concentration in his blood was 17.5 µg/mL (total amount injected estimated about 500 mg).

### Fatal poisoning cases due to a combined drug or multiple drugs including a barbiturate

**Case 1** [27]: a 40–45 year-old (estimated) female was found dead on a bed of a hotel. In her room, 2 tablets of Vegetamin (a combined drug containing, phenobarbital, promethazine and

chlorpromazine) and one capsule of Insumin (flurazepam) were found. From the stomach contents, phenobarbital, promethazine and chlorpromazine were detected. Drug concentrations in blood, the liver and kidney were: phenobarbital, 98.0, 106 and 105  $\mu\text{g/g}$ ; promethazine, 5.05, 38.2 and 6.92  $\mu\text{g/g}$ ; chlorpromazine, 1.68, 22.1 and 3.03  $\mu\text{g/g}$ , respectively.

**Case 2** [28]: A 30-year-old female was found dead by a passer-by at an open-air parking lot close to her home almost in the nude with her clothes being scattered around her body. In the previous night, the victim had drunk and eaten with her friends and left them. Twenty four empty packages of Isomytal (amobarbital) were discovered at her home. From her blood, amobarbital at 10.6  $\mu\text{g/mL}$ , phenobarbital at 28.6  $\mu\text{g/mL}$ , promethazine at 2.8  $\mu\text{g/mL}$  and chlorpromazine at 0.9  $\mu\text{g/mL}$  were detected.

**Case 3** [29]: A 44-year-old male was found dead by his wife in his bedroom with smoke from the right side of his mattress. She called an ambulance, but he had been dead. COHb concentration in his blood was 1 %; burning wounds found in his whole body were negative for vital reaction. From his stomach contents, amobarbital, bromisovalum and levomepromazine were detected. The drug concentrations in blood, the liver, brain and urine were: amobarbital, 25, 47, 30 and 7  $\mu\text{g/mL}$  (g); bromisovalum, 37, 70, 57 and 6  $\mu\text{g/mL}$  (g); levomepromazine, 1.5, 19, 2.0 and not detectable  $\mu\text{g/mL}$  (g), respectively.

## Notes

- a) By the on-column methylation with TMAH, many compounds are methyl-derivatized immediately (▶ *Figure 6.3*). Except for barbiturate drugs, this method is applicable to glutethimide, primidone and oxazolo-benzodiazepines. For thiopental, the derivatization reaction causes some decomposition products together with the methylated product; the analysis of the underivatized form of thiopental gives better results. The 4 mM and 0.4 mM concentrations of TMAH are used for the FID and NPD, respectively.
- b) It should be cautioned that thiopental is desulfurized and decomposed by a peroxide included in diethyl ether.
- c) Similar types of columns from other manufacturers, such as SPB-1, Ultra#1, CBP-1 and CP-Sil5, can be used.
- d) When the injection temperature is not high enough (not higher than 200 °C), the efficiency of the on-column methylation is low.
- e) Blood plasma and whole blood can be also used.
- f) As extraction solvents, diethyl ether, ethyl acetate, chloroform and dichloromethane can be used; however, the present ethyl acetate/diethyl ether (1:1, v/v) gave the cleanest backgrounds with few impurity peaks for human specimens. For metharbital, diethyl ether, ethyl acetate and dichloromethane give low extraction efficiencies (46–63 %).
- g) Each calibration curve showed good linearity in the range of 0.2–10 ng on-column (0.2–10  $\mu\text{g/mL}$ ). The detection limits of this method were 60–90  $\mu\text{g/mL}$  in serum. The recovery rates of 0.1–5.0  $\mu\text{g}$  of barbiturates spiked into 0.2 mL serum were 83–111 %. Mass spectra, retention times, detection limits and each GC chromatograms for underivatized and methylated barbiturates are shown in ▶ *Tables 6.2 and 6.3*, and ▶ *Figure 6.5*.
- h) Similar types of ODS (octadecylsilane type silica gel) columns from other manufacturers, such as Zorbax ODS and Hypersil, can be also used. However, the retention times may be longer, because of 5  $\mu\text{m}$  of particle diameter.

- i) For organ specimens, a 1-g aliquot of a tissue is minced and homogenized with 4 mL distilled water, followed by centrifugation at 12,000 g for 10 min. A 1-mL volume of the supernatant fraction is processed like the blood (urine).
- j) Linear relationship was observed in the range of 0.1–5 µg/mL for most barbiturates. The recovery rates from blood were 95–104 %. In this method using urine as a test specimen, interfering impurity peaks derived from urine appear until 10 min of retention time. The retention times, detection limits, and HPLC chromatograms for barbiturates are shown in [▶ Table 6.4](#) and [▶ Figure 6.6](#).

## References


- 1) National Research Institute of Police Science (ed) (1994–2001) Annual Case Reports of Drug and Toxic Poisoning in Japan, Nos. 37–49. National Research Institute of Police Science, Chiba (in Japanese)
- 2) Terada M, Yamamoto T, Kuroiwa Y et al. (1992) Gel permeation chromatographic clean-up prior to determination of barbiturates in blood extract by gas chromatography. *Jpn J Forensic Toxicol* 10:31–37
- 3) Terada M, Shinozuka T, Yasuda M et al. (1992) Simultaneous determination of acidic and neutral drugs by wide bore column gas chromatography with nitrogen-phosphorus detection. In: Nagata T (ed) TIAFT, Proceedings of the 30th International Meeting. Fukuoka, pp 479–482
- 4) Hattori H, Hoshino N, Seno H et al. (1992) Capillary gas chromatography of underivatized barbiturates in human blood with a nitrogen-phosphorus detector and with splitless injection. *Jpn J Forensic Toxicol* 10:16–22
- 5) Coudore F, Alazard JM, Paire M et al. (1993) Rapid toxicological screening of barbiturates in plasma by wide-bore capillary gas chromatography and nitrogen-phosphorus detection. *J Anal Toxicol* 17:109–113
- 6) Terada M, Shinozuka T, Bai H et al. (1995) Simultaneous determination of barbiturate drugs in human serum by wide-bore capillary gas chromatography with nitrogen-phosphorus detection. *Jpn J Forensic Toxicol* 13:223–231
- 7) Meatherall R (1997) GC/MS confirmation of barbiturates in blood and urine. *J Forensic Sci* 42:1160–1170
- 8) Hall BJ, Brodbelt JS (1997) Determination of barbiturates by solid-phase microextraction (SPME) and ion trap gas chromatography-mass spectrometry. *J Chromatogr A* 777:275–282
- 9) Kudo K, Nagata T, Kimura K et al. (1988) Toxicological analysis of thiamylal in biological materials by gas chromatography/mass spectrometry. *Forensic Sci Int* 37:193–200
- 10) Tanaka E, Terada M, Tanno K et al. (1997) Forensic analysis of 10 barbiturates in human biological samples using a new reversed-phase chromatographic column packed with 2-micrometre porous microspherical silica-gel. *Forensic Sci Int* 85:73–82
- 11) Hart AP, Mazarr Proo S, Blackwell W et al. (1997) A rapid cost-effective high-performance liquid chromatographic (HPLC) assay of serum lamotrigine after liquid-liquid extraction and using HPLC conditions routinely used for analysis of barbiturates. *Ther Drug Monit* 19:431–435
- 12) Biosca YM, Sagrado S, Camanas RMV et al. (1999) Determination of barbiturates in urine by micellar liquid chromatography and direct injection of sample. *J Pharm Biomed Anal* 21:331–338
- 13) Borregon PFG, Lores M, Cela R (2000) Analysis of barbiturates by micro-high-performance liquid chromatography with post-column photo-chemical derivatization. *J Chromatogr A* 870:39–44
- 14) Spell JC, Srinivasan K, Stewart JT et al. (1998) Supercritical fluid extraction and negative ion electrospray liquid chromatography tandem mass spectrometry analysis of phenobarbital, butalbital, pentobarbital and thio-pental in human serum. *Rapid Commun Mass Spectrom* 12:890–894
- 15) Ferslew KE, Hagardorn AN, McCormick WF (1995) Application of micellar electrokinetic capillary chromatography to forensic analysis of barbiturates in biological fluids. *J Forensic Sci* 40:245–249
- 16) Schwenzer KS, Pearlman R, Tsilimidos M et al. (2000) New fluorescence polarization immunoassays for analysis of barbiturates and benzodiazepines in serum and urine: performance characteristics. *J Anal Toxicol* 24:726–732
- 17) Charlier CJ, Plomteux GJ (2000) Evaluation of Emit Tox benzodiazepine and barbiturate assays on the Vitalab Viva analyser and FPIA on the Abbott ADx analyser. *Clin Chem Lab Med* 38:615–618
- 18) Winek CL (1994) Drug & chemical blood-level data
- 19) Moffat AC, Jackson JV, Moss MS et al. (eds) (1986) *Clarke's Isolation and Identification of Drugs*. The Pharmaceutical Press, London

- 20) Inaba T, Tang BK, Endrenyi L et al. (1976) Amobarbital a probe of hepatic drug oxidation in man. *Clin Pharm Ther* 20:439–444
- 21) Sun S, Chum AHC (1977) Determination of pentobarbital in serum by electron-capture GLC. *J Pharm Sci* 66:477–480
- 22) Brodie BB, Mark LC, Papper EM et al. (1950) The fate of thiopental in man and a method for its estimation in biological materials. *J Pharm Exp Ther* 98:85–96
- 23) Goldberg MJ, Berlinger WG (1982) Treatment of phenobarbital overdose with activated charcoal. *JAMA* 247:2400–2401
- 24) Furuno J, Sugawara N (1972) On a fatal case of thiopental shock and the metabolism. *Jpn J Legal Med* 26:71–77 (in Japanese with an English abstract)
- 25) Tadano Y, Yamakawa M, Miura K et al. (1989) Cases of homicide and suicide using thiopental sodium. *Res Pract Forensic Med* 32:117–121 (in Japanese with an English abstract)
- 26) Fukumoto H, Fukumoto K (1970) A case of fatal pentobarbital poisoning – Estimation of pentobarbital dosage from the blood concentration –. *Jpn J Legal Med* 24:68–72 (in Japanese with an English abstract)
- 27) Kageura M, Hara K, Hieda Y et al. (1987) Forensic toxicological study on a combined drug (phenobarbital, promethazine and chlorpromazine). *Res Pract Forensic Med* 30:83–87 (in Japanese with an English abstract)
- 28) Terada M, Yasuda M, Wakasugi C (1993) A case report on the detection of antipsychotic drugs. *Jpn J Legal Med* 47:285–286 (in Japanese)
- 29) Terada M, Yoshimura S, Yamamoto T et al. (1981) A case report on the detection of amobarbital, bromvalerylurea and levomepromazine from the postmortally burnt body. *Jpn J Legal Med* 35:456–461 (in Japanese with an English abstract)

## II.4.1 Diphenylmethane antihistaminics

by Yoko Hieda and Kojiro Kimura

### Introduction

Diphenylmethane antihistaminics are being widely used for treatments of allergy, motion (travel) sickness and cold. They are also being sold as over-the-counter drugs. The structures of principal drugs of this group are shown in  *Figure 1.1*. They are being analyzed by GC [1–6] and HPLC [7–13]. In this chapter, a GC method for simultaneous analysis of diphenylmethane antihistaminics and also HPLC methods for some representative drugs of this group are presented.

### Simultaneous analysis by GC [4]

---

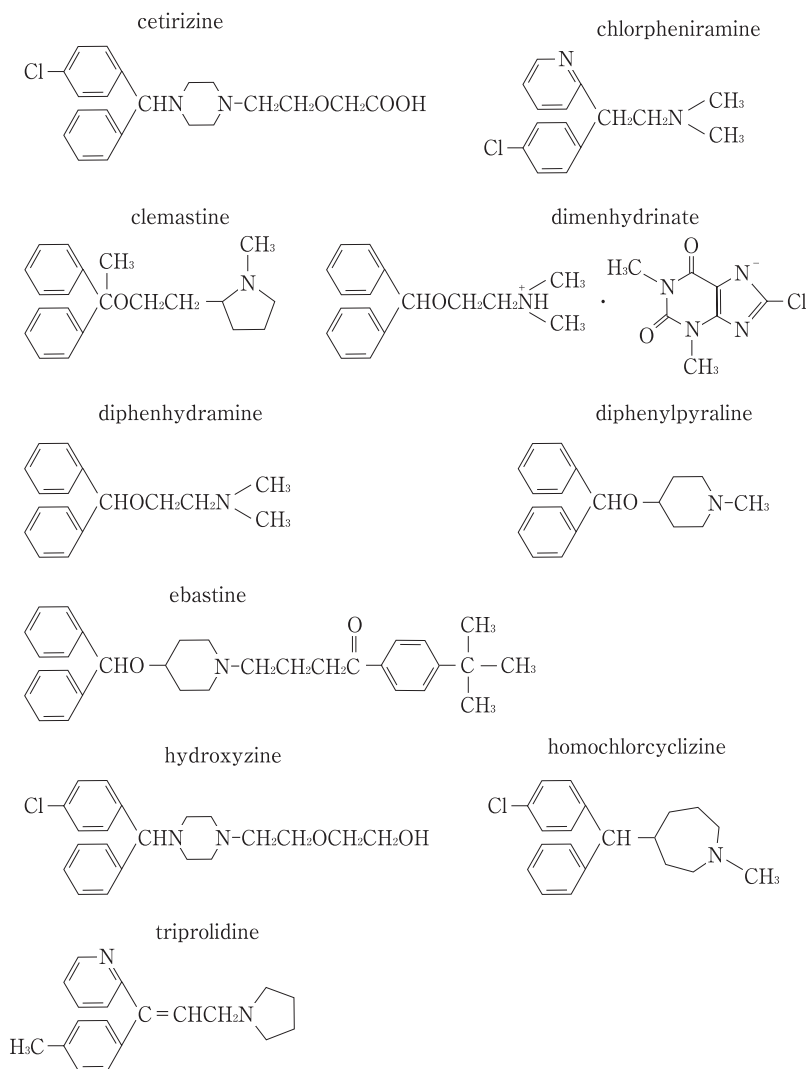
#### Reagents and their preparation

- Diphenhydramine hydrochloride, diphenylpyraline hydrochloride, phenyltoloxamine citrate, orphenadrine hydrochloride, benactyzine hydrochloride, doxylamine succinate, carbinoxamine maleate, chlorpheniramine maleate, triprolidine hydrochloride, homochlorcyclizine dihydrochloride, hydroxyzine dihydrochloride, clemastine fumarate and meclizine dihydrochloride can be purchased from Sigma (St. Louis, MO, USA). Pure powder of terodiline hydrochloride and piperilate hydrochloride was donated by Kissei Pharmaceutical Co., Ltd., Nagano, Japan and Nippon Shinyaku Co., Ltd., Kyoto, Japan, respectively. Sep-Pak C<sub>18</sub> cartridges (classic type) were purchased from Waters (Milford, MA, USA). Other common chemicals were of the highest purity commercially available.
- Care should be taken for that all of the above 15 kinds of drugs are in the salt forms. All compounds (5-mg each as the weight of its free base) are altogether dissolved in methanol to prepare 10 mL solution; a 10- $\mu$ L volume of the mixture solution is spiked into 1 mL of whole blood or urine. One of the 15 drugs is selected for use as internal standard (IS).
- Chloroform/methanol (9:1) and distilled water, 100–200 mL each, are prepared.
- 0.5 M NaHCO<sub>3</sub> solution: a 4.2-g aliquot of NaHCO<sub>3</sub> is dissolved in distilled water to prepare 100 mL solution.

#### GC conditions

GC column<sup>a</sup>: DB-1 (15 m  $\times$  0.32 mm i. d., film thickness 1.0  $\mu$ m), DB-17 (15 m  $\times$  0.32 mm i. d., film thickness 0.25  $\mu$ m) both obtained from J & W Scientific (Folsom, CA, USA).

■ **Figure 1.1**



**Structures of principal diphenylmethane antihistaminics.**

GC conditions: an HP 5890 Series II gas chromatograph<sup>b</sup> (Agilent Technologies, Palo Alto, CA, USA); detector: FID; column temperatures: 160 °C (1 min) → 5 °C/min → 290 °C for the DB-1 column, and 160 °C (1 min) → 5 °C/min → 280 °C for the DB-17 column; injection temperature: 240 °C; detection temperature: 280 °C; carrier gas: He; its flow rate: 3 mL/min; a 1- $\mu$ L aliquot of sample solution is injected into GC in the splitless mode (1 min), followed by the split mode at 160 °C of oven temperature.

## Procedure

- i. A 10-mL volume of methanol and 10 mL distilled water are passed through a Sep-Pak C<sub>18</sub> cartridge<sup>c</sup> for its activation.
- ii. A 10- $\mu$ L aliquot of methanolic solution of a suitable IS<sup>d</sup> (in case of simultaneous analysis of spiked drugs, 5  $\mu$ g each in the 10  $\mu$ L solution) is added to 1 mL whole blood, and mixed well with 9 mL distilled water for complete hemolysis. To this mixture, 5 mL of 0.5 M NaHCO<sub>3</sub> solution is added to make it slightly alkaline. To 1-mL volume of a urine specimen, a 10- $\mu$ L aliquot of the IS solution, 4 mL distilled water and 5 mL of 0.5 M NaHCO<sub>3</sub> solution are added.
- iii. Either mixture of whole blood or urine specimen is poured<sup>e</sup> into the activated cartridge with a flow rate not faster than 5 mL/min using a 10-mL volume glass syringe.
- iv. The cartridge is washed with 10 mL distilled water, and the target compounds are slowly eluted with 3 mL of chloroform/methanol (9:1) into 4-mL volume glass vial.
- v. A small amount of the upper aqueous phase of the eluate is carefully removed with a Pasteur pipette; the lower organic phase is evaporated to dryness under a stream of nitrogen. The residue is dissolved in 100  $\mu$ L methanol, and a 1- $\mu$ L aliquot of it is injected into GC. For quantitation, the peak area ratio of a target compound to IS is obtained.
- vi. For quantitative analysis, a 10- $\mu$ L of IS solution and one of various concentrations of a target compound are added to 1 mL of blank whole blood or urine obtained from healthy subjects; at least 4 vials containing different concentrations of the compound should be prepared. These vials are processed according to the above procedure and analyzed by GC. The calibration curve consists of peak area ratio of a target compound to IS on the vertical axis and the concentration of a target compound on the horizontal axis. The peak area ratio obtained at the step v is applied to the calibration curve to obtain the concentration.

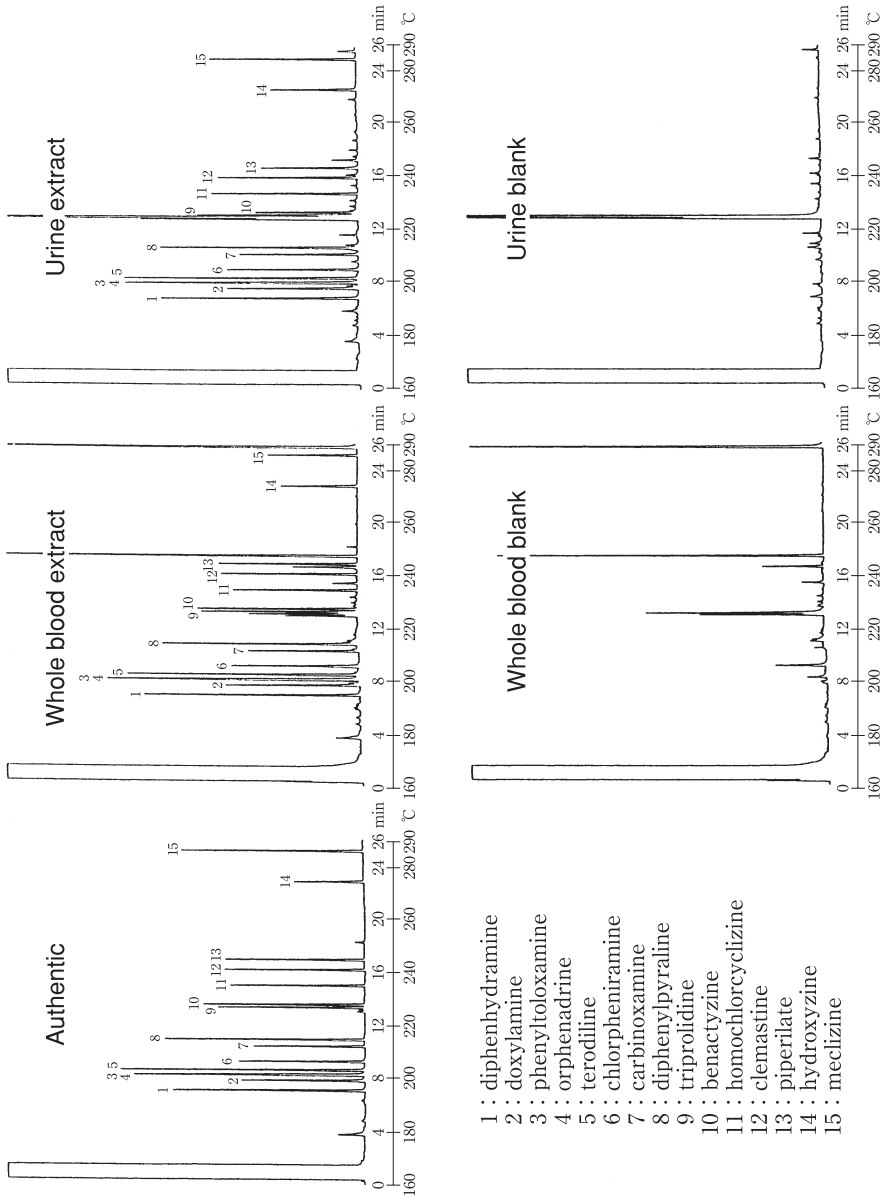
## Assessment and some comments on the method

► *Figure 1.2* shows gas chromatograms for the authentic diphenylmethane antihistaminics and for extracts of whole blood and urine in the presence and absence of 5  $\mu$ g each of drugs per 1 mL obtained by the present method using a DB-1 capillary column. Many compounds appeared as sharp peaks. With an intermediately polar DB-17 capillary column, sharp peaks also appeared. By using both DB-1 and DB-17 columns, most compounds can be separated with sharp peaks; however phenyltoloxamine and orphenadrine (peaks 3 and 4) could not be separated with either column. With the DB-1 column, the peak of triprolidine (peak 9) overlapped an impurity peak of whole blood and urine extracts, and the peak of chlorpheniramine (peak 6) overlapped a small impurity peak of the whole blood extract. These problems could be overcome by using the DB-17 column.

The recoveries of the drugs from human whole blood were not lower than 90 % except for meclizine; the latter shows 49.4 % recovery. The recoveries of the drugs from urine were also not lower than 90 % except benactyzine, piperilate and meclizine; those of the latter drugs were 64.6, 72.2 and 79.8 %, respectively.

The detection limits for diphenylmethane antihistaminics using the capillary GC method are 0.2–0.5  $\mu$ g/mL. To enhance sensitivity and specificity, GC/MS can be used; however, for most compounds, molecular or quasi-molecular peaks are missing in the positive EI mode [4]

Figure 1.2



Capillary gas chromatograms for diphenylmethane antihistaminics extracted from whole blood and urine [4].



except for terolidine and triprolidine. For the latter compounds, relatively intense molecular ions appear to be used for sensitive detection. In the positive and negative CI modes, intense quasi-molecular ions appear for most drugs, which can be used for sensitive quantitation.

## HPLC analysis of diphenhydramine in blood and urine [7]

Diphenhydramine is one of the most popular drugs in this group, and its poisoning cases are many. In this section, one of the most common method by HPLC for diphenhydramine is described.

### Reagents and their preparation

- Diphenhydramine hydrochloride and imipramine hydrochloride can be obtained from Sigma.
- IS: imipramine hydrochloride is dissolved in distilled water to prepare 0.5 µg/mL solution.
- Extraction solutions: hexane/isopropanol (98:2, v/v), saturated potassium carbonate aqueous solution and 0.5 % (v/v) phosphoric acid solution.

### HPLC conditions

An HPLC system includes a usual conveying pump, an injector and a UV detector. Column: reversed phase ODS-1 Spherisorb (15 cm × 0.46 cm i. d., particle diameter 5 µm); mobile phase: acetonitrile/distilled water/1 M sodium dihydrogenphosphate solution (11:7:2, v/v); its flow rate: 1.8 mL/min; detection wavelength: 205 nm.

### Procedure

- To 1 mL of serum or urine, 100 µL of IS solution and 200 µL of saturated potassium carbonate solution are added and extracted with hexane/isopropanol (98:2, v/v) by shaking.
- To the organic phase, 100 µL of phosphoric acid solution for back-extraction of the compounds. An aliquot of the aqueous phase is injected into HPLC.

### Assessment of the method

The retention times of diphenhydramine and IS were 4.6 and 6.4 min, respectively. Linearity could be obtained in the range of 1–100 ng/mL; the detection limit was reported to be 1 ng/mL.

## HPLC analysis of chlorpheniramine and its metabolites in blood and urine [8]

---

Chlorpheniramine is one of the most popular antihistaminics, and has been being used for over 50 years. In this section, HPLC analysis of chlorpheniramine and its metabolites didemethylchlorpheniramine and demethylchlorpheniramine is described.

### Reagents and their preparation

- Chlorpheniramine maleate and brompheniramine maleate are obtainable from Sigma.
- IS: brompheniramine maleate is dissolved in distilled water to prepare 1 µg/mL solution.
- Solutions to be used for extraction: 5 % KOH and 0.5 % phosphoric acid solutions.

### HPLC conditions

An HPLC system to be used includes a usual conveying pump, an injector and a UV detector. Column: a reversed phase C<sub>18</sub> column (30 cm × 0.39 cm i. d., particle diameter 5 µm); mobile phase: acetonitrile/75 mM phosphate buffer solution (pH 2.5) (25:75, v/v); its flow rate: 2 mL/min; detection wavelength: 254 nm.

### Procedure

- To 1 mL of serum or urine, 100 µL of IS solution and 250 µL of 5 % KOH solution were added and extracted with 5 mL ethyl ether.
- The target compounds are back-extracted from the organic phase by adding 0.5 mL of 0.5 % phosphoric acid solution. A 250-µL aliquot of 5 % KOH solution is added to the aqueous phase and again extracted with 5 mL ethyl ether. The organic layer is evaporated to dryness.
- The residue is dissolved in 100 µL of the mobile phase, and an aliquot of it is injected into HPLC.

### Assessment of the method

The retention times of didemethylchlorpheniramine, demethylchlorpheniramine, chlorpheniramine and IS under the conditions were 2.7, 3.2, 4.3 and 5.0 min. Good linearity was found in the range of 0–30 ng/mL; the detection limit was reported to be 1 ng/mL.

## HPLC analysis of hydroxyzine in blood [9]

---

Hydroxyzine has a similar structure to those of diphenylmethane antihistaminics, but is being widely used as an anxiolytic drug.

## Reagents and preparation

- Hydroxyzine dihydrochloride and triprolidine hydrochloride can be obtained from Sigma.
- IS: triprolidine is dissolved in distilled water to prepare 1 µg/mL solution.
- Solutions to be used for extraction: 10 % KOH and 1 % phosphoric acid aqueous solutions.

## HPLC conditions

An HPLC system includes a usual conveying pump, an injector and a UV detector. Column: a reversed phase CN radial compression column (Waters, particle diameter 4 µm); mobile phase: acetonitrile/75 mM phosphate buffer solution (pH 3.0, containing 20 mM dibutylamine<sup>f</sup> and 50 ng/mL triprolidine) (27:73, v/v); its flow rate: 1 mL/min; detection wavelength: 229 nm.

## Procedure

- To 1 mL serum, 100 µL of IS solution and 0.25 mL of 10 % KOH solution are added and extracted with 5 mL of diethyl ether.
- The target compound and IS are back-extracted from the organic phase into an aqueous phase by adding 100 µL of 1 % phosphoric acid solution; an aliquot of the aqueous phase is injected into HPLC.

## Assessment of the method

Under the conditions, the peaks of IS and hydroxyzine appeared at 3.6 and 6.9 min, respectively. Good linearity was observed in the range of 0–100 ng/mL; the detection limit was reported to be 3 ng/mL. In this method, triprolidine is used as IS; therefore, triprolidine can be measured by this method using hydroxyzine as IS conversely.

## Poisoning cases, and toxic and fatal concentrations

The drugs reported to have caused deaths are diphenhydramine, dimenhydrinate and hydroxyzine. The estimated fatal doses of diphenhydramine are 20–40 mg/kg; toxic symptoms usual appear after ingesting 3–5 times the therapeutic dose [14]. Plasma diphenhydramine concentrations are: therapeutic, 0.1–1 µg/mL; toxic, not lower than 1 µg/mL [15]; fatal, not lower than 5 µg/mL [15–17].

Dimenhydrinate is a multi-component drug consisting of diphenhydramine (53–55 %) and 8-chlorotheophylline (44–47 %), and also sometimes very toxic at high doses. There are fatal cases in which 20–40 mg/kg of dimenhydrinate is ingested by adults and not more than 500 mg ingested by infants. In a fatal case of a victim, who had ingested 5 g dimenhydrinate, the concentration of diphenhydramine in urine was 10.8 µg/mL. It was reported that toxic

symptoms appeared for subjects whose urinary concentrations of diphenhydramine were not lower than 100 ng/mL [18]. Another fatal case with dimenhydrinate showing 4.8 ng/mL of blood diphenhydramine was reported [19].

For hydroxyzine, fatal cases were reported with its blood concentrations at 1.1 [20] and 39  $\mu\text{g/mL}$  [21]; a poisoned but survived case was reported with its blood concentration as high as 103  $\mu\text{g/mL}$  [22]. Usually, blood hydroxyzine concentrations not lower than 0.1  $\mu\text{g/mL}$  cause poisoning symptoms [23, 24].

Orphenadrine (Disipal<sup>®</sup>) is being used as an antiparkinsonian drug and shows a weak antihistaminic action; since its structure is very similar to that of diphenhydramine, it is frequently used as IS for analysis of diphenylmethane antihistaminics. The fatal orphenadrine poisoning cases are many; its toxic blood concentrations are not lower than 2  $\mu\text{g/mL}$  [25] and fatal ones not lower than 4–8  $\mu\text{g/mL}$  [25, 26].

A fatal case involving chlorpheniramine was reported [27]. However, most of the poisoned patients survived; their blood concentrations of chlorpheniramine were 20–30  $\mu\text{g/mL}$  [28].

## Notes

- a) Any columns made of non-polar 100 % dimethylsilicone and intermediately polar 50 % phenylsilicone/50 % dimethylsilicone stationary phases can be used, regardless of their manufacturers.
- b) Any GC instrument for a capillary column can be used.
- c) The quality of the Sep-Pak C<sub>18</sub> cartridges (classic type) being sold currently seems inferior to that of the same ones, which had been sold about 10 years ago. The previous ones could be reused after passing urine and plasma specimens, but new ones cannot be reused. With use of the Sep-Pak C<sub>18</sub> cartridges, some impurity peaks due to the cartridges themselves may appear and interfere with the GC analysis according to a lot of the cartridges. In such a case, the conventional liquid-liquid extraction can be made in place of the solid-phase extraction. Briefly, after adding IS to a specimen, the solution is made alkaline by adding KOH or NaOH solution, followed by extraction with an organic solvent (diethyl ether or dichloromethane) [1]; the organic phase is back-extracted with acidic solution (phosphoric acid or hydrochloric acid) [5]. The aqueous extract is again made alkaline, followed by extraction with an organic solvent; the latter is condensed and subjected to GC analysis [2]. According to a specimen, the first organic extract can be directly used for GC analysis without the back-extraction. When an organic extract is evaporated to dryness, the residue is dissolved in a small amount of an organic solvent for GC analysis, or dissolved in a small amount of a mobile phase for HPLC analysis.
- d) As IS, one of other diphenylmethane antihistaminic, which shows a retention time close to that of a target drug, is selected; 5  $\mu\text{g}$  of IS is added to 1 mL of whole blood or urine before extraction procedure.
- e) For a whole blood, a total volume of the specimen solution to be poured into the cartridge is 15 mL; 1 mL of a blood specimen is placed in a 50-mL volume beaker, followed by the addition of IS, 9 mL distilled water and 5 mL NaHCO<sub>3</sub> solution and mixed well. Using a 10-mL volume glass syringe, 7.5 mL of the solution is drawn into it and poured into the cartridge slowly; this procedure is repeated to apply all of the solution onto the cartridge.
- f) It is used for preventing hydroxyzine from its adsorption to the HPLC column.

## References

- 1) Yoo SD, Axelson JE (1986) Determination of diphenhydramine in biological fluids by capillary gas chromatography using nitrogen-phosphorus detection. Application to placental transfer studies in pregnant sheep. *J Chromatogr* 378:385–393
- 2) Blyden GT, Greenblatt DJ, Scavone JM et al. (1986) Pharmacokinetics of diphenhydramine and demethylated metabolite following intravenous and oral administration. *J Clin Pharmacol* 26:529–533
- 3) Hattori H, Yamamoto S, Iwata M et al. (1992) Determination of diphenylmethane antihistaminic drugs and their analogues in body fluids by gas chromatography with surface ionization detection. *J Chromatogr* 581:213–218
- 4) Seno H, Hattori H, Kumazawa T et al. (1993) Positive- and negative-ion mass spectrometry of diphenylmethane antihistaminics and their analogues and rapid clean-up of them from biological samples. *Forensic Sci Int* 62:187–208
- 5) Simons K, Singh M, Gillespie CA et al. (1996) An investigation of the H1-receptor antagonist triprolidine: pharmacokinetics and antihistaminic effects. *J Allergy Clin Immunol* 77:326–330
- 6) Nishikawa M, Seno H, Ishii A et al. (1997) Simple analysis of diphenylmethane antihistaminics and their analogues in bodily fluids by headspace solid-phase microextraction-capillary gas chromatography. *J Chromatogr Sci* 35:275–279
- 7) Selinger K, Prevost J, Hill HM (1990) High-performance liquid chromatography method for the determination of diphenhydramine in human plasma. *J Chromatogr* 526:597–602
- 8) Simons KJ, Simons FER, Lucius GH et al. (1984) Urinary excretion of chlorpheniramine and its metabolites in children. *J Pharm Sci* 73:595–599
- 9) Simons FER, Simons KJ, Frith EM (1984) The pharmacokinetics and antihistaminic of the H1 receptor antagonist hydroxyzine. *J Allergy Clin Immunol* 73:69–75
- 10) Simons KJ, Watson WTA, Chen XY et al. (1989) Pharmacokinetic and pharmacodynamic studies on the H1-receptor antagonist hydroxyzine in the elderly. *Clin Pharmacol Ther* 45:9–14
- 11) Matsuda M, Mizuki Y, Terauchi Y (2001) Simultaneous determination of the histamine H1-receptor antagonist ebastine and its metabolites, carebastine and hydroxyebastine, in human plasma using high-performance liquid chromatography. *J Chromatogr B* 757:173–179 and 765:205 (erratum)
- 12) Nishikawa M, Nakai A, Fushida H et al. (1993) Enantioselective pharmacokinetics of homo-chlorcyclizine. III. Simultaneous determination of (+)- and (–)-homochlorcyclizine in human urine by high-performance liquid chromatography. *J Chromatogr* 612:239–244
- 13) Sakurai E, Yamasaki S, Iizuka Y et al. (1992) The optical resolution of racemic chlorpheniramine and its stereoselective pharmacokinetics in rat plasma. *J Pharm Pharmacol* 44:44–47
- 14) Sakamoto T (ed and translation) (1999) *Poisoning Handbook*. Medical Science International Publication, Tokyo, pp 62–64 (in Japanese)
- 15) Fucci N (1996) A case of lethal intoxication after ingestion of toquilon compositum. *Am J Forensic Med Pathol* 17:231–232
- 16) Hausmann E, Wewer H, Wellhöner HH et al. (1983) Lethal intoxication with diphenhydramine. Report of a case with analytical follow-up. *Arch Toxicol* 53:33–39
- 17) Karch SB (1998) Diphenhydramine toxicity: comparisons of postmortem findings in diphenhydramine-, cocaine-, and heroin-related deaths. *Am J Forensic Med Pathol* 19:143–147
- 18) Winn RE, McDonnell KP (1993) Fatality secondary to massive overdoses of dimenhydrinate. *Ann Emerg Med* 22:1481–1484
- 19) Farrell M, Heinrichs M, Tilelli JA (1991) Response of life threatening dimenhydrinate intoxication to sodium bicarbonate administration. *J Toxicol Clin Toxicol* 29:527–535
- 20) Spiehler VR, Fukumoto RI (1984) Another fatal case involving hydroxyzine. *J Anal Toxicol* 8:242–243
- 21) Johnson GR (1984) A fatal case involving hydroxyzine. *J Anal Toxicol* 6:69–70
- 22) Magera BE, Betlach CJ, Sweatt AP et al. (1981) Hydroxyzine intoxication in a 13-month-old child. *Pediatrics* 67:280–283
- 23) Koyama K, Kikuno T, Kagami H et al. (2000) Blood concentrations and symptoms in acute hydroxyzine poisoning cases. *J Nippon Hosp Pharm Assoc* 26:13–16 (in Japanese)
- 24) Uges DRA (1997) Blood level data. In: Brandenberger H, Maes RAA (eds) *Analytical Toxicology for Clinical, Forensic and Pharmaceutical Chemists*. Walter de Gruyter, Berlin, pp 707–718
- 25) VanHarreweghe I, Mertens K, Maes V et al. (1999) Orphenadrine poisoning in a child: clinical and analytical data. *Intens Care Med* 25:1134–1136

- 26) DeMercurio D, Chiarotti M, Giusti GV (1979) Lethal orphenadrine intoxication: report of a case. *Z Rechtsmed* 82:349–353
- 27) Read D (1981) A fatal case involving chlorpheniramine. *J Toxicol Clin Toxicol* 18:941–943
- 28) Winek CL (1977) Injury by chemical agents. In: Tedeschi CG, Eckert WG, Tedeschi LG (eds) *Forensic Medicine*, Vol. III. Saunders, Philadelphia, pp 1568–1587

## II.4.2 Propionic acid derivative analgesic-antipyretics

by Tatsuo Shinozuka and Rika Nakajima

### Introduction

Propionic acid derivative analgesic-antipyretics (▶ Table 2.1) are non-steroidal and anti-inflammatory drugs. As one of mechanisms of their pharmacological actions, inhibition of prostaglandin biosynthesis can be mentioned. Although fatal cases due to propionic acid derivative analgesic-antipyretics are not many in the world, the incidence of poisoning (including survived cases) by this drug group is relatively high among therapeutic drugs in Japan [1].

Analyses of propionic acid derivative analgesic-antipyretics are being made by TLC [2, 3], HPLC [2, 4–8], GC [9], GC/MS [10] and LC/MS [11]. In this chapter, the methods of analysis of this drug group by TLC, HPLC and GC are presented.

### TLC analysis

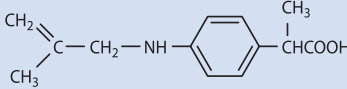
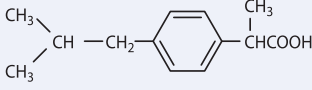
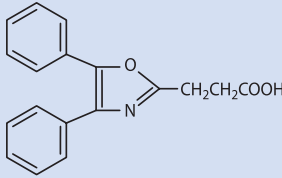
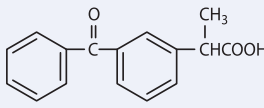
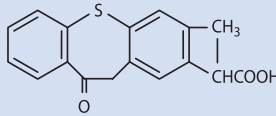
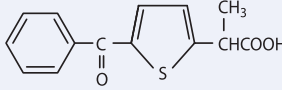
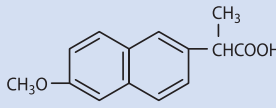
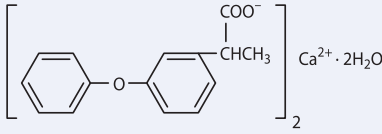
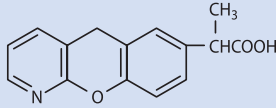
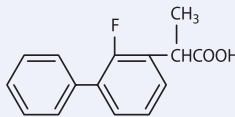
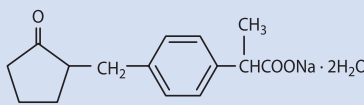
---

#### Reagents and their preparation

- Ibuprofen, ketoprofen, naproxen, fenoprofen calcium, flurbiprofen, loxoprofen and oxa-prozin can be purchased from Sigma (St. Louis, MO, USA). For other drugs, pure powder of each drug can be obtained by direct request to each manufacturer as follows: alminoprofen from Maruho Pharmaceutical Co., Ltd., Tokyo, Japan; zaltoprofen from Japan Chemipharm Pharmaceutical Co., Ltd., Tokyo, Japan; thiaprofenic acid from Aventis Pharma, Strasbourg, France; pranoprofen from Mitsubishi Welfarma, Osaka, Japan.
- High-performance (HP) TLC plate<sup>a</sup>: silica gel 60 F<sub>254</sub> HPTLC (Merck, Darmstadt, Germany).
- Dichloroindophenol reagent: 0.05 g of 2,6-dichloroindophenol sodium (Sigma) is dissolved in 50 mL ethanol.
- Bromocresol green reagent: 0.04 g of bromocresol green sultone form (Sigma) is dissolved in 100 mL of 96 % ethanol.
- Dragendorff reagent: 0.85 g of bismuth subnitrate is dissolved in a mixture of 40 mL distilled water and 10 mL acetic acid to prepare “A” solution. A 8-g aliquot of potassium iodide is dissolved in 20 mL distilled water to prepare “B” solution. Then, a mixture of A/B/acetic acid/distilled water (1:1:4:20, v/v) is prepared.
- Ninhydrin reagent: 0.2 g of ninhydrin is dissolved in a mixture of 5 mL acetic acid and 95 mL *n*-butanol.
- Liebermann’s reagent: 2 g of sodium nitrite is dissolved in 20 mL of concentrated sulfuric acid.

■ **Table 2.1**

**Structures of propionic acid derivative analgesic-antipyretics**

alminoprofen	
ibuprofen	
oxaprozin	
ketoprofen	
zaltoprofen	
tiaprofenic acid	
naproxen	
fenoprofen calcium	
pranoprofen	
flurbiprofen	
loxoprofen sodium	



## Developing solvents

Benzene/acetone (3:2, v/v).

*n*-Butyl ether/*n*-hexane/acetic acid (20:4:1, v/v).

Chloroform/methanol/acetic acid (45:5:1, v/v).

## Procedure

- i. A 0.1-mL volume of urine or serum (plasma) is mixed with 0.9 mL of 0.2 M disodium hydrogenphosphate/0.1 M citric acid buffer solution (pH 3.0), and extracted with 1 mL chloroform three times.
- ii. The combined chloroform extract is mixed well with 0.5 g of anhydrous sodium sulfate to dehydrate it and passed through filter paper; the filtrate is evaporated to dryness under reduced pressure.
- iii. The residue is dissolved in a small amount of methanol to serve as a test solution.
- iv. At a location 1-cm up from the bottom of a TLC plate, the above organic extract is spotted with a size of 1–2 mm diameter. After drying the spot, the plate is placed in a development tank filled with vapor of a developing solvent and the spot is developed with the developing solvent.
- v. After development, the plate is dried with a blower, and the fluorescence is observed under ultraviolet light at 365 nm; light absorbing spots are also observed under the light at 254 nm. After the above observations, the plate is sprayed with each reagent. The tentative identification is made by spotting the authentic standard together with the test extract. After spraying the dichloroindophenol reagent, the TLC plate should be heated at 100 °C to detect spots.

## Assessment of the method

▶ Table 2.2 shows  $R_f$  values of eleven propionic acid derivative analgesic-antipyretics for HPTLC (normal phase) with three solvent systems. ▶ Table 2.3 shows the detection limits and colors of the spots observed under ultraviolet light and after spraying five kinds of reagents.

The screening by TLC is simple and rapid for unchanged drugs. Reversed phase TLC for drug analysis was also reported [2, 3]. The optimization of a solvent system for drug analysis by TLC can give a useful hint for preparing a mobile phase of HPLC or LC/MS.

## HPLC analysis

---

### Reagents

- The sources of drugs are the same as specified in the section of TLC analysis. *N*-Chloromethyl-phthalimide (*N*-CMPI) can be purchased from Sigma.
- Oasis® MAX cartridges<sup>b</sup> were obtained from Waters (Milford, MA, USA).

■ **Table 2.2**

$R_f$  values of propionic acid derivative analgesic-antipyretics obtained by high-performance (HP) TLC

Compound	Developing solvents		
	1	2	3
alminoprofen	0.58	0.30	0.64
ibuprofen	0.67	0.53	0.67
oxaprozin	0.66	0.23	0.61
ketoprofen	0.42	0.32	0.64
zaltoprofen	0.66	0.34	0.63
tiaprofenic acid	0.65	0.29	0.61
naproxen	0.57	0.40	0.66
fenoprofen calcium	0.57	0.47	0.67
pranoprofen	0.36	0.03	0.59
flurbiprofen	0.51	0.46	0.65
loxoprofen sodium	0.52	0.23	0.64

1. benzene/acetone (3:2, v/v).

2. *n*-butyl ether/*n*-hexane/acetic acid (20:4:1, v/v).

3. chloroform/methanol/acetic acid (45:5:1, v/v).

■ **Table 2.3**

Colors and detection limits of spots of propionic acid derivative analgesic-antipyretics observed by HPTLC

Componnd	Detection limits ( $\mu\text{g}$ ) (color)						Ultraviolet light
	3	4	5	6	7		
alminoprofen	1 (light orange)	1 (yellowish green)	–	–	1 (dark brown)	0.1	
ibuprofen	5 (pink)	–	–	–	–	2	
oxaprozin	1 (light orange)	1 (yellow)	1 (orange)	–	1 (brown)	0.1	
ketoprofen	1 (pink)	–	–	–	1 (dark gray)	0.1	
zaltoprofen	1 (light orange)	1 (yellow)	1 (orange)	–	1 (dark brown)	0.1 (fluorescent)	
tiaprofenic acid	1 (light orange)	1 (yellow)	1 (orange)	–	1 (brown)	0.1	
naproxen	1 (pink)	1 (yellow)	1 (orange)	–	0.5 (yellowish brown)	0.1 (fluorescent)	
fenoprofen calcium	1 (pink)	2 (yellowish green)	–	–	1 (brown)	1	
pranoprofen	1 (pink)	1 (yellowish green)	1 (orange)	–	–	0.1 (fluorescent)	
flurbiprofen	1 (pink)	–	–	–	1 (yellowish brown)	0.1	
loxoprofen sodium	5 (pink)	–	–	–	1 (dark gray)	5	

3. dichloroindophenol reagent.

4. bromocresol green reagent.

5. Dragendorff reagent.

6. ninhydrin reagent.

7. Liebermann's reagent.

## Analytical conditions

Instrument: a Hitachi HPLC (L-6200) instrument equipped with a UV detector (L-2400) (Hitachi Ltd., Tokyo, Japan); column: LiChrospher RP-18 (e) (250 × 4.0 mm i.d., Merck, Darmstadt, Germany); mobile phase: methanol/purified water (70:30, v/v); its flow rate: 0.5 mL/min; detection wavelength: 293 nm.

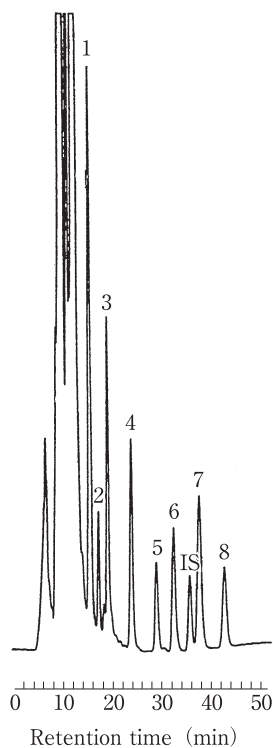
## Procedures

- Preparation-1: the extracts obtained by the procedure i–iii of the TLC analysis section of this chapter are condensed or diluted before instrumental analysis.
- Preparation-2: solid-phase extraction with an Oasis<sup>®</sup>MAX cartridge is made as follows:
  - i. A 0.5-mL volume of urine or serum (plasma) is mixed well with 0.1 mL phosphoric acid and 0.5 mL of purified water and poured into an Oasis<sup>®</sup>MAX cartridge, which had been activated by passing 3 mL methanol and 3 mL purified water.
  - ii. All manipulations are made using a Vac-Elut<sup>®</sup> system (Varian, Harbor City, CA, USA) with aspiration pressure at 15–20 mmHg.
  - iii. The cartridge is washed with 2 mL of 50 mM sodium acetate solution containing 5 % methanol, and drugs are eluted with 3 mL of 100 mM phosphoric acid solution/acetonitrile (20:80, v/v).
  - iv. The eluate is evaporated to dryness, and the residue is dissolved in 100 μL methanol containing *n*-caprylic acid as IS.
  - v. A 50-μL volume of the above solution, 50 μL of 100 mM *N*-CMPI acetonitrile solution, 50 μL of 100 mM triethylamine acetonitrile solution are placed in a screw cap test tube (10 × 1.5 cm) and mixed well.
  - vi. The mixture tube is heated at 80 °C for 30 min in a water bath or on an aluminum block heater. After cooling to room temperature, a 1–3 μL aliquot of it is injected into HPLC.
  - vii. Various concentrations<sup>c</sup> of a target drug are spiked into blank specimens, and processed according to the above procedure to construct a calibration curve; the IS is also added at the step iv. The peak area ratio of a test compound to IS is applied to the calibration curve to obtain its concentration.

## Assessment of the method

➤ Figure 2.1 shows an HPLC chromatogram for methylphthalimide (MPI) derivatives of eight propionic acid derivative analgesic-antipyretics<sup>d</sup>. The retention times and detection limits of the drugs obtained by this method are shown in ➤ Table 2.4.

■ **Figure 2.1**



**HPLC chromatogram for methylphthalimide (MPI) derivatives of propionic acid derivative analgesic-antipyretics extracted from human blood [4]. 1: pranoprofen; 2: loxoprofen; 3: ketoprofen; 4: naproxen; 5: fenoprofen; 6: flurbiprofen; 7: alminoprofen; 8: ibuprofen; IS: *n*-caprylic acid; the concentration of each drug spiked into blood was 10 µg/mL.**

■ **Table 2.4**

**Retention times and detection limits of MPI derivatives of propionic acid derivative analgesic-antipyretics obtained by HPLC-UV**

Compound	Retention time (min)	Detection limit (injected amount) (ng)
alminoprofen	37.3	40.0
ibuprofen	42.0	50.0
ketoprofen	14.0	16.7
naproxen	18.7	9.6
fenoprofen calcium	25.6	22.2
pranoprofen	10.0	8.7
flurbiprofen	29.4	44.4
loxoprofen sodium	12.0	23.5

## GC analysis

### Reagents and their preparation

- The sources of drugs are the same as specified in the TLC analysis section.
- Methylation reagent: phenyltrimethylammonium hydroxide (PTAH) methanolic solution<sup>e</sup> (20–25 %, about 1.3 M, Tokyo Kasei Kogyo Co., Ltd., Tokyo, Japan) is diluted 26-fold with methanol to prepare 50 mM PTAH just before use.
- 9-Anthracenecarboxylic acid (Sigma) is dissolved in purified water to prepare 500 µg/mL solution to be used as IS solution.
- Bond Elut<sup>®</sup> SI column<sup>f</sup> (Analytichem International, Harbor City, CA, USA).

### GC conditions

Instrument: a Shimadzu GC-14A gas chromatograph with an FID (Shimadzu Corp., Kyoto, Japan); column: CBP-1 (25 m × 0.33 mm i. d., film thickness 0.5 µm, Shimadzu Corp.); injection temperature: 280 °C<sup>g</sup>; column (oven) temperature: 100 °C → 3 °C/min → 280 °C; detector temperature: 320 °C; carrier gas (flow rate): He (5 mL/min); make-up gas (flow rate): He (30 mL/min); injection: splitless mode.

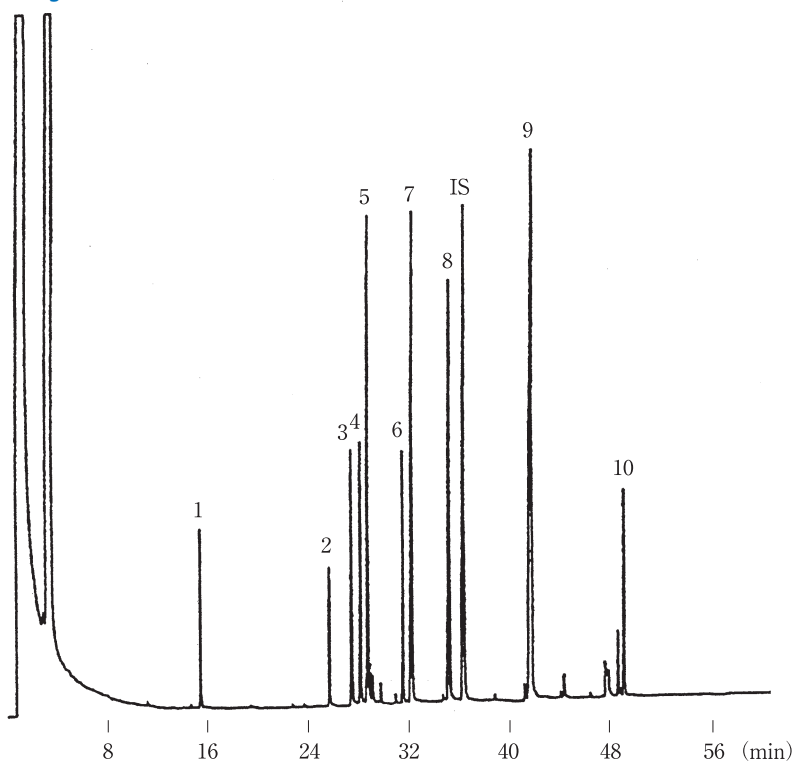
### Procedure

- A 0.1-mL volume of urine or serum (plasma) is mixed with 0.9 mL of 0.2 M disodium hydrogenphosphate/0.1 M citric acid buffer solution (pH 3.0), and extracted with 2 mL chloroform 3 times.
- The combined chloroform extract is condensed to about 1 mL, and poured into a Bond Elut<sup>®</sup> SI column.
- The column is washed with 6 mL of diethyl ether/hexane (1:1, v/v) and the drugs are eluted with 6 mL of chloroform/methanol/acetic acid (45:5:1, v/v).
- A 5-µL aliquot of IS (9-anthracenecarboxylic acid) solution (containing 2.5 µg of the compound) is added to the eluate, and evaporated to dryness under reduced pressure.
- The residue is dissolved in 25 µL of 50 mM PTAH methanolic solution and a 1–2 µL aliquot of it is injected into GC.
- The quantitation is made with a calibration curve, which had been constructed using various concentrations<sup>h</sup> of a target drug and a fixed amount of IS.

### Assessment of the method

➤ Figure 2.2 shows a gas chromatogram for ten propionic acid derivative analgesic-antipyretics using on-column methylation<sup>i</sup>. The retention times and detection limits obtained by this method are shown in ➤ Table 2.5. Maurer et al. [10] have reported GC/MS analysis of 40

Figure 2.2



Gas chromatogram for methyl derivatives of propionic acid derivative analgesic-antipyretics extracted from human blood plasma [9]. 1: ibuprofen; 2: alminoprofen; 3: tiaprofenic acid; 4: fenoprofen; 5: flurbiprofen; 6: naproxen; 7: loxoprofen; 8: ketoprofen; 9: pranoprofen; 10: zaltoprofen; IS: 9-anthracenecarboxylic acid; the concentration of each drug spiked into plasma was 2–20  $\mu\text{g/mL}$ .

Table 2.5

Retention times and detection limits of methyl derivatives of propionic acid derivative analgesic-antipyretics obtained by GC-FID

Compound	Retention time (min)	Detection limit ( $\mu\text{g/mL}$ )
alminoprofen	25.8	1.0
ibuprofen	15.6	0.2
ketoprofen	35.3	0.2
zaltoprofen	49.4	1.0
tiaprofenic acid	27.6	1.0
naproxen	31.7	0.5
fenoprofen calcium	28.3	0.2
pranoprofen	41.8	2.0
flurbiprofen	28.9	0.5
loxoprofen sodium	32.4	2.0

analgesic-antipyretics (including ibuprofen, ketoprofen, tiaprofenic acid, fenoprofen, naproxen and flurbiprofen) with methyl derivatization.

## Poisoning cases, blood concentrations and fatal doses

**Case 1** [12]: a 49-year-old female died during admission to a hospital for treatments of bone fracture of the right leg inflicted by a traffic accident. She had a past history of bronchial asthma. It was estimated that she had died of asthmatic attack due to ketoprofen shock. The concentration of ketoprofen in blood sampled at autopsy was 160 ng/mL, and that in the liver was 10 ng/g.

**Case 2** [13]: a 37-year-old male died during being mentally deranged. It was disclosed that he had ingested 9 tablets (675 mg) of ibuprofen. The action of ibuprofen on the central nervous system was estimated to be related with the cause of his death.

The oral LD<sub>50</sub> values obtained from mice for eleven propionic acid derivative analgesic-antipyretics (alminoprofen, ibuprofen, oxaprofen, ketoprofen, zaltoprofen, tiaprofenic acid, naproxen, fenoprofen calcium, pranoprofen, flurbiprofen and loxoprofen sodium) were reported to be 400–1,500 mg/kg [14].

The blood concentrations of drugs of this group described in literature [15] are as follows. Fenoprofen: therapeutic range, 23–31 µg/mL, a patient recovered even after ingestion of as much as 60 g fenoprofen; flurbiprofen: therapeutic range, 9.1–16.6 µg/mL; ibuprofen: therapeutic range, 18–24 µg/mL, a patient ingested 12 g ibuprofen to attempt suicide, fell into a comatose state with its blood level at 840 µg/mL, but recovered within 24 h; ketoprofen: therapeutic range, 4.7–14.3 µg/mL; naproxen: therapeutic range, 26–69 µg/mL, a patient ingested 25 g naproxen, showed its blood level at 414 µg/mL after 15 h, but recovered; tiaprofenic acid: therapeutic range, 18.6–73.3 µg/mL.

## Notes

- In this method, high-performance (HP) TLC plates were used. They give high resolution and 10–50 times lower detection limits, and are suitable for small amounts of specimens. However, usual TLC plates can be also used for the present analysis.
- The Oasis<sup>®</sup> MAX cartridges are commercially available for solid-phase extraction of neutral and acidic compounds in biomedical specimens such as serum and urine. The cartridge is suitable for pretreatments before analysis by HPLC and LC/MS [11].
- Solutions of each drug at 1–10 µg/mL are prepared.
- There are many reports dealing with HPLC analysis of analgesic-antipyretics including the propionic acid drugs without any derivatization [2, 5–8]. However, the derivatization with *N*-CMPI results in increase of sensitivity several ten times for HPLC analysis with a UV detector. Recently, the authors have reported a method for LC/MS analysis of the propionic acid drugs without any derivatization [11].
- Every propionic acid derivative analgesic-antipyretic listed in Table 2.1 has a carboxylic acid group and is very suitable for the on-column methylation. As on-column methylating reagents, phenyltrimethylammonium hydroxide (trimethylanilinium hydroxide) (PTAH) and tetramethylammonium hydroxide (TMAH) are being sold; the former reagent gives better results for the present propionic acid derivative drugs.

- f) The column should be activated by passing 10 mL methanol before use.
- g) When the injection temperature is not higher than 200 °C, the efficiency of on-column methylation becomes much lower.
- h) Solutions of each drug at 1–10 µg/mL are prepared.
- i) The propionic acid derivative drugs cannot be analyzed by GC without derivatization.

## References


- 1) Japan Poison Information Center (2001) 2000 Annual report by JPIC. *Jpn J Toxicol* 14:145–164 (in Japanese)
- 2) Shinozuka T, Terada M (1995) Standard methods of chemical analysis in poisoning VII, analgesics and anti-pyretics, the 115th Annual Meeting of the Pharmaceutical Society of Japan, the data of the Public Health Council. Pharmaceutical Society of Japan, Tokyo, pp 81–86 (in Japanese)
- 3) Shinozuka T, Terada M, Ogamo A et al. (1996) Data on high-performance thin-layer chromatography of analgesic and antipyretic drugs. *Jpn J Forensic Toxicol* 14:246–252
- 4) Shinozuka T, Takei S, Kuroda N et al. (1996) Simultaneous determination of propionic acid analgesic and anti-pyretic drugs in human blood and urine by high-performance liquid chromatography. *Jpn J Forensic Toxicol* 14:43–51
- 5) Shinozuka T, Terada M, Ogamo A et al. (1997) Simultaneous determination of analgesic-antipyretic drugs by high-performance liquid chromatography in the human serum. Proceedings of the 14th Meeting of the International Association of Forensic Science, Vol. 2. Shunderson Communications, Ottawa, pp 227–230
- 6) Battista HJ, Wehinger G, Henn R (1985) Separation and identification of non-steroidal antirheumatic drugs containing a free carboxyl function using high-performance liquid chromatography. *J Chromatogr* 345:77–89
- 7) Moore CM, Tebbett IR (1987) Rapid extraction of anti-inflammatory drugs in whole blood for HPLC analysis. *Forensic Sci Int* 34:155–158
- 8) Owen SG, Roberts MS, Friesen TW (1987) Rapid high-performance liquid chromatographic assay for the simultaneous analysis of non-steroidal anti-inflammatory drugs in plasma. *J Chromatogr* 416:293–302
- 9) Shinozuka T, Nakajima R, Takei S et al. (1999) Simultaneous analysis of propionic acid analgesic and antipyretic drugs in human plasma by gas chromatography. *Jpn J Forensic Toxicol* 17:51–60
- 10) Maurer HH, Tauvel AX, Kraemer T (2001) Screening procedure for detection of non-steroidal anti-inflammatory drugs and their metabolites in urine as part of a systematic toxicological analysis procedure for acidic drugs and poisons by gas chromatography-mass spectrometry after extractive methylation. *J Anal Toxicol* 25:237–244
- 11) Shinozuka T, Nakajima R, Ohue O et al. (2001) Analysis of analgesic and antipyretic drugs by LC/MS. *Jpn J Forensic Toxicol* 19:172–173 (in Japanese with an English abstract)
- 12) Moriya F, Hashimoto Y (1996) A case of fatal asthmatic attack probably induced by ketoprofen disclosed after screening of non-steroidal anti-inflammatory drugs. *Jpn J Forensic Toxicol* 14:240–245
- 13) Yanai A, Seo Y, Kakizaki E et al. (1998) An autopsy case in which ibuprofen poisoning was estimated. *Res Pract Forensic Med* 41:313–317 (in Japanese with an English abstract)
- 14) Yamazaki F, Mori H (eds) (2000) Guide to Acute Poisonings by Medical Drugs. Van Medical, Tokyo, pp 82–83 (in Japanese)
- 15) Moffat AC, Jackson JV, Moss MS et al. (eds) (1986) Clarke's Isolation and Identification of Drugs, 2nd edn. The Pharmaceutical Press, London, pp 615–616; 631–632; 677–678; 697–698; 799–800; 1024



## 11.4.3 Acetaminophen (paracetamol)

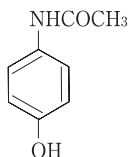
by Einosuke Tanaka

### Introduction

Acetaminophen (paracetamol, APAP) ( Figure 3.1) has been being used as an excellent analgesic-antipyretic for a long time, and is included as an ingredient in many over-the-counter drugs of analgesics and cold drugs. However, when APAP is ingested in large amounts, it was reported to cause liver disorders [1].

For analysis of APAP, HPLC [2–18], LC/MS [19], LC/MS/MS [20], GC [21], GC/MS [22, 23] and capillary electrophoresis [24, 25] are being used. Among the methods, HPLC is most popular for its analysis. In this chapter, HPLC methods for analysis of APAP and its metabolites are presented.

 **Figure 3.1**



Structure of acetaminophen.

### HPLC analysis of APAP and its metabolites in serum [18]

---

#### Reagents and their preparation

- APAP (Sigma, St. Louis, MO, USA) is dissolved in methanol to prepare 1 mg/mL solution.
- Theophylline (internal standard, IS, Sigma) is dissolved in 6 % perchloric acid aqueous solution to prepare 10 mg/mL solution.
- APAP and its metabolites<sup>a</sup> (APAP-glucuronide and APAP-*N*-sulfate) are dissolved in methanol to prepare 1–200 µg/mL solutions for calibration curves.

#### HPLC conditions

Column: a reversed phase column<sup>b</sup> (C<sub>18</sub>, 150 × 4.6 mm i. d., particle diameter 5 µm, Supelco, Bellefonte, PA, USA).

Mobile phase: 0.05 mM sodium sulfate solution (pH 2.2)<sup>c</sup>/acetonitrile (93:7, v/v).

Detection wavelength: 254 nm; flow rate: 1.5 mL/min; column (oven) temperature: 30 °C.

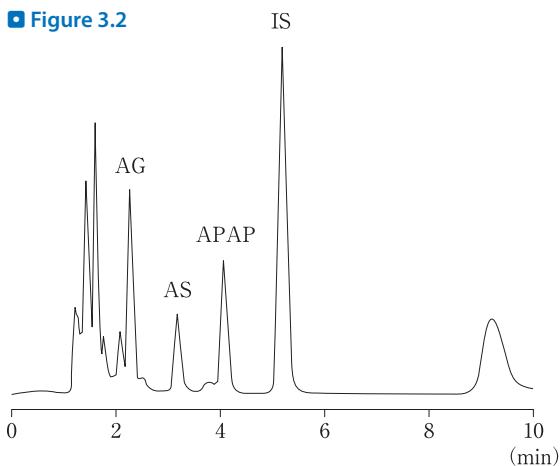
## Procedure

- i. A 10- $\mu\text{L}$ <sup>d</sup> aliquot of serum and 20  $\mu\text{L}$  IS solution<sup>e</sup> are placed in a centrifuge tube.
- ii. The tube is vortex-mixed for 5 s.
- iii. It is centrifuged at 1,700 g and 4 °C for 5 min.
- iv. The supernatant fraction is transferred to a clean glass test tube.
- v. A 10- $\mu\text{L}$  aliquot of it is injected into HPLC.
- vi. The various concentrations of the standard solutions are processed according to the above procedure.

## Assessment of the method

► Figure 3.2 shows an HPLC chromatogram for an extract of rat serum, to which APAP and its metabolites had been added. In this method, APAP and its metabolites can be simultaneously measured with a small amount of a specimen. Linearity could be obtained in the range of 1.56–200  $\mu\text{g}/\text{mL}$  for APAP and its sulfate conjugate, and in the range of 3.5–500  $\mu\text{g}/\text{mL}$  for APAP-glucuronide. The detection limit of all compounds was about 0.05  $\mu\text{g}/\text{mL}$ , and recovery rates were 98–103 %.

■ Figure 3.2



HPLC chromatogram for acetaminophen (APAP) and its metabolites in an extract of rat serum [18]. APAP: acetaminophen (3.1  $\mu\text{g}/\text{mL}$ , retention time 4 min); AG: APAP- glucuronide (7.8  $\mu\text{g}/\text{mL}$ , 2.3 min); AS: APAP-N-sulfate (3.1  $\mu\text{g}/\text{mL}$ , 3.1 min); IS: internal standard (theophylline) (20  $\mu\text{g}/\text{mL}$ , 5.1 min).

## HPLC analysis of APAP and its metabolites in urine [4]

### Reagents and their preparation

- APAP (Eastmann, Rochester, NY, USA) and APAP metabolites<sup>a</sup> (APAP-glucuronide, catechol 3-hydroxyaminophen, APAP-*N*-sulfate, 3-cysteinyl APAP, 3-methoxy APAP and APAP-3-mercaptopic acid) are dissolved in methanol.
- The concentrations of APAP and its metabolites to be prepared for calibration curves are 0.2–500 µg/mL.

### HPLC conditions

Column: a reversed phase column<sup>f</sup>, µBondapak C<sub>18</sub> (300 × 4.6 mm i.d., particle diameter 10 µm, Waters, Milford, MA, USA).

Mobile phase: methanol/0.1 M potassium dihydrogenphosphate containing 0.75 % acetic acid (7:93, v/v).

Detection wavelength: 248 nm or an electrochemical detector<sup>g</sup> (+ 0.60 V).

Flow rate: 1.5 mL/min; column (oven) temperature: room temperature.

### Procedure<sup>h</sup>

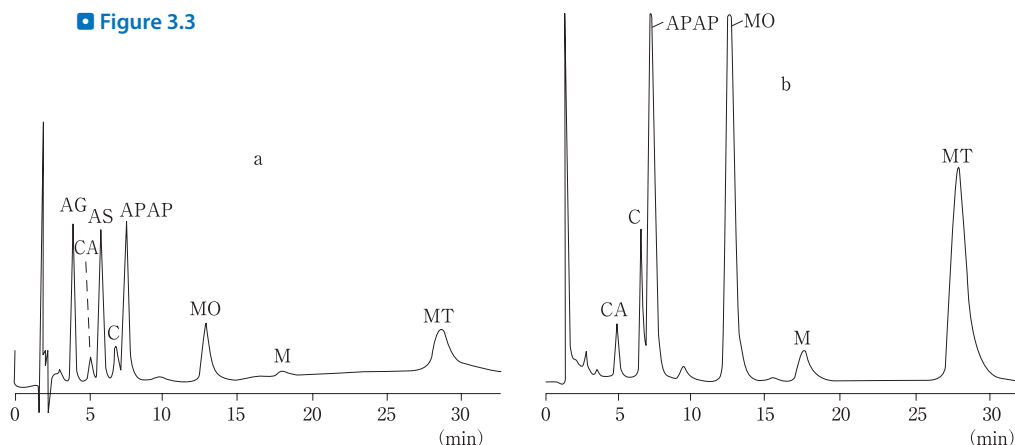
- A 1-mL volume of urine and 4 mL of 2 M acetate buffer solution (pH 5.0) are placed in a centrifuge tube with a stopper in duplicate.
- A 50-µL aliquot of β-glucuronidase-sulfatase (Sigma) is added to one of the tubes, and 50 µL of 2 M acetate buffer (PH 5.0) to the other tube (control).
- Both tubes are incubated at 37 °C overnight with shaking.
- After the incubation, the tubes are cooled with ice to stop the enzymatic reaction.
- After centrifugation, the supernatant solution is subjected to the procedure described in the above section for HPLC analysis in serum of this chapter; a fixed volume of the resulting specimen is injected into HPLC.
- For constructing calibration curves, various concentrations of standard solutions are processed in the same way.

### Assessment of the method

► *Figure 3.3* shows HPLC chromatograms for extract of urine, to which APAP and its metabolites had been added. The electrochemical detector showed much higher sensitivity than the UV detector (about 5 times for APAP and 5–10 times for some metabolites).

About 95 % of APAP is excreted into urine in its glucuronide-conjugate form [26]; therefore, the conjugate can be converted to free APAP with β-glucuronidase-sulfatase to be measured without any authentic standard of APAP-glucuronide.

Figure 3.3



HPLC chromatograms for acetaminophen (APAP) and its metabolites extracted from human urine [4]. APAP: acetaminophen (4.5  $\mu\text{g/mL}$ ); AG: APAP-glucuronide (5.4  $\mu\text{g/mL}$ ); CA: catechol 3-hydroxyaminophen (3.1  $\mu\text{g/mL}$ ); AS: APAP-*N*-sulfate (4.7  $\mu\text{g/mL}$ ); C: 3-cysteinyl APAP (1.7  $\mu\text{g/mL}$ ); MO: 3-methoxy-APAP (2.2  $\mu\text{g/mL}$ ); M: APAP-3-mercapturic acid (1.5  $\mu\text{g/mL}$ ); MT: 3-methylthio-APAP (5  $\mu\text{g/mL}$ ); a: UV detector (248 nm); b: electrochemical detector (+ 0.60 V).

## Toxic and fatal concentrations

See [27, 28]

For therapeutic use, a daily dose of more than 1.2 g of APAP should not be administered for more than 10 days. Its oral toxic doses in adults are 5–10 g; that in infants is 150 mg/kg. The oral fatal dose is 25 g or more. Blood therapeutic concentrations: 2.5–25  $\mu\text{g/mL}$ ; its toxic concentrations: 150–300  $\mu\text{g/mL}$ ; its fatal concentration: not less than 160  $\mu\text{g/mL}$  (average 250  $\mu\text{g/mL}$ ).

## Poisoning cases

**Case 1** [29]: a 28-year-old black male was hospitalized for treatments of abdominal pain and hematemesis; the pain existed in the area of the upper abdomen and radiated towards the back. He had ingested 12–14 capsules (6–7 g) of APAP “Extra Strength” during 24 h. He was a chronic alcoholic and narcotic abuser, but he denied the use of illicit drugs at the time. The biochemical tests for liver and kidney functions showed abnormal data. At 36 h after the admission, it was disclosed that he had ingested a large amount of APAP; the blood APAP concentration was 60  $\mu\text{g/mL}$ . On day 17 after the admission, the liver biopsy showed the findings of liver dysfunction (fibrosis and regenerated nodules), but the symptoms were gradually improved. He was discharged on day 20 after admission.

**Case 2** [29]: a 28-year-old black male was admitted to a hospital, because of headache and fever. His general conditions had been good until 5 days before, when headache and fever were aggravated. He said that he had ingested 2–4 tablets every 4–6 h; it was considered that the total amount ingested had been 5–6 g (10–12 tablets) during 24 h. He denied his massive in-

gestion or suicide attempt. At 36 h after admission, extensive and abnormal pain of his trunk associated with icterus, dark urine, nausea and vomiting appeared. The excretion amounts of urine had decreased gradually before admission; for about 24 h before admission, he had not been able to urinate by himself. He had drunk a lot of beer in his daily life and had habitually ingested glutethimide, methaqualone and drug syrup obtainable without prescription; but he denied his drug abuse. The biochemical tests for liver and kidney functions showed abnormal data. The blood APAP concentration 17 h after admission was 237  $\mu\text{g/mL}$ ; it was decreased to 137  $\mu\text{g/mL}$  24 h later. At 48 h after admission, flapping tremor appeared. Peritoneal dialysis was performed, but he died on the next day.

**Case 3** [29]: a 40-year-old male was admitted to a hospital because of the pain radiating towards the back; he had a past history of alcoholism and chronic pancreatitis. Just before admission, he had ingested 25–35 tablets of “Extra Strength” together with another kind of drug of APAP. During about 3 weeks before admission, he had drunk 12–18 cans of beer daily; but for 2 days just before admission, he did not drink. He had noticed his dark urine; for 3 days just before admission, nausea and vomiting appeared. The biochemical tests for liver and kidney functions showed slight abnormal data. Blood APAP concentration 72 h after admission was 14.5  $\mu\text{g/mL}$ . Liver dysfunction was observed, but his conditions were gradually improved. He was discharged 14 days after admission.

## Notes

- a) The APAP metabolites (APAP-glucuronide, catechol 3-hydroxyaminophen, APAP-*N*-sulfate, 3-cysteiny APAP, 3-methoxy APAP and APAP-3-mercapturic acid) are not commercially available; they should be synthesized [18].
- b) In many reports for HPLC analysis, reversed phase chemical-bonded octadecyl ( $C_{18}$ ) columns are being used.
- c) The pH of the solution is adjusted to 2.2 with phosphoric acid. When only APAP is analyzed, the mobile phase at pH 7.0 or 9.0 can be used (see the analytical application data of Waters and other literature).
- d) This method was established for small amounts of specimens of rat. By increasing the specimen volume, higher sensitivity can be obtained.
- e) Since theophylline is contained in tea and coffee, other ISs, such as 2-acetaminophenol and 4-fluorophenol can be used.
- f) Recently, columns with 10–15 cm length and 2.5–5  $\mu\text{m}$  particle size are being well used.
- g) The electrochemical detector gives much higher sensitivity than the UV detector.
- h) For solid-phase extraction of APAP, the following procedure can be used:
  - i. A 1-mL volume of methanol and 1 mL distilled water are passed through an Oasis<sup>TM</sup> HLB 30 mg/1 mL column (Waters) to activate it.
  - ii. A 1 mL volume of serum is poured into the column.
  - iii. A 1 mL volume of 5 % methanol in water is passed through the column to wash it.
  - iv. APAP is eluted with 1 mL methanol.
  - v. The eluate is evaporated to dryness under a stream of nitrogen with warming at 40 °C.
  - vi. The residue is dissolved in 100  $\mu\text{L}$  of the mobile phase.

- vii. A fixed volume of the solution is injected into HPLC.
- viii. Various concentrations of the authentic solution of APAP are processed according to the above procedure to construct a calibration curve.

## References


- 1) Japan Poison Information Center (ed) (2000) Poisoning Accidents and their Countermeasures with Special Reference to Actual Cases, revised edn. Jiho Inc., Tokyo, pp 121–126 (in Japanese)
- 2) Knox JH, Jurand J (1977) Determination of paracetamol and its metabolites in urine by high-performance liquid chromatography using reversed-phase bonded supports. *J Chromatogr* 142:651–670
- 3) Ameer B, Greenblatt DJ, Divoll M et al. (1981) High-performance liquid chromatographic determination of acetaminophen in plasma: single-dose pharmacokinetic studies. *J Chromatogr* 226:224–230
- 4) Wilson JM, Slattery JT, Forte AJ et al. (1982) Analysis of acetaminophen metabolites in urine by high-performance liquid chromatography with UV and amperometric detection. *J Chromatogr* 227:453–462
- 5) Jung D, Zafar NU (1985) Micro high-performance liquid chromatographic assay of acetaminophen and its major metabolites in plasma and urine. *J Chromatogr* 339:198–202
- 6) Hannotiaux MH, Houdret N, Lhermitte M et al. (1986) High performance liquid chromatographic determination of paracetamol in human serum. *Ann Biol Clin (Paris)* 44:139–141
- 7) Colin P, Sirois G, Chakrabarti S (1987) Rapid high-performance liquid chromatographic assay of acetaminophen in serum and tissue homogenates. *J Chromatogr* 413:151–160
- 8) Ladds G, Wilson K, Burnett D (1987) Automated liquid chromatographic method for the determination of paracetamol and six metabolites in human urine. *J Chromatogr* 414:355–364
- 9) Kinney CD, Kelly JG (1987) Liquid chromatographic determination of paracetamol and dextro-propoxyphene in plasma. *J Chromatogr* 419:433–437
- 10) Osterloh J, Yu S (1988) Simultaneous ion-pair and partition liquid chromatography of acetaminophen, theophylline and salicylate with application to 500 toxicologic specimens. *Clin Chim Acta* 175:239–248
- 11) Mathis DF, Budd RD (1988) Extraction of acetaminophen and theophylline from post-mortem tissues and urine for high-performance liquid chromatographic analysis. *J Chromatogr* 439:466–469
- 12) Aguilar MI, Hart SJ, Calder IC (1988) Complete separation of urinary metabolites of paracetamol and substituted paracetamols by reversed-phase ion-pair high-performance liquid chromatography. *J Chromatogr* 426:315–333
- 13) Bhargava VO, Emodi S, Hirate J (1988) Quantitation of acetaminophen and its metabolites in rat plasma after a toxic dose. *J Chromatogr* 426:212–215
- 14) Rustum AM (1989) Determination of acetaminophen in human plasma by ion-pair reversed-phase high-performance liquid chromatography. Application to a single-dose pharmacokinetic study. *J Chromatogr Sci* 27: 18–22
- 15) Kamali F, Herd B (1990) Liquid-liquid extraction and analysis of paracetamol (acetaminophen) and its major metabolites in biological fluids by reversed-phase ion-pair chromatography. *J Chromatogr* 530:222–225
- 16) Akay C, Gumusel B, Degim T et al. (1999) Simultaneous determination of acetaminophen, acetylsalicylic acid and ascorbic acid in tablet form using HPLC. *Drug Metab Drug Interact* 15:197–205
- 17) Campanero MA, Calahorra B, Garcia-Quetglas E et al. (1999) Rapid liquid chromatographic assay for the determination of acetaminophen in plasma after propacetamol administration: application to pharmacokinetic studies. *J Pharm Biomed Anal* 20:327–334
- 18) Brunner LJ, Bai S (1999) Simple and rapid assay for acetaminophen and conjugated metabolites in low-volume serum samples. *J Chromatogr B* 732:323–329
- 19) Betowski LD, Korfmacher WA, Lay JO Jr et al. (1987) Direct analysis of rat bile for acetaminophen and two of its conjugated metabolites via thermospray liquid chromatography/mass spectrometry. *Biomed Environ Mass Spectrom* 14:705–709
- 20) Celma C, Allue JA, Prunonosa J et al. (2000) Simultaneous determination of paracetamol and chlorpheniramine in human plasma by liquid chromatography-tandem mass spectrometry. *J Chromatogr A* 870:77–86
- 21) Chan K, McCann JF (1979) Improved gas-liquid chromatography-electron-capture detection technique for the determination of paracetamol in human plasma and urine. *J Chromatogr* 164:394–398

- 22) Takayasu T, Nishigami J, Ohshima T et al. (1993) A fatal case due to intoxication with seven drugs detected by GC-MS and TDx methods. *Jpn J Legal Med* 47:63–71 (in Japanese with an English abstract)
- 23) Speed DJ, Dickson SJ, Cairns ER et al. (2001) Analysis of paracetamol using solid-phase extraction, deuterated internal standards, and gas chromatography-mass spectrometry. *J Anal Toxicol* 25:198–202
- 24) Heitmeier S, Blaschke G (1999) Direct determination of paracetamol and its metabolites in urine and serum by capillary electrophoresis with ultraviolet and mass spectrometric detection. *J Chromatogr B* 721:93–108
- 25) Bohnenstengel F, Kroemer HK, Sperker B (1999) In vitro cleavage of paracetamol glucuronide by human liver and kidney beta-glucuronidase: determination of paracetamol by capillary electrophoresis. *J Chromatogr B* 721:295–299
- 26) Tanaka E, Misawa S (2001) Forensic toxicological importance of acetaminophen hepatotoxicity in non-alcoholic and alcoholic subjects. *Jpn J Forensic Toxicol* 19:11–19
- 27) Sakata I (2001) Acetaminophen. *Jpn J Acute Med*; 25:206–207 (in Japanese)
- 28) Stead AH, Moffat AC (1983) A collection of therapeutic, toxic and fatal blood drug concentrations in man. *Hum Toxicol* 2:437–464
- 29) Leist MH, Gluskin LE, Payne JA (1985) Enhanced toxicity of acetaminophen in alcoholics: report of three cases. *J Clin Gastroenterol* 7:55–59

## II.4.4 Acetylsalicylic acid

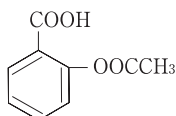
by Einosuke Tanaka

### Introduction

Acetylsalicylic acid (ASA, aspirin) ( *Figure 4.1*) has been being used as an analgesic-anti-pyretic for a long time; it is contained in many of over-the-counter drugs. Although ASA is relatively safe, various poisoning symptoms, such as lowered consciousness levels, hypotension, pulmonary edema and convulsion, were reported upon ingestion of a large amount of this drug [1].

For analysis of ASA, methods by HPLC [2–19], GC [20–23], GC/MS [24] and capillary electrophoresis [25–27] were reported; among these methods, HPLC is most popular. In this chapter, the methods for ASA analysis by HPLC [9, 16] and GC [23] are presented.

 **Figure 4.1**



Structure of acetylsalicylic acid (ASA).

### HPLC analysis of ASA and its metabolites in plasma [16]

---

#### Reagents and their preparation

- ASA, salicylic acid, gentisic acid and salicyluric acid can be purchased from Sigma (St. Louis, MO, USA).
- ASA is dissolved in acetonitrile to prepare 1 mg/mL solution.
- 2-Methylbenzoic acid (MBA) (internal standard, IS; Bayer, Leverkusen, Germany and other manufacturers) is dissolved in purified water to prepare 100 µg/mL solution.
- For constructing each calibration curve, methanolic solutions of ASA and its metabolites at various concentrations in the range of 0.2–100 µg/mL are prepared.

#### HPLC conditions

Column: a reversed phase column <sup>a, b</sup> (Novapak, 150 × 3.9 mm i.d., particle diameter 4 µm, Waters, Eschborn, Germany).

Mobile phase: purified water/85 % phosphoric acid/acetonitrile (740 mL:900 µL:180 mL, v/v) (pH about 2.5).

Detection wavelength: 237 nm; flow rate: 1 mL/min; column (oven) temperature: 30 °C.



## Procedure

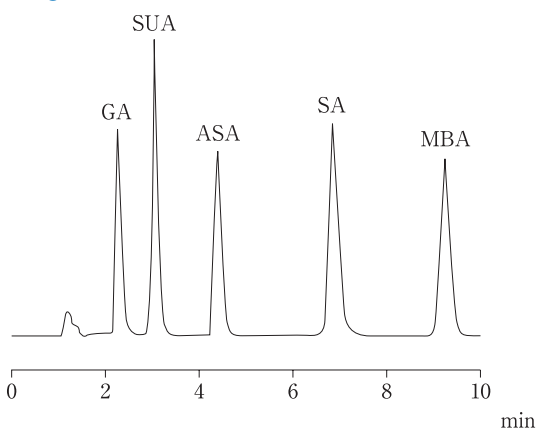
- i. A 200- $\mu$ L volume of plasma<sup>c</sup> and 200  $\mu$ L of MBA<sup>d</sup> solution are placed in a 1.5-mL volume microtube, and mixed well for 1–2 s.
- ii. The pH of the mixture is adjusted to about 2.7.
- iii. A 400- $\mu$ L volume of acetonitrile is added to the above mixture.
- iv. It is vortex-mixed well at 4 °C for 15 min and centrifuged at 10,500 g for 1 min.
- v. The supernatant fraction is transferred to another 1.5-mL volume microtube, followed by addition of 100–120 mg NaCl<sup>e</sup>.
- vi. The microtube is vortex-mixed and left at 4 °C for 10 min.
- vii. It is centrifuged at 10,500 g for 1 min.
- viii. A 10- $\mu$ L volume of the supernatant fraction (acetonitrile layer) is injected into HPLC.
- ix. For solutions of various concentrations of ASA and its metabolites, 200- $\mu$ L aliquot each was processed according to the above procedure for construction of calibration curves.

## Assessment of the method

► *Figure 4.2* shows an HPLC chromatogram for ASA and its metabolites extracted from human plasma. By this method, ASA, salicylic acid, gentisic acid and salicyluric acid, which is formed by glycine conjugation of salicylic acid, can be measured.

ASA and salicylic acid can be quantitated down to 100 ng/mL; the recoveries of ASA and its metabolites were 107–122 %.

■ **Figure 4.2**



HPLC chromatogram for the authentic acetylsalicylic acid and its metabolites [16]. GA: gentisic acid; SUA: salicyluric acid; ASA: acetylsalicylic acid; SA: salicylic acid; MBA: 2-methylbenzoic acid (IS). Each compound was dissolved in 0.01 M hydrochloric acid solution to prepare 50  $\mu$ g/mL solution.

## HPLC analysis of ASA and its metabolites in plasma, tissues and urine [9]

---

### Reagents and its preparation

ASA (Sigma) is dissolved in methanol; for calibration curves, solutions of ASA and its metabolites at 0.2–10 µg/mL are prepared.

### HPLC conditions

Column: a reversed phase column<sup>a</sup> (LiChrosorb RP-18, 150 × 4 mm i.d., particle diameter 5 µm).

Mobile phase<sup>f</sup>: methanol/purified water (60:40, v/v) (pH 3).

Detection wavelength: 280 nm; flow rate: 1.5 mL/min; column (oven) temperature: 45 °C.

### Procedures<sup>g</sup>

#### i. Plasma

- i. A 200-µL volume of plasma<sup>c</sup>, 50 µL phosphoric acid and 600 µL ethyl acetate are placed in a small centrifuge tube.
- ii. The tube is vortex-mixed for 30 s and centrifuged at 600 g for 10 min.
- iii. A 400-µL volume of the organic phase is transferred to a small glass vial, and evaporated to dryness under a stream of air in an ice bath.
- iv. The residue is dissolved in 200 µL of the mobile phase and injected into HPLC.
- v. The solutions of ASA and its metabolites at various concentrations are processed according to the above procedure.

#### ii. Organ tissues

- i. A 500-mg aliquot of an organ tissue is minced in 2 mL of purified water and homogenized with cooling with ice.
- ii. It is centrifuged at 40,000 rpm for 30 s.
- iii. The supernatant fraction is decanted to a test tube, and a 200 µL of it is subjected to the procedure of the above i. plasma.

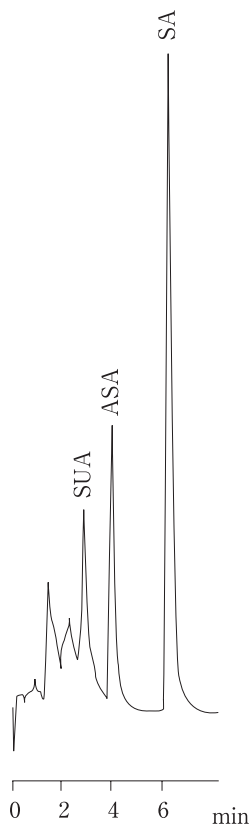
#### iii. Urine

- i. Urine is diluted 10-fold with purified water.
- ii. The diluted specimen is subjected to the procedure of the above i. plasma.

### Assessment of the method

➤ *Figure 4.3* shows an HPLC chromatogram for ASA and its metabolites extracted from plasma of a rabbit, to which ASA had been administered intravenously 15 min before sampling

■ Figure 4.3



HPLC chromatogram for ASA and its metabolites extracted from plasma of a rabbit, to which 50 mg/kg ASA had been administered intravenously 15 min before sampling of its blood [9]. SUA: salicylic acid; ASA: acetylsalicylic acid; SA: salicylic acid.

of its blood. By this method, ASA and its two metabolites in human plasma, tissues and urine can be analyzed. Quantitation limit of ASA and salicylic acid was about 500 ng/mL; the recoveries were 89–101 %.

## GC analysis of ASA and its metabolite in serum [23]

### Reagents and their preparation

- p-Hydroxybenzoic acid ethyl ester (IS, Sigma) is dissolved in purified water to prepare 15 µg/mL solution.
- ASA is dissolved in methanol. For its calibration curve, ASA solutions at 10–250 µg/mL are prepared.

## GC conditions

Column<sup>h</sup>: a packed glass column, 2 % OV-225 Gas Chrom W (80–100 mesh, 1.2 m × 4 mm i. d., obtainable from many manufacturers).

Temperatures: column 110 °C, injection port 250 °C, detector 300 °C; detector: FID; carrier gas (flow rate): nitrogen (60 mL/min); detector gas (flow rate): air (100 mL/min) and hydrogen (30 mL/min).

## Procedure

- i. A 100- $\mu$ L volume of serum<sup>c,i</sup>, 2 mL of 1 M hydrochloric acid solution and 1 mL *p*-hydroxybenzoic acid ethyl ester (IS) solution are placed in a 10-mL volume glass centrifuge tube with a ground-in stopper.
- ii. A 5-mL volume of ethyl ether is added to the above mixture, shaken and centrifuged; this procedure is repeated once.
- iii. The combined organic phase (upper layer) is transferred to a 10–20 mL volume test tube.
- iv. The phase is condensed to a small amount (about 1 mL) under a stream of nitrogen with warming at 42–44 °C. The condensed extract is transferred to a 4-mL volume glass vial with a silicone cap and evaporated to dryness under a stream of nitrogen.
- v. The residue is mixed with 10  $\mu$ L acetonitrile and 5  $\mu$ L *N,O*-bis(trimethylsilyl)trifluoroacetamide (Pierce, Rockford, IL, USA) and heated at 60 °C for 10 min for silylation.
- vi. A 2–3  $\mu$ L aliquot of it is injected into GC.
- vii. Solutions of ASA or salicylic acid at various concentrations are treated according to the above procedure for constructing calibration curves.

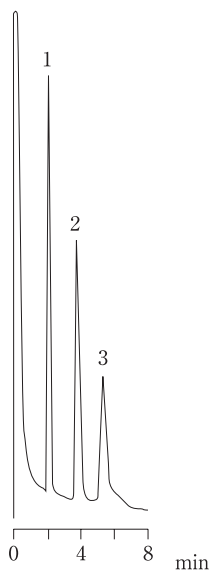
## Assessment of the method

► *Figure 4.4* shows a gas chromatogram for ASA and its metabolite salicylic acid extracted from human serum. Quantitative analysis of both compounds can be made in the range of 25–250  $\mu$ g/mL.

## Toxic and fatal concentrations [28, 29]

When 150–300 mg/kg of ASA is ingested orally, various poisoning symptoms, such as nausea, vomiting and tinnitus, appear; when the dose exceeds 300 mg/kg, the symptoms become serious. Dangerous oral doses of ASA for adults and infants are about 20 and 1.5 g, respectively. Therapeutic blood ASA concentrations: 20–100  $\mu$ g/mL; toxic concentrations: 150–300  $\mu$ g/mL; fatal concentration: not lower than 500  $\mu$ g/mL.

■ **Figure 4.4**



**Gas chromatogram for the spiked ASA and salicylic acid extracted from human serum [23]. 1: salicylic acid; 2: *p*-hydroxybenzoic acid ethyl ester (IS); 3: acetylsalicylic acid (ASA). A 15- $\mu$ g each of the compounds was added to 1 mL serum.**

## Poisoning cases

**Case 1** [30]: a 25-year-old white female had been healthy physically; but she had been diagnosed to be the borderline-type personality disorder. She had attempted suicide several times. She had been habitually taking tranylcypromine (a monoamine oxidase inhibitor). At about 7:00 p. m., she ingested all Ecotrin tablets (enteric coating) in a bottle. This means that she ingested about 30 g of ASA, because the bottle contained 90–100 tablets each containing 325 mg ASA. She vomited the tablets and their residue repeatedly. At 11:00 p. m., she was brought to an emergency hospital in the comatose state for admission. The blood tests showed respiratory alkalosis and metabolic acidosis. As a result of treatments and observation, she was transferred to the psychiatric department of the hospital 4 days after. The blood specimens were sampled at some intervals after the ingestion. The blood concentrations of salicylic acid at 6, 12 and 17 h after ingestion were 30, 200 and 300  $\mu$ g/mL, respectively. The salicylic acid concentrations increased thereafter; the peak concentration was attained at 24 h after slowly ingestion.

**Case 2** [31]: a 64-year-old female received laminectomy, because of chronic articular rheumatism. After the operation, she was administered the long-lasting enteric coating tablets of ASA; she took two tablets (800 mg ASA each) of Solprin twice (in total 3,200 mg ASA) daily. During the admission, the Solprin tablets were changed to Ecotrin tablets each containing 325 mg ASA; she took 3 tablets of Ecotrin 4 times (in total 3,900 mg) daily. After recovery, she returned to her sanatorium, where she took overdoses of ASA; she took 3 tablets (325 mg each ASA) of Ecotrin at 7:00 a. m., 2 tablets (800 mg each ASA) of Solprin at 8:00 a. m., 3 tablets of Ecotrin at 11:00 a. m., 3 tablets of Ecotrin at 4:00 p. m. and 3 tablets of Ecotrin plus 2 tablets

of Solprin at p.m. 9:00. Therefore, she ingested 7.1 g ASA daily (97 mg/kg/day, body weight 73.2 kg) for 10 days. From about 24 h before the second admission to the hospital, slight fever and somnolence appeared. The last ingestion of ASA tablets was made at 9:00 p. m. on the previous day of admission. In the morning of the day for admission, she fell into the comatose state. The blood ASA concentration at 17 h after the last ingestion was 924  $\mu\text{g/mL}$ ; the concentration decreased to 748  $\mu\text{g/mL}$  on day 2 of admission, but she died on day 3.

## Notes

- a) In many reports on HPLC analysis of ASA, reversed phase chemical-bonded octadecyl silica gel columns are being used.
- b) To prevent the peak of salicylic acid from tailing, 400  $\mu\text{L}$  di-*n*-butylamine is mixed with 200 mL of mobile phase, and passed through the column at a flow rate of 0.3 mL/min before injection of a sample solution.
- c) ASA is easily converted into salicylic acid by the action of esterase in blood. To prevent ASA from its postmortem conversion, 4 mg sodium fluoride and 50 I. U. heparin should be added to 1.5 mL blood just after sampling. Blood specimens are preferably stored at not higher than  $-70^\circ\text{C}$ . It is also recommended that the final extract solution prepared is analyzed as soon as possible, and all procedure for extraction is made under cooling with ice.
- d) MBA is dissolved in 0.2 M hydrochloric acid solution/0.2 M phosphoric acid solution (50:50, v/v) to prepare 5  $\mu\text{g/mL}$  solution.
- e) NaCl is added to prevent the test solution from its evaporation. For rapid analysis, the steps vi.–viii. can be skipped.
- f) The pH of the mobile phase is adjusted to 3 by using 5 mM NaOH and 5 mM phosphoric acid solutions.
- g) In this method, no IS is used.
- h) The column should be heated at  $225^\circ\text{C}$  with nitrogen flow overnight for its aging. The silylation of the packing material with hexamethyldisilazane (HMDS) is useful to obtain sharp peaks.
- i) Plasma, serum and whole blood can be used as specimens.

## References

- 1) Japan Poison Center (ed) (2000) Poisoning Accidents and their Countermeasures with Special Reference to Actual Cases, revised edn. Jiho Inc., Tokyo, pp 127–131 (in Japanese)
- 2) Blair D, Rumack BH, Peterson RG (1978) Analysis for salicylic acid in serum by high-performance liquid chromatography. *Clin Chem* 24:1543–1544
- 3) Cham BE, Johns D, Bochner F et al. (1979) Simultaneous liquid-chromatographic quantitation of salicylic acid, salicylic acid, and gentisic acid in plasma. *Clin Chem* 25:1420–1425
- 4) Cham BE, Ross-Lee L, Bochner F et al. (1980) Measurement and pharmacokinetics of acetylsalicylic acid by a novel high performance liquid chromatographic assay. *Ther Drug Monit* 2:365–372
- 5) Harrison LI, Funk ML, Ober RE (1980) High-pressure liquid chromatographic determination of salicylsalicylic acid, aspirin, and salicylic acid in human plasma and urine. *J Pharm Sci* 69:1268–1271
- 6) Wahlin-Boll E, Brantmark B, Hanson A et al. (1981) High-pressure liquid chromatographic determination of acetylsalicylic acid, salicylic acid, diflunisal, indomethacin, indoprofen and indobufen. *Eur J Clin Pharmacol* 20:375–378

- 7) Rumble RH, Roberts MS, Wanwimolruk S (1981) Determination of aspirin and its major metabolites in plasma by high-performance liquid chromatography without solvent extraction. *J Chromatogr* 225:252–260
- 8) Buskin JN, Upton RA, Williams RL (1982) Improved liquid-chromatography of aspirin, salicylate, and salicylic acid in plasma, with a modification for determining aspirin metabolites in urine. *Clin Chem* 28:1200–1203
- 9) Reidl U (1983) Determination of acetylsalicylic acid and metabolites in biological fluids by high-performance liquid chromatography. *J Chromatogr* 272:325–331
- 10) Bakar SK, Niazi S (1983) High-performance liquid chromatographic determination of aspirin and its metabolites in plasma and urine. *J Pharm Sci* 72:1020–1023
- 11) O,Kruk RJ, Adams MA, Philp RB (1984) Rapid and sensitive determination of acetylsalicylic acid and its metabolites using reversed-phase high-performance liquid chromatography. *J Chromatogr* 310:343–352
- 12) Ogunbona FA (1986) Simultaneous liquid chromatographic determination of aspirin and the metabolites in human urine. *J Chromatogr* 377:471–474
- 13) Siebert DM, Bochner F (1987) Determination of plasma aspirin and salicylic acid concentrations after low aspirin doses by high-performance liquid chromatography with post-column hydrolysis and fluorescence detection. *J Chromatogr* 420:425–431
- 14) Gaspari F, Locatelli M (1987) Determination of aspirin and salicylic acid in uremic patients plasma using reversed-phase high-performance liquid chromatography. *Ther Drug Monit* 9:243–247
- 15) Legaz ME, Acitores E, Valverde F (1992) Determination of salicylic acid by HPLC in plasma and saliva from children with juvenile chronic arthritis. *Tokai J Exp Clin Med* 17:229–237
- 16) Kees F, Jehnich D, Grobecker H (1996) Simultaneous determination of acetylsalicylic acid and salicylic acid in human plasma by high-performance liquid chromatography. *J Chromatogr B* 677:172–177
- 17) Krivosikova Z, Spustova V, Dzurik R (1996) A highly sensitive HPLC method for the simultaneous determination of acetylsalicylic, salicylic and salicyluric acids in biologic fluids: pharmacokinetic, metabolic and monitoring implications. *Method Find Exp Clin Pharmacol* 18:527–532
- 18) McMahon GP, Kelly MT (1998) Determination of aspirin and salicylic acid in human plasma by column-switching liquid chromatography using on-line solid-phase extraction. *Anal Chem* 70:409–414
- 19) Pirola R, Bareggi SR, De Benedittis G (1998) Determination of acetylsalicylic acid and salicylic acid in skin and plasma by high-performance liquid chromatography. *J Chromatogr B* 705:309–315
- 20) Walter LJ, Biggs DF, Coutts RT (1974) Simultaneous GLC estimation of salicylic acid and aspirin in plasma. *J Pharm Sci* 63:1754–1758
- 21) Rance MJ, Jordan BJ, Nichols JD (1975) A simultaneous determination of acetylsalicylic acid, salicylic acid and salicylamide in plasma by gas liquid chromatography. *J Pharm Pharmacol* 27:425–429
- 22) Tam YK, Au DS, Abbott FS (1979) Improved gas-liquid chromatographic-flame ionization detection assay of acetylsalicylic and salicylic acids. *J Chromatogr* 174:239–244
- 23) Belanger PM, Lalande M, Dore F et al. (1983) Rapid gas chromatographic determination of serum salicylates after silylation. *J Pharm Sci* 72:1092–1093
- 24) Tsikas D, Tewes KS, Gutzki FM et al. (1998) Gas chromatographic-tandem mass spectrometric determination of acetylsalicylic acid in human plasma after oral administration of low-dose aspirin and guaimesal. *J Chromatogr B* 709:79–88
- 25) Goto Y, Makino K, Kataoka Y et al. (1998) Determination of salicylic acid in human serum with capillary zone electrophoresis. *J Chromatogr B* 706:329–335
- 26) Hansen SH, Jensen ME, Bjornsdottir I (1998) Assay of acetylsalicylic acid and three of its metabolites in human plasma and urine using non-aqueous capillary electrophoresis with reversed electroosmotic flow. *J Pharm Biomed Anal* 17:1155–1160
- 27) Zaugg S, Zhang X, Sweedler J et al. (2001) Determination of salicylate, gentisic acid and salicyluric acid in human urine by capillary electrophoresis with laser-induced fluorescence detection. *J Chromatogr B* 752:17–31
- 28) Naito H (2002) *Poisoning of Industrial Products, Gases, Pesticides, Drugs, and Natural Toxin. Cases, Pathogenesis and its Treatment*, 2nd edn. Nankodo, Tokyo, pp 354–355 (in Japanese)
- 29) Stead AH, Moffat AC (1983) A collection of therapeutic, toxic and fatal blood drug concentrations in man. *Hum Toxicol* 2:437–464
- 30) Kwong TC, Laczin J, Baum J (1983) Self-poisoning with enteric-coated aspirin. *Am J Clin Pathol* 80:888–890
- 31) Shkrum MJ, Gay RM, Hudson P (1989) Fatal iatrogenic salicylate intoxication in a long-term user of enteric-coated aspirin. *Arch Pathol Lab Med* 113:89–90

## II.4.5 Antiepileptics

by Einosuke Tanaka

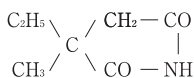
### Introduction

As antiepileptics, phenytoin, mephenytoin, nirvanol and ethotoin are being used for treatments of grand mal and complex partial seizures. A iminostilbene derivative carbamazepine, phenobarbital (one of the barbiturates) and some benzodiazepines are also being well used as antiepileptics (▶ *Figure 5.1*). Poisoning cases due to accidental and suicidal ingestion of these antiepileptics were reported [1].

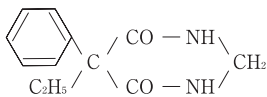
For analysis of antiepileptics, methods using HPLC [2–15], LC/MS [16], GC [17, 18] and GC/MS [19,20] were reported. Among them, HPLC methods are being used most commonly. In this chapter, two HPLC methods, dealing with analysis of phenytoin and other antiepileptics together with their metabolites in serum [11] and plasma [15], are presented.

■ **Figure 5.1**

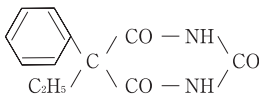
1 ethosuximide



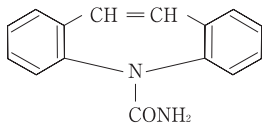
2 primidone



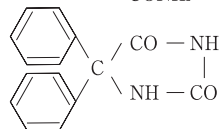
3 phenobarbital



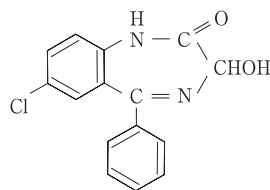
4 carbamazepine



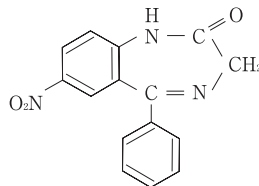
5 phenytoin



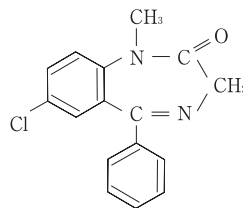
6 oxazepam



7 nitrazepam



8 diazepam



**Structures of antiepileptics and their analogs.**



## HPLC analysis of antiepileptics in serum [11]

### Reagents and their preparation

- Carbamazepine, ethosuximide, phenytoin, primidone, phenobarbital, diazepam, oxazepam, nitrazepam and 5-(4-methylphenyl)-5-phenylhydantoin (internal standard, IS) can be all purchased from Sigma (St. Louis, MO, USA).
- Each of above drugs is dissolved in methanol to prepare 1 mg/mL solution.
- By diluting the 1 mg/mL solution with methanol, solutions at various concentrations in the range of 0.05–5 µg/mL are prepared for drugs to be quantitated, because they are used for constructing each calibration curve.

### HPLC conditions

Column: a reversed phase column<sup>a</sup> (TSK gel super-ODS; 100 × 4.6 mm i. d., particle diameter 2 µm, Tohso, Tokyo, Japan).

Mobile phase: acetonitrile/8 mM phosphoric acid aqueous solution (3:7, v/v); its flow rate: 0.6 mL/min; detection wavelength: 215 nm; column (oven) temperature: room temperature.

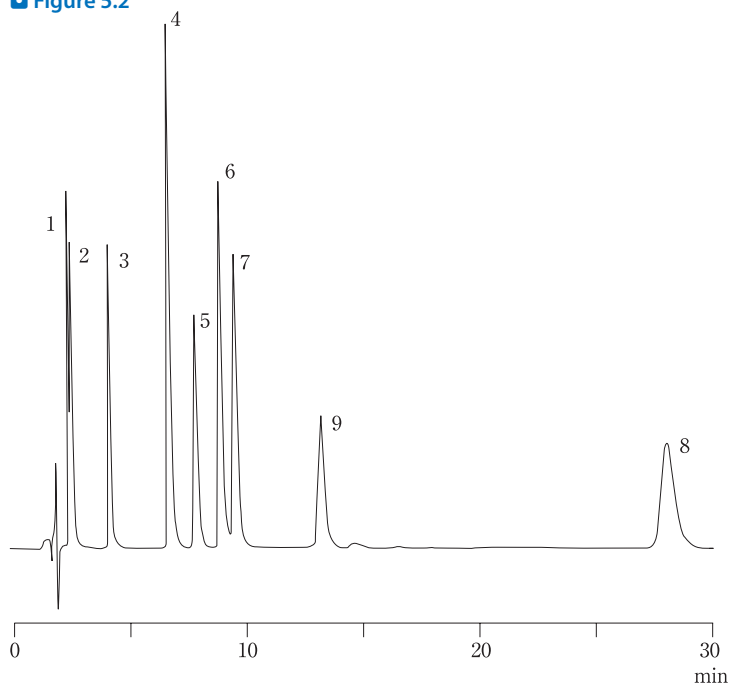
### Procedure

- i. A 0.5-mL volume of serum<sup>b</sup>, 100 µL of 0.2 M hydrochloric acid solution, 50 µL of IS solution and 3 mL dichloromethane are placed in a glass centrifuge tube with a ground-in stopper.
- ii. After shaking for 1 min, the tube is centrifuged.
- iii. The resulting organic phase (lower layer) is transferred to a glass vial with a conical bottom.
- iv. The organic extract is evaporated to dryness under a stream of nitrogen.
- v. The residue is dissolved in 100 µL mobile phase.
- vi. A fixed amount of the above solution is injected into HPLC.
- vii. For constructing calibration curves, various concentrations of standard solution are mixed with 50 µL IS solution each and processed according to the above procedure.

### Assessment of the method

➤ *Figure 5.2* shows an HPLC chromatogram for the eight antiepileptics listed in ➤ *Figure 5.1*, which had been spiked into human serum. The linearity of each compound could be obtained in the range of 0.05–1 µg/mL in serum; recovery rates were 96–104 %. The detection limits were: 0.05 µg/mL for carbamazepine; 0.1 µg/mL for primidone, phenobarbital, phenytoin<sup>c</sup>, oxazepam, ethosuximide, and nitrazepam; and 0.5 µg/mL for diazepam.

Figure 5.2



HPLC chromatogram for 8 antiepileptics spiked into human serum [11]. 1: ethosuximide (10  $\mu\text{g/mL}$ , retention time 2.6 min); 2: primidone (1  $\mu\text{g/mL}$ , 2.7 min); 3: phenobarbital (1  $\mu\text{g/mL}$ , 4.3 min); 4: carbamazepine (1  $\mu\text{g/mL}$ , 6.9 min); 5: phenytoin (1  $\mu\text{g/mL}$ , 8.0 min); 6: oxazepam (1  $\mu\text{g/mL}$ , 9.0 min); 7: nitrazepam (1  $\mu\text{g/mL}$ , 9.6 min); 8: diazepam (1  $\mu\text{g/mL}$ , 28.1 min); 9: 5-(4-methylphenyl)-5-phenylhydantoin (IS, 1  $\mu\text{g/mL}$ ).

## HPLC analysis of antiepileptics and some metabolites in plasma [15]

### Reagents and their preparation

- Ethosuximide, primidone, phenobarbital, carbamazepine, phenytoin and carbamazepine-epoxide can be purchased from Sigma. Lamotrigine, carbamazepine-diol and 9-hydroxy-methyl-10-carbamyl acridan were reported to be obtainable from Chiba-Geigy (Basel, Switzerland)<sup>d</sup>. These compounds are dissolved in methanol to prepare 1 mg/mL solution.
- By diluting the methanolic 1 mg/mL solution, various concentrations of some drugs in the range of 0.5–200  $\mu\text{g/mL}$  are prepared for constructing each calibration curve.

### HPLC conditions


Column: a reversed phase column<sup>a</sup>, Supelcosil LC-18 (150  $\times$  4.6 mm i.d., particle diameter 5  $\mu\text{m}$ , Supelco, Bellefonte, PA, USA).

Mobile phase: 0.01 M potassium dihydrogenphosphate solution/methanol/acetonitrile (65:18:17, v/v) (pH 7.5); detection wavelength: 220 nm; flow rate: 1 mL/min; column (oven) temperature: room temperature.

## Procedure<sup>e</sup>

- i. A 100- $\mu$ L aliquot of plasma<sup>b</sup> and 20  $\mu$ L IS solution are mixed for several seconds in a 2-mL volume microtube.
- ii. A 1-mL volume of diethyl ether is added to the above mixture.
- iii. After shaking for 5 min, the tube is centrifuged at 1,000 g for 10 min.
- iv. The organic phase (upper layer) is transferred to another clean microtube.
- v. The phase is evaporated to dryness under a stream of nitrogen.
- vi. The residue is dissolved in 100  $\mu$ L of the mobile phase.
- vii. A 20- $\mu$ L aliquot of the solution is injected into HPLC.
- viii. For constructing calibration curves, various concentrations of standard solutions are mixed with 20  $\mu$ L IS solution each and processed according to the above procedure.

## Assessment of the method

In this method, 6 kinds of antiepileptics (ethosuximide, primidone, lamotrigine, phenobarbital, phenytoin and carbamazepine) and two carbamazepine metabolites (carbamazepine-diol and carbamazepine-epoxide) can be detected from human plasma ( Figure 5.3). The detection limits of each drug was about 0.2  $\mu$ g/mL; recovery rates were 71–104 %.

## Toxic and fatal concentrations in blood [21]

Phenytoin: therapeutic, 7  $\mu$ g/mL (10–20  $\mu$ g/mL); toxic, 48  $\mu$ g/mL (30–60  $\mu$ g/mL); fatal, not lower than 70  $\mu$ g/mL (average 94  $\mu$ g/mL).

Carbamazepine: therapeutic, 6.4  $\mu$ g/mL (3.5–9.4  $\mu$ g/mL); toxic, 10.1  $\mu$ g/mL (3.2–20.6  $\mu$ g/mL); fatal, 19.6  $\mu$ g/mL.

Ethosuximide: therapeutic, 44  $\mu$ g/mL (13–71  $\mu$ g/mL); toxic, 100–200  $\mu$ g/mL; fatal, 250  $\mu$ g/mL.

Primidone: therapeutic, 10.5  $\mu$ g/mL (6–17.8  $\mu$ g/mL); toxic, 20–50  $\mu$ g/mL; fatal, 65  $\mu$ g/mL.

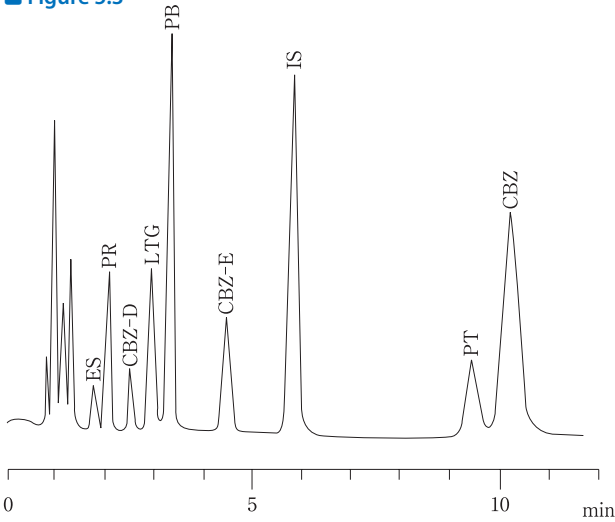
Diazepam: therapeutic, 0.05–2  $\mu$ g/mL; toxic, 2–5  $\mu$ g/mL; fatal, not lower than 5  $\mu$ g/mL.

Phenobarbital: therapeutic, 12.3  $\mu$ g/mL (4–26.2  $\mu$ g/mL); toxic, 16.7  $\mu$ g/mL (3.7–90  $\mu$ g/mL); fatal, 45  $\mu$ g/mL (4.3–120  $\mu$ g/mL).

Oxazepam: therapeutic, 0.5–2  $\mu$ g/mL; toxic, not lower than 2  $\mu$ g/mL; fatal, not clear.

Nitrazepam: therapeutic, 0.044  $\mu$ g/mL (0.026–0.066  $\mu$ g/mL); toxic, 0.2  $\mu$ g/mL (a single oral intake); fatal, 5.2–9  $\mu$ g/mL.

Figure 5.3



**HPLC chromatogram for 6 antiepileptics and two metabolites spiked into human plasma [15].**  
**ES:** ethosuximide (25 mg/mL, retention time 1.80 min); **PR:** primidone (2.5 mg/mL, 2.10 min);  
**CBZ-D:** carbamazepine-di-ol (1 mg/mL, 2.55 min); **LTG:** lamotrigine (1 mg/mL, 2.95 min);  
**PB:** phenobarbital (5 mg/mL, 3.33 min); **CBZ-E:** carbamazepine-epoxide (1 mg/mL, 4.48 min);  
**IS:** 9-hydroxymethyl-10-carbamyl acridan (IS, 5.92 min); **PT:** phenytoin (2.5 mg/mL, 9.45 min);  
**CBZ:** carbamazepine (2.5 mg/mL, 10.2 min).

## Poisoning cases

**Case 1** [22]: a 85-year-old female suffered from fever, muscle stiffness and itching exanthemas at home just before admission to a hospital. As her past history, she had experienced hysterectomy, ischemic heart disease and diabetes mellitus (type II). About one month before admission, she had been diagnosed as complex partial epileptic seizure and had daily taken 300 mg phenytoin (once at night), 500 mg metformin (twice a day), 500 mg tolbutamide (twice a day), 10 mg nifedipine (twice a day) and 1 mg risperidone (once a day). She had no history of smoking, and had quit drinking alcohol since the appearance of the epileptic attack. Upon medical examination for admission to a hospital, she complained of her bad general conditions; her physical conditions were: body temperature 38 °C, heart beat 90/min and blood pressure 120/70 mmHg. There were erythematous exanthemas and the characteristic stiffness of the neck; but neither photophobia nor other pathological neurological findings were observed. Antibiotic, corticosteroid and antihistaminic drugs were administered intravenously. All drugs for oral intake except phenytoin were discontinued on day 3 after admission. The administration of phenytoin was also stopped on day 7.

Benzodiazepine antiepileptics were used to control the attack; the functions of the kidney, liver and heart were aggravated. She died 12 days after admission. The concentration of blood phenytoin at admission was 13.6 µg/mL.

**Case 2** [23]: a 61-year-old female had been suffering from chronic headache and frequent vertigo. As a result of clinical tests, a meningioma had been discovered in the left fronto-peri-

etal lobe of her brain. It had been removed by surgery without any complication. After discharge from the hospital, she took 100 mg phenytoin every 8 h to prevent her from epileptic attack. Four days after her discharge, fever and nausea appeared; on the next day (on day 5 after discharge), itching erythematous exanthemas appeared and extended to the face, chest and extremities. Seven days after the appearance of the exanthemas, icterus, epigastric and right upper abdominal pains, bile-containing urine and polyuria appeared. Her family doctor stopped the administration of phenytoin and prescribed an antihistaminic drug. She had a past history of allergy against lorazepam, but not history of hepatitis, blood transfusion or alcohol intake. Upon visiting a university hospital, her physical conditions were: fever 38 °C, heart beat 90/min and blood pressure 120/80 mmHg. The erythematous exanthemas extended over almost whole skin of the body; in the neck and back, the exanthemas became desquamative. Clinical tests showed normal data except for the liver function. The blood phenytoin concentration was 0.95 µg/mL (normal value 10–20 µg/mL). The findings of liver biopsy showed extensive damages of hepatocytes associated with disarrangement of the lobules and with inflammatory cell infiltration into the portal vein and the parenchyma.

**Case 3** [24]: a 18-year-old male (body weight 60 kg) had attempted suicide by ingesting phenytoin capsules (amount ingested not clear); he had no history of epilepsy. Twelve hours after ingestion, he had been brought to a hospital in the semicomatose state. Just after admission, the blood phenytoin concentration was 45 µg/mL, but his vital signs were stable. The gastro-lavage was performed; but no capsules or their debris could not be found in the lavage fluids. The sounds of the intestinal peristalsis decreased slightly. Thereafter, the blood phenytoin level increased up to 114 µg/mL on the 5th day; in the second week, the level was 105 µg/mL. The patient was still in the state of delirium, which was not improved. Grand mal, which seemed to be secondary to the toxic encephalopathy, appeared twice. By the end of the 2nd week, the sound of intestinal peristalsis became audible; the blood phenytoin concentration decreased to 75 µg/mL. After 3 weeks of admission, the phenytoin could not be detected from his blood.

## Notes

- a) In many reports, reversed phase octadecyl ( $C_{18}$ ) chemical-bonded silica gel columns are being used.
- b) Blood, serum and plasma specimens are stable at  $-20\text{ }^{\circ}\text{C}$  for at least 4 weeks; they are stable at  $25\text{ }^{\circ}\text{C}$  for 24 h.
- c) Phenytoin has optical isomers. Their determination method is described in the reference [6].
- d) Lamotrigine and carbamazepine-diol are not obtainable in Japan; the analytical data of these compounds has been shown only as useful informations.
- e) For extraction of antiepileptics by solid-phase extraction, the following procedure can be recommended.
  - i. A 5-mL volume of 20 % methanol aqueous solution and 5 mL distilled water are passed through a Sep-Pak  $C_{18}$  cartridge (Waters, Milford, MA, USA) to activate it.
  - ii. A 1-mL volume of a serum specimen is poured into the cartridge.
  - iii. The cartridge is washed with 5 mL distilled water.
  - iv. The target compounds are eluted with 5 mL methanol.

- v. The residue is evaporated to dryness under a steam of nitrogen with warming at 40 °C.
- vi. The residue is dissolved in 100 µL of the mobile phase.
- vii. A fixed amount of the solution is injected into HPLC.
- viii. For construction of calibration curves, various concentrations of the standard solutions are processed according to the above procedure.

## References

- 1) Naito H (2002) Poisoning of Industrial Products, Gases, Pesticides, Drugs, and Natural Toxins. Cases, Pathogenesis and its Treatment, 2nd edn. Nankodo, Tokyo, pp 361–365 (in Japanese)
- 2) Rainbow SJ, Dawson CM, Tickner TR (1990) Direct serum injection high-performance liquid chromatographic method for the simultaneous determination of phenobarbital, carbamazepine and phenytoin. *J Chromatogr* 527:389–396
- 3) Szabo GK, Pylilo RJ, Perchalski RJ et al. (1990) Simultaneous separation and determination (in serum) of phenytoin and carbamazepine and their deuterated analogues by high-performance liquid chromatography-ultraviolet detection for tracer studies. *J Chromatogr* 535:271–277
- 4) Hannak D, Haux P, Scharbert F et al. (1992) Liquid chromatographic analysis of phenobarbital, phenytoin, and theophylline. *Wien Klin Wochenschr Suppl* 191:27–31
- 5) Maya MT, Farinha AR, Lucas AM et al. (1992) Sensitive method for the determination of phenytoin in plasma, and phenytoin and 5-(4-hydroxyphenyl)-5-phenylhydantoin in urine by high-performance liquid chromatography. *J Pharm Biomed Anal* 10:1001–1006
- 6) Liu H, Delgado M, Forman LJ et al. (1993) Simultaneous determination of carbamazepine, phenytoin, phenobarbital, primidone and their principal metabolites by high-performance liquid chromatography with photodiode-array detection. *J Chromatogr* 616:105–115
- 7) Kouno Y, Ishikura C, Homma M et al. (1993) Simple and accurate high-performance liquid chromatographic method for the measurement of three antiepileptics in therapeutic drug monitoring. *J Chromatogr* 622:47–52
- 8) Romanyshyn LA, Wichmann JK, Kucharczyk N et al. (1994) Simultaneous determination of felbamate, primidone, phenobarbital, carbamazepine, two carbamazepine metabolites, phenytoin, and one phenytoin metabolite in human plasma by high-performance liquid chromatography. *Ther Drug Monit* 16:90–99
- 9) Rambeck B, May TW, Jurgens MU et al. (1994) Comparison of phenytoin and carbamazepine serum concentrations measured by high-performance liquid chromatography, the standard TDx assay, the enzyme multiplied immunoassay technique, and a new patient-side immunoassay cartridge system. *Ther Drug Monit* 16:608–612
- 10) Johansen K, Krogh M, Andresen AT et al. (1995) Automated analysis of free and total concentrations of three antiepileptic drugs in plasma with on-line dialysis and high-performance liquid chromatography. *J Chromatogr B* 669:281–288
- 11) Tanaka E, Terada M, Misawa S et al. (1996) Simultaneous determination of eight antiepileptic drugs in human serum using a new reversed-phase chromatographic column based on a 2-micrometer porous microspherical silica gel. *Jpn J Forensic Toxicol* 14:182–190
- 12) Bhatti MM, Hanson GD, Schultz L (1998) Simultaneous determination of phenytoin, carbamazepine, and 10,11-carbamazepine epoxide in human plasma by high-performance liquid chromatography with ultraviolet detection. *J Pharm Biomed Anal* 16:1233–1240
- 13) Shimoyama R, Ohkubo T, Sugawara K et al. (1998) Monitoring of phenytoin in human breast milk, maternal plasma and cord blood plasma by solid-phase extraction and liquid chromatography. *J Pharm Biomed Anal* 17:863–869
- 14) May TW, Rambeck B, Jurgens U et al. (1998) Comparison of total and free phenytoin serum concentrations measured by high-performance liquid chromatography and standard TDx assay: implications for the prediction of free phenytoin serum concentrations. *Ther Drug Monit* 20:619–623
- 15) Matar KM, Nicholls PJ, Tekle A et al. (1999) Liquid chromatographic determination of six antiepileptic drugs and two metabolites in microsamples of human plasma. *Ther Drug Monit* 21:559–566
- 16) Abdel-Hamid ME (2000) Comparative LC-MS and HPLC analyses of selected antiepileptics and beta-blocking drugs. *Farmaco* 55:136–145

- 17) Kulpmann WR, Gey S, Beneking M et al. (1984) Determination of total and free phenytoin in serum by non-isotopic immunoassays and gas chromatography. *J Clin Chem Clin Biochem* 22:773–779
- 18) Chen K, Khayam-Bashi H (1991) Comparative analysis of antiepileptic drugs by gas chromatography using capillary or packed columns and by fluorescence polarization immunoassay. *J Anal Toxicol* 15:82–85
- 19) Speed DJ, Dickson SJ, Cairns ER et al. (2000) Analysis of six anticonvulsant drugs using solid-phase extraction, deuterated internal standards, and gas chromatography-mass spectrometry. *J Anal Toxicol* 24:685–690
- 20) Saisho K, Tanaka E, Nakahara Y (2001) Hair analysis for pharmaceutical drugs. I. Effective extraction and determination of phenobarbital, phenytoin and their major metabolites in rat and human hair. *Biol Pharm Bull* 24 : 59–64
- 21) Stead AH, Moffat AC (1983) A collection of therapeutic, toxic and fatal blood drug concentrations in man. *Hum Toxicol* 2:437–464
- 22) Carro JA, Senior J, Rubio CE et al. (1989) Phenytoin induced fatal hepatic injury. *Bol Assoc Med P Rico* 81:359–360
- 23) Mahadeva U, Al-Mrayat M, Steer K et al. (1999) Fatal phenytoin hypersensitivity syndrome. *Postgrad Med J* 75:734–736
- 24) Chaikin P, Adir J (1987) Unusual absorption profile of phenytoin in a massive overdose case. *J Clin Pharmacol* 27:70–73

## 11.4.6 Muscle relaxants

by Mayumi Nishikawa and Hitoshi Tsuchihashi

### Introduction

Muscle relaxants can be classified into the peripheral- and central-acting drug types (▶ Table 6.1). The drugs of the peripheral type are also called neuromuscular blocking agents. The peripheral-acting muscle relaxants are being used for muscle relaxation upon endotracheal intubation and/or general anaesthesia for surgical operation. The central-acting muscle relaxants are used for treatments of painful muscle contracture caused by locomotorial disorders, and for relaxation of muscle stiffness caused by psychotic tension or by neurosis. The cases of poisoning by the peripheral-acting muscle relaxants often take place, because of its strong suppressive action on respiration. However, their poisoning is rare at the scene of medical treatments, because the risk is usually avoided by artificial respiration. Most of poisoning incidents due to the peripheral-acting muscle relaxants are intentional and/or homicidal. In this chapter, therefore, analytical methods only for the peripheral-acting muscle relaxants (▶ Table 6.2) are dealt with. Since these drugs are quaternary ammonium salts, special care should be taken for their stability and efficient extraction [1].

### TLC analysis

#### Reagents and its preparation

- Tubocurarine chloride, suxamethonium chloride (succinylcholine chloride) and pancuronium bromide can be purchased from Sigma (St. Louis, MO, USA). For vecuronium bromide, pure powder is not commercially available; ampoule solution for medical use

■ Table 6.1

#### Classification of muscle relaxants

muscle relaxants	peripheral-acting	non-depolarizing type tubocurarine chloride (alkaloid type), pancuronium bromide and vecuronium bromide (other types)
	central-acting	depolarizing type suxamethonium chloride (choline type) chlorphenesin carbamate, phenprobamate and methocarbamol (carbamate type) chlorzoxazone (chlorzoxazone type) chlormezanone, dantrolene sodium, pridinol mesilate, afloqualone, eperisone hydrochloride, tolperisone hydrochloride, baclofen and tizanidine hydrochloride (other types)

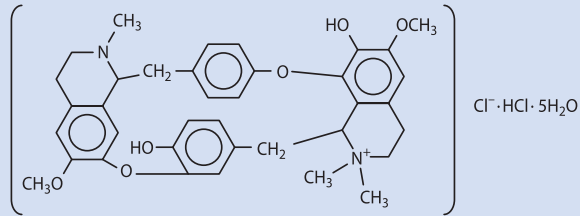


■ Table 6.2

Peripheral-acting muscle relaxants

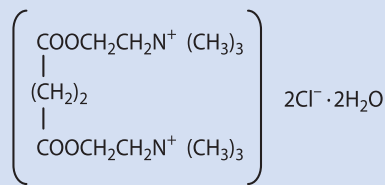
a) alkaloid type

tubocurarine chloride



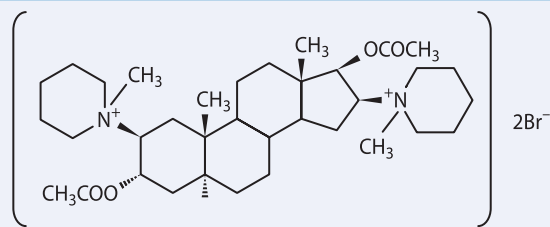
b) choline type

suxamethonium chloride

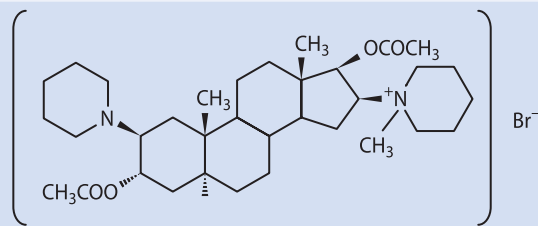


c) others

pancuronium bromide



vecuronium bromide



(Musculax) can be obtained from Japan Organon-Sankyo (Tokyo, Japan). Each standard compound is dissolved in methanol just before use<sup>a</sup>.

- Synthesis of succinylmonocholine iodide [2]: 2.3 g choline iodide and 5 g succinic anhydride are mixed and fused for reaction by heating the mixture at 140 °C for 1–2 h in an oil bath. After cooling to room temperature, the excessive (not reacted) succinic anhydride is washed with 100 mL acetone, succinyl monocholine iodide is crystallized in the mixture of methanol/acetone/diethyl ether.
- A 0.85-g aliquot of bismuth subnitrate is dissolved in a mixture of 40 mL distilled water and 10 mL acetic acid to prepare “A” solution. A 8-g aliquot of potassium iodide is dissolved in 20 mL distilled water to prepare “B” solution. Then, a mixture of A/B/acetic acid/distilled water (1:1:4:20, v/v) is prepared (Dragendorff reagent).

- A 1-mL aliquot of 10 % platinum chloride solution is mixed with 25 mL of 4 % potassium iodide and 24 mL distilled water (iodoplatinate reagent).

## TLC conditions

TLC plates: fluorescent compound-containing silica gel plates (Silica Gel 60 F<sub>254</sub>, Merck, Darmstadt, Germany).

Developing solvents<sup>b</sup>: ① 0.1 M hydrochloric acid solution/acetonitrile (1:1, v/v), ② methanol/tetrahydrofuran/5 % formic acid solution (7:7:6, v/v), ③ methanol/chloroform/acetic acid (5:4:1, v/v).

Detection reagents [3]: ④ Dragendorff reagent, ⑤ iodoplatinate reagent.

## Procedure

- A solution specimen without dilution or a powder specimen after dissolving in methanol is spotted on a TLC plate.
- The spot is developed with a developing solvent in a glass tank.
- After development, the plate is dried with a blower, and the spot is located under ultraviolet light at 254 nm.
- The plate is sprayed with each reagent<sup>c</sup>. The color and  $R_f$  value of the spot are compared with those of the authentic compound for tentative identification.

## Assessment of the method

In poisoning incidents with the muscle relaxants, the injection solution is occasionally left on the spot; in such a case, TLC is a simple and rapid method for identification.

The  $R_f$  values and the detection limits of the spots are shown in  Table 6.3.

**Table 6.3**

$R_f$  value and detection limits of the muscle relaxants observed by TLC

Compound	$R_f$ value			Detection limit ( $\mu$ g)		
	Developing solvents			UV and reagents		
	①	②	③	UV	④	⑤
suxamethonium	0.25	0.15	0.02	–	0.1	0.1
succinylmonocholine	0.37			–	1.0	
choline	0.46			–	0.1	
pancuronium	0.47	0.38	0.10*	–	0.1	0.1
vecuronium	0.51	0.47	0.27*	–	0.1	0.1
tubocurarine	0.59	0.52	0.20*	0.3	0.3	0.2

\*: tailing; –: no UV absorption; ①: 0.1 M HCl/acetonitrile (1:1, v/v); ②: methanol/tetrahydrofuran/5 % formic acid (7:7:6, v/v); ③: methanol/chloroform/acetic acid (5:4:1, v/v); ④: Dragendorff reagent; ⑤: iodoplatinate reagent

## Direct inlet MS analysis [4]

---

### Reagents and their preparation

- A 1-g aliquot of iodine and 2 g potassium iodide are dissolved in distilled water to prepare 20 mL solution ( $KI_3$ ).
- A 13.6-g aliquot of potassium dihydrogenphosphate is dissolved in distilled water to prepare 100 mL solution. A 14.2-g aliquot of disodium hydrogenphosphate is dissolved in distilled water to prepare 100 mL solution. Appropriate amounts of the above two solutions are mixed to obtain phosphate buffer solution at pH 5.0.

### MS conditions

Instrument: an MS QP-5050 mass spectrometer with a direct inlet probe (Shimadzu Corp., Kyoto, Japan); ionization: electron impact ionization (EI) and chemical ionization (CI) modes.

Probe conditions: temperature program at 40 °C/min from 30 to 350 °C.

### Procedure

- i. A 1-mL volume of urine, 1 mL of the phosphate buffer solution (pH 5.0), 100  $\mu$ L  $KI_3$  solution and 1 mL dichloromethane are placed in a glass centrifuge tube with a ground-in stopper, which had been treated with silane, and shaken vigorously for 3 min for extraction.
- ii. After the tube is centrifuged, the organic phase (lower layer) is transferred to a small glass vial with a silicone cap. The organic extract is evaporated to dryness under a stream of nitrogen at room temperature.
- iii. The residue is dissolved in 50  $\mu$ L dichloromethane and a 3- $\mu$ L aliquot of it is placed in a sample tube of the direct inlet probe followed by the evaporation of the solvent.
- iv. MS analysis is performed in the EI mode and in the CI mode with isobutane as reagent gas.

### Assessment of the method

Fragment ions for the muscle relaxants observed in both EI and CI modes are shown in

➤ *Table 6.4.*

$KI_3$  was used as an ion-pairing reagent for extraction of the ionized drugs; other organic ion-pairing reagents can be used [5], but  $KI_3$  is suitable for the mass spectral measurements, because the inorganic  $KI_3$  does not almost interfere with the measurements.

Table 6.4

Principal fragment ions of the muscle relaxants detected by direct inlet MS

Compound	m/z (relative intensity, %)	
	EI	CI
suxamethonium	58 (100), 71 (30)	191 (100), 261 (45)
pancuronium	467 (100), 340 (40)	416 (100), 543 (70), 483 (30)
vecuronium	425 (100), 467 (50)	374 (100), 501 (75), 543 (20)
tubocurarine	298 (100), 594 (25)	264 (100), 306 (40), 320 (35)

## LC/MS/MS analysis

### Reagents and their preparation

- A 0.63-g aliquot of ammonium formate is dissolved in distilled water to prepare 1,000 mL solution. The pH of the solution is adjusted to 6 by adding formic acid or ammonia water (10 mM, pH 6.0).
- A 0.83-mL volume of concentrated hydrochloric acid is diluted with distilled water to prepare 100 mL solution, followed by addition of 100 mL methanol (0.1 M hydrochloric acid solution/methanol, 1:1, v/v).

### LC/MS/MS conditions

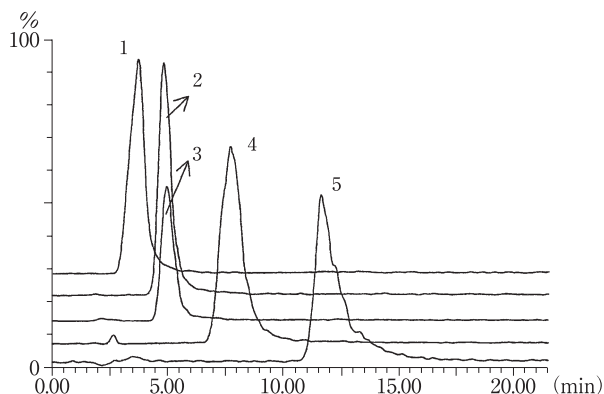
Instrumental conditions; instrument: a Quattro LC/MS instrument (Micromass, Manchester, UK); interface: electrospray ionization (ESI); ionization: positive mode; capillary voltage: 3.7 kV; cone voltage: 25 V; ion source temperature: 100 °C; collision gas: argon ( $2.3 \text{ e}^{-3}$  mbarr); collision energy: 23 V.

HPLC column<sup>d</sup>: TSK gel VMPak-25 (75 × 2.0 mm i. d., Tosoh, Tokyo, Japan); mobile phase: 15 mM ammonium formate solution/acetonitrile (30:70, v/v); its flow rate: 0.08 mL/min.

### Procedure

- A 5-mL volume of methanol, 5 mL distilled water and 10 mL of 10 mM formate buffer solution (pH 6.0) are passed through a Bond Elut CBA cartridge (Varian, Harbor City, CA, USA)<sup>e</sup> to activate it.
- Urine or tissue supernatant<sup>f</sup> is directly poured into the cartridge; serum is diluted 2-fold with distilled water, and a 1–3 mL volume of the solution is mixed with an equal volume of 10 mM formate buffer solution (pH 6.0), followed by application to the cartridge.
- The cartridge is washed with 2 mL distilled water.
- A target compound is eluted from the cartridge with 2 mL of 0.1 M hydrochloric acid solution/methanol (1:1, v/v).
- An fixed volume of the eluate<sup>g</sup> is injected into LC/MS/MS.

■ **Figure 6.1**



Mass chromatogram for some muscle relaxants obtained by LC/MS/MS. 1: succinylmonocholine ( $m/z$  145); 2: vecuronium ( $m/z$  356); 3: pancuronium ( $m/z$  430); 4: tubocurarine ( $m/z$  521); 5: suxamethonium ( $m/z$  130).

## Assessment of the method

By this method, the muscle relaxants in urine, serum and tissue homogenate can be extracted, but especially suxamethonium (succinylcholine) is rapidly hydrolyzed in blood by the action of cholinesterase; since it is very difficult to detect the drug from blood, its detection should be made with a urine specimen. In animal experiments for suxamethonium administration to rats, it was possible to detect the drug from the liver, kidney and heart [6].

➤ *Figure 6.1* shows mass chromatograms for some muscle relaxants obtained with product ions formed by LC/MS/MS. ➤ *Table 6.5* shows principal ions of product ion mass spectra for the drugs.

The peripheral-acting muscle relaxants generally have ionized structures of quaternary ammonium salts. Therefore, LC/MS with an ESI interface is most suitable for obtaining molecular ions. It is also possible to analyze them by thermospray ionization [5], atmospheric pressure chemical ionization and frit fast atom bombardment ionization [6] methods; however, in these methods, fragment ions are generally more intense than the molecular ones. As a characteristic of the ESI method, polyvalent ions can appear; in this method, bivalent molecular ions appear for the 4 muscle relaxants (➤ *Table 6.5*). However, it should be noted that spectrum patterns are different according to the types of instruments and conditions, even if

■ **Table 6.5**

Principal product ions for the muscle relaxants observed by MS/MS analysis

Compound	Precursor ion	Product ion $m/z$ (relative intensity, %)
suxamethonium	$M^{2+}$	130 (100), 158 (35), 204 (15)
succinylmonocholine	$M^+$	145 (100)
pancuronium	$M^{2+}$	430 (100), 206 (50), 332 (30)
vecuronium	$[M+H]^{2+}$	356 (100), 398 (40), 249 (25)
tubocurarine	$M^{2+}$	521 (100), 254 (80), 552 (70)

their interfaces are equally ESI; the patterns should be checked on every occasion of instrumental analysis.

The detection limits of the drugs in the selected reaction monitoring mode were 2–20 ng/mL.

## Poisoning cases, and toxic and fatal concentrations

The depolarizing-type muscle relaxant suxamethonium is bound with acetylcholine receptors of the neuromuscular junctions to produce continuous depolarization, resulting in temporary muscle contraction followed by muscle flaccidness. The non-depolarizing type muscle relaxants, such as tubocurarine, pancuronium and vecuronium, are also bound with acetylcholine receptors of the neuromuscular junctions competitively with acetylcholine to inhibit depolarization, resulting in muscle flaccidness. All of the above muscle relaxants act on the diaphragmatic muscle to suppress respiration; only in their therapeutic doses, the spontaneous respiration stops resulting in danger of life without any artificial respiration. Suxamethonium is usually administered in the dose of 0.8–1.0 mg/kg to gain muscle flaccidness in about 1 min; the muscle activities recover after several minutes. Pancuronium is administered in the dose of 0.08–0.1 mg/kg to produce muscle flaccidness in 1–2 min, which continues for 40–60 min.

Acute toxic effects of suxamethonium, pancuronium and vecuronium expressed as their LD<sub>50</sub> values (mg/kg) were: 0.53 (rabbits, intravenous) [7], 0.036–0.047 (mice, intravenous) [8, 9] and 0.051 (mice, intravenous) [10], respectively. Usually the LD<sub>50</sub> values are lowest by their intravenous administration; by the subcutaneous and intraperitoneal injections, the LD<sub>50</sub> values are several to ten times higher. By oral administration, the values are several hundred to several thousand times higher; it is said that the absorption of the muscle relaxants from the digestive tract is very low.

The concentrations of pancuronium in suicidal cases by its intravenous injection were 0.3 and 0.9 µg/mL in blood and urine, respectively [11]; and 0.26 and 2.0 µg/mL in blood and urine, respectively [12].

The analysis of suxamethonium in a patient receiving intravenous injection of the drug at 2 mg/kg showed its concentrations in blood plasma of about 40, 2.4 and 0.5 µg/mL at 0.5, 4.5 and 15 min after the injection [13]. By intravenous injection of 1 mg/kg suxamethonium, its concentrations of 44.4 µg/mL and 80 ng/mL in blood plasma were obtained 47.5 s and 7 min after the injection [14]. After intravenous administration of 0.5 mg/kg tubocurarine to 7 subjects, 4.49–61.4 µg/mL of the drug was found in their urine within 24 h after the administration [15]. After intravenous injection of 0.1 mg/kg vecuronium in a patient, blood plasma concentrations of the drug at about 4,000 ng/mL immediately after injection and at only 5 ng/mL 5 h after were detected [16]. After intravenous injection of 4 mg pancuronium, serum concentrations of the drug were 0.6 and 0.07 µg/mL 5 min and 4 h after the administration, respectively [17].

## Notes

- a) Since these compounds are easily hydrolyzed under alkaline and neutral conditions, the standard solutions should be prepared just before use. Suxamethonium is easily hydrolyzed in alkaline solution; at above pH 7.5, it is rapidly decomposed by incubation at 37 °C for 10 min [18]. However, there is a report describing that it was stable at 4 °C for 6–8 weeks at pH 5 [19]; it is stable under weakly acidic conditions. The authors have also confirmed that decomposition of suxamethonium is suppressed at pH 4. Succinylmonocholine, a metabolic or decomposition product of suxamethonium, is relatively stable in neutral aqueous solution.
- b) On a silica gel TLC plate, the quaternary amino groups tend to adsorb to the silanol group; it is, therefore, essential to use acidic developing solvents for TLC separation of the muscle relaxants.
- c) Suxamethonium, pancuronium and vecuronium show no UV absorption; it is difficult to detect their spots under ultraviolet light. The colors of the spots are orange for all drugs (reddish orange for choline) with the Dragendorff reagent and dark brown with the iodoplatinate reagent.
- d) For the HPLC column, aqueous type GPC packing material is used. It is preferable to use semimicrocolumns with 2.0 mm internal diameter. Except TSK gel VMPak-25 (Tosoh), Asahi-Pak GS-320 and GF-310 (Shodex, Tokyo, Japan), and Develosil Diol-5 (Nomura Kagaku, Aichi, Japan) can be used with their semimicro-sizes. For each of the above columns, a mobile phase of ammonium formate/acetonitrile or ammonium acetate/acetonitrile can be used. With ODS-type columns, trifluoroacetic acid can be added to a mobile phase as an ion-pairing reagent for analysis of the quaternary amino muscle relaxants [6].
- e) For solid-phase extraction of the drugs, weak cation-exchanger cartridges are used. In this case, the packing material is of carboxylic acid-type. When strong cation-exchanger cartridges of sulfonic acid-type packing material are used, it is difficult to elute the drugs because of firm ionic binding. The extraction of the muscle relaxants with Bond Elut C<sub>1</sub> cartridges was also reported [14, 16].
- f) The organ tissue is minced; a 3-g aliquot of the minced tissue is homogenized with 4 mL distilled water, deproteinized with 1 mL of 1.2 M perchloric acid solution and centrifuged. The pH of the supernatant fraction is adjusted to 6 with ammonia water before application to the cartridge.
- g) When a glassware is used for condensation of the eluate, there is a possibility of loss of the analyte due to its adsorption to the glassware. It is preferable to use a plastic container for condensation under a stream of nitrogen with mild heating (to avoid decomposition of the analyte).

## References

- 1) Tsuchihashi H, Nishikawa M (1995) Analysis of quaternary ammonium drugs. *Jpn J Forensic Toxicol* 13:1–10 (in Japanese with an English abstract)
- 2) Phillips AP (1953) Preparation of the monocholine ester of succinic acid and some related derivatives. *J Am Chem Soc* 75:4725–4727
- 3) The Pharmaceutical Society of Japan (ed) (1992) *Standard Methods of Chemical Analysis in Poisoning – With Commentary*. 4th ed., Nanzando, Tokyo, p 151, p 175 (in Japanese)

- 4) Nisikawa M, Tatsuno M, Suzuki S et al. (1991) The analysis of quaternary ammonium compounds in human urine by direct inlet electron impact ionization mass spectrometry. *Forensic Sci Int* 51:131–138
- 5) Nishikawa M, Tatsuno M, Tsuchihashi H et al. (1994) The analysis of quaternary ammonium compounds in human urine by thermospray liquid chromatography-mass spectrometry. *Jpn J Toxicol Environ Health* 40:534–541 (in Japanese with an English abstract)
- 6) Tsuchihashi H, Nishikawa M, Tatsuno M (1997) The analytical procedure by Frit-FAB LC-MS and detectable period of suxamethonium in rat tissues. *Jpn J Toxicol Environ Health* 43:108–113 (in Japanese with an English abstract)
- 7) Nagata R (1958) Pharmacological study on muscle relaxants, Part 1. The mechanisms of effects of various muscle relaxants. *J Tokyo Med Univ* 16:295–311 (in Japanese with an English abstract)
- 8) Suzuki Y, Masuda H, Tanase H et al. (1970) The safety test of pancuronium bromide. *Ann Sankyo Res Lab* 22:187–208 (in Japanese with an English abstract)
- 9) Buckett WR, Marjoribanks CEB, Marwick FA et al. (1968) The pharmacology of pancuronium bromide (Org. NA97), a new potent steroidal neuromuscular blocking agent. *Br J Pharmacol Chemother* 32:671–682
- 10) Kaneko Y, Sano M, Kamiya H et al. (1986) Acute intoxication tests of OrgNC45 by its oral, intravenous and intraperitoneal administrations using rats and mice. *Clin Rep* 20:807–816 (in Japanese)
- 11) Yashiki M, Miyazaki T, Iwasaki Y et al. (1992) A case of suicide by an intravenous injection of pancuronium. *Jpn J Legal Med* 46:282–285 (in Japanese with an English abstract)
- 12) Uemura K, Fujimiya T, Komura S et al. (1994) An autopsy case of pancuronium intoxication. *Jpn J Legal Med* (48) (suppl.):190 (in Japanese)
- 13) Lagerwerf AJ, Vanlinthout LEH, Vree TB (1991) Rapid determination of succinylcholine in human plasma by high-performance liquid chromatography with fluorescence detection. *J Chromatogr* 570:390–395
- 14) Roy JJ, Boismenu D, Gao H et al. (2001) Measurement of succinylcholine concentration in human plasma by electrospray tandem mass spectrometry. *Anal Biochem* 290:238–244
- 15) Annan RS, Kim C, Martyn J (1990) Measurement of D-tubocurarine chloride in human urine using solid-phase extraction and reversed-phase high-performance liquid chromatography with ultraviolet detection. *J Chromatogr* 526:228–234
- 16) Ducharme J, Varin F, Bevan DR et al. (1992) High-performance liquid chromatography-electrochemical detection of vecuronium and its metabolites in human plasma. *J Chromatogr B* 573:79–86
- 17) McLeod K, Watson MJ, Rawlins MD (1976) Pharmacokinetics of pancuronium in patients with normal and impaired renal function. *Br J Anaesth* 48:341–345
- 18) Ikarashi Y, Hada T, Way EL et al. (1990) Determination of succinylcholine hydrolytic enzyme activity in human plasma. *J Chromatogr* 533:23–33
- 19) Stevens HM, Moffat AC (1974) A rapid screening procedure for quaternary ammonium compounds in fluids and tissues with special reference to suxamethonium (succinylcholine). *J Forensic Sci Soc* 14:141–148



## 11.4.7 $\beta$ -Blockers

by Makoto Ueki

### Introduction

$\beta$ -Blockers ( $\beta$ -adrenergic receptor antagonists) block the effects of catecholamines on signal transmission through  $\beta$ -receptors; they cause hypotension by decreasing the heart beat rate and cardiac output, and prevent the attacks of arrhythmia and angina pectoris. In the brain, the drugs attenuate migraine by suppressing the dilation of blood vessels; in the eye, they decrease intraocular pressure by suppressing the production of aqueous humor. Since the drugs are also effective in suppressing muscle quivering and in suppressing overreaction of the thyroid gland upon being too nervous, they are used as doping drugs in competitive sports such as shooting and archery, which require psychic powers of concentration rather than aerobic performance. As untoward effects of these drugs, chill of extremities due to the contraction of vessels and aggravation of bronchial asthma due to contraction of the bronchi can be mentioned.

The drugs can be classified into  $\beta_1$ - and  $\beta_2$ -blockers; the  $\beta_1$ -receptors are mainly located in the heart muscle, while the  $\beta_2$ -receptors located in the smooth muscles of the airways and blood vessels. The  $\beta_1$ -blockers specifically exert blocking action on the  $\beta_1$ -receptors; otherwise, the  $\beta$ -blockers act on both  $\beta_1$ - and  $\beta_2$ -receptors.

The  $\beta$ -blockers are structurally classified into isopropylamino drugs such as propranolol and tertiary butylamino drugs such as nadolol; and many products containing 26 kinds of  $\beta$ -blockers are commercially available in Japan. The metabolism of  $\beta$ -blockers depends upon the hydrophobicity of their side chain structures. The drugs with hydrophilic side chains, such as atenolol, labetalol and nadolol, are excreted into urine in unchanged forms, while the drugs with hydrophobic side chains are excreted into urine in the glucuronide-conjugated forms after their hydroxylation. Therefore, it is almost difficult to detect unchanged forms of drugs from urine for such hydrophobic  $\beta$ -blockers. The concentration ratio of a metabolite to its precursor drug in urine and the location to be hydroxylated in a drug structure are different according to races and individuals; care should be taken especially when the foreign literature is searched on the metabolism of  $\beta$ -blockers.

### HPLC analysis

---

#### Reagents and their preparation

- Many of the authentic standards of  $\beta$ -blockers can be purchased from Sigma (St. Louis, MO, USA); when compounds are not commercially available, they were directly obtained from their manufacturers with request. Ethyltheophylline<sup>a</sup>, to be used as internal standard (IS), is synthesized by heating theophylline (Sigma) and twice-molar ethyl iodide at 60 °C overnight in acetone in the presence of potassium carbonate. Other common chemicals used were of the highest purity commercially available

- Solid carbonate buffer: the powder of sodium carbonate is mixed with a half-weight of the powder of sodium bicarbonate, and the mixture is well ground in a mortar and stored in a dry state
- IS solution: ethyltheophylline is dissolved in methanol to prepare 100  $\mu\text{g}/\text{mL}$  solution
- Mobile phases for HPLC: mobile phase A, acetonitrile/phosphoric acid/distilled water (15:0.1:85, v/v); mobile phase B, acetonitrile/phosphoric acid/distilled water (60:0.1:40, v/v).

## HPLC conditions

Separation column: Nucleosil7C<sub>18</sub> (250  $\times$  4.6 mm i. d., Macherey-Nagel, Düren, Germany).

HPLC conditions; instrument: L-6200 type<sup>b</sup> (Hitachi Ltd., Tokyo, Japan); autosampler: WISP 714 plus (Waters, Milford, MA, USA); flow rate: 1.5 mL/min. Gradient elution is linearly made from 100 % A to 100 % B during 8 min after injection. Detector: HP1040DAD (Agilent Technologies, Palo Alto, CA, USA); detection wavelengths: 216, 254 and 275 nm, because of low specificity of the detection by ultraviolet absorbance.

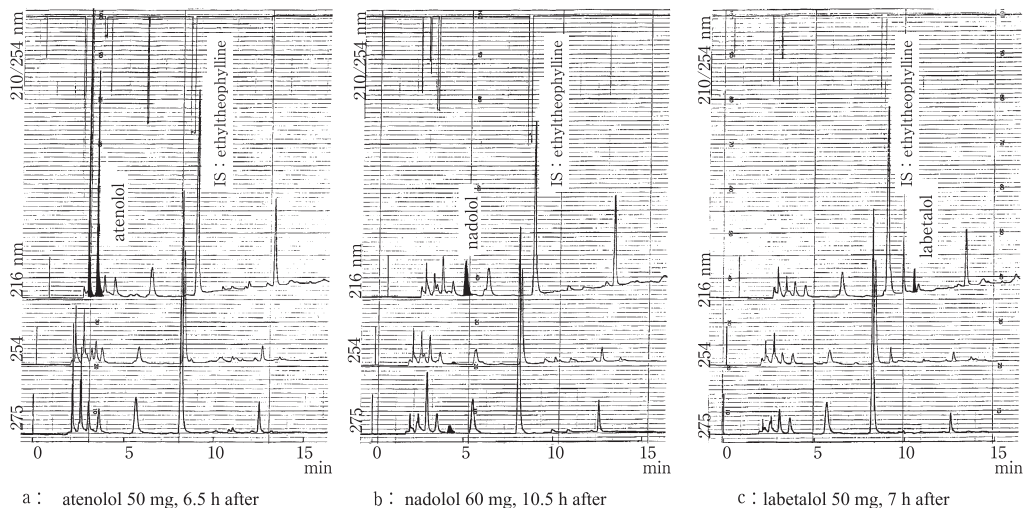
## Procedure

- i. A 1-mL volume of a specimen, 50  $\mu\text{L}$  IS solution (containing 5  $\mu\text{g}$  ethyltheophylline) and 0.5 g of solid carbonate buffer are placed and mixed well in a glass centrifuge tube with a ground-in stopper, followed by the addition of 5 mL diethyl ether and gentle shaking for 5 min.
- ii. After centrifugation at 1,000 g for 5 min, the ether phase is transferred to a vial and evaporated to dryness under a stream of nitrogen.
- iii. The residue is dissolved in 300  $\mu\text{L}$  methanol and a fixed aliquot of it is injected into HPLC<sup>c</sup>.
- iv. Blank specimens are spiked with various concentrations of the authentic standard of a drug and the IS, and are processed according to the above procedure to construct each calibration curve. By applying the peak area ratio of a specimen to the calibration curve, the concentration of a target compound is calculated.

## Assessment of the method

► *Figure 7.1* shows HPLC chromatograms for atenolol, nadolol and labetalol extracted from urine of their users. Atenolol is eluted just after the void volume; however, since it has a couple of asymmetric carbon atoms in its structure and produces two peaks due to the isomers, its identification is relatively easy. Nadolol could be detected until about 7 h after single administration, but it has no characteristic absorbance maximum and lacks in specificity; it should be careful to identify nadolol by HPLC. The detection limit of the  $\beta$ -blockers was about 100 ng/mL (10 ng on-column).

■ **Figure 7.1**



HPLC chromatograms for  $\beta$ -blockers extracted from urine of subjects, who had ingested each of them. The results were obtained after single oral intake of each drug. In the analysis of atenolol, double peaks appeared for this drug, because of two asymmetrical carbon atoms present in its structure.

## Simultaneous GC/MS analysis of $\beta$ -blockers and their metabolites [1–3]

### Reagents and their preparation

- Acquisition of the authentic standard drugs and their preparation are the same as described in the HPLC analysis section
- 1 M Phosphate buffer solution (pH 7.0): a 34.0-g aliquot of potassium dihydrogenphosphate is dissolved in distilled water, followed by adjustment of the solution to pH 7.0 with 10 M NaOH; then the final volume is adjusted to 250 mL
- Solid carbonate buffer: the powder of sodium bicarbonate is mixed with a half-weight of potassium carbonate powder, and the mixture is well ground in a mortar and stored in a dry state
- Derivatization reagents: *N*-methyl-*N*-(trimethylsilyl)trifluoroacetamide (MSTFA) and *N*-methyl-bis(trifluoroacetamide) (MBTFA) were purchased from Macherey-Nagel (Düren, Germany)
- IS solution<sup>d</sup>: bupranolol is dissolved in ethanol to prepare 0.2 mg/mL solution.

### GC/MS conditions

Instrument<sup>e</sup>: HP-5970MSD (Agilent Technologies)

GC column: Ultra-II (12.5 m  $\times$  0.25 mm i. d., film thickness 0.33  $\mu$ m, Agilent Technologies)

Flow rate: 1 mL/min (about 20 kPa/cm<sup>2</sup> of He pressure at 100 °C); injection temperature: 300 °C; split ratio = 11:1; sample volume to be injected: 2  $\mu$ L; ionization mode: EI; electron energy: 70 eV; ion multiplier: auto tune + 300 V

The range in the scan mode:  $m/z$  50–600; dwell time of each ion in the SIM mode: 30 ms/ion. The measurements are made for the following 3 groups by switching them according to retention times.

Ion group 1: from 2.5 min of retention time

$m/z$  86, 129, 200, 284, 365, 373, 427, 478, 479, 505, 526 and 559

Ion group 2: from 5.1 min of retention time

$m/z$  86, 129, 235, 250, 284, 344, 348, 421, 448, 478, 488, 497, 510 and 526

Ion group 3: from 6.0 min of retention time

$m/z$  86, 91, 129, 284, 292, 478 and 515.

## Procedure

- i. A 5-mL volume of urine, 50  $\mu$ L IS solution (containing 10  $\mu$ g bupranolol), 1 mL of 1 M phosphate buffer (pH 7) and 30  $\mu$ L of  $\beta$ -glucuronidase K-2 (3 units, Roche Diagnostics GmbH, Mannheim, Germany) are placed in a glass centrifuge tube with a ground-in stopper, and incubated at 50 °C for 60 min for hydrolysis.
- ii. The hydrolyzed solution is mixed with 5 mL diethyl ether and gently shaken for 5 min for washing the aqueous phase. After removal of the organic phase, 1 mL 2-methylpropanol and about 0.1 g of solid carbonate buffer are added to the aqueous phase and mixed well.
- iii. A 5 mL volume of diethyl ether<sup>f</sup> and 3 g anhydrous sodium sulfate are added to the above aqueous phase, gently shaken for 20 min and centrifuged at 1,000 g for 5 min. The resulting ether phase is transferred to a glass vial with a screw cap and evaporated to dryness under a stream of nitrogen.
- iv. The residue is dissolved in 50  $\mu$ L MSTFA, followed by heating at 50 °C for 5 min after capping the vial for TMS derivatization. After cooling to room temperature, 15  $\mu$ L MBTFA is added to the mixture, followed by heating at 50 °C for 15 min for TFA derivatization. Since the reactions are dependent upon equilibrium, the reaction solution should not be evaporated, but directly injected into GC/MS.
- v. The calibration curves are constructed for quantitation in the same way as that of HPLC analysis.

## Assessment and some comments on the method

► *Figure 7.2* shows an example of mass chromatograms of GC/MS for the extract of urine, into which  $\beta$ -blockers and their metabolites had been spiked. In the automatic searching system of the author, the presence or absence of a  $\beta$ -blocker is displayed after calculating the expected retention time of a candidate drug from the actually measured retention time of IS and the relative retention time of the compound listed in ► *Table 7.1*. Isopropylamino  $\beta$ -blockers and their metabolites, such as alprenolol, oxprenolol, metoprolol, atenolol, propranolol and acebutolol, can be detected in mass chromatograms at  $m/z$  284 and 129

Table 7.1

Indicators for GC/MS analysis of  $\beta$ -blockers

$\beta$ -Blocker	Compound(s) to be detected	Derivatization	Relative retention time*	M. W.	Monitor ions ( $m/z$ )	
acebutolol	acebutolol	<i>N</i> -TFA- <i>O</i> -TMS	2.313	504	284	129
	acetylcebutolol	<i>N</i> -TFA- <i>O</i> -TMS	2.196	476	284	129
alprenolol	hydroxyl alprenolol	<i>N</i> -TFA-bis- <i>O</i> -TMS	1.618	505	284	505
atenolol	atenolol	<i>N</i> -TFA-bis- <i>O</i> -TMS	1.630	559	284	559
betaxolol	betaxolol	<i>N</i> -TFA- <i>O</i> -TMS	2.039	475	284	129
bisoprolol	bisoprolol	<i>N</i> -TFA- <i>O</i> -TMS	2.027	493	284	129
carteolol	carteolol	bis- <i>O</i> -TMS	1.871	436	235	421
celiprolol	celiprolol	bis- <i>O</i> -TMS	1.643	450	86	200
esmolol	esmolol	<i>N</i> -TFA- <i>O</i> -TMS	1.871	448	284	448
labetalol	labetalol (racemic mixture)	nitril- <i>N</i> -TFA-bis- <i>O</i> -TMS	2.442	550	292	91
		nitril- <i>N</i> -TFA-bis- <i>O</i> -TMS	2.476	550	292	91
levobunolol	levobunolol	<i>O</i> -TMS	1.792	363	86	348
metoprolol	hydroxyl metoprolol	<i>N</i> -TFA-bis- <i>O</i> -TMS	1.793	523	284	478
mepindolol	mepindolol	bis- <i>N</i> , <i>N</i> -TFA- <i>O</i> -TMS	1.781	526	284	526
nadolol	nadolol	tris- <i>O</i> -TMS	1.970	525	86	510
oxprenolol	oxprenolol	<i>N</i> -TFA- <i>O</i> -TMS	1.278	433	284	129
	hydroxyl oxprenolol	<i>N</i> -TFA-bis- <i>O</i> -TMS	1.160	521	284	129
penbutolol	hydroxyl penbutolol	<i>N</i> -TFA-bis- <i>O</i> -TMS	1.797	451	86	250
pindolol	pindolol	<i>N</i> -TFA-bis- <i>N</i> , <i>O</i> -TMS	2.061	488	284	488
propranolol	propranolol	<i>N</i> -TFA- <i>O</i> -TMS	1.708	427	284	427
	4-hydroxyl propranolol	<i>N</i> -TFA- <i>O</i> -TMS	2.148	515	284	515
sotalol	sotalol	<i>N</i> -TFA-bis- <i>N</i> , <i>O</i> -TMS	1.851	512	344	497
timolol	timolol	<i>O</i> -TMS	1.627	388	86	373
IS	bupranolol	<i>N</i> -TFA- <i>O</i> -TMS	1.000	439	86	

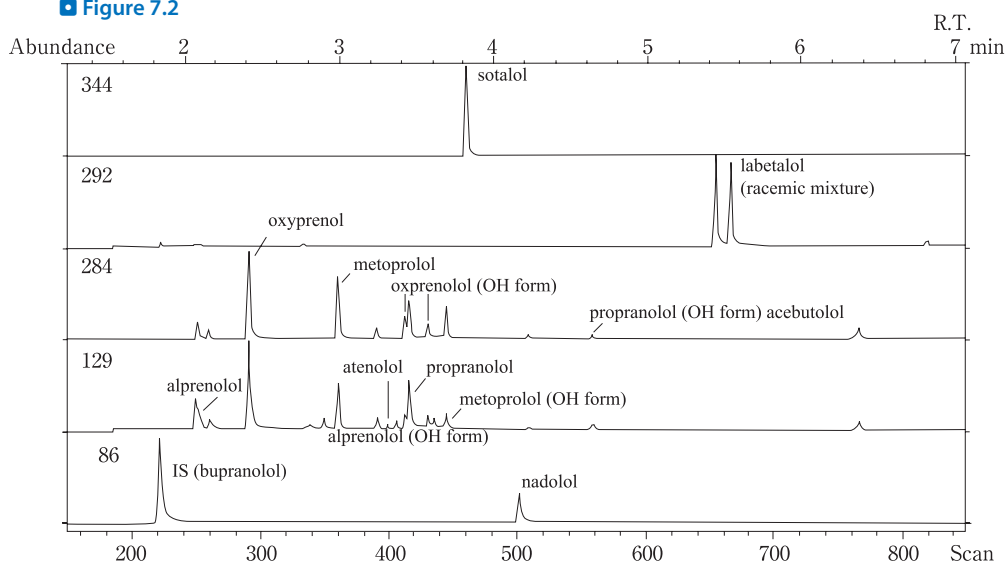
\* Relative retention time: retention times of each compound, when that of IS is assumed as 1.000.

(Fig. 7.2). By examining a pattern (abundance ratios among diagnostic ion traces) of a mass spectrum of a compound, it is easy to discriminate a target compound from an impurity peak. The tertiary butylamino  $\beta$ -blockers are simultaneously detected by mass chromatography at  $m/z$  86; the  $\beta$ -blockers with characteristic structures, such as sotalol and labetalol, can be detected with high sensitivity using their proper ions.

The detection limit of  $\beta$ -blockers obtained by mass chromatography of GC/MS is about 10 ng/mL (about 150 pg on column), while that by HPLC was 100 ng/mL (10 ng on-column).

Table 7.1 summarizes the names of  $\beta$ -blockers and their metabolites detected, the structures of derivatives, relative retention times to that of IS, molecular weights of derivatives and two representative fragment ions each, obtained from urine extracts of volunteers, who had received single oral administration of each  $\beta$ -blocker under informed consent. The metabolites hydroxylated at the aromatic rings followed by its glucuronide conjugation are found in common with most  $\beta$ -blockers; especially for alprenolol, metoprolol, penbutolol and propranolol, the amounts of metabolites to be excreted into urine are larger than those of their unchanged forms.

Figure 7.2



Mass chromatograms of GC/MS for  $\beta$ -blockers extracted from urine of subjects, who had ingested each drug. Many of  $\beta$ -blockers and their hydroxylated metabolites can be simultaneously detected in the mass chromatograms at  $m/z$  284, 126 and 86. It is possible to confirm the presence or absence of a target compound by displaying the location of chromatograms, where the target compound should appear, using a targeting software.

$\beta$ -Blockers are usually derivatized with MSTFA/MBTFA to form *N*-TFA-*O*-TMS derivatives; when they are analyzed by GC/MS in the EI mode, intense fragment peaks can be detected at  $m/z$  284 and 129 for the isopropylamino drugs and at  $m/z$  86 for the tertiary butylamino drugs in common (Table 7.1). By using these ions, it becomes possible to make simultaneous detection of unchanged forms and metabolites of many  $\beta$ -blockers using a small number of ions.

When a  $\beta$ -blocker used can be estimated, various additional informations can be obtained by optimizing analytical conditions for the target compound. For example, when the ionization mode is changed into the CI mode, a protonated molecular ion appears, which is useful to confirm its molecular weight. When the derivatization reagents are changed into trifluoroacetic anhydride, a base peak at a higher mass number due to a TFA derivative of a  $\beta$ -blocker can be obtained after heating and evaporation of the excess reagent; for example, the mass spectrum of nadolol-tris-*O*-TMS gives the base peak at  $m/z$  86, while that of nadolol-tris-*O*-TFA gives the base peak at  $m/z$  266, which can be used for sensitive quantitation.

## Toxic and fatal concentrations [4]

As usual cautions for use of  $\beta$ -blockers, their administration should not be stopped suddenly, because it causes aggravation of symptoms and occasionally cardiac infarction; the suppression of respiration of a neonate may take place, when a mother had been taking a  $\beta$ -blocker during

Table 7.2

The numbers of doping tests conducted for sport athletes and the numbers of positive cases of doping with  $\beta$ -blockers in 1995–2000

Year	1995	1996	1997	1998	1999	2000	Total
Total number of tests	93,937	96,454	106,561	105,250	118,259	117,314	Total
atenolol	2	2	3	4	4	6	21
metoprolol	1	1	2	4	3	2	13
bisoprolol	1	1	2	1	2		7
sotalol				1	4	1	6
carteolol					2	2	4
acebutolol					1	1	2
betaxolol			2				2
carvedilol						1	1
Total number of positive cases	4	4	9	10	16	13	56

pregnancy. As relatively frequent untoward effects of the drugs, exanthemas due to hypersensitivity, bradycardia, headache, diarrhea and decrease in secretion of tears can be mentioned.

LD<sub>50</sub> values vary from 190 (alprenolol hydrochloride) to 4,000 mg/kg (acebutolol hydrochloride) with oral administration to mice; the values are 17–57 mg/kg with intravenous administration of the same drugs to rats, depending on each drug.

Although in Japan reports on  $\beta$ -blocker poisoning are not many, Kiyota et al. [5] reported a fatal poisoning case due to intake of multiple drugs including oxprenolol; the case showed marked circulatory disturbance. The victim had ingested about 11 g of oxprenolol, 96 mg chlorpromazine, a tricyclic antidepressant, a benzodiazepine and other drugs together with wine to attempt suicide. She died of hypotension and circulatory disturbance 34 h after hospitalization. The concentration of oxprenolol in urine sampled several hours after admission was about 20  $\mu$ g/mL, which was very high. Therefore, it was diagnosed that her death was due to poisoning by multiple drugs (mainly oxprenolol).

Table 7.2 shows  $\beta$ -blockers and the numbers of their detection disclosed by doping control tests in 1995–2000. The most frequently used drug was atenolol, followed by metoprolol, bisoprolol, sotalol and carteolol; the numbers of acebutolol, betaxolol and carvedilol were a few.

## Notes

- When the synthesis of ethyltheophylline is difficult, proxiphylline (Sigma) can be used as IS.
- Any type of HPLC instruments, which enables gradient elution and is equipped with a UV- or photodiode array detector, can be used.
- To enhance the sensitivity, the amount of the final solution can be reduced; in that case, the amount of IS to be spiked should be reduced appropriately. To monitor contamination by environmental compounds, mutual contamination among specimens and interference by endogenous components, the same amount samples of distilled water, blank serum (urine) and spiked serum (urine) (for quality assurance) are preferably processed simultaneously.

- d) As IS, one of other  $\beta$ -blockers can be used. The most desirable IS is the deuterated form of the target compound, in which more than two deuterium atoms are labeled.
- e) Any type of GC/MS instruments with the EI ionization can be used. To simultaneously detect many ions in the SIM mode, it is convenient to use an instrument, which supports a software to change an ion group into another group according to retention time intervals for analysis.
- f) For extraction of  $\beta$ -blockers, various solvents much polar than diethyl ether can be used, resulting in a higher peak of a target compound due to higher extraction efficiency; but the impurity peaks are also increased and thus the S/N ratio is sometimes not improved. When a target compound is firmly bound with proteins in a blood specimen, deproteinization or alkalinization treatment should be made; the pH of the resulting clear solution should also be adjusted before extraction with an organic solvent. These treatments may give much better results.

## References

- 1) Ueki M (1997) Application to doping tests. In: Ueno T, Hirayama K, Harada K (eds) *Biological Mass Spectrometry*. Tokyo Kagaku Dojin, Tokyo, pp 204–214 (in Japanese)
- 2) Leloux MS, Maes RAA (1990) The use of electron impact and positive chemical ionization MS in the screening of beta blockers and their metabolites in human urine. *Biomed Environ Mass Spectrom* 19:137–142
- 3) Hemmersbach P, de la Torre R (1996) Stimulants, narcotics and beta-blockers: 25 years of development in analytical techniques for doping control. *J Chromatogr B* 687:221–238
- 4) Osaka Prefectural Society of Hospital Pharmacists (ed) (1988) *Guide Book for Ethical Drugs*, 4th edn. Jiho Inc., Tokyo, p 466 (in Japanese)
- 5) Kiyota K, Ono K, Maekawa K et al. (1997) A fatal poisoning case with multiple drugs including oxprenolol, a  $\beta$ -blocker. *Jpn J Toxicol* 10:425–426 (in Japanese)



## 11.4.8 Local anaesthetics

by Fumio Moriya

### Introduction

Local anaesthetics reversibly block neural transmission in local tissues. The drugs are bound with specific receptors located inside the sodium channels of cell membranes, and thus block the permeability of sodium ions; this is the mechanism of anaesthetic action of these drugs.

As the history of local anaesthetics, Von Anrep discovered the local anaesthetic action of an alkaloid cocaine being contained in the leaves of *Erythroxylon coca*. Then, Karl Koller used cocaine as a local anaesthetic in ophthalmological surgery. Since the middle of 1980s, an explosive abuse of cocaine appeared, because of its strong addictive effects on the central nervous system overwhelming the local effects, causing a serious social problem internationally. In place of cocaine, procaine appeared in 1905 as the first synthetic local anaesthetic, followed by the appearance of many synthetic drugs until nowadays.

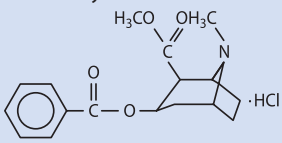
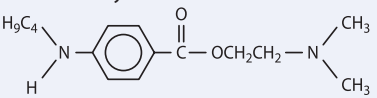
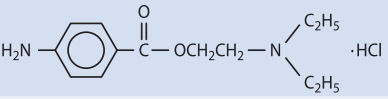
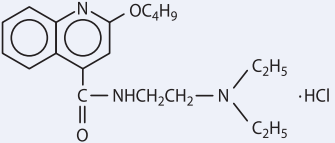
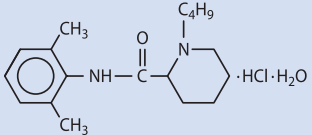
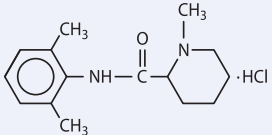
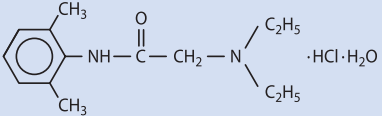
Local anaesthetics can be classified into ester-type and amide-type drugs according to their structures. Both types of the drugs differ in the mode of metabolism and chemical stability. The ester-type local anaesthetics are easily hydrolyzed by the action of pseudocholinesterase in blood plasma, and are also rapidly decomposed in alkaline solutions nonenzymatically. Amide-type drugs are mainly metabolized by the liver microsomes and relatively stable in alkaline solutions. Structures, physicochemical properties and clinical applications for cocaine and other local anaesthetics being frequently used in Japan are summarized in [▶ Table 8.1](#).

According to the literature [1] published by National Research Institute of Police Science, Japan, seven fatal poisoning cases due to local anaesthetics were reported to have occurred in 1995–1999. The contents of the cases were: 4 cases of suicide by oral and intravenous administration of lidocaine; one case each of medical accidents due to lidocaine, mepivacaine and dibucaine. The local anaesthetics show relatively high incidence of anaphylactic shocks due to their administration; dibucaine, lidocaine and procaine sometimes cause problems [2]. The allergenicity observed for local anaesthetics are said to be mainly due to *p*-aminobenzoic acid, the metabolite of the ester-type local anaesthetics, which has strong antigenicity as a haptene. Such shocks due to the amide-type drugs and their metabolites are very rare; but *p*-oxybenzoic acid being added to injection solutions as preservative may provoke the allergic reaction.

Local anaesthetics in biomedical specimens can be detected by various chromatographic techniques [3–5]. Among them, GC analysis is most recommendable, because it is relatively cheap and its handling and conditioning are simple; in addition, the use of the dual column mode and selective detectors enables the screening of many kinds of drugs easily. In this chapter, a method for simultaneous GC analysis of seven local anaesthetics listed in [▶ Table 8.1](#) and monoethylglycinexylidide (MEGX), an active metabolite of lidocaine, is presented [6].

■ **Table 8.1**

**Structures, physicochemical properties and applications of local anaesthetics being widely used in Japan**

Compound	Physicochemical properties	Applications
<p>Ester type cocaine hydrochloride MW = 339.8</p> 	<p>Colorless crystals or white powder; highly soluble in water, easily soluble in glacial acetic acid or ethanol, slightly soluble in acetic anhydride and almost insoluble in ether; melting point: about 197° C.</p>	<p>Topical anaesthesia: mucous membranes, eye drops, and external application</p>
<p>Ester type tetracaine hydrochloride MW = 300.8</p> 	<p>White crystals or powder; highly soluble in formic acid, soluble in water, slightly soluble in ethanol, relatively insoluble in anhydrous ethanol and almost insoluble in ether; melting point: 148° C.</p>	<p>Spinal, epidural, conduction, infiltration and topical anaesthetics</p>
<p>Ester type procaine hydrochloride MW = 272.8</p> 	<p>White crystals or powder; highly soluble in water, slightly soluble in ethanol and almost insoluble in ether; melting point: 155–158° C.</p>	<p>Spinal, epidural, conduction, and infiltration anaesthetics</p>
<p>Amide type dibucaine hydrochloride MW = 379.9</p> 	<p>White crystals or powder; highly soluble in water, ethanol and glacial acetic acid, soluble in acetic anhydride and almost insoluble in ether; hygroscopic; melting point: 95–100° C.</p>	<p>Spinal, caudal, conduction, infiltration and topical anaesthetics</p>
<p>Amide type bupivacaine hydrochloride MW = 342.9</p> 	<p>White crystal; soluble in glacial acetic acid, slightly soluble in water and ethanol and almost insoluble in acetic anhydride, ether and chloroform; melting point: about 250° C</p>	<p>Epidural, conduction and spinal anaesthetics</p>
<p>Amide type mepivacaine hydrochloride MW = 282.8</p> 	<p>White crystal and powder; soluble in water and methanol, slightly soluble in glacial acetic acid, relatively insoluble in anhydrous ethanol and almost insoluble in ether; melting point: about 256° C (decomposed)</p>	<p>Epidural, conduction and infiltration anaesthetics</p>
<p>Amide type lidocaine hydrochloride MW = 288.8</p> 	<p>White powder; highly soluble in water and ethanol, slightly soluble in chloroform and almost insoluble in ether; melting point: 76–79° C.</p>	<p>Epidural, conduction, infiltration, topical and spinal anaesthetics, ventricular arrhythmia</p>

## Reagents and their preparation

- Cocaine hydrochloride and other local anaesthetics can be obtained from Sigma (St. Louis, MO, USA). MEGX hydrochloride was donated by Astra Japan (Osaka, Japan).
- Methanolic solutions of local anaesthetics<sup>a</sup>: 10 mg of hydrochloride salt of each drug is dissolved in 100 mL methanol.
- Internal standard (IS) solution<sup>a,b</sup>: 2 mg of ketamine hydrochloride (Sigma) is dissolved in 100 mL methanol.
- Neostigmine bromide solution (0.05  $\mu\text{mol/mL}$ )<sup>c</sup>: 15.2 mg neostigmine bromide (Sigma) is dissolved in 100 mL purified water.
- 1 M Carbonate buffer solution (pH 9.7): 1 M sodium carbonate solution/1 M sodium bicarbonate solution (7:2).
- 0.1 M Hydrochloric acid solution.
- Diethyl ether and isoamyl alcohol: special grade commercially available.

## GC conditions

GC column<sup>d</sup>: a TC-5 wide-bore capillary column (5 % phenylmethylsilicone, 15 m  $\times$  0.53 mm i. d., film thickness 1.5  $\mu\text{m}$ , GL Sciences, Tokyo, Japan).

GC conditions: a Shimadzu gas chromatograph (GC-14B, Shimadzu Corp., Kyoto, Japan); detector: a flame thermionic detector (FTD)<sup>e</sup>; column (oven) temperature: 150  $^{\circ}\text{C}$  (2 min)  $\rightarrow$  10  $^{\circ}\text{C}/\text{min}$   $\rightarrow$  300  $^{\circ}\text{C}$  (6.5 min); injection and detector temperature: 300  $^{\circ}\text{C}$ ; carrier gas: He<sup>f</sup> (flow pressure 15 kPa).

## Procedures

### i. Body fluid specimens including blood

- A 0.5-mL volume of a specimen and 1.5 mL of neostigmine bromide solution (0.05  $\mu\text{mol/mL}$ )<sup>g</sup> are placed in a test tube with a screw cap (16  $\times$  130 mm with a round bottom) and vortex-mixed for several seconds.
- A 100- $\mu\text{L}$  aliquot of IS solution and 2 mL of the carbonate buffer solution (1 M, pH 9.7) are added to the above mixture and vortex-mixed for several seconds, followed by the addition of 8 mL diethyl ether.
- After the tube is capped, it is gently<sup>h</sup> shaken for 25 min using a shaker and centrifuged at 3,000 rpm for 5 min.
- The upper organic layer is transferred to a new disposable centrifuge tube (16  $\times$  125 mm, with a round bottom) using a disposable polyethylene pipette<sup>i</sup>.
- A 1-mL volume of 0.1 M HCl solution is added to the organic extract, vortex-mixed for 30 s and centrifuged at 3,000 rpm for 5 min.
- The upper organic layer is discarded by aspiration with an aspirator using a Pasteur pipette.
- To the aqueous phase, 4 mL diethyl ether is added, vortex-mixed for 10 s and centrifuged at 3,000 rpm for 5 min, followed by the second removal of the organic layer with the aspirator.

- viii. To the aqueous phase, 1 mL of the carbonate buffer solution (1 M, pH 9.7) and 4 mL diethyl ether are added, vortex-mixed for 30 s and centrifuged at 3,000 rpm for 5 min.
- ix. The upper organic layer is transferred to a new disposable small test tube (12 × 100 mm, with a round bottom) using a transfer pipette.
- x. After addition of 100 µL isoamyl alcohol to the organic layer, the latter is evaporated down to about 100 µL<sup>j</sup> under a gentle stream of nitrogen on an aluminum heating block at 50 °C.
- xi. After cooling the test tube to room temperature, 1 µL of isoamyl alcohol layer<sup>k</sup> is injected into GC.

### ii. Organ specimens

- i. A 1-g aliquot of tissue and 3 mL of neostigmine bromide solution (0.05 µmol/mL) are placed in a disposable test tube (16 × 100 mm, with a round bottom).
- ii. The tissue is minced and homogenized using a homogenizer.
- iii. A 2-mL volume of the homogenate is placed in a test tube with a screw cap, and the following procedure is made according to the steps ii.–xi. for the above body fluid specimens.

### iii. Construction of calibration curves

- i. Various volumes (1–20 µL) of methanolic solution (100 µg/mL) of each drug are placed in more than 5 test tubes with screw caps. The solutions are evaporated to dryness under a gentle stream of nitrogen<sup>l</sup>.
- ii. A 2-mL volume of purified water<sup>m</sup> is added to each tube and vortex-mixed for several seconds.
- iii. The following procedure is conducted according to the steps ii.–xi. for the body fluid specimens.

## Assessment of the method

### i. Advantages of the method

The procedure is simple.

Organ specimens, together with body fluid specimens, can be analyzed.

No extraction columns<sup>n</sup> are not necessary and the cost is cheap.

### ii. Disadvantages of the method

Highly inflammable diethyl ether<sup>o</sup> is used in this method.

When the specimens to be analyzed are many, the time required for the extraction procedure becomes long; in such a case, the organic solvent and buffer solution should be handled using dispensers.

### iii. Detection limits and reproducibility of the method

Limits of detection (S/N=3) from blood obtained by this method using GC-FTD are: 5 ng/mL for lidocaine, mepivacaine, tetracaine and bupivacaine, 10 ng/mL for cocaine and dibucaine, 15 ng/mL for procaine and 20 ng/mL for MEGX.

The calibration curves with blood and water specimens were linear in the range of 0–4 µg/mL with correlation coefficients of 0.995–0.999. The coefficient of a slope for a blood specimen

Table 8.2

Calibration curves and CV values for local anaesthetics in blood and water

Drug	Matrix	Regression equation*	CV value (%, n=3)
lidocaine	blood	$y=0.268x + 0.0262$ ( $r=0.998$ )	0.01–4.86
	water	$y=0.264x + 0.0135$ ( $r=0.999$ )	0.77–3.63
MEGX	blood	$y=0.0528x + 0.0004$ ( $r=0.996$ )	4.34–7.07
	water	$y=0.0578x - 0.0032$ ( $r=0.999$ )	0.01–4.86
procaine	blood	$y=0.120x - 0.0074$ ( $r=0.995$ )	8.04–15.4
	water	$y=0.129x - 0.0171$ ( $r=0.997$ )	7.25–16.1
mepivacaine	blood	$y=0.190x + 0.0155$ ( $r=0.997$ )	2.90–5.61
	water	$y=0.194x - 0.0003$ ( $r=0.999$ )	0.81–3.46
cocaine	blood	$y=0.126x + 0.0054$ ( $r=0.998$ )	2.00–4.05
	water	$y=0.127x - 0.0094$ ( $r=0.999$ )	3.01–9.13
tetracaine	blood	$y=0.249x - 0.0060$ ( $r=0.997$ )	6.18–11.8
	water	$y=0.258x - 0.0303$ ( $r=0.999$ )	4.32–15.7
bupivacaine	blood	$y=0.184x + 0.0142$ ( $r=0.997$ )	0.57–6.21
	water	$y=0.189x - 0.0012$ ( $r=0.999$ )	0.36–3.19
dibucaine	blood	$y=0.148x - 0.0050$ ( $r=0.996$ )	6.98–12.3
	water	$y=0.162x - 0.0174$ ( $r=0.999$ )	4.07–16.5

\* Peak height ratios of a drug to IS in the concentration range of 0–4 µg/mL were used.

was similar to that for a water specimen, for each drug (Table 8.2)<sup>P</sup>. The coefficients of variation were satisfactory with the values of 0.01–16.5 %.

Figure 8.1 shows gas chromatograms obtained from extracts of blank blood and blood spiked with 4 µg/mL of each drug<sup>q</sup>.

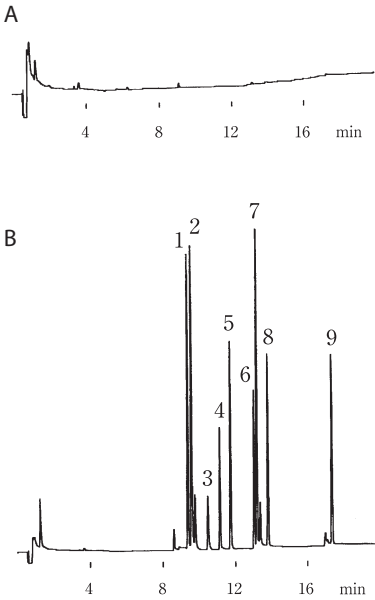
## Poisoning cases, and toxic and fatal concentrations

### Lidocaine

The therapeutic concentrations of lidocaine are 2–5 µg/mL in blood plasma; at not lower than 6–8 µg/mL, the toxic symptoms, such as mental derangement, vertigo, anxiety, delirium, paresthesia, hypotension, CNS suppression and convulsion, may appear [7, 8]. Bromage and Robson [9] reported the peak blood lidocaine concentrations of 9.0–14.0 µg/mL associated with toxic symptoms for 4 subjects, who had been administered 425–1,000 mg of lidocaine by intravenous drop infusion. Edgren et al. [10] reported blood lidocaine concentration of 19.2 µg/mL associated with insufficiency of heart muscle contraction and epileptic grand mal for a 6-year-old child, who had been administered 1,200 mg lidocaine intravenously; but the child could recover later.

When blood plasma lidocaine concentration exceeds 14 µg/mL, the possibility of fatality becomes much higher [7]. In the cases of 5 adult patients, who had received intravenous administration of 250–2,000 mg lidocaine and died several minutes after, their blood lidocaine concentrations were 6–33 µg/mL [11–13]. Grimes and Cates [14] reported blood lidocaine

■ **Figure 8.1**



**Gas chromatograms for the extracts of blood spiked (B) and not spiked (A) with 4 µg/mL each of local anaesthetics. 1: IS (ketamine); 2: lidocaine; 3: a changed form of MEGX; 4: procaine; 5: mepivacaine; 6: cocaine; 7: tetracaine; 8: bupivacaine; 9: dibucaine.**

concentrations of 5 and 9 µg/mL for 2 females, who had died after paracervical block anaesthesia for artificial abortion. In 3 fatal cases of oral lidocaine ingestion (25 g lidocaine ingested in one of the cases), its blood concentrations reached 11–92 µg/mL [12].

Peat et al. [15] reported that the possibility of fatality was high when the tissue lidocaine concentrations were not lower than 15 µg/g for the brain, lung, heart muscle, liver and kidney.

The incidence of fatality due to anaphylactic shock using lidocaine products (injection solutions) is relatively high. One of such cases, which the author et al. experienced, is described as follows.

A 61-year-old female received an intra-gingival injection of Xylocaine™ solution (containing 2 % lidocaine and a small amount of epinephrine) at a dental clinic; the amount of lidocaine hydrochloride salt administered was estimated to be 54 mg. She fell into a shock state soon. After emergent treatments, she was sent to a hospital; but she had been in the state of CPAOA. By cardiopulmonary resuscitation efforts, the heart beat could be regained, but she died about 12 h later. The serum lidocaine concentration<sup>r</sup> was 0.28 µg/mL; its concentrations in the gingiva, into which the drug solution had been injected, were 1.2–1.3 µg/g.

## Procaine

Usubiaga et al. [16] reported a peak plasma lidocaine concentrations of 21–86 µg/mL for 10 patients, who had received intravenous administration (administration intervals: 2–15 min) of 18–55 mg/kg procaine and had shown convulsion; the plasma concentrations decreased to 1–13 µg/mL after the toxic symptoms were improved. Wikinski et al. [17] reported a peak blood procaine concentration of 96 µg/mL for a poisoned patient, who had received intravenous administration of 4,000 mg procaine.

## Mepivacaine

The therapeutic mepivacaine concentrations are being considered to be 2–5 µg/mL in blood plasma [7]. Morishima et al. [18] reported plasma mepivacaine concentrations of 4.4–8.6 µg/mL for 4 pregnant women, who had received its administration at their deliveries and shown toxic symptoms, such as anxiety, mental derangement, muscle contracture, nausea and vomiting. Mepivacaine, administered to a mother, reaches her fetus by passing through the placenta. The mean blood concentrations of such neonates in the presence and absence of toxic symptoms, such as bradycardia, were reported to be 4 and 1 µg/mL, respectively [19].

The blood mepivacaine concentrations of neonates, who had died of its poisoning, were 9.8–52 µg/mL [20,21]. The blood and urine concentrations of the drug for a adult woman, who had received the administration of 3,000 mg of the drug and died of its poisoning, were reported to be 50 and 100 µg/mL, respectively [22]. There is also a report describing an autopsy case, in which 15.8–18.6 µg/mL of mepivacaine was detected from heart blood of a victim [23]; mepivacaine poisoning had been suspected for this victim.

## Cocaine

Cocaine is used only for topical anaesthesia in ophthalmological and otorhinolaryngological fields of medicine. Van Dyke et al. [24] reported peak plasma cocaine concentrations of 0.12–0.474 µg/mL for surgery patients, who had received intranasal administration of 1.5 mg/kg cocaine.

In most poisoning cases (survived and fatal) with cocaine, they are almost due to its abuse; it is described in another chapter of this book in great detail and thus omitted in this section.

## Tetracaine

Since tetracaine is rapidly hydrolyzed to yield *p*-aminobenzoic acid by the action of pseudo-cholinesterase in human bodies, it seems very difficult to detect tetracaine itself from blood or cerebrospinal fluid. Hino et al. [25] could not detect any from blood, the brain stem, cerebrum, liver, skeletal muscle and adipose tissues of a patient, who had died after receiving spinal anaesthesia with 10 mg tetracaine; but they could detect 165, 235, 30.5, 194, 41.5 and 37.1 ng/mL or g of *p*-aminobenzoic acid, respectively. The data on postmortem stability of tetracaine should

be accumulated; but especially for tetracaine poisoning cases, the analysis of *p*-aminobenzoic acid together with unchanged tetracaine seems necessary.

## Bupivacaine

When 400 mg bupivacaine was administered for intercostal nerve block, the peak plasma concentrations in arterial and venous blood were 1.72–4.00 and 1.40–3.45 µg/mL, respectively [26]. The toxicity of bupivacaine is several times higher than that of lidocaine; plasma bupivacaine concentrations at as low as 1.5–2.3 µg/mL can cause poisoning symptoms, such as vertigo, tinnitus and hypotension [27,28]. Yoshikawa et al. [29] reported blood bupivacaine concentrations of 9 and 12 µg/mL for two patients, who had received intercostal nerve block with about 210 mg bupivacaine and fallen into muscle contracture. There is also a report describing a poisoning case, in which convulsion appeared after intravenous administration of bupivacaine; its concentration in arterial blood was 5.4 µg/mL [30].

## Dibucaine


Dibucaine shows toxicity higher than procaine as an injection drug; as a topical anaesthesia drug, dibucaine also shows higher toxicity than cocaine [7]. There is a report describing a fatal case with oral intake of dibucaine; 0.6 µg/mL of dibucaine and 1.5 mg/mL of ethanol were detected from blood of this victim [7].

## Notes

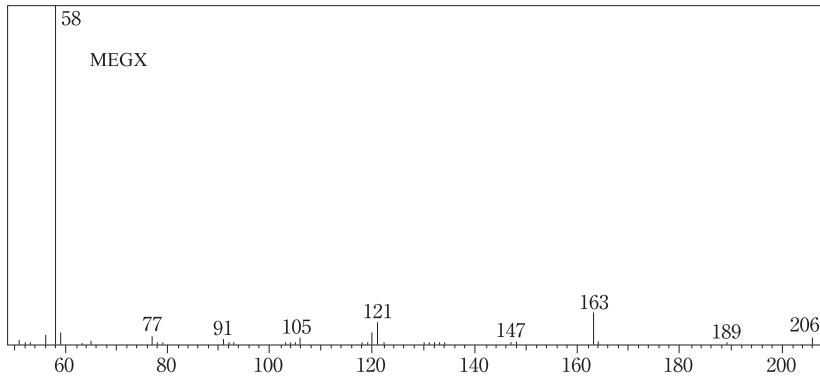
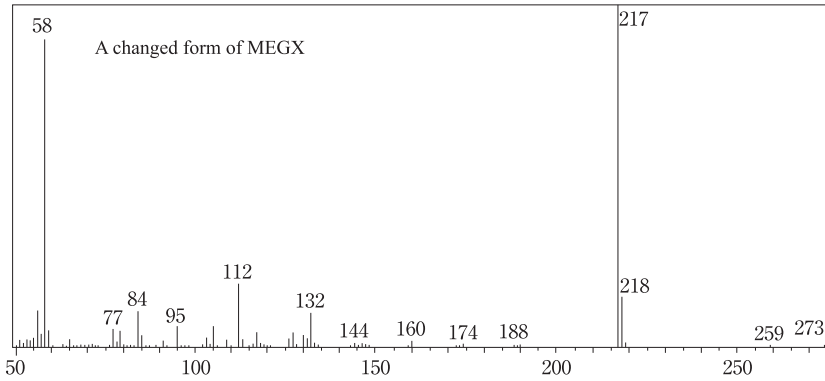
- a) The long storage of the solutions in dark brown bottles is possible at room temperature.
- b) If one of the local anaesthetics except mepivacaine is targeted for analysis, methanolic solution of carbinoxamine maleate (10–20 µg/mL) can be used as IS solution.
- c) Since the ester-type local anaesthetics are hydrolyzed by cholinesterase in biomedical specimens, neostigmine bromide is used to inhibit such reaction. When sodium fluoride (NaF: final concentration 1 %), being usually used as a preservative, was used as a cholinesterase inhibitor, the recovery rates of cocaine and procaine (about 2 µg/mL) from blood were about 100 %, but only about 50 % for tetracaine. The recovery rates of tetracaine decreased according to decrease in its concentration even in the presence of 1 % NaF; at 0.1 µg/mL tetracaine in blood, its recovery rate became to be 0 %. By using neostigmine bromide, almost 100 % recovery from blood could be attained for cocaine, procaine and tetracaine.
- d) For simultaneous screening of many drugs, capillary columns are much superior to packed columns in view of sensitivity and resolution. Wide-bore capillary columns are recommendable, because of its easy handling. Except TC-5 (corresponding to DB-5 and HP-5), TC-1 (corresponding to DB-1 and HP-1) can be used for sensitive simultaneous analysis. With use of TC-17 (corresponding to DB-17 and HP-50+), the separation of cocaine from bupivacaine is insufficient; the sensitivity of dibucaine becomes lower, because the upper limit of oven temperature for TC-17 is 260 °C resulting in the elongation of the retention



time of dibucaine and in broadening the peak. However, the dual column GC using both TC-1 and TC-17 is very useful for screening of local anaesthetics and other drugs with high quality.

- e) A surface ionization detector (SID) can be also used for sensitive detection of local anaesthetics in place of an FTD [31]. The usual FID can be also used, though the sensitivity is about ten times lower than that of an FTD [3].
- f) Nitrogen gas can be also used for sensitive analysis.
- g) When a target compound is an amido-type local anesthetic, it is not necessary to use cholinesterase inhibitor; 1.5 mL purified water can be used instead.
- h) When the mixture is shaken vigorously, emulsion formation may take place according to the nature of a specimen.
- i) ELKAY LIQUIPETTE™ from Tyco Healthcare Group LP (Mansfield, MA, USA) (capacity 3.5 mL, length 150 mm, graduated up to 1 mL) can be used for organic solvents, because no impurity peaks due to the plastic resin of the pipette appear upon GC analysis. The pipette has no possibility of being broken unlike a Pasteur pipette, does not need rubber spoids and is very easy for handling.
- j) When the organic layer is completely evaporated to dryness, local anaesthetics are lost to various extent. For this reason, a small amount of isoamyl alcohol is added to prevent such complete evaporation. However, when the test tube is left on a heating block for a long time, even isoamyl alcohol together with a local anaesthetic is evaporated.
- k) The free form of MEGX is unstable in isoamyl alcohol and changed into a compound having a mass spectrum shown in  Figure 8.2 within 2–3 h after the extraction procedure; the retention time of the changed compound is longer than that of MEGX. Therefore, when MEGX is the object for analysis, the isoamyl alcohol extract should be left for more than 3 h at room temperature to convert MEGX into the changed compound completely. However, such analysis of MEGX is required, only when lidocaine is detected.
- l) When evaporation is made at temperatures higher than the ambient one, a part of a local anaesthetic may be lost.
- m) When the same volume of blank blood is used for constructing a calibration curve, 1.5 mL of 0.05 μmol/mL neostigmine bromide aqueous solution and then 0.5 mL of blank blood should be added in place of 2 mL of purified water. When the blank blood is added first, an ester-type local anaesthetic is hydrolyzed.
- n) To extract local anaesthetics from body fluid specimens, such as urine and cerebrospinal fluid, Sep-Pak®C<sub>18</sub> cartridges (Waters, Milford, MA, USA) [31] or Extrelut® columns (Merck, Darmstadt, Germany) [5] can be used.
- o) Except diethyl ether, the combination of *n*-chlorobutane/isoamyl alcohol (98:2, the 1st extraction solvent) and 2-methylbutane/toluene/isoamyl alcohol (95:4:1, the 2nd extraction solvent) is very useful for extensive screening of basic drugs [6], but the extraction efficiency of MEGX becomes 4–5 times lower. MEGX can be extracted with *n*-chlorobutane, ethyl acetate or dichloromethane from alkaline solution with high efficiency, but the efficiency of back-extraction into 0.1 M HCl solution is very low for MEGX. Unless the repeated extractions are made, the above organic solvents seem suitable for extraction of MEGX.
- p) Since the body fluid or organ specimen had been diluted 8-fold before extraction with diethyl ether in this method, the extraction efficiencies of local anaesthetics are almost not affected by specimen matrices. Therefore, to construct a calibration curve, purified water can be used in place of blank blood without problems.

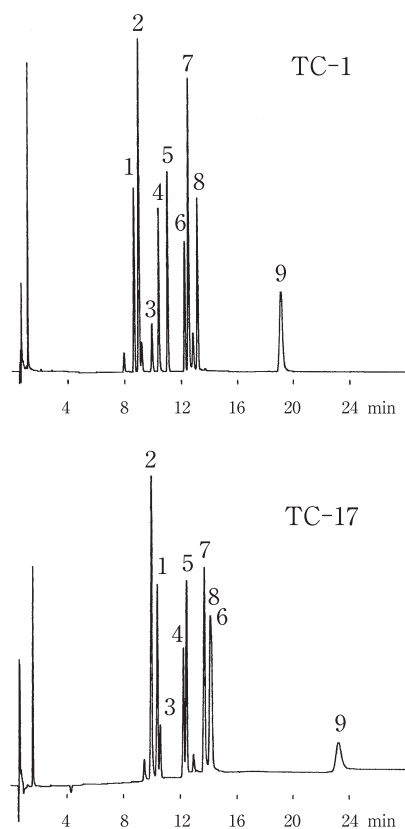
■ **Figure 8.2**



**EI mass spectra of MEGX and its changed form.**

- q) For information, chromatograms for local anaesthetics obtained by the dual column GC (using TC-1 and TC-17 wide-bore capillary columns) are shown in [▶ Figure 8.3](#).
- r) There is an important problem to be mentioned in lidocaine analysis for the cases, in which victims had received emergency treatments. Lidocaine is detected with high incidence from specimens obtained from a victim, who had received endotracheal intubation [32]; in Japan, upon endotracheal intubation, 2–3 g of 2 % Xylocaine™ (lidocaine) jelly is generally applied to the tube for lubricating the intubation. The lidocaine concentrations of heart and peripheral blood are usually lower than 1 µg/mL for victims, who had received endotracheal intubation and died several hours later [32, 33]. In the CPAOA cases (with endotracheal intubation with lidocaine jelly) with a long time (30–60 min) of external cardiac massage, lidocaine can be absorbed into blood through the trachea by the artificial circulation, resulting in the distribution of lidocaine to a whole body [32, 33]; in such cases, the concentrations of lidocaine in heart and peripheral blood are usually lower than 1 µg/mL. However, in the CPAOA cases of small infants, the blood lidocaine concentrations may exceed 10 µg/mL. As shown in this case of anaphylactic shock against lidocaine (no lidocaine jelly was used during the resuscitation), many cases show blood lidocaine concentra-

■ Figure 8.3



Dual-column gas chromatograms for the extracts of blood spiked with 4  $\mu\text{g}/\text{mL}$  each of local anaesthetics using wide-bore capillary columns of both TC-1 and TC-17. Column size for both: 15 m  $\times$  0.53 mm; column (oven) temperature: 150  $^{\circ}\text{C}$  (2 min)  $\rightarrow$  10  $^{\circ}\text{C}/\text{min}$   $\rightarrow$  260  $^{\circ}\text{C}$  (15 min); injection and detector temperature: 260  $^{\circ}\text{C}$ ; detector: FTD; carrier gas:  $\text{N}_2$  (15 kPa); injection volume: 1  $\mu\text{L}$ . 1: IS (ketamine); 2: lidocaine; 3: a changed form of MEGX; 4: procaine; 5: mepivacaine; 6: cocaine; 7: tetracaine; 8: bupivacaine; 9: dibucaine.

tions of less than 1  $\mu\text{g}/\text{mL}$ ; especially in such cases, it should be carefully checked whether lidocaine had been used for the endotracheal intubation or the treatment of arrhythmia by searching medical records. When lidocaine is detected, its distribution should be clarified, followed by the efforts to detect its metabolite MEGX, to enhance the reliability of toxicological assessment (diagnosis) [33, 34].

## References

- 1) National Research Institute of Police Science (ed) (1997–2001) Annual Case Reports of Drug and Toxic Poisoning in Japan, Nos. 39–43. National Police Agency, Tokyo (in Japanese)
- 2) Investigation Committee of the Medico-Legal Society of Japan (1983) Reports on medico-legal data from mass-investigation performed by the Medico-Legal Society of Japan (IX). Autopsy cases of therapeutic complications. *Jpn J Legal Med* 37:434–454 (in Japanese with an English abstract)
- 3) Seno H, Suzuki O, Kumazawa T et al. (1994) Positive and negative ion mass spectrometry and rapid isolation with Sep-Pak C<sub>18</sub> cartridges of ten local anesthetics. *Forensic Sci Int* 50:239–253
- 4) Tanaka E, Nakagawa Y, Zhang SX et al. (1995) A simple high-performance liquid chromatographic method for seven local anesthetic drugs in human serum. *Jpn J Forensic Toxicol* 13:11–16
- 5) Ohshima T, Takayasu T (1999) Simultaneous determination of local anesthetics including ester-type anesthetics in human plasma and urine by gas chromatography-mass spectrometry with solid-phase extraction. *J Chromatogr B* 726:185–194
- 6) Moriya F, Hashimoto Y (1998) Medicolegal implications of drugs and chemicals detected in intracranial hematomas. *J Forensic Sci* 43:980–984
- 7) Moffat AC, Jackson JV, Moss MS et al. (eds) (1986) *Clarke's Isolation and Identification of Drugs*. 2nd edn. The Pharmaceutical Press, London
- 8) Baselt RC, Cravey RH (1995) *Disposition of Toxic Drugs and Chemicals in Man*. 4th edn. Year Book Medical Publishers, Chicago
- 9) Bromage PR, Robson JG (1961) Concentrations of lignocaine in the blood after intravenous, intramuscular, epidural and endotracheal administration. *Anaesthesia* 16:461–478
- 10) Edgren B, Tilelli J, Gehrz R (1986) Intravenous lidocaine overdosage in a child. *J Toxicol Clin Toxicol* 24:51–58
- 11) Christie JL (1976) Fatal consequences of local anesthesia : report of five cases and a review of the literature. *J Forensic Sci* 21:671–679
- 12) Baselt RC, Cravey RH (1977) A compendium of therapeutic and toxic concentrations of toxicologically significant drugs in human biofluids. *J Anal Toxicol* 1:81–103
- 13) Poklis A, MacKell MA, Tucker EF (1984) Tissue distribution of lidocaine after fatal accidental injection. *J Forensic Sci* 29:1229–1236
- 14) Grimes DA, Cates W Jr (1976) Deaths from paracervical anesthesia used for first-trimester abortion, 1972–1975. *N Engl J Med* 295:1397–1399
- 15) Peat MA, Deyman ME, Crouch DJ et al. (1985) Concentrations of lidocaine and monoethyl-glycinexylidide (MEGX) in lidocaine associated deaths. *J Forensic Sci* 30:1048–1057
- 16) Usubiaga JE, Wikinski R, Ferrero R et al. (1966) Local anesthetic-induced convulsions in man. *Anesth Analg* 45:611–620
- 17) Wikinski R, Usubiaga JE, Wikinski RW (1970) Cardiovascular and neurological effects of 4000 mg of procaine. *JAMA* 213:621–623
- 18) Morishima HO, Daniel SS, Finster M et al. (1966) Transmission of mepivacaine hydrochloride (Carbocaine) across the human placenta. *Anesthesiology* 27:147–154
- 19) Shnider SM, Asling JH, Margolis AJ et al. (1968) High fetal blood levels of mepivacaine and fetal bradycardia. *N Engl J Med* 279:947–948
- 20) Sinclair JC, Fox HA, Lentz JF et al. (1965) Intoxication of the fetus by a local anesthetic. *N Engl J Med* 273:1173–1177
- 21) Dodson WE, Hillman RE, Hillman LS (1975) Brain tissue levels in a fatal case of neonatal mepivacaine (Carbocaine) poisoning. *J Pediatr* 86:624–627
- 22) Sunshine I, Fike WW (1964) Value of thin-layer chromatography in two fatal cases of intoxication due to lidocaine and mepivacaine. *N Engl J Med* 271:487–490
- 23) Watanabe T, Namera A, Yashiki M et al. (1998) Simple analysis of local anaesthetics in human blood using head-space solid-phase microextraction and gas chromatography-mass spectrometry-electron impact ionization selected ion monitoring. *J Chromatogr B* 709:225–232
- 24) Van Dyke C, Barash PG, Jatlow P et al. (1976) Cocaine: plasma concentrations after intranasal application in man. *Science* 191:859–861
- 25) Hino Y, Ikeda N, Kudo K et al. (2000) Sensitive and selective determination of tetracaine and its metabolite in human samples by gas chromatography-mass spectrometry. *J Anal Toxicol* 24:165–169

- 26) Moore DC, Mather LE, Bridenbaugh LD et al. (1976) Arterial and venous plasma levels of bupivacaine following peripheral nerve blocks. *Anesth Analg* 55:763–768
- 27) Hollmen H, Korhonen M, Ojala A (1969) Bupivacaine in paracervical block-plasma levels and changes in maternal and foetal acid-base balance. *Br J Anaesth* 41:603–608
- 28) Matouskova A, Hanson B (1979) Continuous mini-infusion of bupivacaine into the epidural space during labor. *Acta Obstet Gynecol Scand (Suppl)* 83:31–41
- 29) Yoshikawa K, Mima T, Egawa J (1968) Blood level of Marcaine (LAC-43) in axillary plexus blocks, intercostal nerve blocks and epidural anesthesia. *Acta Anesthesiol Scand* 12:1–4
- 30) Moore DC, Balfour RI, Fitzgibbons D (1979) Convulsive arterial plasma levels of bupivacaine and the response to diazepam therapy. *Anesthesiology* 50:454–456
- 31) Hattori H, Yamamoto S, Yamada T et al. (1991) Determination of local anaesthetics in body fluids by gas chromatography with surface ionization. *J Chromatogr* 564:278–282
- 32) Moriya F, Hashimoto Y (1998) Absorption of intubation-related lidocaine from the trachea during prolonged cardiopulmonary resuscitation. *J Forensic Sci* 43:718–722
- 33) Moriya F, Hashimoto Y (2000) Determining the state of the deceased during cardiopulmonary resuscitation from tissue distribution patterns of intubation-related lidocaine. *J Forensic Sci* 45:846–849
- 34) Moriya F, Hashimoto Y (2000) Concentrations of monoethylglycinexylidide in body fluids of deceased patients after use of lidocaine for endotracheal intubation. *Legal Med* 2:31–35

## II.4.9 Salicylic acid

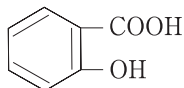
By Einosuke Tanaka

### Introduction

Salicylic acid (▶ *Figure 9.1*) is being used as a keratolytic agent for treatment of corns or verrucae; the acid is included in adhesive plasters, ointments and liquid medicines as their ingredient for removing the stratum corneum. Since such products containing salicylic acid are easily obtainable, salicylic acid poisoning (salicylism) cases are relatively many especially for infants not older than 5 years. Its poisoning symptoms were reported to be headache, vertigo, tinnitus, bradyacusia, amblyopia and sweating [1].

For analysis of salicylic acid, HPLC methods were reported [2–7]. In this chapter, a method for HPLC analysis of salicylic acid in serum specimens is presented [3].

■ **Figure 9.1**



**Structure of salicylic acid.**

### Reagents and their preparation

- 8-Chlorotheophylline (internal standard, IS, Sigma, St. Louis, MO, USA) is dissolved in ethanol to prepare 150  $\mu\text{g}/\text{mL}$  solution.
- Salicylic acid (Sigma) is dissolved in methanol to prepare 5–500  $\mu\text{g}/\text{mL}$  solutions.
- A 2.7-g aliquot of sodium acetate is dissolved in 1 L water, followed by addition of 15 mL acetic acid to prepare acetate buffer solution (pH 3.6).

### HPLC conditions

Column: a reversed phase column<sup>a</sup>,  $\mu\text{Bondapak C18 Radial-Pak}$  (100  $\times$  5 mm i.d., particle diameter 10  $\mu\text{m}$ , Waters, Milford, MA, USA).

Mobile phase: acetate buffer solution (pH 3.6)/methanol (72:28, v/v).

Detection wavelength<sup>b</sup>: 280 nm; flow rate: 1 mL/min; column (oven) temperature: room temperature.

## Procedure

- i. A 100- $\mu$ L volume of serum, 20  $\mu$ L IS solution and 200  $\mu$ L of 1 M hydrochloric acid solution are placed in a glass centrifuge tube with a ground-in stopper and mixed well.
- ii. A 2-mL volume of dichloromethane/isopropanol (9:1, v/v) is added to the above mixture.
- iii. After mixing or shaking for 5 min, it is centrifuged at 2,500 g for 2 min.
- iv. The organic layer (lower phase) is transferred to a clear test tube.
- v. The organic extract is evaporated to dryness under a gentle stream of air (or nitrogen) with warming at 50 °C.
- vi. The residue is dissolved in 100  $\mu$ L of the mobile phase to be used as test solution.
- vii. A 20- $\mu$ L aliquot of it is injected into HPLC.
- viii. For constructing calibration curves, various concentrations of salicylic acid and a fixed amount of IS are processed according to the same procedure.

## Assessment and some comments on the method

► *Figure 9.2* shows HPLC chromatograms for the authentic standard salicylic acid and for the extract of human serum, into which salicylic acid and IS had been spiked. In this method, the linearity of salicylic acid was found in the range of 20–500  $\mu$ g/mL; the detection limit was 3  $\mu$ g/mL.

Since salicylic acid is also a main metabolite of acetylsalicylic acid, the present method can be used for the metabolite analysis for acetylsalicylic acid (see Chapter 4 of general drugs). Conversely, the HPLC conditions described in Chapter 4 can be also used for analysis of salicylic acid. Methyl salicylate, being used as a topical analgesic-antiphlogistic drug, is also metabolized into salicylic acid; therefore, the present method can be used for analysis in methyl salicylate poisoning.

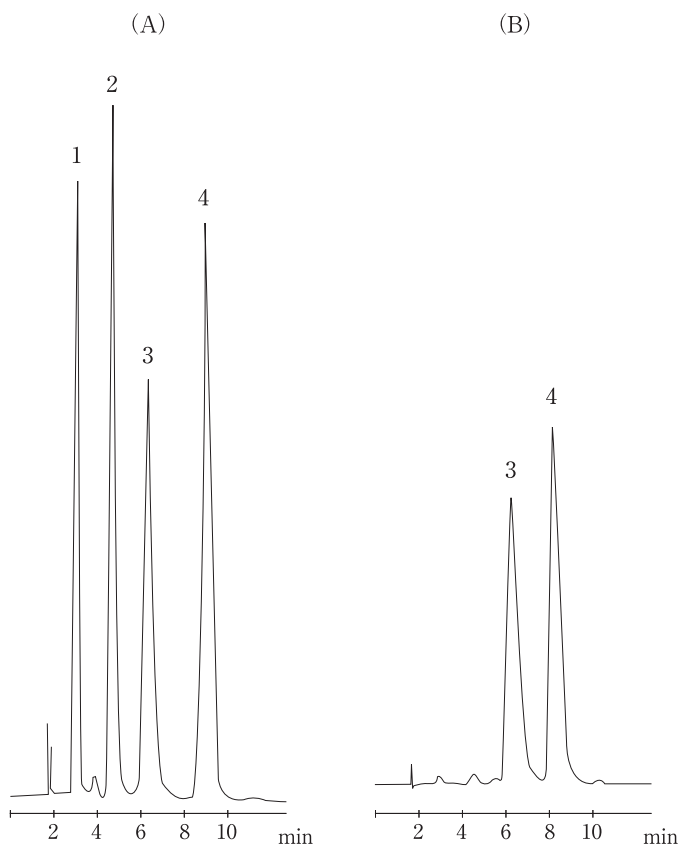
## Blood therapeutic, toxic and fatal concentrations [8]

Blood therapeutic concentrations: 20–250  $\mu$ g/mL; toxic concentrations: 150–500  $\mu$ g/mL; fatal concentrations: not lower than 500  $\mu$ g/mL.

## Poisoning case [9]

Twenty-year-old and 21-year-old brothers were suffering from ichthyosis and were by themselves treating their cornified trichophytia (hyperkeratomycosis) with a drug. It was a gel drug consisting of propylene glycol, 20% ethanol, 20% water and 6% salicylic acid. For one bandage, about 100 g of the gel drug was applied; they continued such treatment for several years. Just after each treatment, they complained of noisy and continuing tinnitus. The concentration of salicylic acid in serum sampled from the elder brother was 366  $\mu$ g/mL, which was at a toxic level. The toxic dose of salicylic acid is about 50 mg/kg. The concentration was estimated to reach its maximum about 12 h after topical application the gel. The body weight of above patient (elder brother) was 62 kg; about 60% (3.6 g in 100 g gel) of the total amount of the drug

Figure 9.2



HPLC chromatograms for the authentic salicylic acid and other compounds (A) and for an extract of human serum, into which salicylic acid and IS had been spiked (B) [3]. 1: acetaminophen (100  $\mu\text{g}/\text{mL}$ , retention time 3 min); 2: theophylline (20  $\mu\text{g}/\text{mL}$ , 4.6 min); 3: salicylic acid (200  $\mu\text{g}/\text{mL}$ , 6.2 min); 4: IS (8-chlorotheophylline) (8.7 min).

applied was considered to be absorbed percutaneously. If this assumption is correct, his dose per kg is calculated to be 58 mg/kg, which exceeds the above toxic dose (50 mg/kg).

## Notes

- In many reports, reversed phase octadecyl ( $C_{18}$ ) chemical-bonded silica gel columns with 10–15 cm lengths and 2.5–5  $\mu\text{m}$  particle sizes are being used.
- The wavelength to be used is somewhat different in different methods; the optimum wavelength should be checked for each detector and for each mobile phase.



## References

- 1) Cooper P (1989) Handbook of Drug Poisonings, 2nd edn. Ishiyaku Publishers Inc., Tokyo, pp 611–612 (in Japanese)
- 2) Rumble RH, Roberts MS, Wanwimolruk S (1981) Determination of aspirin and its major metabolites in plasma by high-performance liquid chromatography without solvent extraction. *J Chromatogr* 225:252–260
- 3) Kinberger B, Holmen A (1982) Simultaneous determination of acetaminophen, theophylline and salicylate in serum by high-performance liquid chromatography. *J Chromatogr* 229:492–497
- 4) Kruk RJ, Adams MA, Philp RB (1984) Rapid and sensitive determination of acetylsalicylic acid and its metabolites using reversed-phase high-performance liquid chromatography. *J Chromatogr* 310:343–352
- 5) Brandon RA, Eadie MJ, Smith MT (1985) A sensitive liquid chromatographic assay for plasma aspirin and salicylate concentrations after low doses of aspirin. *Ther Drug Monit* 7:216–221
- 6) Chubb SA, Campbell RS, Price CP (1986) Rapid method of measuring salicylate in serum by high-performance liquid chromatography. *J Chromatogr* 380:163–169
- 7) Odou P, Barthelemy C, Robert H (2001) Influence of seven beverages on salicylate disposition in humans. *J Clin Pharm Ther* 26:187–193
- 8) Stead AH, Moffat AC (1983) A collection of therapeutic, toxic and fatal blood drug concentrations in man. *Hum Toxicol* 2:437–464
- 9) Soyka PA, Soyka LF (1980) Absorption of salicylic acid. *JAMA* 244:660–661

## II.4.10 $\beta$ -Lactam antibiotics

by Yuko Ito and Hisao Oka

### Introduction

$\beta$ -Lactam antibiotics constitute an important class of antibacterial agents being used extensively for both humans and food-producing animals to treat or prevent infections. The drugs occasionally cause human deaths due to anaphylactic shock during medical treatments, especially when they are parenterally administered without their prior intracutaneous tests. These cases are usually handled as medical accidents (malpractice), and subjected to autopsies and analysis of the drugs used.

These antibiotics are composed of cepheems (▶ Table 10.1) and penicillins (▶ Table 10.2), which are naturally occurring or semi-synthetic. Furthermore, two subclasses of cephem antibiotics are cephalosporins and cephamycins (▶ Table 10.1). The primary structural difference between the cephalosporins and cephamycins is the methoxy group substituted for the  $\alpha$ -hydrogen in the 7-position on the  $\beta$ -lactam ring.

In this chapter, methods for simultaneous analysis of 6 kinds of penicillins and of 4 kinds of cepheems by HPLC-UV are described.

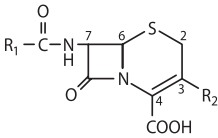
### HPLC-UV analysis of penicillin antibiotics [1]

#### Reagents and their preparation

- Benzylpenicillin, phenoxymethylpenicillin, ampicillin, cloxacillin, dicloxacillin, nafcillin and  $\beta$ -hydroxyethylthiophylline can be purchased from Sigma (St. Louis, MO, USA).
- Acetonitrile is of HPLC grade, and water is purified with a Milli-RO/Q water purification system (Millipore, Bedford, MA, USA).
- A working internal standard (IS) solution is prepared daily with purified water to give a concentration of 20  $\mu\text{g}/\text{mL}$  of  $\beta$ -hydroxyethylthiophylline.
- Calibration standard are prepared daily with drug-free human serum covering the range of 0.5–50  $\mu\text{g}/\text{mL}$ .
- 1 mM Ammonium acetate buffer solution (pH 6.4): 77.8 mg of ammonium acetate is dissolved in purified water to prepare 1 L solution, and adjusted to pH 6.4 with either ammonia water solution or acetic acid solution.
- 0.2 M Tetrabutylammonium hydrogen sulfate solution: 67.9 g of tetrabutylammonium hydrogen sulfate is dissolved in purified water to prepare 1 L solution. It is adjusted to pH 7.7 with the below 0.2 M NaOH solution, and then buffered with 0.2 M borate buffer solution, pH 7.7 (1:1, v/v).
- 0.2 M NaOH solution: 8 g of NaOH is dissolved in purified water to prepare 1 L solution.
- 0.2 M Borate buffer solution: 12.4 g of boric acid is dissolved in purified water to prepare 1 L solution and adjusted to pH 7.7 with 1 M NaOH solution.
- 1 M NaOH solution: 40 g of NaOH is dissolved in purified water to prepare 1 L solution.

■ **Table 10.1**

**Chemical structures of cephem antibiotics**

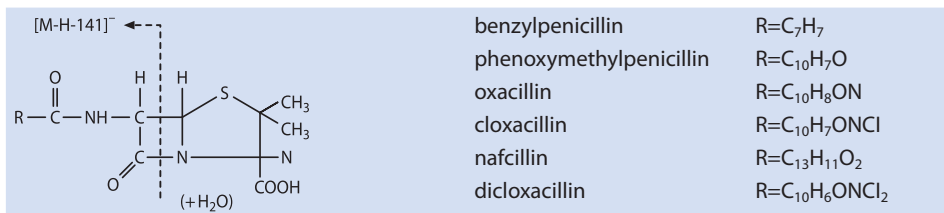


Cephalosporin	Structure of side chain	
	R1	R2
cephalothin		$-\text{CH}_2\text{OAc}$
cephazolin		$-\text{CH}_2-\text{S}-\text{C}(\text{S}=\text{N}-\text{CH}_3)=\text{N}-$
ceftiofur		$-\text{CH}_2-\text{S}-\text{C}(=\text{O})-\text{C}_2\text{H}_3\text{O}$
cephalosporin C	$\text{COOH}-\underset{\text{NH}_2}{\text{CH}}-\text{CH}_2\text{CH}_2\text{CH}_2-$	$-\text{O}-\overset{\text{O}}{\parallel}{\text{C}}-\text{CH}_3$
cephalexin		$-\text{CH}_3$
cephapirin		$-\text{CH}_2-\text{O}-\text{Ac}$
cephaloglycine		$-\text{CH}_2-\text{O}-\text{Ac}$
cefuroxime		$-\text{CH}_2\text{OCONH}_2$
cephaloridine		$-\text{CH}_2-\text{N}^+(\text{C}_6\text{H}_4)-$
Cephamycin	Complete structure	
cefoxitin		
cephamycin A		

Table 10.2

Diagnostic ions of penicillin antibiotics obtained under ESI LC/MS/MS conditions in the negative mode

Penicillins	$[M-H]^-$	$[M-H-CO_2]^-$	$[M-H-141]^-$
benzylpenicillin	333	289	192
phenoxymethylpenicillin	349	305	208
oxacillin	400	356	259
cloxacillin	434	390	293
nafcillin	413	369	272
dicloxacillin	468	424	327



## HPLC conditions

Instrument: a model 620 solvent delivery system (Kontron AG, Zurich, Switzerland), a Uvikon 720LC UV/VIS variable-wavelength detector (Kontron AG), a model 3390A plotting integrator (Hewlett-Packard, Avondale, PA, USA) and model 200 programmer (Kontron AG); column: Spherisorb ODS (250 × 4.6 mm i. d., particle size 5 μm, Kontron AG); guard column: Pell ODS (50 × 4.6 mm i. d., Whatmann, Clifton, NJ, USA); mobile phase: A = 1 mM ammonium acetate buffer solution (pH 6.4), B = acetonitrile with a linear gradient from 90 % A/10 % B to 75 % A/25 % B in 15 min; flow rate: 2 mL/min; UV detection: 208 nm.


## Procedure

- A 50-μL volume of working IS solution and 2.5 mL dichloromethane are added to 200 μL of a test serum or each calibration standard in a 10 mL screw-top centrifuge tube.
- The mixture is vortexed for 30 s, followed by addition of 100 μL of 0.2 M tetrabutylammonium hydrogen sulfate solution.
- After vortex-mixing for 1 min and centrifugation at 2,800 g for 5 min, the upper aqueous layer is discarded.
- A 2-mL volume of the organic phase is transferred to a new 10-mL conical test tube and evaporated to dryness at room temperature in a Speed Vac Concentrator (Savant Instruments Inc., Farmingdale, NY, USA).
- The residue is reconstituted in 50 μL acetonitrile/purified water (10:90, v/v) and a 20-μL aliquot is injected into the chromatograph.

## Assessment and some comments on the method

The recoveries of the six penicillins were 79.4 to 95.7 % for serum specimens. The detection limits were 0.05  $\mu\text{g/mL}$  for benzylpenicillin, 0.10  $\mu\text{g/mL}$  for phenoxymethylpenicillin and cloxacillin, 0.15  $\mu\text{g/mL}$  for ampicillin and dicloxacillin, and 0.20  $\mu\text{g/mL}$  for nafcillin (signal-to-noise ratio = 5). Over the concentration range studied (0.5–50  $\mu\text{g/mL}$ ), a good linear response was found for all penicillins assayed (correlation coefficients for calibration curves > 0.996). The only penicillin antibiotic, which overlaps benzylpenicillin in the chromatogram, is amoxicillin; but the latter does not interfere with the assay, because it is not extracted with this procedure. The separation of the six drugs was relatively good.

Penicillins can be separated using acetonitrile/water alone as a mobile phase. However, when biological samples spiked with penicillins are analyzed, there is a considerable shift in retention times between biological samples and the standards due to matrix effects. To avoid such a phenomenon, in many HPLC methods, various buffers (pH around 7), such as phosphate and acetate solutions, are used as mobile phases.

Because many penicillins do not show specific strong ultraviolet absorption, several HPLC methods utilized pre-column [2–5] and post-column [6–11] derivatization techniques for detection with enhanced selectivity and sensitivity. In addition, some of these methods require the use of mercury (II) chloride, a toxic environmental pollutant. For highly sensitive determinations, LC/MS with ESI can be recommended; but these methods were developed for the analysis of residual penicillins in foods [12–19]. Benzylpenicillin, phenoxymethylpenicillin, oxacillin, cloxacillin, nafcillin and dicloxacillin give three kinds of product ions by ESI LC/MS/MS, which is useful for both identification and quantitation as shown in  Table 10.2 [12, 15]. Because this technique is highly selective, it seems useful for the determination of penicillins in both pharmaceutical and biomedical specimens.

## HPLC-UV analysis of cephem antibiotics in plasma with a column-switching system [20]

---

### Reagent and their preparation

- Cephalixin, cefoxitin, cefuroxime and cefotaxime sodium (IS) can be purchased from Sigma. Cephaloridine can be obtained with request from Eli Lilly & Co., Indianapolis, IN, USA.
- Standard solutions of the 4 cephem drugs are prepared by dissolving each compound in purified water and diluted to appropriate concentrations with 0.01 M acetate buffer solution (pH 3.5).
- IS solution is prepared by dissolving 5 mg cefotaxime in 10 mL of purified water and by diluting 100 times with 0.01 M acetate buffer solution (pH 3.5).
- 0.01 M Acetate buffer solution (pH 3.5): 778 mg of ammonium acetate is dissolved in purified water to prepare 1 L solution, and it is adjusted to pH 3.5 with 1 M acetic acid solution.
- 0.02 M Acetate buffer solution (pH 4.3): 1.6 g of ammonium acetate is dissolved in purified water to prepare 1 L solution, which is adjusted to pH 4.3 with acetic acid.

## HPLC conditions


Instrument: a model M 501 pump (for washing solvent, Waters, Milford, MA, USA), a 10-port multifunction valve (Valco, Houston, TX, USA), a model SP 8800 pump (for mobile phase, Spectra Physics, Santa Clara, CA, USA) a Reodyne 7125 injector with a 10 mL loop (Cotati, CA, USA), a model SP 8450 UV/VIS detector (Spectra Physics) and a model SP 4270 computing integrator (Spectra Physics); precolumn: Corasil RP C18 (40 × 2.0 mm i.d., particle size 37–50 μm, Waters); guard column: Lichrosorb RP-8 (20 × 4.0 mm i.d., particle size 25–40 μm, Merk, Darmstadt, Germany); analytical column: Partisil ODS-3 (250 × 4 mm i.d., Whatman, Clifton, NJ, USA); mobile phase: acetonitrile/0.02 M acetate buffer solution (pH 4.3) (15:85, v/v); washing solvent: 0.01 M acetate buffer (pH 3.5); flow rate: 1 mL/min each; UV detection: 254 nm.

Column switching system; step I (0–4 min): the sample solution is injected onto the pre-column<sup>a</sup>, step II (5–8 min): the retained compounds are eluted from the pre-column<sup>b</sup> to the guard column/analytical column with the mobile phase, step III (9–25 min): the eluted drugs are separated with the analytical column.

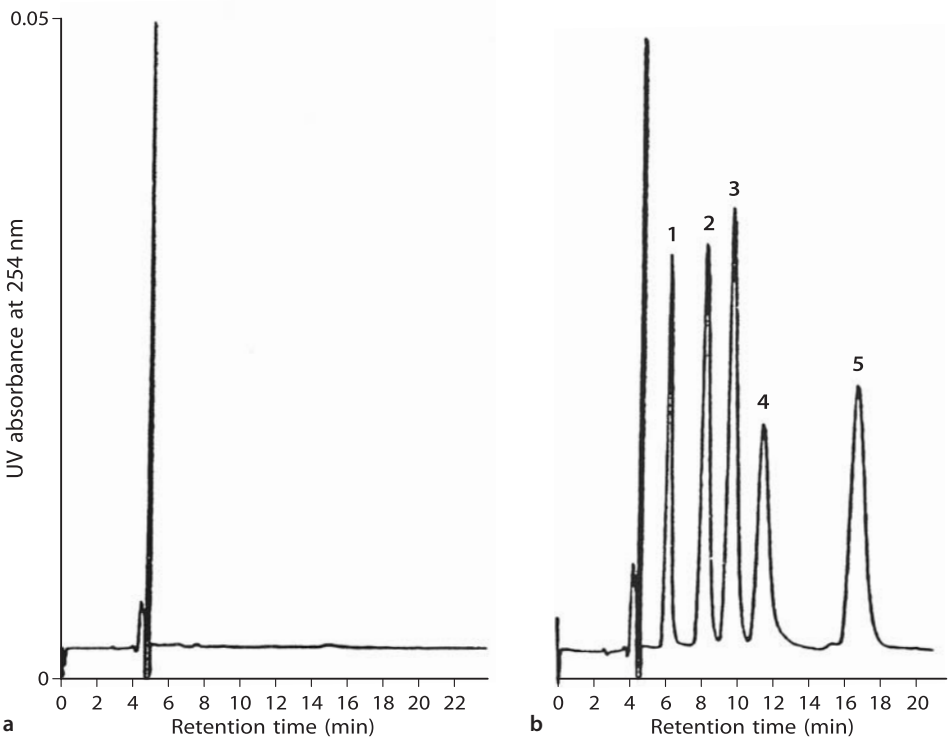
## Procedure

A 100-μL volume of the spiked plasma and 300 μL of IS in 0.01 M acetate buffer solution (pH 3.5) (5.0 μg/mL cefotaxime) are mixed, and 100 μL of the mixture is injected<sup>c</sup> into the HPLC system.

## Assessment of the method

The recoveries of the five cephem drugs ranged from 72.3 to 85.6 % for plasma specimens. The probable reason for their relatively low recoveries is interaction between drug molecules and proteins; minor parts of the drug molecules might have been lost during the pre-column washing. However, the use of cefotaxime as IS can compensate such losses upon calculation. The precision and the accuracy for the assays of cephalexin, cefuroxime, cefoxitin and cephaloridine using the IS were evaluated over the concentration range of 1–100 μg/mL in plasma. The mean coefficients of variation for intra- and inter-assay were both less than 4.9 %, and the relative recoveries ranged from 96 to 105 %.  *Figure 10.1* shows HPLC chromatograms of human blank plasma and blank plasma spiked with the 4 cephem drugs (20 μg/mL each). The detection limit was equally about 0.5 μg/mL (signal-to-noise ratio = 3). The calibration curves with peak-area ratios were linear in the range of 1–100 μg/mL, respectively. The correlation coefficients were better than 0.999. The following drugs did not interfere with the assays of the above 5 cephem drugs: cefotiam, cefadroxil, cefazolin, cefoperazone, cephalothin, cefamandole, aspirin, diclofenac, alcofenac, lonazolac, piroxicam, ibuprofen, indomethacin, ketoprofen, naproxen, phenylbutazone, mefenamic acid and caffeine. The total analysis time per sample was less than 25 min.

**Figure 10.1**



HPLC chromatograms of human blank plasma (a) and blank plasma spiked with cefoxitin, cefuroxime, cephaloridine and cephalixin (each  $20 \mu\text{g/mL}$ ) (b). Peaks: 1 = cephalixin; 2 = cefotaxime (IS); 3 = cefuroxime; 4 = cefoxitin; 5 = cephaloridine. Reproduced from reference [21] with permission of Friedr. Vieweg & Sohn Verlagsgesellschaft mbH.

## Poisoning symptoms, and toxic and fatal concentrations

Since  $\beta$ -lactam antibiotics are considered least toxic among all antibacterial agents, their fatal doses are not clear. However, the presence of high blood levels of these antibiotics can cause seizures, nephritis, leukopenia and bleeding disorders [21]. It is well-known that  $\beta$ -lactam antibiotics occasionally cause allergy reactions. The anaphylactic shock caused by parenteral administration is not so rare. The sensitivity test is, therefore, essential before parenteral administration of  $\beta$ -lactam antibiotics. When such a test is neglected or overlooked, resulting fatality due to anaphylactic shock, such a case is regarded as malpractice.

## Notes

- a) Polar interfering plasma components are passed through the pre-column. Then, the washing solvent is passed through the pre-column to remove interfering impurities. The guard column and the analytical column should be equilibrated with the mobile phase before analysis.
- b) The pre-column is re-equilibrated with the washing solvent for the next injection.
- c) The prepared samples should be kept at 4 °C before injection.

## References

- 1) Mendez-Alvarez E, Soto-Otero R, Sierra-Paredes G et al. (1991) Reversed-phase liquid-chromatographic method for the simultaneous determination of several common penicillins in human serum. *Biomed Chromatogr* 5:78–82
- 2) Haginaka J, Wakai J (1985) High-performance liquid-chromatographic assay of ampicillin, amoxicillin and clocillin in serum and urine using a pre-column reaction with 1,2,4-triazole and mercury(II) chloride. *Analyst* 110:1277–1281
- 3) Rogers ME, Adlard MW, Saunders G et al. (1984) Derivatization techniques for high-performance liquid-chromatographic analysis of beta-lactams. *J Chromatogr* 297:385–391
- 4) Rogers ME, Adlard MW, Saunders G et al. (1983) High-performance liquid-chromatographic determination of penicillins following derivatization to mercury-stabilized penicillic acids. *J Liq Chromatogr* 6:2019–2031
- 5) Miyazaki K, Ohtani K, Sunada K et al. (1983) Determination of ampicillin, amoxycillin, cephalexin and cephadrine in plasma by high-performance liquid-chromatography using fluorimetric detection. *J Liq Chromatogr* 276:478–482
- 6) Haginaka J, Wakai J (1988) Liquid-chromatographic determination of penicillins by post-column alkaline degradation using a hollow-fibre membrane reactor. *Anal Biochem* 168:132–140
- 7) Selavka CM, Krull IS, Bratin K (1986) Analysis for penicillins and cefoperazone by HPLC-photolysis-electrochemical detection (HPLC-hv-EC). *J Pharm Biomed Anal* 4:83–93
- 8) Haginaka J, Wakai J (1985) Liquid-chromatographic determination of penicillins by post-column alkaline degradation. *Anal Biochem* 57:1568–1571
- 9) Kok WT, Halvax JJ, Voogt WH et al. (1985) Determination of thioethers of pharmaceutical importance by liquid chromatography with online generated bromine. *Anal Chem* 57:2580–2583
- 10) Rogers ME, Adlard MW, Saunders G et al. (1983) High-performance liquid-chromatographic determination of beta-lactam antibiotics, using fluorescence detection following post-column derivatization. *J Chromatogr* 257:91–100
- 11) Lee TL, Darconte L, Brooks MA (1979) High-pressure liquid-chromatographic determination of amoxicillin in urine. *J Pharm Sci* 68:454–458
- 12) Ito Y, Goto T, Oka H et al. (2004) Application of ion-exchange cartridge clean-up in food analysis. VI. Determination of six penicillins in bovine tissues by liquid chromatography-electrospray ionization tandem mass spectrometry. *J Chromatogr A*. 1042:107–111
- 13) Fagerquist CK, Lightfield AR (2003) Confirmatory analysis of beta-lactam antibiotics in kidney tissue by liquid chromatography/electrospray ionization selective reaction monitoring ion trap tandem mass spectrometry. *Rapid Commun Mass Spectrom* 17:660–671
- 14) Holstege DM, Puschner B, Whitehead G et al. (2002) Screening and mass spectral confirmation of beta-lactam antibiotic residues in milk using LC-MS-MS. *J Agric Food Chem* 50:406–411
- 15) Ito Y, Ikai Y, Oka H et al. (2001) Application of ion-exchange cartridge clean-up in food analysis. IV. Confirmatory assay of benzylpenicillin, phenoxymethylpenicillin, oxacillin, clocillin, nafcillin and dicloxacillin in bovine tissues by liquid chromatography-electrospray ionization tandem mass spectrometry. *J Chromatogr A* 911:217–223
- 16) Bruno F, Curini R, di-Corcia A et al. (2001) Solid-phase extraction followed by liquid chromatography-mass spectrometry for trace determination of beta-lactam antibiotics in bovine milk. *J Agric Food Chem* 49:3463–3470



- 17) Riediker S, Stadler RH (2001) Simultaneous determination of five beta-lactam antibiotics in bovine milk using liquid chromatography coupled with electrospray ionization tandem mass spectrometry. *Anal Chem* 73:1614–1621
- 18) Daeseleire E, de-Ruyck H, van-Rentergham R (2000) Confirmatory assay for the simultaneous detection of penicillins and cephalosporins in milk using liquid chromatography-tandem mass spectrometry. *Rapid Commun Mass Spectrom* 14:1404–1409
- 20) Blanchflower WJ, Hewitt SA, Kennedy DG (1994) Confirmatory assay for the simultaneous detection of five penicillins in muscle, kidney and milk using liquid chromatography-electrospray mass spectrometry. *Analyst* 119:2595–2601
- 21) Lee YJ, Lee HS (1990) Simultaneous detection of cefoxitin, cefuroxime, cephalixin and cephaloridine in plasma using HPLC and a column-switching technique. *Chromatographia* 30:80–84
- 22) Parry MF (1987) The penicillins. *Med Clin North Am* 71:1093–1112

## 11.5.1 Hypochlorite

By Yasuo Seto

### Introduction

Hypochlorite<sup>a</sup> (HClO) is a weak acid, which exerts oxidative action; it is being widely used in the salt forms for bleaching and other purposes. Sodium hypochlorite (NaClO) aqueous solution is usually used as a disinfectant, bleaching agent, fungicide and ink eraser, and is thus usually included in detergents for laundry. Calcium hypochlorite [Ca(ClO)<sub>2</sub>, bleaching powder] is also used as a bleaching agent and disinfectant. The kinds of household utensils containing hypochlorite are numerous; therefore the poisoning cases, due to accidental ingestion of hypochlorite and due to inhalation of chlorine gas produced upon mixing a hypochlorite salt with an acidic solution, are relatively many. The toxicity of the aqueous solution of a hypochlorite salt is due to injuries of the mucous membranes caused by its strong alkali and oxidizing actions, and due to disturbances of the respiratory organs caused by inhalation of chlorine gas produced under acidic conditions. The oral LD<sub>50</sub> value of hypochlorite for rats is 850 mg/kg.

To detect hypochlorite, a preliminary qualitative test using the iodine-starch paper is being usually used. However, this method is not specific for hypochlorite, but is generally responsive to every oxidizing compound; it is not suitable for specifying hypochlorite. For analysis of hypochlorite, the detection of a hypochlorite ion is most preferable. In this chapter, a capillary electrophoresis (CE) method for analysis of hypochlorite is presented.

### Reagents and their preparation

Sodium hypochlorite solution commercially available is diluted with 0.05 M NaOH solution to prepare 500 µg/mL (in the form of a hypochlorite ion) stock solution. Various concentrations of the solution are prepared by diluting the stock solution with 0.05 M NaOH solution for constructing a calibration curve.

### CE conditions

CE column: a fused silica capillary column (104 cm × 50 µm i. d.)

CE conditions: an HP<sup>3D</sup>CE system (Yokogawa Analytical Systems, Tokyo, Japan); buffer solution: HP Basic Anion Buffer; column temperature: 30 °C; impressed voltage: -30 kV; detection: indirect absorption detection (signal 350/20 nm, reference 275/10 nm); sample injection: pressure injection (50 mbar, 6 s).

## Procedure

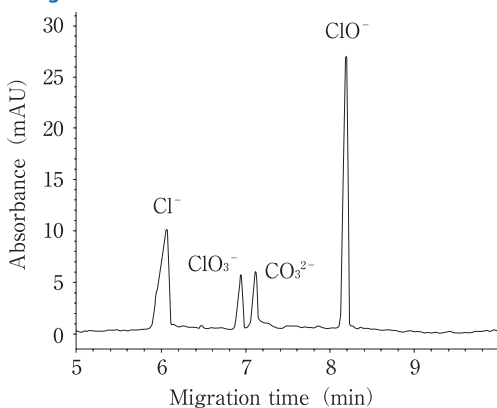
- i. A specimen solution is appropriately diluted with distilled water, and passed through a membrane filter of 0.25  $\mu\text{m}$  cellulose acetate.
- ii. The above solution is placed in a sample vial to be set for CE.
- iii. Calculation: known concentrations of hypochlorite solutions are analyzed by the above CE to construct a calibration curve (concentration of a hypochlorite ion in a specimen vs. peak area). A peak area obtained from a specimen is applied to the calibration curve to obtain its concentration.

## Assessment of the method

► *Figure 1.1* shows an electropherogram for the standard solution of 500  $\mu\text{g/mL}$  hypochlorite ion. The hypochlorite ion ( $\text{ClO}^-$ ) was eluted at 8.2 min. Peaks observable at 6.0, 6.9 and 7.1 min were due to chloride ion ( $\text{Cl}^-$ ), chlorate ion ( $\text{ClO}_3^-$ ) and carbonate ion ( $\text{CO}_3^{2-}$ ), respectively. Even in the undiluted sodium hypochlorite solution, decomposition product chloride and chlorate ions are contained. During preparation of the solutions and also during analysis, there is a possibility of decomposition of the hypochlorite ion. As shown in ► *Figure 1.1*, the peaks of such decomposition products are remarkably observed even in the electropherogram for the standard sodium hypochlorite solution. The carbonate ion observed in the chromatogram is due to atmospheric carbon dioxide, which is easily dissolved in alkaline solution.

The present CE conditions can be used for general analysis of negative ions, including cyanide, azide and arsenate [1, 2]; the conditions can be also applied to chlorate and analogous anions. The pH of the buffer is about 12; under this condition, the decomposition of hypochlorite ion is suppressed. Since it is difficult to prepare the standard hypochlorite solution without any decomposition, the true hypochlorite concentration in a specimen is lower than the value calculated using the calibration curve.

■ **Figure 1.1**



Electropherogram for the hypochlorite ion (data donated by Yokogawa Analytical Systems).

## Toxic and fatal concentrations

The hypochlorite is decomposed very easily. Especially in biomedical specimens, it reacts with proteins and other components and is decomposed very rapidly. Because of such reasons, there are no data available on the fatal blood levels of hypochlorite. There is a report describing the difficulty for detecting hypochlorite from blood of a victim, who committed suicide by ingesting a bleaching agent [3].

## Notes

- a) Hypochlorite is very unstable in acidic aqueous solution. It is decomposed to produce chlorine gas. At neutral pHs, the compound produces both chlorate and chloride ions by disproportionation reaction; at alkaline pHs, it is relatively stable. Hypochlorite is decomposed under weakly alkaline or weakly acidic conditions to produce chloride ion together with oxygen in the activated state, resulting in its bleaching action.

## References

- 1) Yokogawa Analytical Systems (1999) Instruction Manual for the Kit To Be Used for Capillary Electrophoresis Analysis of Toxic Anions, HP5964-3029, Tokyo (in Japanese)
- 2) Soga T, Ross GA (1999) Simultaneous determination of inorganic anions, organic acids, amino acids and carbohydrates by capillary electrophoresis. *J Chromatogr A* 837:231–239
- 3) Kamiyama S, Beppu K (1979) A fatal suicidal case by drinking of liquid bleach. *Jpn J Legal Med* 33:13–19 (in Japanese with an English abstract)

## II.5.2 Benzalkonium chlorides

by Kazuhiro Koyama and Yoko Shimazu

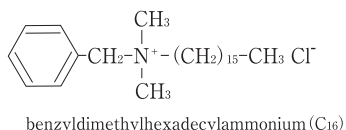
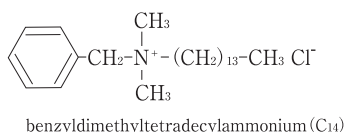
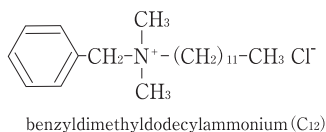
### Introduction

Surfactants can be classified into cationic, anionic and nonionic ones. Benzalkonium chlorides are cationic surfactants and being widely used as a disinfectant and germicide using their strong protein-denaturing action. Especially in hospitals, 10 % solution of benzalkonium chloride mixture is being usually used; it is diluted to 0.05–0.1 % solution to be used for various types of disinfection. The drugs are contained in gargles and preservative solutions for contact lenses.

Fatal benzalkonium chloride poisoning cases, in which the 10 % solution had been ingested, were reported [1, 2]; it can be regarded as one of the most important poisons in daily necessities. As poisoning symptoms, a pungent sense of the oral mucous membranes, sore throat, cyanosis, convulsion and coma can be mentioned [3, 4].

Benzalkonium chlorides are the mixture of multiple analogous compounds. To measure the concentration, it is necessary to combine concentrations of each component. The quaternary ammonium salt benzalkonium chlorides can be expressed as  $[C_6H_5CH_2N(CH_3)_2R]Cl$ , where R is the mixture of  $C_8H_{17}$ – $C_{18}H_{37}$ . In most cases, the major R's are  $C_{12}H_{25}$  ( $C_{12}$ ),  $C_{14}H_{29}$  ( $C_{14}$ ) and  $C_{16}H_{33}$  ( $C_{16}$ ); especially according to the National Formulary XVI,  $C_{12}$ ,  $C_{14}$  and  $C_{12} + C_{14}$  count more than 40, 20 and 70 %, respectively [5]. Therefore, upon analysis of benzalkonium chlorides, it seems necessary to measure at least the  $C_{12}$  and  $C_{14}$  compounds (▶ Figure 2.1).

■ Figure 2.1



**Structures of main components of benzalkonium chlorides.** Benzalkonium chlorides are a mixture of quaternary ammonium salts showing the structures of  $[C_6H_5CH_2N(CH_3)_2R]Cl$ , where R is a mixture of  $C_8H_{17}$ – $C_{18}H_{37}$ . However, main structures of R are  $C_{12}H_{25}$  ( $C_{12}$ ),  $C_{14}H_{29}$  ( $C_{14}$ ) and  $C_{16}H_{33}$  ( $C_{16}$ );  $C_{12} \cong 40\%$ ,  $C_{14} \cong 20\%$ , and  $C_{12}$  plus  $C_{14} \cong 70\%$  [5].

In this chapter, a method for wide-bore capillary GC/MS analysis of benzalkonium chlorides is described and an HPLC method is also mentioned briefly.

## GC/MS analysis

### Reagents and their preparation

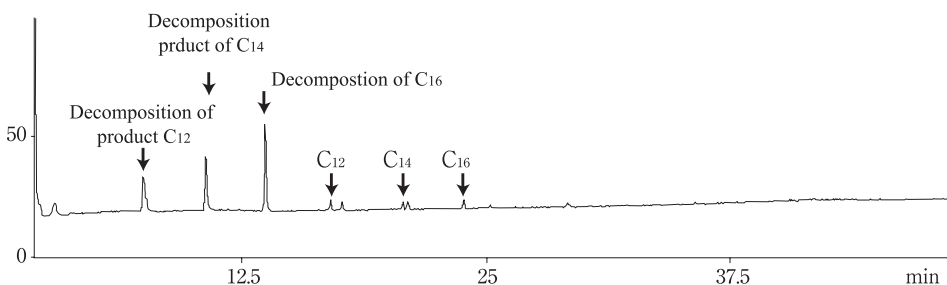
- A 1-mg aliquot each of benzyldimethyldodecylammonium ( $C_{12}$ ) bromide, benzyldimethyltetradecylammonium ( $C_{14}$ ) chloride and benzyldimethylhexadecylammonium ( $C_{16}$ ) chloride (all from Sigma, St. Louis, MO, USA) is dissolved in 100 mL methanol in a 100-mL volumetric flask to prepare 10  $\mu\text{g}/\text{mL}$  solution separately.
- A 4.3-g aliquot of NaOH is dissolved in distilled water to prepare 100 mL solution (1 M NaOH) in a 100-mL volumetric flask.
- A 1-mg aliquot of promazine hydrochloride (Sigma) is dissolved in distilled water to prepare 100 mL solution (10  $\mu\text{g}/\text{mL}$  promazine, internal standard IS) in a 100-mL volumetric flask.

### GC/MS conditions

GC column: SGE BPX35<sup>a</sup> (30 m  $\times$  0.53 mm i. d., film thickness 1.0  $\mu\text{m}$ , Shimadzu GLC Center, Tokyo, Japan).

GC/MS conditions; instrument: GCMS-QP 5050 Ancw (Shimadzu Corp., Kyoto, Japan); column (oven) temperature: 100  $^{\circ}\text{C}$  (1.5 min)  $\rightarrow$  7  $^{\circ}\text{C}/\text{min}$   $\rightarrow$  200  $^{\circ}\text{C}$   $\rightarrow$  5  $^{\circ}\text{C}/\text{min}$   $\rightarrow$  330  $^{\circ}\text{C}$  (7 min); interface temperature: 280  $^{\circ}\text{C}$ ; injection: PTV<sup>b</sup> splitless high pressure injection<sup>c</sup>, initial injection temperature 50  $^{\circ}\text{C}$  (0.01 min)  $\rightarrow$  250  $^{\circ}\text{C}/\text{min}$   $\rightarrow$  330  $^{\circ}\text{C}$  (10 min); initial pressure of injection: 200 kPa, 1.5 min; injection volume: 10  $\mu\text{L}$ ; split ratio: 10; sampling time: 1.9 min; column flow rate: 15 mL/min; MS ionization: EI; scan range (▶ Figure 2.2):  $m/z$  50–509; scan interval: 0.5 s [6].

■ Figure 2.2



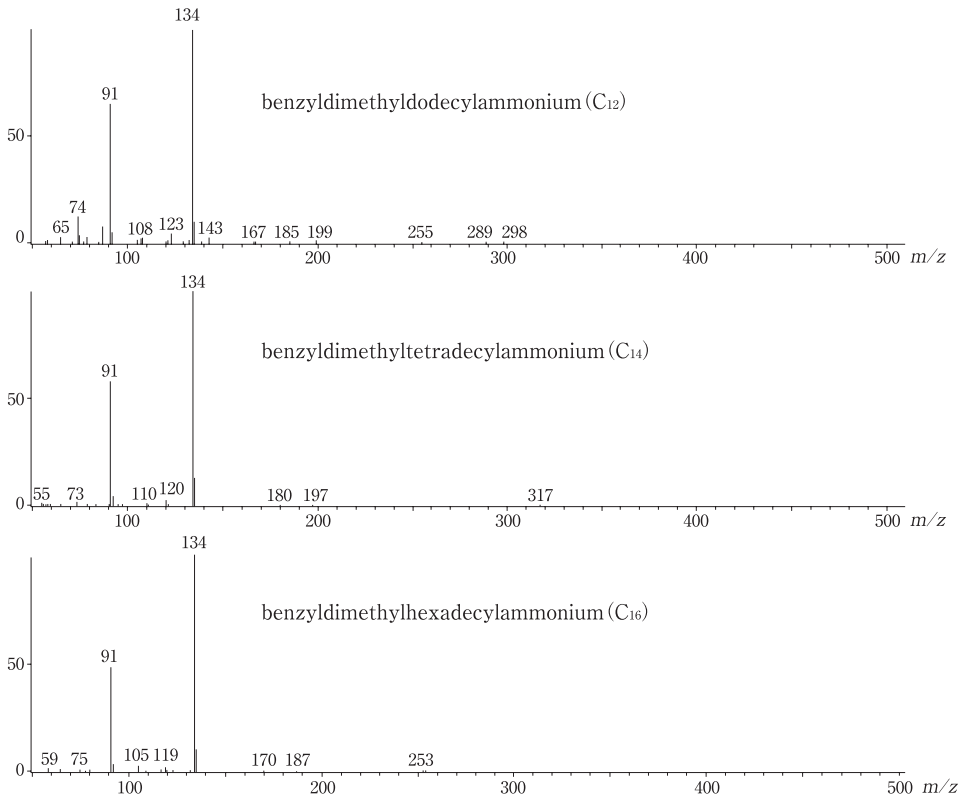
**Total ion chromatogram (TIC) for the authentic benzalkonium chlorides.  $C_{12}$ : benzyldimethyldodecylammonium;  $C_{14}$ : benzyldimethyltetradecylammonium;  $C_{16}$ : benzyldimethylhexadecylammonium.**

## Procedures

### i. Liquid-liquid extraction

- i. A 50- $\mu\text{L}$  volume each of  $\text{C}_{12}$ ,  $\text{C}_{14}$  and  $\text{C}_{16}$  methanolic solutions is placed in a small test tube, and evaporated to dryness under a stream of nitrogen with warming at 50 °C. To the combined residue, 500  $\mu\text{L}$  blank serum is added and mixed well to prepare 1  $\mu\text{g}/\text{mL}$  standard solution<sup>d</sup> for  $\text{C}_{12}$ ,  $\text{C}_{14}$  and  $\text{C}_{16}$  compounds of benzalkonium chlorides.
- ii. A 500- $\mu\text{L}$  volume each of specimens (serum, gastric juice or urine) and a 500- $\mu\text{L}$  volume of the above standard solution are placed in separate test tubes, followed by the addition of 2 mL ethyl acetate, 500  $\mu\text{L}$  distilled water, 50  $\mu\text{L}$  of 1 M NaOH solution and 50  $\mu\text{L}$  IS solution, respectively.
- iii. After vortex-mixing (or shaking) for 3 min, each tube is centrifuged at 3,000 rpm for 5 min. The upper organic phase is transferred to a vial.
- iv. The phase is evaporated to dryness under a stream of nitrogen with warming at 50 °C.
- v. The residue is dissolved in 100  $\mu\text{L}$  ethyl acetate; a 10- $\mu\text{L}$  aliquot is injected into GC/MS.
- vi. The measurements are made in the scan mode (▶ Figure 2.3); quantitation is made by ion chromatography using ions at  $m/z$  134 for  $\text{C}_{12}$ ,  $\text{C}_{14}$  and  $\text{C}_{16}$  compounds of benzalkonium chlorides and at  $m/z$  58 for promazine (IS).

■ Figure 2.3



Mass spectra of benzalkonium chlorides.

## ii. Extraction with Extrelut®

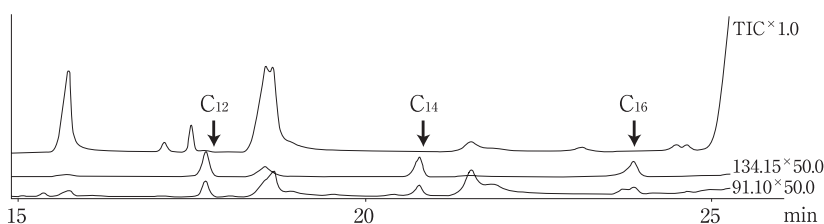
- The standard solutions<sup>d</sup> for the C<sub>12</sub>, C<sub>14</sub> and C<sub>16</sub> compounds of benzalkonium chlorides are prepared according to the above i) step of the liquid-liquid extraction.
- A 500- $\mu$ L volume each of specimens (serum, gastric juice or urine) and a 500- $\mu$ L volume of the above standard solution are placed in separate test tubes, followed by the addition of 500  $\mu$ L distilled water, 50  $\mu$ L of 1 M NaOH solution and 50  $\mu$ L IS solution, respectively.
- Each mixture is poured into Extrelut NTI® (Merck, Darmstadt, Germany) and left for 20 min. The target compounds are eluted with 4 mL ethyl acetate.
- The eluate is evaporated to dryness under a stream of nitrogen with warming at 50 °C and reconstituted in 100  $\mu$ L ethyl acetate.
- After centrifugation<sup>e</sup> at 3,500 rpm for 5 min, a 10- $\mu$ L aliquot of the supernatant fraction is injected into GC/MS.
- The GC/MS detection method is the same as described at the step vi. of the above liquid-liquid extraction.

## Assessment of the method

The detection limits by this method required for library research of a compound in the scan mode were 1–2  $\mu$ g/mL; those for quantitation by mass chromatography were about 10 ng/mL (► Figure 2.4). If higher sensitivity is required, the measurements in the SIM mode become necessary. In the present analytical system, the sensitivity is being increased by large-volume injection<sup>f</sup> using a wide-bore capillary column and the PTV sample injection device; but usual capillary GC/MS can be used without great differences, though the sensitivity becomes lower to some extent. The lower sensitivity can be overcome by using the SIM mode and/or derivatization<sup>g</sup> of the analytes.

In this section, both liquid-liquid and Extrelut extractions are described. According to the experience of the authors, the Extrelut extraction is superior to the liquid-liquid extraction in view of stability and reproducibility.

■ Figure 2.4



TIC and mass chromatograms for an extract of plasma, into which benzalkonium chlorides had been spiked. C<sub>12</sub>: benzyltrimethyl-dodecyl-ammonium; C<sub>14</sub>: benzyltrimethyl-tetradecylammonium; C<sub>16</sub>: benzyltrimethyl-hexadecylammonium. The concentration of each compound spiked was 1  $\mu$ g/mL; GC/MS analysis was made after liquid-liquid extraction.



## HPLC analysis

Benzalkoniums in plasma can be extracted by solid-phase extraction with a  $C_{18}$  column, and analyzed by HPLC using a CN separation column, acetonitrile/propionate buffer solution (0.161 M, pH 5.4) (90:10) as a mobile phase and a UV detector [7]. In another method [8], dimethyldodecylammonium chloride (DDMAC) was used as IS; benzalkoniums and IS were analyzed by HPLC using a CN-NH<sub>2</sub> column, chloroform/methanol (80:20) as a mobile phase and a post-column fluorescence detector with 9,10-dimethoxy-2-anthracene sulfonate (DMAS) as a fluorogenic reagent with excitation at 383 nm and emission at 459 nm.

## Poisoning case, and toxic and fatal concentrations

### Poisoning case

A 22-year-old male attempted suicide by taking 20–100 mL of 10 % benzalkonium chloride solution, which had been mixed with coffee, by eating a quarter of a cigarette and then by slitting his left wrist (about 4 cm long injury). His consciousness was clear and he walked to an emergency room of a hospital by himself.

Upon admission to the hospital, his physical findings were: blood pressure 120/60 mmHg; heart beat rate 94/min; body temperature 36.4 °C; respiration rate 16/min; consciousness, clear (O/JCS, E4V5M6/GCS); light reaction, positive; pupils, equally 3.5 mm; wound, cut injury in the left wrist of about 4 cm length; X-ray photographs, no finding in the chest and intestinal gas observable in the abdomen.

After admission, gastrolavage and administration of activated charcoal and Niflec® (a mixture solution of NaCl, KCl, NaHCO<sub>3</sub> and Na<sub>2</sub>SO<sub>4</sub>) were made. During his admission, no poisoning symptoms due to benzalkonium chlorides could be found; he was discharged on the next day.

Serum concentrations upon admission were: benzalkonium chlorides, 52 ng/mL in total ( $C_{12}$ : 52 ng/mL,  $C_{14}$ : < 10 ng/mL,  $C_{16}$ : < 10 ng/mL); nicotine<sup>h</sup>: < 10 ng/mL. However, the concentrations in gastric juice were: benzalkonium chlorides 54.4 µg/mL ( $C_{12}$ : 50.7 µg/mL,  $C_{14}$ : 3.6 µg/mL,  $C_{16}$ : 0.06 µg/mL); nicotine<sup>h</sup> 5.75 µg/mL.

### Toxic and fatal concentrations

In fatal benzalkonium chloride poisoning cases, solution products, containing not less than 10 % benzalkonium chlorides, were ingested. Human oral fatal doses are 100–400 mg/kg. In cases of non-oral administrations (i.v. and i.m. injections or intrauterine injection) its toxicity is much enhanced; the fatal doses were reported to be 5–15 mg/kg [1, 2].

However, the number of reports describing blood concentrations of benzalkoniums in poisoning cases are very limited. Hitosugi et al. [2] reported a fatal poisoning case, in which a 84-year-old female had taken 50 mL (96.2 mg/kg) of 10 % benzalkonium chloride solution and died 3 h later; her serum benzalkonium chloride concentration was reported to be 1.15 mg/mL. In the above survived case described in the (1) section, the serum benzalkonium chloride concentration upon admission was 52 ng/mL, which is much lower than that in the fatal case.

The survived patient might have ingested only a small amount of coffee containing the compounds; and/or the dilution of the benzalkonium solution with coffee might have resulted in no protein-denaturing action.

## Notes

- a) Any other column of slightly or intermediately polar types seems usable. In this chapter, a wide-bore capillary column was used. The column has a large capacity for loading of specimens, and the leading phenomenon does not appear, even when a trace amount of a drug in serum is measured, followed by the measurement of a large amount of the compound present in stomach contents. However, the wide-bore capillary column shows lower resolution (separation) ability. Since this type of column has a large capacity; an analyst sometimes injects a large volume of a specimen extract, resulting in the carry-over of many residual or impurity peaks during subsequent measurements.
- b) In the usual split/splitless injection mode, a sample solution is injected into an insert at a high temperature to vaporize it immediately. In contrast, the programmed temperature vaporizing (PTV) device enables the injection of a liquid sample without immediate evaporation; gradual elevation of its temperature for mild evaporation. This is useful for more sensitive analysis of thermolabile compounds without heat decomposition to some extent [9]. In this respect, the PTV device seems very useful in clinical analysis cases, in which many thermolabile compounds are dealt with. The glass insert and silica wool to be used should be silanized to prevent drugs from their decomposition [10].
- c) The high pressure injection is used for suppressing the broadening of a peak due to the large volume injection.
- d) In this method, semiquantitative measurements with one point standard are being used, because of too limited times available for analysis at a critical care medical center. For accurate quantitation, a calibration curve made of not less than 3 plots at different concentrations becomes necessary.
- e) When the Extrelut NT1<sup>®</sup> is used for extraction, clogging of a pre-filter for HPLC usually takes place in a relatively early stage; the movement of a plunger of a syringe for autoinjector of GC also becomes not smooth. To prevent these phenomena, insoluble components should be removed by centrifugation.
- f) In this method, large volume injection is being used to enhance the sensitivity for enabling identification of a trace amount of a drug being contained in a biomedical specimen. Our system can also quantitate a drug at the levels of > 10 ng/mL. The large volume injection together with PTV seems to be a powerful tool for analysis of samples obtained from drug-poisoned patients at a very busy critical care medical center, while it requires a time-consuming labor for its maintenance; when a large number of samples are analyzed, the washing of the ion source is necessary several times a week.
- g) Benzalkonium chlorides can be derivatized with 100 mg of potassium *tert*-butoxide in the presence of benzene/dimethyl sulfoxide (DMSO) by its reaction at room temperature for 10 min [11]. They cannot be converted into *t*-BDMS or TMS derivatives in their unchanged forms.
- h) Nicotine can be analyzed by HPLC as follows. A 500- $\mu$ L volume of a specimen solution (serum, gastric juice or urine), 2 mL diethyl ether, 500  $\mu$ L of 5 M NaOH solution, 50  $\mu$ L of

chlordiazepoxide solution (10 µg/mL, IS) are shaken for 3 min and centrifuged. The upper organic (diethyl ether) phase is mixed with 50 µL of 5 M HCl solution, shaken for back-extraction and centrifuged. The lower aqueous phase is evaporated to dryness under a stream of nitrogen with warming at 50 °C. The residue is dissolved in 100 µL of a mobile phase; a 20-µL aliquot is injected into HPLC [12]. HPLC conditions are: column: Shim-pack CLC-ODS (M) (25 cm × 4.6 mm i.d., Shimadzu Corp.); mobile phase: 10 mM NaH<sub>2</sub>PO<sub>4</sub>/10 mM Na<sub>2</sub>HPO<sub>4</sub>/methanol (20:20:60); flow rate: 1 mL/min; column (oven) temperature: 40 °C; detection: UV.

## References

- 1) Akutsu I, Motojima S, Ogata H et al. (1989) A case of benzalkonium chloride poisoning. *J Jpn Soc Intern Med* 78: 1613–1614 (in Japanese)
- 2) Hitosugi M, Maruyama K, Takatsu A (1998) A case of fatal benzalkonium chloride poisoning. *Int J Legal Med* 111: 265–266
- 3) Kotaki M, Fujimura N, Omote T (1996) A case of asphyxia by severe oropharyngeal edema and erosion with 10 % benzalkonium chloride (Osvan®) ingestion. *Jpn J Toxicol* 9:427–429 (in Japanese with an English abstract)
- 4) Berkel MV, Wolff AD (1988) Survival after acute benzalkonium chloride poisoning. *Hum Toxicol* 7:191–193
- 5) Suzuki I, Inoue T, Fukuda H (1991) Benzalkonium chloride. In: *Manual of the 12th Edition of Japanese Pharmacopoeia*. Hirokawa Publishing Co., Tokyo, pp c366–c369 (in Japanese)
- 6) Cybulski ZR (1984) Determination of benzalkonium chloride by gas chromatography. *J Pharm Sci* 73: 1700–1702
- 7) Bleau G, Desaulniers M (1989) High-performance liquid chromatographic assay of benzalkonium in plasma. *J Chromatogr* 487:221–227
- 8) Kummerer K, Eitel A, Braun U et al. (1997) Analysis of benzalkonium chloride in the effluent from European hospitals by solid-phase extraction and high-performance liquid chromatography with post-column ion-pairing and fluorescence detection. *J Chromatogr A* 774: 281–286
- 9) Study group of Gas chromatography of Japanese Society of Analytical Chemistry (translation) (1999) PTV splitless injection. In: *Guidebook of Sample Introduction Techniques in CGC*. Maruzen, Tokyo, pp 256–266 (in Japanese)
- 10) Study Group of Gas chromatography of Japanese Society of Analytical Chemistry (translation) (1989) Inactivation of the insert and packing materials. In: *Guidebook of Sample Introduction Techniques in CGC*. Maruzen, Tokyo, pp 49–54 (in Japanese)
- 11) Suzuki S, Nakamura Y, Kaneko M et al. (1989) Analysis of benzalkonium chlorides by gas chromatography. *J Chromatogr* 463:188–191
- 12) Saito M, Tamura Z (ed and translation) (1982) Nicotine. In: *Drug Level Monitoring*. Hirokawa Publishing Co., Tokyo, pp 254–258 (in Japanese)

## 11.5.3 Hair dyes

by Kazuhiro Koyama and Takaaki Kikuno

### Introduction

Nowadays, numerous kinds of hair dyes are being commercially available. Hair dyes are classified into “reactive hair dyes” with high toxicity and into “adhering hair dyes” with lower toxicity. The reactive hair dyes form a polymerized dye by oxidative reactions inside hair, while the adhering hair dyes only adhere to the outer surface of hair without chemical reaction. In view of poisoning, the reactive hair dyes are objects of interest and of analysis. A reactive hair dye consists of main components for polymerization (▶ Figure 3.1), a coupler for adjusting the color development (▶ Figure 3.2) and an oxidizer (several % hydrogen peroxide and others). Usually, the hair dye components and the coupler are contained in the first bottle, and the oxidizer and other compound(s) contained in the second bottle. The both fluids in the bottles are mixed just before use [1, 2]. Many chemicals (▶ Figures 3.1 and 3.2) are being used for hair dyes. Among them, *p*-phenylenediamine shows the highest toxicity, and fatal poisoning cases due to this compound were reported. For other compounds being used for hair dyes, their toxicities for humans are not well known.

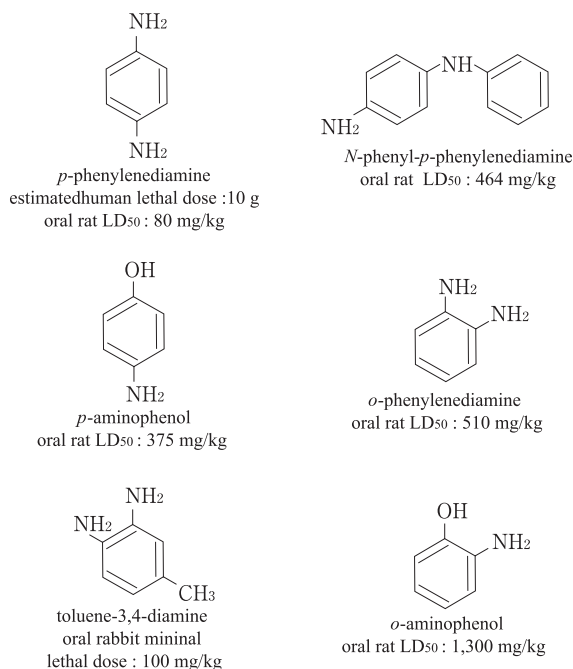
*p*-Phenylenediamine is rapidly absorbed into blood through mucous membranes of the digestive tract after its oral intake, and metabolized into quinonediimine, which acts as a cytotoxin. It is acetylated into *N*-acetyl-*p*-phenylenediamine for detoxification to be excreted into urine [2]. As its poisoning symptoms after oral intake, vomiting, epigastralgia, edemas of the face, neck and pharynx, dyspnea, acute renal failure, rhabdomyolysis, hemolysis, methemoglobinemia, hepatic disorders and others can occur [1, 2]. In 20 fatal *p*-phenylenediamine poisoning cases, convulsion, facial edema and cyanosis were characteristic, and edemas of the epiglottis and vocal folds were observed in all cases [3].

In this chapter, a method for GC/MS analysis of hair dye components is described.

### Reagents and their preparation

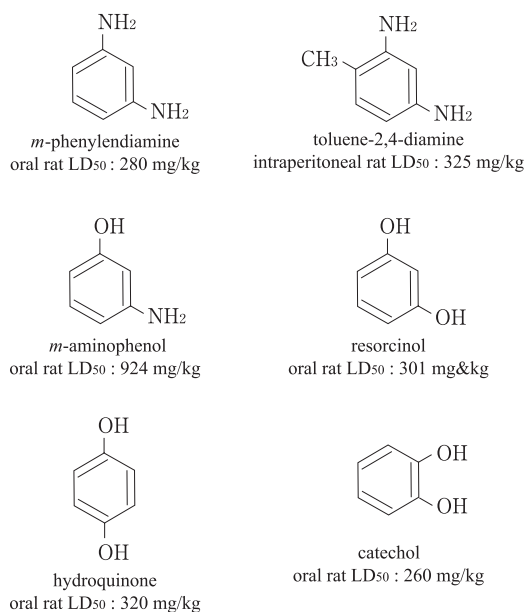
- *o*-Phenylenediamine, *m*-phenylenediamine, *p*-phenylenediamine, *p*-aminophenol, catechol, resorcinol and hydroquinone can be purchased from Sigma (St. Louis, MO, USA); *N*-phenyl-*p*-phenylenediamine, *o*-aminophenol, *m*-aminophenol, toluene-3,4-diamine (3,4-diaminotoluene) and toluene-2,4-diamine (2,4-diaminotoluene), from Aldrich (Milwaukee, WI, USA). A 10-mg aliquot each of the above compounds<sup>a</sup> is dissolved in 100 mL methanol to prepare 100 µg/mL standard solution in a volumetric flask.
- A 1-mg aliquot of promazine hydrochloride (Sigma) is dissolved in 100 mL distilled water to prepare its 10 µg/mL solution (internal standard, IS).

■ **Figure 3.1**



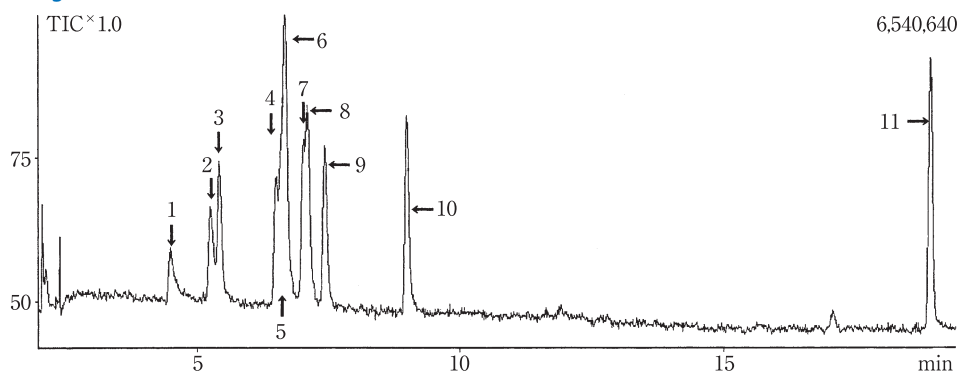
**Structures and LD<sub>50</sub> values of principal hair dye components for oxidative polymerization [1].**

■ **Figure 3.2**



**Structures and LD<sub>50</sub> values of principal hair dye couplers [1].**

**Figure 3.3**



Total ion chromatogram (TIC) for the standard compounds of principal hair dye components.

1: catechol; 2: *o*-aminophenol; 3: *o*-phenylenediamine; 4: hydroquinone; 5: *p*-aminophenol; 6: *p*-phenylenediamine plus resorcinol; 7: *m*-aminophenol; 8: toluene-3,4-diamine; 9: *m*-phenylenediamine; 10: toluene-2,4-diamine; 11: *N*-phenyl-*p*-phenylenediamine.

## GC/MS analysis

GC column: SGE BPX35 (30 m × 0.53 mm i.d.<sup>b</sup>, film thickness 1.0 μm, Shimadzu GLC Center, Tokyo, Japan).

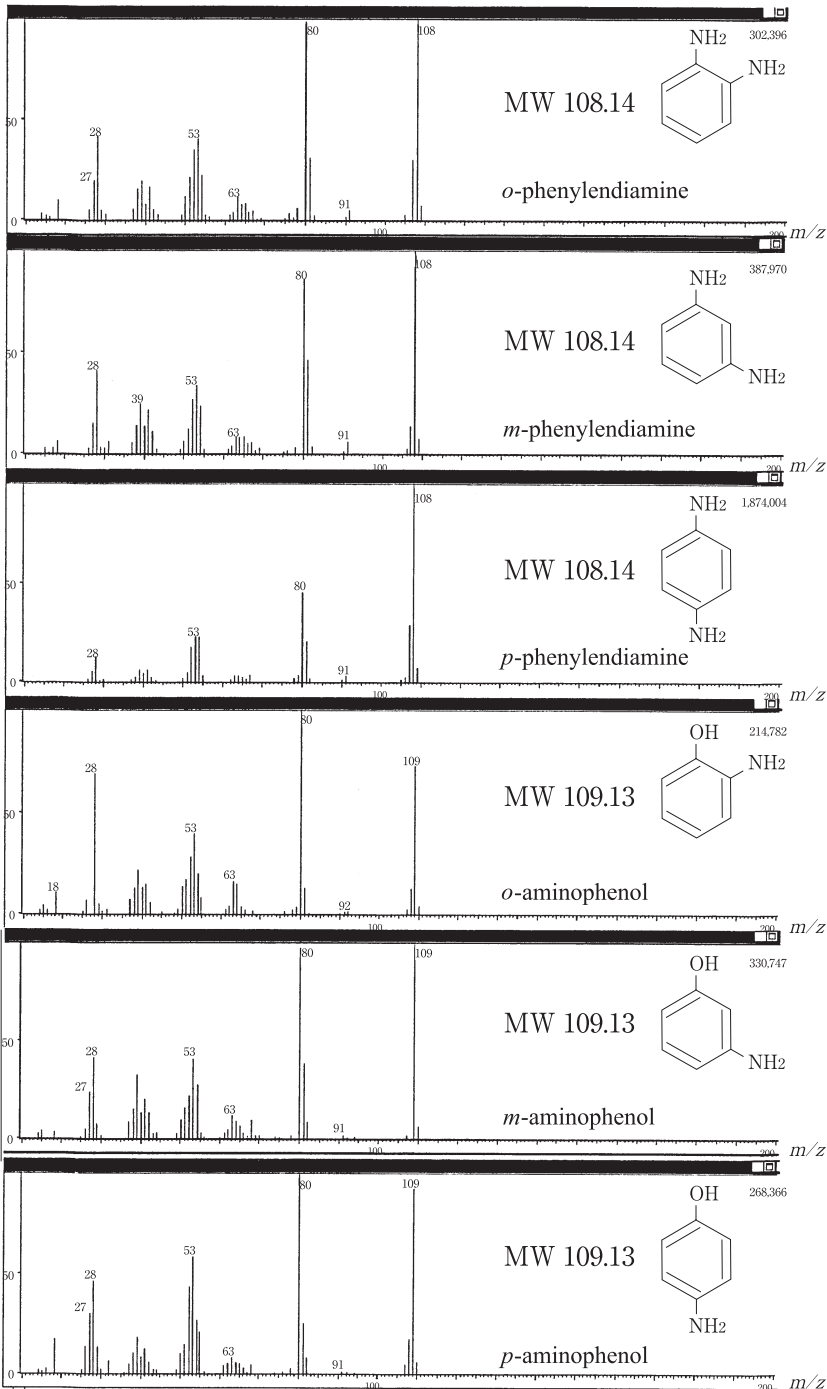
GC/MS conditions; instrument: GCMS-QP5050Ancw (Shimadzu Corp., Kyoto, Japan); column (oven) temperature: 100 °C (1.5 min) → 7 °C/min → 200 °C → 5 °C/min → 330 °C (7 min); interface temperature: 280 °C; injection device: a PTV<sup>c</sup> splitless high-pressure injection<sup>d</sup> method, 50 °C (0.01 min) → 250 °C/(min) → 330 °C (10 min); initial pressure of injection: 200 kPa, 1.5 min; injection volume: 10 μL; split ratio: 10; sampling time: 1.9 min; column flow rate: 15 mL/min; ionization: EI; scan range (▶ Figure 3.3): *m/z* 10–509<sup>e</sup>; scan interval: 0.5 s [4].

## Procedures

### i. Liquid-liquid extraction

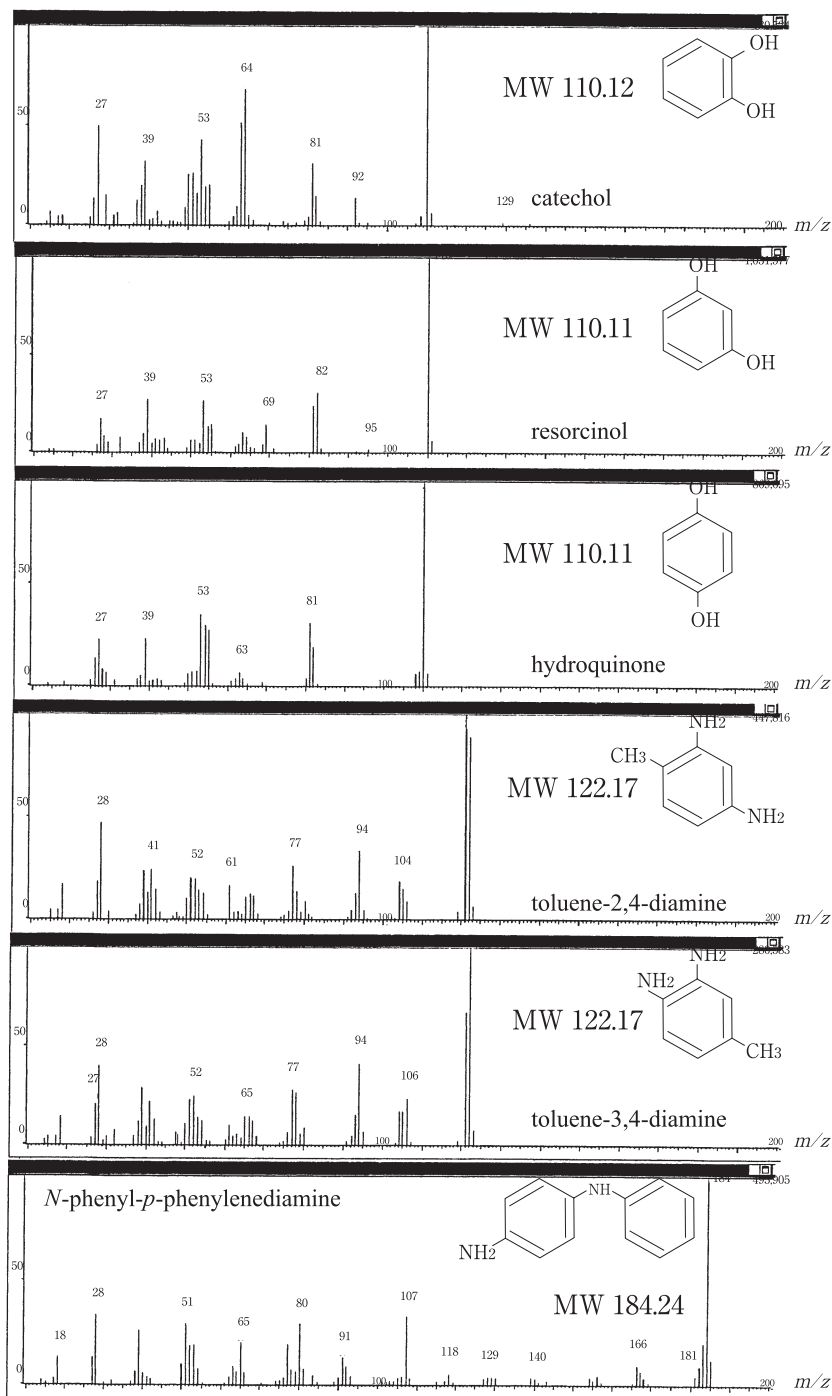
- i. The highly toxic components being contained in a product, which is suspected to be ingested by a patient, are picked up. If three compounds are involved, a 10-μL each of their standard solutions (100 μg/mL) is combined (in total 30 μL) and mixed with 470 μL of blank serum to prepare 500 μL<sup>f</sup> of the spiked standard solution (2 μg each/mL)<sup>g</sup>.
- ii. A 500-μL specimen each of serum, gastric juice and/or urine or the above 500-μL spiked standard solution is mixed with 2 mL ethyl acetate, 500 μL distilled water and 50 μL IS solution in a test tube with a ground-in stopper.
- iii. After shaking for 3 min, each tube is centrifuged at 3,000 rpm for 5 min; the upper phase (ethyl acetate phase) is transferred to a glass vial and evaporated to dryness under a stream of nitrogen at 50 °C.

Figure 3.4



Mass spectra of principal hair dye components.

Figure 3.5



Mass spectra of principal compounds being used as hair dye couplers.



- iv. The residue is dissolved in 100  $\mu\text{L}$  ethyl acetate, and a 10- $\mu\text{L}$  aliquot of it is injected into GC/MS.
- v. Ions at  $m/z$  108 for phenylenediamines, at  $m/z$  109 for aminophenols (▶ Figure 3.4), at  $m/z$  110 for catechol, resorcinol and hydroquinone, at  $m/z$  121 for toluene-2,4-diamine, at  $m/z$  122 for toluene-3,4-diamine, at  $m/z$  184 for *N*-phenyl-*p*-phenylenediamine (▶ Figure 3.5) and at  $m/z$  58 for promazine are used for quantitation by mass chromatography.

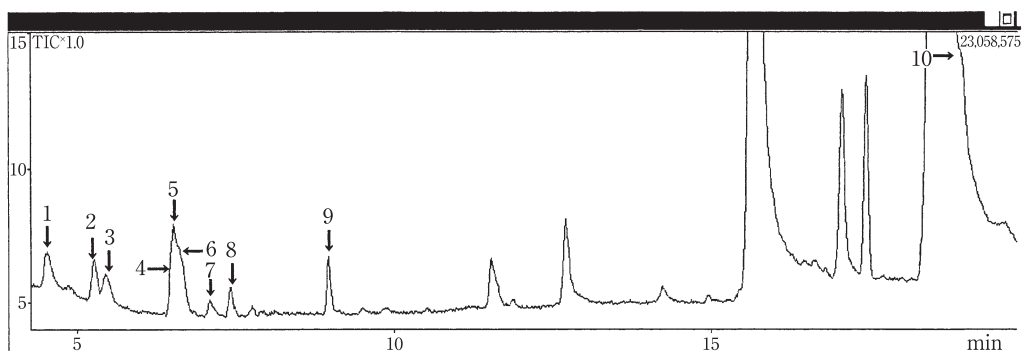
## ii. Extraction with Extrelut

- i. Each solution prepared according to the above i) and ii) steps of the liquid-liquid extraction is poured into Extrelut NTI (Merck, Darmstadt, Germany) and left for 20 min; then target compounds are eluted with 4 mL ethyl acetate.
- ii. The eluate is evaporated to dryness under a stream of nitrogen with warming at 50 °C.
- iii. The residue is dissolved in 100  $\mu\text{L}$  ethyl acetate and centrifuged<sup>b</sup> for 3,500 rpm for 5 min.
- iv. A 10- $\mu\text{L}$  aliquot of the supernatant fraction is injected into GC/MS.
- v. Quantitation is made according to the step v) of the above liquid-liquid extraction.

## Assessment of the method

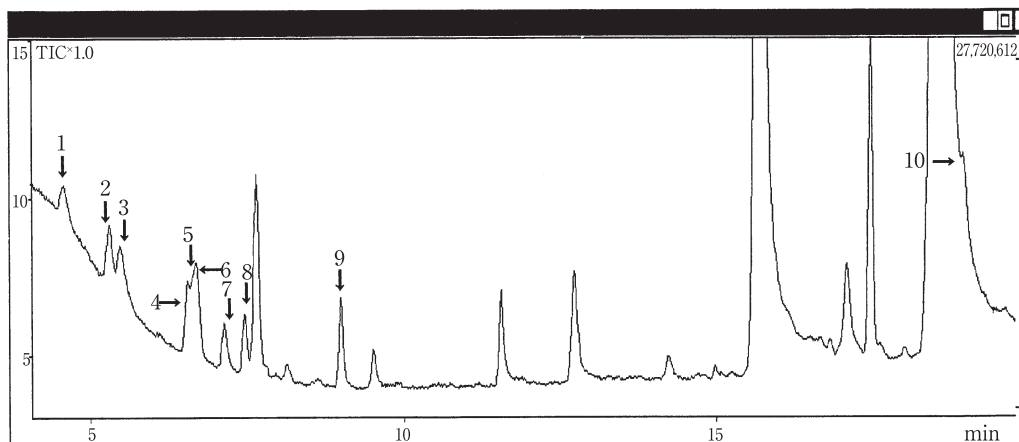
The concentration of a compound capable of library research using its mass spectrum by the present GC/MS with PTV large volume injection is not lower than 1  $\mu\text{g}/\text{mL}$ . There are many compounds with analogous structures and mass spectra; it is essential to exactly determine their retention times. The detection limits in the scan mode are about 10 ng/mL (▶ Figs. 3.6 and 3.7). When higher sensitivity is required, the measurements in the SIM mode should be made. In this method, large-volume injection is being realized by combining a wide-bore capillary column and a PTV sample-introducing device, resulting in higher sensitivity<sup>i</sup>. However, by usual GC/MS, the hair dye components can be also detected, although the sensitivity may be somewhat lower.

▶ Figure 3.6



TIC for the liquid-liquid extract of a serum sample, into which hair dye components (10 compounds, 2  $\mu\text{g}/\text{mL}$  each) had been spiked. 1: catechol; 2: *o*-aminophenol; 3: *o*-phenylenediamine; 4: hydroquinone; 5: *p*-aminophenol; 6: *p*-phenylenediamine; 7: toluene-3,4-diamine; 8: *m*-phenylenediamine; 9: toluene-2,4-diamine; 10: *N*-phenyl-*p*-phenylenediamine.

Figure 3.7



TIC for an Extrelut extract of a serum sample, into which hair dye components (10 compounds, 2 µg/mL each) had been spiked. The peak numbers are the same as specified in Figure 3.6.

Since many of the hair dye components are relatively volatile, their recoveries after pre-treatments become not so good; the recoveries by the liquid-liquid extraction are about 40 %, while those with the Extrelut about 60 %. Both recovery and reproducibility by the Extrelut extraction are superior to those by the liquid-liquid extraction.

## Poisoning case, and toxic and fatal concentrations

### i. A poisoning case

A 47-year-old female was found collapsed biting an end of a gas tube to be connected with a stove in her mouth (there had been a gas-like smell for about 3 h according to allegation of a neighbor). When a rescue squad arrived, her conditions were: consciousness level, 1 (JCS); blood pressure, 100/74 mmHg; pupils, evenly 2 mm. The squad discovered a hair dye (Ashley®) and an over-the-counter hypnotic (Wutt®) in her bathroom. She was sent to a critical care medical center.

The inhaled gas was liquefied petroleum gas, which contained almost no carbon monoxide and thus caused only a hypoxic state. The amount of the drug (Wutt) ingested was estimated to be 12 tablets, which were calculated to contain 1,000 mg bromisovalum, 600 mg apronalide and 100 mg diphenhydramine hydrochloride. The Ashley consisted of 40 mL of the 1st solution (color base: alkaline hair dye components), which contained *o*-aminophenol, *p*-aminophenol, *p*-phenylenediamine, alkylbenzenesulfonic acid salt, propylene glycol, polyethylene glycol, polyoxymethylenelanoline and essence, and of 40 mL of the 2nd solution (cream developer: an oxidizer). She was estimated to have ingested about 70 mL of the above solutions in total; the estimated amount of *p*-phenylenediamine ingested was about 1.4 g.

Her physical conditions 3 h after ingestion were: blood pressure, 116/76 mmHg; heart beat 120/min; body temperature, 35.6 °C; respiration rate, 26/min; consciousness level, 10 (JCS) and E3V5M6 (GCS); pupil diameter, both 2.0 mm; light reaction, positive. There were no obvious edemas of the face and neck.

Thirty liters of gastrolavage was performed (the color of the lavage fluid was dark), and activated charcoal and Niflec® (2 L aqueous solution containing 2.93 g NaCl, 1.485 g KCl, 3.37 g NaHCO<sub>3</sub> and 11.37 g Na<sub>2</sub>SO<sub>4</sub>) were administered orally. At night of the 1st day of admission, the occult blood test of urine became positive (2+); 2 vials of heptoglobin were administered, followed by direct hemoperfusion and administration of 7 mL of 0.8 % methylene blue. On the 2nd day of admission, hemorrhage was found through the stomach tube; the consciousness level was 1–10 (JCS). By endoscopic examination, the hemorrhage was found originating from the cardiac orifice of the stomach. On the 3rd day of admission, the stomach tube was extubated. On the 4th day, she was transferred to a general ward, because of the improvement of the symptoms.

Upon admission, the serum bromisovalum concentration was 0.01 µg/mL and the Ashley components could not be measured in serum. However, the concentration of bromisovalum in gastric juice was 21.3 µg/mL; the concentration of Ashley was also found to be about 10 % in gastric juice by analysis of its UV spectrum [5].

## ii. Toxic and fatal concentrations

Chugh et al. [6] reported a case of a 20-year-old female, who had ingested 40 mL of 4 % *p*-phenylenediamine (1.6 g), had provoked the swelling of the face and neck, upper-abdominal pain, vomiting and acute renal failure (acute necrosis of urinary tubules), but had been able to survive. In the report, they could not detect hair dye components from her blood. By ingestion of about 1.5 g of *p*-phenylenediamine, poisoning symptoms appears, but it seems not fatal. Yagi et al. [7] reported that 12 subjects, who had ingested about 7 g of *p*-phenylenediamine, had become seriously poisoned and 4 of them had died eventually. Therefore, when not less than 2 g of the compound is ingested, fatal poisoning should be kept in mind upon treatments of such patients.

The reports describing the *p*-phenylenediamine concentrations in blood are very limited. In the report by Ashraf et al. [8], a 60-year-old male attempted suicide by ingesting *p*-phenylenediamine, provoked severe edema of the pharynx and rhabdomyolysis and died of cardiac attack 4 h after admission; the concentration of *p*-phenylenediamine in his blood was 1.47 µg/mL, and 6-aminobenzothiazole, the metabolic product of *p*-phenylene-diamine could be identified by mass spectrometry. However, at the present time, the toxicity is known only for *p*-phenylenediamine. For other components being contained in hair dyes, they probably have their own toxicities; but no data are available and they remain to be explored.

## Notes

- a) Except the above compounds, there are many compounds being used as components of hair dyes. In this chapter, compounds with relatively high toxicity are being selected. The above compounds dissolved in methanol may be colored in several weeks even under storage at 30 °C (especially for *p*-phenylenediamine and aminophenols). When the compounds are dissolved in ethyl acetate and stored at 30 °C, such coloration is suppressed for a longer period.
- b) Any slightly or intermediately polar wide-bore capillary column can be used. The present column has advantages that it shows high loading capacity for a sample and no leading phenomenon appears, even when a low level of a drug in serum is measured, followed by

measurement of a much higher concentration of the same drug in the stomach contents. However, the column occasionally shows insufficient dissolution ability, resulting in difficulty of separating peaks. When a large volume of a sample is injected, some impurity or compound peaks may be carried over.

- c) In the split/splitless injection mode of the usual GC, a sample extract solution is injected into an insert space at a high temperature to vaporize it immediately. In contrast, the new programmed temperature vaporizing (PTV) mode enables the gradual increase of injection temperature for mild evaporation of samples. With this mode, the decomposition of thermolabile compounds can be suppressed to some extent, resulting in the increase of sensitivity for such compounds [9]. Since there are many thermolabile compounds among drugs, the PTV system seems very useful for drug analysis. The glass insert and its silica wool stopper should be inactivated by silanization to protect drugs from their decomposition [10].
- d) The high-pressure injection is used to prevent a peak from its broadening due to large volume injection.
- e) The compounds being used for hair dyes are relatively low in molecular weights; there are many compounds with similar structures, showing similar mass spectra. Therefore, to enhance the hit ratio of library search of GC/MS, the scan is started from  $m/z$  10.
- f) Since many of hair dye components are relatively volatile, the spiked standard solution is prepared only by adding methanolic standard solution without any evaporation.
- g) The one-point standard method is being employed for semiquantitation in the critical care medical center, because of limited times for analysis. When an accurate value is required, a calibration curve should be constructed by plotting different concentrations (not less than 3 points).
- h) When extraction is made with an Extrelut NT1 column, the clogging of a pre-filter of HPLC sometimes appears and the movement of a plunger in a syringe of an autoinjector becomes not smooth for GC or GC/MS. These are due to the presence of insoluble impurities appearing in the extracts. To remove them, the centrifugation is necessary.
- i) In this system, large volume injection is being used to identify drugs present in trace amounts in biomedical specimens for drug screening. It is also useful for quantitative analysis of drugs at 10 ng/mL. The system with the PTV is a powerful tool for drug analysis at a critical care medical center with limited times for analysis. In contrast, it requires laborious maintenance of the instrument; when the analysis is made very frequently, the washings of the ion source are required several times every week.

## References

- 1) Ishizawa J, Takahashi N (1996) Hair dyes. *Jpn J Acute Med* 20:1584–1585 (in Japanese)
- 2) Takahashi N, Ishizawa J, Yamashita M et al. (1988) Hair dyes. *Jpn J Acute Med* 12:1509–1512 (in Japanese)
- 3) Shima H (1960) A study on hair dye poisoning. *Med J Nihon Univ* 19:2633–2638 (in Japanese with an English abstract)
- 4) Koyama K, Ogasawara N, Kadomatsu K et al. (2000) A study on a blood concentration determination system for patients in acute drug poisoning. *IRYO* 54:565–570 (in Japanese)
- 5) Koyama K, Kikuno T, Ichikuzaki K et al. (1996) A study on blood bromisovalum concentrations in its acute poisoning. *J Nippon Hosp Pharm Assoc* 22:45–51 (in Japanese)
- 6) Chugh KS, Malik GH, Singhal PC (1982) Acute renal failure following paraphenylenediamine [hair dye] poisoning: report of two cases. *J Med* 13:131–137

- 7) Yagi H, Hind EA, Khalil SI (1991) Acute poisoning from hair dye. *East Afr Med J* 68:404–411
- 8) Ashraf W, Dawling S, Farrow LJ (1994) Systemic paraphenylenediamine (PPD) poisoning: a case report and review. *Hum Exp Toxicol* 13:167–170
- 9) Study Group of Gas Chromatography of Japanese Society of Analytical Chemistry (translation) (1999) PTV splitless injection. In: *Guidebook of Sample Introduction Techniques in CGC*. Maruzen, Tokyo, pp 256–266 (in Japanese)
- 10) Study Group of Gas Chromatography of Japanese Society of Analytical Chemistry (translation) (1999) Inactivation of an insert and packing materials. In: *Guidebook of Sample Introduction Techniques in CGC*. Maruzen, Tokyo, pp 49–54 (in Japanese)

## II.5.4 Permethrin

by Naoto Matsumoto

### Introduction

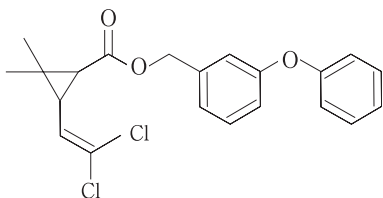
Pyrethroids are the general term for insecticide pyrethrins and their analogs (cinerins and jasmolins) being included in the flowers of pyrethrum or chrysanthemum. Trace concentrations of pyrethroids exert rapid toxic effects on insects, but are rapidly metabolized for detoxification in warm-blooded animals; they are insecticides with very high safety for humans.

On the basis of clarification of chemical structures of the effective components of the pyrethrum, many of new synthetic pyrethroids were developed. Nowadays, the natural pyrethroids are almost replaced by the synthetic ones. They are not only being used for household insecticides, but also being used in agriculture worldwide. They count about 1/3 of the total insecticides, and are even increasing at the present time.

Products containing pyrethroid insecticides are numerous; their toxicities for humans are generally low. However, since phenotrin, permethrin and empenethrin are ubiquitous as powders, emulsions and moth repellants for clothes, there are possibilities of their accidental and suicidal ingestion.

Permethrin<sup>a</sup> (▶ *Figure 4.1*) [3-phenoxybenzyl(1*RS*)-*cis*, *trans*-3-(2,2-dichlorovinyl)-2,2-dimethylcyclopropane-1-carboxylate] is one of the pyrethroids with the lowest toxicities and being used very widely; the author et al. [1] experienced an actual case of ingestion of a large amount of permethrin-containing emulsion (Adio<sup>®</sup>, Agros, Tokyo, Japan) and measured the concentrations of its *cis* and *trans* isomers in blood and gastric juice. In this chapter, a method of HPLC analysis for permethrin in serum is presented.

■ **Figure 4.1**



**Structure of permethrin.**

### Reagents and their preparation

- Pure *cis*- and *trans*-permethrin isomers can be obtained from Wako Pure Chemical Industries, Ltd., Osaka, Japan; the mixture of the isomers from ICN (Costa Mesa, CA, USA). In the case of the mixture, the confirmation of the composition ratio is essential.
- The standard permethrin methanolic solution is prepared at 1–10 µg/mL and stored in a light-shading bottle.

- Other common chemicals are of the special or HPLC grade. The water<sup>b</sup> to be used for a mobile phase or pretreatments should not be stored in a plastic container, but be stored in a glass one.

## HPLC conditions

HPLC column<sup>c</sup>: Bensil 5C<sub>18</sub>-C (15 cm × 4.6 mm i.d., Bentec, Chiba, Japan; guard column: LiChrospher PR 18e (4 × 4 mm i.d., Merck Japan, Tokyo, Japan).

HPLC conditions; instruments<sup>d</sup>: LC-10A; data processor: C-R4A (Shimadzu Corp., Kyoto, Japan); column temperature: 40 °C; mobile phase: acetonitrile/0.01 M K<sub>2</sub>HPO<sub>4</sub> (pH 6.5, adjusted with phosphoric acid) (75:25, v/v); flow rate: 1.0 mL/min; detection wavelength<sup>e</sup>: UV 210 nm.

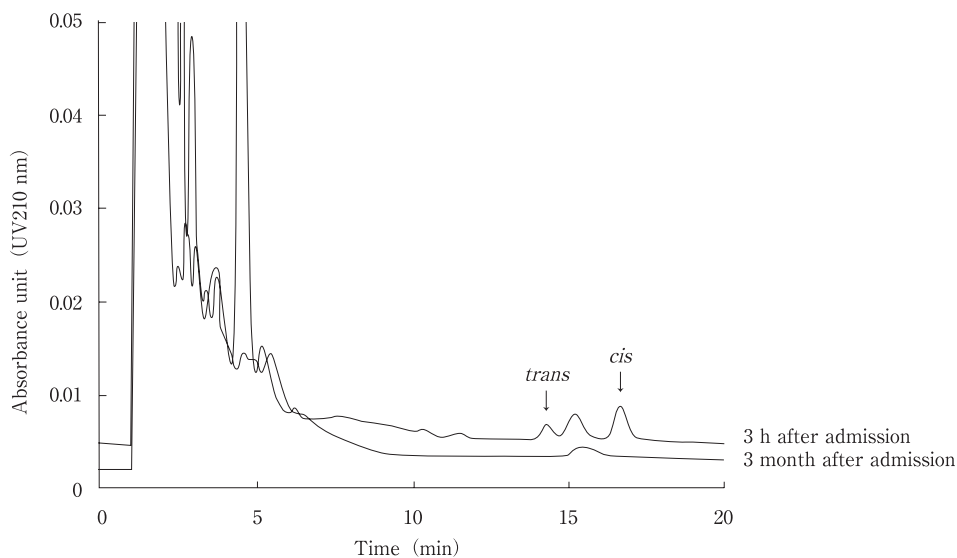
## Procedure

- i. Permethrin is a lipophilic compound. When a plastic blood-collecting tube containing a serum-separating agent is used for sampling a small amount of blood, permethrin is easily adsorbed to the serum-separating agent (polyolefin or polystyrene), causing low recoveries of this compound. For samplings of blood specimens, usual glass blood-collecting tubes should be used.
- ii. A 100-μL volume of serum and 200-μL acetonitrile are placed in a 500-μL volume polypropylene tube, vortex-mixed for 10 s, sonicated for 1 min and centrifuged at 15,000 g for 1 min.
- iii. A 100-μL volume of the supernatant solution is injected into HPLC using an autoinjector.
- iv. When it is within several hours after ingestion, there is a possibility of the presence of permethrin in gastric juice; in such cases, gastric juice and/or gastrolavage fluid should be obtained. Either of them is diluted 100–1,000 fold with water/methanol (1:1) for analysis; a 100-μL of the solution is processed in the same way as that of the above serum specimens.
- v. Construction of a calibration curve: a 10-μL volume each of the standard permethrin solutions (1–10 μg/mL) is placed in a 1.5-mL volume sample tube and evaporated to dryness under a stream of nitrogen or by leaving it at room temperature. A 1-mL volume of serum is added to each residue and vortex-mixed for 10 s; a 100-μL each of the spiked sera at various concentrations is processed according to the above procedure. The external calibration method is used for quantitation using peak areas<sup>f</sup>.

## Assessment and some comments on the method

Since the toxicity of permethrin is low, its poisoning cases are few; the reports on chromatographic analysis of permethrin in human blood are very limited [1]. There are reports on analysis by HPLC or GC (GC/MS) for permethrin in foods (oil [2], milk [3] and grain [4]), chemical products (shampoo and lotion [5]), biological specimens (rat plasma and urine [6–8]) and environmental water [9].

■ **Figure 4.2**



**HPLC chromatograms for extracts of sera obtained from a permethrin-poisoned patient 3 h and 3 months after admission.**

For toxin screening by GC/MS, such analysis becomes possible using gastric juice and/or gastrolavage fluid, if it is within several hours after ingestion. The gastric juice or gastrolavage fluid is diluted 100–1,000 fold with methanol; a 1–2  $\mu\text{L}$  aliquot of the solution is injected into GC/MS. The GC/MS conditions are; column: a methylsilicone chemical-bonded capillary column; column temperature:  $50\text{ }^{\circ}\text{C} \rightarrow 15\text{ }^{\circ}\text{C}/\text{min} \rightarrow 300\text{ }^{\circ}\text{C}$ ; scan range:  $m/z$  50–400. Under these conditions, the isomers of permethrin can be separated; *cis*-permethrin appears earlier than *trans*-permethrin. After identification of permethrin in gastric juice or gastrolavage fluid, its quantitative analysis can be done by HPLC.

In this method, the deproteinization is being employed using a water-soluble organic solvent<sup>6</sup>; it is accomplished only by the addition of 2 volumes of acetonitrile to serum. Such simplicity of the procedure results in good reproducibility; the intra-day CV values are not greater than 3 %.

The detection wavelength<sup>e</sup> is set at 210 nm. The absorbance ratios are:  $200/210\text{ nm} = 1.32$ ;  $220/210\text{ nm} = 0.68$ ;  $260/210\text{ nm} = 0.036$ ;  $270/210\text{ nm} = 0.048$ ;  $280/210\text{ nm} = 0.039$ . The absorbance is higher at shorter wavelengths. When the interference by impurities of serum and the sensitivity are taken into consideration, the wavelength at 210 nm is optimal. ➔ *Figure 4.2* shows HPLC chromatograms for permethrin in sera of a patient, who had ingested a large amount of permethrin emulsion.

The recovery of permethrin from serum was 95.0 % at 500 ng/mL of the spiked concentration. Good linearity could be obtained in the range of 50–1,000 ng/mL. The detection limit was 20 ng/mL ( $S/N = 3$ ).

The advantages of the use of the reversed phase HPLC for analysis of permethrin in serum are the simplicity of pretreatments and rapidness of analysis; it seems more useful than GC in clinical analysis.



For more sensitive analysis, the condensation of permethrin using Sep-Pak C<sub>18</sub> [6] (Waters, Milford, MA, USA) or Extrelut (Merck, Darmstadt, Germany) extraction becomes necessary.

## Poisoning case, and toxic and fatal concentrations

A 59-year-old male [1] attempted suicide by ingesting 600 mL of 20 % permethrin emulsion (Adion<sup>®</sup>) and sent to a hospital under clouding of his consciousness. He had had a past history of mania-depression and renal dysfunction. Upon the first examination, his consciousness level was 100 (JCS), and incontinent diarrhea with whitish water-like stools, which gave a insecticide-like smell, was observed. The laboratory tests showed high values of BUN and creatinine probably due to metabolic acidosis and renal dysfunction. By treatments, such as endotracheal intubation, gastrolavage, administrations of activated charcoal and magnesium citrate and transfusion, his conditions were improved; after 15 h, his consciousness became clear and the metabolic acidosis was improved. On day 11, he was transferred to the psychiatric department.

The concentrations of permethrin isomers were: *trans*-form 96 ng/mL and *cis*-form 118 ng/mL upon admission; *trans*-form 253 ng/mL and *cis*-form 615 ng/mL reaching the maximum levels after 3 h; the levels decreased thereafter. The areas under the curves (AUC) of permethrin at 24 h after ingestion were 2,700 and 6,280 ng · h/mL for *trans*- and *cis*-forms, respectively; the *trans/cis* ratio of the AUC was 0.43 (*trans/cis* concentration ratio for the Adion<sup>®</sup> emulsion, 1.30). This shows faster blood clearance of the *trans*-form of permethrin than that of the *cis*-form in humans.

The metabolic rate of the *trans*-form of permethrin is faster than that of the *cis*-form also in rats and mice; the residual permethrin in cow milk is higher for the *cis*-form than for the *trans*-one [10]. These data are in agreement with those of the patient.

## Notes

- a) The structures of the *cis*- and *trans*-forms of permethrin are due to different locations of the dichlorovinyl group and of the carboxylic acid ester group against the plane of the dimethylcyclopropane ring. In addition, there are optical isomers (1 RS) for each form, which can be separated only with a column having a chiral activity.
- b) The mobile phase conditions for HPLC analysis of permethrin are similar to those for plasticizers to be used for production of plastics. This means that the permethrin measurements may be interfered by plasticizers in HPLC chromatograms; such interference should be taken into consideration, especially when an isocratic mode is changed into a gradient mode.
- c) For separation, any column packed with porous silica gel (particle size, 5 μm) chemically bonded by ODS (C<sub>18</sub>) (carbonization rate, about 15 %) can be used. If the size of the column is the same (15 cm × 4.6 mm i.d.), similar separation property can be obtained.
- d) For HPLC and its data processor, a system, which enables the storage of data in FD or HDD and various manipulations of peaks such as magnification, reduction and other changes on CRT, is most preferable. Without such a system, the sensitivity becomes about 5 times lower (detection limit, about 100 ng/mL).

- e) When a UV detector is used for HPLC analysis, the setting of a wavelength is very important; it is desirable to use a longer wavelength to avoid the interference by biological impurities. The UV absorbance is dependent on the  $\pi$  bond ( $\pi$  electrons). The location of absorption maximum has a regular relationship with the presence of conjugated double bonds (conjugated olefin), and with the kinds and the number of substituents for the unsaturated carbonyl compounds (Woodward rule). The more conjugated double bonds give more shift of absorbance toward a longer wavelength (from UV to visible ranges). UV absorption spectra of compounds having phenyl groups like permethrin show  $\lambda_{\max}$  at 260 °C 280 nm; there is a trend that lower absorbance of a compound is obtained for a lower ratio of phenyl group(s) to the molecular size. When a detection wavelength is set at 200–220 nm, the absorbance becomes higher. However, in this range of wavelengths, the absorbance due to an impurity compound having a single double-bond appears; such absorbance due to impurities interferes with that of a target compound. Therefore, it is not necessary to set a detection wavelength at  $\lambda_{\max}$  of the compound; it is more important to avoid the interference by absorbance of impurity compounds, and it is most preferable to select a wavelength, which is highly specific to a target compound.
- f) For quantitation of a compound by HPLC, the internal or external calibration method is being utilized using peak heights or peak areas. Peak heights are very susceptible to degradation of a separation column or a guard column, and to the increase of dead volumes due to undesirable piping; peak areas are much more resistant to these problems and thus give better reproducibility.
- g) When deproteinization is performed by using a water-soluble organic solvent for the pretreatment of a biomedical specimen such as serum, followed by centrifugation to obtain clear supernatant extract to be directly injected into reversed phase HPLC, there is a possibility of deformation of a peak shape (leading and/or decrease in the number of theoretical plates). This phenomenon is due to the solvent of a specimen to be injected into HPLC; it appears when the elution ability of the solvent is higher than that of the mobile phase. The solvent makes a part of a compound eluted faster. In this method, the deproteinization with acetonitrile gave 67 % acetonitrile extract solution. Therefore, such effect may appear, when the content of acetonitrile in the mobile phase is lower than 67 % (using columns of ODS with a low carbonization ratio or columns of a chemical-bonded octyl or phenyl group).

## References

- 1) Gotoh Y, Kawakami M, Matsumoto N et al. (1998) Permethrin emulsion ingestion: clinical manifestations and clearance of isomers. *J Toxicol Clin Toxicol* 36:57–61
- 2) Ramesh A, Balasubramanian M (1998) Rapid preconcentration for the determination of pyrethroid insecticides in vegetable oils and butter fat and simultaneous determination by gas chromatography-electron capture detection and gas chromatography-mass spectrometry. *Analyst* 123:1799–1802
- 3) Di Muccio A, Pelosi P, Barbini DA et al. (1997) Selective extraction of pyrethroid pesticide residues from milk by solid-matrix dispersion. *J Chromatogr A* 765:51–60
- 4) Dicke W, Ocker HD, Their HP (1988) Residue analysis of pyrethroid insecticides in cereal grain, milled fractions and bread. *Z Lebensm Unters Forsch* 186:125–129
- 5) Garcia E, Garcia A, Barbas C (2001) Validated HPLC method for quantifying permethrin in pharmaceutical formulations. *J Pharm Biomed Anal* 24:999–1004

- 6) Abu-Qare AW, Abou-Donia MB (2000) Simultaneous determination of pyridostigmine bromide, N,N-diethyl-m-toluamide, permethrin, and their metabolites in rat plasma and urine by high-performance liquid chromatography. *J Chromatogr B* 749:171–178
- 7) Abu-Qare AW, Abou-Donia MB (2001) Simultaneous determination of malathion, permethrin, DEET N,N-diethyl-m-toluamide and their metabolites in rat plasma and urine using high performance liquid chromatography. *J Pharm Biomed Anal* 26:291–299
- 8) Abu-Qare AW, Abou-Donia MB (2001) Simultaneous determination of chlorpyrifos, permethrin, and their metabolites in rat plasma and urine by high-performance liquid chromatography. *J Anal Toxicol* 25:275–279
- 9) Rawn GP, Webster GR, Muir DC (1982) Fate of permethrin in model outdoor ponds. *J Environ Sci Health B* 17:463–486
- 10) The Joint FAO/WHO Meeting on Pesticide Residues (1980) JMPR. Pesticide Residues in Food. 1979 Evaluations. Food and Agriculture Organization of the United Nations, Rome, pp 369–425

## 11.5.5 Boric acid

by *Shinichi Suzuki*

### Introduction

Boric acid and borax (sodium tetraborate) had been widely used as antiseptics (preservatives) and/or ethical drugs; however, by reevaluation made in Japan, 1985, the questionability was raised on their effectiveness. Nowadays, they are being permitted to be used only for washing or disinfection of the eye as ethical drugs. In recent year, boric acid has been widely used as a household insecticide especially for cockroaches (called “boric acid ball”), resulting in the increase of boric acid poisoning cases.

The boric acid ball is a toxic bait for cockroaches; its toxicity is slow-acting, but fatal for the insects. Various types of boric acid ball products are commercially available, but it can be hand-made at home very easily. As an attractant material for cockroaches, crushed onions are being usually added to boric acid.

Because of wide availability of the boric acid balls, accidental intake of them by infants can occur frequently. As poisoning symptoms of boric acid, nausea, vomiting, diarrhea and bleeding can be mentioned. When a relatively large amount of boric acid is ingested by an infant, there is a possibility of fatality.

In Japanese trials, only with the presence of a toxic substance in a vomitus, it is difficult to prove that the toxic substance is causative of a poisoning case; namely, it does not verify the intake of the poison by the victim. Therefore, in Japanese law, it is essential to verify the presence of a poison in blood, urine and/or stomach contents (not vomitus).

In this chapter, the methods for analysis of boric acid in blood, urine and stomach contents by spectrophotometry and HPLC are described.

### Spectrophotometric analysis [1, 2]

---

#### Reagents and their preparation

- Boric acid and borax can be obtained from Sigma (St. Louis, MO, USA).
- Curcumin solution: 0.1 g curcumin (Sigma) is dissolved in purified water to prepare 100 mL solution.
- 2-Ethyl-1,3-hexanediol solution: 10 mL of 2-ethyl-1,3-hexanediol (Aldrich, Milwaukee, WI, USA) is dissolved in chloroform to prepare 100 mL solution.

#### Analytical instrument


A DU-70 type UV-Vis spectrophotometer<sup>a</sup> (Beckman, Fullerton, CA, USA).

## Procedure

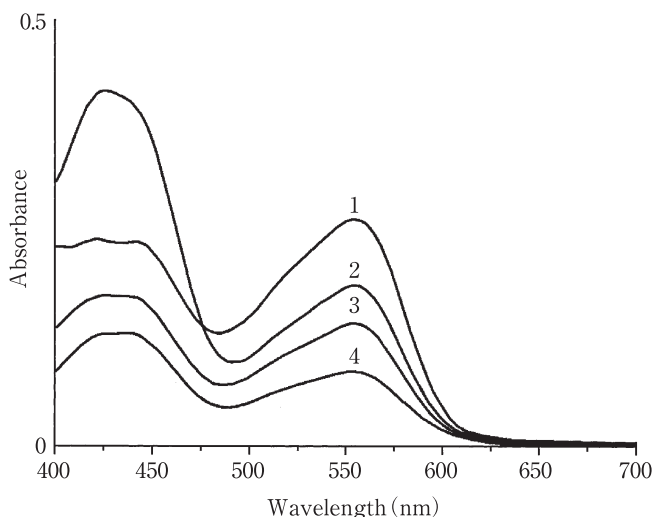
The procedure for blood, urine and stomach contents is described here, but it is, of course, applicable to the solubilized specimens of a boric acid ball itself.

- i. A part of specimens (blood, urine and stomach contents) is mixed well with purified water to serve as sample solution.
- ii. A 0.5-mL volume of the sample solution is diluted with purified water to prepare 5 mL solution.
- iii. To this solution, are added 1 mL of 50 % sulfuric acid and 5 mL 2-ethyl-1,3-hexanediol, followed by shaking for extraction<sup>b</sup>.
- iv. The tube containing the above mixture is centrifuged at 3,000 rpm for 5 min; the resulting 2-ethyl-1,3-hexanediol layer is passed through a filter paper.
- v. A 1-mL volume of the filtrate is mixed with 1 mL of the curcumin solution and 0.5 mL of concentrated sulfuric acid, left for 30 min, then mixed with 25 mL ethanol and finally left for 10 min.
- vi. The absorbance of the above solution is measured with a spectrophotometer at 550 nm to detect and quantitate boric acid.

## Assessment of the method

This method is simple and excellent in quantitiveness; the detection limit is about 1  $\mu\text{g/mL}$  as a concentration in the test tube.  *Figure 5.1* shows absorption spectra for the complex form of boric acid, which had been contained in various matrices.

 **Figure 5.1**



**Absorption spectra for boric acid in various matrices after its chelating extraction and curcumin color reaction. 1: Boric acid standard solution (30  $\mu\text{g/mL}$ ); 2: a blood specimen; 3: a stomach content specimen; 4: a urine specimen.**

By the present spectrophotometric analysis of boric acid in a urine specimen, the value obtained may be slightly greater than the true value. This is probably due to interference by a certain urinary element, which also forms a similar chelated complex.

## HPLC analysis

---

### Reagents and their preparation

- Mobile phase: 5 mM perchloric acid solution is prepared, passed through a membrane filter and degassed.
- 2-Ethyl-1,3-hexanediol solution: the preparation is the same as described in the spectrophotometric analysis section.

### HPLC conditions

Instrument: an LC-5A high-performance liquid chromatograph<sup>c</sup> (Shimadzu Corp., Kyoto, Japan); detector: a Waters 410 type differential refractometer (Waters, Milford, MA, USA).

Column: Shim-pack SCR-102H (30 cm × 8 mm i.d., Shimadzu Corp., a strong anion exchanger).

Mobile phase: 5 mM perchloric acid solution; its flow rate: 0.5 mL/min; column (oven) temperature: 50 °C.

### Procedure

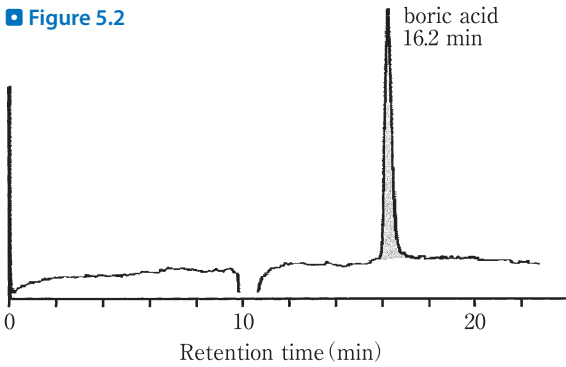
- i. The steps i.–iv. described in the spectrophotometric analysis section are followed. The boric acid chelate is extracted and filtered.
- ii. The 5 mL of the 2-ethyl-1,3-hexanediol filtrate is evaporated to dryness.
- iii. The residue is dissolved in an appropriate amount of the mobile phase; a 5- $\mu$ L aliquot of the solution is injected into HPLC.
- iv. For quantitation, each of various concentrations of the authentic boric acid is added to the blank matrix, and then treated in the same way as described above to construct an external calibration curve.

### Assessment of the method

➤ *Figure 5.2* shows an HPLC chromatogram for the complex of the authentic boric acid (injected amount, 1  $\mu$ g). ➤ *Figure 5.3* shows that obtained from a blood specimen; many impurity peaks appear for biomedical specimens, but specific analysis can be achieved, if the analytical conditions are set appropriately.

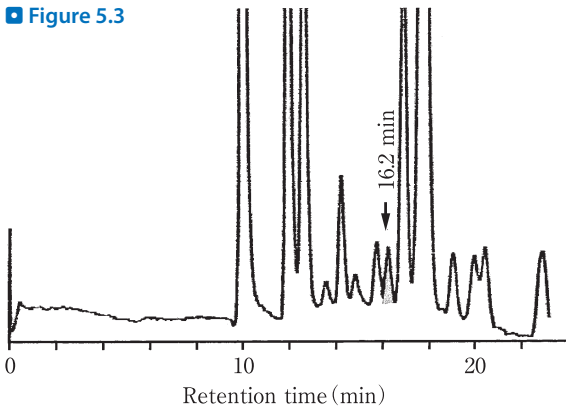
By this method, the detection limits are about 10  $\mu$ g/mL (50 ng in an injected volume).

■ **Figure 5.2**



HPLC chromatogram for the standard boric acid after chelating extraction. The amount of boric acid in an injected volume was 1  $\mu\text{g}$ .

■ **Figure 5.3**



HPLC chromatogram for a chelated extract of blood containing boric acid.

In this method, the analysis is being made with an HPLC instrument equipped with a differential refractometer after chelation of boric acid. To detect borate ion without chelation, ion chromatography should be used; in the latter method, a conductivity detector is usually used. In the modern type of an ion chromatograph, an auto-suppressor mode is being adopted, resulting cleaner backgrounds and higher sensitivity (more than 10 times higher than that of the present HPLC). However, the cost for an ion chromatographic system is much higher than that of the conventional HPLC.

## Poisoning case, and toxic and fatal concentrations

A 83-year-old male [3] ingested 3 balls of hand-made boric acid mixture around noon, and vomited several times after supper in the evening. On the next day, he visited a hospital, because exanthemas appeared in his face, chest and abdomen. At that time, general conditions seemed good, but the laboratory tests showed BUN at 34.2 mg/dL and Cr at 1.6 mg/dL, show-

ing slight renal dysfunction. Five days after admission, the erythematous exanthemas extended to all parts of his body, followed by remarkable desquamation. From the 6th day of admission, general fatigue, dyspnea and respiratory noises appeared. By X-ray irradiation of the chest, pleural effusion was discovered, suggesting the presence of cardiac dysfunction. In addition, he fell into hepatic dysfunction and DIC. The anti-DIC treatments and hemodialysis (2 times) were performed for him. His bad conditions were improved gradually; he was discharged on day 42.

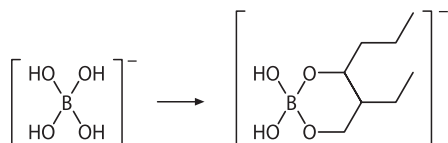
As acute boric acid poisoning symptoms, nausea, vomiting, diarrhea and abdominal pain is most common as observed in the above case; headache, scarlet fever-like exanthemas and desquamation of the skin are sometimes observed. When the poisoning becomes severe, listlessness, convulsions, shock and renal failure appear successively.

The fatal doses of boric acid are 15–20 g for adults, 5–6 g for small children and 2–3 g for babies. When a cockroach ball with a high boric acid content is eaten by a small child, there is a possibility of death. Such concern is not limited to the boric acid ball; caution should be directed also toward boric acid solutions, which are being widely used as preservatives and disinfectants.

In survived cases, in which boric acid had been taken by mistake or for suicidal purpose, the boric acid concentrations were 1–44  $\mu\text{g}/\text{mL}$  in blood and 20  $\mu\text{g}/\text{mL}$  in urine [3]. In a fatal case, its blood concentration was 37.7  $\mu\text{g}/\text{mL}$  30 h after ingestion [3].

## Notes

- Any type of spectrophotometers can be used.
- The chelating complex of 2-ethyl-1,3-hexanediol and boric acid is considered to be formed by the following reaction.



- Any type of HPLC instruments can be used.

## References

- Public Health Council (ed) (1983) *Methods of Analysis in Health Science, Methods for Food Additives, Preservatives, Boric Acid and Its Salts*. The Pharmaceutical Society of Japan, Tokyo, pp 81–83 (in Japanese)
- Fukui S (1983) A method for determination of boric acid in foods using chelating extraction with 2-ethyl-1,3-hexanediol and protonated curcumin. *Eisei Kagaku* 29:323–328 (in Japanese with an English abstract)
- Japan Poison Information Center (ed) (2000) *Poisoning Accidents and their Countermeasures with Special Reference to Actual Cases*, revised edn. Jiho Inc., Tokyo, pp 349–352 (in Japanese)



## 11.5.6 Naphthalene

by Kanako Watanabe

### Introduction

Naphthalene (naphthalin) is being widely used as a moth repellent (insecticide), and being sold at supermarkets and general stores. Since one package of the compound usually contains as much as 1.8–5 g of naphthalene, the accidental ingestion of such a product by a small infant may cause fatality. However, recently, *p*-dichlorobenzene products, to be dealt with in the next chapter, have become more popular as a moth repellent.

Naphthalene exists in the form of colorless crystals at room temperature, but easily sublimes into its gas with an aromatic odor exerting the repellent effect for insects.

In this chapter, a method for headspace GC/MS analysis of naphthalene is presented utilizing its volatile property.

### Reagent and their preparation

#### i. Reagents

Naphthalene can be purchased from Sigma (St. Louis, MO, USA); stable-isotopic naphthalene- $d_8^a$  (internal standard, IS) from Aldrich (Milwaukee, WI, USA). Other common chemicals used are of the highest purity commercially available.

#### ii. Preparation

Naphthalene and naphthalene- $d_8$  (IS) solutions: 2-mg aliquot each is dissolved in 2 mL methanol to prepare stock solution separately. A 1- $\mu$ L aliquot of each stock solution is injected into GC/MS to measure each mass spectrum.

For spiked tests, the above each stock solution is diluted 10-fold with methanol; a different volume of the naphthalene solution (1–10  $\mu$ L containing 0.1–1  $\mu$ g) and 10  $\mu$ L (containing 1  $\mu$ g) of naphthalene- $d_8$  (IS) solution are placed in each glass vial with a Teflon-septum cap containing 0.2 mL of blank whole blood.

### GC/MS conditions

GC column<sup>b</sup>: an Rtx-1 fused silica medium-bore capillary column (30 m  $\times$  0.32 mm i. d., film thickness 0.25  $\mu$ m, Restek, Bellefonte, PA, USA).

GC conditions; instrument: a GC-17A gas chromatograph<sup>c</sup> (Shimadzu Corp., Kyoto, Japan); column (oven) temperature: 50 °C (1 min)  $\rightarrow$  10 °C/min  $\rightarrow$  150 °C  $\rightarrow$  20 °C/min  $\rightarrow$  280 °C; injection temperature: 250 °C; carrier gas: He; its flow rate: 3 mL/min; injection mode: splitless for 1 min after injection, followed by the split mode.

MS conditions; instrument: a Shimadzu QP-5050 quadrupole mass spectrometer<sup>c</sup> (connected with the above GC); ionization: positive ion EI; electron energy: 70 eV; emission current: 60  $\mu$ A; ion source temperature: 280 °C; accelerating voltage: 1.5 kV.

## Procedure

- i. A 0.2-mL volume of a whole blood specimen<sup>d</sup>, 10  $\mu$ L (containing 1  $\mu$ g) of IS solution and 0.8 mL distilled water are placed in a 7-mL volume glass vial with a Teflon-septum screw cap, capped and mixed gently.
- ii. The vial is heated at 80 °C for 30 min on a heat block or in a water bath. At the same time, the 5-mL volume syringe<sup>e</sup> is also heated on the same block. The needle<sup>f</sup> size for the syringe is 23 G. After heating, a 1-mL volume of the headspace vapor is withdrawn into the heated syringe, and carefully injected into GC/MS not to influence the vacuum degree of the MS instrument.
- iii. Detection is made using ions at  $m/z$  128 for naphthalene and at  $m/z$  136 for IS in the SIM mode.
- iv. Construction of a calibration curve: to 0.2 ml each of blank whole blood (not less than 3 vials) obtained from healthy subjects, 10  $\mu$ L IS solution and a different amount of naphthalene are added. The mixture is treated according to the above procedure. The calibration curve consists of peak area ratio of naphthalene to IS on the vertical axis and naphthalene concentration on the horizontal axis. The peak area ratio obtained from a blood specimen is applied to the calibration curve to obtain a naphthalene concentration<sup>g</sup>.

## Assessment of the method

▶ *Figure 6.1* shows mass spectra of naphthalene and IS. By this method, most reliable identification of naphthalene can be achieved. The molecular ions constituted the base peaks; the peaks at  $m/z$  128 and 136 are not interfered with each other. ▶ *Figure 6.2* shows SIM chromatograms for naphthalene and IS, which had been extracted by the headspace method. The detection limit of naphthalene in the SIM mode was about 100 ng/mL in whole blood.

The efficiency (recovery) of naphthalene was tested; about 25–30 % of total naphthalene, which had been added to blank whole blood, were distributed in the headspace gas in the 7-mL volume vial after heating at 80 °C for 30 min.

In this method, in spite of the use of a medium-bore capillary column in the splitless mode, as much as 1 mL gas is injected into GC/MS. Usually, such conditions cause remarkable broadening of a peak to be detected. However, it is not the case in the present method; each peak appears in a sharp shape (▶ *Fig. 6.2*). The author adopted a relatively low temperature (50 °C) of the column (oven) upon injection of the headspace vapor, and confirmed that an entire amount of naphthalene contained in the headspace gas injected was completely trapped inside the column at 50 °C.

It should be kept in mind that naphthalene is contained in gasoline, kerosene and heavy oil [1] and also in tobacco smoke [2].

Figure 6.1

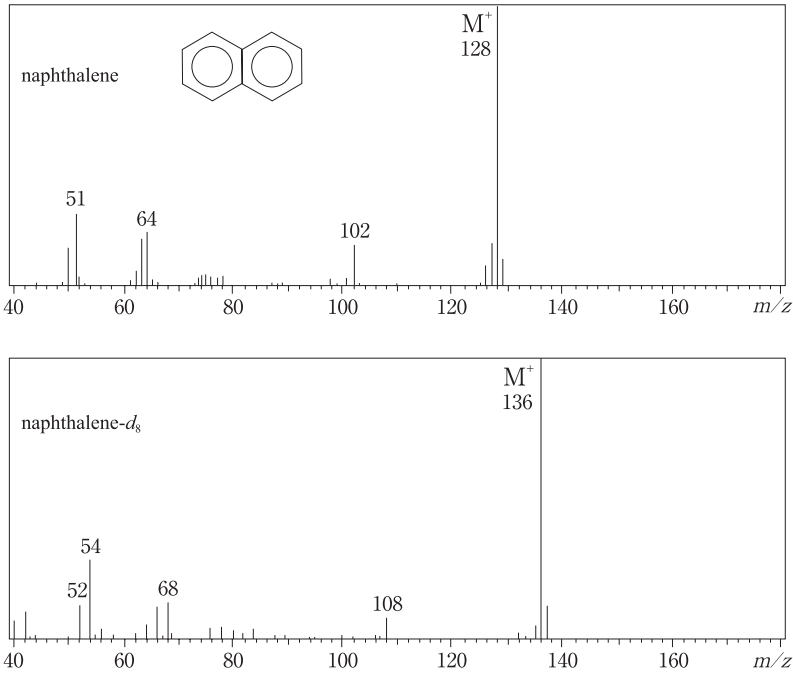
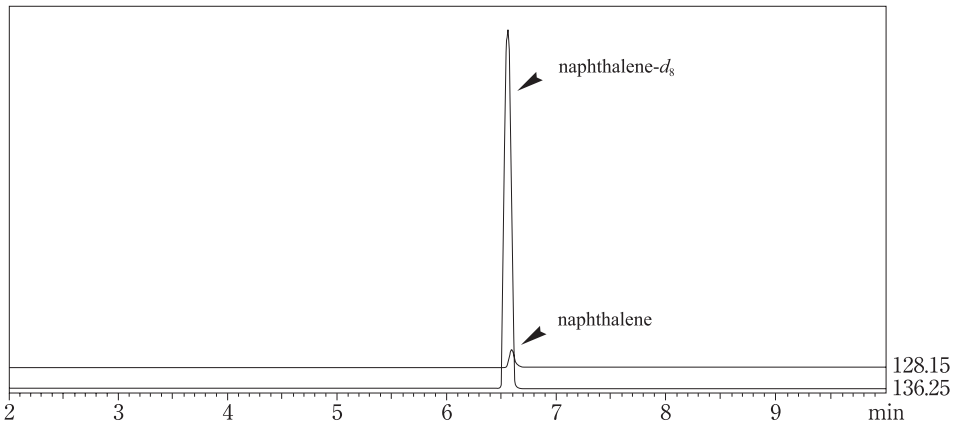
Mass spectra of naphthalene and naphthalene- $d_8$  (IS).

Figure 6.2

SIM chromatograms for naphthalene and IS headspace-extracted from whole blood. The amounts of IS and naphthalene spiked to 0.2 mL blood were 1  $\mu$ g and 50 ng, respectively.

## Poisoning case and fatal concentrations

A 6-month-old male [3] opened two packages of naphthalene (commercial name: Neopas<sup>®</sup>) and seemed to ingest a part of the total amount (18 g) of the compound, because an appreciable amount of its crystals were found attached around his mouth and to the face and scalp hair. At 3 h later, he was cheerful and showed no symptoms upon arrival at a hospital. His skin was immediately washed, and various treatments, such as gastrolavage, administration of activated charcoal and a purgative (magnesium citrate) and enforced diuresis, were given to him. On the 5th day of admission, exanthemas, followed by blisters and erosions, appeared in his back; they were improved by the oral administration of Predonine<sup>®</sup> (prednisolone) together with the topical deterging. On day 6, hemolysis appeared together with the decrease of hemoglobin value from 12.7 to 10.6 g/dL. During careful monitoring of his conditions, no abnormalities were observed for his neurological, hepatic and renal functions. On day 14, he was discharged with complete recovery. In this case, the real amount of naphthalene ingested by him seemed much smaller than that estimated.

When a large amount of naphthalene is taken orally, vomiting takes place in every case; there appears abdominal spasm associated with diarrhea. When naphthalene is absorbed into the body, central nervous system symptoms, such as headache, vertigo, unconsciousness, convulsion and coma appear. Naphthalene is metabolized into  $\alpha$ - and  $\beta$ -naphthols and naphthoquinone, which cause severe hemolysis, followed by hemoglobinemia, methemoglobinemia and then renal dysfunction after several days [4, 5].

Oral fatal doses estimated are 1–2 g for infants and 5–15 g for adults with great variations among individuals [3].

The number of reports describing the concentrations of naphthalene in blood and tissues in its poisoning cases is very limited. Ijiri et al. [6] reported a case, in which a neurotic mother had given her 2-month-old male baby milk mixed with 6 g naphthalene; he had died 30 min–1 h later. The concentrations of naphthalene in blood, the liver and kidney were 0.55, 0.12 and 0.03  $\mu\text{g/g}$  or mL, respectively.

## Notes

- Stable-isotopic naphthalene is commercially available from Aldrich and Sigma (product No. 17,604-4). Its price is not expensive. In MS techniques, the use of a stable-isotopic compound is most desirable for quantitation; this is called “isotope dilution technique”.
- Any type of non-polar dimethylsilicone capillary columns can be used, irrespective of their manufacturers. An Rtx-Volatiles fused silica capillary column (30 m  $\times$  0.32 mm, film thickness 1.5  $\mu\text{m}$ ) was also tested, but the Rtx-1 column gave better results.
- Any type of GC/MS instruments including sector, quadrupole and ion-traps types can be used.
- Since whole blood can be analyzed by this method, urine seems also analyzable with the same procedure.
- Either a usual 5-mL volume glass syringe or a gas-tight syringe can be used.
- The tip of the usual injection-syringe needle is being cut obliquely and sharply. This can be used in this method. However, the author is using a special type of 23 G needles, which has a tip being cut conically; this needle is advantageous, because such a tip prevents the needle from being clogged by septum debris.

- g) It is possible to make quantitation analysis without IS using an external calibration curve. Also in place of the stable-isotopic compound, 1-methylnaphthalene or 2-methylnaphthalene can be used as IS.

## References

- 1) Bertsch W, Holzer G (1995) Analysis of accelerants in fire debris by gas chromatography/mass spectrometry. In: Yinon J (ed) *Forensic Applications of Mass Spectrometry*. CRC Press, Boca Raton, pp 129–169
- 2) Schmeltz I, Tosk J, Hoffmann D (1976) Formation and determination of naphthalenes in cigarette smoke. *Anal Chem* 48 645–650
- 3) Japan Poisoning Information Center (ed) (2000) *Poisoning Accidents and their Countermeasures with Special Reference to Actual Cases*, revised ed. Jiho Inc., Tokyo, pp 65–68 (in Japanese)
- 4) Nishi K (ed) (1999) *Emergency Manual for Poisoning*. Iyaku Journal, Osaka, pp 244–245 (in Japanese)
- 5) Ukai T (ed) (1999) *Manual of Treatments in Acute Poisoning*, 3rd edn. Jiho Inc., Tokyo, pp 156–157 (in Japanese)
- 6) Ijiri I, Shimosato K, Ohmae M et al (1987) A case report of death from naphthalene poisoning. *Jpn J Legal Med* 41:52–55

## 11.5.7 *p*-Dichlorobenzene

by Kanako Watanabe

### Introduction

Nowadays, *p*-dichlorobenzene (paradichlorobenzene, 1,4-dichlorobenzene) is becoming more popular than naphthalene as a moth repellent (insecticide) worldwide. The discrimination between *p*-dichlorobenzene and naphthalene is usually difficult only by their smells and their appearances. However, specific gravities of their crystals are different; they are 1.152 and 1.5 for naphthalene and *p*-dichlorobenzene, respectively. Therefore, when the crystals sink in NaCl-saturated water, it is estimated to be *p*-dichlorobenzene; while when they float in the same solution, it may be naphthalene [1]. Camphor also gives a similar aromatic smell and appearance, but its discrimination is even easier, because its specific gravity is only 0.99; it floats in tap water. The weight of *p*-dichlorobenzene being sold as a moth repellent is about 4 g; the crystal mass of the same compound being used for a toilet mothball ranges from 40 to 200 g. Therefore, when a large amount of this compound is ingested, it is dangerous for life.

Like naphthalene, *p*-dichlorobenzene easily vaporizes from its solid into gas; in this chapter, a method for headspace GC/MS analysis of *p*-dichlorobenzene is presented utilizing the volatile property.

### Reagents and their preparation

#### i. Reagents

*p*-Dichlorobenzene and *p*-dichlorobenzene- $d_4$  (product No. 32,933-9)<sup>a</sup> can be purchased from Aldrich (Milwaukee, WI, USA). Other common chemicals used were of the highest purity commercially available.

#### ii. Preparation

*p*-Dichlorobenzene and *p*-dichlorobenzene- $d_4$  solutions: 2-mg aliquot each is dissolved in 1 mL methanol to prepare stock solutions. A 1- $\mu$ L volume of each stock solution is injected into GC/MS to record each mass spectrum.

For spiked tests, the above each stock solution is diluted 10-fold with methanol; a different volume of the *p*-dichlorobenzene solution (1–10  $\mu$ L containing 0.2–2  $\mu$ g) and 10  $\mu$ L (containing 2  $\mu$ g) of *p*-dichlorobenzene- $d_4$  (IS) are placed in each glass vial with a Teflon-septum cap containing 0.2 mL of blank whole blood.

## GC/MS conditions

GC column<sup>b</sup>: an Rtx-1 fused silica medium-bore capillary column (30 m × 0.32 mm i. d., film thickness 0.25 μm, Restek, Bellefonte, PA, USA).

GC conditions; instrument: a GC-17A gas chromatograph (Shimadzu Corp., Kyoto, Japan); column (oven) temperature: 50 °C (1 min) → 10 °C/min → 150 °C → 20 °C/min → 280 °C; injection temperature: 250 °C; carrier gas: He; its flow rate: 3 mL/min; injection mode: splitless for 1 min after injection, followed by the split mode.

MS conditions; instrument: a Shimadzu QP-5050 quadrupole mass spectrometer<sup>c</sup> (connected with the above GC); ionization: positive ion EI; electron energy: 70 eV; emission current: 60 μA; ion source temperature: 280 °C; accelerating voltage: 1.5 kV.

## Procedure

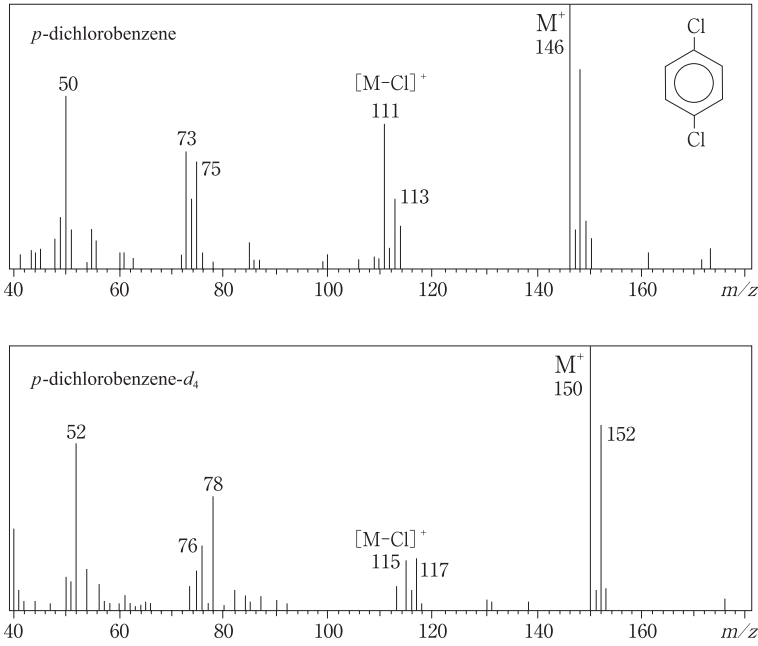
- i. A 0.2-mL volume of a whole blood specimen<sup>d</sup>, 10 μL (containing 2 μg) of IS solution and 0.8 mL distilled water are placed in a 7-mL volume glass vial with a Teflon-septum screw cap, capped and mixed gently.
- ii. The vial is heated at 80 °C for 30 min on a heat block or in a water bath. At the same time, the 5-mL volume syringe<sup>e</sup> is also heated on the block. The needle<sup>f</sup> size for the syringe is 23 G. After heating, a 1-mL volume of the headspace vapor is withdrawn into the heated syringe, and carefully injected into GC/MS not to influence the vacuum degree of the MS instrument.
- iii. Detection is made using ions at  $m/z$  146 and at  $m/z$  152 for IS in the SIM mode.
- iv. Construction of a calibration curve: to 0.2 mL each of blank whole blood (not less than 3 vials) obtained from healthy subjects, 2 μg of IS and a different amount of *p*-dichlorobenzene are added. The calibration curve consists of peak area ratio of *p*-dichlorobenzene to IS on the vertical axis and *p*-dichlorobenzene concentration on the horizontal axis. The peak area ratio obtained from a blood specimen is applied to the calibration curve to obtain its concentration<sup>g</sup>. It is essential that the concentration to be analyzed is within the concentration range of the calibration curve.

## Assessment of the method

➤ *Figure 7.1* shows mass spectra of *p*-dichlorobenzene and IS. *p*-Dichlorobenzene contains two chlorine atoms, which give characteristic isotopic peaks at  $m/z$   $M + 2$  and  $M + 4$ . Therefore, the molecular base peak of *p*-dichlorobenzene found at  $m/z$  146 is not interfered with by any peak of other compounds, while that of *p*-dichlorobenzene-*d*<sub>4</sub> found at  $m/z$  150 is interfered with by a minor peak of non-labelled *p*-dichlorobenzene (➤ *Figure 7.1*). However, the relatively intense isotopic peak at  $m/z$  152 appearing for *p*-dichlorobenzene-*d*<sub>4</sub> is usable, because it is not interfered with by any peak. Thus we have decided to use peaks at  $m/z$  146 and 152 for *p*-dichlorobenzene and IS, respectively.

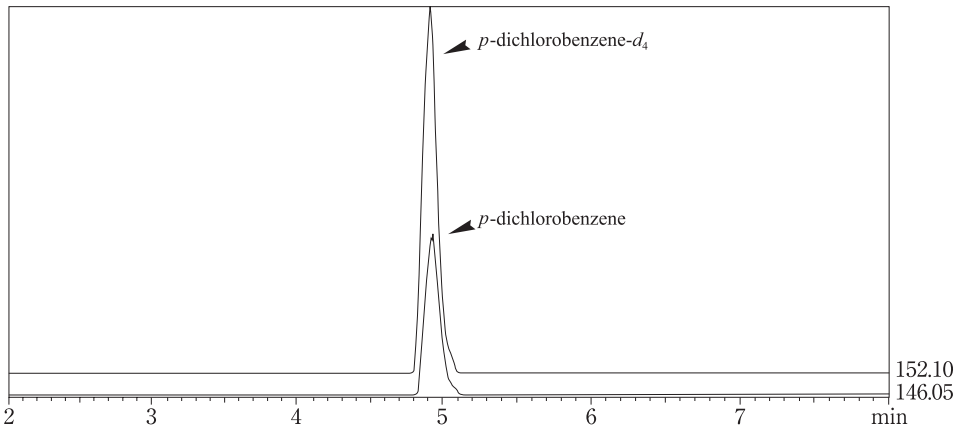
➤ *Figure 7.2* shows SIM chromatograms after headspace extraction of whole blood, to which *p*-dichlorobenzene and IS had been added. The detection limit of *p*-dichlorobenzene in whole blood was about 50 ng/mL.

Figure 7.1



Mass spectra of *p*-dichlorobenzene and *p*-dichlorobenzene-*d*<sub>4</sub> (IS).

Figure 7.2



SIM chromatograms for *p*-dichlorobenzene and IS after their headspace extraction from a whole blood sample. The amounts of IS and *p*-dichlorobenzene spiked into 0.2 mL whole blood were 2  $\mu$ g and 200 ng, respectively.



The extraction efficiency of headspace extraction of *p*-dichlorobenzene was tested; 10–15 % of total compound spiked into blood was distributed in the gaseous phase in the vial under heating at 80 °C for 30 min.

In this method, in spite of the use of a medium-bore capillary column in the splitless mode, as much as 1 mL gas is injected into GC/MS. Usually, such conditions cause remarkable broadening of a peak to be detected, but it was not the case for *p*-dichlorobenzene at 50 °C of the oven temperature (▶ *Figure 7.2*). The author et al. examined various initial oven temperatures by using a trapping device (see Chapter 5 of general nature of this book); it was confirmed that an entire amount of *p*-dichlorobenzene contained in the headspace gas injected was completely trapped inside the column at 50 °C.

## Poisoning cases and fatal concentrations

**Case 1 [2]:** a 74-year-old female ingested a mothball (*p*-dichlorobenzene ingested, 160–200 g) and fell into clouding of her consciousness and severe constipation. When an enema was given to her, strongly aromatic-smelled feces were excreted. Neither gastrolavage, intestinal lavage nor administration of an adsorbent was performed. On day 13, she died of dysfunctions of the liver and kidney.

**Case 2 [3]:** a 85-year-old female ingested 40 pieces of Neoparasol® (*p*-dichlorobenzene 140 g) due to senile dementia. At a clinic nearby, gastrolavage was performed, but she fell into respiratory suppression, bradycardia and a shock state, and was sent to a general hospital. She was treated with gastrolavage, purgative administration, enforced diuresis, oxygen inhalation and administration of Alotec® (metaproterenol sulfate) and Inovan® (dopamine hydrochloride). On day 4, hemoperfusion was performed and she was discharged on day 34.

**Case 3 [4]:** a 73-year-old male kept Neoparaace® (*p*-dichlorobenzene) in a warm kotatsu (Japanese quilt-covered frame with a heat source inside) to dry it up for 3 days, because it had gotten wet with water. Therefore, a strongly irritable smell took place inside the kotatsu and around it. When he was resting with his legs inside the kotatsu, he fell into dyspnea suddenly and was sent to a hospital. Upon his arrival, there was a mild clouding of his consciousness, but no orientation disturbance. He showed tachypnea, cyanosis in every part of his body, and crepitations audible for both lungs by auscultation. PaO<sub>2</sub> was as low as 34.1 mmHg even under oxygen inhalation; PaCO<sub>2</sub> was 58.7 mmHg. Severe lung edema was observed for both lungs by X-ray photography. Under artificial respiration, diuretic and steroid drugs were administered. By these treatments, his respiratory conditions were rapidly improved, and he could get out of the artificial respiration 25 h after the entrance into ICU. Although there were slight increases of liver transaminases and high values of blood sedimentation and CRP, he was discharged without any severe sequela about 1 month after admission.

There is no literature on toxic and fatal blood concentrations of *p*-dichlorobenzene. Human oral lethal dose is estimated to be 0.5–5 g/kg; the minimal lethal dose for adults estimated to be 25 g. There was a case, in which a 2-month-old baby had died after ingestion of 3–6 g of *p*-dichlorobenzene [3].

## Notes

- a) Stable-isotopic *p*-dichlorobenzene is commercially available from Aldrich. Its price is not expensive.
- b) Any type of non-polar dimethylsilicone capillary columns can be used, irrespective of their manufacturers.
- c) Any type of GC/MS, including sector, quadrupole and ion-trap types, can be used.
- d) Urine specimens seem also analyzable with the same procedure, although the author has not tested it yet.
- e) Either a usual 5-mL volume glass syringe or a gas-tight syringe can be used.
- f) The author et al. are using a special type of 23 G needles, which has a tip being cut conically; this shape of the tip prevents the needle from being clogged by septum debris.
- g) The quantitation using a stable-isotopic IS is most desirable. When it is not available, the external calibration method can be used by spiking known amounts of *p*-dichlorobenzene into 0.2 mL each of blank whole blood, followed by treatments according to the same procedure.

## References

- 1) Ukai T (ed) (1999) Manual of Treatments in Acute Poisoning. 3rd edn. Jiho Inc., Tokyo, pp 154–155 (in Japanese)
- 2) Japan Poison Information Center (1995) Poisoning data card No. 56, *p*-dichlorobenzene. Jpn J Toxicol 8:209–210 (in Japanese)
- 3) Nishi K (ed) (1999) Emergency Manual for Poisoning. Iyaku Journal, Osaka, pp 246–247 (in Japanese)
- 4) Tamagawa R, Ito H, Kamihira A et al. (1995) A case of lung edema caused by inhalation of *p*-dichlorobenzene. Jpn J Toxicol 8:450–451 (in Japanese)

## 11.5.8 Ethylene glycol

by Kanako Watanabe

### Introduction

Ethylene glycol is being widely used as solvents, lubricants and surfactants in industries; for daily necessities, it is being used as a component of cold-reserving materials and of nonfreezing coolants of automobiles. There were cases of accidental and suicidal ingestion of such fluids [1–3]. As toxic actions of ethylene glycol, suppression of central nervous system activities similar to that of alcohol and metabolic acidosis caused by glycolic acid produced from ethylene glycol can be mentioned. The glycolic acid is further metabolized into oxalic acid, which is bound with calcium ions to form the insoluble salt; the salt precipitates in various tissues. Especially, such precipitation sometimes causes renal dysfunction (failure) [4].

For analysis of ethylene glycol, methods by GC [5–8], GC/MS [9–11] and HPLC [12–14] were reported. In this chapter, a method of GC/MS analysis of ethylene glycol in human plasma is presented.

### Reagents and their preparation

#### i. Reagents

Ethylene glycol and phenylboronic acid can be purchased from Sigma (St. Louis, MO, USA) and other manufacturers; ethylene glycol- $d_4$  from Aldrich (Milwaukee, WI, USA, No. 34,744-2)<sup>a</sup>. Other common chemicals used were of the highest purity commercially available.

#### ii. Preparation

- After sampling venous blood with the vacuum tubes containing an anticoagulant, they are centrifuged at 3,000 rpm for 5 min to obtain blood plasma<sup>b</sup>.
- Ethylene glycol- $d_4$  (IS) solution: a 8- $\mu$ L aliquot of ethylene glycol- $d_4$  (specific gravity, 1.189) is dissolved in 50 mL acetonitrile.
- Ethylene glycol standard solution: a 9- $\mu$ L of ethylene glycol (specific gravity, 1.135) is dissolved in 1 mL acetonitrile (100  $\mu$ g/10  $\mu$ L).
- Derivatization solution: a 11.8-mg aliquot of phenylboronic acid is dissolved in 1 mL acetonitrile.

### GC/MS conditions

GC column<sup>c</sup>: an Rtx-17 fused silica medium-bore capillary column (30 m  $\times$  0.32 mm i. d., film thickness 0.25  $\mu$ m, Restek, Bellefonte, PA, USA).

GC conditions: a GC-17A gas chromatograph<sup>d</sup> (Shimadzu Corp., Kyoto, Japan); column (oven) temperature: 70 °C (1 min)  $\rightarrow$  10 °C/min  $\rightarrow$  120 °C  $\rightarrow$  5 °C/min  $\rightarrow$  150 °C  $\rightarrow$  20 °C/min  $\rightarrow$

280 °C; injection temperature: 250 °C; carrier gas: He; flow rate: 3 mL/min; injection mode: splitless for 1 min after injection, followed by the split mode.

MS conditions; instrument: a Shimadzu QP-5050A quadrupole mass spectrometer<sup>d</sup> (combined with the above GC); ionization: positive ion EI; electron energy: 70 eV; emission current: 60 μA; ion source temperature: 280 °C; accelerating voltage: 1.5 kV.

## Procedure

- i. A 0.5-mL volume of a plasma specimen<sup>e</sup> and 0.5 mL of ethylene glycol-*d*<sub>4</sub> acetonitrile solution (100 μg IS) are placed in a small test tube, sealed with Parafilm, vortex-mixed for 5 min and centrifuged at 3,000 rpm for 5 min.
- ii. A 0.5-mL volume of the supernatant solution is mixed well with 125 μL of the phenylboronic acid derivatization solution and left at room temperature for 15 min for complete reaction.
- iii. To the above solution, 1 g anhydrous sodium sulfate is added, vortex-mixed and left for several minutes for dehydration.
- iv. The above supernatant solution is transferred to a 4-mL volume glass vial with a screw cap using a Pasteur pipette and evaporated to dryness under a stream of nitrogen. The residue is dissolved in 100 μL acetonitrile. A 1-μL of it is injected into GC/MS for measurements in the SIM mode using ions at *m/z* 148 and 152.
- v. Construction of a calibration curve: to 0.5 mL each of blank plasma (not less than 3 vials) obtained from healthy subjects, 0.5 mL of ethylene glycol-*d*<sub>4</sub> (IS) solution and a different amount (1–50 μL) of the ethylene glycol standard solution are added. The mixture is treated according to the above procedure. The calibration curve consists of peak area ratio of ethylene glycol to IS on the vertical axis, and ethylene glycol concentration on the horizontal axis. The peak area ratio obtained from a plasma specimen is applied to the calibration curve to obtain an ethylene glycol concentration<sup>f</sup>.

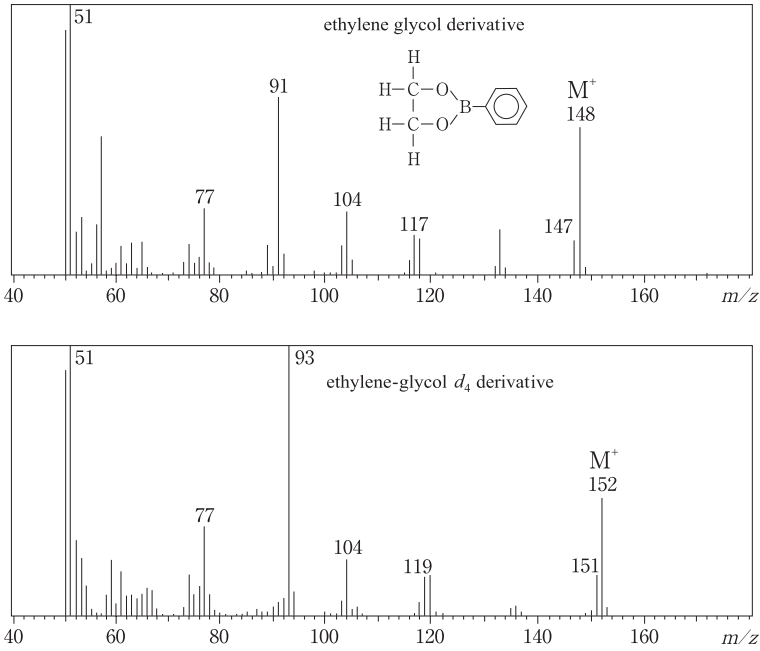
## Assessment of the method

➤ *Figure 8.1* shows mass spectra of the derivatives of ethylene glycol and IS. Although many fragment ions appeared, the molecular ions were relatively intense to be used for SIM. The peaks at *m/z* 148 and 152 were not interfered with by each other. ➤ *Figure 8.2* shows SIM chromatograms for the derivatives of ethylene glycol and IS, which had been spiked into blood plasma. The detection limit of ethylene glycol obtained by this method was about 1 μg/mL in blood plasma.

## Poisoning case, and toxic and fatal concentrations

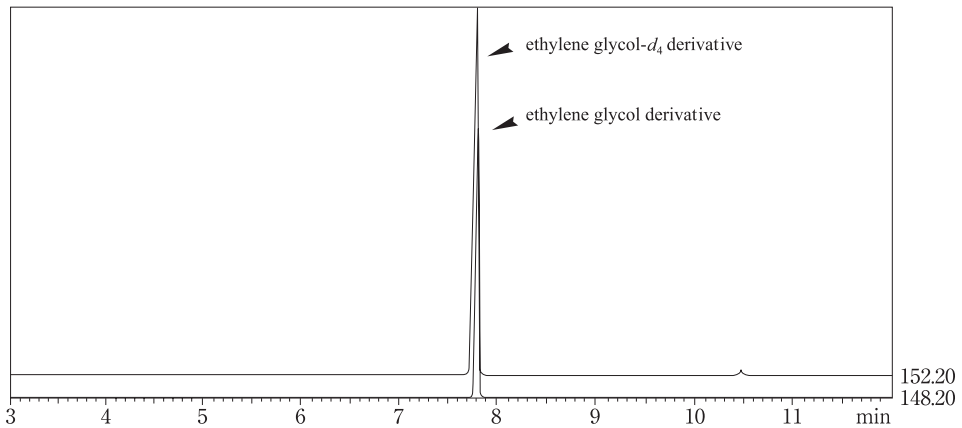
A 20-year-old male [2] attempted suicide by ingesting a large amount of a nonfreezing coolant at about noon, vomited at 1:00 p. m. and was sent to a critical care medical center at 2:25 a. m. on the next day by an ambulance car. Upon arrival at the center, he showed the respiration rate at 40/min, consciousness level at 200 (Japan Coma Scale), macroscopic hematuria, whitish turbid urine suggesting calcium oxalate crystals, severe metabolic acidosis, anion gap of

Figure 8.1



Mass spectra of the derivatives of ethylene glycol and ethylene glycol- $d_4$  (IS).

Figure 8.2



SIM chromatograms for the derivatives of ethylene glycol and IS, which had been spiked into human plasma. The amounts of ethylene glycol and IS spiked into 0.5 mL plasma were 25 and 100  $\mu\text{g}$ , respectively.

38.3 mEq/L, and hypocalcemia (7.0 mg/dL). The treatments with hemodialysis and ethanol administration were started. After the first hemodialysis, his metabolic acidosis and consciousness level were improved; he could answer that he had ingested about a quarter of 2 L of the coolant solution at about noon. Since general tonic convulsion appeared in the morning of the 2nd day of admission, an artificial respiratory control was achieved until the 6th day. Hemodialysis was continued until the 10th day to cope with the acute renal dysfunction; he could get out of the hemodialysis system on day 15, and could move to a general ward on day 17. Although diplopia caused by central gaze palsy remained, he was discharged on day 34, because of general improvement.

The blood ethylene glycol concentrations, at which toxic symptoms appear, are about 500 µg/mL; the oral fatal doses for adults were estimated to be about 100 mL [15].

## Notes

- a) Stable-isotopic ethylene glycol is commercially available from Aldrich. Its price is not expensive.
- b) In these experiments, the author tried to use whole blood, but it was not successful, because erythrocytes aggregated to form masses. It was essential to separate plasma to achieve efficient extraction of ethylene glycol.
- c) Any type of intermediately polar 50 % phenylsilicone/50 % dimethylsilicone capillary columns can be used, irrespective of their manufacturers.
- d) Any type of GC/MS instruments of the sector, quadrupole and ion-trap types can be used.
- e) Urine seems also analyzable with the same procedure.
- f) It is possible to make quantitative analysis without IS using an external calibration method. A 0.5-mL volume of a blood plasma specimen is mixed well with 0.5 mL acetonitrile for deproteinization, followed by the same procedure as described above. The analysis of ethylene glycol by GC-FID is also possible according to the same procedure, because of the high contents of the compound in blood.

## References


- 1) Iguchi Y, Miyakaya Y, Ikuoka T et al. (1994) A case of ethylene glycol poisoning, in which urine precipitates were useful for its diagnosis. *Jpn J Toxicol* 7:430 (in Japanese)
- 2) Kirita A, Hagiwara T, Yoshikawa O (1997) A case of acute ethylene glycol (non-freezing coolant) poisoning. *Jpn J Toxicol* 10:220 (in Japanese)
- 3) Gotoh H, Miyakaya Y, Ota S et al. (1999) Two cases of ethylene glycol poisoning. *Jpn J Toxicol* 12:469 (in Japanese)
- 4) Naito H (2001) Poisoning of Industrial Products, Gases, Pesticides, Drugs, and Natural toxins – Cases, Pathogenesis and its Treatment – 2nd edn. Nankodo Co., Ltd., Tokyo, pp 48–49 (in Japanese)
- 5) Houze P, Chaussard J, Harry P et al. (1993) Simultaneous determination of ethylene glycol, propylene glycol, 1,3-butyleneglycol and 2,3-butyleneglycol in human serum and urine by wide-bore column gas chromatography. *J Chromatogr* 619:251–257
- 6) Aarstad K, Dale O, Aakervik O et al. (1993) A rapid gas chromatographic method for determination of ethylene glycol in serum and urine. *J Anal Toxicol* 17:218–221
- 7) Livesey JF, Perkins SL, Tokessy NE et al. (1995) Simultaneous determination of alcohols and ethylene glycol in serum by packed-or capillary-column gas chromatography. *Clin Chem* 41:300–305

- 8) Yao HH, Porter WH (1996) Simultaneous determination of ethylene glycol and its major toxic metabolite, glycolic acid, in serum by gas chromatography. *Clin Chem* 42:292–297
- 9) Maurer H, Kessler C (1998) Identification and quantification of ethylene glycol and diethylene glycol in plasma using gas chromatography-mass spectrometry. *Arch Toxicol* 62:66–69
- 10) Dasgupta A, Macauley R (1995) A novel derivatization of ethylene glycol from human serum using 4-carbethoxyhexafluorobutyl chloride for unambiguous gas chromatography-chemical ionization mass spectrometric identification and quantification. *Am J Clin Pathol* 104:283–288
- 11) Dasgupta A, Blackwell W, Griego J et al. (1995) Gas chromatographic-mass spectrometric identification and quantitation of ethylene glycol in serum after derivatization with perfluorooctanoyl chloride: a novel derivative. *J Chromatogr B* 666:63–70
- 12) Gupta RN, Eng F, Gupta ML (1982) Liquid-chromatographic determination of ethylene glycol in plasma. *Clin Chem* 28:32–33
- 13) Wu NM, Malinin TI (1987) High performance liquid chromatography determination of ethylene glycol and ethylene chlorohydrin in tissues. *J Anal Toxicol* 11:63–66
- 14) Vollmer PA, Harty DC, Erickson NB et al. (1996) Serum ethylene glycol by high-performance liquid chromatography. *Chromatogr B* 685:370–374
- 15) Ukai T (ed) (1999) *Manual of Treatments in Acute Poisoning*, 3rd edn. Jiho Inc., Tokyo, pp 232–233 (in Japanese)

## II.6.1 Aconite toxins

by Michinao Mizugaki and Kitae Ito

### Introduction

The aconite plants contain *Aconitum* alkaloids (AAs) and other minor components, such as chasmanine, kobusine and higenamine. AAs consist of aconitines, benzoyleaconines and aconines as shown in  Figure 1.1. The most toxic group is the aconitines, including aconitine, mesaconitine, hypaconitine, and jesaconitine; this group is one of the most poisonous compounds being contained in the plant kingdom.

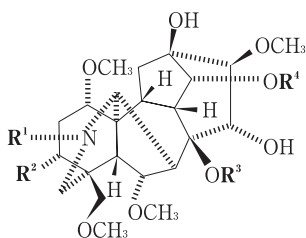
Even nowadays, aconite poisoning cases take place occasionally. These may be due to accidental, suicidal or homicidal ingestion of the plant itself or its extracts.

In this chapter, a specific method for GC/MS analysis of AAs in human specimens is presented.

### Reagents and their preparation

- Aconitine was purchased from Sigma (St. Louis, MO, USA); mesaconitine and hypaconitine from Kishida Kagaku (Osaka, Japan). Jesaconitine, benzoyleaconine, benzoylmesaconine, benzoylhypaconine, 14-anisoylaconine, aconine, mesaconine and hypaconine were donated by Tsumura (Tokyo, Japan). Benzoyleaconine and aconine can be obtained also

 Figure 1.1



	R <sub>1</sub>	R <sub>2</sub>	R <sub>3</sub>	R <sub>4</sub>
<b>Aconitines</b>				
aconitine	C <sub>2</sub> H <sub>5</sub>	OH	COCH <sub>3</sub>	COC <sub>6</sub> H <sub>5</sub>
mesaconitine	CH <sub>3</sub>	OH	COCH <sub>3</sub>	COC <sub>6</sub> H <sub>5</sub>
hypaconitine	CH <sub>3</sub>	H	COCH <sub>3</sub>	COC <sub>6</sub> H <sub>5</sub>
jesaconitine	C <sub>2</sub> H <sub>5</sub>	OH	COCH <sub>3</sub>	COC <sub>6</sub> H <sub>4</sub> OCH <sub>3</sub>
<b>Benzoyleaconines</b>				
benzoyleaconine	C <sub>2</sub> H <sub>5</sub>	OH	H	COC <sub>6</sub> H <sub>5</sub>
benzoylmesaconine	CH <sub>3</sub>	OH	H	COC <sub>6</sub> H <sub>5</sub>
benzoylhypaconine	CH <sub>3</sub>	H	H	COC <sub>6</sub> H <sub>5</sub>
14-anisoylaconine	C <sub>2</sub> H <sub>5</sub>	OH	H	COC <sub>6</sub> H <sub>4</sub> OCH <sub>3</sub>
<b>Aconines</b>				
aconine	C <sub>2</sub> H <sub>5</sub>	OH	H	H
mesaconine	CH <sub>3</sub>	OH	H	H
hypaconine	CH <sub>3</sub>	H	H	H

### Structures of *Aconitum* alkaloids (AAs).



from Sanwa Shoyaku (Tochigi, Japan). As a trimethylsilylating reagent, *N,O*-bis(trimethylsilyl)trifluoroacetamide (BSTFA), containing 1 % trimethylsilylchlorosilane (TMCS)<sup>a</sup> (Pierce, Rockford, IL, USA) is used. Pyridine to be used is of amino acid sequence analysis grade (Wako Pure Chemical Industries, Ltd., Osaka, Japan or Sigma). Other organic solvents are of HPLC grade; other reagents are of special grade.

- Each compound of aconitines, benzoylaconines and aconines is dissolved in acetonitrile to prepare the 1 µg/mL standard solution separately.

## Instrumental conditions

### i. Instrument

A DX-303 GC/MS instrument (JEOL, Tokyo, Japan) equipped with a Van den Berg type solventless injection device and a DA-5000 data processor (JEOL).

### ii. GC/MS conditions

Ionization: EI; ion source temperature: 250 °C; electron energy: 70 eV; trap current: 0.3 mA; accelerating voltage: 3 kV; GC column: a DB-5 chemical bond fused silica capillary column (15 m × 0.25 mm i. d., film thickness 0.25 µm, J&W Scientific, Folsom, CA, USA); column (oven) temperature: 250 °C → 16 °C/min → 320 °C; injection temperature: 320 °C; carrier gas: He; its flow rate: 25 m/min (linear velocity at 250 °C); scan range: *m/z* 100–800; scan speed: 1.2 s (repetition time, 2 s); resolution: 1,000.

### iii. Selected ion monitoring (SIM)

The instrumental conditions are the same as above. Each base peak of the trimethylsilyl (TMS) derivatives of the alkaloids is used for SIM. For hyaconitine, mesaconine, aconitine and jesaconitine, peaks at *m/z* 596, 684, 698 and 728 are used, respectively. For benzoylhyaconine, benzoylmesaconine and benzoylaconine, those at *m/z* 686, 774 and 788 are used, respectively; for hyaconine, mesaconine and aconine, those at *m/z* 654, 742 and 756 are used as monitoring ions, respectively.

## Procedures

### i. Construction of the calibration curve

- i. For plotting different concentrations, 5, 10, 25, 50 and 100 µL aliquots of each AA standard solution (1 µg/mL) are placed in glass vials.
- ii. They are evaporated to dryness under a stream of nitrogen.
- iii. Each residue is dissolved in 50 µL pyridine, followed by addition of 50 µL of 1 % TMCS-BSTFA and being capped airtightly.
- iv. The derivatization reaction is made by leaving the mixture vials overnight at room temperature<sup>b</sup>.
- v. A 1-µL aliquot of each solution is injected into GC/MS.
- vi. Peak areas are plotted against compound concentrations to construct an external calibration curve.

## ii. Extraction and derivatization procedure

- i. A 1.0-mL volume of a body fluid specimen (whole blood, serum or urine<sup>c</sup>) and 10 mL methanol<sup>d</sup> are placed in a glass test tube and mixed well for deproteinization.
- ii. It is centrifuged at 3,000 g for 10 min to obtain supernatant solution.
- iii. To the sediment, 10 mL methanol is again added, mixed well and centrifuged to obtain the second supernatant solution.
- iv. The supernatant solutions are combined and evaporated to dryness at 40 °C under reduced pressure.
- v. The residue is dissolved in 0.25 mL acetonitrile and mixed well.
- vi. A Bond Elut SI cartridge (Analytical International, Harbor City, CA, USA) is equilibrated with 5 mL n-hexane.
- vii. The above acetonitrile solution is poured into the silica gel cartridge.
- viii. To the container (or a test tube) at the step v), 0.25 mL acetonitrile is again added to rinse it well; the solution is also poured into the same cartridge.
- ix. The cartridge is washed with 10 mL chloroform.
- x. It is further washed with 10 mL ethyl acetate.
- xi. A 20-mL volume of diethylamine/chloroform (1:1) is passed through the cartridge to elute AA compounds.
- xii. The eluate is evaporated to dryness under reduced pressure.
- xiii. The residue is dissolved in 50  $\mu$ L pyridine, followed by the addition of 50  $\mu$ L of 1 % TMCS-BSTFA for derivatization at room temperature overnight<sup>e</sup>. A 1- $\mu$ L aliquot of the resulting solution is injected into GC/MS.
- xiv. The peak area of each AA obtained by SIM for a specimen is applied to the above calibration curve to calculate its concentration.

## Assessment of the method

Aconite toxins can exert their toxic effects at very low concentrations, which means that their concentrations in human body fluids are very low. Therefore, it was difficult to identify and quantitate them by the conventional HPLC method, because of its low sensitivity and specificity.

In this chapter, a sensitive GC/MS method for simultaneous analysis of AAs, including aconitines [1], benzoyleaconines and aconines, has been presented [2]. This method allows accurate and simultaneous quantitation of AAs in small volumes of specimens.

### i. EI mass spectra of AA-TMS derivatives

► Figures 1.2–1.4 show EI mass spectra of TMS derivatives of aconitines, benzoyleaconines and aconines.

#### • TMS derivatives of aconitines

By the derivatization with the above reagents, aconitine, mesaconitine and jesaconitine give bis-TMS derivatives; while hypaconitine a mono-TMS derivative. In each mass spectrum, a  $[M-CH_3COOH-OCH_3]^+$  ion appears as the base peak; a few small fragment peaks also appeared (► Figure 1.2).

- **TMS derivatives of benzoylaconines**

Benzoylaconine and benzoylmesaconine give tri-TMS derivatives; while benzoylhyaconine a bis-TMS derivative. In each mass spectrum, a  $[M-OCH_3]^+$  ion appears as the base peak; other fragment peaks are a few and small (▶ *Figure 1.3*).

- **TMS derivatives of aconines**

Aconine and mesaconine give tetra-TMS derivatives; while hyaconine a tri-TMS derivative. In each mass spectrum, a  $[M-OCH_3]^+$  ion appears as the base peak (▶ *Figure 1.4*). As shown in ▶ *Figures. 1.2–1.4*, the ratio of each base peak to the total abundance is relatively high; the base peaks are very useful for trace quantitative analysis by GC/MS-SIM.

## ii. Reliability of the method

▶ *Figure 1.5* shows SIM chromatograms for an extract of 1 mL serum, into which 50 ng each of 9 kinds of aconitines and their hydrolysis products had been spiked. For every compound, a sharp peak<sup>f</sup> appeared at the same retention time as that of the authentic one; no interfering impurity peaks were observed.

The calibration curve consisting of peak area on the vertical axis and compound amount (in an injected volume) on the horizontal axis showed good linearity ( $r^2 = 0.999$ ) in the range of 100 pg–7.5 ng for each alkaloid. The detection limits by this method were about 10 pg (S/N 10) in an injected volume, enabling highly sensitive analysis.

The recoveries of 50 ng each of AAs, which had been spiked into 1 mL human serum, were 85.2–94.4 %. The above pretreatment procedure can be applied to urine, whole blood and tissue<sup>g</sup> specimens. In addition, the authors synthesized *d*<sub>5</sub>-aconitine for use as internal standard (IS), resulting in higher precision and sensitivity in aconitine analysis<sup>h</sup> [3].

## Poisoning cases, and toxic and fatal concentrations

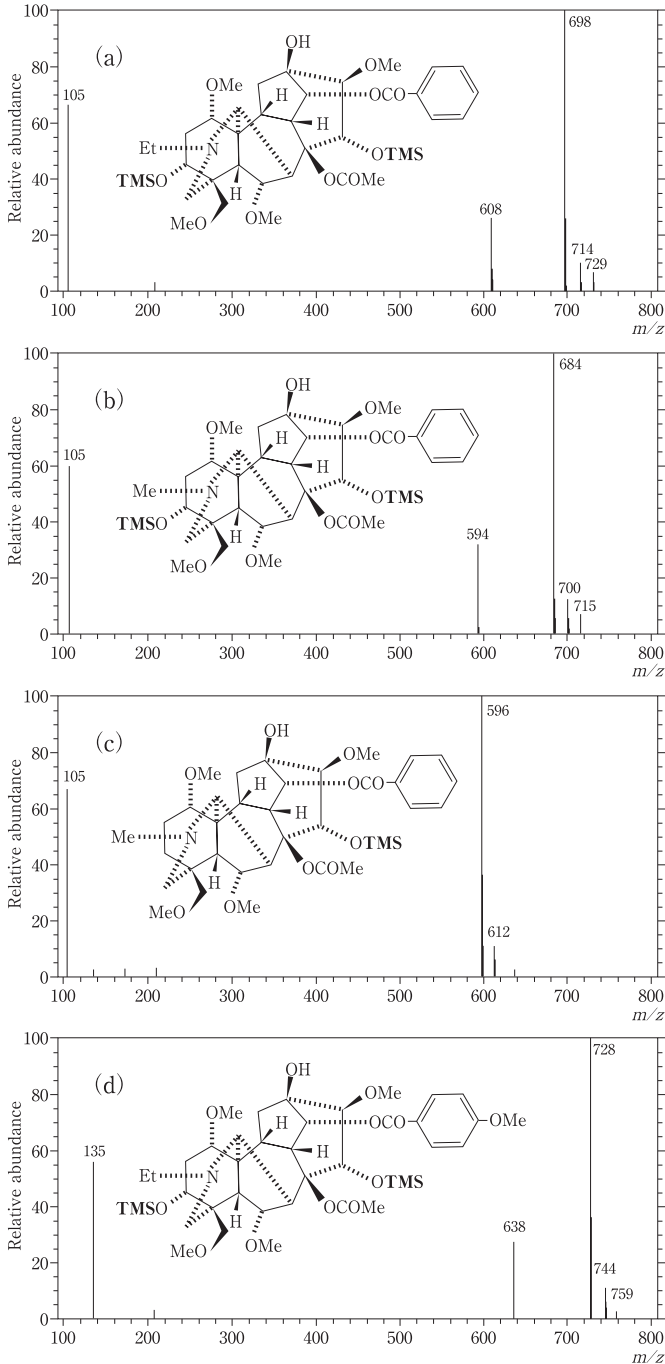
The aconitines are neurotoxic and cardiotoxic; they exert toxic effect by acting on the gate mechanisms of sodium-ion channels of cell membranes and by causing hyperpolarization of cells [4]. One of the most important poisoning symptoms is arrhythmia. Arrhythmia is sometimes changed to ventricular fibrillation, and cardiac and respiratory arrest resulting in death [5].

The history of aconite as a poison is very long, and dates back to ancient times [6, 7]. However, no reports on the concentrations of the aconite toxins (aconitine, mesaconitine, hyaconitine and jesaconitine) were available, because of the low sensitivity of analytical methods.

Now, the authors are undertaking the analysis of AAs in body fluids of aconite-poisoned patients in every area of Japan, and thus accumulating the data [8–14]. ▶ *Table 1.1* shows the concentrations of AAs in blood and urine in 6 poisoning cases.

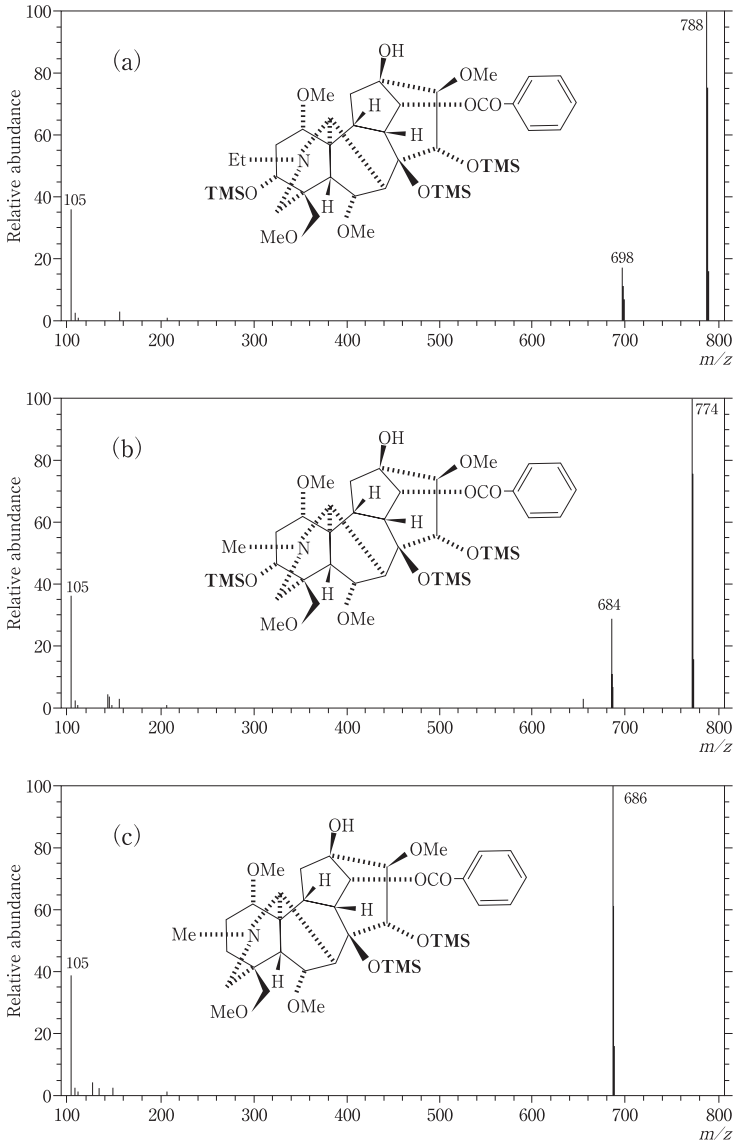
A 50-year-old female attempted suicide by crunching and ingesting one and a half of thumb-sized tubers of aconite, and visited a doctor 30 min later. She had had a history of depression and had received psychiatric treatments. The numbness of the tongue appeared in the midst of her eating; but her consciousness was clear and notified the doctor of her ingestion of aconite for the purpose of suicide. Her blood pressure was 100/60 mmHg; her heart beat 110/min and arrhythmic. She complained of nausea, vomiting and the numbness of her whole body;

**Figure 1.2**



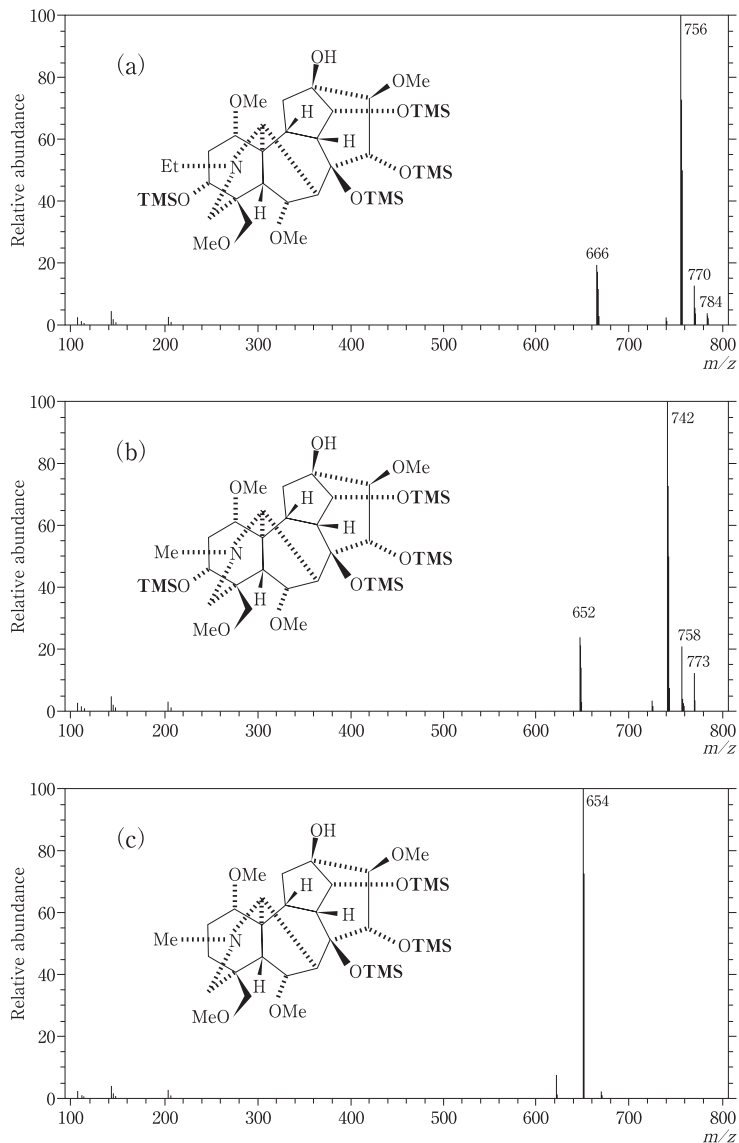
**El mass spectra for TMS derivatives of aconitines. (a): aconitine; (b): mesaconitine; (c) hypaconitine; (d): jesaconitine.**

Figure 1.3



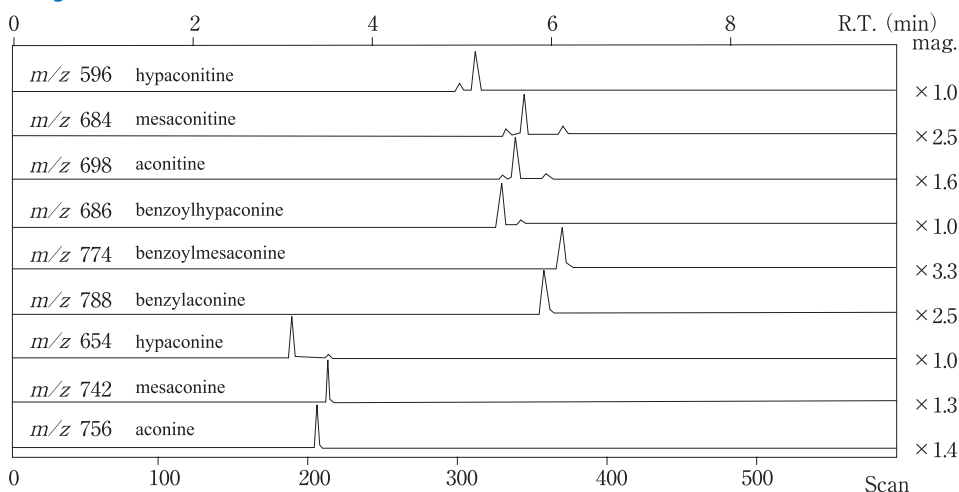
El mass spectra for TMS derivatives of benzoylaconines. (a): benzoylaconine; (b) benzoylmasaconine; (c): benzoylhyaconine.

Figure 1.4



EI mass spectra for TMS derivatives of aconines. (a) aconine; (b) mesaconine; (c) hyaconine.

■ **Figure 1.5**



**SIM chromatograms for TMS derivatives of AAs. Nine kinds of AAs (50 ng each) were spiked into 1 mL serum, and extracted according to the procedure; a 5- $\mu$ L aliquot of the final extract solution (50  $\mu$ L) was injected into GC/MS.**

she could not stand up by herself. Her electrocardiogram showed her continuing arrhythmia; the basic rhythm of her heart beat was the sinus one at about 100/min. Multiple-sourced and frequent ventricular arrhythmia, atrial arrhythmia, intraventricular aberrant conduction, QT elongation and torsades de pointes were observed.

Transfusion, gastrolavage and administration of activated charcoal and a purgative were performed. For the arrhythmias, lidocaine and disopyramide were administered at an early stage, but were not effective. Thus, the administration of phenytoin was started, but unsuccessful. The blood pressure was lowered about 1 h after ingestion, and her respiration was arrested about 2.5 h after; artificial respiration, after endotracheal intubation, was started. Thereafter, although administration of lidocaine, disopyramide and phenytoin was continued, they were not effective. From about 7 h after ingestion, ventricular tachycardia continuing for about 10 s began to take place frequently. Thiopental was administered, because of excitement and vigorous movement of her body. After the administrations of magnesium sulfate and propranolol, the arrhythmias markedly decreased about 11 h after ingestion. Thereafter, her conditions were improved smoothly. She was extubated about 24 h after and discharged on day 6 without any sequela. The concentration values of AAs in this case are shown as the case No. 1 in

▶ **Table 1.1.**

As shown in the above case, in the typical aconite poisoning case, the oral numbness just after ingestion extends to whole body, followed by hypotension and various types of arrhythmias; in the worst case, the arrhythmias are aggravated into ventricular fibrillation and finally death.

**Table 1.1**  
Concentration of *Aconitum* alkaloids in blood and urine in their poisoning cases

Case No.	Age	Sex	Poisoning mode	Presence or absence of cardio-pulmonary arrest	Outcome	Alkaloid	Blood conc. (ng/mL)	Sampling time after ingestion (h)	Alkaloid (ng/mL)	Urine conc. (ng/mL)	Sampling time after ingestion (h)
1 [10]	50	F	suicidal	+	alive	jesaconitine aconitine	2.4 1.0	(2.5)	jesaconitine aconitine	285 74.6	(12)
2	33	F	homicidal	+	dead	aconitine mesaconitine hyapaconitine	22.7 (29.1)* 41.4 (51.0)* 37.8 (47.3)*	at autopsy			
3 [11]	44	M	homicidal	+	dead	jesaconitine	430	at autopsy	jesaconitine	1,070	at autopsy
4 [12]	40	F	suicidal	+	dead	jesaconitine aconitine aconine	69.1 1.1 3.1	at autopsy	jesaconitine aconitine mesaconitine aconine	238 3.3 3.6 3.1	at autopsy
5 [13]	45	M	suicidal	+	alive	mesaconitine aconitine benzoylmesaconine benzoylaconine benzoylhyapaconine mesaconine aconine hyapaconine	4.0 1.7 0.7 0.2 0.2 0.2 0.3 0.2	(3)	mesaconitine aconitine hyapaconitine benzoylmesaconine benzoylaconine benzoylhyapaconine mesaconine aconine hyapaconine	52.9 20.7 3.1 28.4 4.1 6.0 3.5 2.0 4.7	(24)
6 [14]	58	F	accidental**	-	alive	ND		(5)			

\* Corrected value.

\*\* Diagnosed as aconite poisoning after analyzing leaves which the patient had eaten.  
ND: below detection limit.



## ii. Lethal doses of aconitines

The LD<sub>50</sub> values in mice for AAs are shown in [▶ Table 1.2](#). According to the experiments for aconitines using mice, the toxicity is highest for jesaconitine, followed by aconitine, mesaconitine and hypaconitine [15]. The oral lethal doses of aconitine for humans were reported to be 1–2 mg [16, 17].

About 500 species of aconite genus plants are growing in the world. Even in the same species, the composition ratio of the alkaloids and their contents differ according to seasons and growing areas. The contents of aconitines in the plant expressed per weight is highest in the tubers, followed by the flowers, leaves and stems [15]. The authors measured contents of aconitines in the tubers of *Aconitum* species harvested at a mountain in Nishi-Shirakawa-gun, Fukushima Prefecture, according to 4 seasons; the total contents of aconitines per g were 2–4 mg on average [18].

The cases Nos. 2 were fatal; their concentrations of AAs in blood and urine were higher than those in the survived Nos. 1 and 5 cases. Like in the case No. 6 of mistaken eating of aconite for an edible wild plant, the detection of AAs are sometimes difficult at relatively a long time after ingestion.

When the blood concentrations were compared with those in urine, the latter generally gave higher AA values. In the case No. 5, his body fluids could be sampled for analysis according to various time intervals after ingestion; the AAs could not be detected from blood as early as on the 2nd day, but some of the AAs could be detected from urine even on the 7th day [13].

AAs in blood disappear in a relatively short period, but they are excreted into urine in relatively large amounts continuously. Therefore, even if a relatively long time elapses after ingestion in a suspicious case of aconite poisoning, it is useful to analyze urine specimens.

The hydrolytic compounds of aconitines (benzoylaconines and aconines) are being suggested to be metabolites of aconitines [13].

There are various poisoning symptoms observable in aconite poisoning; the relationship between the appearance of the symptoms and AA concentrations in body fluids remains to be explored.

The distribution of AAs in human organs obtained at autopsy for the victim in the case No. 4, who had died 4 h after ingestion, is shown in [▶ Table 1.3](#). The AA concentrations expressed as ng/g wet weight were highest in the right lobe of the liver, followed by the left lobe of

■ **Table 1.2**

LD<sub>50</sub> values of AAs in mice (mg/kg)

Alkaloid	p. o.	subcut.	i. p.	i. v.
aconitine	1.8	0.270	0.380	0.12
mesaconitine	1.9	0.204	0.213	0.10
hypaconitine	5.8	1.190	1.100	0.47
jesaconitine	1.0–2.0	0.2–0.25		
benzoylaconine	1500	280	70	23
benzoylmesaconine	810	230	240	21
benzoylhypaconine	830	130	120	23
aconine				120

The LD<sub>50</sub> values were calculated by the up and down method. The value for aconine was cited from reference [7]; for other compounds, cited from reference [15].

the liver, kidney, heart, right lung, left lung, psoas major, adipose tissue (around psoas major), cerebellum and cerebrum. Especially in right and left lobes of the liver and the kidney, very high concentrations of AAs were found. The ratio of jesaconitine concentration in a organ to that in serum was not less than 3 for the right and left lobes of the liver and the kidney, showing the accumulation of AAs in the organs. On the other hand, such ratio was low for psoas major, adipose tissue, cerebellum and cerebrum; it was only 0.03 for the latter two organs. These results suggest that the liver and kidney are useful for analysis of AAs in fatal poisoning cases.

➤ Table 1.4 shows AA levels in contents of the digestive tracts obtained from a victim in the case No. 4 (➤ Table 1.1) [12]. They were highest in the ileum contents, followed by bile, jejunum contents, stomach contents and duodenum contents.

The high AA levels found in the kidney is in accordance with the high levels in urine. On the other hand, the high AA levels in bile and the contents of the ileum and jejunum show another excretion route for AAs *via* the digestive tract into feces in addition to the urinary route.

■ Table 1.3

#### Distribution of AAs in human organs in Case 4

Specimen	jesaconitine	aconitine (ng/g)	mesaconitine	tissue/serum ratio
right lobe of the liver	254	4.3	3.3	3.67
left lobe of the liver	233	4.2	3.8	3.37
kidney	217	2.8	1.9	3.14
heart	67.5	1.1	ND	0.98
right lung	63.7	1.8	ND	0.92
left lung	62.0	0.9	ND	0.90
psoas major	13.1	0.2	ND	0.19
adipose tissue	3.4	ND	ND	0.05
cerebellum	2.3	ND	ND	0.03
cerebrum	1.9	ND	ND	0.03

AAs other than the above compounds were below the detection limits. The tissue/serum ratios are the data only for jesaconitine. ND: below the detection limit.

■ Table 1.4

#### AA concentrations in the contents of digestive tracts in Case 4

Specimen	jesaconitine	aconitine	14-anisoyl-aconitine (ng/g)	mesaconitine	aconitine	benzoyl-aconitine
ileum contents	471	9.0	5.5	8.5	24.9	2.9
bile	238	6.3	17.2	3.2	ND	ND
jejunum contents	130	3.6	9.6	4.7	1.5	ND
stomach contents	87.7	2.1	ND	2.1	ND	ND
duodenum contents	72.1	2.5	4.9	2.0	ND	ND

AAs other than the above compounds were below the detection limits. ND: below the detection limit.

## Notes

- a) Only with BSTFA, a single derivative form can be obtained for each of aconitines, but not for benzoylaconines and aconines; the derivatized forms are multiple and variable for the latter. Therefore, it is essential to use BSTFA plus TMCS for getting reproducible derivatives.
- b) It can be replaced by incubation at 60 °C for 1 h.
- c) To protect AAs from their hydrolysis, the specimens should be stored in a frozen state and the contamination by alkaline compounds (solutions) should be avoided absolutely.
- d) Ethanol can be used in place of methanol without affecting recovery rates.
- e) The final sample solutions gradually become brownish according to time. This is due to an oxidation product of diethylamine; but it does not affect the analysis. The sample solution, after use, is stable at room temperature for at least one week under airtight conditions.
- f) The TMS derivatization of aconitines gives both big and small peaks for each compound in the chromatogram; this is due to the formation of an isomer in a small part in the injection chamber at high temperature. The peak areas for the two peaks should be combined for calculation of an AA concentration.
- g) For a tissue specimen, a 1-g weight of a tissue is excised from an organ. One gram of it and 0.1 mL of purified water are placed in a small beaker and minced into small pieces with a clean surgical scissors. After addition of 10 mL ethanol, the tissue sample is homogenized using a Polytron type homogenizer; the following procedure is the same as that described for body fluid samples.
- h) By using *d*<sub>5</sub>-aconitine as IS, the recovery rates become to be 96–103%.

## References

- 1) Mizugaki M, Oyama Y, Kimura K et al. (1988) Analysis of *Aconitum* alkaloids by gas chromatography/selected ion monitoring. *Eisei Kagaku* 34:359–365 (in Japanese with an English abstract)
- 2) Ito K, Ohyama Y, Konishi Y et al. (1997) Method for the simultaneous determination of *Aconitum* alkaloids and their hydrolysis products by gas chromatography-mass spectrometry in human serum. *Planta Med* 63:75–79
- 3) Ito K, Tanaka S, Konno S et al. (1998) Report on the preparation of deuterium-labelled aconitine and mesaconitine and their application to the analysis of these alkaloids from body fluids as internal standard. *J Chromatogr B* 714:197–203
- 4) Catterall WA (1988) Structure and function of voltage-sensitive ion channels. *Science* 242:50–61
- 5) Okada Y, Sasaki M, Suzukawa M et al. (1991) Aconitine cardiotoxicity. *Jpn J Toxicol* 4:135–141 (in Japanese)
- 6) Yamazaki M (1985) Story of poisons, *Chukoshinsho*. Chuokoronshinsha, Tokyo, pp 159–172 (in Japanese)
- 7) Bisset NG (1981) Arrow poisons in China. Part II. *Aconitum*-botany, chemistry, and pharmacology. *J Ethnopharmacol* 4:247–336
- 8) Mizugaki M (1996) Studies on the aconites from the viewpoints of forensic medicine and pharmacology. *Jpn J Forensic Toxicol* 14:1–12 (in Japanese with an English abstract)
- 9) Mizugaki M, Ito K (2001) Forensic toxicological studies on *Aconitum* toxins. *Res Pract Forensic Med* 44:1–16 (in Japanese with an English abstract)
- 10) Goto S, Fuke N, Ishikawa Y et al. (2000) A case of *Aconitum* poisoning with suicidal attempt. *J Clin Anaesth* 24:1513–1515 (in Japanese)
- 11) Mori A, Mukaida M, Ishiyama I et al. (1990) Homicidal poisoning by aconite: report of a case from the viewpoint of clinical forensic medicine. *Jpn J Legal Med* 44:352–357 (in Japanese with an English abstract)
- 12) Ito K, Tanaka S, Funayama M et al. (2000) Distribution of *Aconitum* alkaloids in body fluids and tissues in a suicidal case of aconite ingestion. *J Anal Toxicol* 24:348–353
- 13) Mizugaki M, Ito K, Ohyama Y et al. (1998) Quantitative analysis of *Aconitum* alkaloids in the urine and serum of a male attempting suicide by oral intake of aconite extract. *J Anal Toxicol* 22:336–340

- 14) Konya M, Nagata K, Nishimura Y et al. (1999) A case of accidental poisoning due to mistaken eating of aconite in place of an Anemone plant. *Intern Med* 84:1194–1196 (in Japanese)
- 15) Ooizumi Y, Hikino H (1981) Pharmacology of "Bushu" and its components. Part 2. Study on "Fushi". *Shuppan-kagaku-sougo-kenkyusho*, Tokyo, pp 117–154 (in Japanese)
- 16) Camps FE (1968) *Gradwohl's Legal Medicine*. John Wright & Sons, Bristol, p 674
- 17) Rentoul E, Smith H (1973) *Glaister's Medical Jurisprudence and Toxicology*. Churchill Livingstone, Edinburgh, p 520
- 18) Ito K, Ohyama Y, Hishinuma T et al. (1996) Determination of Aconitum alkaloids in the tubers of *Aconitum japonicum* using gas chromatography/selected ion monitoring. *Planta Med* 62:57–59

## 11.6.2 Mushroom toxins

by Kunio Gonmori and Naofumi Yoshioka

### Introduction

As many as 5,000–6,000 mushroom species are growing in the world. Among them, only about 1,000 species are named; the majority of them are unnamed. The number of species of edible mushrooms in Japan is about 300; that of toxic mushrooms is said to be about 30. Various types of toxic mushrooms exist; some show high toxicity, while others show hallucinogenic actions. Morphological and chemical analyses for mushrooms are occasionally required in forensic science practice. In this chapter, the characteristics of the representative toxic mushrooms and some chemical methods for their toxins are presented.

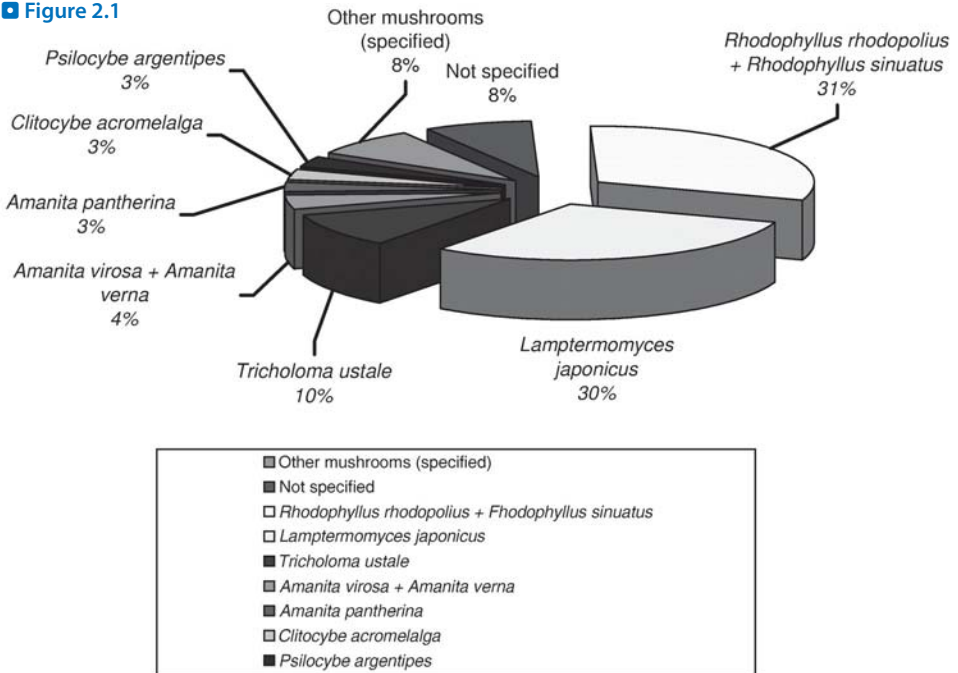
### Current situation of mushroom poisonings in Japan

According to “National Record of Food Poisoning Incidents” [1], the number of mushroom poisoning incidents taking place in Japan in 1974–1997 was 1,068; it was 431 in 1988–1997 (10 years) with 1,842 poisoned people, including 20 fatal victims<sup>a</sup>. Among the 431 incidents, the numbers of incidents according to causative mushrooms are: *Rhodophyllus rhodopolius* plus *Rhodophyllus sinuatus*, 133; *Lampteromyces japonicus*, 127; *Tricholoma ustale*, 42; *Amanita virosa* plus *Amanita verna*, 16; *Amanita pantherina*, 15; *Clitocybe acromelalga*, 15; *Psilocybe argentipes* (a species of magic mushrooms), 12; other mushrooms, 36; not specified, 35 (▶ Figure 2.1)<sup>b</sup>.

Toxic mushrooms can be classified into 6 groups according to their actions as follows.

- Those which destroy cells, injure the liver and kidney and thus may cause death (latent period, 6–10 h; *Amanita virosa*, *Amanita verna* and *Amanita phalloides*).
- Those which act on the autonomic nervous system and provoke symptoms, such as sweating, lacrimation, vomiting and diarrhea (latent period, 20 min–2 h; *Clitocybe gibba*, *Inocybe* species and others).
- Those which inhibit the metabolism of acetaldehyde in blood (disulfiram-like effect), causing a flushing phenomenon and palpitation upon drinking alcohol concomitantly (latent period, 20 min–2 h; *Clitocybe clavipes*, *Coprinus atramentarius* and others).
- Those which act on the central nervous system and provoke abnormal excitement and hallucinations (latent period, 20 min–2 h; *Amanita pantherina*, *Psilocybe argentipes* and others).
- Those which irritate the gastrointestinal tract and provoke symptoms, such as abdominal pain, vomiting and diarrhea (latent period, 30 min–3 h; *Rhodophyllus rhodopolius*, *Lampteromyces japonicus* and others).
- Others which cause swelling or necrosis of tips of extremities or sharp pain due to disturbances of the peripheral nerves (*Clitocybe acromelalga* and others).

■ **Figure 2.1**



Incidence ratio of mushroom poisonings according to species in Japan. It is calculated from the data of "National Record of Food Poisoning Incidents". The number of the mushroom poisoning incidents was 431; the poisoned subjects involved were 1,842 people.

➤ Table 2.1 shows the outline of the mushroom poisoning analyses, which the authors had undertaken in recent 9 years. As shown in this table, the number of the poisoning cases, in which *Amanita virosa* had been (suspected to be) causative, was as many as 10. *Amanita virosa* is highly toxic and sometimes causes fatalities. The highest incidence of the *Amanita virosa* in our laboratories is interpreted to mean that such fatal poisoning cases are selectively brought to our Department for analysis. Two cases were suspected of poisoning by *Rhodophyllus rhodopolius* (➤ Table 2.1).

## Representative mushrooms causing poisoning cases

### *Rhodophyllus rhodopolius* (➤ Figure 2.2)

This mushroom shows the highest incidence of poisoning in Japan, because a very similar edible species *Rhodophyllus crassipes* is available and grows at similar locations. The poisoning symptoms are vomiting, diarrhea and abdominal pain appearing 30 min–3 h after ingestion. The stem of *Rhodophyllus rhodopolius* is easily crushed by pressure with the finger, but that of the edible *Rhodophyllus crassipes* is not. The toxic compound being contained in the mushroom is reported to be muscarine or choline.

**Table 2.1** Outline of mushroom poisoning analyses undertaken by Department of Legal Medicine, Akita University School of Medicine

No.	Year	Requesting institution	Causative mushroom	The patient number	Outcome	Specimen	Detectability of the toxin
1	1993	H Univ. Dept. Legal Med.	<i>Amanita virosa</i>	1	dead	detected from the liver and the mushroom	
2	1996	T Kyodo Hosp. Dept. Anaesth.	<i>Amanita virosa?</i> (mushroom not available)	1	dead	not detected from blood, the liver or kidney	
3	1996	Y Univ. Dept. Intern. Med	<i>Amanita virosa?</i> (mushroom not available)	1	dead	not detected from blood	
4	1997	D Univ. Emerg. Units	<i>Amanita virosa?</i> (mushroom available)	1	alive	not detected from blood or the mushroom	
5	1997	F Univ. Emerg. Units	<i>Amanita virosa?</i> (mushroom available)	1	alive	not detected from blood stomach contents or the mushroom	
6	1998	A Pref. Hosp. Dept. Intern. Med.	<i>Agaricus blazei</i> (mushroom available)	2	alive	not detected from blood or the mushroom	
7	1998	O Pref. Hosp. Emerg. Units	<i>Amanita virosa</i> (mushroom available)	1	alive	not detected from blood urine or the mushroom	
8	1998	J Med. Univ. Emerg. Units and Dept. Nephrol	<i>Amanita virosa</i>	7	1 dead	detected from blood of one patient	
9	1998	J Med. Univ. Emerg. Units and Dept. Nephrol.	<i>Amanita virosa</i>	5	alive	not detected from blood or urine	
10	1998	I Pref. Hosp. Emerg. Units	<i>Amanita virosa</i>	1	alive	not detected from blood or urine	
11	1999	O Munic. Hosp. Dept. Urol.	<i>Amanita neoovoidea</i>	1	alive	not detected from blood	
12	1999	J Med. Univ. Emerg. Units and Dept. Nephrol.	not clear ( <i>Rhodophyllus rhodophilus?</i> ) mushroom-containing wheat-flour noodles	3	alive	not detected from blood, urine or the mushroom	
13	1999	J Med. Univ. Emerg. Units and Dept. Nephrol.	<i>Lampteromyces japonicus</i> (mushroom available)	2	alive	not detected from blood, urine or the mushroom	
14	1999	A Munic. Gen. Hosp. Dept. Intern. Med.	not clear ( <i>Rhodophyllus rhodophilus?</i> )	1	alive	not detected from blood	
15	2000	Y Publ. Health Center	<i>Amanita neoovoidea</i> (only mushroom available)	0	-	not detected from the mushroom	
16	2000	K Med. Univ. Emerg. Unit and Dept. Pediat.	<i>Amanita virosa</i> (mushroom available)	2	alive	not detected from blood or urine, but detected from the mushroom	
17	2001	A Police H. Q.	a magic mushroom (cultivated with a culture medium)	1	dead	detected from blood, urine and the mushroom	

■ Figure 2.2



*Rhodophyllus rhodopolius.*

■ Figure 2.3



*Amanita virosa.*

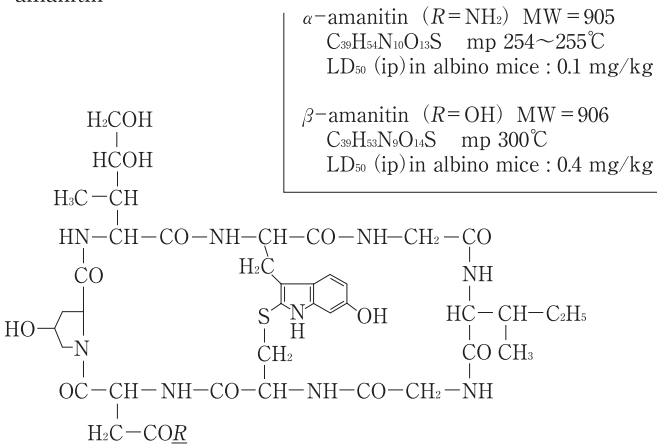


## *Amanita virosa* (▶) **Figure 2.3**

It is a very beautiful white mushroom growing in mountain areas; it is thus being called “destroying”. Only with one mushroom of *Amanita virosa*, 2 or 3 adult subjects can be killed. The *Amanita* genus mushrooms should be watched most carefully also in the forensic toxicological point of view. The main toxin of this genus is considered to be amanitin (▶ **Figure 2.4**) or phalloidin (▶ **Figure 2.5**). The amanitin is subdivided into  $\alpha$ -,  $\beta$ - and  $\gamma$ -amanitins. In Japan, *Amanita virosa* and *Amanita verna* glow generally, while in Europe and America, *Amanita phalloides* is responsible for poisoning. There is a report insisting that phalloidin does not exert toxic effect upon oral intake [2]. When chemical analysis was performed for 45 patients of

■ **Figure 2.4**

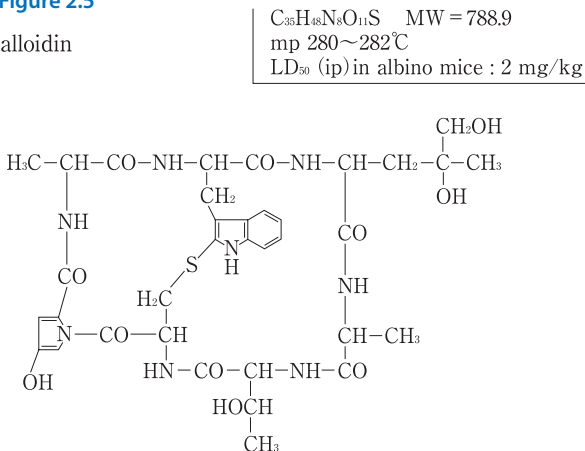
amanitin



**Structure of amanitin.**

■ **Figure 2.5**

phalloidin



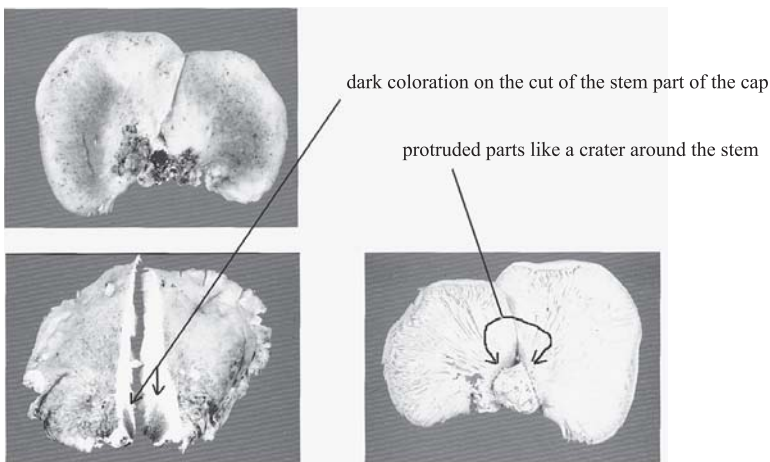
**Structure of phalloidin.**

*Amanita verna* poisoning in France, amanitin could be detected from plasma in only 11 of 43 patients, from urine in 23 of 35 patients, from the contents of the stomach and duodenum in 4 of 12 patients and from feces in 10 of 12 patients [3]. The blood concentrations of amanitin are highly dependent on the intervals after ingestion; the concentrations in urine and the contents of the stomach and duodenum are much higher than those in blood, and these specimens are more suitable for analysis of amanitin [3].

### ***Lampteromyces japonicus***

This is one of the most common toxic mushrooms with the highest incidence of poisoning, like *Rhodophyllus rhodopolius*, in Japan. It is usually mistaken for the edible *Lentinula edodes*, *Pleurotus ostreatus*, *Panellus serotinus* or others. The shape of *Lampteromyces Japonicus* is semicircular or kidney-like; the size is as large as 10–25 cm. When it matures, the color of its cap part becomes purplish brown or dark brown. The stem is as short as 1.5–2.5 cm and located at a side part of the cap; there is a crater like protrusion in the reverse side of the cap just around the stem. When this part of the cap including the stem is cut, dark coloration can be observed there for the matured mushroom (▶ Figure 2.6), and the folds and hyphae luminesce in a light yellow color in the dark; these are very useful for its discrimination. However, it should be cautioned that the above dark coloration is absent or obscure in the immature mushrooms. According to the growing circumstances, the *Lampteromyces japonicus* may show a round cap like *Lentinula edodes*, and thus is confusing (▶ Figure 2.7). Since the *Lampteromyces* mushrooms can grow in colonies on the dead beech or maple trees, a great number of the mushrooms may be harvested at a single location. The harvester distributes them to neighbors and relatives, resulting in simultaneous occurrence of many poisoned patients. Its toxin is lampterol (illudin S), which causes vomiting and diarrhea. The fatality by the toxin is very rare.

■ Figure 2.6



**How to discriminate *Lampteromyces japonicus*.**

▣ Figure 2.7



*Lampteromyces japonicus* mushrooms having circular umbrellas, which tend to be mistaken for edible *Lentinula edodes* mushrooms.

### Magic mushrooms (▶ Figure 2.8)

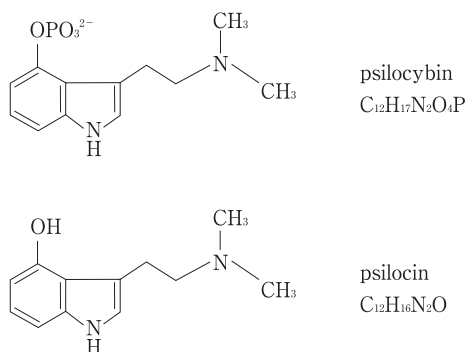
The magic or hallucinogenic mushroom is a popular name for ones which exhibit hallucination (visual and auditory), mental derangement and muscle flaccidness. In central and south America, such mushrooms were being used in religious ceremonies since ancient times. The hallucinogenic effects vary according to different individuals; they are similar to those obtained with LSD, though they are much weaker than those of LSD. They were illegally sold, in the forms of cultivation kits, dried pieces or tablets, on the streets and *via* the Internet before 2002. Various species of the *Psilocybe* genus are being used as magic mushrooms. Most magic

▣ Figure 2.8



Cultivation of “magic mushrooms” (*Psilocybe cubensis*).

■ **Figure 2.9**



**Structures of psilocybin and psilocin.**

mushrooms being circulated in Japan are *Psilocybe cubensis* and/or *P. subcubensis* and *Cope-landia* genus. The responsible toxins are psilocybin and psilocin. The psilocybin is metabolized into psilocin in human bodies (➤ *Figure 2.9*).

From January 1997 to June 1999, 24 inquiries about magic mushrooms were received by the office of Japan Poison Information Center [4]; the numbers of inquiries were 1 in 1997, 10 in 1998 and 13 in 1998 (6 months). An article entitled “Dangerous proliferation of hallucinogenic mushrooms” appeared in the Asahi morning newspaper on July 18, 1999. It described a case, in which a person had had a delusion of being capable of flying in the air, had jumped from a window of the 2nd floor and had been severely injured, and also a case, in which a university student had been mentally deranged on the campus; the article raised the alarm on such dangers. In January, 2001, there was a case, in which a youngster ate a grown magic mushroom, which had been purchased in the form of a cultivation kit *via* the Internet, and provoked hallucinatory symptoms to result in his death due to cold inside a roadside gutter in the nude.

Accidents and incidents by ingestion of magic mushrooms are increasing recently; such abuse should be controlled strictly. In the United States and Japan, the possession, cultivation and intake of magic mushrooms have been completely prohibited recently.

## Chemical analyses

For identification of a mushroom, in addition to the morphological method using the observations of its appearance and the form of its spores, chemical methods for analysis of toxins of mushrooms are also important. In this section, some examples of such chemical methods are described; especially, those for toxins of *Amanita* and *Psilocybe* mushrooms are presented.

### Analysis of toxins of *Amanita* mushrooms

The toxins of *Amanita* mushrooms are usually analyzed by HPLC.

As toxins,  $\alpha$ -amanitin,  $\beta$ -amanitin,  $\gamma$ -amanitin and phalloidin are known. Their authentic standards can be purchased from Sigma (St. Louis, MO, USA).

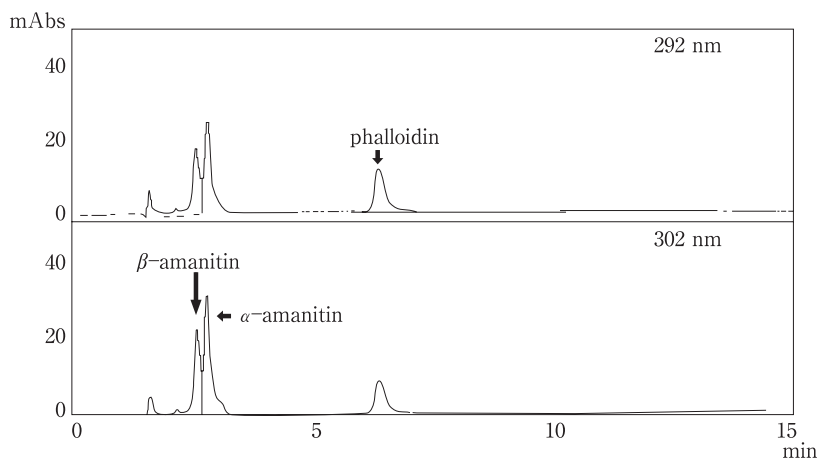
### i. HPLC conditions (▶ Figures 2.10 and 2.11)

Column: Inertsil OD-3 (150 × 4 mm i.d., particle size 5 μm, GL Sciences, Tokyo, Japan); mobile phase: 0.01 M ammonium acetate-acetic acid buffer solution (pH 5.0)/acetonitrile (84:16); its flow rate: 1.0 mL/min; detector: diode array detector (DAD); detector wavelengths: 302 nm for amanitin and 292 nm for phalloidin.

### ii. Extraction from a mushroom

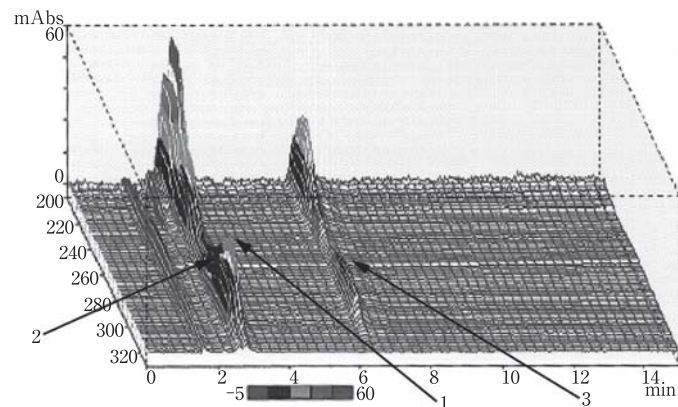
After a mushroom is minced into small pieces with a knife or scissors, they are extracted with 3 mL of methanol/ water/0.01 M HCl (5:4:1) by shaking the mixture at 4 °C for 24 h.

■ Figure 2.10



HPLC chromatograms for amanitins and phalloidin. A 0.25-μg aliquot each of the compounds was injected into HPLC.

■ Figure 2.11



Tridimensional HPLC-DAD chromatograms for amanitins and phalloidin. 1: α-amanitin; 2: β-amanitin; 3: phalloidin. The amount of the compounds injected into HPLC was 0.25 μg each in an injected volume.

After centrifugation, the supernatant solution is condensed under a stream of nitrogen and injected into HPLC for analysis.

### iii. Extraction from a body fluid

- i. A 5-mL volume of serum is mixed with 10 mL acetonitrile, shaken for 10 min and centrifuged at 1,000 g for 10 min.
- ii. The supernatant solution is mixed with 30 mL dichloromethane, shaken for 20 min and centrifuged at 1,000 g for 5 min.
- iii. The supernatant solution is condensed under a stream of nitrogen and injected into HPLC for analysis.

## Analysis of toxins of magic mushrooms (*Psilocybe* species)

For analysis of hallucinogenic toxins, such as psilocybin and psilocin, GC, GC/MS, LC and LC/MS are being used. The authentic standards of psilocybin and psilocin are not commercially available in Japan; the solution vials of psilocin can be imported after an appropriate procedure from Sigma, USA.

### i. HPLC

For HPLC, a spectrophotometric detector or an electrochemical detector (ECD)<sup>c</sup> can be used. If LC/MS or LC/MS/MS is available, analysis with much higher sensitivity and reliability can be realized. Here, an HPLC method with a relatively cheap and highly sensitive ECD detector is described [5].

Column: Inertsil ODS-3 (150 × 4 mm i.d., particle size 5 μm, GL Sciences); mobile phase: pH 3.8 buffer solution (300 mL of 0.1 M citric acid solution + 160 mL of 0.1 M sodium dihydrogenphosphate solution)/ethanol (9:1); its flow rate: 1.0 mL/min; detector: ECD (+1.0 V).

### ii. GC or GC/MS

After ingestion of psilocybin, it is easily metabolized into psilocin in human bodies. In a recent report [6], psilocin is said to exist in the glucuronide-conjugated form in human samples; they have insisted that enzymatic hydrolysis with glucuronidase is required before analysis. Psilocybin is dephosphorylated into psilocin in an injection chamber of GC at high temperature; TMS derivatization is required for GC or GC/MS analysis. The readers can refer to the reference [6] on the details of the method.

Scan range:  $m/z$  50–550; retention index: 2,099; psilocin-di-TMS:  $m/z$  290, 291 and 348.

### iii. Extraction from a mushroom [5]

- i. A 300-mg aliquot of a mushroom is mixed with 30 mL methanol and homogenized.
- ii. After shaking for 24 h, the homogenate is passed through a paper filter.
- iii. The clear solution is evaporated to dryness under a stream of nitrogen; the residue is dissolved in 3.0 mL methanol and a 10-μL aliquot of it is injected into HPLC.

### iv. Extraction from a dried mushroom [7]

- i. A 100-mg aliquot of a dried mushroom is mixed with 9 mL methanol and extracted by sonication for 120 min.

- ii. The volume of the mixture is adjusted to 10 mL and centrifuged at 1,000 g for 15 min. An aliquot of the supernatant solution is injected into HPLC.

#### v. Extraction from cerebrospinal fluid (CSF) [5]

- i. A 5-mL volume of CSF is mixed with 0.35 mL of 70 % perchloric acid solution, and centrifuged at 1,000 g for 30 min.
- ii. After decanting the supernatant solution, its pH is adjusted to 12 by adding 45 % KOH solution with cooling, followed by centrifugation at 1,000 g for 5 min.
- iii. The supernatant solution is mixed with 1 g NaCl, extracted with 6 mL dichloromethane by shaking for 15 min and centrifuged. The organic phase is transferred to another tube, and 6 mL dichloromethane is again added to the aqueous phase; the same extraction procedure is conducted. The resulting organic phases are combined.
- iv. The combined extract is dehydrated with anhydrous Na<sub>2</sub>SO<sub>4</sub> and centrifuged at 1,000 g for 5 min.
- v. The organic extract is evaporated to dryness under a stream of nitrogen, and the residue is dissolved in 200 µL methanol. An aliquot of the solution is injected into HPLC.

#### vi. Extraction from blood or urine [7]

- i. A 1-mL volume of blood or urine is mixed with 10 µL of β-glucuronidase (*E. coli* origin, Sigma) and incubated at 45 °C in a water bath with shaking for 1 h.
- ii. The mixture is diluted with 5 mL of 0.1 M potassium phosphate-NaOH buffer solution (pH 8) and poured into a Bond Elut Certify LRC 300 mg column (Varian, Harbor City, CA, USA). The column had been activated by passing 2 mL methanol and 2 mL of 0.1 M potassium phosphate-NaOH buffer solution (pH 8) in advance.
- iii. The above sample solution is poured into the column at a flow rate of 1–2 mL/min. Thereafter, nitrogen gas is passed through the column to dry it.
- iv. The column is washed with 2 mL water, 2 mL of 0.2 M acetic acid-sodium acetate buffer solution (pH 4) and 2 mL of 30 % methanol aqueous solution.
- v. After passing nitrogen gas through the column to dry it up, 2 mL of methanol/concentrated ammonia solution (98:2) and 1 mL of the same solution are passed for elution of the target compound.
- vi. After both solutions are combined, they are evaporated to dryness under a stream of nitrogen with warming at 40 °C.
- vii. The residue is mixed with 50 µL of *N*-methyl-*N*-trimethyl-silyltrifluoroacetamide (MSTFA), capped airtightly and heated at 80 °C for 15 min.
- viii. After cooling to room temperature, an aliquot of the solution is injected into GC/MS.

## Toxic concentrations

Although there are great variation in concentrations among references, there is a report [3] describing that the concentrations of α-amanitin and β-amanitin are 8–190 and 15.9–162 ng/mL in blood plasma, respectively. Amanitin usually disappears from blood about 36 h after ingestion.

After oral ingestion of 10–20 mg (0.224 ± 0.02 mg/kg) of psilocin, its blood plasma concentrations were reported to be 8.2 ± 2.8 ng/mL [7].

## Conclusion

---

There are some toxic mushrooms, the toxins of which are not clarified; for such types of mushrooms, chemical analysis is useless. Especially for *Amanita neoovoidea*, which has been found to be a toxic mushroom very recently, its toxin is only estimated to be a kind of peptides. The structure of the toxin remains to be clarified.

Upon analysis of mushroom toxins, the causative foods, such as miso soup and sukiyaki, even after being cooked, and/or the corresponding mushrooms should be obtained together with specimens of blood, urine and/or stomach contents. Raw mushrooms should not be frozen, because their forms are destroyed upon thawing; they should be stored in a refrigerator at 4 °C. They should be transported as soon as possible to reach a laboratory for analysis. The morphological findings of mushrooms themselves and their spores are very useful for interpretation of the results obtained by chemical analysis.

## Notes

- a) The numbers are based on only poisoning cases, which had been reported to a local public health center; the unreported cases are not included in the numbers.
- b) Upon totaling the numbers of each mushroom poisoning, the task may be undertaken by a nonexpert for mushrooms. Therefore, it seems difficult to expect the exact classification of mushrooms; the analogous species or genres may be treated as a whole. For example, they are probably treated as *Rhodophyllus rhodopoli* plus *Rhodophyllus sinuatus* and *Amanita virosa* plus *Amanita verna*. In the *Psilocybe argenteipes* mushrooms, other species of hallucinogenic mushrooms may be included.
- c) HPLC-ECD is being widely used for sensitive analysis of catecholamines. Although it is not a common detector, it enables the detection of trace levels of compounds, which cannot be detected by the usual spectrophotometric detector. In addition, by using a CV stabilizer (CV 1000 Denken), clean chromatograms without noises or drift can be obtained.

## References

- 1) Life Hygiene Bureau of the Ministry of Health, Labour and Welfare (ed) (1974–1997) National Record of Food Poisoning Incidents. Japanese Association of Food Hygiene, Tokyo (in Japanese)
- 2) Yamashita M, Furukawa H (1993) Mushroom poisonings. Kyoritsu-shuppan, Tokyo, p 110 (in Japanese)
- 3) Jaeger A, Jehl F, Flesch F et al. (1993) Kinetics of amatoxins in human poisoning. Therapeutic implications. *J Toxicol Clin Toxicol* 31:63–80
- 4) Madono K, Sakai Y, Hatano Y et al. (1999) Hallucinogenic “magic mushroom” poisoning: a report by JPIC. *Jpn J Toxicol* 12:443–447 (in Japanese)
- 5) Kysilka R, Wurst M, Pcakova V et al. (1985) High-performance liquid chromatographic determination of hallucinogenic indoleamines with simultaneous UV photometric and voltammetric detection. *J Chromatogr* 320: 414–422
- 6) Sticht G, Kaferstein H (2000) Detection of psilocin in body fluids. *Forensic Sci Int* 113:403–407
- 7) Musshoff F, Madea B, Beike J (2000) Hallucinogenic mushrooms on the German market. Simple instructions for examination and identification. *Forensic Sci Int* 113:389–395



## II.6.3 Tetrodotoxin

by Sunao Fukushima and Yukio Ohtsuka

### Introduction

Japanese people are very fond of eating fugu (puffer) fishes (especially *Takifugu rubripes*) as a feast especially in the winter season. However, the fish contains highly poisonous toxin tetrodotoxin (TTX) especially in its liver and ovary. Therefore, the number of fugu (puffer) fish poisoning incidents in Japan were 554, in which 912 people were poisoned during 20 years in 1980–1999; among the 912 people, 106 subjects were fatal (mortality rate, 11.6 %) (▶ Table 3.1)<sup>a</sup>. However, in recent 10 years, its incidence has been reduced to about half due to the improvement of early life-saving systems in emergency medicine.

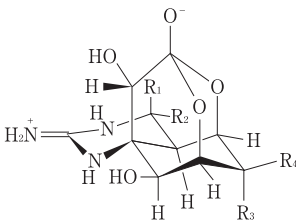
The origins of tetrodotoxin, the presence of its analogs (▶ Figure 3.1) and its mechanisms of action have been being clarified [1,2]. However, for the tetrodotoxin analogs (▶ Figure 3.1), their presence, toxicokinetics and toxicities especially in human puffer fish poisoning cases have not been studied. Therefore, in this chapter, the target is limited to tetrodotoxin only. As a test for tetrodotoxin, a biological method using mice is long being used for testing fish tissues; but it is not suitable for blood and urine specimens of poisoned patients. In this chapter, the methods of analysis of tetrodotoxin in human specimens by GC/MS and HPLC are described [3].

■ Table 3.1

Incidence of fugu (puffer) fish poisoning cases in Japan

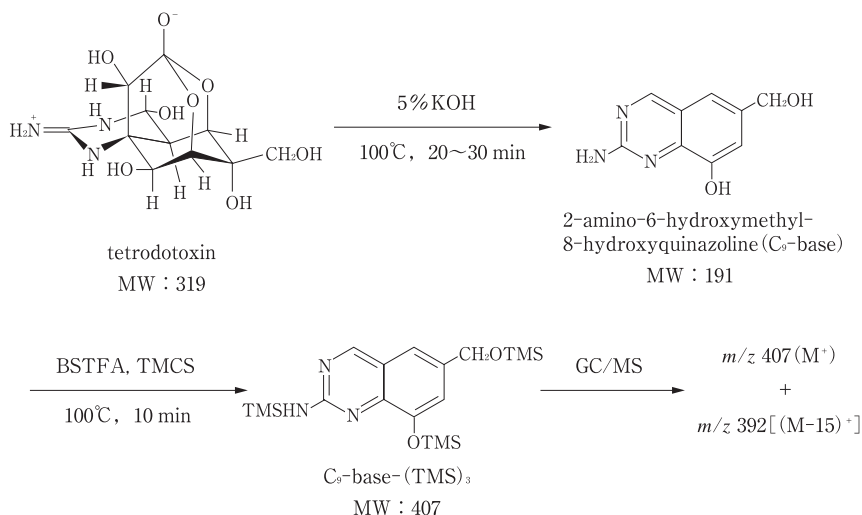
Year	The number of incidents	The number of patients	The number of fatality	Mortality ratio (%)
1980–1984	143	242	47	19.4
1985–1989	147	256	29	11.3
1990–1994	138	221	13	5.9
1995–1999	126	193	17	8.8
Total	554	912	106	11.6

■ Figure 3.1



Structures of tetrodotoxin (TTX) and its analogs.

Figure 3.2



Pretreatment and derivatization procedures for TTX for its GC/MS analysis.

## GC/MS analysis

TTX is soluble only in acidic alcohols; it cannot be analyzed by GC/MS in its unchanged form. TTX should be treated with alkali to form 2-amino-6-hydroxymethyl-8-hydroxyquinazoline (so-called “C<sub>9</sub> base”, M.W. 191), which can be trimethylsilylated [C<sub>9</sub> base-(TMS)<sub>3</sub>, M.W. 407] for GC/MS analysis (▶ Figure 3.2).

## Reagents and their preparation

### i. Reagents

TTX<sup>b</sup>, diethylamine, trifluoroacetic acid (TFA), β-estradiol (BD) and *N,O*-bis(trimethylsilyl)trifluoroacetamide (BSTFA) can be purchased from Sigma (St. Louis, MO, USA); SylonBFT (BSTFA/TMCS, 99:1) from Supelco (Bellefonte, PA, USA); trimethylchlorosilane (TMCS) from Pierce (Rockford, IL, USA). Other common chemicals used were of the highest purity commercially available.

### ii. TTX standard solution

A 1-mg aliquot of TTX is dissolved in 10 μL acetic acid and diluted with distilled water to prepare the standard 10 mL solution (100 μg/mL).

### iii. C<sub>9</sub> base standard solution

A 1-mg aliquot of TTX is dissolved in 0.5 mL of 5% KOH solution and heated at 100 °C for 30 min. After cooling it to room temperature, the solution is neutralized with concentrated HCl solution, saturated with KCl (by addition of KCl if necessary) and extracted with 5 mL of *n*-butanol three times. The combined *n*-butanol extracts are evaporated to dryness under re-

duced pressure; the resulting yellow residue (C<sub>9</sub> base) is dissolved in 10 mL of ethanol containing 2 % acetic acid (C<sub>9</sub> base standard solution, 100 µg/mL).

## GC/MS conditions

GC column<sup>c</sup>: a DB-5 fused silica capillary column (30 m × 0.25 mm i.d., film thickness 5 µm, J&W Scientific, Folsom, CA, USA).

Conditions; instrument: a quadrupole GC/MS instrument<sup>d</sup>; column (oven) temperature: 220 °C → 5 °C/min → 250 °C; injection temperature: 250 °C; detector temperature: 280 °C; carrier gas: He; its flow rate: 1.0 mL/min; injection mode: splitless.

## Procedures

### i. Procedure 1 (body fluid and tissue specimens) [4]

- i. A 2-mL volume of a body fluid specimen (or well-homogenized suspension of a 2-g tissue specimen) is extracted with 30 mL methanol containing 2 % acetic acid 2–3 times with refluxing for 10 min each.
- ii. The extracts are combined, passed through a filter paper and evaporated to dryness under reduced pressure.
- iii. If necessary, the residue is degreased with diethyl ether<sup>e</sup>, dissolved in 5 mL of 0.5 % acetic acid solution and neutralized with 5 % KOH solution.
- iv. The above solution is passed through the first Sep-Pak C<sub>18</sub> cartridge<sup>f</sup> (Waters, Milford, MA, USA), which had been pretreated by passing 5 mL methanol and 10 mL distilled water. A 3-mL volume of distilled water is also passed through it; both filtrates are combined.
- v. The filtrate solution is mixed with 20 % KOH solution to adjust its pH to 9–10, and heated at 100 °C for 20 min<sup>g</sup>.
- vi. After cooling to room temperature, the above solution is neutralized with concentrated HCl solution, and poured into the 2nd Sep-Pak C<sub>18</sub> cartridge<sup>h</sup>, followed by washing with 2 mL water and 2 mL of methanol/distilled water (2:8); the target compound is eluted with 5 mL methanol.
- vii. The eluate is evaporated to dryness under reduced pressure, and the residue is dissolved in a small amount of methanol containing 0.5 % acetic acid and transferred to a small glass vial with a Teflon cap, and again evaporated to dryness under reduced pressure<sup>i</sup>.
- viii. A 10-µL aliquot of dimethylformamide and 30 µL of SylonBFT are placed in the above vial, capped airtightly and heated at 100 °C for 10 min. After cooling to room temperature, 10 µL diethylamine is added to the mixture to neutralize it. A 1-µL aliquot of the final solution is injected into GC/MS<sup>j,k</sup>.


### ii. Procedure 2<sup>l</sup> (blood plasma) [5]

- i. A 2-mL volume of a plasma specimen is mixed with 30 mL of methanol containing 2 % acetic acid and extracted with refluxing in a water bath with heating.
- ii. The mixture is centrifuged at 3,000 rpm for 5 min, and the resulting supernatant solution is evaporated to dryness under reduced pressure.
- iii. The residue is shaken with 10 mL of 0.1 % acetic acid aqueous solution/chloroform (1:1).

- iv. It is centrifuged at 3,000 rpm for 5 min; the aqueous phase is passed through the first Sep-Pak PS-2 cartridge<sup>m</sup> (Waters).
- v. The filtrate is mixed with a half volume of 3 M KOH aqueous solution and heated for 15 min in a boiling water bath; after cooling to room temperature, the solution is neutralized with 2 M HCl solution.
- vi. The above solution is mixed with 17  $\mu$ L TFA and 10 mL of 0.1 M phosphate buffer (pH 7.0) and poured into the 2nd Sep-Pak PS-2 cartridge<sup>m</sup>.
- vii. Just before the completion of the flow through the cartridge, the flow is stopped and left for 60 min<sup>n</sup>; then the cartridge is washed with 10 mL of purified water and dried by passing air through it.
- viii. The C<sub>9</sub> base is eluted from the cartridge with 5 mL of acetonitrile containing 0.5 % acetic acid and evaporated to dryness under a stream of nitrogen.
- ix. The residue is dissolved in a small amount of acetonitrile containing 0.5 % acetic acid and transferred to a small glass vial with a Teflon cap, and again evaporated to dryness in it.
- x. The residue is dissolved in 19  $\mu$ L dimethylformamide containing 0.2 % BD, mixed with 22  $\mu$ L BSTFA and 1  $\mu$ L TMCS, capped airtightly and heated at 95 °C for 10 min for derivatization.
- x. After cooling to room temperature, the above solution is neutralized with diethylamine; a 2- $\mu$ L aliquot of the final solution is injected into GC/MS.

## Assessment of the methods

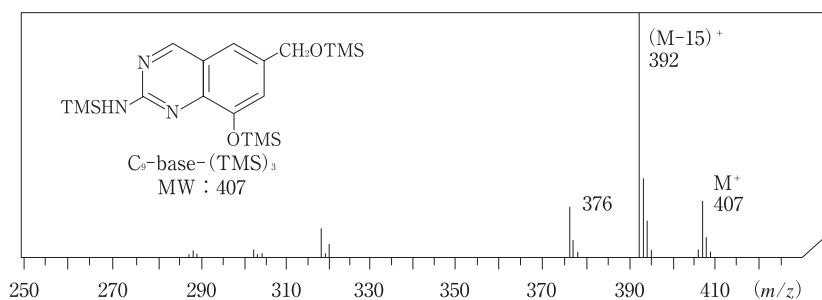
### i. Procedure 1

By GC/MS analysis of C<sub>9</sub> base-(TMS)<sub>3</sub>, a mass spectrum is obtained as shown in  Figure 3.3. Peaks appear at  $m/z$  407, 392 and 376 [6]. The mass spectral profile can be used for identification. The base peak at  $m/z$  392 is used for quantitation with its peak areas by the external calibration method. The detection limit by this method is about 1 ng/mL.

### ii. Procedure 2

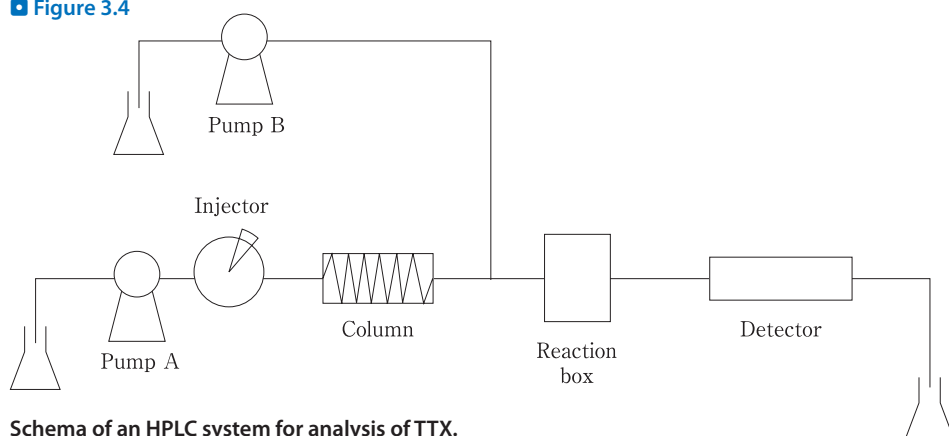
The three ions are used for qualitative analysis. The quantitation is performed using the peak area ratios of the ion at  $m/z$  392 to that at  $m/z$  285 [the base peak of BD-(TMS)<sub>2</sub>]. The detection limit by this method is 0.5 ng/mL<sup>1</sup> in blood plasma.

 Figure 3.3



EI mass spectrum of the C<sub>9</sub> base-(TMS)<sub>3</sub>.

■ Figure 3.4



Schema of an HPLC system for analysis of TTX.

## HPLC analysis

Yasumoto et al. [7, 8] developed a TTX analyzer by combining an HPLC instrument with a fluorophotometer; it enables separation of TTX from crude biological matrices and its quantitation. Fuchi et al. [9] determined TTX in sea foods by a similar method. The authors [10] also tried to measure the compound in urine of poisoned patients; the scheme of the system is shown in [▶ Figure 3.4](#).

A specimen mixed with a mobile phase enters a separation column by the action of Pump A. After separation, TTX is decomposed to a fluorescent compound (a stable intermediate in the middle of reaction into the C<sub>9</sub> base) in a reaction box by alkaline solution, which is supplied by Pump B; the fluorescent compound is measured with the fluorescence detector after cooling the reaction solution to room temperature.

To obtain the best conditions of this system, the concentration of the alkaline solution, reaction temperature, and excitation and emission wavelengths should be optimized.

## Reagents and their preparation

They are almost the same as described in the GC/MS section. Sodium dodecyl sulfate can be obtained from Sigma.

## HPLC conditions

HPLC column: Inertsil ODS-2 (250 × 4.6 mm i. d., GL Sciences, Tokyo, Japan) or other columns of similar quality<sup>o</sup>.

Conditions; pumps: LC-10AD for both; fluorescence detector: RF-550; reaction box: CRB-6A; reaction coil in the box: stainless steel tube to be used for HPLC (15 m × 0.25 mm i.d.) (all obtained from Shimadzu Corp., Kyoto, Japan); mobile phase for Pump A (flow rate): 50 mM sodium potassium phosphate buffer containing 2 mM sodium dodecyl sulfate (pH 6.8)

(0.4 mL/min); mobile phase for Pump B (flow rate): 4 M NaOH (0.4 mL/min)<sup>p</sup>; reaction box temperature: 120 °C; excitation wavelength: 400 nm; emission wavelength: 495 nm<sup>q</sup>.

## Procedure

- i. A 2-mL volume of a urine specimen is mixed with 0.5 mL of 0.5 % acetic acid solution, and poured into a Bond Elut SCX (Varian, Harbor City, CA, USA) cartridge, which had been equilibrated with 5 mL purified water, 5 mL methanol and 5 mL of 0.1 % acetic acid solution.
- ii. The cartridge is washed with 2 mL of 0.1 % acetic acid solution, 2 mL methanol and 4 mL purified water.
- iii. TTX is eluted from the cartridge with 4 mL of 0.1 % sodium potassium phosphate buffer (pH 7.0); 20- $\mu$ L of the eluate is injected into HPLC.
- iv. This method is applicable only to urine specimens at the present time.

## Assessment of the method

After addition of a fixed amount of TTX to urine, its concentration is measured by HPLC and conventional GC/MS (Procedure 1); the values obtained by the methods were almost the same. Therefore, it was concluded that the quantitation of TTX can be made even by HPLC [10].

For urine specimens obtained from TTX poisoning cases, the quantitation was made by both methods as shown in [▶ Table 3.2](#); each case showed very similar values obtained by both methods [11]. Except for Case No. 1, the three patients listed in [▶ Table 3.2](#) showed poisoning symptoms of intermediate severity, but recovered after treatments.

### ■ Table 3.2

Comparison of measurements of tetrodotoxin (TTX) in urine by HPLC with those by GC/MS in actual poisoning cases

Victim (age/sex)	TTX concentration (ng/mL)	
	HPLC	GC/MS
No. 1 (22/M)	2,550	2,480
No. 2 (51/F)	146	132
No. 3 (52/M)	152	135
No. 4 (39/M)	301	288

## Poisoning cases and toxic concentrations

### Blood TTX concentrations and fatal levels

The authors also experienced the analysis of TTX in blood and/or urine of 13 subjects in TTX poisoning. As shown in [▶ Table 3.3](#), the number of blood specimens was 12 in 13 cases. Among the poisoned subjects, 3 subjects were fatal and 10 recovered. In Case No. 1 of the table,

■ **Table 3.3**

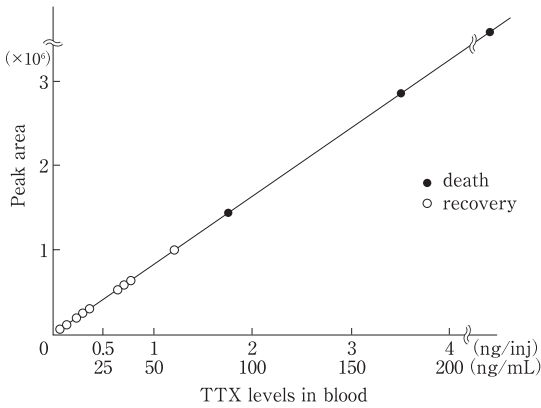
**TTX concentrations in human specimens in its poisoning**

Victim (age/sex)	Specimen	Concentration (ng/mL)	Outcome
No. 1 (93/F)	blood urine	93.0 650	dead
No. 2 (62/M)	blood	36.3	recovered
No. 3 (34/M)	blood	175	dead
No. 4 (65/M)	blood	320	dead
No. 5 (39/M)	blood urine	12.0 295	recovered
No. 6 (57/M)	blood urine	35.5 78.5	recovered
No. 7 (50/M)	blood urine	6.5 443	recovered
No. 8 (?/M)	blood urine	2.5 105	recovered
No. 9 (35/M)	blood urine	63.9 27.2	recovered
No. 10 (39/M)	urine	68.5	recovered
No. 11 (51/M)	blood	37.9	recovered
No. 12 (?/M)	blood	16.1	recovered
No. 13 (49/M)	blood urine	15.3 245	recovered

the victim cooked *Fugu niphobles* in a large amount, was poisoned by eating its liver and died just after arrival at a hospital. In Case No. 3, the victim was found dead in a ship on ocean navigation. In Case No. 4, the victim was found dead in an automobile in a public park. The cases Nos. 3 and 4 were treated as unnatural death. In other cases, all patients recovered after being admitted in hospitals. In Cases Nos 2, 5, 9 and 11, the subjects landed fugu fishes by themselves and ate them after cooking to be poisoned; they were treated as self-negligence cases. In Case No. 6, the victim bought the skin of a fugu fish at a store and was poisoned; in Cases Nos. 7, 8, 10 and 13, the victims ate fugu dishes containing the organs (the liver and/or skin) of the fish at restaurants. All of these cases were treated as negligent homicide incidents; the store and restaurants were ordered to suspend their business. The accidents occurred due to erroneous knowledges on cooking methods of fugu fishes.

➤ *Figure 3.5* shows the plots of blood TTX concentrations on a calibration curve; its concentrations in the fatal cases are higher than those in the survived cases. It can be estimated that borderline blood concentrations between the fatal and survived cases seem to be about 100 ng/mL, which is in accordance with that reported by Suenaga et al. [6]. At 25–100 ng/mL of TTX in blood, paresthesia, verbal paralysis, disappearance of various reflexes and finally respiratory paralysis appear as poisoning symptoms; however, in these cases, by early emergency treatments, they could survive.

■ Figure 3.5

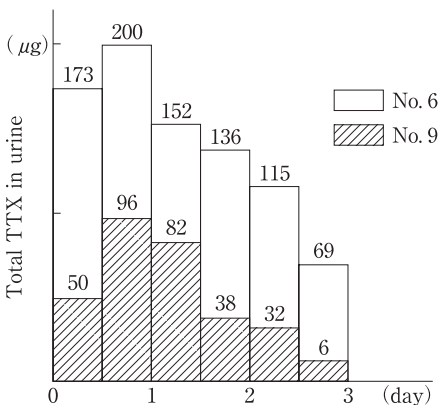


Calibration curve for blood TTX.

## Periods for TTX excretion into urine

Urine is a very advantageous specimen, because it can be obtained noninvasively and contains relatively high concentrations of poisons and relatively low contents of impurities; these advantages make its analysis simple and rapid. As shown in [▶ Table 3.3](#), among 13 victims, urine specimens were available for 8 victims; only one was fatal among the 8 victims with her urinary concentration being 650 ng/mL. The TTX excretion into urine was monitored as a function of time after ingestion. [▶ Figure 3.6](#) shows the time course of TTX excretion into urine obtained by sampling stockpiled urine every 12 h up to 3 days for Cases 6 and 9 listed in [▶ Table 3.3](#). For both subjects, the excretion was highest in the period from 12 to 24 h; TTX was detectable from urine even on the 3rd day. Unfortunately, urine specimens could not be obtained after 3 days; therefore, it is not clear how long the urinary TTX is detectable after ingestion.

■ Figure 3.6



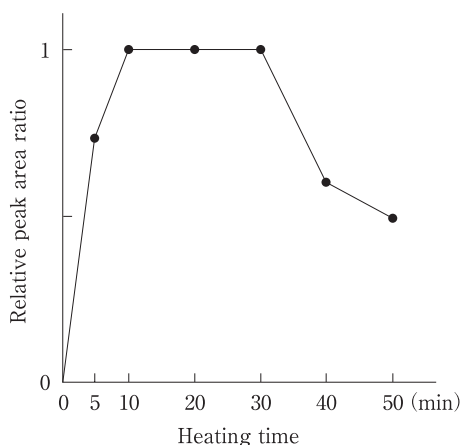
Urinary excretion of TTX as a function of time after ingestion.



## Notes

- a) These figures were obtained from data collected by Bureau of Medical Drugs, Ministry of Health, Labour and Welfare of Japan.
- b) TTX is not commercially available as pure crystals; TTX powder for a biochemical use (about 99 %) is available.
- c) Packed columns (5 % SE-52, 1 m × 3 mm i.d.) or wide-bore capillary columns (DB-17, 15 m × 0.53 mm i.d.) can be also used. However, in view of separation ability and contamination, medium-bore capillary columns are preferable.
- d) For example, Shimadzu QP5050A, Shimadzu 1100EX or HP5971A can be used.
- e) The extent and times of washings of the residue with diethyl ether are different in different specimens (impurities or lipid contents); some skillfulness based on experience is required for the technique.
- f) The first Sep-Pak cartridge is not used for extraction of TTX, but used only for removal of hydrophobic impurities being contained in TTX specimens.
- g) As shown in [▶ Figure 3.7](#), the conversion of TTX into C<sub>9</sub> base is completed in about 10 min; after 30 min of heating, the recovery becomes much lower.
- h) The 2nd Sep-Pak C<sub>18</sub> cartridge is used for extraction of the C<sub>9</sub> base produced by the alkali treatment.
- i) It is essential to dry it up completely for silylation; it is sometimes dried up under reduced pressure in the presence of phosphorus pentaoxide.
- j) The column should be filled with the silylating reagent gas. When the silylating reagent only is injected into GC/MS between the injections of sample extracts, reproducibility of the assay may be enhanced.
- k) When a packed column is used for GC/MS, the residue is mixed with 80 μL DMF, 200 μL BSTFA and 10 μL TMCS and heated at 100 °C for 10 min; after cooling to room temperature, the mixture is neutralized with 10 μL diethylamine [C<sub>9</sub> base-(TMS)<sub>3</sub> derivative mixture, total volume 300 μL] and 3-μL of the solution is injected into GC/MS.

■ **Figure 3.7**



Formation rates of the C<sub>9</sub> base as a function of time of heating TTX at 100 °C.

- l) The procedure 2 gives higher sensitivity than the procedure 1. However, for actual measurements of poisoning specimens (▶ Table 3.3), the procedure 1 had been used.
- m) For activation of Sep-Pak PS-2 cartridges, methanol, purified water, acetonitrile containing 0.5 % acetic acid, purified water, 1.68 % (50 mM) EDTA aqueous solution and purified water, 3 mL each, were passed through them. For the 2nd cartridge, 3 mL of 0.1 M sodium potassium phosphate buffer (pH 7.0) was added at the end for activation. Like the above Sep-Pak C<sub>18</sub> cartridges, the first Sep-Pak PS-2 cartridge is used only for removal of hydrophobic impurities and the 2nd one for extraction of the C<sub>9</sub> base produced by alkali treatment from TTX.
- n) To secure the complete adsorption of the neutral C<sub>9</sub> base to the cartridge, the 60 min interval is necessary.
- o) For the TTX analyzer, Hitachi gel 3011C (400 × 5 mm i. d.) (GL Sciences) is being used.
- p) Since the concentration of NaOH is very high, the whole line system should be washed completely after use.
- q) The ranges of various conditions used for preliminary optimization experiments were: NaOH concentration: 1–5 M; reaction box temperature: 100–140 °C; excitation wavelength: 390–410 nm; emission wavelength: 485–505 nm.

## References

- 1) Hashimoto C (ed) (1988) Recent Advance of Fugu Toxin Studies. Koseisha-koseikaku, Tokyo (in Japanese)
- 2) Noguchi T, Arakawa O, Hashimoto C (1989) Fugu poison: its origins and the mechanisms of toxigenicity. *Jpn J Food Hyg Assoc* 30:281–288 (in Japanese with an English abstract)
- 3) Matsui T, Ohtsuka Y, Sakai J (2000) Recent advance of studies on fugu toxin. *Yakugaku Zasshi* 10:825–837 (in Japanese with an English abstract)
- 4) Fukushima S (1992) Analysis of tetrodotoxin in body fluids and tissues. Reports of Studies by the 9th Trainees of Forensic Science Training Institute, Forensic Science Training Institute, Tokyo, pp 285–295 (in Japanese)
- 5) Ohtsuka Y, Tokunaga H, Fukushima S et al. (1997) Sensitive determination of tetrodotoxin in serum by GC/MS. Proceedings of TIAFT XXXV Annual Meeting, Padova, Italy, pp 614–618
- 6) Suenaga K, Kotoku S (1980) Detection of tetrodotoxin in autopsy material by gas chromatography. *Arch Toxicol* 44:291–297
- 7) Yasumoto K (1989) Analysis and applications of marine toxins. *Chemistry and Biology* 27:401–406 (in Japanese)
- 8) Yasumoto T, Mitshita T (1985) Fluorometric determination of tetrodotoxin by high performance liquid chromatography. *Agr Biol Chem* 49:3077–3080
- 9) Fuchi Y, Morisaki S, Nagata T et al. (1988) Determination of tetrodotoxin in sea foods by high-performance liquid chromatography. *Jpn J Food Hyg Assoc* 5:306–312 (in Japanese with an English abstract)
- 10) Fukushima S (1996) Trace analysis of tetrodotoxin in human specimens. Simple determination by HPLC with fluorescence detection. Abstracts of the 116th Annual Meeting of the Pharmaceutical Society of Japan, p 188 (in Japanese)
- 11) Fukushima S (1996) Analysis of tetrodotoxin in specimens of poisoned victims. *Jpn J Toxicol* 9:473–474 (in Japanese)

## II.6.4 Methylxanthine derivatives

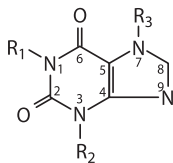
by Osamu Suzuki

### Introduction

Caffeine, theophylline and theobromine are contained in coffee, chocolate (cocoa) and tea (black and green) as weakly basic natural alkaloids. The structures of the methylxanthine derivatives/xanthine derivatives including the above natural alkaloids together with synthetic ones are shown in [▶ Table 4.1](#) [1]. Theophylline, dyphylline (diprophylline) and proxiphylline are being used mainly as bronchodilators and/or heart stimulants.

Caffeine mildly stimulates the central nervous system (CNS), awakens people, relieves them from general fatigue and activates mental activities. It has a relatively wide safe range of doses and its estimated oral lethal dose is said to be about 10 g. Therefore, it is difficult to be poisoned by drinking coffee or tea. Caffeine becomes problematic, when it is mixed in large amounts with an abused drug as an adulterant; in such cases, a large amount of caffeine can be ingested into a human body. As a fatal action of caffeine, it acts on the heart provoking supra-

**Table 4.1**  
Structures of methylxanthine derivatives



	R <sub>1</sub>	R <sub>2</sub>	R <sub>3</sub>	Misc.
caffeine	CH <sub>3</sub>	CH <sub>3</sub>	CH <sub>3</sub>	
1,7-dimethylxanthine	CH <sub>3</sub>	H	CH <sub>3</sub>	
dyphylline	CH <sub>3</sub>	CH <sub>3</sub>	$\begin{array}{c} \text{OH} \\   \\ \text{CH}_2\text{CHCH}_2\text{OH} \end{array}$	
3-isobutyl-1-methylxanthine	CH <sub>3</sub>	$\begin{array}{c} \text{CH}_3\text{CCH}_3 \\   \\ \text{CH}_3 \end{array}$	H	
pentifylline	C <sub>6</sub> H <sub>13</sub>	CH <sub>3</sub>	CH <sub>3</sub>	
pentoxyphylline	$\begin{array}{c} \text{CH}_3\text{C}(\text{CH}_2)_4 \\    \\ \text{O} \end{array}$	CH <sub>3</sub>	CH <sub>3</sub>	
proxiphylline	CH <sub>3</sub>	CH <sub>3</sub>	$\begin{array}{c} \text{OH} \\   \\ \text{CH}_2\text{CHCH}_3 \end{array}$	
theobromine	H	CH <sub>3</sub>	CH <sub>3</sub>	
theophylline	CH <sub>3</sub>	CH <sub>3</sub>	H	
1,3,9-trimethylxanthine	CH <sub>3</sub>	CH <sub>3</sub>	—	8, 9: single bond; 7, 8: double bond; 9: CH <sub>3</sub>

ventricular tachycardia or supraventricular arrhythmia and finally cardiac collapse to death; especially for children, such poisoning can take place more easily [2].

Theophylline is mainly used for treatment of bronchial asthma. Its characteristic is a narrow safe range of its doses. Its blood therapeutic concentrations are said to be 8–20 µg/mL; but when the concentration exceeds 20 µg/mL, untoward effects appear [2]. Therefore, care should be taken upon theophylline administration. In addition, many of the theophylline drugs are being sold as extended-release capsules or tablets [3]. Since such forms of the drug exert its effect for long periods, its poisoning tends to become severe. As the most serious poisoning symptom caused by theophylline, persistent convulsion due to stimulating CNS can be mentioned; such convulsion cannot be suppressed by any anticonvulsant. As other poisoning symptoms, hypotension, vomiting, abdominal pain, diarrhea and bleeding from the digestive tract may appear. It also causes arrhythmias, such as atrial fibrillation, supraventricular arrhythmia, supraventricular tachycardia and ventricular tachycardia, and occasionally causes cardiac arrest [3].

For analysis of methylxanthine derivatives, GC [1, 4–7], GC/MS [8] and HPLC [9–12] were used. In this chapter, a simple GC method for analyzing them [1] is described.

## Reagents and preparation

### i. Reagents and materials

The ten methylxanthine compounds listed in [▶ Table 4.1](#) can be purchased from Sigma (St. Louis, MO, USA); Sep-Pak C<sub>18</sub> cartridges (classic type) from Waters (Milford, MA, USA). Other common chemicals used are of the highest purity commercially available.

### ii. Preparation

- A 2-mg aliquot each (separately or altogether) of the methylxanthines is dissolved in 2 mL methanol as the stock standard solution. Usually, a 10-µL volume of the solution is spiked into 1 mL of blood plasma or urine (spiked concentration, 10 µg/mL). To get various concentrations of the compound(s), the above stock standard solutions are diluted with methanol appropriately.
- Chloroform/methanol (9:1), acetonitrile and distilled water: 100–200 mL each required.
- 0.1 M HCl: 1 mL of conc. HCl (12 M) is carefully mixed with 119 mL distilled water.
- 1 M KOH: 5.6 g of KOH is dissolved in distilled water to prepare 100 mL solution.

## GC conditions

GC column<sup>a</sup>: a DB-17 fused silica capillary column (15 m × 0.32 mm i. d., film thickness 0.25 µm, J&W Scientific, Folsom, CA, USA).

GC conditions<sup>b</sup>: an HP5890 Series II gas chromatograph (Agilent Technologies, Palo Alto, CA, USA); detector: FID; column (oven) temperature: 140 °C → 10 °C/min → 280 °C; injection and detector temperature: 280 °C; carrier gas: He; its flow rate: 3 mL/min; injection: splitless mode for 1 min followed by the split mode.

## Procedures

### i. Urine specimen

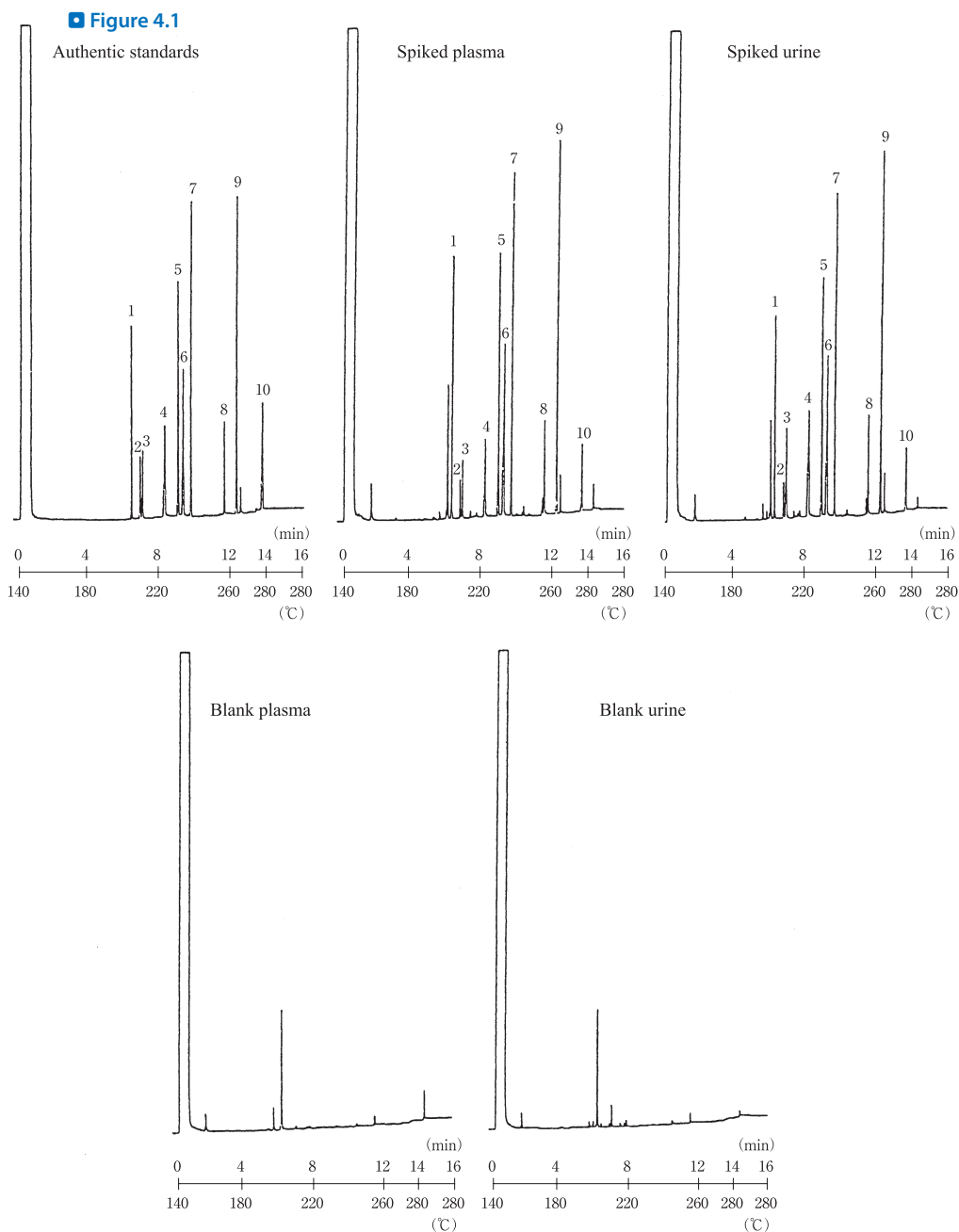
- i. A 5-mL volume of methanol and 5 mL distilled water are passed through a Sep-Pak C<sub>18</sub> cartridge to activate it.
- ii. A 1-mL volume of a urine specimen, which may contain methylxanthine compound(s), is mixed with an appropriate internal standard (IS)<sup>c</sup> solution and 4 mL distilled water, and poured into the activated cartridge with a 10-mL volume glass syringe.
- iii. The cartridge is washed with 10 mL distilled water and the target compound(s) are slowly eluted with 4 mL of chloroform/methanol (9:1); the eluate is collected in a 4-mL volume glass vial.
- iv. After careful removal of the upper aqueous phase, the lower organic phase is evaporated to dryness under a stream of nitrogen. The residue is dissolved in 100  $\mu$ L methanol; 1  $\mu$ L of it is injected into GC<sup>d</sup>. The peak area ratio of a compound to IS is obtained.
- v. For quantitation, a 1-mL volume each of blank urine obtained from a healthy subject, who had not taken coffee or tea for not less than 1 day, is mixed with 10  $\mu$ g IS and a different amount (not less than 4 concentrations) of a target methylxanthine derivative, and treated according to the above procedure to construct a calibration curve, consisting of peak area ratio of a target compound to IS on the vertical axis and target compound concentration on the horizontal axis. The peak area ratio obtained from a urine specimen is applied to the calibration curve to calculate the concentration of a target compound.

### ii. Plasma specimen<sup>e</sup>

- i. Blood is sampled from the median cubital vein into small test tube containing an anticoagulant; after mixing well, it is centrifuged at 3,000 rpm for 5 min to obtain blood plasma.
- ii. A 1-mL volume of plasma is mixed with IS<sup>c</sup> and 4 mL of 0.1 M HCl solution, vortex-mixed and centrifuged at 3,000 rpm for 5 min. The resulting supernatant solution is transferred to another bigger test tube. The sediment is again mixed with 4 mL of 0.1 M HCl solution, vortex-mixed and centrifuged. The 2nd supernatant solution thus obtained is combined with the previous one.
- iii. Using a Pasteur pipette, an appropriate amount of 1 M KOH solution is dropped into the above supernatant solution to adjust its pH to 6.5–7.5.
- iv. The solution is poured into the activated Sep-Pak C<sub>18</sub> cartridge using a 10-mL volume syringe. The following procedure is the same as described in the steps iii–v for the urine specimen. The calibration curve is constructed using blank plasma obtained from a healthy subject, who had not taken coffee or tea for not less than 1 day in the same way.

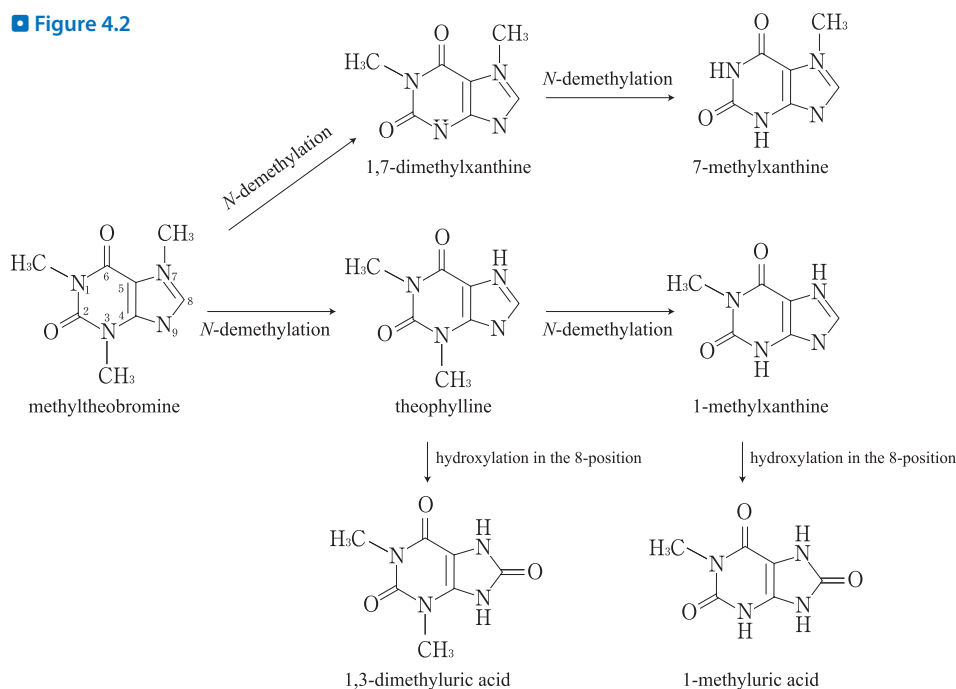
## Assessment and some comments on the method

➤ *Figure 4.1* shows gas chromatograms with a DB-17 capillary column for extracts of plasma and urine, into which 10  $\mu$ g each of methylxanthines had been spiked, obtained by the present method. Although some impurity peaks appeared around 200 °C in the chromatograms obtained from blank specimens, the ten methylxanthines were separated well from each other and from impurity peaks.



Gas chromatograms for the extracts of human plasma and urine in the presence and absence of ten methylxanthines using a DB-17 medium-bore capillary column. 1: caffeine; 2: theobromine; 3: 1,7-dimethylxanthine; 4: theophylline; 5: proxiphylline; 6: 3-isobutyl-1-methylxanthine; 7: pentifylline; 8: dyphylline; 9: pentoxyphylline; 10: 1,3,9-trimethylxanthine. A 10- $\mu$ g aliquot each of methylxanthines was spiked into 1 mL blood plasma or urine.

Figure 4.2



#### Metabolic pathways for caffeine in human bodies.

The recovery rates were not less than 75 % for all compounds. Their detection limits were 0.16–0.83  $\mu\text{g/mL}$ .

Except the DB-17 column, a nonpolar DB-1 capillary column had been tested; however, the tailing phenomenon was markedly observed for theophylline, theobromine, 1,7-dimethylxanthine and 3-isobutyl-1-methylxanthine. The DB-17 capillary column gave much better results for this drug group.

Figure 4.2 shows the metabolic pathways for caffeine. Theophylline and 1,7-dimethylxanthine are the metabolic intermediates of caffeine. When caffeine is taken, the above three compounds can appear simultaneously. It should be noted that theobromine coexists with caffeine in coffee and tea. When both theophylline and caffeine are detected simultaneously, it is difficult to discriminate whether only caffeine or both are taken.

### Poisoning cases, and toxic and fatal concentrations

**Case 1** [13]: 1-year and 2-month-old female ingested 2 g caffeine. From 1 h after ingestion, repeated vomitings appeared; 10 h after, general tonic and clonic convulsion was observed. She was subjected to emergency admission to a hospital. Upon admission, her heart beat and respiration rates were 170 and 40/min, respectively. The blood caffeine concentration at 15 h after ingestion was 148  $\mu\text{g/mL}$ . On the 2nd day of admission, adjustment of electrolytes was performed, because hypopotassemia and hypochloremia appeared. On the 3rd day, the values of CPK and serum myoglobin were 14,220 U/L and 405 ng/mL, respectively, suggesting rhabdo-

myolysis. Thereafter, her conditions were improved and she was discharged on the 10th day without any neurological sequela.

**Case 2** [14]: an 18-year-old female ingested 20–30 of extended-release tablets of theophylline (Theodur<sup>®</sup>) at about 1:30 a.m. From about 3:00 a.m., vomiting was started; at 5:45 a.m., she visited an emergency room of a hospital and was admitted. Until 3:00 p.m., she suffered from vomiting; in the vomitus, the debris of the tablets were included. At about 4:00 p.m., she complained of a bad headache; her heart beat rate was 120/min, and blood theophylline concentration was 66.6 µg/mL. At 4:30 p.m., gastrolavage was performed by inserting a gastric tube. Then, 60 g of activated charcoal, 250 mL of magnesium citrate solution and 500 mL saline solution were orally administered slowly. At the same time, an intravenous drip infusion of 2 ampoules of Primperan<sup>®</sup> (metoclopramide) and 25 mg of Wintermin<sup>®</sup> (chlorpromazine) were made to prevent her from vomiting. Thereafter, she showed a trend of recovery; the blood theophylline concentration in the next morning was as low as 6.1 µg/mL.

Blood therapeutic and toxic concentrations of caffeine are 8–15 µg and > 20 µg/mL, respectively. Blood therapeutic theophylline concentrations are 8–18 µg/mL for adults and 5–10 µg/mL for small infants; blood toxic theophylline concentrations are 20–25 µg/mL for adults and about 15 µg/mL for small infants [15]. It should be noted that the safe range of doses for theophylline is very narrow.

## Notes

- Any capillary column with an intermediately polar 50 % phenylsilicone/50 % dimethylsilicone stationary phase can be used, regardless of its manufacturer.
- Any type of GC instruments, to which a capillary column can be attached, is usable.
- As IS, one of the methylxanthines except caffeine, theophylline, theobromine and 1,7-dimethylxanthine listed in [▶ Table 4.1](#) can be chosen. A 10-µg aliquot of an IS is spiked into 1 mL of urine or plasma before the extraction procedure.
- In place of GC, GC/MS can be used for analysis of methylxanthines with much higher sensitivity and specificity, because all ten compounds dealt with in this chapter give intense or base peaks of molecular ions in the positive EI mode [1].
- Although blood plasma was used as a specimen in this chapter, whole blood seems usable in place of plasma using exactly the same procedure.

## References

- Kumazawa T, Sato K, Seno H et al. (1994) Positive and negative ion mass spectrometry of ten xanthine derivatives and their rapid clean-up with Sep-Pak C<sub>18</sub> cartridges from biological samples. *Forensic Sci Int* 68:53–67
- Kuroiwa Y, Yoshida T (1997) Alkaloids. In: Brandenberger H, Maes RAA (eds) *Analytical Toxicology for Clinical, Forensic and Pharmaceutical Chemists*. Walter de Gruyter, Berlin, pp 621–661
- Naito H (2001) *Poisoning of Industrial Products, Gases, Pesticides, Drugs, and Natural Toxins. Cases, Pathogenesis and Its Treatment*, 2nd edn. Nankodo Co., Ltd., Tokyo, pp 386–388 (in Japanese)
- Bauza MT, Smith RV, Knutson DE (1984) Gas chromatographic determination of pentoxifylline and its major metabolites in human breast milk. *J Chromatogr* 310:61–69
- Verebey K, DePace A (1998) Rapid confirmation of enzyme-multiplied immunoassay test (EMIT) for phencyclidine-positive urine samples with capillary gas chromatography-nitrogen-phosphorus detection. *J Chromatogr* 427:151–156



- 6) Kapil R, Bruyere HJ Jr (1989) Application of capillary gas chromatography to study caffeine distribution in the developing chicken egg. *J Chromatogr* 493:182–187
- 7) Kumazawa T, Seno H, Lee X-P et al. (1999) Extraction of methylxanthines from human body fluids by solid-phase microextraction. *Anal Chim Acta* 387:53–60
- 8) Brooks KE, Smith NB (1991) Efficient extraction of basic, neutral and weakly acidic drugs from plasma for analysis by gas chromatography-mass spectrometry. *Clin Chem* 37:1975–1978
- 9) Hartley R, Smith IJ, Cookman JR (1985) Improved high-performance liquid chromatographic method for the simultaneous determination of caffeine and its N-demethylated metabolites in plasma using solid-phase extraction. *J Chromatogr* 342:105–117
- 10) Setchell KDR, Welsh MB, Klooster MJ et al. (1987) Rapid high-performance liquid chromatography assay for salivary and serum caffeine following an oral load. *J Chromatogr* 385:267–274
- 11) Rund-Christensen M, Aasen AJ, Rasmussen K et al. (1989) High-performance liquid chromatographic determination of (R)- and (S)-propryphyllyne in human plasma. *J Chromatogr* 491:355–366
- 12) Mancinelli A, Pace S, Marzo A et al. (1992) Determination of pentoxifylline and its metabolites in human plasma by high-performance liquid chromatography with solid-phase extraction. *J Chromatogr* 575:101–107
- 13) Yamazaki F, Mori H (eds) (2000) Guide to Acute Poisonings by Medical Drugs. Van Medical, Tokyo, p 76 (in Japanese)
- 14) Yamazaki F, Mori H (eds) (2000) Guide to Acute Poisonings by Medical Drugs. Van Medical, Tokyo, p 149 (in Japanese)
- 15) Uges DRA (1997) Blood level data. In: Brandenberger H, Maes RAA (eds) *Analytical Toxicology for Clinical, Forensic and Pharmaceutical Chemists*. Walter de Gruyter, Berlin, pp 707–718

## II.6.5 Nicotine and cotinine

by Mariko Fukumoto

### Introduction

Nicotine is a main water-soluble alkaloid being contained in the tobacco plant (*Nicotiana tabacum*), which acts as an inducing compound for smoking-dependence. Twelve kinds of nicotine metabolites are known in rats [1]. Among them, cotinine is the major metabolite of nicotine; the half-life ( $T_{1/2}$ ) of cotinine is much longer (10–20 h) than that of nicotine (24–84 min). The qualitative analysis of cotinine in urine and saliva is being thus carried out as indicators for smoking during its abstinence therapy and for confirming passive smoking.

The cases of ingestion of cigarettes or their butts are household accidents taking place very frequently in Japan. The nicotine contents being contained in a single cigarette are 7–24 mg [2], which is sufficient to kill an infant; but thanks to its vomiting-stimulating action or delayed absorption, the fatalities due to such accidental ingestion are rare. However, after suicidal ingestion of nicotine sulfate solution (an insecticide) and of cigarette extract solution obtained by boiling, many people are being brought to critical care medical centers; in such cases, they may be fatal without appropriate and early treatments.

For analysis of nicotine and cotinine in human blood and/or urine, methods by GC [3–5], GC/MS [6–8] and HPLC [9–13] were reported. In this chapter, the methods for GC/MS analysis of nicotine and cotinine in blood and for HPLC (UV detection) analysis of nicotine in tobacco extract solutions are presented.

### GC/MS analysis of nicotine and cotinine in blood and urine

---

#### Reagents and their preparation

- Nicotine and cotinine (Sigma, St. Louis, MO, USA and other manufacturers) are dissolved in the Milli Q water (Millipore, Bedford, MA, USA) to prepare fixed concentrations of their aqueous solutions. The calibration curves are constructed using human blank sera obtained from healthy nonsmokers; various concentrations of nicotine or cotinine are spiked into the blank sera
- 5-Aminoquinoline (internal standard, IS, Aldrich, Milwaukee, WI, USA) is dissolved in the Milli Q water to prepare its 100 ng/mL solution
- The solvent mixture of dichloromethane/isopropyl ether (85:15) is prepared just before use.

■ **Table 5.1**

**Molecular weights, fragment ions and retention times for nicotine, cotinine and 5-aminoquinoline**

	Molecular weight	Fragment ion ( <i>m/z</i> )	Retention time (min)
nicotine	162.23	84, 133, 161	8.0
cotinine	176.22	98, 176	10.4
5-aminoquinoline	144.18	144	10.0

## GC/MS conditions

GC column: a DB-5MS capillary column (30 m × 0.25 mm i. d., film thickness 0.25 μm, J & W Scientific, Folsom, CA, USA).

Instrument: a FinniganMAT GCQ GC/MS system (ThermoFinnigan, San Jose, CA, USA).

Column temperature: 40 °C (2.5 min, split mode) → 30 °C/min → 145 °C → 15 °C/min → 220 °C; injection temperature: 250 °C; carrier gas: He; linear velocity: 40 cm/s; ionization: EI; electron energy: 70 eV; detection mode: selected ion monitoring (SIM); fragment ions to be used for SIM and each retention time are shown in [▶ Table 5.1](#) (total time for the measurements, 11 min).

## Procedure

- i. A 300-μL aliquot of serum (or urine) is mixed with 20 μL of IS solution and 2 μL of 1 M NaOH solution.
- ii. The above mixture is poured into a ChemElut column<sup>a</sup> (Varian, Harbor City, CA, USA) and left at room temperature for 5 min; the target compounds are eluted with 3.0 mL of dichloromethane/isopropyl ether (85:15).
- iii. The eluate is evaporated to dryness under a stream of nitrogen; the residue is dissolved in 30 μL ethyl acetate and 1 μL of it is injected into GC/MS.

## Assessment and some comments on the method

For pretreatments of clinical specimens for analysis of nicotine and cotinine, methods by liquid-liquid extraction [3–5], solid-phase extraction [9], headspace/solid-phase microextraction (SPME) [6] and Extrelut (diatomite) extraction [7, 8, 10–13] were reported.

For the liquid-liquid extraction, repeated extraction procedures (3 times on average) are required; recovery rates vary due to emulsion formation, thus resulting in poor reproducibility. The solid-phase extraction is easier in operationality than liquid-liquid extraction. However, nicotine exists in a liquid form at room temperature; in view of the volatility of nicotine, the solid-phase extraction may not be suitable for nicotine analysis. For every extraction method, as much as 1–5 mL of a specimen is required. For clinical analysis of nicotine and cotinine dealing with many specimens, various technical problems should be overcome.

In the extraction using a diatomite column, the water (containing target compound(s)) of a specimen adsorbs to the diatomite surface to act as a stationary phase; during the passage of an organic solvent through the diatomite column, the contact between the organic and aqueous phases makes the target compounds liquid-liquid extracted into the organic phase. There is no emulsion formation, and excellent cleanup can be realized with high recovery rates. As mentioned above, Extrelut columns were used in many reports; however the author used ChemElut columns made of similar diatomite, which are relatively cheap and easy in handling.

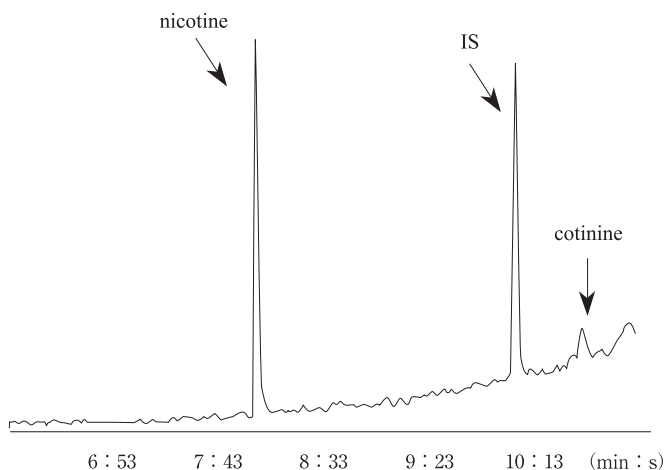
In every extraction method, the final extracts are diluted more than 10 times; therefore, the final solution should be evaporated to dryness, followed by the dissolution of the residue in a small amount of an organic solvent to be injected into GC/MS. The author tried various organic solvents to test recovery rates of nicotine; it was found that an appreciable amount of nicotine is lost during the condensation (evaporation) step. Especially, when water-soluble organic solvents such as acetone, acetonitrile, methanol and ethanol are used, the loss of nicotine during evaporation is remarkable; the recovery rates also become variable. It is known that the boiling point of nicotine is lowered upon its mixing with acetone, by the action of azeotropic effects, causing more volatility of nicotine.

As extraction solvents for the diatomite columns, dichloromethane, diethyl ether, and dichloromethane plus isopropyl alcohol or isopropyl ether are being used. In the author's experience, dichloromethane/isopropyl ether (85:15) gave the best recovery rate.

To prevent nicotine from its loss due to evaporation, hydrochloric acid methanolic solution is sometimes added. The author also tried the addition of various acids including hydrochloric acid, but any acid addition could not improve the recovery rates.

The adsorption of nicotine and cotinine to glassware was tested, because there was a report, in which glassware after the inactivation treatment (silylation) had been used. However, no adsorption of the compounds was found.

Figure 5.1



**SIM chromatogram for nicotine, cotinine and 5-aminoquinoline (IS) extracted from human serum. The peaks of nicotine and cotinine were constructed by combining peak areas at  $m/z$  84, 133 and 161, and at  $m/z$  98 and 176, respectively. The peak of IS is detected with the peak area at  $m/z$  144 only.**

► *Figure 5.1* shows an SIM chromatogram for nicotine and cotinine extracted from a clinical specimen. The detection limit by this method was 5 ng/mL ( $S/N = 3$ ) for both nicotine and cotinine.

## HPLC analysis of nicotine and cotinine in blood and urine

---

### Reagents and their preparation

- The standard solutions of nicotine and cotinine, and spiked serum specimens are prepared as described in the GC/MS section.
- 5-Aminoquinoline (IS) is dissolved in acetonitrile to prepare 500 ng/mL solution.

### HPLC conditions

HPLC column: Mightysil RP18 (250 × 4.6 mm i. d., particle size 5 μm, Kanto Chemicals, Tokyo, Japan).

Instrument: a Hitachi (Tokyo, Japan) HPLC system (pump: Hitachi-7100; data processor: Hitachi D7500; detector: Hitachi L7400 UV detector).

Mobile phase: methanol/water/0.1 M acetate buffer solution (pH 4.0)/acetonitrile (13:65:20:2) is adjusted to pH 6.3 with triethylamine.

Flow rate: 1.0 mL/min; detector wavelength: 262 nm; analysis time: about 25 min; retention times: nicotine 8.5 min, cotinine 17.8 min and IS 22.3 min.

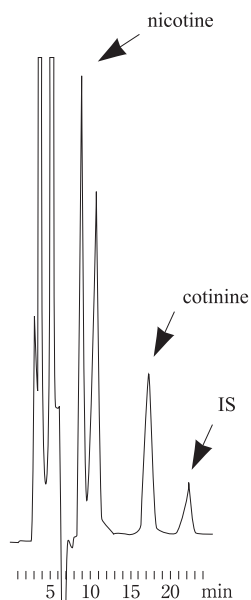
### Procedure

- i. A 100-μL aliquot of serum is mixed well with 100 μL IS solution in a sample tube.
- ii. After centrifugation at 10,000 rpm for 10 min, the supernatant fraction is mixed with a saturating amount of sodium carbonate to separate the acetonitrile phase from the aqueous phase.
- iii. After centrifugation at 10,000 rpm for 10 min, the upper phase (acetonitrile layer) is transferred to a glass vial containing 50 mg anhydrous sodium sulfate and mixed well for dehydration.
- iv. A 20-μL aliquot of the above supernatant solution and 20 μL mobile phase are drawn into a microsyringe to mix<sup>b</sup> them in the syringe. An aliquot of the mixture is injected into HPLC.

### Assessment and some comments on the method

In many reports on HPLC analysis of nicotine with a UV detector (UV: 262 or 254 nm), liquid-liquid extraction or diatomite column extraction was used. They used as large as 1–5 mL serum for each analysis and finally condensed the extract solution by evaporation; their methods resulted in the detection limit as low as 5 ng/mL. However, as mentioned above, the loss of

Figure 5.2




---

rat: SD strain, male, 6-week-old (No.16)
cigarette extract solution: 7 mL/kg, single
oral administration (dose as nicotine:
63 mg/kg) time until death: 2 h 47 min
concentration (retention time):
nicotine 12.1 $\mu\text{g/mL}$ (8.46 min)
cotinine 3.74 $\mu\text{g/mL}$ (17.8 min)
IS 0.50 $\mu\text{g/mL}$ (22.3 min)

---

**HPLC chromatogram for nicotine, cotinine and IS in rat serum after oral dose of cigarette extract solution.**

nicotine by evaporation is inevitable and the reproducibility is not good by the above methods. Therefore, in this method, the author adopted the deproteinization method with acetonitrile to obtain excellent reproducibility. To the acetonitrile supernatant solution, an excessive amount of sodium carbonate is added to separate the acetonitrile layer from the aqueous one. The acetonitrile layer can be immediately injected into HPLC; by mixing with the same volume of the mobile phase, the height of acetonitrile peak can be suppressed.

As mobile phase, acetate buffer solution and triethylamine were used, because such a volatile mobile phase will be able to be used under the same conditions for LC/MS analysis<sup>c</sup> in the future.

Figure 5.2 shows an HPLC chromatogram for nicotine and cotinine in rat serum after a single oral dose of cigarette extract solution.

## HPLC analysis of nicotine in cigarettes

On the packages of cigarettes, the amounts of nicotine and tar are described. The values show the amounts of nicotine and tar being contained in the smoke discharged from a piece of cigarettes, measured under a fixed condition using a smoking machine; such a value for nicotine is called "nicotine yield". Nowadays, the nicotine and tar yields for Japanese domestic cigarette brands are 0.1–2.4 mg and 1–24 mg, respectively; the cigarettes with low nicotine yields are called "low nicotine (tar) cigarettes". To minimize the damage to health by smoking, smokers tend to choose low nicotine yield cigarettes. However, actual amounts of nicotine being contained in a piece of cigarettes (nicotine content) are 7–24 mg [2]. Upon smoking the low nico-

tine cigarettes, the smokers unconsciously inhale the smoke to reach the lungs deeply, because such cigarettes give light feeling to them; the deep inhalation results in the absorbed amounts of nicotine to be as large as 2–3 mg per piece, which are similar to those for high nicotine cigarettes. Moreover, it is being pointed out by specialists that the number of pieces being consumed tends to be increased for the low nicotine cigarettes, because of the sense of security [14].

In this section, a method for HPLC analysis of nicotine in cigarettes is described; it cannot be applied to measurements of nicotine in human specimens, because of its low sensitivity as compared with that of GC/MS, but can be applied to measurements of high levels of nicotine in specimens of experimental animals.

## Reagents and their preparation

The standard solutions of nicotine and cotinine, and spiked serum specimens are prepared as described in the GC/MS section.

## HPLC conditions

HPLC column: Inertsil ODS-3 (150 × 4.6 mm i. d., particle size 5 μm, GL Sciences, Tokyo, Japan).

Instrument: a Hitachi HPLC system (the same as above).

Mobile phase: 67 mM phosphate buffer solution (pH 7.0)/acetonitrile (88:12) containing 2 mM sodium hexanesulfonate (Sigma, St. Louis, MO, USA and other manufacturers).

Flow rate: 1.0 mL/min; detection wavelength: 262 nm; analysis time: about 15 min; retention time of nicotine: 12 min.

## Procedure

- i. A filter and paper are carefully removed, and the chopped tobacco is weighed.
- ii. The tobacco is crushed using a blender into powder for 60 s, and a fixed amount of it is suspended in 100 mL of methanol/0.1 M NaOH solution (1:1) and extracted by sonication for 60 min.
- iii. The supernatant solution is passed through a filter paper, diluted 50-fold with 67 mM phosphate buffer solution (pH 7.0) and passed through a Millipore filter (PTFE, 0.5 μm). A fixed volume of the filtrate is injected into HPLC.
- iv. In this method, quantitation is made without IS using the external calibration method. For HPLC analysis of nicotine in serum specimens, solid-phase extraction should be made according to the method described in the section of GC/MS analysis in this chapter.

## Assessment and some comments on the method

This method can be used for determination of fatal levels (not lower than 0.5 μg/mL) of nicotine in serum. To obtain more excellent separation ability, the composition ratio of the 67 mM

phosphate buffer solution/acetonitrile can be changed to 93:7; the concentration of the ion-pairing reagent sodium hexanesulfonate can be increased up to 5 mM. Under these conditions, the analysis time was about 22 min; the retention times of nicotine and cotinine were 20 and 16 min, respectively.

► *Table 5.2* shows nicotine contents and nicotine yields for 33 brands of cigarettes being sold in Japan. It seems useful for the assessment of toxicity, when a cigarette ingestion incident takes place.

## Poisoning cases, and toxic and fatal concentrations

The ingestion of 2–5 mg nicotine can provoke vomiting, and the estimated minimal oral lethal dose is 40–60 mg in adults. When amounts of nicotine larger than the toxic dose are ingested, acute symptoms, such as salivation, convulsion and respiratory depression will develop in 1 min–1 h, and the victims may die finally in severe cases. However, there were survived cases after ingestion of 1–4 g nicotine. In an autopsy cases, in which victims had ingested 20–25 g of nicotine sulfate and had died within 1 h, the blood nicotine concentrations were 11–63 µg/mL (29 µg/mL on average) [15]. In autopsy cases of nicotine poisoning reported in Japan, the blood concentrations were 64 [16] and 6.3 µg/mL [17]. In animal experiments using male

■ **Table 5.2**

**Nicotine contents and nicotine yields for 33 brands of cigarettes being sold in Japan.**

domestic cigarette brands (n=16)				
brand names	nicotine <sup>(1)</sup> (mg)	contents (%)	nicotine yield (mg)	tobacco content (g)
peace <sup>(2)</sup>	24.0	2.35	2.4	1.02
peak king size	18.3	2.34	2.4	0.78
hi-light*	14.6	2.02	1.4	0.72
echo	13.7	2.43	1.1	0.57
hope	13.3	1.85	1.2	0.72
caster mild*	13.0	2.00	0.4	0.65
marlboro	12.8	1.61	1.0	0.79
cherry	12.6	1.86	1.2	0.68
mildseven*	12.6	1.87	0.9	0.67
sevenstar*	12.4	1.77	1.3	0.70
cabin mild*	12.0	1.86	0.7	0.65
mildseven super light*	11.8	1.76	0.5	0.67
mi-ne	11.5	1.70	1.0	0.68
mildseven lights	10.9	1.63	0.8	0.67
cabin ultra mild*	8.84	1.55	0.2	0.57
frontier lights	6.94	1.14	0.1	0.61
average	13.1**	1.86	1.04***	0.70
(±SD)	(3.79)	(0.33)	(0.66)	(0.11)



■ **Table 5.2**  
(Continued)

Imported cigarette brands (n=17)				
brand names	nicotine <sup>(1)</sup> (mg)	contents (%)	nicotine yield (mg)	tobacco content (g)
camel	15.4	2.04	0.9	0.75
dunhill ultimate light	15.0	2.35	0.1	0.64
next <sup>‡</sup>	12.7	1.88	0.1	0.58
parliament 100 <sup>‡</sup>	12.5	1.62	0.8	0.77
lark mild <sup>‡</sup>	11.6	1.59	0.7	0.73
lark	11.3	1.55	0.9	0.73
kent1 <sup>‡</sup>	11.2	1.71	0.1	0.66
vantage	11.1	1.78	0.7	0.62
salem	10.9	1.63	1.0	0.67
virginia slims lights <sup>‡</sup>	10.9	1.63	0.5	0.67
lucky strike <sup>‡</sup>	10.5	1.57	0.8	0.67
island super lights	10.2	1.44	0.6	0.71
kent	9.97	1.44	0.9	0.69
lark super lights <sup>‡</sup>	9.66	1.62	0.4	0.60
philip morris one <sup>‡</sup>	9.53	1.95	0.1	0.49
philip morris super lights <sup>‡</sup>	9.10	1.59	0.4	0.57
salem slim lights	8.03	1.32	0.5	0.61
average	11.2**	1.69	0.56***	0.66
(±SD)	(1.98)	(0.26)	(0.30)	(0.08)

<sup>(1)</sup> the advertised level determined by a smoking machine.

<sup>(2)</sup> non-filtered cigarette.

\* the best ten brands of domestic cigarettes sold in 1995.

\*\* p < 0.05.

\*\*\* p < 0.01.

‡ the ten top-selling brands of imported cigarettes in 1995.

Sprague-Dawley rats with single oral administration each of tobacco exudates or the standard nicotine solutions, their fatal blood nicotine concentrations were 6.29–34.6 and 0.89–57.5 µg/mL, respectively [18].

A 47-year-old male attempted suicide by ingesting cigarette extract solution obtained by boiling (estimated ingested nicotine amount: 500 mg). One hour and 20 minutes later, the stomach contents were removed to some extent by aspiration with a tube; by measuring the concentration of nicotine in the stomach contents, it was estimated that about 250 mg nicotine still remained in the stomach and the intestine. After gastrolavage and administration of activated charcoal were performed, a blood specimen was sampled for measurement of nicotine concentration about 2 h after ingestion; the result was 79.5 ng/mL. The patient showed early poisoning symptoms, such as, hypersalivation, nausea and vomiting, but was discharged 2 days later, because of improvement.

In Japan, the incidence of accidental ingestion of cigarettes by small infants is very high. By ingestion of one piece of cigarettes or of more than 3 cigarette butts by infants, there is a high possibility of the appearance of poisoning symptoms [19]. In a report describing the blood

nicotine concentrations in the cases of accidental cigarette ingestion by infants, the estimated peak blood concentrations for symptomatic and asymptomatic patient groups were 52.9 and 51.0 ng/mL, respectively; there is no significant difference in the concentration between the two groups [20]. In Europe and the United States, even cases of nicotine poisoning, due to nicotine chewing gum and nicotine patch, were reported; such a type of acute poisoning cases may appear also in Japan according to widespread use of such smoking-abstinence assisting drugs containing nicotine.

## Notes

- a) For the ChemElut columns, various sizes of the columns are available; 0.3–300 mL volumes of sample solution can be applied by selecting each size. Upon elution, the manipulations, such as aspiration under reduced pressure, are not necessary. When a calibration curve with 5 plots is constructed by measuring 10 samples (in duplicate for each plot), the cost for one sample is 570 yen for ChemElut and 1,800 yen for Extrelut.
- b) To well mix the acetonitrile extract with the same volume of the mobile phase inside a microsyringe, a small amount of air is also aspirated into the syringe to include small bubbles in the solution mixture, followed by its gentle shakings 3–5 times.
- c) There is one report describing LC/MS analysis of nicotine [10], but it is not so practical, because it requires as much as 5 mL volume specimens.

## References

- 1) Kyerematen GA, Taylor LH, DeBethizy JD et al. (1988) Pharmacokinetics of nicotine and 12 metabolites in the rat. *Drug Metab Dispos* 16:125–129
- 2) Fukumoto M, Kubo H, Ogamo A (1997) Determination of nicotine content of popular cigarettes. *Vet Hum Toxicol* 39:225–227
- 3) Hengen N, Hengen M (1978) Gas liquid chromatographic determination of nicotine and cotinine in plasma. *Clin Chem* 24:50–53
- 4) Feyerabend C, Russel MAH (1979) Improved gas chromatographic method and microextraction technique for the measurement of nicotine in biological fluids. *J Pharm Pharmacol* 31:73–76
- 5) Kogan MJ, Verebey K, Jafee JH et al. (1981) Simultaneous determination of nicotine and cotinine in human plasma by nitrogen detection gas-liquid chromatography. *J Forensic Sci* 26:6–11
- 6) Yashiki M, Nagasawa N, Kojima T et al. (1995) Rapid analysis of nicotine and cotinine in urine using headspace-solid phase microextraction and selected ion monitoring. *Jpn J Forensic Toxicol* 13:17–24
- 7) Azuma E, Sashikuma F, Itani S et al. (1986) Simultaneous determination of nicotine and cotinine in urine by gas chromatography. *Eisei Kagaku* 32:276–280 (in Japanese with an English abstract)
- 8) Mizunuma H, Hirayama Y, Sakurai S et al. (1982) Sensitive determination of nicotine in urine and blood. *Eisei Kagaku* 28:13–17 (in Japanese with an English abstract)
- 9) Kyerematen GA, Damiano MD, Dvorchik BH et al. (1982) Smoking-induced changes in nicotine disposition: application of a new HPLC assay for nicotine and its metabolites. *Clin Pharmacol Ther* 32:769–780
- 10) Pacifici R, Pichini S, Altieri I et al. (1993) Determination of nicotine and two major metabolites in serum by solid-phase extraction and high-performance liquid chromatography, and high-performance liquid chromatography-particle beam mass spectrometry. *J Chromatogr* 612:209–213
- 11) Zuccaro P, Altieri I, Rosa M et al. (1995) Solid-phase extraction of nicotine and its metabolites for high-performance liquid chromatographic determination in urine. *J Chromatogr B* 668:187–188
- 12) Zuccaro P, Altieri I, Rosa M et al. (1993) Determination of nicotine and four metabolites in the serum of smokers by high-performance liquid chromatography with ultraviolet detection. *J Chromatogr* 621:257–261

- 13) Pichini R, Altieri I, Pacifici R et al. (1992) Simultaneous determination of cotinine and trans-3'-hydroxycotinine in human serum by high-performance liquid chromatography. *J Chromatogr* 577:358–361
- 14) U.S. Department of Health and Human Services (2000) Reducing tobacco use: a report of the Surgeon General, Atlanta, Georgia: U.S. Department of Health and Human Services, Centers for Disease Control and Prevention, National Center for Chronic Disease Prevention and Health Promotion, Office on Smoking and Health
- 15) Baselt RC, Cravey RH (1977) A compendium of therapeutic and toxic concentrations of toxicologically significant drugs in human biofluids. *J Anal Toxicol* 1:81–103
- 16) Fukui M, Takinomi T (1970) A case report of nicotine poisoning. *Jpn J Legal Med* 24:83 (in Japanese)
- 17) Takayasu T, Ohshima T, Lin Z et al. (1992) An autopsy case of fatal nicotine poisoning. *Jpn J Legal Med* 46:327–332 (in Japanese with an English abstract)
- 18) Fukumoto M, Shirai M, Akahori F et al. (2000) Acute toxicity of tobacco in rats. *J Toxicol Clin Toxicol* 38:517–518
- 19) Smolinske SC, Spoerke SK, Spiller SK et al. (1988) Cigarette and nicotine chewing gum toxicity in children. *Hum Toxicol* 7:27–31
- 20) Hoshino K, Matsuura H, Arimoto K et al. (1996) Blood concentrations of nicotine and cotinine after accidental tobacco ingestion. *Jpn J Pediatr* 100:1387–1391 (in Japanese with an English abstract)

## II.6.6 Tropane alkaloids

by Akira Namera

### Introduction

*Datura metel*<sup>a</sup> (jimsonweed) is a plant belonging to the Solanacea family; and contains tropane alkaloids (belladonna alkaloids), such as atropine<sup>b</sup> (*dl*-hyoscyamine) and hyoscyine (*dl*-scopolamine), in its seeds and every part of the plant. Its seeds and leaves have long been being used as a folk medicine in Japan. Seishu Hanaoka, a Japanese surgeon, first used this plant for general anaesthesia in 1804.

Many other species of solanaceous plants, such as *Atropa*, *Scopolia* and *Duboisia*, contain tropane alkaloids, and are distributed worldwide; many of them have been being used as folk medicines and also sometimes causing poisoning cases.

The seeds of *Datura metel* are being sold in gardening stores; people are growing this plant in their own gardens. There were poisoning cases in which *Datura metel* was eaten by mistaking it for Jew's mallow; its root eaten for that of burdock and its seeds eaten for sesame [1]. More enlightenment is required for recognition of *Datura* and *Atropa* plants as being poisonous.

### GC/MS analysis

---

#### Reagent and their preparation

- A 1-mg aliquot of *l*-hyoscyamine (Sigma, St. Louis, MO, USA) is dissolved in 1 mL acetonitrile.
- A 1-mg aliquot of *l*-scopolamine (Sigma) is dissolved in 1 mL acetonitrile.
- A 1-mg aliquot of atropine-*d*<sub>3</sub> (Sigma) is dissolved in 10 mL acetonitrile (0.1 mg/mL) to serve as an internal standard (IS).
- A 990- $\mu$ L volume of *N,O*-bis(trimethylsilyl)trifluoroacetamide (BSTFA, Pierce, Rockford, IL, USA and other manufacturers) is mixed with 10  $\mu$ L of trimethylchlorosilane (TMCS, Pierce and other manufacturers) (99:1, v/v) and used as a derivatization reagent.
- A 38.1-g amount of sodium tetraborate ( $\text{Na}_2\text{B}_4\text{O}_7 \cdot 10 \text{H}_2\text{O}$ ) is dissolved in distilled water to prepare 1,000 mL solution (0.1 M, pH 9.3).
- Extrelut NT-20<sup>c</sup> (granule for repacking, Merck, Darmstadt, Germany) is washed with 3 volumes of diethyl ether and dried under a stream of air in a draft until the disappearance of the ether smell. Moreover, the granule is dried by warming at 40 °C for 1 h. A 2-g aliquot each of the granule is packed in a glass tube (15 cm  $\times$  10 mm i.d.) to be used as an Extrelut column<sup>d</sup>.

## GC/MS conditions

GC column: an HP-5MS fused silica capillary column (30 m × 0.25 mm i.d., film thickness 0.25 µm, Agilent Technologies, Palo Alto, CA, USA).

GC/MS conditions; instrument: a GC5890 Series II gas chromatograph/an MS 5971A mass spectrometer (Agilent Technologies); column (oven) temperature: 50 °C (1 min) → 20 °C/min → 300 °C (5 min); injection temperature: 250 °C; detector temperature: 280 °C; carrier gas: He (50 kPa); monitoring ions: *m/z* 124, 140 and 361 for *l*-hyoscyamine-TMS; *m/z* 138, 154 and 375 for *l*-scopolamine-TMS; *m/z* 127, 143 and 364 for atropine-*d*<sub>3</sub>-TMS.

## Procedure

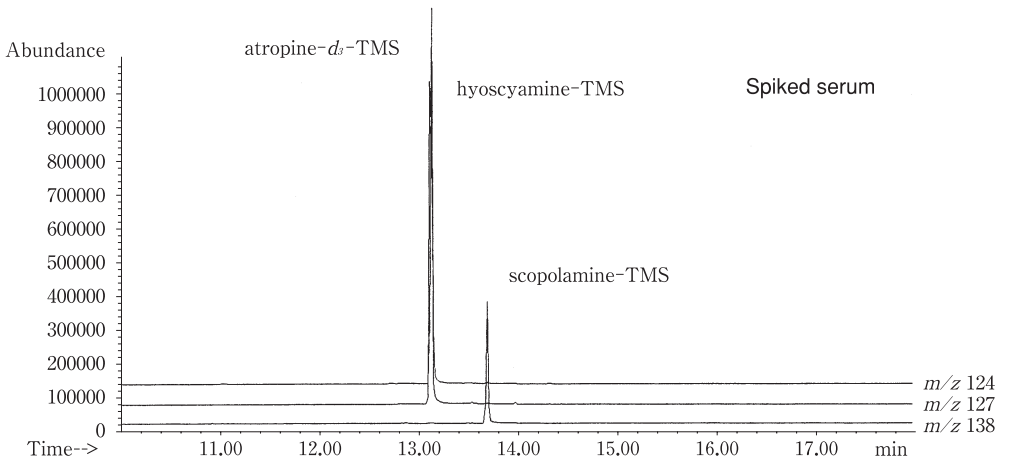
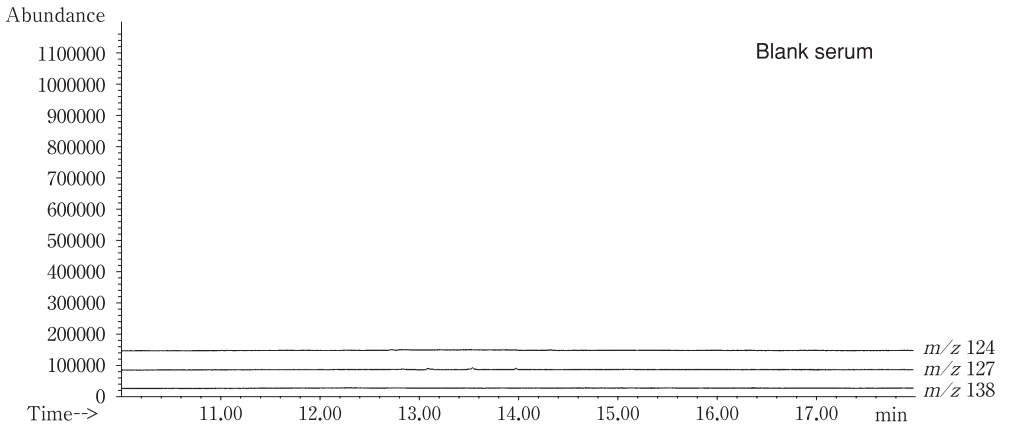
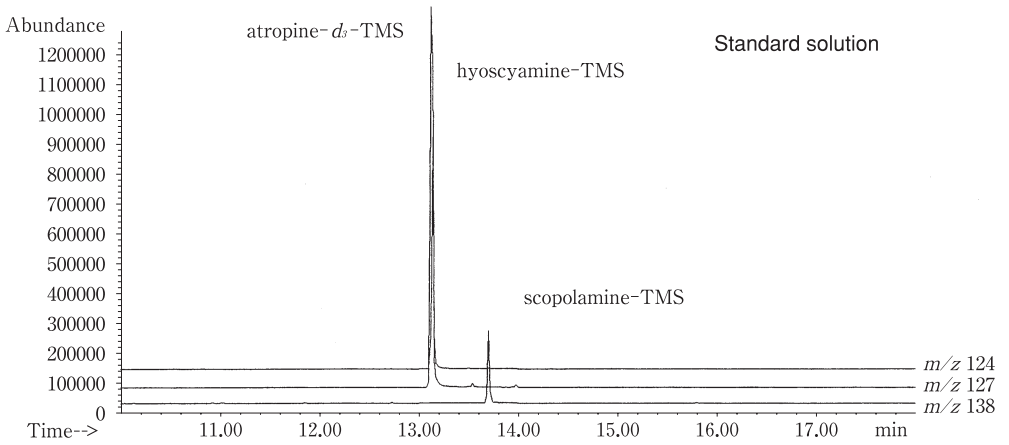
- i. A 0.5 mL volume of a specimen, 5 µL IS solution and 1.0 mL borate solution (0.1 M, pH 9.3) are placed in a test tube, mixed well and poured into an Extrelut column.
- ii. After leaving for 15 min, target compounds are eluted with 4 mL dichloromethane.
- iii. The eluate is evaporated to dryness under a stream of nitrogen.
- iv. The residue is mixed with 50 µL of BSTFA/TMCS (99:1) and warmed at 45 °C for 20 min for TMS derivatization in a glass vial with a Teflon cap.
- v. The resulting solution is mixed with 100 µL dichloromethane; a 1-µL aliquot of it is injected into GC/MS for analysis.

## Assessment of the method

▶ *Figure 6.1* shows SIM chromatograms for *l*-hyoscyamine and *l*-scopolamine, which had been extracted from human serum (the concentration of each compound, 1 µg/mL). These chromatograms were obtained using a slightly polar capillary column; similar chromatograms can be also obtained with a nonpolar capillary column. Even with the same type of columns, there is variation in their property among their lots; it is essential to confirm the retention times using the authentic standards for each column. There is a method for GC(/MS) analysis of the tropane alkaloids without any derivatization; but the derivatization of the alkaloids is recommended, because the underivatized alkaloids are thermolabile and thus cause decomposition by heat [2] and low reproducibility.

By this method, good linearity can be obtained in the range of 10–5,000 ng/mL and the detection limit is about 5 ng/mL for each compound [3]. After intravenous injection of 3 mg atropine sulfate, a peak blood concentration at 11 µg/mL could be obtained [4]. Therefore, therapeutic concentrations of atropine can be measured by this method.

Figure 6.1



SIM chromatograms for tropane alkaloids obtained by GC/MS. The amount of each alkaloid spiked into 1 mL serum was 1  $\mu$ g.

## HPLC analysis

---

### Reagents and their preparation

- The acetonitrile solutions of *l*-hyoscyamine and *l*-scopolamine are prepared as described in the GC/MS section.
- A 2-g aliquot of phosphoric acid is dissolved in Milli Q water<sup>e</sup> to prepare 1,000 mL solution, followed by adjustment of its pH to 3.0 with NaOH solution (phosphate buffer solution).
- Mobile phase: 100 mL acetonitrile (HPLC grade) is mixed with 900 mL of the above phosphate buffer solution, passed through a filter (0.45  $\mu\text{m}$ ) and degassed using an ultrasonic cleaner<sup>f</sup>.
- A 5-mL volume of methanol is mixed with 95 mL of Milli Q water (5 %, v/v).
- Each Oasis<sup>®</sup> HLB cartridge (1 cc/30 mg, Waters, Milford, MA, USA) is washed with 1 mL methanol and 1 mL water to activate it<sup>g</sup>.

### HPLC conditions

HPLC column: a Discovery C<sub>18</sub> octadecyl chemical-bonded silica column<sup>h</sup> (150  $\times$  4.6 mm i.d., particle size 5  $\mu\text{m}$ , Supelco, Bellefonte, PA, USA).

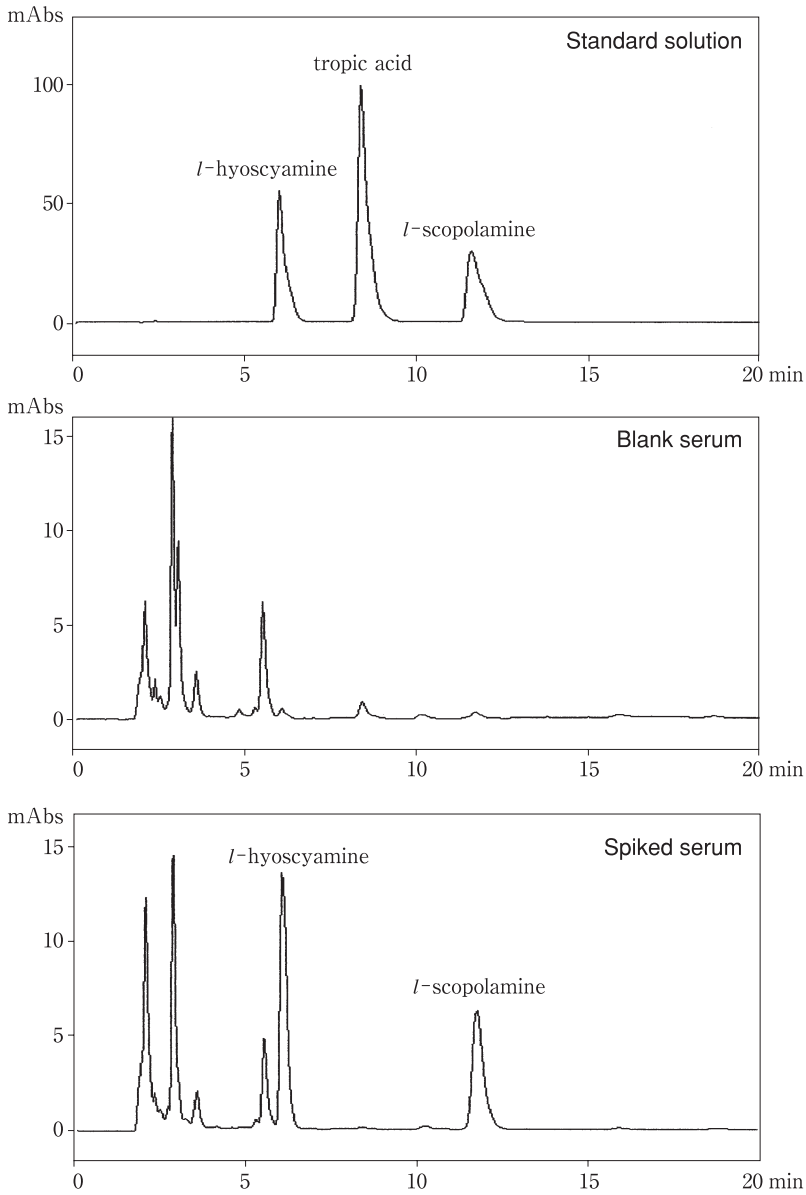
HPLC conditions; instrument: an LC-10A high-performance liquid chromatograph (Shimadzu Corp., Kyoto, Japan); mobile phase: acetonitrile/phosphate buffer solution (1:9, v/v); column (oven) temperature: 40°C; flow rate: 1.0 mL/min; detection wavelength: 215 nm.

### Procedure

- i. A 0.5-mL specimen is poured into an activated Oasis<sup>®</sup> HLB cartridge.
- ii. The cartridge is washed with 1 mL of 5 % methanol<sup>i</sup>.
- iii. The target compounds are eluted with 1 mL methanol.
- iv. The eluate is evaporated almost to dryness under reduced pressure.
- v. The residue is dissolved in 100  $\mu\text{L}$  of the mobile phase; a 10- $\mu\text{L}$  aliquot of it is injected into HPLC.

### Assessment of the method

► Figure 6.2 shows HPLC chromatograms for the authentic standards of *l*-hyoscyamine and *l*-scopolamine, for blank serum and for serum, into which both compounds had been spiked. Under the present conditions, *l*-hyoscyamine could be completely separated from *l*-scopolamine. However optical isomers of each compound cannot be separated. Tropic acid, one of the metabolites for both hyoscyamine and scopolamine, can be detected simultaneously. However, for confirmation of drug identity, the UV spectral patterns of the test peak should be compared with those of the corresponding authentic standard together with the coincidence of

**Figure 6.2**

HPLC-UV chromatograms for tropane alkaloids. The amount of each alkaloid spiked into 1 mL serum was 1  $\mu$ g.



their retention times. The detection limit of this method is about 0.01 µg/mL, and thus toxic and fatal concentrations of the compounds can be detected.

## Chiral analysis of atropine by CE/MS [5]

### Reagents and their preparation

- The acetonitrile solutions of *l*-hyoscyamine and *l*-scopolamine are prepared as described in the GC/MS section.
- A 1-mg aliquot of *dl*-hyoscyamine (atropine, Sigma) is also dissolved in 1 mL acetonitrile.
- A 0.92-g amount of formic acid and 286 g of 2,3,6-tri-*O*-methyl-β-cyclodextrin (Sigma and other manufacturers) are dissolved in Milli Q water to prepare 1,000 mL solution; after degassing, an appropriate volume of the solution is used as an electrophoretic medium.

### CE/MS conditions

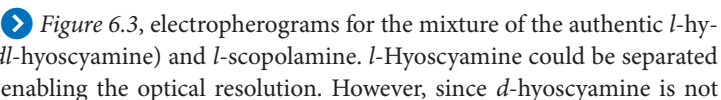
CE column: a fused-silica capillary column (900 mm × 50 µm i.d., 360 µm o.d., Agilent Technologies).

CE conditions: an HP<sup>3D</sup> capillary electrophoresis system (Agilent Technologies); detector: an Agilent 1100 mass spectrometer; electrophoretic medium: solution containing 200 mM trimethyl-β-cyclodextrin and 50 mM formic acid; impressed voltage: 30 kV; column (oven) temperature: 20 °C; sheath solution: 50 % methanol containing 5 mM ammonium acetate (4 µL/min); nebulizer gas: nitrogen (10 psi); drying gas: nitrogen (6 L/min, 300 °C); monitoring ions: *m/z* 290.2 (*l*-hyoscyamine), *m/z* 304.1 (*l*-scopolamine).

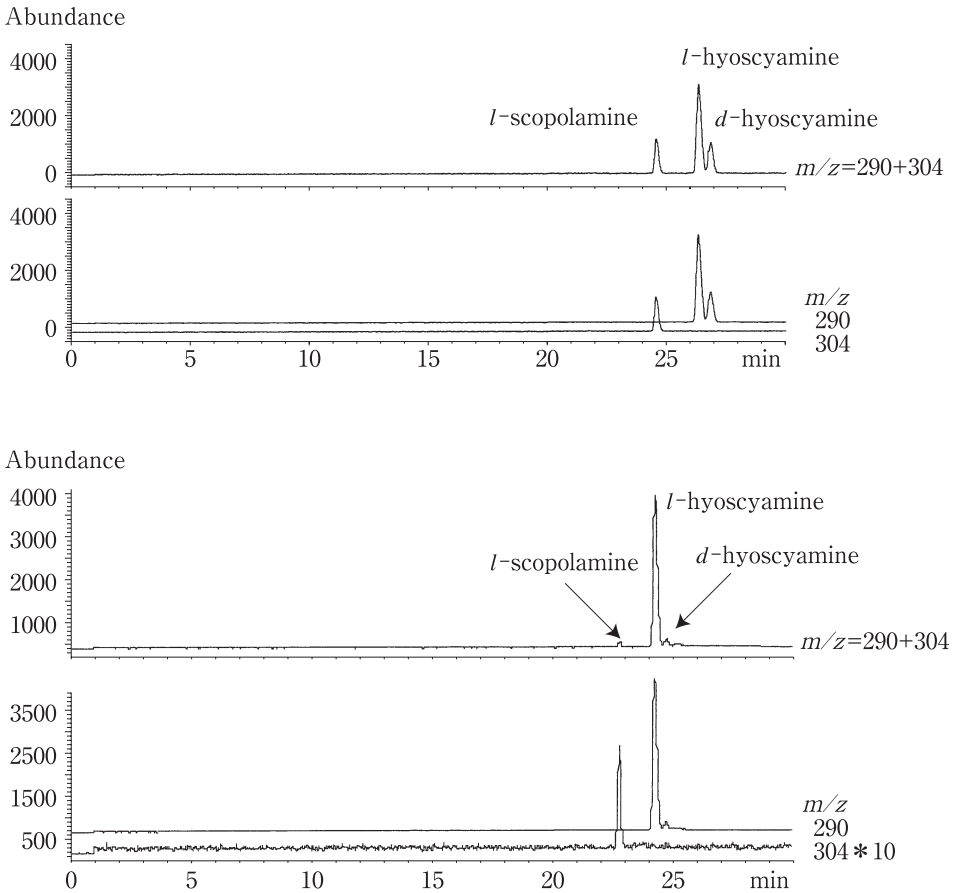
### Procedure

- i. A specimen for analysis is seeds of a plant (*Datura metel* and others).
- ii. A fixed amount of seeds is crushed using a mortar.
- iii. The resulting powder and 1 mL methanol containing 1 % ammonia are placed in a test tube.
- iv. The mixture is sonicated for 3 min for extraction.
- v. The supernatant solution is passed through a membrane filter (0.22 µm); 200 µL of the filtrate is evaporated to dryness under a stream of nitrogen.
- vi. The residue is dissolved in 100 µL Milli Q water and injected into CE/MS.

### Assessment of the method

In the upper panels of  Figure 6.3, electropherograms for the mixture of the authentic *l*-hyoscyamine, atropine (*dl*-hyoscyamine) and *l*-scopolamine. *l*-Hyoscyamine could be separated from *d*-hyoscyamine, enabling the optical resolution. However, since *d*-hyoscyamine is not

■ **Figure 6.3**



Electropherograms for tropane alkaloids obtained by CE/MS. The upper panels show those for the authentic standard solution; the lower panels those using the extract of seeds of *Datura metel*.

available, the optical resolution ability for scopolamine is not clear. Since small shifts appear in migration times of compounds for each electrophoresis in CE analysis, it is essential to confirm migration times using the authentic standard compounds.

By this method, excellent linearity could be obtained in the range of 1–100  $\mu\text{g/mL}$  for aqueous solution of *l*-hyoscyamine, *d*-hyoscyamine and *l*-scopolamine; their detection limit was about 0.5  $\mu\text{g/mL}$ .

## Poisoning cases, and toxic and fatal concentrations

There are many tropane alkaloid poisoning cases, in which solanaceous plants are ingested by mistake. However, in many cases, atropine or hyoscyamine was only detected from the plant or

foods, which the poisoned victim had eaten; the number of reports dealing with the determination of the alkaloids in blood and/or urine of the poisoned patients is very limited. Poisoning cases, in which large amounts of atropine sulfate are ingested for suicidal purpose, were also reported. The therapeutic blood atropine concentrations are 5–70 ng/mL; but its half-life is as short as 2–3 h.

**Case 1** [6]: a 71-year-old female parboiled and ate a plant in the evening, which had been grown in her garden; she had believed it to be the Jew's mallow. About 20 min after ingestion, paresthesia appeared in the hand and then extended to her whole body; she fell into the clouding of consciousness. She was brought to a nearby clinic by an ambulance car at about 10:00 p. m. A doctor at the clinic suspected atropine poisoning, because of her clouded consciousness, mydriasis, dry mouth and palpitations. From about 1:00 p. m. on the next day, gastrolavage was performed; her consciousness was recovered and general conditions improved. The same plant as that eaten by her was examined by a specialist and proved to be *Datura tatula*; the causative food for the poisoning could be identified.

**Case 2** [7]: a pharmacy college student (male) ingested about 1 g of atropine together with alcohol; he was sent to a hospital and survived. His blood atropine concentration was 130 ng/mL.

**Case 3** [7]: a 18-year-old male ingested atropine tablets (30 mg per tablet, but the number of the tablets is not known), and died. The atropine concentration in his whole blood was 200 ng/mL.

## Notes

- a) There are many toxic solanaceous plants in the world. Some examples except *Datura metel* are: *Scopolia japonica* native to Japan, *Hyoscyamine niger* (henbane) and *Atropa belladonna* (deadly nightshade) both native to Europe, *Duboisia myoporoides* (pituri) native to Australia, *Datura stramonium* (jimsonweed) native to India, *Datura (Brugmansia) suaveolens* (angel's trumpet), *Datura ferox* and *Datura stramonium*.
- b) Atropine means the racemic form of hyoscyamine. The tropane alkaloids being contained in *Datura metel* (jimsonweed) are mainly *l*-hyoscyamine and *l*-scopolamine together with trace amounts of *d*-hyoscyamine (▶ Fig. 6.3).
- c) The Extrelut granule might be contaminated by impurities upon packing. It is, therefore, desirable to well wash the granule with a solvent to be used for elution. When various elution solvents are to be used, the granule can be appreciably cleaned by washing with diethyl ether.
- d) Packed Extrelut columns are commercially available.
- e) The Milli Q water means the one, which had been passed through the Millipore filter (Millipore, Bedford, MA, USA) and widely used in laboratories. For a mobile phase for HPLC, the Milli Q water is used in place of distilled water.
- f) The mobile phase for HPLC should be prepared by degassing air dissolved in the liquid using aspiration under reduced pressure together with sonication. Since the pressure is reduced inside the container, a pressure-resistant glassware should be used. When the reduced pressure state is left for a long time, acetonitrile is evaporated from the mobile phase, resulting in the change of composition ratio of acetonitrile and phosphate buffer solution.
- g) The flow rate for the solid-phase extraction cartridge should equally be 1–2 mL/min for adsorption, washing and elution. When the flow rate is too slow upon washing, a part of the

target compound may be lost due to elution with the washing solution. Just after activation of the cartridge, it should not be dried. However, just before the final elution, the cartridge should be dried under reduced pressure. These manipulations should not be confused. Here, the most typical procedure is presented, but there are other procedures using different solvent systems.

- h) According to the kinds of columns to be used (manufacturers, type No., column diameter and column length), the turn of the drugs to be eluted and their retention times become different. When more residual silanol groups exist in a column, longer retention times of target compounds and more broadening of their peaks take place. To overcome these problems, the increase in the ratio of methanol or acetonitrile in a mobile phase or addition of 10–20 mM triethylamine as a counter ion may be useful to some extent.
- i) The washing of the cartridge at this step should be performed perfectly. If not, the final eluate becomes contaminated by protein impurities, which appear as insoluble particles upon its condensation; in such a case the filtration or centrifugation of the final extracts is required before injection into HPLC.

## References

- 1) Goto K, Endo Y, Mori C et al. (1996) A case of poisoning by *Datura metel* as a result of its mistaken ingestion for Jew's mallow. *Jpn J Toxicol* 9:355 (in Japanese)
- 2) Eckert M, Hinderling PH (1981) Atropine; a sensitive gas chromatography-mass spectrometry assay and pre-pharmacokinetic studies. *Agents Actions* 11:520–531
- 3) Unpublished result
- 4) Metcalfe RF (1981) A sensitive radioreceptor assay for atropine in plasma. *Biochem Pharmacol* 30:209–212
- 5) Namera A, Minoura K, Yashiki M et al. (2000) Chiral analysis of tropane alkaloids using CE/MS. *Jpn J Legal Med* 54:148 (in Japanese)
- 6) Kimura S (1995) Food poisoning by *Datura tatura*. *Jpn J Food Hyg* 36:663–664 (in Japanese)
- 7) Baselt RC, Cravey RH (1995) *Disposition of Toxic Drugs and Chemicals in Man*, 4th edn. Chemical Toxicology Institute, Foster City, CA, pp 63–65

## II.6.7 Oleander toxins

by Chiaki Fuke and Tomonori Arao

### Introduction

Oleander (*Nerium oleander* and *Nerium indicum*) is a relatively small evergreen tree of an Indian origin, and growing in Honshu, Shikoku, Kyushu and Okinawa islands in Japan. The plant contains cardiac glycosides in its leaves, stems and flowers and is known as one of poisonous plants; poisoning and fatal cases for domestic animals and humans due to ingestion of this plant were reported [1–6]. The main toxin of oleander is oleandrin.

Oleandrin can be measured using cross-reaction of an immunoassay kit for digoxin [1], TLC [2], HPLC [7, 8] and LC/MS [3, 6]. Oleandrin is thermolabile; it is difficult to analyze it by GC or GC/MS, because it gives 4 peaks due to decomposition.

In this chapter, a method for LC/MS analysis of oleandrin and its metabolite desacetyloleandrin [9] together with their related compounds, such as oleandrigenin and gitoxigenin, contained in human specimens, is presented.


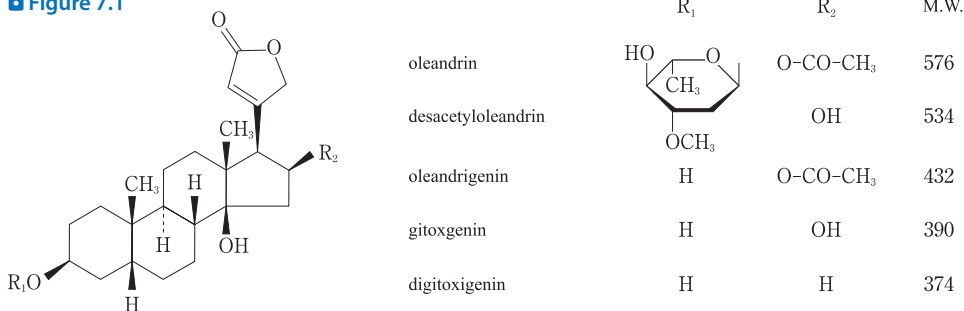
The structures and their molecular weights of oleandrin and its related compounds are shown in  Figure 7.1.

 Figure 7.1



Structures and molecular weights of oleandrin and its related compounds.

### Reagents and their preparation

- A 1-mg aliquot each of oleandrin, oleandrigenin, desacetyloleandrin<sup>a</sup>, gitoxigenin and digitoxigenin (Sigma, St. Louis, MO, USA) is dissolved in 10 mL acetonitrile (100 µg/mL) separately.
- A 0.1-mL volume of the above digitoxigenin solution is diluted with acetonitrile to 10 mL (1 µg/mL; internal standard, IS).

## HPLC conditions

Instrument: a Hitachi M-8000 type LC/3DQMS system; column: GH-C18 (III) (150 × 2.1 mm i.d., particle size 5 μm, Hitachi Ltd., Tokyo, Japan); column temperature: 40 °C; mobile phase: methanol/water (6:4, v/v); its flow rate: 0.2 mL/min.

## MS conditions

Ionization: sonic spray ionization (SSI)<sup>b</sup>; shield temperature: 250 °C; aperture-1 temperature: 150 °C; aperture-2 temperature: 120 °C; drift voltage: 70 V; ion detection mode: positive; microscan: 5 s; mass defect: 55/100 amu; scan range:  $m/z$  350–650; low mass cutoff:  $m/z$  120; accumulation time: 500 ms.

## MS/MS conditions<sup>c</sup>

Ion accumulation step: Ion accumulation mass range:  $m/z$  350–650; low mass cutoff:  $m/z$  120; ion accumulation time: 300 ms; ion accumulation voltage: 0 V.

Ion isolation step (MS-1): Isolation mass range:  $m/z$  595.48–602.77; low mass cutoff:  $m/z$  569.06; isolation time: 10 ms; isolation voltage: 0.175 V.

CID step (MS-2): CID mass range:  $m/z$  584.15–614.64; low mass cutoff:  $m/z$  190; CID time: 50 ms; CID voltage: 0.188 V.

## Procedure

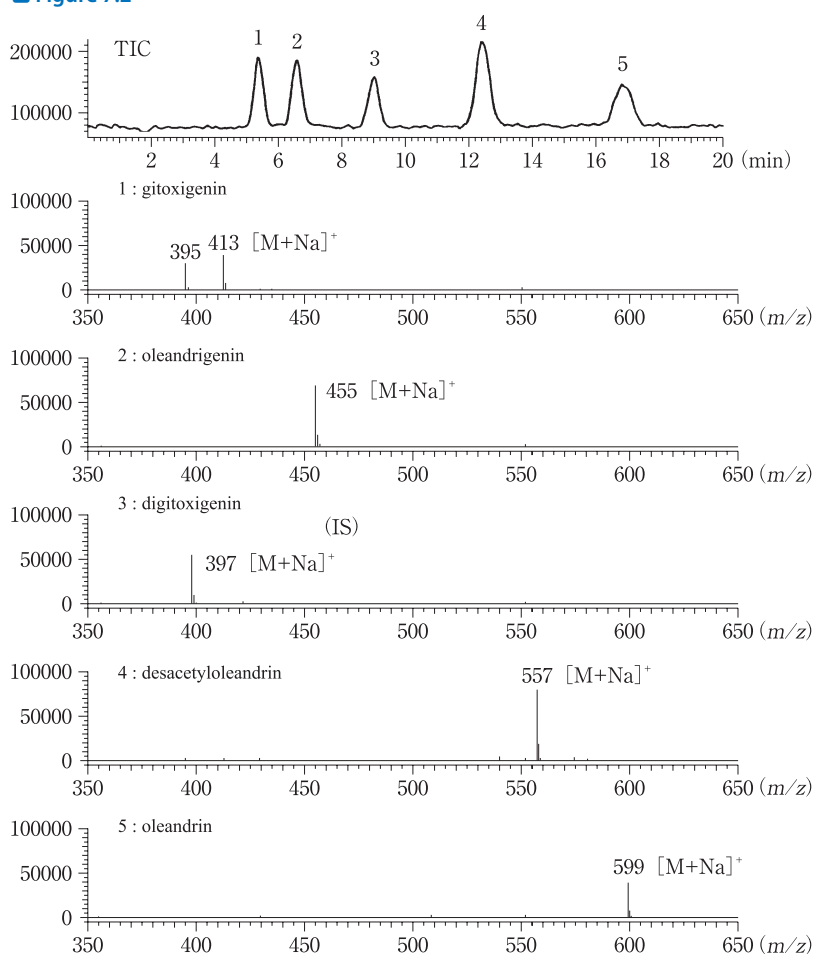
- i. A 1-mL volume of a specimen<sup>d</sup> is mixed with 4 mL distilled water and 100 μL IS solution.
- ii. The above mixture is extracted with 2 mL of 1-chlorobutane by shaking for 15 min.
- iii. It is centrifuged at 2,000 g for 5 min; the organic phase is transferred to a test tube.
- iv. The steps ii and iii are repeated twice.
- v. The organic phases are combined and evaporated to dryness under a stream of nitrogen with warming at 40 °C.
- vi. The residue is dissolved in 0.5 mL of 80 % methanol aqueous solution, and washed with 1 mL hexane twice<sup>e</sup>.
- vii. The 80 % methanol layer is evaporated to dryness under a stream of nitrogen with warming at 40 °C in a water bath.
- viii. The residue is dissolved in 100 μL mobile phase and centrifuged at 12,000 g for 5 min; a 5-μL aliquot of the supernatant solution is injected into LC/MS.
- ix. Each calibration curve is constructed using spiked specimens with digitoxigenin as IS. The concentration of an oleander toxin in a specimen is calculated using the calibration curve.

## Assessment of the method

Oleandrin is one of cardiac glycosides and exerts its effect at low concentrations. To detect its therapeutic concentrations, the detection limit by an analytical method should be in the nano-grams/mL order. When the present method was used in an oleander poisoning case, oleandrin could be detected from blood and cerebrospinal fluid (CSF), showing the applicability of the method.

▶ Figure 7.2 shows a TIC and mass spectra for the authentic standards of the five compounds. The spectra showed intense  $[M + Na]^+$  adduct ions at  $m/z$  599 for oleandrin,  $m/z$  557 for desacetyloleandrin,  $m/z$  455 for oleandrigenin and  $m/z$  397 for digitoxigenin used as IS; for gitoxigenin, both  $[M + Na]^+$  and  $[M + Na - H_2O]^+$  ions appeared at  $m/z$  413 and 395, respectively.

■ Figure 7.2

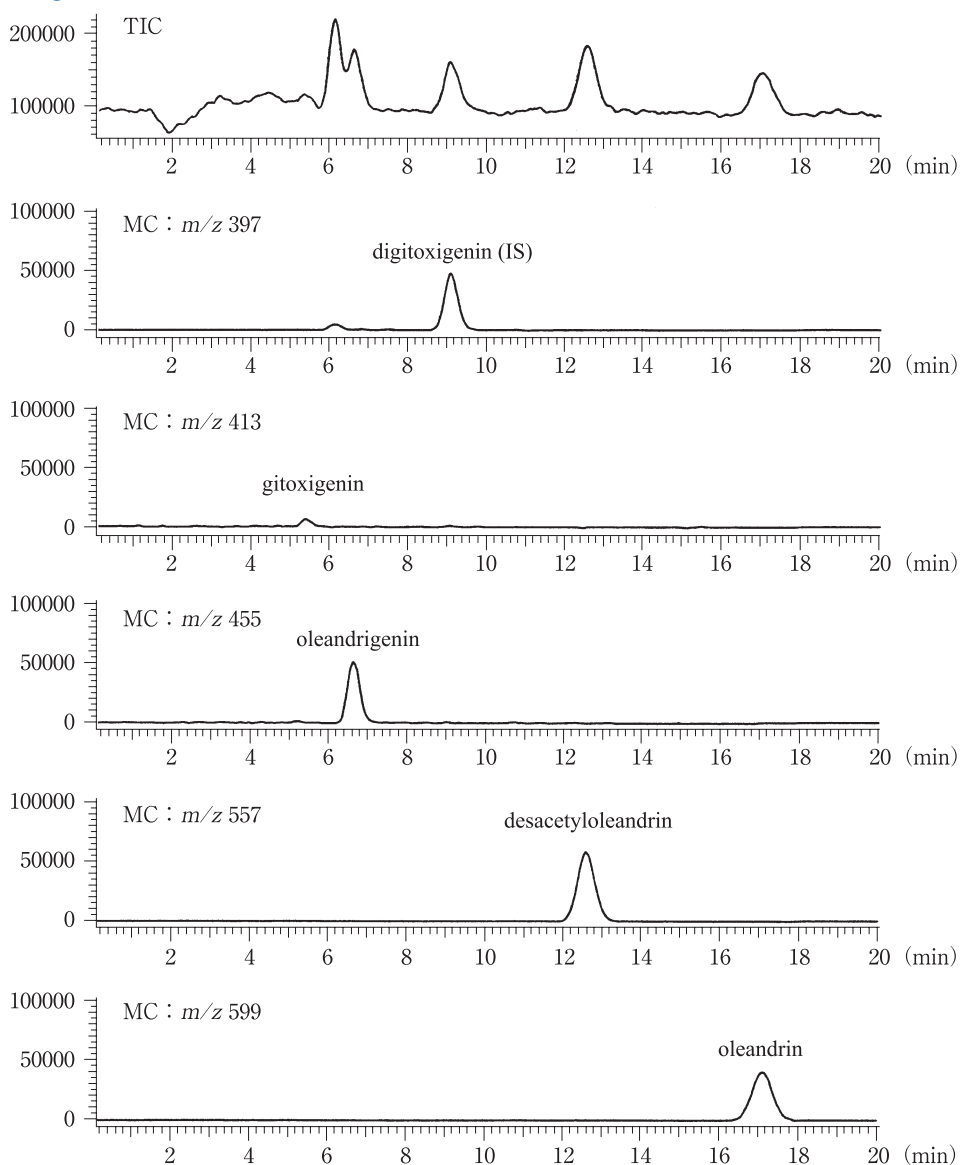


TIC and mass spectra for each peak obtained by LC/MS for the authentic compounds (1  $\mu\text{g/mL}$  each) of oleandrin and its related compounds.

► Figure 7.3 shows a TIC and mass chromatograms (MCs) for the above 5 compounds, which had been spiked into blood (0.1 µg/mL) and extracted from it. There were no interfering impurity peaks for each test compound in the chromatogram of blank blood.

The recovery rates for oleandrin, desacetyloleandrin and oleandrigenin were not lower than 70 %; but that for gitoxigenin was as low as about 20 %. There was good linearity in the

■ Figure 7.3



TIC and MCs obtained by LC/MS for an extract of blood, into which oleandrin and its related compounds had been spiked (0.1 µg/mL each).



range of 5–100 ng/mL for oleandrin, desacetyloleandrin and oleandrigenin. The detection limits from blood were 3 ng/mL for oleandrin, 2 ng/mL for desacetyloleandrin and oleandrigenin, and 30 ng/mL for gitoxigenin.

### Poisoning case, and toxic and fatal concentrations

A 49-year-old female boiled an oleander branch with leaves in water, and took a large amount of the extract solution; she underwent therapy, but died one day later. The blood and CSF specimens obtained at the postmortem inspection of the above victim were analyzed by the present method. The TIC and MCs obtained for the victim by LC/MS are shown in [▶ Figure 7.4](#). Oleandrin could be detected; but desacetyloleandrin, oleandrigenin and gitoxigenin could not. The peak at  $m/z$  599 observed in the MC was confirmed to be due to oleandrin by MS/MS analysis as shown in [▶ Figure 7.5](#). The concentration of oleandrin was 10 ng/mL for both blood and CSF.

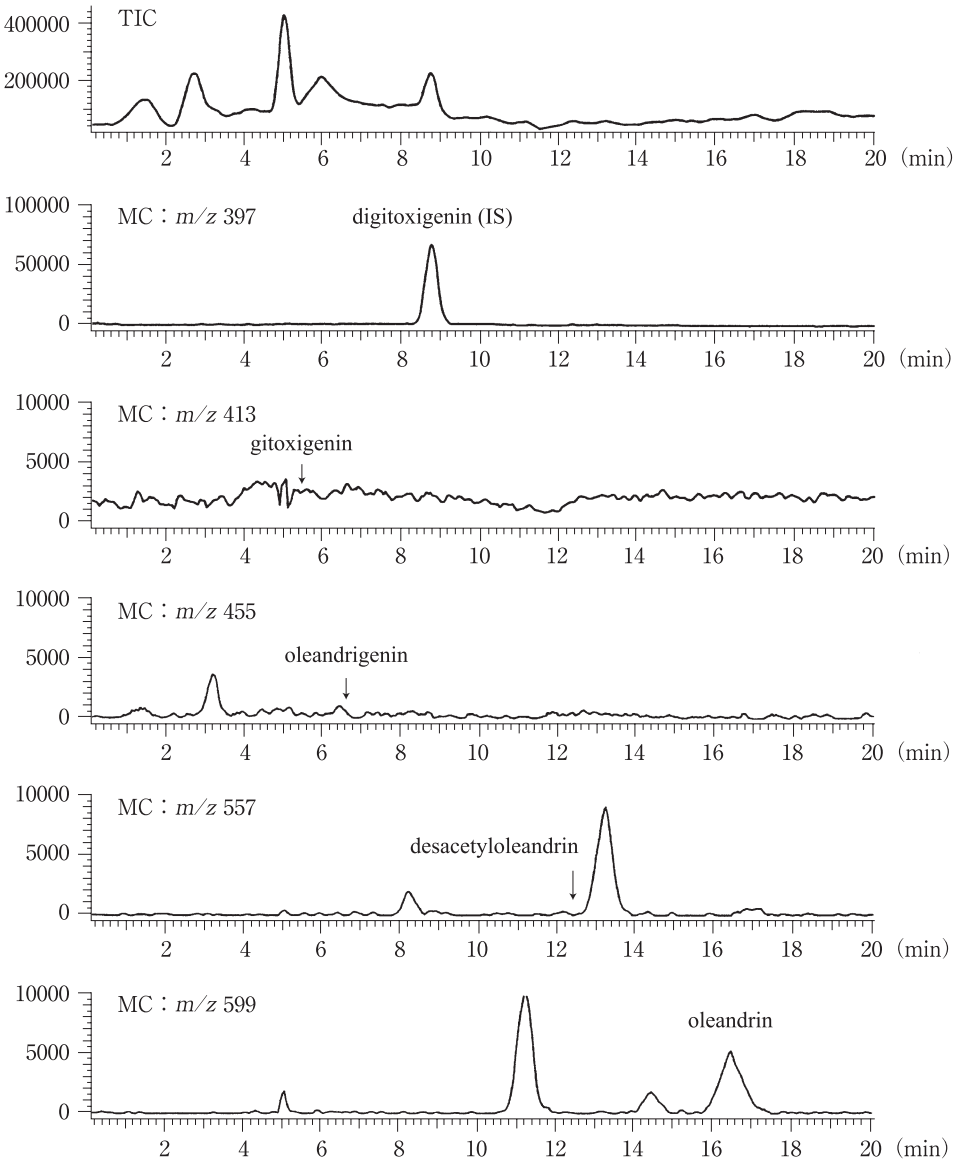
The blood or plasma concentrations in cases of poisoning by oleandrin, digoxin and digitoxin are shown in [▶ Table 7.1](#). There is another report dealing with LC/MS detection of oleandrin in an oleander poisoning case [6] except our case; there are also 2 reports dealing with the immunoassay detection of oleandrin using its cross-reaction [1, 4]; the immunoassay kit had been developed for measurements of digoxin, and thus the values of oleandrin in blood were expressed as the concentrations of digoxin (5.8 and 4.2 ng/mL). However, the digoxin immunoassay method does not give quantitative results for oleandrin; it seems useful only for tentative qualitative analysis, but is not reliable for its quantitation.

**Table 7.1**

**Concentrations of oleandrin, digoxin and digitoxin in blood or plasma of cardiac glycoside poisoning cases**

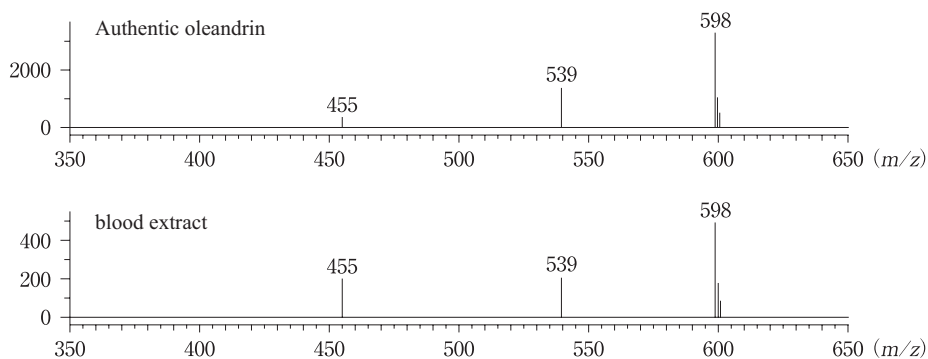
Compound	Concentration (ng/mL)	Specimen	Outcome	Ref.
oleandrin	1.1	blood	survived	[6]
	10	blood	dead	the present case
digoxin	7–24	plasma	dead	[10]
	22	blood	dead	[10]
	30	blood	dead	[10]
digitoxin	260	plasma	survived	[10]
	320	plasma	dead	[10]

■ **Figure 7.4**



TIC and MCs obtained by LC/MS for an extract of blood in a case of oleander poisoning.

Figure 7.5



MS/MS mass spectra of an extract of blood in a case of oleander poisoning and of the authentic oleandrin. Product ions were obtained from peaks detected by mass chromatography at  $m/z$  599.

## Notes

- Desacetyloleandrin was synthesized by deacetylation in anhydrous methanol with sodium methoxide as catalyst.
- Sonic spray ionization (SSI) is relatively similar to atmospheric pressure chemical ionization (APCI). The mobile phase is electrically neutral; but in a small region, especially around the surface layer of the solution, charge separation can occur. In SSI, nebulization is done so that the surface layer of the solution, in the region of charge separation, is stripped by fast nitrogen gas flow and electrically charged airborne droplets are created. The diameters of these electrically charged droplets shrink by vaporization of solvent molecules from the surface, and protonated molecular ions are formed in the gas phase. The interface does not require heating upon nebulizing; thus it is suitable for sensitive analysis of thermolabile compounds.
- The MS/MS conditions with 3-dimensional QMS for oleandrin are described here; the conditions are highly dependent on a compound to be analyzed. It is essential to optimize conditions for each compound.
- As specimens, blood, plasma and urine can be used.
- Such washing to remove compounds of low polarity is useful, especially when repeated analyses are required.

## References

- Osterloh J, Herold S, Pond S (1982) Oleander interference in the digoxin radioimmunoassay in a fatal ingestion. *JAMA* 247:1596–1597
- Blum LM, Rieders F (1987) Oleandrin distribution in a fatality from rectal and oral Nerium oleander extract administration. *J Anal Toxicol* 11:219–221
- Rule G, McLaughlin LG, Henion J (1993) A quest for oleandrin in decayed human tissue. *Anal Chem* 65:857–863
- Nakata M, Miyata S, Endo K et al. (1995) A fatal case of oleander poisoning. *J Okinawa Med Assoc* 34:97 (in Japanese)

- 5) Gupta A, Joshi P, Jortani SA et al. (1997) A case of nondigitalis cardiac glycoside toxicity. *Ther Drug Monit* 19:711–714
- 6) Tracqui A, Kintz P, Branche F et al. (1998) Confirmation of oleander poisoning by HPLC/ MS. *Int J Legal Med* 111:32–34
- 7) Tor ER, Holstege DM, Galey FD (1996) Determination of oleander glycosides in biological matrices by high-performance liquid chromatography. *J Agric Food Chem* 44:2716–2719
- 8) Namera A, Yashiki M, Okada K et al. (1997) Rapid quantitative analysis of oleandrin in human blood by high-performance liquid chromatography. *Jpn J Legal Med* 51:315–318
- 9) Takaesu H, Fuke C, Arao T et al. (1998) A study on the methods of verifying oleander poisoning through the analysis of biological materials. *Jpn J Forensic Toxicol* 16:136–137 (in Japanese with an English abstract)
- 10) Moffat AC, Jackson JV, Moss MS et al. (eds) (1986) *Clarke's Isolation and Identification of Drugs*, 2nd edn. The pharmaceutical Press, London, pp 541–544

## II.7.1 Simultaneous analysis of pesticides by GC/MS

by Shinji Kageyama and Makoto Ueki

### Introduction

Agricultural chemicals include not only pesticides for protecting plants, such as insecticides, germicides, herbicides and rodenticides, but also fertilizers and growth regulating substances being used in agricultural production and horticulture. In poisoning cases with agricultural chemicals, the causative poisons are largely the pesticides. There are many cases, in which the poisoning due to exposure to an organophosphorus pesticide is obvious with clinical symptoms [1]. However, there are more than 5,000 agricultural chemicals registered and commercially available in Japanese markets [2]; it is essential to identify a causative chemical to make the final clinical diagnosis in a poisoning-suspected case.


Since sensitive and simultaneous analysis of multiple compounds is possible using GC/MS, the method is being widely used for analysis of pesticides for environmental specimens, such as water and soil [3–6]. In this chapter, among main pesticides which had been reported causative for poisoning cases [7], more than 30 kinds of pesticides have been picked up from organophosphorus, organochlorine, carbamate and triazine pesticides, and a method for simultaneous analysis of many pesticides by GC/MS is presented. For alkyipyridinium and amino acid type herbicides, their analyses are described in other chapters.

### Reagents and their preparation

#### i. Reagents

- Pure *n*-hexane for organic trace analysis (Merck, Darmstadt, Germany and other manufacturers) is directly used or redistilled before use according to need.
- Many of the authentic standards of pesticides can be purchased from Supelco, Bellefonte, PA, USA; but fenobucarb, salithion, thiometon, ethylthiomethon, propanil, cyanofenphos and isoxathion cannot be obtained from the above manufacturer, but can be obtained from Wako Pure Chemical Industries, Ltd., Osaka, Japan. As internal standard (IS), fenitrothion-*d*<sub>6</sub> was obtained from (Hayashi Pure Chemical Ind., Ltd, Osaka, Japan). Other common chemicals used were of the highest purity commercially available.

#### ii. Preparation

- Standard solutions for each pesticide are prepared by dissolving each compound in ethanol (1 mg/mL); each retention times were determined by GC. The 35 compounds were divided into 3 groups, where each peak did not overlap or interfere with each other as shown in  Figure 1.1. Such 3 mixture standard solutions with known compounds at 1 mg/mL each are also prepared.

- A 10-mL volume of 12 M hydrochloric acid solution is carefully diluted with purified water to prepare 100 mL solution.
- To 2-mL volume each of blank whole blood or urine, which had been obtained from healthy and unexposed subjects, a 100  $\mu$ L of each standard solution (1 mg/mL) is added to be used as a calibrator<sup>a</sup>.


## Analytical conditions

Instrument: HP-6890 type GC/HP-5973 type MS equipped with an HP-6890 type autosampler (all from Agilent Technologies, Palo Alto, CA, USA).

GCcolumn: Ultra-2(25 m  $\times$  0.2 mm i. d., filmthickness 0.33  $\mu$ m, 5 %-phenylmethylsilicone, Agilent Technologies).

Evaporator: REN-1EN type (Asahi Technoglass, Chiba, Japan).

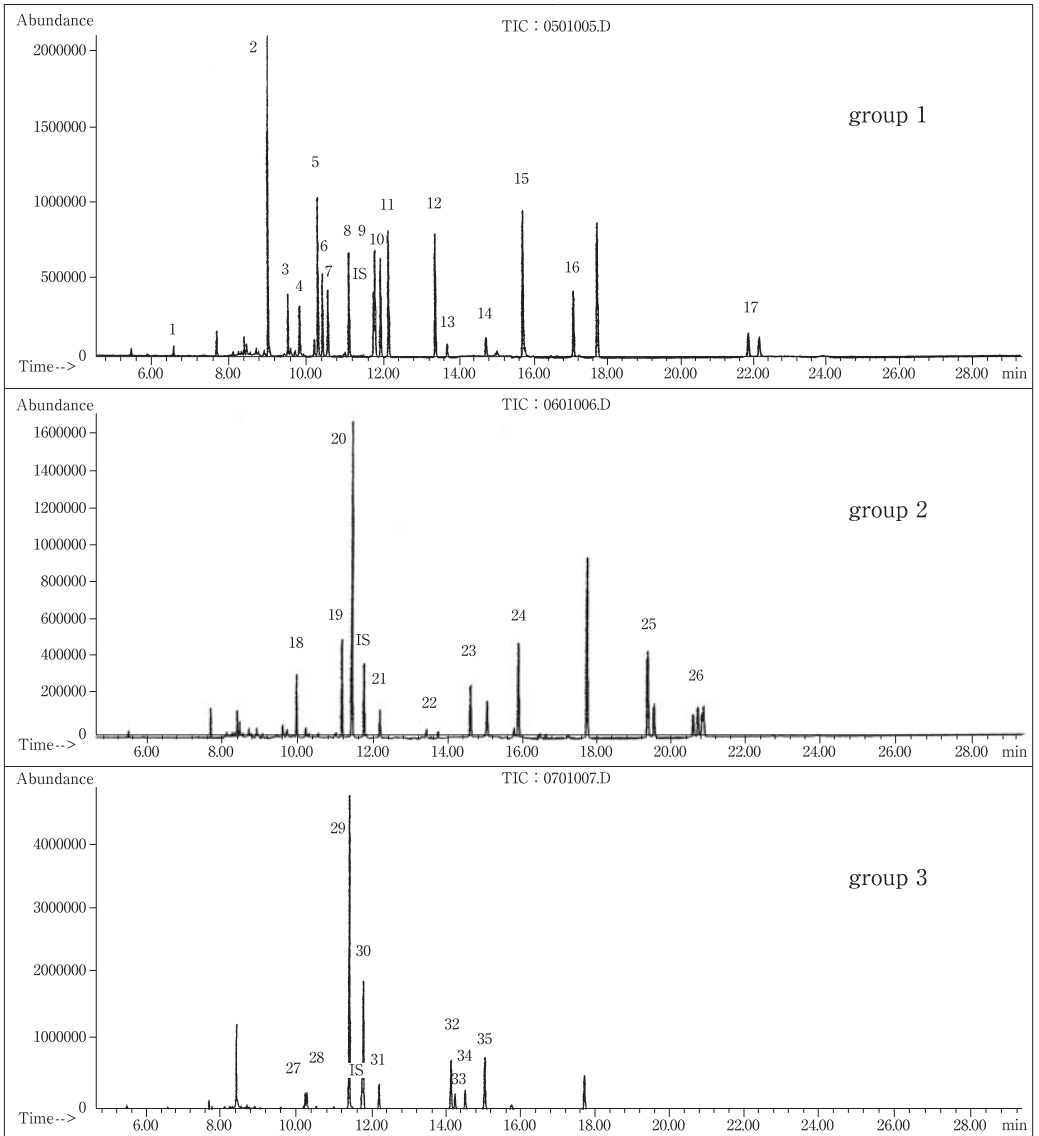
Vials for sampling are those usable for the autosampler. Before analysis, impurities arising from the vials and caps should be checked. Other tools are common ones commercially available.

GC/MS conditions; column (oven) temperature: 50  $^{\circ}$ C (1 min)  $\rightarrow$  20  $^{\circ}$ C/min  $\rightarrow$  200  $^{\circ}$ C  $\rightarrow$  7  $^{\circ}$ C/min  $\rightarrow$  290  $^{\circ}$ C (8 min); analysis time: 29.4 min; injection mode: splitless; injection temperature: 250  $^{\circ}$ C; injection pressure: about 17 psi (helium pressure at 50  $^{\circ}$ C of oven temperature); septum purge flow rate: 11.0 mL/min; purge time: 1.0 min; total flow rate: 14.3 mL/min; column flow rate: 1.0 mL/min (constant flow-rate mode); interface temperature: 150  $^{\circ}$ C; MS ionization mode: EI; electron energy: 70 eV; scan range:  $m/z$  40–550; dwell time of SIM measurements: 10 s; SIM ions to be used: listed in  Table 1.1.

## Procedure

- i. A 2-mL volume of whole blood or urine<sup>b</sup> is mixed well with 3 mL of purified water.
- ii. A 100- $\mu$ L volume of IS (fenitrothion- $d_6$ ) solution is added to the above mixture and mixed well.
- iii. The pH of the mixture is adjusted to 3.5 by adding 1.2 M hydrochloric acid solution.
- iv. A 8-mL volume of *n*-hexane is mixed with the above mixture and shaken for 10 min for extraction<sup>c</sup>.
- v. It is centrifuged at 1,000 g for 10 min.
- vi. The *n*-hexane layer is carefully transferred to a glass vial, and evaporated to dryness under reduced pressure<sup>d</sup>.
- vii. The residue is dissolved in 100  $\mu$ L *n*-hexane.
- viii. A 2- $\mu$ L aliquot of it is subjected to GC/MS analysis<sup>e</sup>.
- ix. By comparison with the data obtained from a spiked specimen, the identification<sup>f</sup> and semiquantitation of a pesticide in a test specimen are carried out.

Figure 1.1



TICs obtained by GC/MS for extracts of urine, into which pesticides had been spiked. 1: DDVP; 2: fenobucarb; 3: salithion; 4: thiometon; 5: cyanophos; 6: diazinon; 7: ethylthiomethon; 8: propanil; 9: fenitrothion; 10: malathion; 11: fenthion; 12: methidathion; 13: endosulfan; 14: endrin; 15: cyanofenphos; 16: EPN; 17: fenvalerate; 18: simazine; 19: metribuzin; 20: alachlor; 21: aldrin; 22: chlordene; 23: nitrofen; 24: *pp'*-DDT; 25: permethrin; 26: cypermethrin; 27: pentachlorophenol; 28:  $\gamma$ -BHC; 29: carbaryl; 30: pirimiphos-methyl; 31: parathion; 32: *pp'*-DDE; 33: dieldrin; 34: isoxathion; 35: *pp'*-DDD. Multiple peaks appear for chlordene (peak 22), cypermethrin (peak 26) and permethrin (peak 25), because of the presence of their isomers. Each specimen was spiked urine, to which each pesticide at a 50  $\mu\text{g}/\text{mL}$  concentration had been added.

■ **Table 1.1**


**SIM ions to be used for simultaneous analysis of pesticides by GC/MS**

Target compound	Relative retention time*	Monitor ions ( <i>m/z</i> )		
From 4.50 min				
Methomyl	0.45	58	105	88
DDVP	0.57	185	109	187
From 8.80 min				
fenobucarb	0.77	150	121	207
salithion	0.81	216	153	201
thiometon	0.84	125	88	158
simazine	0.85	201	173	186
From 10.12 min				
pentachlorophenol	0.87	266	268	165
$\gamma$ -BHC	0.88	181	219	221
cyanophos	0.88	243	109	125
diazinon	0.89	304	137	179
ethylthiomethon	0.90	88	186	274
From 10.84 min				
propanil	0.94	163	161	217
metribuzin	0.95	198	214	144
carbaryl	0.97	144	115	201
alachlor	0.97	160	188	269
From 11.58 min				
fenitrothion- <i>d</i> <sub>6</sub> (IS)	1.00	283	266	
pirimiphos-methyl	1.02	290	305	276
fenitrothion	1.00	277	125	260
malathion	1.02	173	125	285
fenthion	1.03	278	109	125
aldrin	1.04	263	66	364
parathion	1.04	291	109	137
From 12.79 min				
methidathion	1.14	145	85	302
chlordene	1.14	373	375	377
chlordene- <i>trans</i>	1.15	373	375	377
chlordene- <i>cis</i>	1.17	373	375	410
endosulfan	1.17	339	241	341
From 13.91 min				
<i>p, p'</i> -DDE	1.20	246	316	318
dieldrin	1.21	79	380	108
isoxathion	1.24	313	177	208
nitrofen	1.24	283	285	202
endrin	1.25	263	265	81
<i>p, p'</i> -DDD	1.28	235	237	165
From 15.38 min				
cyanofenphos	1.34	157	185	303
<i>p, p'</i> -DDT	1.35	235	237	354
EPN	1.45	157	185	169
permethrin	1.67	183	163	165
cypermethrin	1.85	163	165	209
fenvalerate	2.00	167	419	225

\* Relative retention time: those when the retention time of IS was taken as 1.00.




## Assessment and some comments on the method

TICs for the extracts of 2 mL urine, into which 100 µg each of 35 kinds of pesticides had been spiked, are shown in  *Figure 1.1*. The chromatograms of the 3 groups showed no interference of the test peaks by impurities of urine.

The simultaneous analysis is aimed at screening of compounds in a wide range; the conditions should be set according to an average property of many analytes. Therefore, satisfactory recoveries cannot be obtained for all compounds. By this method, the recoveries of the pesticides from the spiked urine specimens (41–77 ng/mL) were 68–100 % for organophosphorus pesticides (except DDVP), benzoepine, fenobucarb, alachlor, cypermethrin and dieldrin; those from blood specimens were as satisfactory as 68–113 % for all organophosphorus pesticides, fenobucarb, nitrofen and alchlor. The recoveries of DDVP, chlordane, aldrin, DDT, DDE, permethrin, cypermethrin, fenvalerate, metribuzin, simazine and propanil were 42–63 % from urine and only 8–32 % from blood; for quantitation of these pesticides, the recovery rates should be improved. Methomyl cannot be detected after addition of several ten nanograms to blank specimens; but in actual cases, its high concentrations are frequently detected. Therefore, at the first step, a causative compound is identified by screening under the general analytical conditions. At the second step, the extraction procedure is optimized for each compound to achieve accurate quantitation. In many cases, after suitable changes in an extraction solvent and properties of an aqueous phase, it is not necessary to change instrumental conditions. As mentioned above, the recovery of each compound is different according to a specimen matrix; upon quantitation, it is desirable to construct a calibration curve using blank specimens of the same matrix, into which various amounts of a target compound are spiked.

For pesticides with good recoveries, the coefficients of variation were 1.6–9.6 % for urine and 1.3–11.3 % for blood ( $n = 10$ ); for those with low recoveries, the values were 3.2–18.5 %.

By liquid-liquid extraction with *n*-hexane under acidic conditions, the lipid components in blood are also extracted and cause impurity peaks in TICs. Even in such conditions, clean peaks of target compounds can be obtained by mass chromatography using monitor ions listed in  *Table 1.1*.

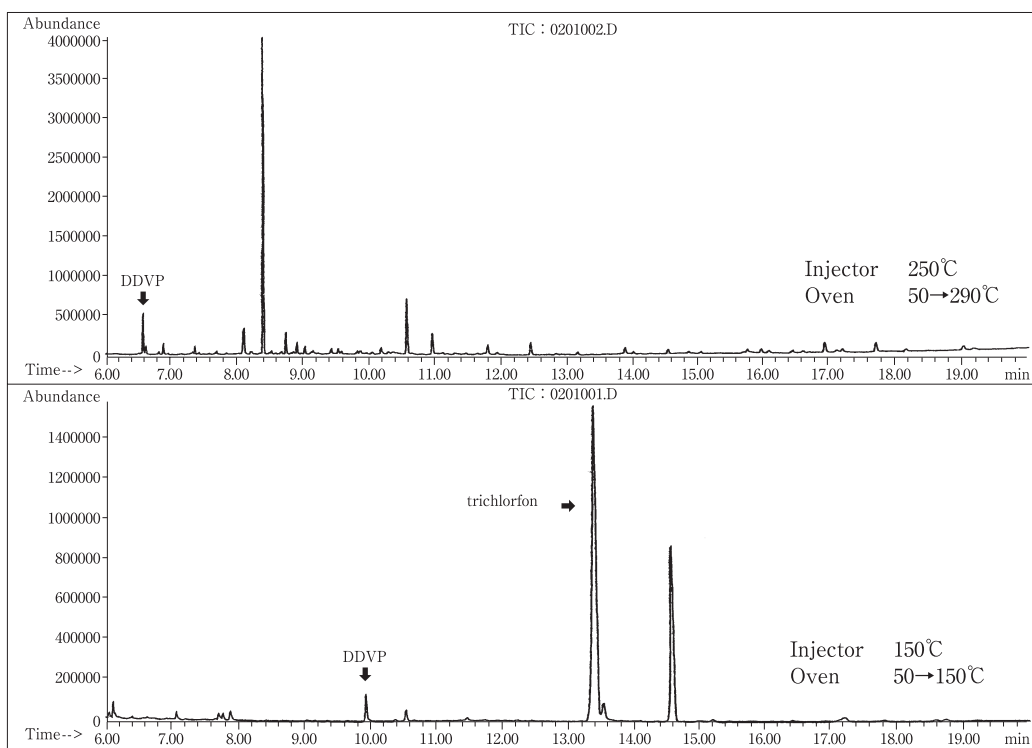
Blood and urine specimens, into which the authentic pesticides had been spiked, were stored at  $-20 \pm 5$  °C and  $4 \pm 3$  °C for 1, 2, 3, 4, 9, 10, 11, 12, 13 and 14 days to test the stability of the pesticides during storage. Most pesticides except DDVP were stable in a frozen state; their coefficients of inter-day variation were as good as 5–10 %. The coefficients of inter-day variation for DDVP were 24 % for urine and 49.3 % for blood; the poor reproducibility found for DDVP is not due to the analytical method, but due to its unstableness during storage. Such unstableness becomes more marked during storage under refrigeration; after storage only for several days, DDVP became undetectable in some specimens. Under refrigerated conditions, most pesticides showed their 10–20 % loss. Upon analysis, an adequate storage of specimens (in a refrigerated or frozen state) is necessary for each compound. For compounds with poor stability, their standard solutions should be prepared just before use to be spiked to blank specimens for quantitative analysis.

The detection limits are different in different pesticides; they were 1–64 ng/mL for blood specimens and 1–254 ng/mL for urine specimens. Therefore the present method is sensitive enough to detect and identify causative pesticides in poisoning cases. The upper limits for linearity of each pesticide are about several hundred nanograms/mL. In actual cases, very high concentrations of pesticides are occasionally encountered; in such cases, the amount of a specimen is reduced or diluted to obtain quantitative results.

By this method, 2 isomers for permethrin, fenvalerate and chlordene, and 4 isomers for cypermethrin could be separated. Usually, for qualitative analysis, the scan mode is employed; for quantitation with high sensitivity, the SIM mode is used. When scan measurements are made in the range of  $m/z$  50–550, the mass spectrum obtained from an unknown peak can be compared with that included in a public library by computer research; this may enable the identification of a metabolite or a decomposition product of a pesticide, and thus may give a useful information for analysis of a causative compound in a poisoning case.

Trichlorfon is one of the thermolabile pesticides; under the present GC conditions (injector temperature 250 °C and the maximal oven temperature 290 °C), trichlorfon can be converted to DDVP or decomposed to some products. In such a case, discrimination between DDVP and trichlorfon can be achieved by lowering the injection and maximal oven temperatures down to about 150 °C (▶ Figure 1.2).

■ Figure 1.2



Changes in TICs obtained by GC/MS according to different injection and oven temperatures for detection of trichlorfon. A 1- $\mu$ L aliquot of the standard trichlorfon solution (10  $\mu$ g/mL) was injected. The conditions for the upper panel were: injection temperature, 250 °C; oven temperature, 50 °C  $\rightarrow$  290 °C; those for the lower panel: injection temperature, 150 °C; oven temperature, 50 °C  $\rightarrow$  150 °C. At 250 °C of injection temperature, trichlorfon was decomposed completely; while at 150 °C trichlorfon appeared as an intense peak. DDVP appeared as a decomposition product under both conditions.

When pesticides are incorporated into human bodies, they undergo various metabolisms; the metabolites are usually very important to estimate a causative poison. Organophosphorus pesticides are usually oxidized by an oxidase in the liver to convert the P = S group into the P = O one. The conversions of malathion into malaoxon and of parathion into paraoxon are well known. Organochlorine pesticides are also oxidized enzymatically; aldrin and DDT are converted into dieldrin and DDE, respectively [8]. Carbaryl and many of organophosphorus pesticides are metabolized into phenolic compounds by acetylcholinesterase; the former compound is known to yield naphthol [9].

In the period from July, 1999 to May, 2000, this method was applied to 304 cases, in which pesticide poisonings had been suspected. The numbers of positive results were: sumithion, 78; malathion, 35; DDVP, 15; propanil, 12; methomyl, 8; carbaryl, 7; EPN, 6; fenthion, 6; isoxathion, 4; pirimiphos-methyl, 4; methidathion, 3; permethrin, 2; fenvalerate, 1; and parathion, 1. Not less than 2 kinds of pesticides were detected from 43 cases. Methomyl was detected in a case, in which paraquat poisoning had been suspected; a high level of sumithion was detected from urine in a case, in which chlorfenapyr ingestion had been suspected. The analytical results were sometimes different from ones, which had been expected on the basis of early informations. For the final identification of a causative poison, the present screening method by GC/MS for a wide range of pesticides is very useful.

## Notes

- a) This is a semiquantitative method using one point standard. The tentative concentration of a pesticide in a specimen is calculated as follows:  

$$\text{Concentration of a pesticide in a specimen} = (\text{calibrator concentration}) \times (\text{peak area obtained from a specimen} \div \text{peak area of IS added to a specimen}) \times (\text{peak area of IS added to the calibrator solution} \div \text{peak area of the calibrator}).$$
- b) Stomach contents can be treated in the same way. For accurate quantitation, a calibration curve is constructed by adding various amounts of a test compound to the blank specimens. The addition tests can be also used by adding a known amount of a test compound to a part of a test specimen; the peak area difference between added and non-added specimens can be used for calculation of the concentration of the test compound in the non-added specimen.
- c) Since emulsion formation easily takes place upon extraction, the shaking should not be vigorous, but gentle.
- d) Upon evaporation to dryness, excessive drying causing sublimation should be avoided. Especially for DDVP, care should be taken for its evaporation, because DDVP is relatively volatile, causing unstableness of its recovery rate.
- e) To find out false-positive results caused by endogenous compounds or contamination from experimental environments, it is desirable to analyze distilled water and blank specimens obtained from unexposed and healthy subjects simultaneously. When a high concentration of a test compound is contained in a specimen, care should be taken against the carry-over of the compound. In such a case, a blank organic solvent such as *n*-hexane should be injected at high injection and oven temperatures for washing before the next analysis.
- f) A guide for identification method by GC/MS: in the SIM mode, three main peaks are selected. Relative ion intensities of the 3 peaks are compared between a test specimen and

the authentic compound; their profile of the test peaks should be similar to that for the authentic compound and their relative similarity should be in the range of 80–120 %. It is also essential that there is no overlapping impurity peaks in a blank specimen. The shift of retention time of the test peak as compared with that of the authentic peak should be within  $\pm 1$  %. All the above conditions are fulfilled, the presence of the compound in a test specimen can be judged positive. When measurements are made in the scan mode, the identification is much easier; with almost the same mass spectra and retention times, the compound of the test peak can be judged identical to the authentic one; however, when interference by various peaks due to a different compound or a peak at a mass number larger than the molecular weight appears in the mass spectrum, the identity of the compound becomes questionable.

## References

- 1) Uemura T, Goto R (eds) (1999) *Rapid Analytical Methods for Poisons Being Mixed with Foods and Poisoning Symptoms in Humans*. Science Forum, Tokyo, pp 15–53 (in Japanese)
- 2) National Pesticide Cooperative Society (ed) (1999) *Guidebook for Safe and Right Use of Pesticides*, 1999 edn. Ueda Word Process Project, Tokyo, p 21 (in Japanese)
- 3) Grasso P, Benfenati E (1998) Deuterated internal standards for gas chromatographic-mass spectrometric analysis of polar organophosphorus pesticides in water samples. *J Chromatogr A* 822:91–99
- 4) Fukushima M (1999) Analytical methods of pesticides. In: *Proceedings of the 24th Meeting of Japanese Society of Environmental Chemistry*. Japanese Society of Analytical Chemistry, Ibaragi, pp 30–45 (in Japanese)
- 5) Mogami K (1999) Analytical methods of organochlorine compounds. In: *Proceedings of the 24th Meeting of Japanese Society of Environmental Chemistry*. Japanese Society of Analytical Chemistry, Ibaragi, pp 58–86 (in Japanese)
- 6) Yamaguchi S, Eto S, Eguchi M et al. (1997) Simultaneous analysis of residual pesticides in crops by gas chromatography/mass spectrometry in the scan mode. *Bunseki Kagaku* 46:905–914 (in Japanese with an English abstract)
- 7) National Research Institute of Police Science (ed) (1990) *Annual Case Reports of Drug and Toxic Poisoning in Japan*, No. 33. National Police Agency, Tokyo, pp 32–102 (in Japanese)
- 8) Pharmaceutical Society of Japan (ed) (1982) *Standard Methods of Chemical Analysis in Poisoning*. With Commentary. 2nd edn. Nanzando, Tokyo, pp 272–307 (in Japanese)
- 9) Tu AT (1999) *Principle of Toxicology – Science of Poisons*. Jiho Inc., Tokyo, pp 15–24 (in Japanese)

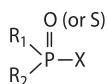
## 11.7.2 Organophosphorus pesticides

by Masakatsu Sakata

### Introduction

Organophosphorus pesticides (organophosphate pesticides) are being most widely used as insecticides, and thus cause poisoning cases frequently. The organophosphorus pesticides at the early stage, such as parathion and TEPP, had powerful insecticidal effects and high toxicity for both humans and beasts, and caused poisoning accidents during spraying. Although many less toxic organophosphorus pesticides were then developed, the resistance to the pesticides was acquired by insects during their repeated use, resulting in less effectiveness of the pesticides. Therefore, the development of new pesticides has been being required. Now, about 40 kinds of organophosphorus pesticides are being commercially available in Japan. They are being controlled by the Poisonous and Deleterious Substances Control Law of Japan. Various types of pesticides with various degrees of toxicity are available; they are classified into poisonous, deleterious and common substances. Even with the common substances, such as malathion and fenitrothion, the ingestion of their large amounts for suicidal purpose causes fatalities.

The fundamental structure of organophosphorus pesticides is:



The pesticides are also structurally classified according to an element bound with the phosphorus into the phosphate type, thiono type, thiol type and dithiol type. Many of  $\text{R}_1$  and  $\text{R}_2$  are dimethoxy or diethoxy groups. To cope with resistant insects, the alkyl moieties of  $\text{R}_1$  and  $\text{R}_2$  groups were replaced by unsymmetrical propyl and ethyl groups, respectively, in some pesticides. As X structures, alkyl, alkoxy, alkylthio, aryl, heterocyclic, aryloxy and arylthio groups can be mentioned.

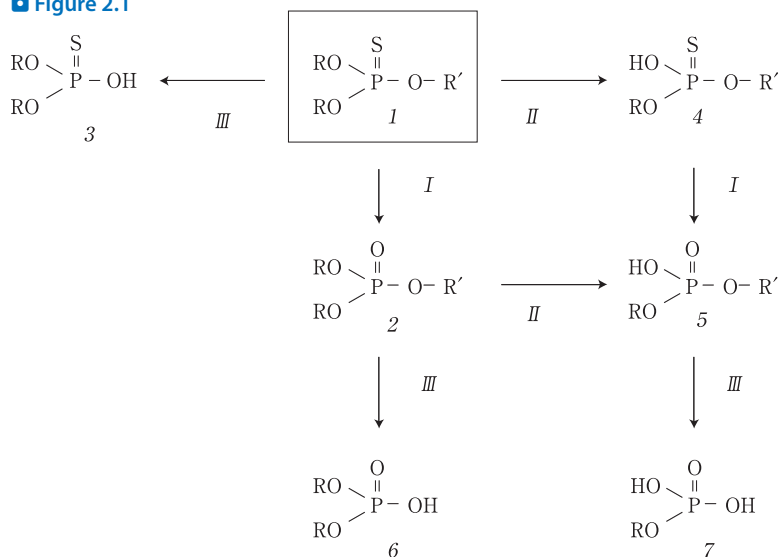
➤ *Figure 2.1* shows the metabolic pathways of a common thiono type organophosphorus pesticide having dialkoxy groups ( $\text{R}_1$  and  $\text{R}_2$ ).

Organophosphorus pesticides undergo both enhancement of their toxicity and detoxification at the same time in mammals. The thiono type pesticide (1) shows almost no inhibitory action on cholinesterase in its unchanged form; it is metabolized by cytochrome P450 (I) into the phosphate type (2), which reveals toxicity. Therefore the phosphate type pesticide can inhibit cholinesterase without any metabolic activation.

As detoxification, dealkylating reaction by enzyme II can be mentioned. The P450 and glutathion are being involved in the enzyme II; the dealkylated form thus produced does not inhibit acetylcholinesterase.

The esterases III, which hydrolyze organophosphorus pesticides, as shown in ➤ *Fig. 2.1*, are phosphotriester hydrolases. There are many different enzymes responsible for such reactions; they are called “paraoxonase, A-esterase, phosphatase or aryylesterase”. Carboxyesterase is

■ **Figure 2.1**



**Typical metabolic pathways for organophosphorus pesticides in mammals.**

related with the metabolism of malathion, which has carboxylic acid esters in its leaving groups.

The metabolisms of organophosphorus pesticides are usually rapid. It is, therefore, necessary to analyze the metabolite(s) together with an unchanged organophosphorus pesticide to assess its poisoning correctly.

As analytical instruments for organophosphorus pesticides, GC and HPLC are being used. Especially GC with detectors specific for phosphorus or sulfur is useful, because of its high sensitivity and specificity. The metabolites are usually highly polar, and thus need derivatizations for GC detection.

## GC and GC/MS analysis

### Materials and preparation

- Standard compounds: highly pure organophosphorus compounds can be obtained from Supelco (Bellefonte, PA, USA) and Wako Pure Chemical Industries, Ltd. (Osaka, Japan).
- Standard solutions: each standard compound is dissolved in acetone to prepare 1–10 µg/mL solutions; these solutions can be further diluted according to needs. As an internal standard (IS), an organophosphorus compound, which does not overlap the peaks of a target compound and impurities, is chosen in preliminary experiments.
- Solid-phase extraction cartridges: Sep-Pak C<sub>18</sub> cartridges (Waters, Milford, MA, USA).
- Methylating reagent: Diazald® (*N*-methyl-*N*-nitroso-*p*-toluenesulfonamide) (Sigma-Aldrich, St. Louis, MO, USA); the distillation device attached with a 25-mL reservoir is constructed

inside a draft; the reservoir is immersed in an ice bath. A 0.4-g amount of KOH is dissolved in 10 mL of ethanol/water (9:1, v/v). A 2.14-g amount of *N*-methyl-*N*-nitroso-*p*-toluenesulfonamide is dissolved in 30 mL diethyl ether (0.01 M) and stored in a 250-mL volume round-bottomed flask under ice-cooling; after 10 mL of the above KOH-ethanol solution is added to the above solution and mixed, the flask containing the mixture is connected with the distillation device and left at room temperature for several minutes. Then, the flask is warmed at 35–40 °C for distillation until the color of the solution in it disappears; this procedure results in collecting about 12 mL diazomethane-diethyl ether solution. If all solution is stored in an airtight container, there is a possibility of its explosion due to generation of N<sub>2</sub> gas. The solution can be stored in a flask with a drying tube at –20 °C. Another method is its storage at –20 °C after putting 2-mL aliquot each in 10-mL volume vials to be capped airtightly. While the ether solution is yellow, it can be used for methylation.

- Organic solvents: they should be of the ultra-pure grade.

## Analytical conditions

GC: an instrument equipped with a flame photometric detector (FPD, with an interference filter for phosphorus) or a flame thermionic detector (FTD, the same as the nitrogen-phosphorus detector, NPD)<sup>a</sup>

GC/MS; qualitative analysis: total ion chromatograms (TICs) or mass chromatograms; quantitative analysis: selected ion monitoring (SIM) (▶ [Table 2.1](#))

Capillary columns: DB-1, DB-5 and DB-210 (J&W Scientific, Folsom, CA, USA); columns with various degrees of polarity should be tested for each pesticide to obtain good separation from other peaks without tailing.

▶ **Table 2.1**

**Mass spectra of organophosphorus pesticides commercially available in Japan**

Compound	M.W.	El fragment ions	Compound	M.W.	El fragment ions
acephate	183	136, 94, 95, 96, 79	malathion	330	125, 93, 127, 173, 158, 99
chlorofenaviphos	358	267, 269, 323, 81, 325	methidathion	302	145, 85, 93, 125, 146
chlorpyrifos	349	197, 199, 97, 314, 125	methyl parathion	263	109, 125, 263
chlorpyrifos-methyl	322	125, 286, 79, 63	monocrotophos	223	127, 67, 97, 109, 192
cyanophos	243	109, 125, 79, 243, 63	naled	381	109, 145, 79, 185, 147
diazinon	304	179, 137, 152, 304, 93, 153	parathion	291	97, 109, 291, 139, 137
dichlorvos (DDVP)	220	109, 185, 79, 220, 145	phenthoate	320	274, 121, 93, 125, 79
dimethoate	229	87, 125, 93, 58, 79, 229	phosalone	367	182, 121, 184, 154, 367, 97
disulfoton	174	88, 89, 60, 61, 97	phosmet	317	160, 61, 76, 77, 133
EPN	323	157, 169, 185, 323	pirimiphos-methyl	305	290, 276, 305, 125, 233
ethion	384	231, 153, 97, 125, 121	profenofos	374	97, 208, 139, 338, 295
fenitrothion	277	109, 125, 127, 277, 260	prothiofos	345	113, 267, 309, 262, 63
fenthion	278	278, 125, 109, 153, 168	salithion	216	216, 183, 153, 78
isofenphos	345	58, 213, 255, 185, 96	trichlorfon	256	79, 109, 72, 93, 221
isoxathion	313	105, 177, 313, 159, 77	vamidothion	287	87, 109, 145, 58, 79, 142

Column temperature: the initial temperature, 60–80 °C; temperature program, 10 °C/min; the final temperature, the maximum permissible temperature; preliminary experiments are made under these conditions to find optimal conditions for each compound.

Injection temperature: the temperature is optimized in the range of 180–260 °C, because organophosphorus pesticides are relatively thermolabile.

## Procedures

### i. Plasma and urine

#### A. Solid-phase extraction

- i. Each Sep-Pak C<sub>18</sub> cartridge (Waters, Milford, MA, USA) is washed with 10 mL of chloroform/isopropanol (9:1), 10 mL acetonitrile, 10 mL of acetonitrile/distilled water (1:1) and 10 mL distilled water.
- ii. A 1-mL volume of plasma or urine is diluted 10-fold with distilled water, and mixed with IS<sup>b</sup>; the mixture solution is poured into the above pretreated cartridge at a flow rate of 5 mL/min to trap target compounds including IS in the cartridge.
- iii. The cartridge is washed with 10 mL distilled water, followed by the elution of the target compounds with 3 mL of chloroform/isopropanol (9:1). The eluate is collected in a glass vial. A small amount of aqueous upper layer is removed with a Pasteur pipette, and the organic layer is evaporated to dryness under a stream of nitrogen. The residue is dissolved in 100 µL acetonitrile, and a 1–2 µL aliquot of it is injected into GC(/MS) [1].

#### B Liquid-liquid extraction

- i. A 1-mL volume of plasma or urine, 2 mL distilled water and IS are placed in a 10-mL volume glass centrifuge tube with a ground-in stopper; the pH of the mixture is adjusted to 2 with 1 M HCl solution.
- ii. After adding 2 mL chloroform, the tube is vortex-mixed for 2 min and centrifuged at 3,000 rpm for 5 min to separate the chloroform phase; this procedure is repeated twice, and the resulting chloroform phases are combined and evaporated to dryness under a stream of nitrogen<sup>c</sup>.
- iii. The residue is dissolved in 50–100 µL acetone; a 1–2 µL aliquot of it is injected into GC/MS.
- iv. Methylation of metabolites: after measurements of the final acetone solution 2–3 times, the remaining acetone solution is evaporated to dryness; the residue is dissolved in 100 µL of the diazomethane-ether solution and left at room temperature for 5 min<sup>d</sup>. After evaporation of the solution to dryness under a stream of nitrogen, the residue is again dissolved in 50–100 µL acetone; 1–2 µL of it is injected into GC(/MS). The obtained TIC is carefully compared with that before methylation. When a new peak appears or the amount of an organophosphorus pesticide is increased, there is a possibility of the presence of a metabolite<sup>e</sup>.

### ii. Organ specimens (acetonitrile extraction)

- i. A 1–2 g amount of an organ specimen is excised and put in 4 volumes of acetonitrile; the organ tissue is minced into small pieces with surgical scissors and homogenized with a



- Polytron homogenizer (Kinematica, Luzern, Switzerland) or Ultra-disperser (Yamato, Tokyo, Japan) for 2 min for both extraction and deproteinization.
- ii. The homogenate is centrifuged at 3,000 rpm for 5 min to separate supernatant solution; to the sediment the same amount of acetonitrile is added, vortex-mixed and centrifuged to obtain the 2nd supernatant solution.
  - iii. Both supernatant solutions are combined and condensed to about 0.5 mL under reduced pressure with warming at not higher than 40 °C.
  - iv. To the condensed solution, 4.5 mL distilled water is added; when insoluble residues are present, they are removed by centrifugation. The clear supernatant solution is subjected to the above liquid-liquid extraction or solid-phase extraction.

## Assessment and some comments on the method

Organophosphorus pesticides show relatively high vapor pressures, and thus suitable for analysis by GC. However, they are generally susceptible to light and heat, and thus unstable. They are also easily hydrolyzed under alkaline conditions; this should be kept in mind upon extraction procedure. It is possible to achieve sensitive trace analysis of organophosphorus pesticides using an FPD or FTD (NPD), which is specific for phosphorus. GC/MS, of course, enables sensitive quantitation in the SIM mode. However, when both GC/MS and GC-FPD (FTD) are available, the identification by GC/MS, followed by quantitation by GC-FPD (FTD) is most desirable.

Unchanged organophosphorus pesticides are lipophilic and thus easily extractable with solid-phase extraction cartridges. However, when various metabolites of the pesticide are simultaneously analyzed, liquid-liquid extraction with chloroform is recommendable. The phosphorus-containing metabolites including dealkylated and hydrolyzed forms are all acidic compounds, which are extractable into chloroform under acidic conditions. When an unchanged organophosphorus pesticide and its metabolite(s) coexist, they can be easily separated; the unchanged form can be extracted into hexane under neutral conditions, while the metabolite(s) can be extracted into chloroform under acidic conditions.

The detection limit of EPN, when measured by wide-bore capillary GC-FID, was reported to be 2 ng in an injected volume [1]. When an FPD or FTD is connected with capillary GC, the detection limits of organophosphorus pesticides are as low as in the pg order on-column.



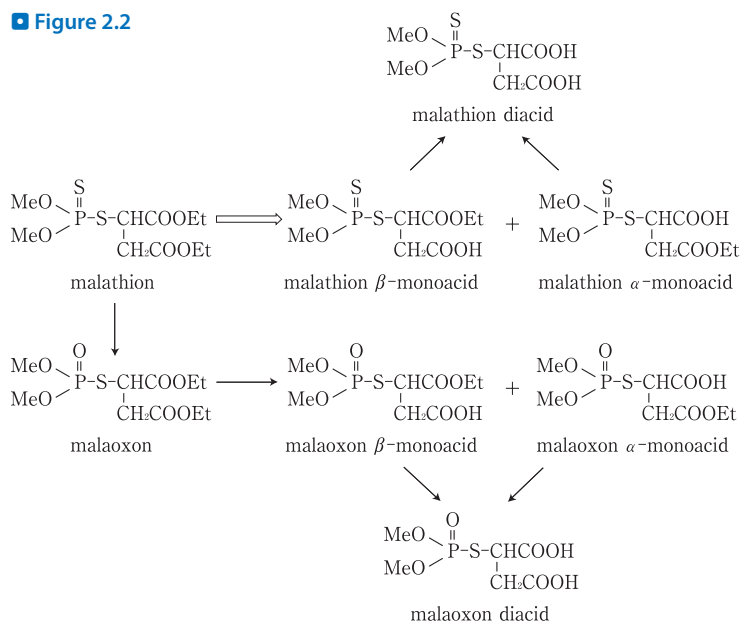
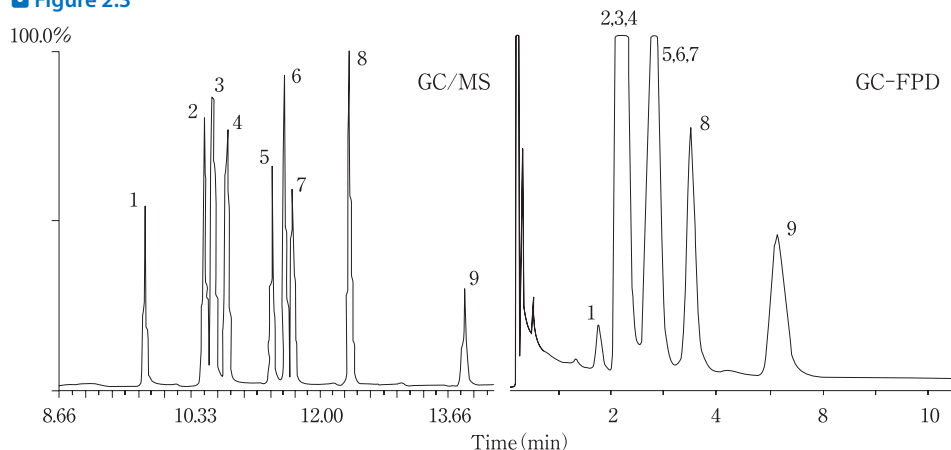
Malathion, one of the most popular organophosphorus pesticides, is converted into acid metabolites by the action of carboxylesterase in mammals as shown in  Fig. 2.2 [2]. By methyl-derivatization of these metabolites, compounds with methyl ester(s) in place of ethyl ester(s) can be obtained. A TIC and a gas chromatogram obtained by capillary GC/MS and packed-column GC-FPD, respectively, are shown in  Fig. 2.3. With the packed column, the peaks overlapped, while with the capillary column, they are well separated.

Figure 2.2



### Metabolic pathways for malathion in mammals.

Figure 2.3



TIC and gas chromatogram for malathion and its metabolites obtained by capillary GC/MS and packed-column GC-FPD, respectively. 1: malaoxon diacid\*; 2: malaoxon  $\beta$ -monoacid\*; 3: malaoxon  $\alpha$ -monoacid\*; 4: malathion diacid\*; 5: malaoxon; 6: malathion  $\beta$ -monoacid\*; 7: malathion  $\alpha$ -monoacid\*; 8: malathion; 9: isomalathion. \* methylated derivatives.

## HPLC and LC/MS analysis

---

### Reagents and their preparation

They are almost the same as described in the section of GC and GC/MS analysis.

### Analytical conditions

LC: any instrument equipped with a UV detector or a photodiode array detector can be used, regardless of its manufacturer.

Column: an ODS (octadecylsilane-bonded silica gel) column.

Mobile phase: a mixture of acetonitrile/distilled water (50:50) is tested for the retention times and peak shapes; the composition ratio is optimized for each analyte.

Detection wavelength: most organophosphorus pesticides are detectable at 207 nm. By using a photodiode array detector, identification of an unknown compound can be achieved to some extent [3, 4].

LC/MS: the methods using atmospheric pressure chemical ionization (APCI) [5] and thermospray (TS) ionization [6] were reported. In the LC/MS analysis of organophosphorus pesticides in the APCI mode, there are three methods of detection, *viz.*, the modes of positive ion, negative ion and both ions [5].

### Procedure<sup>f</sup>

A 0.5-mL volume of plasma or urine is mixed with 0.5 mL acetonitrile, vortex-mixed for 20 s and centrifuged at 9,500 g for 4 min; 20- $\mu$ L of the supernatant solution is injected into HPLC (/MS).

### Assessment and some comments on the method

When a photodiode array detector is used for HPLC analysis, it is possible to know that a peak, appearing at the same retention time as that of a target compound, is not due to the target compound by measuring its UV absorption spectrum. It is useful for identification of a compound to some extent.

Especially for the body fluid specimens, such as plasma and urine, the addition of acetonitrile enables both deproteinization and extraction; only after centrifugation, a part of the supernatant solution can be directly injected into HPLC (/MS). This procedure is very simple and rapid, and thus very suitable for clinical tests in poisoning during emergency treatments.

The detection limits depend upon the structures of aryl groups bound with the phosphate group. The detection limits using 206 nm wavelength are 14 ng/mL for fenitrothion and 110 ng/mL for the pesticides without chromophores, such as ethylthiomethon. Since at 206 nm of wavelength, the slope of an absorption spectrum is generally very steep, the measurements are unstable; reproducible results can be obtained by using 230 nm for quantitation. However,

the sensitivity becomes ten times less at 230 nm. In clinical analysis, there are some pesticides, which cannot be quantitated by HPLC with UV detection.

For LC/MS, various interfaces are commercially available. Among them, electrospray ionization (ESI), ion spray ionization and APCI are excellent in view of sensitivity and stability. The sensitivity of LC/MS is lower in a TIC, but comparable in the SIM mode as compared with that of GC/MS.

## Poisoning case, and toxic and fatal concentrations

An 84-year-old female [7] was found dead with vomitus over the pillow at home. A 500-mL bottle of profenofos emulsifiable concentrate, the concentration of which was 40 %, was found near the deceased. Approximately 220 mL of the concentrate remained in the bottle. The lapse of time after death was estimated to be 27 h at the time of autopsy. Autopsy findings were miosis, erosion of the pharynx, larynx and esophagus, and 87 mL of dark brownish fluid in the stomach. The concentrations profenofos in blood, urine and gastric contents were 1.2, 0.35 and 3,350  $\mu\text{g/mL}$ , respectively, while the concentration of its metabolite desethylated profenofos in blood was as high as 317  $\mu\text{g/mL}$ . These results show that the detection of a main metabolite is important together with that of an unchanged form for analysis of an organophosphorus pesticide.

➤ Table 2.2 shows the distribution of malathion, a most widely used organophosphorus pesticide, and its metabolites among blood, bile and some organs in a fatal malathion poisoning case. The blood concentration of malathion monoacid (21.7  $\mu\text{g/mL}$ ) was much higher than that of the unchanged form (0.36  $\mu\text{g/mL}$ ).

➤ Table 2.3 summarizes the concentrations of various organophosphorus pesticides in blood, urine and stomach contents so far reported [3, 4, 8–17].

■ Table 2.2

**Distribution of malathion and its metabolites in blood, bile and some organs of a human victim in fatal malathion poisoning [8]**

Concentration ( $\mu\text{g/g}$ )				
Sample	Malathion	Malaoxon	Monoacid	Diacid
blood	0.36	N.D.	21.7	2.9
bile	0.97	< 0.10	221	11.4
spleen	1.3	N.D.	59.0	18.6
kidney	1.3	N.D.	106	94.4
brain	6.3	< 0.10	2.0	0.16
adipose	80.4	0.29	14.3	2.5
liver	N.D.	N.D.	13.6	10.6

■ **Table 2.3**

**Concentrations of organophosphorus pesticides in blood, urine and stomach contents in their poisoning cases**

Compound	Dose (product mL)	Blood conc. (µg/mL) (time after ingestion)	Urinary conc. (µg/mL)	Stomach content conc. (µg/mL)	Alive/ dead	Reference
fenitrothion	50	17.1 (2 h)	1.8 (2 h)	6,100	alive	[3]
		14.5 (2 h)	0	557	alive	[3]
		3.9 (1.5 h)	0		alive	[4]
	100	3.9 (6 h)			alive	[9]
	500	1.28 (2 h)			alive	[9]
		2.4 (27 h)		7,500	dead	[10]
malathion		1.89		2,100	dead	[11]
		0.36			dead	[8]
		19.0 (15 h)			dead	[10]
cyanophos		10.9 (8 h)			alive	[10]
		11.4 (3.5 h)	1,060	24,700	alive	[10]
fenthion	10	0.17 (13 h)			alive	[9]
		3.8			alive	[12]
prothiofos	370	4.83 (2 h)	0.16	2,610	alive	[13]
profenofos		1.2	0.35		dead	[14]
salithion		4.6 (2 h)			alive	[4]
EPN plus		3.9 (5 h)			dead	[4]
edifenphos		1.3 (5 h)				
dimethoate		21.2 (1.5 h)			alive	[15]
trichlorfon		234 (5 h)		1,990	alive	[10]
pyridaphenthion	100	10 (6 h)			alive	[16]
methidathion	30	5 (13 h)			dead	[16]
DDVP		29	4.5		dead	[17]

## Notes

- Using these detectors, it is possible to detect an organophosphorus pesticide specifically even in the presence of some impurities in an extract, enabling sensitive analysis. When a target compound is sufficiently separated from impurities, GC-FID can be also used.
- As IS, an organophosphorus compound, which does not overlap peaks of a test compound and impurities, is selected in preliminary experiments. The volume of acetone being used as vehicle for IS should be not larger than 100 µL for the Sep-Pak cartridge extraction, because the presence of a non-negligible amount of acetone in a specimen solution may cause the leakage of a target compound upon pouring the solution into the cartridge. When a large amount of acetone has to be mixed with a specimen solution, the acetone solution containing IS is condensed into a small volume under a stream of nitrogen before adding to plasma or urine.

- c) By shaking with chloroform under acidic conditions, both unchanged form of an organophosphorus pesticide and its acidic metabolite(s) are extracted into the chloroform layer, but other metabolites are not.
- d) When the yellow color of diazomethane-ether solution disappears, a 50- $\mu$ L aliquot of the diazomethane solution should be added again.
- e) In the case of a mono-dealkylated metabolite of an organophosphorus pesticide having a diethyl phosphate structure, an asymmetrical methyl and ethyl phosphate derivative is produced by methylation; this results in appearance of a new peak. In the case of a metabolite of a pesticide having a dimethyl phosphate structure, the desmethylated metabolite goes back to the precursor form by methylation; this reaction results in the increase of the pesticide amount to be detected. The amount of the increase corresponds to that of the dealkylated metabolite.
- f) The extraction procedures described in the GC and GC/MS analysis section can be also used as pretreatments for HPLC and LC/MS.

## References

- 1) Liu J, Suzuki O, Kumazawa T et al. (1989) Rapid isolation with Sep-Pak C<sub>18</sub> cartridges and wide-bore capillary gas chromatography of organophosphate pesticides. *Forensic Sci Int* 41:67–72
- 2) Hayasaka M, Kawabata S, Haba A et al. (1994) Analysis of malathion metabolites in biological samples. *Jpn J Forensic Toxicol* 12:15–25
- 3) Cho Y, Matsuoka N, Kamiya A (1997) Determination of organophosphorus pesticides in biological samples of acute poisoning by HPLC with diode-array detector. *Chem Pharm Bull* 45:737–740
- 4) Mori H, Sato T, Nagase H et al. (1998) A method for rapid analysis of pesticides causing acute poisoning in patients and application of this method to clinical treatment. *Jpn J Toxicol Environ Health* 44:413–427
- 5) Kawasaki S, Ueda H (1992) Screening of organophosphorus pesticides using liquid chromatography-atmospheric pressure chemical ionization mass spectrometry. *J Chromatogr* 595:193–202
- 6) Lacorte S, Barcelo D (1995) Determination of organophosphorus pesticides and their transformation products in river waters by automated on-line solid-phase extraction followed by thermospray liquid chromatography-mass spectrometry. *J Chromatogr* 712:103–112
- 7) Gotoh M, Sakata M, Endo T et al. (2001) Profenofos metabolites in human poisoning. *Forensic Sci Int* 116:221–226
- 8) Morgade C, Barquet A (1982) Body distribution of malathion and its metabolites in a fatal poisoning by ingestion. *J Toxicol Environ Health* 10:321–325
- 9) Kobayashi R, Kono I, Kawaguchi S et al. (1991) Clinical effects of hemoadsorption therapy in organophosphorus pesticide poisoning. *Jpn J Toxicol* 4:35–39 (in Japanese)
- 10) Takahashi A, Taira T, Kanesaka S et al. (1991) Effects of hemoadsorption therapy evaluated by organophosphorus pesticide concentrations in blood. *Jpn J Toxicol* 4:39–42 (in Japanese)
- 11) Suzuki O, Hattori H, Asano M (1985) Detection of malathion in victim by gas chromatography/negative ion chemical ionization mass spectrometry. *Z Rechtsmed* 94:137–143
- 12) Meyer E, Borry D, Lambert W et al. (1998) Analysis of fenthion in postmortem samples by HPLC with diode-array detection and GC-MS using solid-phase extraction. *J Anal Toxicol* 22:248–252
- 13) Sakata M, Goto M, Ubukata K et al. (1999) Prothiofos metabolites in human poisoning. *J Toxicol Clin Toxicol* 37:327–332
- 14) Seno H, Hattori H, Kumazawa T et al. (1998) Quantitation of postmortem profenofos levels. *J Toxicol Clin Toxicol* 36:63–65
- 15) Kojima T, Yashiki M, Ohtani M et al. (1990) Determination of dimethoate in blood and hemoperfusion cartridge following ingestion of formothion: a case study. *Forensic Sci Int* 48:79–88
- 16) Yamashita M (1988) Pharmacodynamics of organophosphorus compounds and their therapeutic drugs in humans. *Jpn J Toxicol* 1:49–54 (in Japanese with an English abstract)
- 17) Shimizu K, Shiono H, Fukushima T (1996) Tissue distribution of DDVP after fatal ingestion. *Forensic Sci Int* 83:61–66

## II.7.3 Glufosinate and glyphosate

by Yasushi Hori and Manami Fujisawa

### Introduction

Non-selective phosphorus-containing amino acid-type herbicides (PAAHs) to be used for foliage exhibit lower toxicities than paraquat and are easily obtainable; they, thus, have come into wide use since 1980. The PAAHs include glufosinate (GLUF), glyphosate (GLYP) and bialaphos (BIAL). In Japan, there are many kinds of products containing GLUF and GLYP commercially available, and the number of suicidal cases using them is increasing [1].

In acute poisoning by GLUF, there is a latent period for 4–60 h before appearance of poisoning symptoms, such as lowered consciousness levels, respiratory arrest and generalized convulsion; when more than 100 mL of BASTA Fluid® (GLUF, 18.5 %; anion surfactant; blue-green in color) is ingested, the physical conditions of the victim are seriously aggravated with high incidence [2]. Respiratory controls, such as securance of the respiratory tract and artificial respiration, are very important for rescuing such victims. Since it is possible to predict the aggravation of the GLUF poisoning for a victim from the time after its ingestion and from a blood GLUF concentration [3], the rapid analysis of blood GLUF becomes very meaningful not to miss the timing for starting the respiratory control; it is critical to prevent a victim from falling into the unfortunate turning point.

For analysis of GLUF and GLYP in biomedical specimens, various methods by a modified technique of the standard GC-NPD with *N*-acetyl and *O*-methyl derivatizations [4], GC/MS using *tert*-butyldimethylsilyl (*t*-BDMS) derivatization [5–7], TLC [8], HPLC with fluorescence detection after post-column derivatization using *o*-phthalaldehyde [9], HPLC with fluorescence detection after pre-column derivatization using 9-fluorenylmethyl chloroformate (FMOC-Cl) [10], HPLC with UV detection after pre-column derivatization using phenyl isothiocyanate [11], ion chromatography with electrochemical detection without any derivatization [12], LC/MS with *N*-acetyl and *O*-methyl derivatizations [13] and HPLC with UV detection after pre-column derivatization using *p*-nitrobenzoyl chloride [14] were reported.

In this chapter, some details on GC/MS [7], HPLC with fluorescence detection [10] and HPLC-UV [14], after each derivatization for analysis of PAAHs, are described.

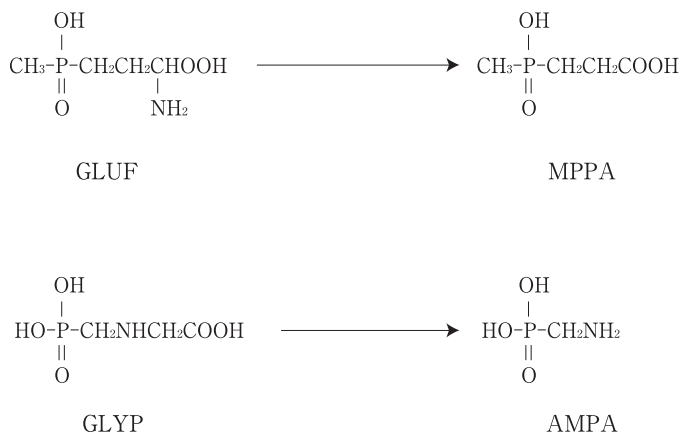
### GC/MS analysis [7]

---

#### Reagents and their preparation

- GLUF (DL-homoalanin-4-yl(methyl)phosphinate monoammonium salt) and its metabolite 3-methylphosphinicopropionic acid (MPPA) can be purchased from Wako Pure Chemical Industries, Ltd., Osaka, Japan; GLYP (*N*-(phosphonomethyl)glycine) and its metabolite

■ **Figure 3.1**



**Structures of glufosinate (GLUF) and glyphosate (GLYP) and their metabolites.**

aminomethyl phosphonic acid (AMPA) from Sigma (St. Louis, MO, USA). Their chemical structures are shown in [▶ Figure 3.1](#). Each compound was dissolved in 10 % methanol aqueous solution; they are stable at least for 6 months under refrigeration. The trace amounts of these compounds can adsorb to glassware; when low levels of the compounds are dealt with, the tools made of Teflon should be used [13].

- DL-2-Amino-3-phosphonopropionic acid (APPA) purchased from Aldrich (Milwaukee, WI, USA) is used as internal standard (IS)<sup>a</sup> and dissolved in 10 % methanol aqueous solution to prepare its 100 µg/mL solution.
- *N*-Methyl-*N*-(*tert*-butyldimethylsilyl)trifluoroacetamide (MTBSTFA) and *N,N*-dimethylformamide can be purchased from Aldrich and should be stored in a dry state (not to be contaminated by water).
- 0.1 M NaOH solution: the 1 M solution of reagent grade is diluted 10-fold with distilled water.
- To construct calibration curves, various amounts of GLUF, MPPA, GLYP or AMPA together with a fixed amount of APPA (IS) are spiked into the extracts of the standard human serum, evaporated to dryness and derivatized before analysis<sup>b</sup>.

## GC/MS conditions


Instrument: a GC 17A gas chromatograph/a QP5050 mass spectrometer (Shimadzu Corp., Kyoto, Japan); column: DB-5MS (15 m × 0.25 mm i.d., film thickness 0.25 µm, J&W Scientific, Folsom, CA, USA); column temperature: 80 °C (2 min) → 15 °C/min → 300 °C (5 min); carrier gas: He; its flow rate; 1.0 mL/min; injection: split/splitless mode (splitless for 2 min); split ratio: 10; injection amount: 1 µL; injection temperature: 300 °C; interface temperature: 280 °C; ionization mode: EI; scan range: *m/z* 70–650.



## Procedure

- i. As a specimen, serum, urine or stomach contents are used; 500  $\mu\text{L}$  of undiluted serum or 500  $\mu\text{L}$  of urine diluted 10-fold with distilled water is subjected to the following procedure.
- ii. The above specimen is mixed with 500  $\mu\text{L}$  acetone, vortex-mixed and centrifuged (3,000 rpm, 5 min) for deproteinization<sup>c</sup>; 100  $\mu\text{L}$  of the supernatant solution is subjected to the next step. For stomach contents, they are diluted with distilled water appropriately and pass through a membrane filter (0.45  $\mu\text{m}$ ); 100  $\mu\text{L}$  of the filtrate is subjected to the next step.
- iii. Isolute<sup>®</sup> HAX 100 mg cartridges (International Solvent Technology, Mid Glamorgan, UK)<sup>d</sup>, which have anion exchanging and hydrophobic interaction properties, are used for extraction. One of the cartridges is activated by passing 1 mL methanol, 1 mL of 0.1 M NaOH solution and 1 mL distilled water through it at a flow rate of 1 mL/min.
- iv. The above 100  $\mu\text{L}$  specimen solution is mixed well with 10  $\mu\text{L}$  of IS solution and 1 mL distilled water, and poured into the cartridge. The pH of the solution should be 6.4–8.5; therefore, it is generally not necessary to adjust pH for the serum or urine specimens.
- v. The cartridge is washed with 1 mL distilled water, and a target compound and IS are eluted with 500  $\mu\text{L}$  of 1 M HCl solution/methanol (4:1) at a flow rate of 500  $\mu\text{L}/\text{min}$ . The eluate is evaporated to dryness under reduced pressure with warming at 50 °C.
- vi. The residue is mixed with 50  $\mu\text{L}$  MTBSTFA and 50  $\mu\text{L}$  *N,N*-dimethyl-formamide, sonicated for 2 min and heated at 80 °C for 30 min<sup>e</sup> for *t*-BDMS derivatization.
- vii. After cooling to room temperature, 1  $\mu\text{L}$  of the final solution is injected into GC/MS.

## Assessment of the method

In this method, solid-phase extraction was used to extract a PAAH and its metabolite in a biomedical specimen for their GC/MS analysis [15] after *t*-BDMS derivatization.  Figure 3.2 shows mass spectra of *t*-BDMS derivatives of GLUF, MPPA, GLYP, AMPA and APPA. The base peaks at *m/z* M–57 appear for all compounds. The quantitation using the selected ion monitoring (SIM) is made with each base peak (GLUF: *m/z* 466; MPPA: *m/z* 323; GLYP: *m/z* 454; AMPA: *m/z* 396; APPA: *m/z* 568).

Various derivatization methods were reported for PAAHs [16]; the advantage of the use of *t*-BDMS derivatization is the one-step reaction<sup>f</sup>, which completes in only 30 min. When pg levels of PAAHs are derivatized with high efficiency, the *N*-acetyl and *O*-methyl derivatizations using acetic acid and trimethyl orthoacetate are useful [17].

The detection limit for both GLUF and GLYP in the scan mode is about 100 pg on-column (about 0.1  $\mu\text{g}/\text{mL}$  in blood); that of both MPPA and AMPA is about 10 pg on-column. In the SIM mode, the CV values reflecting reproducibility for the 4 compounds (100 ng each for derivatization) using APPA as IS are not larger than 3 % ( $n = 5$ ); GLUF and GLYP show linearity in the range of 100 pg–100 ng on-column. The detection limit (S/N ratio = 5) of GLUF and GLYP in the SIM mode is about 10 pg on-column; that of MPPA and AMPA is even lower.

The recovery rates for GLUF and GLYP, which had been spiked into sera at a concentration of 1  $\mu\text{g}/\text{mL}$ , after extraction with the Isolute<sup>®</sup> HAX cartridge, were as good as  $93.3 \pm 6.7\%$  ( $n = 5$ ) and  $92.6 \pm 7.2\%$  ( $n = 5$ ), respectively. Upon extraction with the cartridge, a urine specimen should be diluted sufficiently, because in the presence of strong anions in a specimen, the recovery rate becomes low. Since unchanged forms of GLUF and GLYP are rapidly excreted

Figure 3.2

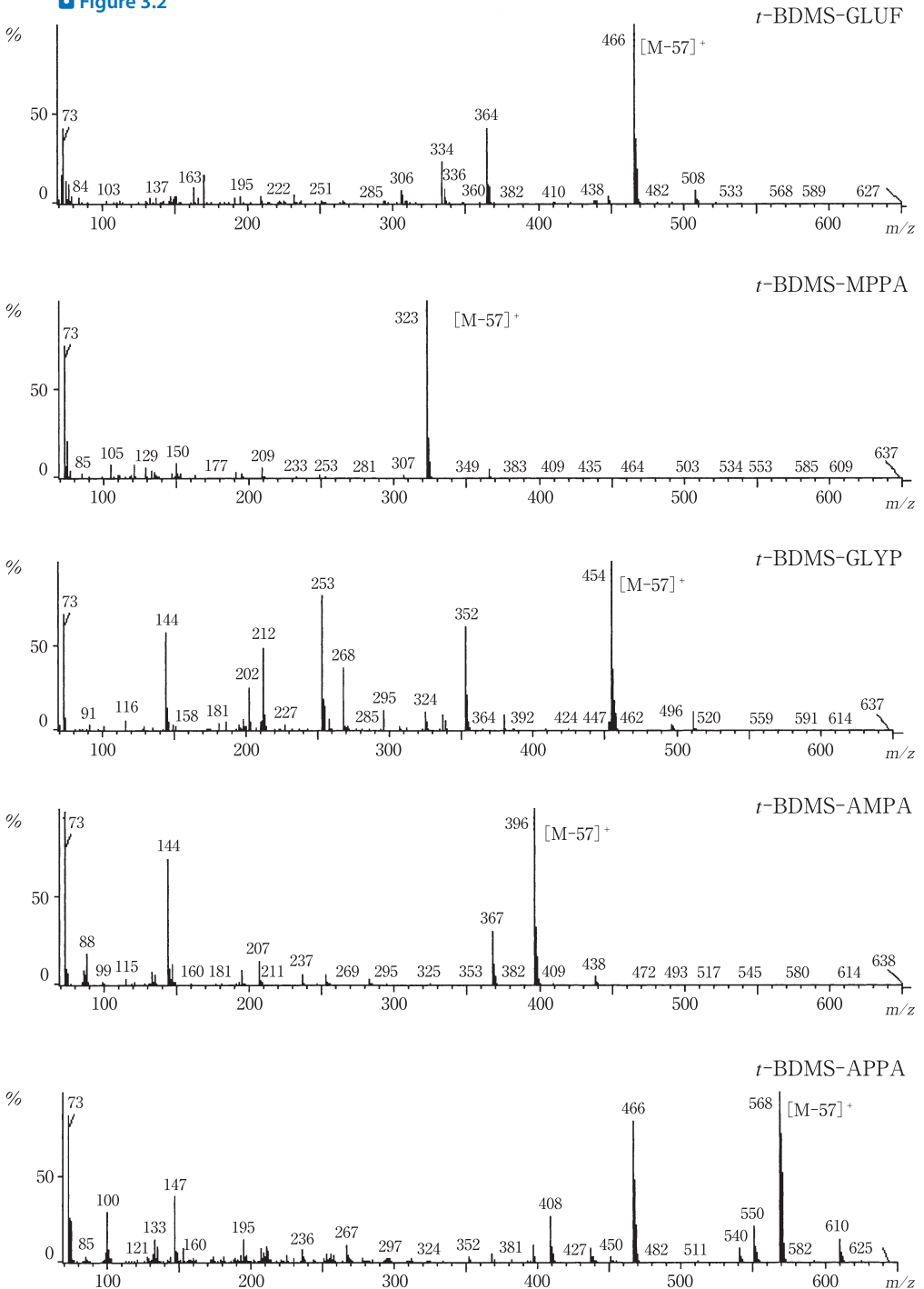
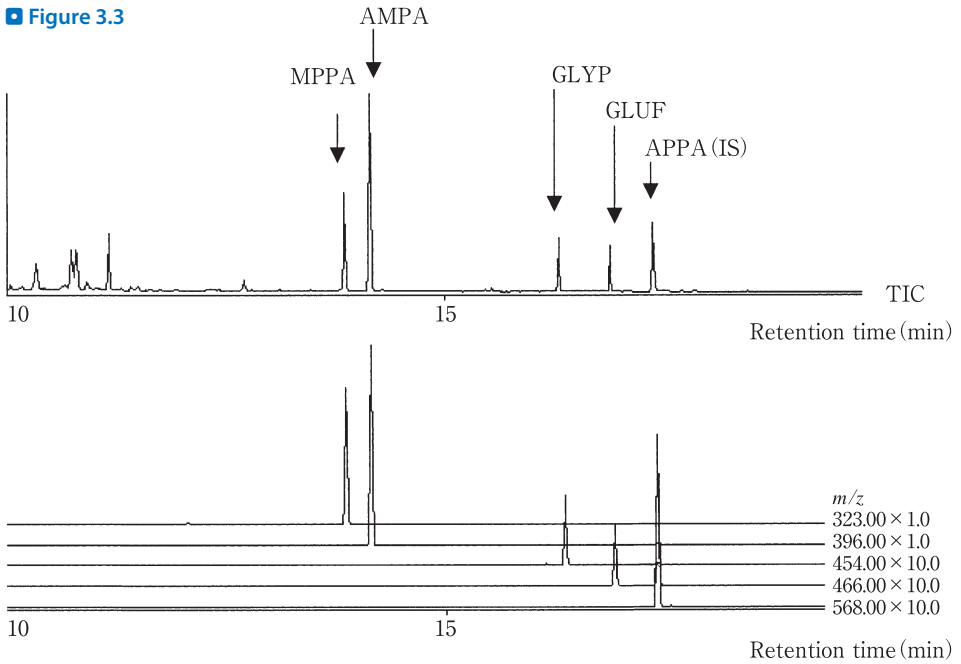
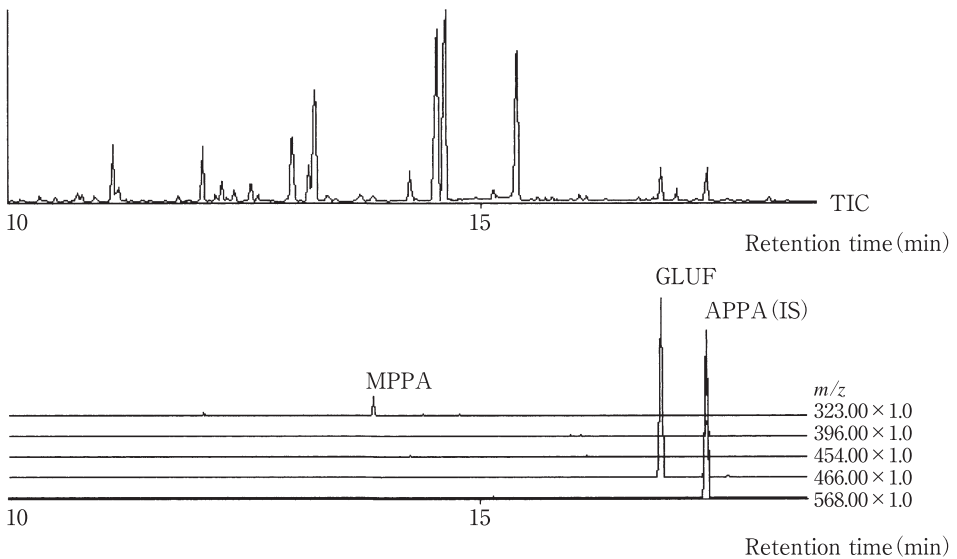
EI mass spectra of *t*-BDMS derivatives of GLUF, MPPA, GLYP, AMPA and APPA (IS).

Figure 3.3



TIC (upper panel) and SIM chromatograms (lower panel) obtained by GC/MS for *t*-BDMS derivatives of GLUF, MPPA, GLYP, AMPA and APPA (IS) (10 ng each on-column).

Figure 3.4



TIC (upper panel) and SIM chromatograms (lower panel) obtained by GC/MS for an extract of serum of a patient, who had ingested a GLUF-containing herbicide.

into urine, there are many cases, in which they are sufficiently detectable even from 100-fold diluted urine.

➤ *Figure 3.3* shows a TIC and SIM chromatograms for *t*-BDMS derivatives of the authentic GLUF, MPPA, GLYP, AMPA and APPA (IS); ➤ *Figure 3.4* shows comparable chromatograms for the extract of serum, which had been obtained from a poisoned victim 7 h after ingestion of 80 mL of a GLUF product (BASTA Fluid®). Using the base peaks at *m/z* M-57, GLUF and MPPA could be specifically detected by SIM from the extract of the crude matrix obtained from the actual case; the concentrations of GLUF and MPPA were 74.3 and 0.32 µg/mL, respectively.

## HPLC analysis with fluorescence detection [10]

### Reagents and their preparation

- FMOC-CL is purchased from Sigma, and dissolved in acetone to prepare its 0.1 % solution just before use.
- Borate buffer solution (0.1 M, pH 8.5): 2 g of sodium tetraborate is dissolved in 100 mL distilled water and the pH is adjusted to 8.5 with 2 M HCl solution.
- Phosphate buffer solution (10 mM, pH 2.5): 240 mg of sodium dihydrogenphosphate is dissolved in 200 mL distilled water and the pH is adjusted to 2.5 with phosphoric acid.

### HPLC conditions

Instruments: an LC-10ADVP pump, a CTO-10ACVP column oven, an RF10AXL fluorophotometer, an SIL-10ADVP autosampler, a CLASS-VP analysis software (all from Shimadzu Corp.); column: Inertsil® ODS-2 (150 × 4.6 mm i.d., particle size 5 µm, GL Sciences, Tokyo, Japan); column temperature: 40 °C; mobile phase: acetonitrile/10 mM phosphate buffer solution (pH 2.5); gradient elution: the ratio of the above acetonitrile and 10 mM phosphate buffer solution of the mobile phase is held at 3:7 (v/v) for 7 min, and changed to 1:1 after 13 min and to 8:2 after 15 min (1 min-hold) (the gradient elution after 13 min is conducted for washing the column); flow rate of the mobile phase: 1 mL/min; detector: a fluorophotometer; excitation wavelength: 265 nm; emission wavelength: 315 nm.

### Procedure

- A 100-µL volume of undiluted serum or urine diluted 10-fold with 0.1 M borate buffer solution (pH 8.5) is mixed with 400 µL of 0.1 M borate buffer solution and 1 mL acetone.
- The above solution is vortex-mixed and centrifuged at 3,000 rpm for 5 min for deproteinization; the resulting supernatant solution is subjected to the below derivatization.
- A 50-µL volume of the above solution is mixed with 200 µL of 0.1 M borate buffer solution (pH 8.5) and 200 µL of 0.1 % FMOC-Cl acetone solution, capped and mixed well<sup>§</sup>. The mixture is incubated at 40 °C for 10 min.

- iv. A 500- $\mu\text{L}$  volume of ethyl acetate is added to the mixture and shaken to remove excessive FMOC-Cl. A 100- $\mu\text{L}$  aliquot of the aqueous layer is mixed with 400  $\mu\text{L}$  of 0.1 M borate buffer solution (pH 8.5); 10  $\mu\text{L}$  of it is injected into HPLC.

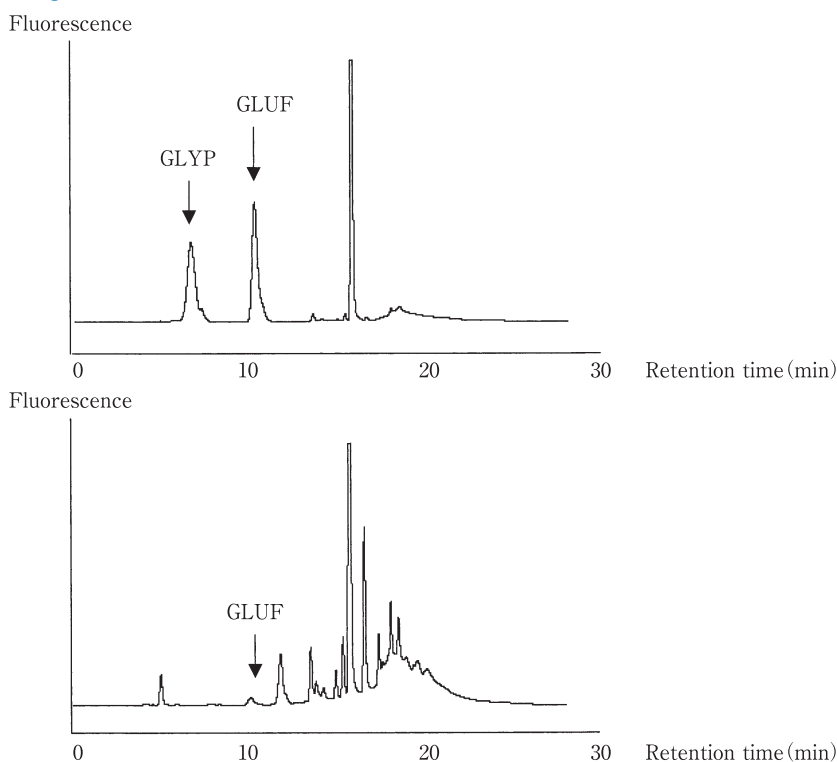
## Assessment of the method

► Figure 3.5 shows HPLC chromatograms for the authentic standard solutions of GLUF and GLYP (10  $\mu\text{g}/\text{mL}$ ) and for an extract of serum sampled 8 h after ingestion from an actual poisoned patient, who had ingested 25 mL of BASTA Fluid®.

GLUF and GLYP are highly polar in their unchanged forms, and thus suitable for separation by ion-exchange chromatography. After derivatization with FMOC-Cl, the compounds become separable by reversed phase HPLC using an acetonitrile-phosphate mobile phase.

The derivatization can be completed under mild conditions at 40 °C for 10 min; the derivatives are stable for at least 19 h. The detection limit is as low as about 1 ng/mL in a specimen; the whole procedure is accomplished in about 40 min.

■ Figure 3.5



Chromatograms obtained by HPLC with fluorescence detection for the authentic GLUF and GLYP (upper panel) and for an extract of serum of a patient, who had ingested a GLUF-containing herbicide (lower panel), after derivatization with FMOC-Cl.

The method with fluorescence detection is higher in both specificity and sensitivity than that with UV detection. There is another report [9] dealing with HPLC with fluorescence detection of PAAHs, in which post-column derivatization with *o*-phthalaldehyde is employed. However, it requires a special device for post-column derivatization. By the method described in this section, PAAHs can be simply measured only by combining usual reversed phase HPLC with a fluorescence detector.

## HPLC analysis with UV absorption detection

---

### Reagents and their preparation

- *p*-Nitrobenzoyl chloride (PNBC) can be obtained from Aldrich (Milwaukee, WI, USA) and other manufacturers; it is dissolved in acetonitrile (of the highest purity)<sup>h</sup> to prepare 1 % solution just before use.
- Borate buffer solution (0.1 M, pH 8.5): 2 g of sodium tetraborate is dissolved in 100 mL distilled water and the pH is adjusted to 8.5 with 2 M HCl solution.
- Ammonium acetate solution (10 mM, pH 5): 154 mg of ammonium acetate (of the highest purity) is dissolved in 200 mL of ultra-pure distilled water and its pH is adjusted to 5 with acetic acid.

### HPLC conditions

Instruments: the same pump, column oven, autosampler and software as described in the section of HPLC analysis with fluorescence detection, and an SPD-M10AVP diode array detector (all from Shimadzu Corp.); column: Inertsil<sup>®</sup> Ph-3 (150 × 4.6 mm i. d., particle size 5 μm, GL Sciences); column temperature: 40 °C; mobile phase: acetonitrile/10 mM ammonium acetate solution (pH 5.0) (1:9, v/v); flow rate: 0.8 mL/min; detection wavelength: 272 nm.

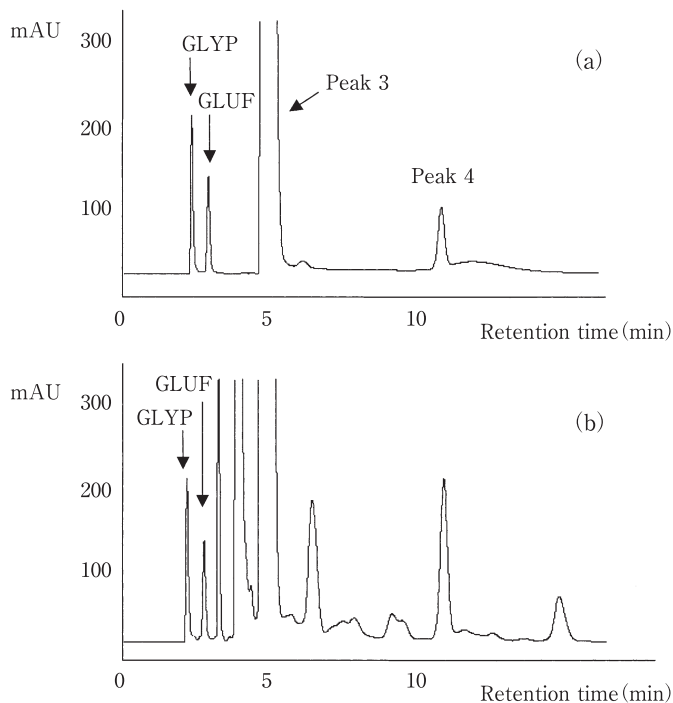
### Procedure

- i. A 500-μL volume of undiluted serum or urine diluted 10-fold with distilled water is mixed with 500 μL acetone, vortex-mixed and centrifuged at 3,000 rpm for 5 min for deproteinization.
- ii. A 100-μL aliquot of the above supernatant solution is mixed with 200 μL of 0.1 M borate buffer solution (pH 8.5) and 100 μL of 1 % PNBC acetonitrile solution, and left at 22–25 °C for 10 min; 10 μL of the solution is injected into HPLC.

### Assessment of the method

The advantages of this method are that the derivatization reaction is completed in 10 min at room temperature and that a usual reversed phase HPLC-UV detection can be used; with the

Figure 3.6



Chromatograms obtained by HPLC with UV absorption detection for the authentic GLUF and GLYP (a) and for an extract of serum (b), into which GLUF and GLYP had been spiked, after derivatization with PNBC. Peaks 3 and 4 are due to the unreacted reagent (PNBC) and a by-product (*p*-nitrobenzoic acid), respectively.

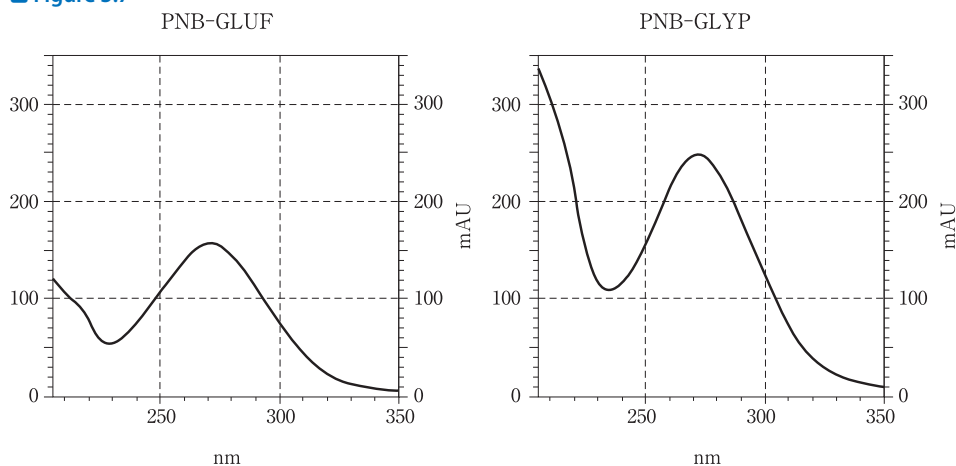
minimum instruments and time, the screening and quantitation of GLUF and GLYP can be achieved.

Figure 3.6 shows HPLC chromatograms for the authentic GLUF and GLYP and for the extract of serum, into which GLUF and GLYP had been spiked. Since the polarity of the compounds is high even after derivatization, their peaks appear at early retention times by the reversed phase HPLC. The peak 3 shown in the upper chromatogram of Figure 3.6 corresponds to the unreacted reagent (PNBC); the peak 4 to *p*-nitrobenzoic acid formed from PNBC by its reaction with water. The  $\lambda_{\max}$  wavelengths for the derivatives of GLUF and GLYP are 272.8 and 273.1 nm, respectively (Figure 3.7).

When a usual ODS column is used, the GLYP peak appears without any interference, but the GLUF peak may be interfered with by impurity peaks derived from the crude matrix. By using the Inertsil® Ph-3 column, which includes phenyl groups for their interaction with the target compounds, the GLUF peak can be better separated from impurities.

The detection limit for both authentic GLUF and GLYP in clean solution is 0.01  $\mu\text{g/mL}$ ; while that for GLUF and GLYP in serum or urine is 0.1  $\mu\text{g/mL}$ . The average recovery of GLUF from sera at the concentration of 1.0  $\mu\text{g/mL}$  was as good as 95.3 % ( $n = 5$ ); that from urine at 10.0  $\mu\text{g/mL}$  97.3 % ( $n = 5$ ).

■ Figure 3.7



UV absorption spectra for GLUF and GLYP after derivatization with PNBC.

## Toxic and fatal concentrations

### GLUF [18]

The number of poisoning cases by GLUF counts 100–200 per year; most cases are due to suicidal ingestion of GLUF products. Its main products are BASTA Fluid® (GLUF, 18.5 % anion surfactant, 30 %; blue-green color) and Hayabusa® (GLUF, 8.5 %; anion surfactant, 50 %; blue color).

The oral  $LD_{50}$  values (mg/kg) for GLUF are 1,660/1,510 (male/female) in rats and 436/464 in mice. In humans, the poisoning symptoms become severe, when more than 100 mL of the 18.5 % solution of GLUF is ingested. The oral  $LD_{50}$  value (mg/kg) for the anion surfactant being contained in the BASTA Fluid® is 4,500 in rats.

In GLUF poisoning, there is a characteristic latent period without any symptom lasting for not less than 6 h; after this period, poisoning symptoms, such as lowering of the consciousness level, respiratory suppression and generalized convulsion, suddenly appear. The severity of the GLUF poisoning can be predicted by plotting the time after ingestion on the horizontal axis and the logarithm of serum GLUF concentration on the vertical axis. Koyama et al. [2] measured serum GLUF levels in 99 patients with GLUF poisoning, and drew two linear lines A and B by connecting a point of 70  $\mu\text{g/mL}$  at 2 h after GLUF ingestion with a point of 5  $\mu\text{g/mL}$  at 8 h for A and by connecting a point of 200  $\mu\text{g/mL}$  at 2 h with that of 15  $\mu\text{g/mL}$  at 8 h for B. They reported that any plot below line A indicated a mild case, and one above line B a severe case; in the area between lines A and B mild and severe cases were mixed. Both GLUF and coexisting surfactant seem exerting toxic effects in many GLUF poisoning cases.

GLUF shows contradictory effects on the central nervous system, *viz.*, its excitation and suppression; it may act on glutamate synthase, glutamate decarboxylase and inhibitory glutamic acid receptors. The surfactant contained in the GLUF product is being considered responsible for vomiting, erosion of the upper digestive tracts, edema appearing from the oral mucosa to the larynx and shock accompanied by the peripheral resistance.



About 20 % of total GLUF, which had been orally administered to rats, is rapidly absorbed into the animal bodies; about 90 % of the absorbed GLUF is excreted into urine also rapidly. In humans, a peak serum GLUF concentration is observed 40–50 min after ingestion; more than 95 % of an absorbed amount of the compound is excreted into urine within 24 h; a major part of the excreted compounds is in the unchanged form. The author confirmed that the concentration ratios of MPPA to GLUF in urine were only 0.005–0.01.

Toxicokinetic parameters were reported in 2 patients, who had ingested the BASTA Fluid®; the results in one case [19] were: distribution half-life, 1.8 h; elimination half-life, 9.6 h; and distribution volume in the body, 1.4 L/kg. In another case [20], they were: distribution half-life 1.2 h; elimination half-life, 9.2 h; and distribution volume in the body, 1.9 L/kg.

It is considered that 99 % of GLUF in human serum is not bound with proteins, but exists in its free form [21]. It is easily expected that GLUF hardly passes through the blood-brain barrier, because of its high polarity. However, there is a case report describing a serum GLUF concentration at 31.7 µg/mL and a cerebrospinal fluid GLUF concentration at 0.4 µg/mL 4 h after ingestion; these values suggest that GLUF can be incorporated into the brain.

## GLYP [22]

The main products of GLYP are Roundup® fluid (GLYP, 41 %; anion surfactant, 15 %; yellow-brown color; odorless fluid at pH 4.8), Touchdown® and Impulse® fluid.

GLYP exerts its herbicidal action by inhibiting the biosynthesis of chlorophylls and carotenoids and is said not to be active on mammals. The oral LD<sub>50</sub> values (mg/kg) of GLYP are 6,250 and 7,810 for male and female rats, respectively; the percutaneous LD<sub>50</sub> value in rabbits is as high as 5,000. The oral LD<sub>50</sub> value of the Roundup® fluid is 2 mL/kg in humans. Masui et al. [23] reported that either oral administration of 15 % surfactant or 41 % GLYP did not cause fatalities of animals, but the mixture of them caused fatalities for all animals, and thus pointed out their synergistic effect. Nowadays, the acute toxicity of a GLYP product is said to be mainly due to the surfactant; the poisoning symptoms are stimulation of the digestive tract, vomiting due to its erosive effect, diarrhea, bleeding of the digestive tract, edema of the intestines, enhanced permeability of the vessels, generalized edema due to swelling of the cells and finally a shock state due to reduced total blood volume.

In animal experiments, about 30 % of an orally administered amount GLYP is absorbed into bodies through the digestive tract, and a peak blood GLYP concentration can be attained in 3–4 h. The main excretion route is the urinary system; but a part is excreted into feces.

## Notes

- a) As an IS except APPA, *N*-(phosphonomethyl)-β-alanine [13] is usable, because its properties for the extraction and the *t*-BDMS derivatization are almost the same as those of PAAHs; the compound is not commercially available and thus should be synthesized. There are reports using *n*-docosane (Aldrich) as IS [15, 17], but the authors have no experience of using them.
- b) The reproducibility of GC/MS analysis of trace amounts (not larger than 10 ng on-column) of the authentic compound only after its evaporation and derivatization with MTBSTFA is

- bad. The cause of this variation is not clear, but the addition of the blank serum extract markedly improves the reproducibility.
- c) The ratios of GLUF bound with serum proteins to total GLUF are not larger than 1 % [21], but the deproteinization process is required to enhance the derivatization efficiency.
  - d) The authors have introduced Isolute<sup>®</sup> HAX cartridges in this chapter. Other cartridges or columns with similar properties, such as Bond Elut Certify<sup>®</sup> II (Varian, Harbor City, CA, USA) and Oasis<sup>®</sup> MAX (Waters, Milford, MA, USA), can be also used; they have both hydrophobic interaction and anion exchanging properties for extraction. These mixed mode cartridges (columns) are less influenced by variation of ion intensities of specimens, and thus give more reproducible results.
  - e) In Tsunoda's report [15], the derivatization was completed at 80 °C in 30–80 min. In authors' experiments, sufficient quantitiveness and reproducibility were secured by derivatization at 80 °C for 30 min.
  - f) The acylation with halogenated acid anhydride-halogenated alcohol also gives one-step derivatization reaction (100 °C, 1 h) for PAAHs; this kind of derivatization is more suitable for trace level ranges, because of better derivatization efficiency [16]. When the resulting derivatives are analyzed with a DB-5MS column, enantiomers are separated for GLUF and APPA, giving 2 peaks for each compound.
  - g) When 50 µL of a specimen is mixed with 200 µL of 0.1 M borate buffer solution (pH 8.5) and 200 µL of 0.1 % FMOCl acetone solution, boric acid occasionally precipitates; this may cause clogging of the autoinjector. Such precipitates should be removed by passing the solution through a membrane filter (0.45 µm) before injection into HPLC.
  - h) PNBC easily reacts with water to produce *p*-nitrobenzoic acid. Although the latter compound does not interfere with the assays, ultra-pure acetonitrile without any water should be used.

## References

- 1) Tsunoda N (1990) Phosphorus-containing amino acid type herbicides. *Jpn J Forensic Toxicol* 8:100–111 (in Japanese)
- 2) Koyama K, Hirose Y, Taze C et al. (2000) An indicator of aggravation in poisoning by intake of BASTA Fluid<sup>®</sup>; comparison of estimated intake amounts with serum glufosinate concentrations ([GLF]s). *Jpn J Toxicol* 13:469 (in Japanese)
- 3) Koyama K, Hirose Y, Okuda T et al. (1997) Relationship between aggravation of poisoning by intake of a glufosinate-containing herbicide (BASTA Fluid<sup>®</sup>) and serum glufosinate concentrations. *J Jpn Assoc Acute Med* 8:617–618 (in Japanese)
- 4) Goto M, Kato M (1987) Method for Analysis of Residual Pesticides, Enlarged edn. Soft Science, Tokyo, p 236 (in Japanese)
- 5) Kageura M, Hieda Y, Hara K et al. (1988) Analysis of glyphosate and (aminomethyl) phosphonic acid in a suspected poisoning case. *Jpn J Legal Med* 42:128–132
- 6) Tsunoda N (1994) Analysis of phosphorus-containing amino acid-type herbicides and their problems in forensic examination. *Jpn J Forensic Toxicol* 12:104–107 (in Japanese with an English abstract)
- 7) Hori Y, Fujisawa M, Shimada K et al. (2001) Determination of glufosinate ammonium and its metabolite 3-methylphosphinicopropionic acid in human serum by gas chromatography-mass spectrometry following mixed-mode solid phase extraction and t-BDMS derivatization. *J Anal Toxicol* 25:680–684
- 8) Suzuki A, Kawana M (1989) Rapid and simple method for identification of glufosinate- ammonium using paper chromatography. *Bull Environ Contam Toxicol* 43:17–21
- 9) Okuda T, Naotsuka K, Sameshima I et al. (1993) A new HPLC analysis of glufosinate caused acute poisoning. *Jpn J TDM* 9:39–44

- 10) Akuzawa N, Akaiwa H (1997) Rapid determination of DL-homoalanin-4-yl-(methyl)phosphinic acid by high-performance liquid chromatography with fluorescence detection. *Bunseki Kagaku* 46:69–74 (in Japanese with an English abstract)
- 11) Nishida K, Narihara M, Tsutsumi K et al. (1998) A study on a screening method for water-soluble herbicides. Abstracts of Annual Meeting of Japanese Association of Science and Technology for Identification, p 69 (in Japanese)
- 12) Sato K, Suetsugu K, Takegoshi Y et al. (2000) Ion chromatography with electrochemical detection for phosphorus-containing amino acid type herbicides. Abstracts of Annual Meeting of Japanese Association of Science and Technology for Identification, p 84 (in Japanese)
- 13) Honda M, Sato M, Kikuchi M et al. (2001) Simultaneous analysis of phosphorus-containing amino acid type herbicides by LC/MS. *Jpn J Forensic Toxicol* 19:176–177 (in Japanese with an English abstract)
- 14) Hori Y, Fujisawa M, Shimada K et al. (2002) Quantitative determination of glufosinate in samples by HPLC with UV detector after p-nitrobenzoyl derivatization. *J Chromatogr B* 767:255–262
- 15) Tsunoda N (1993) Simultaneous determination of the herbicides glyphosate, glufosinate and bialaphos and their metabolites by capillary gas chromatography-ion-trap mass spectrometry. *J Chromatogr* 637:167–173
- 16) Stalikas CD, Konidari CN (2001) Analytical methods to determine phosphonic and amino acid group-containing pesticides. *J Chromatogr A* 907:1–19
- 17) Stalikas CD, Pilidis GA (2000) Development of a method for the simultaneous determination of phosphoric and amino acid group containing pesticides by gas chromatography with massspective detection. Optimization of the derivatization procedure using an experimental design approach. *J Chromatogr A* 872:215–225
- 18) Koyama K (2001) Glufosinate (BASTA Fluid®). *Jpn J Acute Med* 25:141–143 (in Japanese)
- 19) Hirose Y, Kobayashi M, Koyama K et al. (1999) A toxicokinetic analysis in a patient with acute glufosinate poisoning. *Hum Exp Toxicol* 18:305–308
- 20) Honda T, Nakashima K, Higashi H et al. (1999) Analysis of toxicokinetics of glufosinate (GLF) in a case of poisoning by oral intake of BASTA Fluid®. *Jpn J Toxicol* 12:468 (in Japanese)
- 21) Hori Y, Koyama K, Fujisawa M et al. (2001) Protein binding of glufosinate and factors affecting it revealed by an equilibrium dialysis technique. *J Anal Toxicol* 25:439–442
- 22) Japan Poison Information Center (ed) (2000) Glyphosate. In: *Poisoning Accidents and Their Countermeasures with Special Reference to Actual Cases*, revised edn. Jiho Inc., Tokyo, pp 220–223 (in Japanese)
- 23) Masui M, Ikeda H, Takagi K et al. (1988) Forensic toxicological studies on the herbicide Roundup® (II). *Jpn J Legal Med* 42 (Suppl. 116) (in Japanese)

## II.7.4 Carbamate pesticides

by Kiyoshi Ameno

### Introduction

Among many carbamate pesticides commercially available in Japan, those with relatively high toxicities are shown in [▶ Table 4.1](#) [1]. Carbamate pesticides are generally classified into *N*-methylcarbamate insecticides and *N*-allylcarbamate herbicides in view of their chemical structures and biological actions. The number of fatalities due to poisoning by carbamate pesticides is 50–100 every year in Japan; many of them are poisoned by methomyl [2]. According to statistics reported by National Research Institute of Police Science of Japan, the number of fatalities is highest with paraquat plus diquat, followed by organophosphates and then carbamates among pesticides. The toxicity of carbamate pesticides is due to inhibition of acetylcholinesterase (AChE) by their binding with the active site of the enzyme; the inhibition of the hydrolysis reaction of acetylcholine (ACh) results in the accumulation of ACh, provoking poisoning symptoms, such as miosis, lacrimation, sweating, hypersalivation and convulsion of extremities. The binding of carbamate pesticides to AChE is much weaker than that of organophosphorus pesticides, and the former pesticides are easily decomposed<sup>a</sup> in mammalian bodies. Therefore, the damages of organs by carbamate pesticides have not been reported.

For analysis of carbamate pesticides, methods by GC [3–7], GC/MS [5, 7, 8–10], HPLC [11] and LC/MS [10] were reported. In this chapter, the extraction procedures and analytical methods using the above 4 instruments are described for this group of pesticides.

### Reagents and their preparation

- The authentic standards of compounds listed in [▶ Table 4.1](#) and ethion can be purchased from Wako Pure Chemical Industries, Ltd., Osaka, Japan. A standard mixture of seven *N*-methylcarbamate pesticides can be obtained from Kanto Chemicals (Tokyo, Japan)<sup>b</sup>. Carbofuran, carbaryl and ethion are separately dissolved in acetone to prepare 100 µg/mL solutions as stock solutions for internal standards (ISs)<sup>c</sup>. Carbendazole (Aldrich, Milwaukee, WI, USA) is dissolved in distilled water to prepare 100 µg/mL solution. *o*-Methoxyphenol can be also obtained from Aldrich.
- Sep-Pak C<sub>18</sub> and Oasis MCX cartridges are purchased from Waters (Milford, MA, USA).
- The solutions to be prepared are: *n*-hexane/ethyl acetate (1:1, v/v); acetonitrile/distilled water (1:1, v/v); methanol/distilled water (5:59, v/v); 0.1 M HCl solution; and 2 % NaCl solution.
- 0.1 M Phosphate buffer solution (pH 7.0): 6.81 g of KH<sub>2</sub>PO<sub>4</sub> is dissolved in 400 mL distilled water, and the pH of the solution is adjusted to 7.0 with 1.0 M NaOH solution; the final volume is adjusted to 500 mL with distilled water.
- 5 % Ammonia/methanol solution: 2.5 mL of 3 M NH<sub>4</sub>OH solution is mixed with 47.5 mL methanol.
- HPLC mobile phases: methanol/distilled water (65:35, v/v); acetonitrile/2 mM ammonium formate (30:70 and 80:20, v/v, pH 3.0).

■ **Table 4.1**

**Structures, properties and toxicities of carbamate pesticides**

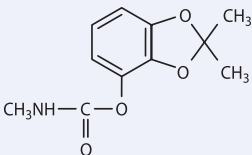
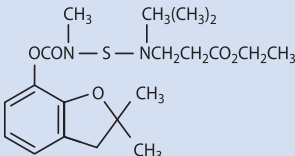
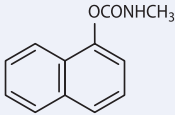
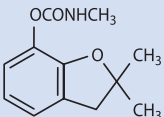
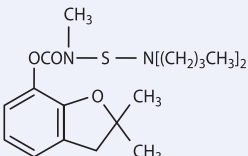
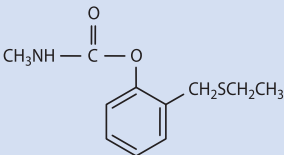
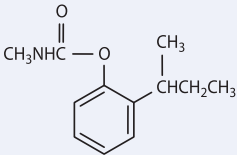
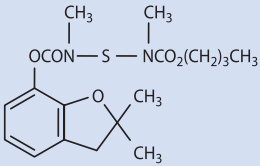
Name, MF, MW, property and structure	Use	Acute oral LD <sub>50</sub> (rat, mg/kg)
bendiocarb $C_{11}H_{13}NO_4$ MW: 223.2 MP: 125 ~ 129	insecticide	40 ~ 156
		
benfuracarb $C_{20}H_{30}N_2O_5S$ MW: 410.5 MP: 110	insecticide	♂223 ♀205
		
carbaryl $C_{12}H_{15}NO_2$ MW: 201.2 MP: 142	insecticide	♂850 ♀500
		
carbofuran $C_{12}H_{15}NO_3$ MW: 221.3 MP: 153 ~ 154	insecticide	8
		
carbosulfan $C_{20}H_{32}N_3O_3S$ MW: 380.5 BP: 124 ~ 128	insecticide	♂623 ♀657
		
ethiofencarb $C_{11}H_{15}NO_2S$ MW: 225.3 MP: 33.4	insecticide	200 approx.
		
fenobucarb $C_{12}H_{17}NO_2$ MW: 207.3 MP: 31 ~ 32	insecticide	♂250 ♀185
		
furathiocarb $C_{18}H_{26}N_2O_5S$ MW: 382.5 BP: 250<	insecticide	53
		

Table 4.1

(continued)

isoprocarb C <sub>11</sub> H <sub>15</sub> NO <sub>2</sub> MW: 225.3 MP: 93 ~ 96		insecticide	450
metolcarb C <sub>9</sub> H <sub>11</sub> NO <sub>2</sub> MW: 162.2 MP: 76 ~ 77		insecticide	♂580 ♀498
methomyl C <sub>5</sub> H <sub>13</sub> N <sub>2</sub> O <sub>2</sub> S MW: 162.2 MP: 78 ~ 79		insecticide	♂17 ♀24
oxamyl C <sub>7</sub> H <sub>13</sub> N <sub>3</sub> O <sub>3</sub> S MW: 219.3 MP: 100 ~ 102		insecticide	5.4
pirimicarb C <sub>11</sub> H <sub>18</sub> N <sub>4</sub> O <sub>2</sub> MW: 238.3 MP: 90.5		insecticide	147
propoxur C <sub>11</sub> H <sub>15</sub> NO <sub>3</sub> MW: 209.2 MP: 90		insecticide	50
thiodicarb C <sub>10</sub> H <sub>18</sub> N <sub>4</sub> O <sub>4</sub> S <sub>3</sub> MW: 354.5 MP: 173 ~ 174		insecticide	66
XMC C <sub>10</sub> H <sub>13</sub> NO <sub>2</sub> MW: 179.2 MP: 99		insecticide	542
xylylcarb C <sub>10</sub> H <sub>13</sub> NO <sub>2</sub> MW: 179.2 MP: 79 ~ 80		insecticide	♂375 ♀325

MF: molecular formula; MW: molecular weight; MP (°C): melting point; BP (°C): boiling point.

## Extraction methods

It is absolutely necessary to extract carbamate pesticides from crude biomedical specimens containing many impurity compounds as pretreatments before instrumental analysis. As specimens, body fluids (whole blood, serum and urine), tissues and stomach contents are objects for analyses. The whole blood should be completely hemolyzed before extraction. Homogenization is needed for tissues (organs) specimens; for stomach contents, the supernatant fraction after their centrifugation should be used.

### Liquid-liquid extraction

- i. A 2-g aliquot of specimens (blood, tissues and stomach contents<sup>d</sup>) is mixed with 10 mL acetonitrile (containing an appropriate IS), homogenized with a Polytron homogenizer and centrifuged at 3,000 rpm for 5 min to obtain clear supernatant solution.
- ii. For the sediment, the above i) step of extraction is repeated two times.
- iii. The three acetonitrile supernatant solutions thus obtained are combined and mixed with 80 mL of 2 % NaCl solution and 25 mL of *n*-hexane/ethyl acetate (1:1, v/v) in a 250-mL volume separating funnel<sup>e</sup>.
- iv. The funnel is shaken for 10 min (with a shaking machine).
- v. The *n*-hexane/ethyl acetate layer is obtained.
- vi. The layer is evaporated to dryness under reduced pressure in a rotary evaporator at room temperature.
- vii. The residue is dissolved in 100  $\mu$ L methanol.
- viii. A 2- $\mu$ L aliquot of it is injected into GC or GC/MS; a 20- $\mu$ L aliquot into HPLC.
- ix. For quantitation, each calibration curve is constructed using peak area ratios of a target compound to IS. A ratio obtained from a specimen is applied to the curve to calculate its concentration.

### Solid-phase extraction-1 [4]

- i. A Sep-Pak C<sub>18</sub> cartridge<sup>f</sup> is washed and activated by passing chloroform, acetonitrile, acetonitrile/distilled water (1:1) and distilled water, 10 mL each, successively.
- ii. A 1-mL volume of a specimen (blood, serum or urine) is mixed with 9 mL distilled water, stirred well<sup>g</sup> and poured into the Sep-Pak C<sub>18</sub> cartridge.
- iii. It is washed with 10 mL distilled water.
- iv. A target compound and IS are eluted with 3 mL chloroform.
- v. A small amount of aqueous layer (upper) of the eluate is carefully removed with a Pasteur pipette<sup>h</sup>.
- vi. The above organic extract is dehydrated with anhydrous Na<sub>2</sub>SO<sub>4</sub><sup>i</sup>.
- vii. It is evaporated to dryness under a stream of nitrogen at room temperature.
- viii. The residue is dissolved in 100  $\mu$ L methanol<sup>j</sup>.
- ix. A 2- $\mu$ L aliquot of it is injected into GC or GC/MS; a 20- $\mu$ L aliquot into HPLC or LC/MS.

## Solid-phase extraction-2 [10]

- i. An Oasis MCX cartridge<sup>k</sup> is activated by passing 1 mL methanol and 1 mL of 0.1 M phosphate buffer solution (pH 7) through it.
- ii. A 1-mL volume of serum is mixed well with 100  $\mu$ L of IS (for example carbendazole) solution and poured into the cartridge.
- iii. The cartridge is washed with 1 mL distilled water.
- iv. The first elution is made by passing 1 mL methanol through it.
- v. The cartridge is washed with 1 mL of 0.1 M HCl solution.
- vi. The second elution is made by passing 1 mL methanol again.
- vii. The third elution is made by passing 1 mL of 5 % ammonia/methanol.
- viii. The three eluates obtained at the steps iv, vi and vii are combined<sup>l</sup>, and evaporated to dryness under a stream of nitrogen.
- ix. The residue is dissolved in 100  $\mu$ L methanol for GC or GC/MS analysis; an appropriate amount is injected into GC (/MS). For HPLC (/MS), the residue is dissolved in 100  $\mu$ L of a mobile phase to be used and injected into HPLC (/MS).

## GC and GC/MS analysis

---

### GC conditions

GC columns<sup>m</sup>: DB-5 and DB-1 fused silica capillary columns (30 m  $\times$  0.25 mm i.d., film thickness 0.25  $\mu$ m, J&W Scientific, Folsom, CA, USA).


GC conditions; instrument: Shimadzu GC14B (Shimadzu Corp., Kyoto, Japan); detector: flame thermionic ionization detector (FTD)<sup>n</sup>; column temperature: 50 °C  $\rightarrow$  20 °C/min  $\rightarrow$  120 °C  $\rightarrow$  5 °C/min  $\rightarrow$  260 °C (10 min); injection and detector temperature<sup>o</sup>: 230 °C; carrier gas: He (13 kPa).

### GC/MS conditions

GC column: a DB-5MS fused silica capillary column (30 m  $\times$  0.25 mm i.d., film thickness 0.25  $\mu$ m, J&W Scientific).

GC/MS; instrument: Shimadzu GC-MS5000 (Shimadzu Corp.); column temperature: 120 °C (1 min)  $\rightarrow$  20 °C/min  $\rightarrow$  240 °C (8 min); injection and separator temperature: 230 °C; carrier gas: He (2.0 mL/min); ionization mode: EI (70 eV).

### Assessment of the method

For GC analysis of carbamate pesticides, an FTD detector is recommendable, because it is specific and sensitive, and is not influenced by impurities and organic solvents appreciably. Qualitative analysis only with a single column is insufficient; multiple columns of different properties should be used for testing an identity of a compound.  Table 4.2 shows retention



■ **Table 4.2**

**Retention times of carbamate pesticides obtained by GC\***

Carbamate	Retention time (min)	Carbamate	Retention time (min)
oxamyl	5.9	bendiocarb	15.1
methomyl-oxime	7.1	carbofuran	16.5
propamocarb	9.3	ethiofencarb	18.8
metolcarb (MTMC)	11.2	pirimicarb	18.8
isoprocarb	12.2	carbaryl	19.7
methomyl	12.2	methiocarb	20.7
XMC	12.6	benthocarb	21.1
xylylcarb (MPMC)	13.3	diethofencarb	21.4
propoxur (PHC)	13.6	furathiocarb	31.5
fenobucarb	13.7	benfuracarb	33.6

\* Detection limits were 0.5–1.0 ng on-column.

Data were obtained in cooperation with Dr. S. Hatta (environmental chemist). Column: a DB-5 fused silica capillary column (30 m × 0.25 mm i. d., film thickness 0.25 μm).

■ **Table 4.3**

**El mass spectra of carbamate pesticides**

Carbamate	Mass spectral ions ( <i>m/z</i> )				
	M <sup>+</sup>	Base	Others		
oxamyl	162	72	98	145	115
propamocarb	188	58	129	143	70
metolcarb (MTMC)	165	108	77	58	107
isoprocarb	193*	121	136	91	103
methomyl-oxime	105	88	58		
methomyl	162*	105	58	88	103
XMC	179	122	107	91	77
xylylcarb (MPMC)	179	122	107	91	77
propoxur (PHC)	209*	110	152	81	58
fenobucarb	207*	121	150	91	77
bendiocarb	223	151	166	126	108
carbofuran	221	164	149	122	131
ethiofencarb	225	107	168	77	57
pirimicarb	238	166	72	132	152
carbaryl	201	144	115	116	145
methiocarb	225	168	153	109	91
benthocarb	257	100	82	125	89
diethofencarb	267	151	225	207	124
furathiocarb	382*	163	135	194	325
benfuracarb	410*	190	163	135	102
APC	274	160	217	176	190

M<sup>+</sup>: molecular ion; Base: base peak; \*: very small peak or not detectable.

times of carbamate pesticides, when a DB-5 fused silica capillary column was used for GC analysis.

▶ *Table 4.3* shows principal ions (5 peaks each including a molecular ion) observed in EI mass spectra for carbamate pesticides obtained by GC/MS [4, 9]. The intensities of molecular ions are generally low; there are compounds without appearance of molecular ions<sup>p</sup>. Sufficient qualitative analysis is achieved by measuring retention times and mass spectra of compounds tested. The sensitive quantitation analysis can be made using the selected ion monitoring (SIM).

Methomyl can be analyzed by GC (/MS) in its underivatized form; but a method using the conversion of methomyl into methomyl-oxime by alkali, followed by silylation (TMS) for GC/MS, was reported [8]. This method is aimed to overcome the thermolability of underivatized methomyl, and a good mass spectrum including the molecular ion can be obtained for the methomyl-oxime-TMS (M.W. 177); the mass spectrum shows ions at  $m/z$  177 (molecular ion), 162, 130, 121 and 105. Chemical ionization (CI) mode is preferably used for quantitation, because it gives the base peaks at  $m/z$  178 and 197 of protonated ions of methomyl-oxime-TMS and *o*-methoxyphenol-TMS (IS). The quantitation can be made with peak area ratios of the ion at  $m/z$  178 to that at  $m/z$  197. The quantitative range is reported to be 0.1–6  $\mu\text{g/mL}$ ; the details of the method can be obtained from the reference [8].

## HPLC and LC/MS analysis

---

### HPLC conditions [11]

HPLC column<sup>q</sup>: Finepak SIL C<sub>18</sub> (25 cm  $\times$  4.6 mm i.d., particle size 5  $\mu\text{m}$ , Nihonbunko, Tokyo, Japan).

HPLC conditions; instrument: Shimadzu HPLC10A (Shimadzu Corp.); detector: UV (wavelength, 254 nm); mobile phase: methanol/distilled water (65:35, v/v); its flow rate: 1 mL/min.

### LC/MS conditions [10]

LC column: NucleosilC18 5  $\mu\text{m}$  (15 cm  $\times$  1.0 mm i.d., Polymer Laboratories, Marseille, France).

LC/MS conditions; MS instrument: PE-Biosystems AP100 (PE Biosystems, Marseille, France); HPLC pump: Shimadzu LC10AD (Shimadzu Corp.); autosampler: Series 200 Perkin-Elmer (Perkin-Elmer, Courtaboeuf, France); mobile phase: gradient 30–80 % acetonitrile/2 mM ammonium formate (pH 3); its flow rate: 50  $\mu\text{L/min}$ ; ionization mode: ion spray (+5 keV).

### Assessment of the method

The analysis of carbamate pesticides by HPLC is much inferior to that by capillary GC in resolution ability, but does not suffer from decomposition of analytes by heat. In HPLC analysis of

■ **Table 4.4**

Retention times and detection limits (on-column) of carbamate pesticides obtained by HPLC

Carbamate	Retention time (min)	Detection limit (ng)
methomyl-oxime	3.5	35
methomyl	4.0	54
metolcarb (MTMC)	5.4	10
propoxur (PHC)	5.5	16
carbaryl (NAC)	6.3	45
ethiofencarb	6.4	12
xylylcarb (MPMC)	6.5	11
XMC (macball)	6.8	6
isoprocarb (MIPC)	6.9	11
EMPC	7.1	35
fenobucarb	8.6	9
terbucarb	23.0	2
allylcarb (APC)	25.0	7

methomyl and methomyl-oxime, the peaks are frequently interfered with by a solvent peak; to avoid the problem, the ratio of water content of the mobile phase is increased to about 50 %. There are various detectors commercially available for HPLC; they are useful for improving specificity<sup>r</sup> and sensitivity<sup>s</sup>.

➤ *Table 4.4* shows retention times and detection limits for carbamate pesticides obtained under the above HPLC-UV conditions.

The analysis by LC/MS has been established recently; it requires no concern about the decomposition by heat and also give mass spectra. The method is very useful for qualitative analysis and enables sensitive quantitation in the SIM mode. ➤ *Table 4.5* shows ions selected

■ **Table 4.5**

Selected ions for qualitative and quantitative LC/MS analysis of carbamate pesticides

Carbamate	Selected ion ( <i>m/z</i> )	
	Quantitative	Qualitative
aldicarb	89	116
ethiofencarb	107	–
methomyl	88	106
carbaryl	145	155
carbofuran	123	165
chlorpropham	172	126
methiocarb	121	169
pirimicarb	239	182
formetanate	110	93
fenoxycarb	302	88
propham	138	120

for qualitative and quantitative analyses. The sensitivity obtained by SIM of LC/MS is as high as that of GC/MS.

## Toxic and fatal concentrations

Although the number of fatalities due to carbamate pesticide poisoning is not small in the world, the reports on their concentrations in blood and organs are not many. The concentrations reported in literature and measured in the author's laboratories are summarized in [▶ Table 4.6](#).

The blood methomyl concentrations in fatalities by its poisoning is 0.6–57 µg/mL (mean concentration in 13 cases, 20 µg/mL) [3, 8, 12–14]. When the blood methomyl concentrations of survived subjects, after ingestion followed by treatments, are also taken into consideration, the fatal blood concentration of methomyl is estimated not lower than 1.0 µg/mL.

The respective blood concentrations of carbofuran, benfuracarb and furathiocarb after their ingestion for suicidal purposes are as follows. The blood carbofuran concentrations in 7 fatality cases after ingestion of the pesticide only were 0.32–29.3 µg/mL ( $n = 7$ , average 9.2 µg/mL) [7, 10, 15, 16]. The blood benfuracarb concentrations after its ingestion were 0.30–2.32 µg/mL ( $n = 3$ , average 0.98 µg/mL) and the blood concentrations of carbofuran, the metabolite of benfuracarb, were not lower than 1.45 µg/mL [6], suggesting that benfuracarb is rapidly metabolized into carbofuran in human bodies. After furathiocarb ingestion, its blood concentrations were 0.1–21.6 µg/mL ( $n = 7$ , average 3.6 µg/mL); but carbofuran, also the metabolite of furathiocarb, has never been analyzed simultaneously<sup>t</sup> [5]. As shown in [▶ Table 4.1](#), the acute toxicities of furathiocarb and benfuracarb in rats are 8–30 times less than that of carbofuran; the both compounds are metabolized into a highly toxic metabolite carbofuran in mammals. In furathiocarb and benfuracarb poisoning cases, carbofuran should be analyzed simultaneously.

In fatal cases of propoxur poisoning, its blood concentrations were 0.3–41.1 µg/mL ( $n = 6$ , average 10.7 µg/mL) [17] and ethanol was also detected from blood in many cases. This suggests that ethanol enhances the toxicity of propoxur.

## Notes

- a) Many of carbamate pesticides are generally decomposed by alkali and occasionally by strong acids. The contact of carbamate pesticides with strongly alkaline and acidic compounds should be avoided. Carbosulfan is decomposed even by weak acids. The metabolism of carbamate pesticides is rapid and gives unstable intermediate metabolites [1]. In this chapter, the methods for analysis of the metabolites are not dealt with.
- b) The standard metabolic solution contains aldicarb, ethiofencarb, oxamyl, carbaryl, fenobucarb, bendiocarb and methiocarb (10 µg/mL each). It is useful for the testing of retention times and as the standards for quantitative analysis.
- c) In GC and GC/MS analysis, one or two of carbofuran, carbaryl and ethion (an organophosphorus compound) are used as IS(s) according to retention time(s) of target compound(s). The peak of ethion appears at about 27 min by GC analysis (DB-5). The solutions of the above ISs should be prepared at the final concentration of 5 or 20 µg/mL.

■ **Table 4.6**

**Blood concentrations of carbamate pesticides in their fatal poisoning cases**

Carbamate	Subject No.	Blood conc. (µg/mL)	Ref.
methomyl	1	0.7	[3]
	2	1.4	
	3	44.0 (1 h)	[8]
	4	0.6	[12]
	5	35.0 4.0 (Al)	[13]
	6	57.0 3.2 (Al)	
	7	8.0 0.5 (Al)	
	8	5.6	
	9	28.0	
	10	4.8	
	11	19.1	
	12	12.8	[14]
	13	43.2	
	average	20.0	
carbofuran	1	8.0	[15]
	2	29.3	[16]
	3	11.6	[7]
	4	10.0	
	5	4.0	
	6	0.32	
	7	1.5	[10]
	average	9.2	
benfuracarb	1	2.32 (NA)	[6]
	2	0.31 1.47 (CA)	
	3	0.30 1.45 (CA)	
	average	0.98 1.46 (CA)	
furathiocarb	1	21.6	[5]
	2	0.7	
	3	0.1	
	4	1.0	
	5	0.4	
	6	0.32	
	7	0.8	
	average	3.6	
propoxur	1	1.3 0.10 (Al)	[17]
	2	13.6 2.26 (Al)	
	3	0.6 1.67 (Al)	
	4	7.5 0.04 (Al)	
	5	41.1 1.38 (Al)	
	6	0.3 0.07 (Al)	
	average	10.7	

NA: not analyzed; CA: carbofuran (µg/mL); Al: ethanol (mg/mL); 1 h: 1 h after ingestion.

- d) When a high concentration of a carbamate pesticide is present in stomach contents, 10 volumes of acetone is added to the specimen, mixed and centrifuged; the supernatant solution directly or after condensation can be analyzed by GC or GC/MS.
- e) For urine or other relatively clean specimens, 1 mL of it is mixed with 5 mL ethyl acetate, shaken and centrifuged to separate the ethyl acetate layer without the use of the separating funnel. The same extraction procedure is repeated two times, and the organic layers are combined, and then subjected to the step vi.
- f) In the solid-phase extraction with a Sep-Pak C<sub>18</sub> cartridge, the flow rate should not be higher than 3 mL/min (the speed at drop by drop). To prevent the lower recovery rates, the Sep-Pak C<sub>18</sub> cartridge should not be dried through the whole procedure. Under the wet conditions, the recovery rates are about 100 %.  
An Oasis HLB cartridge (Waters) with a polymer-resin base does not give low recoveries due to drying up. According to a report by Waters, an Oasis HLB cartridge is activated by passing *t*-butyl methyl ether, methanol and distilled water, 3 mL each, through it. A specimen solution diluted with buffer solution at pH 3 containing a carbamate pesticide is poured into the cartridge, followed by washing with distilled water and 5 % methanol solution, 3 mL each, and by elution with 6 mL of 5 % methanol/*t*-butyl methyl ether. The recovery is not lower than 90 %.
- g) If necessary, the mixture is centrifuged to obtain clear supernatant solution.
- h) It is possible to pass it through a water-repellant filter paper (Advantec, 2S) to remove water.
- i) For GC and GC/MS analysis, this procedure is necessary; for HPLC analysis, the dehydration is not necessary, because the mobile phase contains water.
- j) Acetonitrile acts to shorten the life span of the FTD and should not be used.
- k) There is no lowering of recovery rates due to drying up of the Oasis MCX cartridge.
- l) For GC and GC/MS analysis, anhydrous Na<sub>2</sub>SO<sub>4</sub> should be added for dehydration of the combined eluates.
- m) Fused silica wide-bore capillary columns with the same stationary phases can be used.
- n) An FID can be also used, though many impurity and solvent peaks may appear, resulting in much lower sensitivity.
- o) When the injection temperature is high, the carbamate pesticides are decomposed; relatively low injection temperature should be used.
- p) Even for compounds exhibiting almost no molecular peaks in the EI mode, relatively intense (not lower than 40 %) protonated molecular peaks can be obtained in the CI mode [4, 9].
- q) Even with the similar ODS columns, the retention times are greatly different according to manufacturers and lots, and should be confirmed using the authentic standard for each column.
- r) Using a photodiode array detector (DAD), it is possible to make tentative identification of a compound by comparing the absorption spectrum of a test compound with that of the authentic one.
- s) When *N*-methylcarbamate pesticides are heated in NaOH solution, methylamine is produced. The methylamine can react with *o*-phthalaldehyde and 2-mercaptoethanol to form a highly fluorescent compound. Various HPLC systems equipped with the post-column labelling method are commercially available from various manufacturers. Using this method, aldicarb-sulfoxide, aldicarb- sulfone, oxamyl, methomyl, 3-hydroxycarbofuran,

aldicarb, propoxur, carbofuran, carbaryl and methiocarb can be analyzed at ppb levels simultaneously.

- t) Carbofuran as a metabolite of furathiocarb has never been analyzed. This does not mean “not detectable”, but means “not determined”. If it is analyzed, an appreciable amount of carbofuran seems to be detected.

## References

- 1) Tomlin CDS (ed) (1997) *The Pesticide Manual*. 11th edn. British Crop Protection Council, Surrey
- 2) National Research Institute of Police Science (ed) (1997–2001) *Annual Case Reports of Drug and Toxic Poisoning in Japan*, Nos. 38–43. National Police Agency, Tokyo, (in Japanese)
- 3) Araki M, Yonemitsu K, Kambe T et al. (1982) Forensic toxicological investigations on fatal cases of carbamate pesticide methomyl (Lannate®) poisoning. *Jpn J Legal Med* 36:584–588 (in Japanese with an English abstract)
- 4) Suzuki O, Hattori H, Liu J et al. (1990) Positive-and negative-ion mass spectrometry and rapid clean-up of some carbamate pesticides. *Forensic Sci Int* 46:169–180
- 5) Lee SK, Ameno K, In SW et al. (1999) Acute fatal poisoning cases due to furathiocarb ingestion. *Forensic Sci Int* 101:65–70
- 6) Lee SK, Ameno K, Yang JY et al. (1999) Forensic toxicological implication of acute fatal poisoning cases due to benfuracarb ingestion. *Int J Legal Med* 112:268–270
- 7) Ameno K, Lee SK, In SW et al. (2001) Blood carbofuran concentrations in suicidal ingestion cases. *Forensic Sci Int* 116:59–61
- 8) Miyazaki T, Yashiki M, Kojima T et al. (1989) Fatal and non-fatal methomyl intoxication in an attempted double suicide. *Forensic Sci Int* 42:263–270
- 9) Tsunoda N, Kishi T (1988) Mass spectra of pesticides 4. *N*-Methylcarbamate pesticides. *Rep Natl Res Inst Police Sci* 41:85–91 (in Japanese)
- 10) Lacassie R, Marquet P, Gaulier J-M et al. (2001) Sensitive and specific multiresidue methods for the determination of pesticides of various classes in clinical and forensic toxicology. *Forensic Sci Int* 121:116–123
- 11) Tsunoda N (1985) Analysis of *N*-methylcarbamate pesticides by high-performance liquid chromatography. *Forensic Toxicol News* 3 (3):33–34 (in Japanese)
- 12) Driskell WJ, Groce DF, Hill RH Jr et al. (1991) Methomyl in the blood of a pilot who crashed during aerial spraying. *J Anal Toxicol* 5:339–340
- 13) Tsatsakis AM, Tsakalof AK, Siatitsas Y et al. (1996) Acute poisoning with carbamate pesticides: the Cretan experience. *Sci Justice* 36:35–39
- 14) Tsatsakis AM (1998) More fatal methomyl poisoning in Crete. *Sci Justice* 38:282–283
- 15) Picotte P, Perreault P (1991) Suicide with carbofuran. *Bull Int Assoc Forensic Toxicol* 21 (2):38–40
- 16) Ferslew KE, Hagardorn AN, McCormick WF (1992) Poisoning from oral ingestion of carbofuran (Furadan 4F), a cholinesterase-inhibiting carbamate insecticide and its effects on cholinesterase activity in various biological fluids. *J Forensic Sci* 37:337–344
- 17) Pfordt J, Magerl H, Vock R (1987) Tödliche Vergiftungen mit Propoxur®. *Z Rechtsmed* 98:43–48

## II.7.5 Paraquat and diquat

by Chiaki Fuke

### Introduction

Since 1965, when the paraquat herbicide had started to be sold, its poisoning cases increased year by year. However, in 1986, mixture products of paraquat plus diquat with lower toxicity appeared; just after this year, the number of cases of poisoning by paraquat (plus diquat) decreased suddenly, followed by the gradual decrease until now, but the paraquat (plus diquat) poisoning cases still count as much as about 40 % of the total number of pesticide poisoning [1].

It is necessary to separately detect paraquat and diquat, when specimens obtained from a victim of poisoning by a paraquat-containing product are analyzed. For simultaneous analysis of paraquat and diquat, the methods by HPLC [2–5], GC [6], double wavelength spectrophotometry [7] and second-derivative spectrophotometry [8] were reported. In this chapter, the methods for analysis of paraquat and diquat by simple and rapid second-derivative spectrophotometry and by highly sensitive HPLC are described.

### Second-derivative spectrophotometry

---

#### Reagents and their preparation

- A 13.8-mg amount of paraquat dichloride<sup>a</sup> (Sigma, St. Louis, MO, USA and other manufacturers) is dissolved in 10 mL distilled water (1 mg/mL as paraquat ion).
- A 18.7-mg amount of diquat dibromide<sup>a</sup> (Wako Pure Chemical Industries, Ltd., Osaka, Japan) is also dissolved in 10 mL distilled water (1 mg/mL as diquat ion).
- Deproteinization reagent: 10 g sulfosalicylic acid is dissolved in 100 mL distilled water.
- Chromogenic reagents<sup>b</sup>: for plasma use, 87 mg of sodium hydrosulfite ( $\text{Na}_2\text{S}_2\text{O}_4$ ) is dissolved in 10 mL of 5 M NaOH solution; for urine use, 435 mg sodium hydrosulfite dissolved in 10 mL of 0.5 M NaOH solution.

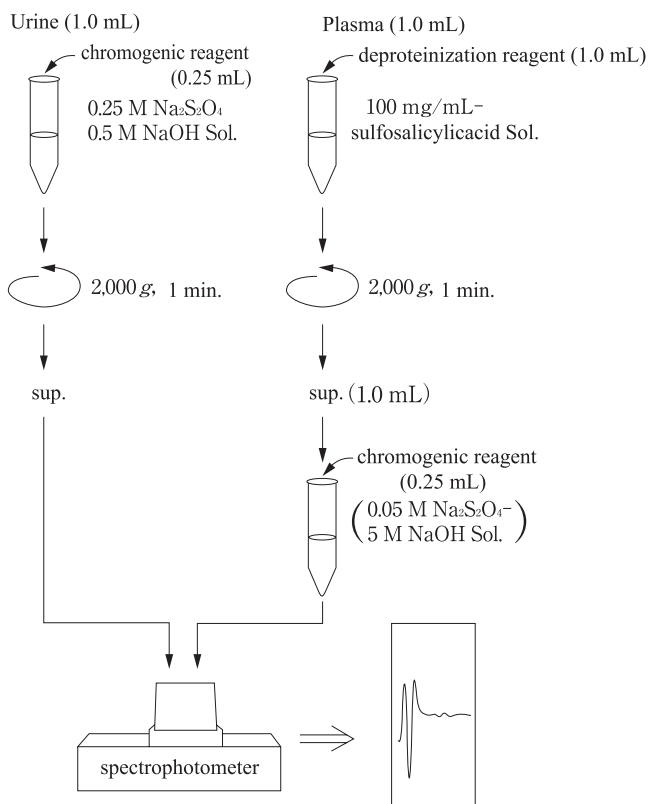
#### Analytical conditions

Instrument<sup>c</sup>: a UV-260 spectrophotometer with a differential analyzing system (Shimadzu Corp., Kyoto, Japan); cell: quartz-made semimicro-cell;

Measurements: a zero-order spectrum (360–500 nm; wavelength space  $\Delta\lambda=0.5$  nm) is first measured and then it is second-differentiated (derivative wavelength space  $\Delta\lambda=4$  nm).



■ **Figure 5.1**



**Pretreatment procedures for paraquat and diquat in urine and plasma before the second-derivative spectrophotometric analysis.**

## Procedures

The procedures for urine and blood plasma specimens are shown in [▶ Figure 5.1](#).

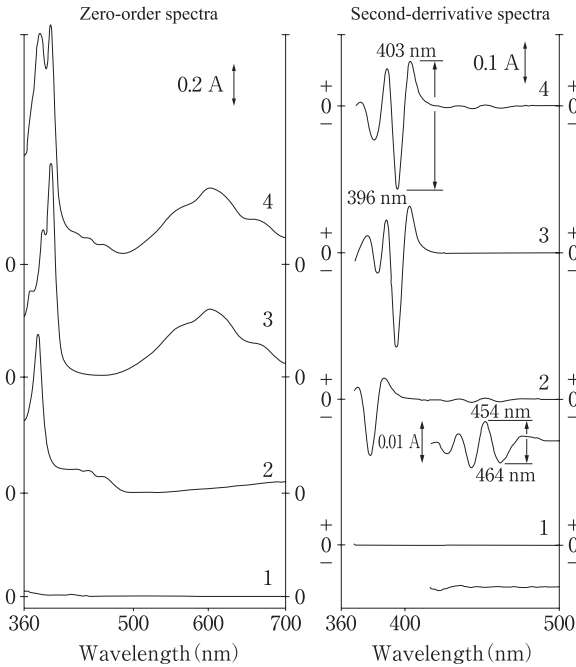
### i. Procedure for plasma

- i. A 1.0-mL volume of blood plasma is mixed well with 1.0 mL of the deproteinization reagent solution.
- ii. The mixture is centrifuged at 2,000 g for 5 min.
- iii. A 1.0-mL volume of the supernatant solution is mixed with 0.25 mL of the chromogenic reagent for plasma, and analyzed immediately<sup>d</sup>.

### ii. Procedure for urine

A 1.0-mL volume of urine is mixed with 0.25 mL of the chromogenic reagent solution for urine and centrifuged at 2,000 g for 1 min; the supernatant solution is subjected to analysis<sup>d</sup>.

Figure 5.2



Zero-order and second-derivative spectra after deproteinization and reduction. 1: blank plasma; 2: diquat-spiked plasma; 3: paraquat-spiked plasma; 4: paraquat plus diquat-spiked plasma. The concentration of the compounds was 10  $\mu\text{g}/\text{mL}$  each.

## Assesemet of the method

By this method, the analytical results can be obtained in a relatively short time; it is actually useful for analysis in emergency rooms. However, when high concentrations of hemoglobin and/or bilirubin are present, the measurements become difficult due to their interference.

➤ Figure 5.2 shows zero-order and second-derivative absorption spectra for blood plasma, into which paraquat and/or diquat (10  $\mu\text{g}/\text{mL}$  each) had been spiked. The qualitative analysis is made by observing the presence of inflection points at about 396 and 403 nm for paraquat and at 437, 445, 454 and 464 nm for diquat. The quantitation is made with amplitudes measurable between 396 and 403 nm for paraquat and between 454 and 464 nm for diquat (➤ Figure 5.2).

The calibration curves are constructed by spiking various concentrations of paraquat or diquat into blank specimens, and processing in the same way as above. The quantitative ranges for paraquat and diquat in blood plasma obtainable by this method are 0.5–10.0 and 1.0–10.0  $\mu\text{g}/\text{mL}$ , respectively; those in urine are 0.25–5.0 and 0.5–5.0  $\mu\text{g}/\text{mL}$ , respectively.

## HPLC analysis

---

In this section, the analysis for diquat-monopyridone and diquat-dipyridone, the metabolites of diquat, are described together with that for paraquat and diquat.

### Reagents and their preparation

- Standard solutions of paraquat and diquat (1 mg/mL each) are prepared as described in the second-derivative spectrophotometry section.
- Diquat-monopyridone was extracted from rat liver homogenate, which had been incubated with diquat at 37 °C for 24 h, and crystallized in methanol [9].
- Paraquat-dipyridone and diquat-dipyridone were synthesized according to Calderbank et al. [10].
- Ethyl paraquat diiodide (ethyl viologen)<sup>e</sup> was synthesized by the method of Philips et al. [11]; 10 mg of the compound is dissolved in 10 mL distilled water (1 mg/mL) as a stock solution. It is diluted 10-fold with distilled water to prepare 100 µg/mL solution (internal standard solution-1, IS-1).
- A 10-mg aliquot of 2-acetamidophenol (Aldrich, Milwaukee, WI, USA and other manufacturers) is dissolved in 1 mL methanol and diluted 10-fold with distilled water (internal standard solution-2, IS-2).

### HPLC conditions

#### i. Conditions for paraquat, diquat and diquat-monopyridone

Instruments; pump: LC-10 AS; detectors<sup>f</sup>: SPD-10A and RF-10A<sub>XL</sub> (all from Shimadzu Corp.); column: Puresil C<sub>18</sub> (150 × 4.6 mm i.d., particle size 5 µm, Waters, Milford, MA, USA); guard column: Guard-Pak Puresil C<sub>18</sub> (Waters); column temperature: room temperature; mobile phase<sup>g</sup>: 10 mM sodium octanesulfonate, 10 mM triethylamine and 500 mM potassium bromide aqueous solution is adjusted to pH 3.0 with phosphoric acid; its flow rate: 1 mL/min; detection wavelength: 290 nm for the UV detector; fluorescence detector: Ex = 350 nm, Em = 460 nm; injection volume: 20 µL.

#### ii. Conditions for diquat-dipyridone

The instruments and columns used are the same as described above; column temperature: room temperature; mobile phase: acetonitrile/distilled water (6:94, v/v); its flow rate: 1 mL/min; detection wavelength: 250 nm for the UV detector; fluorescence detector: Ex = 350 nm, Em = 430 nm; injection volume: 20 µL.

## Procedures

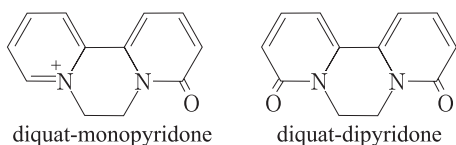
### i. Paraquat, diquat and diquat-monopyridone

- i. A 1-mL or 1-g amount of a specimen<sup>h</sup> is mixed with 10  $\mu$ L of the IS-1 solution.
- ii. For a body fluid specimen, the above solution is mixed with 1 mL of 10 % trichloroacetic acid solution with stirring<sup>i</sup>. For an organ tissue specimen<sup>h</sup>, the mixture at the step i) is mixed with 1 mL distilled water, followed by addition of 5 mL of 10 % trichloroacetic acid solution with stirring<sup>i</sup>.
- iii. Each protein-denatured solution is centrifuged at 2,000 g for 10 min to obtain clear supernatant solution.
- iv. The sediment is again extracted twice with 1 mL each of 10 % trichloroacetic acid solution (with stirring and centrifugation).
- v. The supernatant solutions are combined and adjusted to about pH 11<sup>j</sup> with 2 M NaOH solution.
- vi. It is poured into a Sep-Pak C<sub>18</sub> cartridge<sup>k</sup> (classic type, Waters), which had been activated by passing 5 mL methanol, 5 mL distilled water, 5 mL of 0.1 M hydrochloric acid solution and 5 mL distilled water through it.
- vii. The cartridge is washed with 5 mL water, 3 mL methanol and 5 mL distilled water; target compounds including IS are eluted with 4 mL of 0.1 M HCl solution.
- viii. The eluate is evaporated to dryness<sup>l</sup> under a stream of nitrogen using a boiling water bath.
- ix. The residue is dissolved in 100  $\mu$ L of the mobile phase and centrifuged at 12,000 g for 5 min; 20  $\mu$ L of the supernatant solution is injected into HPLC.
- x. For constructing a calibration curve, various concentrations of a target compound plus IS are added to blank specimens, and treated as above; a peak area ratio of a target compound to IS-1 for a specimen is applied to the above calibration curve to obtain its concentration.

### ii. Diquat-dipyridone

- i. A 0.1-mL or 0.1-g amount of a specimen<sup>h</sup> is mixed with 5  $\mu$ L of the IS-2 solution.
- ii. A 0.1-mL volume of distilled water and 1 mL methanol are added to the above mixture with stirring.
- iii. It is centrifuged at 2,000 g for 5 min to obtain supernatant solution.
- iv. The sediment is again extracted with 1 mL methanol (with stirring and centrifugation).
- v. The supernatant solutions are combined.
- vi. The combined methanolic extract is washed with 2 mL hexane twice<sup>m</sup> (with vortex-mixing and centrifugation).
- vii. The methanolic layer is evaporated to dryness under a stream of nitrogen with heating at 50 °C in a water bath.
- viii. The residue is dissolved in 100  $\mu$ L mobile phase and centrifuged at 12,000 g for 5 min; 20  $\mu$ L of the supernatant solution is injected into HPLC.
- ix. The quantitation is made by the internal calibration method as described in the last part of the above (1) section using IS-2.

■ **Figure 5.3**



**Structures of diquat-monopyridone and diquat-dipyridone.**

## Assessment of the method

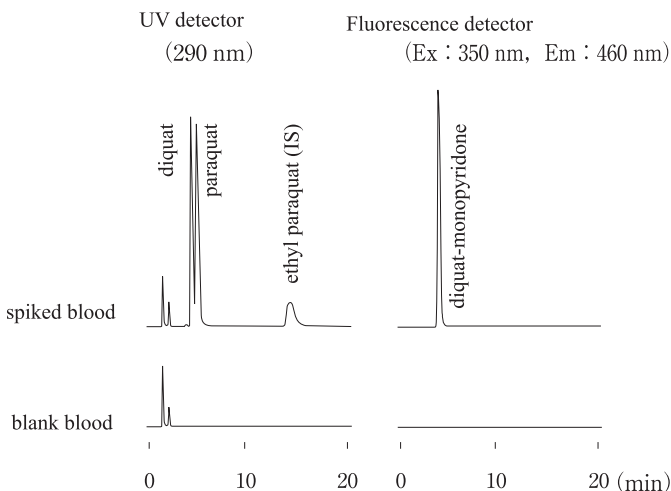
► *Figure 5.3* shows structures of diquat-monopyridone and diquat-dipyridone. Diquat-monopyridone shows the absorption maximum at 363 nm and emits intense fluorescence having its maximum at 462 nm. Diquat-dipyridone shows the absorption maximum at 365 nm and emits intense fluorescence having its maximum at 429 nm. These compounds are detectable with high sensitivity using a fluorescence detector [12].

► *Figure 5.4* shows HPLC chromatograms for blank blood specimens and for those spiked with 1 µg/mL each of paraquat and diquat, and spiked with 0.1 µg/mL diquat-monopyridone. In the blank blood chromatograms, there were no interfering impurity peaks.

There was excellent linearity in the range of 0.1–10 µg/mL for paraquat and diquat, and in the range of 0.01–1 µg/mL for diquat-monopyridone. The detection limit for both paraquat and diquat is 0.5 ng on-column; that for diquat-monopyridone 0.02 ng on-column.

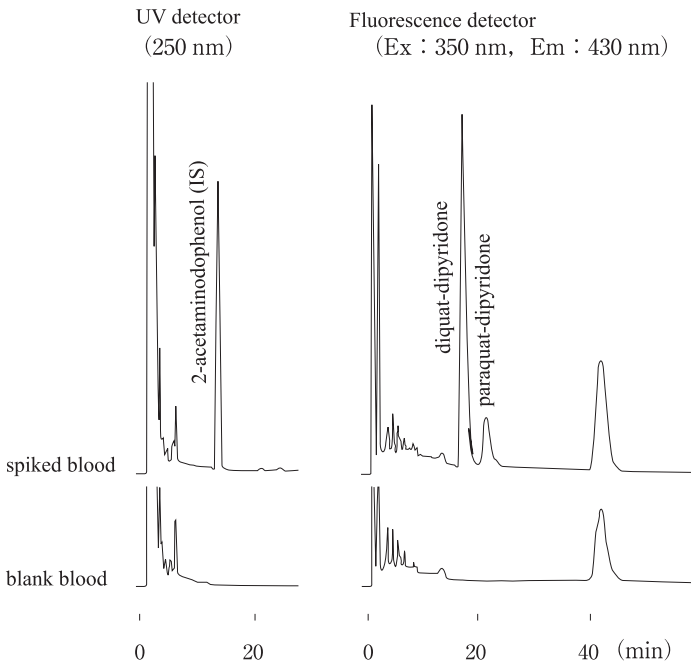
The recovery rates were not lower than 80 % for paraquat, diquat and ethyl paraquat and not lower than 60 % for diquat-monopyridone using Sep-Pak C<sub>18</sub> cartridges. Diquat-dipyridone is not recovered by the solid-phase extraction.

■ **Figure 5.4**



**HPLC chromatograms for extracts of blood in the presence and absence of paraquat, diquat and diquat-monopyridone. The concentrations were: 1 µg/mL for paraquat and diquat; 0.1 µg/mL for diquat-monopyridone.**

■ **Figure 5.5**



**HPLC chromatograms for extracts of blood in the presence and absence of diquat-dipyridone and paraquat-dipyridone. The concentration of each compound was 0.1  $\mu\text{g}/\text{mL}$ .**

► *Figure 5.5* shows HPLC chromatograms for blank blood specimens and for those spiked with 0.1  $\mu\text{g}/\text{mL}$  diquat-dipyridone and paraquat-dipyridone. In the blank chromatograms, there were no interfering impurity peaks.

There was excellent linearity for diquat-dipyridone in the range of 0.01–1  $\mu\text{g}/\text{mL}$ . The recovery rates for diquat-dipyridone and 2-acetamidophenol (IS) from blood specimens were not lower than 85 %.

## Poisoning case

A 42-year-old male was found dead in a parking automobile. Since a positive result could be obtained for the urine specimen by a screening test using hydrosulfite reaction, his specimens were subjected to HPLC analysis. The results obtained are summarized in ► *Table 5.1*.

After paraquat is absorbed into a human body, its majority is excreted into urine in 48 h; blood paraquat concentrations rapidly decrease according to times after ingestion. These phenomena are also true for diquat. The blood concentration in this case was equally 0.6  $\mu\text{g}/\text{mL}$  for both paraquat and diquat at the femoral vein. The concentration is relatively lower than those reported in fatal cases, in which the mixtures of paraquat and diquat had been ingested. Therefore, the antemortem time after ingestion was estimated for the above case. According to the reports by Yoshioka et al. [13] and Ameno et al. [14], the plasma concentrations of para-

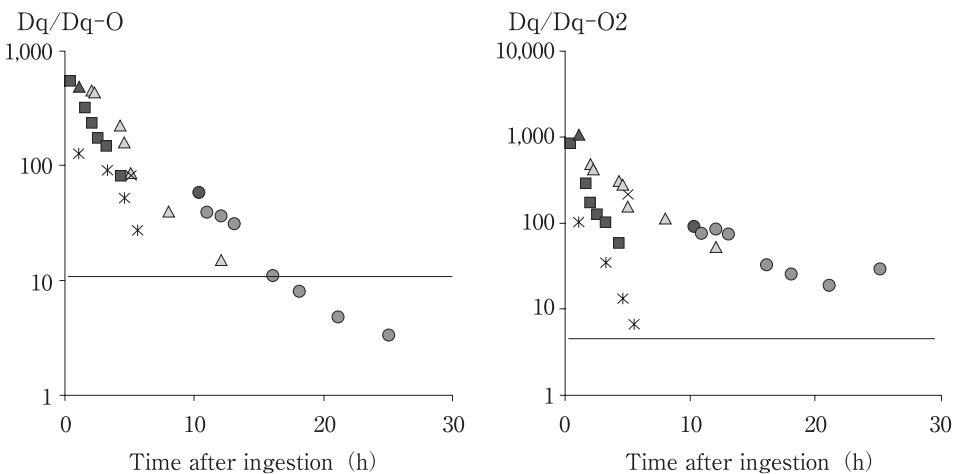
■ **Table 5.1**

Concentrations of paraquat, diquat and diquat metabolites in specimens obtained at autopsy from a poisoned victim ( $\mu\text{g}/\text{mL}$  or g)

Specimen		Paraquat	Diquat	Diquat-monopyridone	Diquat-dipyridone
blood	left heart	0.8	0.6	0.07	0.13
	right heart	1.0	0.5	0.10	0.12
	femoral vein	0.6	0.6	0.05	0.11
urine		10.1	11.2	0.82	0.12
stomach contents		3.9	2.6	0.15	0.12
liver		3.9	2.0	0.51	0.25
brain		0.5	0.5	0.03	0.10

quat are almost equal to those of diquat within 24 h after ingestion of a mixture herbicide product of paraquat and diquat. After 24 h, the diquat concentration become lower than that of paraquat. Since the blood paraquat concentration in the femoral vein was almost equal to that for diquat, the antemortem time until death may be shorter than 24 h. The diquat-monopyridone and diquat-dipyridone concentrations in the femoral vein of the above case were 0.05 and 0.11  $\mu\text{g}/\text{mL}$ , respectively (▶ *Table 5.1*). Since the blood concentration ratios of diquat to diquat-monopyridone or diquat-dipyridone were found to decrease according to times after ingestion using five poisoning cases as shown in ▶ *Figure 5.6* [15], the ratio values of the above case for the femoral vein (12 and 5.45, respectively) were applied to the decreasing curve; it was estimated that more than 12 h had passed from the ingestion until death (▶ *Figure 5.6*).

■ **Figure 5.6**



Concentration ratios of diquat to diquat-monopyridone or diquat-dipyridone as a function of time after ingestion. Dq/Dq-O: diquat concentration : diquat-monopyridone; Dq/Dq-O2: diquat concentration : diquat-dipyridone concentration.

## Notes

- a) Since paraquat dichloride and diquat dibromide include water crystal, they should be heated at 100 °C for 2 h to remove water and kept in a dessicator. After cooling to room temperature, the weighing of the compounds should be made under dry conditions very rapidly.
- b) The chromogenic reagent should be prepared just before use and be consumed within 2 h.
- c) Any spectrophotometric instrument equipped with the second-differential function can be used, regardless of its manufacturer.
- d) Distilled water is processed in the same way and used as the reference. When some of the similar specimens are analyzed successively, the same reference solution can be used without change.
- e) Ethyl paraquat is very suitable for IS and can be added at the initial step of the extraction procedure. This compound is useful for correcting the errors produced during the extraction procedure. Ethyl paraquat is being sold as ethyl viologen (Aldrich).
- f) The detectors should be connected in series (a UV detector first followed by a fluorescence detector).
- g) Since the profile for separation of paraquat from diquat is different in each column, the composition of the mobile phase should be optimized for each column.
- h) The organ tissue is crushed with a homogenizer into a paste state at the first step.
- i) Without stirring, the surface layer may be clotted, resulting in insufficient mixing.
- j) After alkalization, the test solution should be immediately poured into the Sep-Pak C<sub>18</sub> cartridge, followed by washing with distilled water, because paraquat and diquat are easily decomposed under alkaline conditions; this is more marked for diquat.
- k) The flow rate through the Sep-Pak C<sub>18</sub> cartridge is preferably about 2.5 mL/min. When the air is incorporated into the cartridge, the recovery rate may be decreased.
- l) To dry the eluate up, an evaporator or a freeze-drier can be also used. When a large number of specimens have to be dried up, the use of the freeze-drier is convenient. Since the eluate contains hydrochloric acid, care should be taken to clean the device used for evaporation to avoid corrosion by the acid after use.
- m) The washing with hexane can be omitted for specimens with small amounts of lipids, such as urine and serum.

## References

- 1) National Research Institute of Police Science (ed) (2001) Annual Case Reports of Drug and Toxic Poisoning in Japan, No.43. National Police Agency, Tokyo, p 2 (in Japanese)
- 2) Gill R, Qua SC, Moffat AC (1983) High-performance liquid chromatography of paraquat and diquat in urine with rapid sample preparation involving ion-pair extraction on disposable cartridges of octadecyl-silica. *J Chromatogr* 255:483–490
- 3) Fuke C, Ameno K, Shirakawa Y et al. (1992) Simultaneous determination of paraquat and diquat in biological materials using high performance liquid chromatography and its application to poisoned patients. *Jpn J Toxicol* 5:387–393 (in Japanese with an English abstract)
- 4) Ito S, Nagata T, Kudo K et al. (1993) Simultaneous determination of paraquat and diquat in human tissues by high-performance liquid chromatography. *J Chromatogr* 617:119–123
- 5) Kage S, Kudo K, Fukushima S et al. (1998) Selective determination of paraquat and diquat in blood by high-performance liquid chromatography and high-performance liquid chromatography/mass spectrometry. *Jpn J Forensic Toxicol* 16:34–41



- 6) Kawase S, Kanno A, Ukai S (1984) Determination of the herbicides paraquat and diquat in blood and urine by gas chromatography. *J Chromatogr* 283:231–240
- 7) Tayama J, Komatsu M, Doy M et al. (1991) Simultaneous measurement of paraquat and diquat in serum by wavelength spectrophotometry. *Jpn J Toxicol* 4:157–162 (in Japanese with an English abstract)
- 8) Fuke C, Ameno K, Ameno S et al. (1987) Simultaneous analysis of paraquat and diquat in serum and urine by second-derivative spectroscopy. *Igakunoayumi* 143:657–658 (in Japanese)
- 9) Fuke C, Ameno K, Ameno S et al. (1993) In vitro studies of the metabolism of paraquat and diquat using rat liver homogenates – isolation and identification of the metabolites of paraquat and diquat. *Jpn J Legal Med* 47:33–45 (in Japanese with an English abstract)
- 10) Calderbank A, Charlton DF, Farrington JA et al. (1972) Bipyridylum quaternary salts and related compounds. Part IV. Pyridones derived from paraquat and diquat. *J Chem Soc* 10:138–142
- 11) Phillips AP, Mentha J (1955) Synthetic hypotensive agents. III. Some 4,4'-bipiperidenes. *J Am Chem Soc* 77:6393–6395
- 12) Tsuchihashi H, Tatsuno M, Ohtsuki K et al. (1988) Simultaneous analysis of paraquat and diquat by high-performance liquid chromatography with oxidation. *Eisei Kagaku* 34:31–35 (in Japanese with an English abstract)
- 13) Yoshioka T, Hirade A, Kishikawa M et al. (1989) Effects of dilution of paraquat concentration and of mixing of diquat on lifesaving ratios – the comparison between poisoning cases with old and new pesticide products. *Jpn J Toxicol* 2:31–38 (in Japanese)
- 14) Ameno K, Fuke C, Shirakawa Y et al. (1994) Different distribution of paraquat and diquat in human poisoning cases after ingestion of a combined herbicide. *Arch Toxicol* 68:134–137
- 15) Fuke C, Ameno K, Ameno S et al. (1996) Detection of two metabolites of diquat in urine and serum of poisoned patients after ingestion of a combined herbicide of paraquat and diquat. *Arch Toxicol* 70:504–507

## 11.7.6 Cresol

by Chiaki Fuke

### Introduction

Cresol is being used for an antiseptic, disinfectant, maggot-killing agent and cresol soap solution. Since various kinds of more powerful and odorless disinfectants have nowadays become available in practical use, the frequency in the use of cresol seems decreasing. However, the cases of acute poisoning by cresol are still being reported at the present time.

The toxic effects of cresol are due to its corrosive actions, resulting in the destruction of cell membranes and coagulation of proteins, and its suppressive action on the central nervous system [1]. There are three isomeric forms of cresol, *vis.*, *o*-, *m*- and *p*-cresols; the toxicity of each isomer is somewhat different [2]. The composition ratios of cresol isomers are different according to cresol-containing products; it, therefore, seems very important to measure the concentrations of each isomer of cresol to identify a causative cresol product used in its poisoning case.

Cresol, after being absorbed into human bodies, is metabolized into glucuronide- and/or sulfate-conjugated forms and excreted into urine. The half-life of unchanged cresol in blood is as short as about 1.5 h [3]; this means that it becomes undetectable several hours after emergency treatments. However, the metabolites (conjugated forms) remain in the body for relatively a long time [4–6]; the detection of the conjugated form(s) sometimes becomes necessary.

As methods for analysis of cresol, GC [4, 7–9], HPLC [5, 6, 10–14] and capillary electrophoresis [15] were reported. In this chapter, procedures for HPLC and GC/MS analysis of cresol isomers and their conjugates are presented.

### HPLC analysis

---

#### Reagents and their preparation

- A 10-mg aliquot each of *o*-, *m*- and *p*-cresols (Aldrich, Milwaukee, WI, USA and other manufacturers) is dissolved in 10 mL methanol separately (1 mg/mL).
- A 10-mg aliquot of 4-ethylphenol<sup>a</sup> (internal standard, IS, Aldrich and other manufacturers) is dissolved in 10 mL methanol (1 mg/mL).
- $\beta$ -Glucuronidase: 10 mg of bovine liver glucuronidase (EC 3.2.1.31, type B-10, 11,000 units/mg solid, Sigma, St. Louis, MO, USA) is dissolved in 1 mL distilled water.
- Sulfatase: *Aerobacter aerogenes* sulfatase (EC 3.1.6.1, 19 units/mL, Sigma).

#### HPLC conditions

Instruments; pump: LC-10A; detectors: SPD-10A and RF-10A (all from Shimadzu Corp., Kyoto, Japan); column: a Nova-Pak C<sub>18</sub> stainless cartridge column (150 × 3.9 mm i.d., particle size

4  $\mu\text{m}$ , Waters, Milford, MA, USA); guard column: Guard-Pak Nova-Pak  $\text{C}_{18}$  (Waters); mobile phase<sup>b</sup>: acetonitrile/20 mM potassium dihydrogenphosphate buffer solution (pH 3.0, to be adjusted with phosphoric acid) (1:4, v/v), containing 20 mM  $\beta$ -cyclodextrin (Sigma and other manufacturers); its flow rate: 1.0 mL/min; detection wavelength: 270 nm for the UV detector; fluorescence detector: Ex 270 nm and Em 305 nm; injection volume: 20  $\mu\text{L}$ .

## Procedures

### i. Analysis of unconjugated forms

- i. A 100- $\mu\text{L}$  volume of a specimen<sup>c</sup> is mixed with 10  $\mu\text{L}$  of IS solution.
- ii. A 100- $\mu\text{L}$  volume of acetonitrile is added to the above mixture with stirring<sup>d</sup>.
- iii. It is centrifuged at 12,000 g for 10 min.
- iv. A 20- $\mu\text{L}$  aliquot of the supernatant solution is injected into HPLC.
- v. Various concentrations (not less than 4 plots) of a cresol isomer plus 10  $\mu\text{L}$  of IS solution are added to blank specimens and processed in the same way to construct a calibration curve. The concentration of a cresol isomer in a test specimen is calculated with the curve.

### ii. Analysis of the glucuronide-conjugated forms

- i. A 100- $\mu\text{L}$  volume of a specimen<sup>c</sup> is mixed with 10  $\mu\text{L}$  of IS solution.
- ii. A 5- $\mu\text{L}$  volume of 4 M sodium acetate buffer solution (pH 5.0) and 5  $\mu\text{L}$  of  $\beta$ -glucuronidase solution are added to the above mixture and incubated at 37 °C for 2 h.
- iii. After cooling to room temperature, 100  $\mu\text{L}$  acetonitrile is placed in the above mixture with stirring.
- iv. The following procedure is achieved according to the iii–v steps of the above section.

### iii. Analysis of the sulfate-conjugated forms<sup>e</sup>

- i. A 100- $\mu\text{L}$  volume of a specimen<sup>c</sup> is mixed with 10  $\mu\text{L}$  of the IS solution.
- ii. A 5- $\mu\text{L}$  volume of 2.5 M Tris-HCl buffer solution (pH 7.5) and 5  $\mu\text{L}$  of sulfatase are added to the above mixture and incubated at 37 °C for 2 h.
- iii. After cooling to room temperature, 100  $\mu\text{L}$  acetonitrile is added to the above mixture with stirring.
- iv. The following procedure is achieved according to the iii–v steps of the above section for analysis of unconjugated forms.

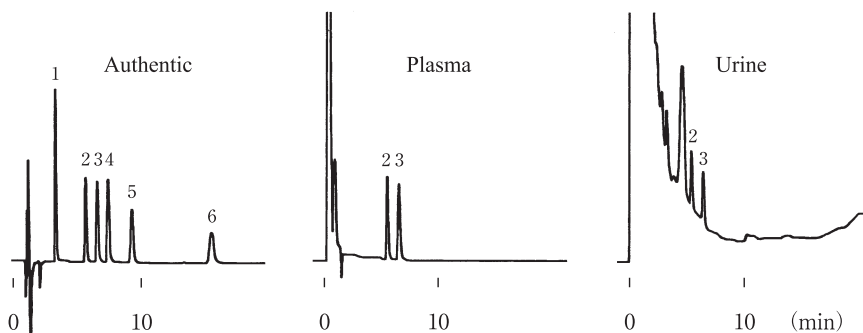
## Assessment of the method

In this method, the pretreatment procedures are very simple and thus enable rapid analysis of cresol isomers and their conjugates. It does not include no condensation step; it means that there is no concern about low recovery rates due to loss of a test compound caused by evaporation. However, a great difference in composition ratio of acetonitrile in the supernatant solution may affect the peak area ratio of cresol to IS; it is preferable to fix the composition ratio of acetonitrile before injection into HPLC.

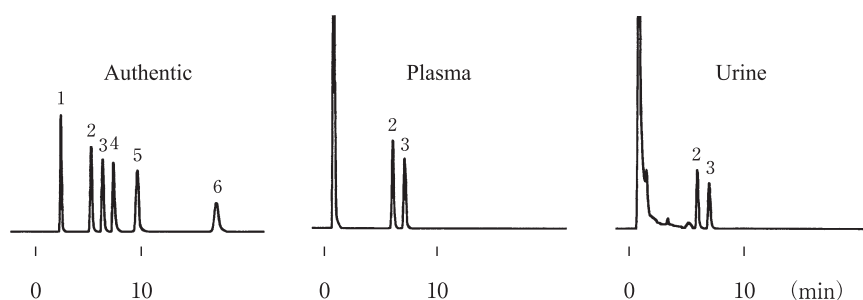
➤ *Figure 6.1* shows HPLC chromatograms for the authentic cresol isomers and related compounds and for extracts of plasma or urine of a poisoning case. The cresol isomers are

■ **Figure 6.1**

UV detector (270 nm)



Fluorescence detector (Ex : 270 nm, Em : 305 nm)



**HPLC chromatograms for the authentic standard cresol isomers and related compounds (10 µg/mL each) and for extracts of plasma and urine of a poisoning case. 1: phenol; 2: *p*-cresol; 3: *m*-cresol; 4: *o*-cresol; 5: 4-ethylphenol; 6: 2,4-xylenol.**

completely separated from each other; in addition, the test peaks are not interfered with by phenol or xylenol being contained in the cresol soap solution commercially available.

With the UV detector, the quantitative range for each cresol isomer is 1–100 µg/mL; the detection limit is 0.1 µg/mL. For the urine specimen, the impurity peaks interfere with that of *p*-cresol; it is difficult to measure *p*-cresol at low concentration (not higher than 1 µg/mL) by HPLC-UV detection.

By using a fluorescence detector, the specificity and sensitivity are increased; the detection limit of cresol isomers by HPLC-fluorescence detection is 0.01 µg/mL.

The concentration of a conjugated form can be calculated by subtracting the amount of a free form of a cresol isomer from its total amount obtained after enzymatic hydrolysis.

## GC/MS analysis

### Reagents and their preparation

*o*-, *m*- and *p*-Cresols and IS are prepared according to the section of reagents and preparation of the HPLC analysis.

### GC/MS conditions

Instrument: an HP 6890 Series GC/MS instrument (Agilent Technologies, Palo Alto, CA, USA).

Condition 1: Column: HP-5 Trace Analysis (30 × 0.25 mm i.d., film thickness 0.25 μm, Agilent Technologies); carrier gas: He (1.0 mL/min); column (oven) temperature: 50 °C (4 min) → 20 °C/min → 300 °C (3.5 min); injection volume: 1 μL (splitless); injection temperature: 300 °C; detector temperature: 280 °C.

Condition 2: Column: DB-WAX (60 m × 0.32 mm i. d., film thickness 0.5 μm, J & W Scientific, Folsom, CA, USA); carrier gas: He (1.0 mL/min); column temperature: 200 °C; injection volume: 1 μL (splitless); injection temperature: 250 °C; detector temperature: 280 °C.

### Procedure

- i. An Oasis HLB (3 cc, 60 mg) cartridge (Waters, Milford, MA, USA) is activated by passing 3 mL methanol and 3 mL distilled water.
- ii. A 0.1-mL volume of a specimen<sup>f</sup> is mixed with 0.9 mL distilled water and 10 μL IS solution, and poured into the activated cartridge.
- iii. The test tube, which had contained the specimen, is rinsed with 1 mL distilled water; the rinsed water is also poured into the cartridge.
- iv. The cartridge is washed with 1 mL distilled water, and the water inside the cartridge is removed by aspiration under reduced pressure.
- v. The target compound(s) and IS are eluted with 1 mL ethyl acetate.
- vi. The organic eluate is condensed<sup>g</sup> into about 100 μL under a stream of nitrogen with warming at 50 °C.
- vii. A 1-μL aliquot of it is injected into GC/MS.

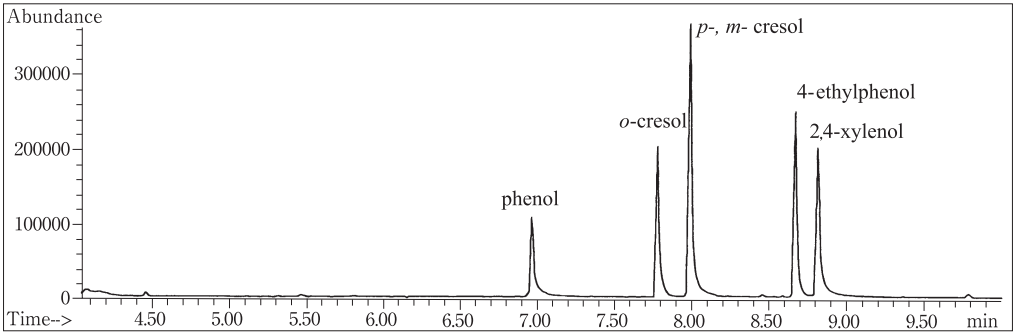
### Assessment of the method

➤ *Figure 6.2* shows total ion chromatograms (TICs) for the authentic cresol isomers and related compounds (10 μg/mL each). When non-polar and slightly polar columns (HP-1 or HP-5) are used, *p*-cresol cannot be separated from *m*-cresol. With use of a DB-WAX column, such separation can be achieved (➤ *Figure 6.2*, lower panel).

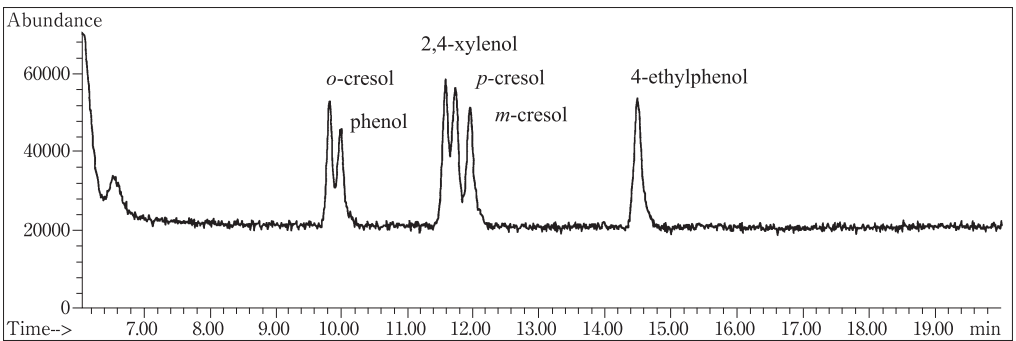
The relative recovery rate of cresol isomers as compared with that of IS was 98 %; their detection limit in the scan mode is about 1 ng on-column.

**Figure 6.2**

HP-5 column



DB-WAX column

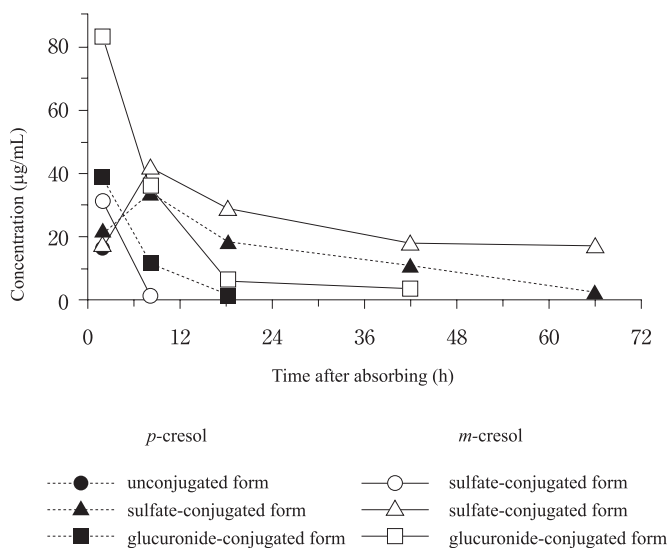


TICs by GC/MS for the authentic cresol isomers and related compounds (10 µg/mL each in ethyl acetate) using different GC columns.

## Poisoning cases, and toxic and fatal concentrations

**Cresol poisoning case due to its percutaneous absorption:** a male child was playing on a slide in a park, and slid into a puddle with his buttocks getting wet with water probably containing a large amount of cresol. After 30 min, he fell into a disturbance of consciousness, underwent treatments at an emergency hospital and was discharged 24 days after, because of improvement of his conditions. The time courses of plasma concentrations of cresol isomers and their conjugates, measured by HPLC, are shown in [▶ Figure 6.3](#). The plasma concentrations of free, sulfate-conjugated and glucuronide-conjugated forms for *p*-cresol 2 h after the accident were 15.7, 21.3 and 38.6 µg/mL, respectively; those for *m*-cresol 31.4, 17.0 and 82.9 µg/mL, respectively. After 8 h, the concentrations of sulfate-conjugated forms were higher than those of the glucuronide-conjugated forms, and detectable for a long time. The urinary concentrations at an early stage of admission were 17.4, 102 and 709 µg/mL for the free, sulfate-conjugated and glucuronide-conjugated forms of *p*-cresol, respectively; 12.0, 151 and 1,510 µg/mL for those of *m*-cresol, respectively.

■ Figure 6.3



**Time courses of plasma concentrations of cresol isomers and their conjugates in a cresol-poisoned patient after percutaneous absorption.**

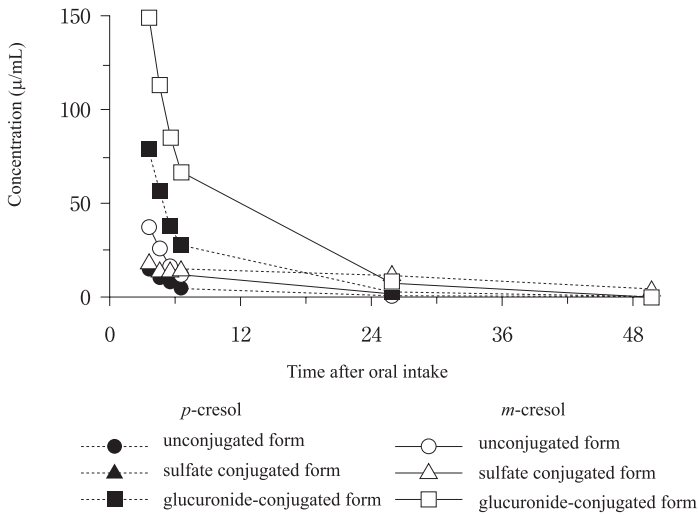
**Cresol poisoning case due to its oral intake:** a female ingested about 80 mL of cresol soap solution for suicidal purpose, underwent treatments, such as gastrolavage and hemophoresis and was remitted. The time courses of plasma concentrations of cresol isomers and their conjugates, measured by HPLC, are shown in [▶ Figure 6.4](#). The plasma concentrations 3.5 h after ingestion were 16.3, 19.6 and 78.5 µg/mL for the free, sulfate-conjugated and glucuronide-conjugated forms of *p*-cresol, respectively; 37.4, 18.7 and 147 µg/mL for those of *m*-cresol, respectively. The concentrations of glucuronide-conjugated forms were higher than those of sulfate-conjugated forms until several hours after ingestion; but the former concentrations become lower than the latter after 26 h ([▶ Figure 6.4](#)).

Phenol and *p*-cresol endogenously exist in humans, because they are produced during metabolic decomposition of tyrosine by enteric bacteria [11]. When plasma and urine specimens from 5 healthy subjects were analyzed, *p*-cresol sulfate-conjugate was found in plasma and urine at concentrations of  $0.4 \pm 0.3$  and  $31.0 \pm 14.4$  µg/mL, respectively; the concentration of *p*-cresol glucuronide-conjugate in urine was  $1.3 \pm 0.9$  µg/mL. The endogenous *p*-cresol concentrations in plasma are relatively low and give no problems upon analysis in acute poisoning; but with urine specimens, appreciable amounts of the endogenous *p*-cresol sulfate-conjugate should be taken into consideration.

Although there are numerous reports dealing with cresol poisoning, the reports describing cresol concentrations are not so many; they are listed in [▶ Table 6.1](#) [3–7, 14, 16–21].

Case 3 shows a high blood cresol concentration; but her cause of death was exsanguinations due to being stabbed in her abdomen. Case 5 died after treatments for 4 days; cresols were measured for the serum, which had been sampled about 24 h after ingestion, and were expressed as a total amount of phenols, but free phenol could not be detected. The victim in Case 6 with blood cresol concentration at only 10 ng/mL was suffering from severe liver cirrhosis,

Figure 6.4



Time courses of plasma concentrations of cresol isomers and their conjugates in a cresol-poisoned patient after its oral intake.

Table 6.1

Cresol poisoning cases

Case No.	Age	Sex	Amount of intake (mL)	Route	Blood or plasma concentration*		Time after intake (h)	Presence/absence of therapy	Outcome	Ref.
					unconjugated form	conjugated form				
1	74	F	–	oral	190	–	–	–	dead	[7]
2	76	F	–	oral	71	–	2	+	dead	[7]
3	52	M	–	oral	99	87	–	–	dead	[14]
4	1	M	–	percut.	120	–	4	+	dead	[16]
5	32	M	30	oral	0	90**	24	+	dead	[17]
6	48	F	–	oral	10	–	–	–	dead	[18]
7	46	M	100	oral	25	–	3	+	alive	[3]
8	46	M	100	oral	29	88	2	+	alive	[4]
9	7	M	–	percut.	47	160	2	+	alive	[5]
10	–	F	80	oral	54	264	3.5	+	alive	[6]
11	62	F	150	oral	9.5**	–	2	+	alive	[19]
12	37	F	100	oral	30	–	–	+	alive	[20]
13	19	M	500	percut.	30	–	11	+	alive	[21]
14	48	M	–	percut.	58**	–	1	+	alive	[21]

\*: cresol concentration, \*\*: cresol + phenol concentration, –: data not available, percut.: percutaneous.



and was thus considered exceptional as a fatal case. The blood concentrations of unconjugated cresol in fatal poisoning cases are 71–190 µg/mL.

In the survived Cases 7–14, the blood specimens were sampled at the first medical examination; the plasma concentrations of unconjugated cresol were 9.5–58 µg/mL.

## Notes

- a) 4-Ethylphenol to be used as IS may contain phenol and *p*-cresol as impurities. The contents of the impurities should be carefully checked before use.
- b) By adding β-cyclodextrin to the mobile phase, the separation of *p*-cresol from *m*-cresol can be realized.
- c) As a specimen, blood, plasma or urine can be used. When organ tissue is used, 1 g of it is put in 4 mL of cold distilled water, minced into small pieces with surgical scissors and homogenized with cooling with ice. The homogenate can be used as a specimen; but the cresol glucuronide-conjugates may be hydrolyzed by the coexisting glucuronidase, resulting in a higher concentration of the unconjugated cresols during the procedure.
- d) Without stirring, the surface layer of the specimen solution may be coagulated, hindering the solution from well-mixing.
- e) To analyze the sulfate-conjugated forms of cresol isomers in organ tissues, the effect of endogenous glucuronidase should be excluded by adding saccharolactone as an inhibitor of the enzyme.
- f) As a specimen, blood, plasma or urine can be used.
- g) The organic eluate should not be evaporated to dryness, because it causes very low recovery rates due to evaporation of free cresol isomers.

## References

- 1) Naito H (1991) Poisoning of Industrial Products, Gases, Pesticides, Drugs, and Natural Toxins – Cases, Pathogenesis and Its Treatment. 2nd edn. Nankodo, Tokyo, pp 65–67 (in Japanese)
- 2) Budavari S (1996) The Merck Index. 12th edn. Merck & Co., Whitehouse Station, pp 436–437
- 3) Kumano H, Kuroki H, Tsutsumi H et al. (1986) Cresol poisoning. The Pharmaceuticals Monthly 28:1697–1701 (in Japanese)
- 4) Yashiki M, Kojima T, Miyazaki T et al. (1990) Gas chromatographic determination of cresols in the biological fluids of a non-fatal case of cresol intoxication. Forensic Sci Int 47:21–29
- 5) Fuke C, Sakai Y, Yagita K et al. (1998) The quantitative analysis of cresols in a case of cresol poisoning following percutaneous absorption. Jpn J Toxicol 11:55–60 (in Japanese with an English abstract)
- 6) Fuke C, Morinaga Y, Arai T et al. (1999) Time course changes of cresols and their conjugates in plasma from two case of cresol poisoning. In: Tatsuno Y (ed) Proceedings of the 6th Indo Pacific Congress on Legal Medicine and Forensic Sciences. INPALMS-1998-KOBE, pp 808–811
- 7) Bruce AM, Smith H, Watson AA (1976) Cresol poisoning. Med Sci Law 16:171–176
- 8) Niwa T, Maeda K, Ohki T et al. (1981) A gas chromatographic-mass spectrometric analysis for phenols in uremic serum. Clin Chim Acta 110:51–57
- 9) Pendergrass SM (1994) An alternative method for the analysis of phenol and *o*-, *m*-, and *p*-cresol by capillary GC/FID. Am Ind Hyg Assoc J 55:1051–1054
- 10) Brega A, Prandini P, Amaglio C et al. (1990) Determination of phenol, *m*-, *o*- and *p*-cresol, *p*-aminophenol and *p*-nitrophenol in urine by high-performance liquid chromatography. J Chromatogr 535:311–316
- 11) Niwa T (1993) Phenol and *p*-cresol accumulated in uremic serum measured by HPLC with fluorescence detection. Clin Chem 39:108–111

- 12) Taguchi T, Horie T, Ogata M (1993) Sensitive simultaneous analysis of cresol isomers in urine by high-performance liquid chromatography. *Medicine and Biology* 126:187–191 (in Japanese)
- 13) Ogata N, Matsushiba N, Shibata T (1995) Pharmacokinetics of wood creosote, glucuronic acid and sulfate conjugation of phenolic compounds. *Pharmacology* 51:195–204
- 14) Fuke C, Ito A, Tamaki N et al. (1997) The analysis of cresols in biological materials from a case of cresol poisoning by high-performance liquid chromatography. In: Takatori T (ed) *Proceedings of the 14th Meeting of the International Association of Forensic Sciences, Vol. 2*. Shunderson Communications, Ottawa, pp 258–261
- 15) Masselter SM, Zemann AJ, Bobleter O (1993) Separation of cresols using coelectroosmotic capillary electrophoresis. *Electrophoresis* 14:36–39
- 16) Green MA (1975) A household remedy misused fatal cresol poisoning following cutaneous absorption, a case report. *Med Sci Law* 15:65–66
- 17) Arthurs GJ, Wise CC, Coles GA (1977) Poisoning by cresol. *Anaesthesia* 32:642–643
- 18) Kashimura S, Kageura M, Hara K et al. (1987) A case of severe liver cirrhosis, in which the victim died after ingesting an insecticide – death of disease or poisoning? *Res Pract Forensic Med* 30:171–175 (in Japanese with an English abstract)
- 19) Thomas BB (1969) Peritoneal dialysis and lysol poisoning. *Br Med J* 3:720
- 20) Ohashi N, Kiyono H (1988) Cresol and phenol. *Jpn J Acute Med* 12:1342–1346 (in Japanese)
- 21) Tabata T, Yoshioka T (1996) Percutaneous intoxication of cresol with or without phenol: report of two cases. *Jpn J Toxicol* 9:101–105 (in Japanese with an English abstract)

## II.7.7 Diazine and triazine herbicides

by Akira Ishii and Yoshinao Katsumata

### Introduction

Diazine and triazine herbicides are being widely used in the world. These herbicides inhibit the electron-transport system in the higher plants and thus suppress the photosynthesis, resulting in the herbicidal action. These compounds are also important as pollutants for crops, soil and groundwater [1, 2]. The attention is usually directed toward chronic toxicities of the herbicides [3]. Although the acute toxicities of the compounds are usually considered low, there are reports dealing with acute poisoning by them; they should be taken into consideration as poisoning-causative substances. As acute poisoning symptoms provoked by diazine and triazine herbicides, nausea, vomiting, skin- and mucosa-stimulating actions, contact dermatitis, circulation insufficiency, shock state, dyspnea, metabolic acidosis and renal insufficiency can be mentioned; as a subacute poisoning symptom, polyneuropathy due to triazines is known [4].

For analysis of diazine and triazine herbicides, methods by GC, GC/MS and immunoassays were reported. However, they were GC analysis of atrazine in bovine tissues [5], ELISA analysis of atrazine and its metabolites in human urine [6] and other methods dealing with surface-water and cow milk [7–9]. There are almost no reports on GC or GC/MS analysis of diazine and triazine herbicides in human body fluids except those reported by the authors' group [10, 11]. There is a review on analysis of herbicides in biomedical specimens from a broader point of view [12]. In this chapter, detailed procedures for GC analysis of diazine and triazine herbicides in human body fluids are described.

### Reagents and their preparation

#### i. Reagents

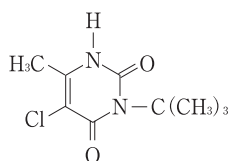
➤ *Figure 7.1* and ➤ *Table 7.1* show structures of diazine and triazine herbicides, respectively. The authentic standards of all herbicides can be purchased from either Wako Pure Chemical Industries, Ltd., Osaka, Japan or Kanto Chemicals, Tokyo, Japan. Other common chemicals used were of the highest purity commercially available.

#### ii. Preparation

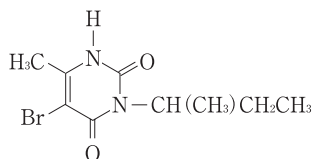
A 1-mg aliquot of each compound is dissolved in 1 mL methanol (1 mg/mL)<sup>a</sup> as a stock solution. The solution is diluted to a desired concentration with methanol just before use.

Figure 7.1

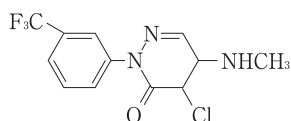
terbacil



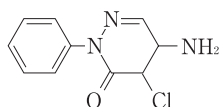
bromacil



norflurazon



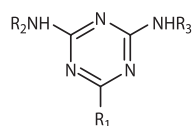
pyrazon



Structures of diazine herbicides.

Table 7.1

Structures of triazine herbicides



	R <sub>1</sub>	R <sub>2</sub>	R <sub>3</sub>
ametryn	SCH <sub>3</sub>	CH <sub>2</sub> CH <sub>3</sub>	CH(CH <sub>3</sub> ) <sub>2</sub>
atrazine	Cl	CH <sub>2</sub> CH <sub>3</sub>	CH(CH <sub>3</sub> ) <sub>2</sub>
cyanazine	Cl	CH <sub>2</sub> CH <sub>3</sub>	CCN(CH <sub>3</sub> ) <sub>2</sub>
prometon	OCH <sub>3</sub>	CH(CH <sub>3</sub> ) <sub>2</sub>	CH(CH <sub>3</sub> ) <sub>2</sub>
prometryn	SCH <sub>3</sub>	CH(CH <sub>3</sub> ) <sub>2</sub>	CH(CH <sub>3</sub> ) <sub>2</sub>
propazine	Cl	CH(CH <sub>3</sub> ) <sub>2</sub>	CH(CH <sub>3</sub> ) <sub>2</sub>
simazine	Cl	CH <sub>2</sub> CH <sub>3</sub>	CH <sub>2</sub> CH <sub>3</sub>
metribuzin			

## GC conditions

Columns: DB-1 and DB-17 fused silica capillary columns (both 30 m × 0.32 mm i.d., film thickness 0.25 µm, J & W Scientific, Folsom, CA, USA) used for diazine herbicides, and the DB-1 column used for triazine herbicides.

GC conditions for diazine herbicides; instrument<sup>b</sup>: a GC-4CM gas chromatograph (Shimadzu Corp., Kyoto, Japan); detector: FID; column (oven) temperature: 100 °C (1 min) → 10 °C/min → 280 °C; injection temperature: 230 °C; detector temperature: 280 °C; carrier gas: He; its flow rate: about 3 mL/min; injection mode: splitless (1 min).

GC conditions for triazine herbicides; instrument<sup>b</sup>: an HP5890 gas chromatograph (Agilent Technologies, Palo Alto, CA, USA); detector: FID or nitrogen-phosphorus detector (NPD)<sup>c</sup>; column (oven) temperature: 120 °C → 2.5 °C/min → 160 °C; other conditions the same as above.

## Procedures for diazine herbicides

### i. Liquid-liquid extraction

- i. A 1-mL volume of whole blood, containing diazine herbicides, (both target and IS compounds) is mixed with 1 mL distilled water and 2 mL diethyl ether, capped and shaken for 1 min.
- ii. After centrifugation at 3,000 rpm for 5 min, the ether layer is transferred to a vial. To the above aqueous layer, 2 mL diethyl ether is again added, shaken and centrifuged in the same way to obtain the second ether layer; this procedure is repeated once more to obtain the third ether layer. The three ether layers are combined and evaporated to dryness under a stream of nitrogen in the vial.
- iii. The residue is dissolved in 100 µL methanol, and a 1-µL aliquot of it is injected into GC.

### ii. Solid-phase extraction with Bond Elut C<sub>18</sub>

- i. A Bond Elut C<sub>18</sub> cartridge (Varian, Harbor City, CA, USA) is activated by passing 10 mL methanol and 20 mL distilled water; this procedure is repeated twice<sup>d</sup> to remove impurities being contained in the cartridge.
- ii. A 1-mL volume of plasma or urine, containing diazine herbicides (both target and IS compound), is mixed with 4 mL distilled water; in the case of whole blood, the 1-mL specimen is well mixed with 9 mL distilled water to hemolyze it completely.
- iii. The above sample solution is poured into the activated cartridge, followed by washing with 20 mL distilled water and elution with 3 mL of chloroform/methanol (9:1).
- iv. After a small amount of the upper aqueous layer is removed with a Pasteur pipette, the lower organic phase is evaporated to dryness under a stream of nitrogen. The residue is dissolved in 100 µL methanol, and a 1-µL aliquot of it is injected into GC.
- v. For determination of terbacil or bromacil, norflurazon (final, 5 µg/mL) is used as IS; for that of norflurazon or pyrazon, bromacil (final, 5 µg/mL) used as IS. Various amounts (0.16, 0.31, 0.63, 1.25, 2.5, 5.0 and 10 µg) of a target compound together with 5 µg of IS are spiked into 1-mL volume blank body fluid specimens and subjected to the above solid-phase extraction to construct a calibration curve. The peak area ratio of a target compound to IS obtained from a test specimen is applied to the calibration curve to calculate its concentration.

## Procedure for triazine herbicides

- i. A Sep-Pak C<sub>18</sub> cartridge (Waters, Milford, MA, USA) is washed with 10 mL methanol and 20 mL distilled water. This washing procedure is repeated not less than twice for activation<sup>d</sup>.
- ii. One of the triazine herbicides is chosen as IS (5 µg for FID and 0.5 µg for NPD) and spiked into 1-mL of a test serum or urine specimen, followed by dilution with 4 mL distilled water.
- iii. The above mixture is poured into the activated cartridge, followed by washing with 20 mL distilled water and elution with 3 mL of chloroform/methanol (9:1) or 3 mL chloroform only.
- iv. After a small amount of the upper aqueous layer is removed with a Pasteur pipette, the eluate is evaporated to dryness under a stream of nitrogen; the resulting residue is dissolved in 100 µL methanol and 1 µL of it is injected into GC. The quantitation procedure is essentially the same as described in the above v step of the solid-phase extraction for diazine herbicides.

## Assessment of the methods

### i. Diazine herbicides

▶ *Figure 7.2* shows gas chromatograms for diazine herbicides with various combinations of an extraction method and a GC column used. The left panels show the chromatograms for the authentic standard directly injected into GC (50 ng each on-column); the right panels those for the extracts of whole blood, into which 5 µg/mL each of diazine herbicides was spiked. It is clear that solid-phase extraction with a Bond Elut C<sub>18</sub> cartridge gives cleaner chromatograms than the liquid-liquid extraction with diethyl ether. This was also true for human serum and urine specimens.

Good linearity was observed in the range of 16 ng–10 µg/mL for diazines. Their detection limits were 1.2–1.4 ng on-column for whole blood and plasma and 1.1–1.2 ng on-column for urine.

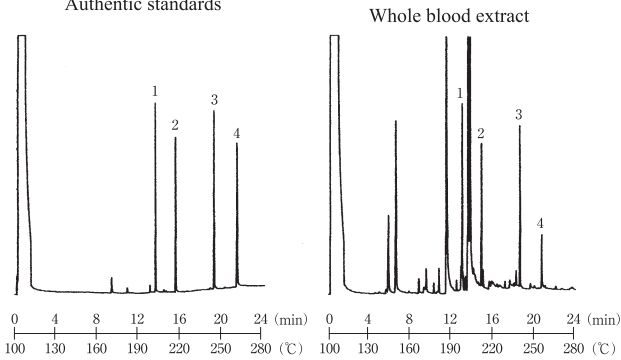
### ii. Triazine herbicides

▶ *Figure 7.3* shows gas chromatograms for triazine herbicides obtained by solid-phase extraction with Sep-Pak C<sub>18</sub> cartridges with different elution solvents and different detectors. The left panels show the chromatograms for the authentic triazine herbicides directly injected into GC (50 ng each on-column for the FID and 5 ng each on-column for the NPD); the right panels those for the extracts of serum specimens, into which 5 µg/mL each of triazine herbicides was spiked. There was almost no difference between elutions with chloroform only and chloroform/methanol (9:1); but the time required for evaporation of the eluates was much shorter for the chloroform only than for the chloroform/methanol mixture. The recovery rates for the FID detection were not less than 65 and 97 % for the serum and urine specimens, respectively. The detection limits by the FID detection were 2 and 14 ng on-column for propazine and simazine, respectively.

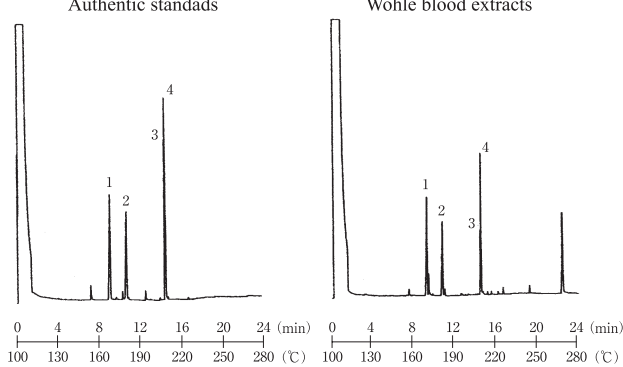
In the chromatograms with the NPD detector, slight tailing was observed for all peaks, because this phenomenon becomes more obvious at the ten times lower concentration (5 ng

Figure 7.2

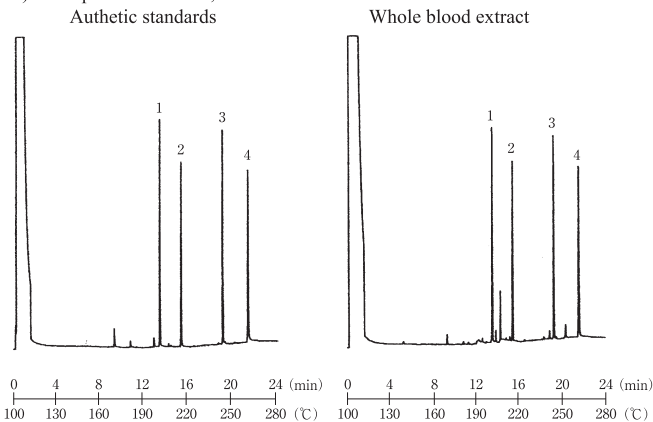
1) Liquid-liquid extraction, DB-1  
Authentic standards



2) Solid-phase extraction, DB-1  
Authentic standards



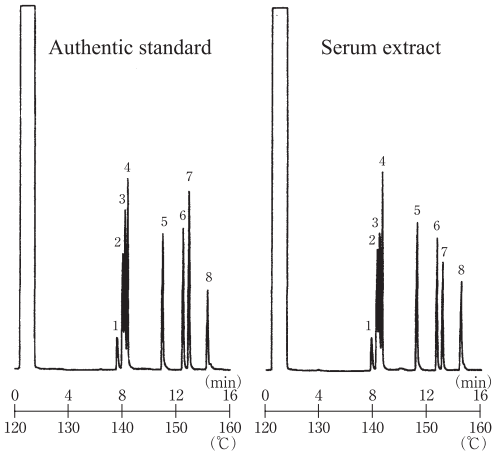
3) Solid-phase extraction, DB-17  
Authentic standards



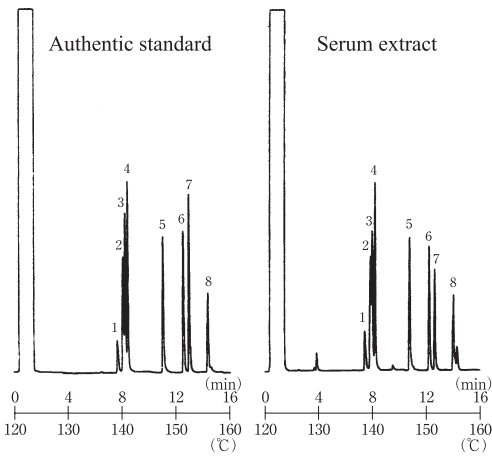
**GC-FID chromatograms for diazine herbicides using different extraction methods and GC capillary columns. 1: terbacil; 2: bromacil; 3: norflurazon; 4: pyrazon. For the authentic standards, the amount for injection was 50 ng on-column each; into the blank blood specimens, 5 µg/mL each of the compounds was spiked.**

Figure 7.3

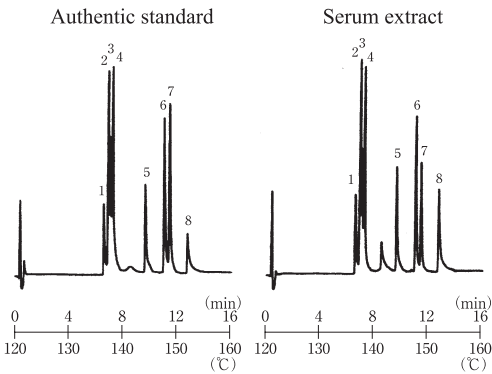
1) Solid-phase extraction,  $\text{CHCl}_3$  elution, FID



2) Solid-phase extraction,  $\text{CHCl}_3/\text{MeOH}$  (9:1) elution, FID



3) Solid-phase extraction.  $\text{CHCl}_3$  elution, NPD





on-column for the authentic standards and 0.5 µg/mL in the serum specimen). The recovery rates were not less than 60 and 78 % for serum and urine, respectively; it was more than 100 % for cyanazine. The sensitivity with NPD was about ten times higher than with FID; the detection limits of triazines with NPD were 0.2–0.6 ng on-column.

## Poisoning cases and toxicities

**Case 1 [13]:** a 38-year-old male ingested 500 mL of a herbicide product containing 100 g atrazine, 25 g aminotriazole (amitrole), 25 g ethylene glycol and 0.15 g formaldehyde. The plasma atrazine concentration was 2.0 µg/mL 1 h after the ingestion. Although the treatment of metabolic acidosis, hemodialysis and administration of ethanol against the ethylene glycol poisoning were carried out, he provoked coma, circulation insufficiency, metabolic acidosis, bleeding from the digestive tract, necrosis of hepatic cells and DIC, and died 3 days later.

**Case 2 [3]:** an adult male ingested 1,000 g of a 50 % atrazine powder product; when he was vomiting and being excited, he was found by his family member. At an early stage, atropine was administered to him, because organophosphorus herbicide poisoning was suspected. Fortunately he recovered without any severe poisoning symptom except only a slight one due to atropine.

The LD<sub>50</sub> values for diazine herbicides are said to be about 5 g/kg in humans; those for triazine herbicides except cyanazine 1–5 g/kg [14].

## Notes

- a) The herbicides dissolved in methanol at 1 mg/mL is stable for at least 2–3 weeks at 4 °C.
  - b) Any type of gas chromatograms for capillary columns can be used, regardless of its manufacturer.
  - c) It is the same as a flame thermionic detector (FTD) and is specific for compounds including nitrogen or phosphorus in their structures; they are being sold by many manufacturers.
  - d) In the original method reported by Suzuki et al. [15], they used chloroform/methanol (9:1), methanol and distilled water, 10 mL each, for activation. When this procedure is applied to a recent product of C<sub>18</sub> cartridges, the elevation of baselines and impurity peaks due to the cartridge matrix are frequently observed. It is recommendable to simply use methanol and distilled water for washing and activation to obtain good results.
- ◀ **Gas chromatograms for the authentic triazine herbicides and solid-phase extracts of serum specimens, into which triazine herbicides had been spiked. 1: simazine; 2: atrazine; 3: prometon; 4: propazine; 5: metribuzin; 6: ametryn; 7: prometryn; 8: cyanazine. For the authentic standards, 50 ng each of the compounds was injected on-column, and 5 µg each was spiked into 1 mL serum to detect peaks with an FID in the panels 1) and 2). With an NPD, the amounts were reduced to 5 ng each on-column and 0.5 µg each spiked into 1 mL serum, respectively, in the panel 3). The GC column used was a DB-1 medium-bore capillary (30 m × 0.32 mm i. d., film thickness 0.25 µm).**

## References

- 1) Alva AK, Singh M (1990) Sorption of bromacil, diuron, norflazon, and simazine at various horizons in two soils. *Bull Environ Contam Toxicol* 45:365–374
- 2) Reddy KN, Singh M, Alva AK (1992) Sorption and leaching of bromacil and simazine in Florida flatwoods soils. *Bull Environ Contam Toxicol* 48:662–670
- 3) Loosli R (1995) Epidemiology of atrazine. *Rev Environ Contam Toxicol* 143:47–57
- 4) Tanaka J (2000) Poisoning data card No. 119, triazinic herbicides. *Jpn J Toxicol* 13:111–113 (in Japanese)
- 5) Jowett PLH (1986) Tissue levels of atrazine in a case of bovine poisoning. *Vet Hum Toxicol* 28:539–540
- 6) Lucas AD, Jones AD, Goodrow MH et al. (1993) Determination of atrazine metabolites in human urine: development of a biomarker of exposure. *Chem Res Toxicol* 6:107–116
- 7) Ferenbaugh RW, Spall WD, LaCombe DM (1981) Detection of bromacil herbicide in ponderosa pine. *Bull Environ Contam Toxicol* 27:268–273
- 8) Thurman EM, Meyer M, Pomes M et al. (1990) Enzyme-linked immunosorbent assay compared with gas chromatography/mass spectrometry for the determination of triazine herbicides in water. *Anal Chem* 62:2043–2048
- 9) Viden I, Rathouská Z, Davídek J et al. (1987) Use of gas liquid chromatography/mass spectrometry for triazine herbicide residues analysis in forage and milk. *Z Lebensm Unters Forsch* 185:98–105
- 10) Lee XP, Kumazawa T, Sato K (1995) Rapid extraction and capillary gas chromatography for diazine herbicides in human body fluids. *Forensic Sci Int* 72:199–207
- 11) Kumazawa T, Sato K, Seno H et al. (1992) Rapid isolation with Sep-Pak C<sub>18</sub> cartridges and capillary gas chromatography of triazine herbicides in human body fluids. *Forensic Sci Int* 54:159–166
- 12) Kumazawa T, Suzuki O (2000) Separation methods for amino group-possesing pesticides in biological samples. *J Chromatogr B* 747:241–254
- 13) Pommery J, Mathieu M, Mathieu D et al. (1993) Atrazine in plasma and tissue following atrazine-aminotriazone-ethylene glycol-formaldehyde poisoning. *J Toxicol Clin Toxicol* 31:323–331
- 14) Naito H (2001) Poisoning of Industrial Products, Gases, Pesticides, Drugs, and Natural Toxins – Cases, Pathogenesis and Its Treatment –, 2nd edn. Nankodo Co., Ltd., Tokyo, pp 290–292 (in Japanese)
- 15) Suzuki O, Kumazawa T, Seno H et al. (1989) Rapid isolation with Sep-Pak C<sub>18</sub> cartridges and wide-bore capillary gas chromatography of some barbiturates. *Med Sci Law* 29:242–248

## II.7.8 Coumarin rodenticides

by Shouichi Sato

### Introduction

As coumarin rodenticides, warfarin, coumatetralyl, coumafuryl, coumachlor and bromadiolone are commercially available in Japan. The coumarin rodenticides do not show direct anticoagulant action causing bleeding, but inhibit the metabolic cycle of vitamin K; the inhibition causes the interference with protein biosynthesis of vitamin K-dependent coagulant factors (II, VII, IX and X factors) in the liver, which are very important for the blood coagulation system. The lowered coagulant factors cause the bleeding deaths of the rodents [1]. Warfarin, coumatetralyl or coumafuryl is not effective with single administration, but becomes effective by repeated intakes of a small amount of each poison for 4–5 days successively. Coumachlor and bromadiolone are much more potent and long-lasting rodenticides with long biological half-lives; they provoke poisoning signs and symptoms, which last for a long time, only with their single administration [2]. Such a potent rodenticide is called “super-warfarin”.

Warfarin is also very popular as an oral anticoagulant drug for treatment and prevention of thromboembolism.

Although the analysis of coumarin rodenticides and anticoagulants is carried out largely by HPLC [3, 4], a GC/MS method for analysis of 4 rodenticides is presented in this chapter.

### Reagents and their preparation

- Coumarin rodenticides can be obtained in the forms of crystals or powder. They are slightly water-soluble and almost stable under storage at room temperature [4].
- Standard compounds: warfarin and coumachlor can be purchased from Sigma (St. Louis, MO, USA); coumatetralyl and bromadiolone from Wako Pure Chemical Ind., Ltd. (Osaka, Japan). A 100-mg aliquot each is dissolved in 100 mL methanol (1 mg/mL) as a stock solution. To use one of them as internal standard (IS), the above solution is diluted 10-fold with 50 % methanol aqueous solution (100 µg/mL). The above solutions should be stored at 4 °C under light-shading conditions.
- Mixed standard solution for calibration curves: 1-mL aliquots of the above 4 stock solutions (1 mg/mL) is mixed with 9 mL of 50 % methanol aqueous solution (final volume 10 mL, 100 µg/mL for each compound).
- Spiked serum solutions for the calibration curves [5]: 50-, 10-, 1- and 0.3-µL volumes of the above mixed standard solution (100 µg/mL) are spiked into 1-mL volume blank serum specimens (final concentration, 5, 1, 0.1 and 0.03 µg/mL, respectively).
- 30 % Methanol buffer solution: 70 mL of 0.1 M citrate buffer solution (pH 6.0) is mixed with 30 mL methanol.
- Extraction solvent: chloroform/isopropanol (9:1, v/v).
- Derivatization reagents: trimethylsilyldiazomethane (TMS-DAM, 10 %, v/v in hexane, GL Sciences, Tokyo, Japan), *N*-methyl-*N*-(*tert*-butyldimethylsilyl)trifluoroacetamide (MTBSTFA)

and *N,O*-bis(trimethylsilyl)trifluoroacetamide (BSTFA) (both from Pierce, Rockford, IL, USA, and other manufacturers).

- Serum: pooled serum obtained from healthy subjects.

## GC/MS conditions

GC column: a DB-5MS methylsilicone medium-bore capillary column (30 m × 0.25 mm i.d., film thickness 0.25 μm, J & W Scientific, Folsom, CA, USA).

Conditions; GC/MS instrument: Shimadzu GCMS-QP5050A (Shimadzu Corp., Kyoto, Japan); column (oven) temperature: 210 °C (1 min, splitless) → 10 °C/min → 330 °C (3 min); injection temperature: 250 °C; carrier gas: He; flow rate: 0.9 mL/min (sampling time, 2 min); interface temperature: 250 °C; detector temperature: 250 °C; ion source: EI; electron energy: 70 eV.

Ions selected for quantitation: those shown in [▶ Table 8.1](#).

## Procedure

- A 0.5-mL volume of a specimen<sup>a</sup> is mixed with 1 mL of 0.1 M citrate buffer solution<sup>b</sup> (pH 6.0) and 20 μL IS solution<sup>c</sup>.
- The solution is poured into an activated Oasis<sup>®</sup>HLB cartridges<sup>d,e,f</sup> (Waters, Milford, MA, USA).
- The cartridge is washed with 3 mL purified water and 3 mL of 30 % methanol buffer solution<sup>g</sup>.

■ **Table 8.1**

### Molecular formulae and mass spectral ions for coumarin rodenticides (anticoagulants)

Common name (IUPAC)	Molecular formula	M.W.	DI*	Principal mass spectral ions ( <i>m/z</i> )			DP**
				ME derivative	TMS derivative	TBDMS derivative	
Warfarin (3-( $\alpha$ -acetylbenzyl)-4-hydroxycoumarin)	C <sub>19</sub> H <sub>16</sub> O <sub>4</sub>	308.4	265	279	337	261	131
			103	322	193	379	103
			131	91	380	423	145
Coumatetralyl (3-[1-(2-furyl)-3-oxobutyl]-4-hydroxycoumarin)	C <sub>19</sub> H <sub>16</sub> O <sub>3</sub>	292.4	292	306	364	407	–
			121	175	260	349	
			188	202	245	321	
Coumachlor (3-[1-(4-chlorophenyl)-3-oxobutyl]-4-hydroxycoumarin)	C <sub>19</sub> H <sub>15</sub> ClO <sub>4</sub>	342.8	299	313	371	261	165
			121	356	414	413	137
			43	125	373	458	180
Bromadiolone (3-[3-(4'-bromobiphenyl-4-yl)-3-hydroxy-1-phenylpropyl]-4-hydroxycoumarin)	C <sub>30</sub> H <sub>23</sub> BrO <sub>4</sub>	527.4	–	–	–	–	158
			–	–	–	–	173
			–	–	–	–	143

\* DI: mass spectra of underivatized compounds by the direct inlet method.

\*\* DP: mass spectra of underivatized compounds measured by GC/MS.

- iv. A target compound and IS are eluted with 4 mL of chloroform/isopropanol (9:1, v/v)<sup>h</sup>.
- v. A small amount of upper aqueous layer is removed with a Pasteur pipette. An appropriate amount of anhydrous Na<sub>2</sub>SO<sub>4</sub><sup>i</sup> is added to the lower organic phase and mixed well. After settlement of the mixture, clear organic phase is transferred to a glass vial with a screw cap and evaporated to dryness under a stream of nitrogen<sup>j</sup>.
- vi. A 50- $\mu$ L volume of TMS-DAM is added to the residue, capped, vortex-mixed for 15 s and heated at 60 °C for 30 min on a heat block or in a water bath for methyl derivatization<sup>k</sup>.
- vii. After cooling to room temperature, the solution is evaporated to dryness under a stream of nitrogen; the residue is dissolved in 50  $\mu$ L ethyl acetate.
- viii. A 1- $\mu$ L aliquot of it is injected into GC/MS for measurements in the selected ion mode (SIM)<sup>l</sup>.

## Assessment and some comments on the method

Warfarin absorbed into a human body is metabolized almost entirely; it is excreted into urine in the forms of 7-hydroxywarfarin, 6-hydroxywarfarin and warfarin alcohol. For analysis of such metabolites in urine, the details of the procedures were reported by de Vries et al. [6] and Maurer et al. [7].

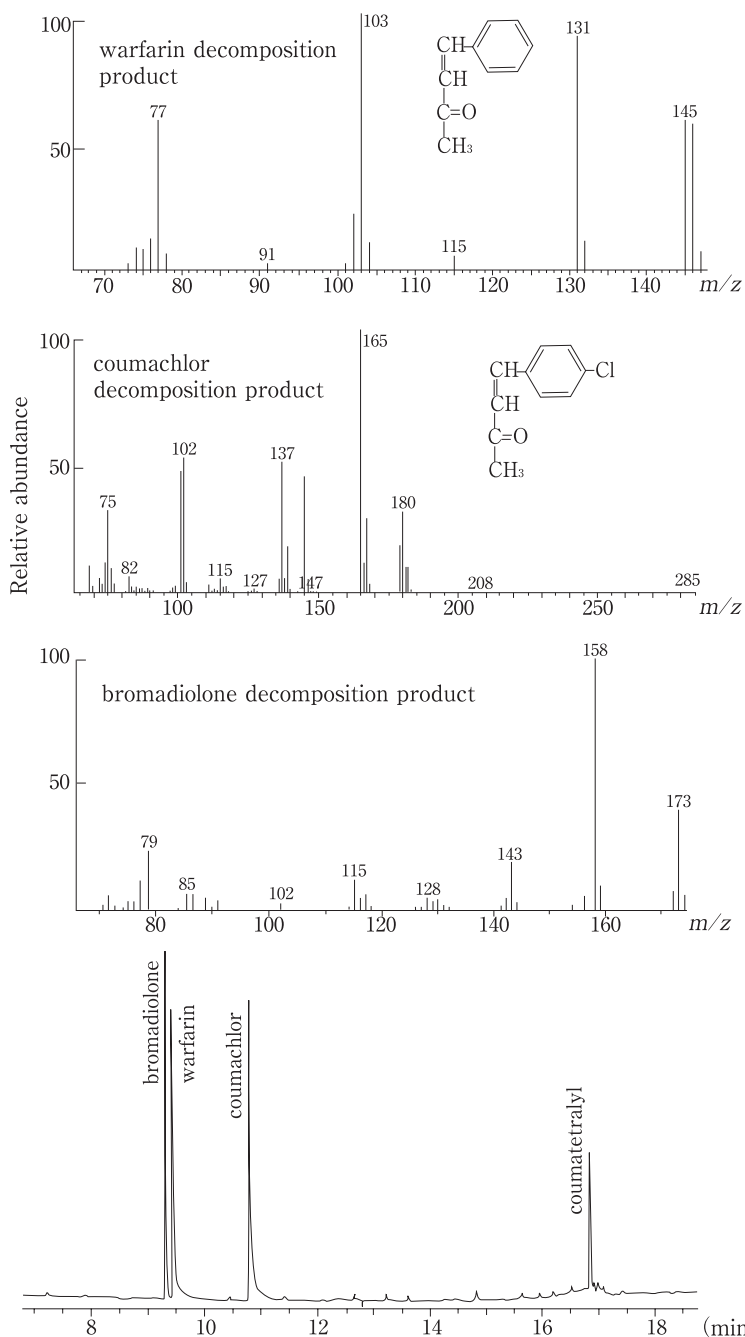
As an elution solvent for the solid-phase extraction cartridge, dichloromethane or chloroform/isopropanol (9:1, v/v) was best to get good recovery rates of the 4 coumarin rodenticides; they gave the rates of 92–97 %. A centrifugal freeze dryer can be used in place of the nitrogen stream, because it is useful for rapid evaporation without decomposition.

The functional group of the coumarin rodenticides is -OH. Because they are nonvolatile and highly adsorptive, derivatization is required for their GC and GC/MS analysis [8–10]. Among the 4 compounds tested, only coumatetralyl can be detected without any derivatization; other 3 compounds are immediately decomposed by heat of injection chamber, resulting in the detection of decomposition products. For warfarin and coumachlor, their derivatization is essential. Both compounds can be methylated with TMS-DAM [11], trimethylsilylated with BSTFA<sup>m</sup> [9,10,12] and *tert*-butyldimethylsilyl (TBDMS)-derivatized with MTBSTFA<sup>n</sup> [9]. For bromadiolone, however, it is difficult to detect the compound by GC (/MS) after any derivatization (➤ Table 8.1). Since bromadiolone is highly toxic, the author dared to detect its decomposition product (➤ Figure 8.1).

For rapid screening analysis of drugs and poisons at the spot of medical treatments, the analysis without derivatization seems more common. Therefore, the results obtained from GC/MS analysis of warfarin, coumachlor and bromadiolone without derivatization are shown in (➤ Figure 8.1). The mass spectra of warfarin, coumatetralyl and coumachlor after different derivatizations are shown in (➤ Figures. 8.2–8.4). The respective principal ions are summarized in (➤ Table 8.1). The identities of the underivatized compounds and their derivatized forms were confirmed by GC/MS in the chemical ionization mode. (➤ Figure 8.5 shows TIC and SIM chromatograms for some coumarin rodenticides; the SIM chromatogram was also obtained from serum of a patient being treated with warfarin.

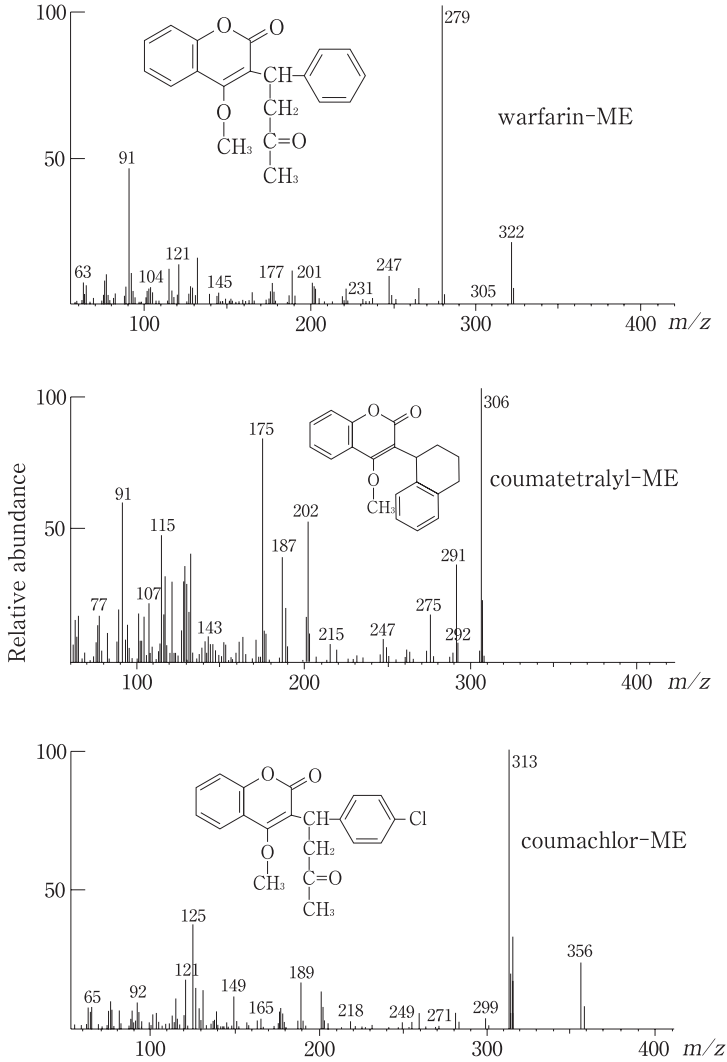
The quantitative ranges in the SIM mode for coumarin rodenticides in sera after methyl derivatization were: 10–2,000 ng/mL for warfarin, 5–2,000 ng/mL for coumatetralyl and 10–5,000 ng/mL for coumachlor; that for a decomposition product of bromadiolone in serum without derivatization, 30–5,000 ng/mL. The detection limits were 20, 10, 20 and 30 ng/mL for

■ **Figure 8.1**



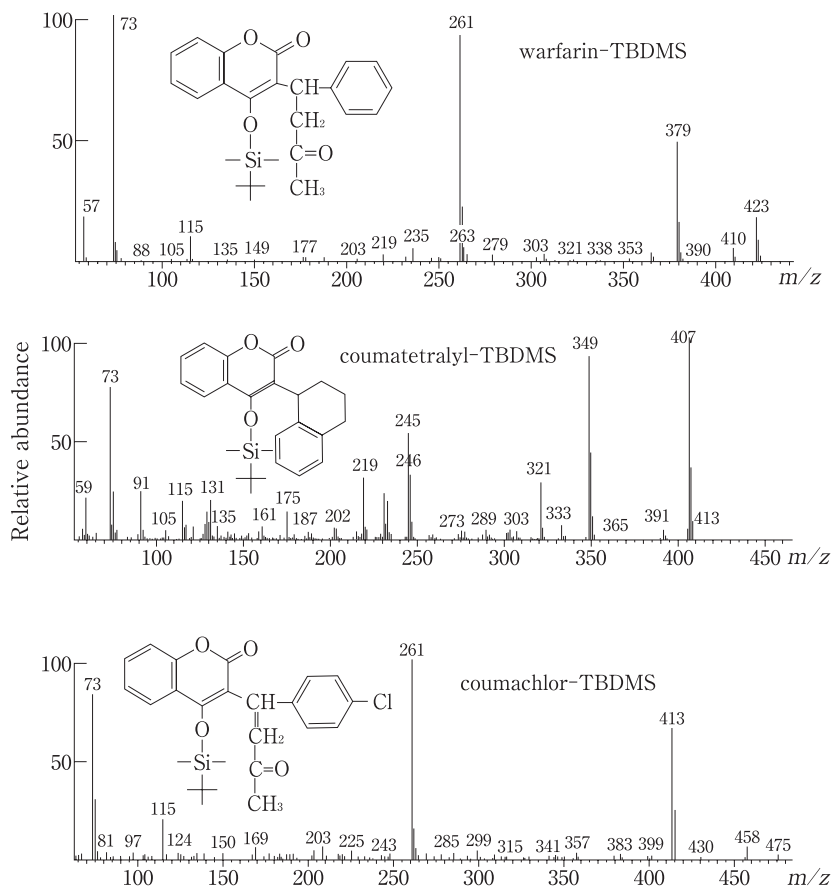
TIC (bottom panel) and mass spectra obtained by GC/MS for coumarin rodenticides (anticoagulants) without any derivatization. The concentration of each rodenticide in the mixture solution was 2  $\mu\text{g/mL}$ . For GC/MS conditions, see text. Column (oven) temperature: 50  $^{\circ}\text{C}$   $\rightarrow$  20  $^{\circ}\text{C}/\text{min}$   $\rightarrow$  330  $^{\circ}\text{C}$ .

Figure 8.2



Mass spectra of methyl derivatives of 3 coumarin rodenticides (anticoagulants). The concentration of each rodenticide was 2  $\mu\text{g/mL}$ . For GC/MS conditions, see text.

Figure 8.3



Mass spectra of TBDMS derivatives of 3 coumarin rodenticides (anticoagulants). The concentration of each compound and GC/MS conditions are the same as specified in Figure 8.2.

warfarin, coumatetralyl, coumachlor and bromadiolone, respectively. There are no interfering impurity peaks due to blood overlapping the test peaks in the SIM chromatograms.

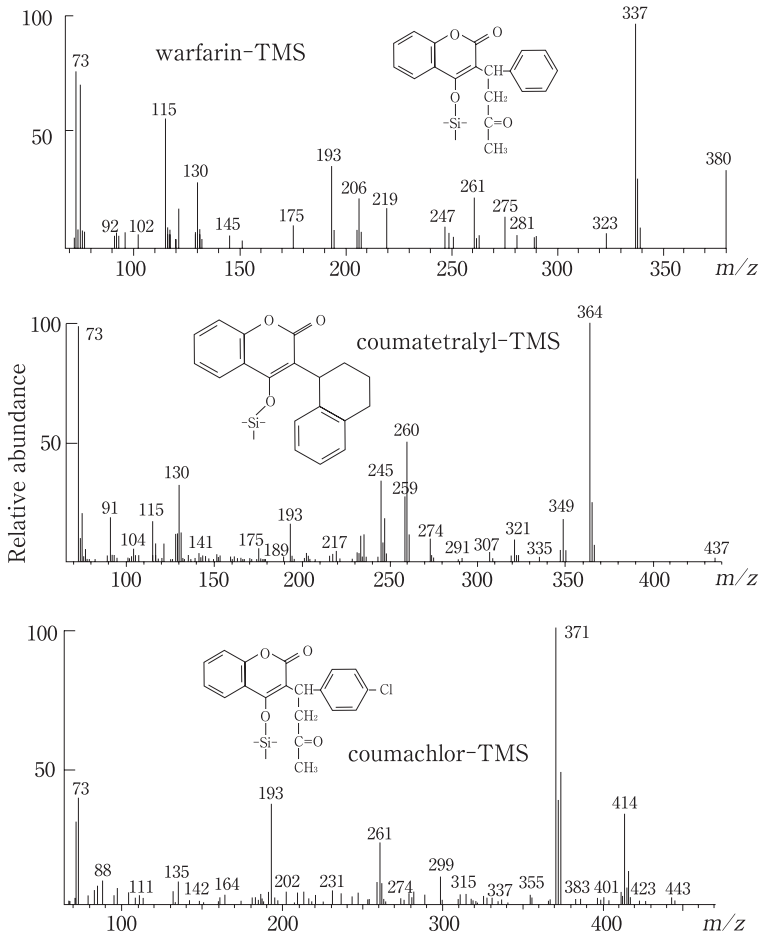
## Therapeutic and toxic concentrations of warfarin

The poisoning symptoms by warfarin do not appear shortly after its administration, but appear 12–48 h after and last for 48–75 h [13]. The symptom most frequently observed is bleeding; necrosis of skin tissues was occasionally reported [1]. Nakahata et al. [13] reported that doses of warfarin to be required for controlling the blood coagulation system differed greatly (about 14-fold) among different patients. Also for poisoning symptoms, great variations are expected among individuals.

Since there is no relationship between blood warfarin concentration and bleeding [1], coagulation tests such as prothrombin time test (PT) and thrombo test (TT) are required for the diagnosis of coumarin anticoagulant poisoning, for the assessment of its severity and for ob-



Figure 8.4



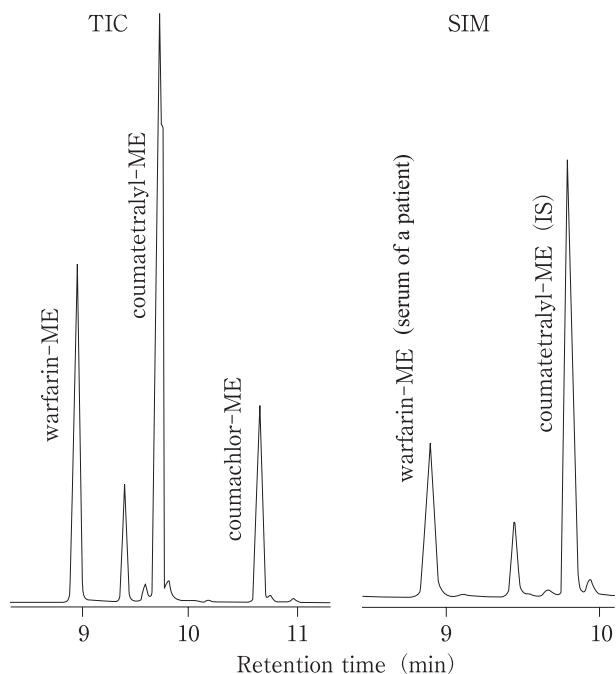
Mass spectra of TMS derivatives of 3 coumarin rodenticides. The concentration of each compound and GC/MS conditions are the same as specified in [▶ Figure 8.2](#).

servation of the process [14]. It depends on the backgrounds of patients; but when the International Normalized Ratio (INR) exceeds its therapeutic range (2.0–3.0), there is a high risk of bleeding. Especially for the second-generation anticoagulant rodenticides effective for long times (super-warfarins), the long-time follow-up of coagulation ability is necessary, because they remain in the body for a period longer than that with the first-generation rodenticides, causing the elongation of the period for hemorrhage.

Warfarin metabolites are excreted into urine and feces (*via* bile); about one third of a total warfarin administered is excreted into urine as its metabolites. Warfarin is not excreted in the unchanged form, but excreted in the metabolite forms. When warfarin is administered orally, 99% of the dose is excreted within 6 days.

When a single small dose of warfarin is administered by mistake, there is no need for treatments. Even for the intake of a large amount of warfarin or for repeated intakes, the oral or

Figure 8.5



TIC for the 3 standard coumarin rodenticides (anticoagulants) and SIM chromatogram for the serum extract of a patient undergoing the warfarin therapy after methyl derivatization. For the TIC, each compound at 2  $\mu\text{g}/\text{mL}$  was used.

intravenous administration of vitamin K is very effective for recovery; the PT values become normal in about 24 h.

Warfarin is used for prevention of thrombosis after the operations of cardiac valve replacement and of the coronary bypass conduit construction. The decision of its proper doses is made by monitoring coagulation ability using PT and TT. However, during such therapies, fatalities due to hemorrhage by the action of various deuteropathic factors were reported [15].

The blood warfarin concentrations in seven patients taking warfarin as a therapeutic drug were 191–800 ng/mL. The therapeutic blood warfarin concentrations were reported to be 0.3–10  $\mu\text{g}/\text{mL}$  in literature; toxic ones not less than 10  $\mu\text{g}/\text{mL}$  [16, 17].

## Notes

- When a specimen is serum, the ratio of warfarin bound with serum proteins is very high; the free warfarin not bound with them is only about 1 % [1, 13].
- A viscous specimen, such as serum, should be diluted with an equal volume or 2 volumes of the buffer solution to get better trapping efficiency.
- As IS, one of the coumarin anticoagulants other than a target compound is chosen. For analysis of warfarin, coumatetraaryl is good as IS.

- d) An Oasis®HLB Plus cartridge is activated by passing 3 mL methanol and 3 mL purified water through it.
- e) It can be replaced by a Sep-Pak C<sub>18</sub> cartridge (Waters). The drying of the cartridge or the inclusion of air does not affect the recovery rate for the Oasis®HLB cartridge, but lowers the rate for the Sep-Pak C<sub>18</sub> cartridge.
- f) The flow rate of the sample solution through the cartridge should not be faster than 2 mL/min.
- g) The same syringe should be used for washing the cartridge, because the residual specimen solution inside the syringe should be completely poured into the cartridge.
- h) The elution should be made at a flow rate not faster than 2 mL/min. After elution, the small amount of upper aqueous layer should be immediately removed with a Pasteur pipette, because water-soluble coumatetralyl and bromadiolone may easily transfer into the aqueous phase. Upon elution with chloroform/isopropanol, the use of a plastic disposable syringe causes its melting; a glass syringe should be used for solutions containing chloroform.
- i) Anhydrous Na<sub>2</sub>SO<sub>4</sub> is used for removing water dissolved in the organic solvent.
- j) The drying up should be made completely. When a trace amount of water remains, the derivatization is not successful, and the derivatized product is easily hydrolyzed [9].
- k) Upon GC/MS analysis of warfarin, coumachlor and bromadiolone, they are decomposed by heat of the injection chamber and detected as heat-decomposition products. Therefore, derivatization is recommendable for warfarin and coumachlor.
- l) Bromadiolone cannot be derivatized by any method. It had to be measured using its heat-decomposition product.
- m) The residue is dissolved in 20 μL of well-dried *N,N*-dimethylformamide and 50 μL BSTFA, capped, vortex-mixed for 15 s and heated at 90 °C for 45 min for TMS derivatization. After cooling to room temperature, a 1-μL aliquot of it is injected into GC/MS for measurements in the SIM mode. It should be noted that the derivative is easily decomposed and thus should be measured soon after derivatization.
- n) The residue is dissolved in 20 μL of well-dried *N,N*-dimethylformamide and 50 μL MTBSTFA, capped, vortex-mixed for 15 s and heated at 60 °C for 20 min in a water bath. After cooling to room temperature, a 1-μL of it is injected into GC/MS for measurements in the SIM mode. *N,N*-Dimethylformamide is used for dissolution of a refractory target compound in derivatization reagent solution and for enhancement of the reactivity.

## Acknowledgement

The author is very grateful to Drs. Yoshiyasu Ushio and Tsuyoshi Kaneko, Forensic Science Laboratory of Chiba Prefectural Police H.Q. and to Dr. Yasushi Hori, Department of Hospital Pharmacy, Niigata City General Hospital for their advices on these studies.

## References

- 1) Aozaki M, Iwade K (eds) (1996) Informations on the Correct Use of Warfarin, 2nd edn. Eisai, Tokyo, pp 68–76 (in Japanese)
- 2) Akahori F (2001) Poisoning data card, No.135 rodenticide. *Jpn J Toxicol* 14:193–196 (in Japanese)
- 3) Kurihara Y, Uesugi K, Hakuno M et al. (1999) Determination of warfarin in human serum and its filtrate by high-performance liquid chromatography with a column switching system using a semi-microcolumn. *J Nippon Hosp Pharm Assoc* 25:169–175 (in Japanese)
- 4) Department of Informations on Chemicals, National Institute of Hygiene (1995) Anticoagulant rodenticides. In: *Safety Assessment of Chemicals*, Vols. 1–3. Kagakukogyo-nipposha, Tokyo, pp 121–130 (in Japanese)
- 5) Forensic Toxicology Working Group of the Japanese Society of Legal Medicine (ed) (1999) *Manual for Forensic Toxicology Analysis of the Japanese Society of Legal Medicine*. Japanese Society of Legal Medicine, Tokyo, pp 1–3 (in Japanese)
- 6) de Vries JX, Simon M, Zimmermann R (1985) Identification of phenprocoumon metabolites in human urine by high-performance liquid chromatography and gas chromatography-mass spectrometry. *J Chromatogr* 338:325–334
- 7) Maurer HH, Arlt JW (1998) Detection of 4-hydroxycoumarin anticoagulants and their metabolites in urine as part of a systematic toxicological analysis procedure for acidic drugs and poisons by gas chromatography-mass spectrometry after extractive methylation. *J Chromatogr B* 714:181–195
- 8) Nishikawa M, Nishioka H, Tsuchihashi H (2000) Gas chromatograph. *Jpn J Toxicol* 13:191–199 (in Japanese)
- 9) Nakamura H (translation and edition) (1996) *Handbook of Derivatives for Chromatography*, 2nd edn. Maruzen, Tokyo, pp 281–308 (in Japanese)
- 10) Tsuchiya M, Ohashi M, Ueno T (eds) (1990) *New Development of Mass Spectrometry*. Tokyo-kagaku-dojin, Tokyo, pp 173–176 (in Japanese)
- 11) Duffield AM, Duffield PH, Birkett DJ (1979) Plasma quantitation of warfarin and warfarin alcohol by gas chromatography chemical ionization in maintenance therapy. *Biomed Mass Spectrom* 6:208–211
- 12) Bush ED, Low LK (1983) A sensitive and specific isotope assay for warfarin and its metabolites. *Biomed Mass Spectrom* 10:395–398
- 13) Nakahata H, Takahashi H, Echizen H et al. (1998) Study on the relationship between serum warfarin concentrations and anticoagulant effects using a new analytical method for measurements of optical isomers of free warfarin. *J Nippon Hosp Pharm Assoc* 24:123–129 (in Japanese)
- 14) Mizutani T (1990) Coumarin rodenticides. In: *Poisonings*, Vol. 6. Medical View, Tokyo, pp 290–291 (in Japanese)
- 15) Hitosugi M, Maebashi K, Abe M et al. (1998) Hemorrhagic shock death caused by not so severe injury during the medication of anticoagulants. *Jpn J Legal Med* 52:331–335 (in Japanese with an English abstract)
- 16) Moffat AC, Jackson JV, Moss MS et al. (eds) (1986) *Clarke's Isolation and Identification of Drugs*, 2nd edn. The Pharmaceutical Press, London, pp 1064–1065
- 17) Uges DRA (1997) Blood level data. In: Brandenberger H, Maes RAA (eds) *Analytical Toxicology for Clinical, Forensic and Pharmaceutical Chemists*. Walter de Gruyter, Berlin, pp 707–718

## II.8.1 Sarin and its decomposition products

by Hiroaki Ando and Yoshihiko Miyata

### Introduction

Chemical weapons (chemical warfare agents), such as sarin and soman, were developed to kill or injure humans by their toxic actions. They are called “nuclear weapon of the poor”, because the weapons are relatively stable during storage, cheap for production and relatively easily synthesized with basic knowledge on organic chemistry. Main advanced countries are making efforts to reduce chemical weapons existing in the world on the basis of the Chemical Weapons Convention (CWC), after the Iran-Iraq War and the Gulf War. In 1990, an incident of human injury using mustard (yperite) took place at a usual residence at Komagome, Tokyo. In 1994 and 1995, unprecedented sarin poisoning terrorism took place in Matsumoto and Tokyo, Japan and surprised the whole world in the fear that similar chemical terrorism would be reproduced in other countries. Also in 1994, an attorney-at-law and his family were killed using VX in Osaka, Japan. The above sarin and VX incidents were found committed by the same cult group. These incidents show that chemical weapons can be used not only for wars, but also can be convenient means of crimes.

To cope with such crimes using chemical weapons, such as yperite and sarin, various preventive measures should be taken on the basis of the Revised Poisonous and Deleterious Substances Control Law and the Chemical Weapons Banning Law of Japan; when such an incident happens, proper and rapid actions should be taken to minimize the damages.

In the list of scheduled chemicals being defined by CWC, there are toxic chemicals and precursors for each of Schedules 1–3. In this chapter the word “chemicals” is used for such scheduled chemicals for simplicity. Before analysis of the chemicals, it is essential to get to know their histories, methods of synthesis, properties, directions for use, toxicities, therapeutic methods, stabilities and analytical methods.

The chemicals directly act on organisms (animals and plants) and exert their toxicities; they are classified into the following 3 groups [1, 2]:

- Poisonous chemicals<sup>a</sup>: they directly exert toxic effects and kill or injure humans and animals.
- Incapacitating chemicals: they neither cause severe injuries nor fatalities, but incapacitate people temporarily.
- Chemicals for plants: they are used as defoliantes using their herbicidal action.

In this chapter, the methods for qualitative analysis of sarin and its decomposition products, which the authors experienced, are presented [3–6]. The chemical name of sarin is methylphosphonofluoridic acid isopropyl ester or *O*-isopropylmethylphosphonofluoridate (US code: GB, CAS registration No.: 107-44-8).

Sarin is an unstable compound and easily decomposed into nonpoisonous isopropylmethylphosphonic acid, followed by further decomposition into methylphosphonic acid<sup>b</sup>. The above

two products stably exist in soils and water for relatively a long period around the spot, where sarin has been sprayed; if isopropyl methyl phosphonic acid is identified, it can be verified that sarin has been used.

## Reagents and specimens

- Sarin: a plastic bag containing about 600 mL of light-brown fluid, which had been obtained at Kasumigaseki Station of the Chiyoda subway line, was carefully opened, and used as the original specimen of sarin.
- VX: the compound hidden by a cult group and seized by police was used.
- Other compounds: *N,N*-diethylaniline (DEA), trimethyl phosphate, methylphosphonic acid, dimethyl methylphosphonate, methyl phosphonic dichloride, acetonitrile-*d*<sub>3</sub>, deuterated chloroform (CDCl<sub>3</sub>), diisopropyl phosphorofluoridate (DFP) and *N*-methyl-*N*-(*tert*-butyl-dimethylsilyl)trifluoroacetamide (MTBSTFA) can be all purchased from Aldrich (Milwaukee, WI, USA); triisopropyl phosphate, isopropyl hydrogenmethylphosphonate and diisopropyl methylphosphonate were synthesized in our laboratories according to the literature [7].

## GC/MS analysis

---

### GC/MS conditions

GC column: an HP-5MS fused silica capillary column (30 m × 0.25 mm i.d., film thickness 0.25 μm, Agilent Technologies, Palo Alto, CA, USA).

GC/MS conditions; injection temperature: 250 °C; injection pressure: 1.05 kg/cm<sup>2</sup>; column (oven) temperature: 50 °C (2 min) → 20 °C/min → 250 °C (10 min); carrier gas: He (13 psi); split ratio, 50; ion source temperature: 250 °C; EI electron energy: 70 eV; CI mode reagent gas: isobutane<sup>c</sup>; CI electron energy: 230 eV; ionization current: 300 μA.

## Procedure

### i. Direct analysis

A part of the original sarin specimen solution is diluted 10–50 fold with hexane (or acetone) and injected into GC/MS.

### ii. Analysis of decomposition products

- About 1 g of the above original sarin specimen solution is mixed with 12 mL of 5 % KOH solution, and left for about 24 h at room temperature. Using the headspace vapor of the mixture, the absence of undecomposed sarin is confirmed by GC/MS.
- The above aqueous solution is extracted with chloroform (30 mL × 3 times).
- After each centrifugation, the chloroform layers are combined, and dehydrated with anhydrous Na<sub>2</sub>SO<sub>4</sub>; the clear supernatant chloroform extract is condensed under reduced pressure (sample A).

- iv. The aqueous layer is also condensed under reduced pressure (sample B).
- v. Parts of the samples A and B are placed in screw-cap glass vials respectively, and equally evaporated to dryness under streams of nitrogen. Each residue is mixed with 30  $\mu\text{L}$  acetonitrile and 30  $\mu\text{L}$  MTBSTFA, heated at 60  $^{\circ}\text{C}$  for 1 h for *tert*-butyldimethylsilyl (TBDMS) derivatization and injected into GC/MS.

## Assessment of the method

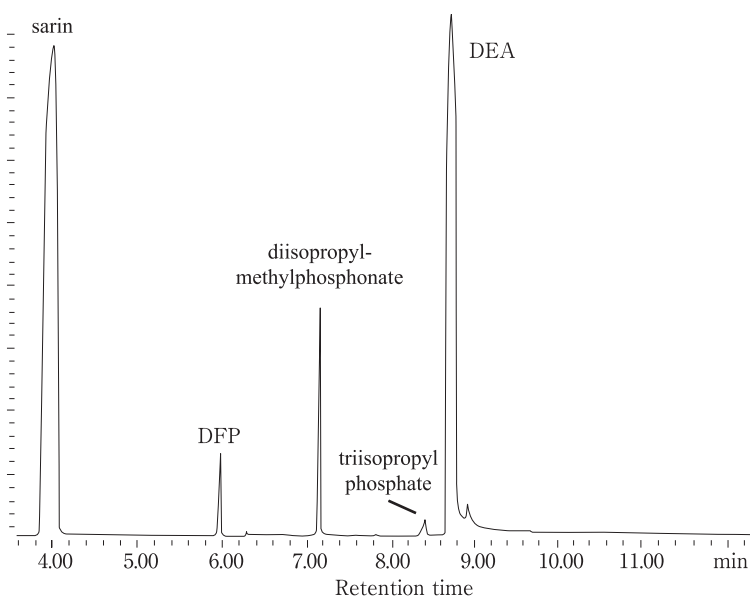
► Figure 1.1 shows a TIC obtained by GC/MS for the diluted original sarin specimen obtained from the Tokyo Subway Sarin Incident. By measuring mass spectra and retention times, the peaks except for sarin were identified as DFP, diisopropyl methylphosphonate, triisopropyl phosphate and DEA.

The big peak appearing at the retention time of 4 min in ► Figure 1.1 is due to sarin. The EI and CI mass spectra of sarin are shown in ► Figures 1.2 and 1.3, respectively. In the EI mass spectrum, no molecular peak ( $m/z$  140) appeared; but a peak of the desmethylated form appeared at  $m/z$  125.

► Figure 1.4 shows a TIC and EI mass spectra for two peaks appearing in the TIC. Peaks 1 and 2 correspond to TBDMS derivatives of isopropyl methyl phosphonic acid and methylphosphonic acid, respectively. For both compounds, neither molecular nor quasi-molecular peak appears. In the CI mode, both compounds showed the base peaks of their protonated molecular ions at  $m/z$  252 and 325, respectively.

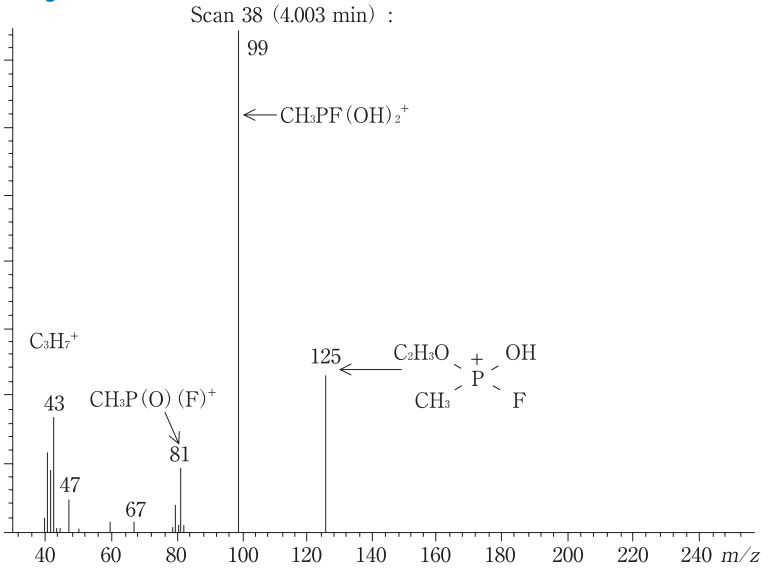
In this connection, ► Figure 1.5 shows an EI mass spectrum of underivatized VX. No molecular peak ( $m/z$  267) appeared; a fragment ion at  $m/z$  114 was the base peak. ► Figure 1.6

■ Figure 1.1



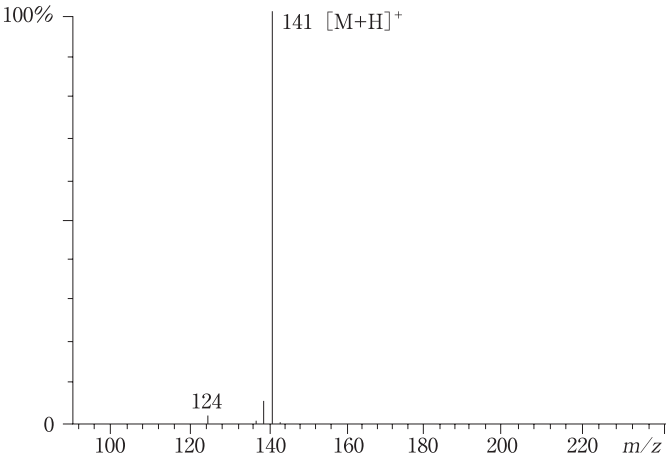
TIC by GC/MS for the original sarin specimen obtained at the Tokyo Subway Sarin Incident.

■ Figure 1.2



EI mass spectrum of sarin.

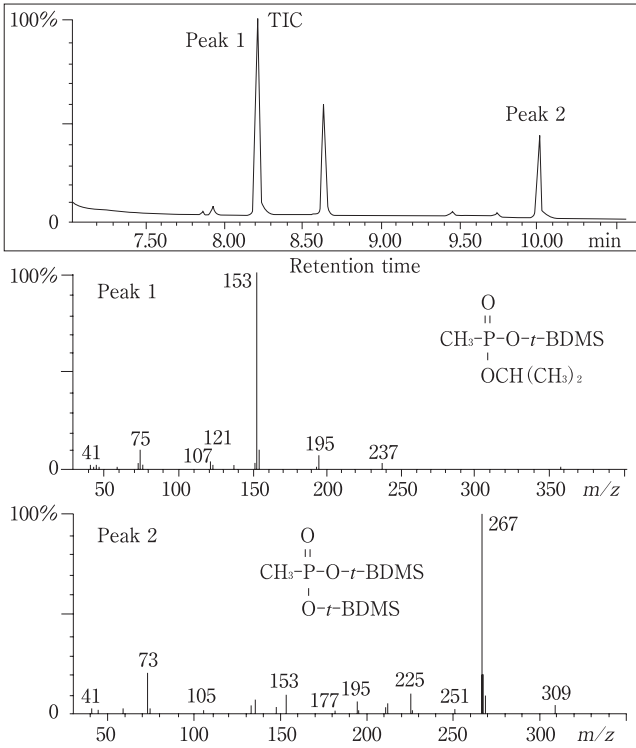
■ Figure 1.3



CI mass spectrum of sarin.

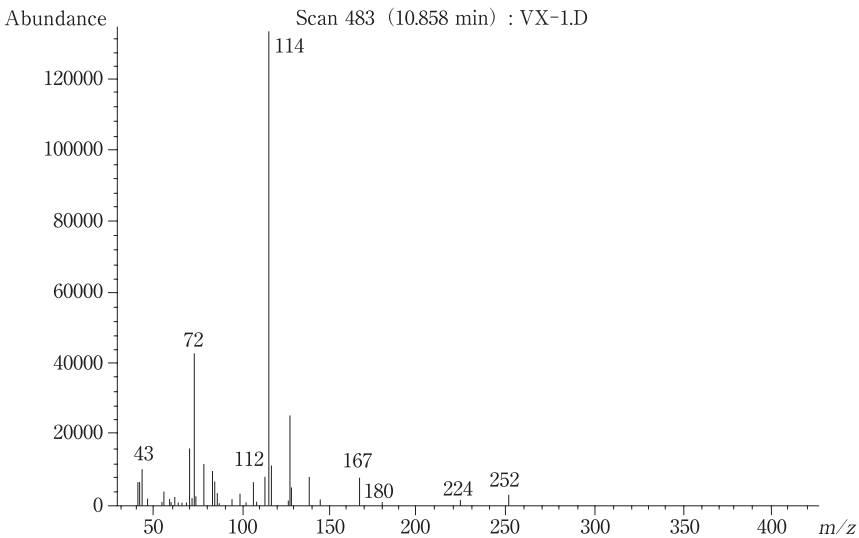


Figure 1.4



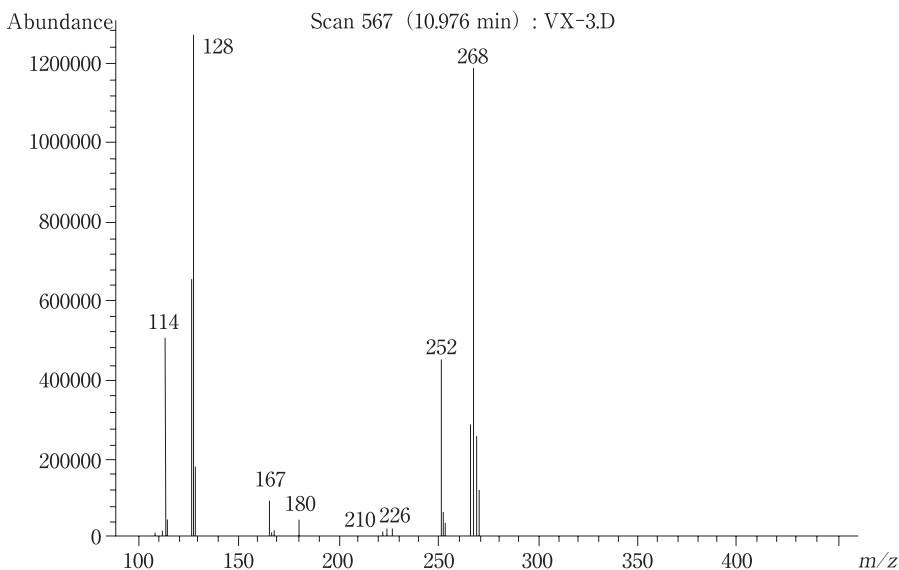
TIC and mass spectra for Peaks 1 and 2 obtained by GC/MS for TBDMS derivatives of hydrolyzed products of sarin.

Figure 1.5



EI mass spectrum of VX.

■ **Figure 1.6**



**CI mass spectrum of VX.**

shows a CI mass spectrum of VX; an intense protonated peak appeared at  $m/z$  268 together with fragment peaks at  $m/z$  252, 128 and 114.

## NMR analysis

### NMR conditions

#### i. NMR instruments

JNM-EX270 and JNM-EX90A (with the tunable module) FT-NMR spectrometers (JEOL, Tokyo, Japan) were used.

#### ii. Analytical conditions

A sample tube with 5 mm i. d. was used. For  $^{13}\text{C}$ , the  $^1\text{H}$  decoupling mode was employed; for  $^{19}\text{F}$ , the  $^1\text{H}$  non-decoupling mode; and for  $^{31}\text{P}$ , both  $^1\text{H}$  decoupling and non-decoupling modes.

The conditions for the JNM-EX270 instrument were: measurement frequency, 109 MHz; mode,  $^1\text{H}$  decoupling; data points, 32 K; pulse width, 6.9  $\mu\text{s}$ ; pulse delay time, 5 s; integration times, 4; measurement temperature, 25  $^\circ\text{C}$ ; and spectral width for chemical shifts, 40,000 Hz.

The parameters for NMR measurements using the JNM-EX90A instrument are summarized in [Table 1.1](#).

Table 1.1

Parameters for NMR measurements of sarin

Nuclear species	$^1\text{H}$	$^{13}\text{C}$	$^{19}\text{F}$	$^{31}\text{P}$
Measurement frequency (MHz)	89.56	22.52	84.26	36.25
standard	internal	tetramethylsilane (TMS)		
	external		trifluoroacetic acid ( $\delta_{\text{F}} = -76.5$ ppm)	85 % phosphoric acid
measurement temperature	26 °C			
data point	16 K	16 K	32 K	32 K
NMR lock	deuterated chloroform ( $\text{CDCl}_3$ )			
spectral width (Hz)	1,800.5	7,507.5	26,041.7	8,000.0
pulse width	6.5 $\mu\text{s}$ (45° pulse)	3.5 $\mu\text{s}$ (45° pulse)	14.5 $\mu\text{s}$ (90° pulse)	12.6 $\mu\text{s}$ (90° pulse)
integration time (repetition time)	32 (7 $\mu\text{s}$ )	2,400 (3 $\mu\text{s}$ )	64 (3 $\mu\text{s}$ )	256 (5 $\mu\text{s}$ )

## Procedures

- For direct NMR analysis, the original sarin specimen was diluted with acetonitrile- $d_3$ , placed and sealed in the sample tube for NMR measurements using the JNM-EX270 instrument.
- The original sarin specimen was purified by vacuum distillation. A major fraction distilled at 60–61 °C/25 mm Hg was collected and diluted with deuterated chloroform ( $\text{CDCl}_3$ ) to make solution at 95 mg/g. The NMR measurements were carried out on the JNM-EX 90A instrument.

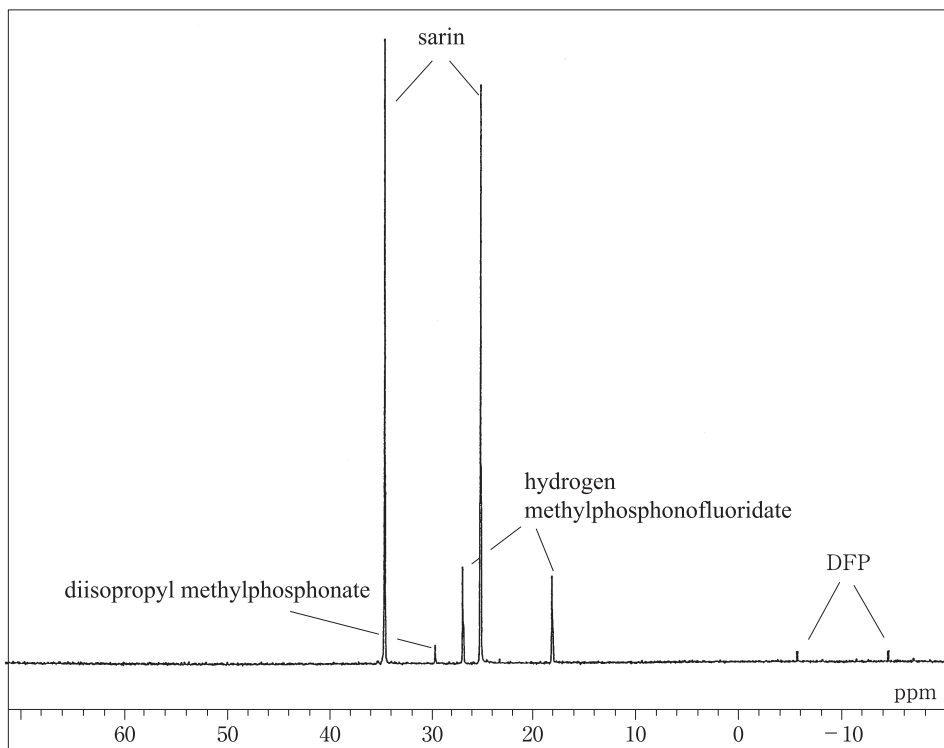
## Assessment of the method

Figure 1.7 shows a  $^{31}\text{P}$ -NMR spectrum obtained from the original sarin specimen. The main doublet signals were judged due to sarin, because they ( $\delta$ : 29.62 ppm,  $J_{\text{PF}} = 1037$  Hz) were almost identical with those of sarin ( $\delta$ : 28.44 ppm,  $J_{\text{PF}} = 1046.3$  Hz) reported in literature. DFP and diisopropyl methylphosphonate could be detected together with sarin by GC/MS (Figure 1.1); in this NMR spectrum, hydrogen methylphosphonofluoridate appears in addition (Figure 1.7).

The  $^1\text{H}$ -,  $^{13}\text{C}$ -,  $^{31}\text{P}$ - and  $^{19}\text{F}$ -NMR data for the purified sample after distillation are shown in Table 1.2; the  $^{31}\text{P}$ -NMR data for decomposition products and by-products of sarin shown in Table 1.3.

The composition of sarin and contaminants in the original specimen solution of the Tokyo Subway Sarin Incident was carefully examined by  $^{31}\text{P}$ -NMR, using trimethyl phosphate as a standard, because it did not overlap any sarin-related compound. The results were (w/w): sarin, 35 %; hydrogen methylphosphonofluoridate<sup>d</sup>, 10 %; diisopropyl methylphosphonate<sup>e</sup>, 1 %; and

■ Figure 1.7



$^{31}\text{P}$ -NMR spectrum in the  $^1\text{H}$  decoupling mode for the original sarin specimen solution obtained at the Tokyo Subway Sarin Incident.

DFP, trace (0.1 %). The content (w/w) of organic solvents (DEA<sup>f</sup> plus hexane) measured by GC after hydrolysis of the original specimen solution was about 53 %.

## Poisoning symptoms, and toxic and fatal concentrations

By the Tokyo Sarin Subway Incident, the poisoning symptoms provoked by sarin were clarified [8]. In its mild poisoning, rhinorrhea, darkness of eyeshot and difficulty in breathing were most common, followed by pain of the eye, dyspnea, cough, nausea, vomiting, headache and feeling of enervation. In severe poisoning, the victims are killed by paralysis of the respiration muscles.

Sarin is highly volatile and shows toxicity higher than that of tabun. In the presence of sarin at  $2 \text{ mg} \cdot \text{min}/\text{m}^3$  in the air, the darkness of the eyeshot and thus visual disturbance appear; the fatal atmospheric concentration was reported to be about  $100 \text{ mg} \cdot \text{min}/\text{m}^3$  [8].

Table 1.2

$^1\text{H}$ -,  $^{13}\text{C}$ -,  $^{31}\text{P}$ - and  $^{19}\text{F}$ -NMR data obtained from sarin [5]

Nucleus	Chemical shift (ppm)	Coupling constants (Hz)
$^1\text{H}$		
1-H	1.62 (dd, 3H)	$^2J_{\text{HP}} = 18.5$ $^3J_{\text{HF}} = 5.7$
2-H	4.90 (m, 1H)	$^3J_{\text{HH}} = 6.3$ $^3J_{\text{HP}} = 7.3$
3-H	1.38 (d, 6H)	$^3J_{\text{HH}} = 6.3$
$^{13}\text{C}$		
1-C	10.42	$^1J_{\text{CH}} = 129.2$ $^1J_{\text{CP}} = 150.3$ $^2J_{\text{CF}} = 27.5$
2-C	72.70	$^1J_{\text{CH}} = 151.2$ $^2J_{\text{CP}} = 6.4$
3-C	23.74    23.90	$^1J_{\text{CH}} = 126.4$
$^{31}\text{P}$	29.62	$^2J_{\text{HP}} = 18.5$ $^3J_{\text{HP}} = 7.3$ $^1J_{\text{PF}} = 1045.4$
$^{19}\text{F}$	-58.07	$^3J_{\text{HF}} = 5.7$ $^1J_{\text{PF}} = 1045.4$

Table 1.3

Chemical shift values for sarin, its related compounds and trimethyl phosphate [6].

Compound	Chemical shift (ppm)*	Coupling constant (Hz)
trimethyl phosphate	2.39	
DFP	-10.42	$J_{\text{PF}} = 967$
diisopropylmethylphosphonate	29.32	
sarin		$J_{\text{PF}} = 1037$
methylphosphonic acid	31.51	
isopropyl hydrogenmethylphosphonate	32.80	

\* 85% phosphoric acid external standard

## Notes

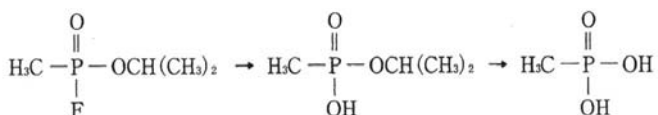
- a) As prerequisites of being the poisonous chemicals, the following 3 items can be mentioned.
- Very high toxicity: it should have toxicity, which can kill a number of humans or animals with a small amount of a poison.
  - Stability under certain conditions: upon the use of a poison, the poisonous effect should last for a required period; upon its storage, it should be highly stable.
  - Low perceptibility of a poison by humans: a compound, which gives a characteristic smell, a color or a taste, is easily detected by one or more of the five senses of humans

and can be treated for protection. The compound should not be easily perceived by any human sense.

In addition, the following items can be also mentioned as their common properties.

- A poison should invade various structures and exert its homicidal action, but does not destroy or ruin the structures themselves.
- A poison can be spread widely, retained for a while to exert its poisonous effects and flown away.
- There are types of poisons with early (within several hours) and delayed onset of poisoning symptoms.
- There are short (within 10 min) and long-acting poisons.
- Because of the low perceptibility of a poison, people are easily exposed and injured by the poison without any consciousness.

b) sarin/isopropyl hydrogenmethylphosphonate/methyl phosphonic acid



- c) As reagent gas, ammonia or methane can be also used.
- d) This compound is an impurity produced by decomposition of methylphosphonic difluoride, the precursor of sarin, or of methylphosphonic chlorofluoride, the disproportionation reaction product.
- e) Methylphosphonic dichloride side-reacts with isopropyl alcohol to produce diisopropyl methylphosphonic acid.
- f) DEA is considered to be added to enhance the reaction of the sarin synthesis.


## References

- 1) Wakai H (2000) Defense against chemical weapon attack. Japanese Bureau of the Organization for the Prohibition of Chemical Weapons (OPCW), Tokyo, pp 142–155 (in Japanese)
- 2) Komoto T (1995) Basic knowledge on chemical weapons. Criminal Data File of the Metropolitan Police Department (Tokyo) 46:17–36 (in Japanese)
- 3) Ando H (1995) Practical study on sarin analysis at the Tokyo Subway Sarin Incident. In: Abstracts of the 1995 Annual Meeting of Kanto District Society of Forensic Technology. Tokyo, pp 49–56 (in Japanese)
- 4) Miyata Y, Nonaka H, Yoshida T et al. (2000) Analyses of sarin and related compounds used in the Tokyo Subway Sarin Incident. *Jpn J Forensic Toxicol* 18:39–48
- 5) Miyata Y, Nonaka H, Ando H (2000) Nuclear magnetic resonance data of sarin obtained at the Tokyo Subway Sarin Incident. *Jpn J Forensic Toxicol* 18:261–267
- 6) Miyata Y, Ando H (2001) Examination of an internal standard substance for the quantitative analysis of sarin using  $^{31}\text{P}$ -NMR. *J. Health Sci* 47:75–77
- 7) Japanese Association of Organic Synthetic Chemistry (ed) (1971) Organophosphorus compounds. In: *Modern Organic Synthesis Series* (5). Gihodo, Tokyo, pp 329–330 (in Japanese)
- 8) Tu AT, Inoue N (2001) Overall View of Chemical and Biological Weapons. Joho Inc., Tokyo, p 27, p 82 (in Japanese)

## 11.8.2 VX and its decomposition products

by Munehiro Katagi and Hitoshi Tsuchihashi

### Introduction

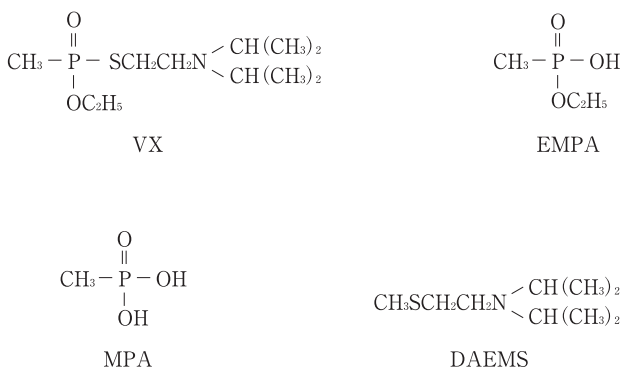
An organophosphorus nerve agent VX (*O*-ethyl *S*-2-diisopropylaminoethyl methylphosphonothiolate,  Figure 2.1) shows potent inhibitory action on acetylcholinesterase; its development, production, stockpiling and use are being prohibited by the CWC international treaty as a chemical weapon together with those of sarin and soman. In addition, even material compounds for VX synthesis are being also controlled strictly.

In the world history, there had been no records on the use of VX in any international dispute. However, in December 1994, a murder terrorism incident using VX committed by a cult group took place in Osaka, Japan. The very high poisoning potency of VX proven in the incident surprised the whole world with a shock and anxiety.

VX is easily hydrolyzed under alkaline conditions, and also in the environmental water and soil to produce ethylmethylphosphonic acid (EMPA) and further methylphosphonic acid (MPA) [1]. VX is rapidly hydrolyzed by both chemical and enzymatic reactions in mammalian bodies to produce EMPA and 2-(diisopropylaminoethyl)methyl sulfide (DAEMS)<sup>a</sup>. These metabolites or decomposition products are detected for verification of the use of VX [2].

Many methods for EMPA and MPA mainly in environmental water and soil were reported using ion chromatography with indirect photometric detection [3], capillary electrophoresis [4], GC/MS after methylation [5], silylation [6–8] and pentafluorobenzyl (PFB) derivatization [9, 10], LC/MS [11] and CE/MS [12, 13] both without any derivatization, LC/MS after derivatization and LC/MS/MS [14]. In actual terrorism cases using VX, the detection of its metabolite products from urine and blood is essential. In this chapter, the details for GC/MS analysis of VX metabolites in human serum<sup>b</sup> are described.

 Figure 2.1



Structures of VX and its hydrolyzed products/metabolites.

## Reagent and their preparation

- A 10-mg aliquot of EMPA (Aldrich, Milwaukee, WI, USA) is dissolved in 10 mL distilled water (1 mg/mL) to prepare aqueous stock solution. Just before use, the solution is appropriately diluted with blank human serum to prepare the standard specimens.
- A 10-mg aliquot of DAEMS is dissolved in 100 mL distilled water to prepare aqueous stock solution (100 µg/mL). Just before use, the solution is appropriately diluted with blank human serum to prepare the standard specimens. DAEMS can be synthesized by reacting 2-(diisopropylamino)ethyl chloride hydrochloride<sup>c</sup> (Aldrich) with sodium thiomethoxide (Aldrich) [2].
- A 10-mg aliquot of diphenylmethane (DPM, internal standard = IS, Aldrich and other manufacturers) is dissolved in 100 mL acetonitrile (100 µg/mL).
- *N*-Methyl-*N*-(*tert*-butyldimethylsilyl)trifluoroacetamide + 1 % *tert*-butyldimethylchlorosilane (Pierce, Rockford, IL, USA) is directly used for *tert*-butyldimethylsilyl (*t*-BDMS) derivatization.
- A 1-mg aliquot of 2-(diisopropylaminoethyl)methoxide (DAEMO, IS) is dissolved in 100 mL dichloromethane (10 µg/mL). DAEMO can be synthesized by reacting 2-(diisopropylamino)ethyl chloride hydrochloride with sodium methoxide (Aldrich and other manufacturers) [2].
- Other reagents are of the highest purity commercially available.

## GC/MS conditions

GC column: a DB-1 fused silica capillary column (30 m × 0.32 mm i.d., film thickness 0.25 µm, J&W Scientific, Folsom, CA, USA).

GC/MS conditions<sup>d</sup>; instrument: a Shimadzu QP5050 gas chromatograph connected with a mass spectrometer (Shimadzu Corp., Kyoto, Japan); column (oven) temperature for EMPA: 80 °C (2 min) → 15 °C/min → 300 °C; column (oven) temperature for DAEMS: 50 °C (2 min) → 10 °C/min → 300 °C; injection temperature: 270 °C; injection mode: splitless; interface temperature: 250 °C; EI electron energy: 70 eV; CI reagent gas: isobutane.

## Procedures

### i. Analysis of VX and its volatile metabolite [2]

- A 1-mL volume of serum is mixed with 1 mL dichloromethane, shaken and centrifuged; the dichloromethane layer is transferred to another test tube. To the above aqueous phase, 1 mL dichloromethane is again added, shaken and centrifuged.
- The resulting dichloromethane layers are combined and dehydrated by adding anhydrous Na<sub>2</sub>SO<sub>4</sub>. The clear dichloromethane solution is transferred to a glass vial and carefully evaporated to dryness under a stream of nitrogen gas at room temperature<sup>e</sup>.
- The residue is dissolved in 100 µL of the dichloromethane solution of DAEMO (IS solution); a 1-µL of it is injected into GC/MS for analysis<sup>f</sup>.



## ii. Analysis of EMPA [2, 8]

- i. The remaining aqueous layer in the above procedure 1) is mixed with 1 mL acetonitrile and centrifuged for deproteinization<sup>g</sup>.
- ii. The resulting supernatant solution is mixed with 1 mL of 0.05 M oxalate buffer solution (pH 1.68)<sup>h</sup>, 0.6 g NaCl and 2 mL acetonitrile<sup>i</sup>, shaken and centrifuged. The resulting acetonitrile layer is transferred to another test tube. To the remaining aqueous phase, 2 mL acetonitrile is again added, shaken and centrifuged.
- iii. The acetonitrile layers obtained are combined, dehydrated with anhydrous Na<sub>2</sub>SO<sub>4</sub>; the clear acetonitrile layer is transferred to a Pyrex test tube<sup>j</sup>, and evaporated to dryness under a stream of nitrogen with heating at 60 °C.
- iv. The residue is mixed with 100 µL of *N*-methyl-*N*-(*tert*-butyldimethylsilyl)trifluoroacetamide + 1 % *tert*-butyldimethylchlorosilane and heated at 60 °C for 30 min for *t*-BDMS derivatization<sup>k</sup>.
- v. To the above reaction mixture, 20 µL of the diphenylmethane (IS) acetonitrile solution is added and mixed; a 1-µL aliquot of it is subjected to GC/MS analysis<sup>l</sup>.

## Assessment of the method

► Figure 2.2 shows a total ion chromatogram (TIC), a mass chromatogram measured at  $m/z$  114 and EI and CI mass spectra<sup>m</sup> for DAEMS (500 ng/mL) extracted from human serum. If VX remains, it is extracted into the dichloromethane layer; however in most cases except for massive VX exposure, VX cannot be detected, because of its rapid metabolism and decomposition in human bodies.

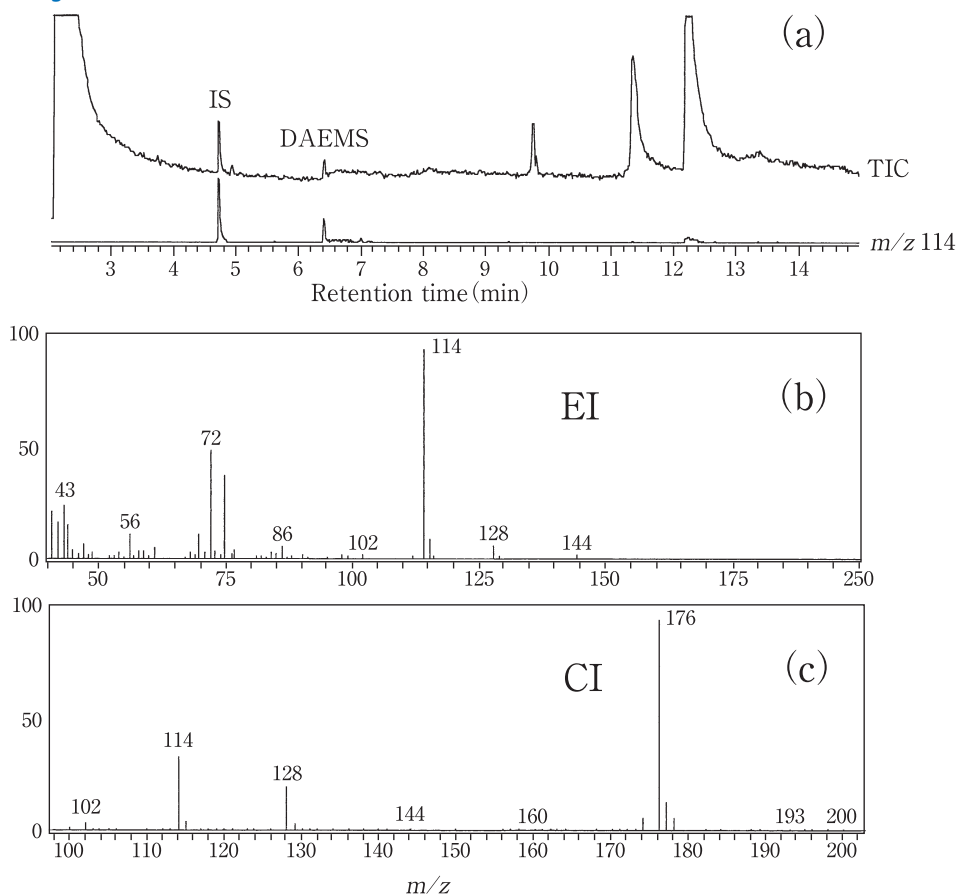
The detection limits of DAEMS in serum are about 50 ng/mL in the scan mode and about 5 ng/mL in the SIM mode.

► Figure 2.3 shows a TIC, mass chromatograms and mass spectra<sup>n</sup> for EMPA (1 µg/mL) extracted from human serum. In humans, who have been exposed to VX, MPA also appears together with EMPA in serum. However, in the present method, the extraction efficiency of MPA is as low as several %; only a trace level of MPA can be detected or it is not detectable in most cases. It should be pointed out that MPA can be equally produced from some organophosphorus nerve agents, such as sarin and soman; the detection of only MPA does not enable specification of a chemical weapon used. The identification of EMPA is most important to verify the exposure to VX.

The detection limit of EMPA in human serum is about 10 ng/mL in the scan mode and about 1 ng/mL in the SIM mode.

Usually, for qualitative analysis of organophosphorus nerve agents, the detection and identification of their metabolite alkyl methylphosphonic acid are carried out. In the VX poisoning cases, DAEMS due to the leaving group can be detected together with EMPA; the detection of both compounds highly enhances the reliability for verification of VX exposure.

■ **Figure 2.2**



**GC/MS analysis for DAEMS in serum. (a) a total ion chromatogram (TIC) and a mass chromatogram; (b) an EI mass spectrum of DAEMS; (c) a CI mass spectrum of DAEMS.**

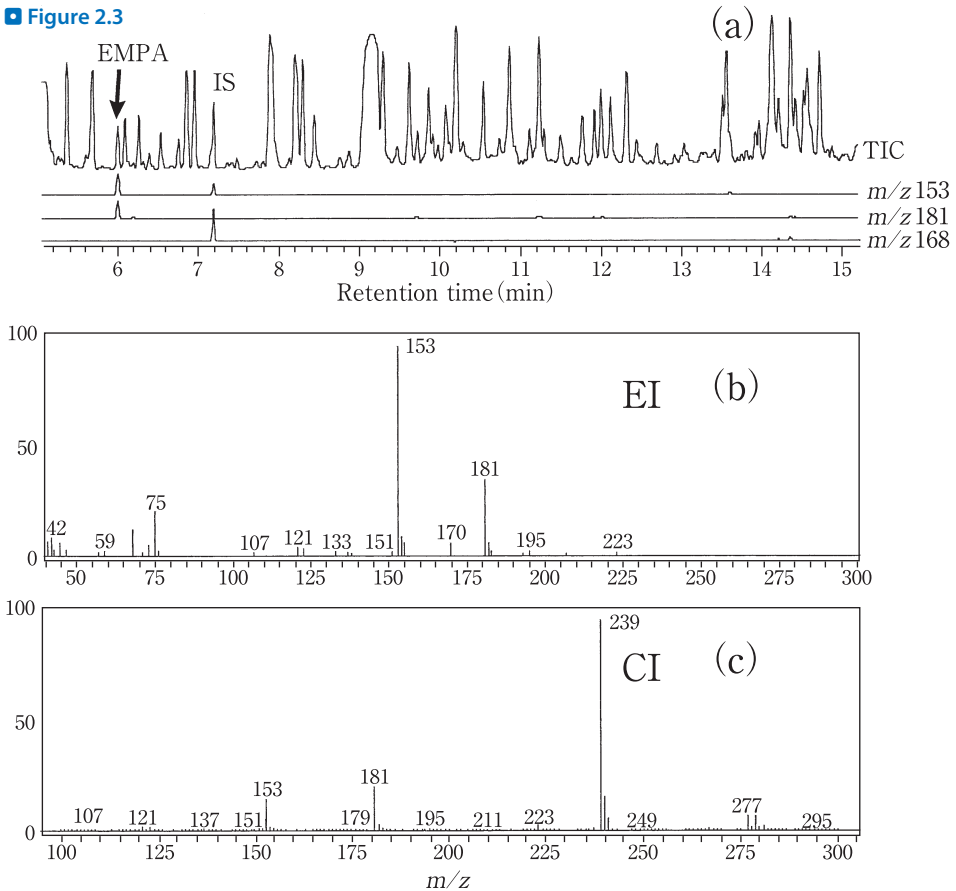
## Poisoning case, and toxic and fatal concentrations

VX is much less volatile than sarin, but is highly permeable through the skin; usually victims are exposed to an aerosol or a liquid form of VX. The absorption of VX through the eye mucosa and the skin results in its poisoning.

In the murder terrorism with VX taking place in Osaka, Japan, 1994, VX was sprayed on the back of the neck of the victim using a syringe (the exposure amount not known); he died 10 days later. As VX poisoning symptoms, marked miosis and lowered levels of cholinesterase activity characteristic for organophosphorus compound poisoning appear first; in severer poisoning, dyspnea, enhanced sweating, convulsion attack, respiratory arrest and finally cardiopulmonary arrest leading to death can be observed.

VX is said to be the most potent poison among the nerve agents. There are no precise data on the toxicity of VX in humans; there are only estimated values based on the experimental

Figure 2.3

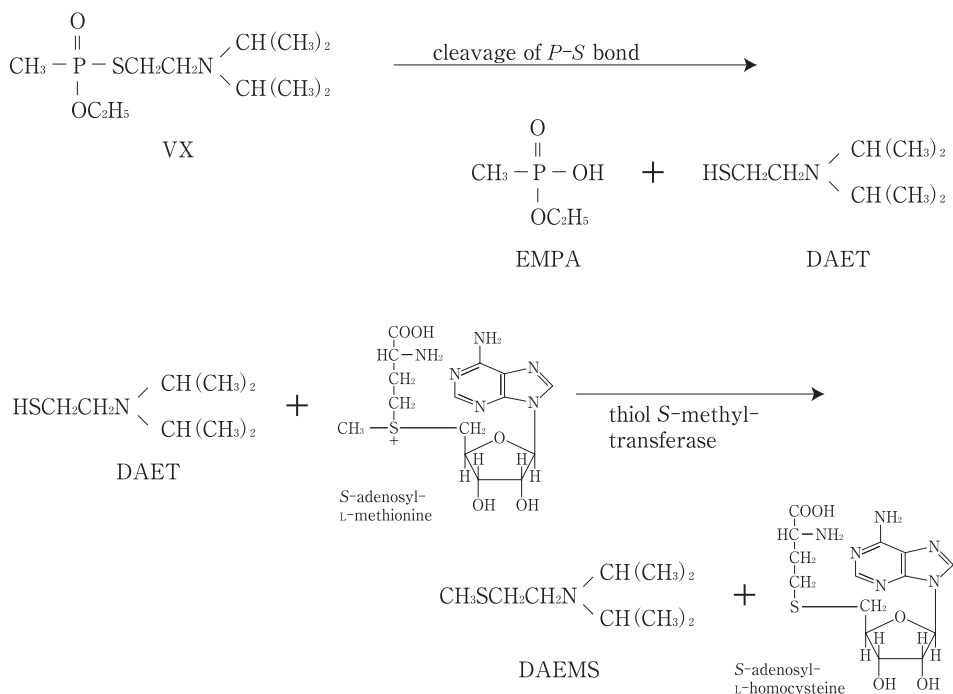


GC/MS analysis for EMPA in serum. (a) a TIC and mass chromatograms; (b) an EI mass spectrum of the *t*-BDMS derivative of EMPA; (c) a CI mass spectrum of the same derivative of EMPA.

data of animals. According to the reports by the US army [15,16], the minimal toxic and lethal concentrations of VX *via* the airway are said to be  $1.1 \times 10^{-5} \text{ mg} \cdot \text{min}/\text{m}^3$  and  $0.1 \text{ mg} \cdot \text{min}/\text{m}^3$ , respectively. According to a report by WHO [17], the percutaneous lethal doses of VX are estimated to be 2–10 mg.

In the above VX- poisoned victim, VX could not be detected from his serum, which had been sampled 1 h after the exposure; however EMPA and DAEMS, the metabolites of VX, could be detected [18].

Figure 2.4



### Main metabolic pathways for VX in human bodies.

### Notes

a) When VX is absorbed into human bodies, it is rapidly hydrolyzed by chemical and enzymatic reactions with alleylesterase to yield EMPA and 2-(diisopropylamino)ethanethiol (DAET). The DAET formed is immediately subjected to methyl-conjugation by the action of thiol S-methyltransferase being contained in the endoplasmic reticulum to produce DAEMS [18]. This reaction requires S-adenosyl-L-methionine (activated methionine) as coenzyme (➔ Figure 2.4).


In addition, the disappearance of the resulting DAEMS from blood is very rapid. According to rat experiments made by Tsuchihashi et al. [18], DAEMS could be detected from 10 min after intraperitoneal administration of a large dose of DEAT (20 mg/kg), but was at detection limit levels only 3 h after the administration. Therefore, in humans, DAEMS may become undetectable only several hours after exposure to VX; thus the blood specimens should be sampled as soon as possible.

b) Urine specimens can be also analyzed with the same procedure.

c) 2-(Diisopropylamino)ethyl chloride hydrochloride is designated as one of the Schedule 1 chemicals listed by CWC. It is also being strictly controlled by the domestic laws. To purchase the compound, proper legal procedures including various documents clarifying the purpose of its use are required.

- d) Upon the use of *t*-BDMS derivatization of EMPA, the final solution containing a large amount of the derivatization reagent has to be injected into GC/MS, resulting in the marked contamination of the ion source of an MS instrument. The lighting-up time for the filament should be delayed as much as possible to protect the ion source and the analytical part of the instrument.
- e) DAEMS is highly volatile, and thus its solvent should be evaporated at a lower temperature gradually and carefully. If VX itself remains, there is a danger of the secondary exposure for an analyst; the manipulations including the above evaporation should be done inside a draft chamber.
- f) For quantitative analysis of DAEMS, various concentrations of DAEMS are spiked into blank serum specimens containing a fixed amount of DAEMO (IS) each and extracted as described before. Since the base peaks of DAEMS and DAEMO (IS) equally appear at  $m/z$  114, the SIM measurements should be made using this single ion to construct a calibration curve for DAEMS consisting of peak area ratio of DAEMS to IS on the vertical axis and DAEMS concentration on the horizontal axis. A peak area ratio obtained from a test specimen is applied to the calibration curve to calculate a DAEMS concentration.
- g) For deproteinization, the ultrafiltration or perchloric acid can be also used. When the perchloric acid is used, the supernatant solution should be neutralized with sodium bicarbonate before the extraction procedure.
- h) The pH adjustment can be made using 1 M hydrochloric acid solution. Since the  $pK_a$  value of EMPA is 2.75, the pH of the aqueous layer should be not higher than 2.0 to extract EMPA into an organic layer efficiently; at higher than pH 3.0, the efficiency becomes much lower.
- i) Usually, acetonitrile and water are well miscible and difficult to be separated. However, the addition of a saturable amount of NaCl, the acetonitrile layer is distinctly separated from the aqueous layer by the salting-out effect.
- j) The adsorption of EMPA to the Pyrex glass test tube is much less than that to a usual glass test tube.
- k) For derivatization of EMPA, trimethylsilylation, PFB derivatization and methyl esterification can be also used. However, in the analysis by EI-MS, the *t*-BDMS derivatization gives the highest sensitivity.

The GC/MS analysis in the negative ion chemical ionization (NICI) mode, the PFB derivatization with pentafluorobenzyl bromide (PFBBBr) is most useful. By this method, the sensitivity ten to several ten times higher than that by the positive ion EI method can be obtained. In the mass spectrum, only a single peak at  $m/z$  123 due to  $[M-PFB]^-$  appears. However, in the NICI mode, the optimization of conditions is relatively complicated; it does not seem recommendable for wide use. Therefore, a simple positive EI method, which is highly reproducible, has been presented here.

- l) For quantitative analysis of EMPA, a calibration curve is constructed with a similar procedure to that described in the above commentary<sup>f</sup>. However, ions at  $m/z$  153 and 168 for *t*-BDMS derivative of EMPA and diphenylmethane (IS), respectively, are used for SIM measurements.
- m) The base peak for DAEMS appearing at  $m/z$  114 in the EI mass spectrum ( Figure 2.2) is a fragment ion due to  $[(iPr)_2 N=CH_2]^+$ . Since the same fragment ion at  $m/z$  114 can be observed also in the spectrum of VX as the base peak [9], it is easy to examine the coexistence of VX and DAEMS by SIM measurements at  $m/z$  114.

In the mass spectrum of DAEMS, other fragment ions at  $m/z$  72, 128 and 75, due to  $[(iPr)N = CH_2]^+$ ,  $[(iPr)(CH_3C = CH_2)NHC_2H_5]^+$  and  $[CH_3SCH_2CH_2]^+$ , respectively, also appear. Very small molecular peak ( $M^+$ ) can be observed at  $m/z$  175.

- n) In EI mass spectra for *t*-BDMS derivatives, intense peaks due to  $[M-57]^+$  are usually observed. However, in the case of the *t*-BDMS derivative of EMPA, a fragment ion, having a structure of  $[CH_3PO(OH)OSi(CH_3)_2]^+$ , is produced by desethylation, and appears at  $m/z$  153 as the base peak; the  $[M-57]^+$  peak due to  $[CH_3PO(OC_2H_5)OSi(CH_3)_2]^+$  also appears at  $m/z$  181 with intensity of about 50 %.

Except for EMPA, the *t*-BDMS derivatives of isopropylmethylphosphonic acid (IPMPA) and pinacolylmethylphosphonic acid (PMPA), the decomposition products of sarin and soman, respectively, also show their base peaks at  $m/z$  153. Therefore close attention should be paid to the discrimination of EMPA from IPMPA or PMPA. However, for all compounds, the relatively intense  $[M-57]^+$  peaks also appear; they can be indicators of their identities. The differences in retention times can be also used for their identification. In addition, upon analysis of EMPA in a specimen, it is essential to analyze its authentic compound simultaneously for comparison.

- o) To detect MPA with high efficiency, the aqueous phase can be directly evaporated to dryness without acetonitrile extraction. When the volume of the aqueous phase is small, it can be realized; but when the volume is large, it requires a long time for evaporation to dryness. In addition, in the aqueous phase, many impurity compounds derived from a specimen matrix are included; in such cases, the extraction with acetonitrile may give better results, though its recovery rate is low.

## References

- 1) Hirsjvi P, Miettinen JK, Paasivirta J et al. (1981) Trace Analysis of Chemical Warfare Agents. An Approach to the Environmental Monitoring of Nerve Agents. Ministry of Foreign Affairs of Finland, Helsinki, pp 27, 28, 37–39, 59–64, 72–79 and 90–99
- 2) Tsuchihashi H, Katagi M, Nishikawa M et al. (1998) Identification of metabolites of nerve agent VX in serum collected from victim of VX murder. *J Anal Toxicol* 22:383–388
- 3) Katagi M, Nishikawa M, Tatsuno M et al. (1997) Determination of the main hydrolysis product of organophosphorus nerve agents, methylphosphonic acids, in human serum by indirect photometric detection ion chromatography. *J Chromatogr B* 698:81–88
- 4) Oehrle SA, Bossle PC (1995) Analysis of nerve agent degradation products using capillary ion electrophoresis. *J Chromatogr A* 692:247–252
- 5) Sega GA, Tomkins BA, Griest WH (1997) Analysis of methylphosphonic acid, ethylmethylphosphonic acid and isopropyl methylphosphonic acid at low microgram per liter levels in groundwater. *J Chromatogr A* 790:143–152
- 6) D'Agostino PA, Provost LR (1992) Determination of chemical warfare agents, their hydrolysis products and related compounds in soil. *J Chromatogr* 589:287–294
- 7) Purdon JG, Pagotto JG, Miller RK (1989) Preparation, stability and quantitative analysis by gas chromatography and gas chromatography-electron impact mass spectrometry of tert-butyl dimethylsilyl derivatives of some alkylphosphonic and alkyl methylphosphonic acids. *J Chromatogr* 475:261–272
- 8) Katagi M, Nishikawa M, Tatsuno M et al. (1997) Determination of the main hydrolysis product of O-ethyl S-2-diisopropylaminoethyl methylphosphonothiolate, ethylmethylphosphonic acid, in human serum. *J Chromatogr B* 689:327–333
- 9) Fredriksson S-Å Hammarstöm L-G, Henriksson L et al. (1995) Trace determination of alkyl methylphosphonic acids in environmental and biological samples using gas chromatography/negative-ion chemical ionization mass spectrometry and tandem mass spectrometry. *J Mass Spectrom* 30:1133–1143

- 10) Miki A, Katagi M, Tsuchihashi H et al. (1999) Determination of alkylmethylphosphonic acids, the main metabolites of organophosphorus nerve agents, on biofluids by gas chromatography-mass spectrometry and liquid-liquid-solid phase-transfer-catalyzed pentafluorobenzoylation. *J Anal Toxicol* 23:86–93
- 11) Black RM, Read RW (1998) Analysis of degradation products of organophosphorus chemical warfare agents and related compounds by liquid chromatography-mass spectrometry using electrospray and atmospheric pressure chemical ionization. *J Chromatogr A* 794:233–244
- 12) Kostianen R, Bruins AP, Hakkinen VMA (1993) Identification of degradation products of some chemical warfare agents by capillary electrophoresis-ionspray mass spectrometry. *J Chromatogr* 634:113–118
- 13) Mercier J-P, Chaimbault P, Morin P et al. (1998) Identification of phosphonic acid by capillary electrophoresis-ion spray mass spectrometry. *J Chromatogr A* 825: 71–80
- 14) Katagi M, Tatsuno M, Nishikawa M et al. (1998) On-line solid-phase extraction liquid chromatography- continuous flow frit fast atom bombardment mass spectrometric and tandem mass spectrometric determination of hydrolysis products of nerve agents alkyl methylphosphonic acids by p-bromophenacyl derivatization. *J Chromatogr A* 833:169–179
- 15) Tu AT (1999) Principle of Toxicology – Science of Poisons. Jiho Inc., Tokyo, pp 131–173 (in Japanese)
- 16) Tu AT, Inoue N (2001) Overall View of Chemical and Biological Weapons. Jiho Inc., Tokyo, pp 79–94 (in Japanese)
- 17) World Health Organization (1970) Health Aspects of Chemical and Biological Weapons. Report of a WHO Group Consultants. Geneva
- 18) Tsuchihashi H, Katagi M, Tatsuno M et al. (2000) Determination of metabolites of nerve agent O-ethyl-S-2-diisopropylaminoethyl methylphosphonothiolate (VX). In: Tu AT, Gaffield W (eds) *Natural and Selected Synthetic Toxins Biological Implications*. Oxford University Press, Oxford, pp 369–386
- 19) D'Agostino PA, Provost LR (1986) Capillary column ammonia chemical ionization mass spectrometry of organophosphorus chemical warfare agents and simulants. *Biomed Environ Mass Spectrom* 13:231–236

## 11.8.3 Sodium azide

by Hitoshi Tsuchihashi and Akihiro Miki

### Introduction

As one of azide salts, lead azide is well known, because it is used as a detonator for air bags of automobiles. Recently, sodium azide has been frequently used for suicides and homicidal attempts. In this chapter, therefore, analytical methods are described only for sodium azide.

Sodium azide<sup>a</sup> is being well used as an antiseptic (preservative)<sup>b</sup> in biochemical researches and as a material for synthesis of organic compounds. It can be also used as a pesticide (herbicide), disinfectant for soil and antiseptic for lumbers; there had been no regulation for its use in spite of its high toxicity. However, in response to a series of imitative poisoning incidents, including many with sodium azide taking place in Japan, 1998, sodium azide was designated as a poisonous substance in January 1999; the handling and management of the compound has become strictly controlled by the Poisonous and Deleterious Substances Control Law in Japan.

### Analysis by the Conway diffusion method<sup>c</sup>-ion chromatography

---

#### Reagents and their preparation

- A 0.4-g amount of NaOH is dissolved in ultrapure water to prepare 100 mL solution (0.1 M).
- A 10-mL volume of concentrated sulfuric acid is carefully diluted 10-fold with ultrapure water to prepare 100 mL (10 %) solution.

#### Ion chromatographic conditions

Column: an IonPac AS15 column (25 cm × 4 mm i.d., Dionex, Sunnyvale, CA, USA); guard column: an IonPac AG15 column (5 cm × 4 mm i.d., Dionex).

Mobile phase: 40 mM KOH solution at a flow rate of 1.2 mL/min.

Instrumental conditions; instrument: a DX 500 ion chromatograph with an autosuppressor<sup>d</sup> (ASRS 4 mm, supplied current 100 mV); detector: a CD 20 conductivity detector (all from Dionex).

#### Procedure

- i. A 1.0-mL volume of 0.1 M NaOH solution is placed in the central round basin of a Conway microdiffusion cell<sup>c</sup>.



- ii. A specimen, such as fruit juice or urine, is placed in the outer groove of the cell without any dilution; blood or curry with high viscosity is diluted about 2-fold with distilled water and placed in the above groove.
- iii. The Conway cell is sealed airtightly with a glass plate cover smeared with Vaseline at the joint part. By sliding the glass plate, a part of the cover above the outer groove is opened; 1.0 mL of 10 % sulfuric acid is added to the specimen placed in the groove and the cell is sealed immediately.
- iv. The cell is gently moved to well mix sulfuric acid with the specimen in the groove, and left at room temperature for 1 h.
- v. The NaOH solution in the central round basin is passed through a membrane filter<sup>e</sup> (0.45  $\mu\text{m}$  for ion chromatography). A 10- $\mu\text{L}$  aliquot of the filtrate is injected into an ion chromatograph.

## Assessment of the method

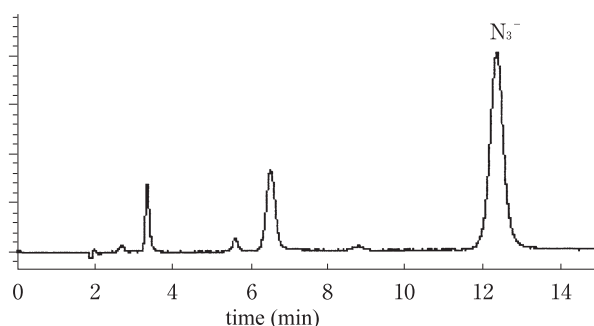
► *Figure 3.1* shows an ion chromatogram obtained under the present analytical conditions. Other anion exchanger columns can be also used, if the mobile phase is optimized for each column. When the pH of a mobile phase is alkaline, the NaOH solution extract in the central basin can be directly injected into an ion chromatograph.

For foods and biological specimens, such as coffee, fruit juice, urine and blood, it is inappropriate to inject each specimen into the instrument only after dilution with distilled water or filtration; sodium azide in such a specimen is converted into gaseous hydrazoic acid, which is trapped in the NaOH solution in the Conway microdiffusion cell. This diffusion extraction method is very useful for extensive purification of azide from a crude specimen.

For a relatively clean specimen with small amounts of impurities, such as tap water or tea, it is possible to directly inject it into the instrument only after dilution plus filtration. A powder specimen should be dissolved in ultrapure water to prepare 1–10  $\mu\text{g}/\text{mL}$  solution, filtered and injected into the instrument.

The detection limit obtainable by this method is about 0.1 ppm. The method is relatively simple, but the cost for the modern ion chromatographic system is more than twice of that for a usual HPLC system.

■ **Figure 3.1**



**Ion chromatogram for azide ion.**

## GC/MS analysis with derivatization

### Reagents and their preparation

- A 75- $\mu$ L (0.13 g) or 300- $\mu$ L (0.52 g) volume of pentafluorobenzyl bromide (PFBBR) is dissolved in acetone to prepare 10 mL solution (50 or 200 mM) (to be used for the below (i) procedure).
- A 30- $\mu$ L volume (52 mg) of PFBBR is dissolved in ethyl acetate to prepare 10 mL solution (20 mM) (for the (ii) procedure).
- A 150- $\mu$ L volume of PFBBR is dissolved in dichloromethane to prepare 10 mL solution (100 mM) (for the (iii) procedure).
- A 7.9-g amount of sodium thiosulfate is dissolved in distilled water to prepare 100 mL solution (0.5 M) (for the (i) procedure).
- A 4.2-mL volume of conc. HCl is carefully dissolved in distilled water to prepare 100 mL solution (0.5 M) (for the (i) procedure).
- A 184-mg amount of tetradecyldimethylbenzylammonium chloride (TDMBA) is dissolved in deoxygenated distilled water, which had been saturated with sodium tetraborate, to prepare 100 mL solution (5 mM) (for the (ii) procedure).
- 0.1 M Phosphate buffer solution (pH 7.7)<sup>b</sup> (for the (iii) procedure): 0.1 M potassium dihydrogenphosphate solution/0.1 M disodium hydrogen-phosphate solution (1:9, v/v).
- Polymer-phase-transfer catalyst (TBMPB; polymer-bound tributylmethylphosphonium bromide)<sup>f</sup> (for the (iii) procedure): 1.0 g of polymer-bound tributylmethylphosphonium chloride (0.90 mmol Cl<sup>-</sup>/g resin, Fluka, Buchs, Switzerland) is mixed with 20 mL of 5 % (w/v) hydrobromic acid solution with stirring at room temperature for 30 min. This procedure is repeated three times by adding the new 5 % hydrobromic acid solutions. Then the polymer is washed with 20 mL distilled water 5 times, with 20 mL methanol 5 times, with 20 mL dichloromethane 3 times and with 20 mL diethyl ether 3 times, and dried under reduced pressure over 24 h.

### GC/MS conditions

Column: a slightly polar fused silica capillary column (30 m  $\times$  0.32 mm i.d., film thickness 0.25  $\mu$ m).

GC/MS conditions; instrument: QP-5050 (Shimadzu Corp, Kyoto, Japan); ionization: positive EI and negative ion chemical ionization (NICI) modes; injection temperature: 250  $^{\circ}$ C; column temperature: 50  $^{\circ}$ C  $\rightarrow$  10  $^{\circ}$ C/min  $\rightarrow$  150  $^{\circ}$ C; ion source temperature: 250  $^{\circ}$ C; injection mode: split (5:1); carrier gas (flow rate): He (4.0 mL/min).

### Procedures

At the first step, qualitative analysis [1] is made by GC/MS for a specimen after its derivatization with PFBBR<sup>g</sup>. Quantitative analysis is then carried out using a calibration curve obtained from blank specimens spiked with various concentrations of sodium azide. There are three methods for derivatization of azide as follows.

**i. Derivatization in the acetone-water mixture in the presence of a base [2]**

- i. Urine specimen: 2 mL of urine is mixed with 0.5 mL of sodium tetraborate-saturated aqueous solution and 1 mL of 50 mM PFBBR acetone solution in a 10-mL volume glass test tube with a ground-in stopper.  
Blood specimen: 0.2 mL of whole blood is mixed with 0.2 mL distilled water, 0.5 mL of sodium tetraborate-saturated aqueous solution and 0.5 mL of 200 mM PFBBR acetone solution in a 10-mL volume glass test tube with a ground-in stopper.
- ii. The mixture prepared above is heated at 50 °C for 20 min. After cooling to room temperature, 1 mL of 0.5 M sodium thiosulfate aqueous solution is added to the mixture and shaken vigorously for 1 min<sup>h</sup>.
- iii. It is again heated at 50 °C for 2 min. After cooling to room temperature, 1.0 g NaCl is added to it and the final volume is adjusted to 6 mL with distilled water.
- iv. After adding 1.0 mL of *n*-hexane and an appropriate internal standard (IS)<sup>i</sup>, the mixture is shaken vigorously.
- v. It is centrifuged; the organic layer is transferred to another test tube and washed with 1.0 mL of 0.5 M HCl. A 2- $\mu$ L aliquot of the organic layer is injected into GC/MS.

**ii. Derivatization in a two-phase system in the presence of an ion-pairing reagent for liquid-liquid extraction [3]**

- i. A 0.5-mL volume of 20 mM PFBBR ethyl acetate solution, 0.8 mL of 5 mM TDMBA solution (dissolved in sodium tetraborate-saturated aqueous solution) and an appropriate IS<sup>i</sup> are placed in a 10-mL volume glass test tube with a ground-in stopper.
- ii. A 0.2-mL volume of urine or blood is added to the above mixture, vortex-mixed for 1 min and heated at 60 °C for 30 min.
- iii. After centrifugation, a 1- $\mu$ L aliquot of the organic phase is injected into GC/MS.

**iii. Derivatization in a tri-phase system using a polymer-phase-transfer catalyst [1]**

- i. The pH of a specimen is adjusted to 7.5–8 with either NaOH or acetic acid aqueous solution.
- ii. The specimen (0.1–1 mL), 100  $\mu$ L of 0.1 M phosphate buffer solution (pH 7.7), 400  $\mu$ L of 100 mM PFBBR dichloromethane solution, 30 mg of the polymer-phase-transfer catalyst TBMPB<sup>f</sup> and an appropriate IS<sup>i</sup> are placed in a 2-mL volume safe-lock tube.
- iii. After shaking at 38 °C for 30 min in a water bath, it is centrifuged, if necessary, to obtain the organic phase.
- iv. The organic phase is dehydrated with anhydrous sodium sulfate, and a 1- $\mu$ L aliquot of it is injected into GC/MS.

**Assessment of the methods**

The procedures for the present method are more complicated than that for ion chromatography. The method consists of conversion of an inorganic azide anion into pentafluorobenzyl azide (PFBN<sub>3</sub>) and measurements of its mass spectrum for identification. This method is best for qualitative analysis. The derivatization can be chosen from the above (1)–(3) procedures in view of simplicity of procedure and availability of reagents. By either derivatization method, PFBN<sub>3</sub> can be obtained almost quantitatively<sup>b, g</sup>.

In the above (1) derivatization, azide is easily derivatized in a homogenous system of water-acetone in the presence of a base. At the steps ii) and iii), excessive PFBBr is converted into water soluble pentafluorobenzyl thiosulfate ion, followed by extraction of PFBN<sub>3</sub> into an organic solvent. The influence of tailing of the PFBBr peak, which appears just before that of PFBN<sub>3</sub>, can be excluded by the liquid-liquid extraction. The procedure of derivatization is relatively complicated, but it is sensitive and useful especially when the target compound is only azide.

In the above (2) and (3) derivatizations, the reactions take place in the two-phase (water-organic phases) and tri-phase (water-organic-solid phases) in the presence of an ion-pairing reagent and a polymer-phase-transfer catalyst, respectively. Both derivatization procedures enable simultaneous detection of PFB derivatives of cyanide and thiocyanate ions together with the azide ion, when these ions coexist in a specimen. Especially in the (3) derivatization, the method was optimized for simultaneous detection of the 3 anions; it is usable even for a large volume of a specimen<sup>j</sup> and gives a clean extract. Even when the polymer-bound tributylmethylphosphonium chloride commercially available is directly used as a phase-transfer catalyst, it gives no problems for analysis of azide and thiocyanate ions; but derivatization efficiency becomes much lower for the cyanide ion<sup>f</sup>.

➤ *Figure 3.2* shows positive ion mass chromatograms, and positive-ion EI and NICI mass spectra after the procedure (3) for a urine specimen (0.5 mL), into which azide ion at the concentration of 10 µg/mL and 5 µg Tetralin<sup>®</sup> (IS) had been spiked.

The detection limits in the scan mode are: 100 ng/mL (whole blood specimen, EI mode) and 10 ng/mL (urine specimen, EI mode) for the (1) procedure [2]; about 20 ng/mL (blood and urine specimen, NICI mode) for the (2) procedure [3]; 200 ng/mL (various beverage specimens, EI mode) and 10–25 ng/mL (various beverage specimens, NICI mode) for the (3) procedure [1].

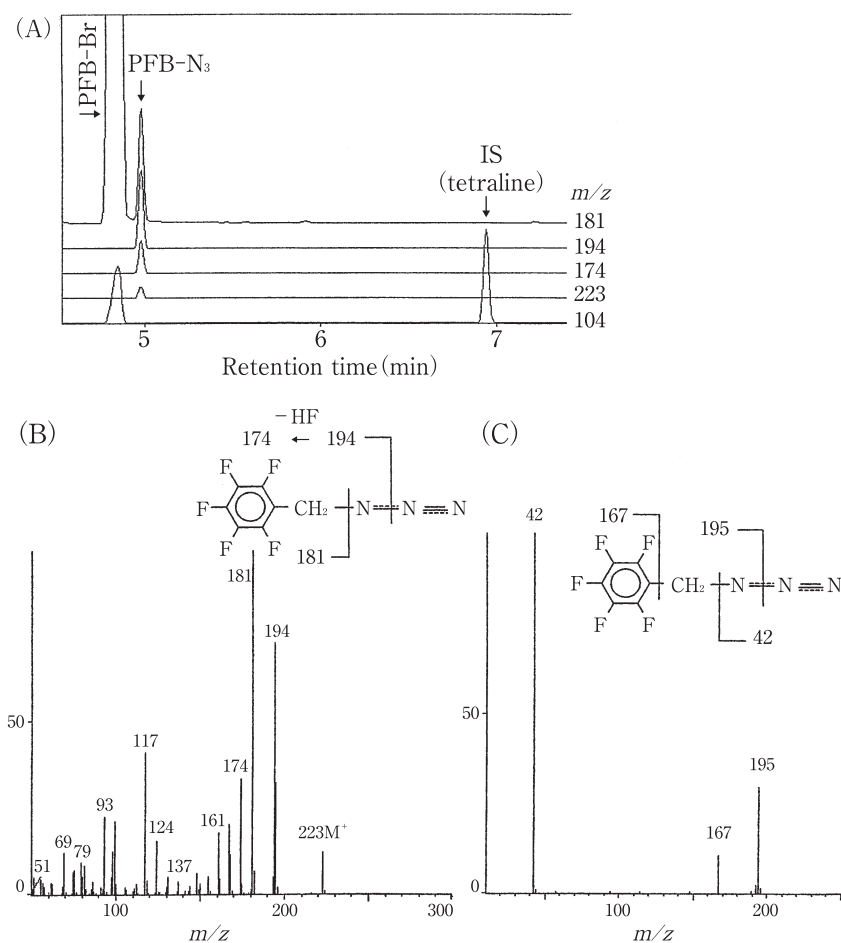
The concentration of azide, which has been added to whole blood, rapidly decrease during storage by refrigeration (4 °C), but such decrease can be prevented by adding sodium tetraborate or NaOH solution to specimens [2].

## Poisoning symptoms, and toxic and fatal concentrations

The toxicity of azide is said comparable to that of cyanide; the azide, like cyanide, is bound with the trivalent iron of cytochrome oxidase to inhibit the enzyme, causing the toxicity of azide. Its toxicity is observed after oral, percutaneous, intraperitoneal, intravenous and subcutaneous administrations. After inhalation of hydrazoic acid vapor and oral intake of azide, respiratory stimulation and tachycardia appear, followed by metabolic acidosis, hypotension, respiratory suppression, bradycardia, convulsion and finally death. Metabolism and excretion of azide in humans have not been well studied [4]. The affinity of azide ion for methemoglobin is much lower than that of cyanide ion; the detoxification of azide poisoning, therefore, cannot be achieved by the administration of sodium nitrite [5].

There was a report [6] describing a victim showing poisoning symptoms after oral intake of 5–10 mg sodium azide. Many years ago, sodium azide had been used for treatment of hypertension with a therapeutic dose of 0.65–1.3 mg. Therefore, the minimum oral toxic dose of sodium azide seems to be several mg. Until this time, a considerable number of cases of sodium azide poisoning were reported [7,8]; there was a survived case, in which as much as 150 mg of sodium azide was ingested [9]. There are reports describing fatalities with doses of 0.7–0.8 g [10] and 1.2–2.0 g [11].

■ **Figure 3.2**

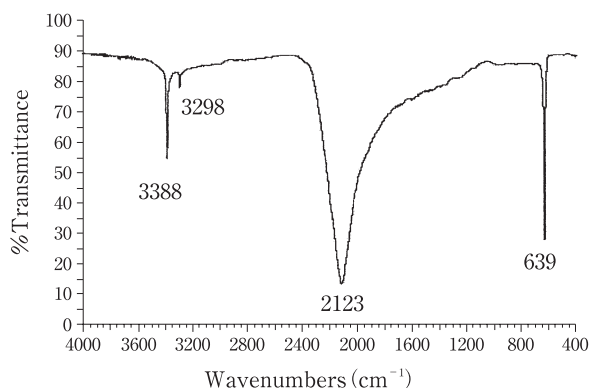


**Analysis by GC/MS for azide ion after PFB derivatization. (A): mass chromatograms in the positive EI mode; (B): a mass spectrum in the positive EI mode; (c): a mass spectrum in the NICI mode.**

## Notes

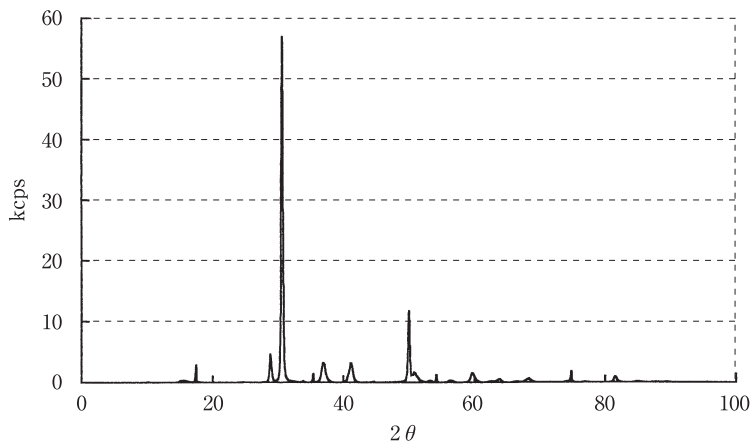
- Pure sodium azide (NaN<sub>3</sub>) is white powder and well soluble in water; its pK<sub>a</sub> is 4.6. In acidic solution, it is converted into poisonous hydrazoic acid gas. The gas reacts with ferric chloride to produce a deep orange color, which can be used for a screening test for azide [12]. For informations, the infrared absorption spectrum and X-ray diffraction profile for sodium azide are shown in [▶ Figures 3.3 and 3.4](#), respectively.
- In some of buffer solutions commercially available, sodium azide is included as a preservative. Before analysis of a test specimen, blank tests should be done to confirm the absence of azide in any material or reagent to be used for azide analysis.
- For the details of the Conway microdiffusion cell, please see Chapter II.1.3, Cyanide of this book.

Figure 3.3



Infrared absorption spectrum of sodium azide.

Figure 3.4



X-ray diffraction profile for sodium azide.

- d) To realize sensitive analysis, an ion chromatograph system equipped with an autosuppressor is most desirable. In this system, the external mode, which uses pure water as regenerating solution, is adopted.
- e) Since interfering ions may be eluted from a membrane filter, it should be sufficiently washed with ultrapure water before use.
- f) Swelling particle polymer (200–400 mesh; polystyrene crosslinked with 1 % divinylbenzene) bound with the phosphonium salt. The commercially available product is the Cl type (0.90 mmol Cl<sup>-</sup>/g. When only a compound with high nucleophilic reactivity like azide ion is targeted, the Cl type catalyst can be directly used. However, when anionic poisons with relatively low nucleophilic reactivity including cyanide ion are analyzed, it is preferable to convert the Cl type catalyst into the Br type according to the procedure described here. This is because the Br type catalyst acts to protect the derivatization reagent PFBBr from its

conversion into less reactive PFBCl by reaction with chloride ions being included in the biological matrix.

- g) Azide ion is easily derivatized by nucleophilic displacement reaction with halogenated alkyl like PFBBBr. The derivative produced is stable. Although PFBBBr is a good derivatization reagent for GC/MS analysis in both positive EI and NICI modes, it is highly corrosive and lacrimatory and thus the handling of the undiluted solution of PFBBBr should be carefully made inside a draft chamber.
- h) By utilizing high nucleophilic reactivity of thiosulfate ion, PFBBBr is converted into water-soluble and non-reactive pentafluorobenzyl-thiosulfate ion, which is removed at the steps iii)–v).  $\text{PFBB-Br} + \text{S-SO}_2\text{-O}^- \rightarrow \text{PFBB-S-SO}_2\text{-O}^- + \text{Br}^-$ . This reaction rapidly proceeds in a homogenous water-acetone system, but does not smoothly in the two- and tri-phase systems.
- i) As ISs, Tetralin<sup>®</sup> [1], 1,3,5-tribromobenzene [3] and *N*-(2-trifluoro-methyl)benzyl pentafluoropropamine [2] were reported.
- j) The specimen should be relatively clean with small amounts of impurities, such as lavage solution for a food and tea solution; as large as 4 mL volume of a specimen can be analyzed using an appropriate test tube with a ground-in stopper.

## References

- 1) Miki A, Nishikawa M, Tsuchihashi H (2000) Simultaneous GC-MS determination of azide, cyanide and thiocyanate via phase-transfer-catalyzed pentafluorobenzoylation. *J Health Sci* 46:81–88
- 2) Kikuchi M, Sato M, Ito T et al. (2001) Application of a new analytical method using gas chromatography and gas chromatography-mass spectrometry for the azide ion to human blood and urine samples of an actual case. *J Chromatogr B* 752:149–157
- 3) Kage S, Kudo K, Ikeda N (2000) Determination of azide in blood and urine by gas chromatography-mass spectrometry. *J Anal Toxicol* 24:429–432
- 4) Baselt RC, Cravey RH (1995) *Disposition of Toxic Drugs and Chemicals in Man*, 4th edn. Chemical Toxicology Institute, Foster City, CA, p 66
- 5) Naito H (1991) *Poisoning of Industrial Products, Gases, Pesticides, Drugs, and Natural Toxins – Cases, Pathogenesis and Its Treatment*, 2nd edn. Nankodo, Tokyo, pp 18–19
- 6) Richardson SGN, Giles C, Swan CHL (1975) Two cases of sodium azide poisoning by accidental ingestion of Isoton. *J Clin Pathol* 28:350–351
- 7) Chiba Y, Ohmichi M, Inaba H (1999) Influence of sodium azide on human bodies and its poisoning accidents. *Jpn J Hyg* 53:572–579 (in Japanese with an English abstract)
- 8) Kikuchi M, Sato M, Ito T et al. (2000) Toxicity of sodium azide and determination of azide ions. *Jpn J Forensic Toxicol* 18:1–13 (in Japanese with an English abstract)
- 9) Burger E, Bauer HM (1965) Akuter Vergiftungsfall durch versehentliches Trinken von Natriumazidlösung. *Arch Toxikol* 20:279–283
- 10) Howard JD, Stogerboe KJ, Case GA et al. (1990) Death following accidental sodium azide ingestion. *J Forensic Sci* 35:193–196
- 11) Klein-Schwartz W, Gorman RL, Oderda GM et al. (1989) Three fatal sodium azide poisoning. *Med Toxicol Adverse Drug Exp* 4:219–227
- 12) Tsuchihashi H, Nishikawa M (2000) Analysis of drugs and poisons in forensic chemistry. *J Anal Bio-Science* 23:149–158 (in Japanese with an English abstract)

## II.8.4 Arsenic compounds and other inorganic poisons

by Sinichi Suzuki and Yasuhiro Suzuki

### Introduction

The Wakayama Curry Poisoning Incident taking place in August 1998, followed by various imitative poisoning incidents, is still fresh in our memory, because they gave a severe shock and anxiety to the Japanese society. The poison, which had been used in the Wakayama Curry Poisoning Incident was an arsenite<sup>a</sup>, a classical poison. However, since the acute poisoning case by an arsenite is rare nowadays, it took some time to identify the compound, and caused confusion at the initial step of criminal investigation.

Diarsenic trioxide ( $\text{As}_2\text{O}_3$ , arsenic (III) oxide) is a trivalent arsenic compound and thus highly toxic, in contrast to less toxic pentavalent arsenates<sup>b</sup> being widely distributed in nature. When diarsenic trioxide is dissolved in water, it is immediately converted into the arsenious acid<sup>c</sup>, which actually exerts its toxicity in humans. The oral  $\text{LD}_{50}$  value of diarsenic trioxide in humans is said to be 60–120 mg. As other inorganic poisons, cadmium, thallium, lead, chromium and copper can be mentioned; however they and their derivatives are much less toxic than arsenious acid. These inorganic compounds can be analyzed by the similar methods to those for arsenic compounds. In this chapter, analytical methods for arsenic compounds together with other inorganic poisons are described.

### Reagents

Diarsenic trioxide and dimethylarsinic acid (DMAA) can be purchased from Sigma (St. Louis, MO, USA) and other manufacturers. Nitric acid and hydrochloric acid should be of ultra pure grade usable for inductively coupled plasma mass spectrometry (ICP-MS). Other reagents are of special grade.

### Instrumental conditions

#### i. X-ray fluorescence analysis

Instrument: a PW1404 type X-ray fluorescence analysis instrument (Philips, Almelo, Netherlands).

Analytical conditions; X-ray tube: target Rh; operating voltage: 50 kV; operating current: 50 mA; crystal: LiF; detectors: scintillation counter and gas flow proportional counter.



**ii. Ion chromatography (IC) analysis**

Instrument: a DX-500 type ion chromatograph equipped with an autosuppressor (Dionex, Sunnyvale, CA, USA).

Analytical conditions; separation column: IonPac AS10 (25 cm × 2 mm i. d., particle size 8.5 μm); guard column: IonPac AC10 (both from Dionex); mobile phase: 75 mM NaOH solution (1-min hold) is subjected to linear gradient up to 150 mM NaOH solution during 7 min; its flow rate: 1.3 mL/min; detectors: conductivity and electrochemical detectors (ECD).

**iii. Inductively couple plasma atomic emission spectrometry (ICP-AES)**

Instrument: an SPS-1700 HVR ICP-AES instrument (Seiko Instruments, Chiba, Japan).

Analytical conditions; high-frequency output: 1.3 kW; plasma gas: argon (16 L/min); assisting gas: argon (0.5 L/min); carrier gas: argon (1.0 L/min); sample flow rate: 0.5 mL/min.

**iv. Inductively couple plasma mass spectrometry (ICP-MS)**

Instrument: an SPQ 8000 type ICP-MS instrument (Seiko Instruments).

Analytical conditions; high-frequency output: 1.2 kW; plasma gas: argon (16 L/min); assisting gas (flow rate): argon (0.75 L/min); carrier gas (flow rate): argon (0.45 L/min); sampling position: 13 mm.

**v. Ion chromatography/inductively coupled plasma mass spectrometry (IC/ICP-MS)**

Instrument HPIC 7000-HP 4500 type IC/ICP-MS (Agilent Technologies, Palo Alto, CA, USA).

IC conditions; column: anion type IC-A15 (150 × 4.6 mm i.d., Hitachi Chemical, Tokyo, Japan); guard column: IC-A15G (Hitachi Chemical); mobile phase: 0.2 mM EDTA/2.0 mM sodium phosphate buffer solution (pH 6.0); flow rate: 1.0 mL/min; column temperature: room temperature.

ICP-MS conditions; high-frequency output: 1.4 kW; plasma gas: argon (1.5 L/min); assisting gas: argon (1.0 L/min); carrier gas (flow rate): argon (1.1 L/min); arsenic detection mass number:  $m/z$  75.

**Procedures****i. Foods and vomitus**


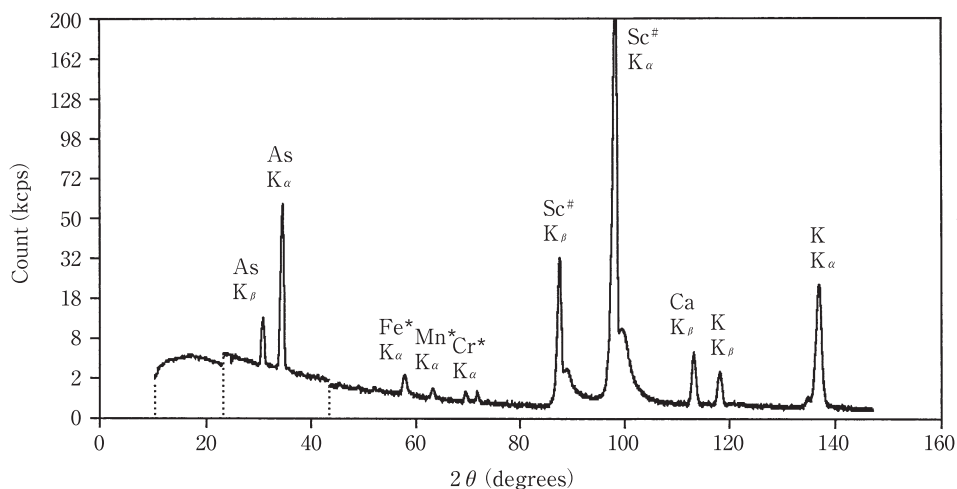
- i. A method to be chosen first is the X-ray fluorescence analysis, which is non-invasive and thus does not destroy a specimen. It gives informations on elements included in a specimen, but cannot discriminate the forms of molecules containing such elements (for example, trivalent or pentavalent). The X-ray fluorescence analysis should be performed, when the presence of an inorganic poison is suspected, after analysis of organic compounds.  *Figure 4.1* shows an X-ray fluorescence spectrum for a food specimen containing poison(s) obtained without any pretreatment.
- ii. At the second step of examination, IC should be performed to define the form of a poison. By this analytical method, discrimination between trivalent (highly toxic) and pentavalent (less- or non-toxic) arsenic compounds can be made.
- iii. A 1-g amount of a food specimen is mixed with 5 mL distilled water, stirred for 1 min and centrifuged at 3,000 rpm for 5 min.

Figure 4.1



X-ray fluorescence spectrum for a food specimen. \*, #: elements derived from the tube.

- iv. The resulting supernatant solution is passed through a cellulose acetate filter (0.45  $\mu\text{m}$ ). An appropriate volume of the filtrate is injected into an ion chromatograph.
- v. An example of the results is shown in [▶ Figure 4.2](#); an intense peak due to a trivalent arsenite (arsenious acid) appeared at 2.4 min.

### ii. Stomach contents

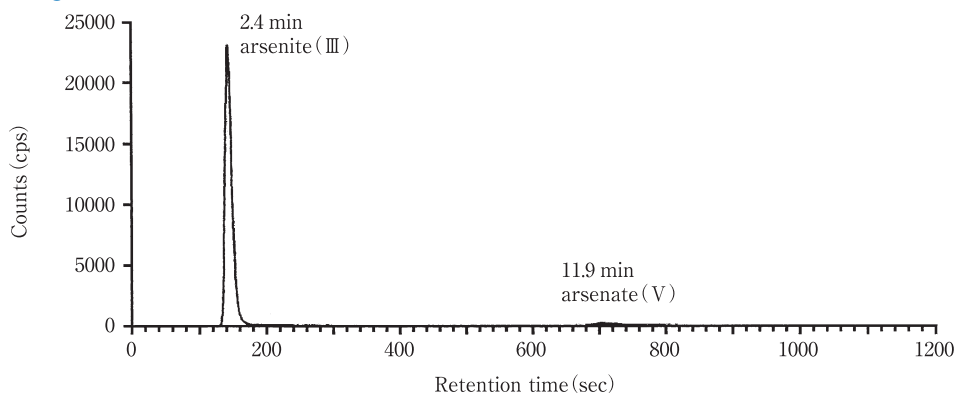
In the Japanese trial system, the ingestion of a poison is not verified, even if the poison is detected from a vomitus. Therefore, a poison or a drug should be detected from stomach contents, blood or urine obtained from an antemortem or postmortem human. [▶ Figure 4.3](#) shows an X-ray fluorescence spectrum for a stomach content specimen obtained without pretreatment; the  $K_{\alpha}$  and  $K_{\beta}$  rays due to arsenic could be observed, showing its presence in the stomach contents.

### iii. Blood

Blood can be an important evidential specimen for proving the ingestion of an arsenite. When the presence of arsenic becomes evident from the results obtained by the above X-ray fluorescence analysis, the following procedure should be made to clarify a chemical form of an arsenic compound.

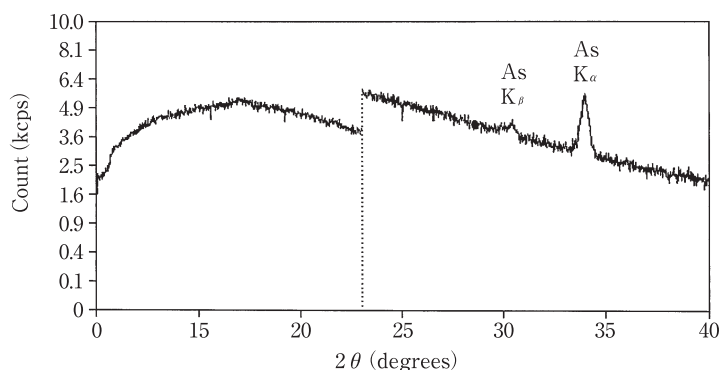
- i. A 1-mL volume of blood is diluted 2–5 times with distilled water.
- ii. A container containing the above specimen is airtightly capped and sterilized in an autoclave at 120  $^{\circ}\text{C}$  for 10 min.
- iii. After cooling to room temperature, the aqueous phase is passed through a cellulose acetate filter (0.45  $\mu\text{m}$ ).
- iv. The filtrate is analyzed by IC/ICP-MS; an SIM chromatogram at  $m/z$  75 is obtained. [▶ Figure 4.4](#) shows an example of SIM chromatograms for an arsenite obtained by IC/ICP-MS. By this method, a trivalent arsenic compound was identified, verifying the ingestion of diarsenic trioxide or other arsenious compound(s).

■ **Figure 4.2**



**Ion chromatogram for arsenic compounds after pretreatments of a food specimen.**

■ **Figure 4.3**



**X-ray fluorescence spectrum for a stomach content specimen.**

#### iv. Urine

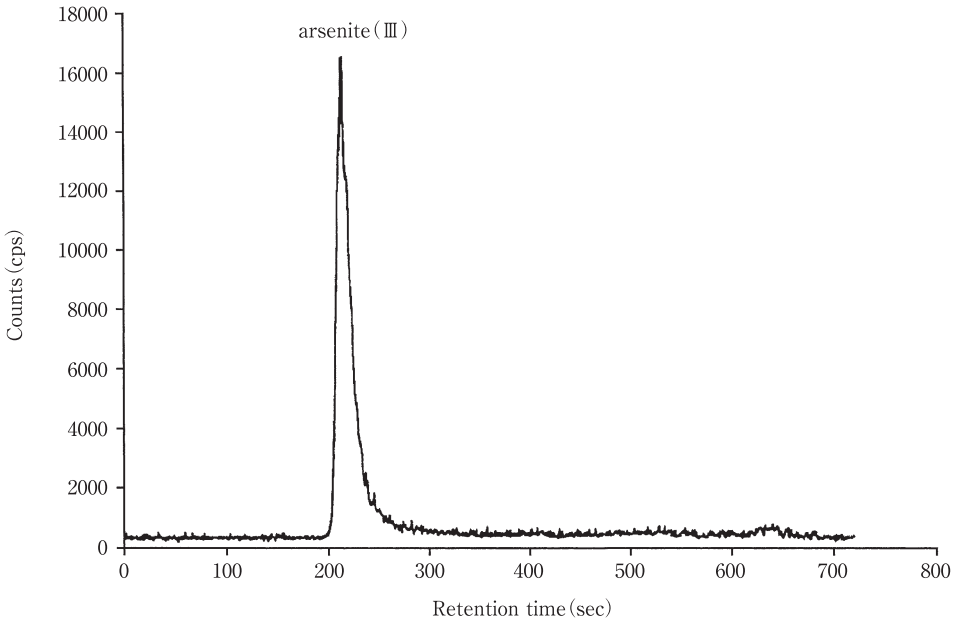
Urine specimens are being used for analysis of drugs and poisons most frequently. Also for inorganic compounds, urine is a good specimen for poison analysis. A metabolite of an inorganic poison formed in human body is usually excreted into urine; the presence of the metabolite in urine gives a most definitive evidence for the ingestion or administration of the poison.

In the case of a urine specimen obtained from a subject, who had attempted suicide by ingesting arsenious acid, a 1-mL volume of urine was diluted 10-fold with distilled water and passed through a Gurand-RP cartridge. The eluate was subjected to the analysis by IC/ICP-MS. As results, arsenious acid, its metabolites DMAA and arsenobetaine were detected with the ion at  $m/z$  75 as shown in [▶ Figure 4.5](#). Their respective structures are shown in [▶ Figure 4.6](#).

#### v. Organs

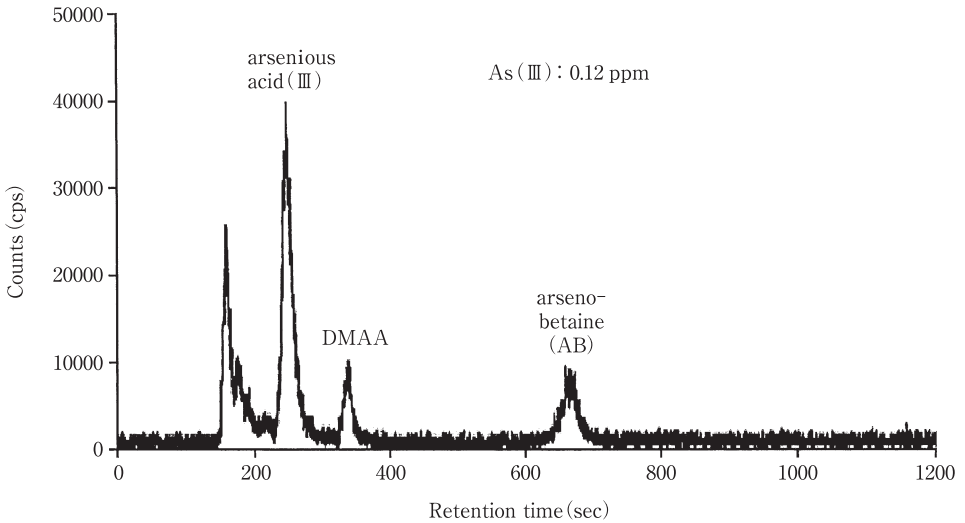
A piece of an organ is dried by leaving it at room temperature; about 50 mg of a dried specimen is mixed with 2 mL nitric acid and heated with microwave to liquefy the tissue completely. The acid solution is diluted with 10 mL distilled water and analyzed by ICP-MS. An example

■ **Figure 4.4**



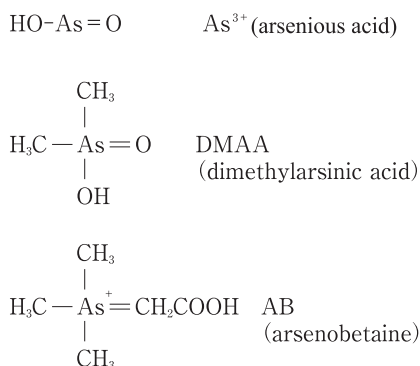
SIM chromatogram obtained by IC/ICP-MS for a blood specimen using an ion at  $m/z$  75.

■ **Figure 4.5**



SIM chromatogram obtained by IC/ICP-MS for a urine specimen using an ion at  $m/z$  75.

■ **Figure 4.6**



**Structures of main metabolites of arsenious acid.**

of mass spectra obtained from an organ tissue is shown in [▶ Figure 4.7A](#). At  $m/z$  75, a peak due to arsenic appeared. Using the intensity of this peak, the content of arsenic in the kidney tissue was calculated using a calibration curve for arsenic; its content was much higher than that in normal subjects.

**vi. Scalp hair**

Scalp hair is very useful to specify a time (period) for ingestion of a heavy metal. It is more easily obtainable than organs.

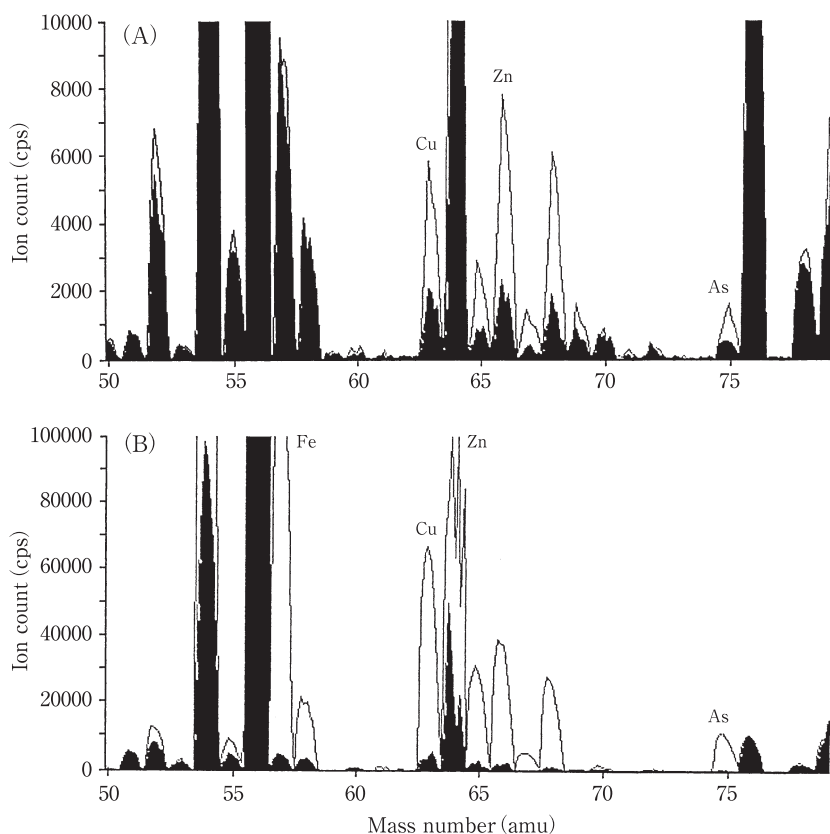
- i. The hair should be cut off at its root level as closely to the scalp as possible. The growth rate of scalp hair is about 1 cm per month. A bundle of about 30 scalp hairs is obtained and washed with either a surfactant solution, an organic solvent or dilute HCl solution using an ultrasonic cleaner.
- ii. The hair bundle is cut into 3-mm segments from the roots to the tips.
- iii. Each segment is digested in nitric acid by heating it with microwave.
- iv. A small volume of the nitric acid digest is diluted with distilled water in a 10-mL volumetric flask before analysis.
- v. An appropriate volume of the diluted solution is analyzed by ICP-MS for identification and quantitation of arsenic.

The mass spectrum of a hair specimen is shown in [▶ Figure 4.7B](#). A high concentration of arsenic can be detected from a hair segment corresponding to the period of arsenic intake. With the same pretreatment and analytical method, other heavy metals, such as iron, copper and zinc can be also detected by ICP-MS from organs and hair as shown in [▶ Figure 4.7](#).

**vii. Discrimination of commercial products of diarsenic trioxide**

In the criminal analysis of poisons, the identification of a poison used for a crime with the one seized is an important task. There are various limitations for the capability of analytical instruments being equipped in common chemical laboratories. Although the cost is high, the most useful instrument for such discrimination analysis of inorganic elements is ICP-MS. However, the concentration of a matrix introducible into the ICP-MS should be not higher than 500 ppm.

Figure 4.7

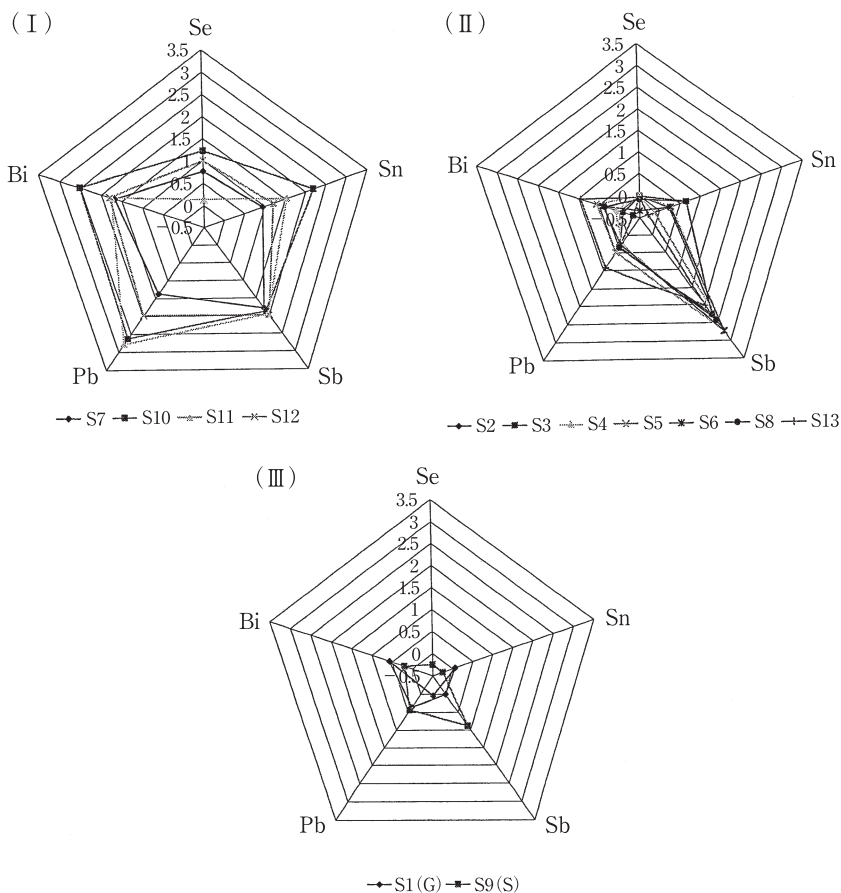


ICP mass spectra for kidney (A) and hair (B) specimens after digestion by microwave. Open areas show the peaks of reagent plus a specimen for analysis; solid areas the peaks of a blank specimen with the reagent only.

Therefore, trace levels of other heavy metals contaminating the arsenious matrix cannot be analyzed by ICP-MS. Therefore, in place of ICP-MS, ICP-AES was used for impurity profiling analysis of the diarsenite trioxide products. In preliminary experiments, heavy metals, such as bismuth (Bi), antimony (Sb), selenium (Se), lead (Pb) and tin (Sn), which show low abundance ratios in nature and thus not influenced by environments, were chosen for profiling analysis by ICP-AES. Each content of the above heavy metals was measured using each calibration curve, and the concentration ratio of each metal to arsenic was calculated. The values obtained were multiplied  $10^6$ -fold and plotted in the logarithmic scale as radar charts as shown in [Figure 4.8](#). The detection wavelengths were 190.0 nm for Sn, 196.1 nm for Se, 206.8 nm for Sb, 220.4 nm for Pb and 223.1 nm for Bi.

The radar charts show that diarsenite trioxide products made in China, Japan and Germany/Switzerland can be clearly discriminated by the profiling of contaminating heavy metals.

■ **Figure 4.8**



**Radar charts of impurity profiling analysis for diarsenic trioxide products made in China (I), Japan (II) and Germany/Switzerland (III).**

## Assessment of the methods

For trace analysis of arsenic, the method by ICP-MS is most sensitive and is usable for hair, nail and organ specimens. In this method,  $\text{ArCl}^+$  ion ( $m/z$  75) may interfere with the ICP-MS analysis of  $\text{As}^+$  ( $m/z$  75), when chloride ion coexists, because of their same mass number. Especially for biomedical specimens, special care should be taken for backgrounds. When such interference by  $\text{ArCl}^+$  is remarkable, IC/ICP-MS should be used for separating them.

As described before, a blood or urine specimen is useful to verify the acute poisoning with an arsenite compound. For the chronic exposure to the poison, scalp hair, nails and organ tissues are suitable for its verification. Since arsenic can be accumulated in hair and nails, it is possible to specify the time (period) of its ingestion by their segmental analysis.

To make impurity profiling analysis for an arsenious compound, which had been mixed with a large amount of a complicated matrix such as foods, it is not possible to accomplish it

only by usual instruments of X-ray fluorescence analysis, ICP-MS and ICP-AES being equipped in chemical laboratories. In such a case, the SPring-8, a large scale instrument for photoemission, enables the very sensitive profiling analysis by microprobe X-ray fluorescence using a powerful excitation beam at as high as 116 keV.

## Poisoning cases, and toxic and fatal concentrations

Acute and chronic cases of poisoning by arsenic are summarized in [▶ Tables 4.1 and 4.2](#) [1–7]. There were many fatalities in acute poisoning cases. In the chronic poisoning cases, the victims were drinking well water originating from an arsenic-containing vein (such as white arsenic stones) for a long period; such a kind of poisoning took place in limited areas ([▶ Table 4.2](#)).

The lethal dose of arsenic is considered to be 1.4 mg/kg (70–180 mg in adults) in the form of arsenious acid. Normal and toxic concentrations of arsenic in human body fluids and organs are summarized in [▶ Table 4.3](#) [8–10].

▣ **Table 4.1**

### Cases of acute arsenic poisoning

Incident	Food material	Year	Country	Ref.
Manchester bear incident	bear	1990	United Kingdom	[1]
dry milk arsenic incident	dry milk	1955	Japan	[2]
“shoyu” arsenic incident	shoyu	1956	Japan	[3]

▣ **Table 4.2**

### Cases of chronic arsenic poisoning due to drinking well water

Area	Country	Year	Ref.
Cordoba	Argentina	1938	[4]
Antfagastan	Chili	1977	[5]
South-east coast	Taiwan	1968	[6]
Sanjyo-shi, Niigata	Japan	1962	[7]

▣ **Table 4.3**

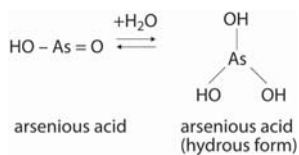
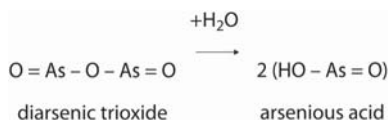
### Normal and toxic concentrations of arsenic in human body fluids and organs (µg/mL or g)

Sample	Normal		Toxic	
	Ref. [8]	Ref. [9]	Ref. [9]	Ref. [10]
blood	0.01–0.59	–	0.6–9.3	0.4–1.7
urine	0–0.1	–	–	4.6
brain	–	0–0.025	0.2–4.0	1.4
lung	0.08–0.17	0–0.085	–	–
liver	0.09–0.3	0–0.092	2.0–120.0	10.0
kidney	0.07–0.14	0–0.068	0.2–70.0	4.9
scalp hair	0.3–1.17	0–1.92	–	39.0, 226.0
nail	0.02–2.9	0–1.7	–	80.0



## Notes

- “Arsenite” is a general term for trivalent inorganic arsenic compounds, such as diarsenic trioxide, arsenious acid and sodium arsenite.
- Organic forms of the pentavalent arsenic compounds, such as DMAA, arsenobetaine and arsenocholine, are almost nontoxic and exist naturally in seaweed, fish and shellfish. Therefore, arsenic is incorporated into mammals *via* their foods. However, disodium arsenate, a pentavalent inorganic arsenic compound showed an i. p. LD<sub>50</sub> value of as low as 14–18 mg/kg in rats.
- Arsenious acid is the same as arsenous acid. When diarsenic trioxide is dissolved in water, the following reactions take place.



Diarsenic trioxide and arsenite salts, such as sodium arsenite and potassium arsenite, exist as white powder; but arsenious acid only exists in acidic aqueous solution. Because of the above immediate conversion of diarsenic trioxide into arsenious acid in water, the former compound is sometimes called “arsenious acid” popularly.

## References

- 1) Reynolds ES (1901) An account of the epidemic outbreak of arsenical poisoning occurring in beer-drinkers in the north of England and Midland countries in 1900. *Lancet* 1:166–170
- 2) Hamamoto E (1955) Infant arsenic poisoning by powdered milk. *Nihon Iji Shinpo* 1649:3–12
- 3) Mizuta N, Mizuta F, Ito T et al. (1956) An outbreak of arsenic poisoning caused by arsenic contained in soy-sauces shoyu. A clinical report of 220 cases. *Bull Yamaguchi Med Sch* 4:131–150
- 4) Arguello RA, Cebge DD, Tello EE (1938) Cancer y arsenicismo regional endemico en Cordoba. *Rev Argentina Dermatosisifilol* 22:461–487
- 5) Zaldivar R, Guillier A (1977) Environmental and clinical investigations on endemic chronic arsenic poisoning in infants and children. *Zbl Bakteriol Hyg* 65:226–235
- 6) Tseng WHP, Chu HW, How SW et al. (1968) Prevalence of skin cancer in an endemic area of chronic arsenicism in Taiwan. *J Natl Cancer Inst* 40:453–463
- 7) Terada H, Katsuta K, Sasagawa C et al. (1960) Clinical observation of chronic arsenic poisoning. *Jpn J Clin Med* 18:2569–2578 (in Japanese)
- 8) IARC (1980) Monographs on the Evaluation of the Carcinogenic Risks on Chemicals to Humans, Vol.23. International Agency for Research on Cancer, Lyon, pp 75–77
- 9) Baselt RC, Cravey RH (1995) Disposition of Toxic Drugs and Chemicals in Man, 4th edn. Chemical Toxicology Institute, Foster City, CA, p 56
- 10) Poklis A, Saady JJ (1990) Arsenic poisoning: acute or chronic? Suicide or murder? *Am J Forensic Med Pathol* 11:226–232

## 11.8.5 Nitrate and nitrite compounds

by Takeshi Saito and Sanae Takeichi

### Introduction

Nitrate and nitrite compounds are being used for various purposes, such as coronary artery dilators, coloring reagents for meat, rust preventives, fertilizers and explosives. When a nitrate salt is ingested by a human, nitric acid is converted into nitrous acid by the action of nitric acid-reducing bacteria inhabiting the upper digestive tract; the nitrous acid oxidizes the divalent ferrous ion of hemoglobin to produce methemoglobin<sup>a</sup> with the trivalent ferric ion. When methemoglobin is produced, its reduction into hemoglobin starts by the action of methemoglobin reductase (identical with cytochrome b<sub>5</sub> reductase requiring NADH as a cofactor) present in mammalian red cells. The concentration of methemoglobin in blood of normal subjects is not higher than 1–2 % [1]; in case of higher concentrations of methemoglobin, it is called methemoglobinemia. Especially in newborn babies and small infants, methemoglobinemia can easily take place, because of lower methemoglobin reductase activities in these periods.

Methemoglobin is not capable of transporting oxygen. When methemoglobinemia becomes severe, it causes cyanosis, headache, easy fatigability, respiratory and consciousness disturbances and finally death. The fatal methemoglobinemia is rare, but fatal ones after ingestion of nitrate or nitrite were reported [2–6].

For analysis of nitrate or nitrite in blood plasma or serum, the methods by ion chromatography [7] and GC/MS [8] were reported. In this chapter, a method for GC analysis of nitrate and nitrite in blood using wide-bore and medium-bore capillary columns after their derivatization with mesitylene<sup>b</sup> is presented.

### Reagents and their preparation

- Potassium nitrate is dried at 110 °C for 4 h; 6.35 mg of the resulting compound is dissolved in 10 mL purified water. The concentration of nitrate ion in this solution is 0.4 mg/mL.
- Sodium nitrite is dried by keeping it in a desiccator for 24 h; 4.5 mg of the compound is dissolved in 10 mL purified water to prepare 0.3 mg/mL (as nitrite ion) solution.
- A 1-mg aliquot of 4-nitro-*o*-xylene (Aldrich, Milwaukee, WI, USA) is dissolved in 1 mL acetone to give internal standard (IS) solution.
- A 1-mg aliquot of 2-nitromesitylene (Aldrich) is dissolved in 1 mL acetone to serve as stock standard solution for the final derivatized product of nitrate or nitrite.
- Silver acetate is dissolved in purified water to prepare its saturated solution.
- Anhydrous sodium carbonate, hydrogen peroxide and sulfuric acid to be used are of atomic absorption spectrometry grade or even purer.
- The purified water being used for the above preparations is prepared with the Milli Q device (Millipore Corp., Bedford, MA, USA). The nitrate or nitrite working standard solution should be prepared just before use.

## GC conditions

Column: a DB-1 fused silica wide-bore capillary column (15 m × 0.53 mm i.d., film thickness 0.25 μm, J&W Scientific, Folsom, CA, USA) and a DB-1 fused silica medium-bore capillary column (30 m × 0.25 mm i. d., film thickness 0.25 μm, J&W Scientific).

GC conditions; instrument: HP5890 Series II and HP6890 Series gas chromatographs<sup>c</sup> (Agilent Technologies, Palo Alto, CA, USA) with nitrogen-phosphorus detectors (NPD); injection volumes: 1 μL for the HP5890 Series II and 4 μL for the pulsed splitless injection with the HP6890 Series.

Conditions for the wide-bore capillary column:

Column (oven) temperature<sup>d</sup>: 100 °C → 5 °C/min → 125 °C (2 min); injection temperature: 250 °C; detector temperature: 270 °C; carrier gas: He; flow rate: 30 mL/min.

Conditions for the medium-bore capillary column:

Column (oven) temperature<sup>d</sup>: 110 °C (3 min) → 10 °C/min → 200 °C (3 min); injection temperature: 280 °C; detector temperature: 280 °C; carrier gas: He; flow rate: 2.1 mL/min.

## Procedures

### i. Analysis of nitrate

- i. A 0.2-mL volume of a test specimen, 20 μL of IS solution and 0.2 mL of the saturated silver acetate solution<sup>e</sup> are placed in a 1.5-mL volume polypropylene tube with a cap, vortex-mixed and centrifuged at 3,000 rpm for 5 min.
- ii. A 0.2-mL volume of the supernatant solution is transferred to another polypropylene tube of the same type, and 0.5 mL of concentrated sulfuric acid<sup>f</sup> is added to the solution slowly.
- iii. A 0.5-mL volume of mesitylene (Aldrich) is added to the mixture, capped and vortex-mixed for 2 min.
- iv. It is centrifuged at 3,000 rpm for 5 min. A 0.2-mL volume of the resulting upper layer is transferred to a new 1.5-mL volume polypropylene tube with a cap, followed by the addition of 20 mg of anhydrous sodium carbonate and vortex-mixed for 1 min.
- v. After centrifugation at 3,000 rpm for 2 min, 1- or 4-μL of the upper layer is injected into GC.
- vi. Various known amounts of nitrate and a fixed amount of IS are added to blank specimens and processed in the same way to construct a calibration curve. The peak area ratio of nitrate to IS obtained from a test specimen is applied to the calibration curve to calculate its concentration.

### ii. Analysis of nitrite

- i. A 0.2-mL volume of a test specimen and 0.1 mL of 0.1 M hydrogen peroxide solution are placed in a 1.5-mL volume polypropylene tube with a cap and vortex-mixed for 3 min.
- ii. After centrifugation, the supernatant solution is decanted into another polypropylene tube of the same type; 20 μL of IS solution and 0.2 mL of the saturated silver acetate solution<sup>e</sup> are added to the above solution, vortex-mixed and centrifuged at 3,000 rpm for 5 min.
- iii. A 0.2-mL volume of the supernatant solution is transferred to a new polypropylene tube of the same type, followed by addition of 0.5 mL of concentrated sulfuric acid<sup>f</sup> and 0.5 mL of mesitylene.

- iv. The mixture is vortex-mixed for 2 min and centrifuged at 3,000 rpm for 5 min.
- v. A 0.2-mL volume of the upper layer is transferred to a new polypropylene tube containing 20 mg anhydrous sodium carbonate and vortex mixed for 1 min.
- vi. After centrifugation at 3,000 rpm for 2 min, 1- or 4- $\mu\text{L}$  of the supernatant solution is injected into GC.
- vii. The above procedure consists of the oxidation of nitrite into nitrate and the same extractions as those for nitrate. A calibration curve for nitrite using blank specimens and IS is also prepared for quantitation in the same way.

## Assessment of the method

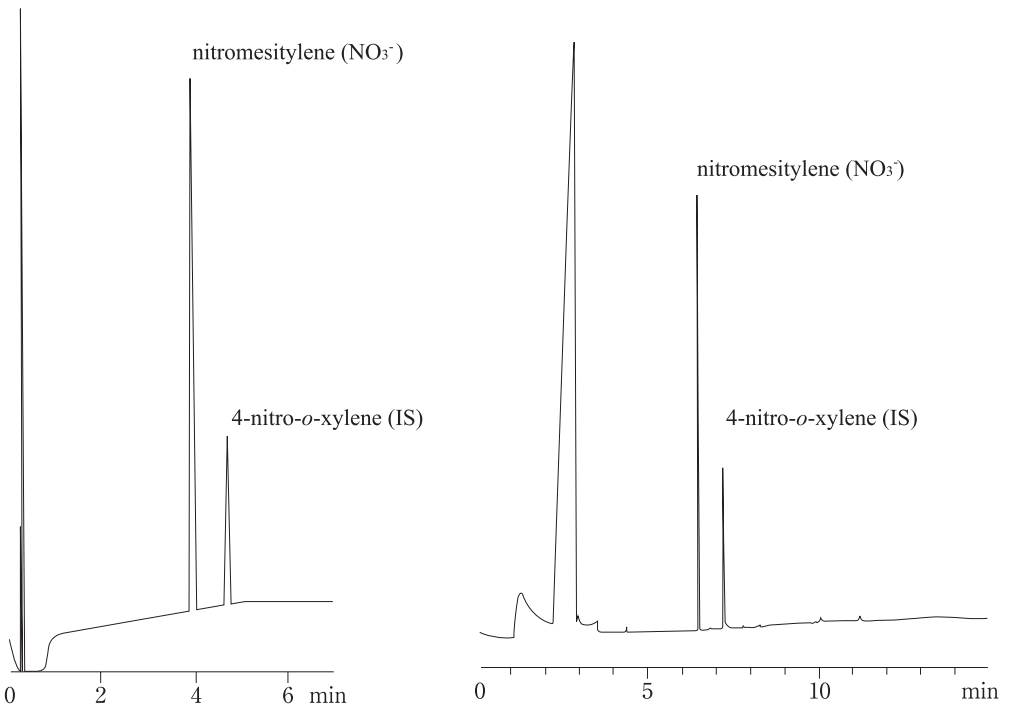
► *Figure 5.1* shows gas chromatograms using wide-bore and medium-bore capillary columns. With the medium-bore capillary column, a big and broad peak due to mesitylene appears.

The detection limits are about 0.3 and 0.1  $\mu\text{g}/\text{mL}$  for wide-bore and medium-bore capillary columns, respectively. Since a fatal blood concentration of nitrite was reported to be 0.55  $\mu\text{g}/\text{mL}$  [2], the present method is sensitive enough to detect it with either column.

■ **Figure 5.1**

Wide-bore capillary column

Medium-bore capillary column



**Detection of nitrite by wide-bore and medium-bore capillary GC after its derivatization into nitromesitylene. The concentration of nitrite was 5  $\mu\text{g}/\text{mL}$  for both chromatograms.**

Except GC-NPD, GC-ECD can be used for analysis of nitrite and nitrate; but the latter detector may suffer from appearance of many interfering peaks. By GC/MS in the EI mode, it is difficult to detect the derivative, because of its lower sensitivity. Although there is a report [9] dealing with sensitive GC/MS analysis for nitrate in the NICI mode, it does not seem recommendable in view of the time required for stabilizing the instrument for reproducible analysis.

## Toxic and fatal concentrations

In [▶ Table 5.1](#), clinical symptoms according to the concentrations of methemoglobin are presented.

■ **Table 5.1**

**Clinical symptoms appearing according to methemoglobin concentrations**

Methemoglobin concentration	Symptom(s)
not higher than 1–2 %	normal
10–15 %	cyanosis
not lower than 20 %	headache, dyspnea, tachypnea, tachycardia and hypertension
40–50 %	mental derangement, listlessness and metabolic acidosis
not lower than 50 %	coma, convulsive attack and hypotension
70 %	death

## A poisoning case [4]

An unidentified male was found naked from the waist up in a park at about 10:00 p. m.; he was suffering from some difficulty in breathing. He was sent to a nearby clinic and diagnosed as exsiccosis; he was brought to a hospital, but he was found dead in the bed of the hospital in the next morning 7 h after admission. On the day of his death, autopsy was performed; there are no notable disorders, but the colors of all organs and blood were chocolate-brown. The blood methemoglobin concentration was thus measured; it was as high as 78 %. Since the fatal concentration of methemoglobin was reported to be about 70 % [1, 2, 5], the cause of his death was diagnosed as methemoglobinemia. The poison causing his methemoglobinemia was analyzed by the present method; it was disclosed that he had ingested nitrate. The analytical results for nitrite and nitrate in his blood and stomach contents are shown in [▶ Table 5.2](#). An example of the gas chromatograms in the present case is also shown in [▶ Figure 5.2](#). The blood nitrite concentration exceeded the fatal level (about 0.5 µg/mL), but nitrite could not be detected from stomach contents; a high concentration of nitrate is detected from stomach contents.

When a large amount of nitrite is ingested, a victim dies in a short time due to methemoglobinemia [2]. When nitrate is ingested, the compound cannot directly convert hemoglobin into methemoglobin; for such conversion, nitrate should be reduced to nitrite in a human body. In the present case, the victim had ingested a preparation including a large amount of nitrate, which was reduced to nitrite by the action of enteric bacteria; the nitrite resulted in accumulation of methemoglobin gradually. Similar methemoglobinemia cases had been sometimes observed after

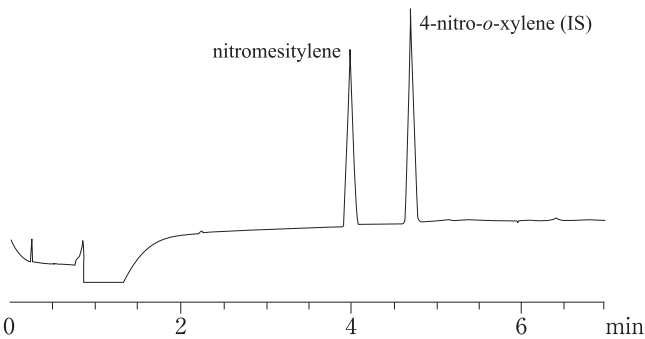
Table 5.2

Concentrations of nitrite and nitrate in blood and stomach contents obtained at autopsy

Specimen	Concentration ( $\mu\text{g/mL}$ )	
	nitrite	nitrate
blood	0.76	1.56
stomach contents	ND	20.3

ND = not detectable.

Figure 5.2



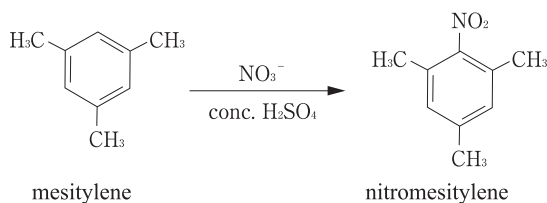
Gas chromatogram for nitrite plus nitrate in human blood obtained at autopsy. The blood specimen was oxidized to convert nitrite into nitrate, which was then derivatized for analysis by wide-bore capillary GC.

drinking well water containing high concentrations of nitrate salt [3, 10–12]. However, in the area where the victim was found, no similar poisoning cases were reported. Except such well water, a fertilizer product containing nitrate salt can be considered. However, a form or a product containing nitrate ingested could not be specified in the present poisoning case.

## Notes

- When nitrite is present in blood, methemoglobin is formed immediately. In severe poisoning cases, the concentrations of methemoglobin are more important than those of nitrate or nitrite. There is no problem when methemoglobin concentrations can be immediately measured with a CO oximeter. However, when the analysis has to be made later, it is necessary to store blood specimens at  $-80\text{ }^{\circ}\text{C}$  or even lower temperature until analyzed [9].
- Figure 5.3 shows derivatization reaction for nitrate being used in this method; 2-nitromesitylene formed is analyzed by GC. The same reaction method is used for analysis of nitrite after its conversion into nitrate. Therefore, when nitrate and nitrite coexist in a specimen, the difference in concentration between a total value after oxidation and a nitrate value shows the concentration of nitrite.
- Any gas chromatograph for a capillary column equipped with a nitrogen-phosphorus detector can be used, regardless of its manufacturer and type.

■ **Figure 5.3**



**Derivatization reaction for nitrite and nitrate used in this method.**

- d) In this procedure, nitrate is derivatized during extraction procedure; the column temperatures are not so high, causing contamination of the column by impurities with high boiling points. When many specimens are analyzed, the column temperature should be frequently elevated to its maximum to remove impurities.
- e) In this method, chloride can be considered as the most prominent interfering substance in human specimens. It is absolutely necessary to remove chloride by its precipitation at an early step; for this purpose, the saturated silver acetate solution is added.
- f) When sulfuric acid is added to the mixture, appreciable heat is produced. The addition of the acid should be as slow as possible, followed by airtight capping of the polypropylene tube. Upon nitrification with vortex-mixing, rubber gloves should be worn, considering the rare accident of leakage of the mixture due to the exothermic phenomenon. However the author et al. have no experience of such accidents.

## References

- 1) Haddad LM, Shannon MW, Winchester JF (1998) *Clinical Management of Poisoning and Drug Overdose*, 3rd edn. Saunders, Philadelphia, pp 226–230
- 2) Standefer JC, Jones AM, Street E et al. (1979) Death associated with nitrite ingestion, report of a case. *J Forensic Sci* 24:768–771
- 3) Tanaka J, Horigome H, Imai H et al. (1996) A case of severe methemoglobinemia for a newborn baby caused by well water. *Jpn J Pediatr* 49:1661–1665 (in Japanese)
- 4) Saito T, Takeichi S, Osawa M et al. (2000) A case of fatal methemoglobinemia of unknown origin but presumably due to ingestion of nitrate. *Int J Legal Med* 113:164–167
- 5) Ellis M, Hiss Y, Shenkman L (1992) Fatal methemoglobinemia caused by inadvertent contamination of a laxative solution with sodium nitrite. *Isr J Med Sci* 28:289–291
- 6) Saito T, Takeichi S, Yukawa N et al. (1996) Fatal methemoglobinemia caused by liniment solution containing sodium nitrite. *J Forensic Sci* 41:169–171
- 7) Monaghan JM, Cook K, Gara D et al. (1997) Determination of nitrite and nitrate in human serum. *J Chromatogr A* 770:143–149
- 8) Rhodes PM, Leone AM, Francis PL et al. (1995) The L-arginine:nitric oxide pathway is the major source of plasma nitrite in fasted humans. *Biochem Biophys Res Commun* 209:590–596
- 9) Sato K, Tamaki K, Tsutsumi H et al. (1990) Storage of blood for methemoglobin determination: comparison of storage with a cryoprotectant at  $-30\text{ }^\circ\text{C}$  or  $-196\text{ }^\circ\text{C}$ . *Forensic Sci Int* 45:129–134
- 10) Miller LW (1971) Methemoglobinemia associated with well water. *JAMA* 216:1642–1643
- 11) Colomy HH (1987) Cyanosis in infants caused by nitrates in well water. *JAMA* 257:2788–2792
- 12) Fan AM, Steinberg VE (1996) Health implications of nitrate and nitrite in drinking water: an update on methemoglobinemia occurrence and reproductive and developmental toxicity. *Regul Toxicol Pharmacol* 23:35–43



## 11.8.6 Methemoglobin

by Keizo Sato

### Introduction

Determination of methemoglobin (Met-Hb) in blood is important for the diagnosis of poisoning by oxidants, such as nitrite, nitrate, chlorate, chlorite, alkyl nitrites, nitroglycerin, aniline and other compounds. In 1938, Evelyn and Malloy [1] had devised a photoelectric method for determination of Met-Hb in blood. Minor modifications of this method were made by several researchers to increase sensitivity [2–4]. These methods are based on a phenomenon that the absorbance maximum of weakly acidic Met-Hb at 630 nm disappears by addition of cyanide. Met-Hb concentration can be easily determined as the ratios of the absorbance changes induced by cyanide before and after addition of potassium ferricyanide.

In forensic science practice, there are many cases, in which Met-Hb has to be measured for blood specimens containing high concentrations of carboxyhemoglobin (CO-Hb); *e.g.*, especially in the cases of fire and exhaust gas poisoning [5]. However, the above methods [1–4] are not suitable for specimens containing high levels of CO-Hb. In 1981, the author et al. [6] developed a modification of the methods, which enabled accurate determination of blood Met-Hb even in the presence of high concentrations of CO-Hb by using about a 100-fold excess of potassium ferricyanide to be added to the Hb iron. In this chapter, a simple procedure of the modified spectrophotometric method for Met-Hb is briefly described.

### Reagents and their preparation

- Potassium ferricyanide, 4 % (w/v) in distilled water. It should be stored in a dark bottle, and be prepared monthly.
- Phosphate buffer solution, 0.1 M, pH 6.8.
- Phosphate buffer solution, 40 mM, pH 6.9. It can be prepared by dilution of two parts of the above reagent with three parts of distilled water.
- Potassium cyanide, 5 % (w/v) dissolved in the above 40 mM phosphate buffer solution. It should be prepared just before use.

### Analytical instrument

A Hitachi 557 dual-wavelength spectrophotometer<sup>a</sup> (Hitachi, Ltd., Tokyo, Japan).

### Procedure

- i. A 6-mL volume of distilled water is placed in a test tube. A 0.2-mL volume of whole blood is added to the tube and mixed well.

- ii. After allowing the tube to stand for 5 min, 4-mL of 0.1 M phosphate buffer solution is added to the mixture and mixed well.
- iii. The hemolysate is centrifuged at 3,000 rpm for 10 min, and the clear supernatant is transferred to another test tube. The pH of the supernatant should be around 6.9.
- iv. Four 4-mL volume cuvettes of the same type are cleaned well by washing with distilled water. The four cuvettes are designated as A, B, C and D.
- v. To cuvettes A and B, a 0.5-mL volume each of distilled water is added. To cuvettes C and D, a 0.5-mL volume each of 4 % potassium ferricyanide solution is added.
- vi. To cuvettes A and C, a 3-mL volume each of 40 mM phosphate buffer solution is added. To cuvettes B and D, a 3-mL volume each of the supernatant of the above hemolysate is added. Each cuvette is mixed well.
- vii. The absorbance of cuvette B at 630 nm is read using cuvette A as reference, and this reading is  $A_1$ . After allowing cuvette D to stand for 10 min, the absorbance at 630 nm is read using cuvette C as reference, and this reading is  $A_3$ .
- viii. To all cuvettes, a 30- $\mu$ L volume each of 5 % potassium cyanide solution is added and mixed well.
- ix. After allowing the cuvettes to stand for 2 min, the absorbances of cuvettes B and D at 630 nm are read using cuvettes A and C as references, respectively. These readings are  $A_2$  and  $A_4$ , respectively.
- x. The percentage of Met-Hb is calculated by the following equation:  $\text{Met-Hb \%} = 100 (A_1 - A_2) / (A_3 - A_4)$ .

## Assessment and some comments on the method

The present method for analysis of Met-Hb in blood is simple and rapid, and is not interfered with by the coexistence of high concentrations of CO-Hb [6]. As low as about 0.2 % of Met-Hb can be measured accurately.

However, when high concentrations of sulfhemoglobin (SHb) may interfere with the present assay [7]; but SHb concentrations in putrefied blood not older than 7 days are usually not high, and do not probably influence the present assay. Caution should be, therefore, made for blood specimens obtained from living subjects or cadavers of sulfide or polysulfide poisoning (see the chapter “Hydrogen sulfide and its metabolite” of this book).

Met-Hb in blood is not stable at room temperature and even at  $-30^\circ\text{C}$ .

When analysis of Met-Hb has to be made later, the blood specimens should be stored at  $-80^\circ\text{C}$  or even lower temperature [8], or at  $-30^\circ\text{C}$  in the presence of a cryoprotective solution<sup>b</sup> [9, 10].

## Toxic and fatal concentrations

Clinical symptoms according to the concentrations of Met-Hb are presented in [▶ Table 5.1](#) of the previous chapter (Chapter II.8.5, “Nitrate and nitrite compounds”).

## Notes

- a) Any type of spectrophotometers can be used, regardless of manufacturers.
- b) The cryoprotectant is aqueous solution containing 28 % glycerol, 3 % mannitol and 0.65 % NaCl. It should be added to blood samples at the ratio of 1:1.

## References

- 1) Evelyn KA, Malloy HAT (1938) Microdetermination of oxyhemoglobin, methemoglobin and sulfhemoglobin in a single sample of blood. *J Biol Chem* 126:655–662
- 2) Leahy T, Smith R (1960) Notes on methemoglobin determination. *Clin Chem* 6:148–152
- 3) van Kampen EJ, Zijlstra WG (1965) Determination of hemoglobin and its derivatives. *Adv Clin Chem* 8:141–187
- 4) Hegesch E, Gruener S, Cohen R et al. (1970) A sensitive micromethod for the determination of methemoglobin in blood. *Clin Chim Acta* 30:679–682
- 5) Katsumata Y, Aoki M, Oya M et al. (1980) Simultaneous determination of carboxyhemoglobin and methemoglobin in victims of carbon monoxide poisoning. *J Forensic Sci* 25:546–549
- 6) Sato K, Katsumata Y, Aoki M et al. (1981) A practical method for the accurate determination of methemoglobin in blood containing carboxyhemoglobin. *Forensic Sci Int* 17:177–184
- 7) Sato K (1983) A method for determination of methemoglobin in blood containing carboxyhemoglobin. *Jpn J Legal Med* 37:133–144 (in Japanese with an English abstract)
- 8) Sato K, Tamaki H, Okajima H et al. (1988) Long-term storage of blood samples as whole blood at extremely low temperatures for methemoglobin determination. *Forensic Sci Int* 37:99–104
- 9) Sato K, Katsumata Y, Aoki M et al. (1987) Long-term storage of blood samples at freezing temperatures in the presence of a cryoprotectant for hemoglobin assay. *Biochem Med Metab Biol* 37:190–196
- 10) Sato K, Tamaki K, Tsutsumi H et al. (1990) Storage of blood for methemoglobin determination: comparison of storage with a cryoprotectant at  $-30^{\circ}\text{C}$  and without any additions at  $-80^{\circ}\text{C}$  or  $-196^{\circ}\text{C}$ . *Forensic Sci Int* 45:129–134

# Subject index

## A

- $\alpha$ -bromoisovalerylurea **293**  
5 $\alpha$ -cholestane 188–190  
 $\alpha$ -DEX 120 150  
 $\alpha$ -hydroxytriazolam 283,  
287, 289, 290  
 $\alpha$ -methylene- $\gamma$ -butyrolac-  
tone 248  
acebutolol 373  
acephate 537  
2-acetamidophenol 339,  
574  
acetaminophen **335**, 336,  
338, 393  
acetonitrile extraction 538  
acetylacetolol 373  
acetylcholinesterase 84, 535,  
559, 619  
acetylcholine receptors 365  
6-acetylmorphine 195, 198,  
201  
6-acetylmorphine-TMS 201  
acetylsalicylic acid **343**, 344,  
346, 348, 392  
acid 187, 377  
acidosis 123  
aconine 458, 461  
aconite toxins **455**  
aconitine **455**, 458, **459**  
aconitum alkaloids **455**  
acylation 30  
adhesives 149  
adulterant 491  
advanced automated sample  
processors 31  
AED 81  
A-esterase 535  
air bags 629  
alachlor 529  
alcohol **135**  
alcohol dehydrogenase 123  
ALD-type 2 137  
aldehyde dehydrogenase  
123, 137  
aldicarb 566  
aldrin 529  
alkylated adducts 85  
alkylated DNAs 85  
alkylation 30  
alkyl nitrites **153**, 655  
allobarbitol 305, 308  
allylesterase 624  
allylcarb 566  
alminoprofen 325, 330, 332  
alprazolam 284, 285, 290  
alternative specimens **9**  
*Amanita neoovoidea* 480  
*Amanita pantherina* 469  
*Amanita phalloides* 469  
*Amanita verna* 469, 474  
*Amanita virosa* 469, 473  
amanitin **473**, 477, 479  
amido-type local anesthetic  
385  
1-amino-4-phenylbutane  
173  
2-amino-6-hydroxymethyl-  
8-hydroxyquinazoline  
482  
aminomethyl phosphonic  
acid 546  
7-aminonitrazepam 19  
5-aminoquinoline 499  
amitriptyline **271**, 274, 276  
amniotic fluid 12  
amobarbital **301**, 303, 305,  
308, 309  
amoxapine 271, 274, 276  
amoxicillin 398  
amphetamine **171**, 172, 178  
ampicillin 395  
amyl nitrite 153  
analgesic-antipyretics 325  
analysis mailing list 52  
anaphylactic shock 395  
angel's trumpet 516  
angel dust 241  
angina pectoris 153  
anhydride 208  
aniline 151, 655  
anti-inflammatory 325  
antidepressants **271**, 272,  
274, 276  
antiepileptics **351**, 355  
antimony 644  
antitussives 195  
9-anthracenecarboxylic acid  
331, 332  
an Oasis HLB 3 cc 260  
AP 171, 179–182  
APAP 335  
APAP-3-mercaptopuric acid  
337, 338  
APAP-glucuronide 335, 336,  
338  
APAP-N-sulfate 335, 336,  
338  
APC 564  
APCI 40, 525  
apronalide 295, 421  
ArCl<sup>+</sup> 42  
ArCl<sup>+</sup> ion 645  
argride 42  
arrythmia 458  
arsenic 637  
arsenic (III) oxide 637  
arsenic poisoning 645  
arsenious acid **637**, 646  
arsenite **637**, 646  
arsenocholine 646  
arylesterase 535  
As<sub>2</sub>O<sub>3</sub> 637  
ASA **343**  
Asahi-Pak GS-320 366  
ascorbic acid 117  
aspirin **343**

- atenolol 370, 373  
 atmospheric chemical  
 ionization 40  
 atmospheric pressure  
 chemical ionization 364,  
 525, 541  
 atomic absorption  
 spectrometry **43**  
 atrazine 597  
 atropa belladonna 516  
 atropine 509, 514  
 atropine-*d*<sub>3</sub> 509  
 automated pretreatments  
 31  
 autosuppressor 629  
 azeotropic effects 501
- B**
- β-adrenergic receptor  
 antagonists **369**  
 β-blockers **369**, 371, 373,  
 374, 375  
 β<sub>1</sub>-blockers 369  
 β<sub>2</sub>-blockers 369  
 β-CD 173  
 β-cyclodextrin 173, 582  
 β-DEX 225 174  
 β-glucuronidase 184, 231,  
 238, 232, 287, 479, 581  
 β-glucuronidase K-2 372  
 β-glucuronidase-sulfatase  
 337  
 β-hydroxyethyltheophylline  
 395  
 β-lactam antibiotics 395  
 β-phenylethylamine 18  
 bacteria 18  
 bacterial food poisoning 2  
 bacterial translocation 18  
 BAL 85  
 barbital 303, 308  
 barbiturates **301**, 302,  
 304–307, 309  
 BASTA Fluid® 545  
 1,4-BD 247, 250  
 BE **207**, 211, 214, 216
- belladonna alkaloids 509  
 benactyzine 315  
 bensil 5C<sub>18</sub>-C 426  
 benthocarb 564  
 bentone-34 150  
 benzalkonium chlorides  
**407**, 410  
 benzene **149**, 151, 165  
 benzodiazepines **283**, 285  
 benzophenones 287  
 benzoylaconine 458, 460  
 benzoylcegonine **207**  
 benzoylhypaconine 460  
 benzphetamine 171  
 benzyltrimethyldecylam-  
 monium 408  
 benzyltrimethylhexadecyl-  
 ammonium 408  
 benzyltrimethyltetradecyl-  
 ammonium 408  
 benzylpenicillin 395  
 betaxolol 373  
 bialaphos 545  
 bismuth 644  
 bisoprolol 373, 375  
 bis(1-phenyl-3-methyl-5-  
 pyrazolone) 114  
 bleaching powder 403  
 blood 2  
 blood ethanol 138  
 body builders 247  
 Bond Elut C<sub>1</sub> 366  
 Bond Elut C<sub>18</sub> 593  
 Bond Elut CBA 363  
 Bond Elut Certify 197  
 Bond Elut Certify®II 191,  
 556  
 Bond Elut Certify LRC 479  
 Bond Elut Glass 242  
 Bond Elut SCX 233, 486  
 Bond Elut SI 331, 457  
 bone marrow 297  
 borax 431  
 boric acid **431**  
 boric ball 431  
 brain-to-blood ratios 213
- breath ethanol **137**, 139, 141  
 bromadiolone 599, 600  
 bromazepam 284, 285  
 bromisovalum **293**, 295,  
 296, 421  
 Bromocresol green reagent  
 325  
 2-bromohexanoylurea 295,  
 297  
 2-bromoisobutyrylurea 298  
 bromovalerylurea **293**  
 bromperidol **263**, 265, 268  
 brompheniramine 320  
 brotizolam 284, 285  
 Brovarin **293**  
 BSA 198, 201  
 BSTFA 75, 191, 205  
 bupivacaine 384, 387  
 bupranolol 373  
 1,4-butanediol 247  
 butyl nitrite 153  
 butyl rubber septa 167  
 butyrophenones **263**  
 by-products 83  
 BZP 171
- C**
- C<sub>9</sub> base 482, 484, 489  
 Ca(ClO)<sub>2</sub> 403  
 cadmium 637  
 caffeine 229, **491**, 494, 495  
 calcium hypochlorite **403**  
 calcium oxalate 452  
 camphor 443  
 cannabichromene 189  
 cannabidiol 187  
 cannabinoids **187**  
 cannabinol 187  
 cannabis 187  
*Cannabis sativa* L. 187  
 Capcell Pak C<sub>18</sub> MG 293  
 Capcell Pak C<sub>18</sub> UG-80 259  
 Capcell Pak SCX 231  
 capillary electrophoresis 60,  
**177**, 181, 403  
 capillary HPLC 38

- carbamate pesticides **559**  
 carbamazepine **271**, 272,  
 274, 276, 278, **351**, 353,  
 354  
 carbamazepine-diol 353,  
 354  
 carbamazepine-epoxide 353,  
 354  
 carbaryl 529  
 carbendazole 563  
 carbinoxamine 315, 384  
 carbofuran 567  
 carbon monoxide **91**, 144  
 carboxyesterase 535  
 carboxyhemoglobin 91, 144,  
 655  
 carboxylic acid 30  
 cardiac glucosides 519  
 cardiac puncture 5  
 cardiopulmonary resuscita-  
 tion 22  
 carry-over 533  
 carteolol 373, 375  
 catechol 3-hydroxyamino-  
 phen 337, 338  
 CBC 189  
 CBD 187, 189  
 CBN 187, 189  
 CBP-1 311, 331  
 CE 172, 177, 403  
 CE/MS 514, 515  
 cefotaxime 398  
 cefoxitin 398, 400  
 cefuroxime 398, 400  
 celiprolol 373  
 cephalixin 398, 400  
 cephaloridine 398, 400  
 cephalosporins **395**  
 cephamycins **395**  
 cepheids **395**  
 cerebrospinal fluid 479  
 changed form of MEGX  
 387  
 chasmanine 455  
 ChemElut 500, 507  
 chemical ionization 40  
 chemical warfare agents **69**,  
**609**  
 chemical weapons **69**, 73,  
**609**  
 Chemical Weapons  
 Convention 69, 609  
 chiral analysis 181, 514  
 Chiral Drug Column 177  
 chiral GC/MS 174, 182  
 chiral LC/MS 177, 180  
 chloramine T 113  
 chlorate 655  
 chlorate ion 404  
 chlordene 529  
 chlordene-*cis* 530  
 chlordene-*trans* 530  
 chlordiazepoxide 285  
 chlorine gas 403  
 chlorite 655  
 chlorocyanogen 115  
 chloroephedrine 171  
 chlorofenaviphos 537  
 chlorofluorocarbon 143  
 chloroform **143**, 145  
 chloromethylephedrine 171  
 1,8-chlorotheophylline 391  
 8-chlorotheophylline 321,  
 393  
 chlorpheniramine **315**, 320,  
 322  
 chlorpromazine **255**, 258  
 chlorpropham 566  
 chlorpyrifos 537  
 chlorpyrifos-methyl 537  
 cholinesterase 17, 208, 364,  
 535  
 cholinesterase inhibitor 208,  
 384  
 chromium 637  
 CI 40  
 cigarettes 499  
 cigarette butts 506  
 cigarette smoke 113  
 cinerins 425  
*cis*-permethrin 427  
*cis* and *trans* isomers 425  
 city gas 91  
 Cl<sup>-</sup> 404  
 clandestine tablets 233  
*Claviceps purpurea* 225  
 clemastine 315  
 clinical analytical toxicology  
 59  
 clinical toxicology 59  
*Clitocybe acromelalga* 469  
*Clitocybe clavipes* 469  
*Clitocybe gibba* 469  
 ClO<sup>-</sup> 404  
 ClO<sub>3</sub><sup>-</sup> 404  
 clomipramine **271**, 274,  
 276  
 clonazepam 284, 285  
 clorazepate 285  
 clordiazepoxide 284  
 cospirazine 259  
 cloxacillin 395  
 clozapine 19  
 club drugs 247  
 CO **91**, 144  
 CO<sub>2</sub> poisoning 37  
 CO<sub>3</sub><sup>2-</sup> 404  
 cocaine **207**, 212, 215, 377,  
 383, 387  
 cockroaches 431  
 codeine **195**, 196  
 codeine-TMS 201  
 codeine glucuronide 204  
 COHb 91, 92, 144  
 cold trap 160, 161  
 collision induced  
 dissociation 41  
 color tests 113  
 combined SIM mode 221  
 complex partial seizures 351  
 computer system for  
 diagnosis **45**  
 conductivity detector 39  
 Conway microdiffusion cell  
**112**, 629  
 copper 637  
*Coprinus atramentarius* 469  
 coronary artery dilators 649

- cosmosil 5CN-MS 266  
 COT 37, 138, 141  
 cotinine 499, 501, 503  
 coumachlor 599, 600  
 coumafuryl 599  
 coumarin rodenticides 599, 603  
 coumatetralyl 599, 600  
 CO oximeter 653  
 CP-Sil5 311  
 cresol 581  
 cresol isomers 581, 585  
 cryogenic oven trapping 37, 120, 138, 141  
 cryoprotectant 657  
 crystal 241  
 cultivation kits 475  
 curcumin 431  
 cutoff values 210  
 CVAA 85  
 CWC 69, 86, 609, 619  
 cyanide 113, 633, 655  
 cyanide poisoning 153  
 cyanmethemoglobin 115  
 cyanmethemoglobin reagent 94  
 cyanofenphos 529  
 Cyanoline Blue<sup>®</sup> 120  
 cyanophos 529, 537, 543  
 cyclized GHB 250  
 cyclobarbital 308  
 cypermethrin 529  
 3-cysteiny APAP 337, 338  
 cytochrome oxidase 113, 123, 633  
 cytochrome P450 535
- D**  
 $\Delta^9$ -tetrahydrocannabinol 187  
 $\Delta^9$ -THC 187, 189  
 $\Delta^9$ -THC-11-oic acid 187, 190–193  
*d*-hyoscyamine 515  
 DAD 174, 266, 370  
 DAEMS 619, 622  
 DAET 624  
 Datura (Brugmansia) suaveolens 516  
*Datura ferox* 516  
*Datura metel* 509, 515  
*Datura stramonium* 516  
*Datura tatula* 516  
 DB-1 135, 144, 156, 160, 167, 190, 197, 231, 261, 303, 316, 384, 537, 563, 593, 620, 650  
 DB-5 78, 174, 190, 283, 384, 456, 483, 537, 563  
 DB-17 160, 167, 220, 231, 316, 385, 489, 492, 494, 593  
 DB-210 537  
 DB-5MS 174, 500, 546, 563, 600  
 DB-624 248  
 DB-WAX 584  
 DDVP 529, 532, 537, 543  
 DEA 610, 611, 618  
 deadly nightshade 516  
 dealkylating reaction 535  
 decomposition products 83  
 decontamination 86  
 defoliants 609  
 demethylchlorpheniramine 320  
 depolarizing-type muscle relaxant 365  
 deprenyl 171  
 deproteinization methods 25  
 derivatization 29, 75  
 desacetyloleandrin 519, 525  
 desipramine 271, 274, 276  
 detection methods 33  
 develosil Diol-5 366  
 develosil ODS-UG-5 174  
 destroying angel 473  
 dextromethorphan 219–223  
 DFP 610, 611, 617  
 di-*n*-butylamine 349  
 dialysis 26  
 diarsenic trioxide 637, 644  
 diatomite column 501  
 Diazald<sup>®</sup> 536  
 Diazald kit 193  
 diazepam 284, 285, 352, 353  
 diazine herbicides 591  
 diazinon 529, 537  
 diazomethane 30, 75, 191, 537  
 dibucaine 384, 387  
 dibutylamine 321  
 1,4-dichlorobenzene 443  
 dichloroindophenol reagent 325  
 dichloromethane 143, 145  
 dichlorvos 18, 537  
 dicloxacillin 395  
 didemethylchlorpheniramine 320  
 didrex 171  
 dieldrin 529  
 diethofencarb 564  
 differential refractometer 433  
 digitoxigenin 519  
 digitoxin 523  
 digoxin 519, 523  
 2-(diisopropylamino)ethanethiol 624  
 2-(diisopropylamino)ethyl chloride hydrochloride 620  
 2-(diisopropylaminoethyl) methoxide 620  
 2-(diisopropylaminoethyl) methyl sulfide 619  
 diisopropylmethylphosphonate 611, 617  
 diisopropyl phosphorofluoridate 610  
 dimenhydrinate 321  
 2,3-dimercaptopropanol 85  
 dimethoate 537, 543  
 dimethylamphetamine 171, 178  
 dimethylarsinic acid 637

- dimethyldodecylammonium 411  
 dimethyl methylphosphonate 610  
 2,4-dimethylpentane 165  
 1,7-dimethylxanthine 493, 494  
 diode 266, 268  
 diode array detector 174, 275, 552  
 2,6-di-*O*-methyl- $\beta$ -cyclo-dextrin 173  
 diphenhydramine 315, **321**, 421  
 diphenylhydramine 319  
 diphenylmethane antihistaminics **315**, 316, 318  
 diphenylpyraline 315  
 dipotassium clorazepate 284  
 diprophylline 491  
 diquat **571**, 572, 578  
 diquat-dipyridone 574, 576, 578  
 diquat-monopyridone 574, 576, 578  
 direct injection method 161  
 direct inlet method 226, 227  
 direct inlet MS 362  
 discovery C<sub>18</sub> 512  
 disodium arsenate 646  
 disulfoton 537  
 dithiol type 535  
 dl-2-amino-3-phosphonopropionic acid 546  
 dl-AP 173  
 dl-hyoscyamine 509  
 dl-scopolamine 509  
 d-MA 173  
 DM- $\beta$ -CD 173  
 DMA 171, 179, 180  
 DMAA 637  
 DMA abuser 178, 179, 180  
 doping drugs 369  
 doping tests 375  
 dosulepin 271  
 double-phase system 632  
 doxylamine 315  
 Dragendorff reagent **225**, 325, 360  
 drug-facilitated sexual assaults 247, 283  
 dual column GC 385, 386  
*Duboisia myoporoides* 516  
 dynamic headspace 161  
 dyphylline 491
- E**
- ECD 38, 156  
 ecgonine 207  
 ecgonine methyl ester **207**  
 eclipse XDB-C8 275  
 ecotrin 348  
 ecstasy 230  
 edifenphos 543  
 EI 39  
 EI mass spectra 156  
 electrochemical detector 203, 268, 337, 478, 638  
 electron capture detector 38  
 electron impact 39  
 electrospray ionization 40, 177, 266, 363, 542  
 ELISA 35  
 electrophoresis 172  
 EME **207**, 211, 214, 216  
 emergency medicine 59  
 EMPC 566  
 empenthrin 425  
 emulsion formation 533  
 endogenous ethanol 136  
 endogenous GHB 251, 252  
 endogenous glucuronidase 588  
 endosulfan 529  
 endotracheal intubation 22, 359, 386  
 endrin 529  
 entactogen 229, 237  
 enteric bacteria 136  
 environmental pollution 159  
 enzyme-immunoassays 35  
 ephedrine 171  
 EPN 529, 537, 543  
 ergot alkaloid 225  
*Erythroxylon coca* Lam 207  
*Erythroxylon novogranatense* 207  
 erythroxyllaceae 207  
 eserine 208  
 ESI 41, 177, 266, 397, 363, 364  
 esmolol 373  
 estazolam 284, 285  
 ester-type local anaesthetics 377  
 esterase 349  
 esterases 535  
 esterification 30  
 esterification reaction 155  
 1,2-ethanedithiol 75  
 ethanol 18, 21, **137**  
 ethenzamide 295, 297  
 ethion 537  
 ethosuximide 352–354  
 ethotoin **351**  
 ethylbenzene 165  
 ethylene glycol **449**, 451  
 ethylene glycol-d<sub>4</sub> 451  
 2-ethyl-1,3-hexanediol 431  
 ethylmorphine-TMS 201  
 4-ethylphenol 581, 583  
 ethyltheophylline 369  
 ethylthiomethon 529  
 4-ethyltoluene 165  
 ethyl alcohol **135**  
 ethylmethylphosphonic acid **619**  
 ethylmorphine 195  
 ethyl paraquat 574  
 ethyl viologen 574  
 etizolam 284, 285  
 explosives 649  
 extraction methods **25**, 27  
 Extra Strength 338  
 Extrelut® 27, 209, 214, **215**, 294, 295, 385, 410, 501  
 Extrelut NT-20 509  
 Extrelut NTI® 410, 420



**F**

FactorFour VF-5ms 242  
 false-positive reaction 115  
 femoral vein 21  
 fenitrothion 529, 535, 537, 543  
 fenitrothion- $d_6$  527  
 fenobucarb 529, 564  
 fenoprofen 325, 330, 332  
 fenoxycarb 566  
 fenthion 529, 537, 543  
 fenvalerate 529  
 FID 38, 94, 124, 144, 149, 154, 160, 174, 188  
 Finepak SIL C18 565  
 fingers 11  
 fire 113, 159  
 flame ionization detector 38  
 flame photometric detector 38, 102, 537  
 flame thermionic detector 38, 379, 537, 597  
 flame thermionic ionization detector 563  
 florisil 188  
 fludiazepam **284**, 285  
 flunitrazepam 284, 285  
 9-fluorenylmethyl chloroformate 545  
 4-fluorophenol 339  
 fluorophotometer 34  
 fluorotabun 81  
 flupentixol 259  
 fluphenazine 259  
 flurazepam 284, 285  
 flurbiprofen 325, 330, 332  
 flushing phenomenon 469  
 flutoprazepam 284, 285  
 formaldehyde 123  
 formalin 123  
 formetanate 566  
 formic acid **123**, 125, 127–129, 131, 133  
 Fourier transform infrared spectrophotometer 35  
 FPD 38, 102, 537

frit-fast atom bombardment 40  
 frit fast atom bombardment ionization 364  
 FT-IR 35  
 FTD 38, 119, 379, 387, 537, 597  
 fugu (puffer) fish poisoning 481  
*Fugu niphobles* 486

**G**

$\gamma$ -aminobutyric acid 247  
 $\gamma$ -BHC 529  
 $\gamma$ -butyrolactone 247  
 $\gamma$ -hydroxybutyric acid **247**  
 gasoline 151, 159, 162, 164, 165  
 gastrolavage fluid 3  
 gas chromatography **36**, 37  
 GBL 247, 250  
 GC **36**, 37, 76, 93, 95, 97, 99, 118, 119, 123, 135, 137, 140, 144, 145, 149, 156, 160, 174, 188, 189, 195, 248, 249, 251, 253, 303, 331, 332, 346, 379, 478, 492, 536, 563, 593, 650  
 GC-FID 178  
 GC-NPD 178, 307  
 GC/MS **40**, 62, 78, 103, 105, 160, 162, 164, 165, 174, 181, 190, 191, 193, 195, 199, 201, 208, 220, 231, 234, 236, 242, 258, 264, 265, 271, 274, 283, 304, 317, 331, 371, 373, 374, 408, 417, 427, 437, 443, 444, 449, 456, 478, 483, 499, 509, 511, **527**, 536, 545, 563, 584, 585, 600, 602, 610, 611, 620, 631  
 GC/MS/MS 41, 85  
 gentisic acid 343, 344  
 Gewodin<sup>®</sup> 172  
 GE SE-30 160

GH-C18 (III) 520  
 GHB **247**  
 gitoxigenin 519  
 GL-SPE Vacuum Manifold 204  
 glufosinate **545**  
 glycolic acid 449  
 glyphosate **545**  
 GPC 366  
 grand mal 351  
 GS-Q 121, 167

**H**

H<sub>2</sub>S **101**  
 hair 3, **9**  
 hair dyes **415**  
 hair dye components 416–418  
 hair dye couplers 416, 419  
 hallucinations 469  
 hallucinatory drugs 225  
 hallucinogen 241  
 haloperidol **263**, 265, 267, 268  
 handling specimens **1**  
 haptene 377  
 hashish 187  
 HClO **403**  
 HCN **113**  
 headspace-GC 118, 119, 121, 143, 153  
 headspace extraction 135, 143, 164, 167  
 headspace gas chromatography (HS-GC) 113  
 headspace GC/MS 437  
 headspace method 160, 438  
 headspace SPME 124, 127, 161, 164  
 headspace SPME-GC 126, 129  
 headspace vapor 150  
 heat-decomposition 607  
 heavy oil 159  
 hemp 187  
 henbane 516

- heptafluorobutyric anhydride 216  
 heptanesulfonate 38  
 1-heptene 165  
 heroin 18, 195, 196, 203  
 hexafluoroisopropanol 208, 216  
 hexamethyldisilazane 349  
 hexanesulfonate 504  
 hexobarbital 303, 305, 308  
 HFIP 208, 216  
 higenamine 455  
 high-performance (HP) TLC 34, 325, 328, 333  
 high-performance liquid chromatography **38**  
 high-pressure injection 408, 417, 423  
 HMA 230, 236  
 HMDMA 233, 234  
 HMMA 230, 236  
 homochlorcyclizine 315  
 household insecticide 431  
 HP-1 384  
 HP-5 264, 384  
 HP-50+ 385  
 HP-5MS 188, 272, 510, 610  
 HP-5 Trace Analysis 584  
 HP-Wax 154  
 HPLC **38**, 174, 175, 179, 201, 204, 265, 273, 275, 277, 279, 281, 293, 295, 296, 306, 308, 309, 319, 320, 395, 398, 400, 327, 330, 335–338, 343–346, 352, 353, 355, 371, 391, 393, 411, 426, 433, 477, 478, 485, 502, 503, 512, 513, 520, 541, 550, 552, 565, 574, 576, 581, 583  
 HPLC-DAD 266, 267, 477  
 HPLC-ECD 480  
 HPLC-UV 276  
 HPTLC 34, 328  
 HP PLOT Q 118  
 HSCN 115  
 hydrazoic acid 630  
 hydrocarbons 159  
 hydrogen cyanide **113**  
 hydrogen methylphosphonofluoridate 615  
 hydrogen sulfide **101**  
 hydrogen sulfide poisoning 104  
 hydroxyl aprenolol 373  
 14-hydroxy-LSD 228  
 4-hydroxy-3-methoxyamphetamine 230  
 4-hydroxy-3-methoxyethylamphetamine 238  
 4-hydroxy-3-methoxymethamphetamine 230  
 9-hydroxymethyl-10-carbamyl acridan 353  
 hydroxyl metoprolol 373  
 hydroxyl oxprenolol 373  
 hydroxyl penbutolol 373  
 4-hydroxyl propranolol 373  
 hydroxyl propranolol 373  
 4-hydroxytriazolam 283, 287, 289, 290  
 6-hydroxywarfarin 601  
 7-hydroxywarfarin 601  
 hydroxyzine 315, **320**, 322  
 hyoscyne 509  
*Hyoscyamine niger* 516  
 hypaconine 461  
 hypaconitine 455, 459  
 hypersil 311  
 hypochlorite **403**, 404  
**I**  
 ibuprofen 325, 330, 332, 333  
 IC **39**  
 IC-A15 638  
 IC/ICP-MS 638, 641  
 ICP 41, 42  
 ICP-AES 638, 644  
 ICP-MS **41**, 638  
 illudin S 474  
 imipramine **271**, 274, 276, 319  
 imipramine-*d*<sub>3</sub> 278  
 imperfect combustion 91, 113  
 impurity profiling analysis 644  
 inductively coupled plasma-MS **41**  
 inductively coupled plasma emission spectrometry 638  
 Inertsil® ODS-2 550  
 Inertsil® Ph-3 552  
 Inertsil OD-3 477  
 Inertsil ODS-2 485  
 Inertsil ODS-3 504  
 infrared absorption spectroscopy 34  
 infrared absorption spectrum 635  
 inorganic nitrite **649**  
 inorganic poisons **637**  
 interface 40  
 International Normalized Ratio 605  
 intratracheal contents 168  
 intratracheal gas 161, 162  
*in vitro* interval 218  
 iodoplatinate reagent 225, 361  
 ion chromatography **39**, 434, 629, 638  
 IonPac AS10 638  
 IonPac AS15 column 629  
 ion-pairing 38, 632  
 ion-pairing reagent 366, 632  
 ion spray ionization 542  
 isoamyl alcohol 380  
 isoamyl nitrite 158  
 isobutanol 140  
 isobutyl alcohol 153, 155, 156  
 3-isobutyl-1-methylxanthine 494

- isobutyl nitrite **153**, 155, 156
- isofenphos 537
- Isolute<sup>®</sup> HAX 547
- isopentane 165
- isopropylamino drugs 369
- isopropylmethylphosphonic acid **609**, 626
- isotope dilution technique 440
- isoxathion 529, 537
- J**
- Japan Information Network **51**
- Japan Poison Information Center **45**
- jasmolins 425
- jesaconitine 455, 459
- jimsonweed 509
- judicial autopsy 2
- K**
- keratolytic agent 391
- kerosene **159**, 162, 164
- ketamine 229, 379, 382
- ketoprofen **325**, 330, 332, 333
- KI<sub>3</sub> 362
- Kieselgel 226
- kobusine 455
- König's reaction 115
- L**
- L-column ODS 175
- l*-deprenyl 171
- l*-hyoscyamine 509
- l*-MA 171
- l*-scopolamine 509
- labetalol 373
- lamotrigine 353, 354
- lampterol 474
- Lampteromyces japonicus* 469, 474
- large-volume injection 410, 420
- latent period 554
- LC/MS **40**, 62, 175, 180, 231, 265, 268, 287, 521, 541, 565
- LC/MS/MS 41, 85, 260, 363, 397
- lead 637
- leading phenomenon 412, 423
- lead azide 629
- levobunolol 373
- levomepromazine **255**, 258
- lewisite 81, 83, 85
- LiChrosorb RP-18 345
- LiChrospher RP-18 329
- lidocaine 22, **377**, 381, 386, 387
- Liebermann's reagent 325
- light oil 159, 164
- liquified petroleum 159
- liquid-liquid extraction **26**, 27, 74, 153, 155, 160, 190, 198, 210, 215, 232, 279, 294, 409, 417, 531, 538, 562, 593
- local anaesthetic 17, 207, **377**, 382
- lofepamine 271
- loss of eyesight 128
- loxoprofen 325, 330, 332
- LSD **225**, 227
- Lysergic acid diethylamide **225**
- lysergide **225**
- M**
- μBondapak C<sub>18</sub> 337
- μBondapak C<sub>18</sub> Radial-Pak 391
- m,p*-xylene 165
- m*-cresol 583
- m*-xylene 150
- MA 171, 179–183
- magic mushrooms 469, 475
- major tranquilizers 255
- malathion 529, 535, 537, 540, 543
- malpractice 395
- maprotiline 271, 274, 276
- marijuana 187
- mass spectrometry **39**
- MA abuser 179, 181, 182
- MBDB 229, 234
- MBTFA 371
- MDA 62, 63, 229, 234
- MDEA **229**, 234
- MDMA 62, 63, 212, **229**, 234
- MDN-5S 188
- meclizine 315
- meconium **12**
- medazepam 284, 285
- medical accidents 395
- medium-bore capillary 36, 141
- MEGX 377, 381, 385
- meperidine 241
- mephenytoin 351
- mepindolol 373
- mepivacaine 383, 387
- mesaconine 461
- mesaconitine 455, 459
- Met-Hb 91, **655**
- metabolism of drugs 17
- metal-plating 113
- metallurgy 113
- methamphetamine **171**, 178
- methanol **123**, 125, 126
- metharbital 303, 305, 308
- methemoglobin 91, 117, 153, 649, 652, **655**
- methemoglobinemia 649, 652
- methemoglobin reductase 649
- methidathion 529, 537, 543
- methiocarb 564
- methomyl-oxime 564, 565

- 3-methoxy-APAP 337, 338  
 methylallobarbital 304  
 methylamobarbital 304  
 Methylating reagent 536  
 methylation 75  
 2-methylbenzoic acid 343, 344  
 3-methyl butyrylurea 295  
 methylcyclobarbital 304  
 methylene chloride 143  
 methylene dichloride 143  
 3,4-methylenedioxyamphet-  
 amine 62, 63, 229  
 3,4-methylenedioxyethylam-  
 phetamine 229  
 3,4-methylenedioxymetham-  
 phetamine 62, 63, 212, 229  
 methylephedrine 171  
 methylhexobarbital 304  
 methylmephobarbital 304, 305  
 methylmetharbital 304  
 1-methyl-3-nitro-1-  
 nitrosoguanidine 193  
 1-methylnaphthalene 441  
 2-methylnaphthalene 441  
 methylphenobarbital 304, 305  
 5-(4-methylphenyl)-5-  
 phenylhydantoin 306, 308, 352, 353  
 methylphosphonic acid 609, 619  
 methylphosphonic chloro-  
 fluoride 618  
 methylphosphonic dichloride 618  
 methylphosphonic difluoride 618  
 methylphosphonofluoridic  
 acid isopropyl ester 609  
 3-methylphosphinico-  
 propionic acid 545  
 methylsecobarbital 304  
 3-methylthio-APAP 338  
 methylxanthine derivatives 491  
 methyl alcohol 123  
 methyl formate 127  
 methyl parathion 537  
 methylphosphonic acid 617  
 methyl phosphonic dichloride 610  
 methyl salicylate 392  
 metoprolol 375  
 metribuzin 529  
 mexazolam 284, 285  
 mianserin 271, 274, 276  
 microdiffusion/pyridine-  
 pyrazolone method 113, 115, 117  
 midazolam 284, 285  
 Mightysil RP18 502  
 Millicup-HV 202, 205  
 Milli Q water 280  
 ml-anal 52  
 Molecular Sieve 5A 94  
 monocrotophos 537  
 monoethylglycinexylidide 377  
 morphine 195, 196, 199, 203, 204  
 morphine-3-glucuronide 195, 204  
 morphine-6-glucuronide 195, 204  
 morphine-6-sulfate 204  
 morphine-TMS 201  
 mothball 443  
 moth repellent 425, 437, 443  
 MS 39, 41, 226, 227  
 MS/MS 41, 520, 525  
 MSTFA 371  
 muscle relaxants 359, 364  
 mushroom poisonings 470  
 mushroom toxins 469  
 mustard gas 81  
 mustard sulfone 84  
 mustard sulfoxide 84
- N**  
*N,N*-diethylaniline 610  
*N,O*-bis(trimethylsilyl)aceta-  
 mide 198  
*N,O*-bis(trimethylsilyl)triflu-  
 oroacetamide 75, 191, 205, 347  
*N*-(phosphonomethyl)-  
 $\beta$ -alanine 555  
*N*-acetyl-*p*-phenylene-  
 diamine 415  
*N*-allylcarbamate herbicides 559  
*n*-butylbenzene 159  
*N*-chloromethylphthalimide 327  
*N*-de-ethyl-LSD 228  
*n*-decane 165  
*n*-heptane 165  
*n*-hexane 165  
*N*-methyl-1-(3,4-methylene-  
 dioxyphenyl)-2-butan-  
 amine 229  
*N*-methyl-1-(3,4-methylene-  
 dioxyphenyl)-3-butan-  
 amine 233  
*N*-methyl-bis(trifluoro-  
 acetamide) 371  
*N*-methyl-*N*-(trimethylsilyl)-  
 trifluoroacetamide 371  
*N*-methyl-*N*-nitroso-*p*-  
 toluenesulfonamide 536  
*N*-methylcarbamate  
 insecticides 559  
*n*-octane 165  
*n*-pentane 165  
*n*-propanol 18, 136, 140  
*n*-propylbenzene 165  
*n*-propyl nitrate 155  
 NaClO 403  
 nadolol 373  
 NaF 18  
 nafcillin 395  
 nails 3, 11  
 naled 537  
 nalorphine 204

- nalorphine-TMS 201  
naphthalene **437**, 439  
naphthalene-*d*<sub>8</sub> 439  
naphthalin **437**  
naphthols 440  
naphthoquinone 440  
naproxen 325, 330, 332  
narcotic analgesics 195  
natural gas 91  
necarboxylic acid 331, 332  
negative ion chemical ionization 631  
negative ion CI 40  
neostigmine 379, 385  
*Nerium indicum* 519  
*Nerium oleander* 519  
nerve agents 84, 621  
neuroleptics 255  
neuromuscler junctions 365  
neuromuscular blocking agents **359**  
nickel catalyst 94  
*Nicotiana tabacum* 499  
nicotine 412, **499**, 501, 503  
nicotine chewing gum 507  
nicotine patch 507  
nicotine sulfate solution 499  
nicotine yield 503  
nimetazepam 284, 285  
ninhydrin reagent 325  
nirvanol 351  
NIST library 78  
nitrate **649**, 650, 655  
nitrazepam 19, **284**, 285, 352, 353  
nitric acid-reducing bacteria 649  
nitrite **649**, 650, 655  
nitrofen 529  
nitrogen-phosphorus detector 38, 303, 593, 650  
nitrogen monoxide 153  
nitroglycerin 655  
NMR 614, 616  
non-depolarizing type muscle relaxant 365  
non-smokers 115  
nonfreezing coolants 449  
5'-nor- $\Delta^8$ -THC-4'-oic acid 190  
norephedrine 171  
normorphine-3-glucuronide 204  
nortriptyline **271**, 274, 276  
Nova-Pak C<sub>18</sub> 202, 581  
Novapak 343  
NPD 38, 118, 120, 174, 303, 305, 306, 593  
nuclear weapon of the poor 609  
Nucleosil7C<sub>18</sub> 370  
Nucleosil C<sub>18</sub> 5  $\mu$ m 565  
N 7-2-[(hydroxyethyl)thio]-ethyl guanine 85
- O**  
O-alkylmethylphosphonic 84  
*o*-cresol 583  
O-isopropylmethylphosphonofluoridate 609  
*o*-xylene 165  
Oasis<sup>®</sup>MX 556  
Oasis<sup>®</sup> MCX 215, 563  
Oasis<sup>®</sup> MAX 327  
Oasis<sup>®</sup> HLB 273, 285, 339, 512, 584  
2-octane 165  
octanesulfonate 38  
ODS-1 Spherisorb 319  
ODS-80 Ts 307  
O-ethyl S-2-diisopropylaminoethylmethylphosphonothiolate 619  
OHMA 181  
OHnorBZP 171, 179, 183  
oleandrogenin 519  
oleander poisoning 524  
oleander toxins **519**  
oleandrin **519**, 521, 523, 525  
on-column derivatization 238  
on-column methylation 303, 311, 333  
opiates **195**  
opium alkaloids **195**  
optical isomers 428  
optic nerves 123  
organophosphate pesticides **535**  
organophosphorus compounds 208  
organophosphorus pesticides **535**  
orphenadrine 315, 322  
2 % OV-225 Gas Chrom W 347  
oxacillin 397  
oxalic acid 449  
oxaprozin 325  
oxazepam 352, 353  
oxazolam 284, 285  
oxidative polymerization 416  
2-oxo-LSD 228  
oxprenolol 373, 375  
ozone layer 143
- P**  
*p*-aminobenzoic acid 377  
*p*-cresol 583  
*p*-cresol glucuronide-conjugate 586  
*p*-cresol sulfate-conjugate 586  
*p*-dichlorobenzene 443, 445  
*p*-dichlorobenzene-*d*<sub>4</sub> 445  
*p*-dimethylbenzaldehyde reagent 225  
*p*-hydroxybenzoic acid ethyl ester 346, 348  
*p*-hydroxymethamphetamine 171, 180  
*p*-nitrobenzoic acid 553  
*p*-nitrobenzoyl chloride 552  
*p*-oxybenzoic acid 377

- p*-phenylenediamine 415, 422  
*p*-xylene 150  
*P. subcubensis* 476  
 paints 149  
 paracetamol **335**  
 paradichlorobenzene 443  
 paraoxonase 535  
 paraquat **571**, 572, 578  
 paraquat-dipyridone 574  
 parathion 529, 535, 537  
 Partisil ODS-3 399  
 PCP 62, 64, **241**  
 penicillins 395, 397  
 pentachlorophenol 529  
 pentafluorobenzyl azide 632  
 pentafluoropropionic anhydride 208, 216  
 pentavalent arsenates 637  
 pentazocine **219**, 222  
 pentazocine abuse 219  
 pentifylline 494  
 pentobarbital 303, 305, 308, 309, 310  
 pentoxyfylline 494  
 pentyl nitrite isomers 158  
 perazine 259  
 perhydroxyl radical 116  
 pericardial fluid **13**  
 peripheral-acting muscle relaxants **359**  
 permethrin **425**, 529  
 perphenazine 259  
 pesticides **527**  
 pethidine 241  
 petroleum components **159**  
 petroleum gas 159  
 PFPA 208  
 phalloidin 473, 477  
 phencyclidine 62, 64, **241**  
 phenobarbital **301**, 302, 303, 305, 308, 309, 351, 353, 354  
 phenol 583  
 phenothiazines **255**, 258  
 phenotrin 425  
 phenoxymethylpenicillin 395  
 phenthoate 537  
 phenylacetic acid 171  
 phenylacetoacetonitrile 171  
 1-phenyl-2-aminopropane 171  
 phenylboronic acid 449  
 1-phenyl-2-dimethyl-amonopropane 171  
 2-phenylethylamine 173  
 1-phenyl-2-methylamino-propane 171  
 1-phenyl-3-methyl-5-pyrazolone 114  
 phenyltoloxamine 315  
 phenyltrimethylammonium hydroxide 331  
 phenytoin 293, **351**, 353–356  
 phosalone 537  
 phosmet 537  
 phosphatase 535  
 phosphate type 535  
 phosphonic acid 84  
 phosphotriester hydrolases 535  
 phosphorus-containing amino acid-type herbicides **545**  
 photodiode array detector 266, 268, 541, 569  
 pinacolylmethylphosphonic acid 626  
 pindolol 373  
 piperilate 315  
 pirimiphos 537  
 pirimiphos-methyl 529  
 pitfalls **17**  
 pituri 516  
 plasticizers 428  
 plunger-in-needle syringe 138  
*p*OHMA 171, 182  
 poison-net 51  
 poisoning 165  
 poison control centers 2, 55  
 polymer-bound tributyl-methylphosphonium bromide 631  
 polymer-bound tributylmethylphosphonium chloride 633  
 polymer-phase-transfer catalyst 632  
 polyolefin 426  
 polystyrene 426  
 polysulfide 105, 656  
 postmortem changes 19  
 postmortem diffusion **21**  
 postmortem inspection 4  
 postmortem interval 218  
 postmortem production **18**, 93, 136, 140  
 postmortem production of GHB 252  
 postmortem redistribution **19**  
 potassium arsenite 646  
 potassium ferricyanide 93, 655  
 potassium *tert*-butoxide 412  
*pp'*-DDD 529  
*pp'*-DDE 529  
*pp'*-DDT 529  
 pranoprofen 330, 332  
 prazepam 284, 285  
 pretreatments of human specimens **25**  
 primidone 352–354  
 procaine 383, 387  
 prochlorperazine 259  
 profenofos 537, 542, 543  
 programmed temperature vaporizing 412, 423  
 promazine 408, 420  
 promethazine **255**, 256, 258, 271, 274, 278  
 propamocarb 564  
 propanil 529  
 propericiazine 259

- propham 566  
propionic acid derivative  
analgesic-antipyretics  
325, 326, 328, 330, 332  
propionic anhydride 205  
prostaglandin biosynthesis  
325  
prothiofos 537, 543  
prothrombin time test 605  
protonated-molecular ion  
40  
proxiphylline 375, 491  
pseudochoolinesterase 377  
psilocin 476, 478, 479  
*Psilocybe argentipes* 469  
*Psilocybe cubensis* 476  
psilocybin 476, 478  
PTAH 331  
PTV 408, 412, 417, 423  
pulmonary vein 22  
Puresil C<sub>18</sub> 574  
purge-and-trap 161, 167  
putrefaction 93, 136  
pyrethrins 425  
pyrethroids 425  
pyridaphenthion 543  
pyridine-pyrazolone method  
116
- Q**  
quality assurance 210  
quality control 210  
quinonediimine 415
- R**  
racemic MA 172  
radar charts 644  
radioimmunoassays (RIA)  
35  
raves 230  
reduced bromperidol 264,  
265  
reduced haloperidol 264,  
265, 267  
reduced Hb 92  
resuscitation treatments 22
- retention index 78  
retention indexes 279  
*Rhodophyllus rhodopolius*  
469, 470  
*Rhodophyllus sinuatus* 469  
RI 78  
Roundup® fluid 555  
Rtx-1 256, 437, 444  
Rtx-17 449  
Rtx-5MS 208  
Rtx-BAC2 123, 126, 135,  
138, 149  
rust preventives 649
- S**  
saccharolactone 588  
salicylic acid 343, 344, 346,  
348, **391**, 393  
salicylism 391  
salicyluric acid 343, 344, 346  
salithion 529, 537, 543  
saliva **11**, 115  
salting-out effect 152, 268  
saponin 93  
sarin 84, **609**, 616, 617, 621  
scalp hair 642  
scheduled chemicals 69, 609  
scopolamine 208, 215  
*Scopolia japonica* 516  
screening tests 61  
SE-30 190  
secobarbital 303, 305, 308  
second-derivative spectro-  
photometry 571  
sedimentation 26  
segmental analysis 10, 645  
selected ion monitoring 40  
selected reaction monitoring  
41  
selegiline 171  
selegiline user 181  
selenium 644  
Sep-Pak®C<sub>18</sub> 202, 220,  
257, 294, 315, 322, 356,  
385, 483, 492, 536, 562,  
575, 594
- Sep-Pak PS-2 484  
setiptiline 271, 274, 276,  
277, 278  
SGE BPX35 408, 417  
Shim-pack CLC-ODS (M)  
413  
Shim-pack SCR-102H  
433  
Shimalite-Ni 94  
sick house syndrome 149  
SID 38, 256, 261, 385  
silanol group 366  
silanol groups 279, 281,  
517  
Silica Gel 60 F<sub>254</sub> 361  
silylation 30, 75, 347  
SIM 40  
simazine 529  
Simon's reaction 176  
Simon's reaction-HPLC  
175, 179  
Simon's reaction TLC  
183  
Simon's reagent 173  
slimming drug 171  
smokers 115  
smoking 93  
smuggling incident 130  
sodium-ion channels 458  
sodium arsenite 646  
sodium azide **629**  
sodium fluoride 208, 216,  
349, 384  
sodium hydrosulfite 571  
sodium hypochlorite **403**  
sodium tetraborate 431  
sodium thiosulfate 102  
solid-phase extraction **28**,  
29, 75, 191, 198, 215, 233,  
279, 285, 356, 538, 562,  
563, 593  
solid-phase microextraction  
**28**, 260  
solprin 348  
solvents 149  
soman 609, 621



sonic spray ionization 175, 520, 525  
 sotalol 373, 375  
 SPB-1 311  
 SPEC · PLUS™ · DAU 215  
 spectrophotometer 34, 91  
 spectrophotometric method 655  
 spectrophotometry 431  
 Spherisorb ODS 397  
 SPME 120, 124, 127, 130, 260  
 sport athletes 375  
 Spring-8 645  
 SRM 41  
 SSI 175, 520, 525  
 static headspace 161  
 stomach 21  
 stomach contents 5  
 stomach puncture 5  
 storage of specimens 93  
 styrene **149**, 151  
 suboccipital puncture 6  
 succinylcholine **359**  
 succinylmonocholine 360  
 Sulf-Hb 93  
 sulfatase 581  
 sulfhemoglobin 656  
 sulfide 104, 656  
 sulfurated hemoglobin 93  
 sulfur mustard 84  
 Supelcosil LC-18 353  
 Supelcowax 10 124  
 super-warfarin 599  
 superoxide anion radical 116  
 suppressor 39  
 surface ionization detection 256  
 surface ionization detector 38, 385  
 surfactants 407  
 sweat **12**  
 switching valve 39  
 symmetry Shield RP18 296  
 synthetic pyrethroids 425

**T**

tabun 616  
*Takifugu rubripes* 481  
 tandem MS 41  
 tar 503  
 TC-1 251, 384, 387  
 TC-17 385, 387  
 TC-5 379  
 TDMBA 103  
 Tenax 82, 161  
 TEPP 535  
 terbucarb 566  
 terodiline 315  
*tert*-butanol 135  
 tertiary amino group 261  
 tertiary butylamino drugs 369  
 tetrabutyl ammonium (TBA) 30  
 tetracaine 383, 387  
 tetracyclic antidepressants **271**  
 tetradecyldimethylbenzylammonium 103  
 tetradecyldimethylbenzylammonium chloride 631  
 Tetralin® 633  
 tetramethylammonium hydroxide 333  
 tetrodotoxin **481**  
 TFAA 208  
 TFET 216  
 thallium 637  
 theobromine 491, 494  
 theophylline 335, 393, **491**, 494  
 thermal desorption device 82  
 thermospray 40  
 thermospray ionization 364  
 thiamylal 303  
 thiaprofenic acid 325  
 thiethylperazine 259  
 thin-layer chromatography **34**  
 thinner solvents 149  
 thiocyanate 633  
 thiocyanic acid 115  
 thiodiglycol 84  
 thiodiglycol sulfoxide 84  
 thiol type 535  
 thiometon 529  
 thiono type 535  
 thiopental 303, 308, 309, 310  
 thioproperazine 259  
 thioridazine 256, 258  
 thiosulfate 108  
 thrombo test 605  
 tiaprofenic 332  
 timolol 373  
 tin 644  
 TLC **34**, 226, 325, 359  
 TMAH 303, 311, 333  
 TMCS 191, 205  
 tobaccos 503  
 tobacco amblyopia 117  
 tobacco exudate 503  
 toes 11  
 tofisopam 284, 285  
 Tokyo Sarin Incident 45  
 Tokyo Subway Sarin Incident 611  
 toluene **149**, 151, 165  
 toluene-*d*<sub>8</sub> 167  
 trachea 21  
*trans*-permethrin 427  
 Triage® 35, 61  
 trial for quality of analysis 56  
 triazine herbicides **591**  
 triazolam **283**, 284, 285, 287, 289, 290  
 trichlorfon 532, 537, 543  
*Tricholoma ustale* 469  
 tricyclic antidepressants **271**  
 triethylamine 279, 281  
 trifluoperazine 259  
 trifluoroacetic acid 366  
 trifluoroacetic anhydride 205, 208, 214, 216, 374



- trifluoroacetyl chloride  
(TFA-Cl) 30
- trifluoroethanol 214, 216
- triflupromazine 256, 258
- triisopropyl phosphate 610, 611
- trimethylanilium hydroxide 303
- 1,2,3-trimethylbenzene 165
- 1,2,4-trimethylbenzene 165
- 1,3,5-trimethylbenzene 165
- trimethylchlorosilane 191
- trimethylsilylation 191
- trimethylsilyldiazomethane 600
- trimethyl phosphate 617
- 1,3,9-trimethylxanthine 494
- 2,3,6-tri-*O*-methyl- $\beta$ -cyclodextrin 514
- trimipramine 271, 276
- triple-phase system 632
- triprolidine 315, 321
- 1,2,3-tris(2-cyanoethoxy)propane 102
- trivalent arsenic compound 637
- tropane alkaloids 509, 511, 513
- TSK gel Super-Octyl 276
- TSK gel super-ODS 352
- TTX 485, 488
- TTX excretion 488
- Twister™ 28
- U**
- Ultra#1 311
- Ultra-2 528
- Ultra-II 371
- ultrafiltration 26
- unnatural death 2
- urinary bladder 21
- urine 3
- V**
- Vac-Elut® system 329
- vamidothion 537
- variation in drug concentration 20
- Vegetamine® 302, 310
- verification analysis 73
- Vicks Inhaler 171
- vital reaction 163
- vitamin K-dependent coagulant factors 599
- vodka 130
- volatile organic compounds 37
- vomitus fluid 3
- VX 84, 613, 619
- W**
- Wakopak WS GP-N6 288
- warfarin 599, 600, 604
- warfarin alcohol 601
- wide-bore capillary 36, 123, 137, 145, 149, 410, 423
- wide-bore capillary column 135
- wide-bore capillary GC 125, 126, 128
- Woodward rule 429
- X**
- xanthine derivatives 491
- X-ray diffraction profile 635
- X-ray fluorescence 42, 637, 639
- XTI-5 160
- xylene 149, 151
- xylene isomers 150
- 2,4-xylenol 583
- xynol 583
- Xylocaine™ 386
- Xylocaine™ jelly 22
- Xyrem® 247
- Z**
- zaltoprofen 325, 332
- Zorbax ODS 311