

How to make an ORGONE FIELD PULSER

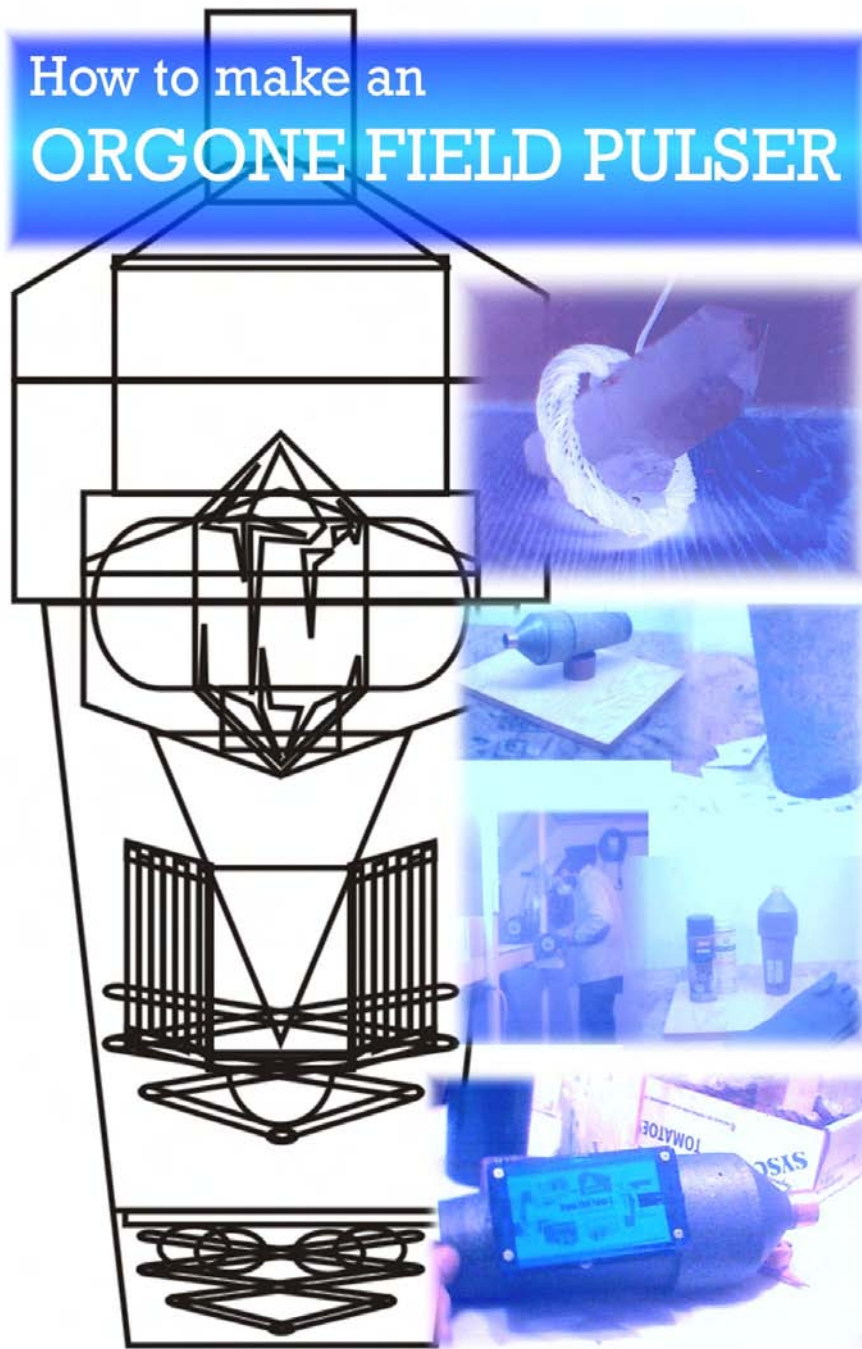

**Previously Unreleased Construction Details of 2nd generation Orgone Field Pulser II
Mobius-driven Bioenergy Generator** Design adapted for construction from readily
available materials with **basic handyman skills & tools. Additional free info included**
Published by Wizzer's Workshop © Jon Logan 2003 - 2005 all rights reserved.

Preface

Hi, and thanks for supporting ongoing Bioenergy research and development taking place at Wizzer's Workshop with your purchase of this booklet.

It is to be understood by the reader that in this booklet, "bioenergy" refers to an omnipresent background energy form which is generally found in higher concentration within living organisms. This energy is known by various names such as Orgone, Reiki energy, Bioenergy, Biomagnetic Energy, Odic force, Prana, Chi, Etheric energy, and Aether, to name a few. It is a biological animative energy which has magnetic, thermal, wave, fluidic and optical properties. It is a form of energy which is capable of influencing its environment in subtle but powerful ways. It causes changes ranging from subtle chemical or magnetic effects through to marked emotional responses in living organisms under some conditions. This is still a growing science.

Personally, it is my view that acknowledging this energy form and understanding it more fully is in the best interest of humankind, and it is to that end that I offer this and other information on the subject. The experimenter (that would be you, dear reader) assumes responsibility for any consequences which arise from the construction of this experimental device and/or its use.

The device illustrated here is a versatile and powerful bioenergy tool which both generates and modulates life energy. **When combined with an audio feed from an audio recording or the sound card of a PC, it demonstrates many of the capabilities of much more complex and expensive frequency therapy devices (like "rife" machines).** It also has applications in radionics, providing both an amplified output for radionics circuits, and (via the mobius coil) a means of modulating the bioenergy discharged with radionic information. It can be used as a standalone device or in conjunction with existing radionics machines.

The OFP is a design I have had consistently good feedback with over several years. The design has gone through successive stages of development and adaptation. In this booklet, I have adapted the design to be made from readily available materials. The design does not depend on precise geometry, pleasant appearance, or even that the materials used be exactly as depicted (even though I would suggest that they should be, until you have at least built one as depicted before making changes to the design). As long as the same basic parts are put together in the same way, it will work. The quality of workmanship and materials, as well as the care put into the construction, do of course have an effect on the finished product.

In simple terms, this device makes use of the fluid characteristics of bioenergy, and also makes use of the wave properties of bioenergy. It is an Aether vortex chamber (created by the mobius coil) surrounded by a casing of Bioenergy-generating material. The result is that you have a stream of Bioenergy coming out of the device, and the stream of Bioenergy carries a wave pattern determined by the signal used to drive the coil. You will get this effect even if you just cast a coil inside of a rough chunk of Ergonite (my name for the bioenergy-generating material). Even when there is no current going through the coil there is still a smaller vortex generated by the coil. The pulser design as offered here is the result of several years R&D and it is my hope that you will find the information useful and comprehensible. My contact information is included at the end of this booklet, and I welcome your feedback.

This book is partially the result of requests via email for more information on how to build this device. If you have just bought this book but have never heard of Orgone Energy before, then there are several free articles with basic information available for download from <http://www.littlemountainmudge.com/info.htm> and links to other informational resources that should help to fill in the blanks.

Sincerely,

Jon Logan

Selecting a Crystal

At the core of the OFP is a mobius coil with a quartz core. Selecting a suitable piece of quartz is the first step. The mass of the quartz is more important than the quality. That is not to say that the quality of the crystal is unimportant, rather that a large enough crystal of relatively poor quality will work much better than a beautiful water-clear crystal which is too small.

If you are a person who already uses crystals because of their bioenergy properties, then you can select one that you like. If you are not familiar with the use of quartz as a bioenergy lens, then it does not matter that you have any special crystal. It matters that the crystal you use be about **4.5 cubic inches** in volume or more. I generally use crystals between 6 and 12 cubic inches in volume. Cracks, inclusions, chips and so forth in the crystal will not stop it from working. In short, the better the crystal quality, the more efficiently the quartz core will work. But any quartz will work, and it is important that it the crystal be large enough. If you are going to go to all the trouble of making this device, you may as well use a big enough piece of quartz or you will be wasting the effort.



The crystal can have one point or two points. It does not have to be perfectly shaped or symmetrical. You could also use a cut prism, cylinder or obelisk of quartz. You could also use Smoky Quartz, Amethyst, Rose Quartz or Citrine, since all of these minerals are basically quartz with a very small amount of metal included in the crystal structure. The metal changes the color of the quartz to give it a yellow, brown, red or purple color.

Most people are able to find natural quartz crystal for sale either on the internet or through the mail. I generally use medium quality, double-terminated clear quartz crystals which measure about 4 inches x 2 inches x 1.5 inches. The design depends on there being a mass of quartz of sufficient volume (4.5 cubic inches or more) inside the coil. So if you are not a "crystal person" then don't worry about it, we are working with physics here (meta-physics, that is) and not with any individual persons belief system. Just get your hands on a chunk of quartz that is big enough, and it will work.

You can get quality crystals from
<http://www.thecrystalman.com/index.htm>

And more quartz vendors are listed on this page:
<http://www.littlemountainmudge.com/links.htm>

Supplement

If for some reason you are unable to find the required quartz crystal, you could use the white variety of landscaping quartz known as “quartzite”, but since it is of lower quality than the clear quartz crystals, you should use a mass of at least ten cubic inches if you elect to use Quartzite.



Another less efficient but workable method of getting the required crystal mass is to take powdered quartz and mix it with just enough plastic casting resin to hold it together. Use polyester (fiberglass) resin or acrylic (craft) resin.

Cast it in the shape of a simple cylinder, and make it about 10 cubic inches in volume or more. It will not work as well as a nice quartz crystal, but it will work.

You can get landscaping quartz (white rocks for putting in your garden) from the hardware store. You can get sandblasting quartz grit (available where welding or auto body supplies are sold) and reduce it to a powder. You can reduce either one of these products to a fine powder with a setup like in the picture above. Wear a dust mask, goggles and gloves, because quartz slivers are very sharp, just like glass.

You could use a length of PVC plastic pipe as the mold to make your own “reconstituted” quartz. Use piece of 2 inch diameter pipe about 5 inches long. Brush the inside of the pipe with vegetable oil or petroleum jelly for a mold release agent. Get some tape and cover one end of the pipe. Mix the resin and catalyst and then mix in the crystal powder until the mixture is thick like oatmeal. Stand the pipe on the closed end and pour the mixture into the open end. Shake it to release air bubbles. If at all possible, expose the mixture to sunlight or bright moonlight while the plastic resin is setting up. It will most likely come out opaque and either a milky white or a pastel color derived from the color of the plastic resin. If you are going to use this method, it may be worthwhile to use acrylic resin instead of polyester, but either will work.

This method of making a “faux crystal” from quartz powder will work, but not as well as an actual crystal, and it really is better to use even a low quality chunk of actual quartz crystal if at all possible.

Making the Mobius Coil

Once you have selected the crystal you are going to use, the next thing to do is make a Mobius Coil to fit it.

First - Make yourself a "mobius Cable" to wind the coil from. While you can wind a mobius coil from single strands of wire, it certainly seems to be a lot more potent when you use a cable made in the manner described here to wind the coil from. Take a length of wire, and double it back on itself twice as shown to the right. Pull a little slack out at the ends of the wire; this will be the leads of the coil when it is finished.

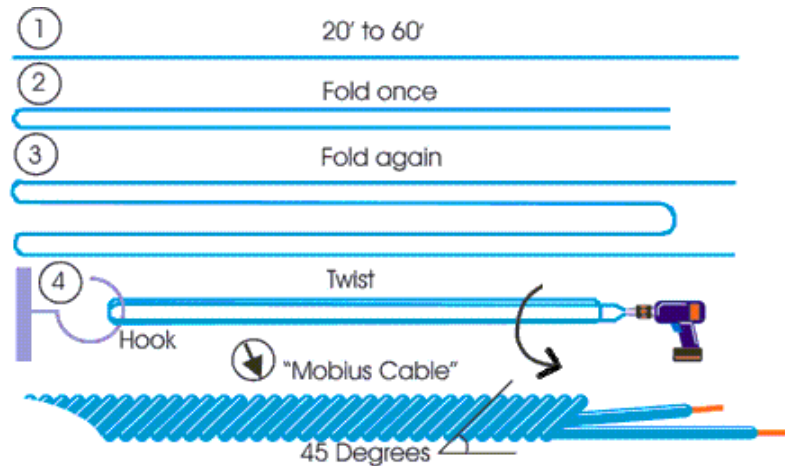

You should leave yourself at least 6" for leads; you can always trim the leads to the required length when the coil is finished. It is much easier to use a drill to twist the wires than doing it by hand. I generally run the drill in reverse to twist the cable. For making the OFP, I recommend using the solid copper wire with lacquer insulation commonly called "magnet wire" in North America. It is called this because they use it to make electromagnets, not because it is magnetic. If you can't get this kind of wire, then use any wire between 20 and 14 AWG. Myself, I generally use #18 AWG copper wire with inverter-duty lacquer insulation. If you are using wire that is not solid but rather composed of many filaments, then be more careful when you twist it, especially if it is # 20 AWG or smaller. In my opinion, solid copper wire is much better but any wire that is insulated will work. Also, it does not have to come out so the spiral is exactly 45 degrees, but get it as close as you can.

Not shown in the picture above is how to fit the cable end into the drill. Before inserting the cable end into the drill to twist it, fold the leads back so that they point towards the end of the cable opposite the end with the leads. Then wrap a few turns of electrical tape around the wires to protect them from the drill. Use about 5 or 6 turns of electrical tape. This provides a cushion so that when you tighten the drill chuck on the wires, it will not scrape off the insulation. While working with the coil in this and subsequent steps to building the OFP, be careful not to scrape the insulation off the wires, or the coil will short out and not work.

While you are twisting the cable, keep just enough tension on it to keep it from bunching up. Don't pull too hard on the wire as you twist it, or you will get knots. If you break the wires by twisting it too tightly, start over again, don't try to repair it. Fortunately, wire is something that is not terribly expensive in most countries. For those of you in industrialized nations, you can generally purchase magnet wire as described above from electrical supply contractors, or the shops where they repair large electric motors. Most major cities have a shop that does electrical coil windings for large motors, and they will often spool you off a few pounds for your "hobby project". Otherwise, go to radio shack and get what wire they have. You need about 30 feet of # 18 AWG to make a coil of appropriate size for the OFP.

Mobius Coil Winding - Series Quadrifilar Cable with Helical Twist / Toroidal Coil Winding.

1. - Starting with the end of the mobius cable which does not have the leads, make a loop in the clockwise direction just a little larger than the size you want the hole in the center of your finished coil to be.



2. - When you complete the first wrap, feed the wire through the center of the circle so it wraps around itself in the clockwise direction as shown. Use a little glue (hot melt glue works well for this because it sets up in minutes) to hold the wire in place where it crosses over itself. It should be glue that is flexible when dry. Put the glue right where the little black arrow is pointing, in the picture below.



3. - Resume winding the wire around the circle in the clockwise direction again.



4. - Go around the circle about one third of the way, and feed the cable around the center again, just like in step 3. Go around the circle another third of the way, and do the same thing again. You should have 3 wraps through the center of the coil for each time you go around the circle formed by the coil. Try to keep it neat and even, but don't worry if it doesn't come out a perfect circle. If you get the spacing of these first 3 nodes even, then the coil will come out more even. Try to get the 3 nodes to form an equilateral triangle.



5. - Continue this way, repeating step 4, until you have used up all of the cable. As shown, stay on the same side of the previous wrap with each new revolution. The 'knots' will run together.

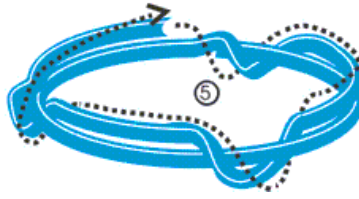

When you are finished, use a little glue to hold the end of the cable in place. The coil should look like this when you are finished.

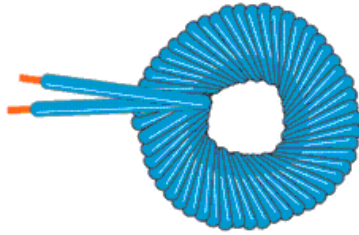

Hopefully, the pictures will be of more use to you than the words, as it is really quite simple to do, just a little cumbersome to try and explain in words. Basically, you just keep looping the cable through the center as you go around the circle. With a little practice, you will find that the windings form a pattern, and if you make a mistake it will be obvious as it does not fit the pattern. You should measure the diameter of the crystal you wish to use, and start with a circle about 15% larger than the diameter of the crystal. It is also a good idea to make a coil for practice before you make the one you will use in the pulser. It does not have to look pretty; it has to be a big knot of wire which is all twisted up in a spiral pattern. That way, the entire length of wire is continually crossing over itself at roughly 90 degrees. The wraps on one side of the cable cross over the wraps on the other side of the cable at 90 degrees. This is what causes it to generate scalar wave patterns when you put an electric current through it.



Mounting the Coil

Well, now you should have a crystal and a coil. The next thing to do is mount the coil on the crystal. Test fit it first. If you find that the coil is too tight for the crystal, then make another coil a little bit larger, or unwind the coil and rewind it a little larger. Do not try to force the coil onto the crystal, or you will scratch off the insulation and have to start over again anyway. The coil can be a little too large for the crystal and it will not hurt anything.



You should arrange it so that the coil sits about one third of the way along the length of the crystal. Instead of placing the coil at the center of the length of the crystal, place it about one third of the way along the length of the crystal. Put it closest to the end without a point if you are using a single terminate crystal, or closest to the end which you have decided will be the “bottom” if you are using a double terminated crystal. In any case, the crystal has to go through the hole in the center of the coil. Once you have a good fit, fasten the coil securely in place with good glue.



You can use either hot melt glue (the heavy duty kind is best, the kind that is yellow and not white) or silicone glue, or vinyl glue like “Goop®” or “Shoe Goo®” brands. For this part I usually use heavy duty hot melt glue with a glue gun. The advantage to using hot melt glue is that it sets up very quickly, and you don’t have to wait hours or days for it to set up. With silicone or vinyl glue, Support the work in place so it cannot move, apply the glue, and let it sit for at least twenty four hours before continuing the work. A simple way to hold the coil in place, if you wish, is to tack it with hot melt glue (even the cheap white kind) and then apply silicone or vinyl glue over the hot melt glue. This produces a durable and flexible joint. For people who live in extremely hot climates, I would suggest this as hot melt glue may soften up and release if it gets too hot. This is not so much a problem with the high-temperature, heavy duty hot melt glue as it is with the low-temperature “econo” or “regular” grade of hot melt glue.

Once you have mounted the coil on the crystal, now you are ready to add the color filter. This is an optional step, but part of the way I do it and therefore part of these plans. What we are doing here is simply “coloring” the energy that will come out of the quartz with the energy signature of another mineral. I



generally use kyanite for this. You could use other minerals, or you could leave it out entirely. Three small slivers of kyanite are attached to one side of the coil, usually the ‘bottom side’ but either side can be used. The three slivers of kyanite are arranged so that they form a triangle. They go right where the crystal meets the coil. Since a quartz crystal has 6 sides, just put one sliver of kyanite on every other side of the crystal. Fasten them in place with a little glue. Wind the coil leads up so they won’t get in your way. (above pic from a different project but shows kyanite)

The Reflector

The next step is to make the reflector. This is basically a metal container that goes around the outside of the coil and crystal assembly. There are several different workable methods of procuring a suitable reflector. On the next page, there is a graphic that can be printed off and used as a template to cut the reflector with metal shears (“tin snips”) from thin aluminum flashing. You can find this thin aluminum flashing at most hardware stores. If you have it, you can also use steel or galvanized steel or thin copper. Generally, aluminum is more easily found and economical, and it more than suffices.



Resize the graphic if necessary, print it out on a sheet of paper, and cut around the outside edges of the black shape. Lay the paper template down on the aluminum flashing, working on a smooth firm surface. Hold the template firmly in place or secure it with a little tape.

Trace around the outside edges to mark the outline on the metal. If you print it out on thick card stock, then you can use a scribe or a sharp nail to scratch the outline into the flashing. Otherwise, print it out on regular paper and carefully trace the outline onto the flashing with an HB pencil or a thin point felt pen. Once you have the outline transferred to the aluminum flashing, carefully cut it out with the metal shears.

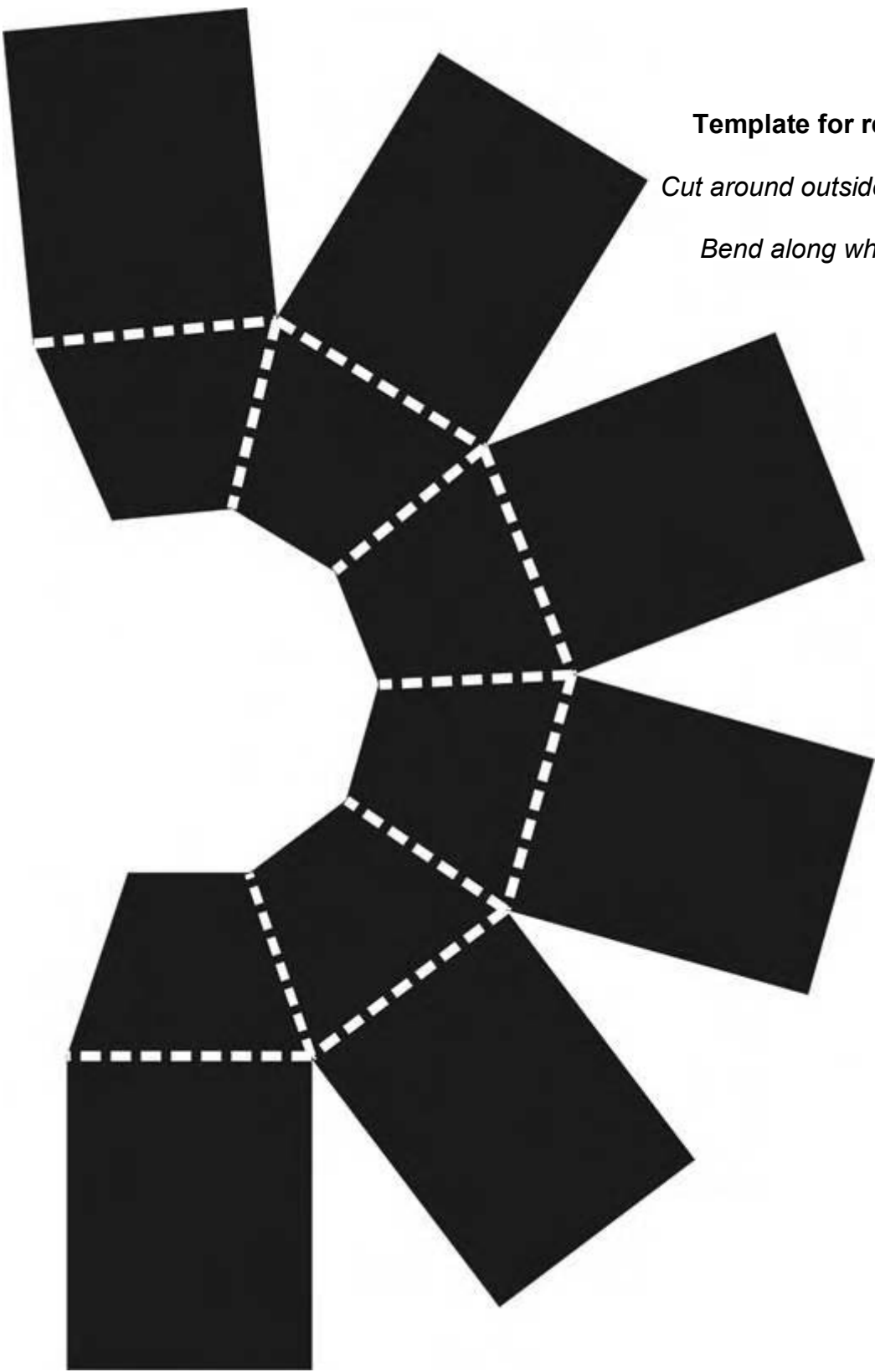

Template for reflector

Cut around outside edges

Bend along white lines

Supplement

Although the plans here depict a reflector made from the template provided, you could alternately use the optical reflector from a large flashlight, if you can find one at least 3 inches in diameter. If you are unable to find the aluminum flashing and the shears to cut it, then you could substitute a small food can like those generally used for canned tuna. These cans measure roughly 1.5 inches x 3.5 inches and are easily found almost anywhere. You would need to cut a hole about 1 inch diameter, centered in the bottom of the can. Alternately, you could cut the top off a plastic pop bottle and coat the outside of the pop bottle top with aluminum tape or metal spray paint. It is more important that the coil be surrounded with a covering of metal than that the metal covering be of any particular shape.



Bend along the white dotted lines to form the metal cutout into the shape shown in the picture. You will wind up with a hexagonal reflector with a small hole at the narrow end. Bend the tabs around the outside of the metal cutout up, so that they form sides for the reflector. Do the best that you can to get it neat, but again what matters here is that you have a metal enclosure for the coil and crystal. It does not have to be pretty. The enclosure should have a

small hole at the end where the “bottom” of the crystal goes, and a wider opening at the end with the “top” of the crystal.

Now you are ready to mount the coil inside the reflector. Adjust the reflector so that it best fits the crystal and coil. Do not worry if the edges of all the tabs do not meet, you are going to wrap it with aluminum tape so that there will be an unbroken metal covering around the outside of the whole crystal and coil assembly.

Once you have the reflector arranged to fit the coil and crystal, tack it in place with a little hot melt glue. Tack each of the six flat inner sides of the reflector to the coil. Do them one at a time, and as you do them, hold each one in place so that it lines up reasonably well. Do your best to get the axis of the crystal centered within the axis of the reflector.



Cut about an inch of plastic tubing. Slide the coil leads through it, so that it forms a sleeve around the coil leads. Feed the ends of the leads through the tubing. Slide the tubing all the way up the leads until it butts against the coil. This is to protect the coil leads where they pass between the sharp edges of the metal reflector. You will have one seam on the reflector that joins the whole thing together. On this seam, at the

base of the reflector meet the side of the reflector, bend the sharp edges of the metal back a little so that they cannot scrape the insulation off the coil leads. Fit the coil leads, inside their protective sleeve of plastic tubing, into this opening. Secure both the coil leads and the seam on the reflector with a little aluminum tape.

By this point you should have the coil tacked in place within the reflector. Now wrap the outside of the reflector with at least 2 layers of aluminum tape. Leave just a little of the metal flashing exposed at the "bottom" of the reflector, and cover the rest of the outside surface of the reflector with aluminum tape. Line the edges and seams of the reflector up as best you can while you are doing this. Make sure that all the seams are covered with at least 2 layers of aluminum tape.



Supplement

If you cannot find aluminum auto body tape, then use first a layer of masking tape to hold the metal flashing in the correct shape, and then a double layer of aluminum foil over the masking tape. Then wrap on another good layer of masking tape to hold the aluminum foil in place. It really is better to use aluminum tape or another metallic tape. In industrialized nations, you can generally find aluminum auto body repair tape in large hardware stores or in painter's supply stores.

<http://doityourself.com/>

Now set the reflector in a jar or cup to hold it vertical, so that the exposed end of the crystal points upward. Use either heavy duty hot melt glue, silicone glue or vinyl glue to fix the coil and reflector permanently together. Use a generous amount of glue, because you don't want it to fall out later on. If it does, you will be unable to get at it to fix it, and the whole project will be a waste. Ask me how I know that ;) I generally use "high temperature" aka "heavy duty" hot melt glue, and I use about 2 ½ to 3 sticks of glue for each coil / reflector assembly. Whatever glue is used, cover the entire side of the coil that you can see when looking down into the reflector. Make sure that the glue is firmly worked into the crevices of the coil, and touches both the sides of the crystal and the inner sides of the reflector. Use a layer of glue a good ¼ inch thick. Set the reflector assembly aside for the moment and let the glue dry.

Output Expansion Chamber

This step is to make a chamber that adjoins and extends the reflector assembly. It is simply a hollow tube with an organic outer layer and a metallic inner layer.

Get some clean, dry corrugated cardboard without any printing or markings of any kind. Select a section of the cardboard that has not been crushed so that it will have enough structural strength. Cover one side of the corrugated cardboard with aluminum tape. Work the tape firmly onto the cardboard with your fingertips or the rounded bottom of a soup spoon. Do not scratch holes in the covering of aluminum. If you make a hole, cover it with another piece of tape. You can use one neat layer or two less-than-neat layers of aluminum tape.



You are going to cut a strip from this laminate sheet. Normally, the strip can be about 3 inches wide. If you used an extremely large crystal, you may have to make the strip wider.



Double check by making the following measurements: go back to the reflector assembly and measure the distance from the exposed tip of the crystal to the surface of the glue covering the coil.

The strip should be at least 2 inches wide. Additionally, the width of the strip must be at least $\frac{1}{4}$ inch greater than the distance from the crystal tip to the surface of the glue. Now measure the circumference (around the outside) of the reflector assembly, and make the strip a little longer than the circumference of the reflector assembly. It has to form a tube that will be inserted in the exposed open end of the reflector. The end has to reach just past the crystal tip.

Neatly cut a strip from the cardboard / aluminum laminate with a utility knife. Make sure to cut the strip so that the ribs in the corrugated cardboard run across (the short way) the strip and not along (the long way) the length of it. When you look at one of the long edges of the strip, you should see the wavy line formed by the corrugations. If you cut it with the ribs running the wrong way, then you will not be able to neatly crease it into a tube. Take the time to make the edges of the strip parallel and the ends square. Use a straight edge to run the utility knife along as you make the cut.

Roll the strip into a tube around a suitable cylindrical form such as small jar or tin can. The cap from a spray paint can is about the right size for a normal crystal. Start at one end of the strip and press firmly against the form as you roll. Put the metallic side inwards so that it will form the inner surface of the tube. Once you have the strip creased into the shape of a tube, insert the tube into the open end of the reflector assembly. It does not have to be perfectly cylindrical, or perfectly round. A little overlap at the ends of the tube is necessary so that you can fasten them together. The sides of the tube should be as close to parallel with each other as you can get them. The sides of the tube should be as close to parallel with the axis of the crystal (not the reflector) as you can get them.

Even if you just mash it into place, it will still work, but it is worth the time to work the cardboard gently into place and get it all lined up nicely. If the end of the strip does not come out square and level, then don't worry you can trim it later with a utility knife or scissors. Make the sides parallel. Tack the tube in place with hot melt glue. Tack the tube to each of the six flat inner sides of the reflector assembly, one at a time. Line each connection point up as best you can before you tack it, and hold it in place while the hot melt glue cools.



Once the tube is tacked in place, let it cool for a few minutes and then fasten it in place permanently with glue. Fill all the holes at the inside corners of the reflector and glue all the way around the seam where the reflector meets the tube. Fill the seam where the two ends of the strip overlap with glue to form a seal. You need

not only to hold the tube firmly in place, but also to form a liquid-tight seal on all the outside surface of the assembly you are building.

Supplement

You could use several methods to form an output expansion chamber, but it should have an organic outer layer with a thin metallic inner layer. You could use a section of PVC water pipe if you painted the inside with metallic paint. You could form the tube from metal flashing and cover the outside with several coats of latex paint. The corrugated cardboard method works well and it is still the way I generally do it. Once you have everything all glued in place, double check the surface of the reflector. Make sure that the tape is worked firmly into place, and that there are no holes in the covering of tape. Soon it will be immersed in liquid.

Well, there you have a sample of the content you can expect to find in this document.

To purchase the full version of this document (59 pages) , visit

[This page](#)

(<http://www.eBookAd.com/eb.php3?ebookid=21413&partner=12002>)



Sincerely, Jon Logan

©2004-2005 Jon Logan, all rights reserved



Wizzers Desk Personal Bioenergy Tools - Orgone Matrix Material Ergonite Orgonite Organite
- Construction info & sales- Radionics Stations -Möbius Coils - EM Pollution Control - DIY Plans & More!
- [Site Map](#) / [Products](#) / [Info](#) / [Ebooks](#) / [Contact](#) / [Legal](#) / [Links](#) / [Orgonite](#) / [Radionics](#)



[Modern Orgone Quarterly magazine in PDF format.](#)

An Introduction to Orgone Matrix Material

AN OVERVIEW OF ORGONE MATRIX MATERIAL

ITS MANUFACTURE - ITS APPLICATION - SELECTED RELATED INFO.

Fifth Edition © 2002-2004 Jon Logan

Published by Wizzer's Workshop - Quality metaphysics tools



☎ 250-446-2032

✉ Mail – PO Box 139, Westbridge BC V0H2B0

🌐 Url – www.littlemountainmudge.com Email – wizzer@littlemountainmudge.com

What is orgonite?

The word "Orgonite" refers to a new class of materials which are composed of a mixture of metallic particles suspended in an organic medium. The term "Orgonite" was coined by Karl Welz, the man who is generally credited with inventing it. Though initially intended by Welz to refer only to his commercial product, the name stuck- and has come into usage by most people familiar with the material. So... I suppose in the mind of Karl Welz and few other folks, orgonite means Welz's individual recipe, but to most others it has come to mean any material produced using the same basic conceptual approach. In any case, it refers to an orgone matrix material, as opposed to a layered orgone accumulator. To a degree, a piece of orgonite will act as an orgone accumulator in that it will tend to attract orgone from the area around it, but with an added dimension. The added dimension is that it will process the orgone energy as it interacts with it, whereas an orgone accumulator more simply condenses orgone energy.

There are many variations on the basic concept of suspending the metal within the organic element (as opposed to using thin layers of organic and metallic substances like in an orgone accumulator), and many other substances which can be added to the mixture to make it more potent, or to specialize it for different applications. Most of the people producing orgonite wind up developing their own exact recipes, I use several different recipes for slightly different applications. At the end of the day, the basic, fundamental ingredients of orgonite are metal particles and an organic medium to suspend them in, usually resin.

A wide range of metaphysical disciplines all work with the same energy, know it by various names ... (orgone, odic force, reiki energy, prana, chi, etheric energy, bio energy, bio magnetic energy, huna energy, animal magnetism, soft electrons, mass free electricity, radiesthetic color, astral energy, 4th dimensional energy, emotional body energy, life force energy, and no doubt a bunch of other names I have never even heard of) ... and so far orgone matrix material has proven itself a to be a readily adaptable and highly functional conceptual approach for work in these areas. Orgonite, (by any name) both releases orgone energy when stimulated by other forms of energy, and has the capacity to change orgone from one state to another. It is especially suited to taking the energy from an unhealthy state into a healthy, balanced state, and/or adding a selected property to the orgone energy which it processes. This makes it useful in a wide range of applications, from alternative health through to radionics and other traditional metaphysics.

Organic substances attract ORgone energy and soak it up like a sponge, while metallic substances tend to repel it. Basically, ORgonite pulls in the ORgone energy, and while the energy is inside the device, The metal particles and organic resin both push and pull on it in all directions at the same time. This puts the energy in a scrambled, chaotic state. When the energy comes back out of the device, it collapses back into an organized, defined state. As a side effect of being scrambled and put back together, it comes out clean! DOR is converted back into OR as it passes through the orgonite. (DOR=Deadly ORgone Radiation... Harmful ORgone. OR=ORgone Energy, the Healthy kind)

Orgone matrix material, or orgonite, has not only the property of changing OR (Orgone) from one form to another, but also the property of 'generating' OR when stimulated by other kinds of energy... like light, sound, physical motion, or electricity. When using a matrix of randomly arranged particles instead of orderly layers of the two substances (metal and organic) you get a different effect. Some benefits of using a matrix are:

A: Increased efficiency (higher proportionate orgone potential to mass) compared to a traditional ORAC.

B: Changes DOR (harmful ORgone) to OR (Healthy ORgone)... When orgone passes/percolates through the matrix, it is in effect reduced to its component polarities of + (positive/masculine/hot), 0 (zero point/omni potential/infinite), and - (negative/feminine/cool). It is then recombined, and re-emitted. The act of being broken down into its positive and negative charges and recombined basically flashes it across the 0 state and has the effect of restoring the orgone to a 'base' state, i.e.. it is no longer 'healthy' or 'unhealthy' orgone, it is no longer orgone of any specific 'color', rather it comes out of the matrix material as more or less undifferentiated orgone. That which makes the orgone 'colored' or differentiated is (oversimplified a tad) basically encoded in the proportions of +/-, (+/-)0, and in oscillation rate between + and -. When the orgone exits the matrix material, the conditions which 'force' it to exist in an undefined state no longer exist, and so it collapses back into a defined state, and is 'colored' to varying degree by the exact composition of the matrix material and any minerals/other substances included in the matrix.

C: Orgonite does not actually generate orgone, in the truest sense of the word, but I suppose that is a technicality. Orgonite, when excited with other forms of energy, both converts a portion of the energy used to excite it into orgone energy, and draws additional orgone energy from the Aether (the cosmic omni potential 'pool' of orgone energy that has yet to be 'put to work' in 3D terms), and puts it to work as orgone manifest in 3D terms. Thus for practical intents and purposes, orgonite 'generates' ORgone on demand when excited by scalar waves, magnetic fields, heat, sound, light, electrical energy, kinetic energy, etc.

HHGs and TBs

The type of orgone device which is commonly called a 'Holy hand grenade' is a medium-sized device which attracts harmful ORgone energy, converts it to healthy ORgone energy, and emits it again as a flow of healthy orgone energy. This is different from other orgone devices used up until this point, which had the ability to block or collect harmful energy, but not convert it to healthy energy. The device gets its name from an old Monty Python movie ;)... When placed in an area, buried, or placed in a body of water, the ORgonite Holy hand grenade will act to continuously clean the ORgone energy within a surprisingly large radius (average 3/4 mile radius from the device). A TB (Towerbuster) does basically the same thing on a little bit smaller scale. The effective range of a towerbuster is generally somewhere around 1/4 mile.

A basic TB is a small (3 to 8 ounce volume), usually cylindrical or conical mass of orgonite with a quartz crystal embedded in it. Generally the xtal is on the vertical axis if the device is tall, and on the horizontal axis if it is disk-shaped. A basic HHG is a little larger (usually 8 to 32 ounce volume), usually conical or pyramidal mass of orgonite with 5 double terminate quartz xtals embedded in it, one of them on the vertical axis and four of them on the horizontal axis. The vertical xtal is near the small end of the device, and the horizontal xtals are arranged radially, near the wide end of the device. Don Croft invented these two devices to counteract the adverse physical and mental health effects of HAARP, GWEN, ELF, SCALAR and HPRF transmission towers. In addition to serving well for this purpose, the HHG and TB devices are highly effective multipurpose energy cleaners. Think of them as air freshener for your aura.

To use one of these devices, simply place the device within an area and leave it alone. If possible, it increases the effectiveness to put them into a body of water or bury them in the earth. It is not necessary to bury them or put them in water, and most folks who use them have a few in their homes, to provide a constant cleaning action for the orgone envelope in their living space. With the HHGs, it helps a bit to align the device with the magnetic field of the earth, so that one of the xtals in the base of the unit points north. People who are familiar with natural energy vortices, Curry and Hartman lines, Ley lines, and so forth have been using these devices to restore many of the earth's energy centers to healthy state. This process is generally referred to as 'gifting' or 'towerbusting'. As should be no surprise to anyone familiar with orgone (by any name), many of us have noticed beneficial changes in the behavior of people within the effective range of such devices, whether they are aware of its presence or not. They are, in effect- getting the same sort of emotional healing and balancing (and in some cases the commensurate physical benefits) that one would expect from more traditional methods of life energy therapy. For several years I used xtals for basic pain relief and first aid in energy work on myself, and now I use something which is basically a fancy TB.

These devices can also be used as meditation aids, used by holding it between the hands while meditating, or by sitting near it while meditating. They can also be carried on the person in order to afford a constant cleaning action for your personal energy fields, and provide shielding against various forms of energy assault, ranging from psychic attack to EM pollution. And, while the devices can be used as intent amplifiers /radionics boosters, IMO there are more specialized orgonite devices which perform that task better. I have noticed that suspending water over the top of an HHG does charge it with orgone energy, and I regularly use this kind of charged water as a general tonic, I find that it has beneficial effects both physically and energetically (vitality, clarity of thought, emotional balance).

One thing which the HHGs and TBs seem to be good at is serving as a basic life energy therapy device, to speed healing and, in some cases, relieve pain. I of course am not a doctor, and am not giving you medical advice, and that applies to everything on this site, bla bla bla. There are several folks who find a TB or a slightly modified TB to be very useful (when held in the practitioner's hand or over the problematic body area on the person being treated) in Reiki, Reflexology, Massage Therapy, healing hands, and so on and so forth (these are all systems which effect healing by working with the human body's orgone energy).

Unlike orgone accumulators, These devices do not have to be carefully protected from EM pollution and DOR. They convert DOR to OR, so I think it is a good idea for most everyone to make at least one or two and put them in their homes, and enjoy the benefits of a healthy life energy environment where they live. As with some of the other similar devices which are already in use, these devices have applications in agriculture and alternative health, in addition to their primary function as an 'energy cleaner'- a device which processes life energy and removes harmful properties in so doing. Every day, we all take a bath in more energy pollution than most folks care to think about, ranging from huge uses of metaphysics with some very nasty intent behind it, to the modern phenomenon of technological assault on natural weather patterns (HAARP), The human mind and body (GWEN), and the harmful effects that various more mundane electrical systems have on life energy. These devices have been shown time and again to have a beneficial effect on the life energy of a given area, being adapted to many uses beyond the original purpose for them, and for which they are still heavily and successfully used, which is to restore natural weather patterns to the environment around us by mitigating or nullifying the effects of weather control technology.

I have seen no evidence that HHGs or TBs will become saturated with DOR from prolonged exposure, but I have seen that such devices have a processing capacity, and that capacity may be exceeded. I have been able to deal with that in most cases by simply using more devices. The capacity of the device is determined by the mass of the device, (larger mass of orgonite = more capacity) the way the internal components are assembled, and the composition of the orgonite itself. I have not found it necessary to move the HHGs and TBs around in order to keep them working, but I have noticed that doing so excites them and 'stirs things up' quite a bit. The exception to this is when you are using them to create a perimeter or clean field in or around your home or another area, in which case you ought to install them by placing them, rotating them clockwise until it 'feels right'... and then try to avoid moving them. Once moved, it takes some time for the fields to re-establish themselves. Where several devices are linked together to create a shield or ley line, moving one causes the whole thing to wobble. Stimulating one of them also stimulates the whole of the field in which the linked devices are included. If you have an SP, or a wand, or even a favorite xtal you use for a beamer you can go around the perimeter clockwise and touch each of the TBs with the tip of your device as you go around. This assists in linking the devices together.

The reason they work better when buried is that the orgonite works a bit more efficiently when in contact with the earth, since the orgone 'resistance' of air is slightly higher than the orgone 'resistance' of earth. Therefore, when the energy flows through the HHG or TB, it can flow a little more quickly if it is buried, because it has a huge potential (the earth or the body of water) to which it is grounded. Even if you do not bury them, just tossing TBs into a problem area works fine, burying them is a boost, and not absolutely necessary. Good thing, because there are many places where burying them is impractical. If possible, toss them where they will land in water (best) or on earth, as opposed to pavement. Drop one in your annoying neighbor's bushes hahaha ...

Orgone Accumulators, Orgone generators and Orgonite

The basic difference between orgone accumulators (ORACs) and orgonite is that orgonite processes orgone energy, whereas ORACs condense orgone energy. Some devices employ orgonites processing ability to 'generate' orgone from other forms of energy, and some devices employ orgonites processing ability to change orgone from one state to another. Examples of this latter use are changing orgone that is in an unhealthy state into a orgone that is in a healthy state, or converting orgone into the state which is most suitable for a given purpose at a given time (say, for therapy or radionics, etc.).

An orgone generator is a device that both collects orgone, and translates other forms of energy into orgone energy. It is possible, using orgonite, to convert heat, light, sound, scalar, kinetic, electrical and magnetic energies into orgone energy. Some people call orgone cleaners 'orgone generators', and in fact the man who invented orgonite has patented the term orgone generator, so indeed there are people who would define these terms differently than I do. However, I am trying to make the point that there are different functions involved, and as long as you are aware of them I suppose it does not matter what you call the, except for the sake of convenience in establishing a cohesive terminology with respect to orgonomy. Orgonomy, by the way, is a name for the study and application of orgone energy.

(Sigh), now... Orgonite does not actually generate orgone, in the truest sense of the word, but I suppose that is a technicality. Orgonite, when excited with other forms of energy, both converts a portion of the energy used to excite it into orgone energy, and draws additional orgone energy from the Aether (the cosmic omni potential 'pool' of orgone energy that has yet to be 'put to work' in 3D terms), and puts it to work as orgone manifest in 3D terms. Thus for practical intents and purposes, orgonite 'generates' ORgone on demand when excited by scalar waves, magnetic fields, heat, sound, light, electrical energy, kinetic energy, etc.

An orgone cleaner is a device that allows orgone to pass through it, and in the passing revitalizes the orgone energy. In addition to revitalizing the orgone, cleaner devices which employ orgonite or other similar conceptual approaches selectively remove and add qualities form the orgone. Again, there will be more articles at some point in the future which go into this matter further, but for now bear in mind that a cleaner is different from both a generator and an accumulator. HHGs, TBs, and Chembusters are examples of orgone cleaners. Also, it bears mentioning that orgonite-based orgone cleaners are not filters, though if overloaded or insufficiently grounded they will still function as filters. A filter picks the bad stuff out and collects it, and you have to periodically clean or replace the filter. Some folks have found that when their HHGs are not grounded well enough, they have to periodically refresh them by sitting them on the earth or in running water for a few hours. But, if the HHG is in contact with earth or moving water, or connected electrically to the house electrical ground (I'll be producing a kit for this so you can modify your HHG easily at home... still in the testing phase, looks promising so far... and of course I'll post instruction so you can do it even if you do not want to buy it from me hahaha), then the HHG actually converts the bad stuff into good stuff, as opposed to just filtering it out. That is the chief benefit of orgonite-based orgone cleaners, and that is what they are designed to do, and that is what they do when they are constructed and installed properly.

An orgone accumulator is rather like a big capacitor. It is a device, usually in the form of a closed container, which collects the orgone energy from the surrounding area and stores it inside the container. Like a capacitor, an ORAC will collect as much orgone 'pressure' as it can hold, and then it will release some of the orgone so that more can come in. Therefore, it runs cyclically, if often the cycles may be days and months apart, instead of the fractions of a second which we call Hertz when considering the cycle duration of electrical capacitors. Unlike orgonite, an ORAC does not process the orgone, so it can collect a store of orgone on the inside of it which is either good for you or bad for you, depending on the condition of the orgone energy fields in which it is located. It will just collect whatever kind of orgone energy is around it. It is a good idea to have an HHG or TB inside your ORAC if you plan to build one, since most of our electrical grid produces a kind of orgone energy that is unhealthy, and ORACs operated within the EM fields produces by electrical appliances or high tension power lines tend to become saturated with this unhealthy orgone. Thanks to the higher levels of masonry for the decision that 60 Hz is the frequency of alternating current we use in North America. In terms of pulse rate, orgone is not in a healthy state when it pulses at 60 cycles per second (orgone energy will often pulse in sympathy to an electrical current which passes through it. 60 cycle electricity passes through the earth's orgone fields and puts them into a state which is more or less inimical to most living organisms). Of the places in your home to place an HHG, near your electrical mains (don't shock yourself and don't sue me. i mean to put it near the mains, not electrically connected to them) or fuse box is a likely candidate.

An ORAC is able to collect the energy because the sides of the container are composed of alternate layers of metallic and organic material. This arrangement of layers produces something like an orgone 'diode'. It is easier for the orgone to travel one direction through the lamination of metallic and organic layers, and much harder for it to travel in the other direction. So, like a diode, the layers move orgone in one direction. Build a box out of this material, and it will collect and condense orgone on the inside, since it can get into the box much more easily than it can get out. The ORAC was invented by Wilhelm Reich about 70 years ago.

Another thing to bear in mind is that TBs, HHGs, and chembusters will, to some degree, respond to the energy environment around them, becoming more active when there is a lot of DOR or unbalanced, harmful life energy around them, and less active (unless excited) when there is little problematic energy around them. They also respond to large potentials of healthy life energy when they are near them, and will often appear to sit inactive when the energy around them is relatively clean and undisturbed. If you are using an HHG to charge water, for example, it is a good idea to use sound or light to stimulate it, so that you can make sure it is active. Assuming you have the proportions of metal and resin correct, and the particle size of the metal is within working parameters, It is not possible for a TB or HHG to become saturated with DOR the same way as an ORAC because the orgonite has a quality of processing the orgone from one state to another, whereas an ORAC does not. I and several other use TBs to keep our ORACS clean, and (with a TB in it) I have been using a small cylindrical ORAC less than two miles from a large power line without any problems, this for years now (a/o mar 2004).

Chembusters and Cloudbusters

There is a lot of controversy on this subject now, and to be honest I consider it important to distinguish between a Croft-style Chembuster and a Reich-style Cloudbuster. After having had a chance to experiment with both devices, I find that they are indeed different in function. A Cloudbuster is a device invented by Wilhelm Reich about seventy years ago, and it uses orgone energy to influence weather patterns. It is basically an array of parallel pipes which are in turn connected by means of rubber or other organic hoses to either an ORAC or a body of moving water. It relies on the circulation of orgone energy within the water bodies of the earth to clean the orgone by virtue of the action of moving water over stone, this action takes place in riverbeds especially. A Chembuster (or Croft-style Cloudbuster) is a slightly different device, which is based on the Cloudbuster in that it uses a parallel array of pipes to channel orgone energy, in order to affect the weather patterns in the area around it. The main difference between a Cloudbuster and a Chembuster are that a Chembuster has a ballast of organite, while a Cloudbuster is grounded directly from the pipes to the earth, or water. And since organite processes orgone energy instead of simply collecting it or moving it around a Chembuster cleans the orgone as it passes through. A cloudbuster does not.

Although both Cloudbusters and Chembusters generally pull orgone in the form of DOR down from the atmosphere and channel it into the Earth, it is possible for both devices to work in the opposite direction and send orgone from the Earth into the atmosphere. In both cases, it is the changing orgone fields which affect weather patterns. I do not approve of novices using Reich-style Cloudbusters, but I do approve of just about anyone using Chembusters. This is because a Chembuster is a great deal more user-friendly than a Cloudbuster. A Cloudbuster, used carelessly, can cause tornadoes, imbalances in the earth's orgone fields, and torrential rains or severe droughts. It is nonetheless a very useful device, but one which requires knowledge both of meteorology and organomy in order to operate beneficially. The Chembuster, on the other hand, functions more like a 'safety release valve' between the earth and atmosphere, so that it becomes more active when there is a large unbalance in the ambient orgone fields and less active when the energy around it is in a balanced and healthy state.

I have some other articles coming which go into this matter further, but for now suffice it to say that you can cause problems with a Cloudbuster if you do not know what you are doing, but this is not true of a Chembuster, and that is because a Chembuster uses organite and quartz crystals to clean the orgone as it passes through, whereas a Cloudbuster does not. It is possible to further enhance the function of a Chembuster by grounding it to the earth. After experimenting with it for some time, I generally ground the organite base of my Chembuster instead of grounding the pipes, because if you ground the pipes, then the device will appear to work more rapidly, but what it is actually doing is dumping the excess DOR into the ground rather than cleaning it. In my opinion, grounding the copper pipes directly is no better than a Reich style cloudbuster, because it is just dumping the DOR into the ground. If you are doing this, then you ought to add some HHGs and TBs or equivalent right near the ground wire where it enters the ground. Also, a wet ground is better than a dry ground. It is better to ground the Chembuster to moving water or wet earth than to dry earth. If you are grounding it to dry earth, you should use a long wire to maximize contact with the earth. You can either attach a length of copper wire to the organite, or just cut the bottom out of your bucket and let the organite touch the earth.

Organite Density

Not all organite is the same. The size of the particles used makes a lot of difference to the finished product. Below is a short description of some of the different grades of organite with which I have worked. Organite can be used for different devices, and the intended function of the device determines what kind of organite is best to use. Different materials offer differing amounts of resistance to the orgone as it flows through it, and the different grades of organite have sequentially higher 'orgone resistance' values.

LD - Low Density Organite

Low Density organite offers very little resistance to the orgone as it flows through the device. This means that the device is not very suited to cleaning the orgone, it will not convert DOR to OR with much efficiency. But, since it attracts the orgone and allows it to flow through it very easily, low density organite is useful for sending and receiving orgone energy, and for collecting and moving orgone energy from one place to another. One place I often use LD organite is to make a channel or layer of LD organite within an orgone device, which acts like a wire to conduct the orgone along a chosen path inside the device. LD organite also works well as an orgone 'antenna' to send and receive orgone energy within a network of devices. LD organite does not work well on its own for making TBs and HHGs, but a thin layer of LD or VLD (Very Low Density) organite at the base of an HHG or TB assists the device in grounding to the earth more efficiently. LD organite will release some orgone when excited, but not very much.

MD - Medium Density organite

MD organite offers enough orgone resistance to foster the cleaning action for which organite is well known, and works as a material from which to make TBs and HHGs. MD organite has a dense enough matrix to convert DOR to OR, but does not work very efficiently in an orgone-on-demand generator. It offers low enough orgone resistance to function well in a passive mode, and high enough orgone resistance to still afford the 'scrubbing' action which is desirable. MD organite will release some orgone energy when excited by external energy sources, but like LD organite, still not very much. The orgone resistance is low enough in MD organite that much of the energy used to excite it either passes through it or is attenuated. It is more suited to use in devices which are meant to operate in a passive mode. TBs, HHGs and Chembusters are generally meant to operate in a passive mode. While MD organite may not be the absolute best thing from which to make TBs and HHGs, it will work nonetheless.

MHD - Medium High Density orgonite

MHD orgonite is imo the most efficient type of orgonite from which to make TBs, HHGs, Chembusters and other devices which operate in a passive mode. MHD orgonite offers just low enough orgone resistance to operate in a passive mode, but offers high enough orgone resistance to maximize the 'scrubbing' action while still in a passive mode. MHD orgonite will convert DOR to OR efficiently without being excited by external energy sources (other than a potential of DOR to convert into OR). Because of its higher density, MHD orgonite will also release orgone when excited, and it will do so with more efficiency than MD orgonite. MHD orgonite works well to construct devices which are intended to operate in both passive and active modes. The spaces between the larger particles are filled with smaller particles. This is also the grade of orgonite that I make my HHGs and TBs from now. See the 3 small pics below? MHD orgonite can be gotten by either using smaller particles, as in the two cases on the left and center, or by adding superfine particles to the resin and then using larger metal particles which would ordinarily produce MD orgonite. Either way will produce MHD orgonite. I use about 2 teaspoons of mineral 'flour' to a liter of resin.

HD - High Density orgonite

HD orgonite offers a much higher orgone resistance than MD or MHD orgonite. The scrubbing action provided by HD orgonite is plentiful, provided it is excited in some way. TBs and HHGs made from HD orgonite need to be placed in an area with extreme inimical energy problems if they are to do much. They also benefit from being electrically grounded, though I suppose it is not absolutely necessary. TBs and HHGs made from HD orgonite can be a bit smaller than ones made from MHD orgonite, and still do the same job, provided they are excited in some way, either by external energy sources or by a LARGE potential of DOR to convert into OR. One place in which TBs and HHGs made from HD orgonite work well is on or near household electrical appliances. To make a long story short, HD orgonite processes orgone more efficiently than MHD orgonite, but you need to 'push on it' in order for the orgone to go through it very fast at all. There are few if any large particles, and that there is not very much space between them. HD orgonite does not work very well for devices which are meant to operate in a passive mode, but it does work well for devices which are meant to operate in an active, or 'powered' mode. HD orgonite works well to make orgone-on-demand generators which convert other forms of energy such as heat, light, sound, EM or scalar waves into orgone. HD orgonite works well to make intent amplifiers. HD orgonite can also be used inside an orgone device made from lower density orgonite to control the pattern of energy flow by offering more resistance at select places inside the device, acting like an 'orgone pressure valve' so that orgone will not pass through it until it has reached a sufficient intensity. HD orgonite is the highest density at which orgonite will work both in the passive and active modes, but is more suited to the active or 'powered' mode.

XHD - Extra High Density orgonite

XHD orgonite does not work very well in a passive mode, and does not appear to be doing much of anything until it is excited by some form of external energy. When excited by heat, light, physical motion, sound, EM fields, electrical current, scalar waves, etc., XHD orgonite is VERY efficient at producing orgone energy. XHD orgonite has uses in the internal composition of orgone devices built from lower densities of orgonite, just like HD orgonite, but is especially suited to making orgone-on-demand generators which are designed to operate in an active or 'powered' mode. Note the particle size, all of the have gone through a 1 mm sieve, the largest are about 1.5 x 1 mm, and the majority of the particles are in the form of a fine powder like flour. When making HD or XHD orgonite, you can add the organic part of the orgonite in the form of small particles, and just use enough resin to hold the mass together. While XHD orgonite works very well for making devices which operate in an active mode, it does not work very well at all for devices which operate in a passive mode, except as a small part of the finished device.

Different materials for making orgonite

While many people now use polyester resin and metal particles from a machine shop, there are many different materials from which orgonite can be made. In my experience, not all of these combinations produce a very durable substance, but in some cases produce more orgone than the basic polyester resin and metal filing mixture

Cheap orgonite from waste paint

An extremely cost-effective and colorful variety of orgonite with which I have been experimenting. The orgonite is not especially durable, and needs to be kept indoors or recast in plastic resin to seal it from the elements. It is made from old latex paint (often free at recycling depots) and commercially available waste paint hardener (about \$3.00 CDN for enough to do 2/3 of a gallon). The waste paint hardener is in the form of a small packet of crystals which, when mixed into the paint, cause it to solidify. The metal has to be mixed into the paint prior to adding the hardener, since it turns stiff almost immediately. The mixture then takes several weeks to dry fully in a large casting like the 3.5" blue TB (with kyanite from revted ;) shown. This can be quickened by making the mixture and spreading it out into a thin sheet, allowing it to dry, and crumbling it into small pieces like the two shown on the right of the picture. The small pieces can then be combined in different colors and recast with just enough resin to hold them together. Doing it this way, you can reduce the cost of polyester resin by 50 to 70 percent, but it takes a lot longer.

Another orgonite recipe is made from polyester autobody filler, mixed with metal shavings and a little aluminum roof patch paint. You have to work quickly, and mix in the metal and paint before adding the catalyst to the autobody filler. While this kind of orgonite is not ideal for TBs and HHGs, it has the advantage of not leaking out of small holes in the molds, and therefore is useful for some hard-to-cast shapes, as it can be forced into the mold in small amounts with a spoon or spatula.

A few notes about using fine powders in orgonite

You don't need to have NASA grade powdered quartz or ultra fine metal particles. You can use them, but you can also make your own. I make most of my own. One source of copper powder that is easy to get is copper spray paint. Get the cheap kind that rubs off on your fingers after its dry. It is basically metal flakes, solvent, and a little oil. When the solvent evaporates, you are left with fine metal flakes and a little oil. Just spray it into the resin and mix thoroughly. Of course, you have to mix the fine powders into the resin before you pour. Also, if you are using any of the following powders (and probably a few I don't know about)...

copper

paramagnetic earth with high iron content

rust (iron oxide)

white polyester pigment (titanium oxide)

decomposed chalcopyrite (oxidized copper and iron and sulphur)

decomposed iron pyrite (oxidized iron and sulphur)

...then you have to add a bit more catalyst than you normally would, since the copper and paramagnetic earth (some kinds, anyway) slow down the curing (of POLYESTER resin) quite a lot.

There is no answer the question 'which is better, powder or shavings' because the two give different effects. That's kind of like asking whether apples or oranges are better. In short, for an orgone generator (which technically an HHG is NOT) powder is better. For an orgone FILTER/CLEANER (which is what an HHG is) powder can be used as an additive, and you will get a bit more out of it.

If you are trying to make HD orgonite at home, and have problems with the powder settling out, then you can do two things: 1... use less resin! 2... add the organic to the mix in a powdered form and then just use enough resin to stick it all together. To make the higher densities of orgonite, you have to actually mix the ingredients, you cannot just pour the resin over them. Mix all the dry stuff up in a vessel, and then add it to catalyzed resin. Use enough powder that you get a slurry, like oatmeal. Just use a little resin. However, for hhgs and tbs, unless you are gonna put them in a really bad spot or make sure to ground them by burying or tossing in water... you don't want it to be ALL powders. HD max, not XHD. Also, you can make the TBs a bit smaller if they are made from HD than the minimum size they would need to be if they were made from MD. A CB made with HD is a bit different because the pipes create a bit of flow, so there is something to push (or pull) the orgone through the orgonite. Depending on how you have it set up and configured, it may work really well, or not very well at all. Even so, it is possible to get the density too high and 'plug up' the device. I have had that happen before. If you can figure out a way to stimulate it enough, then it will work. One thing you can do is increase the diameter of the pipes a bit to compensate for the density of the ballast. The push or pull provided by the pipes of a CB can act as stimulation for the orgonite if it is of sufficient intensity.

There is one density rating that belongs to the orgonite. Then there is another density rating that belongs to the device as a whole. Ideally, the orgonite density of a TB should be as high as you can get it before it starts to 'plug up'. If you make it too dense, and expect it to work in a passive role, then you will get all discouraged perhaps and say 'it doesn't work'... but that will be because you are basically trying to use a pressure release valve set at 500 psi to relieve 20 psi of peak pressure, understand? Orgonite made with fine particles (high density) works just fine, as long as you use it right. ;)

Anyway, for a TB, the orgonite density should be as high as you can get it and still work, but the overall device density should be a bit lower, so that it will allow energy to flow through it relatively easily. A simple way to say this is the more orgone resistance the device has the better it cleans, but the less orgone resistance the device has, easier energy can flow through it. So you have to find the 'sweet spot' in that range. Imo, for things like TBs and HHGs (as opposed to radionics outputs, pulsers, powerwands, etc) that 'sweet spot' is what I call 'MHD' which stands for 'medium high density'. I also make HD (high density) towerbusters, and they work great... as long as they are deployed CORRECTLY which means being either:

A... right on top (metaphorically speaking) of the tower, or on top of your monitor, or TV, or something else which makes a lot of EM noise...

or B... well buried and spread out a bit in the pattern of gifting.

For HHGs and TBs, what most of us do is to use fine powders as an additive to larger metal particles. Doing this enables us to adjust the density of the orgonite to hit that 'sweet spot' and/or add other energy signatures to the output of the device. So, some people say 'powders are garbage, they don't work' because they try to make TBs with only powders, the density is too high, and (no surprise) it doesn't work. And others say 'well, Welz uses powders so they must be good'. Well... Welz doesn't make devices that have to function in a passive sense, or at least that's not what he's known for. He is not known for making HHGs and TBs. Welz makes devices that use EM (Electro-Magnetic) stimulation to translate EM into orgone, which he then integrates into a radionics machine's output stage. That's why he uses HD/XHD orgonite in his devices. And that's why in devices like my pulsers, ring generators, and so forth, I also use higher densities.

Ingredients for orgonite

Here are some of the ingredients I have worked with in orgonite, and a brief description of their properties according to my opinion and observations. All pronunciations of usefulness for a given purpose are my own views and based on my own perceptions. I am not giving you medical advice. I am not a medical doctor, but there's a good chance you may be ;) Experiment and form your own opinions. I will do my best to update this page from time to time. By no means are all possible ingredients listed here, nor are all the possible effects of the ingredients listed here. This list is my opinion, and is a work in progress. There are many different ingredients being used in orgonite. There are many different recipes of orgonite being used. Some perform better than others all around, and some perform better for a single purpose. In terms of energy work and metaphysics, whatever minerals are included in the orgonite will, to some degree, impart their energy qualities to the orgonite. The same holds true so far for the energy effects of hertzian frequencies, sounds, colors of light and energy impressions via reiki work or other traditional metaphysical discipline in application. The rate of success with this effect, the orgone signature programmed into the orgonite while it cures, seems to vary. In other words, say you have a little piece of turquoise that you like to use for body work. Or perhaps it is rose quartz. I dunno, it's up to you. Say this little piece of turquoise you have is 1 cc. 1 cubic centimeter. Say you cast it inside of 10 cc of orgonite. Well, now it's like you have between 1.5 and 7.5 cc of turquoise to work with. Suppose you are really finicky and you match the recipe of the orgonite to the turquoise, use minerals and metals that the turquoise likes in the orgonite, and maybe charge the orgonite with the energy signature of turquoise while it cures. Now, it's like you have 11 or 12 cc of turquoise to work with, all from that little 1 cc chunk of turquoise cast inside the orgonite. There are people in the world who know a lot more about the specific effects of various frequencies and minerals than I do, and in fact there is really a substantial body of information on the web dealing with the specific energy effects of minerals, colors, and frequencies. Point being, most or all of this knowledge is transferable to working with orgonite, and orgonite is complimentary to these already well established means of working with energy (sounds, colors, frequencies, minerals, etc.).

NOTE - Primary indicates that it can be the main ingredient of it's type, and secondary indicates that it can be used as an addition to the orgonite, but should not imo be used as the main ingredient of it's type.. For example, a TB would have to have at least 1 primary ingredient each (or equivalent not listed in the tables below) from the minerals, metals, and organics tables below. Coloration refers to the 'colors' of orgone that a given substance is harmonic to. I am using the same old 7 spectral colors system with which so many of us are familiar.

Minerals for orgonite:

Mineral	Coloration	Primary	Secondary	Effect
Quartz Crystal	All	✓	✓	Focuses and directs energy within the orgonite. Holds a program. The basic standby in TBs and HHGs, pulsers, succor punches, chembusters, radionics machines and other orgone devices. Is like the master crystal which will respond to some degree to virtually any orgone energy signature, regardless of color or frequency.
Quartz Powder	All		✓	Enhances overall function of the orgonite. Increases the output and responsiveness of the orgonite. Can be used to adjust the density of the orgonite.
Selenite Crystal	White, Blue, Cream		✓	Provides some coloration. Useful for healing. Useful for cleansing and invigorating.. Holds a program. Similar effects to kyanite but a bit more gentle.
Selenite Powder	White, Blue, Cream		✓	Enhances overall function of the orgonite. Increases the output and responsiveness of the orgonite. Provides some coloration and is useful for healing and cleansing. Can be used to adjust the density of the orgonite.
Kyanite Crystal	Violet, Blue, Silver, White	✓	✓	Focuses and directs energy within the orgonite. A workable substitute for quartz in TBs and HHGs, with the condition that it significantly colors the output into the blue and violet range. Produces a surprisingly sharp energy considering it is mostly in the blue range. Useful for cleansing. Similar to selenite bit more sharp and stronger cleansing influence. Holds a program sometimes, but program parameters are limited to those harmonic to the coloration of the mineral.
Kyanite Powder	Violet, Blue, Silver, White		✓	Enhances overall function of the orgonite. Increases the output and responsiveness of the orgonite. Can be used to adjust the density of the orgonite. Retains most of the properties of kyanite xtals.
Citrine Crystal	Gold, White, Yellow, Red	✓	✓	Focuses and directs energy within the orgonite. A workable substitute for quartz in TBs and HHGs, with the condition that it significantly colors the output into golds, yellow and some reds, depending on how darkly colored the specimen is. Holds a program sometimes, but program parameters are limited to those harmonic to the coloration of the mineral. Useful for cleansing and invigorating.

Minerals cont.

Citrine Powder	Gold, Yellow, Red		✓	Enhances overall function of the orgonite. Increases the output and responsiveness of the orgonite. Can be used to adjust the density of the orgonite. Provides some coloration to the orgonite. Gives a nice warm feel to the energy.
Amethyst Crystal	Violet, Blue, White, Gold	✓	✓	Focuses and directs energy within the orgonite. A workable substitute for quartz in TBs and HHGs, with the condition that it significantly colors the output into the violet and gold range. Useful for healing, and for divining, and for cleansing. Holds a program sometimes, but program parameters are limited to those harmonic to the coloration of the mineral. Useful for divining. Useful also for self-searching.
Amethyst Powder	Violet, Blue, Gold		✓	Enhances overall function of the orgonite. Increases the output and responsiveness of the orgonite. Can be used to adjust the density of the orgonite. Imparts some of the effects of amethyst xtals to the orgonite.
Rose Quartz Crystal	Pink, White, Red, Violet	✓	✓	Focuses and directs energy within the orgonite. A workable substitute for quartz in TBs and HHGs, with the condition that it significantly colors the output into the red range, but a light red, more like pink. Soothing and healing energy, surprisingly mellow considering it is mostly in the red range. Holds a program sometimes, but program parameters are limited to those harmonic to the coloration of the mineral. Invigorating.
Rose Quartz Powder	Pink, Red, Light Blue		✓	Enhances overall function of the orgonite. Increases the output and responsiveness of the orgonite. Can be used to adjust the density of the orgonite. Gives a people-friendly, smooth feel to the energy. Invigorating.
Smoky Quartz	Gold, Brown, Green, White	✓	✓	Focuses and directs energy within the orgonite. A workable substitute for quartz in TBs and HHGs, with the condition that it significantly colors the output into the reds and browns and golds. Strongly masculine energy. Useful for diving and protecting.
Turquoise	Blue		✓	Soothing and healing, useful for pain reduction and physical healing. Strong feminine energy, good for healing and regrowth on many levels. Some shielding action but imo more useful for stimulating recovery from injuries physical or energetic. Strong synergy with blood coral and hematite. Increases orgonite's connection to water.
Hematite	Black, White		✓	Strong connection to the earth imparts a 'stability' to the energy from the orgonite. Increases orgonite's capacity to drain away harmful energy by increasing device's mean energy flow capacity. Use as a grounding stone in place of / in addition to electrically grounding the orgonite to earth. Strong synergy with many minerals, especially imo turquoise and blood coral. Somewhat invigorating.
Lapis Lazuli	Gold, Blue, Red, Violet		✓	Very high energy output from this stone for a variety of possible uses. Too much to go into here. Potent and worth reading upon elsewhere. Invigorating. Manifesting.
Garnet	Red		✓	Provides coloration into the red range. Synergy with amethyst.
Fluorite	Blue, Green, Violet		✓	Provides coloration into the green range, and sometimes into the blue or violet range. Rounds the feel of the energy. Assist orgonite with absorbing program while curing. Useful for healing. Does not hold and execute program terribly well, but stores an impression rather well. Useful as a means of transferring energy signatures from one device to another or storing them for future use. Increases orgonite's connection to water.

Minerals cont.

Mica	Green, White		✓	Enhances overall function of the orgonite. Increases the output and responsiveness of the orgonite. Can be used to adjust the density of the orgonite. Sharpens the feel of the energy from the orgonite. Can be used as an organic. Provides coloration into the high green range. An energy "astringent".
Paramagnetic Earth Chunk	Varies, Generally includes Red and up the spectrum to a variable height.		✓	Strongly increases orgonite's mean output. Provides some grounding action similar to hematite, pyrite and chalcopryrite. Increases orgonite's responsiveness to electromagnetic stimulation. Sometimes invigorating, sometimes soothing. Depends on actual earth being used.
Azurite	Blue, White, Violet		✓	Provides strong coloration into the blue and violet ranges. Similar to kyanite in that it is a sharp blue, not a soft blue. Strong synergy with malachite.
Malachite	Green		✓	Provides coloration into the green range. Strong synergy with azurite. A relatively sharp kind of green energy, useful for cleansing and invigorating.
Agate	Yellow, Brown, Gold, White	✓	✓	Focuses and directs energy within the orgonite. substitute for Quartz in a pinch, but tends to flow more slowly than if quartz were used. Strong connection to earth and fire, useful for some protective/shielding influences.
Pearls	Gold, Silver, Cream		✓	Imparts a lovely smooth 'creamy' feel to the energy hahaha. Useful for cleansing and invigorating. Increases orgonite connection to water somewhat. Helps to bridge between fire and water.
Bloodstone	Red, Green		✓	Very masculine energy. Coloration into both green and red ranges. Useful for soul- search and overcoming obstacles. Tends to be invigorating, perhaps too much so for some.
Glass	All	✓	✓	Focuses and directs energy within the orgonite. A poor substitute for quartz xtal, but useful as a means of controlling energy flow within a device, especially if faceted. Tends to give the energy a bit of a rounding/mellowing effect, and gives some coloration of the orgone if it is colored glass.
Quartzite	White, All	✓	✓	Focuses and directs energy within the orgonite. A slightly Better substitute for quartz Than Cut Glass, But still not as good as quartz. Recommend using at least 3X the mass you would if you were using Quartz Xtal.
Quartzite Powder	White, All		✓	Enhances overall function of the orgonite. Increases the output and responsiveness of the orgonite. Can be used to adjust the density of the orgonite.
Blood Coral	Red		✓	Provides coloration into the red range. Strong synergy with turquoise and hematite. A gentle masculine to balance the strong feminine of turquoise. Increases orgonite connection to water somewhat.
Tourmaline Red	Red, Blue		✓	Provides coloration into the red range. Gentler than garnet.
Tourmaline Green	Green, Blue		✓	Provides coloration into the green range. Gentle and soothing energy.
Tiger Eye	Brown, Gold, Yellow, Red		✓	Increases orgonite's capacity to drain away harmful energy by increasing device's mean energy flow capacity. Use as a grounding stone in place of / in addition to electrically grounding the orgonite to earth. Useful for manifestation and repelling unwanted influences. Useful also for self-searching.
Pyrite Chunk	Dark Red, Gold, White, Black		✓	Increases orgonite's capacity to drain away harmful energy by increasing device's mean energy flow capacity. Use as a grounding stone in place of / in addition to electrically grounding the orgonite to earth.

Metals for orgonite:

Metal	Coloration	Primary	Secondary	Effect
Gold	Gold, White, All	✓	✓	High frequencies. Healing, and lifting of mind upwards. Head in the clouds. Useful for divining, soul-searching, overcoming obstacles, and of course purification. Increases orgonite's response to intent stimulation.
Copper	All, Blue, Red	✓	✓	Very wide response range of frequencies. Boosts flow of orgone through device by increasing dynamic action within orgonite matrix. Gives a smooth feel to the energy. Strong synergy with steel or iron.
Brass	Gold, Silver, White, Blue	✓	✓	High and subtle effects. Quite potent, but may be difficult for some to feel. Good for clearing. Not so good for grounding. Increases orgonite's response to intent stimulation. Boosts flow of orgone through device by increasing dynamic action within orgonite matrix.
Cobalt (in blue glass)	Blue, Silver, White		✓	Provides strong coloration into the blue range. Increases orgonite's connection to water. Boosts flow of orgone through device by increasing dynamic action within orgonite matrix.
Bronze	Red, Gold, Blue, Red	✓	✓	Similar to brass but a bit lower on the scale. Increases orgonite's response to intent stimulation. A bit more grounding influence than brass.
Aluminum	All, White, Blue	✓	✓	Similar to copper but a second to copper in terms of the feel of the energy. A wide range of frequency response and coloration. Strong synergy with steel or iron.
Titanium	White, Silver, Gold		✓	Very high frequencies, and relatively sharp energy. Good for dissolving blockages / clearing / energy astringent. Boosts flow of orgone through device by increasing dynamic action within orgonite matrix.
Steel	Blue, Red, Black	✓	✓	Provides stability to the energy signature of the orgonite. A relatively low response range. Provides some grounding influence. Increases orgonite's responsiveness to EM stimulation.
Iron	Red, Blue, Black	✓	✓	Provides stability to the energy signature of the orgonite. A very low response range. Provides more grounding influence than steel. grounding influence. Increases orgonite's responsiveness to EM stimulation.
Bismuth	Blue, Brown		✓	Strongly increases orgonite's response to magnetic stimulation. Some grounding influence. Boosts flow of orgone through device by increasing dynamic action within orgonite matrix. Increases orgonite's responsiveness to intent stimulation.
Lead	Black, Silver		✓	Very low response range. Provides some stability to energy signature of orgonite. Some synergy with copper and gold.
Zinc	Silver, Blue		✓	Increases synergy between magnetic and non magnetic metals. Strong synergy with copper. Strong catalyst in energy terms, good for manifestation. Boosts flow of orgone through device by increasing dynamic action within orgonite matrix.
Iron Pyrite	Dark Red, Gold, White, Black	✓	✓	Provides a grounding, stable note to the energy form the orgonite. Gentler and a bit rounder feel to the energy than steel or iron.
Chalcopyrite	Gold, Red, Blue, White	✓	✓	Provides some grounding and some uplifting action to the energy form the orgonite. Since it is a combination of iron and copper, it possesses the synergy between these two metals in its natural form. Gives a pleasant smooth and potent energy if used alone, mellows the output and increases the response range of the orgonite if used as an additive.

Metals cont.

Paramagnetic Earth Powder	Varies, Generally includes Red and up the spectrum to a variable height.		✓	Strongly increases both the orgonite's connection to the earth, and the orgonite's responsiveness to EM stimulation. Increases the orgonite's responsiveness to intent stimulation in some cases. May or may not carry it's own potent energy signature to impart to the orgonite. Varies greatly from place to place. Boosts flow of orgone through device by increasing dynamic action within orgonite matrix.
---------------------------	--	--	---	--

Organics for orgonite:

Organic	Primary	Secondary	Comments
Pitch	✓	✓	Wonderful smooth feeling energy. A bit nicer than polyester resin, but less durable. Better imo as a primary than a secondary. I make a fair amount of stuff out of pitch. Will melt in the sun so must be kept indoors or buried. Is ideal for water gifting. Does not dissolve in water. Absorbs a charge well during curing. Strong connection to earth and water.
Beeswax	✓	✓	A workable if not ideal organic primary. Energy output is less than pitch or polyester, and device must be contained somehow. Works better when cold.
Paraffin Wax		✓	Much less functional in orgonite as primary than natural wax. Dunno why.
Carnuba Wax		✓	A little mixed into the pitch gives it a bit 'brighter' feel.
Latex Paint with hardener added		✓	Gives a warm, comfortable, people-friendly feel to the energy when mixed with polyester based orgonite. Often provides coloration according to the color of the paint, but not always. Depends on the chemistry of the paint. With waste paint hardener added, it is a slightly better primary than wax, but not much. Excels as a secondary with polyester., Useful as a means of transferring energy signature form one botch of orgonite to another, for lightening the weight of the orgonite, or for adjusting the density of the orgonite. Absorbs a charge well during curing.
Flour		✓	Gives a warm, comfortable, people-friendly feel to the energy when mixed with polyester based orgonite. Can be used to adjust the density of the orgonite.
Acrylic Plastic	✓		A somewhat smoother feeling yet much more expensive alternative to polyester resin.
Polyester resin	✓		The basic standby against which I measure other organics. Provides some coloration according to the chemistry of the resin. Absorbs a charge well during curing.
Vegetative Matter		✓	Imparts to varying degrees the energy signature of the plants used to the orgonite. Useful for reproducing in orgonite the effects of various herbs. Recommend using well dried, evenly and finely shredded vegetative matter.
Hair		✓	Can be used to permanently link a body of orgonite to an individual. Caution advised. Useful for custom work or tailoring a device to a specific user.
Blood		✓	Can be used to permanently link a body of orgonite to an individual. Caution advised. Useful for custom work or tailoring a device to a specific user.
Dirt		✓	In small amounts can be used to adjust the density. Increases the orgonite's connection to earth.
Incense	✓	✓	Can be used to impart the energy signature of a given incense to the orgonite, if not always the smell.
Sugar	✓		Have not tried this myself yet, but some are reporting success with sugar (hard candy) as an alternative to polyester, similar to pitch.
Honey	✓	✓	Adds a soft, high frequency overtone to the orgonite.
Carbon		✓	Adds a strong grounding influence to the orgonite.

Recipes for orgonite:

Here are some different kinds of orgonite I have been playing with. All pronunciations of usefulness for a given purpose are my own views and based on my own perceptions. I am not giving you medical advice. I am not a medical doctor, but there's a good chance you may be ;) Experiment and form your own opinions. You are responsible for your own safety. *Note - "resin" in recipes refers to catalyzed resin, if applicable. In some recipes, extra catalyst is needed, and given as a percentage value above the regular mix ration. Eg. catalyst +10% means to use the normal amount of catalyst, plus an extra 10% on top of that. The normal resin / catalyst ration for your resin is generally marked on the side of the container you bought your resin in. Particle sizes are given as follows : fine = 0 - 1mm dia., small = 1 - 5 mm dia., large = 5 - 15 mm dia. Proportions of ingredients are approximate.*

<u>Basic LD</u>			
Ingredient	Amount in parts	Process	Comments
Copper - Fine	.05 - .1	Mix the catalyst into resin. Add all other ingredients, stirring continually and pour into mold.	 Useful for creating a path of lower resistance inside of a device, in order to control the flow of energy. On a more basic note, all HHGs and TBS benefit from a thin layer of something like this at their base. Also works nice as cosmetic second coat for orgonite pieces, and has a bit more output than if just resin were used for the second coat. Also some applications in linking modules for radionics devices.
Quartz Powder - Fine	.05 - .1		
Resin	1		
Catalyst	+50%		

<u>Basic MHD</u>			
Ingredient	Amount in parts	Process	Comments
Aluminum - Large	1.5	Mix dry steel and aluminum together. Place mixture into molds. Add xtals / other internal components as applicable. Mix catalyst and resin. Add Quartz Powder to catalyzed resin and stir thoroughly. Pour resin Over metal particles and allow to seep down. Repeat layers as necessary.	 A good all-purpose orgonite recipe. Other items can be added as desired.
Steel - Small	1		
Quartz Powder - Fine	.01 - .25		
Resin	To fill molds		

<u>Basic HD</u>			
Ingredient	Amount in parts	Process	Comments
Steel - Small	1	Mix all dry ingredients together thoroughly. Add catalyzed resin a bit at a time until there is enough resin to just cover the surface of the particles. The mixture should have the consistency of thick oatmeal, and have just enough resin that all the particles are covered. Allow it to sit for a few minute. If there is more than 1/8" (2mm) of resin covering the surface of the particles, add more steel until the mixture is an even thick slurry like oatmeal. Pour into molds. Stir constantly, including while pouring.	 A good basic recipe for use in either heavy-duty TBs and HHGs, or in actively stimulated orgone generators. Different primary and secondary ingredients can be used as desired.
Secondary metal - Fine (copper or pyrite or bronze suggested)	.1 - .25		
Resin	.75 - 1.15		
Catalyst (if using copper or paramagnetic earth)	+50%		
Secondary Mineral - Fine	.1 - .25		
Secondary Organic - Small	.1 - .25		

<u>Basic XHD</u>			
Ingredient	Amount in parts	Process	Comments
Primary Metal - Fine	1	The particles must be fine enough to suspend in the resin. One way to deal with it if this is not the case is to catalyze the resin, wait until it gels, and quickly mix in the other ingredients. Another is to use a thickening agent. In some cases, the thickening agent and the secondary organic can be the same.	 <p>A useful recipe for making orgone generators designed to be driven by outside power sources like zappers, magnetic pulsers, radionics machines and so forth. Also useful in making small orgonite devices to be carried in a pocket and handled a lot.</p>
Secondary Metal - Fine	1		
Resin	3 - 4		
Secondary Organic - Fine	1.3		
Quartz Powder - Fine	.4	Premix all dry ingredients thoroughly, and then add the dry ingredients to the catalyzed resin, stirring continually. Add the dry ingredients a bit at a time. You should get a creamy thick liquid that pours slowly into the molds and still is liquid enough to smooth itself off at the surface. If the particles are settling out, there is too much resin. Usually, resin to dry ingredients should be about 1 to 1, sometimes a little more or less depending on the absorbency of the secondary organic.	
Secondary Mineral - Fine	.3		
Catalyst if using copper	+ 30% - 50%		

<u>Basic EHD</u>			
Ingredient	Amount in parts	Process	Comments
Primary Metal - Small	1	Mix the catalyst into the resin. Add the fine ingredients to the resin. If it is not thick enough at this point to suspend the primary metal particles, add a bit more flour until it is.	 <p>It may take a bit of messing around to get this recipe working right, but it has (especially when made with wheat flour) a gentle, people-friendly feel to it. This orgonite is good for many things, since it basically behaves like MHD. EHD stands for expanded high density. Good for devices which are meant to be used indoors in living space, and / or handled by people a lot. Useful for both passive and active roles.</p>
Secondary Metal - Fine	.10		
Resin	.75 - 1		
Quartz Powder - Fine	.10	Mix all the small ingredients into the resin, a bit at a time. It should come out looking like a thick slurry, with bits of metal visible in it. The metal should not all pile up on the bottom. Internal components of devices (like crystals) need to be supported in some way during curing since this orgonite will most likely not hold them in place during curing like MHD will.	
Secondary Mineral - Small	.25 - .5		
Secondary Organic - Fine (wheat flour suggested)	.75 - 1		

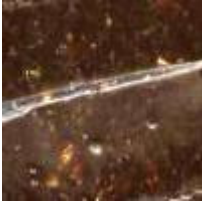
<u>Wood Sprite™</u>			
Ingredient	Amount in parts	Process	Comments
Pitch Resin	2.5 - 3	Melt the pitch slowly over a heat source with no open flame. The fumes from melting pitch may be flammable. Don't burn yourself, wear gloves. Once the pitch is melted, Premix all the dry ingredients except for the citrine. Add the dry ingredients to the pitch and stir well. Then add the citrine. Spoon carefully into molds and allow to cool. You generally have a few minutes only before the mixture sets up once removed from the heat. Charge with either sunlight or a charged water bath (or both) while cooling.	 <p>A lot of work, but well worth it. Strong connection to the earth, have gotten many obvious reactions from animals when gifting this kind of orgonite to natural energy centers. Also a nice kind to have indoors if protected from hot sun. Mixture will melt if exposed to high heat.</p>
Chalcopyrite or Pyrite - Small	.5		
Aluminum - Large	1.5		
Steel - Small	1		
Paramagnetic Earth - Small or Large	.5		
Dried Crumbled Sage or Chaparral - Small	.3 - .5		
Citrine - Fine	.01		

<u>White Light</u>			
Ingredient	Amount in parts	Process	Comments
Aluminum - Large	1	Mix the catalyst into the resin along with the pigment. The resin should come out bright white and opaque. Place the Large metal in the molds and sprinkle a little of the small metal over it. Place xtals if applicable and pour in enough resin to cover the metal. Charge during curing with 741 Hz.	 <p>Produces a kind of MHD which is useful for repelling unwanted entities / energies. Also useful for clearing blockages. Energy tends to feel uplifting (as opposed to grounding) and somewhat astringent.</p>
Titanium Oxide White Pigment	Enough to make resin opaque		
Steel or Iron - Small	.25		
Copper or Chalcopyrite - Small	.25		
Resin	To fill molds		
Catalyst	+50%		

<u>Chocolate Shine™</u>			
Ingredient	Amount in parts	Process	Comments
Steel - Small or Large	1	Mix all the fine ingredients together. Mix catalyst into resin and add fine ingredients. If the steel particles are large, then place them in the mold and pour the resin mixture over them stirring as you pour. If the steel particles are small, add them to the resin mixture and stir constantly as you pour the mixture into the molds. Charge with 15Hz and / or Schumann frequencies while curing.	 <p>Cosmetically appealing and highly EM responsive HD or MHD orgonite. Good for TBS and HHGS as well as generators. Has a warm feel to the energy. Especially suited for work on Geopathic lines, ley lines, Curry / Hartman lines etc. Provided the paramagnetic earth of is sufficient quality, this general recipe has been proven to reduce EMF by conventional testing.</p>
Brass or Copper - Fine	.3		
Paramagnetic earth - Fine	.3		
Citrine Powder - Fine	.05		
Quartz Powder - Fine	.1		
Resin	1.25 - 1.3		
Catalyst	+100%		

<u>Ivory</u>			
Ingredient	Amount in parts	Process	Comments
Copper - Fine	.05	Mix all the dry ingredients together. Add the pigment to the resin along with the catalyst. Sift the dry ingredients into the resin, mixing continually, until you have an event consistency. You should have a slurry with the consistency of oatmeal. Pour into molds and allow to set. This recipe will usually support the internal components at least somewhat, but is still thin enough to pour into complex shapes. Charge with both high and low freqs while curing.	 <p>Produces HD organite that tends to exude a milky white color of orgone. Useful for applications in reiki healing hands radionic therapy body work etc. Useful for removing blockages and stimulating energy circulation. Organite tends to have affinity for human body and sunlight. Useful for active roles.</p>
Titanium Oxide Pigment	Enough to make resin opaque		
Paramagnetic Earth - Fine	.05		
Copper or Chalcopyrite - Small	1		
Iron or Steel - Small	1		
Selenite - Small	.3		
Resin	2.5		
Catalyst	+100%		

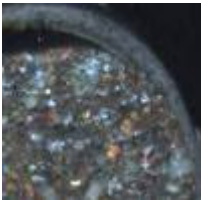
<u>Water Baby™</u>			
Ingredient	Amount in parts	Process	Comments
Blue latex paint with or without charged water added. Paint must be dried out and crumbled.	.3 - .6	The paint is a separate preparation that has to be done ahead of time. Mix 10 drops per liter blue food dye with paint. Then mix the kyanite powder into the paint. Then mix at least .01 part charged water to 1 part paint and dye mixture. Add hardener to paint and / or spread paint out on Wax paper to dry. The paint has to be dry enough you can crumble it into pieces. It does not have to be fully dry as you will be encasing it in resin. Once the paint has dried enough, crumble it into pieces about 5-15mm dia. (1/4" to 1/2"). Mix the blue paint crumbs and the metal (copper) together. Add catalyst to resin and resin. Place metal mixture in molds and pour resin over the metal. Use turquoise or blue glass as the secondary mineral. Charge with the sound of running water while curing, and if possible with moonlight or other silvery blue light. In general, charge in with cool energy as opposed to hot energy.	 <p>Produces MHD or HD with a strong affinity for water. Also can repeat the energy signature of charged water which was added to the paint. Waste paint hardener or other granular, absorbent material is useful to speed the drying out process. Generally the paint takes several weeks to fully dry, so I set a bunch on at time.</p> <p>This kind of organite is pretty to look at if it comes out right, and it is well suited to water gifting. It also has the quality of not containing any ferromagnetic materials, which is useful for some applications. It is a bit less responsive to EM stimulation than other kinds of organite, but it works very well for charging water when placed in proximity to a glass vessel of water.</p>
Chalcopyrite or copper - Small or Large	1		
Blue food dye.	10 drops per L of paint.		
Kyanite Powder	.01		
Turquoise - Large	At least 1 chunk per unit.		
Resin	To fill molds		

Orgonite and the curing process

In other articles, i have mentioned a few times that charging the orgonite while the resin is curing has a large effect. Here, i will go into that in a bit more detail. All information given here is based on my own experiments / perceptions, and/or things which other researchers / orgonite users / colleagues have confirmed. I am not a medical doctor, and you are responsible for your own discretion.

To start out with, not all organic components are not equally responsive to charging while the resin cures. Polyester resin, acrylic resin and pitch all demonstrate this property in significant degrees. The waxes seem a lot less responsive in this area, something which i attribute to the formation of crystalline structures within the resin while solidification takes place. Polyester resin, for example, is well know in conventional scientific circles to have significant electromagnetic attenuation properties. That means that it absorbs electromagnetic energy. Since energy is never created or destroyed and only changes form, the energy soaked up by the resin has to go somewhere, doesn't it?

After experimenting for a couple of years, i can comfortably say that the way orgonite is treated during construction creates **at least a 70% difference** in the finished product. In other words, by paying some attention to the thoughts, emotions, energies, ect to which the orgonite is exposed when you make it, you can generally get at least 70% more functionality than you would if you did not pay attention to these factors.

Now, i would like to point out that the beauty of orgonite is that you can get that 30% functionality, regardless of how you make it. It is not NECESSARY to charge the resin while it cures, it is an improvement. And in many cases, 30% functionality is more than enough to make a significant difference. But if the orgonite can be made yet more potent, why not do so? If you can optimize the orgonite to work with a specific ailment, or to do a chosen task, then it only seems prudent to do so.

There are, imo, 2 main ways in which the orgonite absorbs a charge / program while it is curing. One way is through the person making it, and the way that they influence the energy while handling the materials. Another way is to expose the orgonite to energies generated by various metaphysical tools while it cures. Obviously, both of these approaches encompass many different techniques. Both of these approaches can be used either alone, or in combination with each other. Myself, i generally use a combination of the two.

It is also possible for the orgonite to turn out with either a sympathetic or a counteractive effect. The frequencies used in the following description are just examples. So, if you expose orgonite to a hertzian frequency of say 15kHz, generated by a device of some kind, the orgonite will become more responsive to that 15kHz frequency. The fact that the orgonite is now more responsive to 15kHz can be applied in one of two primary ways, depending on what thoughts and intent you expose it to, or what other frequencies are present. If you expose the resin to 15kHz and leave it at that, the finished orgonite will tend to amplify the 15kHz frequency effects when stimulated by it. It will tend to produce that frequency effect as part of it's output, converting other energies it is stimulated with INTO the frequency effect of 15kHz. The same applies if you expose the resin to both a weak 10Hz signal and a strong 15kHz signal. It will tend to 'capture' the act of 10Hz being drowned out by 15kHz, and have that function programmed into it. Doing it that way, you are getting a sympathetic effect towards 15kHz.

But suppose you flip it around the other way. Suppose you expose the resin to a 15kHz signal, and at the same time give it a clear mental impression that you want to dampen out and get rid of 15kHz. If you do it that way, you will get a counteractive effect, in proportion to the clarity of the mental impression you give the resin. It will tend to respond well to 15kHz, but instead of amplifying 15kHz, it will dampen it out, and convert 15kHz into other energy 'colors' or frequencies. The same applies if you were to expose the orgonite to a strong 10Hz signal and a weak 15kHz signal. It would then capture the act of 15kHz being drowned out by 10Hz, and have that function as a 'program'.

In reality, the way that different frequencies interact with each other has arguably a bigger effect that the volume of each signal. There are frequencies that are harmonic to 15kHz, and they tend to boost it. There are frequencies that are discordant to 15kHz, and they tend to dampen it. So, both the relative strength of each signal and the effects of signals on each other produce an effect.

By default, orgonite seems to produce a sympathetic effect to that which excites it during curing. In other words, if you want to get a counteractive effect, you have to 'tell' it you want a counteractive effect. This, doubtless, is why some towerbusters have a greater effect than others. Many people are programming the orgonite with a counteractive effect to the tower's signals, whether or not they are consciously aware of it. Many other people are not, and so the orgonite is running at varying degrees of efficiency. Rather than criticizing, it is my hope that this will help people all around to improve their orgonite manufacture.

People who are already doing reiki, visualization, or other traditional metaphysical disciplines will find that whatever energy they put into the mixture will, to some degree at least, become a permanent part of the finished orgonite's energy signature. This applies, of course, whether or not a person is consciously using metaphysical discipline of some variety. Even if a person is not consciously directing energy into the orgonite while it cures, their thoughts and emotions, the state of their mind, the things they are thinking about while working with the materials... these all have some effect on the finished product. It appears to me (so far) that consciously directing your energy into the orgonite often produces a greater change in the finished product than not. The exception to this would be states of great emotional intensity. If you are in a state of emotional excitement, then a part of that emotional energy will be picked up and integrated into the orgonite.

So, if you are a person who uses prayers, affirmations, declarations, visualization, intent or the like, then you can program your orgonite with these techniques. One thing to bear in mind if using minerals other than quartz crystals is the kinds of jobs that various minerals are suited to doing. For example, if you are making orgonite and programming it to get rid of toxins in the body, then you could make that process either more efficient or less efficient, depending on what minerals you include. If you include minerals that have the effect of stimulating the body to release toxins, then the mineral and the program are harmonic. If you use a mineral that stimulates the body to absorb energy but program the orgonite with a purgative effect, then the result will generally be a bit less effective. In short, the orgone output spectrum of the finished orgonite is defined by a COMBINATION of the ingredients and the programming, so it pays to give a little thought to how you put those 2 factors together.

So what if you are making orgonite and you inadvertently put a bunch of nasty thoughts / emotions into it? Well, they WILL affect it somewhat, but not enough to reduce its effectiveness beyond the 30% line, in my experience. They will make it work less well, but not stop it from working entirely imo. One thing i have discovered is that say, for example, you think 'issue X is horrible'. well, you don't want the orgonite to enhance the horrible nature of issue X, obviously. But once you have thought that thought, it is difficult if not impossible to take it back. So give the orgonite a counteractive program with respect to issue X. Immediately think another thought, namely, that you wish to direct the healing / clearing properties of the orgonite toward issue X, and work on the problem. This produces orgonite that works specifically (counteractively) on issue X. Not a bad recovery from a little slip of the mind. Practitioners of radionics will likely be familiar with this concept, point being the concept is of course transferable to orgonite manufacture.

Another example. Some time ago i made some orgonite TBs which had a few flies fall into the resin while it was curing. I didn't think it that important, though maybe i felt a little sorry for the flies. The orgonite came out with a sympathetic effect towards houseflies. It was amazing to watch how they just couldn't leave it alone. They would be buzzing around the light bulb, and kept stopping and landing on the TBs, which i must admit i found rather annoying. But at the same time, others have reported success using TBs to get rid of problematic insect infestations, by including a sample of the insect in the orgonite. Whether they knew it or not, and i must assume they did, they included the intent that they wanted a counteractive effect. And they saw that the insect infestation was reduced. The difference between my TBs attracting the insects cast inside them, and their TBs repelling the insects cast inside them was simply the difference between a counteractive effect and a sympathetic effect. Again, those familiar with metaphysics will probably find this familiar territory.

Bearing that in mind, i am sure you will understand why programming the resin with the intent that you want to counteract the inimical health effects of the HAARP and GWEN towers is worthwhile. Also perhaps this sheds some light on why there exists such variance in the observable effects of TBs. Without the intent to get a counteractive effect (since if you live in area with towers the resin is exposed to the signal from the towers while it cures) you will get the cleansing effect in the 30% range. But if you add the simple thought that you want the orgonite to have a counteractive effect, you will get much more efficiency, up to several hundred percent improvement.

Rather than going into detail about how to do visualization or focus your intent, i will just say that your emotions are a big part of it. For example, if you are making orgonite to help your sore back, then you want to make sure that the orgonite is programmed by imagining a healthy back, free from pain. Or perhaps imagining a sore back turning into a comfortable, pain-free back. You do not want to program the orgonite with you wondering if it will work. That saps efficiency. So if you have doubts, well that just means you are human. We can not always instantly finish up with our doubts or uncertainty. But we can put them out of our minds for a few minutes. And in those few minutes when we have put our doubts out of our mind and have stopped thinking about them, that is the time to do your intent or programming or visualization. For posterity, the same thing applies with prayers, affirmations, declarations, etc., with or without orgonite.

Ideally, you want to charge the orgonite for the duration of time it takes to cure. This may or may not be possible. I have found so far that with the mental impressions, it is best to do it at least 3 times. Since polyester resin actually continues to cure for a long time after it has solidified, you generally have about a 3 day window of opportunity to charge the resin, though the initial period when it is solidifying appears to be the most critical. Once the plastic has cured, you cannot reprogram the resin, but you can reprogram the crystals embedded within it. You can also direct the energy that the orgonite is producing to a given task with your intent. Directing the output from the orgonite is different than charging the resin. Using your orgonite's energy output is giving the output a job to do. Charging the resin while it cures is defining what the output will be.

When using a machine to program the orgonite, depending on how strong the machine is, a ten to 15 minute period of exposure is often enough to produce an effect, but where possible i often give it up to 72 hours of exposure.

If you have a radionics machine, succor punch, pulser, wand, or some other kind of intent amplifier / orgone generator, you can use that to either charge the orgonite or enhance the mental impression (intent) that you give the orgonite. You can also set your favorite xtal (if you work with xtals) near it while it cures and use that to charge the resin. Varying methods of charging give varying degrees of success. Any kind of attention to the charging process will produce a more effect than none, i find.

One way you can charge the resin is to devise some means of connecting a quartz crystal wrapped with a mobius coil to the output of your pc sound card. I have a bit of info about one such device on the ring generator page (<http://www.littlemountainsmudge.com/ringgenerator.htm>). Even a smaller device such as a succor punch, connected to the output of a pc sound card, provides a very versatile apparatus for charging orgonite. If you are unable to set up something like that, then even using a tone generator and exposing the orgonite to the sound produced will charge the resin. I am amazed at orgonite's ability to accept a program and repeat it almost indefinitely.

Roberto Forcen, at his site Voicesync (<http://www.voicesync.org/>), has some very impressive sound analysis and sound generation software. One of his programs that i have worked with a fair amount is called mineral sounds. In his own words, it 'Generates resonant three octave compound tones from a list of more than 3000 minerals. Tones are generated using powder X-ray Diffraction parameters.' What i can say is that when i first started playing with it, i was very impressed. When i run the sounds from this program through my big mobius-driven orgone generators, the energy produced is very similar in 'feel' and in 'color' to the energy from the minerals themselves. Aside from using it to program orgonite with the effects of a mineral i would like to have, but don't have on hand (not quite the same as having the actual mineral in the orgonite but close if you let it run several hours), i use it to compliment the ingredients of the orgonite. For example, if the orgonite contains steel, copper and quartz, i will open multiple copies of this program and charge the orgonite with the sounds of iron, copper, quartz, and gold. This gives the orgonite a lot more power when it is finished.

Sunlight is another wonderful thing to expose the resin to while it cures, and so is moonlight. These two methods of charging the orgonite are already in widespread use. Especially with exposing the resin to sunlight, you will often notice a difference in the visible color of the resin when it has cured, indication that you are in fact doing something and this is not all hocus pocus... :)

Astrology also has a certain amount of influence on the orgonite, though not one with which i often work. Using a large orgone generator to charge it can drown out some of the astrological effects, it would appear. One batch i did during the harmonic concordance came out very nice, and it appears to have captured some of the intense catalytic energy of the harmonic concordance.

Another way you can do it is to pour the orgonite outdoors, preferably in contact with the earth, in a clean vortex or ley line. This way tends to both stimulate the vortex or ley line and program the orgonite with a permanent link to the area in which it was poured. Alternately, you can add some dirt or wood chips from the vortex to the orgonite and pour it elsewhere. I have used this technique to link together a few different medicine wheels in the area. Possibly, it could be used to create and/or divert energy lines in the earth's body, leading to or from the vortex.

While i was proofreading this article, i phoned my friend of several years Chris Gozdzik from [diviningmind.com](http://www.diviningmind.com/) (<http://www.diviningmind.com/>), and asked him if he thought i had left out anything glaringly obvious. He reminded me about linking, which is another way that you can do several things with orgonite, including charging it while it cures. Basically, if you link the orgonite to the energy from an existing large source of energy, either by a sample of the source or clear visualization, then the orgonite will not only pick up the energy from the existing source as a program, but will also have a permanent link to the energy source. Thanks, Chris :)

And 2 final notes- If you are building a ring generator, power radionics machine, or other large power-driven orgone generator, first decide what frequencies you plan to use to drive it with. At least pick out a few of the ones you plan to use a lot. Then, charge the orgonite for the generator with the frequencies it will be running at. This increases power in the finished generator. Example, the pulsers run at 5075Hz and 32kHz, so whatever other programming i give them during curing, i give them a good zap of these two frequencies also.

Many of us have noted that orgonite, once cast, sometimes takes a certain amount of time 'start working'. Charging during curing dramatically reduces the amount of time that it takes a device to 'start working'.

Well, that about takes up the time i have today, but here are a few of my favorite hertzian frequencies for charging orgonite, and some the effects i have observed with them.

741Hz (sine wave) - This is one of the solfeggio tones, and is quite potent imo. When i first started using it i immediately felt a buildup of energy and subsequent release in the solar plexus and heart chakras. It may be a bit intense for some people at first, but they should rapidly acclimatize. It appears to have the effect it is reported to by others, that of assisting with finding the solution to a problem. I use it a fair amount these days, and thanks to whomever it was that posted about it on the yahoo cloudbusters (<http://groups.yahoo.com/group/cloudbusters/>) forum some time ago.

528Hz (sine wave) - This is another one of the solfeggio tones, and it has proven useful for me in manifestation.

5075Hz (square wave) - A frequency i chose myself for use in the driver circuits of the pulsers. It tends to have a grounding, stabilizing effect. I use it as a multipurpose frequency to drive generators, and to help me calm down when i get cranky ;)

32kHz (square wave) - Another frequency i chose for use in the pulsers, tends to have the opposite effect than 5075Hz, but meshes well with 5075Hz. I use it for removing blockages in body work, for shielding from energy attacks, and for an aid in the mental 'reach upwards' involved in meditation and remote viewing. When set to a frequency higher than 20 kHz, NCH toner produces a lower harmonic of target frequency. Since square waves especially produce many harmonics ranging up and down the scale, imo you are still getting this frequency (or one close to it) as a harmonic when you use a pc sound card connected to a coil and xtal.

15Hz (square wave) - The frequency many people use to drive their succor punches (<http://www.educate-yourself.org/>). It tends to have a solid, relatively stable effect. Of the low frequencies, it is one commonly used today. It is potent, though imo benefits from the company of a higher frequency. Useful for shielding from energy attacks. Also, if you have a 15Hz driven SP, then charging your orgonite with 15Hz will increase the responsiveness of your orgonite to your SP.

32Hz/31.7Hz (square or sine wave) - A frequency i first heard of from (i believe) Bruce Stenulson (<http://www.stenulson.net/energy/doras.htm>). It has proven very useful as an aid in programming quartz crystals. Because of it's tendency to carry programming information / intent from the user to a quartz crystal, it is useful imo for intent amplification, and as a general purpose frequency for driving mobius-powered orgone generators.

68.635kHz (square or sine wave) - This one of the Hodowanec frequencies. Now, since the upper end of the sound card is well below this frequency, i am not actually getting this frequency when i put it into the NCH toner (<http://www.nch.com.au/tonegen/>) program that i use as a signal generator. When set to a frequency higher than 20 kHz, NCH toner produces a lower harmonic of target frequency. Since square waves especially produce many harmonics ranging up and down the scale, imo you are still getting this frequency (or one close to it) as a harmonic. When run through the nch toner, and a mobius/quartz driven orgone generator, it produces an emission of orgone that is almost all in the violet range. Violet orgone is both soothing and cleansing, good for soul-searching as well as healing.

EHD Orgonite – Another step

As mentioned earlier, one can produce MHD or MD orgonite either by allowing the particle size to determine density (as in using larger, curly metal shavings, such as one would find in the average TB) or by adding the organic to the mixture in a particulate form. In fact, when making HD or higher densities, you basically have to add the organic in a particle form, along with the metal, since there is not enough space between the metal particles (when they are really small) to produce a ratio close to 50/50 between the metal and organic ingredients. Some time ago I began going a step further and using metal (fine and superfine particles) that would ordinarily produce HD and adding enough organic to bring the density of the orgone matrix material down to MHD or MD. The material produced this way has some very interesting differences from the standard TB / HHG mixture of curly shavings and polyester resin.

It appears that the matrix thus derived has a lot more capacity to store orgone than regular MHD. A given mass of EHD (Expanded High Density) orgone matrix material will have a slower rate at which the orgone flows through it than the same mass of regular MHD, and it will have a higher overall orgone field strength than the same mass of regular MHD, even though the density and the resistance afforded to the orgone as it flows through is about the same. I attribute the slower flow rate of EHD not to a difference in resistance from MHD, but to the fact that adding the organic element in both liquid and particle form increases the overall energy storage capacity of the matrix somehow. This effect is observed much more when superfine metal particles are used along with fine metal and organic particles, as opposed to using fine metal and organic particles alone.

After experimenting with several different organic particles, I have settled on flour as preferred material for the time being. One could use wheat flour, wood flour or other finely powdered absorbent organic substance. The particles should be absorbent enough that they combine with the polyester resin to produce a thick liquid the consistency of stiff pancake batter. The organic powder is mixed into the resin along with catalyst initially. The metal is added last, beginning with the superfine particles and finishing with the fine particles. For a readily available source of superfine metal particles, I suggest cheap metal spray paint. Just add extra catalyst and spray the paint directly on the surface of your resin in the mixing container. Another source of superfine metal particles are the bronzing powders and other metal powders sold by crafts stores for plating.

I have noticed that especially when the organic material is a fibrous material, the orgone matrix material both takes much longer to absorb a charge during curing, and absorbs much more of a charge than regular MHD. It absorbs a program, intent or energy signature with much higher fidelity than regular MHD. It also takes longer to accumulate enough energy to begin working. Regular MHD that I make is usually finished the curing process and has 'come online' by about 3 days after casting. EHD seems to take until about 5 to 7 days after casting to be finished the curing process and 'powered up'.

EHD is also efficient for use in power driven orgone generating devices such as powerwands and ring generators and pulsers. It also affords the cleaning action of converting unhealthy orgone to healthy orgone, but the charging and curing process is much more determinative of the end result, in terms of cleaning capacity, than with MHD. In General, since it takes so long to store a charge and stores such a high potential of orgone, the energy it is subjected to while curing are much more an influence on the finished product than with regular MHD. I would not recommend making EHD orgonite without working in a clean energy environment. Provided you can supply a clean environment or preferably a clean and charged environment in bioenergy terms, EHD will produce TBS that have a higher output than regular TBs and are more 'ergonomic', they feel a bit more alive in the hand. If you make TBs from EHD but do not have a clean energy environment to cast them in, then you will get TBs that are not very efficient at doing anything until you pick them up and play with them, at which point you will still likely be able to feel a strong surge of energy when you hold them in your hand.

For personal orgone devices meant to be held in the hands or carried in a pocket, I now prefer EHD to the other recipes I formerly used.

EHD lends itself not so well to making conventional towerbusters which are designed to be high flow filter cleaners. It lends itself very well to making power driven generators or to making TBs and HHGs for indoor use and human contact. It is like taking a snapshot of an energy field (the field in which it cures), and then it will sit there and broadcast an image of that energy field, continuously and with respectable intensity. It will convert other forms of energy into the energy signature (that snapshot) that it has as its output. So, if you can handle the programming and charging end of it, it will turn out much more potent per cubic inch than regular MHD. Instead of producing devices which are simple filter/cleaner devices, making TBs with EHD produce SELECTIVE filter devices, in that they selectively convert orgone into the orgone signature they have as their output. That's why the charging / curing process is so much more critical with EHD.

Though it produces an orgone energy field of higher intensity than MHD, EHD has an output that is much less chaotic than MHD, and the chaotic energy fields are much more contained within the physical matrix than with regular MHD. With regular MHD, the wave fronts of orgone energy collide within the device as they are reflected by curved surfaces which are relatively close together. The waves of orgone energy inside EHD orgone matrix material react less directly with each other, especially the waves reflected by the more widely spaced fine particles. It's like instead of the waves smacking into each other up close, the matrix has to build enough pressure until the energy ARCS across between the more widely spaced fine particles. All the while, the superfine particles afford the waves the opportunity for up-close collisions but to a lesser degree, providing a stable basis for the matrix, if that makes any sense to you. For this reason, EHD made without superfine and fine particles will not work very well at all.

The mixture should be thick enough that the fine metal particles (say between .5 and 2 mm dia.) are fully suspended in the resin and do not settle out at all. The mixture should be just thin enough that it smoothes itself off at the surface when vibrated, but it should be thick enough that you have to vibrate it to get it to smooth over on the surface. You should be able to count 20 to 50 of the suspended fine metal particles in a square inch of surface area. There should be enough of the superfine metal particles that when wet, the mixture appears to be slight shiny and metallic. When the mixture cures, the surface will become dusty and opaque but a bit of sanding and a clear coat takes care of that. The mixture also takes longer to chemically cure than regular MHD, especially if copper or iron is the superfine metal. Extra time should be allowed for curing. EHD to be exposed to the elements should be protected with a clear coat of spray lacquer or poly resin.

So, in short, as long as it is programmed by a competent energy worker, it works really good for TBs and HHGs designed for human contact as opposed to agricultural and other nature gifting or tower busting. It also works pretty well for generators which will be excited in some active way while in use. And, it absorbs a charge of higher potential and with higher fidelity during the curing process.

Simple HHG instructions	Quantity per HHG:
Item:	
- Double terminate Quartz Crystal	- 5 (or 1 DT and 4 STs)
- Polyester Resin & enough Catalyst to cure it	- About 6 Ounces
- Metal particles	- About 5 Ounces of metal particles
- Suitable container to use for a mold	- 1 (min. 4" dia. plastic funnel)
- Small Jar or Can to sit the funnel in (hold it upright)	- 1

Note: While there are many other suitable vessels which could serve as mold for this device, I have used a plastic funnel for this example as it is readily available in most places and relatively durable. In any case, the same technique of construction applies regardless of the container used for a mold, which can be in the shape of a pyramid, cone, cylinder or hemisphere, so long as it has a volume at least great that of a cone 4" wide x 4" tall. Presently, pyramids and cones are the shape this device is most often built in.

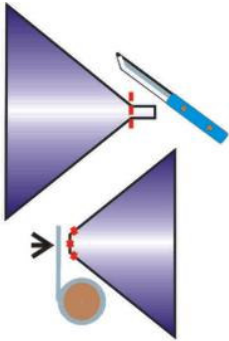

1. - Cut the tip off of the funnel and tape over the hole at the small end of the funnel with aluminum tape (preferable) or parcel tape. Electrical tape, duct tape & masking tape do not work as well for this as aluminum tape. In some way, plug the hole so that the resin does not leak out.

2. - Sit the funnel in the jar so that it is upright and more or less level.

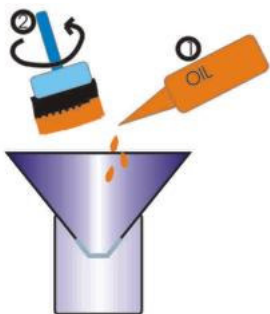
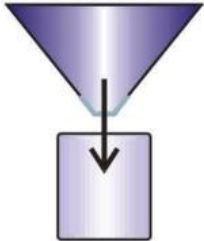

3. - Coat the inside of the funnel with a thin layer of vegetable oil, to keep the resin from sticking to the mold (funnel). Wipe away the excess oil with a brush or clean cloth.

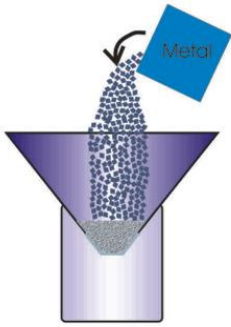

4. - Put about 1" of metal particles in the bottom of the mold.

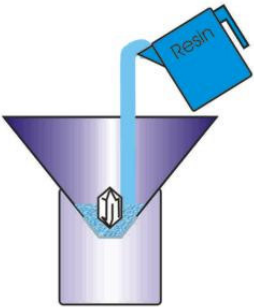

5. - Place one of the Quartz crystals in the tip of the mold, so that it is upright as shown. This one really should be a double terminate, but if you only have a single terminate, put it with the point towards the tip of the funnel. If it is a double terminate, the best tip of the crystal should be pointing towards the tip of the funnel, where you covered the hole with tape.

Mix enough resin and catalyst (be sure to mix well, min. 1 minute of mixing) to come up level with the surface of the metal filings. Pour the resin in and let it run down into the metal filings. Gently shake or tap the mold to release bubbles.

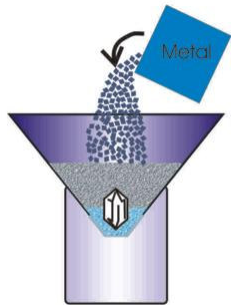

6. - Put in some more metal particles, enough to fill the mold about 1/2 to 2/3 full.

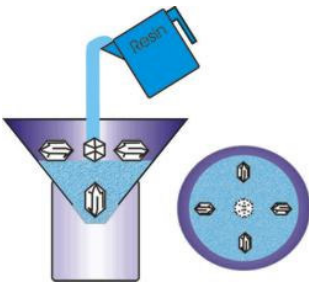

7. - Place the other 4 Quartz crystals on top of the metal filings as shown. They should be arranged like the spokes of a wheel. The better points of the crystals should be pointing towards the outside of the mold. If you have to, you can use single terminate crystals here, and put them with the points either facing in or out (facing out is preferable). Mix some more resin and catalyst, and pour in enough to come up level with the surface of the metal filings again. Gently tap or shake the mold to release bubbles, and let the resin run down into the metal filings.

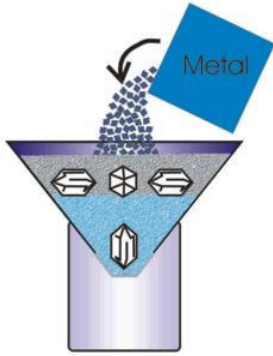

8. - Add some more metal filings, enough to almost (but not quite) fill the mold. Leave about 1/4 inch of empty space at the top of the mold as shown.

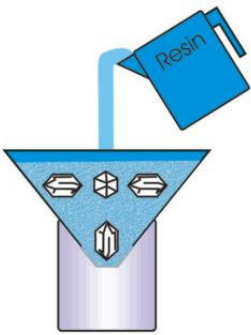

9. - Now, pour in enough resin to finish filling the mold. Let the resin run down into the metal filings, adding a little at a time. Use enough resin to completely cover the metal filings, so that there is a thin layer at the top of the mold which is only resin, no metal. The layer of resin only should be about 1/4" thick. Take a moment to adjust the molds so that they are more or less level at this point.



Time for curing

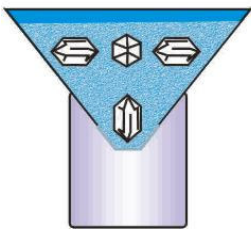

10. - Allow the resin to cure. Keep it warm if possible, cure in a well-ventilated area, and if possible, expose the resin to sunlight while it is curing. If you have a tone generator or other sonotherapy (healing using sound) device, then you can expose the resin to that as well while it cures.

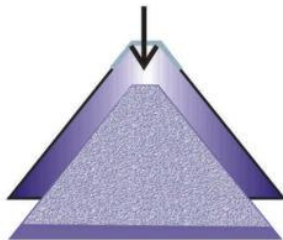

11. - Remove the molds from the jars, turn them upside down, and give them a smack to release the brand new HHG you just made. If the mold sticks, you can either use a thin

bladed knife to push in between the mold and the resin, or you can try spraying penetrating oil around the edges where the mold meets the resin. Dropping it on the floor sometimes works, but sometimes it breaks the resin. There are many ways to modify an HHG for enhanced effects, but the basic model shown above will work just fine the way it is. This is one modification which is easy to perform when you are casting the HHGs. Use an Amethyst point instead of a DT Quartz crystal for the vertical crystal... add a copper SBB coil to the base of the unit, just at the edge of the

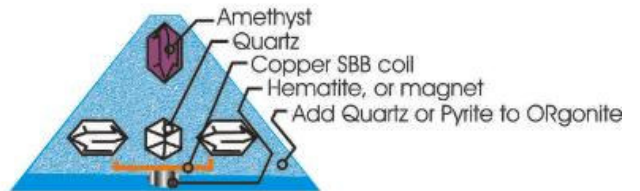

metal filings as shown... add a small piece of hematite, pyrite, or a small permanent magnet to the SBB coil as shown (generally I put the N pole of the magnet facing toward the tip of the HHG)... and mix some crushed quartz, crushed Amethyst, or crushed Pyrite in with the metal particles before you cast it.

Simple TB Instructions	Quantity per Tower Buster:
Item:	
- Quartz Crystal	- 1
- Polyester Resin & enough Catalyst to cure it	- About 3 Ounces
- Metal particles	- About 3 Ounces of metal particles
- Suitable container to use for a mold	- 1 (min. volume about 4 ounces)

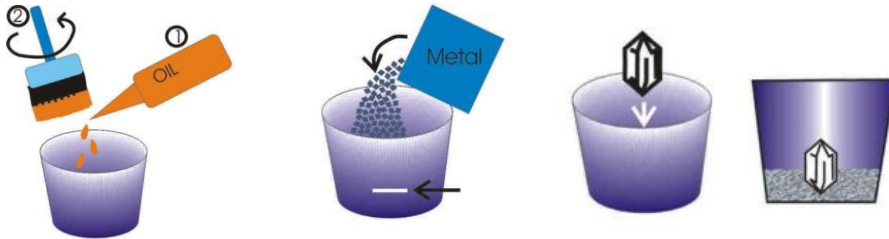

- 1 - Line the containers you will use for molds with a light coat of vegetable oil. This prevents the resin from sticking. Wipe the excess oil off with a brush or clean cloth. cover the surface of the mold evenly.

- 2 - Put about 1" of metal particles in the bottom of each mold.

- 3 - Place the quartz crystal in each mold, using the metal filings to hold it in position. put the crystal in the center of the mold, and if the crystal has a good point on it, most folks put the point towards what will be the top of the unit.

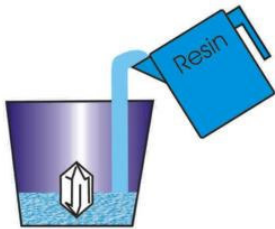

- 4 - Mix enough resin and catalyst to fill each mold level with the metal filings you have placed in the bottom. Pour enough resin into each mold to come up level with the top of the metal filings. Make sure to mix the resin and catalyst well (mix for about 1 full minute) before you pour it into the molds. Allow the resin to run down into the metal filings. Tap the mold lightly or stir carefully to remove bubbles.

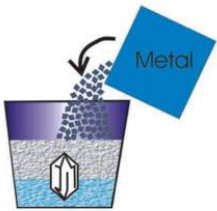

- 5 - Add another inch or so of metal filings to each container, enough to cover the crystal.



- 6 - Mix and add enough resin to cover the metal filings you have placed in the molds. It will not harm the function of the device if some metal filings stick out the bottom, but it is a good idea to use enough resin to fully encase the metal filings. Allow the resin to run down into the metal filings. Tap the mold lightly or stir carefully to remove bubbles.

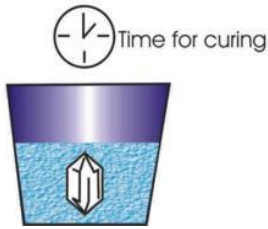

7. - Allow the resin to cure. Keep it warm if possible, cure in a well-ventilated area, and if possible, expose the resin to sunlight while it is curing. If you have a tone generator or other sonotherapy (healing using sound) device, then you can expose the resin to that as well while it cures.

8. - Turn the molds upside down, and give them a smack to release the brand new TB you just made. If the mold sticks, you can either use a thin bladed knife to push in between the mold and the resin, or you can just tear the paper away. Dropping it on the floor sometimes works, but sometimes it breaks the resin. It will not harm the function of the device to leave the paper mold on, but it may be more aesthetically appealing to remove it.

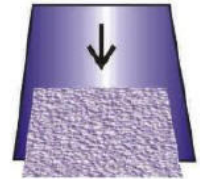

Mobius coils and quartz crystals

Many people have also lately begun using devices in conjunction with orgonite or not, which employ a mobius coil and quartz crystal. The coil can either have it's leads simply shorted together, or, more efficiently, be connected to a signal generator circuit or radionics machine. Doing this is like turbo charging your crystal.

One name this kind of device has become commonly known by as a succor punch, this is the name don Croft gave to it when he made it public domain. Since then, many variants of this device have been adapted for use in general metaphysics as an intent amplifier or powered wand. There are several different ways to make a mobius coil, the basic concept is that you want to have magnetic fields canceling each other out by intersecting at 90 degrees. This is accomplished by winding the coil in such a way that the wires cross each other at or close to 90 degrees. Then, when a current is put through the coil, either by induction of by direct stimulation with a signal generator (a common circuit used for these coils is the Beck or Clark or Croft style 'Zapper' devices invented for bioelectrification) the magnetic fields created by the wires cross at 90 degrees and cancel each other out. When the magnetic fields cancel each other out, they are converted into scalar energy. High voltages are not required in order to produce orgone emissions from the crystal, and could be dangerous. Low voltages are commonly used for this type of device.

The scalar energy then excites the crystal and the crystal produces much more orgone energy output that it would without the coil. The frequency used to stimulate such a device is often determinative of the exact effects, but any signal put through it will produce orgone energy output from the crystal as well as RF emissions. This basic device is at the core of a new generation of rife-style devices, since a pulsed orgone/scalar wave is more efficient at stimulating the human body than either radio waves or ultrasonics. Audio signal will also be translated into orgone/scalar waves when put through this type of coil, and people who use sound therapy will find that inserting this device into their apparatus markedly increases the effects. On the following pages, I have included the instructions for making the style of mobius coil that I use most.

With regard to using an audio signal instead of a simple hertzian frequency to drive this kind of coil, it appears that the underlying emotional current of the audio signal is translated into a pulser orgone / scalar emission. This is quite useful for things like sound therapy and manifestation. However, one should exercise care in the choice of audio signal used, I would stay with the classical music for example instead of heavy metal hahaha. In contrast to a TB or HHG, devices like this can do great good or great harm, depending especially on what kind of intent one is projecting into the device (which intent will be picked up and amplified by the crystal) and what frequencies are used to drive the device. Some frequencies that I know are safe to use are (in Hz) 15, 32, 741, 5075, 5100, 15000, 32000, and 68635. This device is at the core of the large orgone generators I use to charge and program orgonite while the resin is curing. There is a lot of information available on the web about the biological effects of different hertzian frequencies, especially with the Royal Raymond Rife crowd. A device like this will afford a low cost, low – tech, but highly functional output for a Rife style treatment system, without requiring the use of high voltage, plasma tubes, or expensive function generators, since it can be driven by the audio output of a home pc, substituting software for the function generator generally used to drive Rife machines.

As for the waveforms being used to drive the coils, bear in mind that using a frequency to drive a mobius coil has slightly different requirements than just using the properties of a sound. There is a reason that most Zapper circuits used to drive these coil employ a square wave.

When using a frequency for driving scalar producing coils, most of us have generally gotten our minds around the concept that we want to have magnetic fields canceling each other out, so they can be converted into scalar potentials and scalar waves. Well, another concept which applies is magnetic flux. The more rapid the magnetic flux, the more scalar energy you are going to coax out of your mobius coil. Magnetic flux is what you call it when you have a magnetic field that is changing.

Now in a waveform, when you look at that little wavy line, think of it as a line traced by something bobbing up and down, perhaps a pencil if you prefer. And the magnetic field is changing as the pencil goes up and down, understand? As the wave passes by you, the pencil traces it's path and bobs up and down in time with the highs and lows of the waves. How high the pencil goes up and how low the pencil goes down is called amplitude. How long the waves are is called frequency, as in 'how frequently does a wave pass by you' in a given time. The base unit of time used to measure this is the second, and a Hertz (Hz) means "waves per second".

so... a sine wave, which has a smooth and equal curve... work great for some applications where you are just using the sound. It also works to generate scalar waves in a mobius coil, but not as efficiently as a square or sawtooth wave. One difference is that a square wave produces more harmonics in the circuit than a sine wave does. In some cases a sine wave is therefore less efficient in terms of input power to output power, but it is more pure and produces a more 'pure tone' which is advantageous in some cases. The magnetic flux is not very abrupt with a sine wave.

For driving mobius coils, a square wave works best of the ones I have experimented with. See, in a square wave, the pencil does not go smoothly up and down (like it does in the sine wave)... it sits still for a little while, and then it jerks up, and then it sits still again for a while and then it jerks down.

And therefore the magnetic field changes very suddenly, that is to say the magnetic flux is much more abrupt in a square wave than in a sine wave. A sawtooth wave, or a triangle wave... is kind of in the middle. (between square waves and sine waves). A sawtooth wave is far better to use in a mobius coil than a sine wave, from my testing so far. The sine wave produces energy that is much more mellow. You have to crank the power up quite a bit to get similar effects to a square wave.

Triangle waves also will work, but a sawtooth wave seems to work a bit better than a triangle wave. Also, if possible, the leading edge of the sawtooth should not be too spiked. I suppose that phi in relation to the amplitude of the wave would be a good height for the spike at the leading edge of the sawtooth wave, but I cannot say for sure at this time. I do know that imo judging from the amount of energy they produce when put through the same device, square waves are best, followed by sawtooth, followed by triangles, followed by sine waves

Tachyon braking, as it applies to scalar wave generation, is basically a fancy way to say that when you are generating scalar waves in a coil, there is also something else happening. See, there is in the aether an infinite potential of scalar energy which already exists (as opposed to the scalar energy you are 'generating' by converting em fields into scalar energy). When you take magnetic energy and convert it to scalar energy, you also tap into that aether potential and draw on it a little, adding the scalar energy from the aether to the scalar energy you have just produced with your coil.

This in fact is the basic working principle of the majority of the 'free energy' devices out there. That is how you appear to, and in fact do... get more energy out than you put in, because you are tapping on the aether and drawing on it. The 'tachyons' (little bits of energy, or particles in a high energy state, depending on the way you want to look at them) are subject to a process called tachyon braking. They 'brake' (slow down) and change state into something else. From a metaphysics perspective, the energy reduces it's vibratory rate and therefore manifests as another, lower form of energy, which appears to pop out of nowhere. Rampa, Cayce, and a jillion others refer to this in metaphysics teaching, the slowing down of energy to produce effects..

So then if you are trying to get electricity out of it, you want the tachyons to pop out of nowhere as electrical potential. But, if you are only taking the process as far as generating scalar waves to excite quartz or orgonite, then the tachyon braking just makes your mobius coil appear to be more powerful than it actually is hahaha because the scalar energy produced by tachyon braking adds to the scalar energy produced by em fields canceling each other out in the coil.

The more abrupt the magnetic flux is, the more scalar energy you draw from the aether and add to the scalar energy you are generating with your coil.

How to make a mobius coil

First - Make yourself a "mobius Cable" to wind the coil from. While you can wind a mobius coil from single strands of wire, it certainly seems to be a lot more potent when you use a cable made in the manner described here to wind the coil from. Take a length of wire, and double it back on itself twice as shown to the right. Pull a little slack out at the ends of the wire, this will be the leads of the coil when it is finished. You should leave yourself at least 2" for leads, and it is a good idea to give yourself 6" or so, you can always trim the leads to the required length when the coil is finished. It is much easier to use a drill to twist the wires than doing it by hand. Run the drill in reverse and you will get a clockwise twist to the cable. I recommend that you wind the coil itself clockwise also.

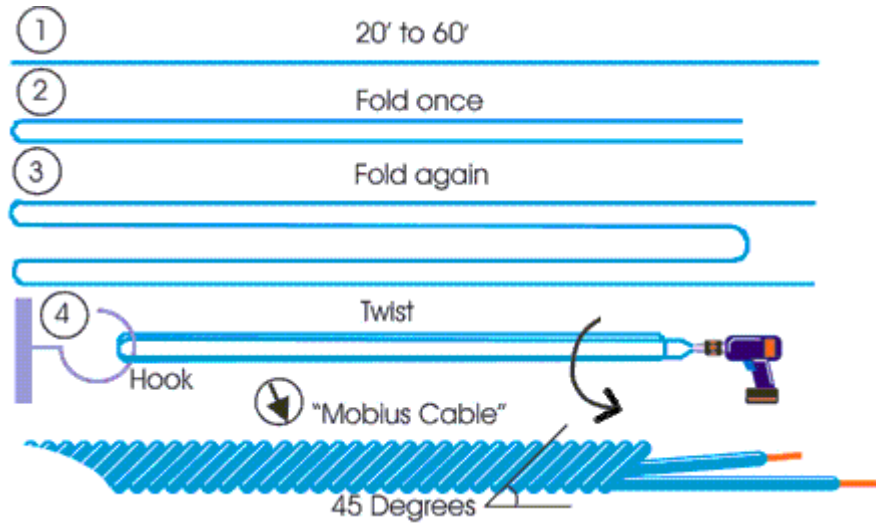

1. - Starting with the end of the cable which does not have the leads, make a circle in the clockwise direction about the size you want your finished coil to be. You can wind the coil around a core (xtal for your SP) or you can wind the coil by itself if you are using stiffer wire.

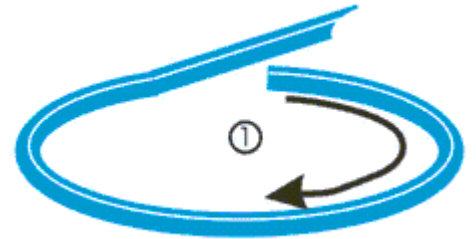

2. - When you complete the first wrap, feed the wire through the center of the circle so it wraps around itself in the clockwise direction as shown. Use a little glue (hot melt or silicone preferable) to hold the wire in place where it crosses over itself.

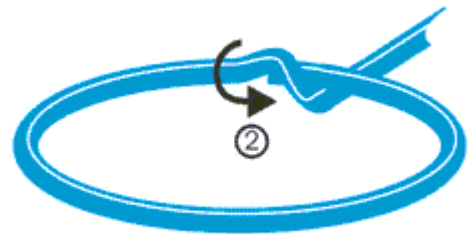

3. - Start winding the wire around the circle in the clockwise direction again.

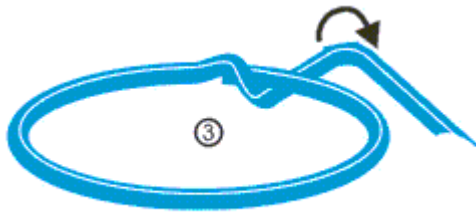

4. - Go around the circle about one third of the way, and wrap the cable around itself again, just like in step 3.

Go around the circle another third of the way, and do the same thing again. You should have 3 wraps around the cable for each time you go around the circle.



5. - Continue this way, repeating step 4, until you have used up all of the cable. As shown to the right, stay on the same side of the previous wrap with each new revolution.

The 'knots' will run together.

When you are finished, use a little glue to hold the end of the cable in place.

The coil should look like this when you are finished.

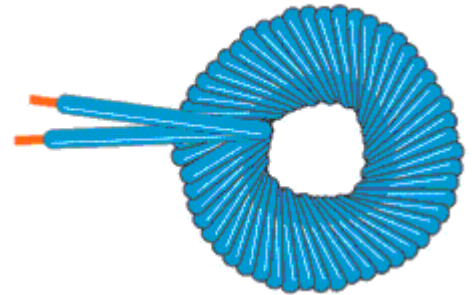
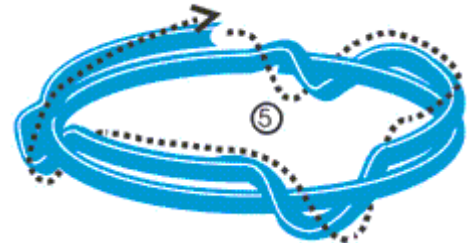

Hopefully, the pictures will be of more use to you than the words, as it is really quite simple to do, just a little cumbersome to try and explain in words. Basically, you just keep wrapping the cable around itself (clockwise) as you go around the circle. With a little practice, you will find that the windings form a pattern, and if you make a mistake it will be obvious as it does not fit the pattern. This coil tends to hold its shape better than the single knot style, and I generally just wind it by itself, not on a core. You should measure the diameter of the object you wish to place in the coil as a core when it is finished, and start with a circle a little larger than the diameter of the intended core.

I recommend using a Quartz, 'Moquis Marble', or Kyanite core for mobius coils, as the energy generated by a mobius coil (scalar waves) can be biologically disruptive when in its raw state. This information is primarily intended for those who wish to use mobius coils as a means of exciting Quartz crystals or ORgonite, and you are responsible for your own safety. By making this coil you agree not to hold me responsible for any damages your experiments may cause to persons or property. Mobius coils generate scalar waves. Scalar waves can interfere with and/or damage electronics when high voltage is put through them. For the purposes of ORgone research, low voltages are sufficient to drive mobius coils.

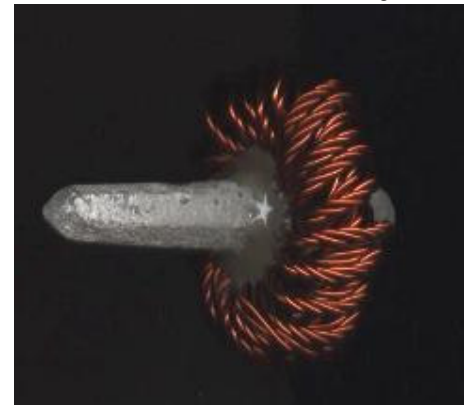

High performance – simple construction orgone generator – the Ring Generator

The design illustrated here is crude in execution and simple in construction. That's the point. My later versions of this device are more evolved than the one illustrated here, but I want to emphasize clearly that a device like this will work really well if you put it together right. This was my main generator for some time. I have posted the design here so that anyone who wants can have heavy-duty orgone generation capability without having to pay for a professionally built unit. It has been my experiences that the do it yourselfers will buy what they want to buy and build what they want to build anyways. A professionally built unit has many refinements over this crude design, but if you wanna do it yourself, here is a way to get a kick-ass if unrefined machine from stuff you probably already have... for about 50 bucks US, not counting the cost of the xtal. Interested?

This is a generator design I have been using for some time now. The design given here is highly adaptable, and can be modified to suit your needs. The pics here are from the first one that I built, and I used it for about 8 months for various things, with great success. The versions of this design I am using now are larger and more refined, but the pics shown here are the actual device which I used as my main generator for several months. In fact, the device is simple enough that it may be somewhat anticlimactic for you when you see how it's made.

The main things that I used this device, and continue to use devices based on this design... for, are as follows:

1- Heavy duty radionics applications, I.E. using the generator to send energy to persons or other entities through the Aether. Have done healing work, remote influence of persons and events, and in one case used this exact device to cut through the spells of a 'nameless' but well-known metaphysics practitioner like a hot knife through butter. Do not ask me for further details about who and when and why, because I will not provide them. It is immaterial. What matters is that the device works. I use the device for some of the radionics undertakings that require a lot of juice but not so much finesse. Finesse comes with refinement of the design and user skill.

2- Heavy duty orgone generation requirements, I.E. weather manipulation experiments, charging of water or other material, or psionics / intent amplification. You will have to figure out how to do that yourself, which if you are familiar with metaphysics should not be too difficult for you. The only input to it from you is by your intent, but you can reach out with your mind and direct the energy from this device same as with any other orgone generator. The frequency used to drive the device makes a lot of difference, and the use of select frequencies or audio signals to achieve desired results is a main aspect of using this device.

3- Charging and programming orgonite while the resin is curing, or cleaning, charging and programming quartz crystals. This use is the main reason why I am posting this design instead of limiting myself to offering much larger and more refined versions of it for sale. In due time I will come out with a production model of this device, but in the meantime it can radically improve the quality of orgonite made by the home orgone crafter. The production model of this device will contain much more orgonite than the one shown here. Pulsers can be used to charge resin while it cures as well. This device is a lot more powerful than a pulser, but less user friendly. Not everyone is going to be making enough orgonite to get their money's worth out of a unit like this when I decide to start selling the, but most people are definitely going to get their 50 bucks worth of use out of a homebuilt unit like this if they make much orgonite. Again, Pulsers, Powerwands and SPs are PORTABLE and therein lies one of their main beauties. This device is not portable, but rather requires both a stationary setup and the input of electrical power, and well as a home computer and an old stereo amplifier to drive it. This device offers more flexibility as well in that you can easily change out the core xtal for pretty much anything you want. Some materials may not be especially healthy for you when you expose them to scalar waves, and you are responsible for your own decision to make and use this device. Depending on how much voltage you put through it you may or may not harm electronics in the area. I have found that relatively low voltages on the RingGen suffice.



Some shots of a Ring Generator built by a man named David in New Jersey.



This is what you need to construct this device:

- 30 feet minimum of 18 to 15 gage copper wire.
- One [large quartz crystal](#). There is a picture to the right of the xtal I used for the device shown. It does not have to be a nice DT like the one I used, but it should be about that size. In a pinch, you can also use several; smaller xtals together to get about the same amount of xtal mass. I got this xtal from ZSL, a generous gift on his part. He got it from [the crystal man](#) (in Canada). Another good place to get xtals is from [revted](#) (in America).
- 6 Plastic binder straps.
- Some aluminum tape.
- Enough stuff to make at least 1 liter of [orgonite](#).
- The rings from 2 mason jar lids.
- A small shelving unit made from metal mesh of some kind. I used an old LP record rack, flipped upside down. You could make one from pieces of window screen stretched across a frame, or see what you can find in your garage or the second hand store. It should be a shelf that has the individual shelves made out of a metal GRID or SLATS, so that there is an open mesh, not solid pieces of metal. On the next one I make, I will probably use copper screens for the mesh. I have not tried using aluminum for the shelves, but I think steel or copper would be better for the shelves. Steel works well, I can attest to that.
- A large diameter hemispherical piece of metal to use as a reflector. I used the canister lid of an old steam cleaning rental unit I happened to have, you could use a large wok lid, or a large metal mixing bowl. It does not have to be a perfect parabolic curve, and aluminum will work for the reflector. Again, on the next one I make I will probably try to use copper. I imagine I will have to form a piece of copper sheet into a reflector. The reflector I am using right now is about 24" diameter, I would recommend it be at least 18" diameter. The metal should be bare on the inside of the reflector, it can be covered with paint or enamel on the outside.
- A long section of speaker wire (2 wires) to connect the device to your PC.
- A household stereo, boom box, or any other audio equipment that has an amplifier built into it, and also has a line in or auxiliary input jack so you can route the signal from your PC's sound card through it. I use an ancient 8-track player that has a 50 watt amplifier in it.
- Adapters to connect you PC sound output to the line in of the amplifier.
- Tone generator software for your PC. You can download it off the web, and there are some links provided on the links page of this site where you can find it. [Roberto Forcen's stuff](#) is amazing, as soon as I can afford it I will be sending him something for his efforts, in the meantime I can at least give him a plug, his site is called voicesync. He has wonderful donaware for sound generation and analysis. Also, [NCH toner](#) is a very adaptable and functional tone generator for your PC with a range from 1 to about 20,000 Hz with control over the waveform. You can also run multiple copies of the program and generate multiple tones at the same time.



Building it... Step 1 -

Build yourself a large [mobius coil](#). Make it big enough you can fit a large xtal in the core, about 2.5" to 3" diameter. It does not have to be a fancy xtal. It can be single point. On the old device shown here I used a single knot mobius coil, but on my new one I am using the continuous knot style. Secure the coil with plastic binders to prevent it from losing it's shape. The coil shown here is from 15 gage magnet wire, and while I recommend using at least 18 gage, it does not have to be magnet wire. magnet wire just works a little better. It isn't necessary to use magnet wire.



Step 2 -

Using aluminum tape, connect 2 mason jar lid rings to the coil as shown. Work the tape firmly into place, and use at least one full wrap of tape all the way around. This is not only for the effect of a metal shroud on the coil, it is to keep the orgonite from leaking into the coil. Do your best to line the rings up evenly with each other, so that the ring on one end is parallel to and plumb with the ring on the other end. Pull the leads from the coil out through the center, or if you want to be more precise you can form a little hole in the tape to pass the leads through, and fill the hole with glue so it doesn't leak.



Step 3 -

Find a suitable mold that is cylindrical, and deep enough to come up to the top of the coil assembly you have just built. It should be at least deep enough that you can cast orgonite up to the top of the coil assembly, and wide enough that there is at least one inch of orgonite all the way around the outside of the coil. On the generator I use now there is a lot more orgonite than on the old one shown here. The old one shown here worked well enough to impress me several times with its effectiveness. Coat the mold with release agent of some form, regular vegetable oil or WD40 will both work fine. If you are using orgonite made from polyester autobody filler, you do not have to seal the bottom of the coil assembly to the mold. If you are using orgonite made from resin, you will have to seal the bottom of the coil assembly to the mold so resin does not leak under the coil assembly into the cavity at the center. You want to cast a ring of orgonite with a hollow center where the coil is. A little hot melt glue

works well for this (sealing it), since it will keep the resin from leaking into the hole, and is easily removable. It also sets fast, so you don't have to wait for it to dry like you would silicone or goop glue.



Step 4 -

Cast it with MHD, HD or XHD orgonite. Allow the orgonite to cure, and remove the coil cast in orgonite from the mold. You should now have a hollow cylinder of orgonite with a coil in the center of it. Place the cylinder with the coil in the center of the reflector as shown below. You can fasten it with a little glue if you want. Then place the reflector on the lowest shelf of the metal shelving unit as shown. The quartz xtal goes in the hole inside the coil, as I imagine ought to be obvious. You can also easily remove and change xtals this way. I have a large cluster of kyanite which I use inside the coil too, gives a great energy. Let your imagination be your guide. Experiment with using different minerals and other things inside the coil, but be aware that not everything you put in there will work as well as a quartz xtal. A safer way to experiment is to ADD things in there with the quartz xtal, and see what kind of orgone they produce before you try them alone. Now you're ready to hook it up. If you want to, you can line the metal shelf up with the compass directions (I.E. so that one side of it faces north) but this is not necessary, it just makes it work a bit more efficiently). The metal shelves and reflector should be insulated from each other electrically, or at least that is the way I find it works best so far. The metal rings on the ends of the cylinder do not have to be electrically insulated from the metal of the reflector.

Not only do the metal screens seem to act like an broadcast antenna / amplifier, they also work really slick for making orgonite. Later on, when making orgonite, fire up the generator and put your molds on them while the resin is curing. The metal in the shelves pulses in rhythm to the scalar energy coming off the coil, and although I guess I still haven't figured out exactly why, they emit a strong stream of orgone as well. Further refinements to the design would involve, among other things, the proportions of the metal shelves in relation to the rest of the assembly.

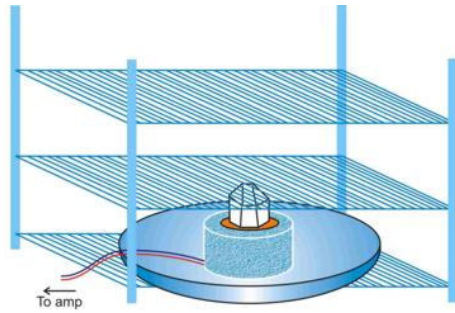

If you are going to use the device for radionics, then use the metal shelves as your witness well. You can also use the cavity inside the coil as witness well, but the energy sent to target that way may not be beneficial unless there is a quartz xtal in the coil along with it. If you just want to generate a big cloud of healthy orgone, then drop a large TB inside the coil and fire it up. If you have a wand or orgone beamer of some form, you can put that inside the coil and supercharge it.

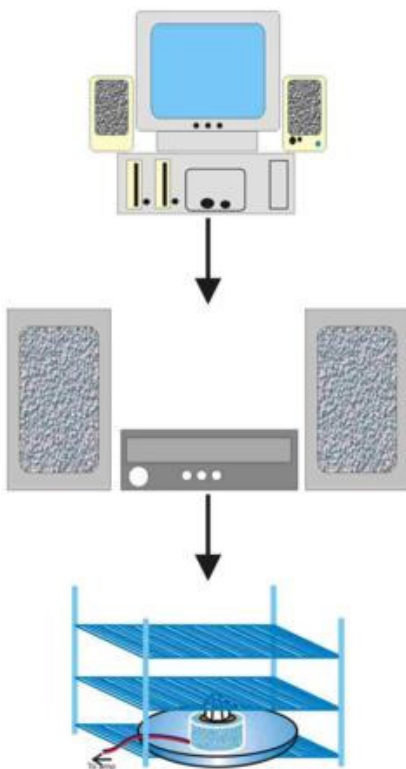

This is basically how you hook it up. You want to take the signal from your PC's sound card, route it through your amplifier, and then run it through the coil in the device. There are several ways you can do this, and no doubt those of you familiar with electronics will see that there are better ways than the method I have illustrated. I chose this method for this page because it is simple. Just use the adapter to connect the sound output from your PC to the line in or aux input of the amplifier. Then take one of the wire pairs leading to a speaker from the stereo, and cut ONE of the wires leading to the speaker. Leave the other wire intact. Preferably, use the positive wire. Then, connect the leads of the coil in the device to either end of the speaker wire which you have cut. This has the downside that you have to listen to the sounds being generated, but it PROTECTS YOUR AMPLIFIER from blowing. Mobius coils have very low resistance, and if you connect it directly to the amplifier output without having enough resistance you may damage your amp. The resistance in the method of connection shown is provided by the speaker. The current comes from the PC, is amplified by the amp, then goes through the coil. After it leaves the coil it goes through the speaker and back into the circuit.

Alternately, you could add a resistor to the mobius coil to give it enough resistance so that the amp would not perceive it as a short. In order to do this, you would need to find out what resistance your speakers are. Usually the speakers are marked (inside the speaker box on the back of the speaker magnet) with a little number beside an ohm symbol. This is the resistance. An ohm symbol looks like a little "O" with the bottom cut off and two little tails (Greek letter omega).

Again, alternately, you could connect the coil directly to your pc sound card by adding 8 ohm resistance to the mobius coil, as I gather 8 ohm is the standard resistance for small speakers like the ones used in PCs. In fact, I may be offering this (the ability to plug it directly into your PC sound output) as an option on the Pro Model Pulsers at some point in the future. For devices the size of the one shown on this page, I think it is better to have the extra power provided by the amp. If you use a device like this to charge your orgonite while it cures, you can increase the potency of your orgonite significantly. Some suggested

frequencies: 15 Hz, 32 Hz, 5075 Hz. Obviously, one could build a more refined device based on this general concept, but hey, I can't give away all of my trade secrets ;). Besides, lots of folks won't mind that it looks hokey as long as it works

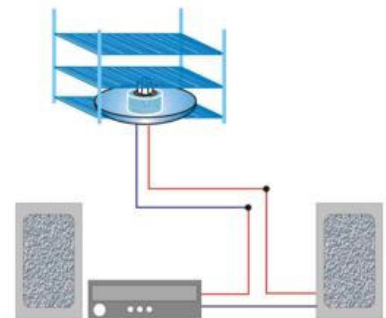

Grow yer own crop circle

Confirmation of subtle energy in action

This was kind of an interesting thing that happened in the backyard a while ago...

The same night as the 'meteor impact' of June 03 2004 near Washington state, this formation appeared in some grass in my backyard. It has some of the earmarks of the much larger and more well-know crop circles, such as bent nodes, grass which continues to grow, and a weaving pattern among the blades of grass which is complex enough it is difficult to photograph.

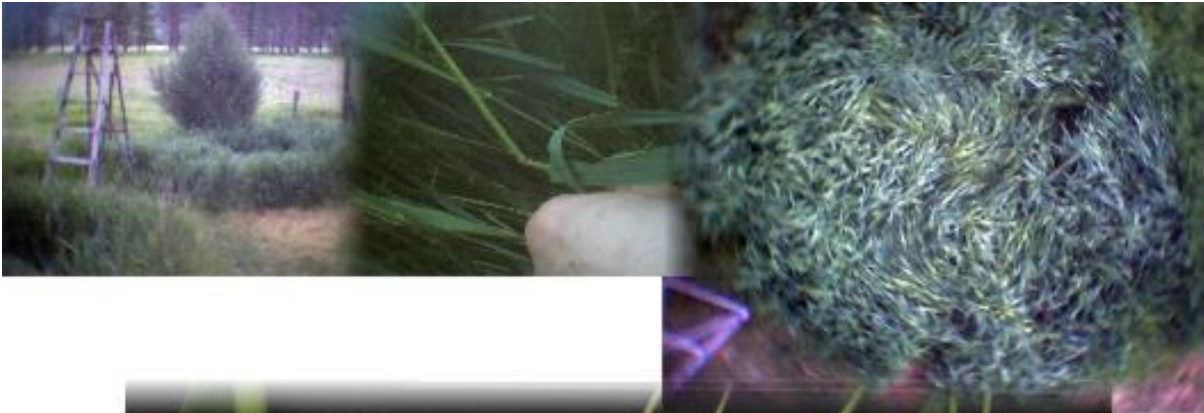

The patch of grass that it appeared in is a patch of grass which I let grow instead of mowing, a small energy vortex in my yard. It is a spot where I had my chembuster for about a year, I moved the chembuster to the other side of the yard a few months before the formation appeared. This pic shows the way it looked when it first appeared.

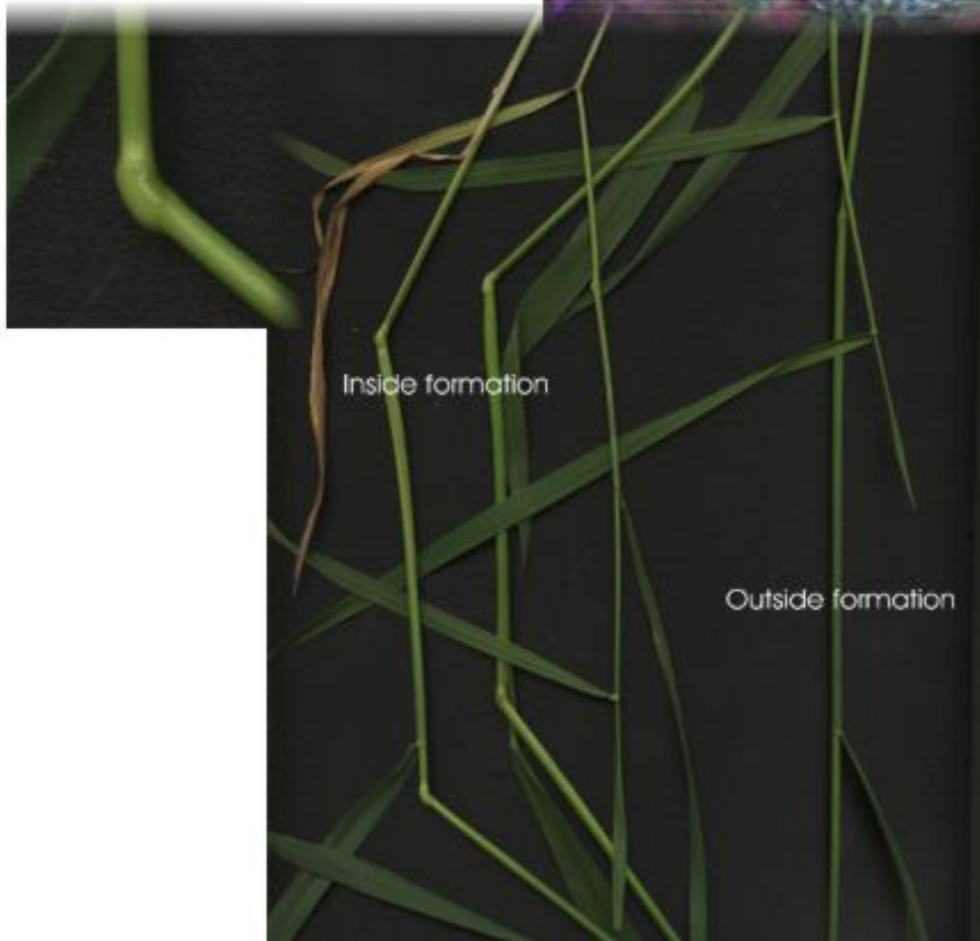

I think that as the energy intensity in the earth's bioenergy and electromagnetic fields continues to build, more formations like this will be observed, if indeed they are not being already. Essentially, I think that anytime an orgone field reaches sufficient strength and excitation, then there is a possibility for that field to be expressed in the plants DNA adaptation. ;) Or something like that. what do I know I never even finished high school hahaha. This pic shows some changes that appeared and some nodes. The nodes in the squared part of the formation appeared to keep bending over a period of several days. The initial pattern formed overnight.



I had planned to post my recollections of the night in question to a different page, but since the two subjects are related in my mind at least, and you may already think I'm nuts;) I will post them here also.

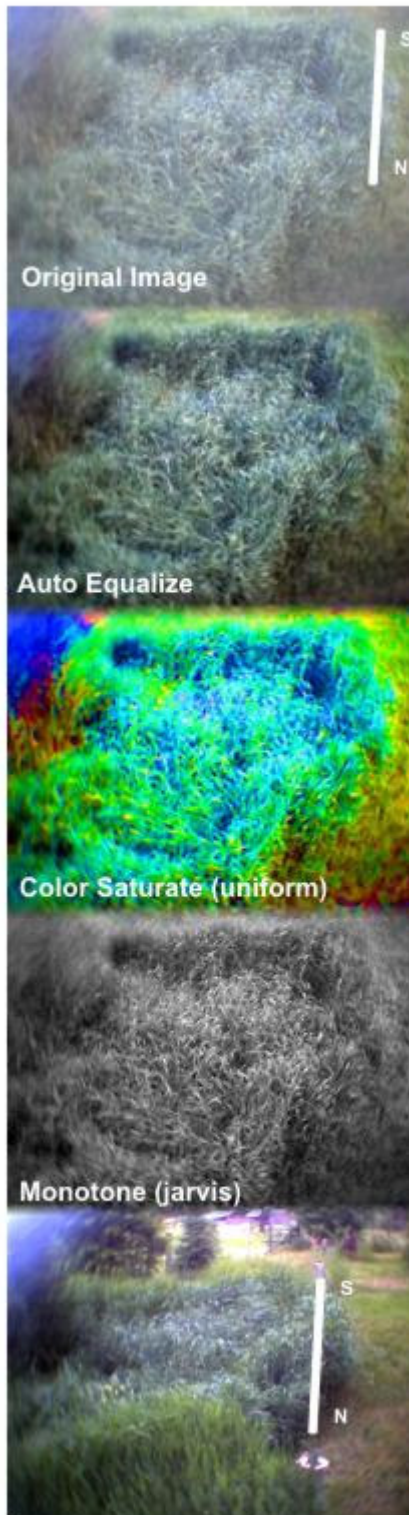

It was a dark and stormy night... *chuckle* actually it was dark anyway.... and since sometimes I work nights, I was up and awake at about 3AM, having what amounts to a lunch break. I felt something outside, so I went outside and had a walk around the yard. I decided to do a little energy work, a defensive cleaning action. I had sensed something 'bad' about to happen, thought maybe some idiot was trying to attack with a radionics machine or something again, or maybe the wolves/coyotes/whatever it was that had taken a few neighbors pets was on the prowl. So while I was out there I went over to 'the spot' in my yard where I normally do energy work, it is just a spot in the yard where a few energy lines from the rest of the yard come together, if you are familiar with earth energy lines. It is a vortex I suppose, but a small one, and one I have worked with a fair amount in the past. And as I focused my thoughts and took some of the energy from the spot, I sent it towards the source of my inner warning. I confronted the energy I was going to repel. I was facing east. And right on cue, the whole sky to the east lit up red. Lots of other people saw the same light in the sky, and even then I was quite certain that I was seeing something with my physical eyes and not with the mind's eye. So you know, that kind of startled me a bit, I have to admit. But I just carried on, I kept up the intent that things would work out ok, and that whatever threat I was feeling would be done with. Leap of faith. You know, that's what you do when you are confronting something nasty and perhaps stronger than you. Have faith.

I wandered over to the other side of the yard where the chembuster is, and I was standing there facing south, and, um, 'having faith'. Then right when I felt the energy change again and some of the 'pressure' was relieved, again, right on cue, the whole sky to the south lit up, and there was a big boom, very loud. My memory does admittedly blur up a bit around there, but I do not have missing time. I just spent a few hours in and out of a semi-meditative state, and at some point I could swear the sky lit up again. I am not certain on the number of times that lights flashed in the sky that night. I am quite certain that the number of flashes I saw in the sky does not match the medias account, I seem to remember that sequence of red in the east and then blue in the south as happening twice, but perhaps that is just a trick the mind plays. I by that point was very much trancing, and just figured 'well, it held, it's all good, thanks God, I'm off to bed..'

So I put the flashes in the sky on a little shelf I keep in the back of my mind, a place where I set things that I need to put down for a little while after which I will have to go deal with them in some way ;) ... and went to bed. It took me along time to fall asleep, I was very keyed up. But as I lay in bed, watching the blue light of early morning, I remember hearing a strong wind blow through.

So the next day I was out wandering around in the yard, and I was standing over in the same spot and noticed that some of the grass was bent down. I didn't make anything of it until a few minutes later, and realized that it was bent in a swirl pattern, and from there on in I was all excited. It was a round swirl pattern at first, and then a squared pattern formed around the round swirl part in the center over a few days. Then a triangle shape appeared at one corner of the square, and over about a week the triangle swirled into a circle also. There are some above. I haven't taken any pics of it lately I'm just letting it do it thing. As the weeks have moved on since, the patterns has continued to grow somewhat. The energy from it feels good, it feels cool and soothing. I have been mentioning casually to friends and co workers that I have really small crop circle in my backyard. you should see the looks on their faces.

The air elementals are involved wherever large orgone things are happening. whatever happened that night, I think I saw something get shot down. It was large enough to affect the orgone fields and the resultant weather patterns and emotional states in people across the western seaboard. I dunno if it was a rock or a missile, at first I was leaning toward it having been a rock but now it think it was likely a missile. Whatever it was, it was not a simple meteor impact. The timing of the lights was all wrong. I think something was destroyed in the air over the US / CANADA border near Washington state. Something big changed in the earth's energy field, it took many people time to acclimatize. I think things could have been worse, so I won't complain. to acclimatize. I think that it was a precursor of larger changes to come. The earth (and the human race, kicking and screaming) is changing.

I do not think that this formation is a message from extra terrestrials, though that is indeed IMO what some large crop circles are. I think that whatever happened that night, it moved around enough energy to leave a pattern in the grass in a spot in my backyard. It appeared in a spot were the energy fields are already concentrated compared to the rest of the property. If it can happen in my yard, it can happen in yours. I would not be surprised to learn that the same bent nodes and interweaving associated with crop circles appear in more subtle ways within nature, along ley lines and in vortices. I also think now that if you create strong enough orgone energy patterns, there is a good chance you will be able to impress an outline of them upon a patch of grass, so long as the grass is on a 'high energy' spot and if for some

reason one wanted to. Probably the use of several large orgone devices has something to do with also. I think that during a very intense set of conditions within the earth's energy fields, an outline of what the energy was doing was 'burnt into' the grass. I use the term 'burnt' loosely because the grass remains healthy and continues to grow. I will experiment with some of the seeds when they are finished forming. The neighbors must have thought I was nuts out there with a camera on a pole snapping pics of this thing. Make of it what you will. Feel free to share with me any impression you get from the pics. And remember... It's really hard to see a formation in the grass when you're on the ground.

A Functional and simple Radionics Machine

A while ago, I started experimenting with using a simple radionics tuner to drive a mobius coil. I was so impressed with the results that I told some of my friends about it, and they asked me to produce a diagram for a simple tuner that could be used to make a 'radionically tuned succor punch'. Better late than never hahaha and here it is. There are many different ways to skin a cat, and there are many refinements to the basic designs shown on this page which could be done. The designs on this page are simple, easy-to-put together from readily available materials, and well within the range of any tinkers' skills. Please feel free to copy these pictures to your hard drive if you find them useful. At some point in the near future, I will be offering printed radionics circuit boards with or without the dials and output in a kit form. But in the meantime, I hope that these schematics will demystify some of the simpler aspects of a radionics machine for the do-it-yourselfers out there who want to make their own. In simple terms, this kind of radionics machine is basically a closed loop circuit, which you tune by adjusting the dials. When you put a sample into the witness well, you are introducing interference into that circuit. when you adjust the dials so that the circuit is resonant to the interference you have introduced, then you are 'tuned in' to that sample. This state of resonance with the sample produces a change in the way that the EM fields of the machine and your body interact, causing the 'stick' where your fingers stick to the pad. With a bit of practice, anyone can use a stick pad. Also, you can use a pendulum over the stick pad and dowse to determine when the dials are adjusted correctly for a given purpose. Pretty simple, huh? Of course there is more to it than that, but that is more than enough to get started with.

First, a brief word about the 'dials' used to make radionics machines. It is not necessary that they be calibrated dials, any variable resistor will work. They are also called variable potentiometers. I have successfully used dials ranging in size from tiny little PCB mount tuning pots up to your average volume dial for a boom box. I have also used slide controls instead of rotary controls, and I like them just fine.

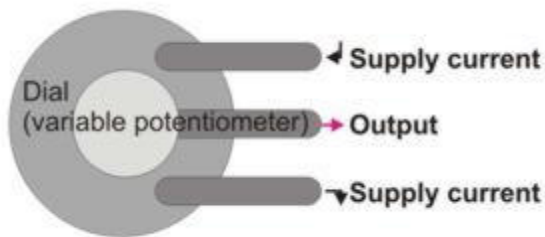

Any potentiometer will work. A potentiometer is just a variable resistor. They do not have to be calibrated dials. However, the number combinations that you wind up with (on the dials) will be unique to your machine. Keep notes on the rates for various samples. They will always be the same on your machine, but they will not be the same number combination on two machines, unless the two machines are identical in componentry, right down to the length of wires used to connect the parts and pieces together.

Many variable potentiometer dials have 3 main terminals. These are the kind I prefer for radionics tuners. Often, the center lead is the output, and for that reason I have drawn the circuits here with the center terminal of the dials shown as the output. When you get your dials, it is a good idea to check and make sure that you know which terminal is the output, and proceed accordingly. A variable potentiometer of this type works by running a supply current across it (that's what the two outside terminals do) and allowing a variable amount of that current to pass through it (which comes out the center terminal). I prefer to use linear dials instead of logarithmic ones, because they are a bit easier to tune. Either will work. (Also included is one of the mini tuners I have been playing with, bottom center. It works ok, but is somewhat awkward to adjust using a precision screwdriver. I also like a solid vessel for the witness well better than the wire coil shown here.) The purple colored tuning pots shown at top left are just about perfect, they are big enough to grasp with your fingers.

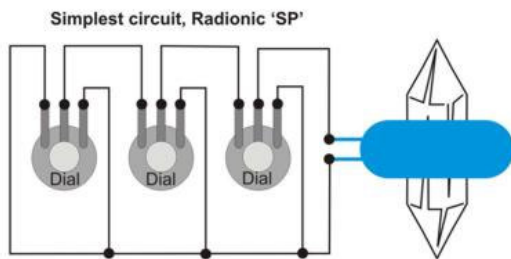

So here it is, the stripped-down, bare essentials radionics circuit for driving your SP, Powerwand, Pulsar, or god knows what. I use (among other things) mobius coils with quartz xtal cores as output devices for radionics circuits. There are many kinds of output devices one can use for radionics machines, and a little later on I will cover the basics in an article. But for this page, I will concentrate more on the tuning section, since that is after all the core of any radionics machine, the tuner. The simple circuit shown here does not have a stick pad, so the person using the device has to be energy sensitive. There are a lot of folks who are more than energy sensitive enough to feel the changes in the energy produced as the dials are adjusted. You can always use the face of the quartz xtal as a stick pad ;)... After thinking about it quite a bit, I have decided not to give specific variable resistor values at this point. I do not see that it matters. I have used many different resistor values and have found that they all work. I

would say that for this kind of a circuit, it is best that they be under 1 mega Ohm maximum resistance. You shouldn't have too much trouble finding dials, as they are fairly common, and easily salvaged from old electronics, or bought from an electronics supply store.

Here is a diagram showing a basic, easy-to-make radionics tuner. This circuit includes a witness well and a stick pad. In circuits like this I often use a 1/8 2-conductor jack to connect to whatever I am going to use as an output. you could also connect the output from this circuit directly to your mobius coil, and leave the jack out. The stick pad is made from a simple piece of copper flashing, covered by a layer of dielectric plastic. You gently rub it with the fingers or thumb of one hand while you adjust the dials with the other hand. When you get the dial 'tuned in' you will feel a sensation in the fingers which are connected to the stick pad. This is imo because of changing static electric properties between your fingers and the pad when resonance with the sample placed in the witness well is achieved. You can use either a simple piece of sheet metal for the witness well, or a small can, cup or bowl. I like to use brass shot glasses.

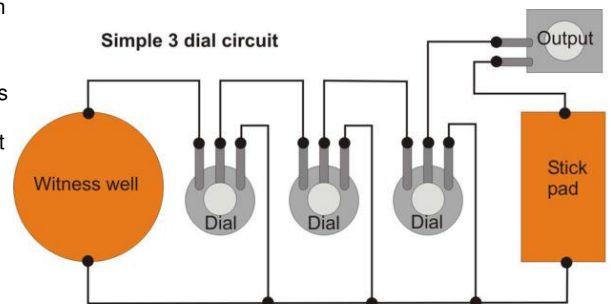

This circuit is a bit more complex, but basically incorporates 3 mobius coils around a common quartz core. One of the circuits is a 'target' circuit. This decides where to send the energy. It is the one with 3 dials, the uppermost coil on the xtal. Next is a basic zapper circuit, a square wave generator. The zapper circuit drives the center mobius on the xtal. In order to prevent the center coil (the one driven by the zapper) from overpowering the other more subtle radionics circuits, the coil is covered with a layer of aluminum which is connected by a wire to a ground ballast provided in the circuit. The aluminum shroud is in turn covered by a dielectric. You could also connect it (the copper pipe) directly to a dry or wet ground. The ground ballast is simply a cylinder of orgonite inside of a section of copper pipe. The radionic circuits are grounded to the orgonite, and shroud around the electrically driven coil is grounded to the copper. The Lower coil is connected to the 'trend' tuning circuit. This circuit decides what kind of energy it is that you are sending. The trend has 6 dials for finer tuning, and the target has 3 which imo is more than enough for accuracy. There are many more complex ways you could go about this, but this circuit is easy to make (relatively) and in my experience performs well. As time permits I will be adding more info about how to use a radionics machine... And the simpler circuit shown above (the one with only 3 dials, the witness well and stick pad) is more than enough to get started with, provided you at least connect it to an antenna of some sort. Have fun :)

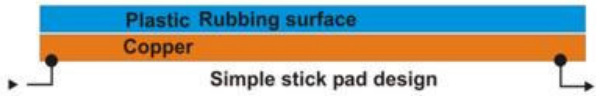
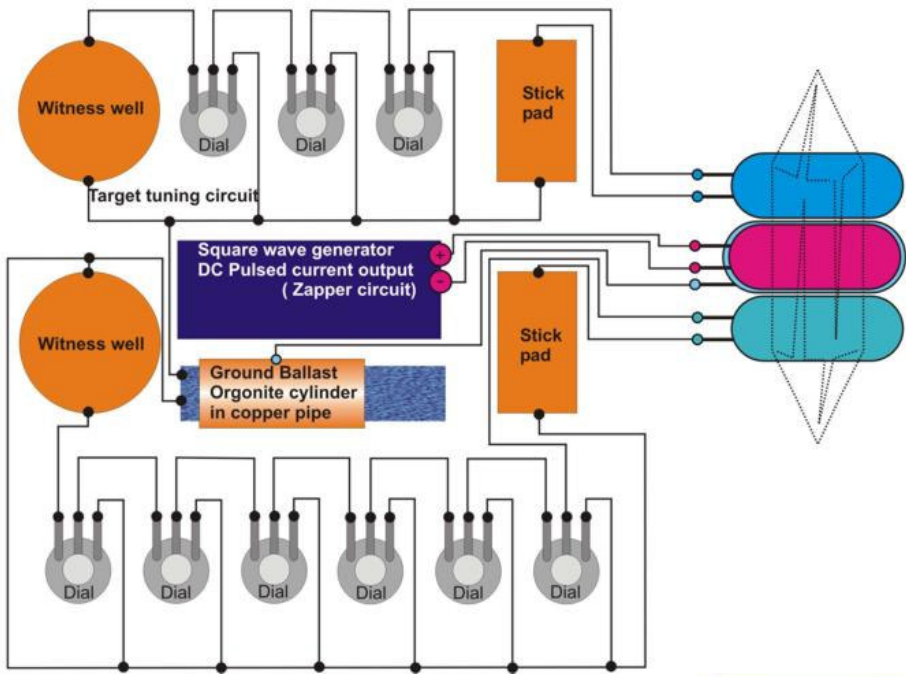

The following is some info (taken from the user manual I give with the machines i make) which might be helpful if you decide to make your own machine.

Disclaimer:
While Radionics Machines have been successfully used for decades in the treatment of various illnesses and the enhancement of various metaphysical discipline's effects, there are two factors which apply:

A: The fact that I am not a medical doctor and cannot by law give you medical advice, so all such notions put forward by me in this manual or elsewhere are to be taken as my opinion, this machine is to be viewed as an experimental device, and you are responsible for your own decision to purchase and use it. If you have a serious health problem, you should consult a medical doctor whether or not you choose an alternative means of treatment.

B: The fact that skill on the part of the user is a critical parameter in the use of a machine like this one. Practice is involved in gaining the ability to use a stick pad accurately, and in determining the correct methodology as regards the application of your radionics machine for a given purpose.

Dials - The dials and/or sliders on your machine should be numbered. Each dial has a number assigned to it, and then a scale of numbers to indicate the dial position. When setting the dials, you should start at the dial marked "1". The dial closest to the witness well is "1".

Witness Wells - The witness wells should be a small metal receptacle or plate upon which to place a sample. While you can use your machine without a sample in the well, it is better to have a sample in the well if possible.

Outputs - Your machine may have a permanently affixed output and/or removable or additional outputs. These are the part of the machine which transmits energy, and if applicable may be positioned so that the output directs the energy to the desired place.

Configuration - Whatever model of machine you have, it is important that when recording the dial setting for a given sample in your log book, you also make a note of how the machine is configured (as regards power on/off, choice of outputs if applicable, signal fed to drive coil if applicable, etc). In short, the conditions which exist when you find a setting should reproduced when you subsequently return to that setting. Those conditions may include more variables than simply the number setting on the dials.

Radionic Circuits - Whether your machine has one circuit or more, the circuits themselves are much the same. A radionic circuit combined with an output forms a tunable orgone generator which allows you to tune into and affect (i.e. reproduce, amplify or dampen) orgone energy (bioenergy) signatures. Using two or more circuits on the same machine allows you to combine effects, like for example using one circuit to generate the energy signature you want to use (trend) and another to direct the energy where you want it to go (target). If your machine has only one circuit, then it generally can be thought of as 'trend' and the target is determined by combining two or more samples in the witness well, or by where you point the output (on small 'SP' models).

Using a Stick Pad

Pay attention to the sensations in your hand while it is touching the pad, or near the pad. You may notice a tingling sensation in the palm of your hand while it is near the pad, or touching the pad (this for persons more familiar with reiki and other 'hands on' energy work systems than with radionics machines). If so, you will likely notice that the sensation is most pronounced at a certain dial position. That would be what you are looking for, and that is the number setting which (if applicable) you should record for that dial in your log book.

Understand that the 'stick' is a subtle sensation. It will be a slight difference in the amount of friction between your hand and the pad. Do not expect it to suddenly clamp your hand to the pad. Use your fingertips or the side of your thumb, and use a steady and even motion. You can either use a circular motion or go back and forth across the pad.

You may find that you get a stick when turning the dial, but then you go past it (with the dial) and cannot find it when turning the dial in the opposite direction. If so, turn the dial all the way to the start position, remove your hand from the pad, and start over. I believe that this phenomenon comes from a buildup of capacitance in the circuit which discharges when the circuit achieves resonance with a component of the emission spectrum of the sample in the witness well, but I am not certain at this point. In any case, it is a relatively common observation, and easily remedied by simply starting over.

Use a little less pressure on the pad as you go from one dial to the next. Start out rubbing relatively firmly against the pad while you set the first dial, and finish by lightly drawing your fingertips across the pad while you set the last dial. Understand that the 'stick' generated by the last dial you set is 'still there', therefore the next dial you tune will be a bit more subtle than the one before it, and so on and so on, through the series of dials.

The machines are generally configured so that the user stands opposite the machine from the output, or to the side of the output. If you are standing 'in' the output, it may be difficult for you to set the dials or use the stick pad.

Do not look at the dials while you are turning them. Look at something neutral or close your eyes.

Do not 'expect' to get a stick at a certain place on the dial, but rather let it be wherever it works out to be. Under different conditions (see notes on configuration above) the same sample may give a different number setting on the dials.

Setting the Dials

1. Place a sample in the witness well.
2. Turn the power on if applicable.
3. Align the machine with the compass direction if applicable (see following page).
4. Set all the dials in the circuit you are working with to the start position. This will be the lowest numerical setting on the scale of numbers for each dial.
 - Start with the first dial in the circuit. This will generally be marked as dial 1, but if your dials are not individually numbered, then it will be the dial closest to the witness well for that circuit.
 - Slowly turn the dial while rubbing the stick pad. When you get a stick, stop turning the dial and wait a second or two before moving on to the next dial.
 - Move on to the next dial in the series and repeat the above step. Keep doing this until all the dials in the series are set to the position that gives the best stick.
 - Alternately, if you are a dowser, you can simply dowse over the stick pad in order to determine when the dial is set correctly.
 - Once the dials for the circuit are set, make a note of the number setting and machine configuration in your log book. Then next time, you can simply put the sample in the witness well and set the dials without having to use the stick pad.
 - Move on to the next circuit if applicable (for systems with 2 or more circuits). You can set either the trend circuit first or the target circuit first.

Power Driven Models

On machines with an additional electronic circuit, the function of the electronic circuit is to boost the performance of the radionic circuit(s). These machines have 2 modes of operation, a 'passive' mode (with the power off) and an 'active' mode (with the power on).

The radionic circuits will work either with or without the electronic circuit powered on, but they may produce different number settings on the dials in the two different modes. Also, the electronic circuit, while in operation, has an effect on the radionic circuits. For this reason, it is best to turn the power on if desired, and **then** set the dials (as opposed to setting the dials and then turning the power on).

Aligning your machine

It is reasonably important that your radionics machine be lined up with the compass directions, in order to work properly. Although most tabletop models have a permanent magnet included in the machine to compensate for improper alignment, it is still preferable to line the machine up with the compass directions if at all possible. Unless clearly marked otherwise on your machine, the side of the machine with the witness wells should be to the north.

Generally speaking, the radionics machine should be 'inline' with the lines of force in the earth's EM field (north/south) and the axis of the output should be at 90 degrees to the lines of force in the earth's magnetic field, especially for remote work.

The exception to this is the 'wand' style of output designed for body work, which can be pointed where ever is expedient, so long as the radionics machine driving it is aligned correctly.

Samples

In the following pages, I give a few examples of minerals suited to various purposes. You could also (if you are familiar with and competent in the use thereof) expose the witness well to hertzian frequencies commonly used for a given purpose.

When writing paper slips to be used as samples, the emotional (primarily) mental (secondarily) state that you are in is what the paper actually records. It is best to keep the wording of the samples as short and to the point as possible. It is best to be in a clear and focused state of mind when you write them. You should, if at all possible, use fresh paper that has not been used for anything before. Once you are finished using the slip of paper, you should burn it (in a safe and contained manner).

When using a physical sample of a person, it is not necessary that living cells be used, nor is it necessary that the cells contain DNA, since there will still be a 'structural link' between the person and the sample. i.e. - a snippet of hair without the follicle will work. However, it is preferable to have living cells if possible, as the structural link between living cells and host organism is stronger than the link between dead cells and former host organism. Once you are finished using the sample, it should be destroyed, preferably by fire (in a contained and safe manner).

Photographs will also work for a sample, and they do not need to be color photographs, but the aspect of the person captured by a photograph is what you are tuning into. Bear this in mind when selecting photographs to use as samples. If the only photograph available reflects an aspect of the sample that you do not want to work with, then attach a note to the photograph clearly stating which aspects you do and do not want to work with.

Another way to obtain a sample is to use fresh, clean water and expose the water to that which you wish to sample. Water records energy signature rather well. This technique is more suited to capturing samples of subtle energy fields and/or hertzian frequencies and/or sounds, or for use in manifestation (hold a vial of water while doing your visualization and use that water as sample).

Examples of material for samples -

Photographs - Written words - Tissue samples - Saliva samples - Hair samples

Quartz crystals w/recorded energy patterns - Charged water - Minerals harmonic to a given task

Symbols (reiki, runes, other)

Sound recordings (via water or via direct stimulation of witness well with sound)

(you are responsible for your own safety in handling/choice to handle biological material - determine approved methods and use them - do not attempt to obtain or use samples of contagious diseases - rather, use a photograph of the infected person or write the name of the disease on a slip of paper - disinfect machine between uses if using biological samples - contain sample in clear glass vial)



Using Your Machine

Using it to repel an energy attack / remove astral parasite

While experiencing the attack, write the word 'attack' (or 'parasite' if applicable) on a slip of paper. Place the slip in the trend witness well. Set the dials for the trend circuit. Then, 'invert the setting'. To do this, adjust the setting each for dial in the trend circuit to its tens complement ((dials marked form 1 to 10). i.e. if you initially came up with 1-4-7-3-8-5, then set the dials to 9-6-3-7-2-5).

Lastly, transfer the slip of paper to the target circuit and set the dials for the target circuit (but **do not** 'invert the setting' for the target circuit by replacing each dial setting with its tens complement).

Alternately, you could use either a sample of yourself or a sample of the source of the attack if you know it... for a sample in the target circuit.

Using it as an intent amplifier

Write your intent on a slip of paper. Make sure that your thoughts are clear and focused while you write the slip of paper. Place the slip of paper in the trend witness well, and set the dials for the trend circuit.

Place a sample of yourself (or other entity if applicable) in the target witness well and set the dials for the target circuit. Leave the machine to run for up to 3 days, but no longer. Remove and burn the slip of paper (in a safe and contained manner). Turn all the dials to the 'off' position and turn the power off. Allow the machine to sit for at least a few hours before repeating the process if necessary. For intent having to do with beginnings, try to do this on or near the new moon. For intent having to do with endings, try to do this on or near the full moon.

Using it for simple pain relief

Place a sample of the person to be treated in the target witness well, and set the dials for the target circuit.

Starting with the first dial in the trend circuit, adjust the dial by small increments and monitor the pain. If there is a dial setting that reduces the pain, then move to the next dial and set the dials for the trend circuit. If the first dial does not have a setting that noticeably diminishes the pain, then use a different method of treatment (following pages). This method works sometimes and does not work sometimes.

Using it to enhance dowsing

Method A:

Place a sample of yourself in the trend witness well, along with a slip of paper with the word 'clear' (or some other word indicating that you wish your thoughts to be clear and uninfluenced by outside sources) written on it. Set the dials for the trend circuit.

Place your pendulum in the target witness well, and set the dials for the target circuit. Dowse over the output of the machine, or near the output of the machine.

Method B:

Place a sample of the entity to be examined in the trend witness well, and set the dials for the trend circuit.

Write your question (or the parameters of your analysis) on a slip of paper and place the slip of paper in the target witness well. Set the dials for the target circuit. Dowse over or near the output of the machine.

Method C:

Place a sample of one of these minerals in the trend witness well and set the dials for the trend circuit.

Amethyst
Citrine
Smoky Quartz
Emerald
Kyanite
Azurite
Malachite
Diamond

Place your pendulum along with a sample of yourself in the target witness well and set the dials for the target circuit. Dowse (not necessary to be near the output of the machine for this method).

Method D:

Place a sample of the entity to be examined in the target witness well and set the dials for the target circuit.

Place your pendulum in the trend witness well and set the dials for the trend circuit. Dowse. (this method for sending energy or remote examination i.e. map dowsing)

Be sure to reset dial to zero and turn machine off when not dowsing if using methods B or D.

Using it to potentize/charge food or water

Method A:

Place a sample of the energy signature that you want to add to the food or water in the trend witness well. If you are using for example a homeopathic treatment, then you would use a sample of the treatment in powder or elixir form, and generally a small clear glass vial works well to contain the sample (place the sample in a glass vial, and then put the sample into the well). Either suspend a vessel (preferably glass, generally not metal, must be non-reactive non-leeching non-conductive non-toxic) of the food or water over the output of your machine, or immerse the output of your machine in the food or water, whichever is appropriate to your equipment. Allow an hour or two and turn the machine off, and sample the food or water.

Different kinds of food are obviously more suited for different methods of charging, and the foods charged should be raw or at least cold when charged. Heating or cooking the food after charging will likely undo the charge.

Method B:

If you have an output that is a quartz crystal and mobius coil on the end of a cable, then you can wrap the output in a clear clean plastic bag (seal with tape around cable) and immerse the whole thing in a vessel for water, this method is often the most convenient.

Author's Note:

You are entirely responsible for the use of this device for self-treatment or the illegal and evil vile nasty healing of friends and neighbors ;) however, the skill of the user in determining which samples to use and determining when the dials are correctly set are significant factors between healing and harming. Share your successes more readily than your experiments, but do experiment. I have given information here based on y own personal experiences with my machines, and from a general metaphysics perspective.

I have tried to cover some of the basic techniques used in operating a radionics machine (in general), techniques which can be conceptually adapted to many different machines, not just those made / designed by me.

We live in a time of struggle and legal reform, and litigation. It is possible that the improper use of this machine when attempting treatment for illness can cause either nothing to happen, or the reverse of what is desired to happen. While in my experience such mistakes are generally not permanently damaging, and are rectified generally by resetting the machine correctly and or aborting the treatment, mistakes do happen in the process of learning to use the. I maintain that these machines are beneficial when used correctly, acknowledge that they can harm a person's bioenergy fields if used incorrectly, and assume no responsibility for your decision in this matter, having done my best to advise you of the best operating procedures I have found, based on my personal experience with my machines in particular and metaphysics in general.

These machines are for experimental purposes. These machines are not intended to be equivalent to a medical doctor's services. Any attempt to use such a machine for healing should be part of a wider picture. This is not a magic wishing machine, it is a device which can record and play back energy signatures. You are responsible for knowing or learning what energy signatures it is appropriate to do what with at a given time, other than the specific samples I have given here in terms of minerals etc. -Jon Logan

Using it to promote healing

Method A:

Take a sample of the person to be treated and place it in the trend witness well, wrapped in a slip of paper with the word 'illness' written on it. If the illness or problem is known, then use the name of the illness or problem on the slip of paper. Set the dials on the trend circuit, tuning the circuit into the energy signature of the **problem**.

Then invert the dials as described in the section on repelling an energy attack. Starting with dial 1, reset each dial in the circuit to it's tens compliment.

Leaving the first sample in the trend witness well, take another sample of the person to be treated and place it in the target witness well. Set the dials on the target witness well and have the person sit to the south of the machine if possible or applicable. Allow no more than an hour for treatment and then shut the machine down and allow the person to rest for an hour or two.

Repeat no more that 2 times per week.

Method B:

If the problem is known, and a medicine for it is available though not of sufficient quantity, take a small sample of the medicine and place in the trend witness well. If a sample of the medicine is not available but the medicine is known, then use a photograph of the medicine if available, or the name of the medicine written on a slip of paper. The first case employs the machine to reproduce a sample, and the second case employs an already existing 'cosmic' structural link between the medicine and it's name or image. Set the dials on the trend circuit.

Transfer the sample to the target witness well and set the dials on the target circuit. Transfer the sample back to the trend circuit and use the machine to either treat by proximity as described above, or to charge water with the energy signature of the medicine. Do not expect results quite as strong as the original medicine, but a useful technique nonetheless.

Method C:

(For person familiar with bioenergy - body work)

Place a sample of the person to be treated in the target circuit and set the dials for the target circuit. Adjust the first dial of the trend circuit and monitor the effects on the person. See if there is a setting on the dial that shows improvement in the person's bioenergy field characteristic, or a change in the discernible amount of pain the person feels, if applicable. If you are bale to find a setting on the first dial using this method, then continue on through the dials. If you do not find a setting on the first dial that shows improvement, use one of the preceding methods instead.

This method is sometimes useful for pain relief when you do it to yourself, but should only be done on others by competent energy healers / dowzers.

Well, that's it for this edition but you can check for the latest copy of this document at www.littlemountainsmudge.com

Legal notice:

Introduction to Orgonite™ copyright 2003 Jon Logan
Introduction to Orgonite™ second edition copyright 2002-2004 Jon Logan
Introduction to Orgonite™ third edition copyright 2002-2004 Jon Logan
Introduction to Orgonite™ fourth edition copyright 2002-2004 Jon Logan
Introduction to Orgonite™ fifth edition "An introduction to Orgone Matrix Material" copyright 2002-2004 Jon Logan

"Introduction to Orgonite™" and/or Introduction to Ergonite™ are compilations of articles written by Jon Logan, concerning Orgone Matrix Material, it's manufacture and application, much of which has been previously published on www.littlemountainsmudge.com. These compilations will be released in updated form as time progresses.

Orgonite™ is a trademark belonging to Karl Welz, the inventor of orgonite, and is used on littlemountainsmudge.com and in this document for educational purposes

Wizzer's Workshop™, Ergonite™, Welzite™, Wood Sprite™, Water Baby™, Chocolate Shine™, O-Matrix Material™ and all text / images on littlemountainsmudge.com, unless clearly otherwise stated, are copyright 2003 Jon Logan, all rights reserved.

Limited authorization to reproduce: This material may be reproduced or reprinted freely, in whole or in part, in printed paper or digital format for educational purposes. Additionally, the trademarks Ergonite™ and Welzite™ may be used freely by anyone for private or commercial purposes, so long as they are specifically used to refer to Orgone Matrix Material, a mixture of metal particles suspended in organic resin.

Owner of copyright for text and images on littlemountainsmudge.com and trademarks used on littlemountainsmudge.com reserves the right to refuse, suspend or revoke limited authorization to reproduce this material if the material is reproduced inaccurately, or if is sold at a cost in excess of it's production without prior written consent from the owner, or if printed material from this site is used commercially without stating in the printed copy that the material is copyright 2003 Jon Logan.

In reference to "Introduction to Orgonite™", **this document may be reproduced freely by anyone for private or commercial purposes without prior written consent so long as the following conditions are met:**

- The document must be reproduced in it's entirety and not altered in any way.
- You may not charge a fee for distributing or reproducing this document in digital format.
- You may charge a fee for distributing hard copies of this document, of not more than 20 Dollars CDN or 17 Dollars US, whichever is greater.

Email – wizzer@littlemountainsmudge.com

Phone – 250-446-2032

Mail – PO Box 139, Westbridge BC V0H2B0

Url – www.littlemountainsmudge.com

Introduction to Orgonite™ fifth edition "An introduction to Orgone Matrix Material" copyright 2002-2004 Jon Logan

How to Beat Problem Energy



2nd Edition copyright ©2002-2005 Jon Logan all rights reserved. Published by Wizzers
Workshop PO Box 139, Westbridge BC Canada V0H2B0 250-446-2032
www.littlemountainmudge.com

You can check for the latest copy of this document or more information on Bioenergy Technology at
<http://www.littlemountainmudge.com/ebooks.htm>

Bioenergy and Orgone Matrix Material: A Primer

Bioenergy, simply put, is a sea of background energy that is usually found in higher concentrations within living tissue. It is an energy form which interacts with its physical environment in subtle but powerful ways and has the capacity to change the magnetic, optical, thermal, electrical, metabolic and chemical properties of its environment to varying degree.

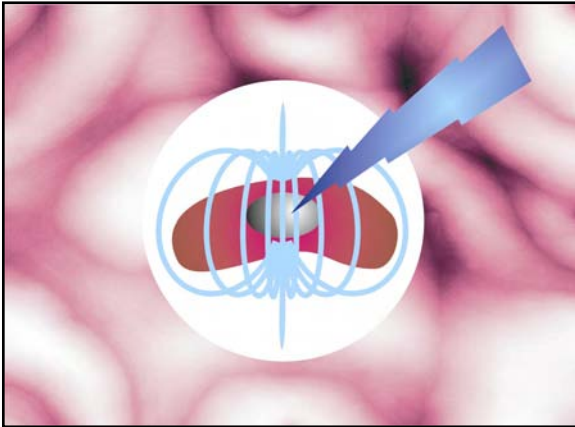

Different metaphysical disciplines, alternative health treatments and ZPE / FE / Quantum research scientists all work with the same background energy in various ways, and know it by various names*. With the advent of the internet and modern communications & data-processing capabilities, these related bodies of knowledge are converging towards a new level of understanding.

**Orgone, Odic Force, Reiki, Prana, Chi, Aether, Etheric Energy, Bioenergy, Biomagnetism, Bioetheric Energy, Huna, Animal Magnetism, Soft Electrons / Negative Ion Clouds, Gravity Wave Effects, Cavity Structures Effect, Dark Matter, Zero Point Energy, Quanta, Bions, Radiesthesia, Radionics Astral Energy, 4th Dimensional Energy, Emotional Body Energy, Life Force, to name a few.*

Throughout this document it is referred to as orgone, bioenergy or radionics.

Orgone Matrix Material is bioenergy-processing material. In simple terms, it both releases bioenergy when stimulated by conventional forms of energy, and has the capacity to change the bioenergy from one state to another. This makes it useful in a wide range of applications, including but not limited to alternative health / plant growth enhancement / radionics / traditional metaphysics.

Applied Bioenergy Science is a rapidly expanding scientific field with significant and largely untapped potential for more ecologically sound, sustainable technologies and new industrial applications.

Bioenergy fields interact with their environment. Some kinds of materials act to absorb and store bioenergy. This stored charge of energy manifests in subtle ways such as changes to the temperature, electromagnetic properties, or chemical composition of the material. Devices can be built which absorb and hold a high concentration of bioenergy. Other devices can be built which generate and emit bioenergy, or process bioenergy from one form to another. Devices which absorb and store this energy can be used to raise the overall energy field strength of land used for farming, resulting in healthier more robust animals and fuller, hardier, more disease-resistant plants. These kinds of devices can be simple, safe, user friendly, and have a blanket effect on the area in which they are positioned. You will learn how to make one kind of such device by the time you finish reading this book.

Bioenergy can produce an emotional response in many living organisms including humans.

The response varies according to the specimen and the conditions. Devices which enhance the circulation of bioenergy and keep it in a healthy state tend to produce a favorable emotional response.

Bioenergy fields can also carry information in the form of wave patterns.

Bioenergy and magnetism are only slightly different forms of the same Aether. Aether is a cosmic omnipresent energy that is successively split down into a spectrum throughout material existence.

Different ranges in the spectrum derived from Aether are manifest as matter and the electromagnetic spectrum. Bioenergy is part of the Electromagnetic spectrum. Bioenergy and the magnetic field generated by electrical current are close to each other in the spectrum and closely mutually influence each other. My research has led me to believe that Bioenergy is more magnetic than electrical in its nature and may indeed be simply a true form of what we partially conceive of as magnetism. Magnetic fields can carry information, radio waves are an example of this. When a wave carries information through a magnetic field it is called a radio transmission. When a wave carries information through a Bioenergy field it is called radionic data.

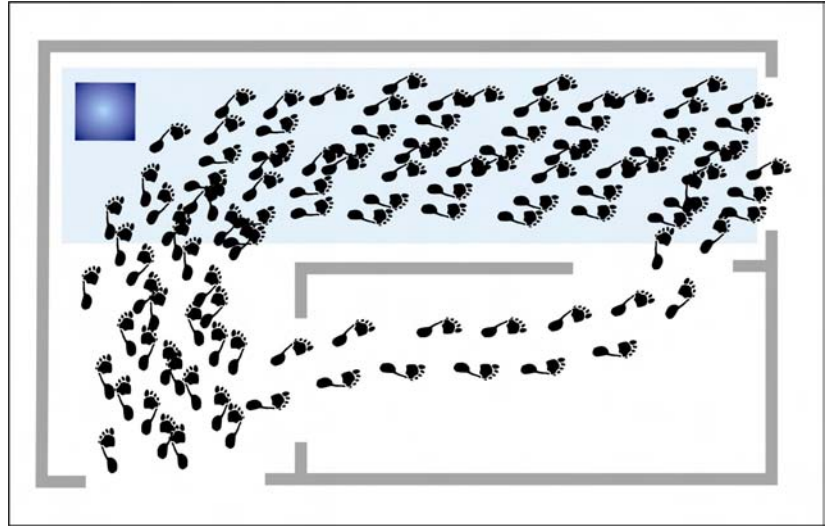

Different kinds of materials and life forms are associated with different wave patterns. Devices which process this energy from one form to another can change the wave pattern. This has an impact on living organisms within the region. It demonstrates the potential to create an area hospitable to a specific living organism, or inhospitable to a pest plant, animal or fungus.

Bioenergy wave patterns can have an adverse or beneficial impact on living organisms.

This effect could be developed to produce a microclimate inhospitable to pests and nurturing to cultivated species, and eliminate the need for many conventional methods of dealing with pest infestations. Potentially, a virus could be selectively targeted and eradicated in populations of livestock the same as in acres of plants, with less adverse side effects. Dependency on expensive and toxic pharmaceuticals can at least be significantly reduced by more cost-effective bioenergy-based technology.

Devices which both generate bioenergy and emit bioenergy wave patterns can be thought of as transmitting antennas, and the wave pattern is the signal to be transmitted.

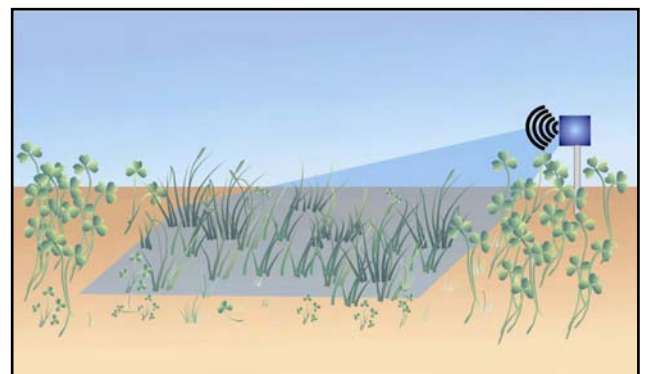

Devices can be constructed to target one wave pattern with another. An example is to use the wave pattern of a pesticide for the first, and the wave pattern of a pest organism for the second. The effect produced is usually reported to be similar to exposing the pest to the actual pesticide, while having less or no impact on other life forms in the treated area compared to conventional methods. Devices could be built to cover a plot of land with the effects of a fungicide or herbicide, without having to spray the field.

It is a well-established fact that Bioenergy can alter the flavor and subtle chemistry of water. This technology offers the potential to generate some or all of the effects of a chemical in a chemical process while reducing or eliminating the need for the chemical itself.

Imagine that the Bioenergy wave pattern (radionic data) produced by a certain element from the periodic table is used as a signal and transmitted. To varying degree, the presence of that element appears to be “simulated” in the area covered by the effect. I theorize that a subtle projected image of an atom is produced which can, under correct circumstances, behave at least partially like a real atom in a chemical process.

This application of bioenergy technology already enjoys considerable exposure in the alternative health > water treatment niche market on the internet. After reading this eBook, you will have the basic information required to make some simple bioenergy devices of your own without having to buy them from a vendor, or at least an idea of some intelligent questions to ask the vendor to determine the quality of the product. With further research into this aetherochemical effect, it is possible that many industrial dependencies on pharmaceuticals or petrochemicals could be reduced or eliminated. The potential industrial applications for this technology are virtually unlimited. Every day around the world a growing ever-growing number of people use radionics + homeopathy + ‘alternative’ energy methods for healing and other purposes. With the advent of Orgone Matrix Material, [Radionics machines](#) became much more powerful.

(<http://www.google.ca/search?hl=en&q=radionics+dowsing+psychotronic&meta=>)

Bioenergy fields are closely linked to weather patterns. They are affected by weather and have been repeatedly observed to manifest an effect on cloud and wind patterns by several independent researchers.

Bioenergy technology also has potential applications in maintaining a microclimate. This application offers the potential to attract clouds or repel storms and has a large area of effect. Devices can be constructed to alter prevailing wind and weather patterns within a region. These are significant capabilities for responsible use, and they need to be more fully understood.

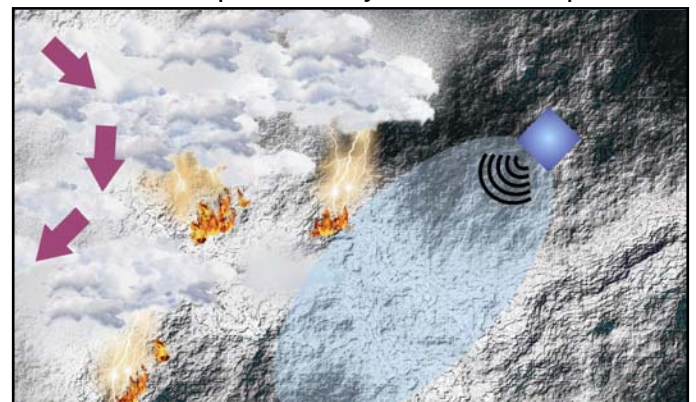
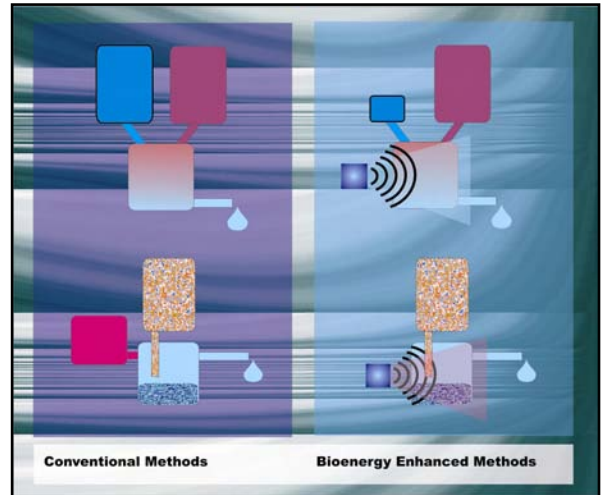

In nature, there are provisions for the Earth to ‘clean’ Bioenergy as it circulates. The friction of moving water over an irregular surface is one means that the planet uses to maintain its equilibrium with respect to Bioenergy fields. The discharge of energy during an electrical storm is another natural event that has the effect of creating a change to the surrounding bioenergy fields. The enhanced Bioenergy field strength in the air is something many people are able to ‘feel’ right before it rains.

Here is a simple application of the ability to change bioenergy from one state to another using Orgone Matrix Material. You can build a “TB”. This is a device which effectively cleanses Bioenergy and causes it to circulate more freely. These devices have a more natural interface with the Earth than the artists conception of a large scale Bioenergy weather effect (*of a kind documented now for about 70 years running without official recognition*) depicted above.



Insofar as their Bioenergy characteristics, TBs are safe for use by anyone, anywhere - in the opinion of the author. These both store a charge of Bioenergy and allow the energy to flow through them. The friction within them caused by metallic and organic components acts the same as the friction of water over rock in a riverbed, and allows the Earths Bioenergy field to clear itself of accumulated toxicity and harmful wave patterns. If one of these devices is placed in an area of stagnant Bioenergy (DOR) the initial effects can be quite dramatic, though by no means is this always the case nor need it be. Sudden changes to the Bioenergy field conditions can produce sudden changes in weather such as the break of a drought or the cessation of a flood, unusual and friendly responses in wildlife, immediate cessation of long felt pains from RF toxicity-related issues, and many other effects have been observed while placing these devices in heavily congested / polluted areas. Whether the installation (often called “gifting”) is dramatic or not, the end result is that the device blends in with the Earth’s natural system of Bioenergy Fields, and their behavior is regulated by the natural cycles of the Earths Bioenergy field.

This is why they do not come with a caution regarding responsible use as do many other more advanced bioenergy tools. You are not the one that controls this tool (TB / HHG), the earth’s natural energy field controls the device.

The device changes its Bioenergy throughput in response to systemic conditions. It becomes part of the Earth Bioenergy “circulation system” and assists in cleaning the Bioenergy as it passes through. This effect is currently used by many persons around the world to provide a constant cleaning effect to the bioenergy fields in and around their homes. This is an important benefit, and one well within the reach of anyone on a modest income with basic handyman skills (*or the desire to learn them*). You do not have to be a Subtle energy experimenter to use TBs or HHGs, or to benefit from this amazingly simple piece of SOLID STATE QUANTUM FLUX TECHNOLOGY that you can make in your garage, in a few hours over the weekend.

These things are easily made by anyone with basic handyman skills. A basic TB is a small (3 to 8 ounce volume), usually cylindrical or conical mass of a specific density of Orgone Matrix Material with a piece of quartz embedded in it. That’s it, in its most basic form.

Right now the Earth's system of self-repair is

severely taxed. TBs & similar devices offer a means of easing the strain placed on the Biosphere by environmental toxins and man made EMF pollution. The Bioenergy is constricted by the friction from the metal particles as it flows through the organic resin. The friction in the Orgone Matrix Material acts to substitute for the friction of moving water over a creek bed, and adds to the self-regulating capacity of the Earths Bioenergy System. Thousands of people from around the world have observed beneficial environmental

changes to the areas where they have been using these devices. The author is most definitely among them in that respect, though perhaps not on all matters philosophical, political or religious. The fact of people from diverse backgrounds observing similar effects from these simple devices moves the concept of a Biological Animative "Life-Energy" out of the realm of mystery and myth and firmly into the zone of real and comprehensible natural law.

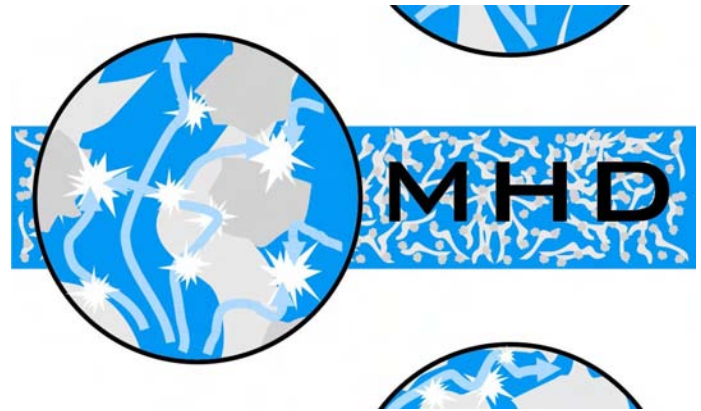

There are several different names, grades and densities of this material, but they all have one thing in common.

Orgone Matrix Materials are composed of a mixture of metallic particles suspended in an organic medium. There are a growing number of persons producing this material using the same basic concept. It is marketed under various trade names including Ergonite™ (from Wizzer's Workshop <http://www.littlemountainmudge.com>). Ergonite, Orgonite, Orgo-tech, Orgontech, Orgonlite, Orgone Material, all various trade names / trademarks for the same material. Orgonite was the first name I heard of for the material, through a man named [Karl Welz](#). He coined the term "Orgonite" back in the nineties and got a registered trademark for it recently.

In the interim, the word Orgonite became a defacto generic name for the material, and remains the most common name for it today regardless of product names used by different manufacturers. About 3.5 years after I had started working with Orgone Matrix Material I was shown some small blue ceramic spheres about 3/4" (19mm) diameter by [Ian Lundgold](#) (<http://www.mayanmajix.com/>) . He got them from a source dating back to the 30s or 40s and they were reportedly based on the work of [Wilhelm Reich](#) (<http://www.wilhelmreichmuseum.org/>). They were small cylinders of what I would call XHD (a very high density) Ergonite but the organic was clay instead of organic plastic resin. Even though I still feel that the stuff we are making now in the high densities is more potent per CC, it provides yet another confirmation of the theory behind Orgone Matrix Material.

For the most part, Orgonite was first widely publicized by Karl Welz as an enhancement to Radionics systems, and then more widely publicized by Don Croft as a means of restoring natural energy & weather patterns and combating atmospheric pollution (*see the section on chembusters and cloudbusters below*). In any case, these names refer to an orgone matrix material, as opposed to a layered orgone accumulator.

Orgone accumulators were invented by Wilhelm Reich about 70 years ago. Dr. Reich was able to condense Bioenergy to high levels within a container made of alternate layers of organic and metallic materials. He is also the man who named it “Orgone Energy” after becoming interested in it because of the emotional response and associated physiological changes it invoked in his patients. Later on, he was able to successfully treat cancer by exposing the subject to high concentrations of Bioenergy within his Orgone Accumulators (ORACs). They drew in energy from outside and concentrated it in a box. The box was made from many alternate layers of wood and metal (Organic and Metallic materials).

To a degree, a piece of Orgone Matrix Material will act as an orgone accumulator in that it will attract orgone from the area around it, but with an added dimension. The added dimension is that it will process the orgone energy as it interacts with it, whereas an orgone accumulator more simply condenses orgone energy. Once it attracts and absorbs enough energy for the matrix to become active, it begins to release energy again, and the energy leaving draws more energy along behind it. From that point, whether it flows really fast or really slow, Bioenergy will keep flowing through the device more or less continually.

One limitation of the ORAC is that it is highly sensitive to it’s environment, and most reputable persons using ORACs for therapy purposes take care to have the device located several miles away from any high levels of EM pollution. 60Hz electricity is known to produce wave patterns in Bioenergy that can be harmful. Today, some persons are beginning to make use of TB style devices in order to allow them to maintain a healthy Bioenergy field inside of their ORACs, and it is my hope that this trend will grow. It would allow for ORACs to be used in the average household without concern, making the ORAC a more practical means of health benefits, enhancing food or water or dealing with stress for the average person. Without a healthy local Bioenergy environment, there is the possibility that an ORAC can become ‘contaminated’ by DOR. DOR stands for Deadly Orgone Radiation, Bioenergy that is “flat-lined” by *(often by over-stimulation via electrical power and communications systems)* and has become stagnant.

The HAARP project and other large weaponized EM / Scalar projects of similar nature, as well as “normal” side effects from electrical power and communications systems ([just go google “haarp”](http://www.google.ca/search?hl=en&q=haarp&meta=) <http://www.google.ca/search?hl=en&q=haarp&meta=>) have created an environment where your personal Bioenergy fields and the Earth’s Bioenergy fields are under a constant **onslaught**. TBs can help to restore the balance of the Bioenergy fields in a localized area. One can purchase these devices from many online sources, but it is often more cost effective to make your own. You can make them for a cost of 0.50-2.00 CAD each depending on where you live *(a/o MAR 2005)*.

There are many variations on the basic concept of suspending the metal within the organic resin. Many other substances can be added to the mixture to make it more potent, or to specialize it for different applications. Most of the people producing it wind up developing their own exact recipes, I use several different recipes for different applications. At the end of the day, the basic, fundamental ingredients of orgonite are metal particles and an organic medium to suspend them in, usually polyester “Fiberglass” resin.

Here's a little about how it works: Organic substances attract Bioenergy and soak it up like a sponge, while metallic substances tend to repel it. Basically, Ergonite pulls in the Bioenergy, and while the energy is inside the device, The metal particles and organic resin both push and pull on it in all directions at the same time. This puts friction on the energy. The friction is great enough at many small points within the matrix to cause the energy to shift upwards in spectrum to Aether, so that it temporarily ceases to exist as a part of the electromagnetic spectrum. When the energy comes back out of the device, it collapses back into an organized, defined state and comes into existence as bioenergy / magnetism.

Quantum physicists have discovered that subatomic particles pop in and out of existence as the shift state back and forth between the states of matter and Aether. The same effects take place with waved energies in the electromagnetic spectrum. Different forms of energy appear and disappear as they shift in spectrum back and forth between Aether and lower spectral forms of energy. In the case of a TB, because of the density, when the bioenergy appears again, it has lost the radionic data it was carrying, the wave patterns it was carrying. Those wave patterns are a large part of what makes the bioenergy "healthy" or "unhealthy" for you and other life forms. This same Aetheric flux within the Ergonite has the effect not only of changing Bioenergy from one form to another, but also the property of 'generating' Bioenergy when stimulated by other kinds of energy... like light, sound, physical motion, or electricity.

Ergonite can change DOR (*harmful Bioenergy*) to OR (*Healthy Bioenergy*). When energy percolates through the matrix, it is in effect reduced to its component polarities. It is then recombined and emitted. The act of being broken down into its positive and negative charges and recombined has the effect of restoring the orgone to a 'base' state. Unless a specific wave pattern is impressed on it within the device, it comes out of the Orgone Matrix Material as more or less undifferentiated Bioenergy. When the energy exits the material, the conditions which 'force' it to exist in an undefined state no longer exist, and so it collapses back into a defined state, and is 'colored' (impressed with a Bioenergy wave pattern) to varying degree by the exact composition of the matrix material.

Many devices which employ Orgonite Matrix Material also function as Bioenergy Generators, But Ergonite does not actually generate Bioenergy, in the truest sense of the word. Ergonite, when excited with other forms of energy, both converts a portion of the energy used to excite it into bioenergy, and draws additional energy from the Aether, and releases it as Bioenergy. Having understood this, for practical intents and purposes, it can be said that Ergonite 'Generates Orgone' on demand when excited by scalar waves, magnetic fields, heat, sound, light, electrical energy, kinetic energy, and bioenergy.

TBs and HHGs - Devices that help to maintain your energy environment

The HHG (*'Holy hand grenade'-name inspired by Monty Python / inventor-Don Croft circa 2000, public domain*) is a medium-sized device which attracts harmful Orgone energy, converts it to healthy Orgone energy, and emits it again as a flow of healthy orgone energy. This is different from other techniques and devices used up to until the early 2000s for dealing with inimical Bioenergy. Up until this point, many Orgone-based devices including the majority of those still reproduced today according to Wilhelm Reich's specifications had the ability to block or collect harmful energy, but lacked the ability to convert it to healthy energy.

Ideally the HHG should be buried under a few inches of soil, or placed in a body of water. The Ergonite HHG will act to continuously clean the Orgone energy within a surprisingly large radius. There is a more pronounced effect right near the device, and many persons who consider themselves “insensitive” to subtle energy fields are able to sense the increased Bioenergy field density and flow surrounding the HHG or TB. But the effects are much broader when considered in a cumulative sense. Even if the “strong” part of the Bioenergy field from the HHG is only felt right up close to it, the EFFECTS of the HHG spread through the natural flow patterns of the background the surrounding area.

The background energy field over most large cities, is analogous to a large closed room with stagnant and polluted air. In fact, that’s not really a metaphor. The air over most large human population centers IS stagnant and polluted, and so it should be no surprise that so are the Bioenergy Fields. I’m not picking on people who live in cities, my point is this: If you put a fan/filter combination in the room and wait a while, the air is cleaner than when you started, even though the fan cleans only a little air at a time. After a while, the effects add up. Every thing above about HHGs applies also to TBs. A TB (*“Tower Buster” name in reference to HPRF and “Cell towers” / inventor - Don Croft circa 2000*) does basically the same thing on a little bit smaller scale.

A basic TB is a small (*3 to 8 ounce volume, usually cylindrical or conical*) mass of MHD Ergonite with a quartz piece embedded in it. A basic HHG is a little larger (*8 to 32 ounce volume, usually conical or pyramidal*) mass of orgonite with one large or several small (*min volume ` 5 Cubic Centimeters*) quartz pieces embedded in it. The original design was 5 DT Quartz Xtals, one on the vertical axis and four on the horizontal axis. The vertical xtal is near one end of the device (*the small end of a cone or pyramid*), and the horizontal xtals are arranged radially, near the wide end of the device

Think of them as air freshener for your aura.

You can use the same basic device to enhance meditation, reduce stress or assist physical healing by strengthening and cleaning your body’s bioenergy fields. Hold it between the hands while meditating, or sit within a few feet of it. Many people now place them under their beds. Another popular use of them is in the home garden, to increase the overall vitality of plants growing within a few feet of the device.

Here’s how to make them. If you don’t want to make your own, there are several online sources listed at the links page of Wizzer’s Workshop:

<http://www.littlemountainmudge.com/links.htm>

Note: To make the right density of Orgone Matrix Material for basic HHGs and TBs you need to use metal particles that are between ~1/4” (6mm) x 1/4” (6mm) and 1/2” (12mm) x 1/2” (12mm) and have a bit of curvature. You should still be able to see a fair amount of open space (shoot for 50%) between the metal shavings when they are shaken together in a container. You can use any metal. Aluminum is fine. Gold is best. Use what is available to you.

Simple TB Instructions	Quantity per TB:
Item:	
-Low Quality Clear Quartz Crystal/Chunk, min volume 1 Cubic Centimeter	- 1
- Polyester "Fiberglass" Resin & enough MEKP Catalyst to cure it	- About 3 Ounces
- Metal particles	- About 3 Ounces of metal particles
- Suitable container to use for a mold (small paper cup or old muffin tray)	- 1 (min. volume about 3 ounces)

1 - Line the containers you will use for molds with a light coat of vegetable oil. This prevents the resin from sticking. Wipe the excess oil off with a brush or clean cloth. cover the surface of the mold evenly.



2 - Put about 1" of metal particles in the bottom of each mold.



3 - Place the quartz crystal in each mold, using the metal shavings to hold it in position. put the crystal in the center of the mold, and if the crystal has a good point on it, most folks put the point towards what will be the top of the unit.

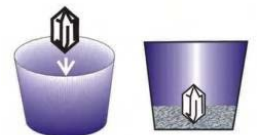

4 - Mix enough resin and catalyst to fill each mold level with the metal shavings you have placed in the bottom. Pour enough resin into each mold to cover the shavings. Make sure to mix the resin and catalyst well (mix for about 1 full minute) before you pour it into the molds. Allow the resin to run down into the metal shavings. Tap or shake the mold gently to release air bubbles.



5 - Add another inch or so of metal shavings to each container, enough to cover the crystal.



6. - Mix and add enough catalyzed resin to cover the metal shavings in the molds. It will not harm the function of the device if some metal filings stick out the bottom, but it is a good idea to use enough resin to cover the shavings by about ¼ inch (6mm). Allow the resin to run down into the metal filings. Tap or shake the mold gently to release air bubbles.



7. - Allow the resin to cure. Keep it warm if possible, cure in a well-ventilated area, and if possible, expose the resin to sunlight while it is curing.

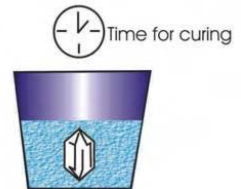

8. - Remove from the mold. That's it!

It may seem anticlimactic, but this is a simple, proven and reliable method of making Bioenergy-based tools to produce a beneficial change in your immediate surroundings. Just because the physics and metaphysics behind it are complex does not need that the device itself needs to be complicated.

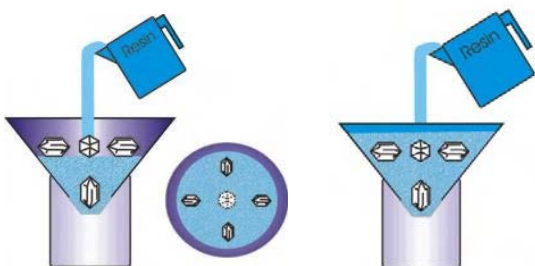

The above process can be easily modified to make an HHG as shown at left. For more detailed information on Bioenergy technology, Ergonite and Tutorials for making your own more advanced Bioenergy tools, visit <http://www.littlemountainsmudge.com/ebooks.htm> .

Links to more information on Wilhelm Reich and Orgone Energy:

<http://www.wilhelmreichmuseum.org/> <http://www.orgone.org/> <http://www.orgonelab.org/>

To use one of these devices, simply place the device within the area you want to treat and leave it alone.

If possible, it increases the effectiveness to put them into a body of water or bury them in the earth. It is not absolutely necessary to bury them or put them in water, but you should take it outside and let it sit on the ground for the night at least twice a year. Most folks who use them have a few in their homes, to provide a constant cleaning action for the orgone envelope in their living space. With the HHGs, it helps a bit to align the device with the magnetic field of the earth, so that one of the xtals in the base of the unit points north. People who are familiar with natural energy vortices, Curry and Hartman lines, Ley lines, and so forth have been using these devices to restore many of the earth's energy centers to healthy state.

Many of us have noticed beneficial changes in the emotional state and general behavior of people & animals within the effective range of such devices, whether they are aware of the devices presence or not. They are, in effect- getting the same sort of emotional healing and balancing (and in some cases the commensurate physical benefits) that one would expect from more traditional methods of life energy therapy such as reiki or dowsing or treatment with radionics or medical DOR Busters. For several years I used xtals for basic pain relief, and now most of the tools I use incorporate Ergonite in some way.

Smaller versions of the TB - style device can be carried on your person in order to afford a constant cleaning action for your personal energy fields, and provide shielding against various forms of energy assault, ranging from conscious radionic attack to EM pollution.

I have noticed that suspending water over the top of an HHG changes the flavor and sometimes the clarity of the water. Treatment time depends on water volume in proportion to available energy. The easiest way to do this is to make a disk-shaped TB and just set a glass food jar full of water on top of the TB. For ` 1 Quart / 1 L of water a treatment time of 3 to 4 hours ought to be enough. If you taste it and the water tastes worse than when you started, let it sit for a while longer and taste it again. It may get worse in taste temporarily during the first half of the treatment time. Generally I have been able to soften and sweeten water this way. It should taste sweet and you may experience a slight flush a few seconds after drinking the water. For this method of charging water with Bioenergy, you should not use water that was undrinkable before the charging treatment.

The general consensus concerning the effects of these simple devices (*Distilled from 3 years of observations and first-hand reports by 1500+ people from all over the world, communicating by a grapevine of chat rooms, message boards, and email*) is distilled below in point form.

- Increases the body's self-repair capacity in a physical sense
- Causes unresolved emotional issues to surface (sometimes in dreams) and be dealt with
- Causes an increase in the frequency of lucid dreaming & helps to deal with stress
- Increases overall vitality of plants in a small localized region
- Tends to stabilize or smooth out violent weather patterns in a larger localized region
- Decreases observable smog / chemtrails / whiteout, especially when used in conjunction with Chembusters and when devices are intelligently dispersed though a reasonably large geographical area.
- Occasional cleansing reactions, a short period wherein the body kicks out toxins, followed by a upswing in general vigor and energy
- Enhances Meditation

There are several folks who find a TB to be useful in Reiki, Reflexology, Massage Therapy, Healing Hands, and other systems which effect healing by working with the human body's orgone energy fields.

Unlike orgone accumulators, TBs and HHGs do not have to be carefully protected from EM pollution and DOR. Rather they convert DOR to a healthy state, so I think it is a good idea for most everyone to make at least one or two and put them near their homes.

Every day, we all take a bath in more energy pollution than most folks care to think about.

These devices have been repeatedly shown to have a localized beneficial effect on the life energy of almost any area. They have also been developed and adapted to many uses beyond the original purpose for them, which is to restore natural weather patterns to the environment around us by mitigating or nullifying the effects of harmful large scale electromagnetic technology.

I have seen no evidence that HHGs or TBs will become saturated with DOR from prolonged exposure, but I have seen that such devices have a processing capacity, and that capacity may be exceeded. I have been able to deal with that in most cases by simply using more devices. The capacity of the device is determined by the mass of the device, (larger mass of Ergonite = more capacity) the way the internal components are assembled, and the composition of the Ergonite itself.

The reason they work better when buried is that then they have a direct connection to the Bioenergy currents in the Earth and a solid electrical ground. The Bioenergy 'resistance' of air is higher than the orgone 'resistance' of earth. Therefore, when the energy flows through the HHG or TB, it can flow a little more quickly if it is buried, because it has a huge potential (the earth or the body of water) to which it is grounded. Even so, just tossing TBs into a problem area works fine in the short term. Good thing, because there are many places where burying them is impractical. If possible, toss them where they will land in water (best) or on earth, as opposed to pavement.

Chembusters and Cloudbusters

There is a lot of controversy on this subject now, and to be honest I consider it important to distinguish between a

Croft-style [Chembuster](http://educate-yourself.org/ct/goodbyects10jan02.shtm)

(<http://educate-yourself.org/ct/goodbyects10jan02.shtm>)

and a **Reich-style [Cloud Buster](http://www.orgone.org/IOOeng/cb.htm)**

(<http://www.orgone.org/IOOeng/cb.htm>).

They are indeed different in function.

A Cloud Buster is a device invented by Wilhelm Reich about seventy years ago, and it uses orgone energy to influence weather patterns. It is basically an array of parallel pipes which are temporarily connected by means of rubber or other organic hoses to either an ORAC or a body of moving water. When the device is to be used it is assembled and then it is taken apart again when not in use. You need to know what you are doing to use a Cloud Buster. It relies on the circulation of orgone energy within the water bodies of the earth to process the orgone by virtue of the action of moving water over stone, this action takes place in riverbeds especially.

A Chembuster is a slightly different device, which is based on the Cloud Buster in that it uses a parallel array of pipes to channel orgone energy, in order to affect the weather patterns in the area around it. The main difference between a Cloud Buster and a Chembuster are that a Chembuster has a ballast of Ergonite, while a Cloud Buster is grounded directly from the pipes to the earth, or water. And since Ergonite processes orgone energy instead of simply collecting it or moving it around, a Chembuster cleans the orgone as it passes through and tends to be controlled by the Earth's natural Bioenergy fields the same as TBs and HHGs. You do not have to know what you are doing in order to use a chembuster, despite what some supposedly knowledgeable persons may say.

Cloudbusters and Chembusters generally pull energy down from the atmosphere and channel it into the Earth. Under some conditions it is possible for both devices to work in the opposite direction and send orgone from the Earth into the atmosphere. In both cases, it is the changing orgone fields which affect weather patterns. I do not approve of novices using Reich-style Cloudbusters, but I do approve of just about anyone using Chembusters. This is because a Chembuster is a great deal more user-friendly than a Cloud Buster. A Cloud Buster, used carelessly, can cause tornadoes, imbalances in the earth's orgone fields, and torrential rains or severe droughts. It is nonetheless a very useful device, but one which requires knowledge both of meteorology and bioenergy dynamics in order to operate properly. The Chembuster, on the other hand, functions more like a 'safety release valve' between the earth and atmosphere, so that it becomes more active when there is a large unbalance in the ambient orgone fields and less active when the energy around it is in a balanced and healthy state.

It is possible to further enhance the function of a Chembuster by grounding it to the earth. After experimenting with it for some time, I generally ground the organite base of my Chembuster instead of grounding the pipes, because if you ground the pipes, then the device will appear to work more rapidly, but what it is actually doing is dumping the excess energy into the ground rather than processing it. In my opinion, grounding the copper pipes directly is no better than a Reich style cloud buster. You can either attach a length of copper wire to the Ergonite, or just set the base into the soil a few inches.

Here are some links websites where you can find out more about using Bioenergy Technology specifically to help restore the Bioenergy conditions in your area to a healthy state. Bear in mind that these groups represent a diverse group of people with many differences in opinion / beliefs / state of mind / politics / etc. Use your own discretion to separate fact from fantasy and be prepared to encounter some people with sizable egos and questionable sanity, as well as some people with abundant brilliance and deep compassion for the human race, and everywhere in between.

They are a spectrum of persons ranging from the brightest and best to the most pitiful and paranoid. But all these people have witnessed some kind of beneficial personal result from using the technology described here, it's one of the **only things they mostly agree on**.

<http://proliberty.com/observer/20030512.htm>

<http://groups.yahoo.com/group/cloudbusters/>

http://groups.yahoo.com/group/Educate-Yourself_Forum

<http://groups.yahoo.com/group/ricksgardeningtips>

<http://groups.yahoo.com/group/chemtrailtrackingusa3/>

http://health.groups.yahoo.com/group/W_V/

<http://forums.quebecorgone.com/index.php> (French Language)

<http://chemtrails.erazor-zone.de/links.htm> (German Language)

<http://www.egelforum.com.ar/forum/> (Spanish Language)

<http://www.littlemountainsmudge.com> (page of many more links)

<http://www.elementals-astrology.co.uk/orgone.html> (page of many more links)

http://groups.yahoo.com/group/psychic_lobbyists/

<http://ethericfreedomfighters.moonfruit.com/>

<http://www.ethericwarriors.com/>

MHD - Medium High Density Ergonite

MHD orgonite is imo the most efficient type of Ergonite from which to make TBs, HHGs, Chembusters and other devices which operate in a passive mode. MHD Ergonite offers just low enough orgone resistance to operate in a passive mode, but offers high enough orgone resistance to afford the 'scrubbing' action desired.

Note - "resin" below refers to catalyzed 'Fiberglass' resin. Proportions of ingredients are approximate.

Particle sizes are given as follows :

fine = 0 - 1mm dia.

small = 1 - 5 mm dia.

large = 5 - 15 mm dia..

Basic MHD Ergonite

Ingredient	Amount in parts by volume	Process	Comments
Aluminum Large	1.5	Mix steel and aluminum particles together. Place mixture into molds. Add xtals / other internal components as applicable. Mix catalyst and resin. Add Quartz Powder to catalyzed resin and stir thoroughly. Pour resin Over metal particles and allow to seep down. Repeat layers as necessary.	A good fool-proof recipe. 
Steel Small (optional)	1		
Quartz Powder Fine (optional)	.01 - .25		
Polyester 'Fiberglass' Resin & MEKP Catalyst	To fill molds		

You can find more detailed information on making Ergonite at <http://www.littlemountainmudge.com/ebooks.htm>

If you are familiar with bioenergy and Ergonite already, you may know that exposing the Ergonite to a radionic wave pattern while the resin cures can increase the potency of the device. With MHD, this is not as important as with some other densities. For the purpose of simplicity, information on the charging / curing process is not included in this book, but is available from the link above. The fidelity of radionic data retention is much better with higher densities of Ergonite, though admittedly it can be also used to enhance the effectiveness of TBs. The reason for this decision is to underscore the point that one does not have to be a mental adept or alternative scientist to reap the benefits of these simple tools.

Bioenergy Induced Micro-Crop Circle - Confirmation of subtle energy in action

This was kind of an interesting thing that happened in the backyard a while ago... The same night as the 'meteor impact' of June 03 2004 near Washington state, this formation appeared in some grass in my backyard. It has the earmarks of the much larger and more well-know crop circles, such as bent but not broken nodes, grass which continues to grow, and a weaving pattern among the blades of grass which is complex enough it is difficult to photograph. The patch of grass that it appeared in is a patch of grass which I let grow instead of mowing. The pattern formed was a spiral vortex with the plants bending at the second and third nodes mostly. The spiral was interwoven in layers in the stalks of grass.

It appeared in a spot where I had my [chembuster](#) for about a year, I moved the chembuster to the other side of the yard a few months before the formation appeared. Large pic shows the way it looked when it first appeared.

I think that anytime an orgone field reaches sufficient strength and excitation, then there is a possibility for that field to be expressed in the plants DNA. I think that as the energy intensity in the earth's bioenergy and electromagnetic fields continues to build, more formations like this will be observed, if indeed they are not being already. Smaller pic shows some changes that appeared and some nodes. The nodes in the squared part of the formation appeared to keep bending over a period of several days. The initial spiral pattern formed overnight.

Did you find this information Useful? You can make a donation by visiting www.littlemountainsmudge.com/info.htm



I hope that you enjoyed this free eBook. Once the changes to our product line are complete, Wizzer's Workshop will continue offering advanced and highly functional Bioenergy tools including Radionics machines, The Orgone Field Pulser, and at least one economical model of TB or HHG. Wizzer's We will also be offering a series of comprehensive eBooks in PDF format detailing the theory and construction process for several pieces of Bioenergy Technology. To download the other free eBook or find more detailed information, visit <http://www.littlemountainsmudge.com/ebooks.htm> now!

Legal notice:

Wizzer's Workshop™, Ergonite™, Welzite™, and all text / images on littlemountainsmudge.com, unless clearly otherwise stated, are copyright 2002-2005 Jon Logan, all rights reserved.

Limited authorization to reproduce: This material may be reproduced or reprinted freely, in whole or in part, in printed paper or digital format for educational purposes.

Additionally, the trademarks Ergonite™ and Welzite™ may be used freely by anyone for private or commercial purposes, so long as they are specifically used to refer to Orgone Matrix Material, a mixture of metal particles suspended in organic resin.

Owner of copyright for text and images on littlemountainsmudge.com and trademarks used on littlemountainsmudge.com reserves the right to refuse, suspend or revoke limited authorization to reproduce this material if the material is reproduced inaccurately, or if is sold at a cost in excess of it's production without prior written consent from Wizzers Workshop / Jon Logan.

Ergonite™ is a trademark belonging to Karl Welz and is used on littlemountainsmudge.com and possibly in this document for educational purposes.

Email – wizzer@littlemountainsmudge.com

Phone – 250-446-2032

Mail – PO Box 139, Westbridge BC V0H2B0

Url – www.littlemountainsmudge.com

How to Beat Energy Pollution second edition copyright ©2002-2005 Jon Logan





Modern Orgone™

APPLIED LIFE ENERGY JOURNAL © ISSUE # 5



Tourmaline, Natural Source of Negative Ions & Far-IR

VOD Project Updates



Wilbert Smith Gravity Control



Scalar Beam Chembuster

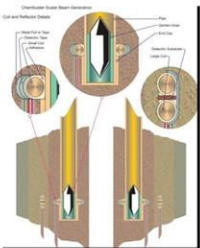

Herman Meinke Orgone Devices

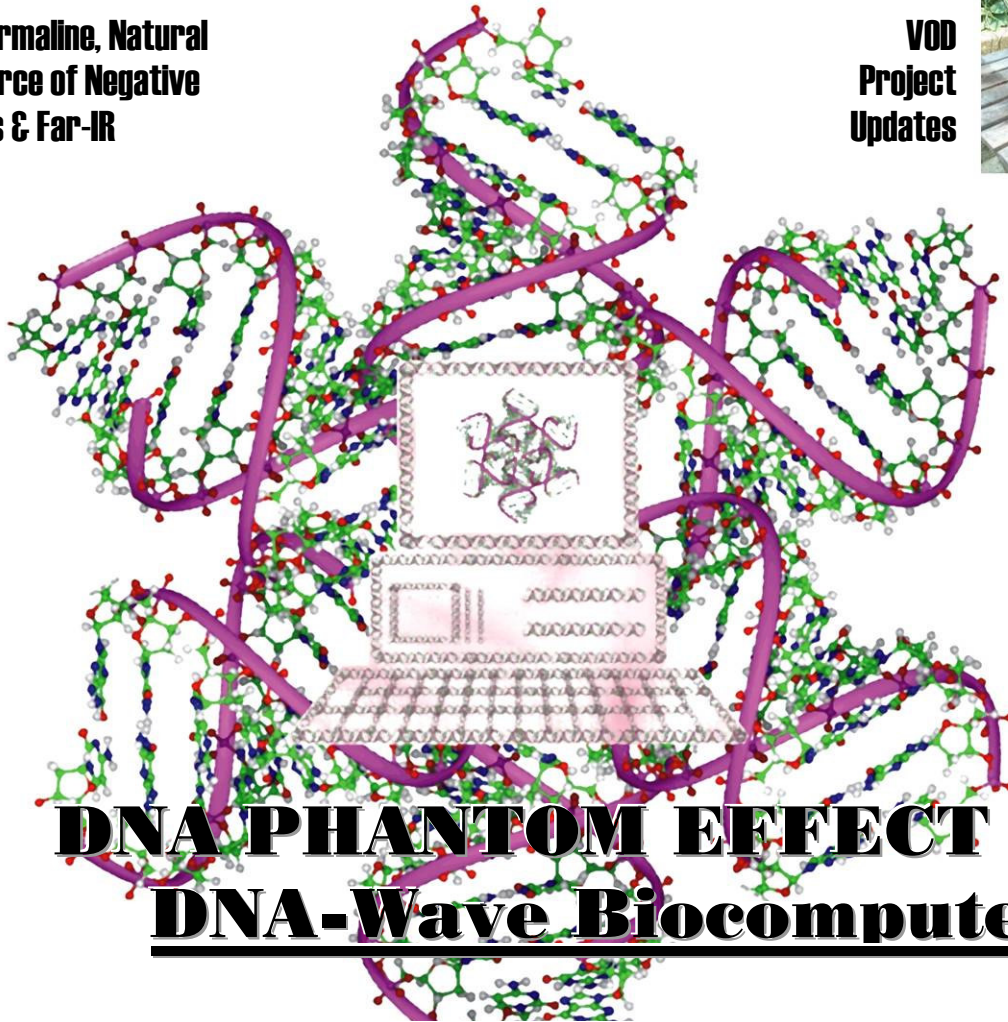
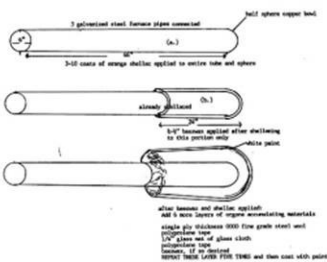

DNA PHANTOM EFFECT & DNA-Wave Biocomputer

PRELIMINARY STUDY OF LIFE-ENERGY™ ASSOCIATED WITH ORGONITE AND ORMUS BY QUANTITATIVE DOWSING

Radionics theory - Sampling and Recording Quantum Data Structures

MRET PLANS - VLF FUNCTION GENERATOR - HHG TIPS - INTELLIGENT PULSARS - THE ARTICLE THAT STARTED THE (2ND) CHEMTRAIL DEBATE

Modern Orgone Electronic Magazine Issue # 5

©2005-2008 Wizzers Workshop / Wizzers Desk and contributing authors / photographers all rights reserved

Modern Orgone Electronic Magazine™ Issue # 5 2005-2008 Wizzers Workshop™ and contributing authors / artists all rights reserved - Individual contributed articles may have copyrights which precede their publication in this magazine and where applicable are reprinted with permission and / or in accordance with fair use by Wizzers Workshop™. This is an opt-in research journal and distributes information for the purposes of fostering scholarly and experimental research. Modern Orgone™ is independently published by Wizzers Desk™ / Wizzers Workshop™ / Jon Logan. The views expressed are the opinion of the contributing author. All contributed articles/images are the intellectual/artistic property of the contributor. The finished issue or example or volume of this publication is copyrighted material belonging to Jon Logan / Wizzers Workshop™. Wizzers Workshop™ is not necessarily affiliated with contributing authors and may or may not share their views. Readers are entirely responsible for their own discretion, discernment, legality and safety in attempting to reproduce any experiments described in Modern Orgone Electronic Magazine, or in attempting to apply any information of any kind contained in Modern Orgone Electronic Magazine™. Modern Orgone Electronic Magazine™ / Wizzers Workshop™ / Wizzers Desk™ and all related Contributing Authors / Electronic Media Distribution Agents / eBook Listing Websites collectively assume no liabilities for any damages of any kind resulting from the use or abuse of the information / theory / techniques or other topic covered in the content of Modern Orgone Electronic Magazine. By acting on this content in any way you warrant that you agree to the following 4 points: 1 - you accept responsibility for the karmic / energetic / physical / legal ramifications of your experiments or other actions, 2- you are of legal age or acting with the consent of a parent or guardian where applicable, 3 - you are interested in applied metaphysical / alternative science subject matter and acting of your own free will, 4 - you will indemnify and hold blameless the aforementioned (Modern Orgone Electronic Magazine™ / Wizzers Workshop™ / Wizzers Desk™ and all related Contributing Authors / Electronic Media Distribution Agents / eBook Listing Websites). This document may only be reproduced legally by the retail purchaser or authorized sales agent. The purchaser may make backup digital copies or paper hard copies of this document in accord with terms and conditions of sale for their own personal use. Contact Modern Orgone Electronic Magazine™ PO Box 139 Westbridge BC Canada V0H2B0 modernorgone@littlemountainmudge.com <http://www.littlemountainmudge.com> telephone contact message Canada Pacific Time Zone 250-446-2032

Better Late Than Never

Tourmaline Gives Off Far-IR Light

Around 1986, it was found in a research station in Japan that, even though tourmaline was broken down in smaller pieces, a positive and a negative electrode existed on both end of the crystal, and the electrodes never disappeared unless tourmaline was boiled near 1000°C...In addition, when the positive and the negative electrodes of a tourmaline crystal were connected to each other, it was proven to show low electricity of 0.06mA.

DNA Phantom Effect

This new phenomenon—the DNA phantom effect—was first observed in Moscow at the Russian Academy of Sciences as a surprise effect during experiments measuring the vibrational modes of DNA in solution using a sophisticated and expensive “MALVERN” laser photon correlation spectrometer (LPCS) [5]. These effects were analyzed and interpreted by Gariaev and Poponin [6].

The new feature that makes this discovery distinctly different from many other previously undertaken attempts to measure and identify subtle energy fields [1] is that the field of the DNA phantom has the ability to be coupled to conventional electromagnetic fields of laser radiation and as a consequence, it can be reliably detected and positively identified using standard optical techniques.

The Quantum Data Structure

The Quantum Data Structure signal is the ‘organizational data field employed in radionics’, and known by several other names. Since the sciences of radionics, dowsing, homeopathy and psionics do not enjoy accreditation, most researchers and innovators have created their own names for the forces, energy forms and relationships involved. By any name, this signal is inherent to all material objects, events and energy forms perceivable from within a material reality.

Front Cover Art 'DNA Desktop' Copyright 2007 Jon Logan all rights reserved

Rear Cover Photo – 1 of 2 Albino Moose photographed near Bevedell, B.C. Canada in February 2007

In This Issue *scroll down or click on title to read articles*

Cover Story

(4) [The DNA PHANTOM EFFECT: Direct Measurement of A New Field in the Vacuum Substructure](#)

by Dr. Vladimir Poponin

(7) [The DNA-wave Biocomputer](#)

Peter P. Gariaev*, Boris I. Birshtein*, Alexander M. Iarochenko*, Peter J. Marcer**, George G. Tertishny*, Katherine A. Leonova*, Uwe Kaempf***.

(19) [DNA Is Created As A Wave](#)

From © [Divine Cosmos.com](#)

Forward courtesy [Sean Sands](#)

Modern Orgone Technology

(22) [Sampling and Recording Quantum Data Structures](#)

By Jon Logan

(37) [Low Frequency Function Generator](#)

By Pieter Fourie

Orgone Matrix Material Shop

(40) [HHG Tips](#)

By Jon Logan

(46) [Scalar Beam Chembuster Modifications](#)

By Jon Logan

Real Deal Radionics

(52) [Andrija Puharich: ELF Shield](#)

Courtesy [Rex Research](#)

(65) [Herman MEINKE Orgone Devices](#)

Courtesy [Rex Research](#)

Dowsing & Radiesthesia -

(75) [A Preliminary Study of the "Life-Energy" associated with Orgonite and Ormus by means of a Quantitative Dowsing Method](#)

By [Roger Taylor](#), addendum by James Lyons

Got Orgone?

(80) [Updates on the VOD project](#)

By Alan D Otterson

Aether & Bioenergy Theory

(57) [Wilbert Smith: Gravity Control \(and more\)](#)

Courtesy [Rex Research](#)

Politics of Free Will

(86) [Had Enough?](#)

By Lee Iacocca with Catherine Whitney

(89) [Internet Doomsday Creeps Closer](#)

by Steve Watson [Infowars.net](#)

New Paradigm Consciousness

(92) [Chemtrails - Facts, Plagiarism, And Propaganda](#)

By Margareta- Erminia Cassani

Metaphysical Adventures

(107) [Book Review](#) By Zuermnovahh-Starr Livingstone - Decoding the Message of the Pulsars, Intelligent Communication From the Galaxy by Paul A. LaViolette, PH.D.

(108) [The Rise And Fall Of Continents](#)

By Zuermnovahh-Starr Livingstone

Bonus Features

(111) [Tourmaline - A source of Far Infrared \(FIR\) and Negative Ions](#)

By Thomas Aaron

(112) [Bio-Magnetic Hydrology: MRET Smirnov The Effect of a Specially Modified Electromagnetic Field on the Molecular Structure of Liquid Water](#)

by Dr. Igor V. Smirnov, Ph.D. & M.S

(114) [Tourmaline \(chemical / mineral info\)](#)

Courtesy Wikipedia

Drawing Board

(118) [MRET with Orgone Matrix Material & LED - Construction Details](#)

Courtesy Thomas Aaron

(121) [Simple Random Number Algorithm](#)

By Jon Logan

[Open Source Car](#) / [Ornithopter](#) / [Spiral Paraffin Molecules](#) / [Pocket FM Jammer](#) / [Lab Ball Lightning](#) / [Cheap Desktop Fabber](#) / [Plastic Strip Recordings](#) / [DCA Cancer Trials](#) / [Poor NASA](#) / [DIY Brain Trust](#) / [Giants In America](#) / [Google Hell](#) / [Treating The Dead](#) / [Vacuum Gap Electronics](#) / [New Electron Wave](#) / [Hollow Earth Revisited](#) / [Silver Particle Clothing](#) / [Light, Matter, ZPE](#) / [Cheap Battery Source](#) / [Overunity Water Heater](#) / [Sixth Sense Radar](#) / [Word Finder](#) / [Quotes](#) / [Note to Self](#) / [43 Uses for WD-40](#) / [Farmer Joe](#) / [Homeopathy Confirmed Empirically](#) / [He Put It Well](#) / [Near Disaster](#) / [Reader Response to Anomalous Cooling](#) / [The Husband Store](#)

Cover Story - part 1

TWM [TOC](#)

www.rialian.com/rnboyd/dna-phantom.htm

The DNA PHANTOM EFFECT: Direct Measurement of A New Field in the Vacuum Substructure

by Dr. Vladimir Poponin

INTRODUCTION

In this contribution I am going to describe some observations and interpretations of a recently discovered anomalous phenomenon which we are calling the DNA Phantom Effect in Vitro or the DNA Phantom for short. **We believe this discovery has tremendous significance for the explanation and deeper understandings of the mechanisms underlying subtle energy phenomena including many of the observed alternative healing phenomena** [1,2]. This data also supports the heart intelligence concept and model developed by Doc Lew Childre [3,4]. (See also contributions by Rollin McCraty and Glen Rein in this volume).

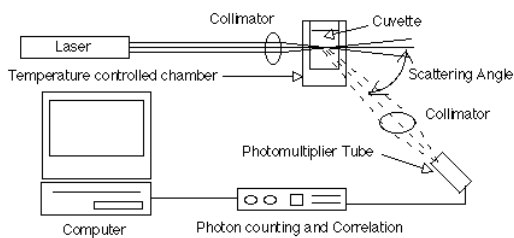

Figure 1. Illustrates a simplified block diagram of the laser photon correlation spectrometer used to detect the DNA phantom.

© 1995 Institute of HeartMath, Boulder Creek, CA

(figure 1-

<http://www.rialian.com/rnboyd/dnafig1.gif> - ed)

This new phenomenon—the DNA phantom effect—was first observed in Moscow at the Russian Academy of Sciences as a surprise effect during experiments measuring the vibrational modes of DNA in solution using a sophisticated and expensive “MALVERN” laser photon correlation spectrometer (LPCS) [5]. These effects were analyzed and interpreted by Gariaev and Poponin [6].

The new feature that makes this discovery distinctly different from many other previously undertaken attempts to measure and identify subtle energy fields [1] is that the field of the DNA phantom has

the ability to be coupled to conventional electromagnetic fields of laser radiation and as a consequence, it can be reliably detected and positively identified using standard optical techniques.

Furthermore, it seems very plausible that the DNA phantom effect is an example of subtle energy manifestation in which direct human influence is not involved. These experimental data provide us not only quantitative data concerning the coupling constant between the DNA phantom field and the electromagnetic field of the laser light but also provides qualitative and quantitative information about the nonlinear dynamics of the phantom DNA fields. **Note that both types of data are crucial for the development of a new unified nonlinear quantum field theory which must include the physical theory of consciousness** and should be based on a precise quantitative background.

RESULTS

The background leading to the discovery of the DNA phantom and a description of the experimental set up and conditions will be helpful. A block diagram of the laser photon correlation spectrometer used in these experiments is presented in Figure 1.

In each set of experimental measurements with DNA samples, several double control measurements are performed. These measurements are performed prior to the DNA being placed in the scattering chamber. When the scattering chamber of the LPCS is void of physical DNA, and neither are there any phantom DNA fields present, the autocorrelation function of scattered light looks like the one shown in [Figure 2a](#). This typical control plot represents only background random noise counts of the photomultiplier. Note that the intensity of the background noise counts is very small and the distribution of the number of counts per channel is close to random. [Figure 2b](#) demonstrates a typical time autocorrelation function when a physical DNA sample is placed in the scattering chamber, and typically has the shape of an oscillatory and slowly exponentially decaying function. When the DNA is removed from the scattering chamber, one anticipates that the autocorrelation function will be the same as before the DNA was placed in the scattering chamber. Surprisingly and counter-intuitively it turns out that the autocorrelation function measured just after the removal of the DNA from the scattering chamber looks distinctly different from the one obtained before the DNA was placed in the chamber. Two

examples of the autocorrelation functions measured just after the removal of the physical DNA are shown in Figures 2c and d. After duplicating this many times and checking the equipment in every conceivable way, we were forced to accept the working hypothesis that some new field structure is being excited from the physical vacuum. We termed this the DNA phantom in order to emphasize that its origin is related with the physical DNA. We have not yet observed this effect with other substances in the chamber. After the discovery of this effect we began a more rigorous and continuous study of this phenomena. We have found that, as long as the space in the scattering chamber is not disturbed, we are able to measure this effect for long periods of time. In several cases we have observed it for up to a month. It is important to emphasize that two conditions are necessary in order to observe the DNA phantoms. The first is the presence of the DNA molecule and the second is the exposure of the DNA to weak coherent laser radiation. This last condition has been shown to work with two different frequencies of laser radiation.

Perhaps the most important finding of these experiments is that they provide an opportunity to study the vacuum substructure on strictly scientific and quantitative grounds. This is possible due to the phantom field's intrinsic ability to couple with conventional electromagnetic fields. The value of the coupling constant between the DNA phantom field and the electromagnetic field of the laser radiation can be estimated from the intensity of scattered light. The first preliminary set of experiments carried out in Moscow and Stanford have allowed us to reliably detect the phantom effect; however, more measurements of the light scattering from the DNA phantom fields are necessary for a more precise determination of the value of the EMF-DNA phantom field coupling constant.

THEORY

It is fortunate that the experimental data provides us with qualitative and quantitative information about the nonlinear dynamical properties of the phantom DNA fields. Namely, these experimental data suggest that localized excitations of DNA phantom fields are long living and can exist in non-moving and slowly propagating states. This type of behavior is distinctly different from the behavior demonstrated by other well known nonlinear localized excitations such as solitons which are currently considered to be the best explanation of

how vibrational energy propagates through the DNA.

It is a remarkable and striking coincidence that a new class of localized solutions to anharmonic Fermi-Pasta-Ulam lattice (FPU) - nonlinear localized excitations (NLE), which have been recently obtained [7], demonstrate very similar dynamical features to those of the DNA phantom. Nonlinear localized excitations predicted by the FPU model also have unusually long life-times. Furthermore, they can exist in both stationary or slowly propagating forms. In Figure 3 (image missing - ed.), one example of a NLE is shown which illustrates three stationary localized excitations generated by numerical simulation using the FPU model [7]. It is worthy to note that this NLE has a surprisingly long life-time. Here, we present only one of the many possible examples of the patterns for stationary excitations which are theoretically predicted. Slowly propagating and long lived NLE are also predicted by this theory. Note that the FPU model can successfully explain the diversity and main features of the DNA phantom dynamical patterns. This model is suggested as the basis for a more general nonlinear quantum theory which may explain many of the observed subtle energy phenomena and eventually could provide a physical theory of consciousness.

XTREMEMIND

<http://www.xtrememind.com/>

"Electric power is everywhere present in unlimited quantities and can drive the world's machinery without the need of coal, oil, gas, or any other of the common fuels."

- Nikola Tesla

"At any point and at any time, one can freely and inexpensively extract enormous EM energy flows directly from the active vacuum itself."

-Tom Bearden

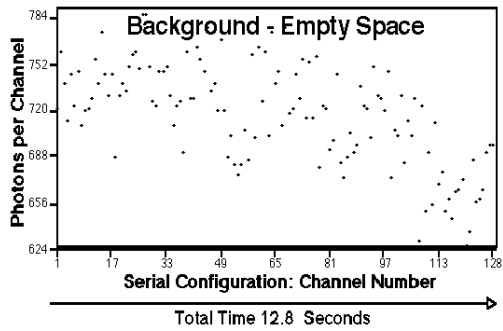

(a) MALVERN <<< K7032 >>> Version 2.1 Date 18-09-1991 Time 10:49:08
Correlator 1 Sample Time per Channel (mS) = 100
Auto-correlation

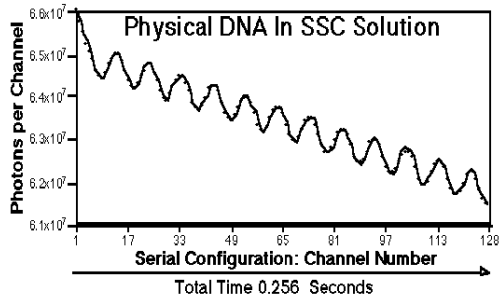

(b) MALVERN <<< K7032 >>> Version 2.1 Date 14-12-1990 Time 12:25:07
Correlator 1 Sample Time per Channel (mS) = 2.0
Auto-correlation

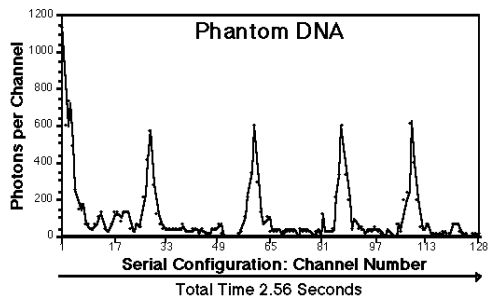

(c) MALVERN <<< K7032 >>> Version 2.1 Date 23-11-1992 Time 13:37:28
Correlator 1 Sample Time per Channel (mS) = 20
Auto-correlation

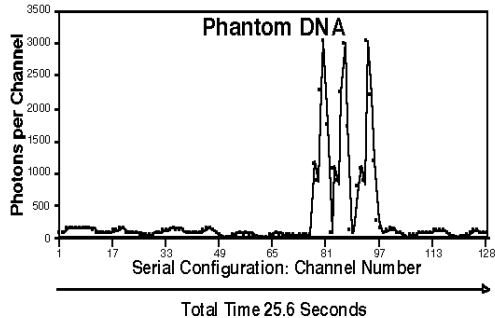

(d) MALVERN <<< K7032 >>> Version 2.1 Date 23-11-1992 Time 14:26:53
Correlator 1 Sample Time per Channel (mS) = 200
Auto-correlation

Figure 2. The top (a) plot illustrates a typical background or control when there is not any physical DNA or the presence of DNA phantom in the scattering chamber. The next plot (b) is typical when physical DNA is placed in the chamber and the bottom plots (c & d) show examples of the DNA phantom effect. Note that in these plots the cuvette containing the physical DNA has been removed from the scattering chamber.

© 1995 Institute of HeartMath, Boulder Creek, CA

According to our current hypothesis, the DNA phantom effect may be interpreted as a manifestation of a new physical vacuum substructure which has been previously overlooked. It appears that this substructure can be excited from the physical vacuum in a range of energies close to zero energy provided certain specific conditions are fulfilled which are specified above.

Furthermore, one can suggest that the DNA phantom effect is a specific example of a more general category of electromagnetic phantom effects [8]. This suggests that **the electromagnetic phantom effect is a more fundamental phenomenon which can be used to explain other observed phantom effects including the phantom leaf effect and the phantom limb [9].**

Dr. Poponin is a quantum physicist who is recognized world wide as a leading expert in quantum biology, including the nonlinear dynamics of DNA and the interactions of weak electromagnetic fields with biological systems. He is the Senior Research Scientist at the Institute of Biochemical Physics of the Russian Academy of Sciences and is currently working with the Institute of HeartMath in a collaborative research project between IHM and the RAS. He can be contacted at Institute of HeartMath, Research Division, 14700 West Park Ave. Boulder Creek, CA 95006. Phone 408-338-8700, Fax 408-338-1182.

References

1. W.A. Tiller. What Are Subtle Energies? Journal of Scientific Exploration. Vol.7, p.293-304 (1993).
2. G. Rein and R. McCraty. Structural Changes in Water and DNA Associated with New Physiologically Measured States. Journal of Scientific Exploration. Vol.8, 3 p.438 (1994).
3. D.L. Childre. Self Empowerment. Boulder Creek: Planetary Publications, 1992.
4. S. Paddison. The Hidden Power of the Heart. Boulder Creek: Planetary Publications, 1992.
5. P.P. Gariaev, K.V. Grigor'ev, A.A. Vasil'ev, V.P. Poponin and V.A. Shcheglov. Investigation of the Fluctuation Dynamics of DNA Solutions by Laser Correlation Spectroscopy. Bulletin of the Lebedev Physics Institute, n. 11-12, p. 23-30 (1992).
6. P.P. Gariaev and V.P. Poponin. Vacuum DNA phantom effect in vitro and its possible rational explanation. Nanobiology 1995 (in press).
7. V.P. Poponin. Modeling of NLE dynamics in one dimensional anharmonic FPU-lattice. Physics Letters A. (in press).
8. V. Tatur. The secrets of new thinking. Progress Publisher, Moscow, 1990, 200 p. (Russian).
9. J. K. Chouldhury et al., J. Inst. Eng. (India). 1979, v. 60, Pt EL3, p. 61-73.

www.rialian.com/mboyd/dna-phantom.htm

Cover Story - part 2 **TOC**

<http://www.rialian.com/rnboyd/dna-wave.doc>

The DNA-wave Biocomputer

Peter P. Gariaev*, Boris I. Birshtein*, Alexander M. Iarochenko*, Peter J. Marcer**

George G. Tertishny*, Katherine A. Leonova*, Uwe Kaempf***

Institute Control of Sciences Russian Academy of Sciences, Moscow, Russia gariaev@aha.ru ,

<http://www.aha.ru/~gariaev> , and

Wave Genetics Inc. 87 Scollard Street, Toronto, Ontario, Canada, M5R 1G4,

gariaev@wavegenetics.com ,

**53 Old Vicarage Green, Keynsham, Bristol, BS31 2DH, UK,

petermarcer@aikido.freeserve.co.uk ,

<http://www.bcs.org.uk/cybergroup.htm> .

*** Institut f. Klinische, Diagnostische und Differentielle Psychologie-
Am Falkenbrunnen - D-01062 Dresden TU, Dresden, Germany,
uwe@psy1.psych.tu-dresden.de

Abstract

This paper reports experimental work carried out in Moscow at the Institute of Control Sciences, Wave Genetics Inc. and theoretical work from several sources. This work changes the notion about the genetic code essentially. It asserts: -

- 1) That the evolution of biosystems has created genetic “texts”, similar to natural context dependent texts in human languages, shaping the text of these speech-like patterns.
- 2) That the chromosome apparatus acts simultaneously both as a source and receiver of these genetic texts, respectively decoding and encoding them, and
- 3) That the chromosome continuum of multicellular organisms is analogous to a static-dynamical multiplex time-space holographic grating, which comprises the space-time of an organism in a convoluted form.

That is to say, the DNA action, theory predicts and which experiment confirms,

- i) is that of a “gene-sign” laser and its solitonic electro-acoustic fields, such that the gene-biocomputer “reads and understands” these texts in a manner similar to human thinking, but at its own genomic level of “reasoning”. It asserts that natural human texts (irrespective of the language used), and genetic “texts” have similar mathematical-linguistic and entropic-statistic characteristics, where these concern the fractality of the distribution of the character frequency density in the natural and genetic texts, and where in case of genetic “texts”, the characters are identified with the nucleotides, and ii) that DNA molecules, conceived as a gene-sign continuum of any biosystem, are able

to form holographic pre-images of biostructures and of the organism as a whole as a registry of dynamical “wave copies” or “matrixes”, succeeding each other. This continuum is the measuring, calibrating field for constructing its biosystem.

Keywords: *DNA, wave-biocomputer, genetic code, human language, quantum holography.*

1. What Theory Predicts.

1.1 Introduction.

How did this new theory take shape? The principle problem of the creation of the genetic code, as seen in all the approaches [Gariaev 1994; Fatmi et al. 1990; Perez 1991; Clement et al. 1993; Marcer, Schempp 1996; Patel, 2000] was to explain the mechanism by means of which a third nucleotide in an encoding triplet, is selected. To understand, what kind of mechanism resolves this typically linguistic problem of removing homonym indefiniteness, it is necessary firstly to postulate a mechanism for the context-wave orientations of ribosomes in order to resolve the problem of a precise selection of amino acid during protein synthesis [Maslow, Gariaev 1994]. This requires that some general informational intermediary function with a very small capacity, within the process of convolution versus development of sign regulative patterns of the genome-biocomputer endogenous physical fields. It lead to the conceptualization of the genome’s associative-holographic memory and its quantum nonlocality. These assumptions produce a chromosome apparatus and fast wave genetic information channels connecting the chromosomes of the separate cells of an organism into a holistic continuum, working as the biocomputer, where one of the field types produced by the chromosomes, are their radiations. This postulated capability of such “laser radiations” from chromosomes and DNA, as will be shown, has already been demonstrated experimentally in Moscow, by the Gariaev Group. Thus it seems the accepted notions about the genetic code must change fundamentally, and in doing so it will be not only be possible to create and understand DNA as a wave biocomputer, but to gain from nature a more fundamental understanding of what information [Marcer in press] really is! For the Gariaev Group’s experiments in Moscow and Toronto say that the current understanding of genomic information i.e. the genetic code, is only half the story [Marcer this volume].

1.2 What experiment confirms, part one.

These wave approaches all require that the fundamental property of the chromosome apparatus is the nonlocality of the genetic information. In particular, quantum nonlocality/teleportation within the framework of concepts introduced by Einstein, Podolsky and Rosen (EPR) [Sudbery 1997; Bouwmeester et al. 1997]. This quantum nonlocality has now, by the experimental work of the Gariaev Group, been directly related (i) to laser radiations from chromosomes, (ii) to the ability of the chromosome to gyrate the polarization plane of its own radiated and occluded photons and (iii) to the suspected ability of chromosomes, to transform their own genetic-sign laser radiations into broadband genetic-sign radio waves. In the latter case, the polarizations of chromosome laser photons are connected nonlocally and coherently to polarizations of radio waves. Partially, this was proved during experiments *in vitro*, when the DNA preparations interplaying with a laser beam ($\lambda = 632.8$ nm), organized in a certain way, polarize and convert the beam simultaneously into a radio-frequency range. In these experiments, another extremely relevant phenomenon was detected: photons, modulated within their polarization by molecules of the DNA preparation. These are found to be localized (or “recorded”) in the form of a system of laser mirrors’ heterogeneities. Further, this signal can “be read out” without any essential loss of the information (as theory predicts [Gariaev 1994; Marcer, Schempp 1996]), in the form of isomorphously (in relation to photons) polarized radio waves. Both the theoretical and experimental research on the convoluted condition of localized photons therefore testifies in favour of these propositions.

These independently research approaches also lead to the postulate, that the liquid crystal phases of the chromosome apparatus (the laser mirror analogues) can be considered as a fractal environment to store the localized photons, so as to create a coherent continuum of quantum-nonlocally distributed polarized radio wave genomic information. To a certain extent, this corresponds with the idea of the genome’s quantum-nonlocality, postulated earlier, or to be precise, with a variation of it.

This variation says that the genetic wave information from DNA, recorded within the polarizations of connected photons, being quantum-nonlocal, constitutes a broadband radio wave spectrum correlated - by means of polarizations - with the photons. Here, the main information

channel, at least in regard to DNA, is the parameter of polarization, which is nonlocal and is the same for both photons and the radio waves. A characteristic feature is, that the Fourier-image of the radio spectra is dynamic, depending essentially on the type of matter interrogated. It can therefore be asserted, that this phenomenon concerns a new type of a computer (and biocomputer) memory, and also a new type of EPR spectroscopy, namely one featuring photon-laser-radiowave polarization spectroscopy. The fundamental notion is, that the photon-laser-radiowave features of different objects (i.e. the Fourier-spectra of the radiowaves of crystals, water, metals, DNA, etc) are stored for definite but varying times by means of laser mirrors, such that the “mirror spectra” concern chaotic attractors with a complex dynamic fractal dynamics, recurring in time. The Gariaev Group experiments are therefore not only unique in themselves, they are a first example, that a novel static storage/recording environment (laser mirrors) exists, capable of directly recording the space-time atomic/molecular rotary dynamical behaviour of objects. Further the phenomena, detected by these experiments described in part two, establish the existence of an essentially new type of radio signal, where the information is encoded by polarizations of electromagnetic vectors. This will be the basis of a new type of video recording, and will create a new form of cinema as well.

Further experimental research has revealed the high biological (genetic) activity of such radio waves, when generated under the right conditions by DNA. For example, by means of such artificially produced DNA radiations, the super fast growth of potatoes (up to 1 cm per day) has been achieved, together with dramatic changes of morphogenesis resulting in the formation of small tubers not on rootstocks but on stalks. The same radiations also turned out to be able to cause a statistically authentic “resuscitation” of dead seeds of the plant *Arabidopsis thaliana*, which were taken from the Chernobyl area in 1987. By contrast, the monitoring of irradiations by polarized radio waves, which do not carry information from the DNA, is observed to be biologically inactive. In this sequence of experiments, additional evidence was also obtained in favour of the possibility of the existence of the genetic information in form of the polarization of a radio wave physical field. This supports the supposition that the main information channel in these experiments is the biosign modulations of polarizations mediated by some version of quantum nonlocality. A well known fact can therefore be seen in new light, namely, that the

information biomacromolecules - DNA, RNA and proteins - have an outspoken capacity to optical rotatory dispersion of visible light and of circular dichroism. Similarly, the low molecular components of biosystems, such as saccharides, nucleotides, amino acids, porphyrins and other biosubstances have the same capacity; a capacity, which until now made little biological sense. Now, however, it supports, the contention that this newly detected phenomenon of quantized optical activity can be considered as the means by which the organism obtains unlimited information on its own metabolism. That is, such information is read by endogenous laser radiations of chromosomes, which, in their turn, produce the regulative ("semantic") radio emission of the genome biocomputer. Furthermore, the apparent inconsistency between the wavelengths of such radiations and the sizes of organisms, cells and subcell structures is abrogated, since the semantic resonances in the biosystems' space are realized not at the wavelength level, but at the level of frequencies and angles of twist of the polarization modes. This mechanism is the basis for the artificial laser-radio-wave *vitro-in vivo* scanning of the organism and its components.

However, chromosome quantum nonlocality as a phenomenon of the genetic information is seen as particularly important in multicellular organisms and as applying on various levels.

The 1-st level is that the organism as a whole. Here nonlocality is reflected in the capacity for regeneration, such that any part of the body recreates the whole organism, as, for example, in case of the worm *Planaria*. That is to say, any local limiting of the genetic information to any part of a biosystem is totally absent. The same concerns the vegetative reproduction of plants.

The 2nd level is the cellular level. Here it is possible to grow a whole organism out of a single cell. However with highly evolved animal biosystems, this will be a complex matter.

The 3rd level is the cellular-nuclear level. The enucleation of nuclei from somatic and sexual cells and the subsequent introduction into them of other nuclei does not impede the development of a normal organism. Cloning of this kind has already been carried out on higher biosystems, for example, sheep.

The 4th level is the molecular level: here, the ribosome "would read" mRNA not only on the

separate codons, but also on the whole and in consideration of context.

The 5th level is the chromosome-holographic: at this level, a gene has a holographic memory, which is typically distributed, associative, and nonlocal, where the holograms "are read" by electromagnetic or acoustic fields. These carry the gene-wave information out beyond the limits of the chromosome structure. Thus, at this and subsequent levels, the nonlocality takes on its dualistic material-wave nature, as may also be true for the holographic memory of the cerebral cortex [Pribram 1991; Schempp 1992; 1993; Marcer, Schempp 1997; 1998]

The 6th level concerns the genome's quantum nonlocality. Up to the 6th level, the nonlocality of bio-information is realized within the space of an organism. The 6th level has, however, a special nature; not only because it is realized at a quantum level, but also because it works both throughout the space of a biosystem and in a biosystems own time frame. The billions of an organism's cells therefore "know" about each other instantaneously, allowing the cell set is to regulate and coordinate its metabolism and its own functions. Thus, nonlocality can be postulated to be the key factor explaining the astonishing evolutionary achievement of multicellular biosystems. This factor says that bioinformatic events, can be instantaneously coordinated, taking place "here and there simultaneously", and that in such situations the concept of "cause and effect" loses any sense. This is of a great importance! The intercellular diffusion of signal substances and of the nervous processes is far too inertial for this purpose. Even if it is conceded that intercellular transmissions take place electro-magnetically at light speeds, this would still be insufficient to explain how highly evolved, highly complex biosystems work in real time [Gariaev 1994; Ho 1993]. The apparatus of quantum nonlocality and holography is in authors' view, indispensable to a proper explanation of such real time working. The 6th level therefore says, the genes can act as quantum objects, and that, it is the phenomenon of quantum non-locality/teleportation, that ensures the organism's super coherency, information super redundancy, super knowledge, cohesion and, as a totality or whole, the organism's integrity (viability).

Indeed it can be said that this new understanding of biocomputers, constitutes a further step in a development of computer technology in general. An understanding that will bring about a total

change of the constituent basis of that technology, in the history of analogue > to > digital > to > now, the figurative semantic (nonlocal) wave computer or biocomputer. This biocomputer will be based on new understanding of the higher forms of the DNA memory, and the chromosome apparatus, as the recording, storing, transducing and transmitting system for genetic information, that must be considered simultaneously both at the level of matter and at the level of physical fields. The latter fields, having been just studied, as showed experimentally in this research, are carriers of genetic and general regulative information, operating on a continuum of genetic molecules (DNA, RNA, proteins, etc). Here, previously unknown types of memory (soliton, holographic, polarization) and also the DNA molecule, work both as biolasers and as a recording environment for these laser signals. The genetic code, considered from such a point of view, will be essentially different from today's generally accepted but incomplete model. This, the wave-biocomputer model asserts, only begins to explain the apparatus of protein biosynthesis of living organisms, providing an important interpretation for the initial stages within this new proposed composite hierarchic chain of material and field, sign, holographic, semiotic-semantic and, in the general case, of figurative encoding and deciphering chromosome functions. Here the DNA molecules, conceived as a gene-sign continuum of any biosystem, are able to form pre-images of biostructures and of the organism as a whole as a registry of dynamical "wave copies" or "matrixes", succeeding each other. This continuum is the measuring, calibrating field for constructing any biosystem.

1.3 Features of the Wave Model

Adleman [1994], for example, has used the mechanism for fast and precise mutual recognition between the DNA anti-parallel half-chains to solve the "the travelling salesman's problem". However in the wave model of biosystems, this is only one aspect of the self-organization taking place. For here, as the experimental evidence now confirms, the mutual recognition of one DNA anti parallel half chain (+) by the other (-) concerns special super persistent/resonant acoustic-electromagnetic waves or solitons. Such DNA solitons have two connected types of memory. The first is typical of the phenomenon discovered by Fermi-Pasta-Ulam (FPU) [Fermi, 1972]. It concerns the capability of non-linear systems to remember initial modes of energisation and to periodically repeat them

[Dubois 1992]. The DNA liquid crystals within the chromosome structure form such a non-linear system. The second is that of the DNA-continuum in an organism. Such memory is an aspect of the genome's nonlocality. It is quasi-holographic/fractal, and relates, as is the case for any hologram or fractal, to the fundamental property of biosystems i.e. to their ability to restore the whole out of a part. This property is well known (grafting of plants, regeneration of a lizard's tail, regeneration of a whole organism from the oocyte). And a higher form of such a biological memory would be a holographic (associative) memory of the brain cortex, i.e. of its neural network [Pribram 1991; Schempp 1992; Marcer Schempp 1997, 1998; Sutherland 1999]. Such wave sign encoding/decoding therefore, like DNA's ability to resolve "the travelling salesman's problem", is, it can be hypothesized, an integral part of DNA's computational biofunctionality. Indeed DNA solitary waves (solitons), and in particular, the nucleotide waves of oscillatory rotation, "read" the genome's sign patterns, so that such sign vibratory dynamics may be considered as one of many genomic non-linear dynamic semiotic processes. The expression "DNA's texts", borrowed earlier as a metaphor from the linguists, is it turns out therefore related directly to actual human speech. For as mathematical-linguistic research into DNA and human speech textual patterns, shows [Maslow, Gariaev 1994] the key parameter of both such patterns is fractality. It can therefore be hypothesized that the grammar of genetic texts is a special case of the general grammar of all human languages.

Returning however to DNA computation based on matter-wave sign functions with a view to realizing its wave coding capabilities, as distinct those used by Adleman, which might be termed its matter capabilities. Such true wave control capabilities of the DNA or chromosomes are, we hypothesize, those conditions that apply inside the living cell, i.e. in an aqueous solution but which correspond to a liquid-crystal condition as well. For under such conditions, in the unique circumstances of cell division, the living cell has the ability to replicate itself, and has the property of what in relation to a self replicating automaton, von Neumann [1966] called "universal computer construction" so that we may say that the living cell is such a computer based on DNA [Marcer Schempp 1997a]. And while the artificial cloning of a single cell is not yet feasible, what we have been able to do, is to record the DNA-wave information appropriate to these wave sign conditions of the DNA in a cell on laser

mirrors, and to use, for example, the recorded DNA-wave information from living seeds in the form of radio waves to resuscitate the corresponding “dead” seeds damaged by radioactivity.

The next step forward is therefore to bring into general use, such wave information and memory as now newly identified in relation to DNA and gene structure. Such applications could be on the basis of, for example,

- i) The FPU-recurrence phenomenon, and/or,
- ii) The ability to record holograms, as well as,
- iii) The recording the polarization-wave DNA’s information onto localized photons.

Regarding volume and speed, such memory could exceed many times over the now available magnetic and optical disks, as well as current classical holographic systems. But in particular, such applications may employ the principles of quantum nonlocality. For DNA and the genome have now been identified as active “laser-like” environments, where, as experimentally shown, chromosome preparations may act as a memory and as “lasers”, with the abilities i), ii) and iii) above. And finally there are the quasi-speech features of the DNA, as these concern both natural gene texts, and artificial (synthesized) sign sequences of polynucleotides, which emulate natural quasi-speech gene programs. However, we believe this maybe a rather dangerous path, where a regulatory system of prohibitions on artificial wave genes is indispensable. The reason is that such an approach to DNA-wave biocomputation means entering new semiotic areas of the human genome and the biosphere in general; areas, which are used by the Nature to create humankind. This thought follows from the theoretical studies on a collective symmetry of the genetic code as carried out by the Eigen’s laboratory [Scherbak, 1988] at the Max Planck Institute in Germany. This research shows, that the key part of the information, already recorded and still being recorded as quasi-speech in the chromosomes of all organisms on our planet, may concern semantic exobiological influences, since in regard to DNA-wave biocomputation, DNA acts as a kind of aerial open to the reception of not only the internal influences and changes within the organism but to those outside it as well. Indeed we regard this as one of our primary findings, which in view of quantum nonlocality of organisms extends not only to the organism’s local environment, but also beyond it to the extent of the entire universe.

With reference to what we have said already, it is possible to offer the following perspectives on the sign manipulations with gene structures.

1. Creation of artificial memory on genetic molecules, which will indeed possess both fantastic volume and speed.

2. Creation of biocomputers, based on these totally new principles of DNA-wave biocomputation, which use quantum teleportation [Sudbury 1997] and can be compared to the human brain regarding methods of data processing and functional capabilities.

3. The implementation of a remote monitoring of key information processes inside biosystems by means of such artificial biocomputers, resulting in treatments for cancer, AIDS, genetic deformities, control over socio-genetic processes and eventually prolongation of the human life time.

4. Active protection against destructive wave effects, thanks to wave-information channel detectors.

5. Establishing exobiological contacts.

2. What Experiment Confirms, part two, the Experiments

Some of the experiments and computer simulations carried out in Moscow are now described. They set out in more detail how the understanding in sections 1. was arrived at. These descriptions concern the specific apparatus used and results obtained, together with computer simulations carried out to validate specific aspects of the developing understanding,



(above –ed.) Photograph 1. This first picture shows a photograph of the experimental apparatus. The principal elements are a laser, the light of which is

directed through a lens system and a DNA sandwich sample as shown diagrammatically below.

(below –ed.) Diagram 1. Illustrates the workings of the experiment which employs a dynamic light scattering system of the type Malvern.

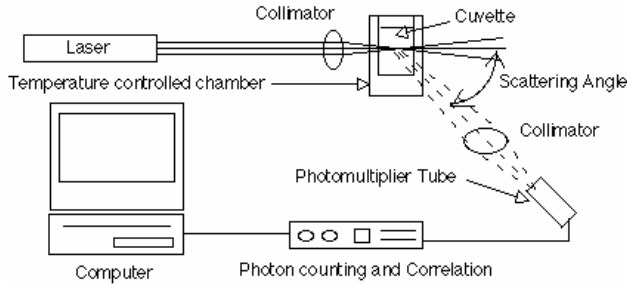

This understanding is then compared in section 3 with an entirely independently researched perspective obtained by Marcer, and Schempp [1996].

This shows the scattering by the DNA sample of the laser light, which is then guided through another lens system into the type Malvern analysing device, which counts the photons registered in different serial channels. The results of two experiments are shown at end of paper: the first entitled “Background - Empty Space”, done without a DNA sample, and the second, with it in place, entitled “Physical DNA in SSC Solution”.

The latter has the typical form of a periodically reoccurring pattern, which is of the same functional type as found in an autocorrelation. Such regularly occurring periodic patterns have an interpretation in terms of the phenomenon of so-called Fermi-Pasta-Ulam recurrence, which concerns solitonic waves. That is to say, this interpretation says that roughly speaking, the DNA, considered as a liquid-crystal gel-like state, acts on the incoming light in the manner of a solitonic Fermi-Pasta-Ulam lattice, as illustrated here:

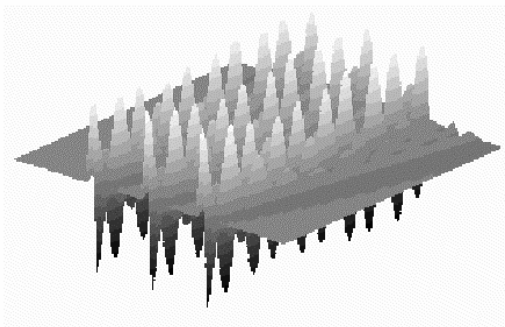

Figure: Synonymy versus Homonymy

Asp	Gln	Lys	Gln	Gln	Gis	Leu	Phe	Ileu	Met
GAc	GAA	AAc	AAA	CAA	CAC	UUA	UUC	AUA	AUG
GAd	GAG	AAo	AAg	CAG	CAo	UUG	UUo	AUc	ATp

Arg	Ser	Trp	Stop	Tyr	Stop
AGs	AGc	UGs	UGs	UAc	UAs
AGc	AGc	UGc	UGc	UAc	UAc

Synonymy ↑

Homonymy →

The leading question, if this is the case, is what could such action achieve? The starting idea was that it must be concerned with the reading of the genetic texts encoded in the DNA, where however this language metaphor is now applied directly to these texts. That is to say, rather than the usual analogy taking such texts as a digital computer language or symbolic instruction code, such texts are considered instead as having the semantic and generative grammatical features of a spoken or written context dependent human language. That is, we conceived of the DNA acting in the same way as the human would, when presented with a text from a good book on a fascinating theme, which, as it is read, invokes actual 3 dimensional pictures/images in the mind’s eye.

The reason for this choice concerned the problem in DNA coding raised by the question of synonymy and homonymy as it applies to the third element/codon of the codon triplets. For while, see figure below, synonymy even seems to provide a kind of redundancy, homonymy constitutes a serious difficulty under the often proposed postulate that only the first two elements of the DNA codon triplet (standing for a particular protein- the picture in the mind’s eye, so to speak) are the significant ones. That is to say, how does the reading ribosome know which protein has to be generated, if the third nucleotide in codon’s triplet does not of itself provide the answer with total certainty? The proposed answer was, that this ambiguity might be resolved by some kind of context dependent reading similar to that inherent in human speech and language understanding. Satisfyingly, this need to explain how such context-dependent reading might be implemented in the DNA reduplication/reading process, as will be shown, led back to the experimental evidence as presented above, for it supports the postulate that such context dependent reading of the DNA is indeed best understood in the framework of a biosolitonic process model.

A soliton is an ultra stable wave train often with a seemingly simple closed shape, which can arise in the context of non-linear wave oscillations. It actually consists of a rather complexly interrelated assembly of sub wave structures, which keep the whole solitonic process in a stationary state over a comparatively long time. In the literature, a soliton is often described as an entity, which is neither a particle nor a wave in much the same way as is a quantum, for it, too has wave/particle duality. It can also be a means to carry information. Solitonic processing in DNA, would therefore, it was hypothesized, relate, in one of its aspects, the reading of the codons, to quantum computing [Patel 2000], and this could therefore concern the soliton viewed as the travelling "window", that opens in the double helix structure as the reading takes place, as is illustrated below:

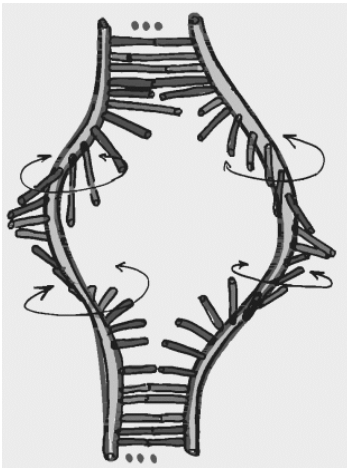

It was therefore decided to model this reading process as a complex mechanical oscillator [Gariaev 1994], capable of producing solitonic wave transmissions, which takes the form of a system of rotary pendulums, like

those in a certain type of pendulum clock, as illustrated,



to see if the computer simulations could shed more light on just what might be happening in the DNA. In the basic model, illustrated and shown below, each of the oscillatory movements of each element of the linked chain of oscillators depends heavily on the motion of its neighbours, and on the differences in the specific weights of the elements. Imagine now that the DNA forms such a kind of pendulum, whilst the intertwined helices/chains are opened at one particular section to provide the travelling window, as in the previous figure. That is to say, the model to be simulated is a chain of non-linear oscillators, the four types of which can be identified with the Adenine (A), Cytosine (C), Guanine (G), and Thymine (T) or Uracil (U) components DNA, all having different spatial structures and masses, and where there is a travelling window opened in the double helix. Such a model allows a rather complex pattern of oscillation in the DNA chain of elements, depending on the actual layout of the elements as specified by the actual genetic code sequence involved. The window as it travels, is therefore highly context dependent.

Starting at the following sequence:

(5' начало) ⇒ GGC CTA TGT GGA GAG GAT GAA CTA CGT
 GCA CCG AGA CCT GCG GGC GGC CAA CAT CCT GGT GGG GGA
 GAA CCT GGT GTG CAA GGT GGC TGA CTT TGG GCT GGC ACG
 CCT CAT CGA GGA CAA CGA GTA CAC AGC ACG GCA AGG TGC
 AAG TTC CCC ATC AAG TGG AGA GCC CCC GAG GCA GCC CTC
 TAT GGC CGG TTC ACC ATC AAG TCG GAT GTC TGG TCC TTC
 GGC ATC CTG CTG ACT GAG CTG ACC ACC AAG GGC CGG GTG
 CCA TAC CCA GGG ATG GGC AAC GGG GAG GTG CTG GAC CGG
 GTG GAG AGG GGC TAC CGC ATG CCC TGC CCG CCC GAG TGC
 CCC GAG TCG CTG CAT GAC CTT ATG TGC CAG TGC TGG CGG
 AGG GAC CCT GGA GGA GCG GCC CAC TTT TCG AGC TAC CTG
 CAG GCC CAG CTG CTC CCT GCT TGT GTG TTG GAG GTC GCT
 GAG TAG TGC GCG AGT AAA ATT TAA GCT ACA ACA AGG CAA
 GGC TTG ACC GAC AAT TGC ATG AAG AAT CTG CTT AGG GTT
 AGG CGT TTT GCG CTG CTT CGC GAT GTA CCG GCC AGA TAT
 ACG CGT ATC TGA GGG GAC TAG GGT GTG TTT AGG CGA AAA
 GCG GGG CTT CGG TTG TAC GCG GTT AGG AGT CCC CTC AGG
 ATA TAG TAG TTT CGC TTT TGC ATA GGG AGG GGG AAA TGT
 AGT CTT ATG CAA TAC TCT TGT AGT CTT GCA ACA TGG TAA
 CGA TGA GTT AGC AAC ATA CCT TAC AAG GAG AGA AAA AGC
 ACC GTG CAT GCC GAT TGG TGG AAG TAA GGT GTA CGA TCG
 TGC CTT ATT AGG AAG GCA ACA GAC CGG GTC TGA CAT GGA
 TTG GAC GAA CCA CTG AAT TCC GCA TCG CAG AGA TAT TGT
 ATT TAA GTG CCT AGC TCG ATA CAA TAA ACG CCA TTT GAC
 CAT TCA CCA CAT TGG TGT GCA CCT GGG TTG ATG GCT GGA
 CCG TCG ATT CCC TAA CGA TTG CGA ACA CCT GAA TGA AGC
 AGA AGG CTT CAT ← 1020 (3'-конец)

the figures, which follow, are those of the computer simulation of this process of the travelling window, carried out in relation to a particular fragment of viral DNA. The first two figures with respect to the simulation, where the vertical is the time axis, show what would happen, in case of a context dependent

reading beginning from two different nucleotides of the DNA chain, namely the 400th and the 450th respectively. In both cases these concern activity in the form of a “kink”, which runs through the chain of nucleotides, A, C, G, T. The second two figures show even more sophisticated types of context dependent effects. These concern the complex dynamic patterns, which arise when also taking into account the non-linear covalent connections between the nucleotides.



<http://www.rexresearch.com/index.htm>

Thus subject to the assumption that DNA is a certain kind of liquid crystal structure with dynamic properties, where the interrelated solitonic activities are linked, as may be supposed, together to form

- a highly coherent wave structure, then:-
- i) The masses of the nucleotides and other parameters show that these oscillatory activities should be located somewhere together in the “acoustic” wave domain, and

- ii) That, as a liquid crystal, the DNA could influence the polarization of the weak light emission known to exist in cells, the so called “biophotons”. This kind of emitted light in cells was first discovered by the Russian investigator Alexander Gurwitsch [1923], who called it the “mitogenic radiation”. Today it is known from the work of Fritz Albert Popp [Popp, 2000], that such biophotonic or mitogenic light, while being ultraweak, is however on the other hand, highly coherent, so that it has an inherent laser-like light quality.

The experimental setting and the resulting simulations therefore say that:-

- iii) The experimental laser beam is simply a substitute for the endogenous intracellular coherent light emitted by the DNA molecule itself, and that
- iv) The superimposed coherent waves of different

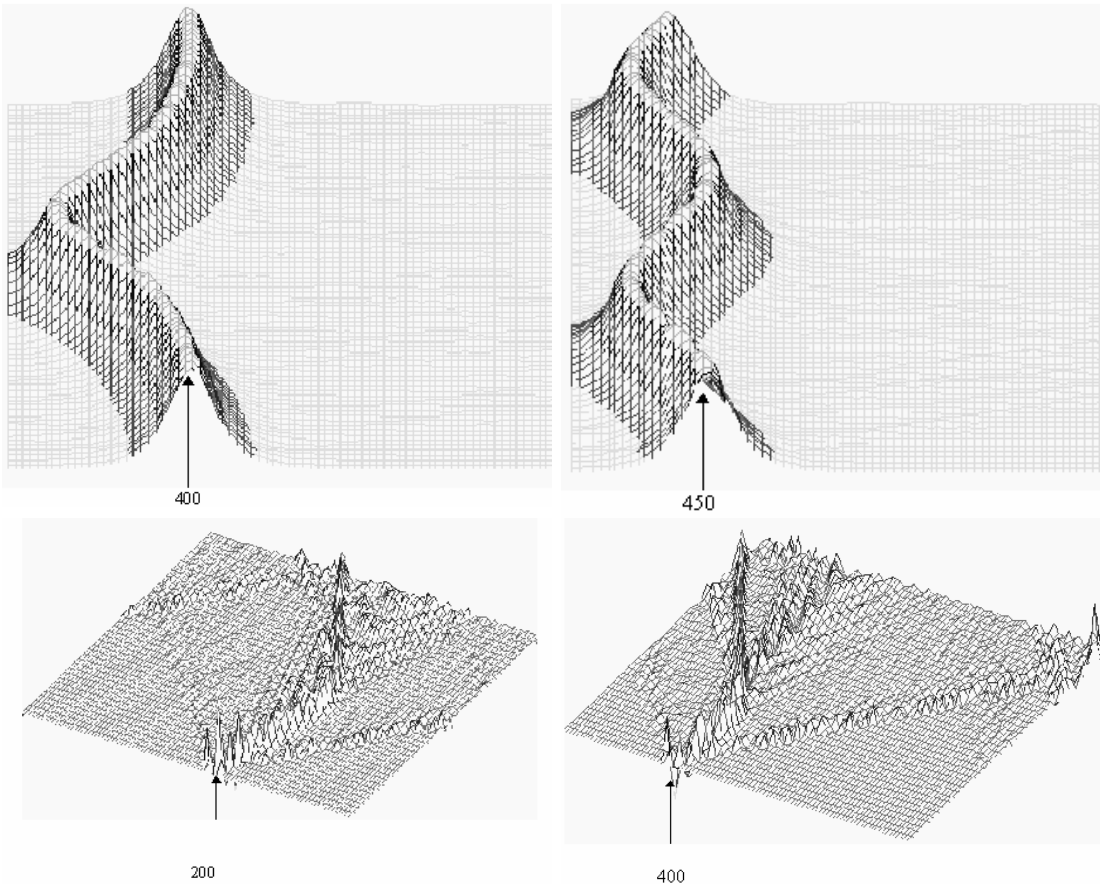

types in the cells are interacting to form diffraction patterns, firstly in the “acoustic” domain, and secondly in the electromagnetic domain. Furthermore such diffraction patterns are by definition (and as is known for example from magnetic resonance imaging (MRI) [Binz, Schempp 2000a,b] a kind of quantum hologram.

Thus, it seems that our original picture is confirmed and that the considered interaction between solitonic oscillations in the liquid crystal structure of DNA, and the polarization vector of the ultraweak biophotonic highly coherent light, could indeed be hypothetically understood as a mechanism of translation between holograms in the “acoustic” frequency domain, which concerns rather short range effects and those in the electromagnetic domain and vice versa.

The basis of such an hypothetical mechanism as a translation process, between acoustic and optical holograms, can be easily illustrated in the laboratory, where, as shown below, there is a fish illuminated in water by means of the acoustic radiation, in such a way that on the surface of the water an interference pattern or hologram forms, such that when this interference pattern is illuminated from above in the right way, by light of a high laser quality, a virtual visual image of the fish appears above the water. It shows that the hologram in question acts as a holographic transducer between the acoustic and electromagnetic domains.

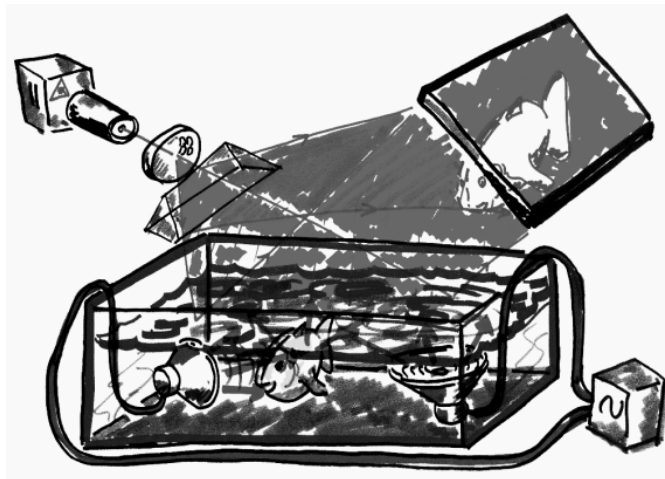

Laboratory illustration of a holographic transducer between the acoustic and electromagnetic domains.

This illustrated transduction when described in terms of the formalization of Huygens’ principle of secondary sources [Jessel 1954], has been used as the basis of a new topological computing principle [Fatmi, Resconi 1988] which defines entire classes of non-commutative control structures, Fatmi et al

[1990]. It was applied to DNA. and more recently to the brain [Clement et al. 1999].

3. Another Theoretical but Experimentally Validated Perspective - Quantum Holography

Sections 1 and 2 are in excellent agreement with the independently researched model of DNA produced by Marcer and Schempp [1996]. This explains the workings of the DNA-wave biocomputer in terms of a quantum mechanical theory called quantum holography [Schempp 1992] used by Schempp [1998] and Binz and Schempp [2000a,b; 1999] to correctly predict the workings of MRI. These two DNA-wave biocomputer models are also, as cited, in good agreement with qubit model explanation of DNA more recently published by Patel [2000], and earlier independent researched models by Clement et al [1993] and Perez [1991].

The quantum holographic DNA-wave biocomputer model describes the morphology and dynamics of DNA, as a self-calibrating antenna working by phase conjugate adaptive resonance capable of both receiving and transmitting quantum holographic information stored in the form of diffraction patterns (which in MRI can be shown to be quantum holograms). The model describes how during the development of the embryo of the DNA’s organism, these holographic patterns carry the essential holographic information necessary for that development. This would explain the almost miraculous way the multiplying assembly of individual cells is coordinated across the entire organism throughout every stage of its development - in complete agreement with the explanation arrived at in Moscow by Gariaev and his co-workers.

The quantum holographic theory requires that the DNA consists of two antiparallel (phase conjugate) helices, between which (in conformity with DNA’s known structure, ie the planes on which the base pairing takes place) the theory says, are located hologram planes/holographic gratings, where the necessary 3 spatial dimensional holographic image data of the organism is stored in agreement with the Gariaev group’s hypothesis. It says, as described in relation to laser illumination of a DNA sample, that such illumination can be expected to turn the DNA into a series of active adaptive phase conjugate mirrors (see figure below)/holographic transducers (see figure of laboratory illustration earlier), from which would resonantly emerge a beam of

radiation, on which is carried the holographic information as encoded in the DNA. As indeed is the case in the Gariaev group experiments already described. These experiments thus confirm the quantum holographic prediction that DNA functions an antenna capable of both encoding and decoding holographic information. This functionality is also in good agreement with the findings of Schempp [1986] that quantum holography is capable of modelling antennae such as synthetic aperture radars, and that this mathematical description of radar can be applied [Marcer and Schempp 1997] to a model, working by quantum holography, of the neuron. This model is in good accord with the biological neuron's information processing morphology and signal dynamics. As indeed are the quantum holographic models of the brain as a conscious system, and of the prokaryote cell [Marcer, Schempp 1996, 1997a]. It is a viewpoint originally voiced by de Broglie, who presciently pictured the electron as being guided by its own pilot wave or radar! These examples including MRI all demonstrate that quantum holography does indeed incorporate signal theory into quantum physics and it can be hypothesized biocomputation.

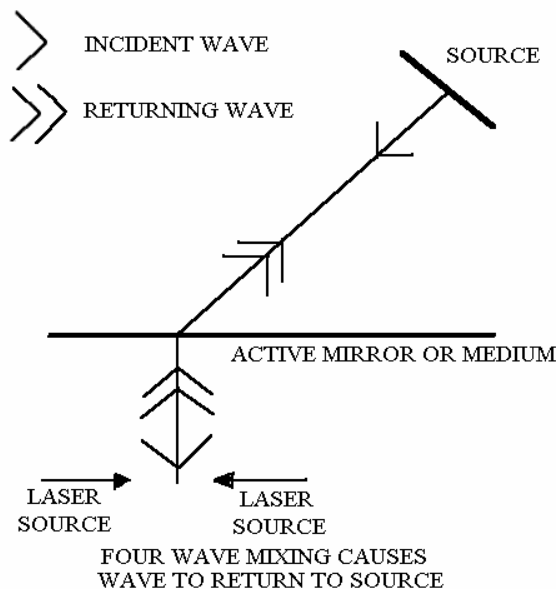

Phase conjugate mechanism or mirror in the laboratory. Action of an active adaptive phase conjugate mirror.

Furthermore, quantum holography predicts that the planes, in which the base pairing takes place, constitute a “paged” associative holographic memory and filter bank (carrying holograms which can be written and read) and which has no cross

talk between the pages. The orthogonality of the holograms encoded on these pages, arises as the result of the sharp frequency adaptive coupling conditions (1), which specify very narrow spectral windows, i.e. the “pages”.

$$(1) \langle H\nu(a,b; x,y) | H\nu(c,d ; x,y) \rangle = 0 \quad \text{when frequency } \nu \text{ is not equal } \nu'$$

$$\langle H\nu(a,b; x,y) | H\nu(c,d ; x,y) \rangle = \langle aOb | cOd \rangle \quad \text{when } \nu = \nu'$$

for non-degenerate four wavelet mixing where a,b,c,d are the corresponding wave functions of the mixing; $H\nu(a,b; x,y)$ is the holographic transform which in quantum holography defines the probability of detecting a wave quantum frequency ν within a unit area attached to the point (x,y) of the hologram plane, where the wavelet mixing aOb takes place and is described in terms of a tensor multiplication O . The orthogonality condition (1) can be seen therefore as specifying a set of diagonal elements or trace Tr in a unit matrix in the frequency domain. It implies, as can be shown, that the Shannon encoding schema employed in DNA is optimally efficient, which following a billion or more years of evolution, in DNA could be expected to be the case.

The conditions (1) are therefore in excellent agreement with Gariaev group's conclusion. It confirms that the planes on which the base pairing takes place, concerns two quantum holograms, ie the wavelet mixings aOb and cOd , where each specifies a “context”, one for the other. Further quantum holography predicts, based on the symmetries of the 3 dimensional representation of the Heisenberg Lie group G , that in relation to the quantum hologram defined by a wavelet mixing aOb , the coherent wavelet packet densities $a(t)dt$ and $b(t')dt'$ are indistinguishable by means of relative time and phase corrections applied to the respective wavelet pathways (x,y) in the hologram plane. That is, to say, the tensor operation O , in the case of quantum holography, describes a quantum entanglement, even though aOb defines a quantum hologram, from which quantum holography shows and MRI proves, holographic information can be both written/encoded and read/decoded.

Thus, mathematically, DNA can on the basis of quantum holography be thought of represented quantum mechanically very simply by the trace $Tr \langle a,b | c,d \rangle$ such that when the double helix is opened, in accordance with the Gariaev description above, this corresponds to the representation $\langle a,b | \gg | c,d \rangle$

The process of completed duplication of DNA can therefore be represented as

$$\text{Tr}\langle a,b | c,d \rangle \langle a,b | c,d \rangle$$

because as it is crucial to understand in the case of DNA, the two strands of the double helix are, quantum holography shows, not the same but phase conjugate, i.e. what biologists call complementary/antiparallel, and so must be represented within the context of DNA itself by a,b and c,d respectively. These pairs differ quantum holography shows, constituting covariant and contragredient representations, which are essentially topologically cohomologous [Marcer 2000]. It could explain why to quote de Duve [1984], just the two elementary base-pairing $\{A,U/T\}$ and $\{G,C\}$ of respectively the nucleotides Adenine and Uracil/Thymine together with Guanine and Cytosine, are needed, to “govern through the two relatively fragile structures they embody, the whole of information transfer throughout the biosphere”. That is to say, in DNA, these two nucleotide base pairings are the universal chemical mechanisms producing the wavelet mixing O on the hologram planes (which they also define) such that DNA can then be given a shorthand description in terms of context dependent genetic texts written in the four letters A,T,G,C .

The topological differentiation referred to above follows from the fact that, while in quantum mechanics, a wave function is only determined up to an arbitrary phase, phase difference is of physical significance (as in holography), because there exists a class of quantum observables, which are the gauge invariant geometric phases of the state vector or wave function [Resta 1997; Schempp 1992; Anandan 1992]. These observables must therefore be distinguished from those which are the eigenvalues of some operator, usually the Hamiltonian or energy function. Such a state vector description (with gauge invariant phases) by means of which each DNA molecule can clearly be expected to be described, would explain the difference between the nature of quantum interference and quantum self interference, which DNA from its double helical structure can thus be recognized to concern.

In the above means of representing DNA therefore, $| \rangle \langle |$ represents by the quantum correspondence principle, the quantum soliton control [see also, Denschlag et al, 2000] or wavepacket activity rather than its classical soliton counterpart, which was the subject of the Moscow computer simulations. These all confirm the Gariaev group’s conclusions reached as a result of their experiments, that DNA

functions as a quantum coherent system/assembly (of now quantum oscillators) or whole, by means of quantum entanglement. A whole, where as (1) shows, this may be decomposed into an orthogonal family of holographically encoded 3 spatial dimensional images in line with the usual description of a quantum mechanical diagonalization. It also says in line with the Gariaev group’s findings that DNA can be described as an “autocorrelation”, where as shown here, this is an optimally efficient decomposition into a decorrelated family of holographic code primitives /holograms, and that this, as Schempp[1992] shows, follows from the fact a quantum mechanical harmonic oscillator (in this case the highly complex DNA molecule itself) is equivalent to an assembly of bosons each having one polarization state. The latter substantiates the Gariaev group conclusion that they have indeed discovered an entirely new form of electromagnetic vector by means of which holographic images are carried in the form of a polarization state, suitable for a new form of cinema, video and computer.

Quantum holography says that DNA satisfies the principle of computer construction [Von Neumann, 1966], since it carries a copy of itself, and is

(a) its own blueprint written in the genetic texts, where the mechanism engineering the DNA replication is the biophotonic electromagnetic field, while the “letters” of the genetic texts A, G, C, U are held invariant, but where,

(b) in the case of the replication of the organism, for which DNA is the blueprint written in the holographic information, the reverse is the case. That is, it is the “acoustic field” in this case, which mechanically constructs/engineers the organism out of the available matter, in accordance with the information held in the electromagnetic field holograms (these being held invariant in this case). This must therefore mean that Adenine, Uracil, Guanine, and Cytosine are invariant structures/weightings in both the acoustic and electromagnetic field domains. These mechanisms therefore correspond with the known basic features of quantum communication/information transfer known as quantum teleportation, which consists of two inseparable signal processes one classical, one quantum. The latter is instantaneous transmission from X to Y (unlimited in principle as to distance), but which cannot be used without the other, which is transmission from X to Y by conventional means at the speed of light or lower. In the case of DNA, therefore, it is the existence of the genetic text of

the organism itself which constitutes the classical signal process of quantum teleportation, able to facilitate the quantum mechanical signal processes of both the copying of the DNA as its own blueprint, and of the construction of the organism (for which DNA is the blueprint) in a massively parallel way by the means of quantum teleportation.

Remarkably too, quantum holography also confirms and is confirmed by another astonishing experimental finding. This is the so-called “DNA-Phantom-Effect” [Gariaev, Junin, 1989; Gariaev et al, 1991; Gariaev, 1994], a very intriguing phenomenon, widely discussed, when it was first found by Peter Gariaev. Later similar phenomenon termed “mimicking the effect of dust” [Allison et al, 1990]. was detected by group of R.Pecora. This is the discovery that the pattern below, found in the first experiment described, when a laser illuminated DNA, does not immediately disappear if the DNA samples are removed from the apparatus. It continues in different form for sometime. An explanation would be that quantum holography defines an admitter/absorber quantum vacuum model of quantum mechanics in terms of annihilation/creation operators [Schempp 1993], implying that DNA does indeed behave like a single quantum, which induces a “hole” temporarily in the vacuum by its removal.



<http://www.divinecosmos.com/>

"I distrust those people who know so well what God wants them to do because I notice it always coincides with their own desires"

- Susan B Anthony.

"See, in my line of work you got to keep repeating things over and over and over again for the truth to sink in, to kind of catapult the propaganda."

- George W. Bush - 43rd US President

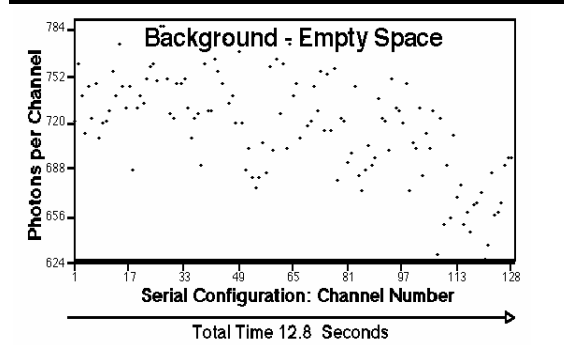

(a) MALVERN <<< K7032 >>> Version 2.1 Date 18-09-1991 Time 10:49:08
Correlator 1 Sample Time per Channel (mS) = 100
Auto-correlation

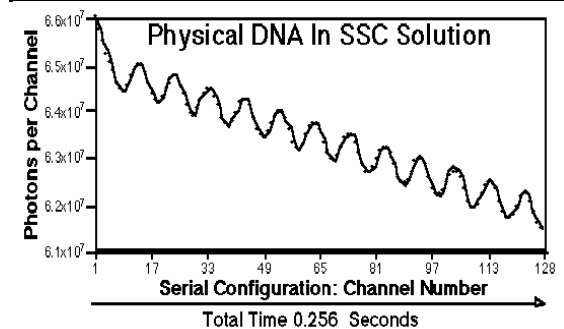

(b) MALVERN <<< K7032 >>> Version 2.1 Date 14-12-1990 Time 12:25:07
Correlator 1 Sample Time per Channel (mS) = 2.0
Auto-correlation

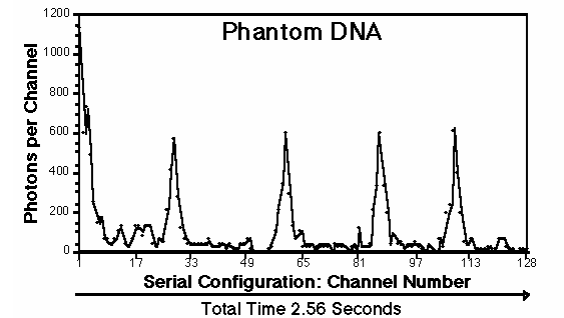

(c) MALVERN <<< K7032 >>> Version 2.1 Date 23-11-1992 Time 13:37:28
Correlator 1 Sample Time per Channel (mS) = 20
Auto-correlation

Graphs (a),(b) and (c): “Background - Empty Space”, “Physical DNA in SSC Solution” and “Phantom DNA” respectively.

<http://www.rialian.com/rnboyd/dna-wave.doc>

References

Adleman L.M. 1994, *Molecular Computation of Solutions to Combinatorial Problems*, Science, 266, 11th November 1021-1024.
Allison S.A., Sorlie S., Pecora R., 1990, *Macromolecules*, v.23, 1110-1118.
Anandan J. 1992, *The geometric phase*, Nature, 360, 26, 307-313
Binz E. Schempp W. 2000a *Creating Magnetic Resonance Images*, Proceedings CASYS'99, International Journal of Computing Anticipatory Systems, 7, 223-232.
Binz E. Schempp W. 2000b, *A Unitary Parallel Filter Bank Approach to Magnetic Resonance Tomography*, American Institute of Physics Proceedings 517 of the 3rd International Conference on Computing Anticipatory System, editor Dubois D. August 9-14, 1999, Liege, Belgium, 406-416.

- Binz E., Schempp W. 1999, Quantum Teleportation and Spin Echo, Unitary Symplectic Spinor Approach. In. Aspects of Complex Analysis, Differential Geometry, Mathematical Physics and Applications, Dimiev S. Sekigawa K. editors, World Scientific, 314-365.
- Bouwmeester D. et al., 1997, Experimental Quantum Teleportation, Nature, 390, 11th December 575-579
- Clement B.E.P. Coveney P.V. Marcer P. 1993, Surreal numbers and optimal encodings for universal computation as a physical process: an interpretation of the genetic code. CCAI Journal, 10, 1/2, 149-164.
- Clement B.E.P. Coveney P.V. Jessel M. and Marcer P. 1999, The Brain as a Huygens' Machine. Informatica 23, 389-398.
- Denschlag J. et al. 2000, Generating Solitons by Phase Engineering of a Bose-Einstein Condensate, Science, 287, 7th January, 97-101
- Dubois D., 1992, The Fractal Machine, Liege University Press, Liege.
- de Duve C. 1984 A Guide Tour of the Living Cell, volume two, Scientific American Library,
- Fatmi H.A. and Resconi G. 1988, A New Computing Principle, Il Nuovo Cimento, 101B, 2, 239-242.
- Fatmi H.A., Jessel M., Marcer P. and Resconi G. 1990, Theory of Cybernetic and Intelligent Machine based on Lie Commutator. International Journal of General Systems, 16, 123-164.
- Fermi E., 1972, Proceedings. Moscow. Science. v.11.
- Gariaev P.P., Junin A.M., 1989, Energy, no10, 46-52. [in Russian]
- Gariaev P.P., Chudin V.I., Komissarov G.G., Berezin A.A., Vasiliev A.A., 1991, Proc. SPIE, v.1621, 280-291.
- Gariaev P.P., 1994, Wave genome, Public Profit. Moscow. 279 pages [in Russian].
- Gurwitsch A., 1923, Versuch einer synthetischen Biologie. Schaxels Abh. Z. theor. Biol. H. 17.
- Ho M-W, 1993, The Rainbow and the Worm: The Physics of Organisms, World Scientific, Singapore.
- Jessel M. 1954, Une formulation analytique du principe de Huygens, Comptes Rendus, 239, 1599-1601.
- Marcer P. 1992, Designing New Intelligent Machines - The Huygens' Machine, CCAI Journal for the Integrated Study of Artificial Intelligence and Applied Epistemology, 9, 4, 373-392. 4, 373-392.
- Marcer P. 2000, Hypercomputation, Third International Conference on Computing Anticipatory Systems, CASYS '99, Liege, Symposium 9 on Quantum Neural Information Processing, Journal of Computing Anticipatory Systems, ed. Dubois D., vol. 7, 288-312.
- Marcer P. this volume, Quantum Millennium, Quantum Universe, Quantum Biosphere, Quantum Man.
- Marcer P. (in press) Anticipation and Meaning, CASYS 2000, International Conference on Computing Anticipatory Systems, AIP Conference Proceedings, ed Dubois D.
- Marcer P. and Schempp W., 1996, A Mathematically Specified Template For DNA And The Genetic Code, In Terms Of The Physically Realizable Processes Of Quantum Holography, Proceedings of the Greenwich Symposium on Living Computers, editors Fedorec A. and Marcer P., 45-62.
- Marcer P., Schempp W. 1997, Model of the Neuron working by Quantum Holography, Informatica 21, 5 19-534.
- Marcer P and Schempp W., 1997a, The Model of the Prokaryote cell as an Anticipatory System Working by Quantum Holography, Proceedings of CASYS 97, 11-15, August, HEC-Liege, Belgium, International Journal of Computing Anticipatory Systems, v.2, 307-315.
- Marcer P., Schempp W. 1998, The brain as a conscious system, International Journal of General Systems, 27, 1/3, 231-248.
- Maslow M.U., Gariaev P.P., Fractal Presentation of Natural Language Texts and Genetic Code, 2nd International Conference on Quantitative Linguistics, QUALICO '94, Moscow, September 20-24, 193-194, 1994
- Patel A. 2000, Quantum Algorithms and the Genetic Code, Proceedings of the Winter Institute of Quantum Theory and Quantum Optics, 1-13 January, S.N. Bose National Centre for Basic Sciences, Calcutta, India.
- Perez J-C, 1991, De l'ordre et du chaos dans l'ADN, Science et Technology, April, 36, 40-47.
- Pribram K.H. 1991, Brain and Perception; Holonomy and Structure in Figural Processing, Lawrence Erlbaum Associates, New Jersey.
- Popp F.A., 2000, Some features of biophotons and their interpretation in terms of coherent states. Biophotonics and Coherent Systems. Proc. 2nd A.Gurwitsch Conference and Additional Contributions. Moscow University Press. Ed. L.Belousov et al., 117-133.
- Resta R., 1997, Polarization as a Berry Phase,(The Berry Phase), Europhysics News, 28,19
- Rice S.A. 1992, New Ideas for Guiding the Evolution of a Quantum System, Science, 258, 16th October, 412-413.
- Schempp W. 1986, Harmonic Analysis on the Heisenberg Group with Applications in Signal Theory, Pitman Notes in Mathematics Series, 14, Longman Scientific and Technical, London.
- Schempp W. 1992, Quantum holography and Neurocomputer Architectures, Journal of Mathematical Imaging and Vision, 2, 279-326.
- Schempp W., 1993, Bohr's Indeterminacy Principle In Quantum Holography, Self-adaptive Neural Network Architectures, Cortical Self-organization, Molecular Computers, Magnetic Resonance Imaging and Solitonic Nanotechnology, Nanobiology 2, 109-164.
- Schempp W. 1998, Magnetic Resonance Imaging, Mathematical Foundations and Applications, John Wiley, New York.
- Scherbak V.I., 1988, J. Theor. Biol., v.132, 121-124.
- Schleich W.P. 1999, Sculpting a Wavepacket, Nature, 397, 21st January, 207-208.
- Sudbery T. 1997, The Fastest Way from A to B., Nature, 390, 11th December, 551-552
- Sutherland J. 1999, Holographic/Quantum Neural Technology, Systems and Applications, an ANDCorporation documented plenary presentation for the 3rd International Conference on Computing Anticipatory Systems, 8-14 August, HEC Liege, Belgium. International Journal of Computing Anticipatory System, 2000, 7, 313-334, sutherland@andcorporation.com and <http://www.andcorporation.com>.
- Von Neumann J. 1966, Theory of A Self-reproducing Automaton, University of Illinois Press, Urbana and London.
- <http://www.rialian.com/rmboyd/dna-wave.doc>
- Peter P. Gariaev*, Boris I. Birshtein*, Alexander M. Iarochenko*, Peter J. Marcer**, George G. Tertishny*, Katherine A. Leonova*, Uwe Kaempff***.
- Institute Control of Sciences Russian Academy of Sciences, Moscow, Russia* gariaev@aha.ru , <http://www.aha.ru/~gariaev> , and
- Wave Genetics Inc. 87 Scollard Street, Toronto, Ontario, Canada, M5R 1G4, gariaev@wavegenetics.com ,
- **53 Old Vicarage Green, Keynsham, Bristol, BS31 2DH, UK, petermarcer@aikido.freeseerve.co.uk ,
- <http://www.bcs.org.uk/cybergroup.htm> .
- *** Institut f. Klinische, Diagnostische und Differentielle Psychologie-Am Falkenbrunnen - D-01062 Dresden TU, Dresden, Germany, uwe@psy1.psych.tu-dresden.de

DNA IS CREATED BY A WAVE TOC

From © [Divine Cosmos.com](http://DivineCosmos.com)

Forward courtesy [Sean Sands](http://SeanSands.com)

Not only does this field create all the physical matter we now see around us, it is the very root from which life itself springs, already built to order. It is the chicken AND the egg.

The DNA molecule is a visible, measurable, 'solid' form of the waves that constantly ripple through this energy field — throughout the entire Universe. These waves, loaded with information, surround

you right now as you read these words — just like radio, satellite TV and cell-phone signals.

When water runs down the side of a mountain, it captures all the loose rocks and rolls them into the bottom of a stream. Similarly, the waves in the Field gather up whatever atoms and molecules they find in a given area — on any planet in the Universe where the right conditions exist, such as liquid water — and immediately push and nudge those little pieces into forming DNA molecules.

The structure of DNA is obviously a lot more complicated than the rocks at the bottom of a stream, but the principle is the same. We can prove scientifically that the Field is doing this. These subtle pressures have been measured and studied in a laboratory.

Little living critters have already been generated spontaneously, in an utterly sterilized environment, from nothing more than distilled water, simple molecules and a little zap of electricity to excite the waves in the Field. All this growth occurs in perfectly sealed environments that had been superheated to white-hot levels, where no living thing could possibly have survived — at least not within any conventional scientific models.

DNA DO-SI-DO

The waves in this field not only create DNA by gathering molecules together — they can also re-arrange a DNA molecule.

Russian scientists have already proven that plants, animals and amphibians can be completely re-arranged into other species — particularly if you catch them in embryonic form. This has nothing to do with cloning or gene splicing. All they do is zap the DNA in the embryo with a beam of light. The light beam carries the ‘wave’ of another organism in it.

In one example we will present, a frog embryo was completely re-arranged, with nothing more than a beam of light, into a salamander. The salamander grew to full adulthood and showed no signs of ever having started as a frog. When it had babies they were salamanders, not frogs. Our little friend never got sick or died prematurely like normal clones would.

How could a solid, real DNA molecule shift around enough to create the codes to build an entirely different body? We are certainly not used to thinking of our DNA as being filled with many

little free agents who can play “Musical Chairs” and move around as the ‘music’ — the wave of life — changes.

Here’s the key: DNA is not a fixed, hard structure. There are indeed many small ‘pieces’ that can break off from one part of a DNA molecule and move around to another part. Scientists call these little pieces ‘retrotransposons.’ When they move around, the code changes.

If you ‘energize’ a creature like a salamander with a beam of light (or other forms of energy), and then re-direct the beam into the embryo of a frog, the ‘wave’ will re-arrange the frog’s DNA to create a salamander.

The little ‘retrotransposons’ in the frog’s DNA move themselves around to fit the new wave from the salamander. This is similar to how rocks will gather in a new area if the stream of water shifts on its way down the mountainside.

This mechanism drives life to evolve on Earth spontaneously, in very short periods of time. All the clues to explain this process already exist in the fossil record and in groundbreaking Russian laboratory experiments with DNA.

Darwin was wrong. Evolution is not random. Evolution is part of an Intelligent Design, and we have not seen the end of the story on Earth yet by any means.

GALACTIC ENERGY FIELDS

In this groundbreaking broadcast, we will lay out comprehensive evidence that each galaxy is naturally divided up into regions with different levels of energy “charge”, and our entire Solar System is now moving into a more energetic area. We can visibly measure this change by what is already happening throughout the entire Solar System.

Multiple ‘whistleblowers’ have said the Soviet and American governments knew about this since at least the 1950s, and decided not to share it with the public in order to avoid panic.

Just like the frog embryo is zapped by the laser beam that has the ‘salamander’ code in it, each planet and moon in our Solar System is now being zapped with a higher intensity of energy that is creating measurable changes in temperature, brightness, magnetic field strength, storms and even the speed of rotation in the case of Saturn.

All the evidence to prove this already exists in NASA studies — it just has never been put together under one roof until now. It explains, for example, why Pluto is getting hotter and hotter even as it drifts farther and farther away from the Sun. We have gathered well over 100 different mainstream scientific references to make the case.

‘Global Warming’ on Earth certainly is being made worse by our widespread industrial pollution — but there are greater energetic causes at work that are creating “global warming” on the Earth AND on all the other planets, where no SUVs exist.

This same instreaming energy is also affecting — and changing — our DNA, as it has in many other periods of Earth’s history. This can be measured in the fossil record. This new energetic influence is awakening dormant brain potentials and abilities we would never have dreamed of — including the “Law of Attraction”.

Real scientific evidence shows that all of this is building up to a stunning conclusion in the year 2012 — as the Mayan Calendar and other sources predicted.

THE SCIENCE OF 2012

For many years now we have been quietly, carefully building this new model. We have leaked bits and pieces of it on this website, DivineCosmos.com, over the years. Now we will give a full public disclosure of scientific evidence that our level of consciousness, and even the quality and structure of our DNA, are already being ‘energetically’ changed for positive purposes — and the best is yet to come.

We will argue that December 2012 is the focal point for this change in DNA and consciousness — which may very well lead to a spontaneous increase in our ESP abilities, making the ‘miracles’ of high masters, yogis and lamas as common as breathing. The terrifying problems we have on Earth now can be seen as part of a giant ‘initiation,’ by the very forces of Nature themselves, to prepare us for this sudden, unexpected evolution.

Older forms of life suddenly disappear from the fossil record in certain moments of Earth’s history, many of which occur in even cycles of time that span millions of years in length.

The reason why the older lifeforms suddenly cease to exist is not some horrific worldwide death — it is that all their DNA has been changed. Embryos in

the mothers’ wombs are the most sensitive to the new ‘waves’ that come in. The mothers then give birth to children that have rapidly evolved into the new, ‘upgraded’ design. Within as little as two or three generations the transition is complete.

All of this is the product of intelligent energy in the Galaxy that has created the ‘blueprint’ for life as we know it, and is consistently seeking to promote growth and evolution. This is not strictly biological in nature either — it is also a spiritual evolution into a greater level of love, wisdom and sentience.

Many New Agers talk about ‘energy’ but only have a vague idea of what they are speaking of. Ancient traditions refer to concepts like “prana,” “chi,” “ki,” the “Holy Spirit,” et cetera — but again, science has been divorced from these concepts ever since its creation during the Renaissance.

© DivineCosmos.com

Forward courtesy [Sean Sands](#)

Courtesy [Keelynet TOC](#)

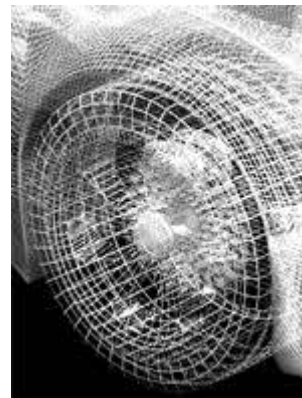

12/19/06 - [OSCAR - the Open Source Car Design free of patents](#)

The open source movement responsible for software like Linux and the browser Firefox is proving contagious. Now a German entrepreneur is applying the same approach to designing a car. Former BMW employee Markus Merz, who now owns an automobile consulting firm in Dingolfing, Germany, calls his project Oscar, shorthand for Open Source Car. The idea behind open source development is to allow anyone to copy, modify and redistribute ordinarily secret information about a technology without paying royalties to the original developers. The hope is that, unrestrained by patents and other conventional restrictions such as profit margin, marketing and technology, a community of experts will come up with fresh solutions. The car will be about 4 metres long and 2 metres wide, and will have four doors. It will be powered by electricity and have a maximum speed of about 150 kilometres per hour. Participants discuss their ideas on online forums organised into four main topics: integration, which includes design, package and distribution; modules, which includes discussion of the body, engine and

safety systems; tools, which includes conversations about computer-aided design tools and simulations; and network, where participants discuss potential partnerships. A group of technicians heads each forum to ensure that the best ideas are moved forward to computer modelling and testing. From there, anyone, including car manufacturers, will be encouraged to build the car. There will be no patents, and no proprietary data.

Courtesy [Keelynet](#)

Courtesy [Keelynet TOC](#)

12/19/06 - [Ornithopter \(flapping wings\) takes flight](#)



Professor Emeritus James DeLaurier and a team of students at the University of Toronto Institute for Aerospace Studies achieved sustained flight by a piloted ornithopter – an airplane with flapping wings that are mechanically operated

– something dreamed of by Leonardo da Vinci, among others. The concept of an ornithopter differs from standard fixed-wing aircraft because when flying its wings flap up and down in a manner similar to that of birds in flight. “It’s an ancient dream, achieving flight with flapping wings,” said DeLaurier, a professor of aerospace engineering at U of T since 1974, who retired this summer. With the help of his current research team of four students, test pilot Jack Sanderson and a few other volunteers, DeLaurier achieved his lifelong dream of flying a full-scale ornithopter July 8 at Downsview Park. Equipped with a 24-horsepower engine and a model airplane turbo booster, the ornithopter flew for 14 seconds at an average speed of 88 km/h, in the process travelling a third of a kilometre. “It was sustained flight; no one can question that. It received help from the booster jet but the majority of the thrust was from the flapping wings,” DeLaurier said. “When it did fly we were pretty happy. I was just hollering with joy.” The flight ended due to a stress-related failure in one section of the left wing. The ornithopter’s nose and front wheel were damaged during landing.

Courtesy [Keelynet](#)



<http://www.divinecosmos.com/>

Modern Orgone Technology

Sampling and Recording of Quantum Data Structures- The Basics [TOC](#)

By Jon Logan © 2007

Note: in this document the terms ‘Quantum Data Structure’ and its abbreviation “QDS” refer to a complex signal. These terms are used interchangeably with the term ‘radionic sample’ in previous articles I have written.

Since it involves a method of data storage inherent to the material universe which stores information in the supposedly random orientations of material structure and energy field interference patterns, I think that the use of the word ‘Quantum’ is warranted.

Quantum theory states that changes in energy state happen to matter (on a very fine level) not in a smooth curve but in discreet steps. These steps are called Quanta.

I (differing somewhat from currently accepted quantum mechanics theory) contend that quanta are fractal (there may be smaller quanta-like divisions inside of quanta, and that quanta may functionally link together in groups to form larger quanta-like volumes.

It would seem that the ‘cogging’ action produced by matter changing state in very small but discreet steps, in combination with the relative orientation of and interference between particles of matter serves as a method of data storage. The data is stored in the matter itself, and emitted from the matter as a multispectral signal. The data describes, on a fundamental level, the matter itself.

Though various material substances have vastly differing properties, typically there is enough ‘room’ for additional data to be stored, over and above the basic data that describes the matter and thus organizes the energy composing the matter – into matter.

The article describes practical physical methods and minimal related theory for working with this complex, multispectral signal. The methods and theory here should be considered experimental and / or hypothetical.

The Quantum Data Structure

The Quantum Data Structure signal is the ‘organizational data field employed in radionics’,

and known by several other names. Since the sciences of radionics, dowsing, homeopathy and psionics do not enjoy accreditation, most researchers and innovators have created their own names for the forces, energy forms and relationships involved. By any name, this signal is inherent to all material objects, events and energy forms perceivable from within a material reality.

The informational signal derives from the fact that an arbitrarily selected atom will contain not only the energy required to maintain the existence of said atom, but also the information required to describe said atom. The energy composing the atom is in motion. The exact paths taken by many small volumes of energy in motion (subatomic particles and orbitals) correspond to the type of atom. The fact of each subatomic particle being in motion causes it to emit waves, and the exact way in which many subatomic particles move in relation to each other creates a characteristic signal to be carried on the waves.

Therefore, a given atom will 'contain' at least the amount of energy required to maintain that atom in existence, and the information required to describe that atom.

'Matter' is actually energy moving in a characteristic pattern that corresponds to a given material entity, and produces an emission spectrum carrying a complex signal. That signal, the Quantum Data Structure, is inherent to material reality.

This applies not only to matter at the atomic level, but also to all material constructs (things built out of atoms) and to the main energy forms that we perceive from within a material environment (light, sound, heat, electromagnetic waves, and other things we typically do not think of as being 'material').

Most material constructs are capable of having more than one state; their QDS may also contain information concerning their state. This means the same object in a slightly different state would have a slightly different QDS.

It also means, in short, that an organism may have a QDS describing not only that organism, but also containing information on the state in which that organism exists.

Therefore, it is also possible for a QDS to contain data about specific experiences, biological or

emotional or mental states, abstract thoughts, or archetypal experiences which an organism may have. All of these are examples of a material entity in different states. The more complex the material entity, the more possible states the material entity may have (as a rule of thumb).

Since events, which may occur in a material environment are played out by material constructs, they also have a QDS.

QDS Effects:

Since the basis of material reality is electromagnetic attraction and repulsion effects, all objects, events and states of objects produce a constant emission.

This emission interferes with and causes a change to other objects which are subjected to the emission.

This effect is usually more pronounced on objects which are close to each other in some important way. The objects may be 'close' in a geographical sense, or they may be close as in locked in resonant relationship with each other, regardless of geographical distance. They may be close in the sense of there being a significant flow of energy (of virtually any type) between them.

Possessing a same or similar QDS forms a close resonant relationship between two or more material constructs.

Resonance effects, working in both commonly and not-commonly known ways, produce the result of two-way interaction, via the QDS, between a material construct and the immediate environment around it (as well as to any remote object with which it shares a sufficiently similar QDS).

The material world around us is awash in a sea of background radiation. This radiation is multispectral and non-homogenous. There are many different types of radiation, in a broad spectral range.

This background energy forms a matrix. It is organized in a mutlifractal pattern – ie. There is more than one fractal organizational pattern to be found within it. There is a system of fractal matrices that form a grid. The lines of the grid are energy-probability vectors. The 'lines of the grid have the 'highest' probability that energy in motion will move along them. The 'spaces' between the lines of the grid have the 'lowest' probability that

energy in motion will move there. The result is a grid which organizes energy-motion. The most obvious example of a part of this grid would be the relatively stable orbital and interference patterns for subatomic particles we call 'matter'.

For the rest of this document, a material construct will be referred to as an Entity, with the understanding that all 'things' in the world which we can perceive are entities. Persons, places, things, forces, events, specific thoughts and specific times can be defined as Entities. In short, an entity is 'anything that has a footprint in the grid'. Therefore, for the purposes of metaphysics, Entity is a purposefully broad term.

Also for the purpose of this document, the 'Astral' plane and other, higher spectrum stable energy-motion bandwidths / environments are also considered to be material.

The matter composing the next stable region in the multiverse upwards in spectrum from this one is less dense than that which composes the physical world, but it is still matter, ie. It is energy organized into a stable, characteristic pattern and in enough variety to form a complex environment which entities and forces may inhabit and in which events may occur.

Anything capable of producing or being affected by a QDS is an entity, and every QDS requires an entity in order to exist. Every entity requires a QDS in order to exist.

The nature of the QDS, in that it exists at all levels of the 'reality grid', and in all regions of the 'reality grid', is such that all known energy forms carry QDS data. Therefore, all known energy forms may be used to transmit or receive QDS data. All known energy forms are inherently modulated at least some QDS data. That said, some energy forms are more efficient than others. Light and Scalar Waves are more efficient than EM Waves and Audio Waves, though all are efficient enough to be workable as a basis for or component in a QDS transmitter, recorder, receiver, etc. The combination of multiple forms of energy tends to be more efficient than the use of a single form alone.

QDS Communication between entities

It is possible for an entity to exist in one region or level of the reality grid and not in another, though existence in one region causes an effect in all regions of the reality matrix. The effect to the rest of the grid caused by an entity is highly variable. In

some places it is an easily observable effect, in others the effect is as small as to be 'theoretical'.

The degree of effects caused by an entity in the reality grid is defined by the way that the entity interacts with other entities and the grid (ie. The state of the entity and the state of its environment), and differ depending on the 'closeness' of the entities to each other. An entity has an effect most strongly on the immediate environment and on the entities closest to it.

This closeness may be due to a similar QDS between 2 entities, or it may be due to geographical closeness within the grid itself.

As an analogy, we can think in terms of being able to communicate with another person. We can do this several ways – for example by speaking, or by shouting, which require physical proximity. To suit our purposes, we can cheat and use a long pipe like they did in early naval vessels, which has the advantage of making our voices go farther (minimally) and sending our voices exactly where we want them to go (more effectively).

We can go a step further and use a long wire and convert our voice into a different type of energy (from audio oscillations to electrical voltage oscillations) at one end of the wire and back again at the other end. A step further yet and we can cut the wire, add an amplifier, tune the circuit and use it to send the oscillations as radio waves, reversing the process on the other end.

The (multispectral) energy field of an entity causes a change to, and is changed by, the energy field of another entity which it encounters. The type of change depends on what the two entities are, and what states they are in, and what the state of their shared environment is.

The degree of change depends on how well they can 'hear' each other. This is what is referred to by 'closeness' in this document, and the closeness of two entities may be derived from their literal proximity or it may be artificially induced by mixing two QDS signals and / or causing a flow of energy to pass between the two entities. The flow of energy (analogous to the pipe or wire) and the QDS (analogous to the audio waves if we shout or the radio waves if we use a radio) act like a telephone wire between them, and allow communication to pass between them.

If the QDS of two differing entities are artificially mixed, then the QDS will also act like a telephone wire between them. This phenomenon forms the basis of radionics, psionics, and homeopathy.

The effects of mixing two identical QDS values are constructive, for the most part. Though phase relationships do apply there is a tendency for two same or similar QDS values to 'sync' and / or 'entrain' with each other on their own, unless the phase difference is very different. It would appear that there are several phase relationships which two identical QDS signal will naturally fall into, and they will fall into the nearest stable phase relationship. So, if we combine them at 5 degrees phase difference, they will drift towards 0 degrees phase difference. If we combine them at 175 degrees phase, they will drift toward 180. The effects of mixing two identical QDS values in causal engineering tend to be constructive and are less often dramatic than when two differing values are mixed. This is based primarily on experience with radionic tuning circuits.

I hypothesize that if you take a gold atom and broadcast the QDS of gold to it, it should have a higher energy state but probably will not undertake any dramatic transformations unless a lot of power is supplied through the QDS link, enough power to cause the gold atom to undergo a dramatic change. (Note: power is equivalent to work over time. Work is to cause a change in reality.)

From conventional wave theory we can evidently gain the basic idea that when two identical waves are mixed, they can either combine to make exactly the same signal just slightly louder (0 degrees phase difference), or can cancel each other out (180 degrees phase difference), creating silence, or combine to create many more harmonics (say at 45 degrees phase difference). When they are perfectly aligned, there is no dramatic change to the signal other than that the amplitude raises.

QDS are complex structures and not simple waves, but many of the same concepts apply.

When we mix two different waves together, they interfere in different ways, depending on how we mix them and what waves we choose to mix together. In any case, they will cause a much greater degree of change to each other than would two identical waves.

The same applies to QDS mixing, combining two differing QDS values has been the basic technique

employed by radionics practitioners for apx. a century in western countries, and this is only in its current western incarnation as radionics psionics / homeopathy. One of the most common examples would be to mix the QDS of a medicine with the QDS of a patient.

Mixing QDS signals

Since any known energy form may be used to carry QDS data, a simple and effective means of mixing 2 QDS values is to send a stream of energy (any known energy form) from point A to point B, and place the two QDS samples to be mixed at points A and B.

The Abrams-architecture radionics machines use the method of sending a stream (a transmission) of energy from A to B (or setting up a loop of energy between them; letting it go back to A again), and they allow you to place a sample on either end of the stream, or to place on sample at the origin point of the steam and to 'point' the stream at the other sample or patient.

Omitting the funky scalar fields for the sake of clear illustration, you could (and in early models they did) set up a simple circuit which dumps electrical current from a battery to a ground (or the battery negative) across 2 bare metal plates. If you put the A and B samples on the 2 metal contact plates, then you are mixing the QDS values. You can exercise some control over how the two samples are mixed by choosing which sample to place on which plate, ie you can send the QDS of sample A to the entity corresponding to sample B, or vice versa.

Most of the electrical energy will simply pass through the circuit to ground, but the 'telephone line' effect of the QDS will still cause an effect on the entity which the sample reflects. A typical example would be to place a sample of an organism on one plate, and a sample of a chemical substance on the other plate, in order to remotely subject the organism to some of the effects of the chemical substance.

This process is made much more effective by 'tuning' the circuit on some way, altering the characteristics of the circuit until the circuit 'best fits' the signal currently in use. In early radionics circuits, this was a potentiometer or series of potentiometers which could adjust the inductance and capacitance of the circuit according to what was then current electro-dynamics at that time.

In other machines, different means may be employed to adjust the circuit characteristics. With radionics machines of a traditional design, the sensor is the operator and the circuits must be adjusted by a trained operator since biofeedback is used to determine when the circuit is correctly adjusted. While this is a less than perfect method, it demonstrably works enough of the time to be useable, and has the advantage of being able to get at least some 'signal locking' for many things not currently measurable with laboratory equipment (like abstract thoughts and emotional states).

Conditions for getting a QDS sample

The energy field emitted by any entity is multispectral, even if we only consider the 'known' energy forms. The energy field of a person, for example, has a thermal component, an optical component, an electromagnetic component and an acoustic component, all of which have scalar components. Oversimplifying somewhat for the sake of ease, we can think of it's scalar field as being the totality of all the field components, and the QDS as a perfect fractal map of the resulting 'multispectral' field, which 'map' is constantly emitted from the field, and updated in real-time as its changes in response to impinging energy.

The QDS is similar to DNA, or to a holograph plate, in that it is fractal in nature. Each part of the whole contains information about the whole. And since the field emitted by the entity changes the QDS, and the QDS changes the entity, we could say that an entity and its QDS are in a resonant feedback loop. They are also 'in step' to some degree with all the other entities that have a similar QDS.

The field components will update to try and sync with the QDS, and the QDS will update to try and sync with the field components. Bear in mind that physical matter is essentially energy fields. The subtle biomagnetic field of a complex organism is more easily moved and more dramatically changed by an external QDS than the physical matter composing the organism, but both respond to external QDS signals. Changes to the QDS of an organism precipitate and / or reflect changes in the biomagnetic field of the organism. In turn, changes in the biomagnetic field of an organism precipitate and / or reflect changes in the (physical) biochemistry of the organism.

The biomagnetic field around an organism is largely defined by the material substance characteristics in the body of the organism. The

characteristics of material substances are largely defined by the properties of atoms. The properties of atoms are defined by the properties of subatomic particles. The contention that quantum effects cannot possibly produce any effects at the macro level is absurd; the effects are just indirect and more subtle than at the quantum level. Characteristics of entities at the macro level are defined by the characteristics of entities at the quantum level.

Since each part contains information about the whole, we need not obtain a perfect emission spectrum image of all the field components in order to get a sample of the entities QDS. Likewise, we need not get a tissue sample of every tissue type in an organism's body in order to get a DNA sample of the organism.

The QDS will be in ANY physical sample or conventional emission recording that we get. It will be in any tissue sample, audio recording of, photograph of, drawing or mathematical representation of, or written words describing- the subject. The more direct the sample is, the 'louder' or 'brighter' the QDS will be in that sample. The more complex the recording media, the 'higher resolution' the sample will be.

Using photography as a metaphor, we need not obtain a perfectly accurate IR-Visible-UV broad-spectrum photograph in order to get a useable picture. It can be a black and white picture and still be useable. The better lighting and film, the better the picture. Even if the picture is fuzzy, it may still capture enough information to suit our purposes, depending on what information we are looking for. We can enhance or diminish various aspects of the subject of the photograph by controlling the lighting. We can, as a general rule of thumb, say that the better the lighting the more accurate the photograph will be, and the film is a secondary consideration. It is easier to get a good shot with economical film if the lighting and composition are good (and suited to the film being used), than it is to get a good shot when the frame and lighting are wrong, regardless of how good the film or camera are. Film quality enhances the photograph but does not substitute for proper lighting and composition of the shot.

In obtaining a QDS sample for radionics, homeopathy, causal engineering or the like, we can think of the field components as the 'lighting'. If we 'light up' the subject with one or more compatible field components, then the image is

more readily transferred to our 'film'. We can effect this by placing the sample of the subject in the focal point of an energy field, or in a stream of energy. Sound, heat, light, scalar and radio waves are all useful for this purpose and easily accessible to most (with the possible exception of scalar waves).

A desktop computer, sound card and monitor are capable of producing a combined acoustic / photonic / RF emission. The monitor emits RF waves (so does the whole computer) and emits light. The sound card makes sound waves when powering speakers. The sound card may also be used to drive scalar wave generators, or EM wave coils. It has the capacity to record, edit, mix, and play back electronic signals through its sound card. The computer is a useful tool in 'backlighting' to produce QDS samples, in broadcasting the finished signals, and in mixing QDS signals which have been embedded in electronic files.

Methods of and basis for QDS sampling

Contact Sampling

Contact sampling is the most direct and accurate method of sampling, and is effected by physical contact with the subject entity on the recording media, or on a suitable contact point in a running circuit which routes energy to the recording media. An example would be to have the subject entity touch a metal plate connected to the input of an audio amplifier and mix the resultant signal into white noise, recording the results. An enhancement would be to 'improve the lighting' by bathing the contact point (or the whole subject) in a scalar field, and take steps to reduce the 60HZ hum you will get when doing this.

Another example would be to have the subject hold a glass of water for several minutes, and the sample is recorded to changes to the randomness of the water molecule alignment in the water, and in changes to the photonic refraction randomness of the glass.

If the subject is for example a mineral or chemical rather than an organism, a sample of the material may be placed in a glass vial for repeated use as a contact sample.

Dedicated sealed glass vessels are the preferred method for storing original samples made this way since the glass protects the water from being 're-written' to some degree.

Glyphic Sampling

Glyphic sampling is the second most direct and accurate sampling method and relies on the fractal nature of the QDS. A photograph is an example of glyphic sampling, as are the Om symbol and reiki symbols in general. The photograph is a near-perfect glyph of the optical component. Some Reiki (and other) symbols are glyphs corresponding to the fundamental structure of the QDS of certain abstract thoughts, forces or emotional states.

Glyphic samples are 2-dimensional images corresponding loosely to the 'actual shape' of one or more of the field components of an entity, or of a repeating fractal pattern inherent to the QDS of the entity.

When written or drawn by a human, the 2-dimensional images are also modulated with the state of mind of the human, and this modulation shows up in changes to the randomness of the ink lines, and also in changes to the randomness of the alignment of the ink molecules while the ink dries. The QDS is also reflected in changes to the dielectric field internal fluctuations of the paper where it was created during the writing.

Even though the actual QDS is a shape in more than 3 dimensions, can we take a 2-dimensional slice of it? If we could, it would not look like English writing, but it may look sort of like a Tibetan mandala - sometimes. Ergo the superiority of glyphic sampling to archetype sampling. While the strength of glyphic sampling is in accuracy, the limitation of glyphic sampling is that one must know the correct glyph to draw, which may look nothing at all like one's written language for the same thought concept.

Archetype Sampling

Archetype sampling is the next most accurate and direct method of sampling, and written samples are the most common example of it. It works via the resonance effects of the reality grid. Each entity has a QDS, and while a person has a QDS, so does an abstract concept. For example, that concept and related emotional state referenced by the word 'happy'. That which is most resonant to a written word is that which writes the word. Next most resonant is the archetype of the concept represented by the written word.

As an example: Since the beginning of time, billions of billions of entities have had their own variant of the experience of 'happiness', lived their lives, and left their mark on the universe by

changing it (the universe) in the act of living their lives. The emergent average of their individual QDS while experiencing happiness is the archetypical QDS of happiness, and is that referenced by the written word 'happy'.

However, the QDS linking of a written word is not direct and includes information on the entity writing the word, state of entity while writing, connotation of word assigned while writing, archetype of language word is written in, and likely a lot of other things too.

A clear mind or a focused mind will enhance the writing or drawing of samples. If it is difficult to have a clear mind, the words may be written by a machine and thereby take a more direct route to the archetypical concept, at the loss of the individual occasion-specific connotation.

Machines may also be used to 'write' a word hundreds, thousands, or millions of times in a compact space. We may use contact sampling to get an original QDS sample, and then copy it onto a written format, and allow a machine to 'repeat' it many times in order to make it more defined through constructive self-similarity resonance.

Despite its inherent limitations, archetypical sampling in written form has the significant advantage of being able to get at least some QDS linking to entities of which we have no other possible sample.

Bearing in mind the effects of mixing QDS values, we can enhance the accuracy of written samples by writing more than one word, though the less the better. Short sentences work better than long paragraphs, as a rule of thumb. We can also use synonyms to correct for extraneous QDS data introduced during the writing process.

We can use external factors (for example, playing our favorite piece of music) to reinforce our state of mind while writing the sample and ensure a better sample.

New clean paper should be used for written samples, and using conductive India ink is a minor improvement over ballpoint pens. Use smooth, non-tentative strokes of the brush or pen and take care to maintain the desired mental focus (or energy bombardment if running a machine) while the ink dries.

If symbols are used instead of words, the same applies.

If photographs are used instead of symbols, then the state of mind captured by the photograph and evoked by the photograph is of more importance than the aesthetic value of the photograph. Also, the age of the photograph is something of a consideration, especially for causal engineering.

For biological effects, microscopic photographs of material substances in some cases serve almost as well as samples of the substances themselves.

So, for causal engineering, the state of mind is a key determinant in any sample. For biological effects, it is best to have an actual sample of 'vitamin X', and next best is a machine-taken microscope photo of 'vitamin x' least efficient would be the word 'vitamin x' written on a slip of paper.

But hey, if you are dying of vitamin x deficiency and have none, the QDS of vitamin x ought to be accessible in some limited way by just writing it on a slip of paper and using a radionics device. Theoretically, a small effect could be gotten by just writing it on a slip of paper, taping the slip to the side of a clear glass of water and shining some light on it for a while.

How? Well, if every atom in existence has a QDS, therefore everything made of atoms has a QDS, then 3 things pop up:

- 1 – The archetypical molecular form of vitamin x has a QDS
- 2 – The paper you are writing on has a QDS
- 3 – Every word in the English language has a QDS (see above (the emergent average of the QDS of every instance of a given word's appearance in the reality grid))

So, when you write 'vitamin x' on a piece of paper, you are mixing the QDS of the paper with the QDS of the concept that the word points to. Of all the slips of paper in all of reality, yours will be most similar to (and thus have the most constructively harmonic resonant relationship with via the QDS) all the other slips of paper in the entire universe with the same thing written on them, and the archetype of that which is referred to in the writing. The emergent average of all of those thoughts in the minds of all the people who wrote the same thing on their paper will be most similar to the archetypical molecular form of 'vitamin x' (as

opposed to all the other archetypical molecular forms).

Realistically, geometric symbols tend to produce better results than the method described above; the above is expressed to show the underlying theoretical premise which IMO accounts for the demonstrable changes to viscosity, taste, specific gravity, crystalline alignment and other subtle (but measurable) properties of water in response to written words (see Masaru Emoto on the web for example).

Also, as stated earlier it would be far better bombard the water with a more powerful energy flow or field, one which carried a more direct sample of the QDS of 'vitamin x'.

The above should not be taken as medical advice and is not designed to substitute for the presence of vitamins where vitamins are available. IMO vitamins are best used by ingestion but in recent times the security of the supply of vitamins is in jeopardy, and basic radionics technique may IMO be likely used to offset some of the resultant lack, if need be.

Random Interference sampling

All off the above methods employ random interference sampling, so the underlying concept is brought into a little closer focus here. For the purposes of random interference sampling, the QDS behaves like an arrangement of energy-probability vectors.

This probability-influence aspect of the QDS is a factor in allowing the field components of an entity to sync with the QDS. How do a bucket of water molecules align to form geometric crystal shapes when contact-sampling the archetypical sample of the abstract concept of love (see Masaru Emoto's work)?

There is not enough of any type of known energy field at work to force water molecules to realign, but there is a probability field associated with the QDS of the written sample, and I contend the probability field influences and harnesses the supposedly random Brownian motion in such a way as to produce an arrangement of water molecules that most closely syncs with the QDS of the written sample. The water responds to the arrangement of energy-probability vectors by assuming the orientation on the molecular level which is its lowest energy state. In short, it is 'easier' for the water molecules to line up with the energy-

probability vector patterns than to line up opposing the energy-probability vectors.

The more energy hitting the water which carries that QDS data, the more rapidly the water picks it up. Shine a bright light on the written sample so it passes through the written sample and then into the water, and the effects are speeded. Water is the substance which does this most readily, more on getting other materials to do this below.

Basics of relative randomness

Think this sounds like impossibly esoteric stuff? The extent of the effects of even the 'known' energy forms is still being discovered. For example, recently, [some researchers claimed to have found an example of analog audio data impressed on an ancient pottery shard](#) (IMO, one part of the QDS). Since then, it has been [claimed that it was an April Fool's joke](#). I leave the mention of it included in this article because I would contend that even if this recent Belgian claim was a hoax, the theory is still sound. If one could get the correct scan speed, filtering and sensors, one could theoretically play the ridges on a piece of pottery and get some information. Why would acoustic waves in the air NOT produce very fine ridges in soft clay being spun on a potter's wheel? Even if you couldn't get it to play audio data, one would (if willing to reason) agree that there would at least be ridge patterns directly related to the vibrations induced while the pot was made, and that the conditions of the pot's manufacture would have an effect on the vibrations induced during the pot's being made. For example, an electrically spun potter's wheel run indoors would probably make different patterns in the clay than a manually-powered wheel being used outdoors.

The controversy on this subject goes on and it is largely dismissed (the Belgian attempt). However, the idea has supposedly been around since the 60s. Below is a quote from one blogger who commented on the issue:

http://tenser.typepad.com/tenser_said_the_tensor/2006/02/pottery_recordi.html

(quote from 'Tensor' at above link, visit the link for more)

"So, you're thinking, it's nothing but science fiction, right? Slow down. Below, I've transcribed the text of a letter published in the Proceedings of the IEEE (August 1969, pp. 1465-6) that I saw mentioned a couple of times when I was googling around researching this post:

Acoustic Recordings from Antiquity

Abstract—Pioneering experiments establishing the principles of recalling ancient sounds from antiquity are reported.

Widespread research on recalling from the past actual sounds, voices, music, etc., adventitiously recorded by ancient peoples (or events) upon the “surface” or within the substance of a wide variety of objects and artifacts crafted (or evolved) from “plastic” media warrants intensified efforts at the present time, because of recent developments in electronic signal analysis which can ferret out “signals” buried in “noise”.

This letter is primarily intended to call attention to the potentials of Acoustic Archaeology and to record the early experiments which established the principle.

Two areas of the author’s investigation, which began in 1961, will be of interest: 1) the recording of sound on wheel-thrown clay pots, and 2) the recording of sound in paint strokes applied to canvas.

The sound-reproducing system used consisted of a crystal cartridge (Asiatic Corp., Model 2) such as is used in phono pickups. The cartridge was connected directly to a set of inexpensive earphones (Trimm “Acme.” 2000 ohms). The chuck of cartridge could be fitted with “needles” of any suitable material, length, shape, etc. In all instances the cartridge was held in the fingers and could be positioned against a revolving pot mounted on a phono turntable (adjustable speed) or “stroked” along a paint stroke, etc.

Sound Recorded on Pottery

First Example

This consisted of a pot of fine clay, hand thrown on a potter’s wheel. The wheel in this example was an old, student-made wheel, constructed of an automobile crankshaft and flywheel mounted in a (too) light wooden frame. Persistently out of alignment, the wheel had a noisy vibration almost amounting to a chatter. The pot produced on this wheel was fired at low temperatures.

When the pot was suitably mounted on the phono turntable and against the side of the revolving pot was held the phono cartridge (fitted, in this instance, with a “needle”

consisting of a flat-ended sliver of wood three-quarters of an inch long) the low-frequency chatter could be heard in the earphones.

Second Example

This was similar to the first example except it was a commercial pot which had been hand thrown on a motor-driven potter’s wheel. The 60 Hz motor was mounted directly on the frame supporting the wheel to which it imparted a loud hum. Using the phono cartridge as above with a similar needle, areas could be found on the surface of the revolving pot where the hum could be picked up.

In both examples, it should be noted, the last act of the potter, prior to removing the pot from the wheel, was to “smooth” the surface of the pot using the “sharp” edge of a thin rib of wood.

Sound Recorded in Paint Strokes

This is of particular interest as it introduces the possibility of actually recalling and hearing the voices and words of eminent personages as recorded in the paint of their portraits or of famous artists in their pictures.

First Example

A canvas affixed to a small, square wooden frame was so stationed as to be able to vibrate freely. This it would do when “spoken to” or where subjected to music from a nearby phonograph—as determined by touching it to the “needle” (wooded sliver) of the crystal cartridge and listening in the earphones.

With an artist’s brush, paint strokes were applied to the surface of the canvas using “oil” paints involving a variety of plasticities, thicknesses, layers, etc., while martial music was played on the nearby phonograph. Visual examination at low magnification showed that certain strokes had the expected transverse striated appearance. When such strokes, after drying, were gently stroked by the “needle” (small, wooden, spade-like) of the crystal cartridge, at as close to the original stroke speed as possible, short snatches of the original music could be identified.

Second Example

This is to record the finding of a spoken word in an oil portrait. The word was “blue” and was located in a blue paint stroke—as if the artist was talking to himself or to the subject. Parenthetically, the search was long and

tedious. The principle, however, was established.

Many situations leading to the possibility of adventitious acoustic recording in past times have been given consideration. These, for example, might consist of scratches, markings, engravings, grooves, chasings, smears, etc., on or in "plastic" materials encompassing metal, wax, wood, bone, mud, paints, crystal, and many others. Artifacts could include objects of personal adornment, sword blades, arrow shafts, pots, engraving plates, paintings, and various items of calligraphic interest. It is believed that this is the first public disclosure in this interesting field.

*Richard G. Woodbridge, III
Box 111
Princeton Junction, N. J. 08550*

*I don't know what to think about this. It could be engineer humor, though it wasn't published in the April issue. "
http://tenser.typepad.com/tenser_said_the_tensor/2006/02/pottery_recordi.html
(end quote from "Tensor" at above link, visit the link for more – ed.)*

The basic idea is to estimate the speed at which the pot would have been spun on the potters wheel, and scan a laser across it at that speed, analyzing the reflected light patterns on a computer. Another technique is to drag a light mechanical stylus like a bit of straw or a wooden sliver across it at about the speed used to spin the pot. They said the surface of the pottery was audio modulated by ambient sounds, using the potters hand as the stylus. The same thing has been postulated about paint strokes. Regardless of the veracity of the Belgian claim, the concept illustrates how an orderly pattern can be created and held within a pocket of 'relative randomness'.

For the purposes of its use as a pot, the microscopic surface texture ridges on the pottery are so small as to appear smooth, and therefore we consider them to be only random fluctuations because they are below the 'zoom' level we are looking at. But if we 'zoom' in and actually look at them they are not truly random. They in fact carry data.
Data = Organization.

All randomness is relative, in that it is only random within parameters. Let us imagine we have a 1 foot square box full of ping pong balls. Each ping pong

ball has a mark somewhere on its surface. So we fill up the box with the ping pong balls and shake it well. The balls should be arranged randomly, right? The marks should point in all different random directions, Right?

Right, but only from one 'zoom' level of perception. They are only 'so' random. The placement of balls is not truly random. They are only random within parameters. What parameters? Dump the box on the floor.

Are they randomly placed now? Nope, they will still, by their order, show you where they hit the floor and from what angle, and how hard. But they are a lot more randomly placed than when they were in the box. Of course, they are still in the larger box formed by the room in which the floor exists. Then in the box formed by the building, etc on up the scale.

Getting a random interference sample is like filling a box with ping pong balls, so that we have a box of randomness, which we can work with in an orderly fashion. Write the word love on the side of it and shake it again. The balls will assume a pattern that most easily syncs with the QDS we introduced through our archetypal sample – more or less.

In order to get a really good sample, we want lots and lots of 'ping pong balls', and we want them to fit into a conveniently small package. We also need a method of reading the memory, other than carefully touching the side of the box so as to not disturb it.

Maybe we could mix a bunch of glue into the ping pong balls before we shake it, and then let the glue set. Now, our sample will stay the same (relatively) and we can pick it up and carry it around without destroying the data.

This same concept applies to the arrangement of atoms and / or molecules in physical matter, as it does to larger material bodies.

All we need to do is get a sufficient quantity of a material which is finely divided, composed of many small parts, and subject it to the energy signature that we want to capture while changing it in some way.

This type of sampling essentially uses the probability influencing of the QDS to create a glyphic sample, using the ping pong balls / molecules / crystals / atoms in a material sample.

Though it may be incomprehensibly complex, the possible alignment combinations of water molecules in a bucket of water is finite. It is a very high number, but not as high as the possible alignment of all water molecules in a swimming pool, for example.

And because of the laws of conservation of energy / a system wanting to 'right itself'... the alignment that the water molecules assume when disturbed will be that which is 'easiest' for them to maintain, and that will be defined by the ambient energy conditions which the water experiences (and those ambient conditions in turn are , I contend, influenced by the QDS).

Water is a passive write material in that it does not generally require a large amount of energy other than the QDS to pick up a sample. It will (metaphorically) take a 'photograph' in very low 'lighting conditions', but the 'photographs' fade rapidly unless the water is insulated in some way from outside influences.

This same tendency of water to easily pick up a QDS means that it is also easily corrupted over time. Water samples should be stored in glass, since the glass allows the QDS to pass through but insulates the water somewhat from outside energies. I can best describe the dynamics of shielding the water QDS data with glass as being similar to the trick of boiling water in a paper cup. Water samples should be stored in a cool dark quiet place or a secure box with thick walls.

Virtually any material will act as a passive write QDS recording media, but only a few materials like water have a broad response range in that will adapt easily to almost any QDS. For recording long, complex, abstract sequences of thought, a good method is to use water as the primary recording media, and then transfer the final sample from the water to a more permanent media to be used in a read only mode when broadcasting.

Metamorphic QDS sampling

Metamorphic sampling is one of the methods which I use most, and have spent considerable time developing. Metamorphic sampling has the advantages of adapting easily to nearly any QDS, being non-rewritable and thus much less prone to degrading over time, and allowing one to impress a QDS on a material compound that would not ordinarily be compatible with the QDS in a passive write mode. It allows you to permanently impress a

'blue' QDS on a 'red' material, metaphorically speaking.

The basic concept in metamorphic sampling is similar to the known and conventional method of determining the condition of the earth's magnetic field in the past by examining the molecular structure of rocks, so a brief description follows.

The earth's magnetic field exerts a subtle influence on the internal (supposedly random) structure of some types of rock, while the rock is forming or solidifying. Once the rock has formed and solidified, the internal structure remains much as it was, though the earth's magnetic field changes in the intervening years. The rocks can tell scientists about the condition of the earth's magnetic field when the rocks formed because the imprint which the earth's magnetic field left on the rock remains in the rock, though the field is now different than when the rocks formed. The rocks have in this case acted as metamorphic recording media for data concerning the earth's magnetic field. At one point in their history, the rocks were susceptible to the earth's magnetic field. Then, they went through a metamorphosis – they changed fundamentally and irreversibly into a different kind of rock, one which is not as susceptible to the earth's magnetic field. So, the impression that the earth's magnetic field left on the rocks was 'frozen' in time, and here for us to look at today.

In this document, we are dealing with Quantum Data Structures and probability fields, but the mechanics is similar.

Metamorphic QDS sampling through reduction

Imagine that you have a glass, and you smash it with a hammer, and then grind it down with a mortar and pestle into powder. What is the QDS of the glass now, and how does it differ from the QDS of the glass before it was reduced to powder? It differs in that where there was one glass, now there are many glasses. Where the original glass had a distinctive shape, the shape of the glass fragments is 'random'.

But if we look at the fragments, we will see two types of order, at least- one which is easy to see in conventional scientific fashion with appropriate equipment I am sure, and it is an order which tells us about the material characteristics of the glass itself. The particles will not be truly random in size; they will have a general shape which is determined by the physical properties of the glass specimen. They will tend to be sharp edged elongated splinters, elliptical chips, or broken fragments

thereof. They will all be unique variations on those themes, but they will for the most part fit that description. So they are not fully random.

The second and more esoteric order which emerges is that the QDS of the ambient surroundings when the glass was crushed will be reflected subtly in the supposedly random variant contours of the glass fragments, since the QDS acts as a probability field which influences the minute chance events occurring when the glass is fractured, forming tinier patterns on the edges of the already tiny splinters, influencing the exact surface contours of the chips ... in the manner that relieves the most 'probability stress' and makes it 'easiest' for the glass to sync with the ambient energy field conditions in its new form.

The third and more subtle QDS will be data concerning the history of the glass before it was crushed, unless the glass was annealed prior to crushing, and this QDS will be 'quieter' than the QDS of the conditions when the glass was broken. In all of reality, there is only one collection of glass fragments that exactly matches this one, and there is only one set of ambient conditions which occurred when this exact individual glass was reduced to powder. Even allowing for alternate worlds, there is still only one instance of this glass and these ambient conditions in all of reality, and so the closest QDS link from the glass will be to the rest of the fragments from the same batch, and then the ambient conditions the glass experienced when it was crushed.

If we divide the collection of glass fragments in half and separate them geographically, the QDS they share will allow us to use them like a QDS 'walkie talkie'. This is the basic concept employed in many 'remote link' modules sold for radionics devices. The glass in such a case may instead be a quartz specimen and it may be a few large pieces instead of a crushed powder, but the concept is the same.

If you play an acoustic sound while reducing the glass to powder, you capture the QDS sample of the sound in the glass. If you focus your thoughts and emotions into a specific state while working the mortar and pestle, the QDS of you, the archetypes of the thoughts you are thinking, etc are captured on the glass. This is a good method of capturing long sequences of abstract thought in non-verbal form, as using a mortar and pestle is suitable repetitive to be conducive to meditation.

Since the write media is the fracture lines in the glass, the sample is a permanent one, though each chip is a small piece of solid glass. Solid glass is normally a slowly-rewritable QDS media, but the fracture lines constantly write to the glass, each time it is stimulated by outside energy the energy will carry the QDS held in the glass fracture lines, and update the QDS of the solid glass fragments with the QDS stored in the fracture lines. This applies especially with small or very small fragments.

Even if instead of breaking the glass, we just sand the outside of it under appropriate conditions (running apparatus generating sample to be copied, contact with sample to be copied, or focused mental state), the same or similar results will be derived, and the glass will (after a few minutes) write the stored QDS to any water put into it.

If instead of abrading the entire outer surface, we just make a tiny scratch on the bottom of the glass, we will still sample the QDS of the conditions the glass experienced while being scratched, but not always with enough efficiency to be useful. Also, though the bottom – center is a better place to put our tiny scratch for maximum effect, it is also likely to be scratched over by normal wear on the base of the glass, and then it's gone.

Reducing a material to powder in the presence of the QDS to be copied is often the most effective reduction-sampling method, as it affords ample randomness in proportion to material volume, and allows one to mix some of the programmed glass into another material or contain it in a vessel for convenient use.

This method may be applied to nearly any suitable material, but quartz and glass are excellent choices (aside from the OBVIOUS safety concerns of working with powdered glass). Possible adaptations of this method include sanding, hammer finishing of metal surfaces, distressing of sheet materials, crumpling of sheet materials, chemical reduction, precipitation or deposition processes, etc.

Metamorphic Sampling through Annealing

Let us borrow another example from known physics and look at the (relatively unused / unknown in North America and Europe but apparently popular in Japan) minidisk audio disk format. This is not a business card CD, though it is similar in size and general appearance. A business card CD, like a regular CD, is optical write / optical read media.

A Minidisk is magneto-optical write / optical read media. When the disk is written, a laser is used to heat the metal of the minidisk magneto-optical disk up to the Curie temperature, and then a magnetic field is applied via a magnetic recording head. When the disk is later played, no magnetic read head exists in the player, but the magnetic data on the metallic layer causes a change to the way that light is reflected from the surface of the metal, and the data is gotten off the disk by looking for these characteristic changes to the reflected light (polarity changes I think, but don't quote me on that).

Ordinarily, the metal would not be magnetically responsive enough to be written to by the magnetic recording head in the magneto-optical disk recorder. But when the metal is heated sufficiently by the laser, it changes into a state where it is magnetically responsive enough to be written magnetically, and then allowed to cool so that it will no longer be as susceptible to external magnetic fields, making the sample permanent (in a perfect world). You do not even need another magnetic head to read it; you only need to look at how the magnetic field changes the optical (or other) characteristics of the disk.

What is of importance here for QDS sampling is the fact that when a material goes through a metamorphosis, it changes in terms of what its characteristics are, and that this is an excellent opportunity to impress QDS data on it.

When a material is annealed, either by heating it either to the melting point, or to just below the melting point, or by working it (if it is a flexible material), the QDS data in the material, (all but the raw data describing the material itself) is more or less 'wiped'.

If the material is cold-annealed, then the previous QDS data describing the ambient conditions when the metal was formed and the metals experiences up to this point is erased by blurring it out, as if it were written in a shallow layer of sand and we shook the table and smoothed out all the sand. The previous data is still there but is removed by one order of random variance magnitude, made into a much 'quieter' signal.

If this cold-annealing is done repeatedly, the previous data is pretty much lost but technically still exists. Cold-annealing is useful for both 'clearing' wire and other materials before use in construction of coils, circuits, etc... and for taking

small QDS samples of abstract thoughts, audio waves or emf waves.

It is also useful for 'layering' more than one QDS sample onto the same recording media, when it is not convenient produce samples of all the desired entities at the same time or in the same sample format.

Although many complex machines could be built to cold-roll a suitable metal in contact with a QDS sample (or modified to do so) the simplest method is to simply choose a clean, new piece of wire and find a small cup hook in a wall or other vertical surface. Loop the center of the wire over the hook and hold one end of the wire in either hand. Run the wire back and forth over the cup hook a few times along the whole wire length (a few feet) to smooth it out. Then, in the presence of the energy field to be sampled, sharply run a few inches of the wire across the hook with a little tug. Snip out the portion (a few inches is enough) that you just wrote. Keep your mind carefully blank while making the 2 cuts.

The resultant short wire may be placed (appropriately and carefully so as to neither damage the electronics or overheat / repeatedly flex and 'erase' the wire) in contact with conventional electronic / radionic circuits in such a way as to transfer some of the QDS from the wire into the electronics for experimentation. It may also be used as a sample for a radionic machine witness plate or well. It may also be attached to glass in order to program water. The technique may also be adapted to 'program' a coil which will later be used for producing magnetic or scalar fields.

Hot annealing is a more permanent method in that the previous QDS data is more fully erased. If the cold annealing process results in blurring of QDS data (in favor of new data being over-written), then the hot annealing process actually erases the background QDS data and leaves only the raw material data describing the sampling media itself. For example, if the data was chiefly stored in a pattern of metal crystal alignments and microscopic cracks in the metal, then we can realign the molecules by cold rolling and make new cracks holding our new data. But the old cracks still exist, and the 'start point of new molecular alignment will be based on the old QDS held by the metal.

If we melt the metal, we not only realign the metal atoms and given them a new 'start point' for their molecular alignments, but we also melt and reform the metal crystals so that the only data stored in the

cracks between metal crystals will be the 'new' data. Additionally, we make the material temporarily responsive to outside energy fields in a different way than it is when it is solid. Ideally, we would use those energy forms to which the metal is temporarily responsive to write the data.

The material need not be melted, it need only be heated enough to soften and normalize it, then allowed to cool, in the presence of the focused though, sound, EM wave, light wave, picture, scalar field, or other sample to be copied. Recently Phil Ledoux circulated a paper describing how another researcher was heating up a marble with a small torch and playing a solfeggio frequency while it cured. This is an excellent correlation to and example of the dynamics discussed here.

Metamorphic Sampling though chemical process

This is a vast heading with many more applications than will be discussed here; this paper is long enough already. I will mention but two examples here: plastic resin setting and salt crystal growth.

While some materials are such that they can be melted down and resolidified many times (like metal, or some plastics, or water), other materials go through metamorphic processes that are truly irreversible in that once solidified, they cannot be melted down again. Using chemical processes allows us to work with these types of materials, like the various plastic casting resins used to make orgone matrix material. While the addition of metallic elements to the plastic resin does a whole lot of interesting things which are discussed elsewhere, the plastic alone is sufficient to store a QDS concerning the events it experienced while solidifying. In polyester resin, for example, we have a material which first forms small molecules, and then the small molecules form long string shaped molecules, and then the strings curl up and tangle together. The QDS data is stored both on the molecular alignments and on the microscopic cracks that form when the material heats, shrinks, and cools. Adding many small particles of metal produces yet more possible alignments of random bits for the QDS to impress itself on. Once the plastic has cured, you cannot melt it down, it does not melt, and it catches fire. If you burn it, you erase the data. If you dissolve it with acid, you erase the data and / or put the data into the acid.

There are other plastics which smell less than polyester, and they will all work to store QDS samples.

Another method is to set up a chemical process which grows crystals and grow them in the

presence of the QDS to be copied. A simple method of doing this is to grow salt or sugar crystals in the presence of the QDS sample. The QDS data will be in the xtal and in the arrangement of many small xtals on the growing surface. If you want to keep the xtals on the growing surface, keep them small and densely packed, when they are grown seal them with a plastic seal coat. Otherwise, let them grow as large as they will grow and take care not to fracture them excessively. Dissolve it in water and the QDS goes into the water.

Methods of reading and broadcasting QDS signals.

Read by contact

Recall the magneto-optical disk and how it reads data off the disk. The changes to reflected light produced by the magnetic component of the disk are subtle changes compared to the way a normal CD player reads a disk, which is why a normal CD player cannot play a magneto-optical disk. Likewise, a normal LP vinyl disk record player will not play back the sounds of ancient Babylon from a pottery shard.

But, due to the effects of contact sampling, a person who has developed 'savant' abilities can gain accurate impressions of the surrounding when both the pottery shard and the LP record were created, by reading the QDS data. Person who do not have developed 'savant' abilities demonstrate biophysical / psychological responses to QDS data reminiscent of hypnotic suggestion or intuitive perception in some cases and reminiscent of conventional exposure to the material source of the recorded QDS data in others, depending on the QDS structure to which the persons are exposed.

This technique may be also used to treat water in pipes if the sample is placed in contact with the exterior of the pipes. Rooms and outdoor areas with QDS encoded paint or paving may be used for contact reading of QDS samples. Drinking and eating vessels similarly treated may be used for contact sampling, or the sample may be used by simply having the person hold it between their hands. If the sample is polarized, then the pos. / output end should go in the left palm and the neg. / input end in the right palm.

Read by throughput

Read by throughput is also a very common method of broadcasting QDS signals. It places a QDS sample in contact with virtually any conventional energy broadcast setup and the QDS is transferred to varying degree on the energy broadcast. Let us

assume that we have the latest orgone matrix material – based QDS sample, which would be something like a small disk or ring shaped casting of EXD orgone matrix material programmed as above. We can shine a light through the hole in the center, if it is a ring.

We can place it on a speaker, and play sound through the speaker to stimulate it. We can place it in contact with or in close proximity to an electrical conductor. These are all methods of getting the QDS into a circuit which is ‘broadcasting’ something.

If we transfer the sample to an electromagnetic format, then we can broadcast it in a variety of ways using off the shelf audio, video, and other components. These practices are more common in the early 21st century than commonly acknowledged, and therefore I feel comfortable writing about them in the interest of equalizing the playing field between multinational corporate and governmental QDS broadcasts for marketing, political or other purposes and the average person. While the necessary setup can certainly be enhanced by scalar, orgone, and other technologies dealing with advanced physics, the setup can be functionally simple as a modified audio or video signal, or a specially treated paint applied to an area, or a sample placed strategically in an area near a light, speaker, fan, or other similar energy-circulating device.

It is advantageous to convert the sample into an electromagnetic format since this allows the embedding of it in signals sent to video, audio, radio, or scalar wave, radionic and psionic devices. Depending on the nature of the QDS to be broadcast, it is often necessary to make an initial, non-permanent sample and then convert this sample to a permanent (non-rewritable) sample. The type of sampling method is often determined by the nature of the sample. For the QDS of a simple sound or frequency or video image, the sound or video image may be directed towards the media while any metamorphic sampling method is used. But if the QDS is of a long, abstract series of thoughts, then it may be convenient to first use one of the other methods, and then convert it into an electronic or audio format.

Assuming that convention subliminal encoding methods are not used, the QDS of a complex thought may be partially captured by focusing the

thoughts clearly while recording nearly any electronic file or tape.

Mixing it into either white noise or silence increases the amount of the QDS captured.

The subject may or may not be in contact with a suitably placed conductor in the circuit.

A simple setup would be to have the subject touch one of the microphone leads (taking care not to damage the recording apparatus) and focus their thoughts while recording the results. Ideally, this signal should be mixed into something like white noise to give it something to interfere with.

A slightly better setup would be to have the L and R channels of a stereo audio line connected to 2 mobius coils. Have the subject hold both coils, one in each hand or place one coil over each temple. Route low volume white noise through the coils while the subject focuses their thoughts, and send the result to the line in of the audio recorder.

This process may omit the mobius coils, in favor of simpler spiral coils. Mobius coils should not be worn over the temples for prolonged periods, nor powered at more than line levels when used in such a fashion.

The resultant white noise signal will carry the QDS signal. In place of white noise, we can use silence, either a blank carrier signal may be routed through the pickups or each pickup may terminate across suitable resistance. Care should be taken to minimize the 60 hum when recording in this method.

An even better method is to use pump wave pairs (2 signals canceling to produce “loud silence”) as the signal routed through the coils. The resultant signal may be mixed into any suitable broadcast system and the QDS will be carried on the audio signal in efficient fashion. In place of a person holding the pickups, the pickups may be placed on either side of a sample of any of the types described above. This concept may be adapted to recording in optical and magnetic media as well as electronic media. Radionics devices, psionics devices, orgone accumulators, and other related technologies may be used to improve the efficiency of the basic concepts described here, but that is the subject of another article.

© Jon Logan Feb 2007

Low Frequency Function Generator

By Pieter Fourie [TOC](#)

<http://www.saa0.ac.za/~pah/vlf/vlf.html>

Due to the unavailability of very low frequency function generators and the problems experiencing with them to generate a wave form starting with a particular trigger input has prompted me to design this function generator.

The system consists of a personal computer and the printer port is used.

Advantages:

- Cheap
- Versatile
- Easy to implement
- Very low frequencies possible
- No large expenses for an instrument which will only be used infrequently.

The system consists of a personal computer, printer port interface and a 10 bit Digital to Analog convertor.

The software was written on the fly and runs under DOS. The printer port interface is not necessary but it makes the system more versatile. The 10 Bit Digital to Analog convertor has two outputs. The one output is a direct output which provides signals from +5V to -5V. The other output has a potentiometer in which allows the amplitude to be adjusted.

A trigger from the external device can be used to trigger the system to allow the wave forms to be synchronized.

To allow for step and transfer functions to be determined the generator can provide a square wave and a sine wave.

The square wave amplitudes can be adjusted from software and therefore the direct output is used when using square waves. To ensure that the sine wave has a very low distortion the adjustable output must be used and the level adjusted accordingly.

The trigger input is a TTL signal level and the system can trigger on the high or low transition.

Radionics depends in part on engineering and in part on user skill. That said, people have insisted on using it for decades, despite the consistent & combined effort of many scientists, doctors, corporations and politicians to the effect that it 'should not be used' and 'is rubbish'. If people were not getting useable results, the field simply would not exist.

- Editor



RevTed's Myth n Lynx web shop

has special crystals, minerals, stones and other supplies for those who are Metaphysically

inclined. Nice selection of Lemurian Seed Crystals, Quartz Crystals, Buddhist Good Luck Amulets and other stones and minerals from various locations around the world. Interested in healing qualities of crystals and stones? Or perhaps you are simply interested in geology and would like some good specimens of rocks and minerals. RevTed specializes in gemstone, minerals, jewelry and, of course, crystals.

[HTTP://WWW.MythnLynx.com/HHG.html](http://WWW.MythnLynx.com/HHG.html)

Hidden Universe 406 North 6th Street P.O. Box 172 Melrose, NM 88124 United States

Worlds Within Worlds



<http://www.rialian.com/rnboyd/>

Educate-Yourself

The Freedom of Knowledge, The Power of Thought ©

<http://www.educate-yourself.org/>

Circuit diagram of the 10 Bit DAC:

The pin numbers on the digital input side are for connection to the printer port interface. If the system will be assembled without the printer port interface then the pin numbers must change to be the same as those on the printer port.

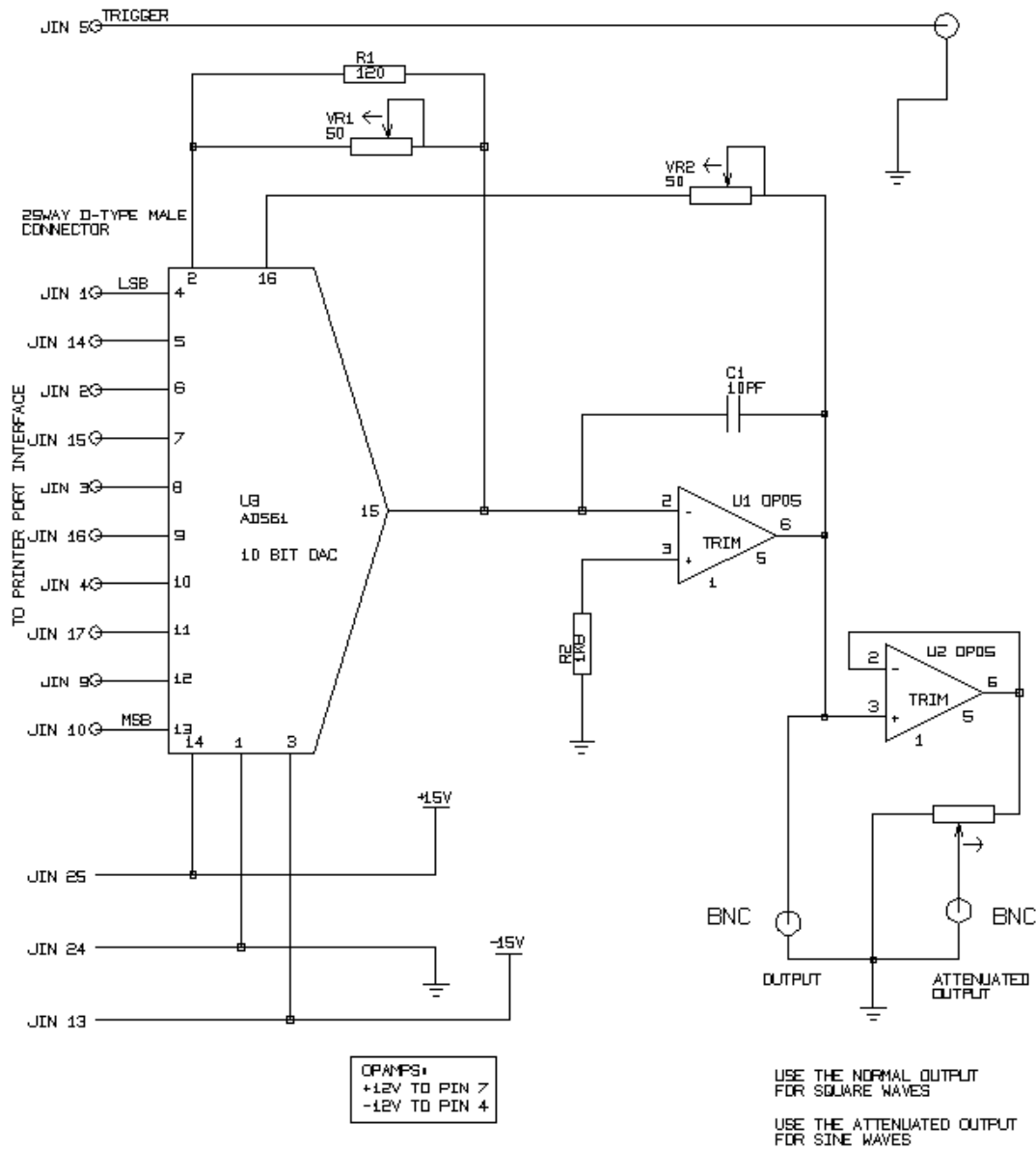

10 BIT DIGITAL TO ANALOG CONVERTOR

Printer port Interface:

The printer port interface was a student project at the observatory and have been used on several occasions to quickly interface something.

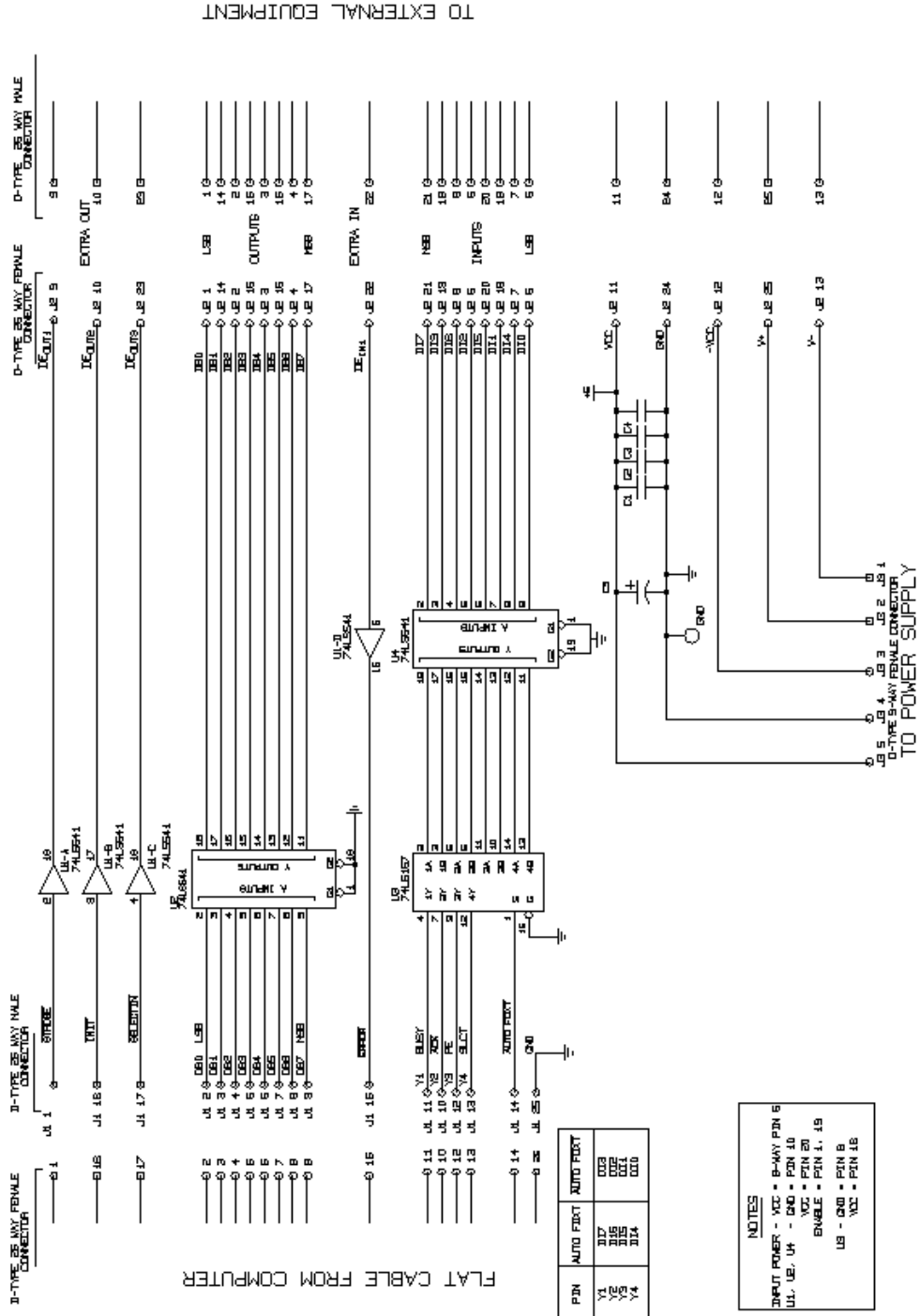

Trigger input:

The trigger input is a TTL level signal connected to bit 0 (lsb) of the printer port interface. Depending on the program running the system can trigger on a positive or negative edge signal.

Adjusting the convertor.

- Turn ON the MSB only, turn OFF all other bits.
- Adjust VR1 to give 0.00V output.
- Turn OFF all bits.
- Adjust VR2 to give a reading of -5.00V
- These adjustments are not critical.

Software:

Several pieces of code were written to implement the generator. The code is in C and Borland C++ compiler were used. No special routines and functions are used so the code should be transportable.

The timing of the system relies on a software routine and the values must be determined empirically for each computer. More about this when the different pieces of code are discussed.

Programs:

- [fr_sin.cpp](#) - This program generates a free running sine wave.
- [fr_sqr.cpp](#) - This program generates a free running square wave generator.
- [mono.cpp](#) - The generator will provide a single pulse of a set duration and voltage levels after a trigger pulse.
- [fr_sin.exe](#) - The executable file.
- [fr_sqr.exe](#) - The executable file.
- [mono.exe](#) - The executable file.

(If your viewer opens the file then simply 'save as')

Note – The links to the files hosted on this author's domain are included in this article, and clicking them should allow you to download the files. However, you must be connected to the internet in order to download the files, they are not embedded in this pdf or word document. - Editor

Program Operation:

FR_SIN.CPP & FR_SIN.EXE

The generator will output a sine wave starting at 0V. The period of the signal must be entered. The minimum period is 1 second. This will continue until a key is pressed. To ensure minimum distortion of the sine wave the full amplitude is

used during the signal generation. The user can adjust the signal level using the adjustable output.

FR_SQR.CPP & FR_SQR.EXE

The generator will output a square wave according to the voltages requested. The user must enter the max. and min. voltages for the wave form and the period in seconds. This will continue until a key is pressed. When using square waves it is advisable to use the normal output since the level of the wave can be adjusted in the program.

MONO.CPP & MONO.EXE

The generator will output a single pulse starting at the trigger signal. The user must specify the min. and max. voltages for the wave form as well as the duration. The user also specify at which level the generator will trigger. When the program starts it will wait for the opposite level before triggering and then start on the requested level. E.g., the user wants the pulse to appear when the trigger goes high. When the program starts the trigger level is also high, this will not cause a trigger to take place. The generator will wait until the trigger level is low and then set itself to trigger on the next high level. If the requested trigger is a high and the level is low when the program starts the system will trigger on the first high transition of the trigger input. The opposite for low level triggering is also true. This is to ensure that the user has sufficient time to connect and start the program. The programs at the moment are compiled to use LPT2 as the printer port. If another port is required the change the line towards the bottom of the code (PORT = LPT#) to the required port and recompile.

For more information or queries contact me

Pieter Fourie e-mail pah@saao.ac.za

web page <http://maia.saao.ac.za/~pah>

This article reprinted with permission from

<http://www.saao.ac.za/~pah/vlf/vlf.html>

Orgone Matrix Material Shop

HHG Tips [TOC](#)

(edited version of a consultation response)

by Jon Logan

I am a person with interests in the broader field of applied 'subtle energy' engineering. That said, HHGs are relatively simple devices and one does not need to be a tech-head in order to make them.

About HHGs:

First off, while it does IMO coax a bit more performance from the units if you use double-terminated quartz crystals in the HHG, you do not NEED to use double-terminated quartz specimens. You can also use single terminated quartz points. You can also use tumbled quartz pieces. Depending on where you live and your financial circumstances, it may or may not be affordable/practical for you to use double-terminated crystals.

(DT = Double terminated; ST = Single Terminated)
If you elect to use a combination of DT and ST crystals, then use the DT for the vertical xtal in the HHG, and the lower quality ST or tumbled pieces for the horizontal crystals. Use the nicest xtal in each group of 5 for the one that 'stands up' in the center of the HHG.

The HHGs can be made in any shape, though generally they are made in some variant of a cone or pyramid shape. Cones are an easy shape to work with and one which you can find suitable molds for with relative ease. Go get some cheap plastic funnels at your local home depot, Wal-Mart, builders supply store, etc. Cut the tip off the funnel and glue, tape or melt it closed to plug the hole. Tape is the best (quick) method of doing this, and I recommend using either a good quality masking tape or (better) aluminum auto body tape.

Grades

Normally MHD or HD is used for HHGs. This is because the matrix must be 'open' enough for the HHG to be reasonably active in a passive mode. With the higher densities, the matrix needs be stimulated in some way in order to process any significant quantity of energy.

Metals

Copper is an excellent choice of metal for the HHGs. Any metal will work, but copper has a bit broader response range than aluminum. Aluminum is probably the single most commonly-used metal for making HHGs, and it works fine despite assertions by some that it is unsuitable. The energy signature of aluminum is not as 'good for you' as that of copper, or steel (see Edgar Cayce regarding suitability of carbon steel for human energy field). But for HHG or TBs made to be 'gifted' in the open, it works fine. For HHGs which you intend to use indoors or which will be handled a lot, then copper is a better choice (IFF it is to be had).

MHD Enhancements

Metals

One thing you can do to enhance the action of the material is to use more than one type of metal. Use 2 different types of metal such as one could construct a battery from, ie. one ferromagnetic, the other diamagnetic... one with a higher conductivity than the other. So for example, you could mix a little bit of steel, iron, pyrite, chalcopyrite or nickel into the copper. An economical source of steel is to get some fine or ultra fine steel wool and cut it up into short pieces about 1/4" long with a pair of scissors. While this is time-consuming, it is economical.

Another source of steel is to go around to local machine shops and ask for steel shavings or filings. Often they will give you this for free if you tell them it is for a craft project. Steel and copper go well together. Brass is also often available as shavings from key cutting machines – go ask them at your local hardware store for the shavings and often you can get them for free.

An example of a an MHD metal mixture for general-purpose use would be:

Copper (or aluminum) 75 to 90%

Steel - 22.5 to 9.5%

Brass – 0.5 to 2.5%

(proportions approximate)

It is OK if the brass and steel particles are much smaller than the copper, and you need only mix in a small amount of the other metals to get the effect. Alternately, if you had lots of steel and only a little copper you could mix a little of the copper into the steel.

Another cheap trick is to add a single, reasonably large gold-plated bead to each HHG. It does not need to be a high quality gold plating. Gold has an excellent energy signature for HHGs and so does silver. If you are using a 'tiny' piece of a precious metal, you can get away with using only a single small piece if it is placed in either the tip of the cone or the center of the base of the cone. If you want to be more finicky then you can carefully tape a small piece of gold or silver to the side of the vertical xtal in the HHG. Point being, you can use a small piece of precious metal to influence the whole energy signature of the HHG if it is placed in a focal point of energy within the cone. The tip, center crystal, and center of base are all focal points of energy within the cone.

Minerals

In addition to the metals, you can add any of the following minerals in small amounts, they are all IMO safe for general purpose use:

Amethyst
Turquoise
Rose Quartz
Citrine
Selenite
Kyanite
Tourmaline

Hematite and lapis lazuli are also great but may too strong for some folks, some people react badly to hematite and some people get over stimulated by lapis lazuli.

That said, I often work with a combination of turquoise, lapis lazuli and hematite in my HHGs and TBs.

Organic Material

Before you ask, the word 'organic' means 'made mostly out of carbon atoms'. It does NOT mean 'formerly living tissue', 'of natural origin', 'non-toxic', 'environmentally friendly' or anything else similar.

The most commonly used organic resin is polyester resin with MEKP catalyst, used normally for fiberglass work. It is nasty to work with but works just fine for making orgone matrix material. Do not go and ask for polyester resin at the hardware store they won't know what you mean; ask for fiberglass resin and they will know what you mean. Polyester resin often cracks while curing and for HHGs the small cracks do not affect the performance of the device much, unless they cause the casting to fall apart.

Another plastic resin you can use is epoxy. Epoxy is also nasty to work with but works just as well for making HHGs. While epoxy is not as prone to cracking as polyester, it also does not shrink away from the sides of the mold when it cures. Sometimes shrinking away from the mold makes it easier to remove the finished casting.

Acrylic casting plastic also works well and is generally a bit more expensive than polyester or epoxy. It is not prone to cracking but tends to trap small air bubbles. It does not shrink away from the side of the mold when it cures. It has a slightly nicer feel than polyester but IMO not nice enough to warrant the often 3x price.

Hardened pitch from trees is a natural resin that you can use. While not as durable and possessed of tendency to soften and sag when left in the hot sun, it is a natural material and has a nice feel to it.

Beeswax can also be used but again is neither as efficient as pitch nor even as durable as pitch.

Plastic resin are generally used because they are easily available, durable and economical compared to most of the other alternatives.

You can mix a small amount of powdered herbs into the resin for a semi-homeopathic effect. I leave it to you to decide what herbs are best used, and suggest that you spend some time reading up on it. As a simple suggestion, I might recommend sage, as it has energetic properties that work well in an HHG, is more or less safe for general use, and is easily accessible in most supermarkets. You only need to use a tiny amount of the sage in the resin, say 0.5 to 1.5 teaspoons of powdered sage per a gallon resin.

I also sell a premix powder blend suitable for using in HHGs (by adding small amounts) or in making EXD (used with just the powder and resin).

You could add a pinch of finely powdered iron oxide (rust from steel or iron, or red earth if you can find red earth where you live) to the resin.

Coils

You do not need to put a mobius coil in an HHG. You can do so, put TBH the flat spiral coils are more suited to use in HHGs than a mobius coil. Adding a mobius coil changes the HHG into a small broadcast device. You then have to pay attention to what is running through that coil.

If you want to make something with a mobius coil in it, then cast a small disk or slab of HD or XHD and put a coil in that.

Programming

An optional step but well worth the effort. You do not need a mobius-coil-driven generator to program resin, though of course you could build a small one to use for this purpose. An easier option to get started would be to just use a PC sound card and some audio speakers. Put the speakers close to the resin and play the solfeggio frequencies while the resin cures. Or, you can download the file in the audio files section of my new site:

(use the word member for the logon and use the word isubscribed for the password), follow the links to the audio files section and download the phi resonance tones file. Link:

www.wizzersworkshop.com/ (click on the members link to access members area) If you don't want to download the file then use NCH toner and play 741 and 528 Hz.

Magnets

You can use magnets in an HHG, but it is not necessary and some care needs to be taken to fit the magnets in correctly. I would suggest you omit the magnets in your first several batches and add them only if you are not getting the results you are looking for. When a magnet is added to an HHG, you have to pay attention to which polarity of the magnet is where, and deploy the HHG accordingly. Magnets are suited for disk shaped HHG and the disks should be used by holding the N pole of the magnet against the skin.

Recap

Since you intend to sell them, I assume you plan to make a few of them. Therefore, I would suggest that you keep the first batch simple. Here is a quick overview of what I would recommend:

Metals:

Mostly copper
Little bit of steel
Tiny bit of brass (optional)

Organic Resin:

Polyester or Acrylic
Herbs / Powders: (optional)
Pinch of Sage
Pinch of Iron Oxide

Quartz Crystals:

ST or DT
try to pick a nice one for the central, vertical xtal
(point up if ST, points In on base if ST)

Minerals (optional):

Turquoise
Gold or Silver
Rose Quartz
Amethyst
Tourmaline
(one or all of above)

Casting:

Try to leave a layer about 1/8" to 1/2" thick on the bottom of the cone (or pyramid, disk / other shape) that is just resin, no metal.

Sanding / Finishing:

Not needed, but it's a good idea to grind or sand off the sharp edges sometimes left by casting. It does not hurt them to paint them if desired. If using a metallic paint, leave the bottom of the cone and a small area at the tip of the cone unpainted.

Use:

For outdoor use, place in a body of water, in contact with a grounded structural building member, or bury under a few inches of soil.

For indoor use, move the item semi-regularly (every few months at least). Also, you should either run cold water over the HHG for a few minutes or place it outdoors in contact with the ground - at least twice a year.

Programming:

Do this while the resin is actively curing, use a tone generator, your favorite 'healthy' music, radionics software, or focused visualizations / chanting/ toning / etc.

© Jon Logan 2007

Courtesy [Keelynet TOC](#)



12/27/06 - [The Wave Bubble: A Pocket Sized FM Jammer](#)

The Wave Bubble touts itself as being a "self-tuning, wide-bandwidth" rig that doesn't require a spectrum analyzer, and can "jam many different frequency bands" all in a pocket-friendly enclosure. Powered by an internal Li-ion cell, this bad boy provides self-tuning via "dual PLL," and you can manually enter new frequencies to vex by simply plugging it into your PC's USB port and inputting the data when prompted. It can purportedly provide up to two hours of jamming on dual bands (such as "cellphones") or four hours on single bands such as "cordless phones, GPS, WiFi, Bluetooth, etc." Additionally, the output power ranges from 0.1-watts (high bands) to 0.3-watts (low bands), and the handy device sports an approximate range of about 20 feet with "well-tuned antennas." Of course, you aren't apt to find this for sale anywhere considering the fit the FCC

would undoubtedly throw, but if you consider yourself a master of the DIY craft, be sure to tag the read link for some in-depth pedagogy.

(<http://www.impactlab.com/modules.php?name=News&file=article&sid=10186>)

Courtesy [Keelynet](#)

Courtesy [Keelynet](#) [TOC](#)

[12/19/06 – 1936 Spiral organization found in Paraffin Crystals](#)

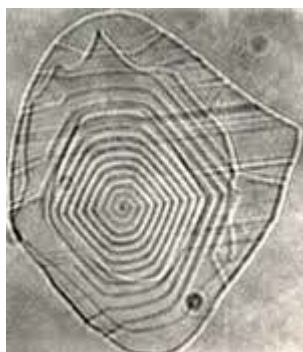

Spiral organization, so common in plant and animal life and almost universal in nebulae, is a very rare phenomenon in inanimate molecular structures. Preserved in Princeton's museum is a carborundum crystal that has on it a spot the size of a pinhead,

which when magnified shows a simple but perfect spiral. Also, in rare cases, the face of a quartz crystal properly etched will show a type of spiral. Spirals in abundance and of rare beauty have recently been discovered by Prof. C.M. Heck of North Carolina State College, and that, too, in common paraffin. Shown on the cover of this week's Science News Letter is one of these spiral crystals as it grew from a solution of paraffin in mineral oil. It is magnified 1,200 diameters and shows each convolution repeating with exactness the exterior outlines of the crystal, a significant element of the discovery. Professor Heck discovered these crystals while researching on the equilibrium conditions shown between solid and liquid compounds of the paraffin chemical series. His findings are proving of much interest to the refiners of oils and gasolines as they show paraffin crystals to be sensitive detectors of foreign materials when in these products. The crystals vary their shape and internal structure markedly. For example, these spirals are found to double and become twin spirals in certain cases, one spiral turning clockwise and the other counter-clockwise in most cases. No explanation of the spiral formation is given by Professor Heck, though he finds strong indications that all tabular paraffin crystals have a spiral structure that becomes visible only in exaggerated cases. Analysis with polarized light so far has not shown any difference between crystals with visible spirals and those without them. (<http://www.sciencenews.org/articles/20061216/timeline.asp>)

Courtesy [Keelynet](#)

Courtesy [Keelynet](#)



[01/11/07 - Lightning balls created in the lab TOC](#)

(Anything for publicity. - JWD) One theory suggests that

ball lightning is a highly ionised blob of plasma held together by its own magnetic fields, while an exotic explanation claims the cause is mini black holes created in the big bang. A more down-to-earth theory, proposed by John Abrahamson and James Dinniss at the University of Canterbury in Christchurch, New Zealand, is that ball lightning forms when lightning strikes soil, turning any silica in the soil into pure silicon vapour. As the vapour cools, the silicon condenses into a floating aerosol bound into a ball by charges that gather on its surface, and it glows with the heat of silicon recombining with oxygen. To test this idea, a team led by Antônio Pavão and Gerson Paiva from the Federal University of Pernambuco in Brazil took wafers of silicon just 350 micrometres thick, placed them between two electrodes and zapped them with currents of up to 140 amps. Then over a couple of seconds, they moved the electrodes slightly apart, creating an electrical arc that vaporised the silicon. The arc spat out glowing fragments of silicon but also, sometimes, luminous orbs the size of ping-pong balls that persisted for up to 8 seconds. "The luminous balls seem to be alive," says Pavão. He says their fuzzy surfaces emitted little jets that seemed to jerk them forward or sideways, as well as smoke trails that formed spiral shapes, suggesting the balls were spinning. From their blue-white or orange-white colour, Pavão's team estimates that they have a temperature of roughly 2000 kelvin. The balls were able to melt plastic, and one even burned a hole in Paiva's jeans. These are by far the longest-lived glowing balls ever made in the lab. Earlier experiments using microwaves created luminous balls, but they disappeared milliseconds after the microwaves were switched off. "The lifetimes of our fireballs are about a hundred or more times higher than that obtained by microwaves," says Pavão.

Courtesy [Keelynet](#)

"Formerly no one was allowed to think freely; now it is permitted, but no one is capable of it any more. Now people want to think only what they are supposed to think, and this they consider freedom."

Oswald Spengler - (1880-1936) Source: The Decline of the West, 1926

Courtesy [Keelynet](#)

01/10/07 - [Desktop fabricator may kick-start home revolution](#) [TOC](#)

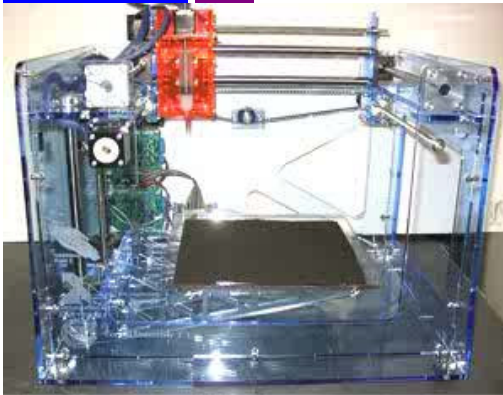

A cheap self-assembly device capable of fabricating 3D objects has been developed by US researchers. They hope the machine could kick start a revolution in home fabrication – or “rapid prototyping” – just as early computer kits sparked an explosion in home computing. Rapid prototyping machines are already used by designers, engineers and scientists to create one-off mechanical parts and models. These create objects by depositing layer upon layer of liquid or powdered material. These machines typically cost from \$20,000 to \$1.5 million, says Hod Lipson from Carnegie Mellon University, US, who launched the Fab@Home project with PhD student Evan Malone in October 2006. The standard version of their Freeform fabricator – or “fabber” – is about the size of a microwave oven and can be assembled for around \$2400 (£1200). It can generate 3D objects from plastic and various other materials. Full documentation on how to build and operate the machine, along with all the software required, are available on the Fab@Home website, and all designs, documents and software have been released for free.

Courtesy [Keelynet](#)

Near Disaster [TOC](#)

Forward Courtesy R Montserrat

Sometimes, we all wonder what may or may not be possible. After seeing this come to my inbox, I just couldn't resist – editor

Look at the first picture, (Top Right) and you can see where this guy broke through the guard rail (right side where the people are Standing on the road).

His truck left the road, travelling from right to left. He flipped end-over-end, across the culvert outlet and landed on the left side of it.



Now look at the 2nd picture (below).

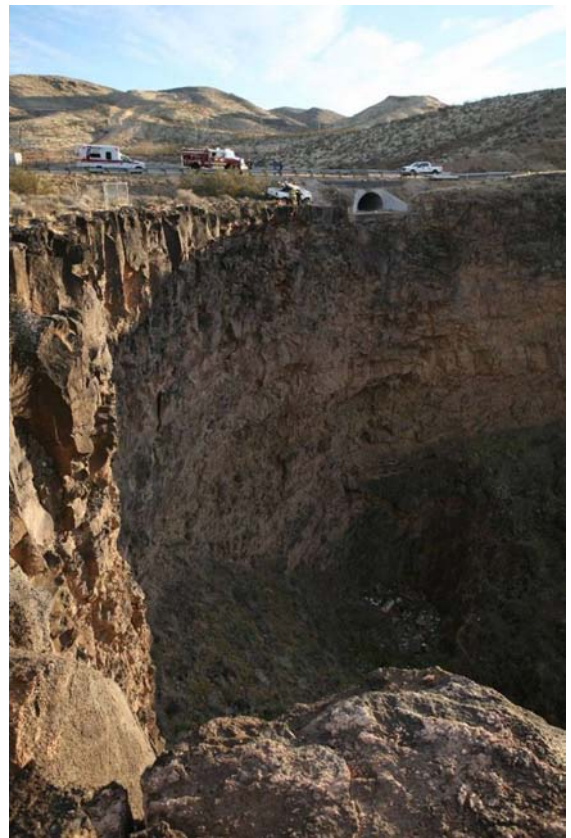

Lucky bloke this, eh?

Scalar Beam Chembuster Modifications

(Edited version of a consultation response)

By Jon Logan [TOC](#)

I have put a fair amount of time into thinking about the design modifications you suggested, and am attaching some schematics for you. I have not built the design depicted here, but based on my understanding of the materials and physics involved it ought to work.

There are many modifications to the basic Chembuster design which have been tried by various folks. In general, they revolve around 2 main themes: optimizing the Chembuster for use in the (standard) passive role OR optimizing the Chembuster to serve in a powered (non standard) role. When the Chembuster is working in a passive role, it functions IMO as a check valve operated by the potential and / or state difference of the orgone fields in the air and the earth respectively. It will change its energy throughput in response to systemic conditions / ambient conditions. In some cases the effects of deploying the Chembuster may be dramatic; in others it may appear to do nothing until the conditions which cause it to function are provided.

In an active role, the Chembuster is used as a large scale radionics output module. While this can make the Chembuster more active, it can also change the effects depending on the signals used to stimulate it. Time needs to be spent determining what signals work best in your area and for you. However, the solfeggio tones in general are a good place to start. Also, pretty much any soothing type of music, recorded chant, or other audio recording with some 'healing' properties would be a good candidate for testing. You could also make the process of broadcasting through your Chembuster more efficient by taking into account the direction in which the Chembuster is pointed; in general alignments based on the compass directions seem to be most effective. It is possible to simply point the Chembuster at a section of the sky for short term usage. For long term usage, it is generally agreed better to find a directional heading and angle (compass degrees and elevation above the horizon) that work well in the area of use and stick with it, changing the alignment only as needed.

You can test the response by pointing the Chembuster at a roughly 30 degree angle to each of

the compass directions and monitoring the weather through the area.

It is well worth reading over the cloud buster use methods described on PORE and OBRL web sites if you plan to use your Chembuster in an actively powered mode. In an actively powered mode, the Chembuster will behave more like a conventional cloud buster, with the added factor that it will have a signal carried on the field of effect.

Orgone Matrix Material Recipe

One of the most fundamental optimizations of the Chembuster for a passive role is to put some thought into the ingredients used for the Orgone Matrix Material base attached to the pipes. There are literally hundreds of different substances that people have added to the material while experimenting, and by no means will all of them be mentioned here. It is recommended that you read over the information my site concerning "Orgone Matrix Material and the curing process" and "orgonite ingredients", these pages can be found through the site map page of my site (<http://www.littlemountainsmudge.com/sitemap.htm>).

Rather than using a simple mixture of aluminum and polyester resin, you can add a ferromagnetic or paramagnetic metal in along with the diamagnetic aluminum. Iron or steel are excellent for use in the Chembuster as they are far more responsive to the earth's magnetic field (and to any EMF which the device encounters) than aluminum alone.

The addition of iron oxide is another means of making the Orgone Matrix Material more responsive to magnetic forces, and more strongly an attenuator of EMF. I often use a red earth which i collect locally and which has (among many other trace minerals) a high iron oxide content.

"The only thing that interferes with my learning is my education."

- Einstein

Chembuster Scalar Beam Generator
Dimensions Overview

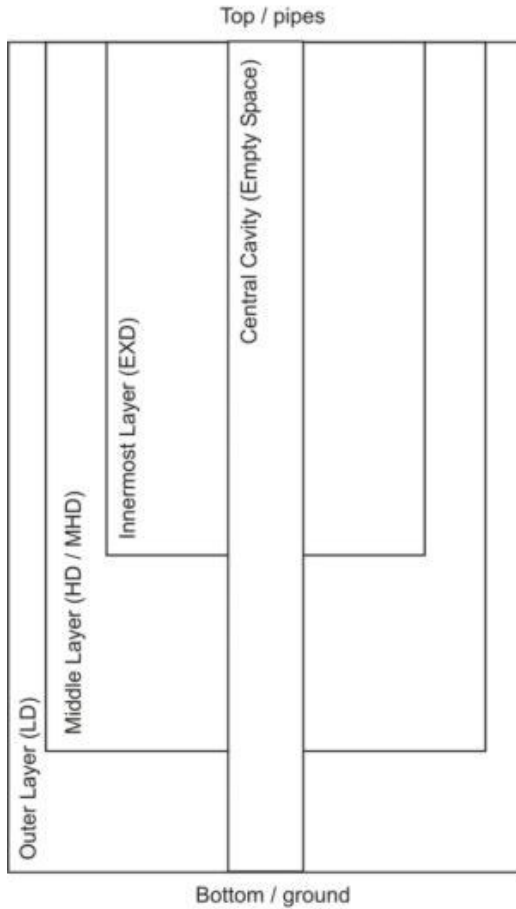

Size Ratios (in percent):

List format = name / diameter / height
all 4 shapes are cylindrical and concentrically arranged
Outer Layer - 100 x 161.81
Middle Layer - 85.415 x 138.19
Innermost Layer - 61.81 x 100
Cavity - 14.59 x 161.81

Pipe length

The length of the pipes does IMO play a role in determining the focal length of the device. The standard six foot length works fine. It is not absolutely necessary that the pipes be six feet long. A simple optimization is to have a competent dowser define the length closest to six feet which will work best in the area you intend to use the Chembuster. A simpler method is to make the pipe length a multiple of the diameter x PHI (1.6181). One way to do this is to split the difference between pipe ID and OD, then multiply this by 1.6181. Keep multiplying the resultant number(s) by 1.6181 until you get to length close to the target length for the pipes.

The PHI Ratio may also be incorporated into the layout of the Chembuster base, and this is shown in the attached schematics. IMO, using the PHI ratio in this application acts to smooth the energy signature of the device and make it less discordant / more harmonic. It allows the device to process more energy because it does so more smoothly. It also IMO allows the devices to build up an internal resonance within the energy fields to a greater degree than it would without the PHI Ratio.

CaDens™

CaDens is short for cascading densities. It is a technique I developed to maximize the efficiency of the Orgone Matrix Material. With respect to a CB, I would suggest that if using CaDens techniques, you pour the Orgone Matrix Material base as a series of concentric rings, with the lowest density material at the outside of the base, and the highest density at the inside of the base. This acts to focus the energy field most strongly at the center of the base. It also acts to simply increase the amount of energy flow through the CB as a whole; the higher density layers attract a flow of energy from the lower density layers, and thereby are stimulated by this flow from the lower density layers.

Typically this requires a set of molds that are successively larger; one mold for each of the layers of the casting. I would suggest that you first assemble the pipes, then do the casting starting with the center layer. Since the molds may be constructed in whatever size you want but the pipes come in fixed sizes, I would suggest that you use the diameter of the pipe as a starting point with respect to the dimensions, and make the molds in multiples of the pipe diameter by PHI.

Central Cavity

If you plan to have a cavity in the base somewhere to hold a vial of water (or other material to use as a sample) then the placement of the cavity has a significant effect in conjunction with the CaDens layers. The most fool-proof setup is to have the cavity in the center of the CaDens layers (see schematics) and this will focus the most energy in the cavity.

A cavity in the highest density material will act as an output filter for the energy field emitted from the CB. A cavity in the lowest density layer will act as an input filter for the energy field emitted by the CB. Since you mentioned that you intend to use it mostly in a powered mode, I will focus on that application. Please note that this means the

Chembuster will not behave the same as a normal Chembuster, and may not be useful in a passive role.

The central cavity runs through the entire axial length of the Chembuster base, in the spot where a center pipe would go if you were using a center pipe. I would suggest that you start with the vial placed as shown in the schematics and experiment with that for a while. If the desired results are not achieved, substitute the vial with a good quality piece of quartz and place the vial either directly above or below the quartz piece (see schematics).

Mobius Coil(s)

There are several ways the Mobius coils could be integrated with the device. I have put some thought into it and given you what I think is the best for your application, and which would give you the most configurability for experimentation. The idea i have involves several Mobius coils, installed in both the Orgone Matrix Material base and on the ends of the pipes.



<http://www.keelynet.com/>

"The West won the world not by the superiority of its ideas or values or religion but rather by its superiority in applying organized violence. Westerners often forget this fact, non-Westerners never do."

-Samuel Huntington, Harvard Professor, "The Clash of Civilizations"

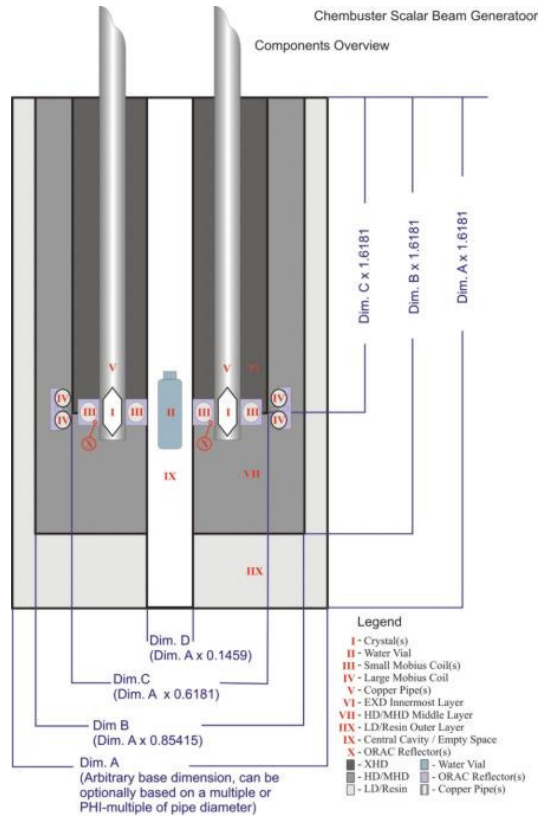

Large Coils

First, make a large Mobius coil with a diameter sized to just fit over the innermost (highest density) layer of the CaDens layers in the base of the CB. Ideally, this coil should have several hundred feet of wire but it is difficult to do the winding in the toroidal fashion with wire lengths in excess of 100 feet. It may still be done with a helper to assist in handling the cable as you loop it through the center of the coil, or several cables may be made and connected in series to form a longer coil. Set this first coil aside and make another the same, but in the exact opposite orientation of the first (twist the cable in the opposite direction and wind the coil in the opposite direction). When you are done, you should have two coils that have the same diameter (sized to fit over the innermost CaDens layer) and are MIRROR IMAGES OF EACH OTHER. Cut a thin spacer of some dielectric material such as poster-board or phenolic sheet and fasten the two coils to the spacer with a little glue. Then, wrap electrical tape around the two coils like you would the cable so that the finished unit is covered entirely with electrical tape. Last, wrap a single layer of aluminum tape or copper foil around the large coil assembly so that it covers the outer periphery of the assembly but does not cover the inner diameter of the assembly. See attached schematics. Once constructed, set the two large coil assembly aside.

Small Coils

Make six smaller coils each with 1/4 or 1/8 or 1/16 the amount of wire that the larger diameter coil has (depending on the the length of the wire in the large coils). Make the diameter of the six smaller coils to fit the copper pipes. Make 3 each of CW and CCW coils; make them in mirror images of each other. Install the small coils on the ends of the pipes, alternating pipes so that if you went around the ends of the pipes it would go CW CCW CW CCW CW CCW. Position the small coils on the pipe ends so that the plane of the coils are centered on the axial length of the crystals inside the pipes.

Cover the small coils, mounted on the pipes with alternating layers of masking tape and aluminum tape or copper foil. Cover the coils first with a dielectric (masking tape) and then alternate layers until you have 3 metallic layers covering the coils. The metallic layers in this reflector should be insulated from each other and from the pipes, no metal touching.

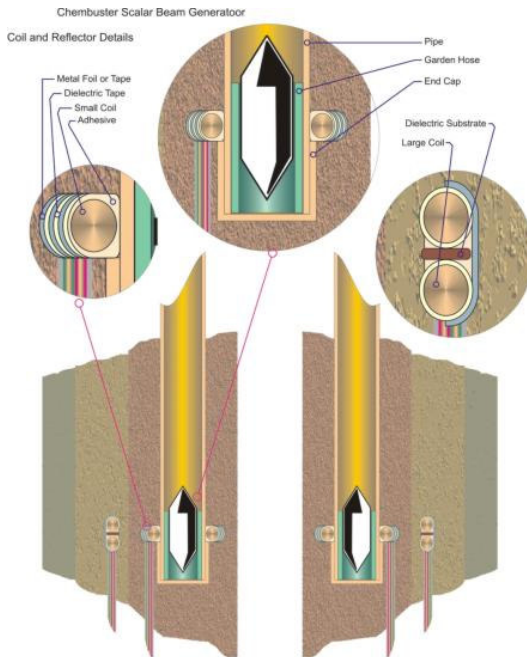

Coil Hookup

The coils on the pipes could be all the same wind, but for maximum configurability you could make them 3 of each, CW and CCW. Rather than connecting them all internally, build a small circuit that allows you to connect them in the following modes:

- 1- all 6 in series (2 sets of 3 series coils, run in parallel).
- 2- 3 CCW in series only

3 - 3CC in series only

The larger coils would normally be driven in parallel, to form a Scalar field in which the smaller coils are placed. The large coils are there to 'pump' energy into the cavity and to the smaller coils. Then, depending on how you run it, the smaller coils would run to make the Scalar field spin CW, CCW, or bucking.

The basic theory of operation is that the large coils assembly excites the Orgone Matrix Material and forms a Scalar field focused on the pipes and small coils. The reason that two coils are used is to increase the strength of the Scalar field; it creates a strain in the Aether focused into a roughly disk-shaped region between the two large coils. In this region of strain are placed the pipe ends with the small coils.

The small coils provide excitation to this region of increased aetheric strain and thereby modulate the output of the Scalar field / beam projected by the pipes.

So, you would 'fire up' the two large coils always. Then, if you want to project a CW spinning Scalar beam you would connect and power the three small CW coils in series.

If you want to project a CCW spinning Scalar beam you would connect and power the three CCW small coils.

If you want to project a balanced or maximum strength Scalar beam then you would connect and power all 6 small coils.

When 3 CCW small coils are run, then the beam should oscillate with the signal applied to the three small CCW coils (and the signal applied to the large coil assembly).

When 3 CW small coils are run then the beam should oscillate with the signal applied to the three small CW coils (and the signal applied to the large coil assembly).

When all 6 small coils are run, they should still be run in sets of 3 series coils. When run in this configuration, the beam should oscillate with the difference between the signal applied to the CW and CCW small coil sets (and the signal applied to the large coil assembly).

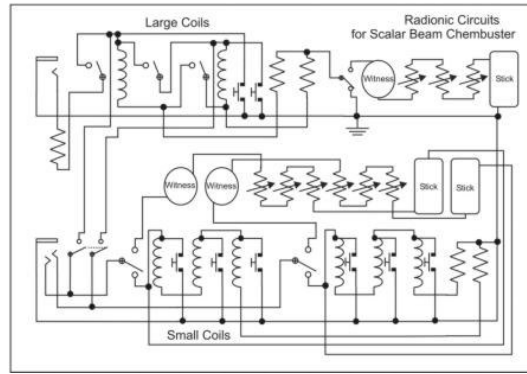
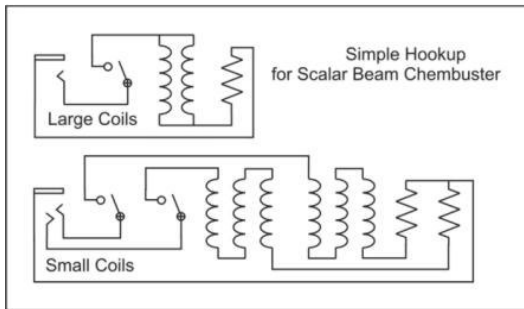

Operation and Other Considerations

I would remind you that you are responsible for your own safety and discretion in experimenting with the device, and that it should not be operated during an electrical storm.

Some study will need to be invested on your part to cover the basic properties of YIN and YANG (google it) and as a rule of thumb you could say that the CW coils have a YANG bias and the CCW coils have a YIN bias.

It is also probable that the device (since it is not a normal Chembuster but rather a Scalar field broadcaster) would function better if installed some distance above the ground, at least a few feet above the ground. It would also be a good idea to install the device on a gimbal or other articulating stand so that it may be pointed in different directions.

A surplus heavy duty telescope base would be almost ideal for this purpose, other simpler mounts could be constructed.

Sample Vial

The sample vial is placed in the center of the highest energy region of the Scalar field and if you were looking at using it as a power source for the device then this is where I would place it. You could experiment with a wide range of materials to place in this cavity, including running water.

If concentrated Ormus were placed in the sample vial I would expect that the Ormus would impart its characteristics to the Scalar beam and possibly be carried out on the Scalar beam. It may deplete the liquid after a while and require replacement. I would be interested to hear your feedback if you do elect to build this device on the changes if any to the Ormus liquid after several tens of hours of use.

Conclusion

Well, that ought to cover the basics. I did take longer than intended to prepare this document but I hope you find at least some food for thought in it. I have enjoyed composing this on my laptop the last few days; it has been the perfect excuse to sit out in the sun. I have included a few examples of how the above circuit could be configured. All the best,

Jon Logan

©Jon Logan May 2007

Applied Biophysics Research Laboratory
 Biophotonics, Magnetic, Scalar, Aether, Orgone, Cymatics, Quantum Sound, Vortex,
 Water, Soil & Geology, Minerals and Crystals, ORME Monoatomic Elements, Biology,
 People, Plants, and Animals, Microbes or unseen friends, Keely - Tesla - Viktor
 Shauberger - Rife - Joel Sternheimer - Rodin

<http://biogenesislab.blogspot.com/>

"Great spirits have always found violent opposition from mediocrities. The latter cannot understand it when a man does not thoughtlessly submit to hereditary prejudices but honestly and courageously uses his intelligence."

"Peace cannot be kept by force. It can only be achieved by understanding."

"Imagination is everything. It is life's preview of coming attractions."

- Albert Einstein 1879 – 1955

Courtesy [RaveOn](#)

Word Finder *TOC*

R	L	M	O	B	I	X	C	H	E	M	T	R	A	I	L	S	M	Y	U
T	E	R	M	D	I	C	C	T	C	Y	V	Z	L	B	E	A	M	T	A
G	U	A	O	D	Y	O	R	I	S	Q	U	A	N	T	U	M	N	I	O
E	K	N	I	E	M	E	C	R	L	I	G	H	T	N	I	N	G	V	W
F	L	E	D	V	M	Y	A	O	R	S	I	L	V	E	R	H	E	A	P
C	R	P	O	M	I	S	N	C	M	T	H	L	A	C	U	R	B	R	O
P	O	E	A	I	L	B	P	O	N	P	I	V	O	M	U	D	S	G	U
V	V	J	Q	U	P	A	R	E	R	R	U	N	J	N	J	M	X	X	H
R	T	N	P	U	R	J	G	A	E	T	T	T	I	W	E	R	C	T	R
A	D	B	V	A	E	I	K	T	T	I	C	T	E	X	X	I	I	V	E
D	X	A	F	B	L	N	P	O	N	I	Y	E	V	R	T	M	H	U	C
A	L	F	T	L	J	O	C	E	Y	J	O	A	L	E	S	C	S	L	O
R	I	N	E	A	H	W	N	Y	I	G	C	N	N	E	I	W	C	B	R
N	R	T	Y	T	O	T	D	P	C	U	O	G	A	R	J	A	A	F	D
W	N	I	I	L	S	P	H	U	U	S	A	L	A	L	H	W	L	A	I
I	P	N	L	Y	O	A	E	M	T	M	T	H	O	D	N	A	A	B	N
P	R	O	H	C	N	W	V	N	O	K	U	S	L	R	E	G	R	B	G
O	H	T	Q	T	Q	W	A	I	Z	P	A	V	Q	B	D	W	G	E	A
A	C	C	O	C	A	I	B	L	N	O	R	G	O	N	E	Y	A	R	Q
X	G	M	T	U	G	P	T	O	U	R	M	A	L	I	N	E	H	C	S

Words to find:

BEAM / BIOCOMPUTER / BIOMAGNETIC / CHEMTRAILS / CONTINENTS / DATA / DNA / ELECTRON / FABBER / FREQUENCY / GIANTS / GRAVITY / HOLLOW / HYDROLOGY / IACOCCA / INTELLIGENT / JAMMER / LIGHTNING / MEINKE / MRET / ORGONE / ORNITHOPTER / OVERUNITY / PARAFFIN / PHANTOM / PUHARICH / PULSARS / QUANTUM / RADAR / RECORDING / SCALAR / SILVER / SMITH / TOURMALINE / VACUUM / VIBRATIONAL

TOC

Thanks for using Camtech Software!

<http://Camtech2000.net>

Jerry Campbell

G	R	S	E	R	.	.	M	A	.	G	E
N	E	N	.	.	M	.	.	.	T	O	.	U	P	.	N	C
I	T	O	T	R	A	N	S	P	A	C	I	T	O	R	T	M
D	A	G	.	.	G	C	.	.	.	X	C	.	.	N	A	D
A	W	Y	.	D	N	O	.	.	.	U	U	.	A	R	L	
C	.	L	.	O	E	N	.	.	.	L	D	.	U	.	E	
S	D	O	.	T	T	S	.	.	.	F	N	.	Q	G	I	
A	E	P	.	T	I	P	T	.	.	.	O	.	.	N	H	
C	L	.	O	C	I	D	.	.	.	C	.	.	A	S	E	
.	A	D	.	M	R	E	.	.	.	R	.	.	S	.	.	
.	W	.	I	E	.	A	.	N	.	.	E	.	.	B	.	
.	A	.	O	.	C	.	S	.	.	P	.	.	O	.	J	
.	R	.	.	R	Y	.	I	Z	.	U	.	.	L	O	S	
Y	R	O	E	H	T	O	.	T	S	.	H	S	.	.	E	
.	T	Y	L	G	.	A	
S	E	L	P	I	C	N	I	R	P	.	.	U	C	.	O	
.	H	O	O	T	E	N	E	M	.	N	A	
.	L	.	S	.	E	
A	R	E	M	A	C	L	.	.	.	I	.	
.	S	H	I	V	A	.	.	B	

Solution to Issue 4 Word Finder (above).

Farmer Joe decided his injuries from his recent accident were serious enough to take the trucking company responsible for the accident to court. In court, the trucking company's fancy lawyer was questioning farmer Joe.

"Didn't you say, at the scene of the accident, that you were fine?"

"Well, I'll tell you what happened. I had just loaded my favorite mule Bessie into the--"

"I didn't ask for any details," the lawyer interrupted. "Just answer the question. Did you not say, at the scene of the accident, that you were fine?"

"Well I had just got Bessie into the trailer and was driving down the road--"

"Judge, I am trying to establish the fact that, at the scene of the accident, this man told the Highway Patrolman on the scene that he was just fine. Now several weeks after the accident he is trying to sue my client. I believe he is a fraud. Please tell him to simply answer the question." By this time the Judge was fairly interested in Farmer Joe's answer and told the lawyer so.

"Well," said the farmer, "as I was saying, I had just loaded Bessie, my favorite mule, into the trailer and was driving her down the highway when this huge semi-truck and trailer ran the stop sign and smacked my truck right in the side. I was thrown into one ditch and Bessie was thrown into the other. I was hurting real bad and didn't want to move. However, I could hear of Bessie moaning and groaning. I knew she was in terrible shape just by her groans. Shortly after the accident a Highway Patrolman came on the scene. He could hear Bessie moaning and groaning so he went over to her. After he looked at her he took out his gun and shot her between the eyes. Then the Patrolman came across the road with his gun in his hand and looked at me. He said, "Your mule was in such bad shape I had to shoot her. How are you feeling?"

Courtesy Mary A.

Real Deal Radionics

Courtesy [Rex Research](#)

Andrija Puharich: ELF Shield [TOC](#)

Note: This article is a must-read for anyone interested in psionics, energy field defense, or the lineage and origins of engineering concepts gradually becoming more common today, including in forms adapted by myself and others for radionics, homeopathy, biofeedback, and other similar uses. –Editor

Method and Apparatus for Shielding a Person from the Polluting Effects of Extremely Low Frequency (ELF) Magnetic Waves, and all Other Environmental Electromagnetic Emissions

By Dr Andrija Puharich

Essentia Research Associates

Invited Paper: The Tesla Centennial Symposium, IEEE Pikes Peak Section, Colorado Springs CO (August 12, 1984)

This paper will describe a novel method and means of defense against the global omnipresence of ELF emissions and other electromagnetic pollution. The use of ELF magnetic emissions in contemporary undeclared warfare is so new that there is little knowledge about it amongst both the lay public and experts in warfare. Therefore, this paper will rely on the history of the development of ELF warfare starting with Nikola Tesla's pioneering work in the 1890s; its contemporary use by several nations; and some new research carried out by the author. This background material is to be found in Reference 1, an unpublished manuscript written by the inventor.

We begin with a description of an objective method of measuring a person's susceptibility to electroencephalographic (EEG) entrainment with respect to magnetic pulses, visual photonic pulses, and auditory sound pulses. From this data set there is calculated a specific set of magnetic pulse frequencies, typically between 7 to 10 Hz that protects that individual from "negative" ELF magnetic waves. This protection extends to all man-made environmental electromagnetic pollution. Reference 2 proves that the magnetic component of electromagnetic pollution can be mutagenic in human tissue. This is the great danger of electromagnetic pollution.

We then describe the three components of the electromagnetic pollution (EMPe) and extremely low frequency magnetic (ELFm) shielding device. We then show how the shielding device effect can be objectively measured. First, the ambient EMPe and ambient ELFm pollution is measured with a detector coil-amplifier of great sensitivity. A typical measurement will show a spread of frequencies ranging from 6 Hz to 120 Hz with a measurable average amplitude, and characteristic wave shape. Then the three components of the shielding device are placed on a person, and the measurements repeated. Typically, the ambient frequencies will narrow down to 7 to 10 Hz with a 3-fold increase in amplitude. These frequencies centering on 8 to 9 Hz are biologically beneficial frequencies.

Thus the shielding device performs two important functions: (1) cancels out all negative polluting EMPe and ELFm emissions in the ambient environment of a person, thus shielded, and (2) selectively amplifies certain beneficial ELFm in the ambient environment of a shielded person, in the range of 7 to 10 Hz with a peak center frequency of 8 to 9 Hz in the EEG power spectrum.

As a beginning to the theory, and hence of the method of operation of the shielding device, I present some brief observations of the way in which one human being can direct and radiate his natural EEG, i.e., ELFm, a magnetic wave at another person, and use them to bring under control the EEG wave system of that person, as measured objectively with dual EEG wave measurements of the two persons. Observations are also made of artificially radiating a person with a magnetic wave generator which can produce behavioral modification in the person being radiated.

A theory and method is developed as to how and why ELFm signals of the order of 2×10^{-9} Tesla per second (2 nanotesla per second) can exert such powerful control effects over biological systems. The experimental work that is the foundation of the theory and of the method is given in some detail. The theory states that external magnetic fields can control biological spin-spin proton-proton coupling constants in DNA, RNA, RNA-transferases, and hydrons (H₂). Such spin-spin coupling constants can be stabilized at equilibrium, against the destabilizing external ELFm frequencies.

Reference 3 shows some of the hysterical press reaction to the existence of the Soviet ELF

emissions. Reference 4 shows the scientific analysis of the phenomena by an engineer.

Description of the Method of Measuring Objectively the Sensitivity of an Individual to Brain wave Entrainment from Polluting Electromagnetic Emissions ~

The author discovered many years ago that when two human beings interact in the well known "laying on of hands" effect (without any body contact) that the brain waves of one of the participants will entrain the brainwaves of the other person. See Reference 5, pp. 7-9. Later it was discovered that the Soviet ELF global emissions could entrain the brain waves of certain individuals. Then it was found that by proper training individuals could entrain their own brain waves at the Alpha Frequencies (7-12 Hz). As a result of such experiments and findings the author developed the system shown in Figure 1 which can be routinely used to measure the effects of polluting EM emissions of the brain waves. These effects on the brainwaves are explainable as an effect on the spin-spin proton-proton coupling constants of every odd-numbered atom in the human body. See Reference 5m pp. 16-21 for the scientific basis of this effect.

Referring to the block diagram of Figure 1 we see that the Head (1) of a person is connected via electrodes to an EEG machine (6) which has the capability of carrying out a Fourier transform analysis of the brain waves in real time. Stimulators (8), Strobe Lights (9), ELF Magnetic Wave Generator (12), Audio Wave Generator (11), Transdermal Wave Generator (10, Puharich, US Patent # 3,563,246) serve to entrain the waves of the brain at characteristic frequencies. These entrained waves from the brain are cross-correlated by computer analysis to yield a profile of frequencies that reveal the particular sensitivities of the individual to brain wave entrainment. In addition there is a set of monitors that detect the ambient earth and atmospheric magnetic waves: ELF Detector Coil (2), ultra-sensitive (0.5 microTesla/sec.) Amplifier (3), A/D Frequency Counter (4), and Oscilloscope (5) to measure the wave shape and the amplitude of the magnetic waves. Systems (3), (4), and (5) are also fed into the computer for cross-correlation analysis with the EEG data. Thus the system of Figure 1 can measure the effects on the brain EEG from the ambient EMPE and ELFm before any use is made of the Shield Device on that person. It can also measure the ambient EMPE and ELFm after the person has

put on the Shield Device. The results of this kind of measurement are shown in Figure 3.

Figure 1: Block Diagram of Brain EEG Recorder, Brain ELF Stimulators, Ambient ELF Detector, and Computer Analysis of Data ~

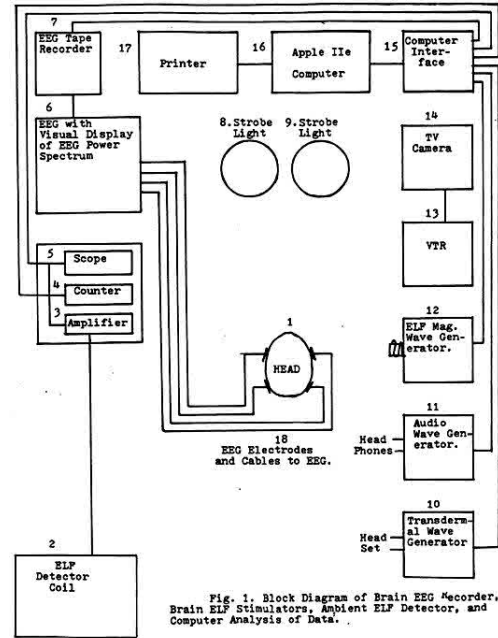

Fig. 1. Block Diagram of Brain EEG Recorder, Brain ELF Stimulators, Ambient ELF Detector, and Computer Analysis of Data.

(following page -ed.)Figure 2: (A) ELFm-EMPe Shield Device Block Diagram. Earth/Atmosphere are energy sources for polluting emissions (I, II). Neutrinos are space energy source of energy for bio-proton detectors (V). The human (III) is the target for these three sources of energy. (B) In the block diagram, IV, VI, VII, VIII, and IX are components of the Shield Device. VI and VII are armbands. IV, VIII, and IX are housed in a metal pen housing and electrically shielded inside from EMPE effects. The solid lines represent conventional EM wiring and coupling. The dashed lines represent scalar wave pathways, and virtual flux pathways.

"Either man is obsolete or war is. War is the ultimate tool of politics. Political leaders look out only for their own side. Politicians are always realistically maneuvering for the next election. They are obsolete as fundamental problem-solvers."

- R. Buckminster Fuller

Figure 2

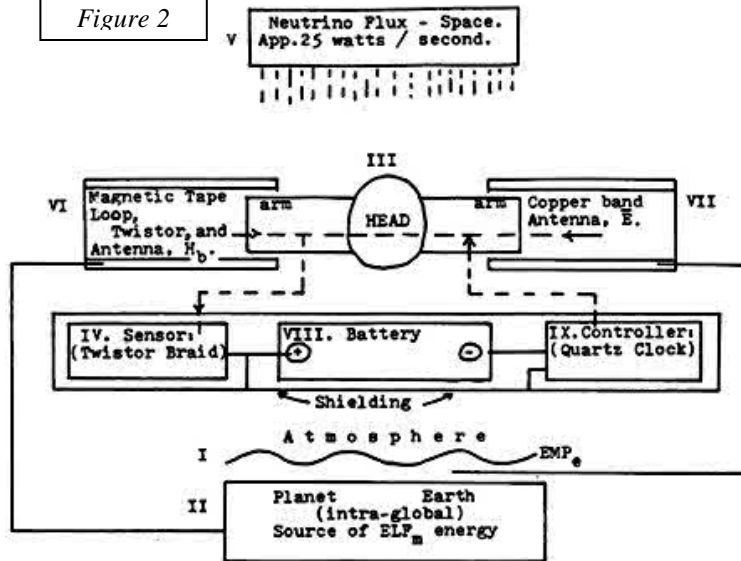

Description of the Shield Device which Protects an Individual from the Negative Biological and Psychological Effects of EMPE and ELFm Polluting Emissions ~

Reference to Figure 2 shows the block diagram of the Shield Device. There are three components of the Shield Device. The first component is the metal shielded circuit made up of three parts respectively labeled: the Sensor (IV), the Battery (VIII), and the Controller (IX), a quartz clock. Now it is to be noted that the first component which is in the form and shape of a ball point type of pencil, and will be called the pencil hereinafter, encloses all of the three parts in a metal Faraday type of shield. This means that the parts are effectively shielded against all EM radiation above about 100 Hz. The pencil is normally held in the hand and can be used as a working ballpoint pen, or it can be worn in a shirt pocket or carried by a cord hung around the neck. The only signals that can get through the shielding of the pen are: (a) the magnetic brain waves of the person wearing it, (b) the ambient neutrino flux from deep space, and (c) virtual sub-quantum anenergy from the environment.

Signal (a) is obvious and needs no further explanation. The brain wave magnetic vector enters the Sensor IV, and is picked up by flat copper braid which is wound in 21 turns on a brass spindle, and each turn is rotated, or twisted 180° on each turn. This rotates the magnetic wave 180 degrees on each turn, and passes on the next turn a magnetic wave that is 180° out of phase with it. The result is that the vectors cancel each other, and the only wave that passes up to the coil is a scalar longitudinal wave. For a definition of the meaning of this term

see Reference 6, pp. 21-25. The scalar wave, when it reaches the positive pole of the battery will orthorotate 180° and release a pulse of charge into the battery that is 180° out of phase with the pulse charge that has just left the battery at the negative pole. This phase control of battery charge emission, and battery charge entrance is managed by the oscillations of the quartz crystal in the clock which is free-running at 256 Hz. The proof of this action is that a battery with a normal life, with load, of one year will last for at least 4 years by our latest measurements, if not longer.

But there is a feedback between the human body, and the first component, the pencil, which has just been described. There is a second component, labeled in Figure 2 as the Magnetic Tape Loop (VI), Twistor and Antenna. This is made up of a plastic film (0.125 inch wide and 0.001 mil thick) coated on one side with magnetite powder (Fe₃O₄). The plastic film is wound on a sheet iron base in the form of a circle that will pass over a person's hand and wrist, and is worn as a bracelet. There are 42 turns of the film on the metal circle, and the film is twisted 180 degrees each turn, The magnetic tape loop cancels all the magnetic vectors of all the frequencies of EMPE and ELFm in the ambient environment, and cancels them by the phase canceling already described for the pencil. The difference is that the magnetic tape loop is not connected to anything --- it is an open circuit, and the scalar longitudinal waves are dumped into the ambient vacuum. When the first component, the pencil, is in skin contact with the person, some of the scalar longitudinal waves will enter part IV of the pencil.

The mechanism of this latter effect is that the quartz resonator IX has a feedback to the Copper Band VII of virtual photonic energy because the skin is a detector for all kinds of waves. See Reference 5, pp. 23-27 for a description of this detector effect discovered by the inventor. This copper band initiates a loop of virtual energy flow as shown by the dashed lines in Figure 2 starting at IX, going to VII through the skin and to the opposite arm where it emerges 180° out of phase with the entrance signal due to the diode property of the skin, the path then goes through the shield into Sensor IV, and by hard wire circuitry back to the Controller IX. This is a complete circuit path in which a part of the path

is hard-wired, and a part of the path is a scalar wave, and virtual photon, in nature. These different parts of the circuit, i.e., the human body, and the three components of the Shield Device come into a self-sustaining resonance. The virtual parts of the circuit are hyper-spatial, i.e., greater than 4 dimensions, and this is proven by the fact that the space in which the detector coil sits will remain clear of EMPE and ELFm for 15 minutes to 90 minutes after the person who wears the Shield Device leaves the area by going at least one-half mile away.

Reference to Figure 3 will show a series of typical measurements made in the region of the Detector Coil (2 in Figure 1) before and after the introduction of the Shield Device. The persistence of a hyperspatial effect is seen in a comparison between Figure 3A and Figure 3c when the person with the shield Device leaves the ELF Detector Coil region, and goes away at a distance of one-half mile. The pattern recorded by the ELF Detector Coil remains as shown in Figure 3C. It is to be noted by reference to the chart on page 20 in Exhibit E, that the beneficial frequencies for the human organism are centered on 8 Hz, and reference to Figure 3d shows that the Shield Device on a person centers his EEG power spectrum on this center frequency at a very high amplitude. This protects the person from polluting emissions and magnifies the natural NMR system of the biological system. See Reference 7 for an introduction to this NMR coupling.

Figure 3 ~ Results of tests with and without the Shield Device on a person as measured by the method shown on Figure 1, in a typical case.

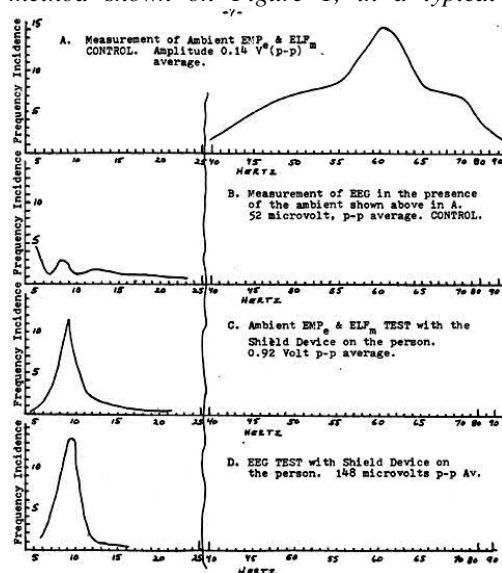

Figure 4 ~ (following page)

Summary and Conclusions ~

- (1) A Method and Means to measure ambient EM Pollution (EMPe) and ambient ELF Magnetic waves (ELFm) in the environment of a person, said waves being of a harmful biological and psychological nature to humans (Figure 1).
- (2) A Method and Means to protect a human being from such harmful emissions with a Shield Device (Figure 2).
- (3) A Method that is based on the known biological spin-spin proton-proton couplings, and is used to influence this nuclear magnetic resonance (NMR) system to strengthen the biological integrity of the human body (Figures 3 and 4).
- (4) The means of the Shield Device which is composed of 3 parts:
 - (a) The Pencil ~ This is a shielded device which serves as a sensor and a controller of Scalar Longitudinal Waves, and converts normal EMPe and ELFm vector waves into scalar waves and virtual energy waves, thereby eliminating the vector waves in the immediate vicinity of a person. The Sensor is made up of 21 turns of flat copper braid wound on a brass cylinder, each turn of braid being twisted 180 degrees from the preceding turn. Braid is connected to the positive pole of the battery, and the negative pole of the battery is in series with a free-running quartz clock.
 - (b) A Magnetic Flat Film Loop (MFFL) ~ 42 turns, each of which is twisted 180° from the previous turn. This circular flat film magnetic coil serves to collect EMPe and ELFm vector waves from the ambient environment and convert them to Scalar Longitudinal waves which are not harmful to man. There is a virtual coupling between the pencil circuit, and the MFFL. A person wears the MFFL on his body skin, preferably on his wrist.
 - (c) A Flat Copper Bracelet ~ Preferably an open loop, that is worn on the wrist. Additional copper bracelets may be worn on the body in order to lower the center frequency of the EEG to 8 Hz.

References ~

- (1) Puharich, Andrija: "TMT, The Magnetic Threat"; unpublished ms (Dell Publishing Co., NY).
 - (2) Liboff, A.R., et al.: "Time-Varying Magnetic Fields: Effect on DNA Synthesis"; Science 223 (February 1984).
 - (3) Bearden, Thomas E.: "Star Wars Now", Tesla Book Co., 1984.
 - (4) Puharich, H.A.: "Successful Treatment of Neoplasms in Mice with Gaseous Superoxide Anion (2) and Ozone (O3): With a Rationale for the Effect"; Yearbook of the Sixth World Congress of the International Ozone Association, Zurich, Switzerland, 1983.
- Courtesy [Rex Research](#)

Figure 4.

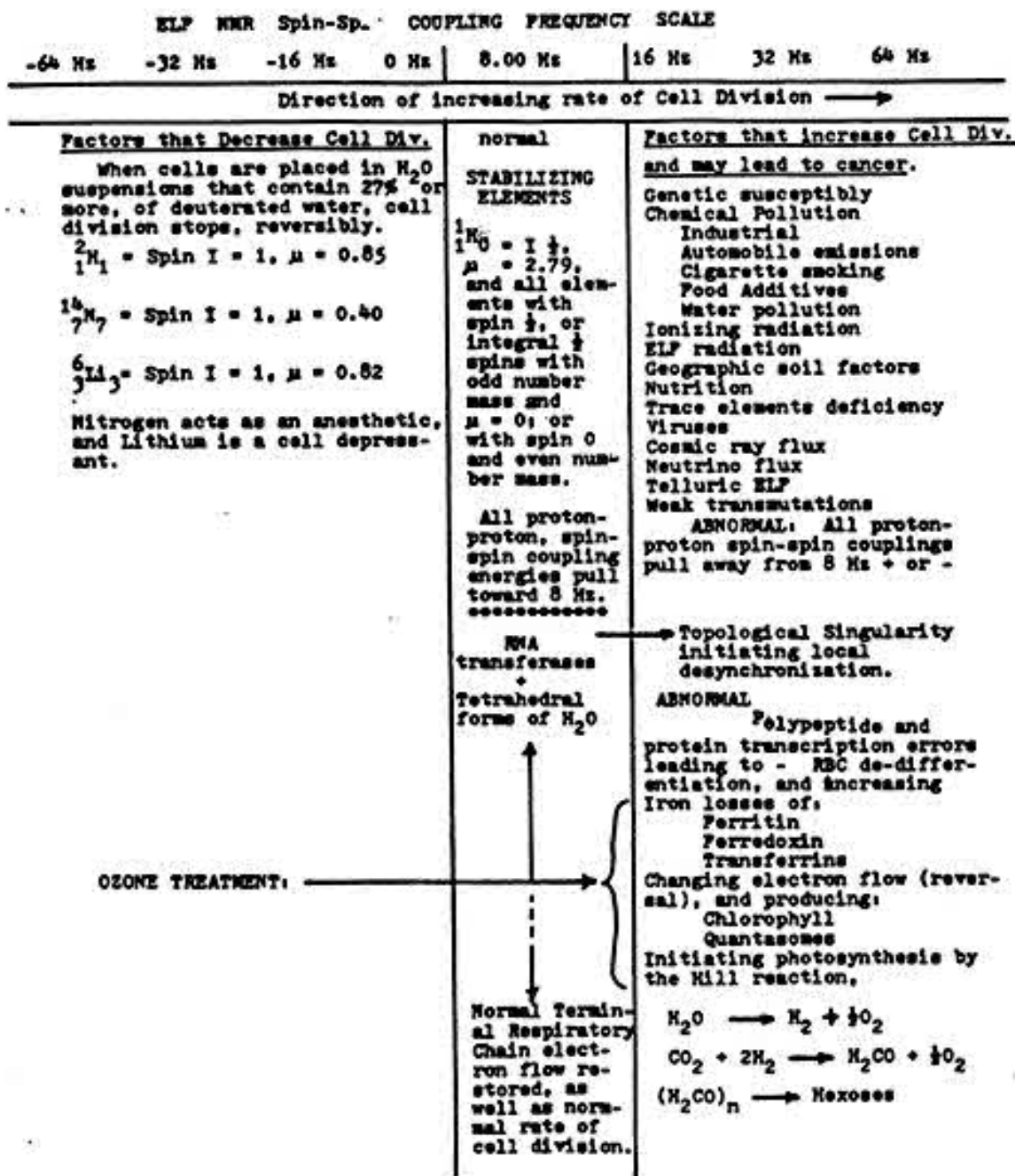

FLOW CHART RELATING NUCLEAR SPIN PROPERTIES, MAGNETIC MOMENT PROPERTIES TO THE RATE OF CELL DIVISION, AND TO ELF NMR COUPLING ENERGIES

Aether and Bioenergy Theory

Courtesy [Rex Research](#)

Wilbert B. Smith: Gravity Control / Binding Force / Caduceus Coil / Geo-Magnetic Generator TOC

Note: For readers only recently familiar with scalar coils and the biofeedback aspect of scalar fields, Wilbert Smith was a pioneer worthy of note... check out what this guy was doing in the 50s! –Editor

Letters, Circuit Diagrams, &c.:

- (1) Letter to Dr William Hooper (July 6, 1959)
- (2) Letter to Dr William Hooper (July 21, 1959)
- (3) Letter to Dr William Hooper (November 10, 1959)
- (4) Letter to Mr Rideout (No date)
- (5) Letter to George Williamson (November 25, 1955)
- (6) Letter to Mr Middleton (January 2, 1955)
- (7) Letter to Editor (John Campbell), Analog Magazine (1971 ?)
- (8) Transcript of a Presentation by W. Smith (Date unknown)
- (9) Electronic Circuits & Test Results



(1) Letter to Dr William Hooper (July 6, 1959)
Wilbert B. Smith
July 6, 1959

Dear Dr Hooper:

Your telegram was phoned to me just as I was getting ready to go on a field trip to determine the electrical conductivity of Lake Ontario, so I grabbed a handful of essays, put them in an envelope and sent them off to you although I didn't have time to write. I hope there were sufficient copies, if not I have a few more and you are welcome to them. You certainly may make of them whatever use you can of this material.

We have rebuilt our machine and are now about to look for some of the answers to some questions. This unit has about 14 ceramic magnets mounted in a groove cut in a ¼ inch thick 6 inch diameter disc. We haven't yet run it up to full speed as we are very cautious after the other exploding. We don't expect much from this machine except maybe answers to a couple of pointed questions.

Our major design effort now is looking towards making a magnetic field move without having to move the magnets. It should be possible, since we found that the converse was true. Also, there are some rules concerning fields, which are not in the literature which might be exploited to attain this end. We refer in particular to the rule that field *s* can and will remain as separate entities if such arrangement has a lower energy level than that of the corresponding field structure. Also, we found that magnetic fields move only at right angles to their vectorial directions, and in strict correspondence with Maxwell's equations. They refuse stubbornly to move in their vectorial direction, and apparent motion in this direction is actually a folding in or out of the field, always at right angles.

We have drawn up quite a few designs to make the field move, but have discarded most of them either because the present technology was inadequate to do the job, or there was too much uncertainty as to what actually would be going on. We have one design which looks promising, namely notching a circular DC field with a $(1 - \cos \theta)$ function which is rotating and confining the whole in a shield so that the lower energy level is attained if the field structure rotates. We haven't tried it yet, and it will probably fall before we can test this principle. However, it looks promising.

With best regards,
W.B. Smith

(2) Letter to Dr William Hooper (July 21, 1959)

July 21, 1959

Dear Dr Hooper,

I want to thank you for your kind interest in our gravity work, and to give you an insight into our current thinking. I am enclosing a couple of sketches of our "gubbine" and what we think is going on around it.

We visualize the magnetic field to have somewhat the configuration of the red lines, with somewhat

more field outside of the ring than inside it. There are discontinuities in the magnet structure due to the fact that the individual vectors are square, but this seems to be an asset rather than a liability as it ensures that the field turns with the magnets, since a higher energy level will be required to bridge the gap between the [magnets ? illegible word] if it did not turn.

Rotation of the magnet-carrying disc causes the field to acquire a velocity throughout its structure, said velocity being directly proportional to the radius. The $v \times b$ will in all cases be at right angles to the velocity and the field vector and will be proportional to the magnetic field strength and the velocity. We hold that this condition will apply within the magnets and outside of them, since the magnetic field exists there also.

Following the above reasoning, it is apparent that a virtual gravitron will form on the outer edge of the magnetic ring and another of opposite polarity on the inner edge. The outer gravitron will be somewhat stronger than the inner one, and the field configuration will be determined by the antecedents of the field (magnitude and direction of the magnetic and charge fields, reducing the gravitron field).

However, since the entire structure is immersed in the earth's gravitational field, the antecedents of which may or may not be compatible with the locally generated field, two complexes are possible, within a field structure or a field aggregate. Experiment must give the answer.

We have considered the use of a conventional gravimeter, but we do not think that it would be as good as the precision balance. The sensing element in the gravimeter is several inches from the bottom of the instrument, and since a table of sorts is necessary, it would not be possible to get the sensing element within a foot of the magnets.

(3) Letter to Dr William Hooper (November 10, 1959)

November 10, 1959

Dear Dr Hooper:

I am very slow in replying to your letter of Oct. 6, but I have really been quite busy. I am sorry that I can't seem to explain my views on gravitational polarization lucidly, but the trouble is probably with me. I shall try to get something worked up to send you but I don't quite know where to start.

Our work here has been progressing slowly because of silly little mechanical troubles. We have built 5 commutators to switch the currents to produce a rotating field and there has been a serious difficulty with each. We are now working on a rolling mercury design which looks promising.

We did try to use the rotating field from the ceramic magnets to drag around a field produced by a coil and current, but there seems to be a problem with the compatibility of the antecedents of the fields, because the limits within which it will spin are apparently narrow and we have not yet been able to determine their magnitude or the rules governing this action.

Because of the commutator difficulties we have not yet been able to try the big rotating field, but we have it all built and if and when we get this last bug licked we should be able to look for a few answers...

Sincerely,
Wilbert B. Smith

(4) Letter to Mr Rideout (No date)

Mr Rideout,

I read your letter of October 23 with appreciation and some amusement. It is quite apparent that my comments on time as a field function did not ring a bell. I am well aware that regarding time as a variable places modern science in the untenable position of trying to lift itself by its bootstraps; but I can only say that these are not my ideas but originates with those to whom our science resembles medieval superstition. I do not understand them fully and I have much to learn, but I have mastered a few basic principles and of these I am sure.

Time as a field function is NOT the same function as registered by our clocks, which record the changing entropy of a system, but is the function which makes this happen.

There is only ONE reality in our universe, and that is the concept of SPIN, and from this derive twelve dimensions. Twelve dimensions are necessary and sufficient to express our universe in its entirety.

Dimensions must include, as well as their vector direction, the component of reality in that direction for without the reality there would be no dimension.

Dimensions are arranged in four fabrics of three each, linked by a "quadrature concept". This is the structure that Relativity strives for by introducing the [square root of -2] between the space and time axis.

The concept of force is a fiction which we invented to stultify our thinking. It is merely a coverup for our lack of understanding of the interaction of reality.

The foregoing will probably sound most sacreligious to the ears of orthodoxy, but I don't mind in the least if these ideas are not immediately subscribed to. Science has a long and lurid history of reluctance to accept ideas which subsequently proved to be of great value.

We are progressing quite well in our gravity research, and ran our unit for the first time on October 26. The effect was measured on a precision chemical balance, when a brass weight increased from 24.4623 grams to 24.4628 grams when active material (cubic inch of aluminum) was 10 inches directly under the weight. Needless to say we have much yet to do and as soon as we have some relationships established we will prepare a suitable paper, a copy of which I will send you if you are interested.

Meanwhile, don't be upset about the above unorthodox ideas; they either click or don't click, and I am quite satisfied that we will come to them sooner or later.

Best regards,
Wilbur B. Smith

(5) Letter to George Williamson (November 25, 1955)

November 25, 1955

Dear George [Williamson],

I am glad that the coil arrived OK, but I am sorry that I can tell you very little about it. All I know is how to build it and that it worked. Apparently the hole down the center of the core is necessary for its proper functioning, as is an adequate power input. It will take a kilowatt comfortably, without heating at all, and we know that it will work on 100 watts, but it won't work for us on 30 watts. It just gets hot on the lower power! I don't know what the lower cutoff power is, nor do I know what the boys topside told me; "Play with it and learn".

Don Steadman built a simplified gravimeter which I have installed on a solid footing at home. It is quite interesting as there have been a couple of time field surges during the last month. Also when the Russians let off the Big Blast, there was a gravity wave which was so strong that it broke the quartz spring in the instrument! If the Yanks set off some bigger ones I fear for the consequences. People just don't know about these things. In the words of Jesus, "Father forgive them, for they know not what they do"...

I understand that plans are under way for a number of trips to pick up earth people for visits top-side during this coming few months. You might check with any of your contacts to see if they are involved...

As ever,
Wilbur B. Smith

(6) Letter to Mr Middleton (January 2, 1955)

January 2, 1955

Dear Mr Middleton,

Many thanks for your Dec. 4 letter...

In attempting to establish communication with the saucers, I can offer very little except to use frequencies which will penetrate the ionosphere. We have used the call M4 AFFA at frequencies around 20 megacycles. In this business we are all in the kindergarten and all I can say is to try anything and everything until something works.

We were told about a system which uses a radio transmitter as an energy source but a special antenna converter, which radiates doughnut-shaped waves, which are not time functions. We built a couple and find they have the most extraordinary properties. If you wish you could build a unit and try to establish a circuit to our group here in Ottawa. Following are the construction instructions. One ferrite core, material with the highest permeability and dielectric constant, about 8 inches to a foot long, and about 1 inch in diameter. About 20 feet of plastic insulated #14 electric house wire. Starting at the center of the wire and at one end of the core wind on the wire as closely as possible, with the first turn under and then over, so that the winding will be exactly symmetrical. It will start at one end of the core and finish at the other end and will resemble a solenoid with a bifilar winding. It is important that the winding be exactly symmetrical. When connected to a transmitter, treat it as any normal antenna for loading and tuning. There will

be a few points of magnetic domain resonance which will be lossy but anywhere else the device will generate the required waves. It will not matter whether or not the antenna converter is shielded as the doughnut waves go through anything. The most remarkable property of this system is that the waves can be directly MENTALLY...

Yours truly,
Wilbur Smith

(7) Letter to Editor (John Campbell), Analog Magazine (1971 ?)

Analog Magazine (Letters to the Editor)[1971 ?] ~

...The coil is said to be a single winding of insulated copper wire, about #16 or #18 gauge, wound on a ferrite core of 1" to 1-1/2" diameter, and about 9" long. The coil is caduceus wound, that is, one begins the winding in the middle of the wire's length, winding the wire in opposite directions around the core and crossing the wires on the same opposite diameter points each time around.

The coil is said to be an energy sink --- that is, current fed into it just disappears, causing no radiation, even of heat. When operating and placed near a grid dip meter, the coil is said to show a large number of resonance points across the spectrum from 200 to 2.0 Mc. This coil is further said to have zero impedance. Further, two or more coils cannot be coupled together.

(8) Transcript of a Presentation by W. Smith (Date unknown)

...According to the theory of relativity, if I climb into a spacecraft and I set out from the earth at a velocity very nearly the velocity of light, and I go out to say, Alpha Proxima, and then I turn around and comeback, people on earth say that I've been gone something like 10 years. According to my clock, I've only been gone a year.

Now that is a result, apparently, of time dilation in the theory of relativity, in that the spacecraft in which I travel was moving relative to the earth at a velocity nearly equal to the velocity of light. The paradox arises when you consider that relative to the spacecraft, the earth was traveling away at exactly the same velocity. Therefore, to the people on the spacecraft, who are relatively stationary, 10 years should have passed, and by the time the earth comes back to them, it should have only been away

a year. So you can see right away that the very premise upon which the theory of relativity is predicated --- namely, that if A is relative to B, then B must be relative to A --- leads you to an impossible paradox. This paradox is resolved completely if you recognize the variable nature of time, and as you move round from one part of the Universe to another you'll encounter all sorts of values of time in certain given intervals. We become slaves to the clock to the extent that we believe that the intervals ticked out by the clock are time itself, so we find it very difficult in readjust. Now I don't propose to say any more about this particular aspect, but I would like to say something on the subject of the craft themselves.

We asked them how they were supported, and they said they were supported on the earth's gravitational field. Further studies on our own, with occasional references to these people from elsewhere, and we figured out that we were able to go into the laboratory and conduct a series of experiments which proved beyond doubt that this is true.

Our laboratory experiments have allowed us to make about a 1% change in the weight of objects -- - we can make them about 1% heavier or 1% lighter. Now that is a long way from holding a spacecraft up, because we have to go over 100% to do that. But the fact that we can do it --- the fact that the principles which these people from outside gave us and guided us to finding out for ourselves are valid --- certainly indicate that, first, these people are what they say they are, and, secondly, that their technology is that they say it is, that it is superior to ours and that ours is inadequate in many respects [Quite a lengthy description on the blackboard followed at this point].

Now we understand that these bells (Mr Smith is referring to the bell-shaped spacecraft said to come from Venus, which have been photographed by Adamski and others) operate on this principle. Underneath the bells are three things that people have referred to as landing gear. They are not landing gear at all --- they are spheres within which a charged sphere is rotating. It is spinning on magnetic bearings. Magnetic bearing is something else the people from outside gave us the design of. It is very simple in section, and this is the north pole and this is south, and in it they have a thing that looks like this, with a south and this is a north [Here obviously Mr Smith is again demonstrating on the blackboard]. They are simply ferrite bearings permanently magnetized. We built them ourselves

and checked them in the lab, and they worked perfectly. They are very simple things. The spheres carry an electric charge and they spin on this type of bearings down inside these big balls. We are told that the tilt is simply produced by rotating the sphere a little bit, which bends the field. The process is much more complicated than would appear from what I am telling you, but these are the first steps and the end results --- even though there are other steps in between.

Now one other thing I would like to mention --- as far as I know, our group in Ottawa is the only group that has actually taken the information which was given to us by the people from outside and translated it into hardware that works. Much information has been given to us through various channels, but people just talk about it. They don't do anything about it. I think that is deplorable. I think that when they give us information, the least we can do is to show our good faith by trying at least to convert that information into hardware.

We have built two items of hardware on their instructions, which I'm rather proud of. One of these pieces of hardware is a coil. It has a ferrite core, and a trick winding on it. To look at it, it looks rather like an oddly wound inductor. When measured on a radio frequency bridge, however, it shows very peculiar properties. There are certain frequencies at which it is impossible to balance the RF bridge, and that is a direct contradiction to what any electrical engineer will tell you should happen with a coil wound on a ferrite core.

The other item that I'm rather proud of resulted from a series of questions that we asked regarding accidental destruction or damage to our aircraft by flying into the vicinity of flying saucers. And we were informed that, although a few of our aircraft had come to an unfortunate end by what they considered the colossal stupidity of our pilots in flying into a region where the aircraft was bound to get into trouble, they said that they are now taking corrective measures and whenever they see one of our aircraft about to commit suicide, they just get out of the way and give him a wide berth. But I asked, if an aircraft was damaged or destroyed, what happened? They said the field surrounds the saucers in order to hold them up. In order to produce the gravity differentials, time field differentials are necessary to operate the ships. These sometimes produced field combinations which reduced the strength of materials to the point where they were no longer strong enough to carry the loads that the materials were expected to carry.

Now as we know, aircraft --- particularly the military type aircraft --- are built with a rather small factor of safety, and if they fly into a region of reduced binding, the material is no longer strong enough to carry the load, and the craft simply comes apart.

Now we asked a series of questions about --- was it possible for our craft to detect these regions so that we would not fly into them, and they said that it certainly was, and they would do this very thing. They also told us that we ourselves were creating regions which were much more dangerous than the regions they established in their vicinity, because we could detect the presence of their craft and give them a wide berth, but we could not detect without instruments the presence of these vortices which we ourselves had produced. They gave us the design of the instrument (See Flying Saucer Review, march-April 1951) which was fundamentally this --- they said to select two materials, one stronger than the other, and to arrange so that these material pulled against each other in such a manner that the weaker material was very near its breaking point, and the strong material was a long way from its breaking point. On that basis we devised instruments, and we built a number of them in the shop and sent them around to various people that we know did quite a lot of traveling. We asked them if they would investigate the regions the regions through which aircraft must have passed just prior to breaking up in mid-air, and we have unfortunately large reports of our airplanes having done just this.

One of these unexplained crashes occurred at a place called Esandon, which is about 20 miles southwest of Quebec City. We investigated the region through which this BOAC aircraft must have passed just prior to its crash, and sure enough, --- big as life and twice as natural --- we found a very large and very strong vortex. Our instruments showed it beyond a doubt. It was about a thousand feet in diameter and roughly circular, with a rather sharp line of demarcation at the edge of it.

You will recall also that about two or three years ago, possibly a little longer, a jet aircraft crashed into a nunnery at Orleans, just out from Ottawa, killed a number of people and did a great deal of damage. In fact, the jet engine was finally dug out of the ground about 30 feet below the foundations of this convent. Once again we found a very strong vortex of reduced binding. We had a number of reports come in from people in the field who found exactly the same thing. I wrote a very stiff [memorandum](#) to the appropriate people in my own

department, pointing out some of these facts. I did not state where we got the information, but simply stated that we had instruments which showed the existence of these regions of reduced binding, and suggested that something be done about. The letter wound up in the "crank" file. I'm afraid that is the fate of most of these things --- they wind up in the "crank" file. However, that does not in any way change the fact that these regions of reduced binding exist. People from outside told us that they existed, they gave us the design of instruments, we built the instruments and we have confirmed the fact.

Figure 1/2/3

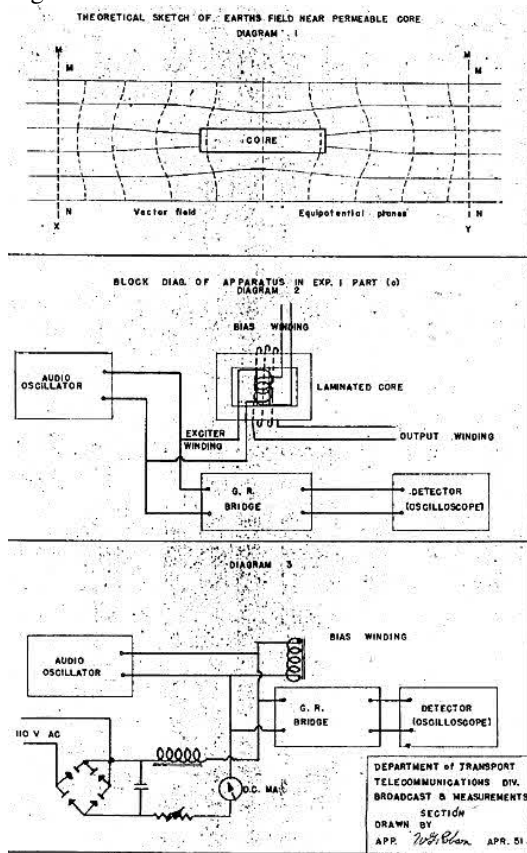

tongues looked to me, from the scale of this picture, to be around 25-50 miles. They were quite comparable in size to the fireball. Now, my guess is that these tongues or prominences were in fact chain reactions... [&c...]

Figures:

1. [Sketch of iron core magnetic field](#)
2. [Apparatus of experiment 1 \(a\)](#)
3. [Apparatus of experiment 1 \(b\)](#)

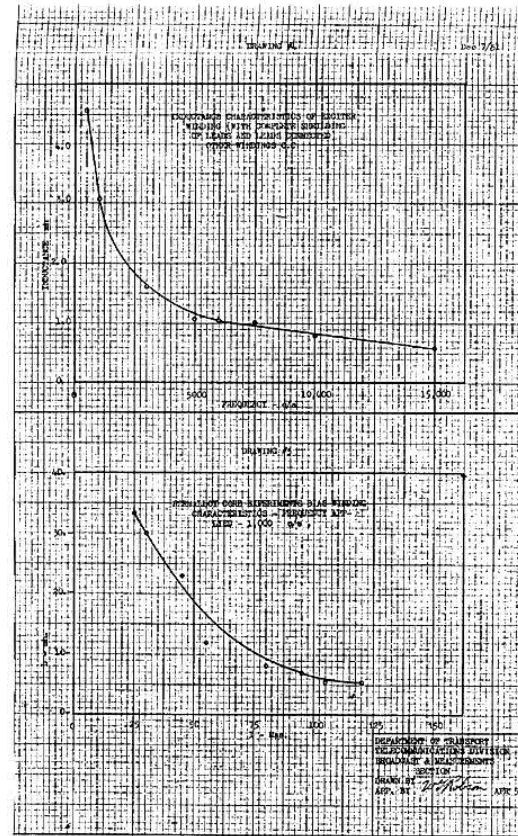

Figure 4/5

4. [Graph of experiment 1 \(a\), excitor winding](#)
5. [Graph of experiment 1 \(b\), Bias winding](#)

Question: Could you explain why they have curtailed the explosions of nuclear bombs?

I can only guess at why the nuclear explosions have been curtailed. I saw a picture which I know was never released to the public, showing a very large explosion in the Bikini series. This picture showed the enormous fireball which I think must have been well over a hundred miles in diameter, and shooting out from it were what looked like solar prominences --- in other words, they were great tongues of activity of some kind. Now these

alex jones' INFOWARS.NET
<http://www.infowars.net/index.html>

rense.com
<http://www.rense.com/>

6. [Apparatus for test in experiment 1 ©](#)

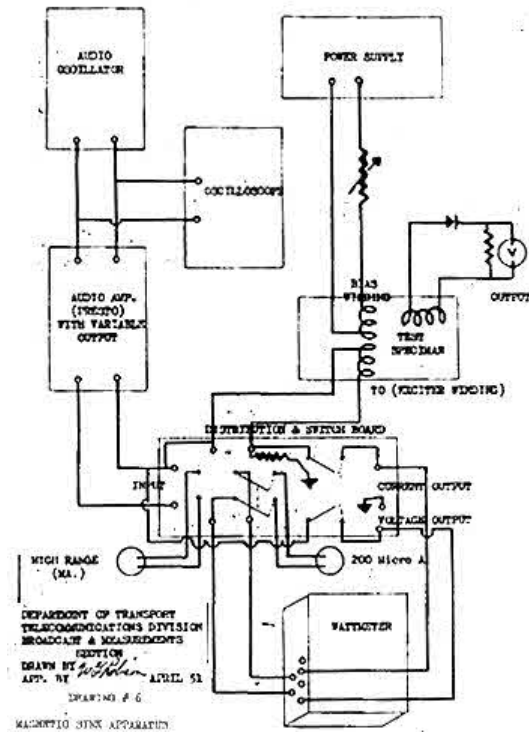

7. [Graph of experiment # 2 \(b\)](#)

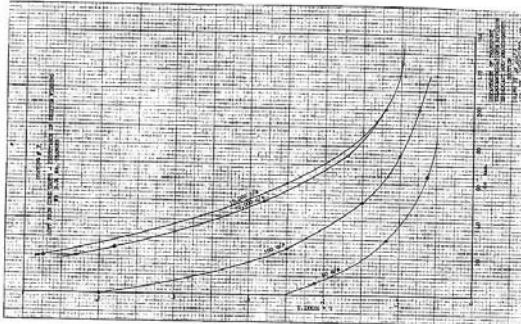

8. [Circuit for determining BH curves](#)

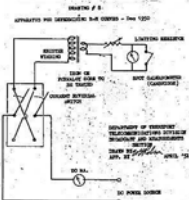

9. [Graph for Permalloy and iron cores --- Saturation curves](#)

(same image as #7 "Graph of experiment #2 (b))

10. [Circuit drawing of low excitation tests showing waveform and measurements](#)

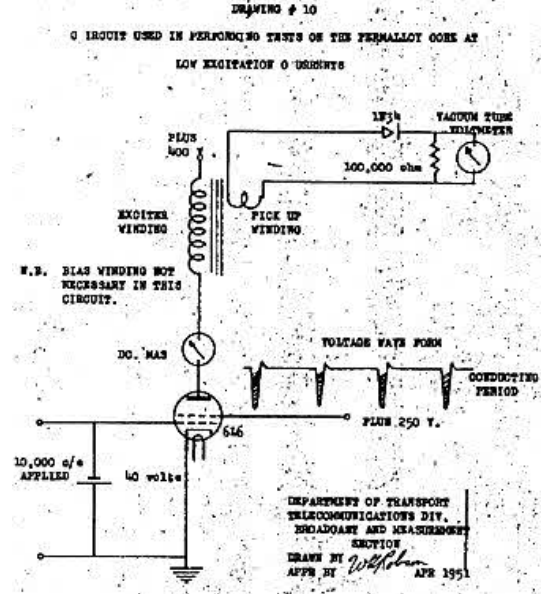

How to start your day with a positive outlook:

1. Open a new file on your PC.
2. Name it "George W. Bush"
3. Send it to the Recycle Bin.
4. Empty the Recycle Bin.
5. Your PC will ask you:
"Are you sure you want to send George W. Bush to the recycle bin?"
6. Answer calmly, "Yes," and click the mouse button.

You will feel even better if you do this at least once a day.

11. Graph of characteristic for Wattmeter (Millivoltmeter)

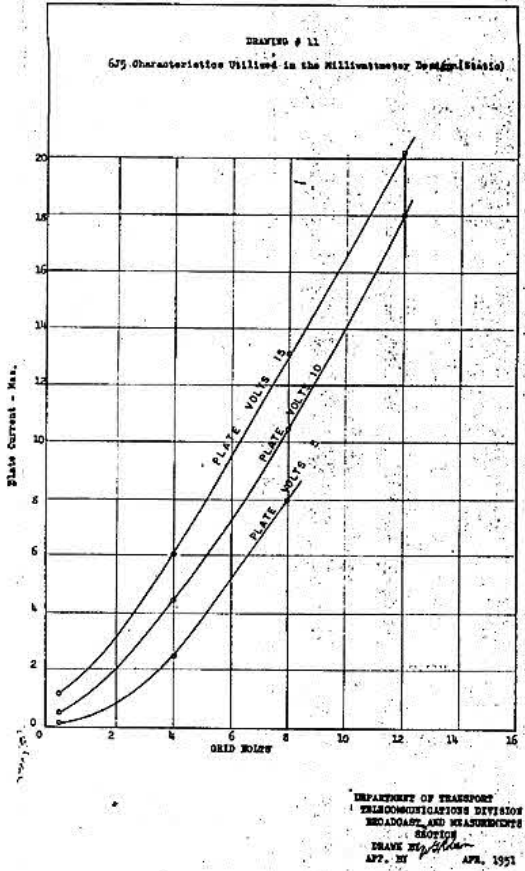

12. Diagram of Wattmeter #1 design

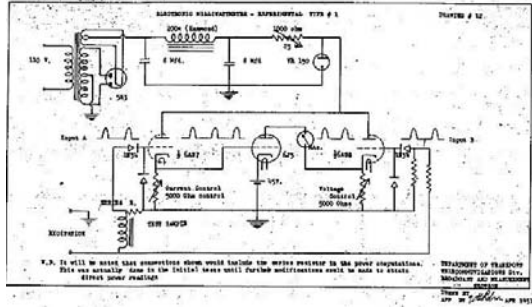

"An honest politician is one who, when he is bought, stays bought."

- Simon Cameron (Lincoln's Secretary of War)

13. Calibrating curves

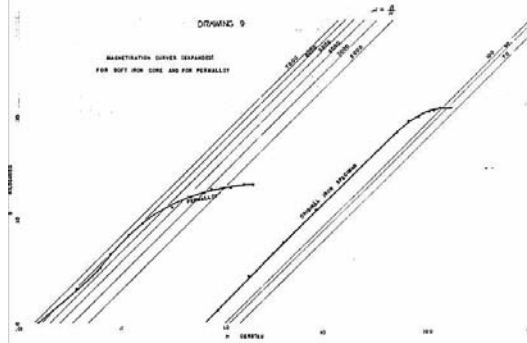

14. Diagram of Wattmeter #2 design

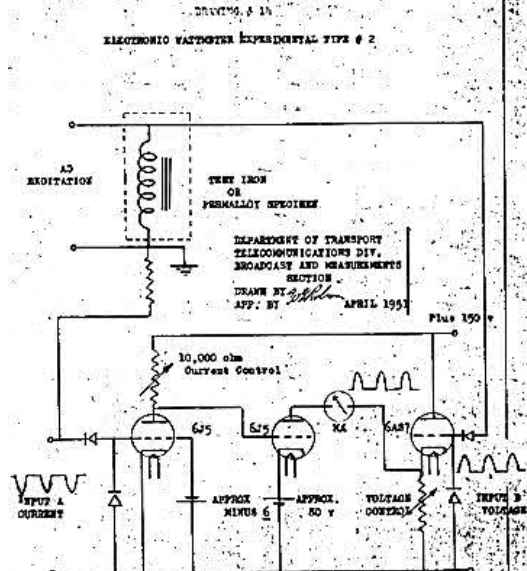

15. Graph of reactance curves for toroids

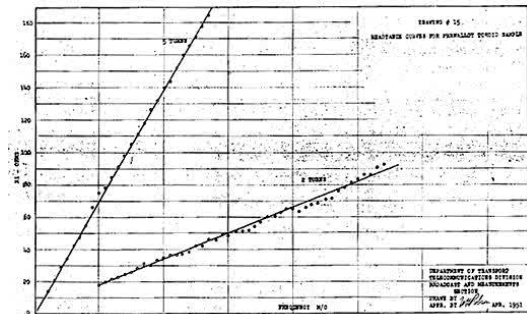

16. Phasing circuits for domain resonance tests

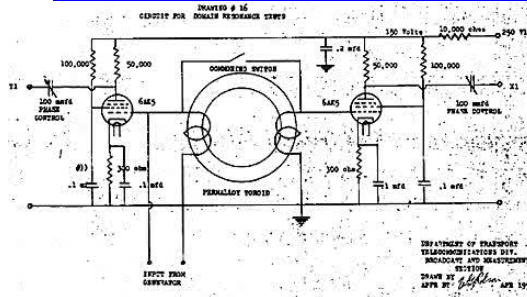

Courtesy [Rex Research](#)

Courtesy [Keelynet TOC](#)



01/08/07 - [Strips of plastic play audio when you run your teeth over them](#)

A long thin plastic strip, about 60cm long. It doesn't look like much, but it talks! Along the length of the strip is a pattern of fine ridges or lines. Run your thumb nail along the ridges, and the tape speaks. However the sound needs to be magnified, so that you can hear it. One method is to hold one end of the strip between your teeth. Then, when you run your nail along the strip you hear it talk, but no-one else does. Or you can stick one end of the strip to an inflated balloon or a paper cup using sticky tape. The balloon or cup acts as an amplifier, and you can then demonstrate it to anyone nearby. What do the tapes say? One says 'Happy Birthday' others say 'Congratulations' or 'Have a Nice Day'. We have 5 different messages, and we supply 4 tapes of each message, making a pack of 20 Talking Tapes.

Courtesy [Keelynet](#)

Courtesy [Keelynet TOC](#)

02/07/07 - [DCA cancer cure trials underway](#)

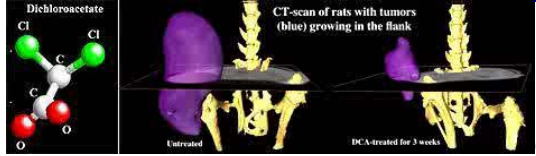

Would be interesting to try this with radionics, just needs one sample to provide the 'signature'. - JWD) Investigators at the University of Alberta have recently reported that a drug previously used in humans for the treatment of rare disorders of metabolism is also able to cause tumor regression in a number of human cancers growing in animals. This drug, dichloroacetate (DCA), appears to suppress the growth of cancer cells without affecting normal cells, suggesting that it might not have the dramatic side effects of standard chemotherapies. At this point, the University of Alberta, the Alberta Cancer Board and Capital Health do not condone or advise the use of dichloroacetate (DCA) in human beings for the treatment of cancer since no human beings have gone through clinical trials using DCA to treat cancer. However, the University of Alberta and the Alberta Cancer Board are committed to performing clinical trials in the immediate future in consultation with regulatory agencies such as Health Canada. We believe that because DCA has been used on human beings in Phase 1 and Phase 2 trials of metabolic diseases, the cancer clinical trials

timeline for our research will be much shorter than usual. This website will be updated frequently to reflect progress in our efforts. / Dichloroacetate (DCA) is a product of water chlorination and a metabolite of certain industrial solvents. DCA is not patented which would make it dirt cheap to produce. / Dichloroacetate (DCA) is a simple molecule with two oxygens, two chlorines, and two carbons. DCA has been used to treat a rare illness in mitochondria, which process energy inside cells. Unlike many new cancer drugs, you can take DCA by mouth. / When the researchers injected human lung cancer cells into rats, tumors shrank significantly in animals that got DCA, compared to the animals that did not get the drug. Tests showed that apoptosis was operating in the tumors in these DCA-treated animals, but not in the control animals. The drug DCA reduces tumors but does not eliminate them.

Courtesy [Keelynet](#)

Herman MEINKE Orgone Devices [TOC](#)

Courtesy [Rex Research](#)

Herman Meinke
Products for Nature
23158 Cora
Farmington Hills, MI 48025

Herman Meinke: [The Odic Disk Machine](#)
H. Meinke: [J. Borderland Research \(May-June 1985\); "Free Energy In Your Own Backyard"](#)
H. Meinke: [J. Borderland Research \(Nov-Dec 19889\): "Ions & Orgone"](#)
H. Meinke: [Tuning In 1\(8\), Dec. 1990; "Cloudbusting: Fact or Mythology \(Part II\)"](#)
H. Meinke: ["Possible Use of Chemical Ether Generators for Drought Removal"](#)

"The Odic Disk Machine"
by Herman Meinke

In the book "The Inner Earth" by Doreal, he mentioned that there are 144 separate and distinct types of magnetic current. The Ancients called this sub-Pranic or sub-aetheric, which can be used for superhuman powers and levitation or for control of the mind.

The following is a description of how we make a machine to allow anyone to work with each of the individual magnetic currents.

In the book "Vital Force" by Baron Charles von Reichenbach, he shows the chart of these forces:

Fig. 1: Von Reichenbach's Chart of Forces

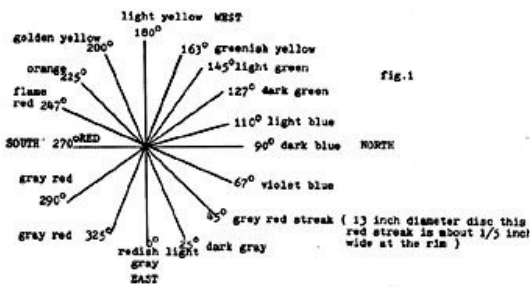

Take a metal disk and put the N or S pole of a magnet in the center. Then place the disk horizontally. Use a compass to line up the dark blue at 90 degrees and red at 270; then you can map out the rest of the lines.

If you can see magnetic auras then you will not need a compass.

Fig. 2 shows how to make a very powerful magnetic spectrum device. The 44-inch diameter disk is made of 10:0:8 soft annealed steel approximately 3/16 inch thick. Between them are placed 16 to 28 ceramic magnets approximately 2 inches in diameter, with a hole in the center and magnetized with the poles across the faces. The blue pole is placed under the top disk and the red pole is placed down on the bottom disk. The top and bottom 2 to 4 magnets are placed so their poles repel, but when put on top of the metal disk they will still attract to the metal disk so as to compress the field out away from the center to the edges of the disk. A brass or copper tube is forced through the holes in the magnets to align them and give them support. A plastic stand or motor is used under the bottom plate.

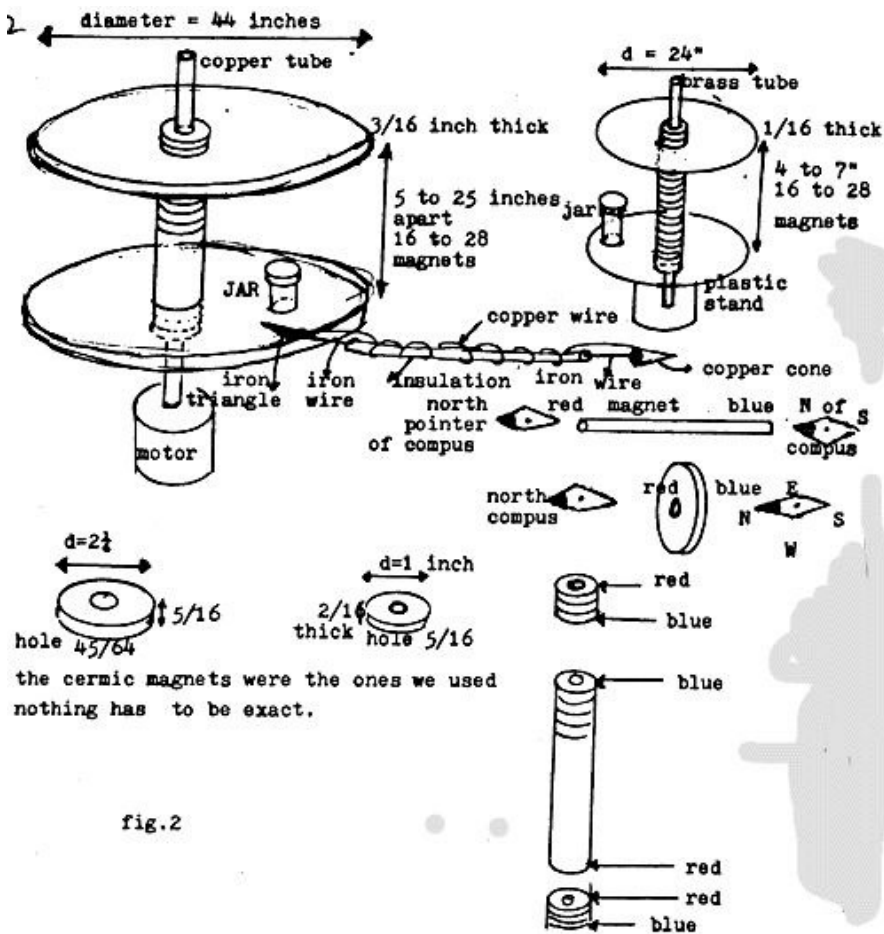

fig.2

An iron triangle was placed on one of the disks to draw off the color to work with it. The width of the colors nearby. The triangle is connected to a copper and iron wire to draw off the energy you want to work with. The cone on the other end increases the efficiency. An iron rod can be placed at the edge just between the top and bottom so you can draw color from the bottom and top plate at the same time.

Fig. 3: How the colors look coming out from the machine: very concentrated near the edge and slightly inside (Geographic N: dark blue ray)

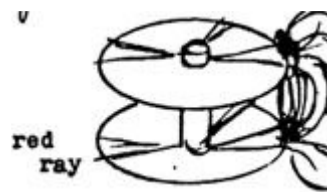

Fig. 2: Magnetic Spectrum Device

As the distance between the plates is increased the separation of the colors increases and the stinging sensation increases to a point where it decreases with further separation.

A jar placed between the disks can be used to charge water or seeds in water. 2 to 4 hours are needed for good results. If the disk is turned slowly by motor or hand (every 10 minutes by hand), all the colors will fill the water. Seeds treated for 1 hour or longer showed up to 5 times as much root growth as compared to untreated. The disk is turned every 15 minutes. When you use the red or blue pole of a magnet you still have the complete rainbow in each color. Now as with color therapy you have each color at your command and it is already in its aura form which makes it more effective and potent than the aura which is attached to color.

On the back of most old TV picture tubes is a gray ferrite collar over copper wire. Remove them and place 2 or more over the copper tubing on the top disk. With three of these ferrite collars the odic field coming from the area between the two iron disks will be extended 10 to 100 times.

Our guess is that the field of energy may be equal to a 16-layer Reich accumulator, but it is of Od (cf. von Reichenbach) rather than Orgone.

Orgone moves west to east; Od moves south to north. They cross each other. We think that Orgone's physical counterpart is electricity, and Od's physical counterpart is magnetism.

When a person sits in an orgone accumulator his body generates a larger aura. When that person puts his hands near the odic disk the orgone aura collapses and a new aura appears that seems different from the orgone aura. Carbon seems to be able to break orgone into its different colors. Reich found red and blue energy under the microscope, and between red and blue is a rainbow. Now that you have electricity and magnetism (orgone and odic) the sky is the limit. Go after it!

J. Borderland Research (May-June 1985)
"Free Energy In Your Own Backyard"
 by Herman Meinke

In looking for grid crossing points or vortexes on your own property you will find both centrifugal and centripetal vortices or whirlpools of energy. Centrifugal vortices move from the center out or

explode. They can be clockwise or counter-clockwise. Counter-clockwise will add to a centrifugal vortex's dominating destructive force effects, while a clockwise motion to a centrifugal energy will subtract from the destructive effects of that force.

Centripetal vortices move from the outside inward, or implosion. They also can be clockwise or counter-clockwise. Now clockwise energy will add to a centripetal vortex, increasing its constructive force, while a counter-clockwise motion to a centripetal energy vortex will subtract from the constructive effects of these forces.

Remember: the mind that forms a vortex tube can be even more important than its rotary direction. The element that formed radium (c-c) will not be the same as the element that formed the element oxygen, clockwise. If you are going to work with vortex energies or grid points which are vortex energy, you should keep a positive outlook and work with love in all you do.

QUALITY DOWSING TOOLS FOR THE PROS AND THE BEGINNERS

Featuring Pendulums developed and created by [Jozef Baj](http://www.diviningmind.com/index.html) of Warsaw, Poland, highly regarded expert in the broad field of radiesthesia, recognized around the world for creating pendulums that show very strong and symmetric aura, and much more!

<http://www.diviningmind.com/index.html>

Fig. 1: Centrifugal and Centripetal Clockwise and Counter-Clockwise Vortices

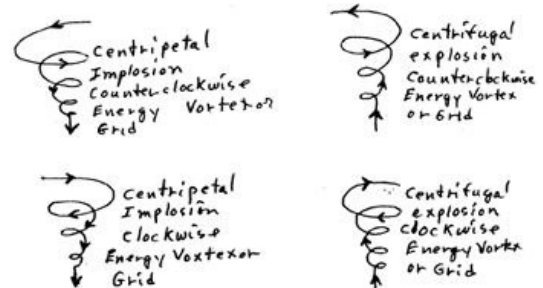

J. Borderland Research (Nov-Dec 1989), p. 17
“Ions and Orgone”
by Herman Meinke

I'm sure you've noticed some foggy days that seemed healthy and alive but others that appeared toxic and lifeless. It became apparent that the same condition occurred in my laboratory experiments on bion growth, there were many days when I worked with silica gels used in the research of bions and their growth later into insects. Eventually I noticed that these particular gels resembled the same phenomenon of toxic DOR (Deadly Orgone) whereby solutions with materials in suspension, such as clay, fell to the bottom and other substances floated upwards instead. This is depicted in the moving nature of orgone-like foggy days. This beautiful orgone experience is seen when fog rises from a swamp at night or when rolling in from a south sea island. In DOR contrast, a smog-filled room that is highly positive (negative ions far outnumbered by positive) has a DOR-type stagnant air. This will clear up, however, when negative ions are reintroduced. I am not, however, saying that negative ions are orgone energy.

This same situation occurs outdoors when the air is charged very positively. Normally, fog doesn't lift easily. This is because the ionosphere is charged with 400,000 positive volts, whereas the earth's ground surface tends to be negative, pulling the positively charged fog downward. This same situation fits other DOR type problems. Since these lighter, more mobile negatively charged particles are no longer present, the heavier and more condensed positively charged particles now repel each other in a manner similar to the particles in the silica gel solution in water, mentioned previously. If I were to pour water on a colloid, the water would tend to move the whole gel. Just like this gel phenomenon, DOR type fogs refuse to move, even when a breeze or wind comes along. It is as though the fog particles form an expanded colloid like sponge for many miles. Under these circumstances, it's easy to see why the air prefers to pass through the sponge instead of struggling to impel it to move. Try to visualize the fog as a 3-dimensional screen with the corners of its cube having positive ions (or DOR particles) and the smaller air particles passing through the screen but not affecting its movement.

As stated earlier, you can experience orgone energy when encountering fog rising from a swamp both early in the morning and late at night when it comes gently rolling off the ocean. It occurs in the

strongly charged negative ions of the misty sprays from cool mountain waterfalls. These particular ions are attracted to the ionosphere (which is highly positive) and they're lifted upward. The negatively charged earth repels this type of orgone fog, causing it to turn into levitational clouds.

This same situation happens when a negative ion generator is used to clear up a smoke-filled room. My research does not indicate that orgone energy is related to negative ions but rather that orgone presence does seem to cause the air to become negatively charged.

Reich himself described fogs that would not move even in the presence of a wind or breeze and referred to them as DOR type fogs.

Some of my previous background involved working as a polymer chemist at Reichbold Chemical Co. along with experience as a plating chemist at Continental Dye Casting Co and automotive head chemist at EZY Products. This particular background helped me to formulate the above theories.

Perhaps other scientists as well as lay people can now use this information to advance their understanding of orgone energy. In the past 20 years, I have personally taken readings of the ion content of the air and used negative ion generators to simulate different effects. These instruments can be very useful in studying both orgone and DOR effects on air.

Remember that negative ion generators are not orgone generators. Negative ion generators will collect all the dirt from a room and deposit it on the walls nearby, actually bonding it to the paint. Further months of usage will also collect DOR dirt, radioactive fallout dust, and other toxic chemicals, confining it to a small area, becoming too dangerous to be near eventually. Negative ion generators produce ORANUR effects. ORANUR is the acronym used to designate Orgone Nuclear Reaction.

There are ways to generate beneficial ions which may prove to be more closely related to orgone energy and thus safer. Refer to British Patent # 1,266,227. If the electricity from a 5000 and 10,000 V AC generator is stored between capacitor plates without producing any electrical breakdown in the dielectric materials between the plates (and if there is no electrical discharge in the air), then a small bluish glow will be observed when there is a small

air gap between the plates. When this happens, the air coming through the plates acts like highly charged orgone energy. Tests run on the above patented device, with air recirculating for over one hour through the device, removed 88% of the CO2. This air also caused rapid healing in highly infected mice.

Tuning In 1(8), Dec. 1990
“Cloudbusting: Fact or Mythology (Part II)”
 by Herman Meinke

In a book called “When Stars Look Down”, George Van Tassel describes a device that will double the size of normal vegetables. It is supposed to charge the ground. You weld a 4 foot cross on top of a 21 foot pole with needles pointed up 2 inches apart at the top. Wires are then buried in the ground 18 inches deep. He sates that the device works by unbalancing the charges between the earth and the air while nature tries to counter balance. It creates an electric flux in the mast and wires. The current in the wire produces a magnetic field around it and brings about a gentle magnetic vortex perpendicular to the ground. This in turn creates accelerated electric activity in the plants and roots which are in the vertical zone of electric flux. Each vegetable then becomes a miniature atomic accelerator and thus increases its growth and current flow.

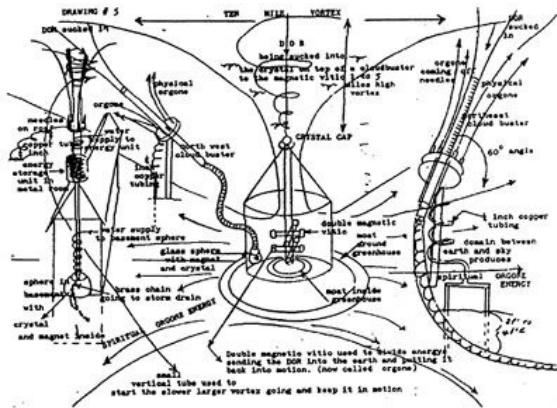

The aura around the plant was usually blue while the wire and need showed red. This is not visibly discernable but rather as light observed by the inner eye.

Several months alter an idea came to me to utilize them around the cloudbuster with each pin connected to the ground. The whole thing nw made sense. I saw a blue haze around the cloudbuster, not unlike the haze of blue I saw around the plants with the loops that discharged over the charged soil. I

was encouraged to think that the points were removing the DOR in acting as a main discharge. If the needles were drawing red energy from the earth and the cloudbuster blue energy from the sky, then this device might prevent a person from being harmed while standing next to a cloudbuster.

[... Missing text...]

Crystals help to attract orgone energy as well as eradicate some of the more harmful types of energies. To test your crystal’s true alignment and effectiveness, obtain a 5-ft galvanized conduit tubing and coat it with three layers of shellac. Align the tube N and S and place the apex of the crystal 1/8 inch away from the S end of the tube.

Don’t obstruct the tube’s opening. If the crystal is smaller than the opening, insert it halfway into the tube. A mild prickly sensation of cold should be felt at the N end of the tube, like a breeze. Reverse the crystal now and note a very weak medical DOR buster effect at the N end of the tube. It feels like energy is being drawn from your body...

[... Missing text...]

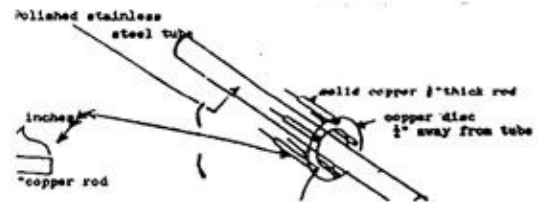

<http://www.item-bioenergy.com/>

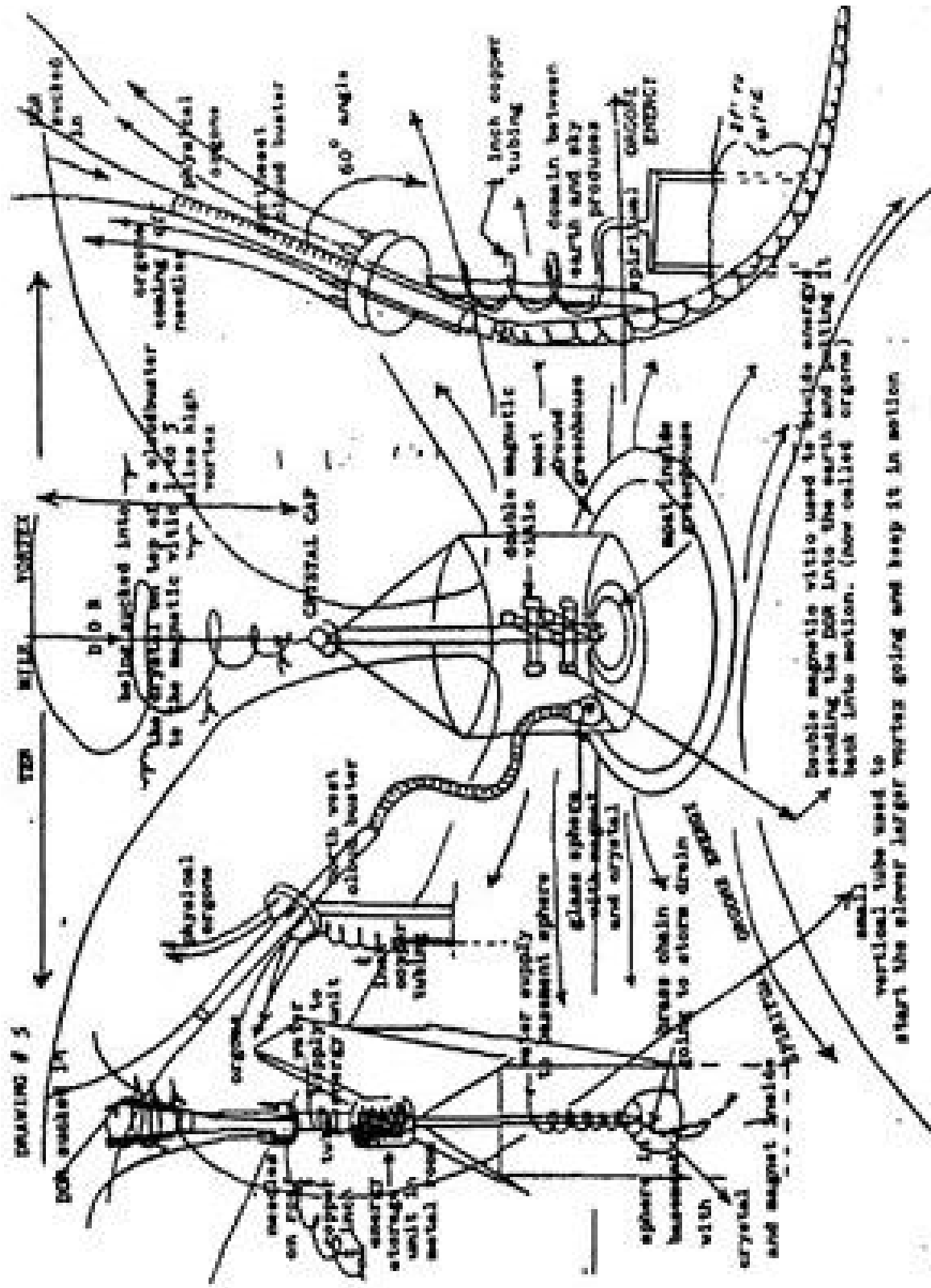
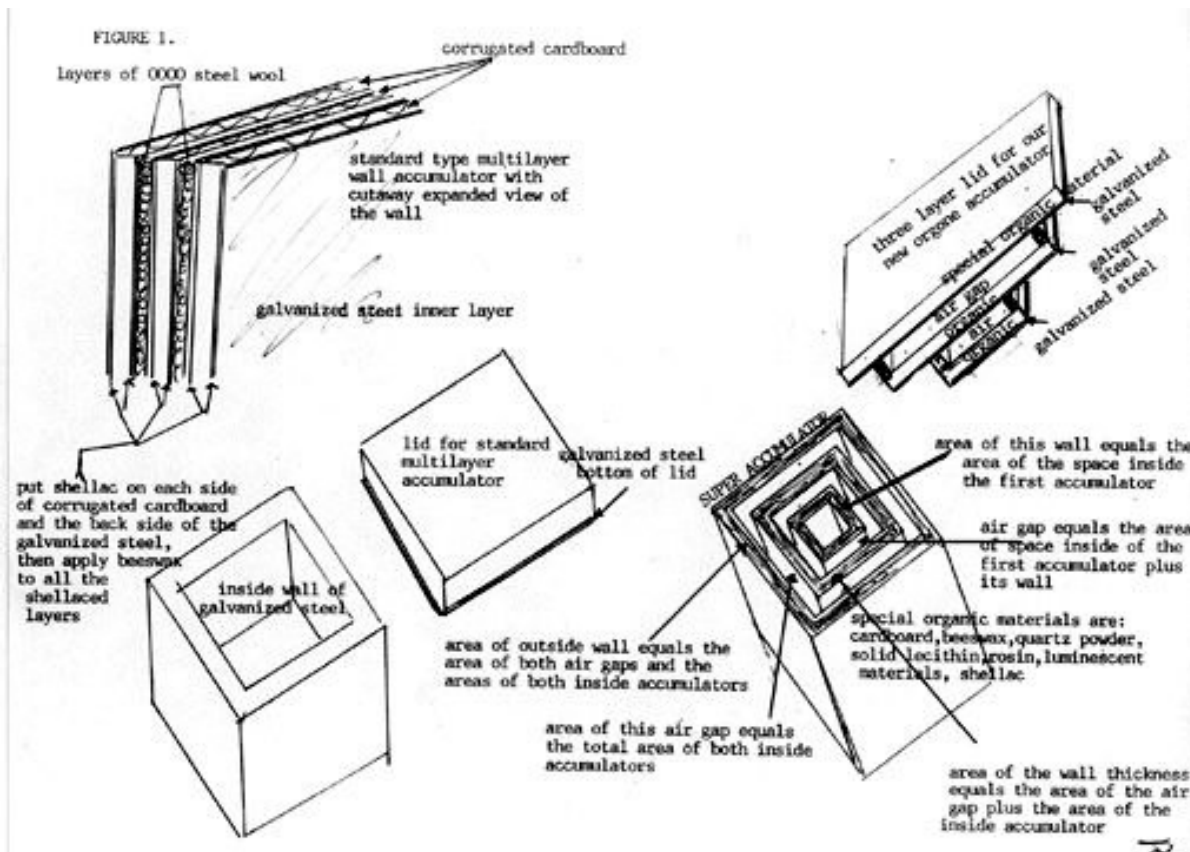
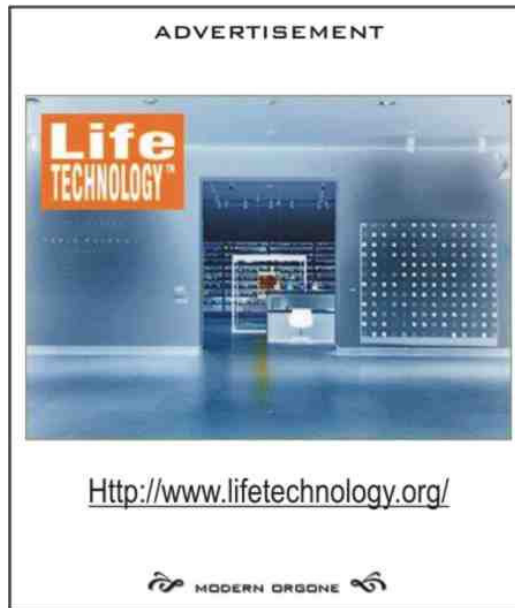

Figure 1 ~



There are two ways that accumulators can be used. Most commonly, specimens such as plants or animals are placed directly inside it. In this case, the box or blanket type is utilized but cylinder shapes also have been used. Another way is to take the energy directly out of the accumulator and send it to the specimen itself. This latter method is employed in construction of the chemical ether generator. A typical approach in its construction is to make a 5-20 layer orgone accumulator, making a small hole through all the layers. A small flexible tube can then be inserted directly inside, thereby drawing out the orgone energy from the multiplayer box. This tube is then aimed right at the specimen. Most of the time a metal cone is connected to the outside end of the metal tube. Both tube and cone should be coated with a good flexible organic insulator to prevent orgone energy from escaping from the sides. This particular coating then creates a long, one-layer cylinder-type Orgone ACCumulator (oraccu). Refer to Fig. 2.



<http://www.lifetechnology.org/>

Figure 2 / Figure 3 ~

In "The Cancer Biopathy", Dr Reich describes his research showing that higher temperatures of 0.2 to

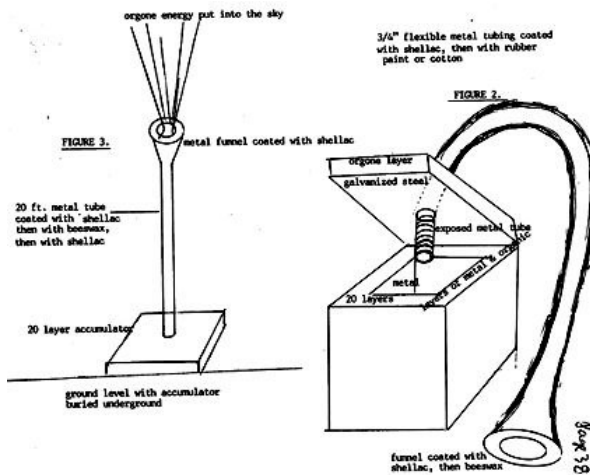

0.5 degrees occurred inside his accumulators versus the room temperature. These particular accumulators were tested inside a building. Similarly, accumulators put directly on the ground showed temperature increases of +2 to +5 C. On summer days with a strong sun, temperature differences of +20 were not uncommon. The important concept to understand is that the effect is 5-50 times greater in an outdoor accumulator placed into the ground versus one indoors. At this point, try to imagine a hollow tube connected to the top of this underground accumulator with a cone placed open-ended at the tube's end so it's not blocked. An open ended galvanized steel funnel will work well. Insulate both tube and cone, as previously described. Instead of directing orgone energy to a specimen, aim it directly upward to the sky. Refer to Fig. 3.

If you were to construct the 10-ply oraccu as described in DeMeo's book, burying it in the ground and pointing its funnel to the sky, the results may not be as promising since most of the energy is meant to stay within the box. To get the energy up to cloud level, its tube would have to be 10-100 ft long to add enough orgone to the sky to make it useful for increasing the probability of rain.

Another problem with an underground oraccu is the need to make them waterproof, for the stainless steel wool will rust, and if the organic material gets wet, the oraccu will cease to function altogether. Fiberglass seems to be the least affected by humidity.

The construction of the chemical ether generator is pictured in Fig. 4. We soldered three 6" diameter steel furnace pipes to create a total length of 66". A 6" copper half-sphere (bowl) then was brazed/soldered to one end of the tube. See Fig. 4A. Next, we applied 10 coats of shellac over the entire outside of both the tube and bowl. A coating of 1/4-1/2" beeswax was then applied to the sphere only and 24" up the sides of the tube. See Fig. 4B.

Figure 4 / 4A / 4B

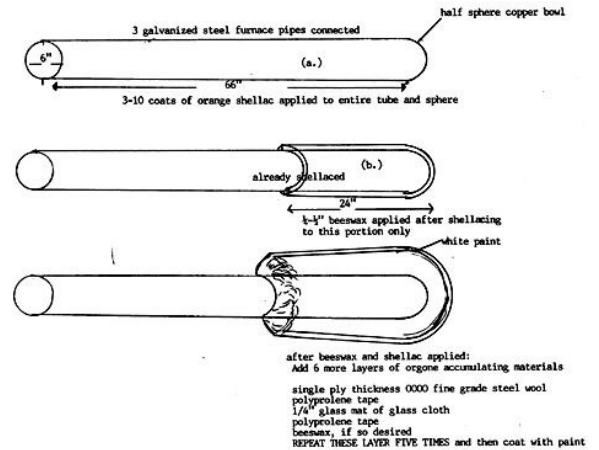

After drying, we added six more layers of oraccu layers to the beeswax area only. The first layer was fine steel wool (Figs. 4C and 5). It was secured with polypropylene tape. Next we wrapped 1/4" of fiberglass and secured this with polypropylene tape. At this stage, if so desired, you can apply a thin layer of unrefined melted beeswax. Now the entire tube is coated with paint to prevent weathering and protect it from rain. An application of titanium oxide enamel paint is recommended.

Figure 4C / Fig. 5

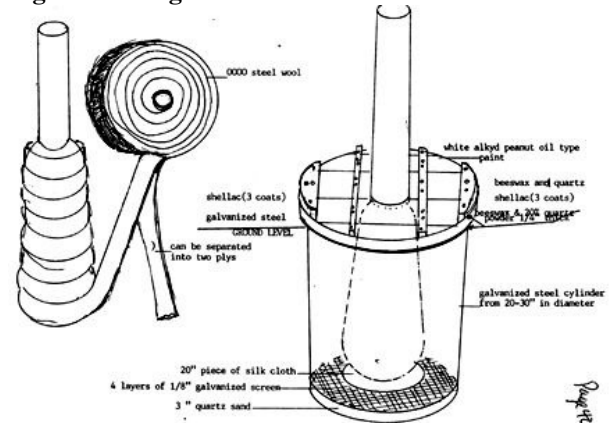

Next, dig a hole in the ground deep enough to accommodate the end of the tube and the following materials. Pour a layer of 3" of white quartz sand followed by four layers of galvanized steel screen (1/8" mesh). Then a 20" piece of silk cloth is placed on the top. The tube rests on this base and the coated portion sits just above the soil line. The diameter of the hole is 24" so that a galvanized steel cylinder will just fit into the hole. It has a protective lid of pine wood with a hole in the center to allow it to fit over the tube. The lid is 28" wide. Both sides are coated with 3 layers of a mixture of shellac and beeswax containing 5% Calcium Silicate, 10% micronized silica, and 85% beeswax. The side of the steel cylinder that contacts the lid is coated with two layers of shellac. The rest of the cylinder is not coated and should be kept clean. The top of the lid is coated with three layers of shellac followed by three layers of titanium oxide paint (peanut oil base).

Before setting the device into the ground, place a steel cap over the end. Never remove it until just before using the device; use a wooden pole about 10 ft long. For safety it is recommended to stay at least 20 ft away.

This device is capable of giving the sky enough orgone to affect a 3-mile radius within hours of its operation. Coupled with use of the new breed of cloudbusters we can remove the DOR and restore the earth and sky to health.

Note that to make the beeswax mixture stronger and more balanced, the following may be added: 0.2 grams of Biodynamic Formula #501 and 0.01 grams of diamond dust. Up to 22 grams of micronized silica has been tried with good results to further accumulate orgone.

There are some important concepts to understand when working with these energies. For instance, Nature does not just plant a forest, allowing it to grow to full size in a few weeks and then suddenly remove it. Likewise, people should not point cloudbusters at the sky to draw out energy and then remove it in less than two weeks. Cloudbusters cannot be used in such a manner without throwing Nature out of balance.

Never point this chemical ether generator toward a storm because this can dam up the orgone and cause very violent weather, even creating a "tidal wave" action somewhere else in the sky. The safest way is to point it vertically straight upward. When the total system is in operation, the energy field

should look like Picture #2 and #4 as well as the effect created when lightning approaches the generator similar to the diagrams in Fig. 8, 9, and 10 (termed Lightning # 1,2,3, and 4). On the first day of successful operation one will feel as though an ocean breeze has just come in to cool the land. If you have moved too fast and overdone it, you will feel as if you are underwater. Sounds will also be very intense. These signs indicate that your generator is too powerful; fewer layers should be used in the construction of the oraccu...

There are devices available which can be used when working with the different energies described. You should build a Vitic, which we have used when becoming overcharged with both orgone and DOR. A cold shower also is recommended, followed by use of an Eeman screen and the Vitic; it is the most effective way we have found to reduce the chance of harm from excess orgone, oranur, or DOR. Information on the construction of Eeman screens and the Vitic are available from Borderland Research.

A firm reminder: When working with orgone remember that it is as dangerous as very high voltage electricity. Even an expert can be injured or killed by this force, even when doing everything correctly.

I have decided to make this information available only because no other qualified person made it available to a planet which needs it so badly. Another reason is that there are people using 1-ft diameter metal drain pipes up to 100 ft long and trying to make rain, as well as other types of devices which could harm people. Many of these people have no idea of what they are doing and are causing more harm than good (such as pointing the device in the wrong direction at the wrong time, which can actually create drought conditions). Even our system has the potential of removing too much orgone energy from the soil and adding too much DOR to the immediate area, so it's wise to be careful.

At this time we are trying to make an even more advanced type of cloudbuster containing small glass tubes of sea salt and baking soda encircling the middle portion of it, to be used with a more standard cloudbuster to draw the DOR out and slow the Oranur process by directly combining with DOR to produce and replenish fresh orgone for the planet. We have not yet fully succeeded. We do feel, however, that people should read "Born to be Magnetic" (Vol. 1 and 2) by Frances Nixon. I

believe that these people have found a way to protect areas from Oranur with the use of sea salt and baking soda (sodium bicarbonate). You could try saturated solutions as well as dry powders in your experiments. Try placing one-inch (or smaller) diameter tubes (2-3 ft long) in running water or buckets of water which should be replaced daily to assist in the removal of DOR and Oranur.

My hope is that by making this information available to the public that it will help to alleviate further destruction of our planet and perhaps save lives.

Since this research was started in 1972 and has been done only in our area, there is no guarantee that anything published here will work as stated since the energies were different and higher then... Some General Rules for Using Cloudbusters with Needles Attached: This information will be helpful for all ether energy-controlling devices. If you want to make rain, you have to take energy from the West, then move toward the North and stop at NorthEast to cool and condense the water. A cloudbuster in the drawing mode (they do not always draw) moving from West to East in a North direction will tend to make rain. Many other things have to be taken into account, but I am only trying to help you use the ancient chart of Fire, Air, Water and Earth:

Picture # 5

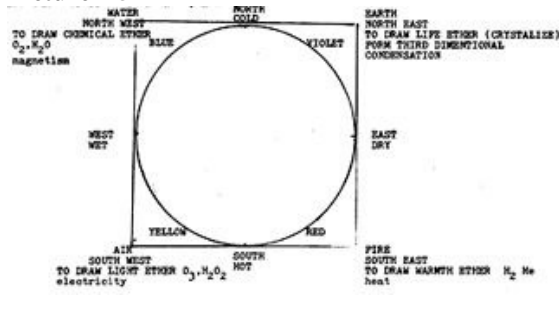

[Top ~](#)

Courtesy [Rex Research](#)



<http://www.reense.com/>

XTREMEMIND

<http://www.xtrememind.com/>

Dowsing and Radiesthesia

A Preliminary Study of the “Life-Energy” associated with Orgonite and Ormus by means of a Quantitative Dowsing Method

Copyright© [Roger Taylor](#) Sep 2007 [TOC](#)

Roger Taylor PhD. The Mu, Brook Lane, Albury, Guildford, UK. e-mail: rogerbt@onetel.com

Abstract

Metal particles set in resin (“Orgonite”) behave as a source of the “orgone” energy of Wilhelm Reich. By dowsing the intensity of such energy quantitatively with rods, the following has been shown: this activity of orgonite depends on the sun; it is abrogated by microwaves; it is taken up from orgonite by water and some other materials; ormus (the “white gold” discovered by David Hudson) exhibits a similar energy. It is suggested that the presence of orgone energy is indicative of some kind of quantum coherence within the source.

Introduction

As is well known, Wilhelm Reich identified a form of energy (“Orgone”), which was favourable to life, and is often equated with the “life-energy” in the human body, otherwise traditionally known as chi, prana, etc. He found orgone would accumulate within a box whose walls consisted of alternate layers of metal and organic material, and could then be detected by sensitive persons, or by a variety of physical means. Much more recently, it has been found that by merely incorporating metal particles into a non-conductive matrix (usually synthetic resin) one can make a powerful source of orgone. Such material has been called “Orgonite”, and patented by its discoverer, Karl Welz, who makes use of it in his radionic devices¹. There are now a number of web sites concerned with orgonite. One of these has much interesting research on the technology²

As a result of suggestions by James Lyons³ - a physicist and expert dowser - I have developed an ability to quantitatively dowse the intensity of such energy. What I do is to place the object on the ground (preferably outside on the lawn) and walk towards it holding dowsing rods. These cross at one or more intervals (indicating an “aura” of one or more rings) and then again finally cross over the source. With a tape-measure on the ground, I record the radius of the innermost ring, which I find to be

related to the intensity of the source. All the data to be presented concern this measurement, and are given in inches rather than centimetres.

Ormus is the name now given to a series of extraordinary elementary substances, also known as “White Gold”. They are thought to be mainly precious metals, in which the electrons are re-arranged in such a way as to render them non-metallic, chemically non-reactive and possibly super-conductive⁴.

Test for quantitative nature of the dowsing method

To study the relationship of the radius of the innermost ring to the quantity of orgone-emitting material, I dowsed measured volumes of an alkaline precipitate from Dead Sea salt - a preparation known to contain ormus. As Fig 1 shows, the relationship is close to linear – though there is necessarily some vagueness with readings close to the source.

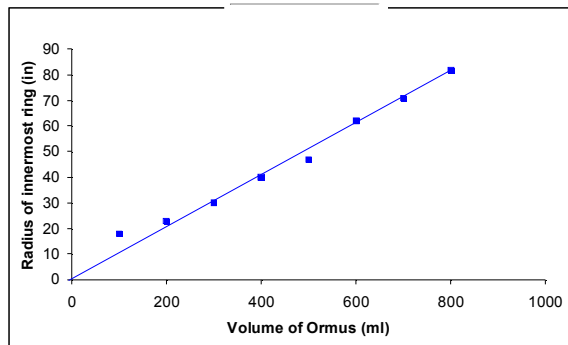
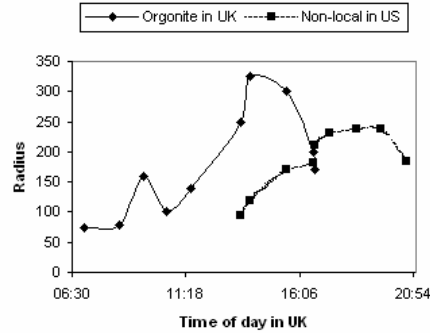

Fig. 1

Relation of weather and time of day

Just as with Reich’s orgone accumulator, the energy depends on the weather and the time of day. The time-course for UK obtained in Fig. 2 was on a bright clear day. The readings were much lower in cloudy and especially rainy conditions. For the US, use was made of the facility for non-local transfer between identical symbols. Here I was dowsing the logo downloaded from Karl Welz’ web site. As detailed later, it exhibits dowsable energy transferred non-locally from an identical logo, which Karl keeps in one of his orgonite-based devices in the US. As Fig. 2 shows, this reached a maximum at about 18:30, which would correspond to the solar maximum in the eastern states at about 12:30.

Fig. 2



Dowsing various objects

The energy of various objects made of orgonite was investigated. One was bought from Alexandre Emard in Canada, and is a type with which he obtained significantly enhanced growth of plants⁵. Among others which I made myself is a pyramid, made with aluminium alloy turnings, about 30cm high, hollow, and with the same geometry as the very large pyramids recently constructed in Russia⁶. It has a quartz crystal at each of its 5 vertices. On testing the effect of compass orientation, the intensity was found to be some 70% higher with the faces oriented N-S than with the angles N-S. Some orgonite pieces were made with a central hole into which a crystal could be put. While, as others have found⁶ the intensity was greatly enhanced by a quartz crystal, it was unexpected (and remarkable) that a crystal of antimony was significantly better than quartz. This finding prompted me to make a piece of orgonite with particles of antimony. This was, on first testing, the most active of all - but see later result.

Shielding

By covering a piece of orgonite with various materials, it was found that 2mm polythene significantly reduced the dowsable field, and a “cold box” insulated with expanded polystyrene completely stopped it. Metals on the other hand had little or no effect – even a heavy cast iron pot.

Charging various materials under orgonite

Various materials were placed under orgonite to see whether they picked up the charge. Not surprisingly, quartz took it up very well, as did quartz-containing minerals such as granite and sand. Most metals (iron, aluminium, and brass were tested) took up the charge very rapidly (in seconds), and then retained it for only about a minute. Most other materials were unaffected. Of a number of crystalline chemicals tested, sugar took up some activity, as did Epsom salts, possibly due their high water of crystallization. Remarkable, and unexpected, was the high uptake by antimony. Bismuth, on the other hand, though very similar to

antimony (e.g. both are highly diamagnetic) did not take up any detectable charge.

A further strange property of antimony became evident a few weeks later, when the orgonite containing antimony was re-tested. Surprisingly, it was completely inactive. During this time, another piece of orgonite, previously shown to be active, had had a large crystal of antimony merely lying in contact – not even in the hole in the bottom. But this also was found, after removing the antimony, to be inactive, and remained so when tested again five days later. Now however, after a further month, its activity has been regained.

Charging water with orgone or orgonite

For taking up this charge, at least as good, or better, than quartz and antimony was water - which of course is well-known to be capable of storing information, as in homeopathy. This was further investigated as shown in Table 1. The orgonite pyramid was at least twice as strong as an orgone accumulator of the type used by Reich. The latter should have been optimal, as it as was built according to instructions of James DeMeo⁷. (In other experiments, I have confirmed Reich's "temperature effect" in finding slightly but consistently higher temperature in this accumulator, compared to a control box without metal). The charging under the orgonite pyramid reached maximum in a little over 30 min. Most surprising is that the water retained its charge, even after boiling, and further microwaving to boiling point.

Table 1

Source	Time	Radius
Orgone accumulator	48h	49
Orgonite pyramid	48h	107
Smaller orgonite	0 min	0
	15 min	27
	38 min	72
	105 min	81
	1440 min	85
	Boiled	95
	Microwave boiled	95

Non-local transfer of dowsable energy

Karl Welz puts on his web site a logo, which is an identical copy of one which has been printed and placed close to the orgonite block of one of his devices in his place in the US. He invites one to download this and feel the energy. While I could not feel anything, I could dowse it easily enough. In further tests I made a random "glyph" in black ink, copied it and put one copy under a piece of

orgonite, and dowsed the other at some 30 metres distant. The transfer of dowsable energy was obvious (Table 2). On dowsing some other images, it was clear that, as Welz maintains, the intensity of transfer depends on the degree of similarity of the two images. It also depends on the "uniqueness" of the pair of images, because the energy becomes diluted if it finds any similar structures in the rest of the world - or the universe presumably. Searching for unique images, I found one which performed particularly well ("orb").

Applied Biophysics Research Laboratory

Biophotonics, Magnetic, Scalar, Aether, Orgone, Cymatics, Quantum Sound, Vortex, Water, Soil & Geology, Minerals and Crystals, ORME Monoatomic Elements, Biology, People, Plants, and Animals, Microbes or unseen friends, Keely - Tesla - Viktor Shauberger - Rife - Joel Sternheimer - Rodin

<http://biogenesislab.blogspot.com/>

Table 2

Image under orgonite	Image dowsed	Radius
Glyph	Identical glyph	64
Glyph	Similar glyph	59
Glyph	Black square	32
Glyph	5 green spots	0
Glyph	Orb	0
Orb	Orb	85
Orb (+10 copies)	Orb	40
Orb (copies burnt)	Orb	70

With the existence of many copies, at another location some 30m distant, an image will be less unique. This was confirmed in the last two lines of the table.

In radionics one frequently makes use of a clip of a hair from the individual being treated: the "witness". This will have something of the unique signature of that individual. Accordingly I cut two samples of my hair, and compared the transfer between them (radius 70) with the transfer from my hair to that of another man (radius 42).

Effect of microwaves on orgonite

Several web sites report placing pieces of this material (often now called "Holy Hand Grenades" – a term derived from the Monty Python show) close to microwave masts, because it is thought (but apparently without objective evidence) that they might neutralise the unhealthy influence of these masts – or even convert the "bad" microwave energy into a more healthy variety⁸. As a source of microwaves I used the base-station of my cordless phone. (I have experienced the effects of this on myself for some time, in the form of daily

headaches – until I replaced it with a German make that shuts off the emission as soon as the handset is returned to the base-station). I found that, when the source of microwaves was close to the orgonite, I could not dowse the usual influence from it. Thinking this might be due to the microwaves upsetting my ability to dowse, I put the base-station close to me, and distant from the orgonite. Now the usual rings could be dowsed, showing conclusively that the microwaves were acting directly on the orgonite, to shut off its dowsable influence. In addition it was clear, by turning the phone on and off that, unlike the influence of antimony, the influence of microwaves was temporary: the orgonite field recovered immediately – even after leaving the phone on for 30 min.

Dowsing torsion field

I have had for some years a small torsion field generator, which I obtained from Alexander Shpilman⁹. In a preliminary test it dowsed very strongly and, in contrast to the field from orgonite, the effects of this persisted in the local environment, being still detectable even one week after switching off and removing the device.

Quantum tunnelling of ormus

The ormus used here was an alkaline precipitate from Dead Sea salt, the bulk of which is probably magnesium hydroxide. Significantly the original Dead Sea salt showed no dowsable activity. The fact that ormus could be dowsed in this way offered a possibility to test for its claimed ability to “quantum tunnel” through a solid barrier. Two concentric containers of thin-walled PVC were set up, with a central tube containing neodymium magnets separated by plastic spacers. The intention was that if ormus atoms were superconductive, they should flee the magnets and pass through the wall of the inner container into the outer. In the outer container was put a half-saturated solution of sodium chloride. Since ormus is attracted to alkali metals it was hoped that this would prevent it being lost altogether to the outside. Having put the magnets in, I poured out the contents of each container at intervals, dowsed them, and poured them back. During the first afternoon the reading from the inner containers declined steadily, but nothing appeared in the outer container. But it did appear on the second day, and by the third day all the activity was found to be in the outer container. The apparent delay between loss of dowsable material from the inner container and its appearance in the outer suggests that it got held up temporarily while passing through the intervening plastic wall (Table 4).

Table 4
Radius

Date	Time	Inner	Outer
4.6.07	13:21	125	0
	14:30	107	0
	16:34	67	0
	18:20	40	0
4.27.07	14:30	25	115
4.28.07	09:30	0	110

Conclusions

It needs first of all to be emphasized that, as a method, dowsing can never be fully objective. Furthermore, since different dowers may respond to different aspects of any particular experimental situation, they would not all necessarily confirm these results. Nevertheless, I hope in due course to obtain independent verification by at least one other dowser. A caveat must also be made about the nature of the “energies” which I detect. The mere fact of their being dowsable by me, in these various experimental situations, does not necessarily mean that they all reflect the same physical reality.

Following again a suggestion by James Lyons², I looked at the theory of Milo Wolff¹⁰. He proposes that there is no such thing as a particle. Thus an electron is a standing wave in the ether, as in Fig. 3.

Fig. 3

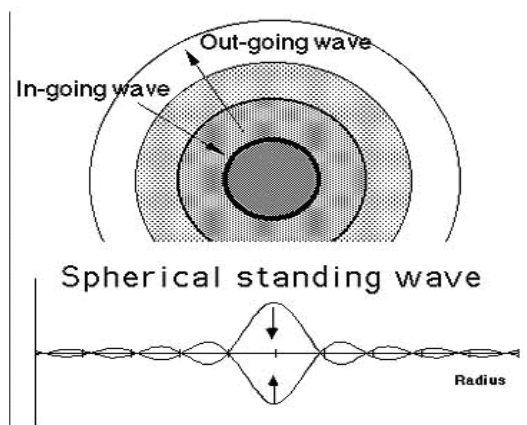

Waves go out from the centre, and reflect back again from the rest of the universe. Such a wave-system is totally coherent, in that there is no space within it, no way in which any “here” or “there” could be defined. This is exactly the condition which obtains, on a much larger scale, in man-made coherent systems such as within a superconductor, or a laser. Here all the “particles”, whether electrons or atoms, behave as one. It has long been argued that a living being is also a centre of such

quantum coherence, and this accounts for its unitary nature, and holistic properties¹¹.

Superconductivity is one of the unusual properties attributed to ormus³, or at least to some types of ormus, and thought to account for certain extraordinary observations. One of these is the appearance of drops of fluid, containing ormus, on the outside of closed containers. This could only happen, it is suggested, if the ormus atoms were quantum-tunneling their way out, and carrying a little water with them. The results obtained here support this suggestion. Here, we may note that dowsable energy was not present in the original Dead Sea salt. Thus the procedure of alkaline precipitation may be bringing the ormus atoms into a collective state of coherence.

It is proposed here that orgonite can also take up some sort of coherence. Here I am borrowing the suggestion of James Lyons² that electron clusters¹² may somehow be formed at the juncture of metal and resin. While, as fermions, electrons normally behave as separate individuals, it is when they get together in “Cooper pairs” that they become bosons, and so become able to merge their individuality into the kind of large-scale quantum coherence seen in a superconductor. But electrons can also get together in much larger clusters, of more than 1,000. Since these clusters are also bosons, we would have the potential for large-scale quantum coherence within orgonite. One might imagine that the metal particles form a system of oscillating dipoles which could, through the medium of electron clusters, self-organize into a coherent state. There is clearly a relation between the power of the sun and the intensity of dowsable energy from orgonite. Just what element from within the sun’s radiation is responsible is a matter for speculation, but the failure of metal to block it suggests it is not electromagnetic. This, together with my finding of only brief retention of the energy by metals, also agrees with Reich’s contention that orgone is “attracted then repelled” by metals, but is absorbed by organic materials.

Of great interest are the effects of influences which inhibit the dowsable field from orgonite. In the case of microwaves one might begin to understand how microwaves could disrupt an electrical coherence. But since the basic structure of the orgonite would remain intact, one would expect its coherent field to be re-established very soon after removal of the source of microwaves. Much stranger, therefore, is the effect of antimony. This can hardly be chemical, so how could it be so long-lasting?

Although both are “subtle energy” fields (in the sense of not being electromagnetically detectable) the torsion field and the field from orgonite are clearly quite different. As has been shown by others^{9,13}, torsion fields can leave a persistent trace. On the other hand the dowsable field from orgonite gave no evidence of persistence – at least in the situation here employed, that is on a background of grass-covered earth. But, considering the ability of quartz to take up the energy, one might expect a sandy ground to show some persistence.

The property of quantum-coherence may be regarded as a *sine qua non* for life¹¹. It is this which enables a living being to defy the second law of thermodynamics. Thus it is that orgonite, and also Reich’s orgone accumulator, may indeed be regarded as producing “life-energy”. The quantum coherent field from orgonite may be seen as an anti-entropic influence, favoring increased complexity and higher levels of integration. This field from orgonite is not only dowsable, but many people can sense it with the hands, and some even see it. In this it is exactly analogous to the human aura. It is this life-enhancing property which makes orgonite such an exciting material to work with. Already there are several groups who distribute Holy Hand Grenades in various places, and make claims that the local environment improves as a result⁸. And, when cast into lakes, they are said to clear up the pollution. The same life-energy may very well be what is produced by the giant pyramids, which have recently been built in Russia⁵. In addition to some well-authenticated results on increased growth of plants, and increased resistance of mice to bacterial infection and cancer, some beneficial effects on the ecology surrounding some of the pyramids have been noted. Thus they may be restoring the complexity of the whole ecosystem – a result only to be expected if one considers the ecosystem itself as a living organism.

Acknowledgements

I am indebted to James Lyons for much helpful discussion.

<http://www.hscti.com/>

<http://www.littlemountainsmudge.com/>

3. Lyons, J.W., *Dowsing: A doorway to quantifying non-localized effects in consciousness studies*. In *Towards a Science of Consciousness*. Tucson, Arizona, April 27 - May 2, 1998, and personal communications, 2007. And see addendum.

4. <http://www.subtleenergies.com/ormus>. Also my articles: *Ormus - a New State of Matter?* *Caduceus* 71 Spring 2007, 25-29, and *Magic and Mystery of Ormus Elements*. *Nexus* 14 (2) 35-40, 2007.

5. <http://www.quebecorgone.com/>

6. <http://www.gizapyramid.com/>

7. *The Orgone Accumulator Handbook. Natural Energy Works, 1989. ISBN 0-9621855-07*
8. <http://www.cloud-busters.com/>
9. <http://www.pmicro.kz/~ufi/ALMANACH/AxionA.htm>
10. <http://quantummatter.com/>
11. *The Rainbow and the Worm by Dr Mae-Wan Ho. 2nd Ed. 1998. World Scientific. ISBN 981-02-3427-9.*
12. <http://www.svn.net/krscfs/Charge%20Clusters%20In%20Action.pdf>
13. <http://www.rialian.com/rmboyd/dna-phantom.htm>.

Copyright© [Roger Taylor](#) Sep 2007

QUALITY DOWSING TOOLS FOR THE PROS AND THE BEGINNERS

Featuring Pendulums developed and created by [Jozef Baj](#) of Warsaw, Poland, highly regarded expert in the broad field of radiesthesia, recognized around the world for creating pendulums that show very strong and symmetric aura, and much more!

<http://www.diviningmind.com/index.html>

Addendum by James Lyons

The latest research is indicating that the nodal harmonic structure of standing waves in the quantum vacuum can readily be detected using a mental technique of intention usually combined with some indicating device such as hand held L-rods. Every object creates its own standing wave pattern in this field, which is discernible by dowsers. Isolated objects induce rings surrounding themselves much like a snapshot of waves generated by a pebble thrown into a pond. The structure of these rings is very stable and well known to experienced dowsers. This process offers a repeatable technique enabling dowsers to assess the inherent energy density embedded in any object. Ring (nodal) radius around an object is directly proportional to its embedded energy density.

Copyright© James Lyons 2007

Courtesy [Keelynet TOC](#)

02/07/07 - [NASA May Have to Buy Trips to Space](#) "Budget cuts could leave NASA without a Space Shuttle replacement, and leave it reliant on private firms to get payloads into space. A similar scenario happened between 1975 and 1981 when NASA made the transition from Apollo to the Space Shuttle. It seems like a strange state of affairs

when a magazine can take people to space, but the USA can't."

Courtesy [Keelynet](#)

Courtesy [Keelynet TOC](#)

02/05/07 - [Want to Take On An Open/Unsolved Problem?](#)



"The accumulation and focusing of knowledge may be the noblest use or purpose of the internet. There are plenty of open or unsolved problems left for

this generation. Why not spend some of your time in the dark of this winter working on one of the big problems facing humanity? Open problems exists in almost every field of study. Wikipedia maintains a small list of them and at least one international group called the Union of International Associations maintains a database of open problems."

Courtesy [Keelynet](#)

Got Orgone?

Updates on the VOD project [TOC](#)

By Alan D Otterson

Edited by Jon Logan

What it Is

Note- In 2005, Alan contacted me with some information about an orgone device he was working on called the VOD / Vibrational Orgone Device. While some details are difficult to make out from the instructions, studying the pictures helps, and the general idea intrigues me.

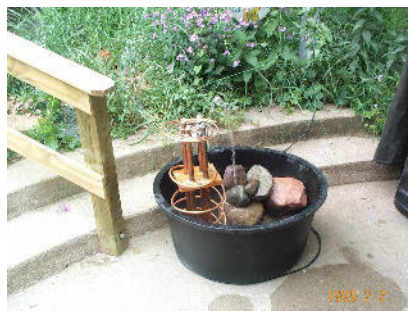

The VOD device is reminiscent of a chembuster, with the difference that a resonating coil is added to the ends of the pipes, and the crystals are moved up to the tops of the pipes, rather than the base. His idea was that the coil and base would set up an oscillation between the base casting of orgonite and

the coil on the device's top. This oscillation would then act to stimulate the device overall, processing orgone energy in the vicinity as it did so.

Since then, Alan has made another similar device which he calls the Harpooner and which employs a set of counter-wound tubing coils as the pipes, with (what seems to me) an inductor placed in each of the tubing coils. Both designs are intriguing to me in that they employ the basic concepts inherent to the chembuster design, but with an added effort to work with the pipes' resonant characteristics, going beyond the basic chembuster design parameters which are arguably more based in fluidics. Normally, the chembuster or the cloudbuster uses the pipes to channel a flow of orgone, as if it were a gas or a fluid. But with these two design ideas, it would seem that the flow of energy through the pipes would be cyclical – a large portion of the energy 'flowing' through the pipes would be redirected to flow through the pipes again - in a repeating pattern. This suggests that the device would emit waves in time with the internal oscillations, and therefore have a relatively large energetic impact on it's surroundings in proportion to it's physical size (which is quite small in comparison with a chembuster or cloudbuster). It also suggests that the device may have applications in broadcasting radionic trends over an area, approximating the strength of electrically powered radionics output modules with a self-powered device.

Alan has a blog which you can visit at <http://supercoil.blogspot.com/> for more information on his experiments, or to contact him.

Two years later, Alan says that the local wildlife shows increased activity in the region where the device is installed, and that the device has had a beneficial impact on the water in a small fountain adjacent the VOD.

The VOD was included in issue 1 of Modern Orgone, and in that issue Alan commented that he made a paste of headache pain pills and applied this base in a thin layer to the base of the VOD, noticing a reduction in the severe headaches which he and his wife had endured.

Later, Alan integrated the VOD with a small water fountain (coiled pipe around the outside of the VID is visibly spraying water if you look close at some of the photos).



Myself, I have not had the free time to construct either of these devices, but intend to when time permits. An interesting concept to explore IMO - Editor

The VOD

By Alan D Otterson

The VOD (Vibrational Orgonite Device) is a means of cleansing the skies of Chemtrails and to return micro climates back to normal patterns.

The VOD uses vibrations to stimulate the Orgone energy (discovered by Wilhelm Reich).

The large SBB coil acts like a harmonic vibrator as in a musical instrument. The four copper pipes act as a coupler from the coil to the Orgonite base. The energy is then transferred back up through the four copper pipes and out through the Crystals and the Genesa Crystal.

The water coil that goes around the Four VOD copper tubes act as a Vortex (a la Viktor Schauberger) Generator in addition to the circulating pond pumps.

The Orgonite base is made from a pour of Resin, Crystals, and other ingredients.

How to Make it

Instructions for building the VOD Vibrational Orgone device.

Items needed for making the VOD:

4 x 3'4" Copper Pipes, each 24" long
4 to 6 " square plywood or wood
Aluminum shavings
Quartz Crystals
Pyrite
BB's
3'8" flexible Copper Tubing
Polyester Resin + hardener



<http://www.rexresearch.com/index.htm>

Make a large SBB coil out of the 3/8" copper coil tubing. Solder the four 24" long Copper pipes to the SBB coil as shown in the photos.



In a small wooden block (4-6" square), drill four 7/8" holes. The holes should be spaced appropriately to fit over the pipes, and hold the pipes in position.



Make a Small SBB coil, and fit it around a Quartz crystal. You will need 4 of these.



XTREMEMIND

<http://www.xtrememind.com/>

A small pail is used for the mold. Spray the inside of the pail with Pam cooking oil or WD-40 if you wish to remove the pail afterwards.



Mix the resin according to instructions and pour a little into the pail, then start adding the crystals and metal shavings in layers as you continue to pour the resin (to whatever thickness you wish). Save a few crystals to place into the top layer as it starts to cure.



After it hardens, place the four coiled quartz crystals in the top of the four copper pipes and its done.

Remember, throughout the process you must use your intent and payers to program the creation to make it work. No guarantees are made; each person might get different Results. Intent is a big part of the success of this device.

"If people behaved like governments, you'd call the cops."

- Kelvin Throop



<http://www.keelynet.com/>

The Harpooner

To make the HAARPOONER, You need to make two coils.



The Beehive coil is made from 3/8" ID flexible copper refrigerator tubing. Bend the coil into the shape of half of a beehive. Use Clockwise turns.



The coil that goes in the inside of the beehive coil is made from 3/8" OD flexible copper refrigerator tubing. This coil is bent counter clockwise.

Wizzers Workshop Personal Bioenergy Tools - Orgone Matrix Material Ergonite Organite Organite - Construction info & sales- Radionics Stations -Mobius Coils - EM Pollution Control - DIY Plans & More!

<http://www.littlemountainsmudge.com/>

Insert the smaller coil into the larger beehive coil. Connect the two coils by a large sleeve and solder the sleeve, or solder the two coils directly together. At this point, it should look like this:



Start by making a large SBB coil that is 20.6" Long (Sacred Geometry discovered by Slim Spurling.)

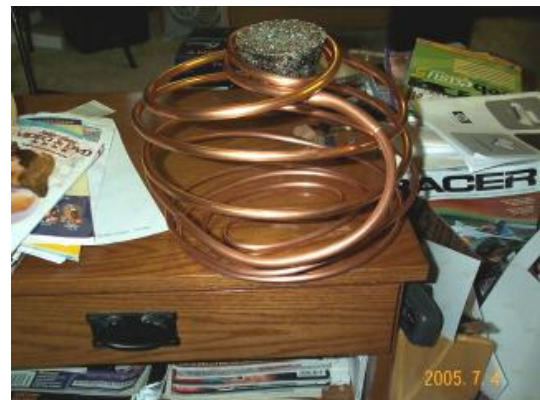

Use a small coffee can for the inner coil pour if desired and pour the base in 2 steps (one for each of the tubing coils), or use a larger container for the mold and do one pour for the whole base.



Make two large (Texas) muffin – sized orgonite castings, using activated charcoal in the mix, along with the other ingredients used in the base. One muffin is placed in the small coil, and the other is placed in the large outer coil.



Place the Smaller coil inside / on top of the larger coil and you're done.

©Alan D Otterson 2005/2007

For more info or to check for updates, visit <http://supercoil.blogspot.com/> and look for Alan's 'Atomiccoil' to be presented in the next issue of Modern Orgone.

TOC

Note to self

(From an Aussie)

Be sure and cancel your credit cards before you die!
This is so priceless and so easy to see happening - customer service, being what it is today!

A lady died this past January, and ANZ bank billed her for February and March for their annual service charges on her credit card, and then added late fees and interest on the monthly charge. The balance had been \$0.00, now is somewhere around \$60.00.

A family member placed a call to ANZ:

Family Member: "I am calling to tell you that she died in January."

ANZ: "The account was never closed and the late fees and charges still apply."

Family Member: "Maybe, you should turn it over to collections."

ANZ: "Since it is two months past due, it already has been."

Family Member: So, what will they do when they find out she is dead?"

ANZ: "Either report her account to the frauds division or report her to the credit bureau, maybe both!"

Family Member: "Do you think God will be mad at her?"

ANZ: "Excuse me?"

Family Member: "Did you just get what I was telling you . . . the part about her being dead?"

ANZ: "Sir, you'll have to speak to my supervisor."

Supervisor gets on the phone:

Family Member: "I'm calling to tell you, she died in January."

ANZ: "The account was never closed and the late fees and charges still apply."

Family Member: "You mean you want to collect from her estate?"

ANZ: (Stammer) "Are you her lawyer?"

Family Member: "No, I'm her great nephew." (Lawyer info given)

ANZ: "Could you fax us a certificate of death?"

Family Member: "Sure." (fax number is given)

After they get the fax:

ANZ: "Our system just isn't set up for death. I don't know what more I can do to help."

Family Member: "Well, if you figure it out, great! If not, you could just keep billing her. I don't think she will care."

ANZ: "Well, the late fees and charges do still apply."

Family Member: "Would you like her new billing address?"

ANZ: "That might help."

Family Member: "Rookwood Memorial Cemetery, 1249 Centenary Rd, Sydney Plot Number 69."

ANZ: "Sir, that's a cemetery!"

Family Member: "What do you do with dead people on your planet?"

-----Courtesy RaveOn-----



Orgone helps flowers grow



Exactly 24 hours after installing the Genesa Crystal This Gold Finch Roosted on it.



Animals love Orgone



Animals Drink and Bathe in the Organized Water, Plants and Trees also benefit



Orgone Water Makes the Birds Sing!

I've added a Genesa Crystal to the VOD Fountain. Wow, What Energy!



Copyright
Alan Otterson 2005-2007

Politics of Free Will

Had Enough? [TOC](#)

By Lee Iacocca with Catherine Whitney

Excerpted from "[Where Have All the Leaders Gone?](#)" Copyright © 2007 by Lee Iacocca. All rights reserved.

Forward Courtesy Janis Dolnick and [Sean Sands](#)

Am I the only guy in this country who's fed up with what's happening? Where the hell is our outrage? We should be screaming bloody murder. We've got a gang of clueless bozos steering our ship of state right over a cliff, we've got corporate gangsters stealing us blind, and we can't even clean up after a hurricane much less build a hybrid car. But instead of getting mad, everyone sits around and nods their heads when the politicians say, "Stay the course." Stay the course? You've got to be kidding. This is America, not the damned Titanic. I'll give you a sound bite: Throw the bums out!

You might think I'm getting senile, that I've gone off my rocker, and maybe I have. But someone has to speak up. I hardly recognize this country anymore. The President of the United States is given a free pass to ignore the Constitution, tap our phones, and lead us to war on a pack of lies. Congress responds to record deficits by passing a huge tax cut for the wealthy (thanks, but I don't need it). The most famous business leaders are not the innovators but the guys in handcuffs. While we're fiddling in Iraq, the Middle East is burning and nobody seems to know what to do. And the press is waving pom-poms instead of asking hard questions. That's not the promise of America my parents and yours traveled across the ocean for. I've had enough. How about you?

I'll go a step further. You can't call yourself a patriot if you're not outraged. This is a fight I'm ready and willing to have.

My friends tell me to calm down. They say, "Lee, you're eighty-two years old. Leave the rage to the young people." I'd love to as soon as I can pry them away from their iPods for five seconds and get them to pay attention. I'm going to speak up because it's my patriotic duty. I think people will listen to me. They say I have a reputation as a straight shooter. So I'll tell you how I see it, and it's not pretty, but at least it's real. I'm hoping to strike a nerve in those young folks who say they don't

vote because they don't trust politicians to represent their interests. Hey, America, wake up. These guys work for us.

Who Are These Guys, Anyway?

Why are we in this mess? How did we end up with this crowd in Washington? Well, we voted for them, at least some of us did. But I'll tell you what we didn't do. We didn't agree to suspend the Constitution. We didn't agree to stop asking questions or demanding answers. Some of us are sick and tired of people who call free speech treason. Where I come from that's a dictatorship, not a democracy.

And don't tell me it's all the fault of right-wing Republicans or liberal Democrats. That's an intellectually lazy argument, and it's part of the reason we're in this stew. We're not just a nation of factions. We're a people. We share common principles and ideals. And we rise and fall together. Where are the voices of leaders who can inspire us to action and make us stand taller? What happened to the strong and resolute party of Lincoln? What happened to the courageous, populist party of FDR and Truman? There was a time in this country when the voices of great leaders lifted us up and made us want to do better. Where have all the leaders gone? The Test of a Leader

I've never been Commander in Chief, but I've been a CEO. I understand a few things about leadership at the top. I've figured out nine points-not ten (I don't want people accusing me of thinking I'm Moses). I call them the "Nine Cs of Leadership." They're not fancy or complicated. Just clear, obvious qualities that every true leader should have. We should look at how the current administration stacks up. Like it or not, this crew is going to be around until January 2009. Maybe we can learn something before we go to the polls in 2008. Then let's be sure we use the leadership test to screen the candidates who say they want to run the country. It's up to us to choose wisely.

So, here's my C list:

A leader has to show CURIOSITY. He has to listen to people outside of the "Yes, sir" crowd in his inner circle. He has to read voraciously, because the world is a big, complicated place. George W. Bush brags about never reading a newspaper. "I just scan the headlines," he says. Am I hearing this right? He's the President of the United States and he never reads a news-paper? Thomas Jefferson once said, "Were it left to me to decide whether we should have a government without news-papers, or

newspapers without a government, I should not hesitate for a moment to prefer the latter.” Bush disagrees. As long as he gets his daily hour in the gym, with Fox News piped through the sound system, he’s ready to go.

If a leader never steps outside his comfort zone to hear different ideas, he grows stale. If he doesn’t put his beliefs to the test, how does he know he’s right? The inability to listen is a form of arrogance. It means either you think you already know it all, or you just don’t care. Before the 2006 election, George Bush made a big point of saying he didn’t listen to the polls. Yeah, that’s what they all say when the polls stink. But maybe he should have listened, because 70 percent of the people were saying he was on the wrong track. It took a “thumping” on election day to wake him up, but even then you got the feeling he wasn’t listening so much as he was calculating how to do a better job of convincing everyone he was right.

A leader has to be CREATIVE, go out on a limb, be willing to try something different. You know, think outside the box. George Bush prides himself on never changing, even as the world around him is spinning out of control. God forbid someone should accuse him of flip-flopping. There’s a disturbingly messianic fervor to his certainty. Senator Joe Biden recalled a conversation he had with Bush a few months after our troops marched into Baghdad. Joe was in the Oval Office outlining his concerns to the President – the explosive mix of Shiite and Sunni, the disbanded Iraqi army, the problems securing the oil fields. “The President was serene,” Joe recalled. “He told me he was sure that we were on the right course and that all would be well. ‘Mr. President,’ I finally said, ‘how can you be so sure when you don’t yet know all the facts?’” Bush then reached over and put a steady hand on Joe’s shoulder. “My instincts,” he said. “my instincts.” Joe was flabbergasted. He told Bush, “Mr. President, your instincts aren’t good enough.” Joe Biden sure didn’t think the matter was settled. And, as we all know now, it wasn’t.

Leadership is all about managing change whether you’re leading a company or leading a country. Things change, and you get creative. You adapt. Maybe Bush was absent the day they covered that at Harvard Business School.

A leader has to COMMUNICATE. I’m not talking about running off at the mouth or spouting sound bites. I’m talking about facing reality and telling the truth. Nobody in the current administration seems

to know how to talk straight anymore. Instead, they spend most of their time trying to convince us that things are not really as bad as they seem. I don’t know if it’s denial or dishonesty, but it can start to drive you crazy after a while. Communication has to start with telling the truth, even when it’s painful. The war in Iraq has been, among other things, a grand failure of communication. Bush is like the boy who didn’t cry wolf when the wolf was at the door. After years of being told that all is well, even as the casualties and chaos mount, we’ve stopped listening to him.

A leader has to be a person of CHARACTER. That means knowing the difference between right and wrong and having the guts to do the right thing. Abraham Lincoln once said, “If you want to test a man’s character, give him power.” George Bush has a lot of power. What does it say about his character? Bush has shown a willingness to take bold action on the world stage because he has the power, but he shows little regard for the grievous consequences. He has sent our troops (not to mention hundreds of thousands of innocent Iraqi citizens) to their deaths for what? To build our oil reserves? To avenge his daddy because Saddam Hussein once tried to have him killed? To show his daddy he’s tougher? The motivations behind the war in Iraq are questionable, and the execution of the war has been a disaster. A man of character does not ask a single soldier to die for a failed policy.

A leader must have COURAGE. I’m talking about balls. (That even goes for female leaders.) Swagger isn’t courage. Tough talk isn’t courage. George Bush comes from a blue-blooded Connecticut family, but he likes to talk like a cowboy. You know, my gun is bigger than your gun. Courage in the twenty-first century doesn’t mean posturing and bravado. Courage is a commitment to sit down at the negotiating table and talk.

If you’re a politician, courage means taking a position even when you know it will cost you votes. Bush can’t even make a public appearance unless the audience has been handpicked and sanitized. He did a series of so-called town hall meetings last year, in auditoriums packed with his most devoted fans. The questions were all softballs.

To be a leader you’ve got to have CONVICTION—a fire in your belly. You’ve got to have passion. You’ve got to really want to get something done. How do you measure fire in the belly? Bush has set the all-time record for number

of vacation days taken by a U.S. President – four hundred and counting. He'd rather clear brush on his ranch than immerse himself in the business of governing. He even told an interviewer that the high point of his presidency so far was catching a seven-and-a-half-pound perch in his hand-stocked lake.

It's no better on Capitol Hill. Congress was in session only ninety-seven days in 2006. That's eleven days less than the record set in 1948, when President Harry Truman coined the term "do-nothing Congress." Most people would expect to be fired if they worked so little and had nothing to show for it. But Congress managed to find the time to vote itself a raise. Now, that's not leadership.

A leader should have CHARISMA. I'm not talking about being flashy. Charisma is the quality that makes people want to follow you. It's the ability to inspire. People follow a leader because they trust him. That's my definition of charisma. Maybe George Bush is a great guy to hang out with at a barbecue or a ball game. But put him at a global summit where the future of our planet is at stake, and he doesn't look very presidential. Those frat-boy pranks and the kidding around he enjoys so much don't go over that well with world leaders. Just ask German Chancellor Angela Merkel, who received an unwelcome shoulder massage from our President at a G-8 Summit. When he came up behind her and started squeezing, I thought she was going to go right through the roof.

A leader has to be COMPETENT. That seems obvious, doesn't it? You've got to know what you're doing. More important than that, you've got to surround yourself with people who know what they're doing. Bush brags about being our first MBA President. Does that make him competent? Well, let's see. Thanks to our first MBA President, we've got the largest deficit in history, Social Security is on life support, and we've run up a half-a-trillion-dollar price tag (so far) in Iraq. And that's just for starters. A leader has to be a problem solver, and the biggest problems we face as a nation seem to be on the back burner.

You can't be a leader if you don't have COMMON SENSE. I call this Charlie Beacham's rule. When I was a young guy just starting out in the car business, one of my first jobs was as Ford's zone manager in Wilkes-Barre, Pennsylvania. My boss was a guy named Charlie Beacham, who was the East Coast regional manager. Charlie was a big Southerner, with a warm drawl, a huge smile, and a core of steel. Charlie used to tell me, "Remember,

Lee, the only thing you've got going for you as a human being is your ability to reason and your common sense. If you don't know a dip of horseshit from a dip of vanilla ice cream, you'll never make it." George Bush doesn't have common sense. He just has a lot of sound bites. You know Mr. they'll-welcome-us-as-liberators-no-child-left-behind-heck-of-a-job-Brownie-mission-accomplished Bush.

Former President Bill Clinton once said, "I grew up in an alcoholic home. I spent half my childhood trying to get into the reality-based world—and I like it here."

I think our current President should visit the real world once in a while.

The Biggest C is Crisis. Leaders are made, not born. Leader-ship is forged in times of crisis. It's easy to sit there with your feet up on the desk and talk theory. Or send someone else's kids off to war when you've never seen a battlefield yourself. It's another thing to lead when your world comes tumbling down.

On September 11, 2001, we needed a strong leader more than any other time in our history. We needed a steady hand to guide us out of the ashes. Where was George Bush? He was reading a story about a pet goat to kids in Florida when he heard about the attacks. He kept sitting there for twenty minutes with a baffled look on his face. It's all on tape. You can see it for yourself. Then, instead of taking the quickest route back to Washington and immediately going on the air to reassure the panicked people of this country, he decided it wasn't safe to return to the White House. He basically went into hiding for the day-and he told Vice President Dick Cheney to stay put in his bunker. We were all frozen in front of our TVs, scared out of our wits, waiting for our leaders to tell us that we were going to be okay, and there was nobody home. It took Bush a couple of days to get his bearings and devise the right photo op at Ground Zero.

That was George Bush's moment of truth, and he was paralyzed. And what did he do when he'd regained his composure? He led us down the road to Iraq, a road his own father had considered disastrous when he was President. But Bush didn't listen to Daddy. He listened to a higher father. He prides himself on being faith based, not reality based. If that doesn't scare the crap out of you, I don't know what will.

A Hell of a Mess

So here's where we stand. We're immersed in a bloody war with no plan for winning and no plan for leaving. We're running the biggest deficit in the history of the country. We're losing the manufacturing edge to Asia, while our once-great companies are getting slaughtered by health care costs. Gas prices are skyrocketing, and nobody in power has a coherent energy policy. Our schools are in trouble. Our borders are like sieve s. The middle class is being squeezed every which way. These are times that cry out for leadership.

But when you look around, you've got to ask: "Where have all the leaders gone?" Where are the curious, creative communicators? Where are the people of character, courage, conviction, competence, and common sense? I may be a sucker for alliteration, but I think you get the point.

Name me a leader who has a better idea for homeland security than making us take off our shoes in airports and throw away our shampoo? We've spent billions of dollars building a huge new bureaucracy, and all we know how to do is react to things that have already happened.

Name me one leader who emerged from the crisis of Hurricane Katrina. Congress has yet to spend a single day evaluating the response to the hurricane, or demanding accountability for the decisions that were made in the crucial hours after the storm. Everyone's hunkering down, fingers crossed, hoping it doesn't happen again. Now, that's just crazy. Storms happen. Deal with it. Make a plan. Figure out what you're going to do the next time.

Name me an industry leader who is thinking creatively about how we can restore our competitive edge in manufacturing. Who would have believed that there could ever be a time when "the Big Three" referred to Japanese car companies? How did this happen and more important, what are we going to do about it?

Name me a government leader who can articulate a plan for paying down the debt, or solving the energy crisis, or managing the health care problem. The silence is deafening. But these are the crises that are eating away at our country and milking the middle class dry.

I have news for the gang in Congress. We didn't elect you to sit on your asses and do nothing and remain silent while our democracy is being hijacked and our greatness is being replaced with

mediocrity. What is everybody so afraid of? That some bobblehead on Fox News will call them a name? Give me a break. Why don't you guys show some spine for a change?

Had Enough?

Hey, I'm not trying to be the voice of gloom and doom here. I'm trying to light a fire. I'm speaking out because I have hope. I believe in America. In my lifetime I've had the privilege of living through some of America's greatest moments. I've also experienced some of our worst crises - the Great Depression, World War II, the Korean War, the Kennedy assassination, the Vietnam War, the 1970s oil crisis, and the struggles of recent years culminating with 9/11. If I've learned one thing, it's this: You don't get anywhere by standing on the sidelines waiting for somebody else to take action. Whether it's building a better car or building a better future for our children, we all have a role to play. That's the challenge I'm raising in this book. It's a call to action for people who, like me, believe in America. It's not too late, but it's getting pretty close. So let's shake off the horseshit and go to work. Let's tell 'em all we've had enough.

Excerpted from "Where Have All the Leaders Gone?" Copyright © 2007 by Lee Iacocca. All rights reserved.

Forward Courtesy Janis Dolnick and [Sean Sands](#)



<http://www.item-bioenergy.com/>

Internet Doomsday Creeps Closer [TOC](#)

Big government pushes for total taxation and restriction on the last great outpost of free speech

© [Steve Watson Infowars.net](#)

Monday, June 4, 2007

Recent proposals in the U.S. Congress are taking a huge swipe at freedom in America once again by aiming to impose multiple different forms of crippling taxation and restriction on users of the internet.

State and local governments this week resumed a push to lobby Congress for far-reaching changes on two different fronts: gaining the ability to impose sales taxes on Net shopping, and being able to levy new monthly taxes on DSL and other Internet-service connections. One senator is even predicting taxes on e-mail, [reports CNet](#).

Several bills were introduced last week that could see all manner of new forms of internet taxation become a reality before the end of the year.

Sen. Michael Enzi, a Wyoming Republican, [introduced a bill](#) (PDF link) for mandatory sales tax collection for Internet purchases, meaning that if you buy items through online sites like eBay or Amazon.com, you might have to start paying additional sales taxes on your purchases.

The [Libertarian party has warned](#) that the bill represents more big government intervention and that while Enzi insists the bill “would not increase taxes,” the Sales Tax Fairness and Simplification Act would open the door for states to charge sales tax on Internet sales. In contrast to his statement, the [C-Net article](#) states that Enzi warned that other taxes may zoom upward if his “mandatory sales tax collection” bill isn’t passed.

In a second and separate proposal during a House of Representatives hearing last week, politicians weighed whether to let a temporary ban on [internet access taxes](#) lapse when it expires on November 1. Such a move would leave open the possibility that simply using the internet would require a tax to be paid which critics suggest could sound a death knell for broadband, DSL and “always on” high speed internet.

Rep. Hank Johnson, a Democrat from Georgia compared the move to taxing people for simply entering shopping malls or libraries. With the U.S. economy already under considerable strain, taking a huge swipe at e-commerce, one of its cornerstones, seems like the worst possible thing Congress could do.

Furthermore, allowing taxation on internet access represents a slippery slope towards opening up the possibilities of taxing all kinds of internet based services.

“They might say, ‘We have no interest in having taxes on e-mail,’ but if we allow the prohibition on Internet taxes to expire, then you open the door on cities and towns and states to tax e-mail or other

aspects of Internet access,” said Sen. John Sununu, a New Hampshire Republican.

An email tax would certainly suit both the government and internet providers who would likely get a cut. Last year it was revealed that [AOL is planning to charge](#) mass-mailers a fee to avoid the ISP’s spam filters and guarantee that their marketing emails arrive straight in AOL subscribers’ inboxes. [Yahoo!](#) is also endorsing the scheme.

Under such a system email considered “uncertified” would risk running through AOL and Yahoo!’s discrimination process. And as this potential profit center for the two net giants takes off, there’s no incentive for either company to deliver the “free email” - and every incentive for them to get the world conditioned to paying for guaranteed delivery.

A [United Nations agency also proposed](#) in 1999 the idea of a 1-cent-per-100-message tax, indicating that the idea has been floating around for almost a decade.

In recent months, a chorus of propaganda intended to demonize the Internet and further lead it down a path of strict control has spewed forth from numerous establishment organs:

- [Time magazine reported](#) last month that researchers funded by the federal government want to shut down the internet and start over, citing the fact that at the moment there are loopholes in the system whereby users cannot be tracked and traced all the time. The projects echo moves we have previously reported on to clamp down on [internet neutrality](#) and even to designate a new form of the internet known as [Internet 2](#).
- In a display of bi-partisanship, there have recently been calls for [all out mandatory ISP snooping](#) on all US citizens by both Democrats and Republicans alike.
- Republican Senator [John McCain recently tabled a proposal](#) to introduce legislation that would fine blogs up to \$300,000 for offensive statements, photos and videos posted by visitors on comment boards. It is well known that [McCain has a distaste](#) for his blogosphere critics, causing a definite conflict of interest where any proposal to restrict blogs on his part is concerned.
- During an appearance with his wife Barbara on Fox News last November, [George Bush senior](#) slammed Internet bloggers for creating an “adversarial and ugly climate.”

- The White House's own recently [de-classified strategy](#) for "winning the war on terror" targets Internet conspiracy theories as a recruiting ground for terrorists and threatens to "diminish" their influence.
- The Pentagon recently announced its effort to [infiltrate the Internet and propagandize](#) for the war on terror.
- In a speech last October, Homeland Security director [Michael Chertoff identified the web as a "terror training camp,"](#) through which "disaffected people living in the United States" are developing "radical ideologies and potentially violent skills." His solution is "intelligence fusion centers," staffed by Homeland Security personnel which will go into operation next year.
- The U.S. Government [wants to force bloggers](#) and online grassroots activists to register and regularly report their activities to Congress. Criminal charges including a possible jail term of up to one year could be the punishment for non-compliance.
- A landmark legal case on behalf of the Recording Industry Association of America and other global trade organizations seeks to [criminalize all Internet file sharing](#) of any kind as copyright infringement, effectively shutting down the world wide web - and their argument is supported by the U.S. government.
- A landmark legal ruling in Sydney goes further than ever before in setting the trap door for the destruction of the Internet as we know it and the end of alternative news websites and blogs by creating the precedent that simply [linking to other websites is breach of copyright](#) and piracy.
- The European Union, led by former Stalinist and potential future British Prime Minister John Reid, has [also vowed](#) to shut down "terrorists" who use the Internet to spread propaganda.
- The EU data retention bill, passed last year after much controversy and with implementation tabled for late 2007, obliges telephone operators and internet service providers to store information on who called who and who emailed who for at least six months. Under this law, investigators in any EU country, and [most bizarrely even in the US](#), can access EU citizens' data on phone calls, sms', emails and instant messaging services.
- The EU also recently proposed legislation that would prevent users from [uploading any form of video](#) without a license.
- The US government is also funding research into social networking sites and how to gather and store personal data published on them, according to the [New Scientist magazine](#). "At the

same time, US lawmakers are attempting to force the social networking sites themselves to control the amount and kind of information that people, particularly children, can put on the sites."

www.infowars.net

The true story behind government sponsored terror, 7/7, Gladio and 9/11, [get Terror Storm!](#)

Let us help you reach a huge audience of potential customers. Help support the website and take advantage of low advertising rates. [Click here](#) for more info.

The development of a new form of internet with new regulations is also designed to create an online caste system whereby the old internet hubs would be allowed to break down and die, forcing people to use the new taxable, censored and regulated world wide web.

Make no mistake, the internet, one of the greatest outposts of free speech ever created is under constant attack by powerful people who cannot operate within a society where information flows freely and unhindered. Both American and European moves mimic stories we hear every week out of State Controlled Communist China, where the internet is strictly regulated and virtually exists as its own entity away from the rest of the web.

The Internet is freedom's best friend and the bane of control freaks. Its eradication is one of the short term goals of those that seek to centralize power and subjugate their populations under a surveillance panopticon prison.

© [Steve Watson](#)
[Infowars.net](http://www.infowars.net)

[XTREMEMIND](http://www.xtrememind.com/)
<http://www.xtrememind.com/>



So, the focus of everything we ever learned in history class was immaterial and irrelevant; the facts may be accurate but as you'll see later, facts are immaterial; all that matters is honour/dishonour, contract, and credit/debit.

We are entrenched in a game of commerce about which we have been kept in the dark for the purpose of our slavery. There may be a few centuries in the history of the world which were not about commerce, but certainly the past two millennia have been for the purpose of enslaving the masses for the profits and lifestyles of the global elite. It is nearly completely in place.

Mary Elizabeth Croft

I want either less corruption or more chance to participate in it.

Ashleigh Brilliant

“Do not believe on the strength of traditions even if they have been held in honour for many generations and in many places; do not believe anything because many people speak of it; do not believe on the strength of sages of old times; do not believe that which you have yourselves imagined, thinking that a god has inspired you. Believe nothing which depends only on the authority of your masters or of priests.

After investigation, believe that which you have yourselves tested and found reasonable, and which is for your good and that of others.”

Buddah



courtesy [RaveOn](#)

New Paradigm Consciousness

Chemtrails - Facts, Plagiarism, And Propaganda

By Margareta- Erminia Cassani

margareta-erminia.cassani@worldnet.att.net

6-18-00 [TOC](#)

From [Rense.com](#)

Note – This article appears on Rense.com. While this article in IMO rather Biased, it is worth a read in the interests of both being balanced in one’s perspective, as well as being in possession of the facts regarding who said what when. There are Two comments following this article, rebuttals from Ken Adachi and Matt Ridgeway. Please understand that this article is reprinted here under the heading of ‘food for thought’, and form your own opinions. It is my experience that both the ‘official’ academic community and the ‘conspiracy’ community are heavily biased, and often it is necessary to view the points put forward by both sides in order to be informed in the best manner possible. – Editor

I am a health and medicine journalist/author/editor for over 20 years. Since November 1998, I have been working on the health aspects of some biological material ejected from low-flying planes. These incidents involved houses splattered with a reddish-brown gel. After a friend had heard Will Thomas’ initial interview on Art Bell’s show in February 1999, we thought my investigation might be related to Mr. Thomas’ investigation of unusual-appearing contrail activity, so I contacted him with information about what I was working on and we agreed to join forces as partners/colleagues and jointly publish our findings together. Since that time, I have contributed information to Will’s investigation in the form of health/medical research into what possibly could be contained in the contrails that might be adversely affecting the health of people exposed to them. I also shared with Will the laboratory analysis of the samples I collected from these homes covered with the red-brown gel.

In April 1999, Will Thomas and I jointly authored an article, Sky Samples Analyzed for the Environmental News Service in which some details of our (then) current investigation were published. Subsequent to that, Will Thomas has also authored articles by himself, either on his website or other places, with contributions by myself regarding

health/medical facts surrounding both the “high altitude” phenomenon, i.e. contrail/Chemtrails, and my own ongoing research into what we came to refer to as the “low level” aerial phenomenon, i.e., residential houses splattered by low-flying planes with the above-mentioned reddish gel material. However, since the publication of Sky Samples Analyzed et al, I have seen numerous Chemtrails-related articles created by a number of people appear on Sightings and other web sites across the Internet. More and more I am greatly disturbed by the “cut, paste and plagiarize” fashion of putting together these articles that take bits and pieces out of Will Thomas’ and my articles and rearranging them into an incredible hodgepodge of confusing, and just plain wrong, information. To make matters worse, these “cut and paste” articles blur the facts with pure fantasy and agenda-pandering, and lately some very dangerous propaganda which I do not want my name or work associated with. I feel VERY responsible for the effect that the misappropriation of my information has had on an increasingly scared public who are looking for FACTS regarding what is happening in our skies, in our air, water and land. Unfortunately, when they read these “cut and paste” jobs they, for the most part, get only far-fetched anecdotes (how about worms small enough to crawl out of human skin pores yet have “ visible teeth?) or agenda-selling rhetoric or downright propaganda. It is for this reason that I wrote this article for Sightings, to set straight the facts of the information I contributed to the Chemtrails research and to disentangle my work and name from those who want to peddle their own agendas, using the contrail issue as their vehicle to do so, and especially those who want to promote and distribute ancient, extremely inflammatory, White Supremacist propaganda using Chemtrails research as the signatory which I will discuss later in this article.

I have stayed out of public view for the last 1-1/2 years because I preferred to work in relative anonymity while looking for the answers to the strange questions that this investigation posed very early on. As a writer/author, when the public spotlight is on you, many times “red herrings” get thrown into the mix by various people who either want to throw you off the correct path or tie your work into their specific agendas that they then want you to champion as a quasi-spokesperson. In addition, I simply did not want my research distorted and/or pre-emptively “borrowed” from other journalists looking for an interesting story to latch onto.

It becomes immediately apparent to me, when reading these “cut and paste” articles and seeing my information turned around so badly, that the author/s of these creations understand very little of what they are conveying to an answer-seeking public. This is most apparent in the information regarding the laboratory samples that I personally collected and shared the results with Will Thomas which appeared in our joint article and his subsequent articles. Many times, I have seen a word-for-word plagiarism of our (Will Thomas’ and mine) work, simply re-arranging words and sentences from our original text and creating wholly different contexts with their new arrangements while taking the liberty to add either their own misunderstanding, or just plain confabulation, resulting in gross distortions of the original facts. Not only do they misrepresent, massage and manipulate facts of the info the “borrow”, but they never attribute any of the information contained in them as coming from either Will Thomas or myself. One would get the idea, from reading one of these “cut and paste” articles, that they were the author’s original thoughts and ideas judging by the lack of documentation or attribution to any source.

In these articles, for the most part, the reader generally gets beat over the head with the impression that United States citizens (even though other countries are experiencing this phenomenon as well) are being either chemically experimented on by the United States government/military and/or are being “culled”, i.e. killed, by the United States government/military. It is very frustrating for me to see the laboratory samples that I had analyzed in a reputable environmental biology lab near where I live, which I hold the test results on, and know full well what disease entities they are capable of causing, be cited as the basis of this “cull” theory. These misconceptions, and distortion of the facts, I believe, stem, in part, from the idea that people apparently believe that the samples mentioned in Sky Samples Analyzed came out of contrail aerosol and that the “Chemtrails” are disease-producing bug and chemical sprays unleashed on the United States. Let me state, unequivocally, for the record here, my samples referred to in Sky Samples Analyzed DID NOT come out of contrail aerosol. To date, no laboratory samples have been taken from contrail aerosol, although gathering sampling data from contrails is still trying to be done. It was stated in Sky Samples Analyzed that these laboratory samples were taken from material dropped or jettisoned from “low-flying planes”, but apparently that terminology was too vague, and

when the text of that article was printed it was wrapped around photographs of contrails, so it is at least understandable, however, wrong, that many people inferred that the samples spoken of in that article came out of contrails. This could not be further from the truth. The samples were taken from residential homes splattered with the aforementioned biological “goo. Since Sky Samples Analyzed and subsequent articles by Will Thomas that contained similar information regarding these lab samples, the “cut and paste” doctors have stretched and stressed the limits and capabilities of these God-made organisms to make their Procrustean bed arguments that our government has cooked up these bizarre biological concoctions in some research laboratory somewhere and are loading them into military jet fuel systems and “spraying” everyone, via contrails, with deadly bugs, viruses, and other cancer-causing chemicals, with the express purpose of killing people, specifically old people and ill people. Or, that these organisms are somehow used to “change around human DNA” which somehow shuts down our neurological systems, making us confused, dizzy, disoriented, dysphasic, and therefore more susceptible to New World Order takeover by United Nations factions. This occurs most frequently in the misunderstanding, hence, misuse of the term restriction enzyme - a term that appeared in the results of my early laboratory samples. See What is a Restriction Enzyme? further in this article for a detailed description of what these organisms are, and what they are biologically capable of. They have nothing to do with the Frankenstein’s monster-type genetic manipulation that some of these cut and paste authors are proposing. I have to say, I feel like the farmer who came to the city when I read these way out in left field scenarios that people have fantasized using my laboratory information as proof.

Interestingly, none of these “authors” explain how laying bug and chemical laden Chemtrails dispersed at high altitudes will accomplish a “cull” or a “mind-control” feat without affecting the rest of the population and/or the perpetrators themselves. Spraying bugs and chemicals at these high altitudes, how do you discern what type of citizen will get hit with what? How do you control the hit? They cite weakened immune systems that occur primarily in the aged and the ill which apparently will determine who lives and dies in this doomsday scenario. I have news for everyone - breathing in bugs and chemicals are going to weaken everyone’s immune systems, even the people doing the spraying, and those doing the

planning of said spraying, so that no one would escape a “cull” scenario such as the ones proposed by these authors. Or is this a Jonestown mass homicide/ suicide CIA mind control experiment on a grander scale? I don’t think so.

Most of us know by now that our United States government, along with some aiding and abetting by our United States Military, performed several open-air bacteriological, chemical and even LSD experiments on unsuspecting American citizens and soldiers. Our CIA also funded research on Canadian territory to do the same and worse, re the mind control experiments of Dr. Ewen Cameron at Ravenscroft, in Montreal. However, knowing that history should not automatically imply that this type of experimentation is necessarily, then, the basis of Chemtrails activity. If we were jurors in a trial, we would be convicting a case based on precedent and what could be the truth rather than what is the truth by examining the facts. To date, no facts support this theory. No CREDIBLE source has come forward to acknowledge that this type of experimental activity is at the core of Chemtrails activity. No one. If anyone out there has information to the contrary, please come forward. Besides, the “cull” theory is just plain illogical in a huge market economy such that the United States is - an economy that depends on lots of warm bodies, old, young, ill, and otherwise, to keep the wheels of Wall Street rolling along. Wall Street, et al, Bilderbergers would not tolerate this scenario, because even if they had no social conscience towards it, they would start losing money and none of them wants that. The stock market would suffer badly. I think all serious Chemtrail researchers should just forget this one and quit scaring the poor senior citizens and chronically ill into heart attacks or committing suicide or homicide out of depression and/or anger brought on by the public airing of these scenarios. It’s a socially irresponsible idea to throw out there without any more evidence or data to back it up other than the lab samples I (and several other people) volunteered to Chemtrails research.

Ironically, what is seriously affecting the health of our older people, the chronically ill, and the very young, in this country, which is getting pooh-pooh’d by many Chemtrail trackers and workers, is a growing environmental fungal infestation problem that can and will take hold of weakened immune systems and bring them down much faster, I would add, than any overhead aerial spraying program could. More on this in my Brief Conclusions later in this article.

Several other theories proposed in these Chemtrails “cut and pastes” which use cite specific organisms found in my laboratory samples as some sort of empirical proof include:

1. The military is trying to “own” the weather. I have seen it stated many times in these articles that some of the organisms contained in the lab samples I collected from low flying planes, NOT contrail aerosol, are organisms that the US Military has hundreds of patents on, and therefore are proof that they are spraying these organisms in the air to facilitate defense-based weather modification programs. That’s a big leap - to nowhere. The US Army stockpiles a lot of biological material for bioremediation purposes, specifically *Pseudomonas fluorescens* and *Aureobasidium pullans* (two of the organisms contained in my samples), one which eats fuel and oil spills and the other is used in creating certain vinyl products (amongst other things). We could not have cleaned up Exxon Valdez if not for the God-made organism *Pseudomonas fluorescens* for it thrives on fuel and oil. In the numerous patents I researched that are listed on the DOD’s website, regarding *Pseudomonas fluorescens*, bioremediation was the objective of these patents, not weather modification, or even human illness. The Exxon Valdez oil spill, et al, are more toxic to the environment and the ecosystem than *Pseudomonas fluorescens* would ever be. People seem to forget, these organisms are NOT manufactured in a laboratory somewhere, they exist in nature. Yes, they can be pathogens to man under certain conditions, but I do not believe they, specifically, are the culprits in the numerous upper respiratory, et al, illnesses people are suffering. Rather, I believe that, in synergy with the over-abundance of fungal organisms present in our environment for the last decade, and dramatically increasing over the last 18 months (a time factor of critical significance), the power of these organisms to cause more serious infections in the human population has strengthened.

I have no doubt that the US Military and other governmental defense agencies are experimenting with weather modification to facilitate defense programs. The HAARP program is one such defense project which, basically stated, manipulates the ionosphere to become a shield that would deflect incoming missiles from entering our country if, suddenly, our global “trading buddies” decide they don’t want to play Monopoly with us anymore and would rather just take us off the playing board completely. How these particular organisms I (or

others) collected would function in a weather-mod scenario has never been explained in these cut and paste articles, but I can’t see that they would contribute anything substantial to this effort. Perhaps, they might act as bioremediation agents in keeping the upper atmosphere “clean” of jet fuel combustion products that would further weaken the ozone layer and thus, perhaps affect the stability of the upper ionosphere, hence, affecting the stability of the “shield”, but other than that, I think they would be of limited value. Granted, the argument could be made that these organisms sprayed in the air for purpose of defense-based weather modification are making people sick when they ultimately fall to Earth and into our breathing space. Could that account for the rise in respiratory flu, bronchitis, pneumonia? The chances of that are very slim as they would have to be some very hardy strains as the exposure to UV rays and cold temperatures at contrail appearing altitudes would render most, if not all, of these organisms harmless by the time they fell down far enough for us to breathe them in. Therefore, the fact that some laboratory samples of gel-material were taken from houses is a very weak foundation to support the idea that the US DOD is injecting organisms into the atmosphere to assist in weather modification and that is what is making people ill. I do not believe that weather modification, and the use of biological organisms to facilitate that goal, is the specific objective of the unusual contrail activity. It certainly could be an unintended by-product of it, or part of a two-fold program, which I will get to in my conclusions, but I do not feel it is its primary intention

2. Another theory I have seen taken in Chemtrails cut and paste articles making use of my lab samples analysis as evidence is the Alien Connection, i.e. aliens are procuring our atmosphere with biological materials to make it a habitable place for them to live as their planet is dying. Even The Star and The Globe rumor rags have run stories of how UFO’s are responsible for splattering brownish-goo on residential roof-tops as far away as London, England. How any one on Earth knows this alien agenda is interesting to ponder and why these aliens would want to come to our environmentally damaged planet on the brink of disaster when they could find some pristine place in God’s infinite universe is beyond me too. Or are they coming here to help us in a time of environmental crisis? In any case, I would wager that aliens would not be using US and/or UN military-type antiquated aerial machinery to accomplish their goal. Sorry, but this

proposal is just a little out there - like past Pluto, and therefore I won't spend much time here.

3. The other less strange and even more credible theory is mass inoculation of American citizens against biological/chemical warfare via aerial dispersal of antigens that might protect us from anthrax, smallpox, or botox, or? Like the global defense theory, mass inoculation has one of the best motives in the world - the United States is totally unprepared on a medical, clinical level to deal with bioterrorism. If we were to be hit by an aviary flu such as the one that infected scores of chickens and other fowl in China not too long ago, and developed the ability to "cross vector" from bird to human, a lot of human life would be lost because we simply do not have either the antigens or the antidotes developed yet to deal with such a crisis. Or, how about another virus recently on the scene, the West Nile, which seems to be exhibiting a very scary propensity lately of "jumping vector" between mammalian (human) and avian (bird) hosts with no intermediary animal host (i.e. pigs, cattle etc).

As recently as June 12, 2000, USA Today reported that several new deaths in the crow population have been confirmed to be from West Nile virus. This same virus had already killed 6 humans back in the fall of 1999, but had been responsible for hundreds of crow deaths at that time. These new crow deaths suggest that the West Nile virus did not die off, as was hoped, over the winter and may come back like a lion this summer when the temperatures start getting hotter and more humid. What does this scenario tell us? That the West Nile is, obviously, more devastating to birds than humans, for the time being. With six human deaths from this virus, the virus has already developed the capability to "jump vector". The question on every health official's mind should be will it now start mutating into a stronger species that can affect humans as devastatingly as it has the crows? If so, we are in big trouble and, quite frankly, could be in for an epidemic of a "flu-like" encephalitic syndrome the likes of the 1918 flu epidemic. And because it infects birds as well, disease containment would be very difficult, if not impossible, as birds could carry the virus hundreds of miles in all directions.

Or, how about a new strain of an old killer, i.e., smallpox (both of which have been developed as biowarfare agents in Russia, China, and perhaps Iraq) - Americans would go down so fast we wouldn't know what hit us. There is only a very small store of smallpox vaccine in this country and

some people necessarily would have to go without, i.e., not be inoculated. Possibly, you could take the existing stores of vaccine and dilute and then aerosolize them and disperse aerially to at least give cursory coverage to a greater group of people. However, in medical terms, cursory coverage equates to very weak coverage, although in an emergency it may be the best "shot" we have. Personally, I would rather have weak than none. In that scenario, an involuntary inhalational vaccine could be the answer, especially with a country of people now skeptical about any type of vaccinations and even military personnel refusing to take the traditional anthrax vaccinations. Even if Ted Koppel announced on ABC Nightly News that a biowarfare attack was imminent and it was imperative to their health to get one of these vaccines, there would simply be those in this country who would not volunteer for a traditional vaccine. These reluctant vaccinees would present an even bigger problem in disease containment control as one infected person can infect an entire community and the death toll could be devastating. The drawback to this method of inoculation is that unfortunately, to date, aerosol inhalational vaccinations have only successfully been developed to be directly sprayed into the nasal mucosal passages and thus function as a "first response" to incoming, inhaled bacterial/viral pathogens that can be caught and short-circuited in nasal cilia before they get to the lungs. Currently, this technology exists in the nasal flu vaccines that were put to use in the fall of 1999 at the outset of the flu season. Disseminating an inoculating antigen in the air, via mass spraying by airplanes, however, would most probably render the antigen/vaccine useless (especially in our polluted breathing air), unless certain protective polymer or protein coats were developed for the material to protect it from environmental damage on its way down. In the best case scenario, this method would still be highly unreliable and more than likely would be an incredible waste of time, money and resources. We do have the nanobomb technology now to greatly lessen the impact of biological attacks, but a nanobomb is only good where the agent is known to have been dropped. Nanobomb technology is progressing in development to being carried in a personal aerosol and sprayed directly into the nasal passages when the infecting agent is theorized or known to be inhaled. This could be very effective on the battlefield with soldiers in combat, but how many American citizens are going to know when they inhale a biological agent when going about their everyday routine? None, I would wager.

The organisms contained in the samples I collected are not viruses and they are not capable of becoming antigens to any viral based disease. There are some bacteria contained in the samples, however, not of the type and caliber to create any type of bacteriological immunity against such killer attacks as anthrax. Besides, the size and volume of the dropped material is reason enough to know that these particular samples are not part of any mass inoculation program involving inhalational organisms - they were not of respirable size, i.e. too big to be breathed in by any human pulmonary system. There does, however, exist the possibility that spores could have formed from the mold and fungal organisms contained in the samples which would be of respirable size. Learning what I have, over the last 1-1/2 years while working on this project, about the sharp rise in mold and fungal based diseases in the United States, and basically the world, I have wondered if the molds and fungus contained in my samples could possibly be canceling agents for other types of fungal organisms proliferating in the environment. That is to say, is it possible that spores from the molds and fungus in my samples could provide some type of immunity to other more infectious, fungal-based organisms? In my more optimistic moments, I like to think that this is what is behind these residential plane drops, i.e., delivering a synergistic mixture of certain organisms into the environment to counteract other more aggressive ones. This theory has some validity to it as frequently "mycoherbicides" contain certain fungal organisms which act as natural predators on certain plant structures and other fungal organisms which allow those plants to proliferate. The United States DEA recently began testing fusarium oxysporum in Florida to see how effectively the fungal elements contained in that mycoherbicide cancel out certain plants and the other "fertilizing" fungal organisms which enable them to grow healthy. These tests are being conducted for the express purpose of using the mycoherbicides in an anti-coca plant program in South America and other places to kill cocaine sources at their root, so to speak. In dropping organisms on residential homes from low-flying planes, it seems more logical and beneficial, though, to open-space drop them where more people might better get the possible intended benefit of them, rather than seemingly "target" one home amongst many as has frequently appeared to be the case in the instances that I have researched. I frown on the accidental transport of biological organisms theory, for the most part, as once or twice an accident, perhaps, but I have documentation of these drops occurring over 33

times since 1998 through May-June of 1999, many occurring in the same areas. These are either some awfully careless pilots or these drops are deliberate for some reason. I tend to believe the latter as that is the direction the evidence points. Calls and FOI request letters to the USDA, who could be the responsible federal department for such "pesticide" drops has yielded no answers at this date.

LAB SAMPLES - JUST THE FACTS

First and foremost, I will re-state this as clearly as possible to try and dispel this error once and for all: The laboratory samples that I collected, referred to in Will Thomas' and my joint articles as well as his solo articles, were taken from material that was ejected out of low-flying planes, one of which was positively identified as a C-130 Hercules, military issue transport plane, on residential property, i.e., houses and/or garages. They absolutely DID NOT come out of contrail aerosol.

Where/What: 1. The first sample I collected was in November 1998, in Michigan. At the request of the homeowner, I have left their names and location of their residence out of any writings regarding the material taken from their home. This material was a reddish-brown gel-like substance that covered the garage, and was dropped from a low-flying, unidentified plane. The owner of the home did not see the drop occur. I learned of the drop through the local news. Being a health and medical writer, my curiosity was more than piqued at the strangeness of this occurrence and I was also concerned about the possible health hazards of this material, thinking at first it was airplane waste that had been jettisoned somehow on the plane's landing into the nearby airport. This was the first thought of choice as many people who lived near Detroit's Metropolitan Airport had previously reported having airplane toilet waste material splattered on their homes before. I called the homeowner and asked if I may come out and take a look at what she had on her garage. As soon as I saw the material, I knew immediately that it was not commercial airline toilet waste. It did not have the characteristic blue preservative agent that is poured into airline waste holding tanks that necessarily would have been present if it had been jettisoned from a commercial fly-over. Rather it had an ominous appearance, like splattered and dried blood. My second thought was a large, bird perhaps dripping blood from a wound flew over the house, but this was quickly ruled out after noting the splatter pattern on the garage which could only have been caused by a higher velocity spray. I videotaped the material, documenting it across the entire garage,

driveway, and parts of the back of the house. It marked the garage in a pattern that made it obvious it had been dropped from a low flying plane, thick, wide gobs of material in a left to right, north to south pattern, that also ran across the driveway. Strangely, no one else's house in this area had any of the material on it, except for the next door neighbor's who had a few small drops on a door facing this house. I then proceeded to collect this material with saline soaked Q-tips and placed them in plastic Ziploc bags. I then called several local laboratories and none of them wanted to take the material. They simply were not interested. I then called a marine biologist at the University of Michigan, Dr. Peter Maier, who was a huge help to me and agreed to take a look at the material. An early analysis of the material revealed nothing until Dr. Maier turned up the magnification of the lenses which immediately revealed minute protozoan life-forms, i.e., algae, which were highly motile, something Dr. Maier found odd being that these samples had sat outside in cold weather for a while. They should not have been alive and yet were swimming on the slide quite vigorously. Dr. Maier then took this material and tried to grow it in typical lab Petri dishes and several colors blossomed on the cultures, meaning that several distinct organisms were present in this material. However, Dr. Maier did not have the capacity, nor the time, to further identify these distinct species and I then took the samples to an environmental biology lab (I had not yet received authorization to use the name of this lab at this writing and therefore it will not appear at this time). There, over the weekend, these lab samples blossomed floridly, i.e., they overgrew their Petri dishes rapidly as they were ripe with organisms. When I was asked by the lab's manager, where did you get these samples? I told her that I had collected the material off a house that had been splattered with it and she was very surprised. She offered her guess that the material must be some type of biohazard materials that accidentally fell out of a plane on its descent to Metropolitan Airport, as the combination of organisms indicated more a clinical setting rather than a natural, environmental setting. However, there was no evidence of such an accident, no containers, no broken glass, no boxes, nothing to suggest a biohazard accident, just this blood- red material all over the garage and driveway with several splatters on the back of the house. These organisms were clinically identified as:

a. *Pseudomonas fluorescens* - this is a bacterium that has a "day-glo" quality to it, like a fluorescent light. It is commonly found in soil and water and is also associated with food spoilage of protein (eggs, meat, fish, milk). It is used, as mentioned earlier, in bioremediation programs as it thrives on fuel and oil. "It is generally an environmental contaminant and occasionally an opportunistic pathogen for humans causing infections of the urinary tract, wounds and the blood stream. It also occurs as a contaminant of blood and blood products used for transfusions, sometimes causing fatal shock" [Dorland's Medical Dictionary, p 1378]

b. *Bacillus amyloliquefaciens* - Common to soil, not known to be a human pathogen. However, it is used many times in clinical settings as a restriction enzyme. See below for further definition of this.

c. *Vibrio splendidus* 2 - *Vibrio* species of bacteria are commonly known to affect humans in a serious way (the disease cholera comes from the *Vibrio* family of bacteria), however, this particular strain of *Vibrio* is not a known human pathogen. Its value seems to lie in its ability to "light up" its surrounding area. It is found in coral reefs and provides a day-glo type of light, like the *fluorescens* species do. It is also being researched as a bacterial marker for poultry and other foods. The theory being that it would light up in the presence of certain contaminants, thus telling the buyer that the product was not fit for consumption. Theoretically, if someone were later wanting to test for the presence of "their" organisms which they dropped into the environment, for whatever reason, the inclusion of this one organism, *Vibrio splendidus*, would help them find "their" specific drops, i.e., allowing them to pick out their organisms from naturally occurring background organisms.

d. *Staphylococcus* - a large amount of *Staph* organisms were found in the samples. This species of bacteria can be responsible for many infections of the skin and the blood. This is a fairly common bacteria. We carry it on our hands and skin without incident most of the time.

e. *Aureobasidium pullans* - This is commonly considered a contaminant and is a causative agent of a disease process called *phaehypomycosis* - an opportunistic infection in humans derived from dematiaceous fungi, fungi that grow in rotting wood (black mold). This can cause a severe fungal form of pneumonia. It is used in making certain types of vinyl products.

From: sightings@pop.mindspring.com Date: Sun, 18 Jun 2000 01:46:24 -0700 To: neff1@mindspring.com Subject: Fwd: PART II: CHEMTRAILS: FACTS, PLAGIARISM, PROPAGANDA (PART II:) delete 'part three here' at bottom

f. *Streptomyces* - a fungus-like bacteria. More than half of the valuable antibiotics in use in medicine are created from streptomyces organisms. However, it can be parasitic to plants and animals, as well as bacteria.

g. *Nigrospora* - another contaminant, commonly referred to as the black molds which form spores.

The second sample was sent to me from Pennsylvania in January 1999, but the original incident had occurred January 1998. The names and exact location have been omitted at the homeowner's request for this specific writing. However, they will appear later in a book form. This plane drop was witnessed by a neighbor who described the plane as "huge, dull gunmetal gray, unmarked", flying so low this person thought the plane was going to crash into his barn. He said he could feel the windows shake as it went over his house and subsequently sprayed the entire three-story-high farm home of his neighbor on several sides. These homeowners also videotaped the damage and sent me a copy of it. The organisms identified in this sample include:

a. *Bacillus amyloliquefaciens* - this organism was present in an overpowering amount, so much so that only one other organism could be identified. As noted above, this bacterium is not usually known to be pathogenic to humans. It was also present in the Michigan sample.

b. *Turicella otitidis* - this was the second organism identified. This is an organism responsible for middle-ear infections, particularly the otitis media type.

c. *Streptomyces* - same as contained in the Michigan samples.

d. *Rhizomucor* - this is a mold that grows on corn plants or bread. e. *Penicillium* species - another mold which is used primarily to create penicillin.

What is a Restriction Enzyme?

As mentioned earlier on, this term has been misunderstood and used inappropriately in its mention in many Chemtrails-related articles. Restriction enzymes are not organisms cooked up in a genetics lab somewhere which are capable of creating bizarre distortions in human DNA by spraying them in the air and people inhaling them. A restriction enzyme is nothing more than an enzyme which is present in just about all bacterial and viral organisms. It functions like a genetic

"scissor" which allows DNA to be cut into at desired levels for the purpose of studying a certain level in the DNA chain, or for hybridizing purposes. It is not man-made, it is God-made.

The third sample came from Birch Island, Ontario, Canada, August 1999. I also collected this sample with the aid of Mr. Ben McNenly, a resident of Espanola, Ontario. Birch Island was a "turning point" of sorts in my investigation of this low-level plane-drop phenomena, as it was the first time that eyewitnesses were present at the exact time the drop from the plane occurred. I have been asked by these eyewitnesses to delete their names from this article, which they know will appear on the Internet, for the purpose of privacy, but have allowed me to publicly use their name in association with this story at a later date. At this point, I will refer to these two eyewitnesses as Bob and Jean. What happened at Birch Island is an extraordinary story. Bob and Jean are retirees who live on Birch Island for several months out of the year. It is located on an Ojibway Indian Reservation. They have a beautiful home that overlooks McGregor Bay. On July 18th, 1999, as they were sitting out on their patio that overlooks the Bay, Jean suddenly caught sight of a nearly silent, extremely low-flying, very large, grey plane literally gliding over the roof of their home, skimming the treetops of their property - it was that low, no more than 50 to 100' off the ground! Seeing her surprise, Bob jumped up to see this huge, completely unmarked (save for one distinguishing symbol which shall not be published at this time) plane gliding right over them and their patio. Stunned, and too afraid to move, they stood watching the plane glide silently out towards the water, trailing a reddish-brown powdery trail which covered their patio, their dock, and their neighbors dock. They ran to the water's edge and watched the plane glide silently down the bay until it was out of sight, all the while dropping the reddish powder that fell quietly and disappeared into the waters of McGregor Bay.

I was told about this aerial drop soon after and I made a trip to Espanola, Ontario first, and gathered Mr. McNenly. We then visited Bob and Jean at their Birch Island home and collected samples of the reddish powder that had fallen into their neighbor's boat and into the holding pans of their septic tank in front of their home. The powder must have reconstituted somewhat from water in the bottom of their neighbor's boat as the entire bottom of the boat was covered with a very red sticky film, almost as if blood had been wiped from the bottom

and sides of the boat. The anchor pail caught the lot of the drop and it truly was a deep, crimson red. Mr. McNenly and I videotaped the collection of this material from the pail in their neighbor's boat. I covered my hands with surgical gloves and using large Q-tips stuck my hand down into the water and scraped the Q- tip along the bottom of the pail. What came up on the Q-tip was incredible, a blood-red substance that adhered to the Q-tip like a gelatinous gob. I collected numerous samples until the entire bottom of the pail had been scraped of the substance.

After collecting the samples, I interviewed Bob and Jean on videotape in which they re-told their experience. It was at this time that Bob, without prompting from either Mr. McNenly or myself, recounted that the plane that flew over their home that day was identical to an American C-130 Hercules transport plane. Indeed, Bob pointed to this type of plane in a book of specific airplane photographs which included numerous types of planes. Bob and Jean also recounted that they and their neighbors, even the neighbors dog, became ill with fever, chills, malaise, a "flu-like" syndrome, after this material was dropped on their property and their waterfront. The neighbors boy who swam in the water of McGregor Bay after the drop came down with pneumonia after returning home to Toronto that weekend. It should be noted that on this Indian Reservation, on Bob and Jean's property, drinking water is gotten from a conduit pipe that leads from the lake into their home which then runs through a filtering system before it is fit for drinking and/or cooking, etc. So, conceivably, the powder-contaminated water could have been gathered in this conduit pipe and carried right into their home which they later drank. Filtration systems do not always filter out every organism possible.

I then took all the samples from Birch Island home with me and had them analyzed at the same lab that did the other two samples. These samples were very similar to both the Michigan and the Pennsylvania samples in the genus of organisms they contained, with slight variations. In the interim from March 1999, when the last samples from Pennsylvania were analyzed, the lab who did the work on the samples instituted an automated classification system which, unfortunately, only identifies the larger genus and not the species of each organism. Therefore, more exact identification than what follows is not known, however, the genus of bacteria present in these samples is identical to the other samples.

Bacteria:

- a. Pseudomonas
- b. Staphylococcus
- c. Bacillus

Fungus/Yeasts/Molds:

- a. Penicillium - as noted above, makes penicillin.
- b. Acremonium - a rather nasty organism, found in patients who are immunocomprised, most frequently AIDS patients.
- c. Yeasts - a primitive mold.

OTHER PLANE DROPS:

The rest of the "drop" incidents have no samples or laboratory analysis attached to them, at least that are in my possession, and exist through what was gleaned from local news reports in their areas and talking to the people that these incidents occurred to in the area, as well as the local officials. A total of 29 of these fly-over "goo drops" reports from the state of Utah alone. What's so special about Utah that they might have such occurrences? The fact that Dugway Proving Ground is only minutes away from where all these drops occurred might shed some light on the phenomenon. If anyone there were talking, that is. Dugway, in Provo, is one of the country's centers for biological open-air testing and development. Could these fly-over goo drops in Utah have been part of either open-air biological testing or accidents of transport of some biological materials? Maybe. When talking to a few of the "victims" of these fly-over goo drops, it was learned that all of these occurrences happened at night, with the homeowners waking up and finding their houses splattered with this (again) brownish goo. A young man whom I interviewed, via telephone, a Bryan Petersen, told me how he and his family were housesitting their parents home while they were away on a religious mission in another country. They woke up to go to work in the morning at 7 a.m. and found the garage, driveway and part of the house splattered with this material. Bryan also told me that the local HAZMAT team, complete in head to toe biochemical hazard gear, were quickly dispatched from the Fire Department. They didn't take samples, they just quickly sprayed the entire area down with bleach after taking photos.

Another man, Thomas Perkins' home was hit on April 10th, 1999. Mr. Perkins and his family discovered the "goo hit" and immediately contacted the Salt Lake County Fire Department. At first they were reluctant to wash away the material, fearing it could contaminate storm-water systems. The Fire

Department told Mr. Perkins to contact a private biohazard-cleanup company who were also reluctant to clean up the material. However, a day later, the Fire Department relented and eventually cleaned the material off Perkins' home using, again, a bleach concoction which is used in laboratories to kill bacterial and viral contaminants. Mr. Perkins was told by the county health department to keep his family and his pets out of the yard but declined further explanation to Mr. Perkins as to the why of their warning.

My questions to the Director of Public Health, a pediatrician named Kathryn Vedder, M.D. were left unanswered. However, her secretary referred me directly to the laboratory who collected some samples from one of the plane drops, although the majority of them were simply washed away and untested. I left numerous messages for the technicians working on these lab samples and they never returned my phone calls. I was told later, however, by Dr. Vedder's secretary, that Dr. Vedder had issued a public statement that the material contained in these plane drops were "sewage" and the result of a "prankster" filling up a plane with raw sewage and flying over the city. Twenty-nine times. Even though no one had seen the plane or planes that made these drops, FAA spokesperson Mitch Barker told the Salt Lake Tribune: "There is a possibility this is some type of low, slow flying aircraft fitted with some ejection device and it is able to target a spot on the ground". If so, "It would certainly seem to be intentional", he said. Interestingly, the description of a "low, slow flying" plane conjectured to have been the culprit also fits the description given by the neighbor in Pennsylvania who saw such a plane cruise over his neighbor's property before dumping its mysterious biological payload, as well as it fits the description given by Bob and Jean in Birch Island, Canada of the plane that littered their property with red-brown powder. So, in essence, we have similarly described planes at opposite ends of the country, and at least one instance in Canada, dropping similar substances on residential homes. What do they all have in common?

PROPAGANDA

As mentioned earlier, I would like to detach information I contributed to Chemtrails research from some dangerous propaganda that is being woven into many of these "cut and paste" Chemtrails articles. Propaganda, I would like also to say, has absolutely nothing to do with Chemtrail tracking/research and quite frankly reeks of White Supremacist conspiracy agendas, re: the inclusion

of an ancient racist tract, The Protocols of The Learned Elders of Zion, with New World Order take-over paranoia which is being purported now as masterminded by an elite group of Jewish financiers who propose to "rule the world". About a month ago, I received an e-mail, from a Chemtrail tracker which spoke of the ancient Protocols of the Elders of Zion and how, in these modern days, it is really the rallying plan of those who would create The New World order, i.e. the United Nations, through a takeover of individual world governments, the United States being one of them. It was a fairly lengthy e-mail distributed by a Christian minister to people, including myself, on Chemtrail tracker/researcher mailing lists. My heart sunk when I read this e-mail, to think that this piece of trash that wreaked so much pain and havoc in the world was still circulating, now with a 21st century face as the foundation of The New World Order, and associating itself with Chemtrails work. That was just the shot in the foot we all needed.

The Protocols of the Learned Elders of Zion is a totally fake document. It was created circa 1897 during the reign of Czar Nicholas II of Russia, just prior to the Russian Revolution. It was created by that Czar's cabinet as an excuse to crack down on the Bolsheviks who were threatening to overturn the Imperial Crown of Russia. These cabinet members penned this "secret" document detailing the plan of the "Elders of Zion", i.e., an elite group of Jewish leaders who wanted to "control the hearts, minds, money of the Gentile world" [re: The Protocols of the Learned Elders of Zion]. The document was written in the form of minutes of meetings between these Jewish elders, meetings that never took place. The minutes of this fictitious meeting revealed the plan of these Jewish Elders to take over the world, overthrow the Imperial Crown nations, and institute their own oligarchy rule, control the world economy, and take away individual freedoms. The Russian cabinet members who created this fake document then signed Jewish names (as many Bolsheviks were Russian Jews, like Trotsky) to the document as being the authors of it. They then distributed this document throughout St. Petersburg and Russia. Soon after, the Imperial Guard did crack down, horribly and violently, on Jewish citizens. Rioting ensued in the streets of St. Petersburg and hundreds of Russian Jewish peasants were killed and injured. The Russian film, The Odessa Steps is all about the massacre of scores of Russian Jews by the Imperial Russian guard instigated by this fake document, The Protocols of the Learned Elders of Zion. It was also this document that fired the Russian

Revolution as, after this massacre, the stage had been set for the revenge of the Bolsheviks.

Eventually, the document found its way to England and Europe as the crown heads of Europe were related by blood to the Russian Imperial Crown, and thus, all Crown nations were at risk by these Jewish Elders proposal to do away with Imperial rule and rule the world with their own elite group of Jewish financiers. This document circulated throughout Europe and decades later, in pre-WWII Germany where the document re- surfaced at the hands of the Nazi and began its most devastating damage to date. It was championed by Goebbels, Hitler's propaganda minister, as something that would help the Third Reich convince the German people of the growing "Jewish Menace". Suffice it to say, that The Protocols of the Elders of Zion , in the hands of the Nazi's this time around, became the torch that lit the fires of the Holocaust and kept the ovens of Auschwitz burning night and day until 6,000,000 souls had perished. And, despite a formal U.S. Congressional hearing in 1964 which publicly proclaimed the document a fake, The Protocols of the Learned Elders of Zion flourishes still. In Saudi Arabia, the document is given away free at their Embassy. It also appears on White Supremacist websites all over the Internet as their reason why Hitler should have finished the "final solution".

The e-mail I received, detailing this document, essentially stated that The United Nations' heads were, in fact, the "Elders of Zion" in disguise and that the New World Order was really the original plan described over a century ago by these Jewish Elders in The Protocols. The very fact that it is included in Chemtrails correspondence between fellow researchers/trackers, interested supporters, etc, makes the Chemtrails phenomenon appear to be some sort of "proof" or "evidence" that the Elders of the New World Order are now implementing their plan by aerial biological and chemical poisoning. And, that Chemtrails researchers support this propaganda either tacitly or explicitly. It is truly sad to see this level of ignorance being bandied about like its acceptable reading material, like it has some validity to what Chemtrail researchers/workers believe. If anyone wonders why the mainstream media will not touch the Chemtrails story with a 10 foot pole, this one incident may just have dashed any hope of that. If Chemtrails researchers truly want to be heard by the mainstream media, I suggest they disentangle themselves from this dangerous nuclear weapon of propaganda that is being distributed to Chemtrails researchers. No one, and I do mean NO ONE, in the mainstream media, nor the United States Senate or

Congress, will so much as give any of us the time of day with this racist, hate-mongering albatross around the Chemtrails issue's neck.

So let it go on record here, in this public venue, that I do not support this pitiful, piece of trash, The Protocols of the Learned Elders of Zion , as having any association or relation to serious Chemtrails research, and I, for one, completely dissociate myself, my work, my name, my anything, with anyone who does support it, whether they are fellow Chemtrails researchers or whom they are. You are no colleague of mine if you support this and/or passively keep silent on its distribution. And I certainly do not wish to be considered a member in a group who would pander, for even a moment, to this White Supremacist, Neo-Nazi brainwashing material.

SOME BRIEF CONCLUSIONS:

Although my research and investigation is ongoing, I will offer a tentative conclusion here to Sightings readers as to what appears to be a preponderance of evidence regarding the unusual contrail activity of at least the last 2 years and actually much longer. Briefly stated, as there is much more that needs to be researched and written about the mechanisms involved in this issue, it appears that there have been experimental efforts, on a global level, to create artificial "cloud cover" shields from devastating UV rays that have resulted from an increasingly damaged ozone layer. Recent study findings reported by NASA and NOAA reveal a 60% loss in ozone when measured in an area 11 miles above the North Polar region. This represents a much greater increase in the Arctic ozone depletion than what was measured in the previous decade. Aerial research programs into the ozone problem spearheaded by top aerobiological specialists from Italy and China are leading the way this summer into finding some lasting solutions to the seriously damaged ozone [re: Istituto di Aerobiologica, Florence, Italy] This is a global problem, not just an American problem. From what research I have done into this area, yes, the United Nations is involved, but not for the purpose of instituting The New World Order. Rather, for the express purpose of pooling resources of the best scientific minds throughout the world to devise a solution to the damaged ozone problem with involvement and contribution from just about every world country.

It may have gone unnoticed, and there are those who will disagree with these findings, but the reality is that we have reached a critical stage for

ozone damage. Consider these facts: In the thousands of years that the Earth has been turning every day, in the last 50 years alone, we have managed to destroy a huge percentage of the Earth's ozone layer by the burning of enormous amounts of fossil fuels, and release of chlorofluorocarbons into our atmosphere. In those same years, biologists have noted a 50% decline in the amphibian population [re: Biology Archives, United States Department of Energy], at an average rate of 4-5% a year, though some of these losses have been much more sudden. Just a little less than 7% of the amphibian populations studied have gone totally extinct, with the surviving populations in "strong decline" [re: Nature, April 20, 2000]; In the last few years, coral reefs in the world's oceans have been dying. Just recently, off the coast of Florida, marine biologists found the reason - a fungal organism that has proliferated in unprecedented numbers in the oceans is eating them and many other marine lifeforms at a breakneck speed; emaciated sea mammals have beached themselves on shores with holes in their skin, dying from some cancer-like disease process we don't quite understand; "red tides" of pfiesteria, an ancient organism from the days of dinosaurs, eating holes in fish, infecting fishermen, and anyone else wandering into the water, with devastating illnesses and skin infections; scores of water fowl and fish have turned up dead on Great Lakes shorelines from polluted waters; plants and trees are increasingly infected by fungi and molds, like scaly crawler and worse, rotting them away; the human population in the last several years is experiencing dramatic increases in devastating fungal based diseases.

What's happening here? When the first creatures to swim in the primordial waters of Earth - the amphibians - those creatures who have been here long before man ever stepped on the Earth, suddenly become prey for another prehistoric fungus, chytrids, in the last 20 months, after previously cohabiting alongside them without incident, then begin wiping out amphibian populations around the world - something is seriously, seriously wrong with our ecosystem. And, the human population is just now starting to feel the effects. That something seriously wrong is, in part, a perilously damaged ozone layer that has allowed a dramatic increase in UV/UV-B ionizing radiation which can penetrate water several feet. This could account for the cancer-like skin diseases of sea mammals. Skin cancers in the human population, from UV radiation exposure, has experienced a sharp increase in the last several

years as well. The constant release of an overabundance of CFCs into the atmosphere has also caused a serious warming of the Earth which allows the proliferation of fungal organisms, bacteria, and viruses. The other side of that coin is an increasingly polluted environment from our slavish dependence on fossil fuels, "superfarming" and the overuse of fertilizing agents which run-off into ponds, lakes, rivers, streams, and provide the perfect breeding grounds for the overgrowth of fungal organisms. Team that with acid rain and you've added some more food to the fungal growth factor. All these factors have a synergistic effect on each other and result in an ecosystem dangerously out of balance, teetering on being overrun by fungal organisms that are causing the demise of many life forms, plant and animal. These organisms (algae, and its relatives molds and fungus) were the very first lifeforms on Earth dating all the way back to the days of purely protozoan life forms. That they are still around today not only going stronger than ever but apparently mutating into a predator for our oldest ancestors, the amphibians, says a lot for their formidable constitutions and does not bode well for us.

What do Chemtrails have to do with fungus? It is my belief that the increased aerial activity needed to create a reasonably constant, at least partial, cloud cover, necessary to keep dangerous UV/UV-B rays at bay, have sensitized human respiratory systems to such an extent that leaves them susceptible to the growing fungal menace in our environment. These sensitizations, or allergic reactions, could be caused by either by the kerosene-like jet fuel (JP-8 and JP8 + 100) used by the jets that make these cloud-cover contrails. These kerosene-like fuels have a high carbon burn-off residue and their aerosol has been cited by OSHA to be problematic to human respiratory systems [re: OSHA studies JP-8 ground crew results, March 1999] resulting in prolonged bouts of bronchitis with a hacking cough and sore throat. Or, perhaps, there is an as of yet unknown ingredient present in the contrails themselves that could be causing the sensitization, although I would think this less likely. To date, inquiries into efforts to perform spectragraphic studies on contrail aerosol have not yielded any agencies willing to take on the task.

In people with asthma or already-existing environmental allergies, their symptoms are much more acute. I have interviewed many people who tell me that they have environmental allergies and/or asthma and that when they go out under heavily contrail'd skies their symptoms increase

dramatically. Conversely, individuals who don't have environmental allergies seem to suffer much less severely from being exposed to contrail laden skies and some not at all. This nearly constant sensitization by the constant exposure in the environment to the fine carbon particulate combustion residue from jet fuel in our breathing space, compounded by other environmental pollutants, works to create an environment inside the lungs, nasal passages, eyes, skin, i.e. increased fluid, that promotes fungal growth and assists fungal infections to take stronger hold. And once a fungal infection takes hold in lungs and other organs this makes a person much more susceptible to bacterial and/or viral infections setting in, creating a seriously ill patient. I believe this is what accounts for the "flu-like" illnesses that people have reported - not flu at all, but a fungal respiratory syndrome with more than likely bacterial and/or viral accompaniments. Airborne fungal pathogens (from inhalation of their spores) affect the upper respiratory system, as well as ears and eyes, causing symptoms similar to flu, pneumonia and even tuberculosis, as well as conjunctivitis "pinkeye". These fungi also can spread to tissues throughout the body, causing widespread disease.

Really good statistics on fungal based diseases do not exist as they are not, as of yet, communicable, i.e. passed from person to person, diseases like STDs, TB, etc. and do not need to be reported to the CDC or state health departments. However, it is reported in clinical literature on fungal infections that they are quite definitely on a dramatic rise in the human population. They have always affected those with comprised immune systems, but people with normal immune systems have experienced a dramatic rise in fungal infections recently in the United States. For instance, in the 1980s, in California, one of the sunshine states that typically have low growths of fungus because of the relative dryness, fungal infections were low. In the last five years, fungal infections in California, and other dry western states with typically lower fungal infection rates have literally skyrocketed. And in states, like Michigan, with dark, lush forestry and lots of rain and not a lot of hot sunshine that provides the perfect growing fields for fungus, fungal infections of all types are at an all time high. Unusual fungal infections, like rhinosporidiosis, are more and more cropping up in nonindigenous areas like North America where previously they were only found in India and Asia. The infecting fungal organism is either being carried by the jet stream or tropical storms, or, perhaps, birds. Global warming

compounded by El Nino has caused this fungal overgrowth, and even bacterial and viral proliferation. Organisms that would normally die off in cold weather have stayed around longer, allowing for a much more concentrated proliferation of pathogens present in the atmosphere. Every time we take a breath in our current environment, we breathe in fungal spores, bacteria and viruses of a much higher degree than we ever have in the past, accompanied by environmental pollutants which serve to sensitize our lungs and our bodies to becoming the perfect host for these organisms to take root in causing numerous disease processes like pneumonia, and other upper respiratory illnesses, ENT illnesses, meningitis, heart disease, gastrointestinal disease, vision problems, hearing problems and skin problems.

And what about those low-level C-130 biological material drops? Although I have no definitive proof of this, and may never find it, judging by the research and facts I have to date, I believe these are efforts to address the ensuing fungal infestation problem at ground or near-ground level. These "goo drops" in residential areas, by the way, have also been reported in Italy, Australia, and England. By dropping organisms into the environment in this way, perhaps, these are efforts to try and eradicate, or slow down the rapid environmental growth of, these organisms.

This is a brief synopsis of on-going research I am doing into this phenomenon, and I will continue to document this phenomenon throughout the summer of 2000 and hope to have more definitive answers by then which I will then share publicly with everyone. If we are at a critical level for ozone damage and experimental efforts via creating man-made cloud cover are underway, and human illness may necessarily be a part of it, is there anything that the public can do to minimize getting one of these fungal infections? Yes. They are:

From: sightings@pop.mindspring.com Date: Sun, 18 Jun 2000 01:47:34 -0700 To: neff1@mindspring.com Subject: Fwd: PART III: CHEMTRAILS: (FACTS, PLAGIARISM, PROPAGANDA (PART III))

1. Eat a low refined sugar diet. Fungal infections thrive on sugar.
2. Keep your homes as clean as possible. Use bleach to clean your showers and basements on a regular basis. Fungus thrives in dark, wet environments, especially black mold which causes a very serious upper respiratory illness.

3. Stay away from yeast products if at all possible. This includes all bakery items like bread, cake, doughnuts, etc., in short anything that contains yeast.

4. Use antibiotics judiciously. Although antibiotics do not have a large effect on killing fungal infections, you really need antifungal medications to accomplish that, antibiotics weaken the immune system and set up perfect environments in the intestinal tract for candida, a fungal organism, to overgrow. Candidal infections are often overlooked as they cause symptoms that mimic other disease processes. Use acidophilus products, or plain yogurt, to restore the correct balance of intestinal flora if you absolutely have to take antibiotics.

5. Keep yourself clean. If you garden, wash your hands extremely well after handling trees and/or plants with any fungal infestation on them.

6. Eradicate, as best as possible, any fungal growths near your home, on trees, on plants, etc. 7. Stay as healthy as possible. Eat a diet high in protein and low in carbohydrates. Take such supplements as grapefruit seed extract, olive leaf, and other anti-fungal supplements which will help you fight fungal infections from gaining a stronghold.

8. Stay away from alcohol, specifically beer. The ingredients in beer cause candidal infections to flourish. If you must drink alcohol, drink red or white wine but sparingly as the sugar in alcohol also contributes to fungal infections.

I welcome any comments on the information given in this article. If anyone would like to contact me, feel free to do so at the following e-mail address. In another month or so, my website will be back up and functioning and I would invite anyone to please visit it for regular updates on the research I am doing into both programs to repair the ozone layer and the growing fungal disease threat.
(End of article by M Cassani)

Comment

Ken Adachi. <Editor@educate-yourself.org>
6-21-00

*Dear Jeff,
Just read "Chemtrails-Facts, Plagiarism, And Propaganda" posted at Sightings.com. by Margaret-Erminia Cassani, the woman who jointly*

*authored the "Sky Samples Analysis" with William Thomas back in April '99.
Printed out, it ran to 33 pages.*

Conclusion? The government is really trying to help and protect us from diseases caused by an escalating proliferation of airborne fungal pathogens due to excess UV radiation which is caused by ozone depletion, which in turn is due to Global Warming (Gee, where have I heard that explanation before? Hmmm...). All attempts by "cut & paste" (1) chemtrail authors to assign nefarious government motives ("the 'cull' theory is just plain illogical") or New World Order hysteria (2) to such phenomena are now on notice to keep their distance and give her wide berth.

*After all, she's a 'serious' Chemtrails researcher.
Some quotes:*

(1) "I would like to detach information I contributed to chemtrails research from some dangerous propaganda that is being woven into many of these 'cut and paste' Chemtrails articles."

(2) "I think all serious Chemtrail researchers should forget this one and quit scaring the poor senior citizens and chronically ill into heart attacks or committing suicide or homicide out of depression and/or anger brought on by the public airing of these scenarios."

Oh yes, "The Protocols of The Learned Elders of Zion", is a "totally fake document".

(the only thing she left out, it seems, is that Billy Meier is a nut case and made the whole thing up)

(End of Comment by K Adachi)

Comment

From: "Matt Ridgway"

<matt@abacuspub.com>

I'm not quite sure what Margareta- Erminia Cassani has accomplished with her verbose diatribe regarding the chemtrail issue other than to set the world record regarding the use of the phrase "cut and paste". (No less than 11 times, count em, ELEVEN!!) Cassani states early in her post that the chemtrail issue is completely separate from her research, with the main crux being that authors of dubious worth have co-opted her research to extrapolate totally unrelated conclusions. Bravo. In the future I'd suggest that a legal copyright infringement suit might prove more productive than composing this self-serving yawn-fest of a manifesto. If authors are to be chastised for broad speculation then I would respectfully submit the fault lies more with state and federal agencies who continue to ignore this issue, thus assuring it

remains firmly planted in the 'fringe lunatic' venue.

We base our conclusions on admittedly flawed personal observation and experience, as apparently much of Cassani's research has been. Without a doubt there are unreliable, half-baked theories that abound on the Internet. It is the reader's responsibility to decide for themselves what information is germane and what is not. Cassani's post is filled with so many ill-conceived notions and contrary aspects that I would take up as much space as the original article to effectively dispute it, something I'm sure NO ONE would have the attention span to undertake. I do find Cassani's insulting demeanor and self-importance amusing to say the least. Billing herself as a 'health and medical writer', (a vague reference to a career that has thus far yielded little, if any notoriety since I've never heard of her. Although I'm sure her upcoming book will at least land her her 15 minutes on 'Dreamland'!) she sites her scientifically valid investigations yet again and again refuses to name anyone associated with these investigations.

This is supposedly for 'security' or 'privacy' issues, however, I find it extremely hard to believe that by merely mentioning someone's name that they must then be 'flooded' with web lunatics clamoring for...what...brown goo? Cassani's take on HAARP is also woefully misinformed, bordering on downright ignorant. Cassani states that HAARP's purpose is: "The HAARP program is one such defense project which, basically stated, manipulates the ionosphere to become a shield that would deflect incoming missiles from entering our country if, suddenly, our global "trading buddies" decide they don't want to play Monopoly with us anymore and would rather just take us off the playing board completely." WHAT?!?? A shield to deflect missiles?!?? I won't even dignify this unbelievably ignorant statement by correcting it, suffice to say that HAARP does indeed manipulate the Ionosphere but is totally incapable of generating a defensive shield of any kind. A glaring mistake for such a learned science author. It seems that tossing around regurgitated 'science speak' like 'cross vector' and 'jumping vector' is meant to dazzle the reader with Cassani's undeniable mental prowess. yawn I remain unimpressed.

Cassani rails about everything from complex chemistry to early Russian Bolshevik history without missing a beat, leaving me with the impression she's either the most intellectually diverse and impressive researcher ever or simply another armchair 'cut and paster' with a decent

vocabulary. Cassani veers from writing a serious treatise on her research to employing classic disinformation techniques to muddy the overall issue. When addressing the possibility of the spraying being a vaccination program, Cassani virtually states that such a practice, though most-likely ineffective, would be useful in today's 'biological terrorist society' we live in (another classic fed excuse for justifying illegal activity). That is except for all the fools and malcontents who, despite being plainly warned of an impending threat, would STILL refuse a federally mandated vaccination, thus proving themselves a bigger threat than the illness itself.

What the HELL is she talking about? That people who refuse vaccinations are STUPID? That's not a judgement she gets to make. And finally, Cassani's 'conclusions' are the single worst aspect of this wrong-headed treatise. Invoking such cliché'd causitives as El Nino and global warming, Cassani reckons that the whole chemtrail issue (which she started out stating, and reiterated several times as a completely separate issue from her research) is little more than an attempt to compensate for ozone depletion. It should be obvious by now based on all available information and activity that I myself have witnessed again and again, that the chemtrail spraying is most likely weather modification.

The end result of chemtrail spraying is invariably a re-inforcement of existing cloud structures, or the creation of completely new ones. No big mystery there. I almost look forward to Cassani's book being released. The proof will definitely be in the pudding, and I daresay that I suspect her conclusions in novel form will be every bit as biased and wrong as they were in this article. Send me a copy, I'll be glad to review it for Rense.com.

Matt Ridgway
(End of Comment by M Ridgway)
From Rense.com



Courtesy Keelynet
TOC
02/04/07 - Giants in Americas - Death Valley, California - Cavern Temple of Giants
The following are actual accounts of giants in North America. "Atlantis in the Colorado River

Desert” - 1947 Nevada news: Near the Nevada - California - Arizona border area, 32 caves within a 180 square mile area were discovered to hold the remains of ancient, strangely costumed 8 -9 foot giants. They had been laid to rest wearing the skins of unknown animals similar to sheepskins fashioned into jackets with pants described as “prehistoric Zoot suits”. The same burial place had been found 10 - 15 years earlier by another man who made a deal with the Smithsonian. The evidence of his find was stolen and covered up by Darwinian scientists. Dr. Russell reported seeing hieroglyphics chiseled on carefully polished granite within what appeared to be a cavern temple. Another cave led to their sacred hall which contained carvings of ritual devices and markings similar to those of the Masonic Order. A long tunnel from this temple led to a room where, Hill said, “Well-preserved remains of dinosaurs, saber-toothed tigers, imperial elephants, and other extinct beasts were paired off in niches as if on display.” University of Arizona professor Vine Deloria, himself a Native American, made a similar accusation against the Smithsonian for covering up the remains found within the burial mounds of the Moundbuilder civilization. Surviving diaries from before the time Darwin attest to these discoveries. The Moundbuilders were a different civilization than that of the Indians, they said. The mounds contained the remains of hundreds of giants along with the bones of giant mastodons. In Cincinnati, Ohio the giant bones were found with large shields, swords, and engraved stone tablets. In Kentucky and Tennessee the bones of “powerful men of towering stature” were excavated. One of these 7 foot men was buried with an engraved copper plate beneath his head. A woman was also found. She was wearing a silver girdle with letters written on it. The Detroit Free Press reported in 1884 the discovery in Garterville, Mississippi of the remains of a giant with waist-length jet-black hair. He was wearing a copper crown. With him in his timber burial vault were his children who wore garments decorated with bone beads. The tomb was covered with large flagstones engraved with inscriptions. In Cayuga, Niagra there is a place called “The Cemetary of the Giants” which was discovered in 1880. Those giants were 9 feet tall and appear to have died violent deaths. Their axes were found with them. Giant bones were also unearthed from a rock fissure on Lake Erie Island. In some of the finds of giant bones, the bones lay in confusion as if left on a battlefield.

<http://english.pravda.ru/science/mysteries/01-02-2007/86972-giants-0>

Courtesy [Keelynet](#)

Courtesy [Keelynet](#) [TOC](#)

05/02/07 - [Businesses Scramble To Stay Out of Google Hell](#) (Murphy’s Law in action. - JWD)

“Forbes has up an article on the consequences of being dumped into a claimed ‘supplemental index’, also known as ‘Google Hell’. It uses the example of Skyfacet, a site selling diamonds rings and other jewelery, which has dropped in Google’s rankings and saw a \$500,000 drop in revenue in only three months after the site owner paid a marketing consultant to improve the sites. The article claims that sites in the supposed ‘supplemental index’ may be visited by Google’s spiders as infrequently as once per year. The problem? Google’s cache shows that Google’s spiders visited the site ss recently as late April. ‘Google Hell is the worst fear of the untold numbers of companies that depend on search results to keep their business visible online. Getting stuck there means most users will never see the site, or at least many of the site’s pages, when they enter certain keywords. And getting out can be next to impossible—because site operators often don’t know what they did to get placed there.’”

Courtesy [Keelynet](#)

Metaphysical Adventures

Note- This review was included in this column not only for the interesting thoughts therein, but also because the basic idea could offer lots of fodder for the creative Remote Viewer - Editor

Book Review [TOC](#)

By Zuerrnovahh-Starr Livingstone

Decoding the Message of the Pulsars, Intelligent Communication From the Galaxy

by Paul A. LaViolette, PH.D.

Publisher: Bear & Company, Rochester, Vermont

This book was a Christmas present from Joan. I finished reading it on January 27, a bit slow for me but it is dense with information. The key point LaViolette makes is that pulsars, radio frequency stars, are beacons located near nova or super nova remnants by extra terrestrial intelligences (ETI).

Over 1500 pulsars have been discovered in our galaxy since their discovery in 1967. The theory that still holds sway in the astrophysics departments around the world is the “neutron star lighthouse beacon model”: A twenty mile diameter neutron star remains after a super nova and spins rapidly with a strong magnetic field at ninety degrees to the spin axis. The theory has so many patches covering its deficiencies that it is nothing but patches.

LaViolette goes into great detail on how the lighthouse model has fallen apart and how the only adequate explanation is that they are artificial beacons. He lists fourteen characteristics of the pulsar signals lending credence to the ETI model.

Talking about this book review with Ken Adachi, he directed me to look into Dr. Richard Boylan's "Aviary" list of Majestic 12 scientists. Dr. Paul A. LaViolette is not cited in the old guard of the of special study group but he does include information in this book only a select few would know. Definitely he is one who favours public disclosure of knowledge of aliens as some of the members of the Aviary have advocated.

In order to construct an Earth based beacon able to return a signal to the stars LaViolette explores the possibility of scaling up existing Star Wars (SDI) technologies. I have suspected the existence of such powerful beams but have not read about them elsewhere. It was new to me. He also goes into microwave frequency repelling rays theoretically useful in protecting Earth from solar coronal mass ejections, supernova superwaves and galactic core superwaves. He quotes the actual US Patent proving that microwaves can exert a repelling force. He theorizes it is possible to create a microwave bubble around the solar system to protect life on Earth from cosmic rays, x-rays and other high energy particles of a nearby nova or another galactic core superwave.

Paul LaViolette believes the pulsars are an ETI warning system for galactic core superwaves. In his earlier book, "Earth Under Fire: Humanity's Survival of the Ice Age", Laviollette writes the sudden thaw could have been caused by a galactic superwave. The ice got warm rather quickly. The novae near the present pulsars locations burst as the galactic core superwave washed over them in sequence. The new superwave travelling at nearly the speed of light would be upon us soon after the pulsars and stars nearer the core winked out due to a veil of high velocity particles.

I slept many nights on this doomsday scenario. I awoke each day with a bit more information. First of all, I saw the Earth is already girded with many layers of protection. Second, only 1500 out of a hundred billion stars went nova. That is 0.0000015% of the star population went nova in our galaxy. Third, those stars who went nova coordinated their starbursts with the galaxy and nearby stars. The nova is an act of a new creation, and new stars being born. Fourth, all the planets

with third dimensional life were protected or the beings were moved to other planets. Earth today is a Noah's Arc of Life for 3700 planets. Meaning, Earth is well protected indeed.

Paul LaViolette recognizes the Crab Nebula Nova as an artificial explosion. It is as if a huge nuclear shape charge blew it into a galaxy shape. There are other examples of artificial starbursts including the much photographed Hourglass Nebula.

It is important for remote viewers who travel to distant stars to recognize everything, stars, planets and moons as living beings. Native shamans get better information because they see life everywhere. Those who search the stars considering them as dead matter find dead matter and many conundrums.

Carl Sagan is mentioned in this book with respect to the plaque he helped designed for the Pioneer 10 spacecraft. Sagan uses pulsars to pin-point Earth's location. In all likelihood Sagan had realized pulsars as ETI beacons thirty years ago. In his book and movie "Contact", Sagan again recognizes there is a network of nodes for communications and travel between the stars in our galaxy.

Another galactic core superwave might be coming but I do not fear it.

Zuerrnovahh-Starr Livingstone
© *educate-yourself.org*

The Rise And Fall Of Continents [TOC](#) *By Zuerrnovahh-Starr Livingstone*

The current continental drift theory does not address the rise and fall of continents. Supposedly the ancient Pangaea super continent split into pieces and the pieces migrated to where they are now a bit battered on the edges but still the same landmass. The lack of an explanation for fossils high in the mountains is unsatisfactory. Accepted as fact but unexplained are the many times the Great Plains of America were submerged. The fossil record shows inland seas covering much of the Mississippi Basin.

A theory on the mechanism driving this process is what I will be covering in this short essay.

In the essay "What Resides At Depth" I describe the different types of Hot Spots and the different

materials rising out of the earth's mantle. I ended the essay with an explanation the ancient stonemasons 12,000 years ago understood the shifting continents and were able to anchor most of Africa in one relatively stable position. This continent of stability on a dynamic world minimized the loss of civilizations after the sinking of Atlantis.

I believe the now submerged Atlantis was the island continent of which Plato wrote, lying between the Azores and Canary Islands in the North Atlantic. Those remaining islands are the highest points on the Mid-Atlantic Ridge and at one time snowy mountains of the central mountain range of Atlantis. The mechanism which lifted Atlantis is the same one now lifting Iceland. Iceland is a remnant of Atlantis uplift. These are pieces of land are not included in the Pangaea Theory as they are proposed to be part of the thin crust underlying the oceans. Are the ocean bottoms always to remain beneath the waves? I do not believe so.

The crust under the ocean depths is about ten miles thick according to seismic research. The crust under the continents is up to forty miles thick from the same earthquake readings. Even though there are differences in the thickness of the crust it is still possible for ocean bottom to rise above sealevel.

Research of the depths of the mantle show plumes of hot materials rising from deep in the planet. In an article in Scientific American in the late 1990s a strong plume is now pushing at the underside of Australia. The continent is being lifted and may double in size. Australia is also moving northward into Indonesia and the collision of lands will lift the volcanic islands. As Australia is on the same tectonic plate as India, as Australia rises India will tilt down. The same article reported the plume under North America is ebbing and the continent is slowly sinking. The American inland sea is returning as our dynamic planet rebalances its topography.

In other essays I wrote I was taught the Earth is hollow. The hollow Earth is explainable by electro-gravity and nesting multi-dimensional energies. The Earth is also an ancient highly salient living being. Seismic anomalies in transit times at the theorize core/mantle layer are due to the brittle second crust inside the planet. The transmission of "straight through" P-waves is due the core acting a single structure again due to its cooler nature. The whole of the core acts like the resonant box of a

guitar. The plumes of hot matter flowing from the inner mantle to the outer crust is the rebalancing of internal energies generated by the multi-dimensional living Earth. The decision to lift Atlantis was a conscious choice by Gaia. The decision to submerge Atlantis was likewise a choice. The slow sinking of North America serves a purpose. The new lands of Australia also have a purpose. The purpose is the spiritual evolution of all the living beings inside and outside the planet. When a land like Atlantis become heavily polluted the only way to wash it clean is to submerge it. The pollution was physical, mental, psychic and spiritual. Horrendous acts of black magic had crippled spiritual evolution on the continent. The imbalances had threatened the stability of the whole planet. 12,000 years ago the Giza complex was built to address the problem of the submergence of Atlantis and anchor the grid energies of the World Tree.

The mantle is the living wood of the World Tree. The inner and outer crusts are the bark of the World Tree.

Atlantis, volcanic and rough was fertile. It grew every kind of fruit and tree. It lacked in minerals and so it created a commerce to gather what it needed. The commerce made the island continent the destination of the wealth of the planet, impoverishing the majority of the people. The wealth of Atlantis was coveted and resented. The Atlantean civilization was worldwide and the pieces of the culture are spread around the planet. Megalithic structures have an Atlantean origin. As the land had many earthquakes it was necessary to work with stone in a way that the structures would survive. Pyramids dotted the landscape and were copied in Sumer, Egypt, Central America and China. A pyramid is an inherently stable structure. Stones of great size were cut with sound and lifted by song. Alas, they poisoned their land and it sank into the sea...if they had not poisoned the land it might still be above the Atlantic not awash with cleansing saltwater.

The ultimate decision to raise and lower continents is made by the Earth. The mechanisms are multidimensional. The spirit of the planet is not cruel. This is an evolutionary world where young souls learn their first lessons. Mothers are constantly tending and washing their young, Mother Earth does the same.

Zuerrnovahh-Starr Livingstone
© *educate-yourself.org*

Courtesy [Keelynet TOC](#)

05/04/07 - [To Treat the Dead](#)



Consider someone who has just died of a heart attack. His organs are intact, he hasn't lost blood. All that's happened is his heart has stopped beating—the definition of “clinical death”—and his brain has shut down to conserve oxygen. But what has actually died?

According to Dr. Lance Becker, an authority on emergency medicine at the University of Pennsylvania. “After one hour,” he says, “we couldn't see evidence the cells had died. We thought we'd done something wrong.” In fact, cells cut off from their blood supply died only hours later. But if the cells are still alive, why can't doctors revive someone who has been dead for an hour? Because once the cells have been without oxygen for more than five minutes, they die when their oxygen supply is resumed. Biologists are still grappling with the implications of this new view of cell death—not passive extinguishment, like a candle flickering out when you cover it with a glass, but an active biochemical event triggered by “reperfusion,” the resumption of oxygen supply. Mitochondria control the process known as apoptosis, the programmed death of abnormal cells that is the body's primary defense against cancer. “It looks to us,” says Becker, “as if the cellular surveillance mechanism cannot tell the difference between a cancer cell and a cell being reperfused with oxygen. Something throws the switch that makes the cell die.” When someone collapses on the street of cardiac arrest, if he's lucky he will receive immediate CPR, maintaining circulation until he can be revived in the hospital. But the rest will have gone 10 or 15 minutes or more without a heartbeat by the time they reach the emergency department. And then what happens? “We give them oxygen,” Becker says. “We jolt the heart with the paddles, we pump in epinephrine to force it to beat, so it's taking up more oxygen.” Blood-starved heart muscle is suddenly flooded with oxygen, precisely the situation that leads to cell death. Instead, Becker says, we should aim to reduce oxygen uptake, slow metabolism and adjust the blood chemistry for gradual and safe reperfusion. “In an emergency department, you work like mad for half an hour on someone whose heart stopped, and finally someone says, ‘I don't think we're going to get this guy back,’ and then you just stop,” Becker says. The body on the cart is dead, but its trillions of cells are all still alive. Becker wants to resolve that paradox in favor of life.

Courtesy [Keelynet](#)

Courtesy [Keelynet](#)

05/06/07 - [Nature inspired Vacuum gap electronics TOC](#)



IBM is learning from naturally-forming patterns that create seashells, snowflakes and tooth enamel to build its next family of computer chips. IBM said the “self-assembling nanotechnology,” expected to be integrated into its chips in 2009, increases the flow of

electrical signals by 35 percent while using 15 percent less power in comparison with traditional chip-building techniques. The new process involves the use of “airgap” insulation for the millions of electrical paths, or ultra thin copper wires that make up each chip. Carbon silicate glass insulation is now used to keep the electrical signal in each path separated so data can be processed properly. Without proper insulation, the signals could become jumbled. Airgap technology relies on a vacuum between the wires to keep data paths separated. Vacuum is a better insulator than carbon silicate, which becomes more fragile as chip components and circuits get smaller, the company said.

Courtesy [Keelynet](#)

07/06/07 - [Researchers Prove Existence Of New Type Of Electron Wave TOC](#)

“The acoustic surface plasmon, which will have implications for developments in nano-optics, high-temperature superconductors, and the fundamental understanding of chemical reactions on surfaces. [...] ‘The existence of this wave means that the electrons on the surfaces of copper, iron, beryllium and other metals behave like water on a lake's surface,’ says Diaconescu, a postdoctoral research associate in the Condensed Matter Group of the physics department at UNH. ‘When a stone is thrown into a lake, waves spread radially in all directions. A similar wave can be created by the electrons on a metal surface when they are disturbed, for instance, by light.’”

Courtesy [Keelynet](#)

“People who shut their eyes to reality simply invite their own destruction, and anyone who insists on remaining in a state of innocence long after that innocence is dead turns himself into a monster.”

James Baldwin Biography - Fiction Writer, Essayist, Social Critic, 1924-1987

Courtesy [Keelynet](#)
06/01/07 - [Hollow Earthers' favorite experiment analyzed](#) [TOC](#)

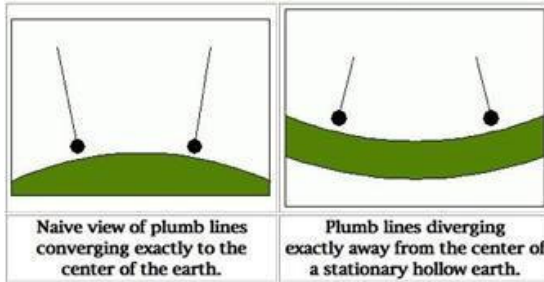

In 1901 a mining engineer named J.B. Watson was said to have dropped plumb bobs down two 4250 foot mine shafts spaced 3200 feet apart. His measurements indicated that the plumb lines were farther apart at the bottom than they were at the top. In other words, they diverged as they descended. Common sense would tell you that the lines would converge as they descended, because the lines should point towards the center of the Earth. For the last century, some people like to point to the Tamarack Mines experiment as proof that the Earth is hollow. Donald E. Simanek, who writes for MAKE magazine about curious physics has an excellent article on his website that recounts the history of the alleged experiment, and examines the different frequently-offered reasons why plumb lines might diverge like this. [More Info](#)
Courtesy [Keelynet](#)

Bonus Features

Tourmaline, Water and the MRET

Be sure to check out
<http://oregonite.blogspot.com/>
and <http://biogenesislab.blogspot.com/>
for a ton of tech info on materials similar to orgone matrix material and other alternative technologies.

Tourmaline - A source of Far Infrared (FIR) and Negative Ions [TOC](#)

By Thomas Aaron
courtesy <http://oregonite.blogspot.com/>
and <http://biogenesislab.blogspot.com/>

Bi-coloured tourmaline crystal, 0.8 inches long (2 cm).



Made without a camera by laying the item on a flat bed scanner.

Taken by Adrian Pingstone in May 2003 and released to the public domain.

(courtesy wikipedia)

Tourmaline is prized as a beautiful, semi-precious gem.

Now, as a mineral, it has become a focus of research at universities and research centers worldwide.

The reason - infrared Tourmaline is the only one mineral to show permanent electricity on the earth and is also a natural (non-manufactured) source of negative ions and far infrared (FIR) rays.

It is also known to be helpful for improving circulation, relieving stress, increasing mental alertness and strengthening the immune system function (Niwa Institute for Immunology, Japan. Int J. Biometeorol 1993 Sep; 37(3) 133-8).

Around 1986, it was found in a research station in Japan that, even though tourmaline was broken down in smaller pieces, a positive and a negative electrode existed on both end of the crystal, and the electrodes never disappeared unless tourmaline was boiled near 1000°C.

In addition, when the positive and the negative electrodes of a tourmaline crystal were connected to each other, it was proven to show low electricity of 0.06mA.

Tourmaline, in your filter, is used to naturally transform water into mild alkaline water, reduce water clustering (what happens to our stored water) and has anti-bacterial and deodorant qualities.

Treated water applied to the skin gives an excellent effect of moisturizing and absorption.

In addition, Tourmaline generates FIR that purifies the water, and acts like a 'supercharger', assisting the water alkalizer to ionize and alkalize.

Tourmaline has been researched and found to activate animal & plant metabolism.

Tourmaline has an immediate and powerful effect on water in the filter with the surfactant effect (makes water wetter) increasing by 101%.

Negatively ionizes water and supports extra negative ionization in the water alkalizer. (24,140/cc) / FIR (96%)

Reduces cluster size

Enhances taste

Assists alkalization

Minimizes water odor

Increases DO (Dissolved Oxygen)

The far infrared energy that Tourmaline naturally emits causes a resonance in the body at the same frequency as water.

All matter is made up of uniquely-arranged electrons and molecules all moving in unison.

When molecules are illuminated with electromagnetic radiation of the same intrinsic vibration frequency as the substance itself, the electromagnetic wave energy is absorbed and the amplitude of that substance's molecular vibration is increased.

That's why when FIR, having the same vibration frequency, illuminates a substance, that substance will filter out the FIR and experience a "resonance absorption." This is a process known as "resonance-absorption to heat-generation" with the aid of FIR.

In other words, the vibration of atoms and molecules will result in resonance absorption.

When we feel hot, we will instinctively seek shade. When we feel cold, we seek the warmth of sunshine. No one teaches us these responses. We have an innate desire for a comfortable temperature. Comfortable temperatures are actually synonymous with a comfortable energy frequency or "wavelength." That wavelength happens to be 8 to 14 microns - the same as FIR.

The seventy-five percent of our bodies composed of water, protein, fat and other substances - all must function properly to sustain life.

When living things absorb FIR of 8 to 14 micron wavelength, they experience resonance absorption. The vibrating movement of molecules in living tissue produces an increase in energy which in turn activates cells and enhances metabolism.

FIR has three properties: radiation, deep penetration, and resonance absorption. Let's look at the relationship between these three properties and living things.

First, radiation: it means it can directly reach human bodies just like light does. For example, sunlight, which is also radiation, reaches earth through the vastness of space.

Second, deep penetration: FIR can reach well into subcutaneous layers of the body (or water) with its deep penetration ability, generating internal warmth suitable for molecule activation in living tissue.

The third feature is resonance absorption: Once illuminated, there is intrinsic vibration of body components - water, protein, fat, enzymes. And, the interior of molecules - atoms and atomic structures - experience the resonance absorption of FIR of their same frequency. This elevation of molecular energy is known as "resonance and absorption."

© Thomas Aaron

Bio-Magnetic Hydrology: MRET Smirnov The Effect of a Specially Modified Electromagnetic Field on the Molecular Structure of Liquid Water [TOC](#)

© Copyright 2003 by Dr. Igor V. Smirnov, Ph.D. & M.S., and President, Global Quantec, Inc.; USA
(Explore Issue: Volume 13, Number 1)
courtesy <http://oregonite.blogspot.com/>
and <http://biogenesislab.blogspot.com/>

Water is the foundation for all life processes. Although even today most of people still assume that water is only H₂O. It has been proven that water has a very complicated structure which was only recently begun to be researched. It is not surprising, therefore, that when judging the quality of water, its structure (molecular orientation in space) is seldom considered. Modern research in biophysics proved that even slight change in molecular structure of water could dramatically change physical and physiological properties of water. Water has the capacity to receive, store and to pass on information in the form of electromagnetic signals. In general this process is

similar to the process of receiving and storing information in the silicon chips of modern electronics. It is probable that the information retention within water results from dynamic modification of the molecular structure of water. This property of water is especially important for living organisms: on the one hand water acts as an information carrier within the organism itself, while on the other hand; essential information necessary for life is carried by water from the outside environment into the metabolism. It is generally known that all metabolic reactions in two living organisms take place within colloidal solutions. In colloidal solutions substances are dispersed in such a fine manner that they can no longer be differentiated from the liquid.

Important examples are blood, plant juices, etc. Disturbances of these colloidal systems, or even worse, their total disruption, are synonymous with degenerative conditions of diseases. There is a relationship between the health of living organisms and the colloidal state in its tissues. The stability of colloidal solutions stands in a direct physical relationship to the molecular structure of water. It is important for the stability of colloidal systems that the structure of water exerts a great degree of organization upon the colloidal particles. The extent and propagation of such an ordered state throughout the water could be described as its information content. Another word the more organized the molecular structure of water the more stable is colloidal system. In this way we can recognize the relationship between the function of water as the carrier of information and its role as the fundamental carrier medium for colloidal systems. Good drinking water, which meets these requirements, can stabilize the colloidal condition within our body fluids and considerably influence and promote cellular health. Whether or not water can meet these requirements cannot be determined exclusively through quantitative analysis of dissolved substances or chemical purity tests. An equally important determining factor, perhaps having even greater significance, is the prior physical history of the water itself.

There are lots of types of purified waters such as spring, distilled, colloidal, and nanoclustered waters. But no process has previously been known which can alter the molecular structure of water without any foreign substances being introduced into the water. This invention relies on the idea that electromagnetic radiation can affect the atomic and molecular structures of substances. This fact was proved by specific class of experiments involving

Rydberg atoms - atoms with an electron in a highly extended orbital (Rydberg Atoms - Giants of the Atomic World by F. Barry Dunning in Science Spectra issue 3, pp. 34-38, 1995).

The effect an electromagnetic force has on an atom depends on the atom's electronic structure during the interaction. One could imagine that the application of the appropriate time-dependent force to an atom could alter its electronic structure in a specific way, thereby controlling its response to subsequent radiative or collisional processes. Furthermore, the specificity of certain reactions of electronic structure might be exploited to reconstruct the motion of the atomic electron cloud. The key to the manipulation of electronic structure in atoms is the generation of electromagnetic fields or radiation that will push and pull the electronic wave function in a controlled and reproducible way. (Modifying Atomic Architecture by Robert R. Jones in Science Spectra Issue 22, pp. 52-59, 2000). The mechanism that explains the effect of electromagnetic fields on water is related to the existence of defects in molecular structure of water. The stable structural changes in water were detected in experiments by the UV luminescence spectrophotometer. They have been attributed to different water structural defects that include specific centers of luminescence. The nuclear proton spins were considered to be a primary targets of external magnetic fields, since proton lattice of water molecules is unstable and asymmetric. The structural metastability of water was associated with microscopic orbital currents of protons in water-molecular hexagons, and deviation from the stoichiometric composition of water. The effects of memory of water interacting with electromagnetic fields were supposed to originate from the oscillations of water molecular hexagons.

© Copyright 2003 by Dr. Igor V. Smirnov, Ph.D. & M.S., and President, Global Quantec, Inc.; USA (Explore Issue: Volume 13, Number 1)

SUPERCOIL



<http://supercoil.blogspot.com/>

Tourmaline TOC

Courtesy Wikipedia

<http://en.wikipedia.org/wiki/Tourmaline>



Tourmaline in cluster with other minerals This image has been (or is hereby) released into the public domain by its author, Reno Chris at the wikipedia project. This applies worldwide. In case this is not legally possible: Reno Chris grants anyone the right to

use this work for any purpose, without any conditions, unless such conditions are required by law.

The tourmaline [mineral](#) group is chemically one of the most complicated groups of [silicate minerals](#). Its composition varies widely because of isomorphous replacement (solid solution), and its general formula can be written as

$XY_3Z_6(T_6O_{18})(BO_3)_3V_3W$, where:^[3]

X = Ca, Na, K, vacancy

Y = Li, Mg, Fe²⁺, Mn²⁺, Zn, Al, Cr³⁺, V³⁺, Fe³⁺, Ti⁴⁺

Z = Mg, Al, Fe³⁺, Cr³⁺, V³⁺

T = Si, Al, B

B = B, vacancy

V = OH, O

W = OH, F, O

Tourmaline belongs to the [trigonal](#) crystal system and occurs as long, slender to thick prismatic and columnar [crystals](#) that are usually triangular in cross-section. Interestingly, the style of termination at the ends of [crystals](#) is asymmetrical, called hemimorphism. Small slender prismatic crystals are common in a fine-grained [granite](#) called [aplite](#), often forming radial daisy-like patterns. Tourmaline is distinguished by its three-sided prisms; no other common mineral has three sides. Prisms faces often have heavy vertical striations that produce a rounded triangular effect. Tourmaline is rarely perfectly [euhedral](#). An exception was the fine dravite tourmalines of [Yinnietharra](#), in western [Australia](#). The deposit was discovered in the [1970s](#), but is now exhausted.

All hemimorphic crystals are [piezoelectric](#), and are often [pyroelectric](#) as well. Tourmaline crystals when warmed become positively charged at one end and negatively charged at the other. Due to this

effect, tourmaline crystals in collections may attract unsightly coatings of dust when displayed under hot spotlights. Tourmaline's unusual electrical properties made it famous in the early 18th century. Brightly colored [Sri Lankan](#) gem tourmalines were brought to Europe in great quantities by the [Dutch East India Company](#) to satisfy a demand for curiosities and gems. At the time it was not realised that schorl and tourmaline were the same mineral.

Tourmaline has a wide variety of [colors](#). Usually, iron-rich tourmalines are black to bluish-black to deep brown, while magnesium-rich varieties are [brown](#) to [yellow](#), and lithium-rich tourmalines are practically any color: blue, green, red, yellow, pink etc. Rarely, it is colorless. Bi-colored and multicolored crystals are relatively common, reflecting variations of fluid chemistry during crystallisation. Crystals may be green at one end and pink at the other, or green on the outside and pink inside: this type is called [watermelon](#) tourmaline. Some forms of tourmaline are [dichroic](#), in that they appear to change color when viewed from different directions.

The most common variety of tourmaline is schorl. It may account for 95% or more of all tourmaline in nature. The early history of the mineral schorl shows that the name "Schorl" was in use prior to the year [1400](#) (AD) because a village known today as [Zschorlau](#) (in [Saxony, Germany](#)) was then named "Schorl" (or minor variants of this name). This village had a nearby tin mine where, in addition to [cassiterite](#), a lot of black tourmaline was found. The first relatively detailed description of schorl with the name "schürle" and its occurrence (various tin mines in the [Saxony Ore Mountains](#)) was written by [Johannes Mathesius](#) (1504-1565) in [1562](#) under the title "Sarepta oder Bergpostill" (Ertl, 2006). Up to about [1600](#), additional names used in the [German language](#) were "Schurel", "Schörle", and "Schurl". From the 18th century on, the name "Schörl" was mainly used in the German-speaking area. In [English](#), the names "shorl" and "shirl" were used in the 18th century for schorl. In the 19th century the names "common schorl", "schörl", "schorl" and "iron tourmaline" were used in the Anglo-Saxon area (Ertl, 2006). The word tourmaline has two etymologies, both from the [Sinhalese](#) word turamali, meaning "stone attracting ash" (a reference to its pyroelectric properties) or according to other sources "mixed gemstones". The meaning of the word "schorl" is a mystery, but it may be a [Scandinavian](#) word.

The name dravite was used for the first time by Gustav Tschermak (*1836 - †1927; Professor of

mineralogy and petrography at the University of Vienna) in his book “Lehrbuch der Mineralogie” (published in 1884) for Mg-rich (and Na-rich) tourmaline from the village Unterdrauburg, Drava river area, Carinthia, Austro-Hungarian Empire. Today this tourmaline locality (type locality for dravite) at the village Dravograd (near Dobrova pri Dravogradu), is a part of the Republic of Slovenia (Ertl, 2007). Tschermak gave this tourmaline the name dravite, for the Drava river area, which is the district along the Drava River (in German: Drau, in Latin: Drave) in Austria and Slovenia. The chemical composition which was given by Tschermak in 1884 for this dravite approximately corresponds to the formula $\text{NaMg}_3(\text{Al,Mg})_6\text{B}_3\text{Si}_6\text{O}_{27}(\text{OH})$, which is in good agreement (except for the OH content) with the endmember formula of dravite as known today (Ertl, 2007).



Schorl This image is a work of the “Minerals in Your World” project, a cooperative effort between the United States Geological Survey and the Mineral Information Institute. The images were featured in the “Minerals and Materials Photo Gallery” on the website of the U.S House Subcommittee on Energy and Natural Resources. As a work of the U.S. federal government, the image is in the public domain.

Tourmaline is found in two main geological occurrences. [Igneous rocks](#), in particular [granite](#) and granite [pegmatite](#) and in [metamorphic](#) rocks such as [schist](#) and [marble](#). Schorl and lithium-rich tourmalines are usually found in [granite](#) and granite [pegmatite](#). Magnesium-rich tourmalines, dravites, are generally restricted to [schists](#) and [marble](#). Also, tourmaline is a durable mineral and can be found in minor amounts as grains in [sandstone](#) and [conglomerate](#).

Today, gem and specimen tourmaline is mined chiefly in [Brazil](#) and [Africa](#). Some placer material

suitable for gem use comes from Sri Lanka. Some fine gem and specimen material has been produced in the US, with the first discoveries having been made in 1822, in the state of [Maine](#). [California](#) became a large producer of tourmaline in the early 1900s. The Maine deposits tend to produce crystals in raspberry pink-red as well as minty greens. The California deposits are known for bright pinks, as well as interesting bicolors. During the early 1900s, Maine and California were the worlds largest producers of gem tourmalines. The Empress Dowager [Tz'u Hsi](#), the last Empress of [China](#), loved pink tourmaline and bought large quantities for gemstones and carvings from the then new Himalaya Mine, located in [San Diego County](#), California. ^[4]

Almost every color of tourmaline can be found in Brazil, especially in the Brazilian states of [Minas Gerais](#) and [Bahia](#). In [1989](#), miners discovered a unique and brightly colored variety of tourmaline in the state of Paraiba. The new type of tourmaline, which soon became known as paraiba tourmaline, came in unusually vivid blues and greens. These colors were often described as “neon” since they appeared to glow. Brazilian paraiba tourmaline is usually heavily included. Much of the paraiba tourmaline from Brazil actually comes from the neighboring state of Rio Grande do Norte. Material from Rio Grande do Norte is often somewhat less intense in color, but many fine gems are found there. It was determined that the element [copper](#) was important in the coloration of the stone. The demand and excitement for this new material, which has fetched more than \$50,000 per carat, earned more respect for the other colors of tourmaline. In the late 90s, copper-containing tourmaline was found in Nigeria. The material was generally paler and less saturated than the Brazilian materials, although the material generally was much less included. A more recent [African](#) discovery from Mozambique has also produced beautiful tourmaline colored by copper, similar to the Brazilian [paraiba](#). While its colors are somewhat less bright than top Brazilian material, Mozambique paraiba is often less included and has been found in larger sizes. The Mozambique paraiba material usually is more intensely colored than the Nigerian. There is a significant overlap in color and clarity with Mozambique paraiba and Brazilian paraiba, especially with the material from Rio Grande do Norte. While less expensive than top quality Brazilian paraiba, some Mozambique material sells for well over \$5,000 per carat, which still is extremely high compared to other tourmalines.

Another unique variety that is also highly valued is chrome tourmaline, a rare type of dravite tourmaline from [Tanzania](#) which occurs in a very rich green color caused by chromium, the same element which causes the green in emerald. Of the standard Elbaite colors, generally blue indicolite gems are the most expensive, followed by green verdelite and pink to red rubellite. There are also yellow tourmalines, sometimes known as canary tourmaline. Ironically the rarest variety, colorless achroite, is not appreciated and is the least expensive of the transparent tourmalines. In addition to Brazil, significant amounts of tourmaline are also mined in [Tanzania](#), [Nigeria](#), [Kenya](#), [Madagascar](#), [Mozambique](#), [Namibia](#), [Afghanistan](#), [Pakistan](#), and [Sri Lanka](#), and [Malawi](#).^[5]

Some tourmaline gems, especially pink to red colored stones, are altered by [irradiation](#) to improve their color. Irradiation is almost impossible to detect in tourmalines, and does not impact the value. Heavily-included tourmalines, such as rubellite and Brazilian paraiba are sometimes clarity enhanced, which must be disclosed to the buyer. A clarity-enhanced tourmaline (especially paraiba) is worth much less than a non-treated gem.^[6]

Tourmaline Species and Varieties

- Dravite Species: from the Drave district of [Carinthia](#)
Dark yellow to brownish black - dravite
- Schorl Species:
Bluish or brownish black to Black - schorl
- Elbaite Species: named after the island of [Elba, Italy](#)
Rose or pink - rubellite variety (from [ruby](#))
Dark blue - indicolite variety (from [indigo](#))
Light blue - [Brazilian sapphire](#) variety
Green - verdelite or Brazilian [emerald](#) variety
Colorless - achroite variety (from the [Greek](#) for "colorless")
The 14 recognized minerals in the group (endmember formulas)
[Buergerite](#)
 $\text{NaFe}^{3+}_3\text{Al}_6\text{Si}_6\text{O}_{18}(\text{BO}_3)_3\text{O}_3\text{F}$
[Chromdravite](#)
 $\text{NaMg}_3\text{Cr}_6\text{Si}_6\text{O}_{18}(\text{BO}_3)_3(\text{OH})_4$
[Dravite](#)
 $\text{NaMg}_3\text{Al}_6\text{Si}_6\text{O}_{18}(\text{BO}_3)_3(\text{OH})_4$
[Elbaite](#)
 $\text{Na}(\text{Li}_{1.5}\text{Al}_{1.5})\text{Al}_6\text{Si}_6\text{O}_{18}(\text{BO}_3)_3(\text{OH})_4$
[Feruvite](#)
 $\text{CaFe}^{2+}_3(\text{MgAl}_5)\text{Si}_6\text{O}_{18}(\text{BO}_3)_3(\text{OH})_4$
[Foitite](#)
 $(\text{Fe}^{2+}_2\text{Al})\text{Al}_6\text{Si}_6\text{O}_{18}(\text{BO}_3)_3(\text{OH})_4$
[Liddicoatite](#)
 $\text{Ca}(\text{Li}_2\text{Al})\text{Al}_6\text{Si}_6\text{O}_{18}(\text{BO}_3)_3(\text{OH})_3\text{F}$
[Magnesiofoitite](#)
 $(\text{Mg}_2\text{Al})\text{Al}_6\text{Si}_6\text{O}_{18}(\text{BO}_3)_3(\text{OH})_4$

Olenite

$\text{NaAl}_3\text{Al}_6\text{Si}_6\text{O}_{18}(\text{BO}_3)_3\text{O}_3\text{OH}$

Povondraite

$\text{NaFe}^{3+}_3(\text{Fe}^{3+}_4\text{Mg}_2)\text{Si}_6\text{O}_{18}(\text{BO}_3)_3(\text{OH})_3\text{O}$

Rossmannite

$(\text{LiAl}_2)\text{Al}_6\text{Si}_6\text{O}_{18}(\text{BO}_3)_3(\text{OH})_4$

Schorl

$\text{NaFe}^{2+}_3\text{Al}_6\text{Si}_6\text{O}_{18}(\text{BO}_3)_3(\text{OH})_4$

Uvite

$\text{CaMg}_3(\text{MgAl}_5)\text{Si}_6\text{O}_{18}(\text{BO}_3)_3(\text{OH})_3\text{F}$

Vanadiumdravite

$\text{NaMg}_3\text{V}_6\text{Si}_6\text{O}_{18}(\text{BO}_3)_3(\text{OH})_4$

References

- ^ [a b c d e f g h i](#) [Gemological Institute of America](#), GIA Gem Reference Guide 1995, [ISBN 0-87311-019-6](#)
- ^ [Mindat tourmaline group](#) Accessed [September 12, 2005](#). This website details specifically and clearly how the complicated chemical formula is structured.
- ^ Hawthorne, F.C. & Henry, D.J. (1999). Classification of the minerals of the tourmaline group. *European Journal of Mineralogy*, 11, pp 201-215.^[1]
- ^ [Exploring and Mining Gems and Gold in the West](#), By Fred Rynerson - Naturegraph Publishers.
- ^ [Manual of Mineralogy](#) (after Dana), 19th Edition, By Hurlbut and Klein - John Wiley and Sons, Publishers
- ^ [Gemstone Enhancement: Heat, Irradiation, Impregnation, Dyeing, and Other Treatments](#) by Kurt Nassau; Butterworth Publishers 1984
- Ertl, A., Pertlik, F. & Bernhardt, H.-J. (1997) Investigations on olenite with excess boron from the [Koralpe](#), Styria, Austria, *Österreichische Akademie der Wissenschaften, Mathematisch-Naturwissenschaftliche Klasse, Abt. I, Anzeiger*, 134, pp 3-10. [Article Online](#)
- Ertl, A. (2006) About the etymology and the type localities of schorl *Mitteilungen der Österreichischen Mineralogischen Gesellschaft*, 152, 2006, pp 7–16. [Article Online](#)
- Ertl, A. (2007) About the type locality and the nomenclature of dravite *Mitteilungen der Österreichischen Mineralogischen Gesellschaft*, 153, 2007, pp 265–271. [Article Online](#)
- Schumann, Walter (2006) *Gemstones of the World 3rd Edition* Sterling Publishing, New York; pp 126-127
Courtesy Wikipedia
<http://en.wikipedia.org/wiki/Tourmaline>
(this article's) Text is available under the terms of the [GNU Free Documentation License](#). (See [Copyrights](#) for details.)
Wikipedia® is a registered trademark of the [Wikimedia Foundation, Inc.](#), a U.S. registered [501\(c\)\(3\) tax-deductible nonprofit charity](#).

Courtesy [Keelynet](#)

05/07/07 - [Garments treated with metallic nanoparticles prevent colds and flu](#) [TOC](#)

Fashion designers and fiber scientists at Cornell have taken "functional clothing" to a whole new level. They have designed a garment that can prevent colds and flu and never needs washing, and another that destroys harmful gases and protects the wearer from smog and air pollution. Ong's dress

and jacket, part of her original fashion line called “Glitterati,” look innocently hip. But closer inspection—with a microscope, that is—shows an army of electrostatically charged nanoparticles creating a protective shield around the cotton fibers in the top part of the dress, and the sleeves, hood and pockets of the jacket. Dong explained that the fabrics were created by dipping them in solutions containing nanoparticles synthesized in Hinestroza’s lab. The resultant colors are not the product of dyes, but rather, reflections of manipulation of particle size or arrangement. The upper portion of the dress contains cotton coated with silver nanoparticles. Dong first created positively charged cotton fibers using ammonium- and epoxy-based reactions, inducing positive ionization. The silver particles, about 10-20 nanometers across (a nanometer is one-billionth of a meter) were synthesized in citric acid, which prevented nanoparticle agglomeration. Dipping the positively charged cotton into the negatively charged silver nanoparticle solution resulted in the particles clinging to the cotton fibers. Silver possesses natural antibacterial qualities that are strengthened at the nanoscale, thus giving Ong’s dress the ability to deactivate many harmful bacteria and viruses. The silver infusion also reduces the need to wash the garment, since it destroys bacteria, and the small size of the particles prevents soiling and stains. The denim jacket includes a hood, sleeves and pockets with soft, gray tweed cotton embedded with palladium nanoparticles, about 5-10 nanometers in length. To create the material, Dong placed negatively charged palladium crystals onto positively charged cotton fibers.

Courtesy [Keelynet](#)



<http://www.physorg.com/>

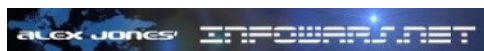

<http://www.infowars.net/index.html>

[TOC](#) (cont. on pg. 133)

WD 40

I had a neighbour who had bought a new pickup. I got up very early one Sunday morning and saw that someone had spray painted red all around the sides of this beige truck (for some unknown reason). I went over, woke him up, and told him the bad news. He was very upset and was trying to figure out what to do probably nothing until Monday morning, since nothing was open. Another neighbour came out and told him to get his WD-40 and clean it off. It removed the unwanted paint beautifully and did not harm his paint job that was on the truck. I'm impressed! WD-40 who knew?

Water Displacement #40. The product began from a search for a rust preventative solvent and degreaser to protect missile parts. WD-40 was created in 1953 by three technicians at the San Diego Rocket Chemical Company. Its name comes from the project that was to find a "water displacement" compound. They were successful with the fortieth formulation, thus WD-40. The Convair Company bought it in bulk to protect their atlas missile parts.

Ken East (one of the original founders) says there is nothing in WD-40 that would hurt you.

When you read the "shower door" part, try it. It's the first thing that has ever cleaned that spotty shower door. If yours is plastic, it works just as well as glass. It's a miracle! Then try it on your stovetop... Voila! It's now shinier than it's ever been. You'll be amazed.

Here are some of the uses:

- 1) Protects silver from tarnishing.
- 2) Removes road tar and grime from cars.
- 3) Cleans and lubricates guitar strings.
- 4) Gives floors that 'just-waxed' sheen without making it slippery.
- 5) Keeps flies off cows.
- 6) Restores and cleans chalkboards.
- 7) Removes lipstick stains.
- 8) Loosens stubborn zippers.
- 9) Untangles jewellery chains.
- 10) Removes stains from stainless steel sinks.
- 11) Removes dirt and grime from the barbecue grill.
- 12) Keeps ceramic/terra cotta garden pots from oxidizing.
- 13) Removes tomato stains from clothing.
- 14) Keeps glass shower doors free of water spots.
- 15) Camouflages scratches in ceramic and marble floors.
- 16) Keeps scissors working smoothly.
- 17) Lubricates noisy door hinges on vehicles and doors in homes
- 18) It removes black scuff marks from the kitchen floor! Use WD-40 for those nasty tar and scuff marks on flooring. It doesn't seem to harm the finish and you won't have to scrub nearly as hard to get them off. Just remember to open some windows if you have a lot of marks.
- 19) Bug guts will eat away the finish on your car if not removed quickly!

Use WD-40! (cont. on pg. 133)

Drawing Board TOC

MRET Construction Details – courtesy Thomas Aaron

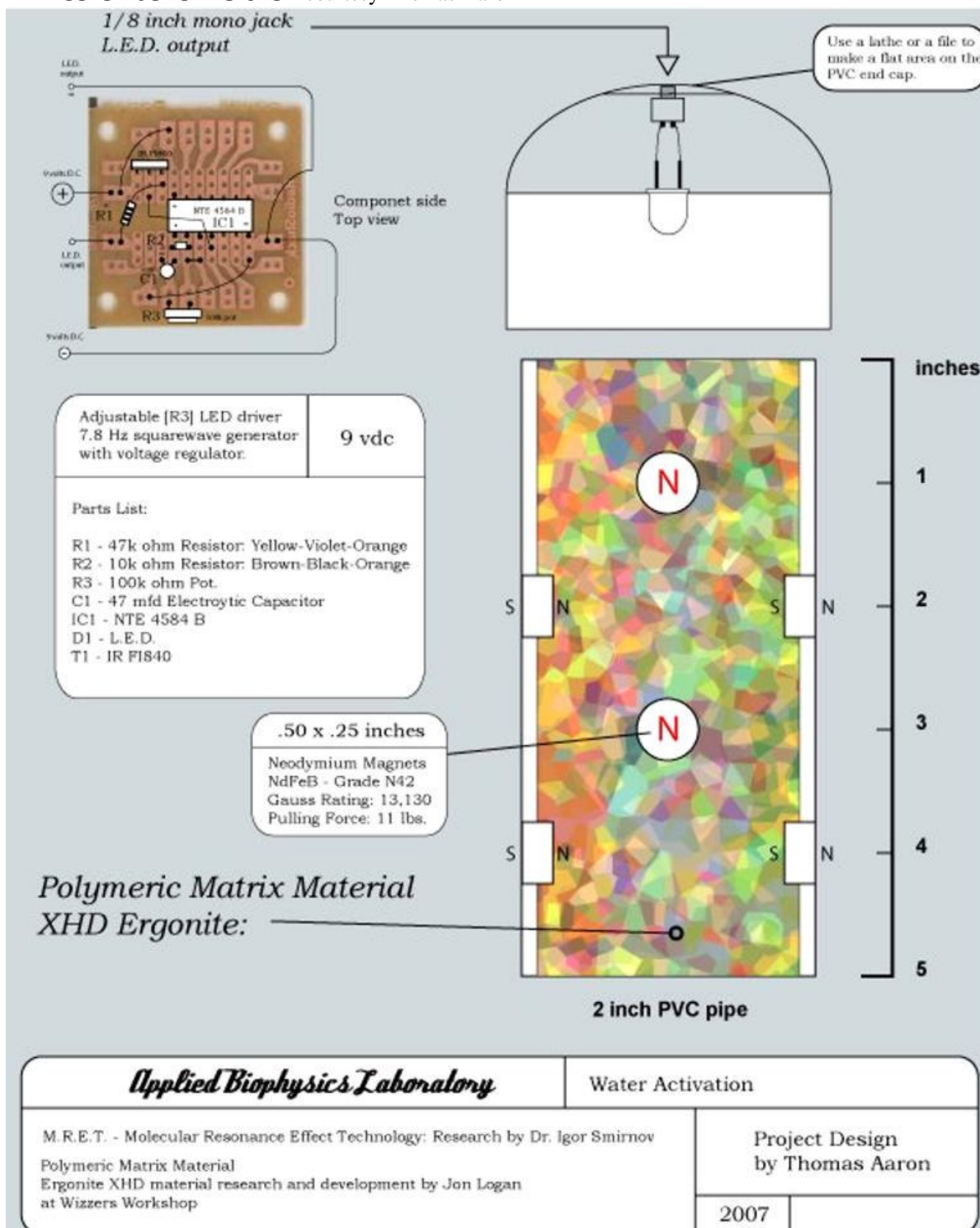

MRET Construction Details – courtesy Thomas Aaron – <http://biogenesislab.blogspot.com/>

Courtesy [Keelynet](#)
07/04/07 - [Brilliant Disguise: Light, Matter and the Zero-Point Field](#) [TOC](#)

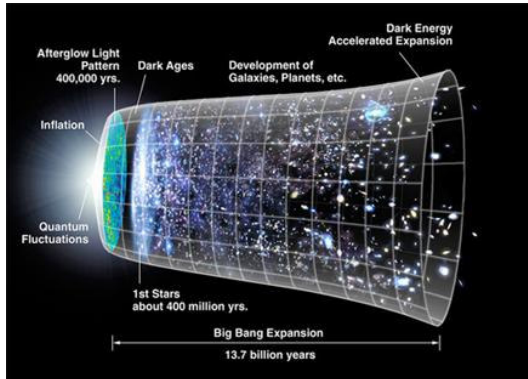

My first inkling that the deceptively simple “Let there be light” might actually contain a profound cosmological truth came in early July 1992. Alfonso Rueda had succeeded in doing was to derive the equation: $F=ma$. Most people will take this in stride with a “so what?” or “what does that mean?” After all what are F , m and a , and what is so noteworthy about a scientist deriving a simple equation? Isn’t this what scientists do for a living? But a physicist will have an incredulous reaction because you are not supposed to be able to derive the equation $F=ma$. That equation was postulated by Newton in his Principia, the foundation stone of physics, in 1687. A postulate is a law that you assume to be true, and from which other things follow: such as much of physics, for example, from that particular postulate. You cannot derive postulates. How do you prove that one plus one equals two? The answer is, you don’t. You assume that abstract numbers work that way, and then derive other properties of addition from that basic assumption. But indeed, as I discovered when I began to write up a research paper based on what Rueda soon sent to Garching, he had indeed derived Newton’s fundamental “equation of motion.” And the concept underlying this analysis was the existence of a background sea of light known as the electromagnetic zero-point field of the quantum vacuum. If you add up all these ceaseless fluctuations, what you get is a background sea of light whose total energy is enormous: the zero-point field. The “zero-point” refers to the fact that even though this energy is huge, it is the lowest possible energy state. All other energy is over and above the zero-point state. Take any volume of space and take away everything else — in other words, create a vacuum — and what you are left with is the zero-point field. We see things by way of contrast. The eye works by letting light fall on the otherwise dark

retina. But if the eye were filled with light, there would be no darkness to afford a contrast. The zero-point field is such a blinding light. Since it is everywhere, inside and outside of us, permeating every atom in our bodies, we are effectively blind to it. It blinds us to its presence. The world of light that we do see is all the rest of the light that is over and above the zero-point field. “Let there be light” is indeed a very profound statement, as one might expect of its purported author. The solid, stable world of matter appears to be sustained at every instant by an underlying sea of quantum light. [Haisch Article](#) - (via [Zpenegy.com](#)) and [The Neutral Center and the Aether Spectrum](#).
 Courtesy [Keelynet](#)

Courtesy [Keelynet](#) [TOC](#)
09/20/07 - [Video - 32 AA batteries for \\$5?](#)
 Don’t want to spend a wad of cash on AA batteries to power your gadgets? Trim down your spending by cracking open the case of a single 6 volt battery which sells for about \$5. Inside you’ll find a whopping 32 AA batteries! Considering that you can get 8 watch batteries from a 12-volt battery and 6 AAA batteries from a 9-volt battery, this isn’t surprising, but since AA batteries are the most popular among the three, this should yield considerable savings. (via [lifehacker.com](#))
 Courtesy [Keelynet](#)



<http://www.reense.com/>

Courtesy [Keelynet](#)
09/18/07 - [EcoWatts: another “free energy” company touts their ‘invention’](#) [TOC](#)

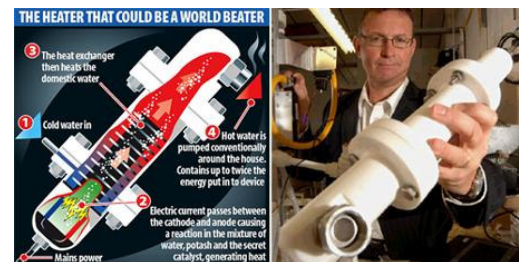

There is another company making claims of free energy. Simply put, nobody is really expecting this machine to work either. The company is called EcoWatts, and they claim that their machine gives off hot water containing twice the energy that it

took to produce the hot water. Call us skeptical. / [12inch miracle tube could halve heating bills](#) - Even the makers of the device are at a loss to explain exactly how it works - but sceptical independent scientists carried out their own tests and discovered that the 12in x 2in tube really does produce far more heat energy than the electrical energy put in. The system - developed by scientists at a firm called Ecowatts in a nondescript laboratory on an industrial estate at Lancing, West Sussex - involves passing an electrical current through a mixture of water, potassium carbonate (otherwise known as potash) and a secret liquid catalyst, based on chrome. This creates a reaction that releases an incredible amount of energy compared to that put in. If the reaction takes place in a unit surrounded by water, the liquid heats up, which could form the basis for a household heating system. If the technology can be developed on a domestic scale, it means consumers will need much less energy for heating and hot water - creating smaller bills and fewer greenhouse gases. We have examined this interesting technology and when we got the rig operating, we were getting 150 to 200 per cent more energy out than we put in, without trying too hard. Ecowatts says the device will cost between £1,500 and £2,000, in line with the price of traditional systems.

Courtesy [Keelynet](#)

Courtesy [Keelynet](#)

09/20/07 - [Haptic Radar Headband Gives Wearer "Sixth-Sense" TOC](#)

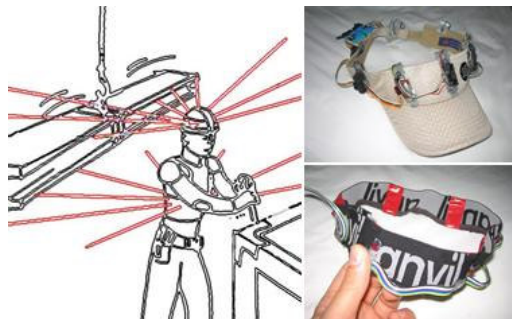

"New Scientist reports on a headband developed at the University of Tokyo that allows the wearer to feel their surroundings at a distance — as if they had cats whiskers. Infrared sensors positioned around the headband vibrate to signal when and where an object is close. There are also a few great videos of people using it to dodge stuff while blindfolded." / The system is composed of an array of "optical-hair modules", each of which senses range information and transduces it as an appropriate vibro-tactile cue on the skin directly

beneath it. An analogy for our artificial sensory system in the animal world would be the cellular cilia, insect antennae, as well as the specialized sensory hairs of mammalian whiskers. In the future, this modular interface may cover precise skin regions or be distributed in over the entire body surface and then function as a double-skin with enhanced and tunable sensing capabilities. In a word, what we are proposing here is to build artificial, wearable, light-based hairs (or antennae). The actual hair stem will be an invisible, steerable laser beam. In the near future, we may be able to create on-chip, skin-implantable whiskers using MOEMS technology. Results in a similar direction have been already achieved in the framework of the smart laser scanner project in our lab. Our first prototype (headband configuration) provides the wearer with 360 degrees of spatial awareness and had very positive reviews in our proof-of-principle experiments.

Courtesy [Keelynet](#)

Reader Response to Anomalous Cooling Effect (issue 3)

[TOC](#)

"Jon-

I've really enjoyed reading your "Modern Orgone" magazine that you allowed us at Crystal Devices to access. I expect to buy any future issues as they become available. I'd say it's the best of its kind, but it's the only of its kind that I've seen. My hat is off to you!

In volume 3, in the article on Lumin White, that heat pump thing was really a brain twister! I'm thinking that some tests could be done that might help shed some light on this phenomenon.

It would be helpful to observe any temperature variances in all of the following wiring schemes:

1. Right channel to mobius 1 & 2 (with their respective ballast resistors)

Left Channel to mobius 3 (with its ballast)

2. Right channel to mobius 1 (with its ballast)

Left Channel to mobius 2 & 3 (with their respective ballast resistors)

3. Right channel to mobius 1 (with its ballast)

Left Channel to mobius 3 (with its ballast)

There are three combinations with all three mobius coils used and three with only two mobius coils. Probably they should all be tested to eliminate the possibility of some irregularity in one of the coils being a causative factor in these temperature differences.

I suspect the temperature differences observed have something to do with negentropy and the asymmetry of the wiring hookup.

Maybe some big antennae would make this thing into a "free" energy heatpump."

-[Bob Roper](#)

Simple Random number algorithm

Courtesy Jon Logan

First, let me say I have taken a long absence from writing software, almost 20 years. Then, less than a year ago, a friend gave me the gift of Visual Studio 6, and I have been tinkering in my spare time since.

I plan to develop an application designed for radionics work with the Scalar Wave Generators that I produce. One of the first things to work on is the ability to 'get a sample' of a radionic data pattern into the computer somehow. This is the aim of the code below. The code is not sufficient for this purpose as is; it needs to be more sensitive. It is just an example of a general coding approach to radionic sampling, and since so little information is available on the internet regarding the code for radionics software, I thought this code might interest some. I offer it as a food for thought, nothing more at this point.

It charts the deviation from perfect randomness associated with each character you type into a text box. The deflection from perfect randomness, seed number, highest and lowest responses, etc. all combine to produce a very primitive form of encoding to represent the subtle energy fields present when the program runs, by looking at the way those subtle energy fields influence the random number generator.

The encoding shows the way the randomness of the number generator changes in real time as you type. This change in randomness (more random or less random) is represented on a scale, and can be used to form a coded 'picture' of the subtle energy fields of the user (if the scan button is pushed), or the intent of the text typed (if text is input manually).

The code in this article may be used freely for **private hobbyist purposes only**.

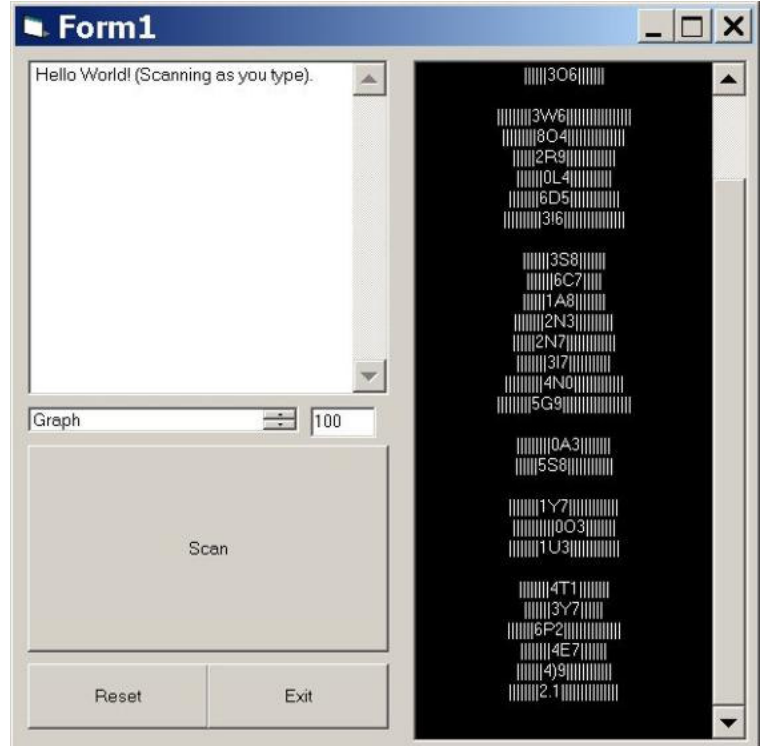

Basically, you give it a seed number (in this case derived from a character typed by the user) and it generates a sequence of random numbers between 0 and 9. Then, it looks at the numbers it rolled and sees which one came up most often and which ones least often. It looks at which number between 0 and 9 'wanted' to be rolled. You enter this number on the smallest text box, near the center of Form1 in the pics here. By default I have set it to 100 (iterations) in the code, program crashes if set to 1000000 (1 million) but runs ok at 100000 (1 hundred thousand) on my machines. Best resolution with the code in this article seemed to be around 100 iterations. More iterations = less changes in the graph, less iterations = more changes in the graph (as one would expect from conventional math).

We rely on subtle energy to influence the random number generator, and then let it roll a whole bunch of times and look at what it did. The way that the randomness changes shows us something about the characteristics of the subtle energy field.

Some numbers will show up more than 'normal' (10% of the time) and other less than normal (10% of the time).

The software is written in Visual Basic 6, and there are additional comments in the code to explain a little more.

In Graph mode, it charts the ‘deflection’ from perfect randomness so that you can see as you type which characters / states of mind provoke a strong, weak or median response from the software.

To use the software (once you have constructed a VB6 project per the info below), Either type some text into the white text box, or press the ‘scan’ button.

Tinker, have fun, but do bear in mind this is just a demo of the concept. The code below only an illustration of a concept.

How to create this software (requires Microsoft Visual Basic 6™/®)

(where applicable(if a line of code takes more than one line of column space in this ezine), remove word wrap and / or delete line breaks from lines of code below when pasting the code into your VB6 project)

- 1 - Open VB6 and create a new (Standard EXE) project.
- 2 - Resize Form1 to 7008 x 7008 twips.
- 3 - Create a textbox on Form1 and modify its properties as follows:
 - change Name to txtCode
 - size it to 3132 x 6372 twips
 - change alignment to 2 - Center
 - change BackColor to Black
 - change ForeColor to White
 - change ScrollBars to 2 - Vertical
 - change MultiLine to True
 - blank the .Text (delete where it says Text1)

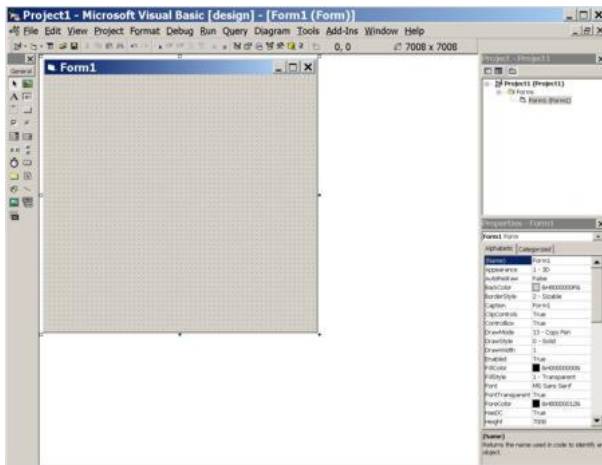

4 - Create another textbox on Form1 and modify its proerties as follows:

- size it to 3372 x 3132 twips
- change Name to txtInput
- change MultiLine to True
- blank the Text (delete where it says Text1)

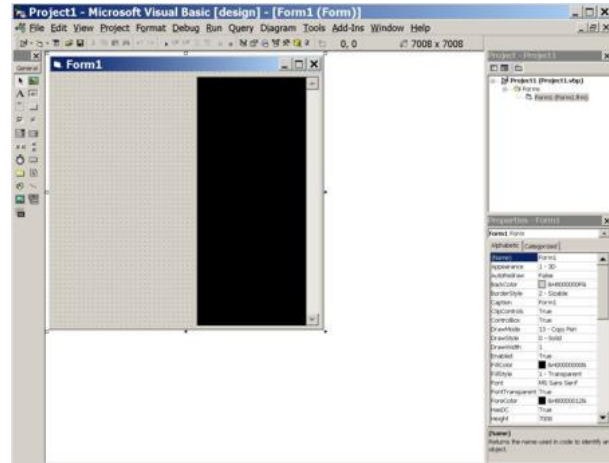

5 - Create another smaller text box on Form1 and modify its properties as follows:

- change Name to txtLoop
- blank the Text (delete where it says Text1)

6 - Create a listbox on Form1 and modify its properties as follows:

- change Name to lstState

7 - Create a command button on Form1 and modify its properties as follows:

- change Name to cmdReset
- change Caption to “Reset”

8 - Create a command button on Form1 and modify its properties as follows:

- change Name to cmdScan
- change Caption to “Scan”

9 - Create a command button on Form1 and modify its properties as follows:

- change Name to cmdExit
- change Caption to “Exit”

10 - Add a new module to the project (Project > Add Module > New > Module > Open).

Copy and paste the following code into Module1: (next several pages)
 ‘(Begin Module1 code)
 Option Explicit

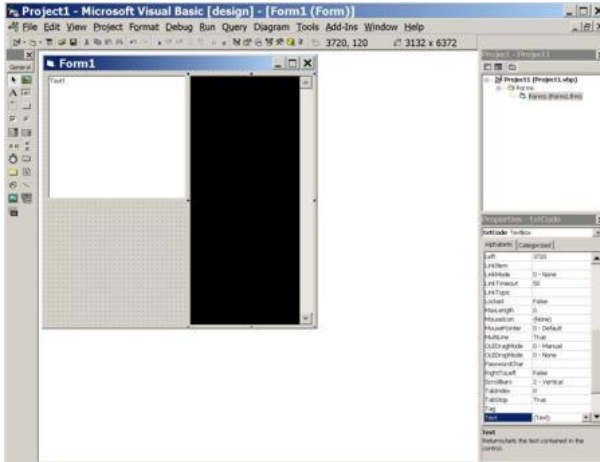

Public Function fncQaballahChar(varCharacter As String) As Integer

‘ Copyright Jon Logan 2008

‘ Free for personal, hobbyist use.

‘ This subroutine converts a single character of input to

‘ a numerological equivalent

‘ variable to carry a number associated with a character

Dim varQaballahChar As Integer

‘ Convert alphabetic characters to numerological equivalent

‘ via Chaldean-Hebrew Qabbalah

If varCharacter = "A" Then varQaballahChar = 1

If varCharacter = "B" Then varQaballahChar = 2

If varCharacter = "C" Then varQaballahChar = 3

If varCharacter = "D" Then varQaballahChar = 4

If varCharacter = "E" Then varQaballahChar = 5

If varCharacter = "F" Then varQaballahChar = 8

If varCharacter = "G" Then varQaballahChar = 3

If varCharacter = "H" Then varQaballahChar = 5

If varCharacter = "I" Then varQaballahChar = 1

If varCharacter = "J" Then varQaballahChar = 1

If varCharacter = "K" Then varQaballahChar = 2

If varCharacter = "L" Then varQaballahChar = 3

If varCharacter = "M" Then varQaballahChar = 4

If varCharacter = "N" Then varQaballahChar = 5

If varCharacter = "O" Then varQaballahChar = 7

If varCharacter = "P" Then varQaballahChar = 8

If varCharacter = "Q" Then varQaballahChar = 1

If varCharacter = "R" Then varQaballahChar = 2

If varCharacter = "S" Then varQaballahChar = 3

If varCharacter = "T" Then varQaballahChar = 4

If varCharacter = "U" Then varQaballahChar = 6

If varCharacter = "V" Then varQaballahChar = 6

If varCharacter = "W" Then varQaballahChar = 6

If varCharacter = "X" Then varQaballahChar = 5

If varCharacter = "Y" Then varQaballahChar = 1

If varCharacter = "Z" Then varQaballahChar = 7

If varCharacter = "" Then varQaballahChar = 100

If varCharacter = "" Then

varQaballahChar = vbNull

MsgBox "No characters entered for Qaballah."

Exit Function

End If

‘ Handle some non-alphabetic characters

If varCharacter = "0" Then varQaballahChar = 0

If varCharacter = "1" Then varQaballahChar = 1

If varCharacter = "2" Then varQaballahChar = 2

If varCharacter = "3" Then varQaballahChar = 3

If varCharacter = "4" Then varQaballahChar = 4

If varCharacter = "5" Then varQaballahChar = 5

If varCharacter = "6" Then varQaballahChar = 6

If varCharacter = "7" Then varQaballahChar = 7

If varCharacter = "8" Then varQaballahChar = 8

If varCharacter = "9" Then varQaballahChar = 8

If varCharacter = "." Then varQaballahChar = 0

If varCharacter = ">" Then varQaballahChar = 9

If varCharacter = "," Then varQaballahChar = 0

If varCharacter = "<" Then varQaballahChar = 6

If varCharacter = "?" Then varQaballahChar = 7

If varCharacter = "/" Then varQaballahChar = 2

If varCharacter = "!" Then varQaballahChar = 1

If varCharacter = "@" Then varQaballahChar = 6

If varCharacter = "#" Then varQaballahChar = 9

If varCharacter = "\$" Then varQaballahChar = 5

If varCharacter = "%" Then varQaballahChar = 5

If varCharacter = "^" Then varQaballahChar = 9

If varCharacter = "&" Then varQaballahChar = 6

If varCharacter = "*" Then varQaballahChar = 8

If varCharacter = "(" Then varQaballahChar = 9

If varCharacter = ")" Then varQaballahChar = 0

If varCharacter = "+" Then varQaballahChar = 6

If varCharacter = "-" Then varQaballahChar = 0

‘ Return the value that fits the character supplied

Let fncQaballahChar = varQaballahChar

End Function

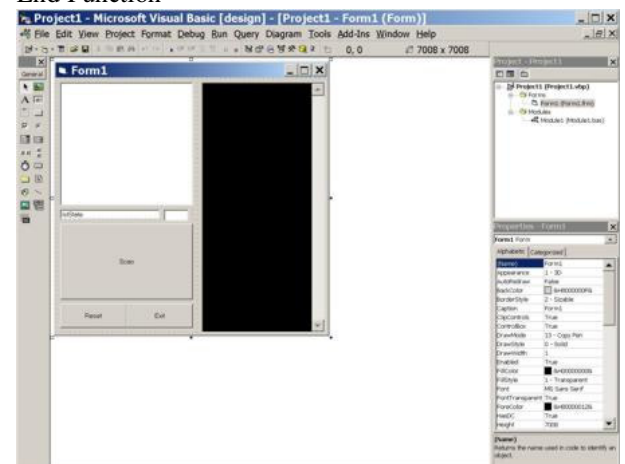

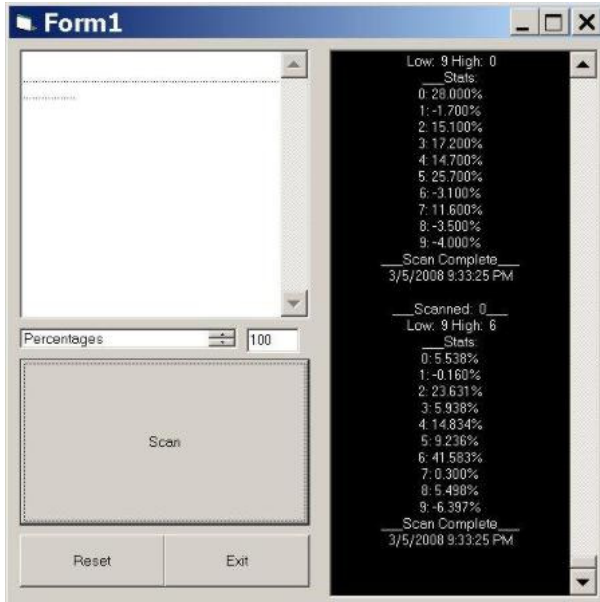

```
Public Function fncRNDScanDemo(varSeed As Double, varLoop As Long, varState As Integer, varCharacter As String) As String
    ' Copyright Jon Logan 2008
    ' Free for personal, hobbyist use
```

```
    ' This function generates a succession of random numbers in response to a
    ' seed number, and then performs a simple analysis of the results, returning a string
    ' which is used to form a simple graphical representation of the amount of
    ' deflection from perfect randomness accompanies a given keystroke.
```

```
    ' Syntax Eg.: Let txtCode.text = fncRNDScanDemo(7,1000,1)
    ' would return the graph for a 1000+ length sequence of numbers, and the seed
    ' number 7 would be used to initiate the sequence.
```

```
    ' Syntax Eg.: Let txtCode.text = fncRNDScanDemo(7,1000,2)
    ' would return the list of 1000+ numbers rolled during the sequence, and
    ' the seed number 7 would be used to initiate the sequence.
```

```
    ' Trim the seed number to 5 decimal places
    Let varSeed = FormatNumber(varSeed, 5)
```

```
    ' Initialize random number generator with seed number
    Randomize (varSeed)
```

```
    ' Setup iteration variable
```

```
    Dim varIteration As Long
```

```
    ' Setup roll variables
```

```
    Dim varRoll As Double
    ' Setup roll hit counter variables
```

```
    Dim varRoll0 As Double
```

```
    Dim varRoll1 As Double
```

```
    Dim varRoll2 As Double
```

```
    Dim varRoll3 As Double
```

```
    Dim varRoll4 As Double
```

```
    Dim varRoll5 As Double
```

```
    Dim varRoll6 As Double
```

```
    Dim varRoll7 As Double
```

```
    Dim varRoll8 As Double
```

```
    Dim varRoll9 As Double
```

```
    Dim varRollx As Double
```

```
    ' Setup roll tracking variables
```

```
    Dim varRollHigh As Double
```

```
    Dim varRollLow As Integer
```

```
    Dim varRollFloat As Long
```

```
    Dim varRollLog As String
```

```
    Let varRollLog = Str(varSeed) + " : "
```

```
    ' Setup roll percentage variables
```

```
    Dim varRollPer0 As Double
```

```
    Dim varRollPer1 As Double
```

```
    Dim varRollPer2 As Double
```

```
    Dim varRollPer3 As Double
```

```
    Dim varRollPer4 As Double
```

```
    Dim varRollPer5 As Double
```

```
    Dim varRollPer6 As Double
```

```
    Dim varRollPer7 As Double
```

```
    Dim varRollPer8 As Double
```

```
    Dim varRollPer9 As Double
```

```
    Dim varHighPer As Double
```

```
    Dim varLowPer As Double
```

```
    'Start the Loop,
    For varIteration = 1 To varLoop
```

```
        ' Generate a random number between 10 and 0
        Let varRoll = ((10 - 0) * Rnd)
```

```
        'Bump one of the following hit counters dependant
        ' on the result of the random roll
```

```
        ' If it rolled in the 0 range
        If varRoll > 0 And varRoll < 1 Then
```

```
            ' Simple hit counter
```

```
            Let varRoll0 = varRoll0 + 1
```

```
            ' Add the number rolled to the Log
```

```
            Let varRollLog = varRollLog & "0"
```

```
            ' Re-Initialize the random number generator based
            on system time for
```

```
            ' 0 and 9 (numbers on the extreme ends of the
            range)
```

Randomize (Time)

```

' Roll again, and give the software the chance
' to roll the same number again
Let varRollx = ((10 - 0) * Rnd)
' If it rolls the same number
If Int(varRollx) = 0 Then
' Boost the hit counter to reward the double roll
' and subtract the same amount from the rest of the
field
' subtract it from the rest of the field according to
proximity
' (subtract most from numbers farthest from the
number rolled)

```

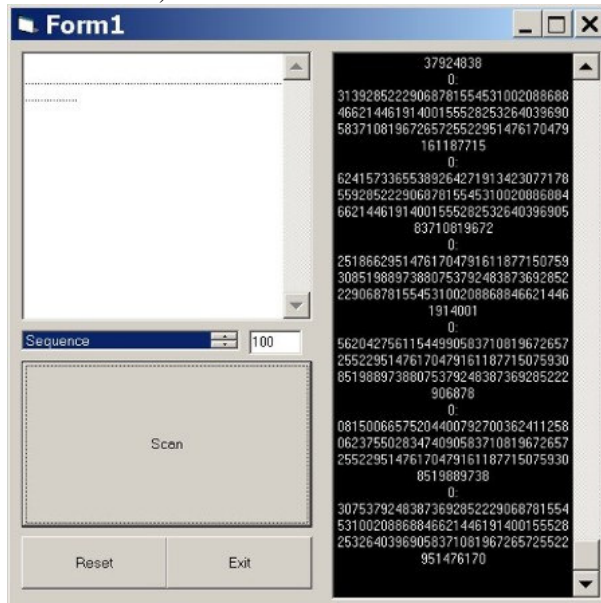

```

Let varRoll0 = varRoll0 + 12
Let varRoll1 = varRoll1 - 0.5
Let varRoll2 = varRoll2 - 1
Let varRoll3 = varRoll3 - 1.5
Let varRoll4 = varRoll4 - 1.5
Let varRoll5 = varRoll5 - 1.5
Let varRoll6 = varRoll6 - 1.5
Let varRoll7 = varRoll7 - 1.5
Let varRoll8 = varRoll8 - 1.5
Let varRoll9 = varRoll9 - 1.5
Let varRollLog = varRollLog & "0"
End If
End If
' If it rolled in the 1 range
If varRoll > 1 And varRoll < 2 Then
Let varRoll1 = varRoll1 + 1
' Add the number rolled to the Log
Let varRollLog = varRollLog & "1"
Let varRollx = ((10 - 0) * Rnd)
If Int(varRollx) = 1 Then
Let varRoll0 = varRoll0 - 0.5
Let varRoll1 = varRoll1 + 12

```

```

Let varRoll2 = varRoll2 - 0.5
Let varRoll3 = varRoll3 - 1
Let varRoll4 = varRoll4 - 1.66
Let varRoll5 = varRoll5 - 1.66
Let varRoll6 = varRoll6 - 1.66
Let varRoll7 = varRoll7 - 1.66
Let varRoll8 = varRoll8 - 1.66
Let varRoll9 = varRoll9 - 1.66
Let varRollLog = varRollLog & "1"
End If

```

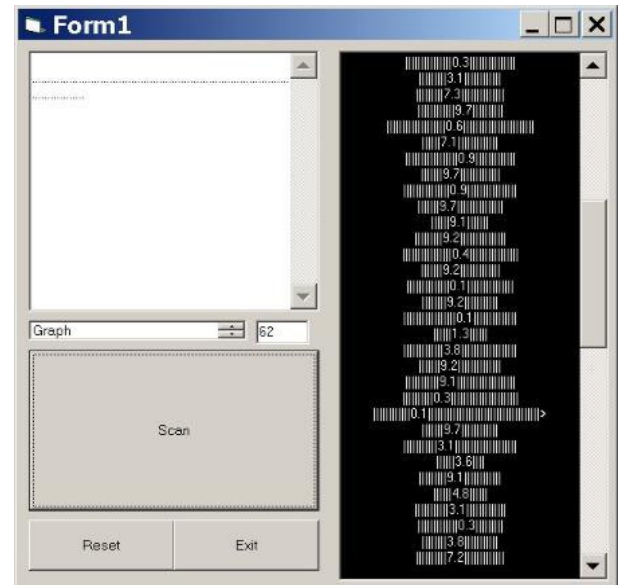

```

End If
' If it rolled in the 2 range
If varRoll > 2 And varRoll < 3 Then
Let varRoll2 = varRoll2 + 1
' Add the number rolled to the Log
Let varRollLog = varRollLog & "2"
Let varRollx = ((10 - 0) * Rnd)
If Int(varRollx) = 2 Then
Let varRoll0 = varRoll0 - 1
Let varRoll1 = varRoll1 - 0.5
Let varRoll2 = varRoll2 + 12
Let varRoll3 = varRoll3 - 0.5
Let varRoll4 = varRoll4 - 1
Let varRoll5 = varRoll5 - 1.8
Let varRoll6 = varRoll6 - 1.8
Let varRoll7 = varRoll7 - 1.8
Let varRoll8 = varRoll8 - 1.8
Let varRoll9 = varRoll9 - 1.8
Let varRollLog = varRollLog & "2"
End If
End If
' If it rolled in the 3 range
If varRoll > 3 And varRoll < 4 Then
Let varRoll3 = varRoll3 + 1
' Add the number rolled to the Log
Let varRollLog = varRollLog & "3"
Let varRollx = ((10 - 0) * Rnd)

```

```

If Int(varRollx) = 3 Then
Let varRoll0 = varRoll0 - 1.8
Let varRoll1 = varRoll1 - 1
Let varRoll2 = varRoll2 - 0.5
Let varRoll3 = varRoll3 + 12
Let varRoll4 = varRoll4 - 0.5
Let varRoll5 = varRoll5 - 1
Let varRoll6 = varRoll6 - 1.8
Let varRoll7 = varRoll7 - 1.8
Let varRoll8 = varRoll8 - 1.8
Let varRoll9 = varRoll9 - 1.8
Let varRollLog = varRollLog & "3"
End If
End If
' If it rolled in the 4 range
If varRoll > 4 And varRoll < 5 Then
Let varRoll4 = varRoll4 + 1
' Add the number rolled to the Log
Let varRollLog = varRollLog & "4"
Let varRollx = ((10 - 0) * Rnd)
If Int(varRollx) = 4 Then
Let varRoll0 = varRoll0 - 1.8
Let varRoll1 = varRoll1 - 1.8
Let varRoll2 = varRoll2 - 1
Let varRoll3 = varRoll3 - 0.5
Let varRoll4 = varRoll4 + 12
Let varRoll5 = varRoll5 - 0.5
Let varRoll6 = varRoll6 - 1
Let varRoll7 = varRoll7 - 1.8
Let varRoll8 = varRoll8 - 1.8
Let varRoll9 = varRoll9 - 1.8
Let varRollLog = varRollLog & "4"
End If
End If
' If it rolled in the 5 range
If varRoll > 5 And varRoll < 6 Then
Let varRoll5 = varRoll5 + 1
' Add the number rolled to the Log
Let varRollLog = varRollLog & "5"
Let varRollx = ((10 - 0) * Rnd)
If Int(varRollx) = 5 Then
Let varRoll0 = varRoll0 - 1.8
Let varRoll1 = varRoll1 - 1.8
Let varRoll2 = varRoll2 - 1.8
Let varRoll3 = varRoll3 - 1
Let varRoll4 = varRoll4 - 0.5
Let varRoll5 = varRoll5 + 12
Let varRoll6 = varRoll6 - 0.5
Let varRoll7 = varRoll7 - 1
Let varRoll8 = varRoll8 - 1.8
Let varRoll9 = varRoll9 - 1.8
Let varRollLog = varRollLog & "5"
End If
End If
' If it rolled in the 6 range
If varRoll > 6 And varRoll < 7 Then

```

```

Let varRoll6 = varRoll6 + 1
' Add the number rolled to the Log
Let varRollLog = varRollLog & "6"
Let varRollx = ((10 - 0) * Rnd)
If Int(varRollx) = 6 Then
Let varRoll0 = varRoll0 - 1.8
Let varRoll1 = varRoll1 - 1.8
Let varRoll2 = varRoll2 - 1.8
Let varRoll3 = varRoll3 - 1.8
Let varRoll4 = varRoll4 - 1
Let varRoll5 = varRoll5 - 0.5
Let varRoll6 = varRoll6 + 12
Let varRoll7 = varRoll7 - 0.5
Let varRoll8 = varRoll8 - 1
Let varRoll9 = varRoll9 - 1.8
Let varRollLog = varRollLog & "6"
End If
End If
' If it rolled in the 7 range
If varRoll > 7 And varRoll < 8 Then
Let varRoll7 = varRoll7 + 1
' Add the number rolled to the Log
Let varRollLog = varRollLog & "7"
Let varRollx = ((10 - 0) * Rnd)
If Int(varRollx) = 7 Then
Let varRoll0 = varRoll0 - 1.8
Let varRoll1 = varRoll1 - 1.8
Let varRoll2 = varRoll2 - 1.8
Let varRoll3 = varRoll3 - 1.8
Let varRoll4 = varRoll4 - 1.8
Let varRoll5 = varRoll5 - 1
Let varRoll6 = varRoll6 - 0.5
Let varRoll7 = varRoll7 + 12
Let varRoll8 = varRoll8 - 0.5
Let varRoll9 = varRoll9 - 1
Let varRollLog = varRollLog & "7"
End If
End If
' If it rolled in the 8 range
If varRoll > 8 And varRoll < 9 Then
Let varRoll8 = varRoll8 + 1
' Add the number rolled to the Log
Let varRollLog = varRollLog & "8"
Let varRollx = ((10 - 0) * Rnd)
If Int(varRollx) = 8 Then
Let varRoll0 = varRoll0 - 1.66
Let varRoll1 = varRoll1 - 1.66
Let varRoll2 = varRoll2 - 1.66
Let varRoll3 = varRoll3 - 1.66
Let varRoll4 = varRoll4 - 1.66
Let varRoll5 = varRoll5 - 1.66
Let varRoll6 = varRoll6 - 1
Let varRoll7 = varRoll7 - 0.5
Let varRoll8 = varRoll8 + 12
Let varRoll9 = varRoll9 - 0.5
Let varRollLog = varRollLog & "8"

```



```

End If
End If
' If it rolled in the 9 range
If varRoll > 9 And varRoll < 10 Then
Let varRoll9 = varRoll9 + 1
' Add the number rolled to the Log
Let varRollLog = varRollLog & "9"
Randomize (Time)
Let varRollx = ((10 - 0) * Rnd)
If Int(varRollx) = 0 Then
Let varRoll0 = varRoll0 - 1.5
Let varRoll1 = varRoll1 - 1.5
Let varRoll2 = varRoll2 - 1.5
Let varRoll3 = varRoll3 - 1.5
Let varRoll4 = varRoll4 - 1.5
Let varRoll5 = varRoll5 - 1.5
Let varRoll6 = varRoll6 - 1.5
Let varRoll7 = varRoll7 - 1
Let varRoll8 = varRoll8 - 0.5
Let varRoll9 = varRoll9 + 12
Let varRollLog = varRollLog & "9"
End If
End If
' If it rolled out of range too low
If varRoll < 0 Then
MsgBox "Error roll below zero"
Exit Function
End If
' If it rolled out of range too high
If varRoll > 10 Then
MsgBox "Error roll above nine"
Exit Function
End If
'
' Having generated and logged the random number
or numbers for this iteration,
' go back and do the next iteration
Next varIteration
'
' Primitive error handling
On Error Resume Next
'
' Calculate Percentages
'(The percentage of the total score that each of the
' numbers 0 through 9 scored in this sequence) - A
score is based on
' a simple count of how many times a given number
is 'rolled'.
' Also, to make it interesting, the scores rise or fall
in response to
' the conditions a little. A score can be:
' Augmented above the actual count value if it
rolls the same number twice,
' or
' Reduced in value below the actual count value
if it does not.

```

```

' This is done in the loops above (varIteration).
'
' Setup a variable to hold the total of all the
scores
Dim varRollMorph As Double
' Tally the scores of numbers 0 through 9
Let varRollMorph = (varRoll0 + varRoll1 + _
varRoll2 + varRoll3 + varRoll4 + varRoll5 + _
varRoll6 + varRoll7 + varRoll8 + varRoll9)
'
' Calculate Score Percentages per Number from
0 to 9
'
' Calculate and assign the percentage of total that
each number from 0 to 9
' scored in the sequence. This number is the
'response'
' from the random number generator. If a number
shows up many times,
' and / or rolls doubles many times, it will get a
high score, possibly
' higher than 100%. If a number shows up few
time, and / or never rolls
' doubles, it will receive a low score, possibly
lower than 0%.
'
' Theory being, a high percentage in the number
most commonly rolled shows a strong
' probability influence in favor of the number
(and in response to the seed),
' and the same would apply in opposite fashion
for the number least commonly
' rolled.
'
' So for radionic purposes, the percentage score
can serve as a 'signal strength'
' meter for each of the characters typed and fed
to the algorithm. It shows
' (albeit in very simplistic form) the amount of
deflection from 'normal'
' randomness associated with a given character
fed to the algorithm.
Let varRollPer0 = (varRoll0 / (varRollMorph /
100))
Let varRollPer1 = (varRoll1 / (varRollMorph /
100))
Let varRollPer2 = (varRoll2 / (varRollMorph /
100))
Let varRollPer3 = (varRoll3 / (varRollMorph /
100))
Let varRollPer4 = (varRoll4 / (varRollMorph /
100))
Let varRollPer5 = (varRoll5 / (varRollMorph /
100))
Let varRollPer6 = (varRoll6 / (varRollMorph /
100))

```

```

    Let varRollPer7 = (varRoll7 / (varRollMorph /
100))
    Let varRollPer8 = (varRoll8 / (varRollMorph /
100))
    Let varRollPer9 = (varRoll9 / (varRollMorph /
100))
    ‘ Sift through the scores to find the highest and
lowest
    ‘
    ‘ Find the highest score and assign that value to
the
    ‘ appropriate variable
    Let varRollFloat = varRoll0
    Let varRollHigh = 0
    If varRoll1 > varRollFloat Then
        Let varRollFloat = varRoll1
        Let varRollHigh = 1
    End If
    If varRoll2 > varRollFloat Then
        Let varRollFloat = varRoll2
        Let varRollHigh = 2
    End If
    If varRoll3 > varRollFloat Then
        Let varRollFloat = varRoll3
        Let varRollHigh = 3
    End If
    If varRoll4 > varRollFloat Then
        Let varRollFloat = varRoll4
        Let varRollHigh = 4
    End If
    If varRoll5 > varRollFloat Then
        Let varRollFloat = varRoll5
        Let varRollHigh = 5
    End If
    If varRoll6 > varRollFloat Then
        Let varRollFloat = varRoll6
        Let varRollHigh = 6
    End If
    If varRoll7 > varRollFloat Then
        Let varRollFloat = varRoll7
        Let varRollHigh = 7
    End If
    If varRoll8 > varRollFloat Then
        Let varRollFloat = varRoll8
        Let varRollHigh = 8
    End If
    If varRoll9 > varRollFloat Then
        Let varRollFloat = varRoll9
        Let varRollHigh = 9
    End If

    ‘ Find the lowest score and assign that value to
the
    ‘ appropriate variable
    Let varRollFloat = varRoll0

```

```

    Let varRollLow = 0
    If varRoll1 < varRollFloat Then
        Let varRollFloat = varRoll1
        Let varRollLow = 1
    End If
    If varRoll2 < varRollFloat Then
        Let varRollFloat = varRoll2
        Let varRollLow = 2
    End If
    If varRoll3 < varRollFloat Then
        Let varRollFloat = varRoll3
        Let varRollLow = 3
    End If
    If varRoll4 < varRollFloat Then
        Let varRollFloat = varRoll4
        Let varRollLow = 4
    End If
    If varRoll5 < varRollFloat Then
        Let varRollFloat = varRoll5
        Let varRollLow = 5
    End If
    If varRoll6 < varRollFloat Then
        Let varRollFloat = varRoll6
        Let varRollLow = 6
    End If
    If varRoll7 < varRollFloat Then
        Let varRollFloat = varRoll7
        Let varRollLow = 7
    End If
    If varRoll8 < varRollFloat Then
        Let varRollFloat = varRoll8
        Let varRollLow = 8
    End If
    If varRoll9 < varRollFloat Then
        Let varRollFloat = varRoll9
        Let varRollLow = 9
    End If
    ‘
    ‘ Now that we have done the sequence of rolls,
and have the data,
    ‘ return the result based on state (selected when
this subroutine was called)
    ‘
    ‘ State 0 = Display State Descriptions
    If varState = 0 Then fncRNDScanDemo = “
Random Scan Demo” & vbNewLine & _
“States: 0 = Display this message, 1 = Sequence,
2 = Percentages, 3 = Graph.”
    ‘ State 1 - Sequence
    If varState = 1 Then
        ‘ Return the following:
        ‘ (Seed Number) : (Sequence of Numbers
Rolled)
        Let fncRNDScanDemo = varRollLog &
vbNewLine

```

```

End If
‘
If varState = 2 Then
‘ Return a short summary of the seed number
and stats for the numbers rolled
fncRNDScanDemo = “__Scanned: “ &
Str(varSeed) & “__” & vbNewLine & _
“Low: “ & Str(varRollLow) & “High: “ &
Str(varRollHigh)
Let fncRNDScanDemo = fncRNDScanDemo
& vbNewLine
Let fncRNDScanDemo = fncRNDScanDemo
& “__Stats:” & vbNewLine
Let fncRNDScanDemo = fncRNDScanDemo
& _
“0: “ & FormatNumber(varRollPer0, 3,
vbTrue) & “%” & vbNewLine
Let fncRNDScanDemo = fncRNDScanDemo
& _
“1: “ & FormatNumber(varRollPer1, 3,
vbTrue) & “%” & vbNewLine
Let fncRNDScanDemo = fncRNDScanDemo
& _
“2: “ & FormatNumber(varRollPer2, 3,
vbTrue) & “%” & vbNewLine
Let fncRNDScanDemo = fncRNDScanDemo
& _
“3: “ & FormatNumber(varRollPer3, 3,
vbTrue) & “%” & vbNewLine
Let fncRNDScanDemo = fncRNDScanDemo
& _
“4: “ & FormatNumber(varRollPer4, 3,
vbTrue) & “%” & vbNewLine
Let fncRNDScanDemo = fncRNDScanDemo
& _
“5: “ & FormatNumber(varRollPer5, 3,
vbTrue) & “%” & vbNewLine
Let fncRNDScanDemo = fncRNDScanDemo
& _
“6: “ & FormatNumber(varRollPer6, 3,
vbTrue) & “%” & vbNewLine
Let fncRNDScanDemo = fncRNDScanDemo
& _
“7: “ & FormatNumber(varRollPer7, 3,
vbTrue) & “%” & vbNewLine
Let fncRNDScanDemo = fncRNDScanDemo
& _
“8: “ & FormatNumber(varRollPer8, 3,
vbTrue) & “%” & vbNewLine
Let fncRNDScanDemo = fncRNDScanDemo
& _
“9: “ & FormatNumber(varRollPer9, 3,
vbTrue) & “%” & vbNewLine
Let fncRNDScanDemo = fncRNDScanDemo
& “__Scan Complete__” & vbNewLine

```

```

Let fncRNDScanDemo = fncRNDScanDemo
& Str(Now) & vbNewLine
Let fncRNDScanDemo = fncRNDScanDemo
& vbNewLine

End If
‘
‘ State 3 - Graph
If varState = 3 Then
‘ Return a text-based horizontal bar graph
showing the
‘ low percentage, low, character typed, high
and high percentage
‘
‘ Find the highest percentage
If varRollHigh = 0 Then Let varHighPer =
varRollPer0
If varRollHigh = 1 Then Let varHighPer =
varRollPer1
If varRollHigh = 2 Then Let varHighPer =
varRollPer2
If varRollHigh = 3 Then Let varHighPer =
varRollPer3
If varRollHigh = 4 Then Let varHighPer =
varRollPer4
If varRollHigh = 5 Then Let varHighPer =
varRollPer5
If varRollHigh = 6 Then Let varHighPer =
varRollPer6
If varRollHigh = 7 Then Let varHighPer =
varRollPer7
If varRollHigh = 8 Then Let varHighPer =
varRollPer8
If varRollHigh = 9 Then Let varHighPer =
varRollPer9
‘
‘ Find the lowest percentage
If varRollLow = 0 Then Let varLowPer =
varRollPer0
If varRollLow = 1 Then Let varLowPer =
varRollPer1
If varRollLow = 2 Then Let varLowPer =
varRollPer2
If varRollLow = 3 Then Let varLowPer =
varRollPer3
If varRollLow = 4 Then Let varLowPer =
varRollPer4
If varRollLow = 5 Then Let varLowPer =
varRollPer5
If varRollLow = 6 Then Let varLowPer =
varRollPer6
If varRollLow = 7 Then Let varLowPer =
varRollPer7
If varRollLow = 8 Then Let varLowPer =
varRollPer8

```



```

    If varHighPer > 32.5 Then fncRNDScanDemo
= fncRNDScanDemo & "I"
    If varHighPer > 35 Then fncRNDScanDemo =
fncRNDScanDemo & "I"
    If varHighPer > 37.5 Then fncRNDScanDemo
= fncRNDScanDemo & "I"
    If varHighPer > 40 Then fncRNDScanDemo =
fncRNDScanDemo & "I"
    If varHighPer > 42.5 Then fncRNDScanDemo
= fncRNDScanDemo & "I"
    If varHighPer > 45 Then fncRNDScanDemo =
fncRNDScanDemo & "I"
    If varHighPer > 47.5 Then fncRNDScanDemo
= fncRNDScanDemo & "I"
    If varHighPer > 50 Then fncRNDScanDemo =
fncRNDScanDemo & "I"
    If varHighPer > 52.5 Then fncRNDScanDemo
= fncRNDScanDemo & "I"
    If varHighPer > 55 Then fncRNDScanDemo =
fncRNDScanDemo & "I"
    If varHighPer > 57.5 Then fncRNDScanDemo
= fncRNDScanDemo & "I"
    If varHighPer > 60 Then fncRNDScanDemo =
fncRNDScanDemo & "I"
    If varHighPer > 62.5 Then fncRNDScanDemo
= fncRNDScanDemo & "I"
    If varHighPer > 65 Then fncRNDScanDemo =
fncRNDScanDemo & "I"
    If varHighPer > 67.5 Then fncRNDScanDemo
= fncRNDScanDemo & "I"
    If varHighPer > 70 Then fncRNDScanDemo =
fncRNDScanDemo & "I"
    If varHighPer > 72.5 Then fncRNDScanDemo
= fncRNDScanDemo & "I"
    If varHighPer > 75 Then fncRNDScanDemo =
fncRNDScanDemo & "I"
    If varHighPer > 77.5 Then fncRNDScanDemo
= fncRNDScanDemo & "I"
    If varHighPer > 80 Then fncRNDScanDemo =
fncRNDScanDemo & "I"
    If varHighPer > 82.5 Then fncRNDScanDemo
= fncRNDScanDemo & "I"
    If varHighPer > 85 Then fncRNDScanDemo =
fncRNDScanDemo & "I"
    If varHighPer > 87.5 Then fncRNDScanDemo
= fncRNDScanDemo & "I"
    If varHighPer > 90 Then fncRNDScanDemo =
fncRNDScanDemo & "I"
    If varHighPer > 92.5 Then fncRNDScanDemo
= fncRNDScanDemo & "I"
    If varHighPer > 95 Then fncRNDScanDemo =
fncRNDScanDemo & "I"
    If varHighPer > 97.5 Then fncRNDScanDemo
= fncRNDScanDemo & "I"
    If varHighPer > 100 Then fncRNDScanDemo
= fncRNDScanDemo & ">"

```

```

    fncRNDScanDemo = fncRNDScanDemo &
vbNewLine
    End If
End Function
' (End Module1 code)

```

11 - In object view, double click the form background (Form1). Copy and paste the following code so the subroutine looks like this:

```

Private Sub Form_Load()
'
' Setup the state list box
lstState.AddItem "State Descriptions", 0
lstState.AddItem "Sequence", 1
lstState.AddItem "Percentages", 2
lstState.AddItem "Graph", 3
lstState.TopIndex = 3
'
' Setup the Loop text box
txtLoop.Text = "100"
' Reset the form
cmdReset = True
End Sub

```

12 - In object view, double click the 'Reset' button (cmdReset). Copy and paste the following code so the subroutine looks like this:

```

Private Sub cmdReset_Click()
' Clear the input textbox
txtInput.Text = ""
' Clear the Output textbox
txtCode.Text = "" & vbNewLine
End Sub

```

13 - In object view, double click the 'Scan' button (cmdScan). Copy and paste the following code so the subroutine looks like this:

```

Private Sub cmdScan_Click()
' Clear the form
cmdReset = True
' Setup IO variables
Dim varLoop As Integer
' Send a stream of 100 characters through the
input text box
For varLoop = 1 To 100 ' or higher for longer
scans
    txtInput.Text = txtInput.Text & "."
Next varLoop
End Sub

```

14 - In object view, double click the 'Exit' button (cmdExit). Copy and paste the following code so the subroutine looks like this:

```
Private Sub cmdExit_Click()
End
End Sub
```

15 - In object view, double click the white textbox (txtInput). Copy and paste the following code so the subroutine looks like this:

```
' (Begin txtInput code)
Private Sub txtInput_Change()
' Primitive error handling
If txtInput.Text = "" Then txtInput.Text = " "
' Setup IO variables
Dim varInput As String
Dim varOutput As String
Dim varInNum As Long
Dim varOutNum As Long
Dim varQaballahChar As Long
'
' Grab the character most recently typed from the
input textbox
' and assign it to the appropriate variable
Let varInput = Right$(UCase$(txtInput.Text), 1)
'
' Convert the character to its numerological
equivalent and
' assign the result to the appropriate variable
Let varInNum = fncQaballahChar(varInput)
'
' Check for the space character
If varInNum = 100 Then
' Add a blank line, move to the latest line and
update the display
Let txtCode.Text = txtCode.Text + " " &
vbNewLine
Let txtCode.SelStart = Len(txtCode.Text)
txtCode.Refresh
Exit Sub
End If
'
' Feed the parameters to the random scanning
module
If varInNum < 9 Then
Let varOutput =
fncRNDScanDemo(Val(varInNum),
Val(txtLoop.Text), Val(1stState.TopIndex),
varInput)
Let txtCode.Text = txtCode.Text & varOutput
' move to the latest line and update the display
Let txtCode.SelStart = Len(txtCode.Text)
txtCode.Refresh
End If
End Sub
' (End txtInput code)
```

That's it! Feedback welcome, and have fun.

Copyright © Jon Logan 2008

The Husband Store [TOC](#)

A store that sells new husbands has opened in New York City, where a woman may go to choose a husband. Among the instructions at the entrance is a description of how the store operates: You may visit this store ONLY ONCE! There are six floors and the value of the product increases as the shopper ascends the flights. The shopper may choose any item from a particular floor, or may choose to go up to the next floor, but you cannot go back down except to exit the building! So, a woman goes to the Husband Store to find a husband. On the first floor the sign on the door reads: Floor 1 - These men Have Jobs. The second floor sign reads: Floor 2 - These men Have Jobs and Love Kids. The third floor sign reads: Floor 3 - These men Have Jobs, Love Kids, and are Extremely Good Looking. "Wow," she thinks, but feels compelled to keep going. She goes to the fourth floor and the sign reads: Floor 4 - These men Have Jobs, Love Kids, are Drop-dead Good Looking and Help With Housework. "Oh, mercy me!" she exclaims, "I can hardly stand it!" Still, she goes to the fifth floor and the sign reads: Floor 5 - These men Have Jobs, Love Kids, are Drop-dead Gorgeous, Help with Housework, and Have a Strong Romantic Streak. She is so tempted to stay, but she goes on to the sixth floor and the sign reads: Floor 6 - You are visitor 31,456,012 to this floor. There are no men on this floor. This floor exists solely as proof that women are impossible to please. Thank you for shopping at the Husband Store. To avoid gender bias charges, the store's owner also opened a New Wives Store just across the street. The first floor has wives that love sex. The second floor has wives that love sex and have money. The third through sixth floors have never been visited.

Courtesy R. Montserrat

WD-40 (Part II)

- 20) Gives a children's play gym slide a shine for a super fast slide.
- 21) Lubricates gear shift and mower deck lever for ease of handling on riding mowers.
- 22) Rids kids rocking chairs and swings of squeaky noises.
- 23) Lubricates tracks in sticking home windows and makes them easier to open.
- 24) Spraying an umbrella stem makes it easier to open and close.
- 25) Restores and cleans padded leather dashboards in vehicles, as well as vinyl bumpers.
- 26) Restores and cleans roof racks on vehicles.
- 27) Lubricates and stops squeaks in electric fans.
- 28) Lubricates wheel sprockets on tricycles, wagons, and bicycles for easy handling.
- 29) Lubricates fan belts on washers and dryers and keeps them running smoothly.
- 30) Keeps rust from forming on saws and saw blades, and other tools.
- 31) Removes splattered grease on stove.
- 32) Keeps bathroom mirror from fogging.
- 33) Lubricates prosthetic limbs.
- 34) Keeps pigeons off the balcony (they hate the smell).
- 35) Removes all traces of duct tape.
- 36) Folks even spray it on their arms, hands, and knees to relieve arthritis pain.
- 37) Florida's favourite use is: "cleans and removes love bugs from grills and bumpers."
- 38) The favourite use in the state of New York WD-40 protects the Statue of Liberty from the elements.
- 39) WD-40 attracts fish. Spray a LITTLE on live bait or lures and you will be catching the big one in no time. Also, it's a lot cheaper than the chemical attractants that are made for just that purpose. Keep in mind though, using some chemical laced baits or lures for fishing are not allowed in some states.
- 40) Use it for fire ant bites. It takes the sting away immediately and stops the itch.
- 41) WD-40 is great for removing crayon from walls. Spray on the mark and wipe with a clean rag.
- 42) Also, if you've discovered that your teenage daughter has washed and dried a tube of lipstick with a load of laundry, saturate the lipstick spots with WD-40 and re-wash. Presto! Lipstick is gone!
- 43) If you sprayed WD-40 on the distributor cap, it would displace the moisture and allow the car to start.

P. S. The basic ingredient is FISH OIL.

Forward Courtesy [Reinhard](#)

Courtesy [Keelynet TOC](#)

03/14/07 - [Belfast Homeopathy Results confirms](#)



[Efficacy](#)

MADELEINE Ennis, a pharmacologist at Queen's University, Belfast, was the scourge of homeopathy. She

railed against its claims that a chemical remedy could be diluted to the point where a sample was unlikely to contain a single molecule of anything but water, and yet still have a healing effect. Until, that is, she set out to prove once and for all that homeopathy was bunkum. In her most recent paper, Ennis describes how her team looked at the effects of ultra-dilute solutions of histamine on human white blood cells involved in inflammation. These "basophils" release histamine when the cells are under attack. Once released, the histamine stops them releasing any more. The study, replicated in four different labs, found that homeopathic solutions - so dilute that they probably didn't contain a single histamine molecule - worked just like histamine. Ennis might not be happy with the homeopaths' claims, but she admits that an effect cannot be ruled out. So how could it happen? Homeopaths prepare their remedies by dissolving things like charcoal, deadly nightshade or spider venom in ethanol, and then diluting this "mother tincture" in water again and again. No matter what the level of dilution, homeopaths claim, the original remedy leaves some kind of imprint on the water molecules. Thus, however dilute the solution becomes, it is still imbued with the properties of the remedy. You can understand why Ennis remains sceptical. And it remains true that no homeopathic remedy has ever been shown to work in a large randomised placebo-controlled clinical trial. But the Belfast study (Inflammation Research, vol 53, p 181) suggests that something is going on. "We are," Ennis says in her paper, "unable to explain our findings and are reporting them to encourage others to investigate this phenomenon." If the results turn out to be real, she says, the implications are profound: we may have to rewrite physics and chemistry.

Courtesy [Keelynet](#)

non-classified message listings

Contact Unique and Discerning People through your message in this magazine - FREE [toc](#)

Send an email to wizzer@littlemountainmudge.com with your text message up to 40 words in length, include "FREE PERSONAL MESSAGE" in the subject line. If your message is accepted you will receive a confirmation email within a few days. internet address counts as one word, email address counts as one word. Telephone numbers count as one word. Mailing address counts as 3 words. Home-based business and personal messages accepted. Messages must be text only, we reserve the right to refuse or remove any message without notice, no porn no dating services no hate literature messages must relate to the subject matter of metaphysics.

Alternative Science researcher with technical background seeks possible collaboration with experienced Radionics and / or Orgone technicians for remote effects testing / documentation of the concrete effects of subtle energy - serious enquiries only contact distanceeffects@littlemountainmudge.com

Wanted: Used ORMUS Spin separator (North America Only) for reasonable price - the kind with magnet ring & plastic vortex tube / produces oily liquid ORMUS concentrate from clean water - contact usedormus@littlemountainmudge.com

Photos relating to Chemtrail activity tracking and documenting Chemtrail activity on the web since 2000, 500+ members. <http://groups.yahoo.com/group/ricksgardeni ngtips/>

Parting Chuckles

Kulula is an Airline with head office situated in Johannesburg. Kulula airline attendants make an effort to make the in-flight "safety lecture" and announcements a bit more entertaining. Here are some Real examples that have been heard or reported:

On a Kulula flight, (there is no assigned seating, you just sit where you want) passengers were apparently having a hard time choosing, when a flight attendant announced, "People, people we're not picking out furniture here, find a seat and get in it!"

On another flight with a very "senior" flight attendant crew, the pilot said, "Ladies and gentlemen, we've reached cruising altitude and will be turning down the cabin lights. This is for your comfort and to enhance the appearance of your flight attendants."

On landing, the stewardess said, "Please be sure to take all of your belongings. If you're going to leave anything, please make sure it's something we'd like to have."

After a particularly rough landing during

thunderstorms in the Karoo, a flight attendant on a flight announced, "Please take care when opening the overhead compartments because, after a landing like that, sure as hell everything has shifted."

From a Kulula employee: "Welcome aboard Kulula 245 to Calgary. To operate your seat belt, insert the metal tab into the buckle, and pull tight. It works just like every other seat belt; and, if you don't know how to operate one, you probably shouldn't be out in public unsupervised."

Another flight attendant's comment on a less than perfect landing: "We ask you to please remain seated as Captain Kangaroo bounces us to the terminal."

Part of a flight attendant's arrival announcement: "We'd like to thank you folks for flying with us today. And, the next time you get the insane urge to go blasting through the skies in a pressurized metal tube, we hope you'll think of Kulula Airways."

Heard on a Kulula flight. "Ladies and gentlemen, if you wish to smoke, the smoking section on this

airplane is on the wing. If you can light 'em, you can smoke 'em."

---o0o---

A plane was taking off from Durban Airport. After it reached a comfortable cruising altitude, the captain made an announcement over the intercom, "Ladies and gentlemen, this is your captain speaking. Welcome to Flight Number 293, non-stop from Durban to Cape Town, The weather ahead is good and, therefore, we should have a smooth and uneventful flight. Now sit back and relax... OH, f#\$k!" Silence followed, and after a few minutes, the captain came back on the intercom and said, "Ladies and Gentlemen, I am so sorry if I scared you earlier. While I was talking to you, the flight attendant accidentally spilled a cup of hot coffee in my lap. You should see the front of my pants!" A passenger then yelled, "That's nothing. You should see the back of mine!!"

*Forward
Courtesy Robert
Montserrat*

(Right)
N. Bhanutej/Mysore
interviewing
[Mr Somendar Singh](#)

[TOC](#)

He Put It So Well

The grainy photocopies show a man who seems a lifetime younger, his eyes black and staring, his rugged mug framed with thick black hair. Below the photos, and a menacing poster of two jets about to collide in midair, is a sign bearing Singh's motto:

We specialize in work which few understand.

"And this has been my problem sir," Singh says with a shrug. He settles in behind a metal desk heaped with paper and parts. "It has been my problem ever since I started this whole business of whatever I started doing in my life."

Modern Orgone Electronic Magazine Issue # 5

©2005-2008 Wizzers Workshop / Wizzers Desk and contributing authors / photographers all rights reserved

Modern Orgone Electronic Magazine™ Issue # 5 2005-2008 Wizzers Workshop™ and contributing authors / artists all rights reserved - Individual contributed articles may have copyrights which precede their publication in this magazine and where applicable are reprinted with permission and / or in accordance with fair use by Wizzers Workshop™. This is an opt-in research journal and distributes information for the purposes of fostering scholarly and experimental research. Modern Orgone™ is independently published by Wizzers Desk™ / Wizzers Workshop™ / Jon Logan. The views expressed are the opinion of the contributing author. All contributed articles/images are the intellectual/artistic property of the contributor. The finished issue or example or volume of this publication is copyrighted material belonging to Jon Logan / Wizzers Workshop™. Wizzers Work shop™ is not necessarily affiliated with contributing authors and may or may not share their views. Readers are entirely responsible for their own discretion, discernment, legality and safety in attempting to reproduce any experiments described in Modern Orgone Electronic Magazine, or in attempting to apply any information of any kind contained in Modern Orgone Electronic Magazine™.



Albino Moose – Beaverdell, B.C. Canada

Modern Orgone Electronic Magazine™ / Wizzers Workshop™ / Wizzers Desk™ and all related Contributing Authors / Electronic Media Distribution Agents / eBook Listing Websites collectively assume no liabilities for any damages of any kind resulting from the use or abuse of the information / theory / techniques or other topic covered in the content of Modern Orgone Electronic Magazine. By acting on this content in any way you warrant that you agree to the following 4 points: 1 - you accept responsibility for the karmic / energetic / physical / legal ramifications of your experiments or other actions, 2- you are of legal age or acting with the consent of a parent or guardian where applicable, 3 - you are interested in applied metaphysical / alternative science subject matter and acting of your own free will, 4 - you will indemnify and hold blameless the aforementioned (Modern Orgone Electronic Magazine™ / Wizzers Workshop™ / Wizzers Desk™ and all related Contributing Authors / Electronic Media Distribution Agents / eBook Listing Websites). This document may only be reproduced legally by the retail purchaser or authorized sales agent. The purchaser may make backup digital copies or paper hard copies of this document in accord with terms and conditions of sale for their own personal use. Contact Modern Orgone Electronic Magazine™ PO Box 139 Westbridge BC Canada V0H2B0 modernorgone@littlemountainmudge.com <http://www.littlemountainmudge.com> telephone contact message Canada Pacific Time Zone 250-446-2032