



Professional Edition

Includes coverage of intake structures, wells, storage and distribution systems, and sanitary sewer design

Water *and* Wastewater Engineering

Design Principles and Practice

Mackenzie L. Davis

 **wefpress**
for the water quality professional

List of the elements with their symbols and atomic masses*

Element	Symbol	Atomic Number	Atomic Mass [†]	Element	Symbol	Atomic Number	Atomic Mass [†]
Actinium	Ac	89	(227)	Mendelevium	Md	101	(258)
Aluminum	Al	13	26.98	Mercury	Hg	80	200.6
Americium	Am	95	(243)	Molybdenum	Mo	42	95.94
Antimony	Sb	51	121.8	Neodymium	Nd	60	144.2
Argon	Ar	18	39.95	Neon	Ne	10	20.18
Arsenic	As	33	74.92	Neptunium	Np	93	(237)
Astatine	At	85	(210)	Nickel	Ni	28	58.69
Barium	Ba	56	137.3	Niobium	Nb	41	92.91
Berkelium	Bk	97	(247)	Nitrogen	N	7	14.01
Beryllium	Be	4	9.012	Nobelium	No	102	(259)
Bismuth	Bi	83	209.0	Osmium	Os	76	190.2
Bohrium	Bh	107	(262)	Oxygen	O	8	16.00
Boron	B	5	10.81	Palladium	Pd	46	106.4
Bromine	Br	35	79.90	Phosphorus	P	15	30.97
Cadmium	Cd	48	112.4	Platinum	Pt	78	195.1
Calcium	Ca	20	40.08	Plutonium	Pu	94	(244)
Californium	Cf	98	(251)	Polonium	Po	84	(209)
Carbon	C	6	12.01	Potassium	K	19	39.10
Cerium	Ce	58	140.1	Praseodymium	Pr	59	140.9
Cesium	Cs	55	132.9	Promethium	Pm	61	(145)
Chlorine	Cl	17	35.45	Protactinium	Pa	91	(231)
Chromium	Cr	24	52.00	Radium	Ra	88	(226)
Cobalt	Co	27	58.93	Radon	Rn	86	(222)
Copper	Cu	29	63.55	Rhenium	Re	75	186.2
Curium	Cm	96	(247)	Rhodium	Rh	45	102.9
Dubnium	Db	105	(262)	Rubidium	Rb	37	85.47
Dysprosium	Dy	66	162.5	Ruthenium	Ru	44	101.1
Einsteinium	Es	99	(252)	Rutherfordium	Rf	104	(261)
Erbium	Er	68	167.3	Samarium	Sm	62	150.4
Europium	Eu	63	152.0	Scandium	Sc	21	44.96
Fermium	Fm	100	(257)	Seaborgium	Sg	106	(266)
Fluorine	F	9	19.00	Selenium	Se	34	78.96
Francium	Fr	87	(223)	Silicon	Si	14	28.09
Gadolinium	Gd	64	157.3	Silver	Ag	47	107.9
Gallium	Ga	31	69.72	Sodium	Na	11	22.99
Germanium	Ge	32	72.64	Strontium	Sr	38	87.62
Gold	Au	79	197.0	Sulfur	S	16	32.07
Hafnium	Hf	72	178.5	Tantalum	Ta	73	180.9
Hassium	Hs	108	(277)	Technetium	Tc	43	(98)
Helium	He	2	4.003	Tellurium	Te	52	127.6
Holmium	Ho	67	164.9	Terbium	Tb	65	158.9
Hydrogen	H	1	1.008	Thallium	Tl	81	204.4
Indium	In	49	114.8	Thorium	Th	90	232.0
Iodine	I	53	126.9	Thulium	Tm	69	168.9
Iridium	Ir	77	192.2	Tin	Sn	50	118.7
Iron	Fe	26	55.85	Titanium	Ti	22	47.88
Krypton	Kr	36	83.80	Tungsten	W	74	183.9
Lanthanum	La	57	138.9	Uranium	U	92	238.0
Lawrencium	Lr	103	(262)	Vanadium	V	23	50.94
Lead	Pb	82	207.2	Xenon	Xe	54	131.3
Lithium	Li	3	6.941	Ytterbium	Yb	70	173.0
Lutetium	Lu	71	175.0	Yttrium	Y	39	88.91
Magnesium	Mg	12	24.31	Zinc	Zn	30	65.41
Manganese	Mn	25	54.94	Zirconium	Zr	40	91.22
Meitnerium	Mt	109	(268)				

*All atomic masses have four significant figures. These values are recommended by the Committee on Teaching of Chemistry, International Union of Pure and Applied Chemistry.

[†]Approximate values of atomic masses for radioactive elements are given in parentheses.

Source: Chang, R. *Chemistry*, 7th ed. Copyright © 2002 The McGraw-Hill Companies, Inc. New York. Reproduced with permission.

1 1A																	18 8A
1 H 1.008	2 2A																2 He 4.003
3 Li 6.941	4 Be 9.012											13 3A	14 4A	15 5A	16 6A	17 7A	10 Ne 20.18
11 Na 22.99	12 Mg 24.31	3 3B	4 4B	5 5B	6 6B	7 7B	8	9	10	11 1B	12 2B	13 Al 26.98	14 Si 28.09	15 P 30.97	16 S 32.07	17 Cl 35.45	18 Ar 39.95
19 K 39.10	20 Ca 40.08	21 Sc 44.96	22 Ti 47.88	23 V 50.94	24 Cr 52.00	25 Mn 54.94	26 Fe 55.85	27 Co 58.93	28 Ni 58.69	29 Cu 63.55	30 Zn 65.41	31 Ga 69.72	32 Ge 72.64	33 As 74.92	34 Se 78.96	35 Br 79.90	36 Kr 83.80
37 Rb 85.47	38 Sr 87.62	39 Y 88.91	40 Zr 91.22	41 Nb 92.91	42 Mo 95.94	43 Tc (98)	44 Ru 101.1	45 Rh 102.9	46 Pd 106.4	47 Ag 107.9	48 Cd 112.4	49 In 114.8	50 Sn 118.7	51 Sb 121.8	52 Te 127.6	53 I 126.9	54 Xe 131.3
55 Cs 132.9	56 Ba 137.3	57 La 138.9	72 Hf 178.5	73 Ta 180.9	74 W 183.9	75 Re 186.2	76 Os 190.2	77 Ir 192.2	78 Pt 195.1	79 Au 197.0	80 Hg 200.6	81 Tl 204.4	82 Pb 207.2	83 Bi 209.0	84 Po (209)	85 At (210)	86 Rn (222)
87 Fr (223)	88 Ra (226)	89 Ac (227)	104 Rf (261)	105 Db (262)	106 Sg (266)	107 Bh (262)	108 Hs (277)	109 Mt (268)	110	111	112	(113)	114	(115)	116	(117)	118

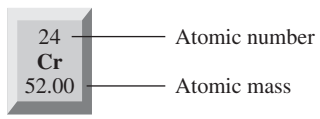

58 Ce 140.1	59 Pr 140.9	60 Nd 144.2	61 Pm (145)	62 Sm 150.4	63 Eu 152.0	64 Gd 157.3	65 Tb 158.9	66 Dy 162.5	67 Ho 164.9	68 Er 167.3	69 Tm 168.9	70 Yb 173.0	71 Lu 175.0
90 Th 232.0	91 Pa (231)	92 U 238.0	93 Np (237)	94 Pu (242)	95 Am (243)	96 Cm (247)	97 Bk (247)	98 Cf (251)	99 Es (252)	100 Fm (257)	101 Md (258)	102 No (259)	103 Lr (262)

The 1–18 group designation has been recommended by the International Union of Pure and Applied Chemistry (IUPAC) but is not yet in wide use. No names have been assigned for elements 110–112, 114, 116, and 118. Elements 113, 115, and 117 have not yet been synthesized.

Source: Chang, R. *Chemistry*, 7th ed. Copyright © 2002 The McGraw-Hill Companies, Inc. New York. Reproduced with permission.

**WATER AND
WASTEWATER
ENGINEERING**

This page intentionally left blank

WATER AND WASTEWATER ENGINEERING

Design Principles and Practice

Mackenzie L. Davis, Ph.D., P.E., BCEE
Michigan State University



New York Chicago San Francisco Lisbon
London Madrid Mexico City Milan New Delhi
San Juan Seoul Singapore Sydney Toronto

Copyright © 2010 by The McGraw-Hill Companies, Inc. All rights reserved. Except as permitted under the United States Copyright Act of 1976, no part of this publication may be reproduced or distributed in any form or by any means, or stored in a database or retrieval system, without the prior written permission of the publisher.

ISBN: 978-0-07-171385-6

MHID: 0-07-171385-9

The material in this eBook also appears in the print version of this title: ISBN: 978-0-07-171384-9, MHID: 0-07-171384-0.

All trademarks are trademarks of their respective owners. Rather than put a trademark symbol after every occurrence of a trademarked name, we use names in an editorial fashion only, and to the benefit of the trademark owner, with no intention of infringement of the trademark. Where such designations appear in this book, they have been printed with initial caps.

McGraw-Hill eBooks are available at special quantity discounts to use as premiums and sales promotions, or for use in corporate training programs. To contact a representative please e-mail us at bulksales@mcgraw-hill.com.

Information contained in this work has been obtained by The McGraw-Hill Companies, Inc. (“McGraw-Hill”) from sources believed to be reliable. However, neither McGraw-Hill nor its authors guarantee the accuracy or completeness of any information published herein, and neither McGraw-Hill nor its authors shall be responsible for any errors, omissions, or damages arising out of use of this information. This work is published with the understanding that McGraw-Hill and its authors are supplying information but are not attempting to render engineering or other professional services. If such services are required, the assistance of an appropriate professional should be sought.

TERMS OF USE

This is a copyrighted work and The McGraw-Hill Companies, Inc. (“McGrawHill”) and its licensors reserve all rights in and to the work. Use of this work is subject to these terms. Except as permitted under the Copyright Act of 1976 and the right to store and retrieve one copy of the work, you may not decompile, disassemble, reverse engineer, reproduce, modify, create derivative works based upon, transmit, distribute, disseminate, sell, publish or sublicense the work or any part of it without McGraw-Hill’s prior consent. You may use the work for your own noncommercial and personal use; any other use of the work is strictly prohibited. Your right to use the work may be terminated if you fail to comply with these terms.

THE WORK IS PROVIDED “AS IS.” MCGRAW-HILL AND ITS LICENSORS MAKE NO GUARANTEES OR WARRANTIES AS TO THE ACCURACY, ADEQUACY OR COMPLETENESS OF OR RESULTS TO BE OBTAINED FROM USING THE WORK, INCLUDING ANY INFORMATION THAT CAN BE ACCESSED THROUGH THE WORK VIA HYPERLINK OR OTHERWISE, AND EXPRESSLY DISCLAIM ANY WARRANTY, EXPRESS OR IMPLIED, INCLUDING BUT NOT LIMITED TO IMPLIED WARRANTIES OF MERCHANTABILITY OR FITNESS FOR A PARTICULAR PURPOSE. McGraw-Hill and its licensors do not warrant or guarantee that the functions contained in the work will meet your requirements or that its operation will be uninterrupted or error free. Neither McGraw-Hill nor its licensors shall be liable to you or anyone else for any inaccuracy, error or omission, regardless of cause, in the work or for any damages resulting therefrom. McGraw-Hill has no responsibility for the content of any information accessed through the work. Under no circumstances shall McGraw-Hill and/or its licensors be liable for any indirect, incidental, special, punitive, consequential or similar damages that result from the use of or inability to use the work, even if any of them has been advised of the possibility of such damages. This limitation of liability shall apply to any claim or cause whatsoever whether such claim or cause arises in contract, tort or otherwise.

Dedication

To all the professionals in the water and wastewater industry who give of their time and wisdom to the generations that follow, and especially to

Myron Erickson, P.E

Thomas C. Gavin, P.E.

Timothy D. McNamara, P.E.

Thomas Newhof, P.E., BCEE

Lucy B. Pugh, P.E., BCEE

Carlos A. Sanlley, Ph.D.

Jimmy L. Spangler, P.E.

Jeffrey R. Stollhans, P.G.

for the advice and wisdom they shared to make this book possible.

This page intentionally left blank

ABOUT THE AUTHOR

Mackenzie L. Davis is an Emeritus Professor of Environmental Engineering at Michigan State University. He received all his degrees from the University of Illinois. From 1968 to 1971 he served as a Captain in the U.S. Army Medical Service Corps. During his military service he conducted air pollution surveys at Army ammunition plants. From 1971 to 1973 he was Branch Chief of the Environmental Engineering Branch at the U.S. Army Construction Engineering Research Laboratory. His responsibilities included supervision of research on air, noise, and water pollution control and solid waste management for Army facilities. In 1973 he joined the faculty at Michigan State University. He has taught and conducted research in the areas of air pollution control, hazardous waste management, and water and wastewater engineering.

In 1987 and 1989–1992, under an intergovernmental personnel assignment with the Office of Solid Waste of the U.S. Environmental Protection Agency, Dr. Davis performed technology assessments of treatment methods used to demonstrate the regulatory requirements for the land disposal restrictions (“land ban”) promulgated under the Hazardous and Solid Waste Amendments.

Dr. Davis is a member of the following professional organizations: American Chemical Society, American Institute of Chemical Engineers, American Society for Engineering Education, American Meteorological Society, American Society of Civil Engineers, American Water Works Association, Air & Waste Management Association, Association of Environmental Engineering and Science Professors, and the Water Environment Federation.

His honors and awards include the State-of-the-Art Award from the ASCE, Chapter Honor Member of Chi Epsilon, Sigma Xi, election as a Fellow in the Air & Waste Management Association, and election as a Diplomate in the American Academy of Environmental Engineers with certification in hazardous waste management. He has received teaching awards from the American Society of Civil Engineers Student Chapter, Michigan State University College of Engineering, North Central Section of the American Society for Engineering Education, Great Lakes Region of Chi Epsilon, and the Amoco Corporation. In 1998, he received the Lyman A. Ripperton Award for distinguished achievement as an educator from the Air & Waste Management Association. In 2007, he was recognized as the Educational Professional of the Year by the Michigan Water Environment Association. He is a registered professional engineer in Michigan.

Dr. Davis is the co-author of two previous books: *Introduction to Environmental Engineering*, 4th ed. with Dr. David A. Cornwell and *Principles of Environmental Engineering and Science*, 2nd ed. with Dr. Susan Masten.

In 2003, Dr. Davis retired from Michigan State University.

This page intentionally left blank

PREFACE

This book is designed for use by professionals. The book covers the design of municipal water and wastewater facilities. I have assumed that the reader has had an introductory environmental engineering course and a first course in fluid mechanics. That is, I have assumed the reader is familiar with notation such as mg/L and acronyms such as BOD as well as the concepts of mass balance, Bernoulli's equation, and friction loss. Because I could not assume that the reader has used either *Introduction to Environmental Engineering* or *Principles of Environmental Engineering and Science*, some material from those texts is used to introduce the subject matter included here.

A Professional Advisory Board has provided their experience and expertise to vet the material in *Water and Wastewater Engineering*. The Board is composed of licensed engineers, a licensed geologist, and licensed treatment plant operators. A short biographical sketch and affiliation of the Professional Advisory Board members is presented following this preface. They have read and commented on all of the chapters. In addition, a number of operators have been interviewed to obtain hints on methods for improving designs.

The book format is one that I used successfully over the 20 years that I taught the material. The book starts with an overview of the design and construction process including the application of the code of ethics in the process. The first half of the book addresses water treatment. Because my course was built around a term design project, the subject matter follows the flow of water through the unit processes of coagulation, flocculation, softening (including NF and RO), sedimentation, filtration (including MF and UF), disinfection, and residuals management.

The topics of wastewater treatment follow a similar pattern of following the flow through a plant, that is, preliminary treatment, primary treatment, secondary treatment, tertiary treatment, and residuals management. Special attention is given to the application of membranes.

Each subject in each chapter is introduced with a discussion of the theoretical principles that are to be applied in the design of the unit process. In addition, in each chapter, appropriate design criteria from the Great Lakes–Upper Mississippi River Board of State and Provincial Public Health and Environmental Managers (known to the elders of the profession as the Ten State Standards) as well as alternative approaches from the literature are addressed.

The text features over 100 example problems, 500 end-of-chapter problems, and 300 illustrations. A highlight of the book is the inclusion of safety issues in the design requirements as well as operation and maintenance activities. Hints from the field bring real-life experience in solving technical issues.

For those using this book for a formal university level course, an instructor's manual is available online for qualified instructors. Please inquire with your McGraw-Hill representative for the necessary access password. The instructor's manual includes sample course outlines for both a one-semester option and a two-semester option, solved example exams, and detailed solutions to the end-of-chapter problems. In addition, there are suggestions for using the pedagogic aids in the text.

McGraw-Hill hosts a website at <http://www.mhprofessional.com/wwe>. It includes over 500 annotated photos of equipment and the construction process as well as a primer on engineering economics, and seminar presentations by professional engineers and operators.

There is a student edition of this book under the same title. It does **not** contain chapters on the following subjects: (1) intake structures, (2) wells, (3) chemical handling and feeding, (4) removal of specific contaminants, (5) water plant process selection and integration, (6) storage and distribution systems, (7) sanitary sewer design, and (8) clean water plant process selection and integration.

I appreciate any comments, suggestions, corrections, and contributions for future editions.

Mackenzie L. Davis

Acknowledgements

The following individuals provided opportunities for photographs, insight on current design practice, operational problems, and hints from the field:

John Allen, Plant Superintendent, Grand Rapids Water Filtration Plant
 Tom Arlington, Project Manager, United Water, Armada WWTP
 Michael P. Avrill, Operations Supervisor, Wyoming Water Treatment Plant
 Richard S. Bacon, Project Manager, Wixom WWTP
 Don Baron, District Manager, Johnson Screens
 Larry Campbell, Plant Superintendent, PARRC Wastewater Treatment Plant
 Gerald H. Caron, Plant Superintendent, Wyoming Water Treatment Plant
 Jim Carrol, Operations Supervisor, East Lansing, Meridian Township Water Authority
 Patrick Cook, P.E., Michigan Department of Environmental Quality
 Ryan Craven, Project Foreman, C&D Hughes, Inc., Charlotte, MI
 Jerry Crisp, Assistant Superintendent, Wastewater Treatment Plant, Brownsburg, IN
 Delvin E. DeBoer, South Dakota State University
 Bruce DeVantier, Southern Illinois University-Carbondale
 Stanley Diamond, P.E., Associate, Greeley and Hansen, Indianapolis, IN
 Kathy Dillon, Superintendent, Wastewater Treatment Plant, Brownsburg, IN
 Chad Everts, Site Engineer, FTC&H, Grand Rapids, MI
 Larry Fitzgerald, Director of Operations, Southern Clinton County Municipal Utilities Authority
 Ira Gabin, P.E., Vice President, Dixon Engineering, Lake Odessa, MI
 Brock Howard, P.E., Michigan Department of Environmental Quality
 James E. Kilduff, Rensselaer Polytechnic Institute
 Dave Koch, P.E., Project Manager, Black and Veatch, Grand Rapids, MI
 Brian Lee, Operator, United Water, Armada Project
 Andy Linebaugh, Michigan State University Physical Plant
 Benjamin S. Magbanua, Jr., Mississippi State University
 K. Andrews Miller, P.E., Associate, Greeley and Hansen, Indianapolis, IN
 Pauline Rampanelli, Utility Plant Operator, Clean Water Plant, Wyoming, MI
 Ed Renkie, Landing Board of Water and Light, Lansing, MI

Larry Sanford, Assistant Supervisor, Ann Arbor Water Treatment Plant

Mike St. Bernard, Plant Superintendent, East Lansing, Meridian Township Water Authority

T. J. Short, P.E., Associate, Greeley and Hansen, Indianapolis, IN

Gary J. Timmer, Area Manager, United Water

Don Uitvlugt, Utility Plant Operator, Clean Water Plant, Wyoming, MI

Art K. Umble, Ph.D., P.E., BCEE, Associate and Director of Process Engineering, Greeley and Hansen, Indianapolis, IN

Benjamin Whitehead, P.E., Project Engineer, Black & Veatch, Grand Rapids, MI

Tom Wilson, Maintenance Supervisor, Utilities Department, Clean Water Plant, Wyoming, MI

Brian Wood, Oregon State University

David Yonge, Washington State University

Rebecca Hullman, Terry Stines, Heather Wilkinson, and Adam Wolfsen provided technical editing, checked problem solutions, and typed the solution manual. Dr. Susan J. Masten, P. E. provided insights and suggestions to improve the instructional content of the book.

To each and all of these people, I give a hearty thank you.

An especial thank you to my editors, Lora Kalb-Neyens, Debra Hash, and Joy Bramble for their creative support in bringing the book to fruition.

This page intentionally left blank

PROFESSIONAL ADVISORY BOARD

Myron Erickson, P. E., Laboratory Services Manager, City of Wyoming, MI

Mr. Erickson holds a bachelor's degree from the University of Evansville (IN) and a master's degree in environmental engineering from Michigan State University. He is licensed as a Class B operator in the State of Michigan. In his 15 years with the City of Wyoming (MI) utilities department he has served as the environmental compliance and research specialist for the City's programs in industrial sewer use, biosolids disposition, disinfection byproducts, and PPCPs. Currently he manages the laboratories for both the wastewater and drinking water utility plants. While the biosolids and IPP programs were under his direction, the City won a First Place EPA Award for Biosolids Public Education and a Second Place EPA Award for overall excellence of their IPP program.

The 35 employees of City of Wyoming Clean Water Plant serve a population of about 170,000. The maximum design flow of the plant is 24 MGD. With about 35 employees, the Drinking Water Plant serves a population of about 210,000. The maximum design flow is 120,000 MGD. The laboratory is a certified drinking water lab.



Clean Water Plant
2350 Ivanrest, SW
Wyoming, MI 49418

Thomas C. Gavin, P. E., Senior Process Engineer, FTC&H

Mr. Gavin received his B.S. in Civil Engineering and his M.S. in Environmental Engineering from Northwestern University. His 30 years of experience in process design includes three new water treatment plants and renovation/expansion of eight others. This experience includes conventional surface water treatment, lime-soda softening, deep-bed high-rate direct filtration, and membrane filtration. His wastewater experience includes design and start-up of eight activated sludge plants treating high-strength industrial wastewaters. In addition, his experience includes design of four water distribution systems and three wastewater collection systems. Mr. Gavin has been with FTC&H for 21 years.

Established in 1956, Fishbeck, Thompson, Carr, & Huber (FTC&H) is a full-service engineering and architectural firm with 350 employees that is headquartered in Grand Rapids, Michigan. FTC&H has four other offices located in Michigan and Ohio. FTC&H specializes in engineering, architecture, environmental science, and construction management.



Fishbeck, Thompson, Carr & Huber, Inc.
1515 Arboretum Drive, SE
Grand Rapids, Michigan 49546

Timothy D. McNamara, P. E., Senior Vice President, FTC&H

Mr. McNamara received his B.S. in Civil Engineering and his M.S. in Sanitary Engineering from Michigan State University. He is Principal-in-Charge of his firm's Process Engineering Department and of their Construction Division. He has over 28 years of progressive design and management experience with water supply and treatment, wastewater collection and treatment, and environmental engineering projects. His design experience includes 27 water supply projects, 18 water treatment plants, and 12 wastewater treatment projects. He has particular expertise with membrane filtration, iron filtration, and lime-soda softening processes, and has been with his firm for 25 years. He is the former Chair of the Michigan Section of the American Water Works Association.

Established in 1956, Fishbeck, Thompson, Carr, & Huber (FTC&H) is a full-service engineering and architectural firm with 350 employees that is headquartered in Grand Rapids, Michigan. FTC&H has four other offices located in Michigan and Ohio. FTC&H specializes in engineering, architecture, environmental science, and construction management.



Fishbeck, Thompson, Carr & Huber, Inc.
1515 Arboretum Drive, SE
Grand Rapids, Michigan 49546

Thomas Newhof, P. E., BCEE, Chairman of the Board, Prein&Newhof

Mr. Newhof received his B.S. degree from Calvin College and his M.S. in Sanitary Engineering from the University of Michigan. He is a licensed professional engineer in Michigan, Wisconsin, and Illinois. As both a Project Manager and Principal-in-Charge of many of Prein&Newhof's environmental and civil engineering projects, his experience includes: planning and design of water treatment and wastewater treatment facilities with conventional or membrane filtration technology, water and sewer systems, intakes, pipelines, pumping stations, storm drainage and flood control, airport and road improvements, and residential and commercial development.

The American Water Works Association recognized Thomas Newhof's contributions to the profession with the 1998 George Warren Fuller Award. The University of Michigan honored him with the Jack A. Borchardt Award in 2008.

Mr. Newhof co-founded Prein&Newhof in 1969 with a fellow civil engineer. He is the Chairman of the firm's Board of Directors, providing leadership for Prein&Newhof's 100 employees who work in its environmental laboratory and five offices located throughout West Michigan.



Prein&Newhof
3355 Evergreen Drive, NE
Grand Rapids, MI 49525

Lucy B. Pugh, P. E., BCEE, Vice President, AECOM

Ms. Pugh received her B.S.E. and M.S.E. in Civil/Environmental Engineering from the University of Michigan. Her 28 years of experience in municipal process water and wastewater treatment design includes three new water treatment plants, two new wastewater treatment plants, and renovation/expansion of seven other wastewater treatment plants. Ms. Pugh's industrial water and wastewater design experience includes over 25 facilities. She has also provided process troubleshooting and optimization at numerous other municipal and industrial treatment facilities. Her experience spans a broad range of technologies, including ion exchange, greensand filtration, low pressure membrane filtration, reverse osmosis, dissolved air flotation, conventional activated sludge, oxidation ditches, SBRs, biological nutrient removal, PACT, UV disinfection, upflow anaerobic sludge blanket reactors, anaerobic fluidized bed reactors, and first application of GAC/fluidized bed for perchlorate removal.

AECOM is a global provider of professional, technical, and management support services to a broad range of markets, including water/wastewater, environmental, transportation, building and energy. With 43,000 employees providing services in over 100 countries around the globe, AECOM is a leader in all key markets that it serves. Ms. Pugh has been with AECOM for 22 years.



AECOM
5555 Glenwood Hills Pkwy, SE
Grand Rapids, Michigan 49512

Carlos A. Sanlley Pagán, Ph.D., Design Engineer, Greeley and Hansen

Dr. Sanlley received his Ph.D. from Michigan State University in 2009. His thesis research identified byproducts formed during Advance Oxidation Processes. His work experience includes the design of CSO control structures, design of a fermentation system to enhance VFA production for a Bardenpho wastewater treatment process, and design and analysis of a water intake structure in Lake Michigan. He is the firm-wide resource on AQUIFAS modeling and IFAS process design.

Greeley and Hansen, founded in 1914, is a leader in developing innovative engineering solutions for a wide array of water, wastewater, water reuse, and solid waste challenges aimed at improving public health, safety, and welfare. The projects that Greeley and Hansen has completed for clients continue to receive various industry awards for design and engineering excellence. *Engineering News Record* ranks Greeley and Hansen among the Top 25 Designers in Wastewater Treatment, Sewerage, and Solid Waste Management.



Greeley and Hansen
6640 Intech Boulevard, Suite 180
Indianapolis, IN 46278

Jimmy L. Spangler, P. E., Senior Manager, Municipal Group, Tetra Tech

Mr. Spangler received his B.S. in Civil Engineering from Michigan State University. He holds a Class A operator's license from the State of Michigan. His 36 years of experience includes 29 years of wastewater collection and treatment as a certified operator in positions of Plant Engineer (Washington Suburban Sanitary Commission—3 yrs), Assistant Superintendent (City of Pontiac, MI—3 yrs), and Superintendent (City of Lansing, MI—19 yrs) and 4 years as Deputy Public Service Department Director (City of Lansing). These facilities ranged in capacity from 40,000 gpd to 50 mgd. The processes included screening, grit removal, primary treatment, various activated sludge processes, phosphorous and ammonia nitrogen removal, chemical precipitation, tertiary filtration, chlorination, dechlorination, UV disinfection, aerobic digestion, anaerobic digestion, elutriation, WAS thickening, wet air oxidation, dewatering, incineration, and land application of biosolids. He also has had direct involvement in facility expansion and rehabilitation projects. For the last seven years he has been with Tetra Tech, Inc. His work includes conducting facility evaluations, reviewing designs, preparing and reviewing operation and maintenance manuals, plant operation reviews and inspections, process evaluations, preparing studies, and long-term capital plans.

Tetra Tech provides consulting, engineering, and technical services worldwide. The 10,000 employees of Tetra Tech provide expertise in water and wastewater facility design and operation, water resource management, program management, and construction services.



1921 E. Miller Road, Suite A
Lansing, MI 48911

Jeffrey R. Stollhans, P.G., District Manager, Layne-Northern

Mr. Stollhans received his B.S. in Geology from Illinois State University. His 24 years of experience in water well design and construction includes hundreds of well and pump installations throughout Michigan, Illinois, Indiana, and Ohio as well as multiple water treatment plants throughout Michigan. He is a Registered Water Well Contractor and Pump Installer in Michigan, Illinois, and Indiana and a Registered Geologist in Illinois, Missouri, and Kentucky. Prior to joining Layne Christensen in 1989, Mr. Stollhans worked in the Ground Water Section of the Illinois State Water Survey in Champaign, Illinois.

Layne Christensen's Water Resources Division provides a full line of water-related services and products including hydrological studies, site selection, well design, drilling and well development, pump installation, and repair and maintenance. The division's offerings include the design and construction of water treatment facilities and the manufacture and sale of products to treat volatile organics and other contaminants such as nitrates, iron, manganese, arsenic, radium, and radon in groundwater.



Layne-Northern
3126 N. Martin Luther King Jr. Blvd.
Lansing, MI 48906

CONTENTS

Preface	ix
1 The Design and Construction Processes	1-1
1-1 Introduction	1-2
1-2 Project Participants	1-2
1-3 The Professional–Client Relationship and The Code of Ethics	1-3
1-4 Responsible Care	1-9
1-5 Overall Design Process	1-10
1-6 Overall Construction Process	1-19
1-7 Hints from the Field	1-23
1-8 Chapter Review	1-24
1-9 Problems	1-24
1-10 Discussion Questions	1-25
1-11 References	1-26
2 General Water Supply Design Considerations	2-1
2-1 Water Demand	2-2
2-2 Water Source Evaluation	2-7
2-3 Water Quality	2-22
2-4 Evaluation of Process Options	2-37
2-5 Plant Sizing and Layout	2-37
2-6 Plant Location	2-39
2-7 Chapter Review	2-39
2-8 Problems	2-40
2-9 Discussion Questions	2-45
2-10 References	2-46
3 Intake Structures	3-1
3-1 Introduction	3-2
3-2 Design Elements	3-2
3-3 Design Criteria	3-8
3-4 Operational Considerations	3-31
3-5 Operation and Maintenance	3-34
3-6 Chapter Review	3-35
3-7 Problems	3-36
3-8 Discussion Questions	3-41
3-9 References	3-41
4 Wells	4-1
4-1 Introduction	4-2
4-2 Design Elements	4-2

4-3	Well Protection	4-3
4-4	Well Design	4-15
4-5	Chapter Review	4-41
4-6	Problems	4-42
4-7	Discussion Questions	4-51
4-8	References	4-51
5	Chemical Handling and Storage	5-1
5-1	Introduction	5-2
5-2	Redundancy and Capacity Provisions	5-2
5-3	Delivery, Handling, and Storage	5-2
5-4	Chemical Feed and Metering Systems	5-7
5-5	Chemical Compatibility	5-14
5-6	Materials Compatibility	5-14
5-7	Designing for Safety and Hazardous Conditions	5-17
5-8	Operation and Maintenance	5-17
5-9	Chapter Review	5-21
5-10	Problems	5-22
5-11	Discussion Questions	5-24
5-12	References	5-25
6	Coagulation and Flocculation	6-1
6-1	Introduction	6-2
6-2	Characteristics of Particles	6-3
6-3	Coagulation Theory	6-5
6-4	Coagulation Practice	6-22
6-5	Flocculation Theory	6-23
6-6	Mixing Theory	6-24
6-7	Mixing Practice	6-26
6-8	Operation and Maintenance	6-49
6-9	Chapter Review	6-49
6-10	Problems	6-50
6-11	Discussion Questions	6-57
6-12	References	6-58
7	Lime-Soda Softening	7-1
7-1	Hardness	7-2
7-2	Lime-Soda Softening	7-6
7-3	Softening Processes	7-11
7-4	Chemical Dosages Based on Stoichiometry	7-15
7-5	Concurrent Removal of Other Constituents	7-26
7-6	Process Configurations and Design Criteria	7-27
7-7	Operation and Maintenance	7-34
7-8	Stabilization	7-34
7-9	Chapter Review	7-39

7-10	Problems	7-40
7-11	Discussion Questions	7-46
7-12	References	7-47
8	Ion Exchange	8-1
8-1	Introduction	8-2
8-2	Fundamental Concepts of Ion Exchange	8-2
8-3	Process Operation	8-10
8-4	Ion Exchange Practice	8-13
8-5	Operation and Maintenance	8-24
8-6	Chapter Review	8-25
8-7	Problems	8-25
8-8	Discussion Question	8-28
8-9	References	8-29
9	Reverse Osmosis and Nanofiltration	9-1
9-1	Introduction	9-2
9-2	Theory	9-3
9-3	Properties of RO and NF Membranes	9-6
9-4	RO and NF Practice	9-8
9-5	Electrodialysis	9-18
9-6	Chapter Review	9-18
9-7	Problems	9-19
9-8	Discussion Question	9-20
9-9	References	9-20
10	Sedimentation	10-1
10-1	Introduction	10-2
10-2	Sedimentation Theory	10-2
10-3	Sedimentation Practice	10-20
10-4	Sedimentation Basin Design	10-25
10-5	Operation and Maintenance	10-38
10-6	Chapter Review	10-39
10-7	Problems	10-40
10-8	Discussion Questions	10-43
10-9	References	10-44
11	Granular Filtration	11-1
11-1	Introduction	11-2
11-2	An Overview of the Filtration Process	11-2
11-3	Filter Media Characteristics	11-5
11-4	Granular Filtration Theory	11-9
11-5	Theory of Granular Filter Hydraulics	11-12
11-6	Granular Filtration Practice	11-20

11-7	Operation and Maintenance	11-45
11-8	Chapter Review	11-46
11-9	Problems	11-47
11-10	Discussion Questions	11-54
11-11	References	11-55
12	Membrane Filtration	12-1
12-1	Introduction	12-2
12-2	Membrane Filtration Theory	12-3
12-3	Properties of MF and UF Membranes	12-7
12-4	MF and UF Practice	12-13
12-5	Chapter Review	12-19
12-6	Problems	12-19
12-7	Discussion Questions	12-21
12-8	References	12-21
13	Disinfection and Fluoridation	13-1
13-1	Introduction	13-2
13-2	Disinfection	13-2
13-3	Emergency Disinfection	13-42
13-4	Fluoridation	13-42
13-5	Operation and Maintenance	13-46
13-6	Chapter Review	13-47
13-7	Problems	13-48
13-8	Discussion Questions	13-55
13-9	References	13-55
14	Removal of Specific Constituents	14-1
14-1	Introduction	14-2
14-2	Arsenic	14-2
14-3	Carbon Dioxide	14-6
14-4	Fluoride	14-8
14-5	Iron and Manganese	14-11
14-6	Nitrate	14-14
14-7	Natural Organic Material (NOM)	14-15
14-8	Perchlorate	14-18
14-9	Pharmaceuticals and Endocrine-Disrupting Compounds (EDCs)	14-20
14-10	Radionuclides	14-21
14-11	Synthetic Organic Chemicals (SOCs) and Volatile Organic Compounds (VOCs)	14-22
14-12	Taste and Odor (T&O)	14-31
14-13	Chapter Review	14-36
14-14	Problems	14-37
14-15	Discussion Questions	14-40
14-16	References	14-40

15	Water Plant Residuals Management	15-1
15-1	Introduction	15-2
15-2	Solids Computations	15-3
15-3	Solids Production and Characteristics	15-6
15-4	Minimization of Residuals Generation	15-11
15-5	Recovery of Treatment Chemicals	15-13
15-6	Residuals Conveyance	15-15
15-7	Management of Sludges	15-15
15-8	Management of Liquid Residuals	15-44
15-9	Disposal of Specific Residuals Constituents	15-45
15-10	Ultimate Disposal	15-49
15-11	Chapter Review	15-51
15-12	Problems	15-52
15-13	Discussion Questions	15-57
15-14	References	15-58
16	Drinking Water Plant Process Selection and Integration	16-1
16-1	Introduction	16-2
16-2	Process Selection	16-2
16-3	Process Integration	16-16
16-4	Security	16-31
16-5	Chapter Review	16-35
16-6	Problems	16-36
16-7	Discussion Questions	16-47
16-8	References	16-47
17	Storage and Distribution Systems	17-1
17-1	Introduction	17-2
17-2	Demand Estimates	17-2
17-3	Service Pressures	17-9
17-4	Pipe Network Design	17-10
17-5	Storage Tank Design	17-22
17-6	Pump Selection	17-32
17-7	Network Analysis	17-36
17-8	Sanitary Protection	17-38
17-9	Chapter Review	17-40
17-10	Problems	17-41
17-11	Discussion Questions	17-50
17-12	References	17-51
18	General Wastewater Collection and Treatment Design Considerations	18-1
18-1	Wastewater Sources and Flow Rates	18-2
18-2	Wastewater Characteristics	18-7

18-3	Wastewater Treatment Standards	18-11
18-4	Sludge Disposal Regulations	18-14
18-5	Plant Sizing and Layout	18-20
18-6	Plant Location	18-22
18-7	Chapter Review	18-22
18-8	Problems	18-23
18-9	Discussion Questions	18-27
18-10	References	18-28
19	Sanitary Sewer Design	19-1
19-1	Introduction	19-2
19-2	Pre-design Activities	19-9
19-3	Gravity Sewer Collection System Design	19-9
19-4	Alternatives Sewers	19-28
19-5	Pump Station Design	19-31
19-6	Operation and Maintenance	19-39
19-7	Sewer Safety	19-40
19-8	Chapter Review	19-41
19-9	Problems	19-42
19-10	Discussion Questions	19-48
19-11	References	19-48
20	Headworks and Preliminary Treatment	20-1
20-1	Introduction	20-2
20-2	Pump Station	20-2
20-3	Flow Measurement	20-5
20-4	Bar Racks and Screens	20-9
20-5	Coarse Solids Reduction	20-23
20-6	Grit Removal	20-25
20-7	Flow Equalization	20-36
20-8	Alternative Preliminary Process Arrangements	20-46
20-9	Chapter Review	20-47
20-10	Problems	20-48
20-11	Discussion Questions	20-52
20-12	References	20-52
21	Primary Treatment	21-1
21-1	Introduction	21-2
21-2	Sedimentation Theory	21-2
21-3	Sedimentation Practice	21-3
21-4	Sedimentation Basin Design	21-6
21-5	Other Primary Treatment Alternatives	21-25
21-6	Chapter Review	21-26
21-7	Problems	21-27
21-8	References	21-30

22	Wastewater Microbiology	22-1
22-1	Introduction	22-2
22-2	Role of Microorganisms	22-2
22-3	Classification of Microorganisms	22-2
22-4	Microbial Biochemistry	22-4
22-5	Population Dynamics	22-10
22-6	Decomposition of Waste	22-15
22-7	Microbiology of Secondary Treatment Unit Processes	22-16
22-8	Operation and Maintenance	22-24
22-9	Chapter Review	22-25
22-10	Problems	22-26
22-11	Discussion Questions	22-28
22-12	References	22-28
23	Secondary Treatment by Suspended Growth Biological Processes	23-1
23-1	Introduction	23-2
23-2	Processes for BOD Removal and Nitrification	23-2
23-3	Processes for Denitrification	23-8
23-4	Processes for Phosphorus Removal	23-10
23-5	Biological Treatment with Membrane Separation	23-12
23-6	Suspended Growth Design Principles	23-14
23-7	Suspended Growth Design Practice	23-39
23-8	Membrane Bioreactor Design Practice	23-95
23-9	Chapter Review	23-98
23-10	Problems	23-99
23-11	Discussion Questions	23-109
23-12	References	23-113
24	Secondary Treatment by Attached Growth and Hybrid Biological Processes	24-1
24-1	Introduction	24-2
24-2	Attached Growth Processes	24-2
24-3	Attached Growth Design Principles	24-4
24-4	Attached Growth Design Practice	24-6
24-5	Hybrid Processes	24-12
24-6	Chapter Review	24-14
24-7	Problems	24-15
24-8	References	24-16
25	Secondary Settling, Disinfection, and Postaeration	25-1
25-1	Introduction	25-2
25-2	Secondary Settling	25-2
25-3	Disinfection	25-15
25-4	Postaeration	25-21

25-5	Chapter Review	25-22
25-6	Problems	25-23
25-7	Discussion Questions	25-24
25-8	References	25-25
26	Tertiary Treatment	26-1
26-1	Introduction	26-2
26-2	Chemical Precipitation of Phosphorus	26-2
26-3	Granular Filtration	26-5
26-4	Membrane Filtration	26-10
26-5	Carbon Adsorption	26-12
26-6	Chapter Review	26-15
26-7	Problems	26-16
26-8	References	26-17
27	Wastewater Plant Residuals Management	27-1
27-1	Sludge Handling Alternatives	27-2
27-2	Sources and Characteristics of Solids and Biosolids	27-3
27-3	Solids Computations	27-6
27-4	Grit Handling and Sludge Pumping	27-11
27-5	Management of Solids	27-17
27-6	Storage and Thickening of Sludges	27-18
27-7	Alkaline Stabilization	27-23
27-8	Aerobic Digestion	27-27
27-9	Anaerobic Digestion	27-33
27-10	Sludge Conditioning	27-52
27-11	Dewatering	27-53
27-12	Alternative Disposal Techniques	27-58
27-13	Land Application and Biosolids	27-59
27-14	Chapter Review	27-60
27-15	Problems	27-61
27-16	References	27-68
28	Clean Water Plant Process Selection and Integration	28-1
28-1	Introduction	28-2
28-2	Process Selection	28-2
28-3	Simulation Modeling	28-24
28-4	Process Integration	28-25
28-5	Chapter Review	28-31
28-6	Problems	28-34
28-7	References	28-36

Appendix A <i>Properties of Air, Water, and Selected Chemicals</i>	A-1
Appendix B <i>U.S. Standard Sieve Sizes</i>	B-1
Appendix C <i>Pipe, Fitting, and Valve Data</i>	C-1
Appendix D U.S. Environmental Protection Agency Ct Values for Disinfectants	D-1
Index	I-1

This page intentionally left blank

CHAPTER

1

THE DESIGN AND CONSTRUCTION PROCESSES

If it works, it is good. The trick, of course, is designing something that works.

*P. Arne Vesilind
Wastewater Treatment Plant Design
Water Environment Federation, 2003*

The devil is in the details.

Anonymous

- | | |
|--|---|
| 1-1 INTRODUCTION | 1-6 OVERALL CONSTRUCTION PROCESS |
| 1-2 PROJECT PARTICIPANTS | 1-7 HINTS FROM THE FIELD |
| 1-3 THE PROFESSIONAL–CLIENT
RELATIONSHIP AND THE CODE
OF ETHICS | 1-8 CHAPTER REVIEW |
| 1-4 RESPONSIBLE CARE | 1-9 PROBLEMS |
| 1-5 OVERALL DESIGN PROCESS | 1-10 DISCUSSION QUESTIONS |
| | 1-11 REFERENCES |

1-1 INTRODUCTION

Overview

Water and wastewater engineering encompasses the planning, design, construction, and supervision of water and wastewater systems. This chapter gives an overview of the design and construction process as an introduction to planning. Chapters 2 through 17 address water treatment. The subject matter follows the flow of water (and the design of unit processes) from the development of a source through the unit processes of coagulation, flocculation, softening, reverse osmosis, nanofiltration, sedimentation, granular filtration, membrane filtration, disinfection, and residuals management. The topics of wastewater treatment follow a similar pattern of following the flow through a plant. Chapters 18 through 28 address preliminary treatment, primary treatment, secondary treatment, tertiary treatment, and residuals management. Special attention is given to the application of membranes.

Setting the Stage

Before presenting the design and construction processes, the stage is set by identifying the project participants and their roles. The *Code of Ethics* provides a framework to discuss the professional–client relationship. *Responsible care* is introduced as a higher level of performance than demanded by the code of ethics.

1-2 PROJECT PARTICIPANTS

Decision making for any municipal water or wastewater engineering design involves many participants: the public, the regulator, the legal counsel, the owner, the designer, the financier/investment banker, the operator, and the contractor. The owner serves as the focus of all the project's activities. The design professional, as a member of the design team under the owner's direction, responds to the project's design needs. The design team consists of principal design engineers and supporting specialists (WEF, 1991).

All projects begin with an identification of a problem by the regulator, the public, legal counsel, or owner. The design professional then enters the project during the idea generation and evaluation phase of the problem-solving activity. Thereafter, the design professional or firm generally participates actively in all of the project's activities, typically until the end of the first year of operation. (WEF, 1991)

The design professional may enter the process by many routes. Typically one of the following three methods or a combination of the methods are used to obtain engineering design services:

- *Request for Qualifications (RFQ)*: The owner solicits qualifications from firms that wish to be considered for engineering services on a design project.
- *Request for Proposals (RFP)*: The owner solicits proposals for engineering services on a project. The RFP usually includes a requirement to provide a statement of qualifications. Alternatively, the RFQ may be a second step following the evaluation of the responses to the RFP.
- *Qualified Bidder Selection (QBS)*: The owner selects the design firm from a list of previously qualified companies.

TABLE 1-1
Some observed professional–client relationship models

Model	Description and comments
Agency	Professional acts as an expert for agency, but agency has authority and responsibility. Plausible for an attorney or a consultant to a government agency such as the Corps of Engineers.
Contract	Authority and responsibility shared equally. This model assumes bargaining between equals. Not likely for an engineering consultant in classical design and construction.
Paternal	Professional has superior knowledge and makes all the decisions for the client. This model assumes the professional has not only superior technical knowledge but also knows what is in the client's best interest. Paternalism requires justification because it involves performing on behalf of the client regardless of that person's consent.
Fiduciary	Professional's superior knowledge is recognized, but the client retains significant authority and responsibility for decision making. The professional supplies ideas and information and proposes courses of action. The client's judgement and consent are required.

Extracted from Bayles, 1991.

In the case of the focus of this text, the *owner* is a municipality or an operating authority representing several municipalities.

The central issue in the professional–client relationship is the allocation of responsibility and authority in decision making—who makes what decisions. These are ethical models that are, in effect, models of different distributions of authority and responsibility in decision making. One can view the professional–client relationship as one in which the client has the most authority and responsibility in decision making, the professional being an employee; one in which the professional and the client are equals, either dealing at arm's length or at a more personal level; or one in which the professional, in different degrees, has the primary role (Bayles, 1991). The models are summarized in Table 1-1.

1-3 THE PROFESSIONAL–CLIENT RELATIONSHIP AND THE CODE OF ETHICS

The professional–client relationship may move back and forth between two or more models as the situation changes. However, for the professional engineer, the requirements of the Code of Ethics are overarching. The American Society of Civil Engineers (ASCE) Code of Ethics is shown in Figure 1-1.

First Canon

This canon is paramount. It is held superior to all the others.

Regulations, codes, and standards serve as the engineer's guidance in ensuring that the facilities are safe and protect the health of the community. A large portion of this book and, for that

**AMERICAN SOCIETY OF CIVIL ENGINEERS
CODE OF ETHICS**

Fundamental Principles

Engineers uphold and advance the integrity, honor and dignity of the engineering profession by:

1. using their knowledge and skill for the enhancement of human welfare and the environment;
2. being honest and impartial and serving with fidelity the public, their employers and clients;
3. striving to increase the competence and prestige of the engineering profession; and
4. supporting the professional and technical societies of their disciplines.

Fundamental Canons

1. Engineers shall hold paramount the safety, health and welfare of the public and shall strive to comply with the principles of sustainable development in the performance of their professional duties.
2. Engineers shall perform services only in areas of their competence.
3. Engineers shall issue public statements only in an objective and truthful manner.
4. Engineers shall act in professional matters for each employer or client as faithful agents or trustees, and shall avoid conflicts of interest.
5. Engineers shall build their professional reputation on the merit of their services and shall not compete unfairly with others.
6. Engineers shall act in such a manner as to uphold and enhance the honor, integrity, and dignity of the engineering profession.
7. Engineers shall continue their professional development throughout their careers, and shall provide opportunities for the professional development of those engineers under their supervision.

FIGURE 1-1

American Society of Civil Engineers code of ethics.

matter, the education of environmental engineers is focused on these two issues. They will be discussed in more detail at appropriate points in the remaining chapters.

The public “welfare” is not articulated in regulations, codes, and standards. It is comprised of two parts: prosperity and happiness. The public prospers when the decisions of the professional result in economical projects. The public is “happy” when their trust and reliance on the professional is justified by successful completion of a project.

Economical projects do not imply the cheapest project. Rather, they imply projects that serve the client’s needs and satisfy the client’s elective options while conforming to regulatory constraints. In the classical engineering approach economical projects are achieved by the following:

- Scoping of the engineering contract (Bockrath, 1986 and Sternbach, 1988).
- Economic analysis of alternatives (GLUMRB, 2003; WEF, 1991; WPCF, 1977).
- Selection of lowest responsible bidder (Bockrath, 1986).
- Diligent inspection of the work in progress (Firmage, 1980).

In alternative approaches such as design-build, economy is achieved by alternate delivery methods.

At the beginning of a project, on approval of the selection of a specific consulting engineer, it is customary to hold a “scope meeting.” At the scope meeting a typical agenda includes (Firmage, 1980 and Sternbach, 1988):

- Identification of primary contacts for the owner and engineering firm.
- Scope and extent of engineering work.
- Starting and completion dates.
- Construction inspection.
- Responsibility for allied engineering services.
- Procedures for out-of-scope requests.
- The fee.

Many times these items are addressed in the engineering firm’s proposal. In the proposal process, the clarity with which these are addressed may serve as a basis for selection of the engineering firm.

The scope and extent of engineering work should be explicitly defined, in writing, to avoid misunderstanding. The scope ensures that the client understands the limits of the work the engineer is willing and/or able to perform. It provides the engineer with a framework for establishing the fee and level of effort to be provided as well as ensuring that the engineer is not expected to perform work outside of the area of competence. It may include such things as personnel assigned to the project, their qualifications and responsibilities, evaluation of alternatives, design of the facility, preparing detail drawings, cost estimates, evaluating bids, as well as bidder qualifications, surveying, staking the project, preparation of operation and maintenance manuals, attendance at meetings, and documentation.

The starting and completion dates provide both the client and the engineer with realistic expectations as to the progress of the project.

The scope meeting should identify the design engineer’s responsibilities for construction inspection. Typically, the design engineering firm provides a field engineer and/or a construction observer to diligently observe and, to the best of their ability, assure the owner that the construction is taking place in accordance with the plans and specifications as the project is being built. Although a field engineer from a firm not involved in the design may be retained, it is preferable that the design firm provide the engineer to ensure continuity. While construction observers may be competent to do routine examinations of the progress of work, they generally do not have the technical background to assure compliance with design specifications unless they are given specific training. For large projects, a full-time field engineer is on site. For small projects, periodic inspection and inspection at critical construction milestones is provided.

Small engineering firms may not have the expertise to provide the design specifications for all of the components of the design. In this instance, the responsibility for providing allied engineering services such as geotechnical/soils consultants and electrical, mechanical, and structural engineering as well as architectural services should be spelled out in writing at the scope meeting. The professional engineering qualifications of those supplying the allied engineering should also

TABLE 1-2
Common fee structures

Model	Description and comments
Fixed percentage	The engineering fee is a fixed percentage of the final cost of the constructed facility. There is a negative incentive for the engineer to produce an economical design. This fee system is outdated and rarely, if ever, used.
Fixed fee (lump sum)	The engineering fee is a stated sum. There is no incentive for the engineer to explore alternatives when it is specified as part of the work. There is an incentive to get the work done as expeditiously as possible.
Time and materials (T&M) or time and expenses (T&E)	The cost of engineering services (the amount paid for salaries, fringe benefits, retirement allowances, and operating costs) plus a percentage for overhead and a fee for profit. In this procedure, the client will pay the “true” cost of the engineering. However, without a scope of work and deadline, there is an no incentive for the engineer to expedite the work.
Time and materials, not to exceed	Same as T&M above but a maximum fee is specified. This provides the engineer some incentive to expedite the work but only so as not to exceed the ceiling fee. On the other hand, the owner has an incentive to expand the scope. Both parties need to be alert to these possibilities and make appropriate adjustments.

be explicitly defined. For example, structural engineers that specialize in building design may not be appropriate for designing structures subject to aggressive wastewater.

Billing schedules and expectations of payment are also included in the scope meeting. Typical fee structures are outlined in Table 1-2.

Economic analysis of alternatives, selection of lowest responsible bidder, and diligent inspection of the work in progress will be discussed in the context of the design/construction process described below.

Turning to the issue of “happiness” or more formally “How is trust and reliance on the professional justified?”, three elements are to be considered:

- The engineer’s view of the client.
- The client’s view of the project.
- Minimal versus appropriate standards.

For all but the very largest municipal systems, the first two models of the professional–client relationship, Agency and Contract, do not apply. That leaves us with the latter two models. “Although a professional and a client are not equals, sufficient client competence exists to undermine the paternalistic model as appropriate for their usual relationship. Clients can exercise judgement over many aspects of professional services. If they lack information to make decisions, professionals can provide it.” (Bayles, 1991) This is not meant to suggest that the public needs to be taught environmental engineering. Rather, it suggests that educated members of our modern society are capable of understanding alternatives and making reasonable choices based on their values. They should be provided enough information to make choices that accomplish their purposes—not those of the professional.

The client's view of the project is most closely matched by the Fiduciary model, where the client has more authority and responsibility in decision making than in the Paternal model. The client must exercise judgement and offer or withhold consent in the decision making process. In the Fiduciary model, the client depends on the professional for much of the information they need to give or withhold their consent. The term *consents* (the client consents) rather than *decides* (the client decides) indicates that it is the professional's role to propose courses of action. It is not the conception of two people contributing equally to the formulation of plans, whether or not dealing at arm's length. Rather, the professional supplies the ideas and information, and the client agrees or not. For the process to work, the client must trust the professional to analyze accurately the problem, canvass the feasible alternatives and associated costs, know as well as one can their likely consequences, fully convey this information to the client, perhaps make a recommendation, and work honestly and loyally for the client to effectuate the chosen alternative. In short, the client must rely on the professional to use his or her knowledge and ability in the client's interests. Because the client cannot check most of the work of the professional or the information supplied, the professional has special obligations to the client to ensure that the trust and reliance are justified.

This is not to suggest that the professional simply presents an overall recommendation for the client's acceptance or rejection. Rather, a client's interests can be affected by various aspects of a professional's work, so the client should be consulted at various times (Bayles, 1991).

"Sustainable development is development that meets the needs of the present without compromising the ability of future generations to meet their own needs." (WECD, 1987) If we look beyond the simple idea of providing water and controlling pollution to the larger idea of sustaining our environment and protecting the public health, we see that there are better solutions for our pollution problems. For example:

- Pollution prevention by the minimization of waste production.
- Life cycle analysis of our production techniques to include built-in features for extraction and reuse of materials.
- Selection of materials and methods that have a long life.
- Manufacturing methods and equipment that minimize energy and water consumption.

Second Canon

Engineers are smart, confident people. With experience, we gain wisdom. The flaw of our nature is to overextend our wisdom to areas not included in our experience. Great care must be taken to limit engineering services to areas of competence. Jobs may be too large, too complicated, require technology or techniques that are not within our experience. Competence gained by education or by supervised on-the-job training sets the boundaries on the areas in which we can provide service. Others more qualified must be called upon to provide service beyond these experiences.

Engineers are creative. We pride ourselves in developing innovative solutions. We believe that civilization advances with advances in technology. Someone has to build the first pyramid, the first iron bridge, the first sand filter. Many times "the first" design fails (Petroski, 1985). Thus, there may be a conflict between creativity and service in an area of competence. The conflict must be resolved very carefully. Although safety factors, bench and pilot scale experiments, and computer simulations may be used, the client and professional must, in a very explicit way,

agree on a venture into uncharted territory. If the territory is simply uncharted for the design engineer but not for the profession, then the design engineer must employ a partner that can bring experience or obtain the necessary training to become competent.

Third Canon

It may not seem that engineers would be called upon to issue public statements. Yet, there are numerous times that public statements are issued. Often these are formal, such as signing contracts, making presentations to a city council or other public body, and issuing statements to the news media. In other instances it is not so obvious that the statements are public. Verbal statements to individual members of the public, posting of signs, and signing change orders on government financed projects are examples of informal public statements.

Fourth Canon

A faithful agent is more than a loyal one. A faithful agent must be completely frank and open with his/her employer and client. This means getting the facts, explaining them, and not violating the other canons to please the client or your employer.

Conflicts of interest may be subtle. A free lunch, a free trip, or a golf outing may not seem like much of a conflict of interest, but in the eyes of the public, any gift may be seen as an attempt to gain favors. Appearances do count and, in the public's view, perception is reality.

Fifth Canon

This canon appears to be self-explanatory. We understand that cheating on exams is unethical. Likewise, cheating by claiming credit for work that someone else has done is unethical.

Unfair competition has taken a broad meaning in the review of ethics boards. For example, offering services to a potential client that has retained another engineer to do the same work falls into the category of unfair competition if the engineer solicits the work. The circumstances are different if the client solicits the engineer after having already retained another engineer. This type of request must be treated with great care. It is best to decline this type of employment until the client and original engineer resolve or dissolve their relationship.

Similarly, a request to review the work of another engineering firm may be construed to be unfair competition. The best procedure is for the client to advise the original firm of their desire to have an independent review. Another alternative is to advise the originating engineering firm that the request has been made. This is a matter of courtesy, if not a matter of ethics.

Sixth Canon

This canon has two elements. The first is to treat others with the same courtesy that you would expect from them. The second is to behave such that the credibility of your work is not jeopardized.

Seventh Canon

Engineers use technology both in the process of doing their job and in the provision of solutions to problems. It is incumbent on them to keep up with the technology. One of the best means of doing this is to participate in one of the relevant professional societies by attending meetings,

reading journal articles, and participating in workshops. Appropriate organizations for municipal water and wastewater engineering include the American Society of Civil Engineers (*Journal of Environmental Engineering*), American Water Works Association (*Journal AWWA*), and the Water Environment Federation (*Water Environment Research*).

1-4 RESPONSIBLE CARE

Codes of ethics are minimalist (Ladd, 1991). They stipulate only the minimal acceptable standards. To say that only minimal standards qualify as reasonable and sufficient is to suggest that these standards result in a product that is as good as anyone could expect it to be (Harris et al., 1995). This is belied by the fact that others in the profession choose to exceed the minimal standards:

“A major responsibility of the engineer is to precisely determine the wants of the client.” (Firmage, 1980).

“. . . the first task of the engineer is *find out what the problem really is.*”

“An important aspect of the problem definition that is frequently overlooked is *human factors*. Matters of customer use and acceptance are paramount.” (Kemper and Sanders, 2001)

The responsibilities of engineers are to (Baum, 1983):

1. “Recognize the right of each individual potentially affected by a project to participate to an appropriate degree in the making of decisions concerning that project.”
2. “Do everything in their power to provide complete, accurate, and understandable information to all potentially affected parties.”

To go beyond the minimalist requirements is to endorse the concepts of *responsible* or *reasonable care* and *informed consent*. Reasonable care is “a standard of reasonableness as seen by a normal, prudent nonprofessional” (Harris et al., 1995). Informed consent is understood as including two main elements: knowledge and voluntariness. To elaborate, informed consent may be defined by the following conditions (Martin and Schinzinger, 1991):

1. The consent is given voluntarily without being subjected to force, fraud, or deception.
2. The consent is based on the information that a rational person would want, together with any other information requested, presented to them in an understandable form.
3. The decision is made by an individual competent to process the information and make rational decisions.
4. The consent is offered in proxy by an individual or group that collectively represents many people of like interests, concerns, and exposure to the risks that result from the decision.

To go beyond the minimalist level of holding the public welfare paramount, the professional engineer must view the relationship to the client as fiducial. They owe the client responsible care. The client must be given the right and opportunity to express informed consent or to withhold

consent as they deem fit. This is not to say that the client must consent to the selection of every nut and bolt in the project, but rather that *critical decision points* must be identified for the client. At these decision points the client must be provided enough information to allow rational decisions. This information should include the alternatives, the consequences of choosing one alternative over another, and the data and/or logic the engineer used to arrive at the consequences.

1-5 OVERALL DESIGN PROCESS

Project Design and Construction Delivery Processes

The design process is not like a computer program that is executed exactly the same way for every project. The process described here is an overview of the classical engineering approach to design- and construction-related activities. In this approach, vendor-furnished equipment is procured according to performance or prescriptive specifications through contractors who are bidding from drawings and specifications prepared by a consulting engineer. All funding and ownership of the facilities rest with the owner in the classical approach. In actual practice some of the steps described below will be bypassed and others, not described, will be inserted based on the experience of the designer and the complexity of the design.

Other approaches to the design and construction process include (1) design-build, (2) construction management-agent, (3) construction management-at risk, (4) design engineer/construction manager. These alternative approaches are discussed at the website <http://www.mhprofessional.com/wwe>.

The classic design procedure includes the following steps:

- Study and conceptual design
- Preliminary design
- Final design

These steps will be examined in more detail in the following paragraphs. Each of these steps forms a major decision point for the owner. He or she must be provided enough information to allow a rational decision among the alternatives, including the alternative to not proceed.

The design process is iterative. Each step requires reevaluation of the design assumptions made in previous steps, the ability of the design to meet the design criteria, the compatibility of processes, and integration of the processes. At key decision points, the economic viability of the project must be reassessed.

Study and Conceptual Design

In this phase of the design, alternatives are examined and appropriate design criteria are established. It is in this stage of the project that alternatives to facility construction are examined. For water supply, the alternatives to facility construction might include purchasing water from a nearby community, instituting water conservation, or having individual users supply their own water by private wells. For wastewater treatment, the alternatives to facility construction might include connection to a nearby community's system or controlling infiltration and inflow into the sewer system. In addition, the *null alternative*, that is the cost of doing nothing must also be considered.

Establishment of Design Criteria. Design criteria are the boundary conditions that establish the functional performance of the facility. Two general types of criteria are used: *performance* and *prescriptive*. Performance criteria define the desired objective, but not the means of achieving it. Prescriptive criteria define the explicit details of how the facility will be built. The design criteria are frequently a combination of the two types of criteria.

Water and wastewater treatment systems will be used for illustration in the following paragraphs. Some of the factors to be considered will differ for water supply and sewer systems. Six factors are normally considered in establishing the design criteria for water and wastewater treatment systems:

- Raw water or wastewater characteristics.
- Environmental and regulatory standards.
- System reliability.
- Facility limits.
- Design life.
- Cost.

Raw water or wastewater characteristics. Water characteristics include the demand for water and the composition of the untreated (*raw*) water. Wastewater characteristics include the flow rate of the wastewater and its composition.

Sound design practice must anticipate the range of conditions that the facility or process can reasonably be expected to encounter during the design period. The range of conditions for a plant typically varies from a reasonably certain minimum in its first year of operation to the maximum anticipated in the last year of the design service period in a service area with growth of customers. . . . Often the minimum is overlooked and the maximum is overstated. (WEF, 1991)

Consideration of the flowrates during the early years of operation is often overlooked, and over sizing of equipment and inefficient operations can result. (Metcalf & Eddy, Inc., 2003).

The water characteristics include:

- Raw water composition.
- Hourly, daily, weekly, monthly, and seasonal variations in raw water composition and availability.
- Variations in demand from domestic, industrial, commercial, and institutional activities.

The wastewater characteristics include:

- Composition and strength of the wastewater.
- Hourly, daily, weekly, monthly, and seasonal variations in flow and strength of the wastewater.
- Contributions from industrial and commercial activities.
- Rainfall/runoff intrusion.

- Groundwater infiltration.
- Raw water mineral composition.

Water quality standards to be met. Early consideration of the water quality standards provides the basis for elimination of treatment technologies that are not appropriate. The standards are prescribed by the regulating agency. The standards require that the treatment facility provide potable water or discharge wastewater that meets numerical requirements (*performance* standards). They are based on statutory requirements. For example, regulations specify the concentration of coliform organisms that may be delivered to consumers or discharged into a river. For wastewater, modeling studies of the stream or river may also be required. For the river, the regulating agency will focus on the critical seasonal parameters for the stream or river. Normally, this will be in the summer dry-season because the flow in the river or stream will be low (reducing the capacity for assimilation of the treated wastewater), the oxygen carrying capacity of the stream will be low (stressing the aquatic population), and the potential exposure from recreational activities will be high. The potable water or wastewater effluent standards do not prescribe the technology that is to be used in meeting the standards, but they do establish the goals that the engineer uses to select the appropriate treatment processes.

Other requirements. In addition to the numerical standards, other requirements may be established by the regulatory agency as well as the owner. For example, drinking water limits on taste and odor, and specific minerals such as calcium, magnesium, iron, and manganese may be specified. For wastewater, in addition to the numerical standards, the absence of foam, floating material, and oil films may be required.

System reliability. System reliability refers to the ability of a component or system to perform its designated function without failure. Regulatory reliability requirements are, in fact, redundancy requirements. True *reliability* requirements would specify the mean time between failure for given components or processes. This is difficult, if not impossible, criteria to specify or, for that matter, to design, for the wide range of equipment and environmental conditions encountered in municipal water and wastewater projects.

For water supply systems, some redundancy recommendations of the Great Lakes–Upper Mississippi River Board of State and Provincial Public Health and Environmental Managers are shown in Table 1-3 (GLUMRB, 2003).

There are three “reliability” classes for wastewater treatment facilities established by the U.S. Environmental Protection Agency (EPA). Class I reliability is required for those plants that discharge into navigable waters that could be permanently or unacceptably damaged by effluent that was degraded in quality for only a few hours. Class II reliability is required for those plants that discharge into navigable waters that would not be permanently or unacceptably damaged by short-term effluent quality, but could be damaged by continued (several days) effluent quality degradation. Class III reliability is required for all other plants (U.S. EPA, 1974). Table 1-4 provides EPA guidance on minimum equipment to meet reliability requirements. In reviewing the design that is submitted by the engineer, the regulatory agency uses this guidance to establish *prescriptive requirements* prior to the issuance of the permit to construct the facility. Some states may require more stringent requirements than the federal guidance. For example, Michigan requires Class I reliability for all plants.

TABLE 1-3
Guidance for minimum equipment and process reliability for water treatment

Component	Recommendation
Source	
Surface water	
Capacity	Meet a one-in-50-year drought with due consideration for multiple year droughts
Intake structures	Where intake tower is used, provide two independent intake cells, each with three intake ports at different elevations
Pumps	Minimum of two; meet the maximum day demand with one unit out of service
Groundwater	
Capacity	Equal or exceed maximum day demand with largest producing well out of service
Wells	Minimum of two
Treatment	
Rapid mix	Minimum of two; meet the maximum day demand with one unit out of service
Flocculation	Minimum of two; meet the maximum day demand with one unit out of service
Sedimentation	Minimum of two; meet the maximum day demand with one unit out of service
Disinfection	Minimum of two; meet the maximum day demand with one unit out of service
Power	
	Provide primary transmission lines from two separate sources or standby generator
Finished water storage	
Capacity	Equal to the average day demand when fire protection is not provided Meet domestic demand and fire flow demand where fire protection is provided
Distribution	
High service pumps	Minimum of two; meet the maximum day demand with one unit out of service
System pressure	Minimum of 140 kPa at ground level at all points in the system Nominal working pressure should be 410 to 550 kPa and not less than 240 kPa

Sources: Foellmi, 2005; GLUMRB, 2003.

TABLE 1-4
EPA Construction Grants Program guidance for minimum equipment and process reliability for the liquid-processing train

Component	Reliability classification					
	I		II		III	
	Treatment system	Power source	Treatment system	Power source	Treatment system	Power source
Holding basin	Adequate capacity for all flows		Not applicable		Not applicable	
Degritting		Optional		No		No
Primary sedimentation	Multiple units ^a	Yes	Same as class I		Two minimum ^a	Yes
Trickling filters	Multiple units ^b	Yes	Same as class I	Optional	No backup	No
Aeration basins	Two minimum w/equal volume	Yes	Same as class I	Optional	Single unit permissible	No
Blowers or mechanical aerators	Multiple units ^c	Yes	Same as class I	Optional	Two minimum ^c	No
Diffusers	Multiple sections ^d		Same as class I		Same as class I	
Final sedimentation	Multiple units ^b	Yes	Multiple units ^a	Optional	Two minimum ^a	No
Chemical flash mixer	Two minimum or backup ^e	Optional	No backup	Optional	Same as class II	No
Chemical sedimentation	Multiple units ^b	Optional	No backup	Optional	Same as class II	No
Flocculation	Two minimum	Optional	No backup	Optional	Same as class II	No
Disinfection basins	Multiple units ^b	Yes	Multiple units ^a	Yes	Same as class II	

^aRemaining capacity with largest unit out of service must be for at least 50% of the design maximum flow.

^bRemaining capacity with largest unit out of service must be for at least 75% of the design maximum flow.

^cRemaining capacity with largest unit out of service must be able to achieve design maximum oxygen transfer; backup unit need not be installed.

^dMaximum oxygen transfer capability must not be measurably impaired with largest section out of service.

^eIf only one basin, backup system must be provided with at least two mixing devices (one may be installed).

Source: U.S. EPA, 1974.

Site limitations. The location and area available for the treatment plant, availability of power, roads, and a connection to the raw water supply or point to discharge define the facility limits. In addition, the need for easements for the water distribution system and sewer system, and connection to the power and road grid are limitations that must be considered.

Design life. The basis for economic comparison of alternatives is the design life. Processes and components of processes with different design lives must be brought to an equivalent life for valid economic comparison. Standard engineering economic techniques are available to perform this analysis. A primer on economic analysis is given at <http://www.mhprofessional.com/wwe>.

Cost. Cost is part of the design criteria because “(t)he ultimate selection among otherwise acceptable unit processes or process trains is based on an economic evaluation.” (WPCF, 1977) The degree of effort and care taken to estimate the capital investment cost and the operating and maintenance cost depends on the stage of development of the project. In the early stages, rough and relatively rapid estimation methods are usually the only ones justified. These are called *order-of-magnitude* estimates. In the middle stages of the development of the project more sophisticated estimates are made based on better information about the alternatives. These are called *study* estimates. *Authorization* estimates are made to make the final choice between competing alternatives to complete the project. *Bid* estimates are made when the decision is made to proceed with construction of the project. To provide an accurate document against which to control expenditures during construction, a *project control* estimate is made using detailed drawings and equipment inquiries (Valle-Riestra, 1983).

Cost estimates consist of two parts: capital costs and operating costs. “The capital cost and operating cost estimated for each alternative must be made equivalent to make an economic comparison.” (WPCF, 1977) Several alternative methods may be used to make equivalent economic comparisons. These include *present worth* analysis, *annual cash flow* analysis, *rate of return* analysis, *benefit-cost* analysis, and *breakeven* analysis. These are described in numerous standard textbooks on engineering economic analysis, for example, Newnan et al. (2000) and Thuesen and Fabrycky (2000). Consideration of **both** the capital cost **and** the operating cost on an equivalent basis *is an essential part of making the correct choice in selecting the most economical alternative*, as illustrated in Table 1-5. Using Table 1-5, on the basis of capital cost alone, alternative B would be selected as the more economical plant. On an equivalent basis (total annual costs), alternative A is the more economical plant. The selection of alternative B on the basis of capital cost alone would result in an excess expenditure of more than \$1,000,000 over that of alternative A over the 25-year life of the project.

A frequent omission failure in the examination of alternatives is the failure to consider the null alternative. In addition, care must be taken not to include *sunk costs* (that is, past costs) in the economic analysis and decision making process. The only relevant costs in an engineering economic analysis are present and future costs (Newnan and Johnson, 1995).

Screening of alternatives. Alternative designs are examined for the feasibility of meeting design criteria. Either experience, literature review, or rough calculations are used to determine sizes to be used in examining feasibility. Potential sites for the project are identified based on the rough sizes. An *order-of-magnitude* level of cost is made at this point.

This is a *critical decision point* for the project. The owner must be provided enough information to allow a rational decision about the choices available. This information should include the

TABLE 1-5
Comparison of design alternatives by equivalent costs^a

Cost Items	Equivalent Costs ^b	
	Alternative A	Alternative B
Capital costs		
Construction cost	\$6,300,000	\$5,300,000
Engineering	945,000	795,000
Land	130,000	200,000
Legal, fiscal, administrative	50,000	80,000
Interest during construction	189,000	159,000
Subtotal	\$7,614,000	\$6,534,000
Inflation prior to construction	228,000	196,000
Total capital costs	\$7,842,000	\$6,730,000
Annualized capital cost ^c	557,000	478,000
Operating and maintenance costs		
Personnel	220,000	290,000
Power	120,000	60,000
Chemicals	15,000	128,000
Miscellaneous utilities	30,000	30,000
Miscellaneous supplies and materials	50,000	50,000
Annual operating and maintenance costs	\$ 435,000	\$ 558,000
Total annual costs ^d	\$ 992,000	\$1,036,000

^aAdapted from Water Pollution Control Federation, *MOP 8, Wastewater Treatment Plant Design*, Washington, D.C., 1977.

^bCost basis = 2006. Engineering News Record Construction Cost Index = 7690.72.

^cAlso called "debt service." Capital cost recovery factor (A/P, 5%, 25) = 0.0710.

^dAnnualized capital cost + annual operating and maintenance costs.

alternatives, the consequences of deciding one alternative over another, and the data and/or logic the engineer used to arrive at the consequences.

In the iterative process of design, the engineer must return to this step each time the list of alternatives or the cost estimates change to verify the original decision or to make a new decision.

Preliminary Design

At this stage, the engineer is given approval to perform the initial stages of design. This stage of design is to allow a more rigorous comparison of the alternatives that appear to meet the goals of the client.

The engineer develops a work plan and schedule. These provide the client with realistic expectations of the timing of the project, while ensuring that the level of effort and degree of detail developed by the engineer are appropriate for making decisions about the economic feasibility of the project.

In conjunction with the client, the engineer establishes the level of sophistication of the facility. The following are examples of the items to be established:

1. Degree of automation.
2. Nature of maintenance history.
3. Number of people to operate the facility.
4. Qualifications of personnel required to operate and maintain the facility.

The availability and responsibility for providing connection to the electric grid, road access, fuel requirements, and sludge disposal alternatives are also established at this stage. In addition, facility aesthetics (architecture) and construction impacts on the local community are discussed.

The engineer completes a design of the major processes. This design includes sufficient calculations to firm up the estimated land requirements, directs the location of soil borings, and establishes horizontal and vertical control surveying.

An *authorization estimate* is made to provide a basis for making the final choice of the treatment processes and to allow the client's budget planning to proceed. Sufficient information is available at this stage to allow a rigorous cost estimate comparison, such as that shown in Table 1-5, to be completed.

This is another *critical decision point* for the project. As noted previously, the owner must be provided enough information to allow a rational decision about the choices available. This information should include the alternatives, the consequences of deciding one alternative over another, and the data and/or logic the engineer used to arrive at the consequences. This is also an opportunity to revisit the assumptions made in screening the alternatives to determine if they have changed due to circumstances or the passage of time. The null alternative should also be explicitly addressed.

Final Design

At this point the project alternative has been selected. Detailed calculations and justifications are prepared. In these calculations, a range of conditions are examined. For example, minimum values for hydraulics, reactor oxygen, mixing, biological nutrient control, alkalinity, seasonal nitrification temperature, and unit equipment sizing and maximum values for waste solids, reactor sizing, oxygen demand, and return sludge are recommended (WEF, 1991). In addition, in cold weather regions, the following should be addressed in the detailed design (WEF, 1991):

- The potential for ice formation on equipment.
- Freezing of the process equipment.
- Freezing of chemicals in storage.
- Freezing of pipes not located below the frost line.
- Viscosity changes in lubricants.
- Snow and ice accumulations on structures, equipment, and roads.
- Changes in the reaction rates of biological, physical and chemical processes.

Extreme heat must also be considered. The following should be addressed in a detailed design:

- Operator heat exposure.
- Equipment temperature limits.
- Flammability of chemicals and fuels in storage.
- Viscosity changes in lubricants.
- Expansion of joints and piping.
- Changes in the reaction rates of biological, physical, and chemical processes.

The design is completed in sufficient detail to select standard manufacturers' equipment, prepare specifications in draft form, and firm up the site plan and layout of the facilities. The choice of equipment is another *critical decision point* for the project. It is frequently to the economic advantage of the owner to purchase the equipment directly, rather than through the construction contract, because the contractor may have to pay taxes on the purchase and the municipality will not. *Owner-procured equipment* provides the owner greater control in selection of specific equipment. Thus, the equipment choices should be thoroughly reviewed with the owner.

As the design is finalized, well-developed drawings and specifications are prepared. *Bid estimates* are prepared based on the detailed design. The economics of alternative means of completing the selected treatment process are considered in the bid estimate. For example, the choice of a variable-speed drive or constant-speed drive for pumps is analyzed on a life-cycle cost basis (capital plus operating, maintenance, and replacement). Quotes are obtained to finalize cost estimates, and an engineer's opinion of the probable cost and cash flow projections are prepared. Because the financial arrangements for funding the project are based on this estimate, it is imperative that an accurate estimate of the cost be made.

The detailed design process is completed with an ongoing review of the project with the client. Typically, these occur at 30, 60 and 90 percent completion. These are *critical decision points* for the project. As before, the owner must be provided enough information to allow a rational decision about the choices available. This is not to imply that the owner needs to consent to every nut and bolt in the design, but they should have the opportunity to review alternatives with major economic and/or operating implications. This is also an opportunity to revisit the assumptions made at the preceding decision points to determine if they have changed due to circumstances or the passage of time. The *null alternative* should also be explicitly addressed.

At this point the project is sufficiently well understood to submit an application to the permitting authority for a construction permit.

Once the final design is complete, bid documents are prepared and the bid is *let*. This is the end of the formal design process and the beginning of the construction phase of the project. Unusual circumstances such as the unavailability of specified equipment or materials or unexpected soil conditions may require more design work. At this point the engineer's scope of work may have to be renegotiated.

Incremental Design and Iteration

As noted earlier, the design process is incremental. In addition, individual steps as well as critical decision points often may require iteration. That is, a trial design may not meet performance

requirements because an initial assumption to start the design is not valid. For example, a pipe diameter may be assumed to carry an estimated flow rate. The selection of this pipe diameter may not be large enough based on friction loss calculations. Thus, a larger pipe must be selected, and a second friction loss calculation must be completed.

1-6 OVERALL CONSTRUCTION PROCESS

From the owner's perspective, the construction process has the following important steps or stages:

- Initiation of project financing arrangements.
- Acquisition of land or easements.
- Project design.
- Completion of project financing.
- Bid letting.
- Construction.
- Preparation of project record documents.
- Preparation of the O&M manual.
- Start-up and shake-down.
- Acceptance of the project.

The owner's perspective is taken because the contracts for construction are with the owner and, ultimately, the facility belongs to the owner, not the engineer. None the less, the engineer's role is critical because he/she must diligently observe and, to the best of their ability, assure the owner that the facility is built according to the plans and specifications.

The construction process should not begin before the design process and project financing are complete. Practicing engineers recommend that with the classical design-bid-construct project delivery, construction **not** begin until the design is complete. Other delivery methods, such as design-build, may begin the construction process before the design is complete. Although starting before the design is complete expedites the process, it imposes a need for extreme care in making commitments.

Project Financing

The funds to pay for the project may come from a variety of sources. Bonds, state aid funds, operating revenue, and user fees are some examples. Discussion of these are beyond the scope of this book. They are discussed at length in *Water Utility Capital Financing* (AWWA, 1998).

Acquisition of Land or Easements

Once the study phase is completed, enough information is available to begin identifying suitable sites for the project and, in the case of sewers and other utilities, routes for easements.

In general this is the responsibility of the client because, as noted in the second canon of the Code of Ethics, it falls outside of the area of competence of the engineer. The client hires some combination of qualified and experienced people to do this work. A team may consist of a registered land surveyor, attorney, and government official familiar with the community. The engineer's role is to provide guidance with respect to the requirements of the design. If necessary, the engineer may also be called on to perform environmental site investigations to ensure the site(s) are free of hazardous materials. Of course, this effort should be included in the scope of work.

Options on the land to be purchased and freely given easements provide a means of expediting the construction process without making an unalterable commitment before the detailed design and bid estimate are completed. These are essential for the final design, and they also provide cost information for the estimate of total funding of the project.

Once property bids have been accepted, final land acquisition can begin. For those not willing to give or sell land for the treatment facility or easements for the water main or sewer, condemnation proceedings may be instituted. This may cause a substantial delay in the start and completion of the project and should be anticipated in the bid documents.

Bid Letting

Bid documents may be disseminated in a variety of ways. Many municipalities have developed a program of prequalification of bidders and an invitation to bid is sent only to qualified bidders.

At some reasonable time interval, after the bid package is disseminated to interested contractors, a prebid meeting is held to answer questions and clarify requirements of the bidders. This meeting may be either mandatory or optional. The engineer and the owner's contracting officer are present at this meeting. Substantive questions are answered, in writing, to all participants by issuing a bid document addendum.

When the bids are received, the engineer assists the owner in determining the lowest qualified bidder. The bid must be responsive in that it meets the specifications without unacceptable substitutions and agrees to meet the stated completion date. In addition, the bidder must have appropriate licenses, bonding, and insurance. A qualified bidder must also be free of outstanding claims and liens from previous work. Appropriately licensed personnel and people qualified to supervise the work should also be included in consideration of whether or not the bidder is qualified.

This is a critical decision point in the project. First, the decision to proceed must be made. Second, the decision(s) on the awardee(s) must be made. As at all the previous decision points, the client must be given appropriate information to make informed decisions.

Construction

Before construction begins, a preconstruction meeting is held. All parties (engineer, owner, contractor) meet to review the contractor's schedule, special provisions, sequence of construction, payment process, and progress meetings schedule.

During the construction process the engineer determines if the work is proceeding in accordance with the contract documents. For large projects, a full-time *resident project representative* (RPR) is on site. For small projects, the engineer provides periodic inspection and special inspection at critical construction milestones. Thus, for small projects it is imperative that critical

points in the construction be identified and that the contractor's progress be monitored so that timely inspection can be made.

The RPR acts as the engineer's agent at the site. He/she will have various duties as spelled out in the contract between the owner and the engineer. Some examples include (EJCDC, 2002):

- Review schedules of progress, schedules of drawing submittals.
- Attend conferences and meetings.
- Serve as the engineer's liaison with the contractor through the contractor's superintendent.
- Report to the engineer when clarification and interpretation of the contract documents are required and transmit these to the contractor.
- Receive samples and shop drawings for review and approval.
- Consult with the engineer in advance of scheduled major inspections, tests, and systems start-ups.
- Accompany visiting inspectors representing public or other agencies having jurisdiction.
- Maintain records and daily log book.

The engineer makes visits to the site at intervals appropriate to the various stages of construction. Based on information obtained during these visits, the engineer will determine if the work is proceeding in accordance with the contract documents and will keep the owner informed of the progress of the work. The engineer recommends to the owner that the contractor's work be rejected while it is in progress if, on the basis of his/her observations, the engineer believes that the work will not produce a completed project that conforms to the contract documents or that it will threaten the integrity of the project (EJCDC, 2002). In addition the engineer

- Clarifies contract documents for the contractor.
- Recommends change orders as appropriate.
- Reviews and approves shop drawings provided by the contractor.
- Reviews samples and other data submitted by the contractor.
- Recommends the amounts the contractor be paid based on observation of the progress and quality of the contractor's work (EJCDC, 2002).

As work progresses, it is prudent for the contractor, engineer, and owner to have periodic progress meetings. These should be scheduled at regular intervals as well as at milestone points. Typical topics for discussion include percent completion, projections for completion in the next period, staffing, and unexpected problems.

Preparation of Project Record Documents

Progress record documents show the results of the construction process. They record changes from the design drawings that occurred during the construction process. These are important documents for the owner as they provide the first step in performing maintenance or repair work.

The contractor and/or the engineer may be responsible for the “as-built” drawings. This responsibility should be clearly indicated in contract documents or the engineer’s scope of work. The accuracy of as-built drawings is increased substantially if they are prepared as the work progresses rather than after it has been completed.

Preparation of the Operation and Maintenance Manual

The engineer or the contractor may be responsible for preparing the operation and maintenance (O&M) manual. Even for a small plant, the O&M manual addresses a large number of items. A small set of examples include: start-up and shut-down of pumps, preventive maintenance for pumps and compressors, sampling and analysis methods to meet permit requirements, operation of analytical equipment in the laboratory, emergency procedures in the case of equipment failure, methods for repair of equipment or procedures for obtaining repair services, procedures for weatherproofing equipment for winter, building maintenance, sewer maintenance, and other appurtenances. The O&M manual may also include a computer-based management system (often called an *asset management system*) for maintaining records of preventive maintenance, repair, and replacement.

Work on the manual must be complete before start-up and shake-down can commence because “testing” of the manual is part of the start-up and shake-down.

Start-up and Shake-down

When the facility construction is substantially complete and functional, the permitting authority issues a discharge permit. At this point equipment can be started up and checked for performance. The contractor and equipment manufacturers perform the start-up. Routine and non-routine operation is checked for each individual component and for the components working together. The engineer provides inspection services to verify that the equipment works as specified and that the O&M manual is adequate.

Acceptance of the Project

Substantial completion. When the contractor considers the entire work ready for its intended use, the engineer in company with the owner and contractor performs an inspection to determine if the work is substantially complete. A “punch list” of deficiencies is created during this inspection. If after considering any objections of the owner, the engineer considers the work substantially complete, he/she delivers a Certificate of Substantial Completion to the owner and contractor.

Final Notice of Acceptability. The contractor then uses the punch list for final completion of the work. Once the punch list is completed, the engineer conducts a final inspection to determine if the completed work of the contractor is acceptable. If he/she agrees that it is, the engineer recommends final payment to the contractor. In addition, the engineer provides a *Notice of Acceptability of Work* to the owner that certifies that the completed work furnished and performed by the contractor under the contract is acceptable (EJCDC, 2002). The notice is **not** a guarantee or warranty of the contractor’s performance nor is it an assumption of responsibility for any failure of the contractor to furnish and perform the work in accordance with the contract

documents (EJCDC, 2002). Notwithstanding the engineer's contract exculpatory provisions, the courts have insisted that the engineer provide a standard of responsible care (Loulakis and McLaughlin, 2007).

1-7 HINTS FROM THE FIELD

Experienced engineers have provided the following insights on the design and construction process:

- The option for a municipal owner to purchase equipment should be considered carefully. Tax issues should be discussed with appropriate legal counsel. Other issues include potential late or early delivery of equipment. In these cases what is the impact/responsibility for contract completion? Who stores equipment delivered early? Who insures it?
- Construction cost estimates should be conservatively high. A low estimate may require redoing the bond application and authorization including the potential requirement for an election to approve additional bonding authority.

Operation and maintenance personnel who have to live with the results of the engineer's design have offered the following suggestions:

- The engineer's job is not done when the owner accepts the project. Good engineering practice, as well as good client relations, requires that the design team keep in contact with the facility. Immediately after project completion, a monthly phone call for a status check, and to hear about problems and/or concerns, is a first step. This is to get issues raised early by the owner, so they do not become major sore points. After a reasonable time of operation, generally within six months and perhaps again a year or two later, the design team should visit the facility. The purpose of the visit is to assess the practical operation of the facility as well remove the impression that "It's built, I am paid, so I am gone." Often these visits will reveal some enhancement that operators have made to make the operation of the facility easier or more economical.

The visit can also serve as an after-action summary of the communications issues that occurred and corrections to enhance future work. It is also useful at this time to compare the economic analysis assumptions with actual operating experience.

- O&M manuals do not give much operational guidance. Their focus is the mechanics of equipment start-up, shut-down, and maintenance. Frequently, they only include the equipment suppliers' O&M manuals. In general operators must prepare standard operating procedures (SOPs) for process control. This means the operators should be hired before project construction is completed so they have a chance to ask questions and prepare the SOPs. Because hiring is the owner's responsibility, the need for operators to be on board before construction is complete should be brought to their attention by the engineer.

Visit the text website at www.mhprofessional.com/ww for supplementary materials and a gallery of photos.

1-8 CHAPTER REVIEW

When you have completed studying this chapter, you should be able to do the following without the aid of your textbook or notes:

1. Select the appropriate client–professional relationship for a given situation that describes the nature of the work and the knowledge/experience of the client.
2. Decide if any of the ASCE canons of the Code of Ethics may be violated for a given situation that describes the proposed action.
3. Describe the five steps of the overall design process to a client that has not had previous experience with the design process for a municipal water or wastewater project.
4. Explain the role of each of the six elements of the design criteria in setting the boundary conditions of the design.
5. Identify the critical decision points for a client in the design process.
6. Describe the six steps of the overall construction process to a client that has not had previous experience with the construction process for a municipal water or wastewater project.

With the aid of the text, you should be able to do the following:

7. Select the appropriate design alternative based on an engineering economic analysis of the alternatives given the appropriate cost data, interest rate, and design life.

1-9 PROBLEMS

NOTE: An engineering economic analysis primer is available at <http://www.mhprofessional.com/wwe>.

- 1-1. At the end of the preliminary design-stage of a small water treatment system design, the following three options remain feasible. The consulting firm uses an interest rate of 6.00% and a design life of 20 years for project evaluation. Based on cost, which alternative should the engineering firm recommend?

Option	Capital cost	Annual operation and maintenance cost
Connect to nearby WTP	\$1,500,000	\$300,000 ^a
Membrane A	\$2,374,000	\$209,000
Membrane B	\$2,162,000	\$258,000

^a The community will not have to provide O&M, but the nearby WTP will charge a monthly service fee equivalent to this amount.

- 1-2. During the conceptual design stage of Problem 1-1, the design firm identifies the need for iron removal that was not anticipated in the screening of alternatives.

The capital cost for each of the membrane alternatives is now estimated to be an additional \$500,000. Is the Membrane A alternative still the best choice? Use the interest rate and design life from Problem 1-1.

- 1-3.** In the design of a water treatment plant, the design engineer has a choice of selecting a constant speed pump or a adjustable-frequency drive (AFD) pump. The capital and operating costs for each pump are shown below. Assume an interest rate of 6.00% and a 10 year life. Which pump should the engineer recommend?

Option	Capital cost	Annual electric cost
Constant speed pump	\$10,000	\$16,000
AFD pump	\$20,000	\$10,000

- 1-4.** Using a spreadsheet you have written, by trial and error determine the construction cost of Alternative B in Table 1-5 that will make its total annual cost equal to the total annual cost of Alternative A. With the significant figures given, the costs may be assumed to be “equal” when they are within \$1,000 of each other. Note: the interest during construction and inflation prior to construction used in Table 1-5 was 3.00%.

1-10 DISCUSSION QUESTIONS

- 1-1.** The city engineer has called your firm to ask that you review the design of a sewer that has had periodic flooding. The design was performed by another consulting firm in the community. What actions should you take before accepting the job?
- 1-2.** The professional organization that you belong to has been offered the opportunity to meet in the facilities of a local casino free of charge. As the person in charge of arrangements, what action would you recommend to the executive committee of your organization?
- 1-3.** A small community of lakefront homes believes that the algae bloom in their lake is the result of leaking septic tanks and tile fields. They retained an engineering firm to explore alternatives for building a collection system and wastewater treatment plant. An exhaustive feasibility study of alternative wastewater treatment systems to replace the existing septic tank and tile field system has been completed. The engineering firm has recommended a sewer system and a wastewater treatment plant to be operated by the community. After the report and recommendation to build has been accepted by the client, the Department of Natural Resources and county health department provide a report that declares that the existing system does not contribute to pollution of the lake and the likely source of pollution is upstream agricultural runoff. Should the engineering firm pursue the development of a wastewater treatment system? Explain your reasoning.

- 1-4.** The chairperson of the civil engineering department has asked that a local engineer teach a one-semester course on engineering economics. The person that he is recruiting has never taught before but is a registered professional engineer and does economic analysis routinely. Does the candidate comply with the second canon? Explain.
- 1-5.** List three methods to maintain your professional development throughout your career.

1-11 REFERENCES

- ASCE (1996) *Code of Ethics*, American Society of Civil Engineers, Reston, VA.
- AWWA (1998) *Water Utility Capital Financing*, Manual M29, American Water Works Association Denver, CO.
- Baum, R. (1983) "The Limits of Professional Responsibility," reprinted from *Values and Public Works Professional*, University of Missouri, proceedings from American Public Works Association workshop in *Engineering Professionalism and Ethics*, edited by J. H. Schaub, K. Pavlovic and M. S. Morris, John Wiley & Sons, New York, p. 293.
- Bayles, M. D. (1991) "Obligations Between Professionals and Clients," reprinted from *Professional Ethics*, by M. D. Bayles, Wadsworth, Boston, 1989 in *Ethical Issues in Engineering*, edited by D. G. Johnson, Prentice Hall, Englewood Cliffs, NJ, pp. 305–316.
- Bockrath, J. T. (1986) *Dunham and Young's Contracts, Specifications, and Law for Engineers*, 4th ed., McGraw-Hill, New York, pp. 141, 330.
- EJCDC (2002) *Standard Form of Agreement Between Owner and Engineer for Professional Services*, Engineers Joint Contract Documents Committee, a joint publication of American Council of Engineering Companies, American Society of Civil Engineers, and National Society of Professional Engineers.
- Firmage, D. A. (1980) *Modern Engineering Practice: Ethical, Professional, and Legal Aspects*, Garland STPM Press, New York, pp. 111–114, 126, 144–146, 149.
- Foellmi, S. N. (2005) "Intake Facilities," in E. E. Baruth (ed.), *Water Treatment Plant Design*, McGraw-Hill, NY, pp. 4.1–4.35.
- GLUMRB (2003) *Recommended Standards for Water Works*, Great Lakes–Upper Mississippi River Board of State and Provincial Public Health and Environmental Managers, Health Education Services, Albany, NY.
- Harris, C. E., M. S. Pritchard and M. J. Rabins (1995) *Engineering Ethics: Concepts and Cases*, Wadsworth, Boston, pp. 32, 56–58.
- Kemper, J. D. and B. R. Sanders (2001) *Engineers and Their Profession*, 5th ed., Oxford University Press, New York, pp. 159–167.
- Ladd, J. (1991) "The Quest for a Code of Professional Ethics: An Intellectual and Moral Confusion" reprinted from R. Chalk, M. S. Frankel and S. B. Chafer, editors, *AAAS Professional Ethics Project: Professional Activities in the Scientific and Engineering Societies*, American Association for the Advancement of Science, 1980, in *Ethical Issues in Engineering*, edited by D. G. Johnson, Prentice Hall, Englewood Cliffs, NJ, pp. 130–136.
- Loulakis, M. C. and L. P. McLaughlin (2007) "Court Ignores Engineer's Contractual Disclaimer for Inspections," *Civil Engineering*, April, p. 88.
- Martin, M. W. and R. Schinzinger (1991) "Engineering as Social Experimentation," reprinted from *Ethics in Engineering*, edited by M. W. Martin and R. Schinzinger, McGraw Hill, 1989, in *Ethical Issues in Engineering*, edited by D. G. Johnson, Prentice Hall, Englewood Cliffs, NJ, pp. 200–201.

- Metcalf & Eddy, Inc. (2003) *Wastewater Engineering: Treatment and Reuse*, 4th ed., McGraw-Hill, Boston, pp. 186, 199.
- Newnan, D. G. and B. Johnson (1995) *Engineering Economic Analysis*, 5th ed., Engineering Press, San Jose, CA, p. 124.
- Newnan, D. G., J. P. Lavelle and T. G. Eschenbach (2000) *Engineering Economic Analysis*, 8th ed., Engineering Press, Austin, TX.
- Petroski, H. (1985) *To Engineer Is Human: The Role of Failure in Successful Design*, Barnes & Noble Books, New York.
- Sternbach, J. (1988) *Negotiating and Contracting for Professional Engineering Services*, Transportation Research Board, National Research Council, Washington, D.C., pp. 29–30.
- Thuesen, G. J. and W. J. Fabrycky (2000) *Engineering Economy*, 9th ed., Prentice-Hall, Englewood Cliffs, NJ.
- U.S. EPA (1974) *Design Criteria for Mechanical, Electrical, and Fluid Systems and Component Reliability*, supplement to *Federal Guidelines: Design, Operation, and Maintenance of Wastewater Treatment Facilities*, U.S. Environmental Protection Agency Report No. 430-99-74-001, Washington, D.C.
- Valle-Riestra, J. (1983) *Project Evaluation in the Chemical Process Industries*, McGraw-Hill, New York, pp. 64–65.
- WCED (1987) *Our Common Future*, World Commission on Environment and Development, Oxford University Press, Oxford, England.
- WEF (1991) *Design of Municipal Wastewater Treatment Plants*, vol. 1, Water Environment Federation, Alexandria, VA, pp.18, 22–23, 132, 155.
- WPCF (1977) *Wastewater Treatment Plant Design*, Water Pollution Control Federation, Lancaster Press, Lancaster, PA, pp. 19–20.

This page intentionally left blank

**GENERAL WATER SUPPLY DESIGN
CONSIDERATIONS**

2-1 WATER DEMAND

2-2 WATER SOURCE EVALUATION

2-3 WATER QUALITY

2-4 EVALUATION OF PROCESS OPTIONS

2-5 PLANT SIZING AND LAYOUT

2-6 PLANT LOCATION

2-7 CHAPTER REVIEW

2-8 PROBLEMS

2-9 DISCUSSION QUESTIONS

2-10 REFERENCES

2-1 WATER DEMAND

A fundamental prerequisite to begin the design of water supply facilities is a determination of the design capacity. This, in turn, is a function of water demand. The determination of water demand consists of four parts: (1) selection of a design period, (2) estimation of the population, commercial, and industrial growth, (3) estimation of the unit water use, and (4) estimation of the variability of the demand.

Design Period

The *design period* (also called the *design life*) is not the same as the *life expectancy*. The design period is the length of time it is estimated that the facility will be able to meet the demand, that is, the *design capacity*. The life expectancy of a facility or piece of equipment is determined by wear and tear. Typical life expectancies for equipment range from 10 to 20 years. Buildings, other structures, and pipelines are assumed to have a useful life of 50 years or more.

New water works are generally made large enough to meet the demand for the future. The number of years selected for the design period is based on the following:

- Regulatory constraints.
- The rate of population growth.
- The interest rate for bonds.
- The useful life of the structures and equipment.
- The ease or difficulty of expansion.
- Performance in early years of life under minimum hydraulic load.

Because state and federal funds are often employed in financing water works, their requirements for establishing the design period often govern the selection of the design period. This time period may be substantially less than the useful life of the plant.

Because of their need for population data and forecast estimates for numerous policy decisions, local government entities in the United States generally have the requisite information for water works planning. In the absence of this data, U.S. census data may be used. Historic records provide a basis for developing trend lines and making forecasts of future growth. For short-range forecasts on the order of 10 to 15 years, data extrapolation is of sufficient accuracy for planning purposes. For long-range forecasts on the order of 15 to 50 years, more sophisticated techniques are required. These methods are beyond the scope of this book. McJunkin (1964) provides a comprehensive discussion of alternative methods for developing a population growth projection estimate.

Although all of the indicators mentioned above may lead to the conclusion that a long design period is favored, serious consideration must be given to the impact of low flow rates in the early years of the facility. In addition to the behavior and efficiency of the unit operations, the impact on the energy efficiency of the equipment should be evaluated. A successful alternative is the use of modular units and construction of hardened facilities without installation of mechanical equipment until the units are needed.

Design periods that are commonly employed in practice and commonly experienced life expectancies are shown in Table 2-1.

TABLE 2-1
Design periods for water works

Type of facility	Characteristics	Design period, y	Life expectancy, y
Large dams and pipelines	Difficult and expensive to enlarge	40–60	100+
Wells	Easy to refurbish/replace	15–25	25+
Treatment plants			
Fixed facilities	Difficult and expensive to enlarge/replace	20–25	50+
Equipment	Easy to refurbish/replace	10–15	10–20
Distribution systems			
Mains > 60 cm	Replacement is expensive and difficult	20–25	60+
Laterals and mains ≤ 30 cm	Easy to refurbish/replace	To full development ^a	40–50

^aFull development (also called *build-out*) means that the land area being serviced is completely occupied by houses and/or commercial and institutional facilities.

Unit Water Use

When the proposed project is in a community with an existing community supply, the community's historic records provide the best estimate of water use. Conversion of total demand to per capita demand (liters per capita per day, Lpcd) allows for the separation of population growth from the growth in unit consumption. If the proposed project is to improve the water quality, consideration should be given to the likelihood that unit demand will increase because of the improved water quality. In the absence of existing data for the client community, nearby communities with similar demographics are a good alternative source. When the demographics differ in some particular aspect such as a higher or lower density of commercial facilities or a major industrial component, adjustment in the total demand will be appropriate. Although they were developed for wastewater flow rates, Tables 2-2 and 2-3 can provide a basis for adjustment of commercial and institutional users. Likewise, flow rates for recreational facilities may be estimated using Table 2-4 on page 2-6.

Community adoption of the use of one or more flow-reduction devices such as flow-limiting shower heads and low-flush toilets may have a substantial impact on per capita consumption. Typical results are shown in Table 2-5 on page 2-7. The implementation of requirements for water saving devices conserves both water resources and energy. These aspects should be addressed in strategic planning for community development as well as requirements for new or expanded facilities.

Gross estimates of unit demand may be made using statewide data. Hutson et al. (2001) have estimated water use by state and the U. S. Bureau of Census (Census, 2006) maintains a population database by state. Great care should be used in making estimates from generalized data. Due consideration must be given to the following local factors that modify gross estimates:

1. Climate
2. Industrial activity
3. Meterage

TABLE 2-2
Typical wastewater flow rates from commercial sources in the United States

Source	Unit	Flow rate, L/unit · d	
		Range	Typical
Airport	Passenger	10–20	15
Apartment	Bedroom	380–570	450
Automobile service station	Vehicle	30–60	40
	Employee	35–60	50
Bar/cocktail lounge	Seat	45–95	80
	Employee	40–60	50
Boarding house	Person	95–250	170
Conference center	Person	40–60	30
Department store	Restroom	1,300–2,300	1,500
	Employee	30–60	40
Hotel	Guest	150–230	190
	Employee	30–60	40
Industrial building (sanitary wastewater only)	Employee	60–130	75
Laundry (self-service)	Machine	1,500–2,100	1,700
	Customer	170–210	190
Mobile home park	Mobile home	470–570	530
Motel with kitchen	Guest	210–340	230
Motel without kitchen	Guest	190–290	210
Office	Employee	25–60	50
Public restroom	User	10–20	15
Restaurant without bar	Customer	25–40	35
Restaurant with bar	Customer	35–45	40
Shopping center	Employee	25–50	40
	Parking space	5–10	8
Theater	Seat	10–15	10

Adapted from Metcalf and Eddy, 2003.

4. System management

5. Standard of living

The extent of sewerage, system pressure, water price, water loss, age of the community, and availability of private wells also influence water consumption but to a lesser degree.

Climate is the most important factor influencing unit demand. This is shown dramatically in Table 2-6 on page 2-7. The average annual precipitation for the “wet” states is about 100 cm per year,

TABLE 2-3
Typical wastewater flow rates from institutional sources in the United States

Source	Unit	Flow rate, L/unit · d	
		Range	Typical
Assembly hall	Guest	10–20	15
Hospital	Bed	660–1,500	1,000
	Employee	20–60	40
Prison	Inmate	300–570	450
	Employee	20–60	40
School ^a			
With cafeteria, gym, and showers	Student	60–120	100
With cafeteria only	Student	40–80	60
School, boarding	Student	280–380	320

^aFlow rates are L/unit-school day.

Adapted from Metcalf and Eddy, 2003.

while the average annual precipitation for the “dry” states is only about 25 cm per year. Of course, the dry states are also considerably warmer than the wet states.

The *influence of industry* is to increase average per capita water demand. Small rural and suburban communities will use less water per person than industrialized communities. Tables 2-2 and 2-3 can provide a basis for adjustment for commercial and institutional users.

The third most important factor in water use is whether individual consumers have water meters. *Meterage* imposes a sense of responsibility not found in unmetered residences and businesses. This sense of responsibility reduces per capita water consumption because customers repair leaks and make more conservative water-use decisions almost regardless of price. Because water is so inexpensive, price is not much of a factor.

Following meterage closely is the aspect called *system management*. If the water distribution system is well managed, per capita water consumption is less than if it is not well managed. Well-managed systems are those in which the managers know when and where leaks in the water main occur and have them repaired promptly.

Climate, industrial activity, meterage, and system management are more significant factors controlling water consumption than *standard of living*. The rationale for the last factor is straightforward. Per capita water use increases with an increased standard of living. Highly developed countries use much more water than less developed nations. Likewise, higher socioeconomic status implies greater per capita water use than lower socioeconomic status.

For a community supply system that includes a new treatment plant and a new distribution system, water loss through leaks is not a major factor in estimating demand. For a new plant with an existing old distribution system, water loss through leaks may be a major consideration.

Older communities that lack modern water saving devices will use more water than newer communities with building codes that require water saving devices. For example, modern water closets use about 6 L per flush compared to older systems that use about 18 L per flush.

TABLE 2-4
Typical wastewater flow rates from recreational facilities in the United States

Facility	Unit	Flow rate, L/unit · d	
		Range	Typical
Apartment, resort	Person	190–260	230
Cabin, resort	Person	30–190	150
Colateria	Customer	10–15	10
	Employee	30–45	40
Camp:			
With toilets only	Person	55–110	95
With central toilet and bath facilities	Person	130–90	170
Day	Person	55–75	60
Cottages, (seasonal with private bath)	Person	150–230	190
Country club	Member present	75–150	100
	Employee	40–60	50
Dining hall	Meal served	15–40	25
Dormitory, bunkhouse	Person	75–190	150
Playground	Visitor	5–15	10
Picnic park with flush toilets	Visitor	20–40	20
Recreational vehicle park:			
With individual connection	Vehicle	280–570	380
With comfort station	Vehicle	150–190	170
Roadside rest areas	Person	10–20	15
Swimming pool	Customer	20–45	40
	Employee	30–45	40
Vacation home	Person	90–230	190
Visitor center	Visitor	10–20	15

Adapted from Metcalf and Eddy, 2003.

The total U.S. water withdrawal for all uses (agricultural, commercial, domestic, mining, and thermoelectric power) including both fresh and saline water was estimated to be approximately 5,400 liters per capita per day (Lpcd) in 2000 (Hutson et al., 2001). The amount for U.S. public supply (domestic, commercial, and industrial use) was estimated to be 580 Lpcd in 2000 (Hutson et al., 2001). The American Water Works Association estimated that the average daily household water use in the United State was 1,320 liters per day in 1999 (AWWA, 1999). For a family of three, this would amount to about 440 Lpcd.

Variability of Demand

The unit demand estimates are averages. Water consumption changes with the seasons, the days of the week, and the hours of the day. Fluctuations are greater in small than in large communities, and during short rather than long periods of time (Fair et al., 1970). The variation in demand is normally reported as a factor of the average day. For metered dwellings the U. S. national

TABLE 2-5
Typical changes in water consumption with use of water saving devices

Use	Without water conservation, Lpcd	With water conservation, Lpcd
Showers	50	42
Clothes washing	64	45
Toilets	73	35

Source: AWWA, 1998.

average factors are as follows: maximum day = $2.2 \times$ average day; peak hour = $5.3 \times$ average day (Linaweaver et al., 1967). Figure 2-1 provides an alternative method of estimating the variability. As noted above, when the proposed project is in a community with an existing community supply, the community's historic records provide the best estimate of water use. This includes its variability. The demand for water for fire fighting is normally satisfied by providing storage.

The *Recommended Standards for Water Works* (GLUMRB, 2003) stipulates that the design basis for the water source and treatment facilities shall be for the maximum day demand at the design year. Pumping facilities and distribution system piping are designed to carry the peak hour flow rate. When municipalities provide water for fire protection, the maximum day demand plus fire demand is used to estimate the peak hour flow rate.

2-2 WATER SOURCE EVALUATION

Although the portion of the population of the United States supplied by surface water is 150 percent of that supplied by groundwater, the number of communities supplied by groundwater is more than a factor of 10 times that supplied by surface water (Figure 2-2 on page 2-9). The reason for this

TABLE 2-6
Total fresh water withdrawals for public supply

State	Withdrawal, Lpcd ^a
Wet	
Connecticut	471
Michigan	434
New Jersey	473
Ohio	488
Pennsylvania	449
Average	463
Dry	
Nevada	1,190
New Mexico	797
Utah	1,083
Average	963

Compiled from Hutson et al. (2001).

^aLpcd = liters per capita per day.

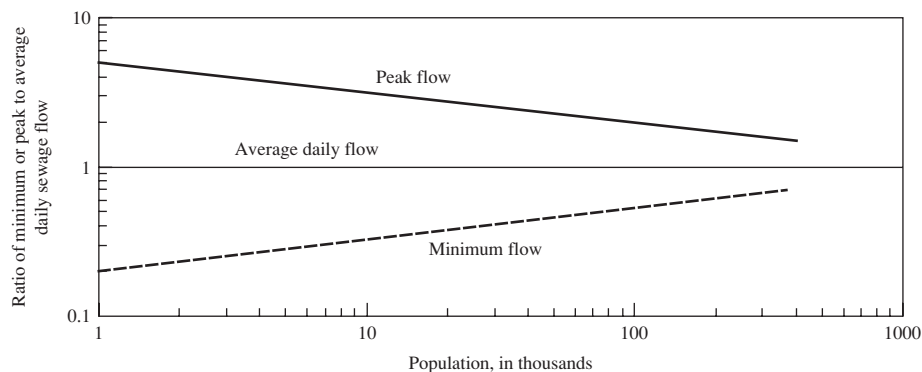

FIGURE 2-1
Ratio of extreme flows to average daily flow

pattern is that larger cities are supplied by large surface water bodies while many small communities use groundwater.

Groundwater has many characteristics that make it preferable as a water supply. First, groundwater is less subject to seasonal fluctuations and long-term droughts. Second, the aquifer provides natural storage that eliminates the need for an impoundment. Third, because the groundwater source is frequently available near the point of demand, the cost of transmission is reduced significantly. Fourth, because natural geologic materials filter the water, groundwater is often more aesthetically pleasing and to some extent protected from contamination.

Groundwater as a supply is not without drawbacks. It dissolves naturally occurring minerals which may give the water undesirable characteristics such as hardness, red color from iron oxidation, and toxic contaminants like arsenic.

Yield

One of the first considerations in selecting a water supply source is the ability of the source to provide an adequate quantity of water. One measure of quantity is yield. *Yield* is the average flow available over a long period of time.

Surface Water

When the proposed surface water supply is to be the sole source of water, the design basis is the long-term or “safe” yield. The components of the design are: (1) determination of the allowable withdrawal, (2) completion of a complete series analysis and, if the design drought duration exceeds the recorded data interval, completion of a partial duration series analysis, and (3) completion of an extreme-value analysis to determine the probable *recurrence interval (return period)* of a drought.

The allowable withdrawal is determined from regulatory constraints. Obviously, the municipality desiring to use the surface water for supply cannot withdraw all of the available water. Enough must be left for the ecological health of the river or stream as well as for downstream users.

In some cases, such as the Great Lakes, the water body is so large that the classic analysis of drought conditions is not warranted. However, the fluctuation of the lake level does impact the design of the intake structure, and it must be evaluated.

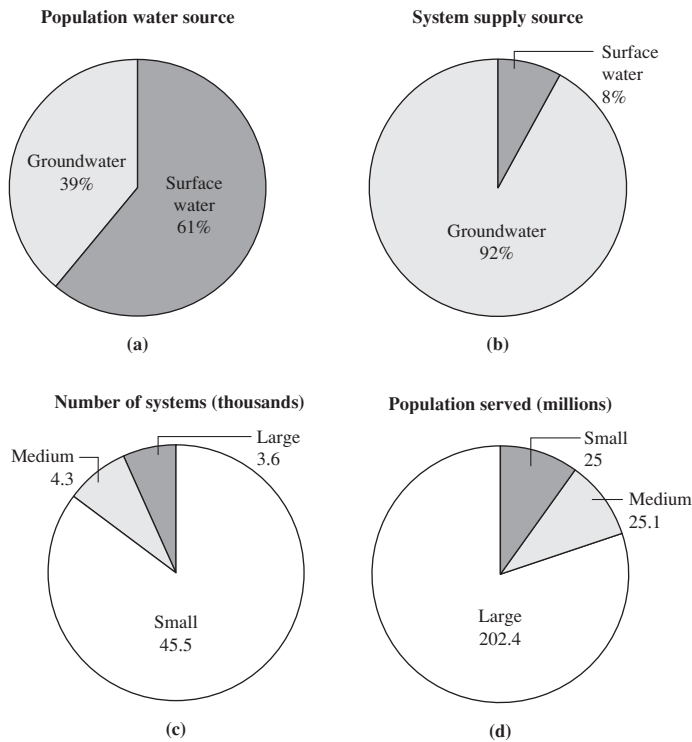
**FIGURE 2-2**

(a) Percentage of the population served by drinking-water system source. (b) Percentage of drinking-water systems by supply source. (c) Number of drinking-water systems (in thousands) by size. (d) Population served (in millions of people) by drinking-water system size.

Source: 1997 National Public Water Systems Compliance Report. U.S. EPA, Office of Water. Washington, D.C. 20460. (EPA-305-R-99-002).

(Note: Small systems serve 25-3,300 people; medium systems serve 3301-10,000 people; large systems serve 10,000 + people.)

Complete Series. A complete series analysis is used to construct a flow-duration curve. This curve is used to determine whether or not the long-term average flow exceeds the long-term average demand. All of the observed data are used in a complete series analysis. This analysis is usually presented in one of two forms: as a *yield curve* (also known as a *duration curve*, Figure 2-3) or as a cumulative probability distribution function (CDF). In either form the analysis shows the percent of time that a given flow will be equaled or exceeded. The percent of time is interpreted as the probability that a watershed will yield a given flow over a long period of time. Thus, it is sometimes called a *yield analysis*.

To perform a yield analysis, discharge data are typed into a spreadsheet in the order of their occurrence. Using the spreadsheet “sort” function, the data are arranged in descending order of flow rate. The percent of time each value is equaled or exceeded is calculated. The spreadsheet is then used to create the duration curve: a plot of the discharge versus the percent of time the discharge is exceeded. This is demonstrated in Example 2-1 using the data in Table 2-7.

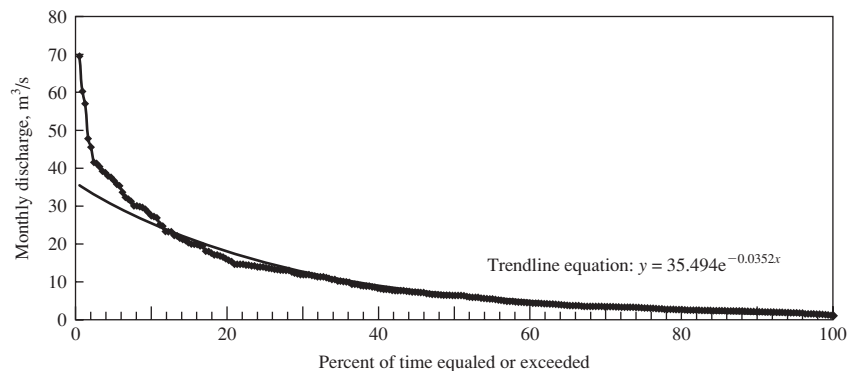

FIGURE 2-3
Complete series analysis for Troublesome Creek at Nosleep.

Example 2-1. Perform a complete series analysis on the Troublesome Creek data in Table 2-7. Determine the mean monthly discharge. If the average demand for Nosleep's municipal supply is $0.25 \text{ m}^3/\text{s}$, and the regulatory agency will permit a withdrawal of 5% of the flow, will the Troublesome Creek provide a safe yield?

Solution. A spreadsheet was used to perform the calculations and plot the duration curve. The first few values in the spreadsheet are shown below. A sample calculation for the spreadsheet is shown below the spreadsheet.

Rank	Monthly discharge, m^3/s	% of time equaled or exceeded
1	69.1	0.38
2	59.8	0.76
3	56.6	1.14
4	47.4	1.52
5	45.1	1.89
6	41.1	2.27
7	40.8	2.65

There are 264 values in the table ($12 \text{ months/year} \times 22 \text{ years of data}$). The highest discharge in the table is $69.1 \text{ m}^3/\text{s}$. It is assigned a rank of 1.

The percent of time this value is equaled or exceeded is:

$$\% \text{ of time} = \frac{1}{264}(100\%) = 0.38\%$$

The plot of the duration curve is shown in Figure 2-3. From the data sort, find that the flow rate that is exceeded 50% of the time is $5.98 \text{ m}^3/\text{s}$.

TABLE 2-7
Average monthly discharge of Troublesome Creek at Nosleep, m³/S

Year	Jan	Feb	Mar	Apr	May	Jun	Jul	Aug	Sep	Oct	Nov	Dec
1987	2.92	5.10	1.95	4.42	3.31	2.24	1.05	0.74	1.02	1.08	3.09	7.62
1988	24.3	16.7	11.5	17.2	12.6	7.28	7.53	3.03	10.2	10.9	17.6	16.7
1989	15.3	13.3	14.2	36.3	13.5	3.62	1.93	1.83	1.93	3.29	5.98	12.7
1990	11.5	4.81	8.61	27.0	4.19	2.07	1.15	2.04	2.04	2.10	3.12	2.97
1991	11.1	7.90	41.1	6.77	8.27	4.76	2.78	1.70	1.46	1.44	4.02	4.45
1992	2.92	5.10	28.7	12.2	7.22	1.98	0.91	0.67	1.33	2.38	2.69	3.03
1993	7.14	10.7	9.63	21.1	10.2	5.13	3.03	10.9	3.12	2.61	3.00	3.82
1994	7.36	47.4	29.4	14.0	14.2	4.96	2.29	1.70	1.56	1.56	2.04	2.35
1995	2.89	9.57	17.7	16.4	6.83	3.74	1.60	1.13	1.13	1.42	1.98	2.12
1996	1.78	1.95	7.25	24.7	6.26	8.92	3.57	1.98	1.95	3.09	3.94	12.7
1997	13.8	6.91	12.9	11.3	3.74	1.98	1.33	1.16	0.85	2.63	6.49	5.52
1998	4.56	8.47	59.8	9.80	6.06	5.32	2.14	1.98	2.17	3.40	8.44	11.5
1999	13.8	29.6	38.8	13.5	37.2	22.8	6.94	3.94	2.92	2.89	6.74	3.09
2000	2.51	13.1	27.9	22.9	16.1	9.77	2.44	1.42	1.56	1.83	2.58	2.27
2001	1.61	4.08	14.0	12.8	33.2	22.8	5.49	4.25	5.98	19.6	8.50	6.09
2002	21.8	8.21	45.1	6.43	6.15	10.5	3.91	1.64	1.64	1.90	3.14	3.65
2003	8.92	5.24	19.1	69.1	26.8	31.9	7.05	3.82	8.86	5.89	5.55	12.6
2004	6.20	19.1	56.6	19.5	20.8	7.73	5.75	2.95	1.49	1.69	4.45	4.22
2005	15.7	38.4	14.2	19.4	6.26	3.43	3.99	2.79	1.79	2.35	2.86	10.9
2006	21.7	19.9	40.0	40.8	11.7	13.2	4.28	3.31	9.46	7.28	14.9	26.5
2007	31.4	37.5	29.6	30.8	11.9	5.98	2.71	2.15	2.38	6.03	14.2	11.5
2008	29.2	20.5	34.9	35.3	13.5	5.47	3.29	3.14	3.20	2.11	5.98	7.62

The regulatory agency will only permit a withdrawal of 5%. Therefore, the allowable withdrawal will be

$$(0.05)(5.98 \text{ m}^3/\text{s}) = 0.30 \text{ m}^3/\text{s}$$

This is sufficient to meet the safe yield of $0.25 \text{ m}^3/\text{s}$ required for the municipality.

If the determination is made that the 50 percentile allowable withdrawal is less than the required safe yield, then, even with storage, the safe yield cannot be met. An alternative source should be investigated. If the determination is made that the allowable withdrawal will be adequate, then an analysis is performed to determine the need for a storage reservoir for droughts. This analysis is called an *annual series* or *extreme-value* analysis.

Annual Series. Extreme-value analysis is a probability analysis of the largest or smallest values in a data set. Each of the extreme values is selected from an equal time interval. For example, if the largest value in each year of record is used, the extreme-value analysis is called an *annual maxima series*. If the smallest value is used, it is called an *annual minima series*.

Because of the climatic effects on most hydrologic phenomena, a water year or *hydrologic year* is adopted instead of a calendar year. The U.S. Geological Survey (U.S.G.S.) has adopted the 12-month period from October 1 to September 30 as the hydrologic year for the United States. This period was chosen for two reasons: “(1) to break the record during the low-water period near the end of the summer season, and (2) to avoid breaking the record during the winter, so as to eliminate computation difficulties during the ice period.” (Boyer, 1964)

The procedure for an annual maxima or minima analysis is as follows:

1. Select the minimum or maximum value in each 12-month interval (October to September) over the period of record.
2. Rank each value starting with the highest (for annual maxima) or lowest (for annual minima) as rank number one.
3. Compute a return period using Weibull’s formula (Weibull, 1939):

$$T = \frac{n + 1}{m} \quad (2-1)$$

where T = average return period, y
 n = number of years of record
 m = rank of storm or drought

4. Plot the annual maxima or minima series on a special probability paper known as Gumbel paper. (A blank copy of Gumbel paper may be downloaded from the website: <http://www.mhprofessional.com/wwe>.) Although the same paper may be used for annual minima series, Gumbel recommends a log extremal probability paper (axis of ordinates is log scale) for droughts (Gumbel, 1954).

From the Gumbel plot, the return period for a flood or drought of any magnitude may be determined. Conversely, for any magnitude of flood or drought, one may determine how frequently it will occur.

In statistical parlance a Gumbel plot is a linearization of a Type I probability distribution. The logarithmically transformed version of the Type I distribution is called a log-Pearson Type III distribution. The return period of the mean (X) of the Type I distribution occurs at $T = 2.33$ years. Thus, the U.S.G.S. takes the return period of the mean annual flood or drought to be 2.33 years. This is marked by a vertical dashed line on Gumbel paper (Figure 2-4).

The data in Table 2-8 were used to plot the annual minima line in Figure 2-4. The computations are explained in Example 2-2.

Example 2-2. In continuing the evaluation of the Troublesome Creek as a water supply for Nosleep (Example 2-1), perform an annual minima extreme-value analysis on the data in Table 2-7. Determine the recurrence interval of monthly flows that fail to meet an average demand of $0.31 \text{ m}^3/\text{s}$. Also determine the discharge of the mean monthly annual minimum flow.

Solution. To begin, select the minimum discharge in each hydrologic year. The first nine months of 1987 and the last three months of 2008 cannot be used because they are not complete hydrologic years. After selecting the minimum value in each year, rank the data and compute the return period. The 1988 water year begins in October 1987.

The computations are summarized in Table 2-8. The return period and flows are plotted in Figure 2-4. From Figure 2-4 find that for the 22 years of record, the minimum flow exceeds a demand of $0.31 \text{ m}^3/\text{s}$ and that the mean monthly minimum flow is about $1.5 \text{ m}^3/\text{s}$.

However, as noted in Example 2-1, the regulatory agency will only permit removal of 5% of the flow. The fifth column in Table 2-8 shows the computation of 5% of the flow. Obviously, storage must be provided if the Troublesome Creek is to be used as a water source.

Partial-Duration Series. It often happens that the second largest or second smallest flow in a water year is larger or smaller than the maxima or minima from a different hydrologic year. To take these events into consideration, a partial series of the data is examined. The procedure for performing a partial-duration series analysis is very similar to that used for an annual series. The

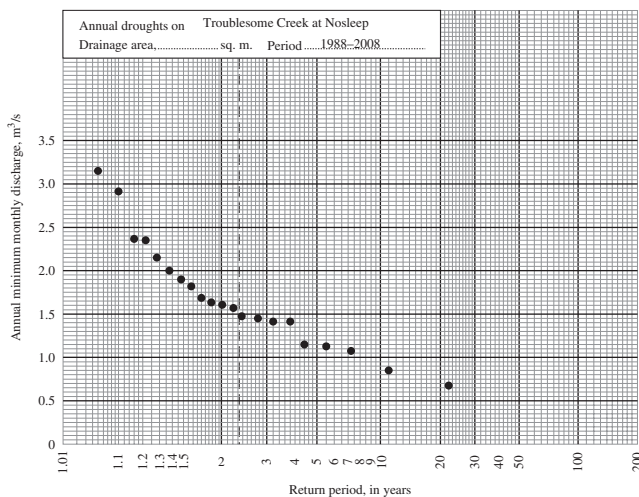

FIGURE 2-4
Annual droughts on Troublesome Creek at Nosleep.

TABLE 2-8
Tabulated computations of annual minima for Troublesome Creek at Nosleep

Year	Annual minima, m ³ /s	Rank	Return period, years	5% of Minima, m ³ /s
1992	0.67	1	22.00	0.034
1997	0.85	2	11.00	0.043
1988	1.08	3	7.33	0.054
1995	1.13	4	5.50	0.057
1990	1.15	5	4.40	0.058
1996	1.42	6	3.67	0.071
2000	1.42	7	3.14	0.071
1991	1.46	8	2.75	0.073
2004	1.49	9	2.44	0.075
1994	1.56	10	2.20	0.078
2001	1.61	11	2.00	0.081
2002	1.64	12	1.83	0.082
2005	1.69	13	1.69	0.085
1989	1.83	14	1.57	0.092
2003	1.90	15	1.47	0.099
1998	1.98	16	1.38	0.099
2007	2.15	17	1.29	0.108
2006	2.35	18	1.22	0.118
1993	2.38	19	1.16	0.119
1999	2.92	20	1.10	0.146
2008	3.14	21	1.05	0.157

theoretical relationship between an annual series and partial series is shown in Table 2-9. The partial series is approximately equal to the annual series for return periods greater than 10 years (Langbein, 1949).

If the time period over which the event occurs is also taken into account, the analysis is termed a *partial-duration series*. While it is fairly easy to define a flood as *any* flow that exceeds the capacity of the drainage system, in order to properly define a drought, one must specify the low flow and its duration. For example, if a roadway is covered with water for 10 minutes, one can say that it is flooded. In contrast, if the flow in a river is below our demand for 10 minutes, one certainly would not declare it a drought! Thus, a partial-duration series is particularly relevant for low-flow conditions.

Low-Flow Duration. From an environmental engineering point of view, three low-flow durations are of particular interest. The 10-year return period of seven days of low flow has been selected by many states as the critical flow for water pollution control. Wastewater treatment plants must be designed to provide sufficient treatment to allow effluent discharge without driving the quality of the receiving stream below the standard when the dilution capacity of the stream is at a 10-year low.

A longer duration low flow and longer return period are selected for water supply. In the Midwest, drought durations of 1 to 5 years and return periods of 25 to 50 years are used in the

TABLE 2-9
Theoretical relationship between partial series and annual series return periods in years

Partial series	Annual series
0.5	1.18
1.0	1.58
1.45	2.08
2.0	2.54
5.0	5.52
10.0	10.5
50.0	50.5
100.0	100.5

Source: W. B. Langbein, "Annual Floods and Partial Duration Series," *Transactions of the American Geophysical Union*, vol. 30, pp. 879-881, 1949.

design of water-supply reservoirs. Where water supply is by direct draft (withdrawal) from a river, the duration selected may be on the order of 30 to 90 days with a 10-year return period. When alternate sources are available, shorter return periods may be acceptable.

When to Use Which Series. The probability of occurrence ($1/T$) computed from an annual series will not be the same as that found from a complete series. There are many reasons for this difference. Among the most obvious is the fact that, in computing an annual series, 1/12 of the data is treated as if it were all of the data when, in fact, it is not even a representative sample. It is only the extreme end of the possible range of values.

The following guidelines can be used to decide when to use which analysis:

1. Use a complete series to determine the long-time reliability (yield) for water supply.
2. Use an annual minima series to determine the need for storage.
3. Use a partial-duration series to predict low-flow conditions.

In practice the complete-series analysis can be performed to decide whether or not it is worth doing a partial series for water supply. If the complete series indicates that the mean monthly flow will not supply the demand, then computation of an annual minima series to determine the need for storage is not worth the trouble, since it would be impossible to store enough water to meet the demand.

Volume of Reservoirs. The techniques for determining the storage volume required for a reservoir are dependent both on the size and use of the reservoir. This discussion is limited to the simplest procedure, which is quite satisfactory for small water-supply impoundments.* It is called the *mass diagram* or *Rippl method* (Rippl, 1883). The main disadvantage of the Rippl method is

*It is also useful for sizing storm-water retention ponds and wastewater equalization basins.

that it assumes that the sequence of events leading to a drought or flood will be the same in the future as it was in the past. More sophisticated techniques have been developed to overcome this disadvantage. These techniques are left for advanced hydrology classes.

The Rippl procedure for determining the storage volume is an application of the mass balance method of analyzing problems. In this case it is assumed that the only input is the flow into the reservoir (Q_{in}) and that the only output is the flow out of the reservoir (Q_{out}). Therefore, with the assumption that the density term cancels out because the change in density across the reservoir is negligible,

$$\frac{dS}{dt} = \frac{d(\text{In})}{dt} - \frac{d(\text{Out})}{dt} \tag{2-2}$$

becomes

$$\frac{dS}{dt} = Q_{in} - Q_{out} \tag{2-3}$$

If both sides of the equation are multiplied by dt , the inflow and outflow become volumes (flow rate \times time = volume), that is,

$$dS = (Q_{in})(dt) - (Q_{out})(dt) \tag{2-4}$$

By substituting finite time increments (Δt), the change in storage is then

$$(Q_{in})(\Delta t) - (Q_{out})(\Delta t) = \Delta S \tag{2-5}$$

By cumulatively summing the storage terms, the size of the reservoir can be estimated. For water supply reservoir design, Q_{out} is the demand, and zero or positive values of storage (ΔS) indicate there is enough water to meet the demand. If the storage is negative, then the reservoir must have a capacity equal to the absolute value of cumulative storage to meet the demand. This is illustrated in the following example.

Example 2-3. Using the data in Table 2-7, determine the storage required to meet Nosleep’s demand of 0.25 m³/s for the period from August 1994 through January 1997.

Solution. The computations are summarized in the table below.

Month	Q_{in} (m ³ /s)	$(0.05)(Q_{in})$ (m ³ /s)	$(0.05)(Q_{in})(\Delta t)$ (10 ⁶ m ³)	Q_{out} (m ³ /s)	$Q_{out}(\Delta t)$ (10 ⁶ m ³)	ΔS (10 ⁶ m ³)	$\Sigma(\Delta S)$ (10 ⁶ m ³)
1994							
Aug	1.70	0.085	0.228	0.25	0.670	-0.442	-0.442
Sep	1.56	0.078	0.202	0.25	0.648	-0.446	-0.888
Oct	1.56	0.078	0.209	0.25	0.670	-0.461	-1.348
Nov	2.04	0.102	0.264	0.25	0.648	-0.384	-1.732
Dec	2.35	0.1175	0.315	0.25	0.670	-0.355	-2.087

(continued)

1995

Jan	2.89	0.1445	0.387	0.25	0.670	-0.283	-2.370
Feb	9.57	0.4785	1.158	0.25	0.605	0.553	-1.817
Mar	17.7	0.885	2.370	0.25	0.670	1.701	-0.166
Apr	16.4	0.82	2.125	0.25	0.648	1.477	
May	6.83	0.3415	0.915	0.25	0.670	0.245	
Jun	3.74	0.187	0.485	0.25	0.648	-0.163	-0.163
Jul	1.60	0.08	0.214	0.25	0.670	-0.455	-0.619
Aug	1.13	0.0565	0.151	0.25	0.670	-0.518	-1.137
Sep	1.13	0.0565	0.146	0.25	0.648	-0.502	-1.638
Oct	1.42	0.071	0.190	0.25	0.670	-0.479	-2.118
Nov	1.98	0.099	0.257	0.25	0.648	-0.391	-2.509
Dec	2.12	0.106	0.284	0.25	0.670	-0.386	-2.895

1996

Jan	1.78	0.089	0.238	0.25	0.670	-0.431	-3.326
Feb	1.95	0.0975	0.236	0.25	0.605	-0.369	-3.695
Mar	7.25	0.3625	0.971	0.25	0.670	0.301	-3.394
Apr	24.7	1.235	3.201	0.25	0.648	2.533	-0.841
May	6.26	0.313	0.838	0.25	0.670	0.169	-0.672
Jun	8.92	0.446	1.156	0.25	0.648	0.508	-0.164
Jul	3.57	0.1785	0.478	0.25	0.670	-0.192	-0.355
Aug	1.98	0.099	0.265	0.25	0.670	-0.404	-0.760
Sep	1.95	0.0975	0.253	0.25	0.648	-0.395	-1.155
Oct	3.09	0.1545	0.414	0.25	0.670	-0.256	-1.411
Nov	3.94	0.197	0.511	0.25	0.648	-0.137	-1.548
Dec	12.7	0.635	1.701	0.25	0.670	1.031	-0.517

1997

Jan	13.8	0.69	1.848	0.25	0.670	1.178	
-----	------	------	-------	------	-------	-------	--

The data in the first and second columns of the table were extracted from Table 2-7. The third column is the product of the second column and the regulatory restriction of 5%. The fourth column is the product of the second column and the time interval for the month. For example, for August (31 d) and September (30 d), 1994:

$$(0.085 \text{ m}^3/\text{s})(31 \text{ d})(86,400 \text{ s/d}) = 227,664 \text{ m}^3$$

$$(0.078 \text{ m}^3/\text{s})(30 \text{ d})(86,400 \text{ s/d}) = 202,176 \text{ m}^3$$

The fifth column is the demand given in the problem statement.

The sixth column is the product of the demand and the time interval for the month. For example, for August and September 1994:

$$(0.25 \text{ m}^3/\text{s})(31 \text{ d})(86,400 \text{ s/d}) = 669,600 \text{ m}^3$$

$$(0.25 \text{ m}^3/\text{s})(30 \text{ d})(86,400 \text{ s/d}) = 648,000 \text{ m}^3$$

The seventh column (ΔS) is the difference between the third and fifth columns. For example, for August and September 1994:

$$\begin{aligned} 227,664 \text{ m}^3 - 669,600 \text{ m}^3 &= -441,936 \text{ m}^3 \\ 202,176 \text{ m}^3 - 648,000 \text{ m}^3 &= -445,824 \text{ m}^3 \end{aligned}$$

The last column ($\Sigma(\Delta S)$) is the sum of the last value in that column and the value in the sixth column. For August 1994, it is $-441,936 \text{ m}^3$ since this is the first value.

For September 1994, it is

$$(-441,936 \text{ m}^3) + (-445,824 \text{ m}^3) = -887,760 \text{ m}^3$$

The following logic is used in interpreting the table. From August 1994 through March 1995, the demand exceeds the flow, and storage must be provided. The maximum storage required for this interval is $2.370 \times 10^6 \text{ m}^3$. In April 1995, the storage (ΔS) exceeds the deficit ($\Sigma(\Delta S)$) from March 1995. If the deficit is viewed as the volume of water in a virtual reservoir with a total capacity of $2.370 \times 10^6 \text{ m}^3$, then in March 1995, the volume of water in the reservoir is $2.204 \times 10^6 \text{ m}^3$ ($2.370 \times 10^6 - 0.166 \times 10^6$). The April 1995 inflow exceeds the demand and fills the reservoir deficit of $0.166 \times 10^6 \text{ m}^3$.

Because the inflow (Q_{in}) exceeds the demand ($0.25 \text{ m}^3/\text{s}$) for the months of April and May 1995, no storage is required during this period. Therefore, no computations were performed.

From June 1995 through December 1996, the demand exceeds the inflow, and storage is required. The maximum storage required is $3.695 \times 10^6 \text{ m}^3$. Note that the computations for storage did not stop in May 1996, even though the inflow exceeded the demand. This is because the storage was not sufficient to fill the reservoir deficit. The storage was sufficient to fill the reservoir deficit in January 1997.

Comment. These tabulations are particularly well suited to spreadsheet programs.

The storage volume determined by the Rippl method must be increased to account for water lost through evaporation and volume lost through the accumulation of sediment.

Groundwater

Unlike surface water supplies, groundwater is less subject to seasonal fluctuations and long-term droughts. The design basis is the long term or “safe” yield. The safe yield of a ground water basin is the amount of water which can be withdrawn from it annually without producing an undesired result. (Todd, 1959) A yield analysis of the aquifer is performed because of the potential for over-pumping the well with consequent failure to yield an adequate supply as well as the potential to cause dramatic ground surface settlement, detrimental dewatering of nearby ponds or streams or, in wells near the ocean, to cause salt water intrusion.

Confined Aquifer. The components of the evaluation of the aquifer as a water supply are: (1) depth to the bottom of the aquiclude, (2) elevation of the existing piezometric surface, (3) drawdown for sustained pumping at the design rate of demand, and (4) recharge and drought implications.

The depth to the bottom of the aquiclude (Figure 2-5) sets the limit of drawdown of the piezometric surface. If the piezometric surface drops below the bottom of the aquiclude, ground settlement will begin to occur and, in addition to structural failure of the well, structural damage will occur to buildings and roadways. In populated areas of the United States, regulatory agencies gather hydrogeologic data reported by well drillers and others that may be used to estimate the depth to the aquiclude. In less densely populated areas, exploration and evaluation by a professional hydrogeologist is required.

The existing piezometric surface sets the upper bound of the range of drawdown. That is, the difference between the existing piezometric surface and the bottom of the aquiclude (s_{\max} in Figure 2-5) is the maximum allowable drawdown for a safe yield. As noted above, in populated areas, regulatory agencies will have a database that includes this information. Otherwise, a hydrogeologic exploration will be required.

Drawdown Estimation. The derivation of equations relating well discharge to water-level drawdown and the hydraulic properties of the aquifer is based on the following assumptions (Bouwer, 1978):

1. The well is pumped at a constant rate.
2. Flow toward the well is radial and uniform.
3. Initially the piezometric surface is horizontal.
4. The well fully penetrates the aquifer and is screened for the entire length.
5. The aquifer is homogeneous, isotropic, horizontal, and of infinite horizontal extent.
6. Water is released from the aquifer in immediate response to a drop in the piezometric surface.

Although the steady state will seldom occur in practice, it may be approached after prolonged pumping when the piezometric surface declines at a very slow rate. The Thiem equation

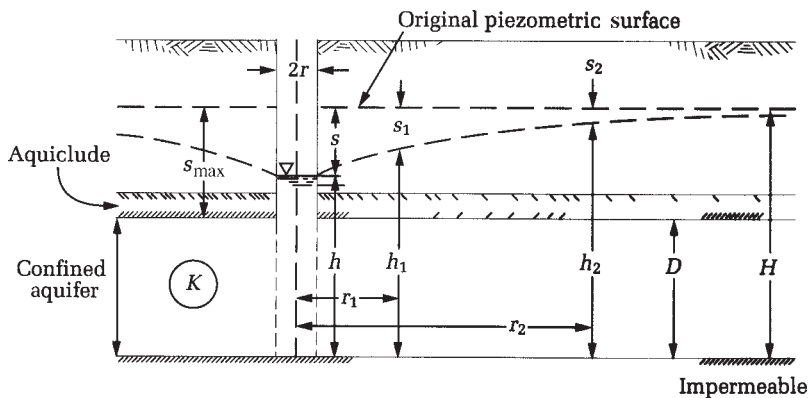

FIGURE 2-5

Geometry and symbols for a pumped well in a confined aquifer. (Source: H. Bouwer, 1978.)

may be used to estimate the maximum pumping rate that can be sustained by a single well in a confined aquifer (Thiem, 1906):

$$Q = \frac{2\pi T(h_2 - h_1)}{\ln(r_2/r_1)} \quad (2-6)$$

where Q = pumping flow rate, m^3/s

$T = KD$ = transmissivity of aquifer, m^2/s

K = hydraulic conductivity, m/s

D = thickness of aquifer, m

h_1, h_2 = height of piezometric surface at r_1, r_2 from the pumping well

In practice, the transmissivity (T) of the aquifer is determined from a pumping test. For academic purposes, the typical values of hydraulic conductivity given in Table 2-10 may be used.

The maximum sustainable pumping rate is found by setting h_1 equal to the height of the aquifer (D in Figure 2-5) and h_2 equal to the height of the piezometric surface before pumping (H in Figure 2-5). If the required Q cannot be achieved using one well for the design flow, multiple wells may be required. Except for very small demands, this is the rule rather than the exception.

Multiple wells may be used to take advantage of the fact that wells will “recover” their original piezometric surface when pumping ends if there is adequate water in the aquifer. Thus, if the cones of depression of multiple wells do not interfere with one another, the wells can be operated on a schedule that allows them to recover. Theoretically, if the non-pumping time equals the pumping time, the recovery will be complete (Brown, 1963). If the cones of depression do overlap, each well interferes with each of the other wells and the resultant drawdown is increased.

TABLE 2-10
Values of aquifer parameters

Aquifer material	Typical porosity (%)	Range of porosities (%)	Range of specific yield (%)	Typical hydraulic conductivity (m/s)	Range of hydraulic conductivities (m/s)
Unconsolidated					
Clay	55	50–60	1–10	1.2×10^{-6}	$0.1-2.3 \times 10^{-6}$
Loam	35	25–45		6.4×10^{-6}	10^{-6} to 10^{-5}
Fine sand	45	40–50		3.5×10^{-5}	$1.1-5.8 \times 10^{-5}$
Medium sand	37	35–40	10–30	1.5×10^{-4}	10^{-5} to 10^{-4}
Coarse sand	30	25–35		6.9×10^{-4}	10^{-4} to 10^{-3}
Sand and gravel	20	10–30	15–25	6.1×10^{-4}	10^{-5} to 10^{-3}
Gravel	25	20–30		6.4×10^{-3}	10^{-3} to 10^{-2}
Consolidated					
Shale	< 5		0.5–5	1.2×10^{-12}	
Granite	< 1		—	1.2×10^{-10}	
Sandstone	15	5–30	5–15	5.8×10^{-7}	10^{-8} to 10^{-5}
Limestone	15	10–20	0.5–5	5.8×10^{-6}	10^{-7} to 10^{-5}
Fractured rock	5	2–10	—	5.8×10^{-5}	10^{-8} to 10^{-4}

Adapted from Bouwer, 1978, Linsley et al., 1975, and Walton, 1970.

Unconfined Aquifer. The components of the evaluation of the aquifer as a water supply are: (1) depth of the aquifer, (2) annual precipitation and resultant aquifer recharge, and (3) draw-down for sustained pumping at the design rate of demand.

The depth of the aquifer for a unconfined aquifer is measured from the static, unpumped water level to the underlying impermeable layer (Figure 2-6). In theory, the depth of the aquifer sets one dimension of the maximum extent of pumping. Once the water level is lowered to the impermeable layer, the well “drys up.” In actuality, this depth cannot be achieved because of other constraints. In populated areas, regulatory agencies have data that permit estimation of the depth of the aquifer. In less densely populated areas, exploration and evaluation by a professional hydrogeologist is required.

Aquifer Recharge. A hydrologic mass balance is used to estimate the potential volume of water that recharges the aquifer. An annual time increment rather than the shorter monthly periods used in surface water analysis may be used for estimation purposes because the aquifer behaves as a large storage reservoir. Under steady-state conditions, the storage volume compensates for dry seasons with wet seasons. Thus, like the analysis of reservoirs, a partial duration series analysis for drought durations of 1 to 5 years with return periods of 25 to 50 years are used in evaluation of an unconfined aquifer as a water source.

Even though vast quantities of water may have accumulated in the aquifer over geologic time periods, the rate of pumping may exceed the rate of replenishment. Even with very deep aquifers where the well does not dry up, the removal of water results in removal of subsurface support. This, in turn, results in loss of surface elevation or land subsidence. Although this occurs in nearly every state in the United States, the San Joaquin Valley in California serves as a classic example. Figure 2-7 is a dramatic photograph showing the land surface as it was in 1977 in relation to its location in 1925. The distance between the 1925 sign and the 1977 sign is approximately 9 m.

Reclaimed Wastewater

Another source of water is recycled or reclaimed water. In regions where potable water is scarce, literally hundreds of communities are recycling wastewater for nonpotable uses. This provides an

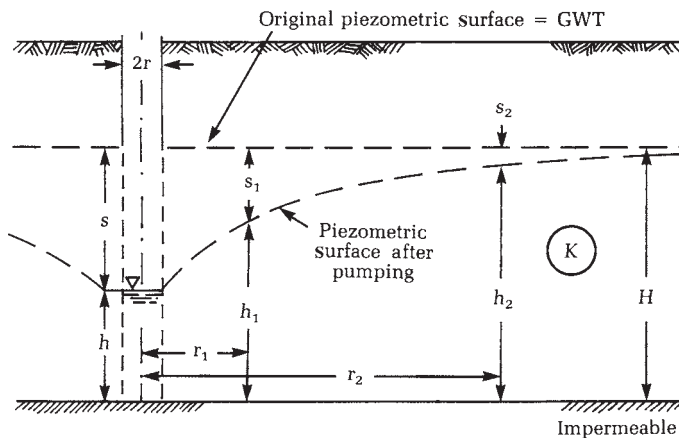

FIGURE 2-6

Geometry and symbols for a pumped well in an unconfined aquifer. (Source: H. Bouwer, 1978.)



FIGURE 2-7

Land subsidence in the San Joaquin Valley, 16 km southwest of Mendota, CA.

(Source: US Geological Survey Professional Paper 1401-A, *Ground Water in the Central Valley, California—A Summary Report*. Photo by Dick Ireland, USGS, 1977.)

initial means of extending a fully exploited water source. A half dozen cities, including El Paso, Texas and Los Angeles, California, are using treated wastewater to recharge potable aquifers. Los Angeles has been doing so since 1962 (Pinholster, 1995).

2-3 WATER QUALITY

The following four categories are used to describe drinking water quality:

1. *Physical*: Physical characteristics relate to the quality of water for domestic use. They include color, turbidity, temperature, and, in particular, taste and odor.
2. *Chemical*: Chemical characteristics of waters are sometimes evidenced by their observed reactions, such as the comparative performance of hard and soft waters in laundering. Most often, differences are not visible. However, in some cases, such as the oxidation of iron, the reactions result in highly objectionable color.

3. *Microbiological*: Microbiological agents are very important in their relation to public health and may also be significant in modifying the physical and chemical characteristics of water.
4. *Radiological*: Radiological factors must be considered in areas where there is a possibility that the water may have come in contact with radioactive substances. The radioactivity of the water is of public health concern in these cases.

Physical Characteristics

Color. Dissolved organic material from decaying vegetation and certain inorganic matter cause color in water. Occasionally, excessive blooms of algae or the growth of aquatic microorganisms may also impart color. Often the color in water is not true color but *apparent color* that results from a colloidal suspension. Tea is an example of apparent color. While color itself is not usually objectionable from the standpoint of health, its presence is aesthetically objectionable and suggests that the water needs appropriate treatment.

Taste and Odor. Taste and odor (T&O) in water can be caused by foreign matter such as organic compounds, inorganic salts, or dissolved gases. These materials may come from domestic, agricultural, or natural sources. Algae are frequently the source of T&O in surface water supplies. T&O can also result as a byproduct of chlorine disinfection. Drinking water should be free from any objectionable taste or odor at the point of use.

Temperature. The most desirable drinking waters are consistently cool and do not have temperature fluctuations of more than a few degrees. Groundwater and surface water from mountainous areas generally meet these criteria. Most individuals find that water having a temperature between 10°C–15°C is most palatable. Municipal drinking water is not treated to adjust the temperature. However, the temperature of the water may be an important water quality objective for a client and may be an important consideration in the selection of the water source.

Turbidity. The presence of suspended material such as clay, silt, finely divided organic material, plankton, and other particulate material in water is known as turbidity. The unit of measure is a nephelometric turbidity unit (NTU). It is determined by reference to a chemical mixture that produces a reproducible refraction of light. Turbidities in excess of 5 NTU are easily detectable in a glass of water and are usually objectionable for aesthetic reasons.

Clay or other inert suspended particles in and of themselves may not adversely affect health, but water containing such particles may require treatment to make it suitable for disinfection. In general, turbidity reduces disinfection efficiency by consuming the disinfectant and shielding the microorganisms. Following a rainfall, variations in the groundwater turbidity may be considered an indication of surface or other introduced pollution entering the aquifer.

Chemical Characteristics

Arsenic. Arsenic occurs naturally in some geologic formations. It is widely used in timber treatment, agricultural chemicals (pesticides), and the manufacture of computer chips, glass, and alloys. Arsenic in drinking water has been linked to lung and urinary bladder cancer.

Chloride. Most waters contain some chloride. The amount present can be caused by the leaching of marine sedimentary deposits or by pollution from sea water, brine, or industrial or domestic wastes. Chloride concentrations in excess of about 250 mg/L usually produce a noticeable taste in drinking water. Domestic water should contain less than 100 mg/L of chloride to be palatable.

Fluoride. In some areas, water sources contain natural fluoride. Where the concentrations approach optimum levels, beneficial health effects have been observed. In such areas, the incidence of *dental caries* (tooth decay) has been found to be below the levels observed in areas without natural fluoride. Many cities choose to add fluoride to the water supply to reduce the incidence of dental caries. The optimum fluoride level for a given area depends upon air temperature because temperature greatly influences the amount of water people drink. Excessive fluoride in drinking water supplies may produce fluorosis (mottling) of teeth,* which increases as the optimum fluoride level is exceeded.

Iron. Small amounts of iron frequently are present in water because of the large amount of iron in the geologic materials. The presence of iron in water is considered objectionable because it imparts a reddish color to the water, stains bathroom fixtures and laundered goods with a yellow to reddish-brown color, and affects the taste of beverages such as tea and coffee.

Lead. Lead occurs in drinking water primarily from corrosion of lead pipes. Lead exposure is associated with a large number of pathological effects including but not limited to interference with red blood cell formation, kidney damage, and impaired cognitive performance.

Manganese. Naturally occurring manganese is often present in significant amounts in groundwater. Anthropogenic sources include discarded batteries, steel alloy production, and agricultural products. It imparts a dark brown or black color to water and stains fixtures and cloth that is washed in it. It flavors coffee and tea with a medicinal taste.

Sodium. The presence of sodium in water can affect persons suffering from heart, kidney, or circulatory ailments. When a strict sodium-free diet is recommended, any water should be regarded with suspicion. Home water softeners may be of particular concern because they add large quantities of sodium to the water.

Sulfate. Waters containing high concentrations of sulfate, caused by the leaching of natural deposits of magnesium sulfate (Epsom salts) or sodium sulfate (Glauber's salt), may be undesirable because of their laxative effects.

Zinc. Zinc is found in some natural waters, particularly in areas where zinc ore deposits have been mined. Zinc is not considered detrimental to health, but it will impart an undesirable taste to drinking water.

Toxic Inorganic Substances. Nitrates (NO_3^-), cyanides (CN^-), and heavy metals constitute the major classes of inorganic substances of health concern. Methemoglobinemia (infant cyanosis or "blue baby syndrome") has occurred in infants who have been given water or fed formula prepared with water having high concentrations of nitrate. Cyanide ties up the hemoglobin sites that bind oxygen to red blood cells. This results in oxygen deprivation. A characteristic symptom

*Mottled teeth are characterized by black spots or streaks and may become brittle when exposed to large amounts of fluoride.

is a blue skin color, which gives the syndrome its name, *cyanosis*. This condition is called *cyanosis*. Cyanide also causes chronic effects on the thyroid and central nervous system.

The toxic heavy metals include arsenic (As), barium (Ba), cadmium (Cd), chromium (Cr), lead (Pb), mercury (Hg), selenium (Se), and silver (Ag). The heavy metals have a wide range of effects. They may be acute poisons (As and Cr^{6+} , for example), or they may produce chronic disease (Pb, Cd, and Hg, for example).

Toxic Organic Substances. There are over 120 toxic organic compounds listed on the U.S. EPA's Priority Pollutant list (Table 2-11). These include pesticides, insecticides, and solvents. Like the inorganic substances, their effects may be acute or chronic.

Microbiological Characteristics

Water for drinking and cooking purposes must be made free from pathogens. These organisms include viruses, bacteria, protozoa, and helminths (worms).

Some organisms that cause disease in people originate with the fecal discharges of infected individuals. Others are from the fecal discharge of animals.

Unfortunately, the specific disease-producing organisms present in water are not easily identified. The techniques for comprehensive bacteriological examination are complex and time-consuming. It has been necessary to develop tests that indicate the relative degree of contamination in terms of an easily defined quantity. The most widely used test estimates the number of microorganisms of the coliform group. This grouping includes two genera: *Escherichia coli* and *Aerobacter aerogenes*. The name of the group is derived from the word "colon". While *E. coli* are common inhabitants of the intestinal tract, *Aerobacter* are common in the soil, on leaves, and on grain; on occasion they cause urinary tract infections. The test for these microorganisms, called the *Total Coliform Test*, was selected for the following reasons:

1. The coliform group of organisms normally inhabits the intestinal tracts of humans and other mammals. Thus, the presence of coliforms is an indication of fecal contamination of the water.
2. Even in acutely ill individuals, the number of coliform organisms excreted in the feces outnumber the disease-producing organisms by several orders of magnitude. The large numbers of coliforms make them easier to culture than disease-producing organisms.
3. The coliform group of organisms survives in natural waters for relatively long periods of time but does not reproduce effectively in this environment. Thus, the presence of coliforms in water implies fecal contamination rather than growth of the organism because of favorable environmental conditions. These organisms also survive better in water than most of the bacterial pathogens. This means that the absence of coliforms is a reasonably safe indicator that pathogens are not present.
4. The coliform group of organisms is relatively easy to culture. Thus, laboratory technicians can perform the test without expensive equipment.

Current research indicates that testing for *Escherichia coli* specifically may be warranted. Some agencies prefer the examination for *E. coli* as a better indicator of biological contamination than total coliforms.

TABLE 2-11
EPA's priority pollutant list

1. Antimony	43. Trichloroethylene	87. Fluorene
2. Arsenic	44. Vinyl chloride	88. Hexachlorobenzene
3. Beryllium	45. 2-Chlorophenol	89. Hexachlorobutadiene
4. Cadmium	46. 2,4-Dichlorophenol	90. Hexachlorocyclopentadiene
5a. Chromium (III)	47. 2,4-Dimethylphenol	91. Hexachloroethane
5b. Chromium (VI)	48. 2-Methyl-4-chlorophenol	92. Indeno(1,2,3-cd)pyrene
6. Copper	49. 2,4-Dinitrophenol	93. Isophorone
7. Lead	50. 2-Nitrophenol	94. Naphthalene
8. Mercury	51. 4-Nitrophenol	95. Nitrobenzene
9. Nickel	52. 3-Methyl-4-chlorophenol	96. N-Nitrosodimethylamine
10. Selenium	53. Pentachlorophenol	97. N-Nitrosodi-n-propylamine
11. Silver	54. Phenol	98. N-Nitrosodiphenylamine
12. Thallium	55. 2,4,6-Trichlorophenol	99. Phenanthrene
13. Zinc	56. Acenaphthene	100. Pyrene
14. Cyanide	57. Acenaphthylene	101. 1,2,4-Trichlorobenzene
15. Asbestos	58. Anthracene	102. Aldrin
16. 2,3,7,8-TCDD (Dioxin)	59. Benzidine	103. alpha-BHC
17. Acrolein	60. Benzo(a)anthracene	104. beta-BHC
18. Acrylonitrile	61. Benzo(a)pyrene	105. gamma-BHC
19. Benzene	62. Benzo(a)fluoranthene	106. delta-BHC
20. Bromoform	63. Benzo(ghi)perylene	107. Chlordane
21. Carbon tetrachloride	64. Benzo(k)fluoranthene	108. 4,4'-DDT
22. Chlorobenzene	65. bis(2-Chloroethoxy)methane	109. 4,4'-DDE
23. Chlorodibromomethane	67. bis(2-Chloroisopropyl)ether	110. 4,4'-DDD
24. Chloroethane	68. bis(2-Ethylhexyl)phthalate	111. Dieldrin
25. 2-Chloroethylvinyl ether	69. 4-Bromophenyl phenyl ether	112. alpha-Endosulfan
26. Chloroform	70. Butylbenzyl phthalate	113. beta-Endosulfan
27. Dichlorobromomethane	71. 2-Chloronaphthalene	114. Endosulfan sulfate
28. 1,1-Dichloroethane	72. 4-Chlorophenyl phenyl ether	115. Endrin
29. 1,2-Dichloroethane	73. Chrysene	116. Endrin aldehyde
30. 1,1-Dichloroethylene	74. Dibenzo(a,h)anthracene	117. Heptachlor
31. 1,2-Dichloropropane	75. 1,2-Dichlorobenzene	118. Heptachlor epoxide
32. 1,3-Dichloropropylene	76. 1,3-Dichlorobenzene	119. PCB-1242
33. Ethylbenzene	77. 1,4-Dichlorobenzene	120. PCB-1254
34. Methyl bromide	78. 3,3-Dichlorobenzidine	121. PCB-1221
35. Methyl chloride	79. Diethyl phthalate	122. PCB-1232
36. Methylene chloride	80. Dimethyl phthalate	123. PCB-1248
37. 1,2,2,2-Tetrachloroethane	81. Di-n-butyl phthalate	124. PCB-1260
38. Tetrachloroethylene	82. 2,4-Dinitrotoluene	125. PCB-1016
39. Toluene	83. 2,6-Dinitrotoluene	126. Toxaphene
40. 1,2-trans-dichloroethylene	84. Di-n-octyl phthalate	
41. 1,1,1-Trichloroethane	85. 1,2-Diphenylhydrazine	
42. 2,4 Dichlorophenol	86. Fluoranthene	

Source: Code of Federal Regulations, 40 CFR 131.36, July 1, 1993.

The two protozoa of most concern are *Giardia lamblia* and *Cryptosporidium parvum*. Both pathogens are associated with gastrointestinal illness. The dormant *Giardia* cysts and *Cryptosporidium* oocysts are carried in animals in the wild and on farms.

Radiological Characteristics

The use of atomic energy as a power source and the mining of radioactive materials, as well as naturally occurring radioactive materials, are sources of radioactive substances in drinking water. Drinking water standards have been established for alpha particles, beta particles, photons emitters, radium-226 and -228, and uranium.

Although no standard has been established for radon, it is of concern because it is highly volatile and is an inhalation hazard from showering. Its decay products (^{218}Po , ^{214}Po , and ^{214}Bi) release alpha, beta, and gamma radiation.

Raw Water Characteristics

The quality of the *raw* (untreated) water plays a large role in determining the unit operations and processes required to treat the water. A comparison of the source water quality with the desired finished water quality provides a basis for selecting treatment processes that are capable of achieving the required treatment efficiency.

In addition to the regulated constituents discussed under “Water Quality Standards” in the next section there are a number of other common analyses used to assess the characteristics of the water with respect to potential treatment requirements. That is, the need for treatment, the difficulty of treatment, and the unit operations and processes that may be required. These are listed in Table 2-12 by the test used for their determination.

If the client’s water quality objectives include a soft finished water and the source water is a groundwater or a surface water with a large groundwater contribution, the dissolve cations and anions as well as alkalinity, carbon dioxide, pH, and total hardness are of particular interest. For surface water that will not be softened, sodium, alkalinity, conductivity, pH, and total organic carbon provide useful information beyond the regulated compounds.

For expansion of existing plants, these data may be readily available. Because groundwater quality is not highly variable, annual grab samples provide sufficient data for plant design. Because

TABLE 2-12
Common analyses to characterize raw water

Alkalinity	Iron
Bicarbonate	Manganese
Carbonate	Magnesium
Total	pH
Ammonia	Nitrate
Arsenic	Nitrite
Calcium	Silica
Carbon dioxide	Sodium
Chloride	Total hardness
Conductivity	Total Kjeldahl nitrogen
Hydrogen sulfide	Total organic carbon
Hydroxide	Turbidity

surface water is often highly variable in composition, more extensive time dependent data are desirable.

The ability of a selected design to consistently meet regulatory and client water quality goals is enhanced when the range of the source water quality is within the range of quality that the plant can successfully treat (Logsdon et al., 1999). A probability plot, like that shown in Figure 2-8, provides a comprehensive view of the range of constituent concentrations that must be treated. (A blank copy of probability paper may be downloaded from the website: <http://www.mhprofessional.com/wwe>.) It will be easier to maintain product water quality for source water with a shallow slope (Water A in Figure 2-8) than it will for a source water with a steep slope (Water B).

In addition to the chemical analyses, it is imperative that the design engineer conduct a *sanitary survey* (AWWA, 1999). This is a field investigation that covers a large geographic area beyond the immediate area surrounding the water supply source. The purpose of the sanitary survey is to detect potential health hazards and assess their present and future importance. This assessment includes such things as landfills, hazardous waste sites, fuel storage areas, industrial plants, and wastewater treatment plants. Examples of sources to be investigated during the sanitary survey are listed in Table 2-13.

Water Quality Standards

Water quality standards are a crucial element in setting the design criteria for a water supply project. The standards apply to both the treatment plant and the distribution system. Because of their crucial role, they are examined in detail in the following paragraphs.

The National Safe Drinking Water Act (SDWA) was signed into law on December 16, 1974. The Environmental Protection Agency (EPA) was directed to establish *maximum contaminant levels* (MCLs) for public water systems to prevent the occurrence of any known or anticipated adverse health effects with an adequate margin of safety. EPA defined a *public water system* to be any system that either has 15 or more service connections or regularly serves an average of

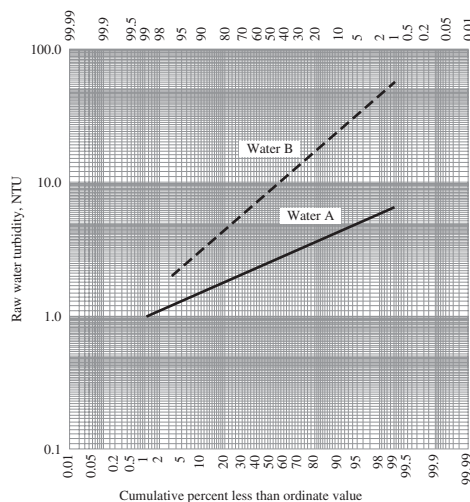

FIGURE 2-8

Cumulative log-probability plot of a water quality constituent.

TABLE 2-13
Examples of sources to be investigated during the sanitary survey

Surface water	Groundwater
Land use and zoning	Land use and zoning
Local geology and soils	Local geology and soils
Cultivated areas	Cultivated areas
Orchards	Orchards
Pastures	Pastures
Bathing areas	Raw materials storage
Gross erosion	Landfills
Marinas	Septic tank tile fields
Septic tank tile fields	Well logs
Sewer outfalls	
Storm water drains	
Swamps	
Upstream tributaries	
Vegetation	

at least 25 or more people daily for at least 60 days out of the year. The SDWA defines two types of public water supply: community and noncommunity. A *community system* serves a residential, year-round, population greater than 25 people or 15 living units. A *noncommunity system* is one that is not a community system but that serves not fewer than 25 individuals on an average daily basis for not less than 60 days per year. The noncommunity systems are further separated into two groups: transient and nontransient. The *transient systems* serve intermittent nonresidential users. Examples are campgrounds and restaurants. *Nontransient systems* are nonresidential systems that routinely serve the same individuals. Schools and places of business are examples of this category.

From 1975 through 1985, the EPA regulated 23 contaminants in drinking water supplied by public water systems. These regulations are known as National Interim Primary Drinking Water Regulations (IPDWRs). In June of 1986, the SDWA was amended. The amendments required EPA to set *maximum contaminant level goals* (MCLGs) and MCLs for 83 specific substances. This list included 22 of the IPDWRs (all except trihalomethanes). The amendments also required EPA to regulate 25 additional contaminants every three years beginning in January, 1991 and continuing for an indefinite period of time.

Table 2-14 lists each regulated contaminant and summarizes its adverse health effects. Some of these contaminant levels are being considered for revision. The notation “TT” in the table means that a treatment technique is specified rather than a contaminant level. The treatment techniques are specific processes that are used to treat the water. Some examples include coagulation and filtration, lime softening, and ion exchange. These are discussed in Chapters 6 through 14.

Lead and Copper. In June 1988, EPA issued proposed regulations to define MCLs and MCLGs for lead and copper, as well as to establish a monitoring program and a treatment technique for both. The MCLG proposed for lead is zero; for copper, 1.3 mg/L. The MCL action levels, applicable to water entering the distribution system, are 0.005 mg/L for lead and 1.3 mg/L for copper.

TABLE 2-14
Standards and potential health effects of the contaminants regulated under the SDWA

Contaminant	Maximum contaminant level goal mg/L	Maximum contaminant level mg/L	Best Available Technology (BAT)	Potential health effects
Organics				
Acrylamide	Zero	TT	PAP	Cancer, nervous system effects
Alachor	Zero	0.002	GAC	Cancer
Atrazine	0.003	0.003	GAC	Liver, kidney, lung, cardiovascular effects; possible carcinogen
Benzene	Zero	0.005	GAC, PTA	Cancer
Benzo(a)pyrene	Zero	0.0002	GAC	Cancer
Bromodichloromethane	Zero	See TTHM	GAC, NF [†]	Cancer
Bromoform	Zero	See TTHM	GAC, NF [†]	Cancer
Carbofuran	0.04	0.04	GAC	Nervous system, reproductive system effects
Carbon tetrachloride	Zero	0.005	GAC, PTA	Cancer
Chlordane	Zero	0.002	GAC	Cancer
Chloroform	0.07	See TTHM	GAC, NF [*]	Cancer
Chlorodibromomethane	No MCLG	See TTHM	GAC, NF [*]	Cancer
2,4-D	0.07	0.07	GAC	Liver, kidney effects
Dalapon	0.2	0.2	GAC	Kidney, liver effects
Di(2-ethylhexyl)adipate	0.4	0.4	GAC, PTA	Reproductive effects
Di(2-ethylhexyl)phthalate	Zero	0.006	GAC	Cancer
Dibromochloropropane (DBCP)	Zero	0.0002	GAC, PTA	Cancer
Dichloroacetic acid	No MCLG	See HAA5	GAC, PTA	Cancer
<i>p</i> -Dichlorobenzene	0.075	0.075	GAC, PTA	Kidney effects, possible carcinogen
<i>o</i> -Dichlorobenzene	0.6	0.6	GAC, PTA	Liver, kidney, blood cells effects
1,2-Dichloroethane	Zero	0.005	GAC, PTA	Cancer
1,1-Dichloroethylene	0.007	0.007	GAC, PTA	Liver, kidney effects, possible carcinogen
<i>cis</i> -1,2-Dichloroethylene	0.07	0.07	GAC, PTA	Liver, kidney, nervous system, circulatory effects
<i>trans</i> -1,2-Dichloroethylene	0.1	0.1	GAC, PTA	Liver, kidney, nervous system, circulatory effects
Dichloromethane (methylene chloride)	Zero	0.005	PTA	Cancer
1,2-Dichloropropane	Zero	0.005	GAC, PTA	Cancer
Dibromoacetic acid	No MCLG	See HAA5	GAC, NF [*]	Cancer
Dichloroacetic acid	No MCLG	See HAA5	GAC, NF [*]	Cancer
Dinoseb	0.007	0.007	GAC	Thyroid, reproductive effects
Diquat	0.02	0.02	GAC	Ocular, liver, kidney effects
Endothall	0.1	0.1	GAC	Liver, kidney, gastrointestinal effects
Endrin	0.002	0.002	GAC	Liver, kidney, nervous system effects
Epichlorohydrin	Zero	TT	PAP	Cancer

Organics

Ethylbenzene	0.7	0.7	GAC, PTA	Liver, kidney, nervous system effects
Ethylene dibromide (EDB)	Zero	0.00005	GAC, PTA	Cancer
Glyphosate	0.7	0.7	OX	Liver, kidney effects
Haloacetic acids (sum of 5; HAA5) ¹	No MCLG	0.060	GAC, NF*	Cancer
Heptachlor	Zero	0.0004	GAC	Cancer
Heptachlor epoxide	Zero	0.0002	GAC	Cancer
Hexachlorobenzene	Zero	0.001	GAC	Cancer
Hexachlorocyclopentadiene	0.05	0.05	GAC, PTA	Kidney, stomach effects
Lindane	0.0002	0.0002	GAC	Liver, kidney, & nervous, immune, circulatory system effects
Methoxychlor	0.04	0.04	GAC	Development, liver, kidney, nervous system effects
Monochlorobenzene	0.1	0.1	GAC, PTA	Cancer
Monochloroacetic acid	0.07	See HAA5	GAC, NF*	Cancer
Monobromoacetic acid	No MCLG	See HAA5	GAC, NF*	Cancer
Oxamyl (vydate)	0.2	0.2	GAC	Kidney effects
Pentachlorophenol	Zero	0.001	GAC	Cancer
Picloram	0.5	0.5	GAC	Kidney, liver effects
Polychlorinated biphenyls (PCBs)	Zero	0.0005	GAC	Cancer
Simazine	0.004	0.004	GAC	Body weight and blood effects, possible carcinogen
Styrene	0.1	0.1	GAC, PTA	Liver, nervous system effects, possible carcinogen
2,3,7,8-TCDD (dioxin)	Zero	5×10^{-8}	GAC	Cancer
Tetrachloroethylene	Zero	0.005	GAC, PTA	Cancer
Toluene	1	1	GAC, PTA	Liver, kidney, nervous system, circulatory system effects
Toxaphene	Zero	0.003	GAC	Cancer
2,4,5-TP (silvex)	0.05	0.05	GAC	Liver, kidney effects
Trichloroacetic acid	0.02	See HAA5	GAC, NF [†]	Cancer
1,2,4-Trichlorobenzene	0.07	0.07	GAC, PTA	Liver, kidney effects
1,1,1-Trichloroethane	0.2	0.2	GAC, PTA	Liver, nervous system effects
1,1,2-Trichloroethene	0.003	0.005	GAC, PTA	Kidney, liver effects, possible carcinogen
Trichloroethylene	Zero	0.005	GAC, PTA	Cancer
Trihalomethanes (sum of 4; TTHM's) ²	No MCLG	0.080	GAC, NF [†]	Cancer
Vinyl chloride	Zero	0.002	PTA	Cancer
Xylenes (total)	10	10	GAC, PTA	Liver, kidney, nervous system effects

(continued)

TABLE 2-14 (continued)
Standards and potential health effects of the contaminants regulated under the SDWA

Contaminant	Maximum contaminant level goal mg/L	Maximum contaminant level mg/L	Best Available Technology (BAT)	Potential health effects
Inorganics				
Antimony	0.006	0.006	C-F ³ , RO	Decreased longevity, blood effects
Arsenic	Zero	0.010	IX,AA,RO, C-F,LS,ED, OX-F	Dermal, nervous system effects, cancer
Asbestos (fibers > 10 µm)	7 million (fibers/L)	7 million (fibers/L)	C-F ³ , DF, DEF	Possible carcinogen by ingestion
Barium	2	2	IX,RO, LS ³	Blood pressure effects
Beryllium	0.004	0.004	IX,RO, C-F ³ LS ³ , AA,IX	Bone, lung effects, cancer
Bromate	Zero	0.010	DC	
Cadmium	0.005	0.005	C-F ³ , LS3, IX, RO	Kidney effects
Chlorite	0.8	1.0	DC	Nervous system effects
Chromium (total)	0.1	0.1	C-F ³ , LS ³ , (Cr III), IX, RO	Liver, kidney, circulatory system effects
Copper	1.3	TT	CC, SWT	Gastrointestinal effects
Cyanide	0.2	0.2	IX, RO, Cl ₂	Thyroid, central nervous system effects
Fluoride	4	4	AA, RO	Skeletal fluorosis
Lead	Zero	TT	CC, PE, SWT, LSLR	Cancer, kidney, central and peripheral nervous system effects
Mercury	0.002	0.002	C-F ³ (influent < 10 µg/L), LS ³ , GAC, RO (influent < 10 µg/L)	Kidney, central nervous system effects Methemoglobinemia (blue baby syndrome)
Nitrate (as N)	10	10	IX,RO,ED	
Nitrite (as N)	1	1	IX,RO	Methemoglobinemia (blue baby syndrome)
Nitrate + nitrite (both as N)	10	10	IX,RO	
Selenium	0.05	0.05	C-F ³ (Se IV), LS ³ , AA,RO,ED	Nervous system effects
Thallium	0.0005	0.002	IX, AA	Liver, kidney, brain, intestine effects
Radionuclides				
Beta particle and photon emitters	Zero	4 mrem	C-F,IX,RO	Cancer
Alpha particles	Zero	15 pCi/L	C-F,RO	Cancer
Radium-226 + radium-228	No MCLG	5 pCi/L	IX,LS,RO	Cancer
Uranium	Zero	30 µg/L	C-F ³ , LS ³ , AX	Cancer

Microbials

<i>Cryptosporidium</i>	Zero	TT	NA	Gastroenteric disease
<i>E. coli</i>	Zero	TT ⁵	NA	Gastroenteric disease
Fecal coliforms	Zero	TT ⁵	NA	Gastroenteric disease
<i>Giardia lamblia</i>	Zero	TT	NA	Gastroenteric disease
Heterotrophic bacteria	No MCLG	TT	NA	Gastroenteric disease
<i>Legionella</i>	Zero	TT	NA	Pneumonialike effects
Total coliforms	Zero	TT ⁴	NA	Indicator of gastroenteric infections
Turbidity		PS	NA	Interferes with disinfection, indicator of filtration performance
Viruses	Zero	TT	NA	Gastroenteric disease, respiratory disease, and other diseases, (e.g. hepatitis, myocarditis)

*Consecutive systems can use monochloramine (NH₂Cl) as BAT.

AA–activated alumina, AX–anion exchange, CC–corrosion control, C-F–coagulation and filtration, Cl₂–chlorination, DC–disinfection system control, DEF–deatomaceous earth filtration, DF–direct filtration, EF–enhanced coagulation, ED–electrodialysis, GAC–granular activated carbon, IX–ion exchange, LS–lime softening, LSLR–lead service line replacement, NA–not applicable, N-F–nanofiltration, OX–oxidation, OX-F–oxidation and filtration, PAP–polymer addition practices, PE–public education, PR–precursor removal, PS–performance standard, PTA–packed-tower aeration, RO–reverse osmosis, SWT–source water treatment, TT–treatment technique.

1. Sum of the concentrations of mono-, di-, and trichloroacetic acids and mono- and dibromoacetic acids.
2. Sum of the concentrations of bromodichloromethane, dibromochloromethane, bromoform, and chloroform.
3. Coagulation-filtration and lime-softening are not BAT for small systems for variance unless treatment is already installed.
4. No more than 5 percent of the samples per month may be positive. For systems collecting fewer than 40 samples per month, no more than 1 sample per month may be positive.
5. If a repeat total coliform sample is fecal coliform- or *E. coli*-positive, the system is in violation of the MCL for total coliforms. The system is also in violation of the MCL for total coliforms if a routine sample is fecal coliform- or *E. coli*-positive and is followed by a total coliform-positive repeat sample.

Compliance with the regulations is also based on the quality of the water at the consumer's tap. Monitoring is required by means of collection of first-draw samples at residences. The number of samples required to be collected will range from 10 per year to 50 per quarter, depending on the size of the water system.

The SDWA amendments forbid the use of pipe, solder, or flux that is not lead-free in the installation or repair of any public water system or in any plumbing system providing water for human consumption. This does not, however, apply to leaded joints necessary for the repair of old cast iron pipes.

Disinfectants and Disinfectant By-Products (D-DBPs). The disinfectants used to destroy pathogens in water and the by-products of the reaction of these disinfectants with organic materials in the water are of potential health concern. One class of DBPs has been regulated since 1979. This class is known as trihalomethanes (THMs). THMs are formed when a water containing an organic precursor is chlorinated. In this case it means an organic compound capable of reacting to produce a THM. The precursors are natural organic substances formed from the decay of vegetative matter, such as leaves, and aquatic organisms. THMs are of concern because they are known or potential carcinogens. The four THMs that were regulated in the 1979 rules are chloroform (CHCl_3), bromodichloromethane (CHBrCl_2), dibromochloromethane (CHBr_2Cl), and bromoform (CHBr_3). Of these four, chloroform appears most frequently and is found in the highest concentrations.

The D-DBP rule was developed through a negotiated rule-making process, in which individuals representing major interest groups concerned with the rule (for example, public-water-system owners, state and local government officials, and environmental groups) publicly work with EPA representatives to reach a consensus on the contents of the proposed rule.

Maximum residual disinfectant level goals (MRDLGS) and *maximum residual disinfectant levels (MRDLs)* were established for chlorine, chloramine, and chlorine dioxide (Table 2-15). Because ozone reacts too quickly to be detected in the distribution system, no limits on ozone were set.

The MCLGs and MCLs for disinfection byproducts are listed in Table 2-16. In addition to regulating individual compounds, the D-DBP rule set levels for two groups of compounds: HAA5 and TTHMs. These groupings were made to recognize the potential cumulative effect of several compounds. HAA5 is the sum of five haloacetic acids (monochloroacetic acid, dichloroacetic acid, trichloroacetic acid, monobromoacetic acid, and dibromoacetic acid). TTHMs (total trihalomethanes) is the sum of the concentrations of chloroform (CHCl_3), bromodichloromethane (CHBrCl_2), dibromochloromethane (CHBr_2Cl), and bromoform (CHBr_3).

The D-DBP rule is quite complex. In addition to the regulatory levels shown in the tables, levels are established for precursor removal. The amount of precursor required to be removed is a function the alkalinity of the water and the amount of *total organic carbon (TOC)* present.

TABLE 2-15
Maximum residual disinfectant level goals (MRDLGs) and
maximum residual disinfectant levels (MRDLs)

Disinfectant residual	MRDLG, mg/L	MRDL, mg/L
Chlorine (free)	4	4.0
Chloramines (as total chlorine)	4	4.0
Chlorine dioxide	0.8	0.8

TABLE 2-16
Maximum contaminant level goals (MCLGs) and maximum contaminant levels (MCLs) for disinfectant by-products (DBPs)

Contaminant	MCLG, mg/L	Stage 1 MCL, mg/L	Stage 2 MCL, mg/L
Bromate	Zero	0.010	
Bromodichloromethane	Zero		
Bromoform	Zero		
Chloral hydrate	0.005		
Chlorite	0.3	1.0	
Chloroform	0.07		
Dibromochloromethane	0.06		
Dichloroacetic acid	Zero		
Monochloroacetic acid	0.03		
Trichloroacetic acid	0.02		
HAA5		0.060	0.060 ^a
TTHMs		0.080	0.080 ^a

^aCalculated differently in Stage 2.

The D-DBP rule was implemented in stages. Stage 1 of the rule was promulgated in November 1998. Stage 2 was promulgated in 2006.

When chlorine is added to water that contains TOC, the chlorine and TOC slowly react to form THMs and HAA5. The concentrations of THM and HAA5 continuously increase until the reactions go to completion. Compliance with the regulation is based on samples taken from the distribution system. Although the number of samples may vary, generally it is about four samples collected quarterly. In the Stage 1 rule, the sample points are averaged over four quarters of data. Thus, for the case of four samples for four quarters, 16 data points are averaged to determine compliance. In the Stage 2 rule, four samples (one from each quarter) from a single site are averaged. Each site must be below the MCL. This is referred to as a *locational running annual average* (LRAA). Although the MCLs in Stage 1 and 2 are the same, compliance is more difficult with the Stage 2 rule.

Surface Water Treatment Rule (SWTR). The Surface Water Treatment Rule (SWTR) and its companion rules, the Interim Enhanced Surface Water Treatment Rule (IESWTR) and the Long-Term Enhanced Surface Water Treatment Rules (LT1ESWTR and LT2ESWTR), set forth primary drinking water regulations requiring treatment of surface water supplies or groundwater supplies under the direct influence of surface water. The regulations require a specific treatment technique—filtration and/or disinfection in lieu of establishing maximum contaminant levels (MCLs) for turbidity, *Cryptosporidium*, *Giardia lamblia*, viruses, *Legionella*, and heterotrophic bacteria, as well as many other pathogenic organisms that are removed by these treatment techniques. The regulations also establish a maximum contaminant level goal (MCLG) of zero for *Giardia lamblia*, *Cryptosporidium*, viruses, and *Legionella*. No MCLG is established for heterotrophic plate count or turbidity.

Turbidity Limits. Treatment by conventional or direct filtration must achieve a turbidity level of less than 0.3 NTU in at least 95 percent of the samples taken each month. Those systems using slow sand filtration must achieve a turbidity level of less than 5 NTU at all times and not more

than 1 NTU in more than 5 percent of the samples taken each month. The 1 NTU limit may be increased by the state up to 5 NTU if it determines that there is no significant interference with disinfection. Other filtration technologies may be used if they meet the turbidity requirements set for slow sand filtration, provided they achieve the disinfection requirements and are approved by the state.

Turbidity measurements must be performed on representative samples of the system's filtered water every four hours or by continuous monitoring. For any system using slow sand filtration or a filtration treatment other than conventional treatment, direct filtration, or diatomaceous earth filtration, the state may reduce the monitoring requirements to once per day.

Disinfection Requirements. Filtered water supplies must achieve the same disinfection as required for unfiltered systems (that is, 99.9 or 99.99% removal, also known as *3-log and 4-log removal* or *inactivation*, for *Giardia lamblia* and viruses) through a combination of filtration and application of a disinfectant.

Giardia and viruses are both fairly well inactivated by chlorine. Thus, with proper physical treatment and chlorination, both can be controlled. *Cryptosporidium*, however, is resistant to chlorination. Depending on the source water concentration, EPA establishes levels of treatment that include physical barriers and disinfection techniques. Ozonation and disinfection with ultraviolet light are effective in destroying *Cryptosporidium*.

Total Coliform. On June 19, 1989, the EPA promulgated the revised National Primary Drinking Water Regulations for total coliforms, including fecal coliforms and *E. coli*. These regulations apply to all public water systems.

The regulations establish a maximum contaminant level (MCL) for coliforms based on the presence or absence of coliforms. Larger systems that are required to collect at least 40 samples per month cannot obtain coliform-positive results in more than 5 percent of the samples collected each month to stay in compliance with the MCL. Smaller systems that collect fewer than 40 samples per month cannot have coliform-positive results in more than one sample per month.

The EPA will accept any one of the five analytical methods noted below for the determination of total coliforms:

- Multiple-tube fermentation technique (MTF)
- Membrane filter technique (MF)
- Minimal media ONPO-MUG test (colilert system) (MMO-MUG)
- Presence-absence coliform test (P-A)
- Colisure technique

Regardless of the method used, the standard sample volume required for total coliform testing is 100 mL.

A public water system must report a violation of the total coliform regulations to the state no later than the end of the next business day. In addition to this, the system must make public notification according to the general public notification requirements of the Safe Drinking Water Act, but with special wording prescribed by the total coliform regulations.

TABLE 2-17
Secondary maximum contaminant levels

Contaminant	SMCL, mg/L ^a
Chloride	250
Color	15 color units
Copper	1
Corrosivity	Noncorrosive
Foaming agents	0.5
Hydrogen sulfide	0.05
Iron	0.3
Manganese	0.05
Odor	3 threshold odor number units
pH	6.5–8.5
Sulfate	250
Total dissolved solids (TDS)	500
Zinc	5

^aAll quantities are mg/L except those for which units are given.

Secondary Maximum Contaminant Levels (SMCLs). The National Safe Drinking Water Act also provided for the establishment of an additional set of standards to prescribe maximum limits for those contaminants that tend to make water disagreeable to use, but that do not have any particular adverse public health effect. These secondary maximum contaminant levels are the advisable maximum level of a contaminant in any public water supply system. The levels are shown in Table 2-17.

AWWA Goals. The primary and secondary maximum contaminant levels are the maximum allowed (or recommended) values of the various contaminants. However, a reasonable goal may be much lower than the MCLs themselves. The American Water Works Association (AWWA) has issued its own set of goals to which its members try to adhere. These goals are shown in Table 2-18.

2-4 EVALUATION OF PROCESS OPTIONS

In the design process, the data gathered in the sections outlined to this point in the chapter would be sufficient to begin screening alternative supply and treatment options. In most cases a number of options will be available. The pros and cons of these selections are discussed in Chapters 3 through 16.

2-5 PLANT SIZING AND LAYOUT

Once the preliminary selection of the water treatment unit operations and processes has been made (the screening process discussed in Chapter 1), rough calculations are made to determine sizes to be used in examining feasibility of site locations and cost. The elements to be considered

TABLE 2-18
American Water Works Association water quality goals

Contaminant	Goal, mg/L ^a
Turbidity	< 0.1 turbidity units (TU)
Color	< 3 color units
Odor	None
Taste	None objectionable
Aluminum	< 0.05
Copper	< 0.2
Iron	< 0.05
Manganese	< 0.01
Total dissolved solids (TDS)	200.0
Zinc	< 1.0
Hardness	80.0

^aAll quantities are mg/L except those for which units are given.

in plant sizing include: (1) number and size of process units, and (2) number and size of ancillary structures. The layout should include: (1) provision for expansion, (2) connection to the transportation net, (3) connection to the water distribution system, and (4) residuals handling system.

Number and Size of Process Units

To ensure the provision of water to the public water supply, in general, a minimum of two units is provided for redundancy. When only two units are provided, each shall be capable of meeting the plant design capacity. Normally, the design capacity is set at the projected maximum daily demand for the end of the design period. The size of the units is specified so that the plant can meet the design capacity with one unit out of service (GLUMRB, 2003). Consideration should also be given to the efficiency/effectiveness of the process units with the low demand at start up of the facility.

Number and Size of Ancillary Units

The ancillary units include: administration building, laboratory space, storage tanks, mechanical building for pumping facilities, roads, and parking. The size of these facilities is a function of the size of the plant. In small to medium sized facilities, particularly in cold climates and when land is expensive, administration, laboratory, pumping and storage are housed in one building.

The storage tanks include those for chemicals, treated water, and in some instances fuel. Space for storage of chemical residuals must also be provided.

Plant Layout

When space is not a constraint, a linear layout generally allows the maximum flexibility for expansion. Redundancy is enhanced if the units are interconnected in such a way that the flow through the plant can be shuttled from one treatment train to another. Because chemicals must be delivered to the plant, connection to the transportation net becomes an integral part of the layout.

Likewise, because residuals are generally transported off-site, the residuals handling system is an integral part of the plant layout.

2-6 PLANT LOCATION

Ideally a site comparison study will be performed after alternatives have been screened and rough sizing of the processes is complete. Many factors may preclude the ideal situation. For example, in highly urbanized areas the availability of land may preclude all but one site. In some cases the availability of land may force the selection of processes that fit into the available space.

Given that more than one site is available, there are several major issues to be considered. As noted in Chapter 1, cost is a major element in the selection process. In addition, the site should allow for expansion. The location of the plant relative to the transportation net, raw water supply, and the service area should be weighed carefully. The physical characteristics of the site alternatives that must be evaluated include the potential for flooding, foundation stability, groundwater intrusion, and the difficulty in preparing the site. For example, the need for blasting of rock may make the cost prohibitive for an otherwise ideal site. Other issues to be considered include wetland infringement, the availability of alternate, independent sources of power, waste disposal options, public acceptance, and security.

Visit the text website at www.mhprofessional.com/wwe for supplementary materials and a gallery of additional photos.

2-7 CHAPTER REVIEW

When you have completed studying this chapter, you should be able to do the following without the aid of your textbook or notes:

1. Explain to a client the influence of regulatory constraints on the selection of a design period.
2. For a given population growth rate, select an appropriate design period.
3. Explain to a news media person the influence of local factors such as climate, industrial development, and meterage on a national estimate of unit demand.
4. Explain to a client why groundwater is often preferred as a source of water.
5. Use a yield curve to estimate a safe yield.
6. Describe the potential deleterious effects of overpumping a confined or an unconfined aquifer.
7. Explain the implications of a flat or steep slope in a log-probability plot of a water quality parameter in the design of a water treatment plant.

With the use of this text, you should be able to do the following:

8. Construct a yield curve.
9. Construct an annual minima series.

10. Use mass balance techniques to estimate the required volume of a small reservoir.
11. Estimate the maximum sustainable drawdown of a well pumping from a confined aquifer.
12. Compare the results of a water analysis with water quality criteria and determine deficiencies that need to be remedied by treatment.
13. Estimate the demand flow rate for the average day, maximum day, and peak hour for a small nonindustrial community.

2-8 PROBLEMS

- 2-1. Estimate the demand (in m^3/d) of a new suburban subdivision of 333 houses for the average, maximum, and minimum day. Assume that both the AWWA household average demand and Figure 2-1 apply. Also assume that each house is occupied by three residents.
- 2-2. A resort community has been platted in Arizona. The year round population when it is fully developed is estimated to be 7,000. A gross estimate of the average day demand is required for planning purposes. Using Hutson et al. (2001) and census population data, estimate the demand. Assume that the “public water supply” category applies.
- 2-3. A ski lift operation in Colorado plans to expand to include a 250 room hotel, a restaurant to seat 250, and dormitory-style living quarters for a staff of 25 individuals. Estimate the increase in average daily demand during the ski season that must be provided. Assume the average hotel occupancy is two people per room.
- 2-4. Using a spreadsheet you have written, perform a complete series analysis on the data for the Squannacook River near West Groton, MA, given on page 2-41. Plot a yield curve. What is the safe yield of the river if the regulatory agency will allow a withdrawal of 6%?
- 2-5. Using a spreadsheet you have written, perform a complete series analysis on the data for the Clear Fork Trinity River at Fort Worth, TX, given on page 2-42. Plot a yield curve. What is the safe yield of the river if the regulatory agency will allow a withdrawal of 3%?
- 2-6. Using a spreadsheet you have written, perform an annual minima analysis on the data for the Squannacook River near West Groton, MA, given on page 2-41. Plot the data on Gumbel paper and determine the minimum monthly discharge for the mean annual drought. If the demand is $0.131 \text{ m}^3/\text{s}$, will storage be required if the regulatory agency will allow a withdrawal of 6%?
- 2-7. Using a spreadsheet you have written, perform an annual minima analysis on the data for the Clear Fork Trinity River at Fort Worth, TX, given on page 2-42. Plot the data on Gumbel paper and determine the minimum monthly discharge for the mean annual drought. If the demand is $0.021 \text{ m}^3/\text{s}$, will storage be required if the regulatory agency will allow a withdrawal of 3%?

Squannacook River near West Groton, MA

Mean monthly discharge (m³/s)

Year	Jan	Feb	Mar	Apr	May	June	July	Aug	Sept	Oct	Nov	Dec
1951	3.48	8.18	6.63	6.63	3.20	2.38	2.40	1.49	1.06	1.82	6.60	4.47
1952	6.68	5.07	6.51	9.94	5.44	3.71	.87	1.01	.69	.45	1.05	3.37
1953	4.79	6.77	11.44	9.80	6.34	1.21	.52	.42	.29	.51	1.34	3.65
1954	2.06	3.20	4.67	4.53	9.71	2.75	1.21	1.05	6.94	2.27	6.26	7.16
1955	2.92	3.06	5.41	6.17	2.77	1.44	.46	1.63	.61	8.38	8.61	2.17
1956	9.15	3.29	3.82	14.56	5.21	2.50	.77	.40	.50	.54	1.14	2.33
1957	2.92	2.63	4.22	3.99	2.65	.87	.37	.22	.22	.29	.97	3.91
1958	5.89	3.48	6.60	12.40	5.35	1.29	.81	.49	.45	.62	1.13	1.49
1959	2.07	2.05	5.41	8.67	2.37	1.22	1.17	.59	.82	2.55	4.08	5.55
1960	3.51	3.96	3.03	14.73	5.52	2.41	1.09	1.21	2.71	2.18	3.34	2.49
1961	1.57	3.09	7.28	11.10	4.67	2.31	1.03	.80	1.23	.99	2.06	1.73
1962	3.14	1.80	5.47	10.93	3.71	1.25	.56	.69	.50	2.95	4.73	4.30
1963	2.19	1.76	6.83	7.53	2.66	.77	.38	.24	.25	.35	1.52	1.98
1964	3.77	2.57	7.33	6.57	1.85	.59	.38	.25	.21	.27	.36	.79
1965	.65	1.33	2.38	3.79	1.47	.59	.23	.20	.19	.27	.45	.64
1966	.61	1.96	5.55	2.92	2.46	.80	.26	.18	.27	.52	1.75	1.35
1967	1.68	1.53	2.64	10.62	6.29	3.17	2.22	.72	.47	.60	1.07	3.03
1968	2.02	2.14	9.60	3.79	3.82	4.79	1.92	.61	.48	.46	1.88	4.33
1969	2.21	2.17	5.81	10.70	2.80	1.01	.58	1.03	.93	.52	5.24	5.83

Clear Fork Trinity River at Fort Worth, TX

Mean monthly discharge (m³/s)

Year	Jan	Feb	Mar	Apr	May	June	July	Aug	Sept	Oct	Nov	Dec
1940	—	—	—	—	—	—	—	—	—	0.00	5.63	15.4
1941	4.59	23.8	7.50	6.91	10.2	17.0	2.07	2.29	0.20	1.71	0.631	0.926
1942	0.697	0.595	0.614	58.93	24.1	9.09	0.844	0.714	1.21	10.0	2.38	1.87
1943	1.33	1.00	3.99	3.71	8.38	3.77	0.140	0.00	1.33	0.014	0.00	0.139
1944	0.311	4.93	2.83	2.25	13.3	1.68	0.210	0.609	4.11	0.985	0.515	1.47
1945	3.06	30.38	35.23	28.85	5.69	21.7	2.14	0.230	0.162	0.971	0.617	0.541
1946	1.88	5.75	3.54	1.89	6.57	5.86	0.153	1.45	4.02	0.906	12.2	10.3
1947	4.64	2.62	4.87	5.13	2.27	4.25	0.292	0.054	0.535	0.371	0.331	3.51
1948	3.99	16.9	9.06	1.91	2.64	1.11	1.22	0.00	0.00	0.00	0.00	0.003
1949	0.309	4.19	9.94	4.16	55.21	11.1	1.38	0.450	0.447	4.53	0.711	0.614
1950	3.28	14.7	3.26	12.7	15.1	2.50	3.60	2.44	10.6	1.12	0.711	0.801
1951	0.708	0.994	0.719	0.527	1.37	6.20	0.980	0.00	0.00	0.00	0.006	0.090
1952	0.175	0.413	0.297	1.93	3.65	0.210	0.003	0.029	0.007	0.00	0.368	0.167
1953	0.099	0.080	0.134	0.671	0.934	0.008	0.286	0.249	0.041	0.546	0.182	0.066
1954	0.108	0.092	0.114	0.088	0.278	0.017	0.021	0.015	0.008	0.047	0.024	0.063
1955	0.091	0.153	0.317	0.145	0.464	0.640	0.049	0.050	0.119	0.104	0.055	0.058
1956	0.069	0.218	0.026	0.306	1.35	0.30	0.026	0.019	0.029	0.266	0.030	0.170
1957	0.065	0.300	0.385	12.8	23.6	59.9	6.97	1.36	0.501	0.476	0.855	1.55
1958	1.65	1.61	4.59	5.69	28.1	0.589	0.524	0.456	0.549	0.572	0.490	0.566
1959	0.759	0.776	0.120	0.261	0.097	0.685	0.379	0.668	0.473	9.03	1.64	3.65
1960	11.8	4.45	3.26	1.42	0.631	0.379	0.660	0.566	0.467	0.498	0.241	0.648
1961	2.05	1.92	3.40	1.02	0.306	2.34	0.821	0.816	1.08	0.824	0.297	0.504
1962	0.311	2.03	0.467	0.759	0.459	0.236	0.745	1.41	6.94	1.31	0.405	0.767
1963	0.345	0.268	0.379	1.74	3.79	1.48	0.527	0.586	0.331	0.277	0.249	0.266
1964	0.416	0.266	1.16	0.813	1.02	0.374	0.535	0.963	3.96	0.351	1.47	0.886
1965	2.13	14.6	4.16	2.28	20.5	2.45	1.22	0.821	0.776	0.394	0.476	0.213
1966	0.169	0.354	0.462	6.40	23.1	18.5	5.32	0.951	0.294	1.37	0.15	0.134
1967	0.244	0.244	0.198	0.688	1.04	3.65	0.354	0.068	0.697	0.473	0.394	0.558
1968	1.64	3.85	23.2	1.89	15.7	6.12	0.583	0.144	0.220	0.419	0.396	0.206
1969	0.259	0.555	2.66	12.1	21.2	0.745	0.674	0.30	1.56	0.917	0.459	1.94
1970	5.78	6.37	27.0	3.31	15.0	1.03	0.521	0.697	1.23	—	—	—

- 2-8.** Using a spreadsheet you have written and the data in Table 2-7, continue the analysis of the required storage volume begun in Example 2-3 through April, 2001. What size reservoir is required? Is it full at the end of the April 2001? Ignore the need for increased volume for sediment.
- 2-9.** Using a spreadsheet you have written and the data for the Hoko River near Sekiu, WA, below, determine the required storage volume for a uniform demand of $0.35 \text{ m}^3/\text{s}$ for the period January 1969 through December 1973. Assume a regulatory restriction that allows only 6% of the flowrate to be withdrawn. What size reservoir is required? Is it full at the end of December, 1973? Ignore the need for increased volume for sediment.
- 2-10.** Eudora is served by a single well that pumps at a rate of $0.016 \text{ m}^3/\text{s}$. They anticipate the need for a pumping rate of $0.025 \text{ m}^3/\text{s}$. They would like to use the current well and replace the pump with a higher capacity pump. The artesian aquifer is 10 m thick with a piezometric surface 40 m above the bottom confining layer. The aquifer is a medium sand. After 300 days of pumping, the drawdown at a nonpumping well 200 m from the pumping well is 1 m. The pumping well is 1 m in diameter. Assuming a typical hydraulic conductivity for medium sand, determine the maximum allowable sustained pumping rate.

Hoko River near Sekiu, WA

Mean monthly discharge (m^3/s)

Year	Jan	Feb	Mar	Apr	May	June	July	Aug	Sept	Oct	Nov	Dec
1963	12.1	15.0	8.55	9.09	5.78	1.28	2.59	1.11	.810	13.3	26.1	20.3
1964	27.3	12.2	18.0	8.21	4.08	3.62	4.53	2.44	4.28	7.67	13.3	14.7
1965	27.4	27.3	5.01	5.61	6.68	1.38	.705	.830	.810	7.31	16.8	19.6
1966	29.8	11.3	17.6	5.18	2.67	2.10	1.85	.986	1.54	10.3	17.0	39.0
1967	35.6	26.8	18.5	6.51	3.43	1.46	.623	.413	.937	25.7	14.2	27.8
1968	34.2	22.4	15.7	9.20	3.68	2.65	1.72	1.55	9.12	16.8	16.5	25.2
1969	17.2	18.5	12.9	12.8	3.74	2.23	1.19	.810	6.15	7.84	9.15	15.9
1970	17.3	12.1	8.50	17.7	3.85	1.32	.932	.708	4.22	7.96	13.9	25.4
1971	32.7	21.0	21.1	8.13	3.43	2.83	1.83	.932	2.22	10.7	22.7	22.0
1972	27.4	26.9	25.4	14.6	3.00	1.00	5.32	.841	2.00	1.14	11.8	37.8
1973	28.0	9.23	11.3	4.13	5.30	4.93	1.63	.736	.810	13.1	29.8	31.5

- 2-11.** Your supervisor has asked you to make a first approximation estimate of the maximum allowable sustained pumping rate for a 1 m diameter well located in a confined aquifer. She has given you the well boring log shown below. Your firm uses a 2 m safety factor to ensure that the piezometric surface is not lowered below the aquiclude. She has said you may assume that the aquifer has a typical hydraulic conductivity. For a first trial assume that the drawdown in an observation well 100 m away from the pumping well is 0.0 m; that is, the pumping well's radius of influence is $\leq 100 \text{ m}$.

Typical well boring log

Aquifer material	Depth, m	
Clay and sand	12	static water level = 12 m
Fine gray sand	10	
Hardpan	2	
Shale	2	
Fractured rock	55	
Shale	2	well terminated

2-12. Your firm has been employed to perform a preliminary data analysis for renovation and expansion of a surface water treatment plant. The plant operator has provided the following summary of daily turbidity readings. Using a spreadsheet you have written, perform a cumulative probability analysis on the data shown below and prepare a plot on probability paper. Using the plot, write a short summary report for your supervisor that discusses the following:

- A general description of the behavior of the data.
- Your impression of the degree of difficulty in operating the plant and the need for operational flexibility.
- A recommendation regarding further data analysis.

Monthly Average Turbidity 2005–2007 for Lake Michigan

Month	Turbidity, NTU	Month	Turbidity, NTU	Month	Turbidity, NTU
1	6.89	13	4.26	25	5.76
2	4.63	14	2.95	26	4.37
3	3.42	15	2.07	27	3.59
4	1.40	16	1.56	28	2.31
5	1.25	17	1.11	29	0.66
6	0.91	18	0.59	30	0.73
7	1.18	19	1.01	31	0.84
8	0.79	20	0.59	32	0.67
9	1.07	21	1.09	33	0.87
10	1.06	22	2.70	34	2.09
11	5.41	23	1.07	35	1.68
12	6.15	24	4.51	36	6.20

2-13. Your firm has been employed to perform a preliminary data analysis for renovation and expansion of a surface water treatment plant. The plant operator has provided the following summary of daily turbidity readings. Using a spreadsheet you have written, perform a cumulative probability analysis on the data shown below and prepare

a plot on probability paper. Using the plot, write a short summary report for your supervisor that discusses the following:

- A general description of the behavior of the data.
- Your impression of the degree of difficulty in operating the plant and the need for operational flexibility.
- A recommendation regarding further data analysis.

Daily Turbidity for the Alma River, January, 2005

Day	Turbidity, NTU	Day	Turbidity, NTU
1	11.50	17	8.47
2	5.53	18	7.10
3	7.40	19	6.47
4	5.83	20	3.77
5	3.35	21	3.60
6	2.80	22	2.65
7	3.00	23	2.77
8	3.20	24	2.63
9	2.75	25	2.30
10	2.47	26	2.10
11	1.95	27	2.03
12	4.00	28	2.10
13	63.67	29	1.95
14	59.60	30	2.15
15	24.33	31	2.00
16	12.70		

2-9 DISCUSSION QUESTIONS

- 2-1. Your design office has been contracted to design a municipal well field for a small village. The planning meeting has yielded the following information: no federal or state money will be involved in the project, the bond rate is 6%, the population growth rate is negligible. What design period would you recommend to the client? Explain your reasoning.
- 2-2. Explain why a favorable yield analysis alone is not a sufficient reason to select a surface water supply.
- 2-3. An intern has asked why a unit demand of less than 440 Lpcd was selected for a village of 2,000 in the upper peninsula of Michigan. Explain why. Would your answer be different if the village was in the southern half of Arizona? Why?
- 2-4. Can a well fail without “going dry”? Explain.
- 2-5. A probability plot of turbidity for a surface water results in a very steep slope. What does this imply for the difficulty of operating the plant?

2-10 REFERENCES

- AWWA (1998) *1998 Residential Water Use Survey*, American Water Works Association, Denver, Co.
- AWWA (1999) *Design and Construction of Small Water Systems*, 2nd ed.
- Bouwer, H. (1978) *Groundwater Hydrology*, McGraw-Hill, New York, p. 70.
- Boyer, M. C. (1964) "Streamflow Measurement," in V. T. Chow (ed) *Handbook of Applied Hydrology*, McGraw-Hill, New York, pp. 15–41.
- Brown, R. H. (1963) *Drawdowns Resulting from Cyclic Intervals of Discharge*, in *Methods of Determining Permeability, Transmissibility and Drawdowns*, U.S. Geologic Survey Water Supply, paper 1537-I, Washington, D.C.
- Census (2006) at <http://www.census.gov>.
- Cooper, Jr., H. H. and C. E. Jacob (1946) "A Generalized Graphical Method for Evaluating Formation Constants and Summarizing Well Field History," *Transactions, American Geophysical Union*, vol. 27, pp. 520–534.
- Fair, G. M., J. C. Geyer and D. A. Okun (1971) *Elements of Water Supply and Wastewater Disposal*, John Wiley & Sons, New York, pp. 18, 33.
- GLUMRB (2003) *Recommended Standards for Water Works*, Great Lakes–Upper Mississippi River Board of State and Provincial Public Health and Environmental Managers, Health Education Services, Albany, New York.
- Gumbel, E. J. (1954) "Statistical Theory of Droughts," *Proceedings of the American Society of Civil Engineers*, (sep. no. 439), vol. 80, pp.1–19, May.
- Hutson, S. S., N. L. Barber, J. F. Kenny, et al. (2001) *Estimated Use of Water in the United States in 2000*, U.S. Geological Survey Circular 1268, Washington, D.C., <http://www.usgs.gov>.
- Langbein, W. B. (1949) "Annual Floods and Partial Duration Series," *Transactions of the American Geophysical Union*, vol. 30, pp. 879–881.
- Linaweaver, F. P., J. C. Geyer and J. B. Wolff (1967) "Summary Report on the Residential Water Use Research Project," *Journal of the American Water Works Association*, vol. 59, p. 267.
- Linsley, R. K., M. A. Kohler, and J. L. H. Paulhus (1975) *Hydrology for Engineers*, McGraw-Hill, New York, p. 200.
- Logsdon, G., A. Hess and M. Horsley (1999) "Guide to Selection of Water Treatment Processes," in R. D. Letterman (ed.), *Water Quality and Treatment*, 5th ed., American Water Works Association, McGraw-Hill, New York, pp. 3.1–3.26.
- McJunkin, F. E. (1964) "Population Forecasting by Sanitary Engineers," *Journal of the Sanitary Engineering Division*, America Society of Civil Engineers, vol. 90, no. SA4.
- Metcalf and Eddy (2003) *Wastewater Engineering: Treatment and Revise*, 4th edition, McGrawHill, Boston, MA, pp. 157–160.
- Pinholster, G. (1995) "Drinking Recycled Wastewater," *Environmental Science & Technology*, vol. 29, pp. 174A–179A.
- Rippl, W. (1883) "The Capacity of Storage Reservoirs for Water Supply," *Proceedings of the Institution of Civil Engineers* (London), vol. 71, p. 270.
- Thiem, G. (1906) *Hydrologische Methoden*, J. M. Gebbart, Leipzig, Germany.
- Todd, D. K. (1959) *Ground-water Hydrology*, John Wiley and Sons, New York, p. 200.
- Walton, W. C. (1970) *Groundwater Resource Evaluation*, McGraw-Hill, New York, p. 34.
- Weibull, W. (1939) "Statistical Theory of the Strength of Materials," *Ing. Vetenskapsakad. Handl.*, Stockholm, vol. 151, p. 15.

CHAPTER

3

INTAKE STRUCTURES

3-1 INTRODUCTION

3-2 DESIGN ELEMENTS

3-3 DESIGN CRITERIA

3-4 OPERATIONAL CONSIDERATIONS

3-5 OPERATION AND MAINTENANCE

3-6 CHAPTER REVIEW

3-7 PROBLEMS

3-8 DISCUSSION QUESTIONS

3-9 REFERENCES

3-1 INTRODUCTION

Intakes are structures constructed in or adjacent to lakes, reservoirs, or rivers for the purpose of withdrawing water. In general, they consist of an opening with a grate or strainer through which the water enters, and a conduit to conduct the water by gravity to a *low-lift pumping station*.* The water is pumped from the low-lift pumping station to the water treatment facility. Schematic diagrams of lake and river intake systems are shown in Figures 3-1 and 3-2.

The key requirements of the intake structures are that they are:

- Reliable.
- Of adequate size to provide the required quantity of water.
- Located to obtain the best quality water.
- Protected from objects that may damage equipment.
- Easy to inspect and maintain.
- Designed to minimize damage to aquatic life.
- Located to minimize navigational hazards.

3-2 DESIGN ELEMENTS

Reliability

Reliability is an essential feature of intake structures. The water supply system ceases to function when the intake system fails. Small systems with only one intake structure are particularly vulnerable. For larger systems, current design practice provides for duplicate intake structures that include multiple inlet ports, screens, conduits, and pumping units.

Capacity

Because they are very difficult to expand to provide additional capacity, a design life of the intake structures in the range of 20 to 40 years (minimum) should be considered (Foellmi, 2005). Although reliable intake systems are very expensive, perhaps as much as two to four times the cost of a similar project built on dry land, the additional cost of increasing capacity may be relatively small. In one case, increasing the capacity by more than 70 percent resulted in a construction cost increase of less than 20 percent (ASCE, 1990).

Location

The major factors to be considered in locating the intake are listed in Table 3-1 on page 3-4.

*The pumping station is called “low-lift” or “low-service” because the function of the pumps is to raise the water from the surface water supply to the treatment facility. “High-service” pumps that supply water to the distribution system are selected with the objective of providing a high enough pressure to make water flow at a high rate through service connections at various elevations throughout the distribution system.

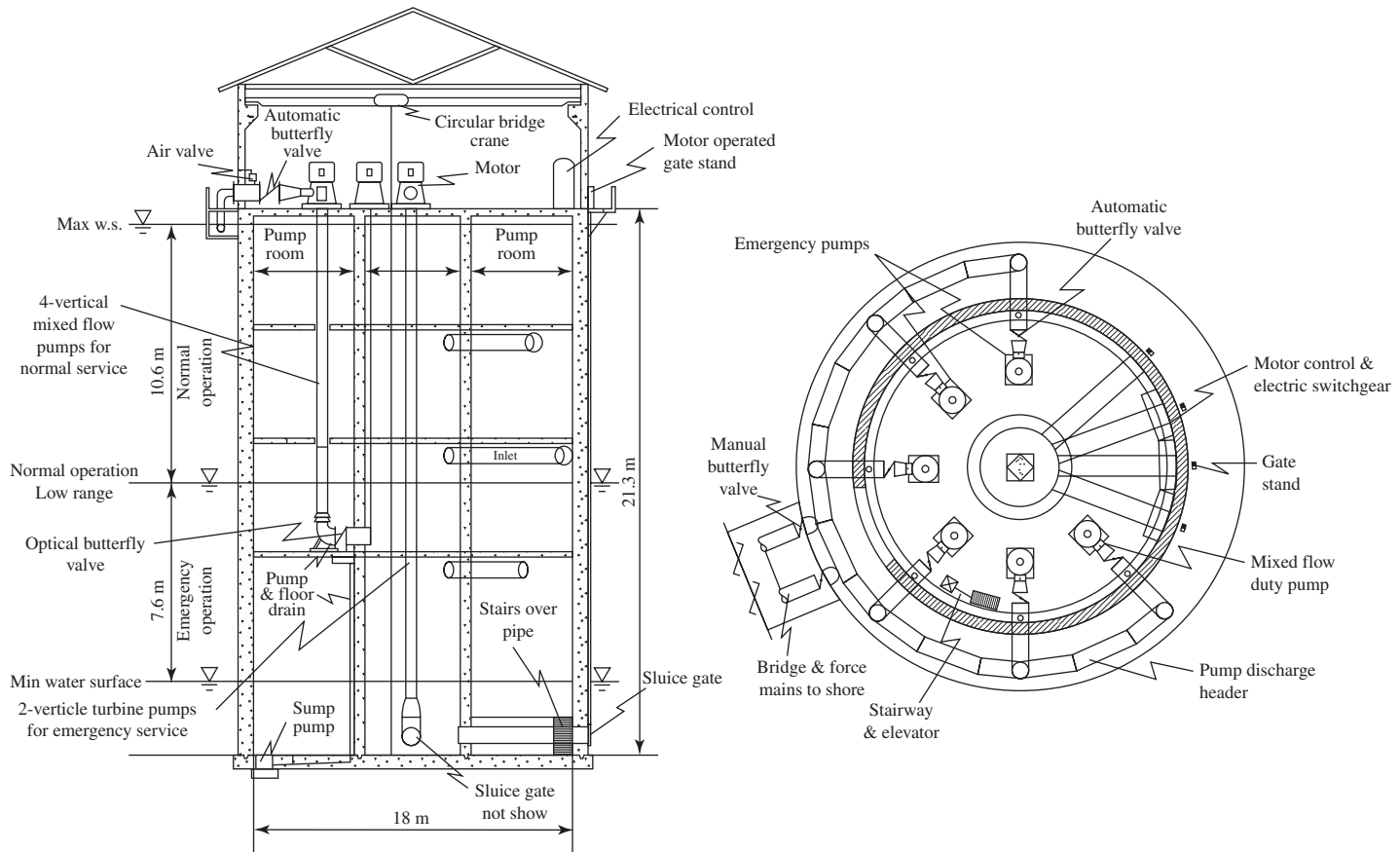

FIGURE 3-1
Tower intake in a lake. w.s. = Water surface

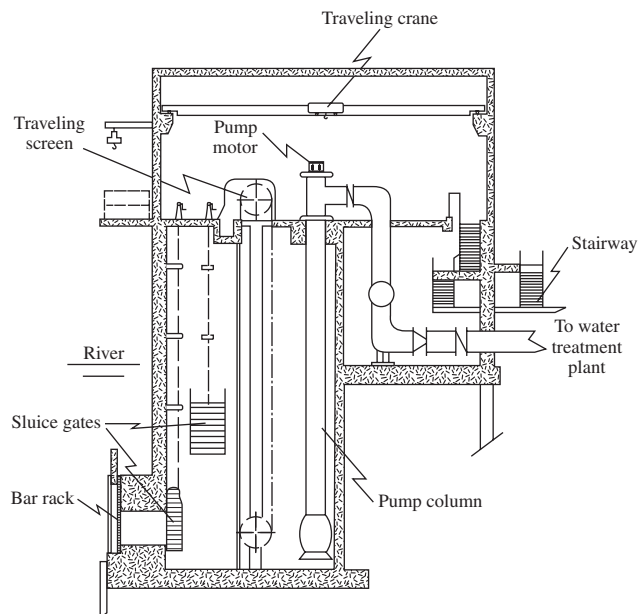

FIGURE 3-2
River intake.

TABLE 3-1
Considerations in locating water intakes

Criteria	Remarks
Water quality	See Section 2-3 and Table 2-14 Lake and stream currents Wind and wave impacts Variation with water depth due to stratification Infiltration galleries “under the influence” of surface water must comply with surface water regulations
Water depth	Maximum available Adequate submergence over inlet ports Avoid ice problems
Silt, sand	Locate to minimize impact
Treatment facility	Minimize conduit length to treatment plant
Cost	Minimize consistent with long-term performance and operation & maintenance requirements

Adapted from Foellmi, 2005.

Type of Intake

In a broad sense, intake structures may be classified into two categories as noted in Table 3-2. Many varieties of these types have been used. The selection of the type of intake is highly dependent on local circumstances. Because the circumstances are fundamentally different, the systems are often classified as either river intakes or lake/reservoir intakes.

TABLE 3-2
Types of intake structure

Category	Design type	Remarks
Exposed	Tower integral with dam	Applicable to large systems, expensive
	Tower in lake	Navigational impact
	Shore inlet	Design for floating debris and/or ice
	Floating or movable	Good access for O&M ^a
	Siphon well	Applicable to small systems, flexible, easy to expand
Submerged	Plain-end pipe or elbow	Applicable to small systems
	Screened inlet crib	No navigational impact No impact from floating debris or ice ^b Not flexible Difficult O&M ^a
	Gravel-packed well(s)	No navigational impact No impact from floating debris or ice ^b Must have favorable geology
	Horizontal collection systems (also called infiltration gallery or infiltration bed)	No navigational impact No impact from floating debris or ice ^b Must have favorable geology

^a O&M = operation and maintenance.

^b With sufficient depth, ice impacts are minimized.

Adapted from Foellmi, 2005.

Lakes and Reservoirs. Because of their navigational impacts as well as severe winter weather and consequent difficulties in their *operation and maintenance* (O&M), exposed structures are not often used in the Great Lakes and other large cold-climate lakes. On the other hand, exposed intake structures have been widely used in more warm-climate lakes and in reservoirs. A classic tower design (Figure 3-3) includes multiple intake ports at different elevations, screens for each port, and access for maintenance. The tower may be divided into two sections or cells to provide redundancy. It is accessed by a bridge, causeway, or boat.

Submerged intake structures avoid many of the problems of the exposed systems but are significantly more difficult to maintain because of lack of access. On the other hand, the lack of exposed mechanical parts lowers the amount of maintenance time required. A typical submerged inlet structure is shown in Figure 3-4. With a favorable geologic strata of sand and gravel on the shore or the bottom of the lake or reservoir, either an infiltration gallery as shown in Figure 3-5 or a horizontal collection system (called a “Ranney well” after its inventor) under the lake bottom (Figure 3-6) may be appropriate.

Rivers. Both exposed and submerged inlet structures have been used in rivers. In large rivers that are controlled by locks and dams, the variation in flow and consequent variation in water surface elevation are of less concern than in unregulated waterways. For most water supplies,

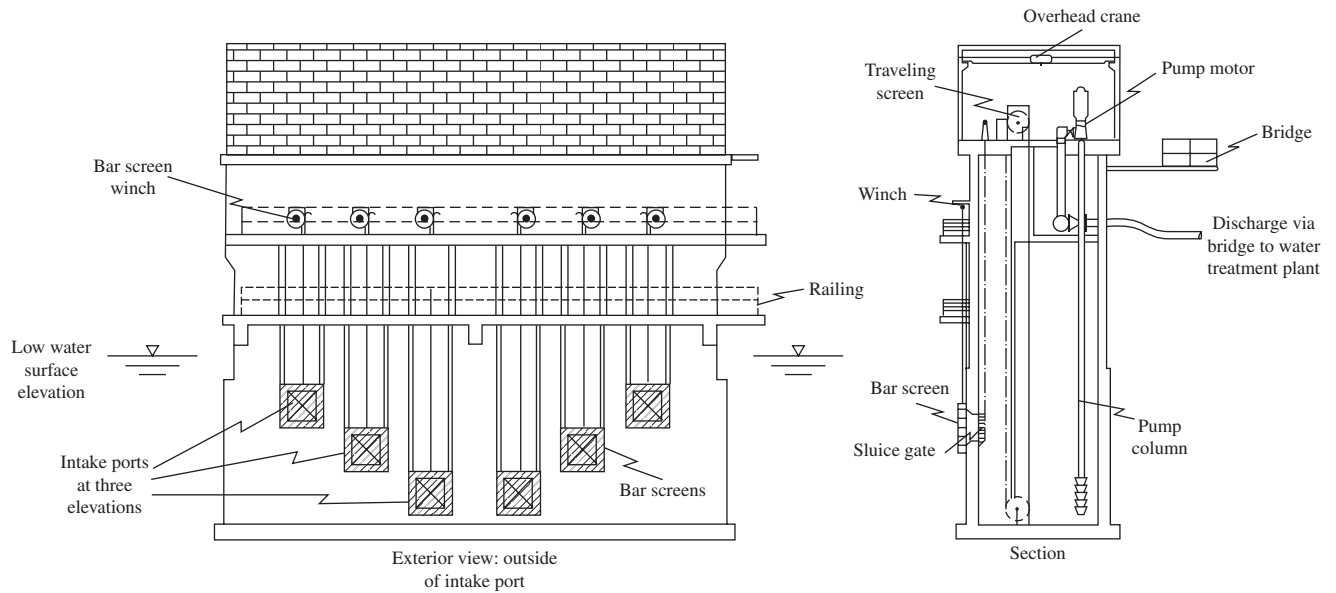

FIGURE 3-3
Classic tower design with multiple ports.

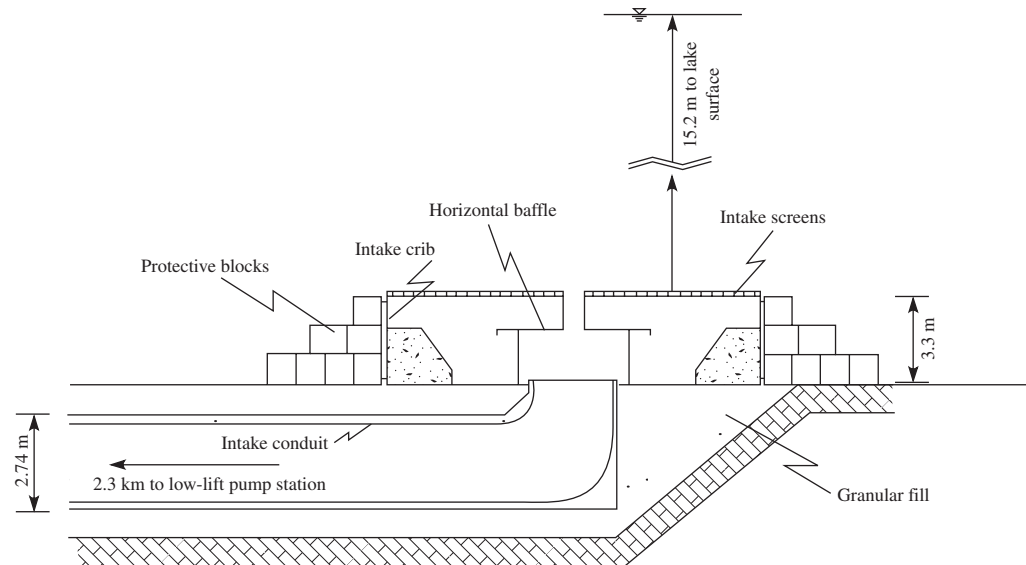

FIGURE 3-4
Lake intake crib. Crib is steel octagonal.

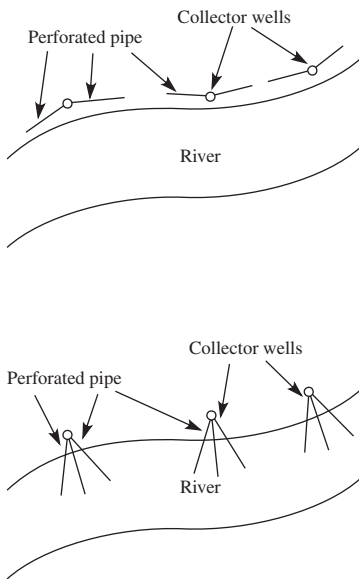

FIGURE 3-5
Two arrangements of infiltration galleries with wells.

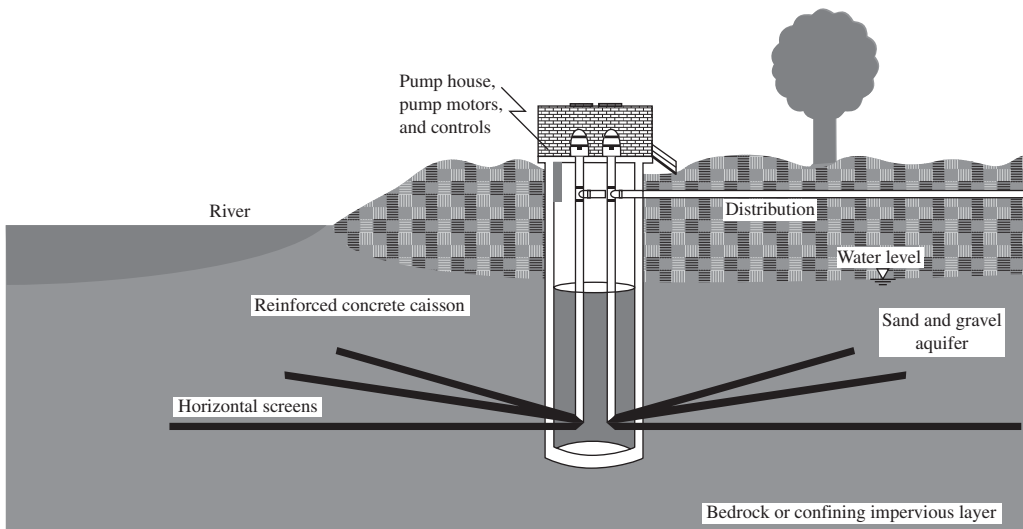

FIGURE 3-6
Collector well with horizontal groundwater collection screens.

shore-based systems provide the best combination of access for operation and maintenance and reliable supply (Bosserman et al., 2006).

Unlike lakes and reservoirs, special consideration must be given to the impact of floods and droughts on river intakes. In the first instance, structural integrity, availability of power, and access must be considered in the design. In the second instance, provision must be made for

alternative access to water when drought conditions lower the water level below the lowest intake port.

While a reservoir or lake will have suspended matter during high wind events, it will seldom have the quantity or quality of the grit produced during flood events on rivers. The river intake structure must be designed to protect the pumps and valves in the transmission system from undue wear from grit.

Conduits

The intake conduit connects the inlet works with the low-lift pump station. Either a tunnel or a pipeline may be used. Although tunnels have a high degree of reliability, they are expensive to construct. For large water systems, they may be the more economical choice when both capital and long-term maintenance costs are considered.

3-3 DESIGN CRITERIA

Design Capacity

The design process to select a design flow rate (Q) is based on a forecast demand. With Q , the hydraulics of the intake structure design are based on the worst case estimate of friction loss, an estimate of potential sand intrusion into the conduit, the all-time historic low water level, and a life expectancy of 60+ years. Some hydraulic design capacities are listed in Table 3-3. Because the life expectancy is very long, prudent engineers use the ultimate flow to design the hydraulic structures (intake tower or crib, conduit, gates, etc.). The design flow is used to select pumps and motors. Space is provided for additional pumps that will be required to meet the ultimate flow.

Layout

Division of the intake system into two or more independent cellular or parallel components is recommended for all but the smallest systems. This enhances reliability, provides flexibility in operation, and simplifies maintenance. The *operating deck* (also called the *operating floor* and *pump station floor*) that houses the motors, control systems, and so on should be located 1.5 m or more, depending on the maximum wave height, above the high water level of a lake or reservoir or the 500-year flood level of a river supply. The area of the operating deck should be sufficient to allow for the installation and servicing of the pumps, intake gates, and screens. Overhead cranes are an essential feature (Foellmi, 2005; Kawamura, 2000).

TABLE 3-3
Hydraulic criteria

Flow criteria	Capacity	Remarks
Design flow	Q	Capacity at design life under worst case conditions
Minimum flow	0.10 Q to 0.20 Q	System specific
Ultimate flow	2.0 Q or higher	At life expectancy

Adapted from Foellmi, 2005.

TABLE 3-4
Intake port design criteria

Criterion	Typical recommendation
Number	Multiple; three minimum
Vertical spacing	3 to 5 m maximum
Depth of lowest port	0.6 to 2 m above bottom depending on “muck” quality
Depth of top port	Variable; 5 to 9 m below surface to avoid wave action
Ice avoidance	At least one port 6 to 9 m below the surface
Port velocity	Gross area of ports at same elevation sized to limit velocity to less than 0.3 m/s. To avoid ice buildup, limit velocity to less than 0.1 m/s.

Sources: Foellmi, 2005, and Kawamura, 2000.

Intake Tower

Location. Intake towers should be located as close to the shore as possible, consistent with the variation in water depth. With the exception of very small intakes, the minimum depth should be 3 m (Kawamura, 2000).

Intake Ports. Gated ports are provided at various depths to allow for changes in water elevation and changes in water quality due to wind/wave action, stratification, and lake turnover. Typical design criteria are listed in Table 3-4.

The port area may be estimated using the relationship

$$Q = vA \quad (3-1)$$

where Q = flow rate, m^3/s

v = velocity of flow, m/s

A = cross-sectional area of flow, m^2

Example 3-1. A two-cell intake tower located in a cold climate reservoir is being designed for a winter design flow rate of $6,000 \text{ m}^3/\text{d}$. The tower will have three ports at three different elevations in each cell. Each port must be able to deliver the design flow rate operating alone. Determine the area of each port opening.

Solution. For a cold climate reservoir, the intake velocity should be limited to less than $0.10 \text{ m}/\text{s}$ (Table 3-4). Using an intake velocity of $0.08 \text{ m}/\text{s}$ and Equation 3-1,

$$A = \frac{Q}{v} = \frac{6,000 \text{ m}^3/\text{d}}{(0.08 \text{ m}/\text{s})(86,400 \text{ s}/\text{d})} = 0.868 \text{ or about } 0.9 \text{ m}^2$$

This area is a preliminary estimate that will have to be enlarged because it does not take into account the area of the screen that has to be installed to prevent debris from entering the tower.

Comment. Note that the design flow rate specified was for winter conditions. Summer flow rates generally are higher than winter flow rates, and the velocities will be higher.

TABLE 3-5
Typical rack and screen characteristics

Type	Remarks
Coarse screens	
Bar racks	Clear opening 2 to 8 cm between bars Steel bars 1 to 2 cm in diameter
Trash racks	Inclined or vertical; if inclined, angle is 20 to 30° from vertical Clear opening 8 to 10 cm between bars Steel bars 2 to 4 cm in diameter
Fine screens	
	Inclined or vertical; if inclined, angle is 20 to 30° from vertical Clear opening 0.5 to 1 cm between elements Mechanically cleaned on either a continuous or intermittent schedule Inclined or vertical; equipment supplier specifies angle Provide head space or other means to raise the screen entirely out of the water for inspection and maintenance

Adapted from Foellmi, 2005, and Kawamura, 2000.

Gates. *Sluice gates* may be used on either the interior or exterior of the tower. Historically, gate valves have been preferred because the other valves become fouled with debris.

Coarse Screens. Also known as *bar racks*, these screens are provided to prevent leaves, sticks, and other large pieces of debris from entering the tower. They are located as shown in Figure 3-3. Rack and screen characteristics are summarized in Table 3-5. Bar rack screenings are taken to a licensed landfill.

To maintain the desired inlet design velocity, the design of the port must take the area occupied by the bars into account.

Example 3-2. Revise the area estimate made in Example 3-1 to take into account the area occupied by a bar rack with a clear opening of 4 cm and a bar 1 cm in width. Assume that the opening is a square.

Solution. The arrangement of a bar and opening is shown in the sketch below.

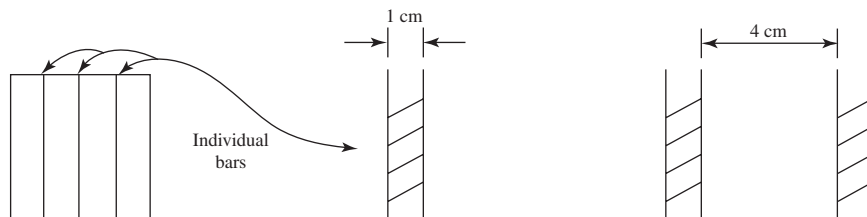

The unit space occupied by a bar and the adjacent opening is $4 \text{ cm} + 1 \text{ cm} = 5 \text{ cm}$. The fraction of the area occupied by the bar is $1 \text{ cm}/5 \text{ cm} = 0.20$ or 20 percent. To account for the bars, the area of the port opening must be increased by 20 percent or

$$A = (1.20)(0.9 \text{ m}^2) = 1.08 \text{ or } 1.1 \text{ m}^2$$

Fine Screens. A fine screen is placed downstream of the coarse screen. Its purpose is to collect smaller material that has passed through the coarse screen but is still large enough to damage downstream equipment. Generally, it is placed in the low-lift pump station ahead of the pump intake. Fine screen characteristics are given in Table 3-5.

Intake Crib

Location. The desired location of the intake crib is in deep water where it will not be buried by sediment, be washed away, be a navigational hazard, or be hampered by problems associated with ice. The minimum suggested depth is 3 m from the surface. In rivers, where the depth exceeds 3 m, the top of the intake should be 1 m above the river bottom. In cases where the water depth is less than 3 m, the crib is buried 0.3 to 1 m (Kawamura, 2000).

Structure. The Milwaukee, Wisconsin, intake crib shown in Figure 3-4 is a classic design. It is octagonal in shape. A similar circular design was used for the Cincinnati, Ohio, intake (Figure 3-7). Other structures include hydraulically balanced inlet cones and inlet drums. The intake is protected by riprap or a concrete slab.

Intake Ports. In warm climates, the intake crib ports are sized to provide a maximum velocity of less than 0.3 m/s (Kawamura, 2000). In cold climates, where frazil ice is anticipated, the intake velocity is limited to less than 0.1 m/s.

Screens. Submerged intakes are screened with coarse screens. The T-screen (Figure 3-8) has found application in both river and reservoir applications. It is especially employed to prevent small fish from entering the intake structure. It is cleaned by a burst of air at a pressure of 1,000 kPa.

Conduit

The conduit may be either a tunnel or a pipeline. Generally, it is designed to flow by gravity.

Size. The conduit is sized to carry the maximum design flow rate (Table 3-3). To minimize the accumulation of sediment the flow velocity should be greater than 1 m/s (Kawamura, 2000). The

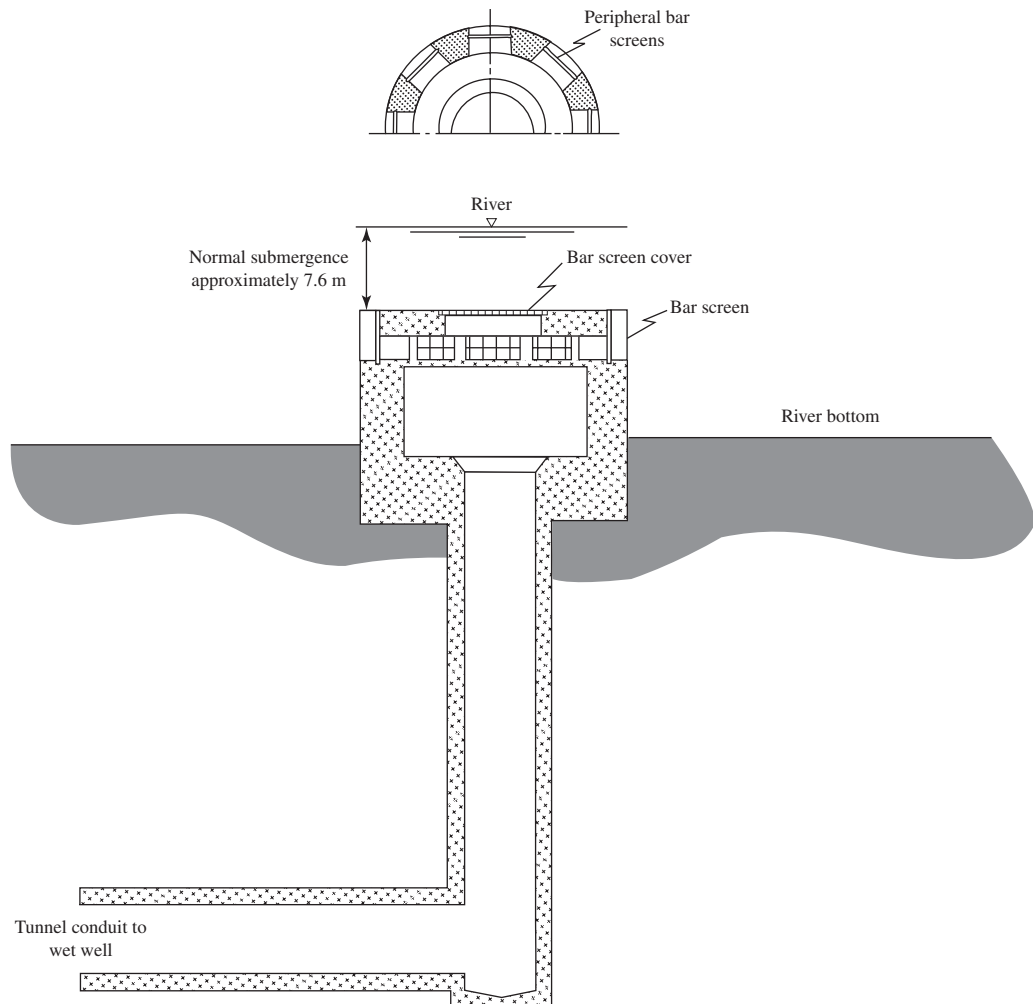

FIGURE 3-7
River intake.

Hazen-Williams equation is the one most commonly used to describe the flow of water in pipes. In terms of flow rate, it is given as

$$Q = 0.278 CD^{2.63}S^{0.54} \quad (3-2)$$

- where Q = flow rate, m^3/s
- C = Hazen-Williams coefficient of roughness
- D = diameter of pipe, m
- S = slope of energy grade line, m/m

Williams and Hazen (1905) investigated a number of different types of pipe to determine C . A table of updated values is given in Appendix C.

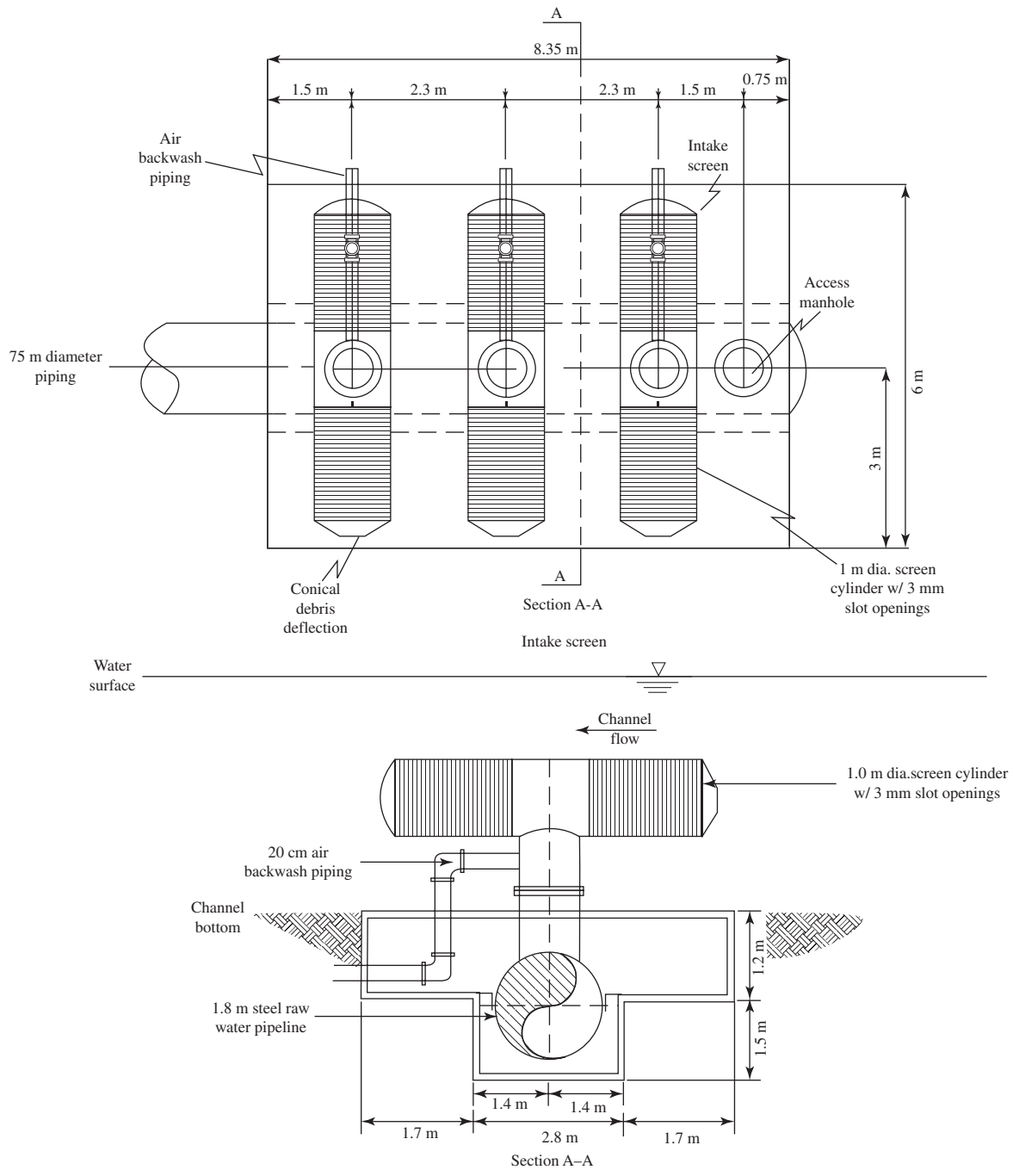
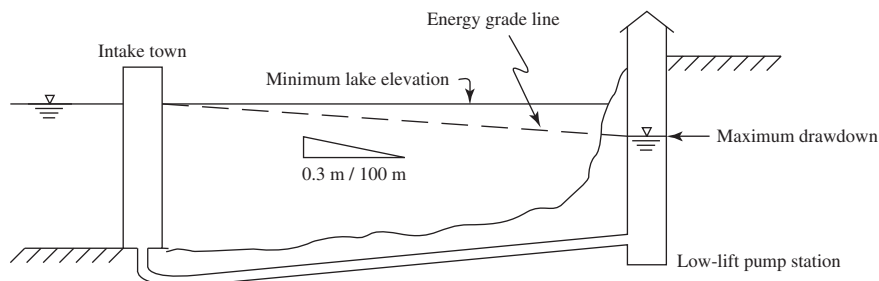

FIGURE 3-8
Submerged intake T-screens with typical dimensions.

Example 3-3. Determine the diameter of a concrete conduit to transport the water from the intake tower described Example 3-1 to a low-lift pump station on shore. From Table 3-3, the maximum flow rate is assumed to be $2.0(Q)$, that is, twice the winter design flow rate. A sketch of the minimum lake elevation and the maximum allowable drawdown in the low-lift pump station is shown below.



Solution. From Example 3-1, the winter design flow rate is $6,000 \text{ m}^3/\text{d}$. The maximum flow rate is

$$2.0(Q) = 2(6,000 \text{ m}^3/\text{d}) = 12,000 \text{ m}^3/\text{d}.$$

Solving Equation 3-2 for D :

$$D = \left[\frac{Q}{(0.278)(C)(S)^{0.54}} \right]^{0.380}$$

Convert Q to appropriate units:

$$Q = \frac{12,000 \text{ m}^3/\text{d}}{86,400 \text{ s/d}} = 0.139 \text{ m}^3/\text{s}$$

Because of the very long life expectancy for the conduit, from Appendix C, select a very conservative $C = 80$ for concrete pipe. The slope in appropriate units is $0.3 \text{ m}/100 \text{ m} = 0.003 \text{ m/m}$.

$$D = \left[\frac{0.139 \text{ m}^3/\text{s}}{(0.278)(80)(0.003)^{0.54}} \right]^{0.380}$$

$$D = \left[\frac{0.139 \text{ m}^3/\text{s}}{0.966} \right]^{0.380}$$

$$= 0.479 \text{ or } 0.5 \text{ m or } 500 \text{ mm}$$

Protection. When a pipeline is used, the pipe is laid in a trench at the bottom of the lake, reservoir, or river. The soil cover for the pipe is about 1 m over the top of the pipe with an additional protective layer of crushed rock (Foellmi, 2005). Richardson (1969) suggests a rule of thumb is to use 2.5 m^3 of rock per linear meter of pipe ($2.5 \text{ m}^3/\text{m}$).

Slope. To avoid air blockage, the conduit must be laid on a continuously rising or falling grade.

Shore Intake

Location. The minimum water depth for a shore intake should be about 2 m. For river intakes, a stable channel is preferred. In general, the outside bank of an established river bend is preferred over the inside bank because of low river velocities, shallow water, and the formation of sand bars (Foellmi, 2005).

Intake Bay. The structure should be divided into two or more independent inlets to provide redundancy. The inlet velocity may be as high as 0.5 m/s in warm climates but should be reduced to 0.3 m/s or less if large amounts of debris are expected (Kawamura, 2000). In cold climates, inlet velocities below 0.10 m/s are used to minimize ice buildup (Foellmi, 2005).

Screens. Trash racks as described in Table 3-5 are used to remove large objects. An example is shown in Figure 3-9. These are followed by fine screens to protect the pumps. Screenings from the fine screen are collected in a roll-off box and disposed of in a municipal solid waste landfill.

The maximum head loss from clogging of the trash racks should be limited to between 0.75 and 1.5 m. The screen bars should be designed to withstand the differential hydraulic load.

As shown in Figure 3-9, a mechanical cleaning device is used to remove the debris from the trash rack.

Wet Well

The *wet well** should be divided into cells so that a portion can be taken out of service for inspection and maintenance of the equipment.

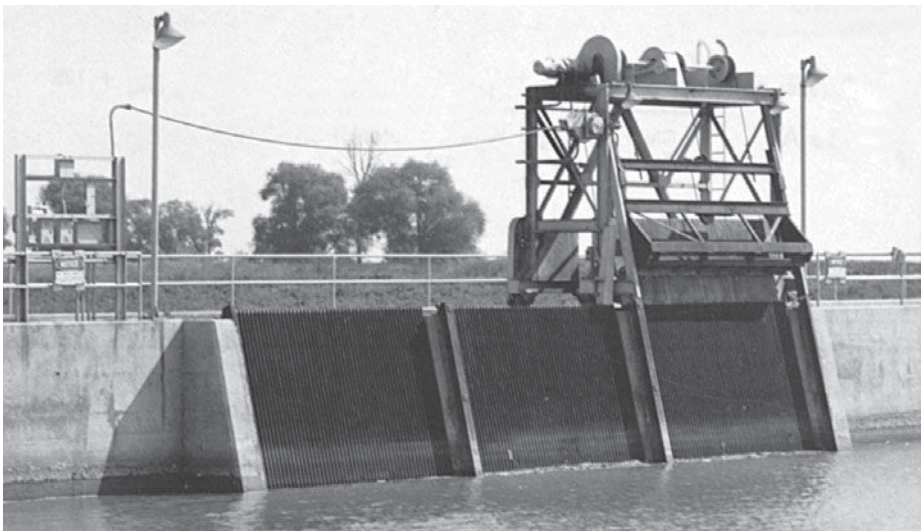

FIGURE 3-9

Coarse bar screen, mechanically cleaned.

(Source: Foellmi, 2005.)

*The wet well is that portion of the low-lift pump station that serves as a reservoir of water in which the pump and screens are placed.

Location. With the exception of the tower intake, the wet well is located at the shore or river bank. The decision whether or not to locate the wet well in a tower intake is dependent on the distance between the tower and the shore. When the tower is close to shore, it may be more economical to place the wet well in the tower rather than build two structures close together—one for the intake and another for the wet well.

Dimensions. The area of the wet well must be large enough to accommodate the fine screen and pumps. Sufficient space must be provided to service or remove the mechanical equipment. The overhead space above the operating deck must be sufficient to raise the equipment from the wet well to the deck.

The depth of the wet well is governed by hydraulic considerations. The high water level is set at the highest elevation of the lake or reservoir or at the 500-year flood level for rivers. The bottom of the wet well must be low enough to allow drawdown of the wet well while pumping at the design flow rate when the source water elevation is at its minimum level. In addition, there must be enough depth to maintain the pump manufacturer's required submergence to prevent cavitation of the pump.

Vertical turbine pumps may be mounted in a *can* or *barrel* that extends from the pump inlet to near the bottom of the wet well. The entrance to the barrel is bell-shaped. Dimensions of wet well appurtenances are given in terms of the bell diameter, D . To avoid interference between adjacent intakes, they are spaced $2.5D$ center-to-center with the additional provision of a minimum distance between adjacent pumps of 1.2 m for access clearance. The bell is set at $0.5D$ above the wet well floor (Figure 3-10). The water velocity into the pump intake bell should be limited to 1.1–1.2 m/s at *runout*, that is, the pump flow rate at the least possible dynamic head. In clean water wet wells, cones are sometimes placed below the pump intake to prevent vortices. The top of the cone is located 12 mm below the bell (Jones and Sanks, 2006).

Rectangular pump intake basins with multiple pumps are provided with dividing walls between the pumps. The walls improve the flow patterns in the intake throat. The dividing walls should be at a distance of at least $5.75D$ apart from each other to be effective (Jones and Sanks, 2006).

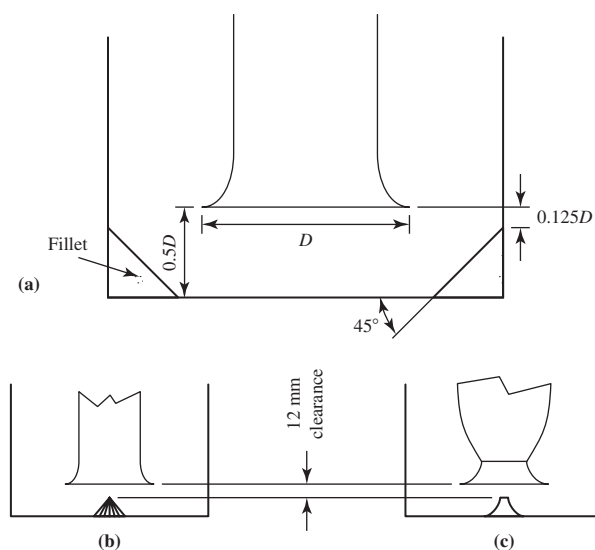

FIGURE 3-10 Pump intake bell (a) and floor cones: right cone; (b), (c) flat cone.

Pump Criteria

Pump Type. The most common pump used in the low-lift pump station is a *vertical turbine pump* as shown in Figure 3-11 (Honeycutt and Clopton, 1976). The water enters the pump through the strainer or screen. It is lifted by one or more *impellers* located inside the *pump bowl* (Figure 3-12).

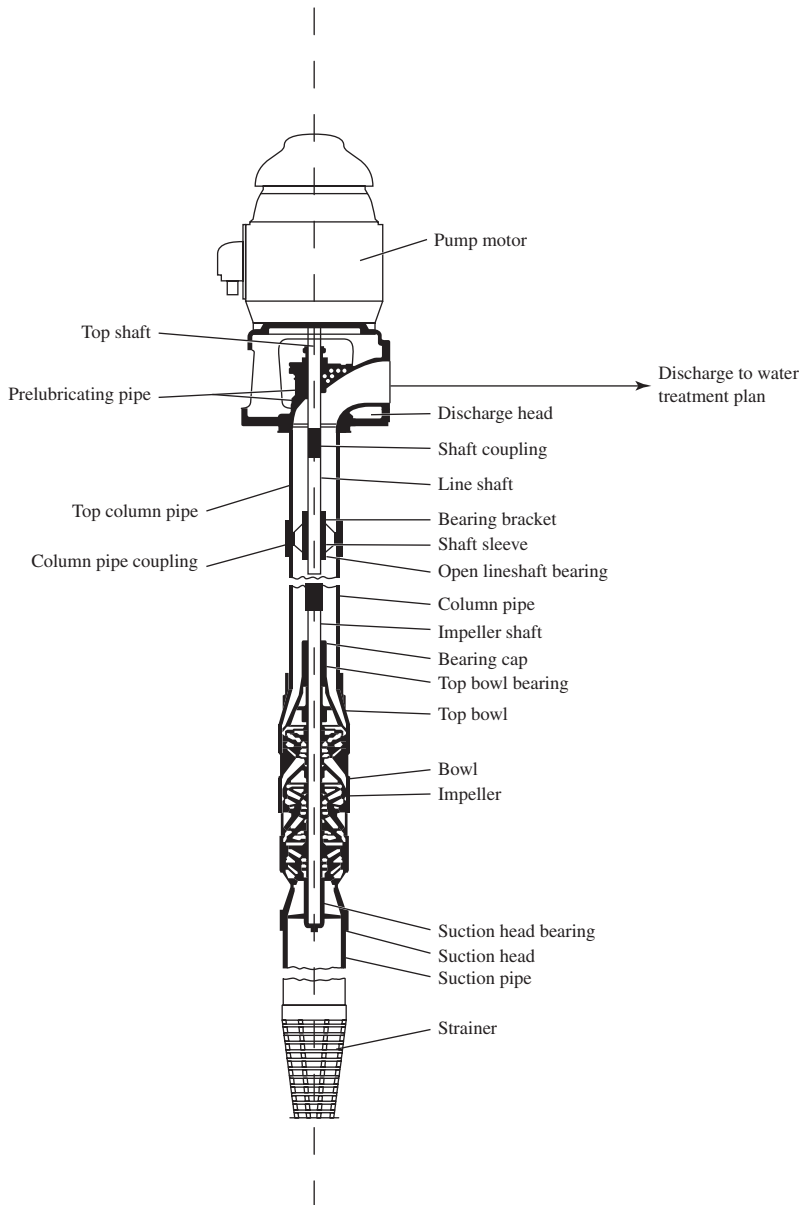

FIGURE 3-11
Section of vertical turbine pump with closed impellers and open-line shafting (water lubrication).

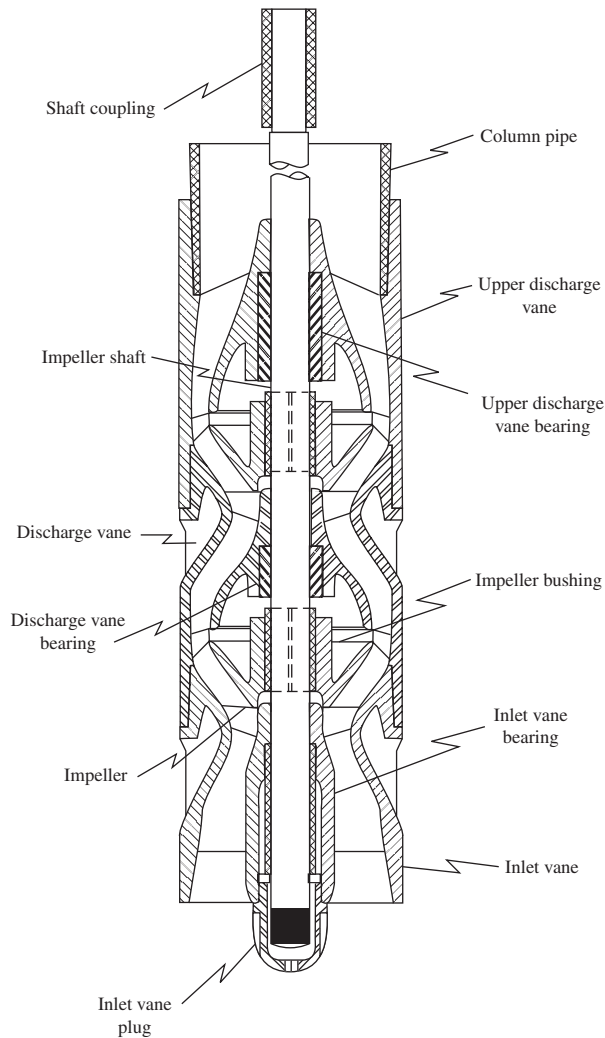

FIGURE 3-12

Section of bowls of a vertical turbine pump with open impellers for a connection to open-line shafting.

The water is discharged from the top impeller up through the *column pipe* to the discharge pipe. Each impeller is designed to lift the water to a given height. This is the *discharge head* or *pressure* delivered by the impeller. The flow rate of the pump is a function of its diameter and rotational speed. For a given impeller design, higher discharge pressures are achieved by adding impellers or *stages* to the stack. There are, for example, three impellers shown in Figure 3-11.

Pump Drive. Low-lift pumps are commonly driven by electric motors. These are mounted on the operating deck. The range of demands (daily, weekly, seasonal) can be met with either multiple pumps with *constant speed drives* or, in some cases, with fewer pumps with *variable speed drives*. One type of variable speed equipment that is frequently used is the *adjustable frequency drive** (AFD).

*Practitioners and operators refer to this as a *variable frequency drive* or, more commonly, a VFD.

The AFD allows changes in the flow rate by changing the frequency of the alternating current (AC) electrical supply. The selection of the number of pumps and drive arrangement is based on an economic evaluation of the alternatives that includes the capital investment for the pump(s) and the drive(s) and the required operating floor area as well as the cost of power and maintenance. The AFD has a higher capital cost than constant speed drives but is often more efficient to operate because of lower power costs that result from being able to match pumping rate to the demand for water.

The power input of the drive is estimated from the following equation:

$$P = \frac{\gamma Q H_t}{E_p} \quad (3-3)$$

where P = brake power, kW

γ = specific weight of fluid, kN/m³
= 9.807 kN/m³ for water at 5°C

Q = flow rate, m³/s

H_t = total dynamic head, m

E_p = efficiency of pump

Pump Capacity. The flow rate of the pump is called the *capacity* or *discharge* (Q). The capacity is usually expressed in cubic meters per second (m³/s) for large pumps and cubic meters per hour (m³/h) for small pumps.

Although the wet well structure is designed for anticipated demands at a design life of 50 to 75 years, common practice is to provide initial pumping capacity for a 20-year life. As the demand increases over time, additional capacity may be added as required by the addition or replacement of pumping units (Honeycutt and Clopton, 1976).

Head. The term *head* is the elevation of a free surface of water above or below a reference datum. The reference datum for a vertical flow centrifugal pump is the inlet to the impeller. Two cases are illustrated in Figures 3-13 and 3-14. The definition of terms used in the figures is given in Table 3-6 on page 3-22.

The total energy required to deliver the water from the wet well to the discharge point at the water treatment plant is commonly calculated in terms of equivalent elevation of a water column. This is termed the *total head* or *total dynamic head* (H_t or TDH). It is expressed in meters (m). It is calculated as

$$\text{TDH} = H_{stat} + h_{ent} + h_{fs} + h_{fd} + \Sigma h_{fvs} + \Sigma h_{fvd} + \frac{v_d^2}{2g} \quad (3-4)$$

where, with the exception of h_{ent} (which is the entrance loss), the terms are described in Table 3-6.

The friction losses may be calculated from a revised form of the Hazen-Williams equation:

$$h_{fs} \text{ or } h_{fd} = 10.7 \left(\frac{Q}{C} \right)^{1.85} \left(\frac{L}{D^{4.87}} \right) \quad (3-5)$$

where h_{fs} or h_{fd} = head loss in m, L = equivalent length of pipe in m, and the other terms are as defined previously.

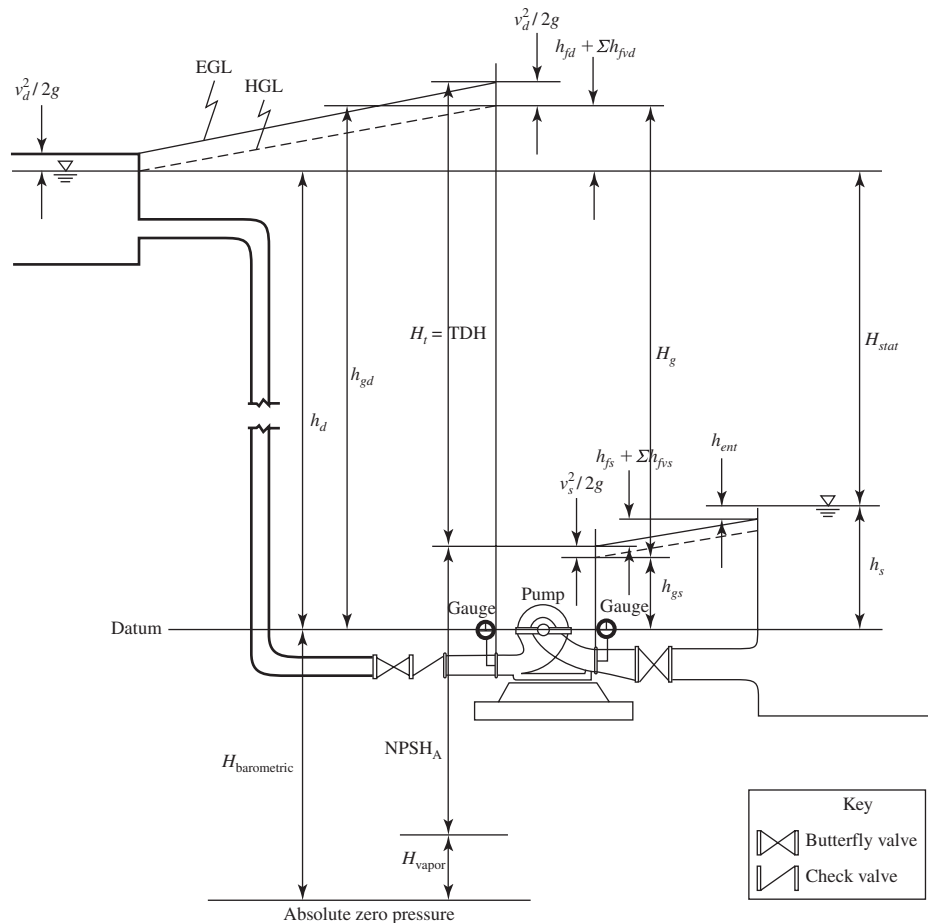

FIGURE 3-13
Terminology for a pump with a positive suction head.

Sanks (2006) offers several warnings in the use of this equation for estimating friction losses. Errors of up to 40 percent may be encountered for pipes less than 200 mm in diameter and more than 1,500 mm in diameter, for very cold or hot water, and for unusually high or low velocities. Growths of slime layers and corrosion add to the inherent potential for errors in using the Hazen-Williams equation or, for that matter, any equation for estimating friction losses. The prudent engineer will use a range of coefficients to define a probable region of losses that may be encountered.

The fitting and valve losses are estimated using Equation 3-6:

$$h_{fvs} \text{ or } h_{fvd} = K \frac{v^2}{2g} \quad (3-6)$$

where K = energy loss coefficient. Energy loss coefficients are given in Appendix C.

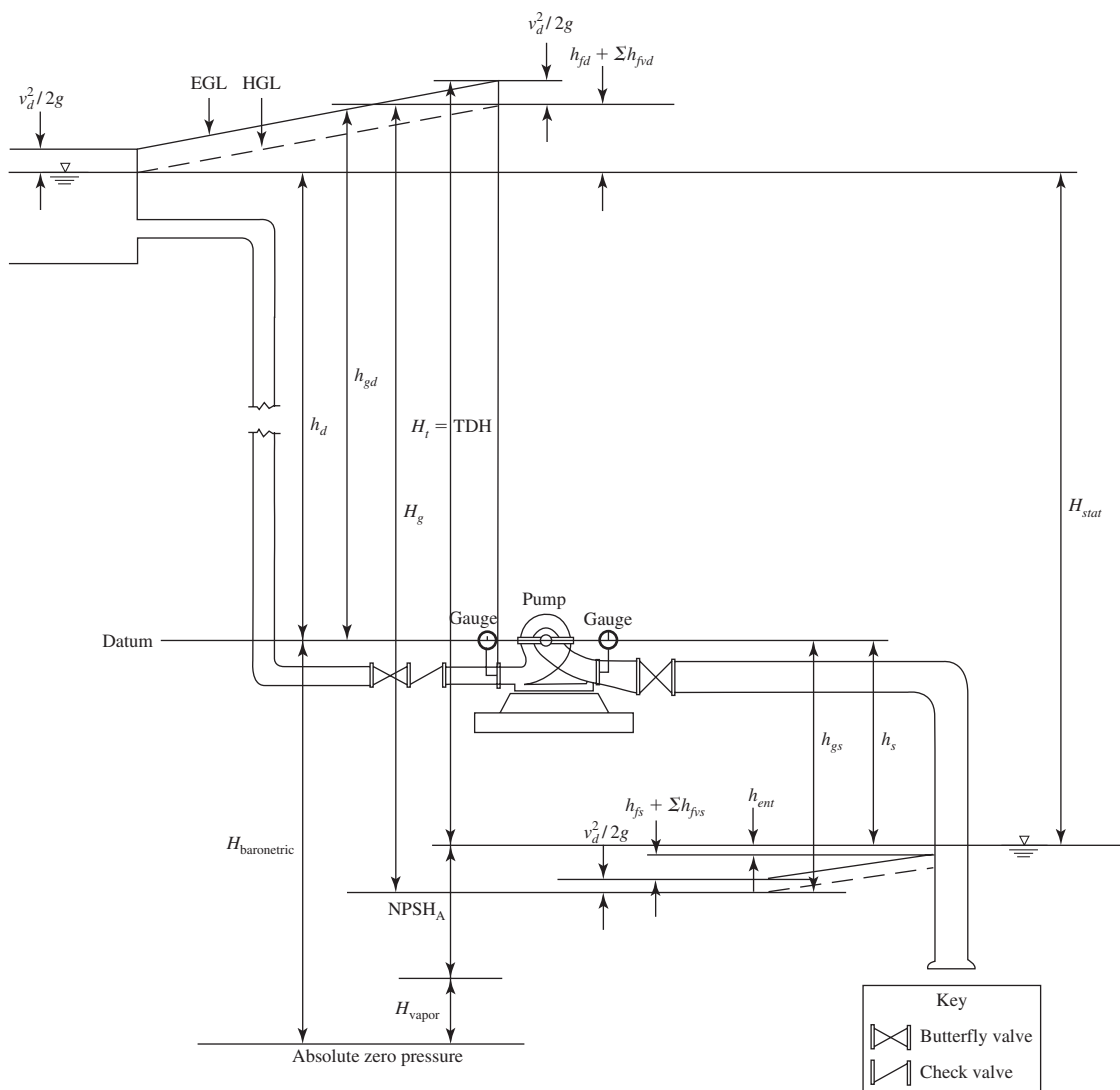

FIGURE 3-14
Terminology for a pump with a negative suction head.

Net Positive Suction Head. Liquids at temperatures above their freezing point have a corresponding vapor pressure. If the pressure in a pump suction pipe is reduced below the vapor pressure, the liquid will flash, that is, it will form a vapor. Because no water pump of ordinary design can pump only vapor, flow to the pump decreases and the pump is said to be “vapor-bound.” A more serious consequence occurs when the vapor and water mixture move toward the pump discharge. Here the pressure is increased, and the vapor bubbles collapse from bubble size to particle size. This implosion is violent and destructive. The implosion blasts small particles of metal from the impeller. This process is called *cavitation*. Ultimately it destroys the impeller. The most common method to avoid cavitation is to provide enough head on the pump suction so that the pressure in the suction pipe is always greater than the vapor pressure of the liquid. This is called the *required*

TABLE 3-6
Definition of terms for Figures 3-13 and 3-14

Term	Definition
Absolute pressure (h_a)	Barometric pressure in vessels open to the atmosphere
Energy grade line (EGL)	Total energy at any point in the pumping system
Fitting and valve losses (h_{fvs} , h_{fvd})	Energy loss due to eddy formation and turbulence as the water passes through a fitting or valve
Friction headloss (h_{fs} , h_{fd})	Head of water that must be supplied to overcome friction losses in the pipe system
Hydraulic grade line (HGL)	Locus of all pressure head values—always below the energy grade line by the amount of the velocity head
Manometric suction head (h_{gs})	Suction gauge reading
Manometric discharge head (h_{gd})	Discharge gauge reading
Manometric head (H_g)	Difference between the manometric suction head and the manometric discharge head ($h_{gd} - h_{gs}$)
$NPSH_A$	Net positive suction head available
$NPSH_R$	Net positive suction head required
Static suction head (h_s)	Difference in elevation between the wet well water level and the reference datum of the pump impeller
Static discharge head (h_d)	Difference in elevation between the reference datum of the pump impeller and the discharge water level
Total static head (H_{stat})	Difference in elevation between the water level in the wet well and the water level at the discharge ($h_d - h_s$)
Velocity head ($v^2/2g$)	Kinetic energy in the water being pumped at any point where v = velocity of water and g is the acceleration due to gravity = 9.81 m/s^2

Adapted from Cooper and Tchobanoglous, 2006.

Net Positive Suction Head ($NPSH_R$). The $NPSH_R$ is a function of the pump design and operating conditions (capacity, speed, and discharge head). Each model pump has a different $NPSH_R$. It is provided by the manufacturer along with other data graphically on a *head-discharge curve*.

As part of the process of selecting an appropriate pump, the design engineer must evaluate the *available Net Positive Suction Head* ($NPSH_A$) and, if appropriate, adjust the head (depth of water). Two operating conditions are of interest: (1) source of water above the pump and (2) source of water below the pump. Using Figure 3-15 to identify terms, the equations for these conditions are

For water above pump:

$$NPSH_A = h_a + h_s - h_{fs} - h_{va} \quad (3-7)$$

For water below pump:

$$NPSH_A = h_a - h_s - h_{fs} - h_{va} \quad (3-8)$$

where h_{va} is the absolute vapor pressure and other terms are as described in Table 3-6. The absolute pressure of the standard atmosphere is a function of altitude above or below mean sea level as shown in Table 3-7. The vapor pressure is a function of the water temperature as shown in Table 3-8 on page 3-24.

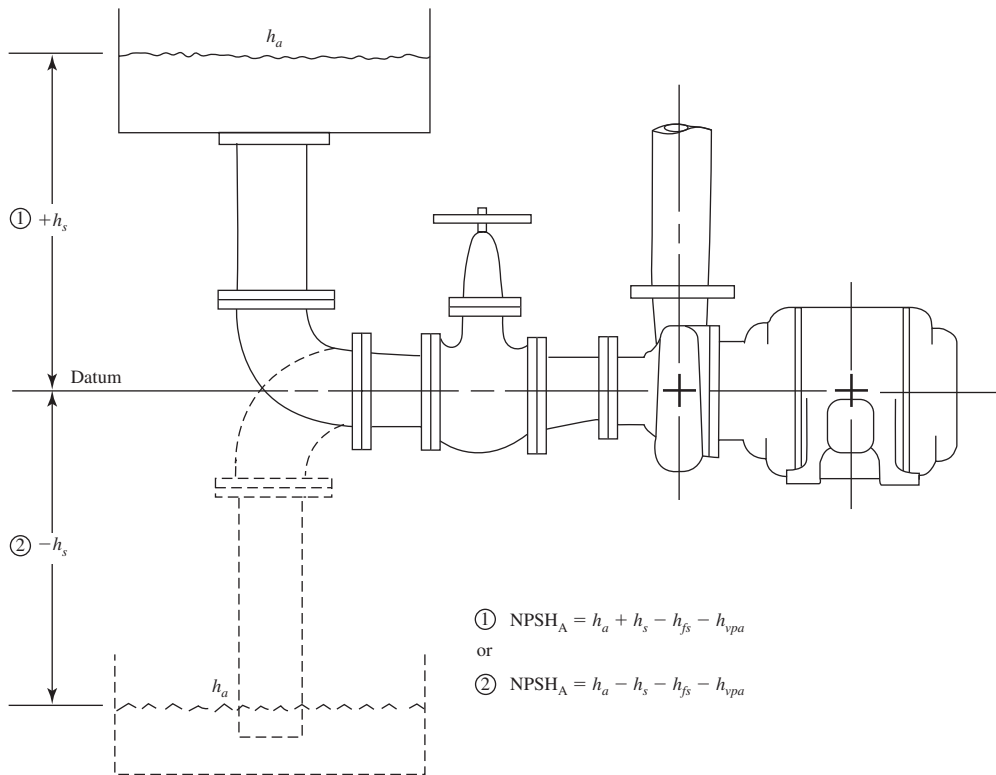

FIGURE 3-15
 Nomenclature for $NPSH_A$.

TABLE 3-7
Atmospheric pressure as a function of altitude

Altitude, m	Atmospheric pressure	
	kPa	m of water
-1,000	113.9	11.62
-500	107.5	10.97
0	101.3	10.33
500	95.46	9.74
1,000	89.88	9.17
1,500	84.56	8.66
2,000	79.50	8.11
2,500	74.69	7.62
3,000	70.12	7.15

Adapted from COESA, U.S. Standard Atmosphere, U.S. Government Printing Office, Washington, D.C., 1976.

TABLE 3-8
Vapor pressure as a function of temperature

Temperature, °C	Vapor pressure	
	kPa	m of water
0	0.611	0.0623
5	0.872	0.0889
10	1.228	0.1253
15	1.706	0.1740
20	2.339	0.2386
25	3.169	0.3232
30	4.246	0.4331
35	5.627	0.5740
40	7.381	0.7529
50	12.34	1.259

Adapted from L. Haar, J. S. Gallagher, and G. S. Kell, *NBS/NRC Steam Tables*, Hemisphere Publishing Corp., New York, 1984.

The design must provide $NPSH_A \geq NPSH_R$. Of the terms in Equations 3-7 and 3-8, the designer can adjust the height of the water surface (h_s) and the friction losses (h_{fs}). Because of the requirements for piping to the pump, h_s is generally the most easy to manipulate. Example 3-4 illustrates the calculations.

Example 3-4. A pump intake is located 0.5 m below the water surface in a wet well located at an elevation of 1,500 m above sea level. The water temperature is 5°C. The pump intake friction headlosses amount to 0.015 m. The selected pump requires a NPSH of 1.0 m. Does the design of the wet well provide $NPSH_R$?

Solution:

- From Table 3-7, find $h_a = 8.66$ m of water at 1,500 m elevation.
- From Table 3-8, find $h_{va} = 0.0889$ m of water at 5°C.
- With $h_s = 0.5$ m, the net positive suction head available is

$$NPSH_A = 8.66 + 0.5 - 0.015 - 0.889 = 8.256 \text{ or } 8.26 \text{ m}$$

- $NPSH_A$ is $> NPSH_R$. Therefore, this design is acceptable.

System Head Curves. The system head curve is the TDH curve formed over the range of design flow rates (that is, the minimum, average, maximum). The TDH will vary with the flow rate and will be approximately proportional to the square of the flow through the system because of the change in the velocity head term in Equation 3-3. In addition, the TDH will vary as the static head changes because of drawdown in the wet well and changes in the surface elevation of the lake or

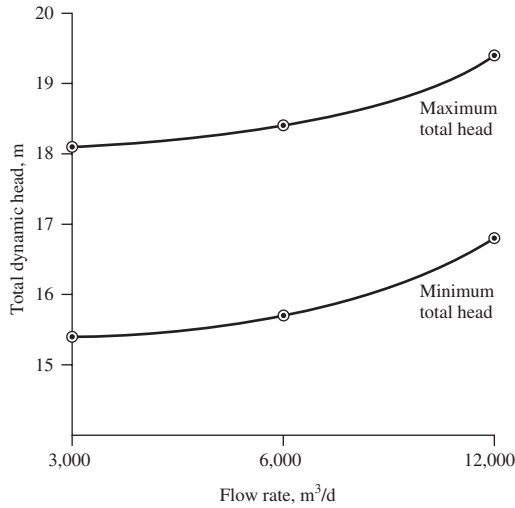
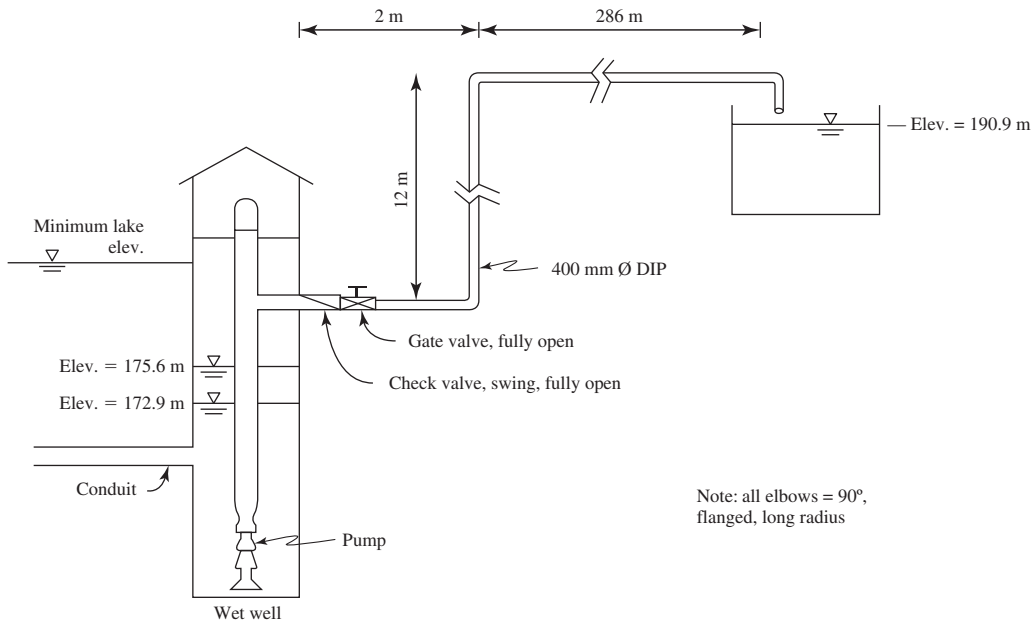

FIGURE 3-16
System total head curves.

river. Appropriate pumps and pump valve systems must be selected to operate in the range of the system head curve. Common practice is to plot two curves. One curve is plotted for the maximum system total head and one for the minimum system total head as shown in Figure 3-16.

Example 3-5. Develop the system head curves for the low-lift pump station to the water treatment plant pumping system shown in the sketch below. The minimum flow rate is 3,000 m³/d. The average flow rate is 6,000 m³/d. The maximum flow rate is 12,000 m³/d.



Solution:

- a. Calculate H_{stat} for the maximum and minimum drawdown in the wet well.

Using the sketch elevations, the maximum static head is

$$H_{stat} = 190.9 \text{ m} - 172.9 \text{ m} = 18.0 \text{ m}$$

and the minimum static head is

$$H_{stat} = 190.9 \text{ m} - 175.6 \text{ m} = 15.3 \text{ m}$$

- b. Calculate the friction losses using Equation 3-5 for a 400 mm diameter ductile iron pipe (DIP) at three flow rates.

From Appendix C, select $C = 100$ for DIP. At the maximum flow rate of 12,000 m³/d or 0.139 m³/s, for the 300 m long pipe the total friction headloss is

$$\begin{aligned} h_{fd} &= 10.7 \left(\frac{0.139 \text{ m}^3/\text{s}}{100} \right)^{1.85} \left(\frac{300 \text{ m}}{(0.4 \text{ m})^{4.87}} \right) \\ &= 1.44 \text{ m} \end{aligned}$$

Similarly for the average and low flow rates

$$h_{fd} = 0.399 \text{ or } 0.4 \text{ m at average flow}$$

$$h_{fd} = 0.11 \text{ m at low flow}$$

- c. Compared to the values calculated in (a) and (b), the losses for valves and fittings are negligible and are neglected here. Likewise, the velocity headloss ($v^2/2g$) is very small and is neglected here.
- d. The plotting points for the system curves for the maximum drawdown are

$$18.0 \text{ m} + 1.44 \text{ m} = 19.44 \text{ m at } Q = 12,000 \text{ m}^3/\text{d}$$

$$18.0 \text{ m} + 0.4 \text{ m} = 18.4 \text{ m at } Q = 6,000 \text{ m}^3/\text{d}$$

$$18.0 \text{ m} + 0.11 \text{ m} = 18.11 \text{ m at } Q = 3,000 \text{ m}^3/\text{d}$$

For the minimum drawdown the plotting points are

$$15.3 \text{ m} + 1.44 \text{ m} = 16.74 \text{ m at } Q = 12,000 \text{ m}^3/\text{d}$$

$$15.3 \text{ m} + 0.4 \text{ m} = 15.7 \text{ m at } Q = 6,000 \text{ m}^3/\text{d}$$

$$15.3 \text{ m} + 0.11 \text{ m} = 15.4 \text{ m at } Q = 3,000 \text{ m}^3/\text{d}$$

These points are plotted in Figure 3-16.

Pump Selection. Multiple pumps and/or variable speed pumps are selected to cover the range of conditions described by the system head curve. It is important to select a pump that will have its best efficiency within the operating range of the system and preferably at the operating point (head and discharge) where the pump will operate most often.

Pumps are selected from those commonly available from pump manufacturers. This then becomes a problem of matching a *pump characteristic* or *head-discharge* curve from a pump manufacturer's catalog or database to the system head curve.

A typical, constant speed, vertical turbine curve is shown in Figure 3-17. Important features of the curve to be noted are:

- The head delivered (ordinate) is *per stage*. Thus, for higher heads than noted, multiple stages are identified in the selection of the pump.
- The maximum number of stages that may be used is specified.
- The *best efficiency point* (BEP) is a function of the flow rate and the head.
- The required net positive suction head (NPSH_R) may be specified *per stage* or as a total for the maximum number of stages. Typically, it is only critical for the first stage.
- Multiple impeller sizes allow some adjustment over the range of capacity and head.

Radial loads on the impeller and problems with cavitation are minimized when the pump is operated at its BEP. Although it is not possible to operate at the BEP all the time, there is a range of operating conditions that is preferred to optimize the life of the pump. The American National

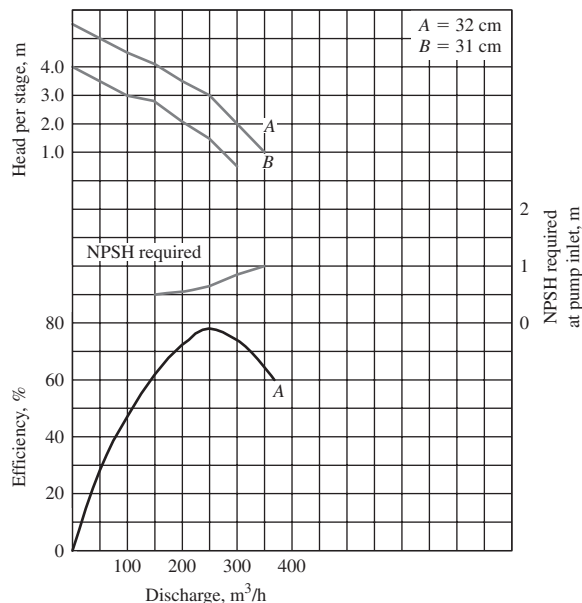
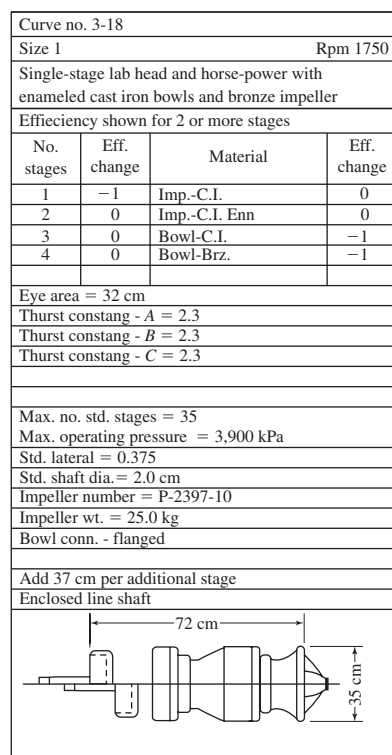

FIGURE 3-17
Typical vertical head-discharge curve.

Standards Institute (ANSI) has provided the following guidance for the *Preferred Operating Range* (POR) for vertical pumps (ANSI/HI 9.6.3-1997):

For specific speeds less than 87, the bounded region is between 70 and 120 percent of the BEP flow rate.

For higher specific speeds, the bounded region is between 80 and 115 percent of the BEP flow rate.

Specific speed is defined as

$$n_s = \frac{nQ^{0.5}}{H_t^{0.75}} \quad (3-9)$$

where n = revolutions per minute

Q = flow rate, m³/s

H_t = total dynamic head, m

ANSI also established a wider region than the POR called the *Acceptable (or Allowable) Operating Region* (AOR). It “is that range of flow recommended by the pump manufacturer over which the service life of a pump is not seriously compromised. Minimum bearing life will be reduced and noise, vibration, and component stresses will be increased when a pump is operated outside its POR. As a result, service life within the AOR may be lower than within the POR.” The pump may be operated in this region for short, infrequent periods without significant equipment deterioration (Cooper and Tchobanoglous, 2006).

Example 3-6. Using the pump head-discharge curve shown in Figure 3-17 for the system head curve shown in Figure 3-16, and data from Example 3-5, specify the following at the average flow rate: (1) BEP, (2) number of stages, (3) efficiency at BEP, (4) the operating range of flow rate, (5) motor power, (6) the depth of the wet well, and (7) the location of the pump intake.

Solution:

- a. From Figure 3-16, the maximum total system head is 18.4 m at the average flow rate of 6,000 m³/d. On Figure 3-17, the BEP is found at a flow rate of

$$\frac{6,000 \text{ m}^3/\text{d}}{24 \text{ h/d}} = 250 \text{ m}^3/\text{h}$$

and a head of 3 m/stage.

- b. The number of stages required is

$$\text{No. of stages} = \frac{\text{Total system head}}{\text{Head per stage}} = \frac{18.4 \text{ m}}{3} = 6.13 \text{ or } 7$$

This is less than the maximum number of stages allowed of 35 noted in the box in Figure 3-17.

- c. From Figure 3-17 at 250 m³/h and 3 m head per stage, the efficiency is 78 percent for impeller A.
- d. From Figure 3-17, the rpm = 1,750. The flow rate is

$$\frac{250 \text{ m}^3/\text{h}}{3,600 \text{ s/h}} = 0.0694 \text{ m}^3/\text{s}$$

- e. From Figure 3-16, the maximum TDH at $250 \text{ m}^3/\text{h}$ is 18.4 m.

The specific speed is

$$n_s = \frac{(1,750 \text{ rpm})(0.0694 \text{ m}^3/\text{s})^{0.5}}{(18.4 \text{ m})^{0.75}} = \frac{461.0}{8.88} \\ = 51.92$$

- f. For specific speeds less than 87, the POR is from 70 to 120 percent of the BEP flow rate or

$$(0.70)(250 \text{ m}^3/\text{h}) = 175 \text{ m}^3/\text{h}$$

to

$$(1.2)(250 \text{ m}^3/\text{h}) = 300 \text{ m}^3/\text{h}$$

- g. The pump curve is plotted on the system curve in Figure 3-18.

- h. Using Equation 3-3, the motor brake power is

$$P = \frac{(9.807 \text{ kN/m}^3)(0.0694 \text{ m}^3/\text{s})(18 \text{ m})}{0.78} \\ = 15.7 \text{ kW}$$

- i. The depth of the wet well is determined by the hydraulics of the conduit, the depth of the conduit carrying water to the wet well, and the minimum submergence required by the pump. The following sketch shows the relationships using the results of calculations in Example 3-3, the NPSH_R for the selected pump, and the NPSH_A assuming an altitude of 500 m and a temperature of 5°C .

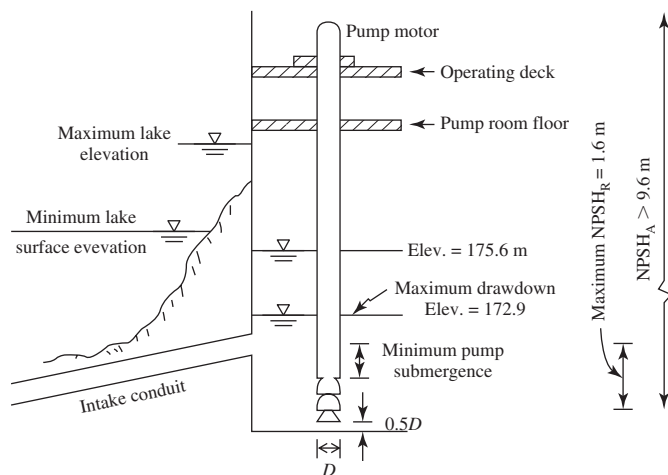

Comment. The selected pump is not “ideal” for the system curves. A pump with fewer stages and a flatter head-discharge curve would be a better choice.

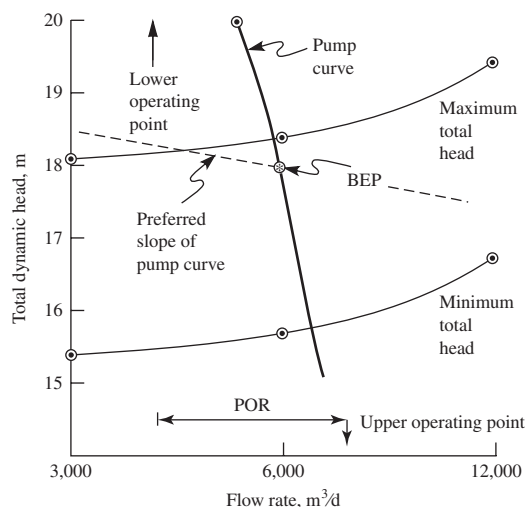

FIGURE 3-18
Pump and system curves.

Infiltration Gallery or Ranney Wells

When the geological conditions are favorable, an infiltration gallery or collector wells may be placed onshore or offshore.

Direction. The infiltration gallery consists of perforated pipe laid parallel to the shore for lakes. For rivers, the pipe gallery may be either at a right angle to the river flow or parallel to shore depending on the groundwater flow pattern (Kawamura, 2000). As shown in Figure 3-6, the Ranney well system will have well screens radiating from a collector caisson.

Depth. The actual depth should be determined by hydrogeological studies that identify the piezometric surface and its variability. Common depths are generally in the range of 4 to 5 m below the bottom of the river or lake.

Pipe Material. Because of the high potential for corrosion, perforated polyvinyl chloride (PVC) or concrete pipe is used for the collection gallery. Ranney well screens are generally made of stainless steel.

Orifice Size. The diameter of each orifice is generally 1 to 2 cm. The number of orifices is 20 to 30 per square meter of the collector surface (Kawamura, 2000).

Length. The gallery must be long enough to meet the design capacity. The velocity into each orifice at the design capacity is limited to 0.03 m/s to minimize entrainment of sand.

Slope. The gallery can be horizontal, but a slight slope of 500:1 will minimize air binding/blockage (Kawamura, 2000).

Pipe Velocity. At design capacity, the velocity is limited to 1 m/s at the outlet of the gallery.

Backfilling. Because the Ranney well screens are bored into the natural aquifer material, there is no backfilling required. The pipe laid in the gallery is backfilled with gravel and sand similar to that used in filter bed gradation (see Chapter 11 for details).

Junction Wells. At junction points in the gallery where the pipe changes direction and at the end of the gallery, a well is provided. The recommended minimum diameter is 1 m (Kawamura, 2000).

Regulatory Considerations. In addition to the withdrawal restrictions that may be imposed, the water removed from the infiltration gallery may be considered *under the influence of the surface water* and thus subject to water quality regulations that apply to surface water. Nonetheless, the filtering action of the ground improves the quality of the water and makes it easier to treat.

3-4 OPERATIONAL CONSIDERATIONS

Grit

Abrasive materials such as silt, sand, and shells is called *grit*. This material is very abrasive and will result in excessive wear to mechanical equipment as well as potentially settling out during low-demand flows.

When the source water bottom is soft and subject to scour or when flood conditions result in a high sediment load and turbidity, grit chambers are provided. The grit chamber is a horizontal flow settling tank (Figure 3-19). The theoretical design basis of the grit chamber is Stokes' law which is discussed in Chapter 10.

The design objective of the grit chamber is to remove sand or silt particles greater than 0.1 mm in diameter. Generally, particles smaller than this do not pose a hazard to pumps and pipelines. The design objectives for raw water grit chambers are significantly different from those used for wastewater treatment. Thus, wastewater treatment plant designs should not be used for raw water grit removal. Typical design criteria are listed in Table 3-9.

Ice

In cold regions, ice in its various forms is of concern. Surface ice and ice floes create structural hazards to exposed intakes. Selection of submerged intake alternatives alleviates this problem.

Frazil ice is small, disk-shaped ice crystals (Foellmi, 2005). It has also been described as slush. Frazil ice adheres to surfaces such as intake screens and pipe walls. The reduction in area lowers the flow rate into the intake structure and ultimately will plug it. Frazil ice forms when turbulent water is supercooled.

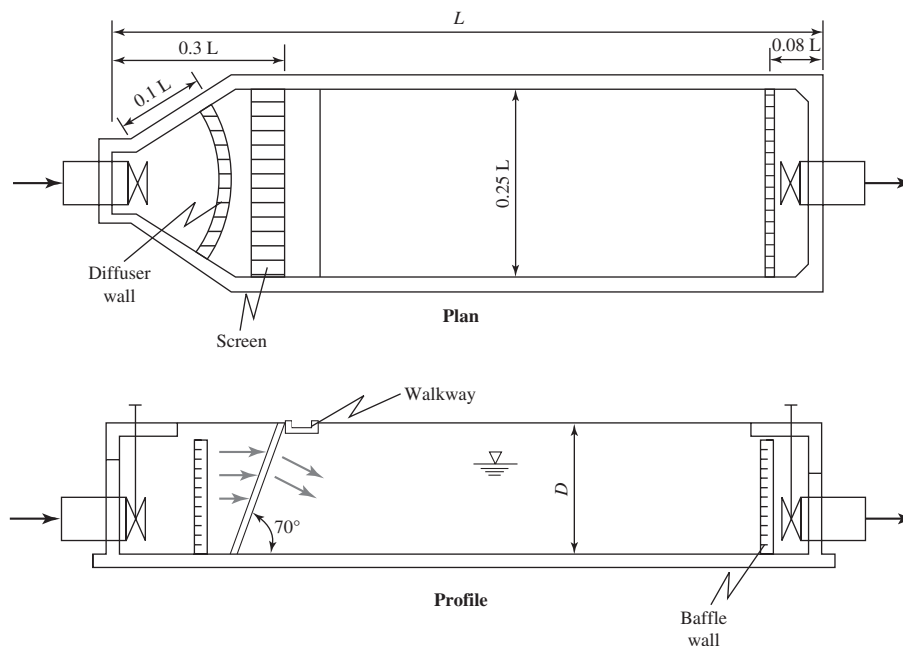

FIGURE 3-19
Grit chamber.

TABLE 3-9
Water intake grit chamber design criteria

Parameter	Range of values
Location	Downstream of the fine screen and upstream of the raw water pumps
Number of chambers	2
Water depth	
Mechanical grit removal	3 to 4 m
Manual grit removal	4 to 5 m
Length to width	4:1
Length to depth	6:1
Velocity	0.05 to 0.08 m/s
Detention time	6 to 15 min
Overflow rate ^a	10 to 25 m/h.

^aOverflow rate = Q /surface area of water in tank.
Adapted from Kawamura, 2000.

Experience on the Great Lakes and elsewhere indicates that location and design features of submerged intakes can significantly reduce the buildup of frazil ice but probably cannot eliminate it. Submerging intakes in deep water (10 m appears to be the minimum with 12 to 14 m preferred) and sizing inlet ports for a maximum velocity of 10 cm/s minimizes frazil ice buildup.

Heating the water at the intake port to 0.1°C also appears to work, but the energy requirements are extremely large. Using smooth materials such as solid plastic and plastic-coated metal also helps (Foellmi, 2005, Bosserrman et al., 2006). Wood is commonly used because of its low thermal conductivity.

Anchor ice is differentiated from frazil ice in that it forms in sheets and grows by attachment of frazil ice. The methods of control are the same as those for frazil ice.

Zebra Mussels

The zebra mussel (*Dreissena polymorpha*) is a small bivalve mollusk that has alternating dark and light bands on its shell and averages about 2.5 cm in length. The mussel grows filamentous threads that allow it to attach to hard surfaces. Zebra mussels reproduce prolifically and as a consequence clog intakes and pumps. They are well established in the Great Lakes and are forecast to infest all freshwater in two-thirds of the United States and all of southern Canada.

The control techniques currently in use are listed in Table 3-10. In the Great Lakes area, chlorine and potassium permanganate feed systems piped to the inlet port have been successful in mitigating the problem. Intermittent chlorination is used to kill the juveniles (velligers) before shells develop and attachment becomes virtually permanent. This dosing scheme minimizes the use of chlorine. Periodic cleaning of the screens is required to remove adult and dead mussels as the chemical treatment does not remove them. Care should be used in the application of chlorine as the presence of naturally occurring organic matter may lead to the formation of trihalomethanes, a group of compounds that are regulated (see Chapter 2 for details).

Fish Protection

The need to provide a means to prevent fish from entering the intake structure is addressed by one of three approaches:

- Physical barrier screens,
- Behavioral guidance systems, and
- Capture and release systems.

The highest standard of protection is for juvenile, endangered species. The National Oceanic and Atmospheric Administration (NOAA) has developed guidelines for inlets to protect these fish.

TABLE 3-10
Zebra mussel control

Treatment technique	Remarks
Thermal	35°C for 2 h 100% effective Repeat 2 to 3 times per year
Chemical	Oxidizing chemicals such as chlorine, potassium permanganate, and ozone Continue for 2 or 3 weeks; continuous application may be required
Mechanical	Shovel or scrape, high-pressure hose, sandblasting
Other	Ultrasound, electrocution, oxygen depletion, UV light

Physical barrier screens are the most widely accepted and successful approach. The screens are fine mesh with openings of 1.75 mm. The inlet velocity is designed to be a maximum of 12 cm/s (Foellmi, 2005).

Behavioral guidance may be accomplished with either electric shock (Bosserman et al., 2006) or, for submerged intakes, a velocity cap (Foellmi, 2005). The velocity cap on top of a submerged intake, such as shown in Figure 3-20, forces water to enter horizontally. Fish tend to swim against horizontal currents.

Frazil ice complicates the fish protection issue because fine mesh systems are very susceptible to clogging (Bosserman et al., 2006). As noted above, air burst systems with 1,000 kPa pressure have been used to alleviate this problem. For T-screens at shore-based facilities, mounting the screen on a boom that can be rotated out of the water for mechanical cleaning has also been used as a method to alleviate the frazil icing problem.

3-5 OPERATION AND MAINTENANCE

With a well designed and constructed intake system, very little operation and maintenance (O&M) is required. O&M tasks include regular preventive maintenance of the mechanical equipment such as the fine screens, pumps, and gates. The tasks include removal of large floating objects on the racks, deicing, lubrication and adjustment of the moving parts on the screens and pumps, and exercising the port gates to prevent them from freezing up because of corrosion. Periodically, divers must be employed to examine the condition of underwater structures.

For installations with multiple level ports, regular chemical analysis of the water at various port levels will allow for adjustment of the intake level to reduce treatment costs. This is particularly important when algal blooms and taste and odor problems are evident.

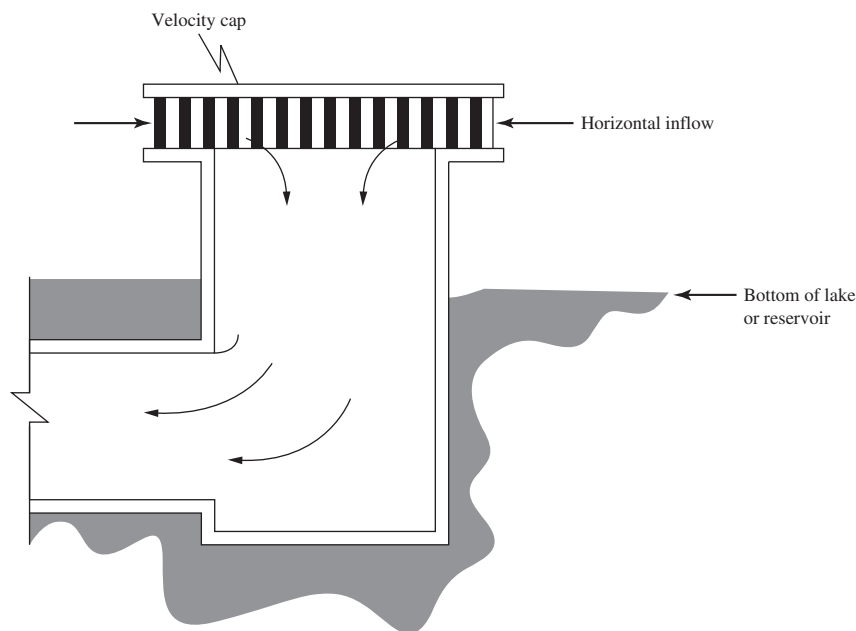

FIGURE 3-20
Velocity cap.

Hints from the Field. Operation and maintenance personnel who have to live with the results of the engineer’s design have offered the following suggestions:

- The overhead crane supplied to facilitate maintenance of the pumps and motors should also provide a means to move the equipment outside of the building to facilitate replacement of equipment that has reached its life expectancy. Alternatively, a hatch in the roof with a means of positioning the equipment to be removed below the hatch should be provided. In the second instance, a crane can be rented to remove the old equipment and transfer the new equipment into the building. The hatch should be sized to consider the likelihood that the replacement equipment will be larger than the equipment being removed.
- For zebra mussel control, a chlorine feed line should be supplied to the screen/bar rack of the intake. The feed line is commonly located inside the conduit carrying water from the intake structure to the low-lift pump station. Sodium hypochlorite solution is used to supply the chlorine. Care should be taken in selecting the pipe material and joining cements because sodium hypochlorite may adversely affect the material and/or the cement. This includes polyvinyl chloride (PVC) cements.
- In hard water, with high concentrations of calcium and magnesium carbonate, the addition of commercial sodium hypochlorite may cause precipitation of carbonates on the interior of the pipe. Operators call this “plating out” of the hardness. Over time this will limit the capacity of the supply pipe. The addition of sodium hexametaphosphate to the hypochlorite feed will help to mitigate the precipitation.
- The conduit from the intake to the low-lift pump station should be inspected regularly (preferably annually). For large conduits (1.5 m or large in diameter) a diver is employed to “swim” the conduit and make the inspection. For small pipes, a TV camera inspection may be used. The inspection should include such items as structural integrity of the pipe, build-up of zebra mussels and slime layers, and the condition of the chlorine supply line (both the pipe and the hangers).
- Because the air supply used by divers will be released inside of the conduit during the inspection, some means must be provided to release the gas; otherwise the gas “bubble” that accumulates in the pipe will limit the flow rate. This is particularly true if the discharge into the wet well is through a downward facing bell. One solution is to provide a small (5 cm diameter) tap at the terminus to the pipe just above the bell and use it to release the accumulated air.

Visit the text website at www.mhprofessional.com/wwe for supplementary materials and a gallery of photos.

3-6 CHAPTER REVIEW

When you have completed studying this chapter, you should be able to do the following without the aid of your textbook or notes:

1. For a client, sketch a diagram of a lake intake structure and a river intake structure. Identify the following features: bar screen, sluice gate, fine screen, pump, operating floor, water level in surface water supply relative to the intake structure vertical profile.
2. List and discuss the key requirements of intake structures.

3. Select the appropriate screen type (coarse or fine) for a given scenario, that is, placement in the intake structure or type of material to be removed.
4. Select the appropriate type of pump from a pump catalog for a deep low-lift pump station.
5. Explain the advantages and disadvantages of an adjustable frequency drive for a pump to a client.
6. Explain, to a client, what frazil ice is and how its buildup on the intake structure may be minimized.
7. Explain, to a news media person, why zebra mussels are an operational problem and list two control techniques.

With the use of this text, you should be able to do the following:

8. For a given scenario (river or lake) with appropriate data on depth, sediment, and climate, select an acceptable type of intake structure.
9. Design an intake port given the seasonal flow rates and climate conditions.
10. Design a bar rack for an intake port given the seasonal flow rates and climate conditions.
11. Design the conduit to carry water from an offshore intake structure to a low-lift pump station.
12. Construct a system head curve given the elevations, pipe dimensions, and identification of the fittings.
13. Given a system head curve and a set of head-discharge curves, select an appropriate pump and specify (1) BEP, (2) number of stages, (3) efficiency at BEP, (4) the operating range of flow rate, and (5) motor power.
14. Design the wet well for a low-lift pump station including specifications of (1) the depth of the wet well and (2) the location of the pump intake given the surface water level, intake conduit specifications, and pump NPSH.

3-7 PROBLEMS

- 3-1. Design a tower intake to be placed in a reservoir in a warm climate. Provide the minimum number of ports. The design conditions are:

Summer design flow rate = 38,000 m³/d

Maximum reservoir elevation = 499.0 m

Minimum reservoir elevation = 480.7 m

Lake bottom elevation = 477.7 m

Bar rack bars: 1 cm diameter; 8 cm between bars

Specify the following:

Number and location of intake ports

Spacing of the ports

Depth of lowest port

Depth of top port

Dimensions of a port

Provide a sketch of the following:

Intake tower with elevations of ports, reservoir elevations, and lake bottom elevation

- 3-2.** Design a shore river intake system in a cold climate. Provide the minimum number of ports. The design conditions are:

Winter design flow rate = $4,300 \text{ m}^3/\text{d}$

Minimum river elevation held constant by lock and dam system = 99.0 m

500-year flood elevation = 113.3 m

River bottom elevation = 90.4 m

Assume a muck bottom

Trash rack: 2 cm diameter; 8 cm between bars

Specify the following:

Number and location of intake ports

Spacing of the ports

Depth of lowest port

Depth of top port

Dimensions of a port

Provide a sketch of the following:

Intake tower with elevations of ports, reservoir elevations, and lake bottom elevation

- 3-3.** Design a conduit to carry water from a submerged intake structure to the wet well of a low-lift pump station. The design conditions are:

Low water surface elevation = 353.5 m

Elevation of lake bottom = 306.6 m

Length of pipe from intake structure to wet well = 1,500 m

Maximum demand at design life = $53,000 \text{ m}^3/\text{d}$

Concrete pipe

Assume the lake bottom is flat

Specify the following:

Wet well drawdown elevation

Minimum slope of energy grade line required to carry the maximum demand

Diameter of the conduit

Velocity in the conduit

Depth of soil cover at the intake structure and at the wet well

Provide a sketch showing the following:

Low water surface elevation

Surface elevation of water in the wet well at maximum flow rate

Pipe profile from the intake structure to the low-lift pump station

Elevation of bottom of conduit at the intake structure and at the wet well

Note: Because both the slope of the energy grade line and the diameter are unknown, a trial and error solution is required. A spreadsheet solution for the trial and error calculation is recommended.

- 3-4.** Design a conduit to carry water from a submerged intake structure to the wet well of a low-lift pump station. The design conditions are:

Low water surface elevation = 153.5 m

Elevation of lake bottom = 106.6 m

Length of pipe from intake structure to wet well = 2,500 m
 Maximum demand at design life = 26,000 m³/d
 Concrete pipe
 Assume the lake bottom is as shown in Figure P-3-4

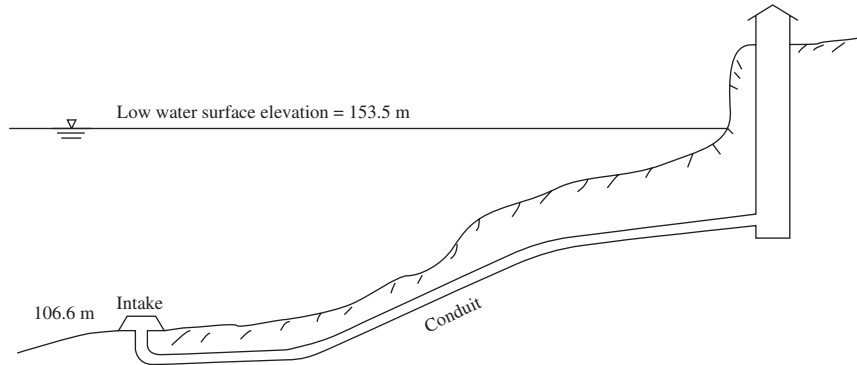

FIGURE P-3-4

Specify the following:

- Wet well drawdown elevation
- Minimum slope of energy grade line required to carry the maximum demand
- Diameter of the conduit
- Velocity in the conduit
- Depth of soil cover at the intake structure and at the wet well

Provide a sketch showing the following:

- Low water surface elevation
- Surface elevation of water in the wet well at maximum flow rate
- Pipe profile from the intake structure to the low-lift pump station
- Elevation of bottom of conduit at the intake structure and at the wet well

Note: Because both the slope of the energy grade line and the diameter are unknown, a trial and error solution is required. A spreadsheet solution for the trial and error calculation is recommended.

- 3-5. Show by calculation that losses for valves, fittings, and velocity head are negligible compared to the static head at the maximum flow rate for Example 3-5.
- 3-6. Develop the system head curves for the low-lift pump station to the water treatment plant pumping system shown in Figure P-3-6. The minimum flow rate is 9,500 m³/d. The average flow rate is 19,000 m³/d. The maximum flow rate is 38,000 m³/d. You may ignore losses from valves, fittings, and velocity head.
- 3-7. Develop the system head curves for the low-lift pump station to the water treatment plant pumping system shown in Figure P-3-7. The minimum flow rate is 4,500 m³/d. The average flow rate is 9,000 m³/d. The maximum flow rate is 18,000 m³/d. You may ignore losses from valves, fittings, and velocity head.

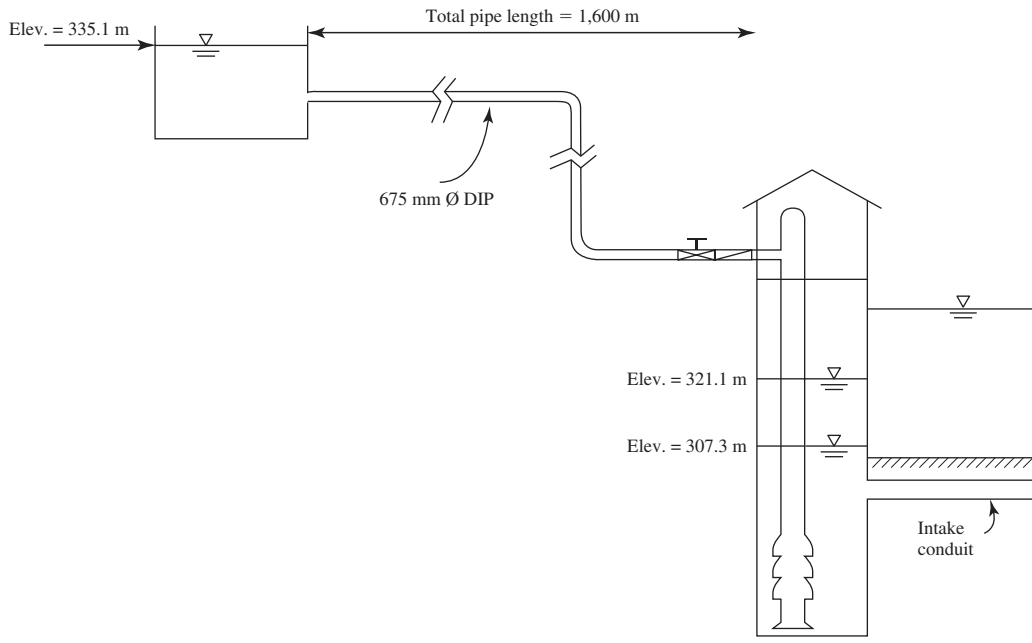

FIGURE P-3-6

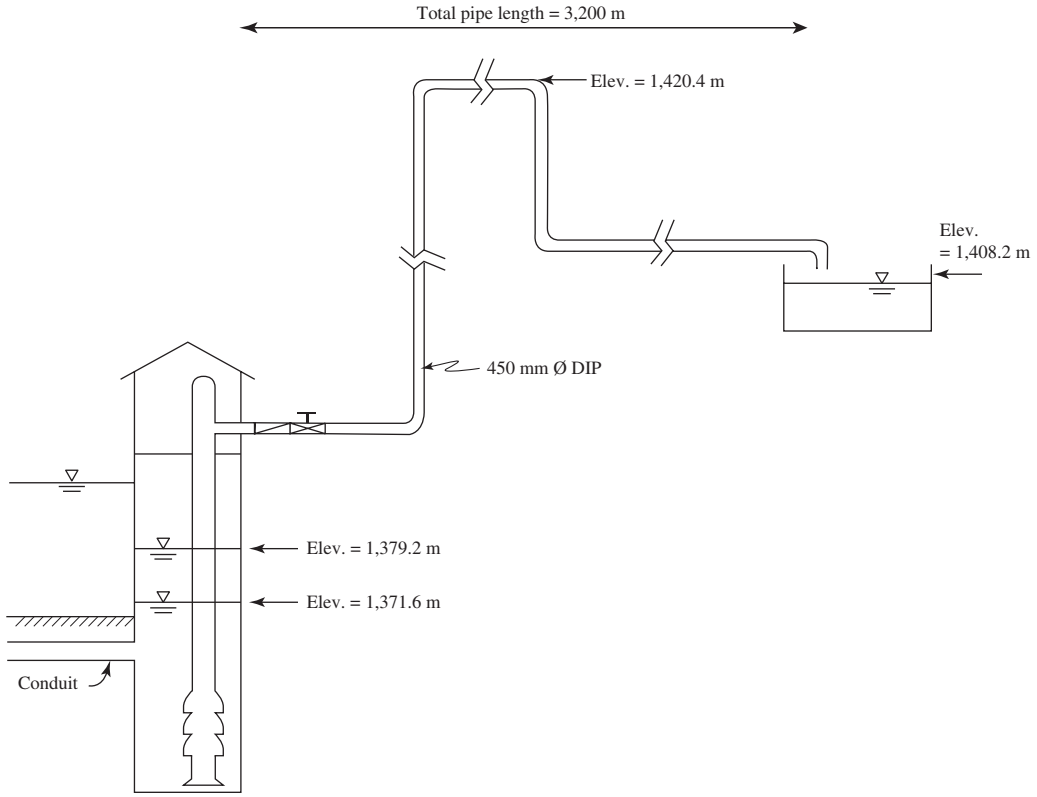

FIGURE P-3-7

- 3-8. For the system head curve shown in Figure P-3-8, select a pump. Specify the following at the average flow rate of 9,000 m³/d: (1) BEP, (2) number of stages, (3) efficiency at BEP, (4) the operating range of flow rate, and (5) motor power. Sketch and label (1) the depth of the wet well and (2) the location of the pump intake.

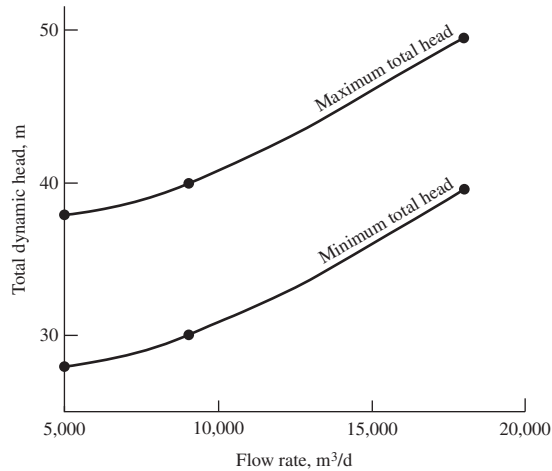

FIGURE P-3-8

- 3-9. For the system head curve shown in Figure P-3-9, select a pump. Specify the following at the average flow rate of 24,000 m³/d: (1) BEP, (2) number of stages,

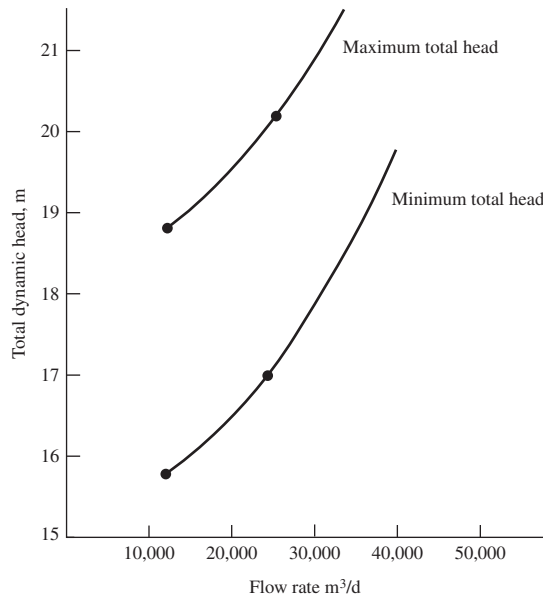

FIGURE P-3-9

(3) efficiency at BEP, (4) the operating range of flow rate, and (5) motor power. Sketch and label (1) the depth of the wet well and (2) the location of the pump intake.

3-8 DISCUSSION QUESTIONS

- 3-1. A city council member has suggested that the council would avoid having to comply with surface water rules for water treatment if an infiltration gallery was used instead of a shoreline intake structure on the river water supply for their community. Explain to the council member why this statement may not be true.
- 3-2. Given a choice of a sluice gate or butterfly valve for controlling the flow into an intake port, which would you select? Explain why.
- 3-3. What design data must you have to establish the depth of the wet well?
- 3-4. Which of the following depths for a submerged intake structure is the best to minimize the formation of frazil ice:
 - 5 m
 - 10 m
 - 15 m
- 3-5. What chemical(s) would you recommend in setting up a zebra mussel control system?

3-9 REFERENCES

- ASCE (1990) *Water Treatment Plant Design*, 2nd ed., American Society of Civil Engineers and American Water Works Association, McGraw-Hill, NY, pp. 27–56.
- Bosserman, B. E., R. J. Ringwood, M. D. Schmidt, and M. G. Thalhamer (2006) in G. M. Jones et al. (eds.) *Pump Station Design*, Elsevier, Boston, pp. 18.5–18.16.
- Cooper, P. and G. Tchobanoglous (2006) “Performance of Centrifugal Pumps,” in G. M. Jones (ed.), *Pump Station Design*, Elsevier, New York, pp. 10.1–10.44.
- Foellmi, S. N. (2005) “Intake Facilities,” in E. E. Baruth (ed.), *Water Treatment Plant Design*, McGraw-Hill, NY, pp. 4.1–4.35.
- Honeycutt, F. G. and D. E. Clopton (1976) “Water Supply,” in I. J. Karassik et al. (eds.), *Pump Handbook*, McGraw-Hill, NY, p. 10–6.
- Jones, G. M. and R. L. Sanks (2006) “Pumps: Intake Design, Selection, and Installation,” in G. M. Jones (ed.), *Pump Station Design*, Elsevier, New York, pp. 12.2–12.82.
- Kawamura, S. (2000) *Integrated Design and Operation of Water Treatment Facilities*, 2nd ed., John Wiley & Sons, NY, pp. 409–412.
- Richardson, W. H. (1969) “Intake Construction for Large Lakes and Rivers,” *Journal of American Water Works Association*, vol. 61, no. 8, p. 365.
- Sanks, R. L. (2006) “Flow in Conduits,” in G. M. Jones (ed.), *Pump Station Design*, Elsevier, NY, pp. 3.1–3.37.
- Williams, G. S. and A. Hazen (1905) *Hydraulic Tables*, John Wiley, New York.

This page intentionally left blank

CHAPTER

4

WELLS

4-1 INTRODUCTION

4-2 DESIGN ELEMENTS

4-3 WELL PROTECTION

4-4 WELL DESIGN

4-5 CHAPTER REVIEW

4-6 PROBLEMS

4-7 DISCUSSION QUESTIONS

4-8 REFERENCES

4-1 INTRODUCTION

The design of a well field and/or individual wells begins after the completion of the evaluation of the groundwater source to establish that a safe yield is available to meet the demand and that water quality standards can be met. These issues were discussed in Chapter 2. The design must provide for protection of the well from contamination, and it must conform to the hydraulic and hydrogeologic constraints of the aquifer.

4-2 DESIGN ELEMENTS

The key requirements of wells are that they are:

- Located in an aquifer that has adequate long-term capacity (see Chapter 2 for a detailed discussion).
- Protected from contamination.
- Reliable.
- Of adequate size and/or number to provide the required quantity of water.
- Located to obtain the best quality water.
- Not located where they will cause an adverse resource impact.

Protection from Contamination

A significant effort is made to protect wells from contamination because of their vulnerability to numerous sources of contamination. Aquifers lack the inherent protection of replenishment that is afforded to surface water supplies. Unlike surface waters that are replenished in hours, days, weeks, or even years, contaminated groundwater may only be replenished over geologic time scales—lifetimes in the shortest instances and centuries in most cases.

Reliability

Reliability is an essential requirement of groundwater supplies. The water supply system ceases to function when the well system fails. Small systems are particularly vulnerable because they typically have only a few wells.

Capacity

Unlike surface water systems, well systems may be expanded relatively inexpensively as communities grow. However, the ability of the aquifer to yield adequate water is not infinite. The geologic structure of the aquifer limits both the total quantity of water and the rate at which it can be withdrawn.

Quality

All groundwater is not equal in quality. Contact with geologic minerals guarantees an abundance of chemical constituents in the water. While most groundwater may be treated to meet water

quality standards, the strata that serve as aquifers may differ both in the constituents and the concentration of the constituents.

Adverse Resource Impact

As noted in Chapter 3, one method of withdrawing water from a surface water body is by the installation of a gallery or a Ranney well system. Individual wells may also cause water from a surface water body to flow out of the water body into the aquifer. If the pumping rate is too high, this may lower the water level in the surface water body enough to have a negative impact on its aquatic life.

4-3 WELL PROTECTION

The elements employed to protect the well include:

- Isolation from sources of contamination.
- Sanitary considerations in well construction.
- Provision of structural protection.

Although the provisions of the Michigan Safe Drinking Water Act (MSDWA, 1976) that are discussed in the following paragraphs serve as guidelines for good practice, individual state requirements vary, and these should be consulted as a matter of normal engineering practice.

Isolation

For the purpose of this discussion, the Michigan Safe Drinking Water Act definitions of different types of water supplies discussed in Chapter 2 are classified as follows:

- Type I: all community supplies.
- Type II: all noncommunity supplies.
 - Type IIa: average daily water production for the maximum month equal to or greater than 75 m³/d.
 - Type IIb: average daily water production for the maximum month less than 75 m³/d.
- Type III: all public supplies that are not Type I or Type II.

This classification is used to set isolation distances based on the probable radius of influence of the well and the risk to the population exposed. The recommended isolation distances are shown in Table 4-1 on page 4-5.

Well Construction

Geologic conditions dictate two general types of well construction. A well that taps an aquifer of water-bearing sand is cased through the overburden and screened in the water-bearing sand as shown in Figure 4-1a (Johnson, 1975). A well that taps an aquifer of consolidated rock consists

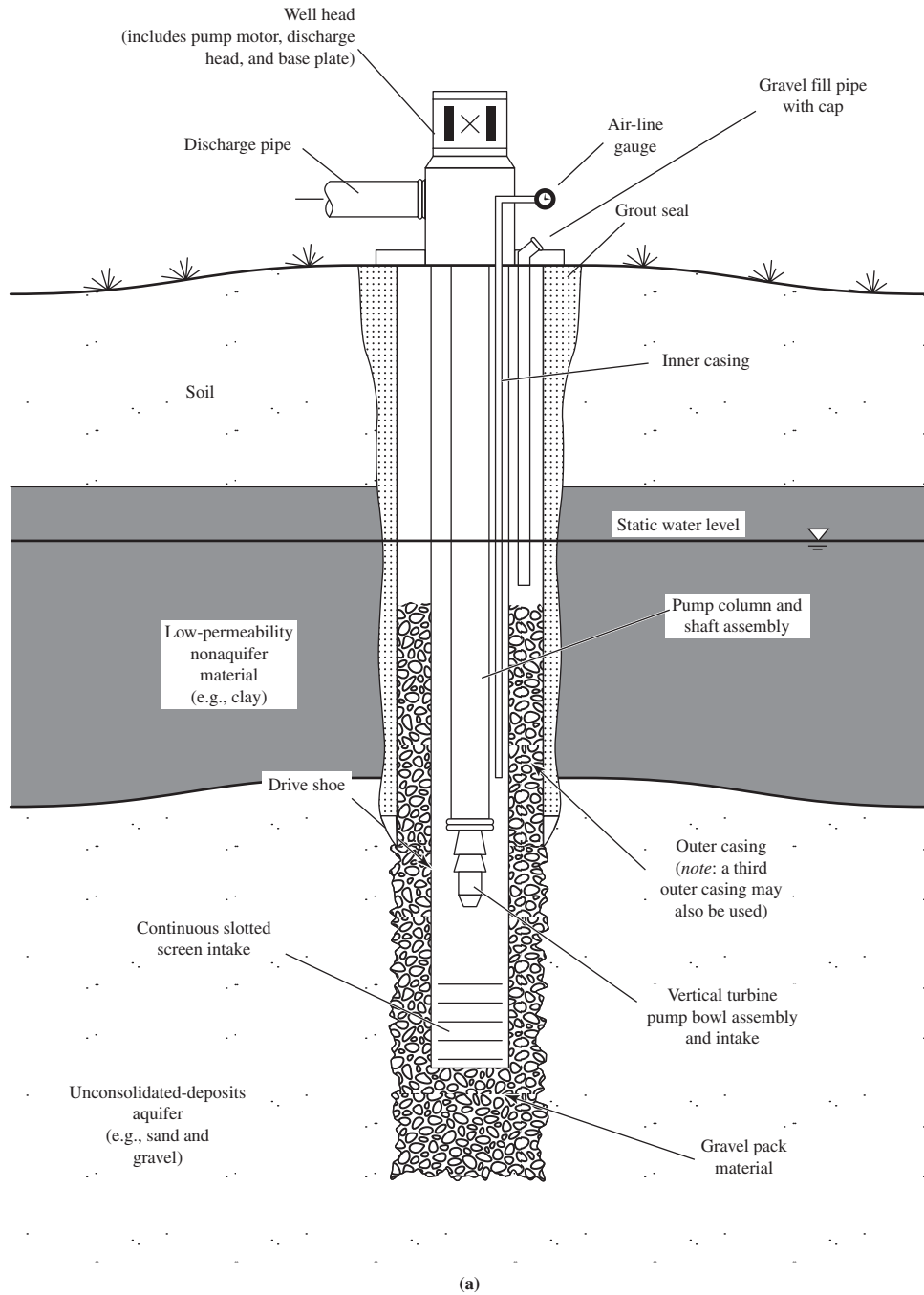

FIGURE 4-1
(a) Typical construction of a screened, gravel-packed well in an unconsolidated-deposits aquifer.

TABLE 4-1
Typical isolation distances^a

Contaminant source	Type I	Type IIa	Type IIb	Type III
Barnyards	60	60	20	20
Chemical or waste chemical storage or disposal facilities	600	600	250	250
Land application of wastewater or sludges	600	600	250	250
Municipal solid waste landfill	600	600	250	250
Pipelines	60	60	20	20
Septic tanks, drain fields, dry wells, cesspools, leaching beds	60	60	20	20
Sewers—storm or sanitary	60	60	20	20
Surface water	60	60	20	20

^a Distances are in meters.

Adapted from MSDWA, 1976.

of a cased portion that passes through the loose overburden material and an open borehole in the rock (Figure 4-1b).

Well Drilling. There are numerous methods for drilling the well. A few of these are highlighted here.

- **Cable-tool percussion:** The drilling operation is carried out by lifting and dropping a heavy string of drilling tools. The reciprocating action of the drilling tools mixes the crushed or loosened particles with water to form a slurry that is removed by a sand pump or bailer.
- **Jet drilling:** The drill tools for the jet-percussion method consist of a chisel-shaped bit attached to the lower end of a string of pipe. Water is pumped through the drill bit and flows upward in the annular space around the drill bit carrying the cuttings to the surface.
- **Hollow-rod or hydraulic percussion:** This method is similar to jet drilling except the water is pumped down through the annular space, and the cuttings are carried up through the pipe by the reciprocating motion and a set of valves that keeps the water from flowing downward.
- **Rotary drilling:** The borehole is cut by a rotating bit. The cuttings are removed by drilling fluid that passes down the drill pipe system and out through the nozzles of the bit. When the fluid reaches the surface, it is pumped to a pit where the bulk of the cuttings settle out. The drilling fluid is then reused.
- **Reverse circulation rotary drilling (RCR):** The flow of drilling fluid is reversed from that used in conventional drilling. A schematic of this drilling method is shown in Figure 4-2 on page 4-7. This is a common method for drilling community wells. This method is favored when completion of the well is to be by artificial gravel packing.

The suitability of these methods for different geological conditions is summarized in Table 4-2 on page 4-8.

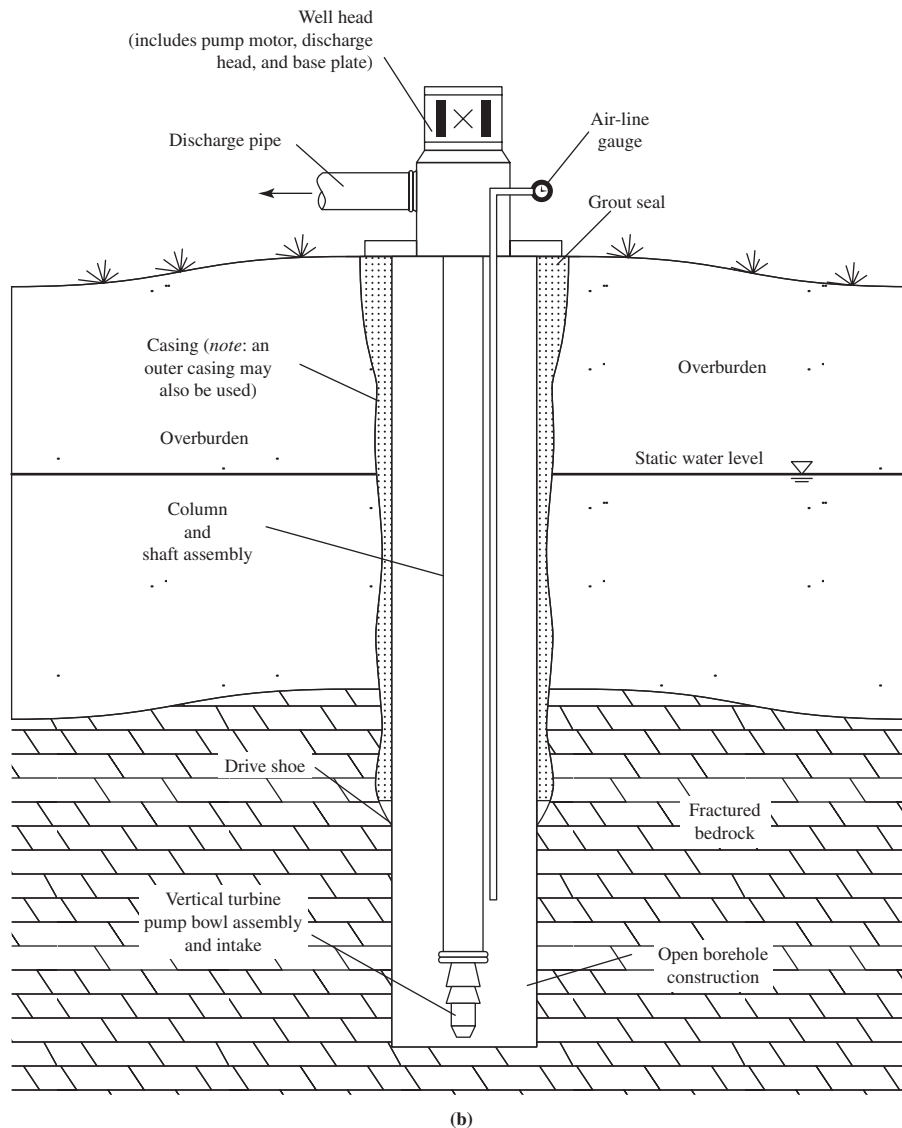

FIGURE 4-1 (Continued)

(b) Typical construction components of an open-borehole well in a bedrock aquifer.

Casing. The purpose of the casing is two-fold. It provides a means of maintaining the bore opening by keeping loose and unstable soil from falling in. In addition, it is a key feature in protecting the well from contamination.

Steel pipe is commonly used for the casing. There are several types of pipe available: drive pipe, line pipe, reamed and drifted pipe, standard pipe, and water well casing. Electric-resistance-welded and seamless “line pipe” is preferred (Johnson, 1975). The most commonly accepted specifications for water well casing are those prepared by:

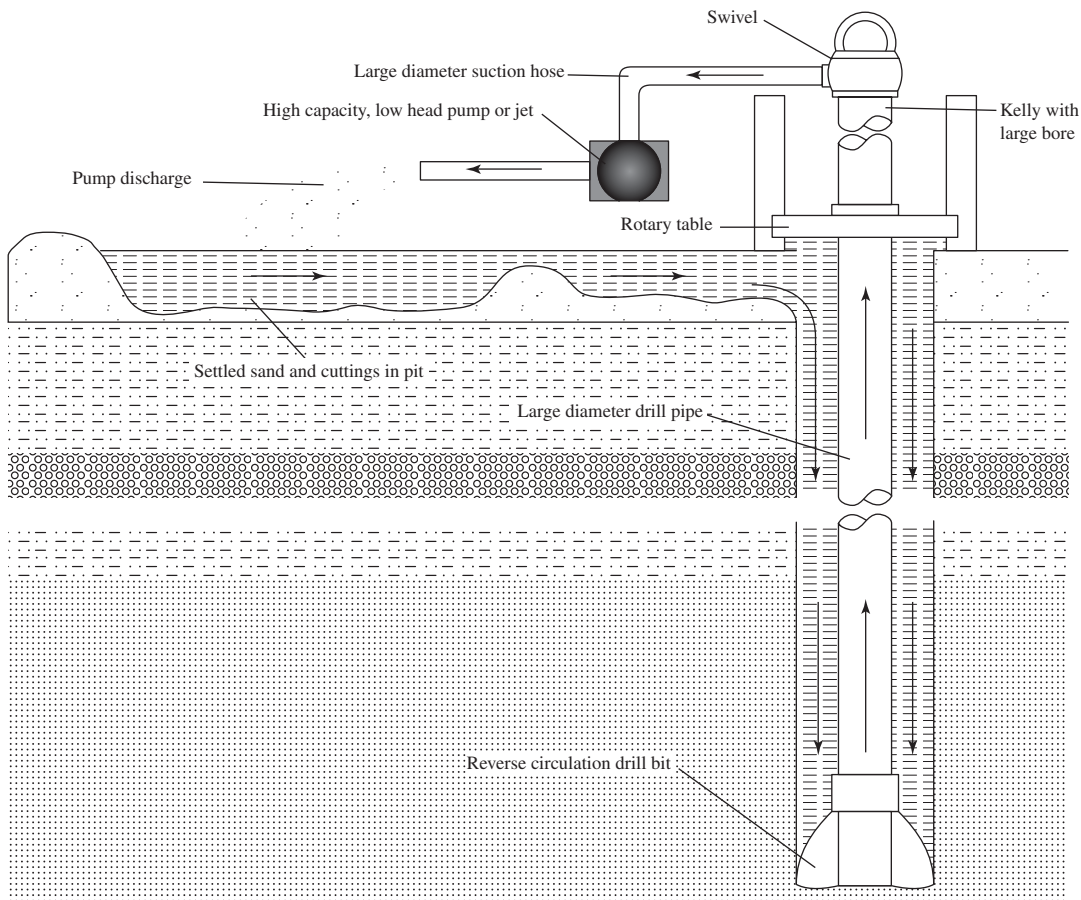

FIGURE 4-2

Basic principles of reverse-circulation, rotary drilling are shown in this schematic diagram. Cuttings are lifted by upflow inside the drill pipe. The Kelly is a part of the Kelly drive. It is square, hexagonal-or octagonal-shaped tubing which connects to the drill pipe for drilling wells.

- American Society for Testing Materials (ASTM).
- American Petroleum Institute (API).
- American Iron and Steel Institute (AISI).
- American Water Works Association (AWWA).
- U.S. federal government.

Typically one of the following is specified: AWWA A-100, ASTM A-120 and A-53B grade, “stenciled” or API 5-L. Minimum weights and thicknesses may be found in *Recommended Standards for Water Works* (GLUMRB, 2003).

TABLE 4-2
General suitability of well construction methods^a

Characteristics	Hollow-rod	Jetted	Cable-tool	Rotary drilling	Reverse circulation rotary drilling
Practical range of depth	30 m	60 m	600 m	1,000 m	1,000 m
Diameter	0.1 m	0.3 m	0.6 m	1.5 m	1.5 m
Geologic formation					
Clay	yes	yes	yes	yes	yes
Silt	yes	yes	yes	yes	yes
Sand	yes	yes	yes	yes	yes
Gravel	< 0.5 cm	< 0.5 cm	yes	yes	yes
Cemented gravel	no	no	yes	yes	yes
Boulders	no	no	no	yes	yes
Sandstone	no	no	no	yes	no
Limestone	no	no	no	yes	no
Igneous rock	no	no	no	yes	no

^a The ranges of values in this table are based on general conditions. They may be exceeded for specific areas or conditions or advances in technology.

Sources: Campbell and Lehr, 1973; Johnson, 1975; Stollhans, 2007; U.S. EPA, 1973.

Grouting and Sealing the Well Casing. The annular space between the casing and the drill hole is one of the principal avenues for contamination to enter the well. To block this route of entry into the well, the space is filled with *neat cement grout*.

Neat cement grout is a mixture of cement and water in the ratio of between 1.9 to 2.25 kg of cement to 1 L of clean water with the higher ratio of cement preferred. Hydrated lime, up to 10 percent of the volume of cement, may be added to make the grout mix more fluid. Up to 5 percent by weight of bentonite clay may be added to reduce shrinkage (U.S. EPA, 1973).

Careful attention should be given to see that:

- The grout mixture is properly prepared and mixed well.
- The grout material is placed in one continuous mass.
- The grout material is placed upward from the bottom of the space to be grouted.

One method of introducing the grout is shown in Figure 4-3. A packer connection with a one-way valve is provided at the bottom of the casing to prevent the grout from flowing into the casing while grouting is in progress. The valve is called a *cementing shoe* or a *float shoe*. Grout is pumped through the grout pipe and forced upward around the casing.

The procedure to be followed with this arrangement is as follows:

The casing, with float shoe attached and grout pipe properly installed, is suspended a short distance above the bottom (3 cm is recommended to prevent clogging). The casing is filled with water to provide sufficient mass to prevent flotation of the pipe. Grout is pumped into the annular space until it appears at the surface

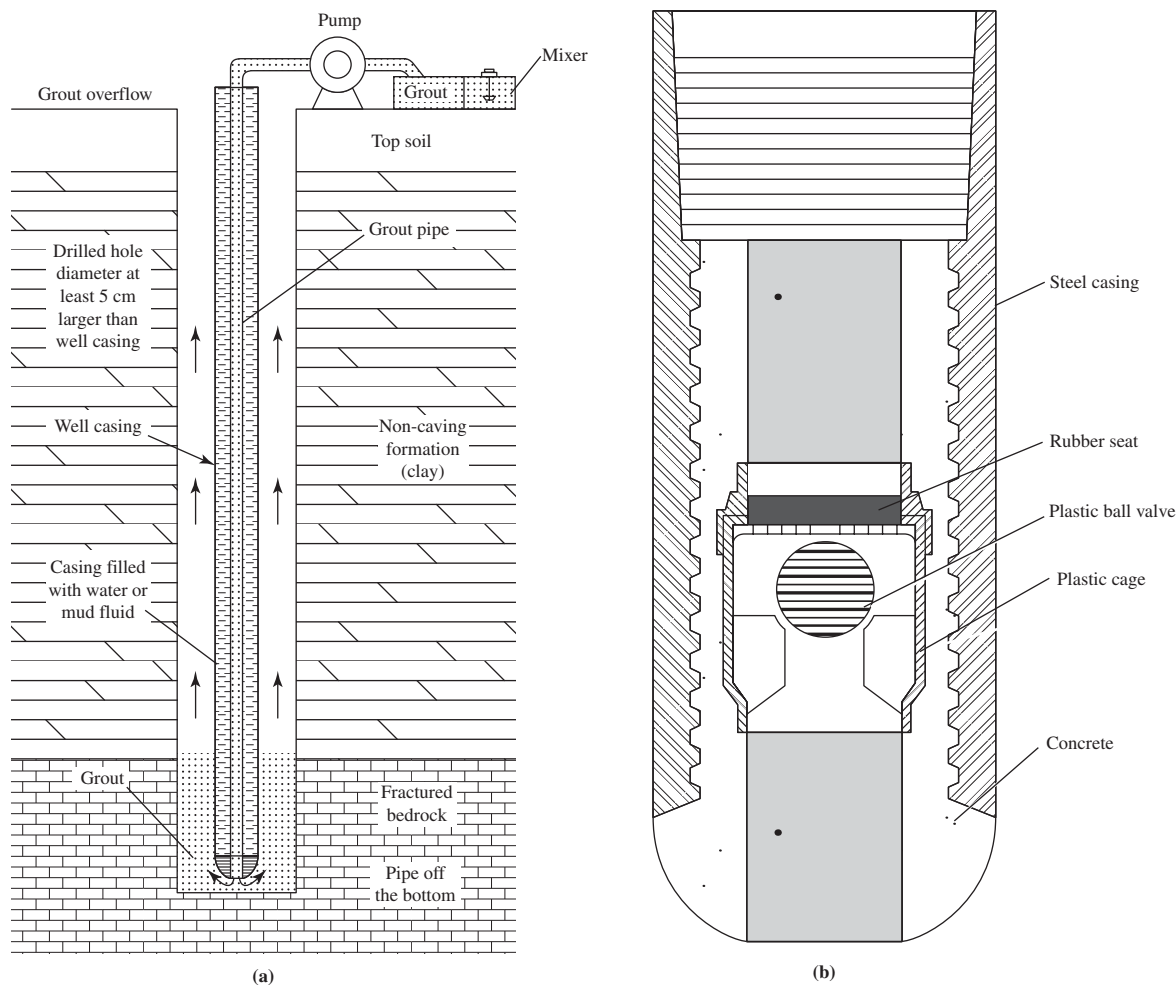

FIGURE 4-3

Grout pipe inside casing connects to drillable cementing plug or float shoe at bottom of casing pipe (a). After the grout has set, the bottom plug is drilled out and drilling continues. Detail of cementing shoe or float shoe with ball check valve (b).

and all other fluid has been displaced. The grout pipe is disconnected from the float shoe, and it is washed in place with water. It is then removed. After the grout has set, the bottom plug is drilled out and drilling is continued below the grouted section (Johnson, 1975).

The bore hole for this method of placing the grout should be 10 cm larger in diameter than the nominal casing size (U.S. PHS, 1965). The entire casing length is to be grouted. Screened wells are to be grouted from a point not more than 3 m above the screen to the ground surface (MSDWA, 1976). For wells ending with an open borehole in a rock formation, the casing is grouted from the top of the borehole to the ground surface. For artesian aquifers, the casing is

sealed to the upper confining layer from within 1.5 m of the top of the aquifer to the ground surface (U.S. PHS, 1965).

Grout made from Type I, Ia, or III cement should cure a minimum of 24 hours before drilling operations resume. When a cement/bentonite mixture is used, a waiting period of 48 hours is recommended (MSDWA, 1976). Some rules require a curing time of three to seven days.

Well Screen. A well screen is installed when the water-bearing formation is unconsolidated material such as sand. The well screen prevents fine material from entering the well and then causing undue wear on the pump and, potentially, filling the well.

Gravel-Packed Well. When the water-bearing formation is unconsolidated, the gravel-packed well (Figure 4-1a) is used. As shown in Figure 4-4, there are numerous configurations for the gravel pack. The gravel wall retains the water-bearing sand while the screen keeps the gravel

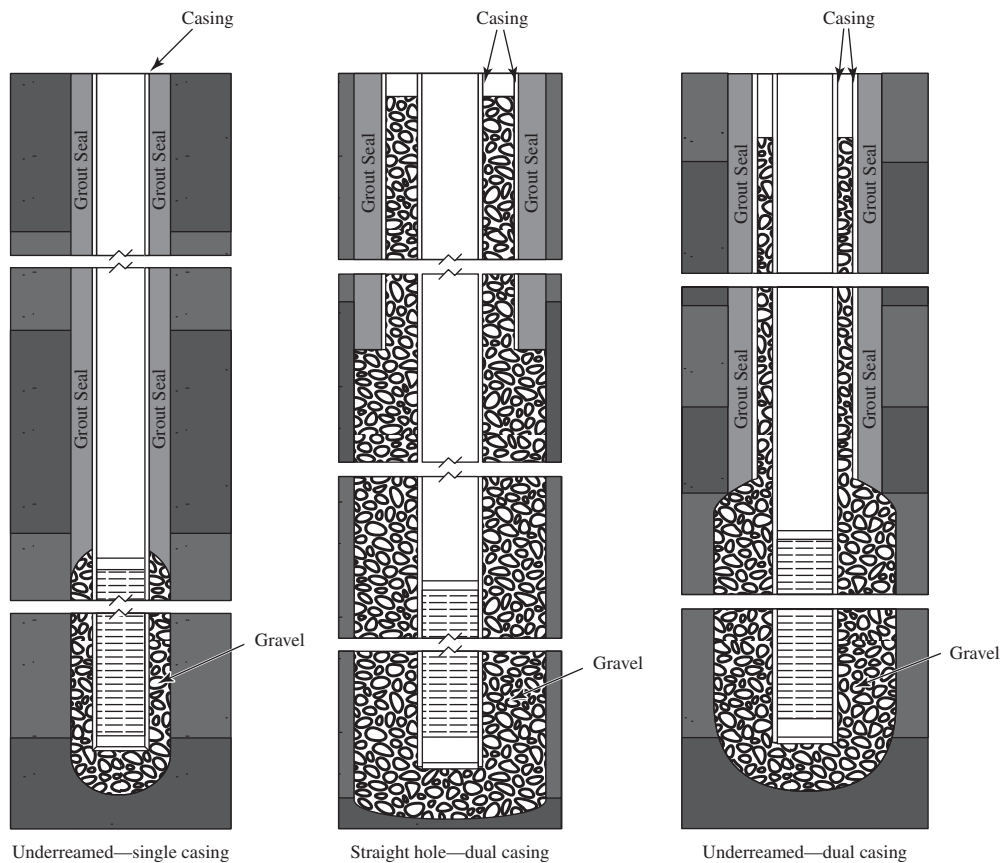
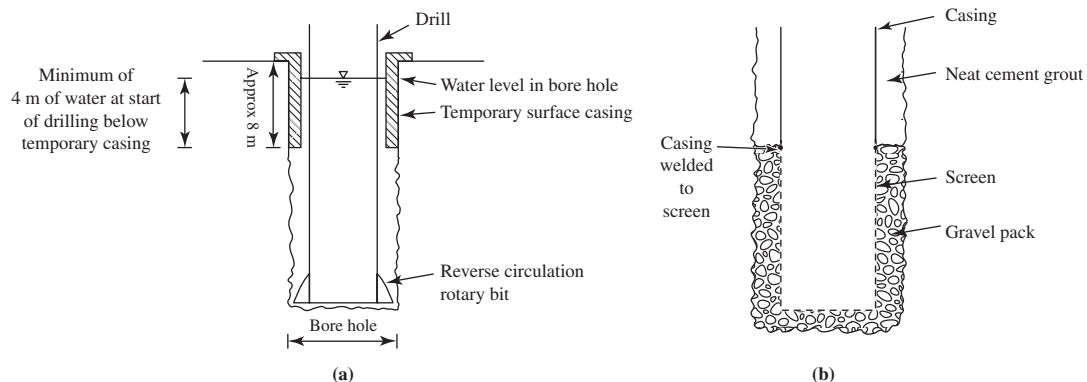

FIGURE 4-4
Some alternative schemes for packing gravel in a gravel-packed well.

**FIGURE 4-5**

Installation of gravel-packed well. (a) Start of drilling. (b) Finished bore hole with casing and screen lowered into place, gravel in place, and casing grouted.

from entering the well casing. The gravel-packed well is one of the most commonly used well designs in the United States. This system improves the efficiency of the well by increasing the inlet volume, specific capacity, retention of sand, and size of the screen openings, and by reducing the entrance friction, entrance velocity, drawdown, operating cost, and maintenance. All of these factors contribute to increasing the life of the well.

The reverse circulation rotary method of drilling is well suited to the installation of a gravel-packed well system. As shown in Figure 4-5, the bore-hole is begun with a temporary surface casing. The annular space between the drill and the bore-hole wall is about 10 to 15 cm. When the well is completed to its final depth, the casing and screen are lowered into the hole. Water in the hole maintains static pressure on the assembly and the walls of the hole. The annular space is filled with gravel to the desired level. The assembly must be supported from the ground surface until the gravel and grout are in place as the column is too long to be self-supporting.

Well Development. The aim of well development is to remove finer material from the aquifer to enlarge passages in the aquifer formation, so water can enter the well more freely.

Development has the following benefits:

- It corrects any damage or clogging that may occur during drilling.
- It increases the porosity and permeability of the natural formation in the vicinity of the well.
- It stabilizes unconsolidated material around a screened well.

The fundamental intent of the development operation is to cause reversals of flow through the well screen to rearrange the particles in the formation to break down bridging of small groups of particles. There are a number of procedures used to create the reversal. Some of these are mechanical surging with air and backwashing. Alternatively, high-velocity jetting with water may be employed. Details of these techniques are described in Hanna (2007).

Both gravel-packed wells and those in consolidated formations benefit from well development because the placement of the rock and the drilling operations tend to smear and seal the surface of the aquifer material around the well. The development operations will break up this layer. This effort is worthwhile to obtain the maximum capacity of the well.

Other Sanitary Considerations. Figure 4-6 summarizes several sanitary considerations in well construction. The sanitary well seal is a gasket to prevent contamination from entering the top of the casing. It is to be water tight with an air vent to relieve the negative pressure caused by lowering of the water in the well. Because it keeps the air above the water at atmospheric

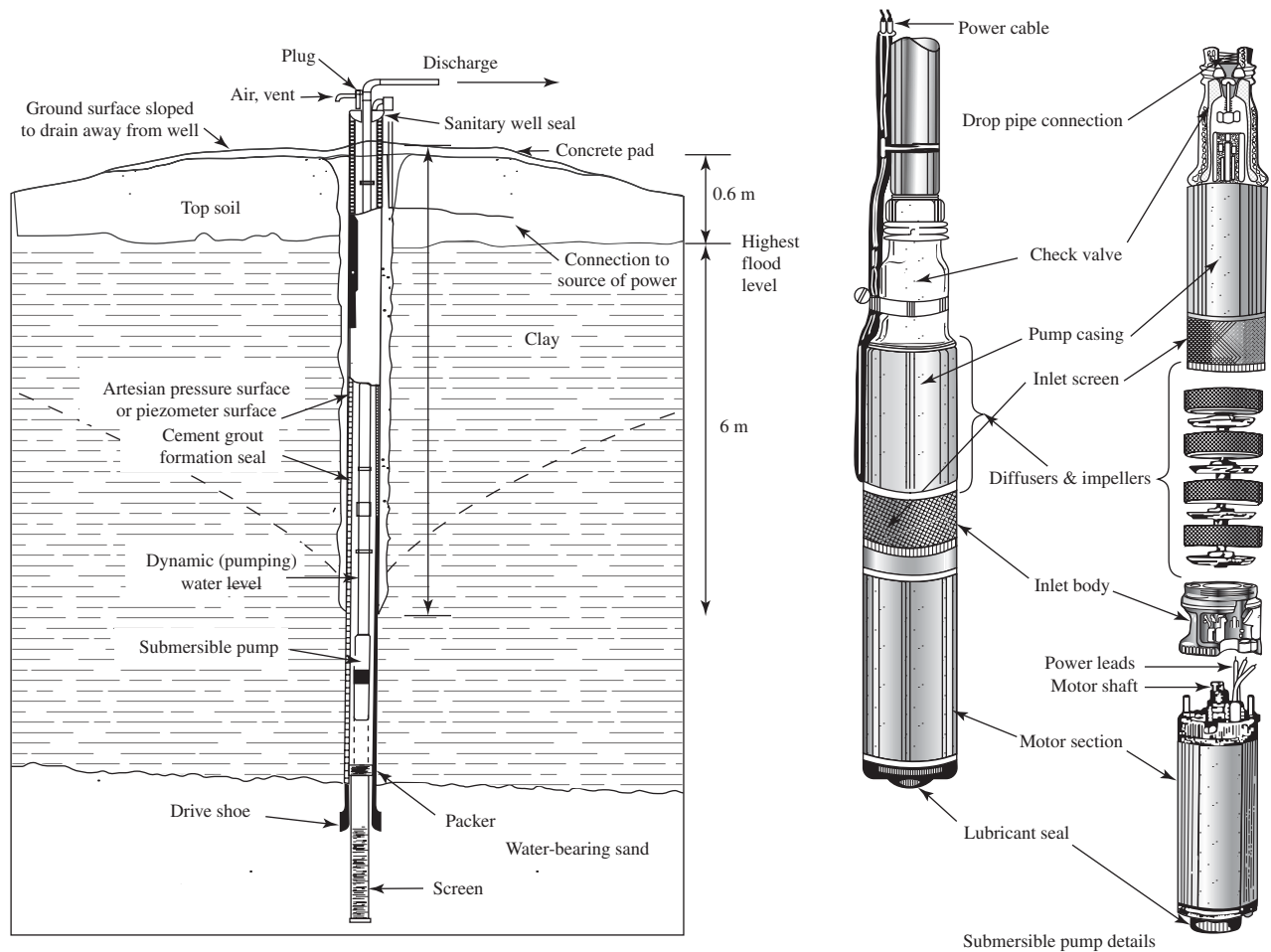

FIGURE 4-6
 Drilled well with submersible pump.
 (Source: U.S. EPA, 1973.)

pressure, the vent is essential to ensure that the calculated $NPSH_A$ represents actual conditions. The seal should be located 0.6 m above the highest known flood level.

The well casing is **never** used as the discharge pipe to bring water to the surface.

Disinfection. All newly constructed wells as well as those that have been repaired should be disinfected before being put into service. The well should be thoroughly cleaned before disinfection is initiated. Foreign substances such as sediment, soil, grease, joint dope, and scum should be removed.

Calcium hypochlorite ($\text{Ca}(\text{OCl})_2 \cdot 4\text{H}_2\text{O}$) containing approximately 65 percent available chlorine is the most common disinfectant in use. Alternatively commercial sodium hypochlorite (12 to 15 percent available chlorine) or household bleach (5.25 percent available chlorine) may be used.

Calcium hypochlorite, also known as high-test calcium hypochlorite or HTH[®], is a granular material that contains minor amounts of impurities. It has the advantage that it is cheaper than the other forms of chlorine as well as being able to be handled as a solid in the field. Because it is a solid, dissolving the material requires some care.

Sodium hypochlorite is a liquid. While it is more expensive than HTH[®], less preparation time is required to use it.

The recommended procedure for disinfection once all foreign substances have been cleared from the well is to prepare a sufficient amount of solution to achieve 100 mg/L of available chlorine in the water in the well without pumping, that is, the water that has risen to the static water level. The solution is placed in the well. A 20 to 40 L excess of solution is added to force the chlorinated water into the formation. The well is then pumped until the odor of chlorine is apparent. Pumping should then be shut down, valves closed, and the solution held in place for a minimum of 4 hours with 24 hours preferred. The well is then pumped until the water is free of chlorine odor. A field test is conducted to ensure that no chlorine is present and then a sample is taken for coliform analysis (Johnson, 1975; U.S EPA, 1973).

Example 4-1. Calculate the volume of solution and the amount of HTH[®] to be added to it to disinfect a 300 mm diameter well. The static water level in the well is 18 m above the bottom of the well.

Solution. The volume of water in the well is

$$V = (18 \text{ m}) \left(\frac{\pi(0.30 \text{ m})^2}{4} \right) = 1.27 \text{ m}^3 \text{ or } 1,270 \text{ L}$$

plus the recommended 40 L excess.

For the recommended concentration of 100 mg/L, the mass of chlorine required is

$$\text{Chlorine mass} = (100 \text{ mg/L})(1,310\text{L}) = 131,000 \text{ mg or } 131 \text{ g}$$

Because the HTH[®] is only 65 percent available chlorine, the mass of HTH[®] required is

$$\text{HTH}^{\text{®}} \text{ mass} = \frac{131 \text{ g}}{0.65} = 201.5 \text{ g}$$

Although the solubility of HTH[®] is about 215 g/L at 0°C, a more practical working solution is at about one-third of this concentration, that is

$$\frac{215 \text{ g/L}}{3} = 71.66 \text{ or } 72 \text{ g/L}$$

The volume of stock solution is then

$$V_{\text{stock}} = \frac{201.5 \text{ g}}{72 \text{ g/L}} = 2.799 \text{ or } 2.8 \text{ L}$$

Structural Protection

Every well should be provided with an overlapping, tight fitting cover at the top of the casing to prevent contaminated water from entering the well. In Figure 4-6 this is done with a concrete pad 1.2 m in diameter. The concrete pad should slope away from the well head. The slab should be poured separately from the grout seal and, where the threat of freezing exists, insulated from it and the well casing by a plastic or mastic coating to prevent bonding of the concrete to either.

The top of the well should be readily accessible for inspection, servicing, and testing. This requires that any structure over the well be easily removable to provide full, unobstructed access.

Well House. For municipal wells, a well house is a common means of providing structural protection. Figure 4-7 is an example of a typical well house. In addition to the sanitary protection features noted in Figure 4-6, the following are typically specified:

- A removable roof or hatch to allow for access to the top of the pump by a crane. This will make maintenance of motors, pumps, and screens much easier.
- Thermostatically controlled auxiliary heat in cold climates. This will prevent lines from freezing when the pump is not running or when the heat from the pump cannot compensate for excessively low temperatures.
- Ventilation with a thermostat controller. Although motors are designed to “run hot,” in warm climates the introduction of ambient air is required to keep them operating within their service range.
- Lightning protection. Valve type arresters are preferred. The arrester must be connected to a good ground. Connecting the ground terminal of the arrester to a copper rod driven into the ground does not provide a good ground. It should be connected to the motor frame of a submersible pump or to a casing that reaches the groundwater when the pump motor is at the ground surface.
- Security features. Typically these include the absence of windows, doors without windows, keyed locks, intrusion alarms.

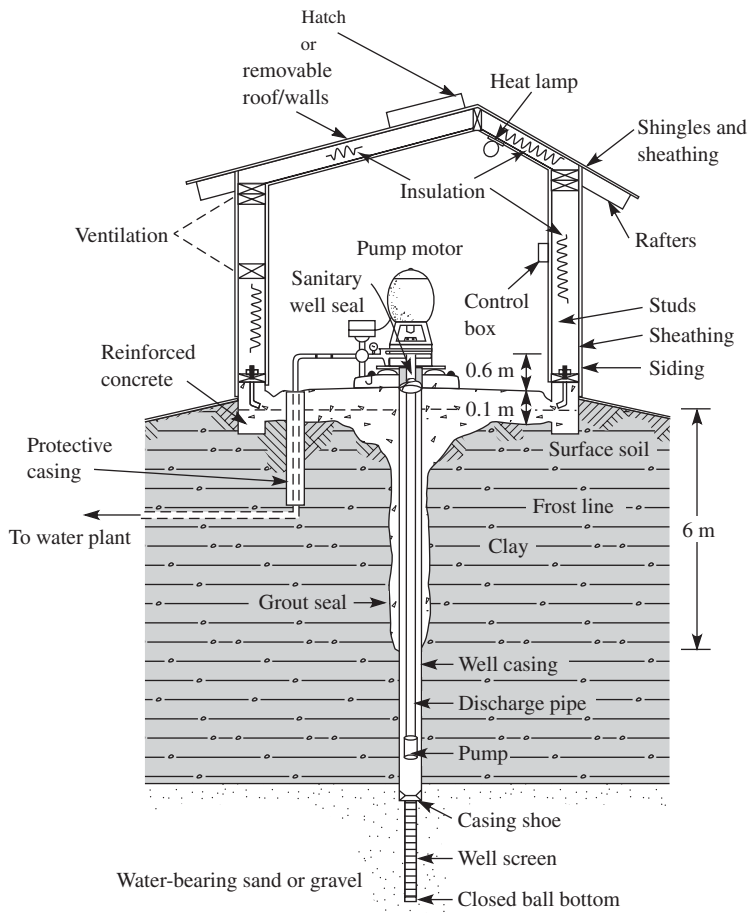

FIGURE 4-7
Pumphouse. (U.S. EPA, 1973.)

4-4 WELL DESIGN

The elements to be selected and/or designed include:

1. Number of wells
2. Location of wells
3. Pump type
4. Pump size (capacity)
5. Well diameter
6. Well depth
7. Well screen length

8. Screen slot size
9. Screen diameter
10. Screen entrance velocity
11. Pump power

Number of Wells

Redundancy Requirement. Many states require at least two wells. The maximum day demand must be met with one well out of service. Thus, a complete backup system is available in case one well fails. With the two-well system, it is better to alternate the operation of the redundant and prime system than to operate just the prime and allow the redundant to remain idle.

Demand Requirement. When the demand is such that pumping from one well dewateres the aquifer, then multiple wells must be operated at the same time (parallel operation). When wells are operated in parallel or when the time sequencing of operation of nearby wells is not sufficient to allow recovery of the cone of depression that results from drawdown, the overlap of the cones of depression will result in an additional lowering of the piezometric surface (Figure 4-8). The wells must be far enough apart that the interference of the cones of depression is not excessive.

Location of Wells

An initial estimate in setting the location of wells relative to one another may be made using one of the two following rules of thumb (Walton, 1970):

- For two wells, if the aquifer is 30 m or less in thickness, the distance between the two wells should be at least $2D$ where D is the thickness of the aquifer.
- For more than two wells, the distance between wells should be at least 75 m regardless of the thickness of the aquifers.

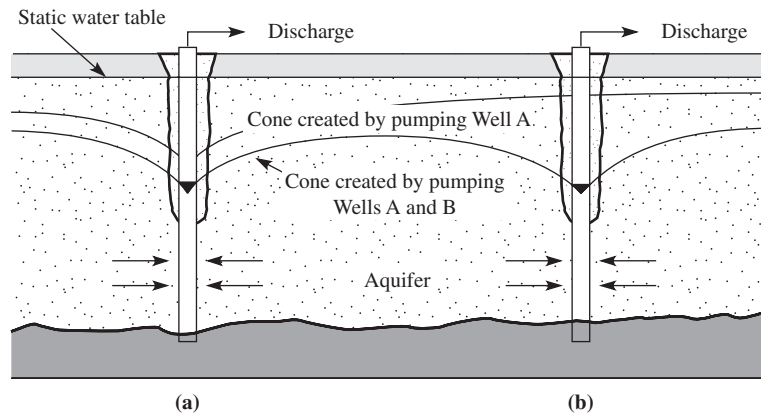

FIGURE 4-8
Effect of overlapping cones of depression. (U.S. EPA, 1973.)

In either instance, the degree of interference and its impact on capacity must be evaluated. This can be accomplished by an investigation of the well interference hydraulics.

The degree of interference, that is, the additional drawdown in a well that is caused by the operation of another well, is a function of the duration of pumping as well as the aquifer properties. When multiple wells are used, it is generally more efficient to operate the well for time periods substantially less than those required to achieve steady state. Thus, the selection of a time period for investigation of interference effects is a critical part of the analysis.

The Michigan Safe Drinking Water Act (MSDWA, 1976) requires that the *design drawdown* be that which results from 100 days of continuous drawdown at the design yield. If the maximum day demand can be met with only one well in service, then the drawdown may be calculated for only one well. Otherwise, the calculation must be made with all the wells required to meet the maximum day demand.

Unsteady Flow in a Confined Aquifer. Pumping times that are too short to achieve steady state drawdown result in unsteady flow in the aquifer. A solution for estimating drawdown resulting from unsteady flow in a confined aquifer (transient-flow) was developed by Theis (1935). Using heat-flow theory as an analogy, he found the following for an infinitesimally small diameter well with radial flow:

$$s = \frac{Q}{4\pi T} \int_u^\infty \left(\frac{e^{-u}}{u} \right) du \quad (4-1)$$

where s = drawdown ($H - h$), m

$$u = \frac{r^2 S}{4Tt}$$

r = distance between pumping well and observation well, or radius of pumping well, m

S = storage coefficient

T = transmissivity, m^2/s

t = time since pumping began, s

Note that u is dimensionless. Some explanations of the other terms may be of use. The lower case s refers to the drawdown at some time, t , after the start of pumping. Time does not appear explicitly in Equation 4-1 but is used to compute the value of u to be used in the integration. The transmissivity and storage coefficient also are used to calculate u . You should note that the r term used to calculate the value of u may take on values ranging upward from the radius of the well. Thus, you could, if you wished, calculate every point on the cone of depression (i.e., value of s) by iterating the calculation with values of r from the well radius to infinity. The integral in Equation 4-1 is called the “well function of u ” and is evaluated by the following series expansion:

$$W(u) = -0.577216 - \ln u + u - \frac{u^2}{2 \cdot 2!} + \frac{u^3}{3 \cdot 3!} - \dots \quad (4-2)$$

A table of values of $W(u)$ was prepared by Ferris et al. (1962). Values of $W(u)$ are reproduced in Table 4-3. The following example demonstrates the evaluation of the integral and calculation of drawdown.

TABLE 4-3
Values of $W(u)$

N^u	$N \times 10^{-15}$	$N \times 10^{-14}$	$N \times 10^{-13}$	$N \times 10^{-12}$	$N \times 10^{-11}$	$N \times 10^{-10}$	$N \times 10^{-9}$	$N \times 10^{-8}$	$N \times 10^{-7}$	$N \times 10^{-6}$	$N \times 10^{-5}$	$N \times 10^{-4}$	$N \times 10^{-3}$	$N \times 10^{-2}$	$N \times 10^{-1}$	N
1.0	33.9616	31.6590	29.3564	27.0538	24.7512	22.4486	20.1460	17.8435	15.5409	13.2383	10.9357	8.6332	6.3315	4.0379	1.8229	0.2194
1.1	33.8662	31.5637	29.2611	26.9585	24.6559	22.3533	20.0507	17.7482	15.4456	13.1430	10.8404	8.5379	6.2363	3.9436	1.7371	0.1860
1.2	33.7792	31.4767	29.1741	26.8715	24.5689	22.2663	19.9637	17.6611	15.3586	13.0560	10.7534	8.4509	6.1494	3.8576	1.6595	0.1584
1.3	33.6992	31.3966	29.0940	26.7914	24.4889	22.1863	19.8837	17.5811	15.2785	12.9759	10.6734	8.3709	6.0695	3.7785	1.5889	0.1355
1.4	33.6251	31.3225	29.0199	26.7173	24.4147	22.1122	19.8096	17.5070	15.2044	12.9018	10.5993	8.2968	5.9955	3.7054	1.5241	0.1162
1.5	33.5561	31.2535	28.9509	26.6483	24.3458	22.0432	19.7406	17.4380	15.1354	12.8328	10.5303	8.2278	5.9266	3.6374	1.4645	0.1000
1.6	33.4916	31.1890	28.8864	26.5838	24.2812	21.9786	19.6760	17.3735	15.0709	12.7683	10.4657	8.1634	5.8621	3.5739	1.4092	0.08631
1.7	33.4309	31.1283	28.8258	26.5232	24.2206	21.9180	19.6154	17.3128	15.0103	12.7077	10.4051	8.1027	5.8016	3.5143	1.3578	0.07465
1.8	33.3738	31.0712	28.7686	26.4660	24.1634	21.8608	19.5583	17.2557	14.9531	12.6505	10.3479	8.0455	5.7446	3.4581	1.3089	0.06471
1.9	33.3197	31.0171	28.7145	26.4119	24.1094	21.8068	19.5042	17.2016	14.8990	12.5964	10.2939	7.9915	5.6906	3.4050	1.2649	0.05620
2.0	33.2684	30.9658	28.6632	26.3607	24.0581	21.7555	19.4529	17.1503	14.8477	12.5451	10.2426	7.9402	5.6394	3.3547	1.2227	0.04890
2.1	33.2196	30.9170	28.6145	26.3119	24.0093	21.7067	19.4041	17.1015	14.7969	12.4964	10.1938	7.8914	5.5907	3.3069	1.1829	0.04261
2.2	33.1731	30.8705	28.5679	26.2653	23.9628	21.6602	19.3576	17.0550	14.7524	12.4498	10.1473	7.8449	5.5443	3.2614	1.1454	0.03719
2.3	33.1286	30.8261	28.5235	26.2209	23.9183	21.6157	19.3131	17.0106	14.7080	12.4054	10.1028	7.8004	5.4999	3.2179	1.1099	0.03250
2.4	33.0861	30.7835	28.4809	26.1783	23.8758	21.5732	19.2706	16.9680	14.6654	12.3628	10.0603	7.7579	5.4575	3.1763	1.0762	0.02844
2.5	33.0453	30.7427	28.4401	26.1375	23.8349	21.5323	19.2298	16.9272	14.6246	12.3220	10.0194	7.7172	5.4167	3.1365	1.0443	0.02491
2.6	33.0060	30.7035	28.4009	26.0983	23.7957	21.4931	19.1905	16.8880	14.5854	12.2828	9.9802	7.6779	5.3776	3.0983	1.0139	0.02185
2.7	32.9683	30.6657	28.3631	26.0606	23.7580	21.4554	19.1528	16.8502	14.5476	12.2450	9.9425	7.6401	5.3400	3.0615	0.9849	0.01918
2.8	32.9319	30.6294	28.3268	26.0242	23.7216	21.4190	19.1164	16.8138	14.5113	12.2087	9.9061	7.6038	5.3037	3.0261	0.9573	0.01686
2.9	32.8968	30.5943	28.2917	25.9891	23.6865	21.3839	19.0813	16.7788	14.4762	12.1736	9.8710	7.5687	5.2687	2.9920	0.9309	0.01482
3.0	32.8629	30.5604	28.2578	25.9552	23.6526	21.3500	19.0474	16.7449	14.4423	12.1397	9.8371	7.5348	5.2349	2.9591	0.9057	0.01305
3.1	32.8302	30.5276	28.2250	25.9224	23.6198	21.3172	19.0146	16.7121	14.4095	12.1069	9.8043	7.5020	5.2022	2.9273	0.8815	0.01149
3.2	32.7984	30.4958	28.1932	25.8907	23.5880	21.2855	18.9829	16.6803	14.3777	12.0751	9.7726	7.4703	5.1706	2.8965	0.8583	0.01013
3.3	32.7676	30.4651	28.1625	25.8599	23.5573	21.2547	18.9521	16.6495	14.3470	12.0444	9.7418	7.4395	5.1399	2.8668	0.8361	0.008939
3.4	32.7378	30.4352	28.1326	25.8300	23.5274	21.2249	18.9223	16.6197	14.3171	12.0145	9.7120	7.4097	5.1102	2.8379	0.8147	0.007891
3.5	32.7088	30.4062	28.1036	25.8010	23.4985	21.1959	18.8933	16.5907	14.2881	11.9855	9.6830	7.3807	5.0813	2.8099	0.7942	0.006970
3.6	32.6806	30.3780	28.0755	25.7729	23.4703	21.1677	18.8651	16.5625	14.2599	11.9574	9.6548	7.3526	5.0532	2.7827	0.7745	0.006160
3.7	32.6532	30.3506	28.0481	25.7455	23.4429	21.1403	18.8377	16.5351	14.2325	11.9300	9.6274	7.3252	5.0259	2.7563	0.7554	0.005448
3.8	32.6266	30.3240	28.0214	25.7188	23.4162	21.1136	18.8110	16.5085	14.2059	11.9033	9.6007	7.2985	4.9993	2.7306	0.7371	0.004820
3.9	32.6006	30.2980	27.9954	25.6928	23.3902	21.0877	18.7851	16.4825	14.1799	11.8773	9.5748	7.2725	4.9735	2.7056	0.7194	0.004267
4.0	32.5753	30.2727	27.9701	25.6675	23.3649	21.0623	18.7598	16.4572	14.1546	11.8520	9.5495	7.2472	4.9482	2.6813	0.7024	0.003779
4.1	32.5506	30.2480	27.9454	25.6428	23.3402	21.0376	18.7351	16.4325	14.1299	11.8273	9.5248	7.2225	4.9236	2.6576	0.6859	0.003349
4.2	32.5265	30.2239	27.9213	25.6187	23.3161	21.0136	18.7110	16.4084	14.1058	11.8032	9.5007	7.1985	4.8997	2.6344	0.6700	0.002969
4.3	32.5029	30.2004	27.8978	25.5952	23.2926	20.9900	18.6874	16.3884	14.0823	11.7797	9.4771	7.1749	4.8762	2.6119	0.6546	0.002633
4.4	32.4800	30.1774	27.8748	25.5722	23.2696	20.9670	18.6644	16.3619	14.0593	11.7567	9.4541	7.1520	4.8533	2.5899	0.6397	0.002336
4.5	32.4575	30.1519	27.8523	25.5497	23.2471	20.9446	18.6420	16.3394	14.0368	11.7342	9.4317	7.1295	4.8310	2.5684	0.6253	0.002073
4.6	32.4355	30.1329	27.8303	25.5277	23.2252	20.9226	18.6200	16.3174	14.0148	11.7122	9.4097	7.1075	4.8091	2.5474	0.6114	0.001841
4.7	32.4140	30.1114	27.8088	25.5062	23.2037	20.9011	18.5985	16.2959	13.9933	11.6907	9.3882	7.0860	4.7877	2.5268	0.5979	0.001635
4.8	32.3929	30.0904	27.7878	25.4852	23.1826	20.8800	18.5774	16.2748	13.9723	11.6697	9.3671	7.0650	4.7667	2.5068	0.5848	0.001453
4.9	32.3723	30.0697	27.7672	25.4646	23.1620	20.8594	18.5568	16.2542	13.9516	11.6491	9.3465	7.0444	4.7462	2.4871	0.5721	0.001291
5.0	32.3521	30.0495	27.7470	25.4444	23.1418	20.8392	18.5366	16.2340	13.9314	11.6289	9.3263	7.0242	4.7261	2.4679	0.5598	0.001148
5.1	32.3323	30.0297	27.7271	25.4246	23.1220	20.8194	18.5168	16.2142	13.9116	11.6091	9.3065	7.0044	4.7064	2.4491	0.5478	0.001021
5.2	32.3129	30.0103	27.7077	25.4051	23.1026	20.8000	18.4974	16.1948	13.8922	11.5896	9.2871	6.9850	4.6871	2.4306	0.5362	0.0009086
5.3	32.2939	29.9913	27.6887	25.3861	23.0835	20.7809	18.4783	16.1758	13.8732	11.5706	9.2681	6.9659	4.6681	2.4126	0.5250	0.0008086
5.4	32.2752	29.9726	27.6700	25.3674	23.0648	20.7622	18.4596	16.1571	13.8545	11.5519	9.2494	6.9473	4.6495	2.3948	0.5140	0.0007198

TABLE 4-3 (continued)
Values of $W(u)$

N^u	$N \times 10^{-15}$	$N \times 10^{-14}$	$N \times 10^{-13}$	$N \times 10^{-12}$	$N \times 10^{-11}$	$N \times 10^{-10}$	$N \times 10^{-9}$	$N \times 10^{-8}$	$N \times 10^{-7}$	$N \times 10^{-6}$	$N \times 10^{-5}$	$N \times 10^{-4}$	$N \times 10^{-3}$	$N \times 10^{-2}$	$N \times 10^{-1}$	N
5.5	32.2568	29.9542	27.6516	25.3491	23.0465	20.7439	18.4413	16.1387	13.8361	11.5336	9.2310	6.9289	4.6313	2.3775	0.5034	0.0006409
5.6	32.2388	29.9362	27.6336	25.3310	23.0285	20.7259	18.4233	16.1207	13.8181	11.5155	9.2130	6.9109	4.6134	2.3604	0.4930	0.0005708
5.7	32.2211	29.9185	27.6159	25.3133	23.0108	20.7082	18.4056	16.1030	13.8004	11.4978	9.1953	6.8932	4.5958	2.3437	0.4830	0.0005085
5.8	32.2037	29.9011	27.5985	25.2959	22.9934	20.6908	18.3882	16.0856	13.7830	11.4804	9.1779	6.8758	4.5785	2.3273	0.4732	0.0004532
5.9	32.1866	29.8840	27.5814	25.2789	22.9763	20.6737	18.3711	16.0685	13.7659	11.4633	9.1608	6.8588	4.5615	2.3111	0.4637	0.0004039
6.0	32.1608	29.8672	27.5646	25.2620	22.9595	20.6569	18.3543	16.0517	13.7491	11.4465	9.1440	6.8420	4.5448	2.2953	0.4544	0.0003601
6.1	32.1533	29.8507	27.5481	25.2455	22.9429	20.6403	18.3378	16.0352	13.7326	11.4300	9.1275	6.8254	4.5283	2.2797	0.4454	0.0003211
6.2	32.1370	29.8344	27.5318	25.2293	22.9267	20.6241	18.3215	16.0189	13.7163	11.4138	9.1112	6.8092	4.5122	2.2645	0.4366	0.0002864
6.3	32.1210	29.8184	27.5158	25.2133	22.9107	20.6081	18.3055	16.0029	13.7003	11.3978	9.0952	6.7932	4.4963	2.2494	0.4280	0.0002555
6.4	32.1053	29.8027	27.5001	25.1975	22.8949	20.5923	18.2898	15.9872	13.6846	11.3820	9.0795	6.7775	4.4806	2.2346	0.4197	0.0002279
6.5	32.0898	29.7872	27.4846	25.1820	22.8794	20.5768	18.2742	15.9717	13.6691	11.3665	9.0640	6.7620	4.4652	2.2201	0.4115	0.0002034
6.6	32.0745	29.7719	27.4693	25.1667	22.8641	20.5616	18.2590	15.9564	13.6538	11.3512	9.0487	6.7467	4.4501	2.2058	0.4036	0.0001816
6.7	32.0595	29.7569	27.4543	25.1517	22.8491	20.5465	18.2439	15.9414	13.6388	11.3362	9.0337	6.7317	4.4351	2.1917	0.3959	0.0001621
6.8	32.0446	29.7421	27.4395	25.1369	22.8343	20.5317	18.2291	15.9265	13.6240	11.3214	9.0189	6.7169	4.4204	2.1779	0.3883	0.0001448
6.9	32.0300	29.7275	27.4249	25.1223	22.8197	20.5171	18.2145	15.9119	13.6094	11.3068	9.0043	6.7023	4.4059	2.1643	0.3810	0.0001293
7.0	32.0156	29.7131	27.4105	25.1079	22.8053	20.5027	18.2001	15.8976	13.5950	11.2924	8.9899	6.6879	4.3916	2.1508	0.3738	0.0001155
7.1	32.0015	29.6989	27.3963	25.0937	22.7911	20.4885	18.1860	15.8834	13.5808	11.2782	8.9757	6.6737	4.3775	2.1376	0.3668	0.0001032
7.2	31.9875	29.6849	27.3823	25.0797	22.7771	20.4746	18.1720	15.8694	13.5668	11.2642	8.9617	6.6598	4.3636	2.1246	0.3599	0.00009219
7.3	31.9737	29.6711	27.3685	25.0659	22.7633	20.4608	18.1582	15.8556	13.5530	11.2504	8.9479	6.6460	4.3500	2.1118	0.3532	0.00008239
7.4	31.9601	29.6575	27.3549	25.0523	22.7497	20.4472	18.1446	15.8420	13.5394	11.2368	8.9343	6.6324	4.3364	2.0991	0.3467	0.00007364
7.5	31.9467	29.6441	27.3415	25.0389	22.7363	20.4337	18.1311	15.8286	13.5260	11.2234	8.9209	6.6190	4.3231	2.0867	0.3403	0.00006583
7.6	31.9334	29.6308	27.3282	25.0257	22.7231	20.4205	18.1179	15.8153	13.5127	11.2102	8.9076	6.6057	4.3100	2.0744	0.3341	0.00005886
7.7	31.9203	29.6178	27.3152	25.0126	22.7100	20.4074	18.1048	15.8022	13.4997	11.1971	8.8946	6.5927	4.2970	2.0623	0.3280	0.00005263
7.8	31.9074	29.6048	27.3023	24.9997	22.6971	20.3945	18.0919	15.7893	13.4868	11.1842	8.8817	6.5798	4.2842	2.0503	0.3221	0.00004707
7.9	31.8947	29.5921	27.2895	24.9869	22.6844	20.3818	18.0792	15.7766	13.4740	11.1714	8.8689	6.5671	4.2716	2.0386	0.3163	0.00004210
8.0	31.8821	29.5795	27.2769	24.9744	22.6718	20.3692	18.0666	15.7640	13.4614	11.1589	8.8563	6.5545	4.2591	2.0269	0.3106	0.00003767
8.1	31.8697	29.5671	27.2645	24.9619	22.6594	20.3568	18.0542	15.7516	13.4490	11.1464	8.8439	6.5421	4.2468	2.0155	0.3050	0.00003370
8.2	31.8574	29.5548	27.2523	24.9497	22.6471	20.3445	18.0419	15.7393	13.4367	11.1342	8.8317	6.5298	4.2346	2.0042	0.2996	0.00003015
8.3	31.8453	29.5427	27.2401	24.9375	22.6350	20.3324	18.0298	15.7272	13.4246	11.1220	8.8195	6.5177	4.2226	1.9930	0.2943	0.00002699
8.4	31.8333	29.5307	27.2282	24.9256	22.6230	20.3204	18.0178	15.7152	13.4126	11.1101	8.8076	6.5057	4.2107	1.9820	0.2891	0.00002415
8.5	31.8215	29.5189	27.2163	24.9137	22.6112	20.3086	18.0060	15.7034	13.4008	11.0982	8.7957	6.4939	4.1990	1.9711	0.2840	0.00002162
8.6	31.8098	29.5072	27.2046	24.9020	22.5995	20.2969	17.9943	15.6917	13.3891	11.0865	8.7840	6.4822	4.1874	1.9604	0.2790	0.00001936
8.7	31.7982	29.4957	27.1931	24.8905	22.5879	20.2853	17.9827	15.6801	13.3776	11.0750	8.7725	6.4707	4.1759	1.9498	0.2742	0.00001733
8.8	31.7868	29.4842	27.1816	24.8790	22.5765	20.2739	17.9713	15.6687	13.3661	11.0635	8.7610	6.4592	4.1646	1.9393	0.2694	0.00001552
8.9	31.7755	29.4729	27.1703	24.8678	22.5652	20.2626	17.9600	15.6574	13.3548	11.0523	8.7497	6.4480	4.1534	1.9290	0.2647	0.00001390
9.0	31.7643	29.4618	27.1592	24.8566	22.5540	20.2514	17.9488	15.6462	13.3437	11.0411	8.7386	6.4368	4.1423	1.9187	0.2602	0.00001245
9.1	31.7533	29.4507	27.1481	24.8455	22.5429	20.2404	17.9378	15.6352	13.3326	11.0300	8.7275	6.4258	4.1313	1.9087	0.2557	0.00001115
9.2	31.7424	29.4398	27.1372	24.8346	22.5320	20.2294	17.9268	15.6243	13.3217	11.0191	8.7166	6.4148	4.1205	1.8987	0.2513	0.000009988
9.3	31.7315	29.4290	27.1264	24.8238	22.5212	20.2186	17.9160	15.6135	13.3109	11.0083	8.7058	6.4040	4.1098	1.8888	0.2470	0.000008948
9.4	31.7208	29.4183	27.1157	24.8131	22.5105	20.2079	17.9053	15.6028	13.3002	10.9976	8.6951	6.3934	4.0992	1.8791	0.2429	0.000008018
9.5	31.7103	29.4077	27.1051	24.8025	22.4999	20.1973	17.8948	15.5922	13.2896	10.9870	8.6845	6.3828	4.0887	1.8695	0.2387	0.000007185
9.6	31.6998	29.3972	27.0946	24.7920	22.4895	20.1869	17.8843	15.5817	13.2791	10.9765	8.6740	6.3723	4.0784	1.8599	0.2347	0.000006439
9.7	31.6894	29.3868	27.0843	24.7817	22.4791	20.1765	17.8739	15.5713	13.2688	10.9662	8.6637	6.3620	4.0681	1.8505	0.2308	0.000005771
9.8	31.6792	29.3766	27.0740	24.7714	22.4688	20.1663	17.8637	15.5611	13.2585	10.9559	8.6534	6.3517	4.0579	1.8412	0.2269	0.000005173
9.9	31.6690	29.3664	27.0639	24.7613	22.4587	20.1561	17.8535	15.5509	13.2483	10.9458	8.6433	6.3416	4.0479	1.8320	0.2231	0.000004637

Source: Ferris et al., 1962.

Example 4-2. If the storage coefficient is 2.74×10^{-4} and the transmissivity is $2.63 \times 10^{-3} \text{ m}^2/\text{s}$, calculate the drawdown that will result at the end of 100 days of pumping a 0.61 m diameter well at a rate of $2.21 \times 10^{-2} \text{ m}^3/\text{s}$.

Solution. Begin by computing u . The radius is 0.305 m and

$$u = \frac{(0.305 \text{ m})^2(2.74 \times 10^{-4})}{4(2.63 \times 10^{-3} \text{ m}^2/\text{s})(100 \text{ d})(86,400 \text{ s/d})} = 2.80 \times 10^{-10}$$

From the series expansion, find

$$W(u) = -0.577216 - \ln(2.80 \times 10^{-10}) + 2.80 \times 10^{-10} - \frac{(2.80 \times 10^{-10})^2}{2!} + \dots = 21.42$$

and compute s as

$$\begin{aligned} s &= \frac{2.21 \times 10^{-2} \text{ m}^3/\text{s}}{4(3.14)(2.63 \times 10^{-3} \text{ m}^3/\text{s})} (21.42) \\ &= 14.32 \text{ or } 14 \text{ m} \end{aligned}$$

Comment. In this example, the transmissivity and storage coefficient are given. Obviously, they need to be determined to use Equation 4-2. The method of estimating T and S are given in the next section.

Determining the Hydraulic Properties of a Confined Aquifer. The estimation of the transmissivity and storage coefficient of an aquifer is based on the results of a pumping test. The preferred situation is one in which one or more observation wells located at a distance from the pumping well are used to gather the data. In the transient state, we cannot solve for T and S directly. The Cooper and Jacob method has been selected from the several indirect methods that are available (Cooper and Jacob, 1946). For values of u less than 0.01, they found that Equation 4-1 could be rewritten as:

$$s = \frac{Q}{4\pi T} \ln \frac{2.25Tt}{r^2S} \quad (4-3)$$

A semilogarithmic plot of s versus t (log scale) from the results of a pumping test (Figure 4-9) enables a direct calculation of T from the slope of the line. From Equation 4-3, the difference in drawdown at two points in time may be shown to be

$$s_2 - s_1 = \frac{Q}{4\pi T} \ln \frac{t_2}{t_1}$$

Solving for T , we find

$$T = \frac{Q}{4\pi(s_2 - s_1)} \ln \frac{t_2}{t_1} \quad (4-5)$$

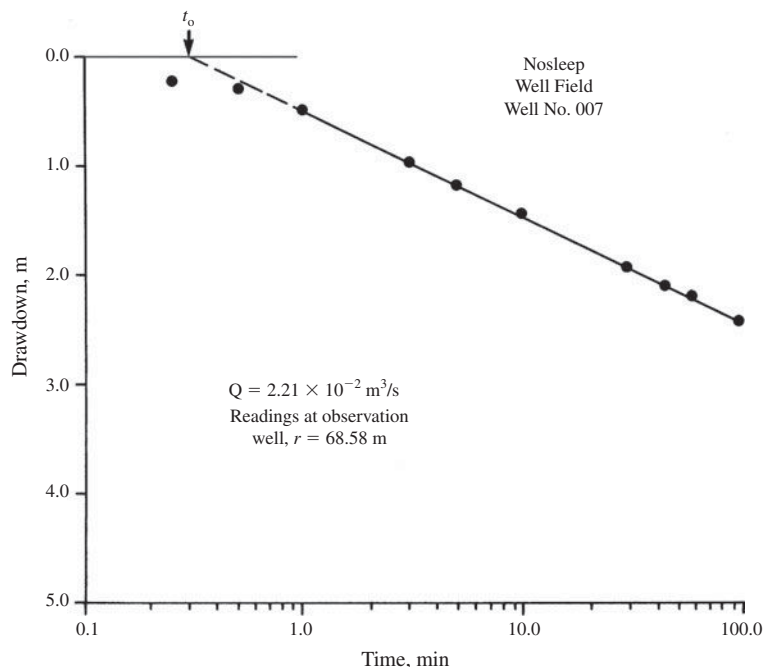
**FIGURE 4-9**

Pumping test results.

(Source: Davis and Cornwell, 2008.)

Cooper and Jacob showed that an extrapolation of the straight-line portion of the plot to the point where $s = 0$ yields a “virtual” (imaginary) starting time (t_0). At this virtual time, Equation 4-3 may be solved for the storage coefficient, S , as follows:

$$S = \frac{2.25 T t_0}{r^2} \quad (4-6)$$

The calculus implies that the distance to the observation well (r) may be as little as the radius of the pumping well itself. This means that although it is preferable to have a second observation well to use for drawdown measurements, drawdown measured in the pumping well may be used as a source of data.

Example 4-3. Determine the transmissivity and storage coefficient for the Nosleep’s well field based on the pumping test data plotted in Figure 4-9.

Solution. Using Figure 4-9, we find $s_1 = 0.49$ m at $t_1 = 1.0$ min, and at $t_2 = 100.0$ min, we find $s_2 = 2.37$ m. Thus,

$$\begin{aligned} T &= \frac{2.21 \times 10^{-2} \text{ m}^3/\text{s}}{4(3.14)(2.37 \text{ m} - 0.49 \text{ m})} \ln \frac{100.0}{1.0} \\ &= (9.35 \times 10^{-4})(4.61) = 4.31 \times 10^{-3} \text{ m}^2/\text{s} \end{aligned}$$

From Figure 4-9, we find that the extrapolation of the straight portion of the graph to a drawdown of 0.0 m yields $t_0 = 0.30$ min. Using the distance between the pumping well and the observation ($r = 68.58$ m), we find

$$s = \frac{(2.25)(4.31 \times 10^{-3} \text{ m}^2/\text{s})(0.30 \text{ min})(60 \text{ s/min})}{(68.58 \text{ m})^2}$$

$$= 3.7 \times 10^{-5}$$

Now we should check to see if our implicit assumption that u is less than 0.01 was true. We use $t = 100.0$ min for the check.

$$u = \frac{(68.58 \text{ m})^2(3.7 \times 10^{-5})}{4(4.31 \times 10^{-3} \text{ m}^2/\text{s})(100.0 \text{ min})(60 \text{ s/min})}$$

$$= 1.68 \times 10^{-3}$$

Thus, the assumption is acceptable. In this example, the pumping test curve plots as a straight line on semilog paper. In most instances a more complex curve results. Analysis of the more complex case is left for more advanced texts.

Calculating Interference. As was mentioned earlier, the cones of depression of wells located close together will overlap. This interference will reduce the potential yield of the wells. In severe circumstances, well interference can cause drawdowns that lower the piezometric surface below the bottom of the aquiclude and, thus, cause structural failure of the well and surrounding structures due to settlement of the ground surface.

The method of superposition is used to estimate the total drawdown due to interference. This method assumes that the drawdown at a particular location is equal to the sum of the drawdowns from all of the influencing wells. Mathematically this can be represented as follows:

$$s_{\text{resultant}} = \sum_{i=1}^n s_i \quad (4-7)$$

where s_i = individual drawdown caused by well i at location r .

This method is illustrated in the next example for the case of three identical wells located symmetrically in a line.

Example 4-4. Three wells are located at 75-m intervals along a straight line. Each well is 0.50 m in diameter. The coefficient of transmissivity is $2.63 \times 10^{-3} \text{ m}^2/\text{s}$, and the storage coefficient is 2.74×10^{-4} . Determine the drawdown at each well if each well is pumped at $4.42 \times 10^{-2} \text{ m}^3/\text{s}$ for 10 days.

Solution. The drawdown at each well will be the sum of the drawdown of each well pumping by itself plus the interference from each of the other two wells. Because each well is the same diameter and pumps at the same rate, we may compute one value of the term $Q/(4\pi T)$ and apply it to each well.

$$\frac{Q}{4\pi T} = \frac{4.42 \times 10^{-2} \text{ m}^3/\text{s}}{4(3.14)(2.63 \times 10^{-3} \text{ m}^2/\text{s})} = 1.34 \text{ m}$$

In addition, because each well is identical, the individual drawdowns of the wells pumping by themselves will be equal. Thus, we may compute one value of u and apply it to each well.

$$u = \frac{(0.25 \text{ m})^2 (2.74 \times 10^{-4})}{4(2.63 \times 10^{-3} \text{ m}^2/\text{s})(10 \text{ d})(86,400 \text{ s/d})} = 1.88 \times 10^{-9}$$

Using Equation 4-2 with $u = 1.88 \times 10^{-9}$, find $W(u) = 19.51$. The drawdown of each individual well is then

$$s = (1.34 \text{ m})(19.51) = 26.15 \text{ m}$$

Before we begin calculating interference, we should label the wells so that we can keep track of them. Let us call the two outside wells A and C and the inside well B. Let us now calculate interference of well A on well B, that is, the increase in drawdown at well B as a result of pumping well A.

Because we have pumped only for 10 days, we must use the transient-flow equations and calculate u at 75 m.

$$u = \frac{(75 \text{ m})^2 (2.74 \times 10^{-4})}{4(2.63 \times 10^{-3} \text{ m}^2/\text{s})(10 \text{ d})(86,400 \text{ s/d})} = 1.70 \times 10^{-4}$$

Using Equation 2-8 with $u = 1.70 \times 10^{-4}$, find $W(u) = 8.10$. The interference of well A on B is then

$$s_{A \text{ on } B} = (1.34)(8.10) = 10.86 \text{ m}$$

In a similar fashion, we calculate the interference of well A on well C.

$$u_{150} = (150)^2 (3.01 \times 10^{-8}) = 6.78 \times 10^{-4}$$

and $W(u) = 6.72$. The interference of well A on well C is then

$$s_{A \text{ on } C} = (1.34)(6.72) = 9.00 \text{ m}$$

Because the well arrangement is symmetrical, the following equalities may be used:

$$s_{A \text{ on } B} = s_{B \text{ on } A} = s_{C \text{ on } B}$$

and

$$s_{A \text{ on } C} = s_{C \text{ on } A}$$

The total drawdown at each well is computed as follows:

$$\begin{aligned} s_A &= s + s_{B \text{ on } A} + s_{C \text{ on } A} \\ s_A &= 26.15 + 10.86 + 9.00 = 46.01 \text{ or } 46 \text{ m} \\ s_B &= s + s_{A \text{ on } B} + s_{C \text{ on } B} \\ s_B &= 26.15 + 10.86 + 10.86 = 47.86 \text{ or } 48 \text{ m} \\ s_C &= s_A = 46.01 \text{ or } 46 \text{ m} \end{aligned}$$

Drawdowns are measured from the undisturbed piezometric surface.

The results of these calculations have been plotted in Figure 4-10.

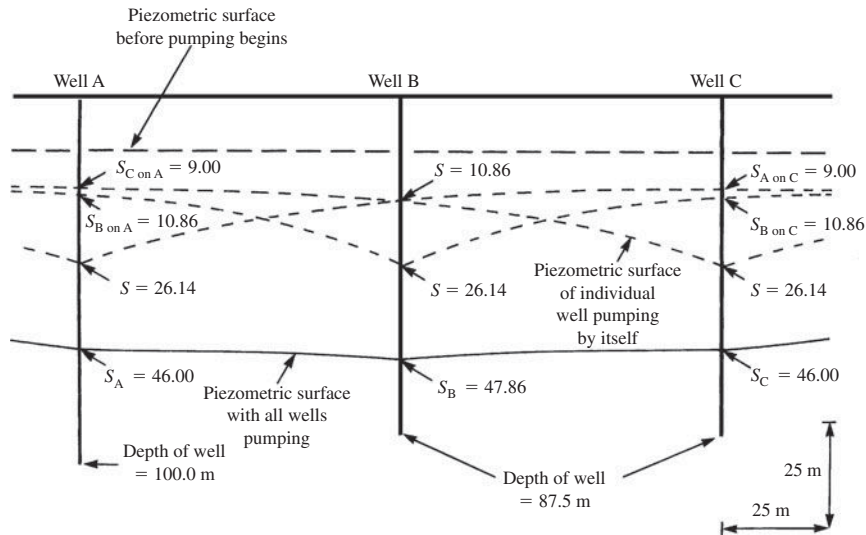

FIGURE 4-10
Interference drawdown of three wells.
(Source: Davis and Cornwall, 2008.)

Comment. Note that if the wells are pumped at different rates, the symmetry would be destroyed and the value $Q/(4\pi T)$ would have to be calculated separately for each case. Likewise, if the distances were not symmetric, then separate u values would be required.

Unsteady Flow in an Unconfined Aquifer. There is no exact solution to the transient-flow problem for unconfined aquifers because T changes with time and r as the water table is lowered. Furthermore, vertical-flow components near the well invalidate the assumption of radial flow that is required to obtain an analytical solution. If the unconfined aquifer is very deep in comparison to the drawdown, the transient-flow solution for a confined aquifer may be used for an approximate solution. For larger drawdowns, Boulton (1954) presented a solution that is valid if the water depth in the well is greater than the half of the height of the nonpumping water level above the bottom confining layer, that is $0.5H$ in Figure 4-11.

The height of the water level in a pumping well (taking into account the surface of seepage but neglecting well losses) can be estimated from

$$h_{iw}^2 = H^2 - \frac{Q}{\pi K} \ln \left\{ 1.5 \left(\frac{Kt}{Sr_w} \right) \right\}^{0.5} \quad (4-8)$$

- where h_{iw} = height of water inside pumped well, m
 H = static height of piezometric surface (the water table), m
 K = hydraulic conductivity, m/s
 t = time from beginning of pumping, s
 S = specific yield
 r_w = radius of well, m

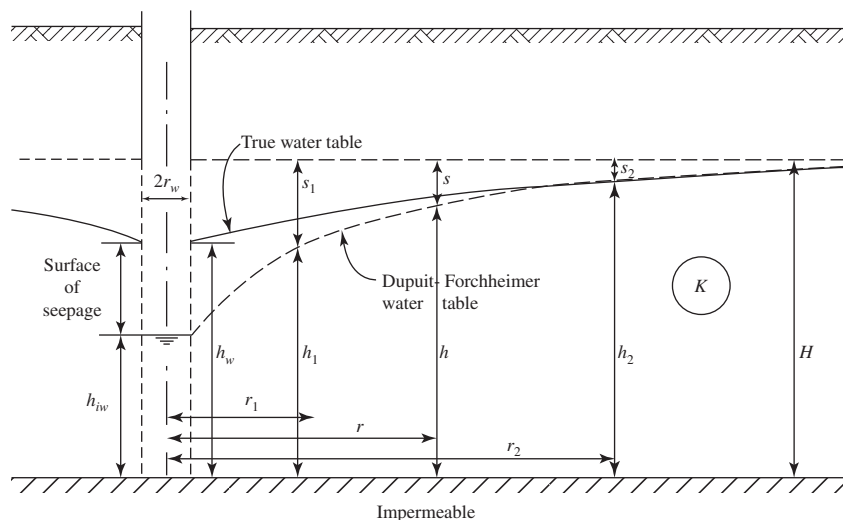

FIGURE 4-11

Geometry and symbols for pumped well in unconfined aquifer.

(Source: Bouwer, 1978.)

The equation is valid if the ratio Kt/SH is greater than 5 (Boulton, 1954). If the ratio is greater than 0.05 but less than 5, an alternative form of the equation is used:

$$h_w = H - \frac{Q}{2\pi KH} \left\{ m + \ln \frac{H}{r_w} \right\} \quad (4-9)$$

where m is a function of Kt/SH and can be obtained from a curve plotted through the following points (Boulton, 1954):

Kt/SH	0.05	0.2	1	5
m	-0.043	0.087	0.512	1.288

The range $Kt/SH < 0.05$ will usually be of minor practical significance (Bouwer, 1978).

This is an approximation technique. The estimate of K and S is crucial to the technique. Field methods for obtaining these are discussed in Bouwer (1978).

Calculating Interference. As with confined aquifers, operation of multiple wells will result in interference. The height of water in individual wells can be estimated from Equations 4-8 and 4-9. The interference of one well on another well can be estimated with a modified form of Thiem's steady-state equation (Thiem, 1906):

$$Q = \frac{\pi K (h_2^2 - h_1^2)}{\ln(r_2/r_1)} \quad (4-10)$$

where Q = pumping flow rate, m^3/s

K = hydraulic conductivity, m/s

h_1, h_2 = height of piezometric surface above the confining layer, m
 r_1, r_2 = radius from pumping well, m

The term $h_2^2 - h_1^2$ may be written as $2(h_2 - h_1)(h_2 + h_1)/2$, where $(h_2 + h_1)/2$ is the average height of the aquifer between r_2 and r_1 . The product $K(h_2 + h_1)/2$ represents the average transmissivity between r_2 and r_1 (Bouwer, 1978).

The procedure then is to calculate the individual drawdowns (h_{iw}) at r_w at time t with Equation 4-8 and use this value as h_1 at r_1 in Equation 4-10 to determine the value of h_2 (and consequently s_2) at another well located at r_2 . Then, as with the confined aquifer system discussed above, determine the total drawdown by the method of superposition.

In general, finite-element numerical methods for estimating interference yield more satisfactory results than the approximation technique presented here. These are left for more advanced texts.

Evaluation of Interference Calculations. The first criteria in evaluating the results of the interference calculation is to determine whether or not the operation of the wells results in failure of the well.

- For a confined aquifer, this is a drawdown that lowers the resultant piezometric surface below the bottom of the upper confining layer, that is, the top of the confined aquifer. If it does, then the solution is unacceptable because the dewatering of the aquifer will cause ground settlement and structural failure of the wells as well as buildings in or near the well field.
- For an unconfined aquifer, failure occurs when the drawdown lowers the piezometric surface below the pump. In effect, the well “drys up.”

These are “catastrophic” events. Prudent engineering design will ensure that the operation of the well does not approach failure.

Because there is a need to provide a reliable groundwater source, it is unusual to pump all the wells in the well field at the same time. Some wells must serve as a backup in case of pump failures, downtime for maintenance, and emergency demand such as fires. Thus, the evaluation of the interference calculations is guided by the need to assess the impact on the reserve wells, that is, will the piezometric surface of the nonpumping wells be lowered to such an extent that pumping from them is impractical or uneconomical?

A general operational technique then is to operate a fraction of the wells for shorter periods of time and to rotate between wells to allow time for recovery.

Well Field Layout. The selected arrangement of wells and the number of wells is based on the hydraulic analysis and the operational schedule that can be employed. The maximum day demand must be satisfied with enough pumping reserve capacity to allow for pumps to be out of service for repairs. The wells must be spaced to meet the hydraulic constraints of the aquifer as well as property boundaries and any existing pipe network.

Pump Type

Vertical turbine pumps are frequently selected for municipal water supply. These are the same type of pump that was discussed in Chapter 3. They may be either submerged pumps, where the

motor and pump are in the water in the well, or they may be a motor at ground level with the pump submerged in the water.

Pump Size

The pump capacity is a function of the demand, the demand cycle, the distribution system design, the yield of the aquifer, screen size, casing diameter, and column pipe size.

Small Systems. For small systems* that pump directly to elevated storage, the capacity of the pump required is determined by the daily water consumption and the volume of the storage tank. In general, it may be assumed that the daily total consumption takes place in 12 to 16 hours. The pump capacity (m^3/h) is normally selected to deliver the average daily water demand to the storage tank in 6 to 12 hours. In very small systems, the pump may be sized to supply the average demand in 2 hours. This is done to take advantage of the increased efficiency of larger pumps.

If the maximum daily demand is two times the average day (a rule of thumb commonly used in small systems), a pump capable of supplying the average daily demand in 12 hours will, after the maximum day, be able to refill a storage tank sized to provide one full day of storage at average demand by 24 hours of continuous pumping. Obviously, larger capacity pumps that deliver the daily demand in a shorter time provide an additional margin of safety in pumping capacity. However, very short pumping times are also undesirable because of dynamic structural loading effects on the storage vessel and the requirement for larger transmission lines.

In small systems, no attempt is made to supply fire demand by pumping. Fire demand is satisfied from the storage reservoir.

Pump Capacity Selection Criteria. The results of the hydraulic analysis set the boundary conditions for the maximum capacity that the aquifer will yield without adverse effects.

The operational characteristics of the well field should take into account the demand cycle, over various periods (daily, weekly, monthly). For example, the minimum flow rate during the winter period can be used to establish the minimum capacity to be supplied by the well field and the minimum number of wells that need to be operated. In extreme, this may mean operating for only a fraction of the day at the beginning of the design life.

The maximum demand flow rate is used to establish the capacity to be supplied by the well field and the minimum number of wells that need to be operated to do this. In addition, extra well capacity must be provided to comply with redundancy requirements.

The distribution system design, and, in particular, the available storage capacity will also play a role in selection of the pumping capacity. Storage provides a means of reducing the pumping capacity. Nighttime pumping to storage during off-peak hours will allow for smaller pumping capacity for the well field as part of the daytime demand can be met from storage rather than the well field.

The following two examples illustrate some of the decisions that must be made.

*For example, those where one pump satisfies the maximum day demand and is without an adverse impact on the aquifer operating at maximum capacity over long periods of time.

Example 4-5. A very small village has an average day design demand of $190 \text{ m}^3/\text{d}$ and a maximum day design demand of $380 \text{ m}^3/\text{d}$. They will have a distribution system. Compare the number of wells and the capacity of each well for a system that includes the wells and one elevated storage tank and a system that does not have an elevated storage tank.

Solution. To meet regulatory redundancy requirements there must be a minimum of two wells. Each well must be capable of meeting the maximum day design demand with one pump out of service.

Some alternative selections are:

- Two wells, each well rated at $380 \text{ m}^3/\text{d}$. For the average day, one well would pump for 12 hours, that is

$$\left(\frac{12 \text{ h}}{24 \text{ h}}\right)(380 \text{ m}^3/\text{d}) = 190 \text{ m}^3/\text{d}$$

- Two wells, each well capable of providing the average day demand in two hours to take advantage of a higher efficiency pump. For the maximum day, the pump would operate for four hours. Each well would have a rated capacity of

$$\left(\frac{24 \text{ h}}{2 \text{ h}}\right)(380 \text{ m}^3/\text{d}) = 4,560 \text{ m}^3/\text{d}$$

Thus, the provision of an elevated storage system gives a range of pumping capacity from $190 \text{ m}^3/\text{d}$ to $4,560 \text{ m}^3/\text{d}$. Without the storage tank, the pump capacity is restricted to $190 \text{ m}^3/\text{d}$.

Example 4-6. A community well system is to provide $11,450 \text{ m}^3/\text{d}$ for the average day at its design life. The minimum demand at the beginning of the design life of the well field is estimated to be $3,800 \text{ m}^3/\text{d}$. A hydraulic analysis of three wells operating at a maximum day demand of $22,900 \text{ m}^3/\text{d}$ sustained for a 10-day period will lower the piezometric surface to the bottom of the confining layer of the artesian aquifer. The distribution system has storage capacity for one day at the maximum demand.

Recommend a well system (number of wells and pumping rate) for this community.

Solution. The three-well system is not satisfactory for two reasons. First it does not provide the redundancy requirement of one well out of service at the time of the maximum demand. Second, it provides no margin of safety to protect the aquifer from overpumping. Even if the demand fell to the average day demand after the sustained maximum demand, continued pumping would lower the piezometric surface below the aquiclude. More likely, pumping to meet the average day demand prior to the 10 days of maximum demand would have lowered the piezometric surface sufficiently so the aquifer would be dewatered.

One alternative solution is to provide six wells with a capability of meeting the maximum day requirement with only three wells operating. This would meet the regulatory requirement to have one spare well available at the time of the maximum demand. The six wells would have to be

located by hydraulic analysis to lower the interference effects sufficiently so that the piezometric surface would not be lowered below the aquiclude over a long term pumping cycle that included the 10 day maximum demand.

Comment. One day's storage in the system has little impact on the well system design for this case.

Well Diameter

For practical purposes, the well diameter is equal to the screen diameter, and the screen diameter is generally taken to be equal to the casing diameter. The casing diameter must be large enough to accommodate the pump and to permit entry of the groundwater without undue head losses. Table 4-4 provides guidance on the relationship between expected well yield and the recommended inside diameter (ID) of the well casing.

These are recommended casing diameters. The casing **must** be large enough to hold the selected pump with some additional clearance to provide space for installation of a sounding tube or air line to measure depth of water in the well, and to allow for free operation of the pump shaft and, for submersible pumps, the cable, as well as an allowance for misalignment during drilling. It is recommended that the casing diameter be increased a minimum of an additional 50 mm greater than the selected pump diameter. For submersible pumps, a further 50 mm increase in the diameter is recommended. Likewise, for pumps set more than 120 m from the surface, a further 50 mm in diameter is recommended (RMC, 2007).

Well Depth

The well must be deep enough to penetrate the water-bearing aquifer. Generally the well is completed to the bottom of the aquifer. This allows use of more of the aquifer thickness. It results in a higher *specific capacity* (flow rate per unit fall of the water level in the well, $\text{m}^3/\text{d} \cdot \text{m}$) as well as potential for more drawdown that results in a greater yield.

Michigan Safe Drinking Water Act rules require that the depth of a well in an unconfined aquifer be below the design drawdown plus the length of the screen, plus 1.5 m. The additional 1.5 m is provided to enhance uniform velocities through the screen. In a confined aquifer, the

TABLE 4-4
Recommended well casing diameter

Expected well yield, m^3/d	Well casing ID, mm
< 500	150
400–1,000	200
800–2,000	250
2,000–3,500	300
3,000–5,000	350
4,500–7,000	400
6,500–10,000	500
8,500–17,000	600

ID = inside diameter.

Adapted from Johnson, 1975.

depth of the well is not dependent on the drawdown. However, the drawdown must not lower the piezometric surface below the top of the aquifer (MSDWA, 1976).

Well Screen Length

The factors that affect the choice of the screen length include: the open area per unit length of screen, the character of the aquifer, the cost of the screen, the desired yield, and the design service life of the well. The optimum length of well screen depends on the thickness of the aquifer, available drawdown, and stratification of the aquifer. As long a screen as possible should be used to reduce entrance velocities and the effects of partial penetration of the aquifer. For unconfined aquifers, optimum specific capacity and yield are generally obtained by screening the lower 30 percent to 50 percent of the aquifer (Walton, 1970). Because the drawdown must be kept above the top of the screen, longer screens reduce the available drawdown.

In homogeneous artesian aquifers, 70 to 80 percent of the water-bearing sand should be screened. If the aquifer is less than 10 m thick, 70 percent is satisfactory. Between 10 and 20 m thick aquifers should be screened about 75 percent of the thickness. Aquifers greater than 20 m thick should be screened for 80 percent of their depth (Johnson, 1975).

There are some exceptions to this approach. One is to center the well screen between the top and bottom of the aquifer to make more efficient use of a given length of screen in a uniform artesian aquifer. Another exception is when a portion of the aquifer is not screened because it yields a poor quality water (Johnson, 1975).

Walton made a study of well failures due to partial clogging of the well walls and screen openings. He found that, on the average, about one-half of the open area of the screen will be blocked by aquifer material. Thus, the effective open area of the screen is about 50 percent of the actual open area. He developed a technique for estimating the screen length taking this into account (Walton, 1962). The length of screen for a *natural pack well* may be selected using Table 4-5 and Walton's equation:

$$S_L = \frac{Q}{A_o v} \quad (4-11)$$

where Q = flow rate, m³/s
 A_o = effective open area per meter of screen, m²/m
 v = optimum screen velocity, m/s

TABLE 4-5
Optimum screen entrance velocities

Hydraulic conductivity, m/d	Optimum screen entrance velocity, m/s
< 20	0.010
20	0.015
40	0.020
80	0.030
120	0.040
160	0.045
200	0.050
240	0.055
> 240	0.060

Source: Walton, 1962.

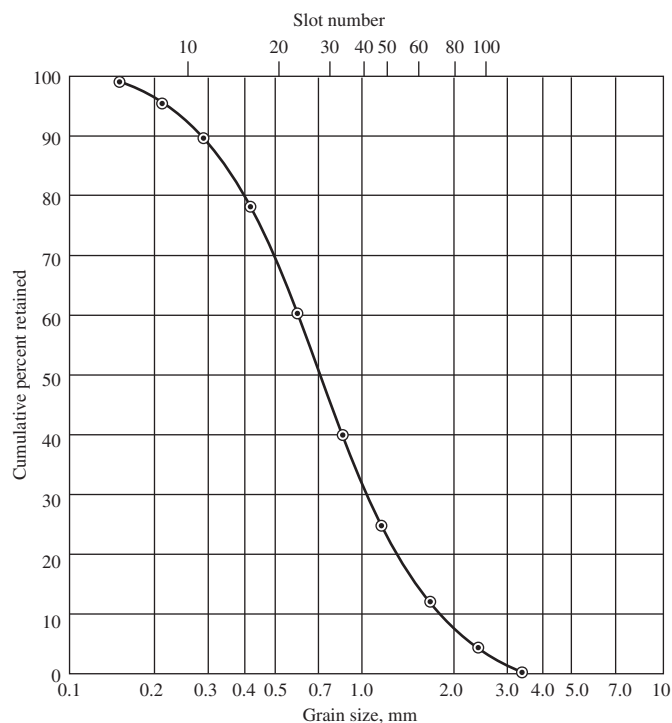

FIGURE 4-12

Grain size analysis for selection of screen slot size.

Screen Slot Size

The size of the screen openings, commonly called the *slot size*, is selected on the basis of a sieve analysis of the aquifer material. A plot of the results of a sieve analysis is shown in Figure 4-12. Table 4-6 is an example of slot size options that are obtained from screen manufacturers. For relatively fine and uniform materials (*uniformity coefficient** < 3), the slot size may be taken as the size of the sieve opening that will retain 40 percent of the material ($D_{40\%}$) if the groundwater is noncorrosive and $D_{50\%}$ if the groundwater is corrosive. If the aquifer is coarse sand and gravel, the slot size may be $D_{30\%}$ to $D_{50\%}$ of the sand fraction. For nonuniform materials (uniformity coefficient > 6), slot sizes should be about equal to $D_{30\%}$ if the overlying material is stable. If it is unstable, the slot size should be $D_{60\%}$.

The grain size of the gravel pack is selected to retain the grains of native material while allowing the maximum amount of water into the pump. A typical approach is to select the 70 percent retained size of the unconsolidated aquifer material and then multiply that grain size by 4 to 6 in specifying the grain size of the gravel. The screen opening is then sized to retain 100 percent of the gravel.

*The uniformity coefficient is defined as the quotient of the 40 percent size ($D_{40\%}$) of the sand divided by the 90 percent size ($D_{90\%}$). The $D_{40\%}$ is the size of the sieve opening that retains 40 percent of the sand upon sieving. U.S. Standard sieve sizes are given in Appendix B.

TABLE 4-6
Representative open areas of screens

Nominal screen diameter, mm	No. 10 slot	No. 15 slot	No. 20 slot	No. 25 slot	No. 30 slot	No. 40 slot	No. 50 slot	No.60 slot	No. 80 slot	No. 100 slot
	0.25 mm	0.38 mm	0.50 mm	0.64 mm	0.76 mm	1.0 mm	1.3 mm	1.5 mm	2.0 mm	2.5 mm
Intake area, m ² /m of screen length										
150	0.053	0.076	0.097	0.116	0.133	0.165	0.193	0.214	0.252	0.282
200	0.087	0.123	0.152	0.182	0.207	0.252	0.288	0.320	0.370	0.409
250	0.061	0.091	0.116	0.142	0.163	0.205	0.243	0.275	0.332	0.379
300	0.074	0.106	0.138	0.167	0.193	0.243	0.288	0.326	0.394	0.449
350	0.080	0.116	0.150	0.182	0.212	0.267	0.313	0.358	0.432	0.491
400	0.085	0.125	0.161	0.195	0.226	0.286	0.339	0.387	0.470	0.538
450	0.095	0.138	0.178	0.216	0.252	0.318	0.375	0.428	0.519	0.595
500	0.114	0.167	0.214	0.260	0.303	0.379	0.447	0.508	0.614	0.701
600	0.097	0.142	0.184	0.226	0.265	0.339	0.404	0.466	0.578	0.671
660	0.104	0.152	0.197	0.241	0.284	0.360	0.432	0.497	0.614	0.715
760	0.119	0.174	0.226	0.277	0.326	0.415	0.497	0.572	0.707	0.821
900	0.144	0.210	0.273	0.332	0.389	0.497	0.597	0.688	0.849	0.986

Note: these screens are hypothetical and do not represent actual choices. Screen manufacturers data must be used to select the screen.

Screen Diameter

The selection of a screen diameter equal to the casing diameter is recommended because a screen diameter equal to the casing diameter minimizes the headloss through a restricted tube, facilitates development and when necessary, redevelopment of the well. The selection of a screen diameter equal to the casing diameter also facilitates repairs and increasing well depth at a later time if the well depth becomes necessary (RMC, 2007).

Because the cost of the screen is quite high, some designers will reduce the diameter of the screen if the reduction does not adversely affect the entrance velocity. In wells deeper than 350 m, a reduction in screen diameter of 10 cm for a nominal screen diameter (based on the casing diameter) of 30 cm may be practical (RMC, 2007).

The length of the screen, slot opening, and diameter are used to estimate the entrance velocity. This is compared to the recommended values in Table 4-5.

Screen Entrance Velocity

The entrance velocity of the water is selected to avoid excessive well losses and incrustation rates, both of which increase with increasing entrance velocity. The “optimum” values given by Walton (Table 4-5) are higher than those suggested by others. Johnson (1975) and Hunter Blair (1970) recommend that the velocity not exceed 0.03 m/s.

Pump Power

The selection of an appropriate pump and the calculation of the power requirement follows the process discussed in Chapter 3. The placement of the pump is determined by the regulatory restrictions in reference to the top of the well screen and the requirements for Net Positive Suction Head (NPSH) as shown in Figure 4-13.

The following example illustrates the complete well design for a very small system.

Example 4-7. Because individual shallow wells in the community have become contaminated, the village of Knotwell has decided to provide a well system for the community. A two-well system with elevated storage has been proposed. System water pressure will be maintained by the elevated storage tank. The design data are as follows:

Design flow rate = 190 m³/d for the average day
 Top of reservoir = 50 m above ground level
 Friction losses + minor losses in piping from well to top of reservoir = 0.15 m
 Altitude = 500 m above mean sea level
 Static water level before pumping = 5.2 m below grade

Extract from Well Log

Strata	Thickness, m	Depth, m
Sand	7.6	7.6
Glacial till	19.8	27.4
Gravel	9.1	36.5
Dolomite	53.3	89.8
Shale	61.0	150.8
Sand	38.7	189.5
Shale	well terminated	

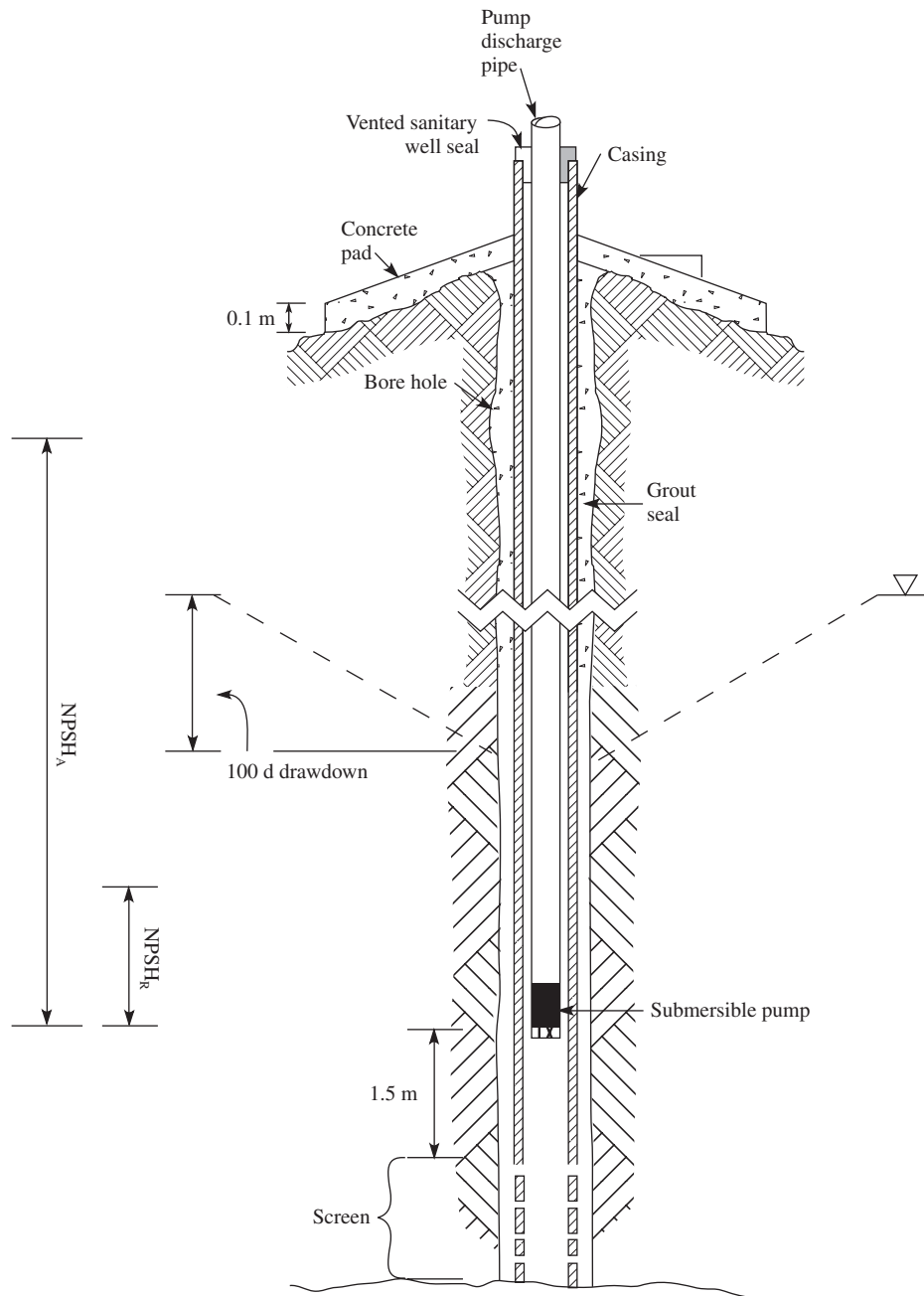

FIGURE 4-13

Placement of pump with respect to drawdown, height above screen, and NPSH_R.

Note: With the NPSH_R and NPSH_A shown, the pump could be set at a higher elevation.

An analysis of the water indicates that it is corrosive

Sieve analysis of water-bearing sand

U.S. sieve no.	Cumulative % passing
100	1.0
70	4.0
50	10.0
40	22.0
30	40.0
20	60.0
16	75.0
12	88.0
8	96.0
6	100.0

Water temperature = 5°C

Pumping test results

Drawdown at observation well 300.0 m from test well pumped at 0.035 m³/s

Time, min	Drawdown, m
100	3.10
500	4.70
1,700	5.90

Solution:

a. Number of wells

Two wells will be provided. One will be a duplicate well and pump. Both will be of the same design. These will be provided to meet the regulatory requirement to have one spare available for the maximum day demand.

b. Pump size

From the estimated average day demand, select pumping rate based on rules of thumb for a small system. In this instance, a six-hour pumping time is selected for each daily cycle.

$$Q = \frac{190 \text{ m}^3/\text{d}}{6 \text{ h}} (1 \text{ day}) = 31.66 \text{ or } 32 \text{ m}^3/\text{h}$$

Therefore, one well can supply the maximum day (estimated maximum day demand = (2)(190 m³/d) = 380 m³/d) in 12 hours.

c. Well diameter

From Table 4-4, based on the demand, select a trial diameter of 15 cm. Note this will have to be adjusted if the actual pump selected will not fit with the recommended clearances.

d. Check for potential well failure due to dewatering aquifer

From the well log and the static water level in the well, the sand layer is determined to be an artesian aquifer. Therefore, the transient flow equations for a confined aquifer may be

used to estimate the drawdown. Estimates of the transmissivity and storage coefficient are required to use the transient flow equations.

(1) Transmissivity

Transmissivity can be obtained from the pumping test data. The pumping test data given in the example problem statement are plotted on semilog paper as shown in Figure 4-14. From the straight line portion of the curve, select two points and calculate the transmissivity using Equation 4-5:

$$T = \frac{Q}{4\pi(s_2 - s_1)} \ln\left(\frac{t_2}{t_1}\right)$$

$$T = \frac{0.035 \text{ m}^3/\text{s}}{4\pi(5.90 - 3.10)} \ln\left(\frac{1,700 \text{ min}}{100 \text{ min}}\right) = 2.818 \times 10^{-3} \text{ m}^2/\text{s}$$

Note that Q is **not** the design pumping rate of 32 m³/h. It is the pumping rate used in the pumping test.

(2) Storage coefficient

Using the Michigan Department of Environmental Quality rules, the drawdown must be estimated based on 100 days of pumping. Because only one pump is required to meet the maximum day demand, only the drawdown for one operating pump is required. The storage coefficient (S) is estimated as follows:

In Figure 4-14, extrapolate the straight line portion of the graph to the virtual starting elevation of 0.0 m to find the virtual time: $t_0 = 4.2 \text{ min}$.

Use Equation 4-6 to estimate S .

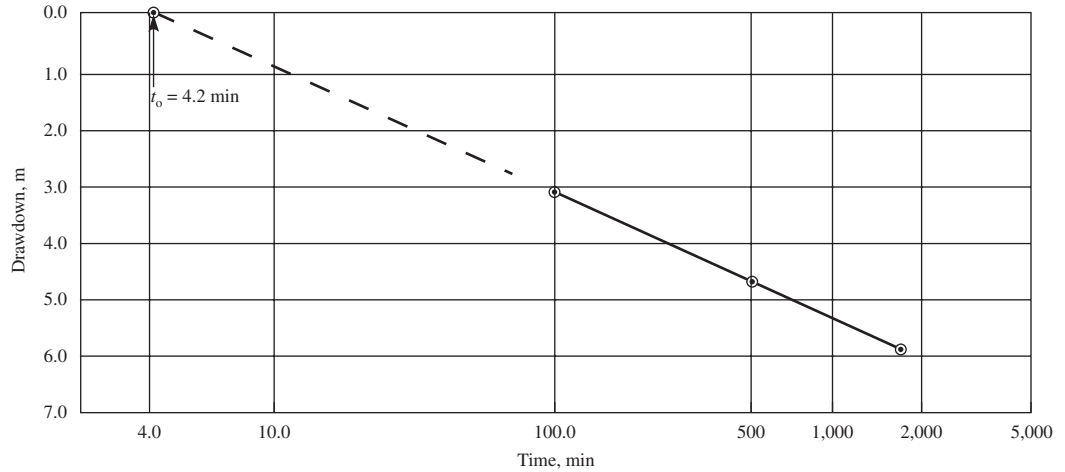

FIGURE 4-14
Pumping test curve for Example 4-7.

$$S = \frac{(2.25)(2.818 \times 10^{-3} \text{ m/s})(4.2 \text{ min})(60 \text{ s/min})}{(300 \text{ m})^2} = 1.775 \times 10^{-5}$$

where $r = 300 \text{ m}$, the distance from the pumping well to the observation well.

(3) Estimate drawdown

Calculate the drawdown with Equation 4-1.

With $T = 2.818 \times 10^{-3} \text{ m}^2/\text{s}$, $S = 1.775 \times 10^{-5}$, and a well diameter of 15 cm selected in step (c) above ($r = 15 \text{ cm}/2 = 7.5 \text{ cm}$ or 0.075 m), calculate u as

$$u = \frac{(0.075 \text{ m})^2(1.775 \times 10^{-5})}{4(2.818 \times 10^{-3} \text{ m}^2/\text{s})(100 \text{ d})(86,400 \text{ s/d})} = 1.025 \times 10^{-12}$$

and

$$\begin{aligned} W(u) &= -0.577216 - \ln 1.025 \times 10^{-12} + 1.025 \times 10^{-12} - \frac{(1.025 \times 10^{-12})^2}{2 \cdot 2!} + \frac{(1.025 \times 10^{-12})^3}{3 \cdot 3!} - \dots \\ &= 27.03 \end{aligned}$$

$$s = \frac{(32 \text{ m}^3/\text{h}) \left(\frac{1}{3,600 \text{ s/h}} \right)}{(4)(\pi)(2.818 \times 10^{-3} \text{ m}^2/\text{s})} (27.03) = 6.785 \text{ or } 6.8 \text{ m}$$

The 6.8 m is measured from the static piezometric surface that is 5.2 m below grade. The drawdown piezometric surface will be a total of $5.2 + 6.8 = 12.0 \text{ m}$ below the ground surface. The top of the artesian aquifer is 150.8 m below grade. Thus, there is no potential for failure of the well due to dewatering the aquifer.

e. Well depth, casing length, and grout requirements

(1) From the well log, select the water-bearing aquifer

The well penetrates an impervious layer of shale, extends through a sand layer, and terminates in shale. From the well log and the static water level in the well, the sand layer is determined to be an artesian aquifer.

(2) A fully penetrating well is selected. Therefore, the well depth is 189.5 m.

(3) The casing length and grout requirements are based on MSDWA rules, that is:

For artesian aquifers, the casing is sealed to the upper confining layer from within 1.5 m of the top of the aquifer to the ground surface.

f. Slot size

Plot the grain size analysis as “Cumulative % Retained” versus “Grain Size, mm.” The points in Figure 4-12 were plotted using the data provided for this example. Note that the data are presented as “Cumulative % passing” and that they are plotted as “Cumulative

% Retained” by subtracting each value from 100 percent. From the graph, select the grain sizes to calculate the uniformity coefficient:

$$U = \frac{D_{40\%}}{D_{90\%}} = \frac{0.84}{0.297} = 2.83$$

For a corrosive water (from the water analysis given in the problem statement) with a uniformity coefficient less than 3, the recommended slot size is $D_{50\%}$. From the graph, select the 50 percent point on the graph. An acceptable slot number is 20. Note that it is acceptable to have more percent retained than 50 percent but *not* less.

g. Screen diameter

Select a screen diameter equal to the casing diameter.

h. Screen length

Screen length is a function of aquifer homogeneity and aquifer depth. Based on Johnson’s rules of thumb, the aquifer should be screened for 80 percent of its depth. This is a screen length of

$$S_L = (0.8)(38.7 \text{ m}) = 30.96 \text{ or } 31 \text{ m}$$

This estimate must be checked using Equation 4-11.

i. Hydraulic conductivity

An estimate of the hydraulic conductivity is required to use Equation 4-11. Hydraulic conductivity (K) and the transmissivity (T) are related (from Equation 2-6, $T = KD$). Transmissivity was estimated in step c (1) above.

The hydraulic conductivity is

$$K = \frac{T}{D} = \frac{2.818 \times 10^{-3} \text{ m}^2/\text{s}}{38.7 \text{ m}} = 7.28 \times 10^{-5} \text{ m/s or } 6.29 \text{ m/d}$$

The value of D is the thickness of the sand layer (that is, the artesian aquifer) given in the well boring log.

j. Check of screen length and entrance velocity

Using Table 4-6, a slot number of 20 and a well diameter of 15 cm has an effective open area of $0.097 \text{ m}^2/\text{m}$ of screen length. From Table 4-5, for a hydraulic conductivity of 6.29 m/d , the screen velocity should be 0.010 m/s . The recommended screen length is

$$S_L = \frac{(32 \text{ m}^3/\text{h}) \left(\frac{1}{3,600 \text{ s/h}} \right)}{(0.097)(0.010 \text{ m/s})} = 9.16 \text{ m}$$

The selected screen length of 31 m exceeds this recommended length.

Check the entrance velocity:

The open area of the screen is

$$A = (0.097 \text{ m}^2/\text{m})(31 \text{ m}) = 3.0 \text{ m}^2$$

The velocity is

$$v = \frac{(32 \text{ m}^3/\text{h}) \left(\frac{1}{3,600 \text{ s/h}} \right)}{3.0 \text{ m}^2} = 0.003 \text{ m/s}$$

Thus, the entrance velocity criteria are met with the longer screen. The decision on whether or not to shorten the screen (or reduce its diameter) is based on economic considerations: well efficiency, the cost of the screen, and design life.

k. Pump selection

The required head and discharge are used to select an appropriate pump from manufacturer's data. The total dynamic head (TDH) is calculated as

$$\text{TDH} = \text{static lift to ground level} + \text{static lift to the top of the reservoir} \\ + h_f + h_v + \text{minor losses}$$

The drawdown was estimated as 6.8 m in step d(3). The 6.8 m is measured from the static piezometric surface that is 5.2 m below grade. The drawdown piezometric surface will be a total of $5.2 + 6.8 = 12.0$ m below the ground surface.

The total dynamic head required for the pump is

$$\text{TDH} = 12.0 \text{ m} + 50 \text{ m to the top of the reservoir} + h_f + h_v + \text{minor losses}$$

From the problem statement $h_f + h_v + \text{minor losses} = 0.15$ m. Therefore,

$$\text{TDH} = 12.0 \text{ m} + 50 \text{ m} + 0.15 \text{ m} = 62.15 \text{ m}$$

From manufacturer's catalogs, find a pump characteristic curve with maximum efficiency at $32 \text{ m}^3/\text{h}$ and 62.15 m TDH. For this example, the pump in Figure 4-15 on page 40 was selected. At a discharge of $32 \text{ m}^3/\text{h}$, a head per stage of 3.2 m is shown. The number of stages to achieve the TDH is

$$\text{No. stages} = \frac{\text{TDH}}{\text{head/stage}} = \frac{62.15 \text{ m}}{3.2 \text{ m/stage}} = 19.4 \text{ or } 20 \text{ stages}$$

From the box at the left of the head-discharge curve, the maximum number of stages is 35. Therefore this pump will work.

l. Elevation of pump intake

The pump intake elevation must meet both the requirements of the regulatory agency (in this instance MSDWA rules) and the NPSH.

The MSDWA requires that the pump be set a minimum of 1.5 m above the top of the well screen. The required NPSH is that at run-out. For the pump in Figure 4-15, it is about 1.5 m. Using Tables 3-7 and 3-8 for the water temperature and altitude given

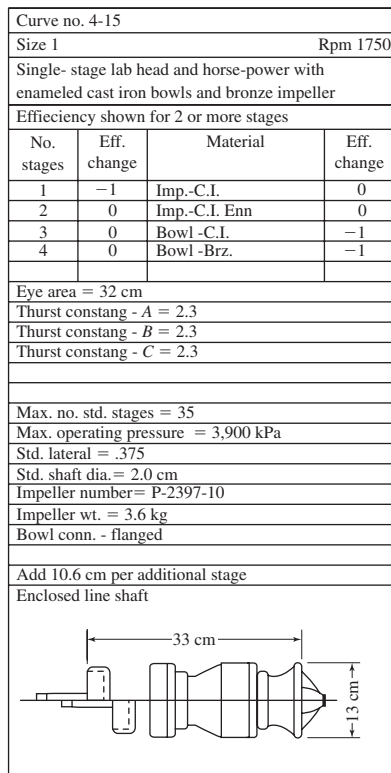
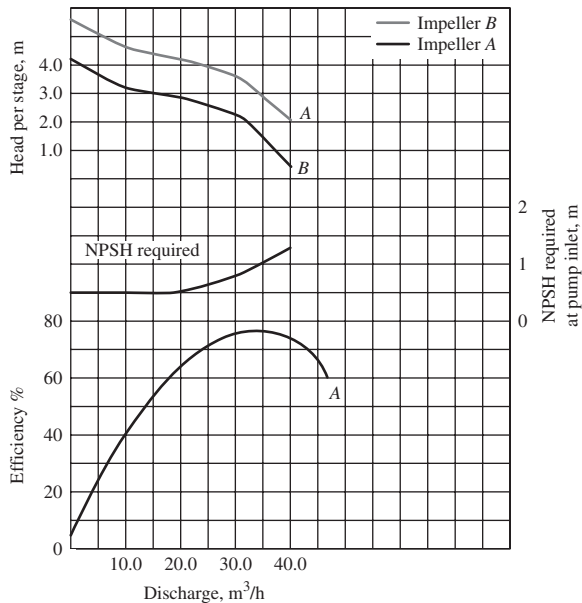

FIGURE 4-15
Vertical turbine head—discharge curve for Example 4-7.



in the problem data (i.e., 5°C and altitude of 500 m), the $NPSH_A$ is greater than 9.6 m. If the pump intake is set 1.0 m below the maximum 100 day drawdown as shown in Figure 4-16, it will meet both requirements.

- m. Check the dimension drawing for the diameter to see if the pump will fit in the casing. Its diameter is 13 cm, and the casing inside diameter is 15 cm. While the pump will fit, the recommended minimum clearance of 5 cm is not met. The next larger diameter casing of 20 cm should be chosen and the calculations reworked for screen length, velocity, and drawdown. Because the estimates with the smaller diameter casing met the guidelines for screen length and velocity with a substantial margin of safety, in this instance they do not need to be reevaluated. However, the drawdown calculation and TDH will need to be adjusted to account for the larger diameter.

Comments:

1. The number of stages for the pump is **very** high. A more reasonable number would be on the order of three to five stages. A more extensive search of available pumps should be conducted.
2. For some well systems, a submersible pump may be more appropriate than a line pump. These should also be investigated.

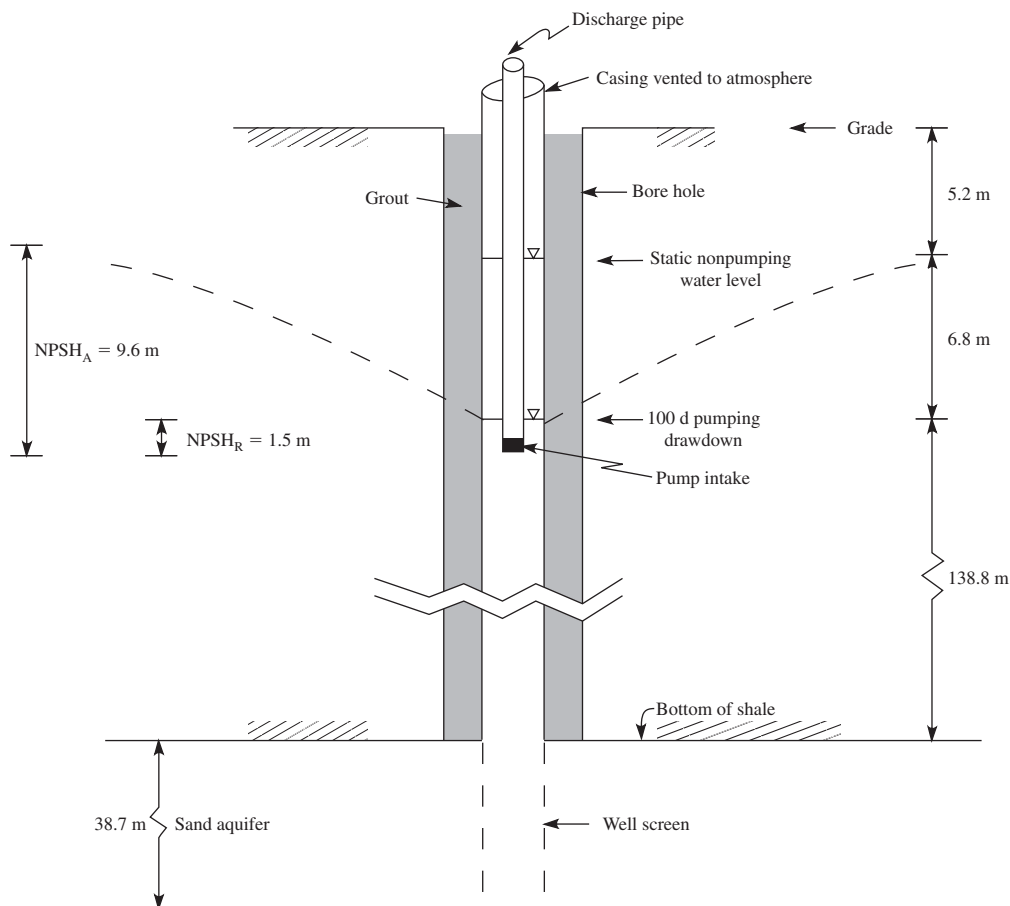

FIGURE 4-16
Sketch of elevations for setting pump.

Visit the text website at www.mhprofessional.com/wwe for supplementary materials and a gallery of photos.

4-5 CHAPTER REVIEW

When you have completed studying this chapter, you should be able to do the following without the aid of your textbooks or notes:

1. Sketch a subsurface cross section from the results of a well boring log and identify pertinent hydrogeologic features.
2. Define “isolation” as it applies to wells.
3. Sketch a well and label the major sanitary protection features according to this text.

4. Explain the purpose of a removable roof, auxiliary heat, and ventilation in a well house.
5. Sketch a piezometric profile for a single well pumping at a high rate, and sketch a profile for the same well pumping at a low rate.
6. Sketch a piezometric profile for two or more wells located close enough together to interfere with one another.
7. Sketch a well-pumping test curve which shows (a) the interception of a barrier and (b) the interception of a recharge area.

With the use of this text, you should be able to do the following:

8. Select the correct isolation distances for a well based on a description of the users.
9. Calculate the appropriate amount of disinfectant for a well given the diameter, depth of water in the well, and the reagent to be used.
10. Calculate the drawdown at a pumped well or observation well if you are given the proper input data.
11. Calculate the transmissivity and storage coefficient for an aquifer if you are provided with the results of a pumping test.
12. Calculate the interference effects of two or more wells.
13. Determine the number of wells for a small community's well field.
14. Select an appropriate type of pump and the required discharge capacity to meet demand.
15. Select and check the appropriate diameter for a well casing.
16. Determine the required depth of a well.
17. Determine the appropriate length of well screen for a given aquifer formation.
18. Select the appropriate slot size given a grain size distribution.
19. Determine the appropriate screen diameter given the hydraulic conductivity of the aquifer and the slot size.
20. Select an appropriate pump and specify the number of stages based on a TDH calculation you have performed.

4-6 PROBLEMS

- 4-1. A 0.30 m diameter well fully penetrates a confined aquifer that is 28.0 m thick. The aquifer material is fractured rock. If the drawdown in the pumped well is 6.21 m after pumping for 48 hours at a rate of $0.0075 \text{ m}^3/\text{s}$, what will the drawdown be at the end of 48 days of pumping at this rate?
- 4-2. An aquifer yields the following results from pumping a 0.61 m diameter well at $0.0303 \text{ m}^3/\text{s}$: $s = 0.98 \text{ m}$ in 8 min; $s = 3.87 \text{ m}$ in 24 h. Determine its transmissivity. Report your answer to three significant figures.

- 4-3. Determine the transmissivity of a confined aquifer that yields the following results from a pumping test of a 0.46 m diameter well that fully penetrates the aquifer.

$$\begin{aligned} \text{Pumping rate} &= 0.0076 \text{ m}^3/\text{s} \\ s &= 3.00 \text{ m in } 0.10 \text{ min} \\ s &= 34.0 \text{ m in } 1.00 \text{ min} \end{aligned}$$

- 4-4. An aquifer yields a drawdown of 1.04 m at an observation well 96.93 m from a well pumping at $0.0170 \text{ m}^3/\text{s}$ after 80 min of pumping. The virtual time is 0.6 min and the transmissivity is $5.39 \times 10^{-3} \text{ m}^2/\text{s}$. Determine the storage coefficient.
- 4-5. Using the data from Problem 4-4, find the drawdown at the observation well 80 days after pumping begins.
- 4-6. If the transmissivity is $2.51 \times 10^{-3} \text{ m}^2/\text{s}$ and the storage coefficient is 2.86×10^{-4} , calculate the drawdown that will result at the end of two days of pumping a 0.50 m diameter well at a rate of $0.0194 \text{ m}^3/\text{s}$.
- 4-7. Determine the storage coefficient for an artesian aquifer from the pumping test results shown in the table below. The measurements were made at an observation well 300.00 m away from the pumping well. The pumping rate was $0.0350 \text{ m}^3/\text{s}$.

Time (min)	Drawdown (m)
100.0	3.10
500.0	4.70
1,700.0	5.90

- 4-8. Rework Problem 4-7, but assume that the data were obtained at an observation well 100.0 m away from the pumping well.
- 4-9. Determine the storage coefficient for an artesian aquifer from the pumping test results shown in the table below. The measurements were made at an observation well 100.00 m away from the pumping well. The pumping rate was $0.0221 \text{ m}^3/\text{s}$.

Time (min)	Drawdown (m)
10.0	1.35
100.0	3.65
1,440.0	6.30

- 4-10. Rework Problem 4-9, but assume that the data were obtained at an observation well 60.0 m away from the pumping well.
- 4-11. Determine the storage coefficient for an artesian aquifer from the following pumping test results on a 0.76 m diameter well that fully penetrates the aquifer. The pumping rate was $0.00350 \text{ m}^3/\text{s}$. The drawdowns were measured in the pumping well.

Time (min)	Drawdown (m)
0.20	2.00
1.80	3.70
10.0	5.00

- 4-12.** Two wells located 106.68 m apart are both pumping at the same time. Well A pumps at $0.0379 \text{ m}^3/\text{s}$ and well B pumps at $0.0252 \text{ m}^3/\text{s}$. The diameter of each well is 0.460 m. The transmissivity is $4.35 \times 10^{-3} \text{ m}^2/\text{s}$ and the storage coefficient is 4.1×10^{-5} . What is the interference of well A on well B after 365 days of pumping? Report your answer to two decimal places.
- 4-13.** Using the data from Problem 4-12, find the total drawdown in well B after 365 days of pumping. Report your answer to two decimal places.
- 4-14.** If two wells, no. 12 and no. 13, located 100.0 m apart, are pumping at rates of $0.0250 \text{ m}^3/\text{s}$ and $0.0300 \text{ m}^3/\text{s}$, respectively, what is the interference of well no. 12 on well no. 13 after 280 days of pumping? The diameter of each well is 0.500 m. The transmissivity is $1.766 \times 10^{-3} \text{ m}^2/\text{s}$ and the storage coefficient is 6.675×10^{-5} . Report your answer to two decimal places.
- 4-15.** Using the data from Problem 4-14, find the total drawdown in well 13 after 280 days of pumping. Report your answer to two decimal places.
- 4-16.** Wells X, Y, and Z are located equidistant at 100.0 m intervals. Their pumping rates are $0.0315 \text{ m}^3/\text{s}$, $0.0177 \text{ m}^3/\text{s}$, and $0.0252 \text{ m}^3/\text{s}$ respectively. The diameter of each well is 0.300 m. The transmissivity is $1.77 \times 10^{-3} \text{ m}^2/\text{s}$. The storage coefficient is 6.436×10^{-5} . What is the interference of well X on well Y and on well Z after 100 days of pumping? Report your answer to two decimal places.
- 4-17.** Using the data in Problem 4-16, find the total drawdown in well X at the end of 100 days of pumping. Report your answer to two decimal places.
- 4-18.** For the well field layout shown in Figure P-4-18, determine the effect of adding a sixth well. Is there any potential for adverse effects on the well or the aquifer? Assume all the wells are pumped for 100 days and that each well is 0.300 m in diameter. Well data are given in the table below. Aquifer data are shown below the well field data.

Knotquite Well Field No. 1

Well no.	Pumping rate (m^3/s)	Depth of well (m)
1	0.0221	111.0
2	0.0315	112.0
3	0.0189	110.0
4	0.0177	111.0
5	0.0284	112.0
6 (proposed)	0.0252	111.0

The aquifer characteristics are as follows:

$$\text{Storage coefficient} = 6.418 \times 10^{-5}$$

$$\text{Transmissivity} = 1.761 \times 10^{-3} \text{ m}^2/\text{s}$$

$$\text{Nonpumping water level} = 6.90 \text{ m below grade}$$

$$\text{Depth to top of artesian aquifer} = 87.0 \text{ m}$$

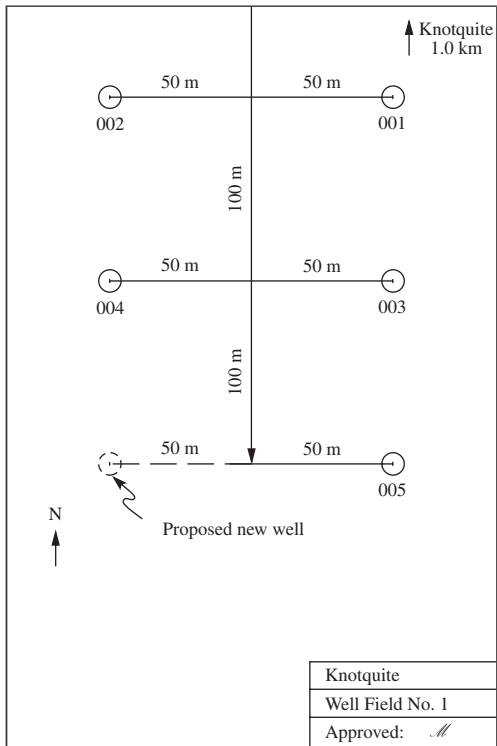

FIGURE P-4-18

- 4-19.** For the well field layout shown in Figure P-4-19 on page 4-46, determine the effect of adding a sixth well. Is there any potential for adverse effects on the well or the aquifer? Assume all the wells are pumped for 100 days and that each well is 0.300 m in diameter. Aquifer data are shown below the well field data.

Fair Well Field No. 2

Well no.	Pumping rate (m ³ /s)	Depth of well (m)
1	0.020	105.7
2	0.035	112.8
3	0.020	111.2
4	0.015	108.6
5	0.030	113.3
6 (proposed)	0.025	109.7

The aquifer characteristics are as follows:

$$\text{Storage coefficient} = 2.11 \times 10^{-6}$$

$$\text{Transmissivity} = 4.02 \times 10^{-3} \text{ m}^2/\text{s}$$

Nonpumping water level = 9.50 m below grade

Depth to top of artesian aquifer = 50.1 m

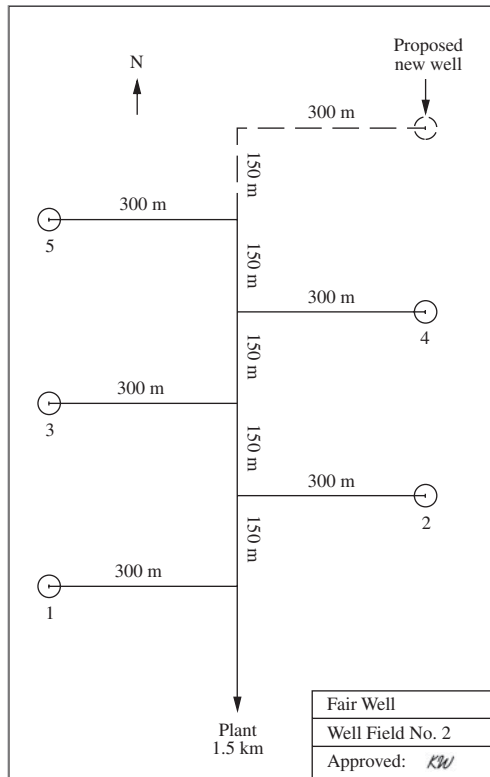

FIGURE P-4-19

- 4-20. What pumping rate, pumping time, or combination thereof can be sustained by the new well in Problem 4-19 if all of the well diameters are enlarged to 1.50 m?
- 4-21. For the well field layout shown in Figure P-4-21 on page 4-47, determine the effect of adding a sixth well. Is there any potential for adverse effects on the well or the aquifer? Assume all the wells are pumped for 180 days and that each well is 0.914 m in diameter. Well data are given in the table below. Aquifer data are shown below the well field data.

Bode Well Field No. 3

Well No.	Pumping rate (m ³ /s)	Depth of well (m)
1	0.0426	169.0
2	0.0473	170.0
3	0.0426	170.0
4	0.0404	168.0
5	0.0457	170.0
6 (proposed)	0.0473	170.0

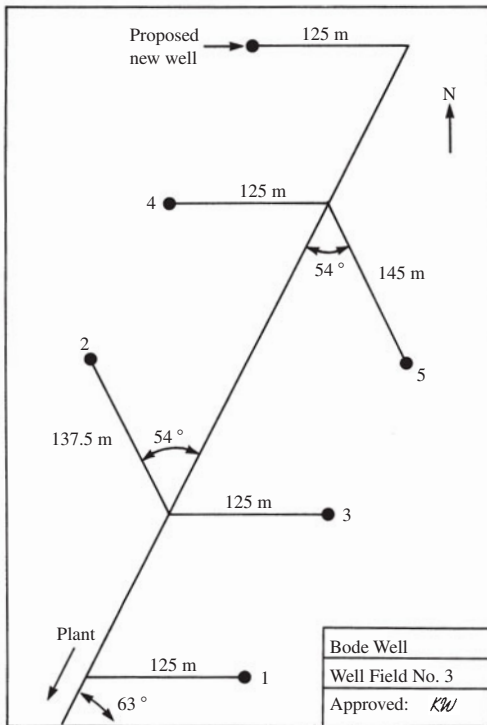

FIGURE P-4-21

The aquifer characteristics are as follows:

$$\text{Storage coefficient} = 2.80 \times 10^{-5}$$

$$\text{Transmissivity} = 1.79 \times 10^{-3} \text{ m}^2/\text{s}$$

Nonpumping water level = 7.60 m below grade

Depth to top of artesian aquifer = 156.50 m

4-22. What pumping rate, pumping time, or combination thereof can be sustained by the new well in Problem 4-21 if all of the well diameters are enlarged to 1.80 m?

The design elements required in the following problems are:

- a. Demand estimate
- b. Well details
 - (1) Number
 - (2) Distance between wells
 - (3) Diameter
 - (5) Depth and anticipated 100-day drawdown
 - (6) Screen dimensions
 - (5) Slot size

- c. Well protection requirements
 - (1) Casing
 - (2) Grouting
 - (3) Disinfection
 - (4) Well house specifications
 - d. Pump details
 - (1) Capacity
 - (2) Select a candidate pump
 - (3) Specify the number of stages and NPSH
- 4-23. Your firm has been retained to develop plans for a well system for the village of Waffle. Using the design elements listed above Problem 4-23 and the following data, design the well system.
- a. Population: 250
 - b. Demand: 570 Lpcd
 - c. Water is to be supplied from wells. No treatment will be provided.
 - d. Top of reservoir is 66.0 m above ground level
 - e. Friction losses + minor losses in piping from well to top of reservoir = 0.5 m
 - f. Water supply is to be chlorinated, but no other treatment will be provided.

TEST BORING RESULTS, WAFFLE

Bore hole no. 2 (surface elevation: 335 m)

Strata	Thickness, m	Depth to bottom of strata, m
Soil (Rubicon)	1.2	1.2
Sand	13.1	14.3
Clay, red	6.1	20.4
Galena dolomite	44.8	65.2
Maquoketa shale	39.0	104.2
Someko sand	41.9	146.1
Eau Claire shale	Boring terminated at 146.1 m	

An analysis of the water indicates that it is not corrosive.

Grain size analysis of Someko sand

U.S. sieve no.	Wt. % retained
8	2
12	1
16	2
20	15
30	35
40	33
50	6
70	2
100	2
PAN	2

EXTRACT FROM WELL LOG

Location: Pancake, TX (approx. 5.6 km west of Waffle)

Boring results (surface elevation at 323 m)

Depth, m	Soil description
0–1.8	Soil (Selkirk)
1.8–8.2	Clay, red
8.2–54.0	Galena dolomite
54.0–92.0	Maquoketa shale
92.0–133.9	Someko sand
133.9	Well terminated in shale

Pumping test results

Static water level before pumping began: 38.7 m below grade

Drawdown in observation well 91.4 from test well pumped at 0.095 m³/s.

Time from start of pumping, min	Drawdown from static water level, m
20	2.00
100	2.68
1500	3.79

4-24. Your firm has been retained to develop plans for a well system for the Bastogne Retirement Center. Using the design elements listed below Problem 4-22 and the following data, design the well system.

- a. Population: 150
- b. Demand: 400 Lpcd
- c. Water is to be supplied from wells. No treatment will be provided.
- d. Top of reservoir is 35.8 m above ground level
- e. Friction losses + minor losses in piping from well to top of reservoir = 0.25 m
- f. Water supply is to be chlorinated, but no other treatment will be provided.

TEST BORING RESULTS

Bastogne Retirement Center

Bore hole no. 3 (surface elevation: 164 m)

Strata	Thickness, m	Depth to bottom of strata, m
Soil (Emmet-Trenary)	1.5	1.5
Sandy loam	5.1	6.6
Silty clay	6.1	12.7
Clay	6.1	18.8
Unconsolidated sandy clay (water at 6.7 m)	75.6	94.4
Clay	30.5	124.9
Sand and gravel	45.7	170.6
Shale	Boring terminated at 170.6 m	

An analysis of the water indicates that it is not corrosive.

Grain size analysis of sand and gravel

U.S. sieve no.	Wt. retained, g
6	16.7
8	44.5
10	23.0
16	56.6
20	63.1
30	48.5
40	34.0
50	53.4
60	23.3
80	43.5
100	57.3
PAN	50.2
Total	494.1

EXTRACT FROM WELL LOG

Location: Mt Blanc (approx. 3 km east of Bastogne Retirement Center)

Boring Results (surface elevation at 158.5 m)

Depth, m	Soil description
0–0.5	Sandy loam
0.5–0.9	Sandy clay loam
0.9–1.5	Silty clay
1.5–10.7	Clay
10.7–11.1	Sandy loam
11.1–11.7	Sandy clay loam
11.7–12.1	Unconsolidated sandy clay (water at 17.0 m)
12.1–103.6	Clay
103.6–152.5	Shale
Well terminated in shale at 152.5 m	

Pumping test results

Static water level before pumping began: 2.4 m below grade

Test well pumped at 0.006 m³/s.

Drawdown in observation well 38.1 m from pumping well.

Time from start of pumping, min	Drawdown from static water level, m
1.0	0.42
2.0	0.53
4.0	0.69
8.0	0.79
10.0	0.85
20.0	0.96

40.0	1.11
60.0	1.17
100.0	1.28
120.0	1.31
180.0	1.39
240.0	1.45

4-7 DISCUSSION QUESTIONS

- 4-1. An artesian aquifer is under pressure because of the weight of the overlying geologic strata. Is this sentence true or false? If it is false, rewrite the sentence to make it true.
- 4-2. For the following well boring log, identify the pertinent hydrogeologic features. The well screen is set at 6.0–8.0 m, and the static water level after drilling is 1.8 m from the ground surface.

Strata	Depth, m	Remarks
Top soil	0.0–0.5	
Sandy till	0.5–6.0	Water encountered at 1.8 m
Sand	6.0–8.0	
Clay	8.0–9.0	
Shale	9.0–10.0	Well terminated

- 4-3. For the following well boring log (Bracebridge, Ontario, Canada), identify the pertinent hydrogeologic features. The well screen is set at 48.0–51.8 m, and the static water level after drilling is 10.2 m from the ground surface.

Strata	Depth, m	Remarks
Sand	0.0–6.1	
Gravelly clay	6.10–8.6	
Fine sand	8.6–13.7	
Clay	13.7–17.5	Casing sealed
Fine sand	17.5–51.8	
Bedrock	51.8	Well terminated

- 4-4. Sketch the piezometric profiles for two wells that interfere with one another. Well A pumps at $0.028 \text{ m}^3/\text{s}$ and well B pumps at $0.052 \text{ m}^3/\text{s}$. Show the ground water table before pumping, the drawdown curve of each well pumping alone, and the resultant when both wells are operated together.

4-8 REFERENCES

- AWWA, 1999 *Design and Construction of Small Systems*, American Water Works Association, Denver, Colorado.
- Boulton, N. S. (1954) "The Drawdown of Water Table under Nonsteady Conditions near Pumped Well in an Unconfined Formation," *Proceedings of Institute of Civil Engineering (London)*, vol. 3, part III, pp. 564–579.

- Bouwer, H. (1978) *Groundwater Hydrology*, McGraw-Hill, New York, pp. 68, 76–79, 175–176.
- Campbell, M. D., and J. H. Lehr (1973) *Water Well Technology*, McGraw-Hill, New York, pp. 45, 137, 139–140.
- Cooper, H. H. and C. E. Jacob (1946) “A Generalized Graphical Method for Evaluating Formation Constants and Summarizing Well Field History,” *Transactions American Geophysical Union*, vol. 27, pp. 526–534.
- Davis, M. L. and D. A. Cornwell (2008) *Introduction to Environmental Engineering*, McGraw-Hill, Borton, Massachusetts.
- Ferris, J. G., D. B. Knowles, R. H. Brown, and R. W. Stallman (1962) *Theory of Aquifer Tests*, U.S. Geological Survey Water-Supply Paper 1536-E, p. 96.
- GLUMRB (2003) *Recommended Standards for Water Works*, Great Lakes–Upper Mississippi River Board of State and Provincial Public Health and Environmental Managers, Health Education Services, Albany, New York, p. 21–31.
- Hanna, T. M. (2007) “Development of Water Wells,” in R. J. Sterrett (ed.), *Ground Water and Wells*, Johnson Screens, A Weatherford Company, New Brighton, Minnesota, pp. 501–550.
- Hunter Blair, A. (1970) “Well Screens and Gravel Paces,” *Ground Water*, vol. 8, No. 1, pp. 10–21.
- Johnson (1975) *Ground Water and Wells*, Johnson Division, UOP, Inc., Saint Paul, Minnesota, pp. 208–276.
- MSDWA (1976) Michigan Safe Drinking Water Act, Acts of State of Michigan.
- RMC (2007) *A Guide to Water Well Casing and Screen Selection*, Roscoe Moss Company, Los Angeles, California, pp. 15–16.
- Stollhans, J. R. (2007) personal communication.
- Theis, C. V. (1935) “The Relation Between Lowering the Piezometric Surface and the Rate and Discharge of a Well Using Ground Water Storage,” *Transactions American Geophysical Union*, vol. 16, pp. 519–524.
- Thiem, G. (1906) *Hydrologische Methoden*, J. M. Gebhart, Leipzig, Germany.
- U.S. EPA (1973) *Manual of Individual Water Supply Systems*, U.S. Environmental Protection Agency, Office of Water Supply Programs, Washington, D.C.
- U.S. PHS (1965) *Recommended State Legislation and Regulations*, U.S. Public Health Service, Department of Health Education and Welfare, Washington, D.C.
- Walton, W. C. (1962) “Selected Analytical Methods for Well and Aquifer Evaluation,” Illinois State Water Survey Bulletin 49.
- Walton, W. C. (1970) *Groundwater Resource Evaluation*, McGraw-Hill, New York, p. 300.

CHAPTER

5

CHEMICAL HANDLING AND STORAGE

- 5-1 INTRODUCTION
- 5-2 REDUNDANCY AND CAPACITY PROVISIONS
- 5-3 DELIVERY, HANDLING, AND STORAGE
- 5-4 CHEMICAL FEED AND METERING SYSTEMS
- 5-5 CHEMICAL COMPATIBILITY
- 5-6 MATERIALS COMPATIBILITY
- 5-7 DESIGNING FOR SAFETY AND HAZARDOUS CONDITIONS
- 5-8 OPERATION AND MAINTENANCE
- 5-9 CHAPTER REVIEW
- 5-10 PROBLEMS
- 5-11 DISCUSSION QUESTIONS
- 5-12 REFERENCES

5-1 INTRODUCTION

Principal components of the design of water and wastewater treatment plants are the selection of appropriate chemicals, calculation of their dosage, selection of their physical state (gas, liquid, or solid), how they are to be stored, how much is to be stored, and the type of feed equipment to be used. The selection of appropriate chemicals and calculation of dosage will be discussed in Chapters 6, 7, 13, 22, 23, 25, and 26. This chapter summarizes some of the alternatives and design criteria for storage and handling as well as consideration of safety and security issues.

Of the over 50 chemicals used in treating water and wastewater, four chemicals have been selected for illustration purposes: aluminum sulfate (alum), ferric chloride, lime (CaO), and chlorine. Detailed discussion of the other chemicals may be found in Anderson (2005) and Metcalf & Eddy (2003).

5-2 REDUNDANCY AND CAPACITY PROVISIONS

Redundancy

The requirement for redundancy is dependent on whether or not the application of the chemical is noncritical and, therefore, interruptible or, critical, and, therefore, noninterruptible. Where chemical feed is necessary for the protection of the water supply or, in the case of wastewater, where the receiving body could be permanently or unacceptably degraded, the chemical is considered to be noninterruptible. For example, coagulants and chlorine in water supplies are noninterruptible (GLUMRB, 2003). Chemicals used for corrosion control, taste-and-odor control, and fluoridation are interruptible.

For small plants where one feeder may be adequate for the range of anticipated flows a minimum of two feeders shall be provided for noninterruptible chemicals (GLUMRB, 2003 and U.S. EPA, 1974). In larger plants, where it is necessary to have three or more feeders, there should be one feeder for each application point plus one or more standby units in reserve of sufficient capacity to replace the largest unit when a unit is out of service (GLUMRB, 2003).

Capacity

The required capacity of feeding equipment is based on two requirements: ability to meet the maximum dosage required and capability to feed that dosage at the maximum flow rate while still maintaining reserve units. Multiple units of different capacity may be required because the minimum feed rate may be less than that provided by the *turn-down ratio*, that is, the ratio of the maximum feed rate to the minimum feed rate, of standard manufacturer's equipment. This may be especially true during low flows at the beginning of the design life of the plant. In this case, a larger number of units may be required to cover the range of the feed equipment. It may be more economical to plan chemical feed equipment for a shorter design life than the entire facility with an incremental increase in the number of units or replacement of smaller units as the flow rate increases.

5-3 DELIVERY, HANDLING, AND STORAGE

Delivery and Handling

Dry Chemicals. For small plants, dry chemicals are purchased in bags or barrels and delivery is by truck to a loading dock. For large plants, dry chemicals are delivered by truck or railcar.

Unloading may be accomplished by pneumatic equipment (blower or vacuum), screw conveyors, or bucket elevators.

Pneumatic truck unloading is through a pipe conveying system. The trucks are equipped with air compressors to off-load the chemical. The compressors are capable of providing air flow rates of up to 20 m³/min. The design of the conveying system includes a truck inlet panel, piping to the storage silo, a safety release valve, and a dust collector located on top of the silo. The piping diameter is generally standardized at 100 mm with bends having a minimum radius of 1.2 m. The maximum length of piping depends on the material. Pebble lime may be blown 30 m vertically if the total length of pipe is less than 50 m. Powder can be transported over 90 m over a combined vertical and horizontal distance (Anderson, 2005).

Liquid Chemicals. For delivery by tank truck, the plant design must provide labeled fill-pipe connections with protective caps. To avoid adverse chemical reactions with residue in the pipe, separate pipes are provided for each chemical. The pipe connection should be surrounded with a concrete drip sump that has a chemically resistant coating.

To prevent accidental overflows, level indicators and high level audible alarms are provided on the storage tank. The alarm should be mounted at the unloading station to alert the vehicle operator.

For smaller deliveries of liquid chemicals in drums or carboys, loading dock and staging are elements to consider for the delivery system. For very large plants, railcar delivery may need to be considered.

Liquified Gases. Gases such as chlorine and ammonia are shipped as pressurized liquids. Chlorine is shipped in containers of the following sizes: 70 kg cylinders, 900 kg cylinders,* and railroad tank cars. It is important to note that the mass designation only refers to the mass of chemical contained in the cylinders and does not reflect the additional mass of the container itself. In all of the containers, liquid chlorine occupies a maximum of about 85 percent of the volume when it is delivered. The 15 percent free space is to allow the chlorine to expand if the container becomes warm.

The 70 kg cylinders are physically moved into the plant by a hand truck. The 900 kg cylinders are moved by an overhead crane.

GLUMRB (2003) specifies that weighing scales shall be provided for weighing the chlorine gas as it is used.

Storage

Suggested chemical storage requirements are listed in Table 5-1.

Dry Chemicals. Bins and silos can be designed with rectangular, square, hexagonal, or circular cross sections: the first three make optimum use of plant space, but the circular silo is less susceptible to sidewall hang-ups that occur in bins and silos of other shapes (Anderson, 2005). This is particularly true of chemicals, like lime, that are hygroscopic. Hopper bottoms should have a slope of at least 60° from the horizontal; for the storage of lime, an even greater slope is

*In the United States, these cylinders are commonly referred to as “one-ton” cylinders because the contents weigh 1 short ton in U.S. Customary units.

TABLE 5-1
Suggested chemical storage provisions

Provision	Critical, Noninterruptible	Noncritical, interruptible
Minimum storage volume	1.5 truck loads ^a	1.5 truck loads ^a
Minimum stock to be maintained in days	30	10
Additional allowance based on shipping time in days	2 times shipping time	1.5 times shipping time

^a Because a full truck load is a normal delivery quantity, the extra 0.5 truck load provides a factor of safety.

Data from Hudson, 1978, and GLUMRB, 2003.

desirable (Anderson, 2005). Provision of vibrators on the silo cone minimizes bridging. Relief valves, access hatches, and dust collectors must be airtight as well as watertight to reduce the hygroscopic effects. Because the surface of the dry material is generally not level, exact inventory level cannot be measured by systems that measure the height of material in the silo. The best and most reliable method of keeping inventory is the installation of load cells to weigh both the silo and its contents (Kawamura, 2000).

The design volume should be based on the purity and average bulk density of the chemical. Purity and average bulk densities of some chemicals used in water and wastewater treatment are given in Appendix A.

Example 5-1. Determine the lime storage volume required for the following conditions:

Average water demand = 0.18 m³/s

Maximum dosage = 200 mg/L as CaO

Shipping time = 1 week

Lime is an interruptible chemical

Assume the bulk density and purity of lime is the average of the values given in Appendix A.

Solution:

a. The average purity of lime from the range given in Appendix A is

$$\frac{(75 + 99)}{2} = 87\%$$

b. The daily lime consumption is

$$(200 \text{ mg/L})(0.18 \text{ m}^3/\text{s})(10^3 \text{ L/m}^3)(86,400 \text{ s/d})\left(\frac{1}{0.87}\right)(10^{-6} \text{ kg/mg}) = 3,575 \text{ kg/d}$$

- c. From Table 5-1, an interruptible chemical should have a 10-day supply plus 1.5 times the shipping time of one week. The mass to store is

$$(3,575 \text{ kg/d})(10 \text{ d} + (1.5)(7 \text{ d})) = \text{or } 73,287.5 \text{ or } 73,000 \text{ kg}$$

- d. Using the bulk density from Appendix A, the volume of lime to be stored is

$$\frac{73,287.5 \text{ kg}}{850 \text{ kg/m}^3} = 86.22 \text{ or } 86 \text{ m}^3$$

Liquid Chemicals. The majority of storage tanks are located in the lower or basement areas of the water treatment plants. If they are located out-of-doors, above ground storage rather than underground storage is preferred as it allows the operator to inspect for leaks. The temperature regimen of the tanks and the concentration of the solution should be considered carefully for outside storage because some chemicals will crystallize. For example, a 50.7 percent commercial liquid alum solution will crystallize at $+8.3^\circ\text{C}$ while a 48.8 percent alum solution has a crystallization point of -15.6°C . In climates with severe cold weather, the storage tanks may have to be heated.

The storage tank must have a liquid level indicator, vent, overflow line, access hatches, and secondary containment capable of preventing uncontrolled discharge.

The storage tank design volume should be based on the solution strength and percent active ingredient of the chemical. Characteristics of common liquid chemicals used in water and wastewater treatment are given in Appendix A.

Secondary containment, that is, an additional tank that completely surrounds the primary storage vessel, must be provided for liquids (Figure 5-1). Typical secondary containment consists of a basin with dike walls sufficiently high that the volume of the secondary containment will hold 100 percent of the volume of the single largest primary storage vessel in the containment

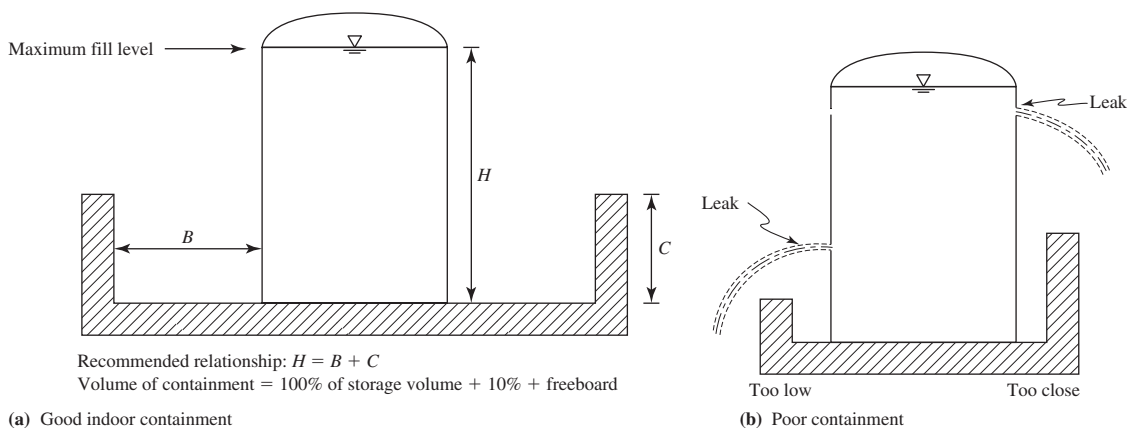

FIGURE 5-1

Secondary containment relationships. Storage tanks placed out-of-doors must either have a roof or provide additional volume for a 25-year, 24-hour rainfall.

area plus a safety factor of 10 percent and freeboard. If the primary storage vessel is located out-of-doors uncovered, the containment structure should be capable of holding 100 percent of the volume of the largest vessel plus precipitation from the 25-year, 24-hour rainfall (40 CFR 264.193(e)). The secondary containment structure is constructed of concrete with a chemical resistant coating. It should not have floor drains or penetrations for personnel entry, piping, control valves, electrical conduits, or other appurtenances.

The model facility provides secondary containment for bulk and day tanks, pumping equipment, safety valves, and unloading piping associated with each chemical. Incompatible chemicals are not stored in the same secondary containment structure. Motorized remote control components should be considered to limit the number of times personnel must enter the containment area.

Day tanks are smaller tanks that are used to supply the chemical feeders or to make dilutions of the higher concentration solution held in the bulk storage tanks. They allow more accurate measurement of smaller volumes on an hourly, shift, or daily basis. The capacity of the day tank is nominally sufficient that it can supply the maximum day volume of solution for a 24-hour period (a “day”), so the operator only needs to service it once a day. Day tanks should hold no more than a 30-hour supply because of chemical degradation of the diluted solution over time (GLUMRB, 2003).

Example 5-2. Determine the alum storage volume required for the following conditions:

- Average water demand = 0.18 m³/s
- Maximum dosage = 60 mg/L as alum
- Shipping time = one week
- Alum is a noninterruptible chemical

Solution:

- a. From Appendix A, alum is shipped as a 50% solution with 100% active ingredient.
- b. At the maximum dosage, the daily mass of alum used is

$$(60 \text{ mg/L})(0.18 \text{ m}^3/\text{s})(86,400\text{s/d})(10^3\text{L/m}^3)(10^{-6} \text{ kg/mg}) = 933.12 \text{ or } 930 \text{ kg/d}$$

- c. The mass of solution required is

$$\frac{933.12 \text{ kg/d}}{0.50} = 1,866.24 \text{ or } 1,900 \text{ kg/d}$$

- d. From Table 5-1, a noninterruptible chemical should have a 30-day supply plus 2 times the shipping time. The mass to store is

$$(1,866.24 \text{ kg/d})(30 \text{ d} + (2)(7\text{d})) = 82,114.56 \text{ or } 82,000 \text{ kg}$$

- e. Using the density of alum from Appendix A, the volume of solution to be stored is

$$\frac{82,114.56 \text{ kg}}{1,340 \text{ kg/m}^3} = 61.28 \text{ or } 61 \text{ m}^3$$

Liquified Gases. Gases are normally stored in their shipping containers. The recommended standards for chlorine are provided here in detail because of the extreme hazard of the gas and the wide use of chlorine gas for disinfection (GLUMRB, 2003):

- Chlorine gas feed and storage shall be enclosed and separated from other operating areas. The chlorine room shall be:
 - Provided with a shatter resistant inspection window installed in an interior wall,
 - Constructed in such a manner that all openings between the chlorine room and the remainder of the plant are sealed, and
 - Provided with doors equipped with panic hardware, assuring ready means of exit and opening outward only to the building exterior.
- The room shall be constructed to provide the following:
 - Each room shall have a ventilating fan with a capacity that provides one complete air change per minute,
 - The ventilating fan shall take suction near the floor as far as practical from the door and air inlet,
 - Air inlets should be through louvers near the ceiling,
 - Separate switches for the fan and lights shall be located outside the chlorine room and at the inspection window,
 - Vents from the feeders and storage shall discharge to the outside atmosphere through chlorine gas collection and neutralization systems,
 - Floor drains are discouraged. Where provided, the floor drains shall discharge to the outside of the building and shall not be connected to other internal or external drainage systems.
- Chlorinator rooms should be heated to 15°C and be protected from excessive heat.
- Pressurized chlorine feed lines shall not carry chlorine gas beyond the chlorinator room.
- A continuous chlorine sensor and alarm is recommended.

5-4 CHEMICAL FEED AND METERING SYSTEMS

Figure 5-2 provides a diagrammatic system for the classification of chemical feed systems.

Dry Chemical Feed Systems

A typical dry chemical feed system consists of a storage silo or day hopper, a feeder, a dissolving tank, and a distribution system as shown in Figure 5-3. Gravimetric feeders have an accuracy range of 0.5 percent to 1 percent of the set feed rate. Volumetric feeders have an accuracy range of 1 percent to 5 percent. Gravimetric feeders are preferred for chemicals with varying bulk densities (Anderson, 2005).

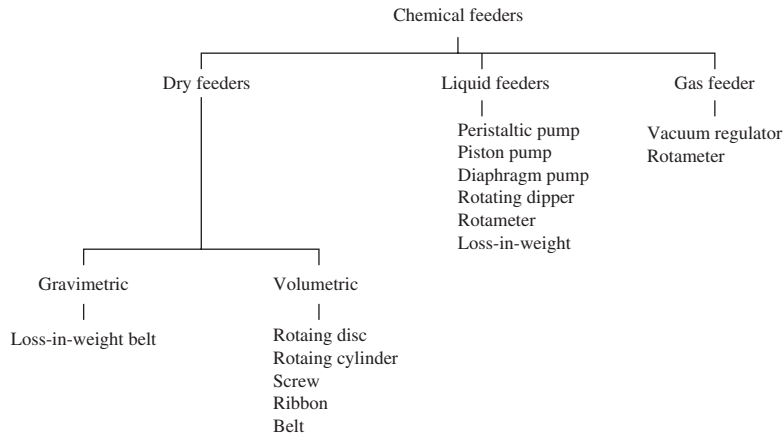

FIGURE 5-2
Chemical feed systems.

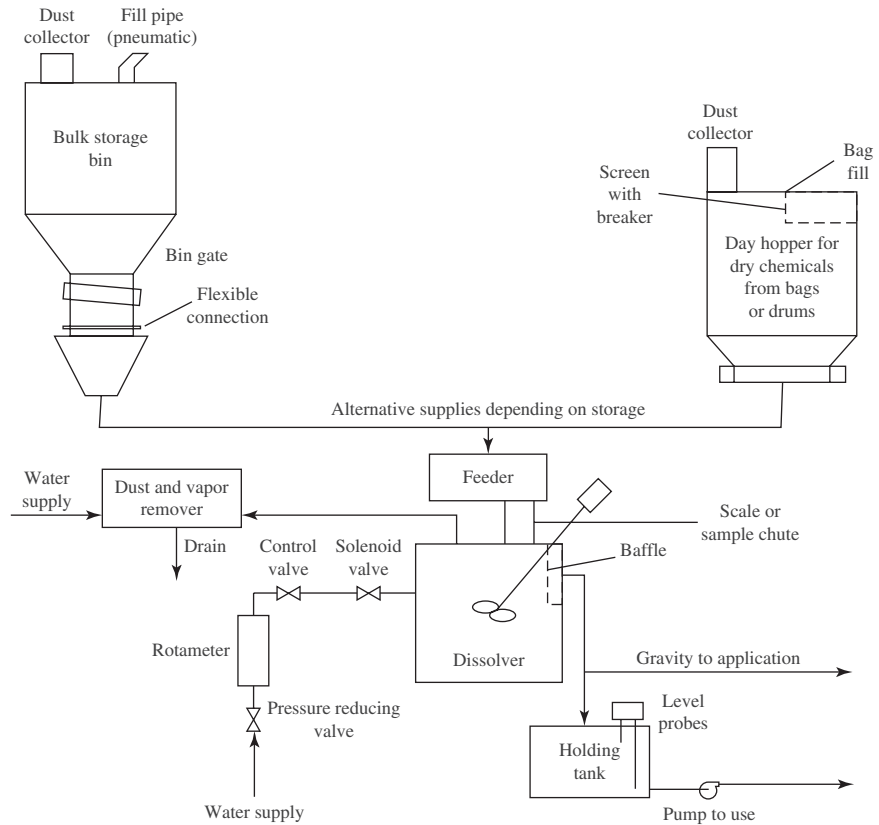

FIGURE 5-3
Dry chemical feed system. (Source: Metcalf & Eddy, 2003.)

TABLE 5-2
Dry feeder characteristics

Type of feeder	Application	Capacity m ³ /h	Turn-down ratio	Remarks
Gravimetric				
Loss-in-weight	Granules, powder or lumps	6×10^{-4} to 2	100:1	
Continuous belt	Dry, free-flowing granules	6×10^{-4} to 0.06	100:1	Use hopper agitator to maintain constant density
Volumetric				
Rotating disc	Dry, free-flowing granules or powder	3×10^{-4} to 1	20:1	Use disk unloader for arching
Rotating cylinder	Dry, free-flowing granules or powder	0.2 to 60	10:1	
Screw	Dry, free-flowing granules or powder	1×10^{-3} to 1	20:1	
Ribbon	Granules, powder or lumps	6×10^{-5} to 5×10^{-3}	10:1	
Belt	Dry, free-flowing granules or powder up to 3 cm size	3×10^{-3} to 85	10:1	

Adapted from Hudson, 1981, and Kawamura, 2000.

The characteristics of dry chemical feeders are summarized in Table 5-2.

Gravimetric Feeders. There are two types: loss-in-weight and belt-type. The loss-in-weight type uses a feed hopper suspended from scale levers, a material feed control mechanism, and a scale beam with a motorized counterpoise. The rate of weight loss of the hopper equals the weight loss equivalent of a traveling counterpoise when the feeder is in balance. If it does not, the scale beam deflects and the feed mechanism adjusts the feed rate.

A feed hopper and control gate regulate the flow and depth of material on the belt-type feeder. A scale counterpoise is adjusted to establish the desired belt loading. The gate releasing material and the speed of the belt are adjusted to produce the desired flow of material.

The loss-in-weight type feeder capacity is limited to about 400–500 kg/h. The belt-type feeders have capacities of 225 Mg/h and up.

Volumetric Feeders. The volumetric feeders provide good overall performance at low feed rates and acceptable accuracy for materials with stable density and uniformity. They do not perform well when the density of the material is not stable or is hygroscopic. They must be calibrated frequently.

Lime Slakers. *Slaking* means combining water with *quicklime* (CaO) in various proportions to produce milk of lime or a lime slurry. Lime feed systems combine the addition of the chemical

and mixing it with water into one system. They include a quicklime feeder, water control valve, grit removal device, and a reaction vessel.

The slaking reaction is highly exothermic. The reaction vessel is designed for the high heat release rate. It is completely contained to protect the operator from “boil up” of the slurry.

Example 5-3. Select a feeder for the lime described in Example 5-1. The quicklime is lumpy.

Solution:

- a. From Example 5-1, the average purity of lime is 87% and the daily lime consumption is 3,575 kg/d.
- b. The feeder must be capable of handling a lumpy material. The first choice of feeder from Table 5-2 is “loss-in-weight.”
- c. Check the capacity:

$$(3,575 \text{ kg/d}) \left(\frac{1}{24 \text{ h/d}} \right) \left(\frac{1}{850 \text{ kg/m}^3} \right) = 0.18 \text{ m}^3/\text{h}$$

where 850 kg/m^3 is the average bulk density of lime from Appendix A. This is within the operating range of 6×10^{-4} to $2 \text{ m}^3/\text{h}$ for the loss-in-weight feeder.

Liquid Feed Systems

A typical liquid feed system consists of a storage tank and/or a day tank, pump, meter, and distribution system as shown in Figure 5-4.

The characteristics of liquid chemical feeders are summarized in Table 5-3 on page 5-12.

Piston and Diaphragm Pumps. The capacity of these pumps depends on the stroking speed and the length of the stroke. In contrast to the piston pump where the piston is in direct contact with the chemical, diaphragm pumps, as the name implies, use the movement of a diaphragm to move the fluid.

Progressive Cavity Pumps. These pumps use a combination of an eccentric rotation of a shaft combined with stator elements to move the fluid. They are particularly suited to moving viscous, shear sensitive fluids, pastes, and gritty slurries.

Eductors. A stream of water passing through a venturi in the eductor creates a vacuum that draws the liquid chemical into the eductor. Because the eductor is incapable of flow rate control, the chemical must be metered in some fashion. This system has found success in moving lime slurry from a slaker to a mixing system.

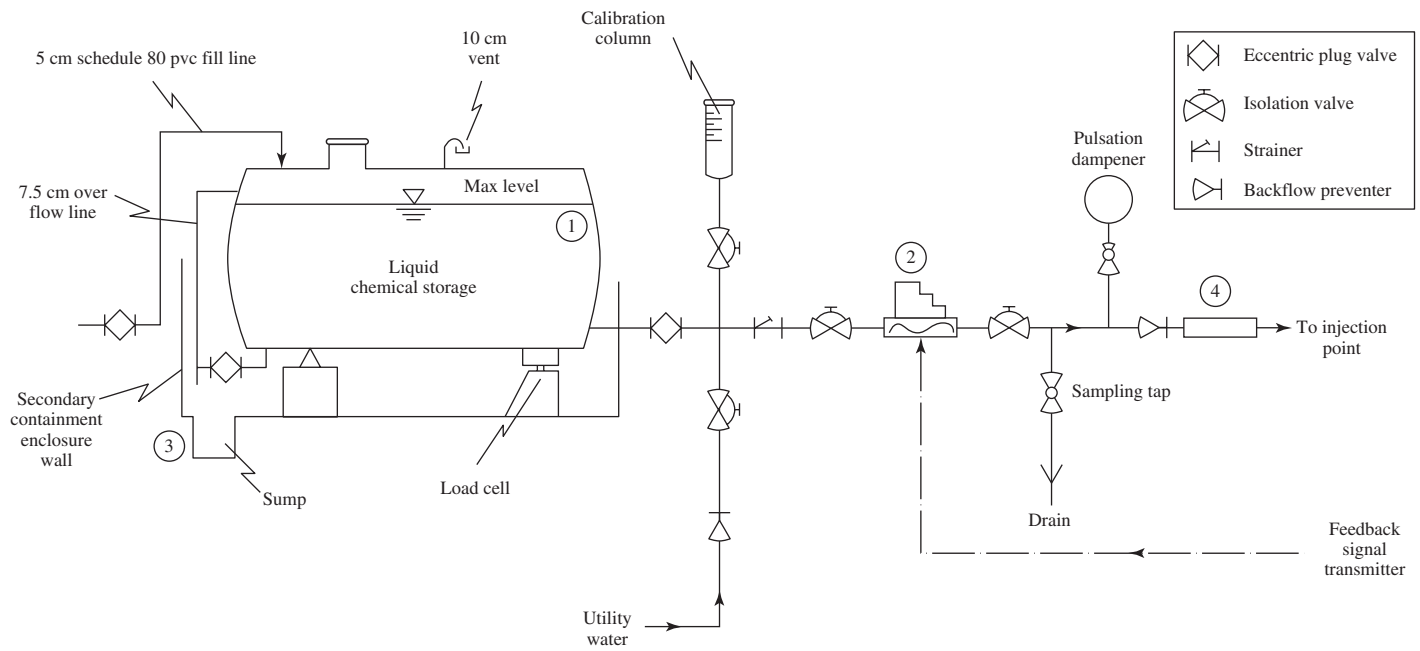

FIGURE 5-4
Liquid chemical feed system.

Notes:

1. Tanks, horizontal or vertical.
2. Flow pacing—variable speed motor. Provide two in parallel.
3. Volume of enclosure around storage tank shall be 100% of liquid volume of tank + 10% + freeboard.
4. Magnetic flowmeter for monitoring (optional).

TABLE 5-3
Liquid feeder characteristics

Type of feeder	Application	Capacity m ³ /h	Turn-down ratio	Remarks
Proportioning pump				
Peristaltic	Most solutions	10 ⁻⁶ to 10 ⁻³	10:1	Flow rate very sensitive to changes in head
Positive displacement				
Piston at low feed	Most solutions, light slurries	3 × 10 ⁻⁴ to 5	10:1 ^a	Higher turn-down ratio leads to inaccuracy
Diaphragm at low feed	Most solutions	1 × 10 ⁻⁴ to 4 × 10 ⁻³	10:1	Higher turn-down ratio leads to inaccuracy
Rotating dipper	Most solutions or slurries	3 × 10 ⁻³ to 0.8	100:1	
Nonpositive displacement				
Rotameter	Clear solutions	1 × 10 ⁻⁴ to 5 × 10 ⁻³	10:1	Calibrated valve
Loss-in-weight	Most solutions	6 × 10 ⁻⁵ to 6 × 10 ⁻³	30:1	Tank with control valve

^aAlthough manufacturers sometimes claim the capability of high turn-down ratios (i.e., 100:1) by using a combination of stroke length and speed, pumps should be sized so that the turn-down ratio does not exceed 10:1 to ensure accuracy at low feed rates (Anderson, 2005).

Peristaltic Pumps. These pumps use a rotating cam to create successive waves of contraction on a flexible tube to move the fluid. They are particularly well suited to small flow rates of chemical on the order of a few milliliters per minute up to about 1 L per minute.

Gas Feed System

A conventional gas feed system for chlorine, called a *chlorinator*, is shown in Figure 5-5. It consists of an inlet pressure reducing valve, a rotameter, a metering control orifice, a vacuum differential regulating valve, and a venturi injector. The vacuum created by the chlorine injector moves the gas from the storage cylinders to the injection system. Evaporators may be used on very large systems.

The chlorine passes through the rotameter that measures the gas flow rate, then through a metering or control orifice. A vacuum differential regulator is mounted across the control orifice to stabilize the flow for a particular setting of the orifice. Current design practice is to locate the vacuum regulators as close as possible to the storage containers to minimize the amount of pressurized gas piping in the plant.

Typically, the control orifice has a range of 20 to 1, and the vacuum differential regulator has a range of about 10 to 1. The overall range is thus about 200 to 1. Because rotameter ranges are generally limited to about 20 to 1, their selection controls the actual operating range without changing rotameters (Anderson, 2005).

To maintain an inventory of the chemical remaining in a cylinder, it is placed on a scale before being put into service. The weight is noted periodically.

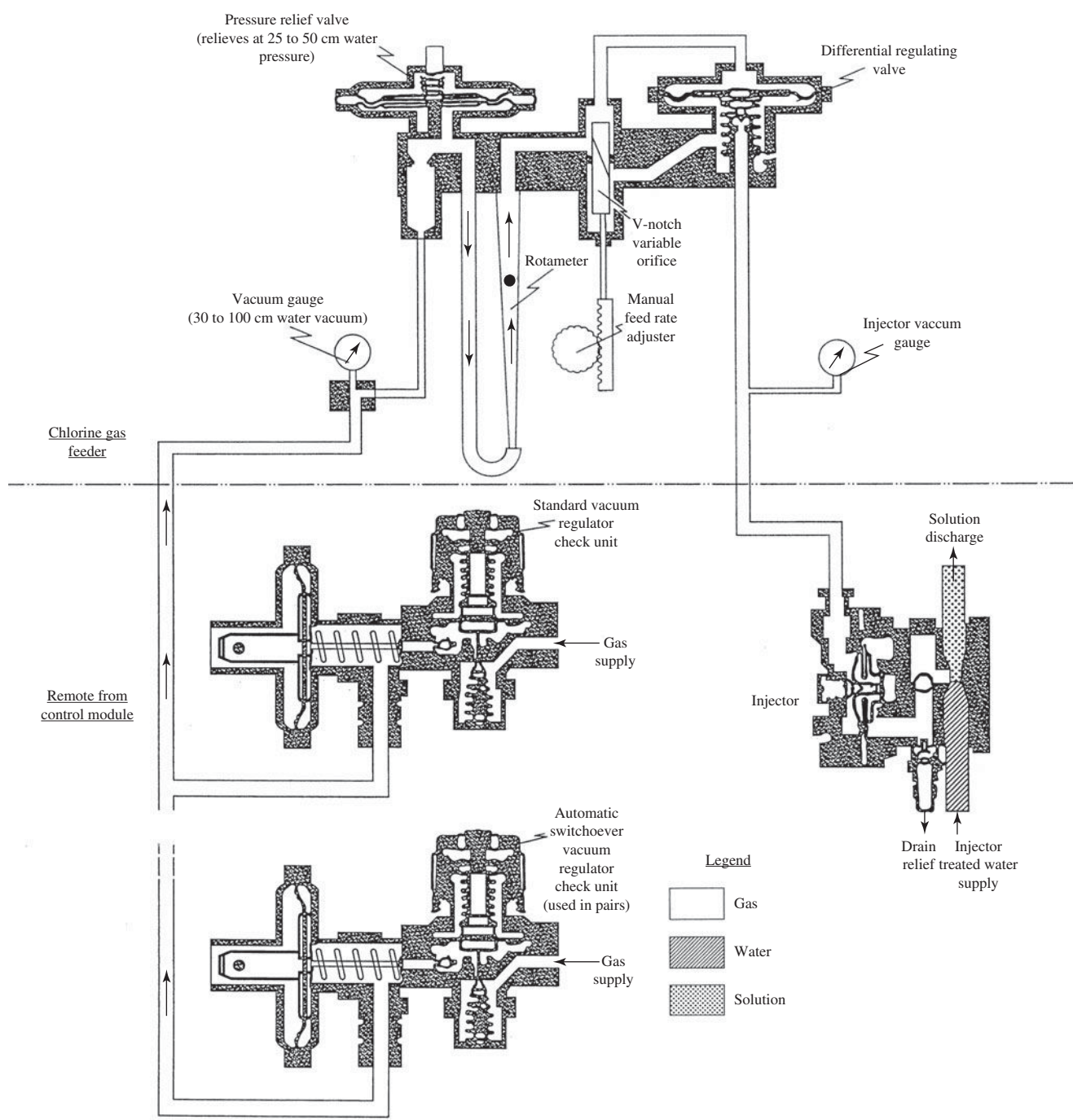

FIGURE 5-5
Flow diagram for conventional chlorinator.

5-5 CHEMICAL COMPATIBILITY

It is not intended here to present an exhaustive list of incompatible chemicals but rather to highlight combinations that may lead to violent reactions. Many others used in water and wastewater require care. In particular, the design should provide sufficient piping and storage vessels that the potential for residues from prior-use chemicals reacting with new-use chemicals is minimized.

Because there is a tendency for water of crystallization from alum to slake lime, it is imperative that mixture of these two chemicals be avoided. In a closed container, this combination may lead to a violent explosion. For the same reason, ferric sulfate and lime should not be mixed (Anderson, 2005). Mixtures of potassium permanganate and ferric chloride will form toxic chlorine gas (Kawamura, 2000).

An abbreviated list of incompatible chemicals is presented in Table 5-4. A rigorous search for chemical combinations not shown in Table 5-4 is recommended as part of the design process.

5-6 MATERIALS COMPATIBILITY

For very corrosive chemicals such as ferric salts, sodium hypochlorite, and sodium hydroxide, nonmetallic materials are preferred. These include fiberglass-reinforced plastic (FRP) and various forms of polyethylene (PE) such as high-density, cross-linked polyethylene (HDXLPE).

Polyvinyl chloride (PVC), polypropylene, rubber-lined steel and type 316 stainless steel are used for alum. In warm climates where the temperature of liquid alum may exceed 50°C, chlorinated polyvinyl chloride (CPVC) is recommended.

Lime and soda ash can be stored in concrete or mild steel silos.

Suitable materials for storage containers for other chemicals are listed in Appendix A. Recommended materials for piping are given in Table 5-5.

TABLE 5-4
A short list of incompatible chemicals used in water and wastewater treatment

Chemicals	Keep out of contact with:	Remarks
Activated carbon	Oxidizing agents such as chlorine, hypochlorites, potassium permanganate, sulfuric acid	Potential for fire
Alum	Lime, milk of lime—Ca(OH) ₂	Violent exothermic reaction
Ammonia	Concentrated chlorine and chlorine compounds	Violent exothermic reaction
Ferric chloride	Potassium permanganate	Formation of chlorine gas
Fluorine compounds	All chemicals	Etches glass
Sulfuric acid	Strong bases, light metal compounds containing potassium and sodium	Violent exothermic reaction

TABLE 5-5
Recommended materials for piping

Chemical	Piping material									
	Iron or steel	Type 316 stainless	Type 304 stainless	Copper	PVC—type 1	Fiberglass-reinforced polyester (FRP)	Polypropylene	Rubber tubing	Glass	
Activated carbon (slurry)		X				X		X		
Alum	NR	S	NR		S	X	X		X	
Ammonia, aqua	S	X								
Calcium hydroxide (slurry)	S	X	X		X		X	X		
Calcium hypochlorite					X		X		X	
Carbon dioxide (dry)	S	X	X	X	X	X	X	X		
Chlorinated copperas					X			X		
Chlorine (dry gas)	S			X	NR		NR			
Chlorine solution	NR	NR	NR		S	X		X		
Chlorine dioxide (3% soln.)					X				X	
Coagulant aids			Consult manufacturer—generally not corrosive							
Copper sulfate		X			S	X	X	X		
Dolomitic lime (slurry)	X	X	X		X		X	X		
Ferric chloride	NR	NR	NR	NR	S	X	X	X	X	
Fluosilicic acid	NR	NR	NR		X		X		NR	
Hydrochloric acid	NR	NR	NR	NR	X	X	X	X		
Potassium permanganate (2% soln.)	X	X			X	X	X			
Sodium carbonate (soln.)	S				X	X	X	X		
Sodium chloride		X			X	X	X		X	
Sodium chlorite					X	X	X		X	
Sodium fluoride (1% to 5% soln.)		X			X	X	X	X		
Sodium hexametaphosphate (soln.)		X			X	X		X		
Sodium hydroxide (to 50% soln.)	X	X	X		X	X	X	X		
Sodium hypochlorite (to 16% soln.)					S		X	X	X	
Sodium silicate	S	X	X		X	X	X	X		
Sodium silicofluoride			X		X			X		
Sulfur dioxide (dry gas)	X	X	X						X	
Sulfur dioxide (soln.)		X								
Sulfuric acid (conc.)	S									
Sulfuric acid	NR				S	X	X	X	X	

Key: S = Industrial standard or excellent for handling

X = Suitable for handling

NR = Not recommended

Source: Anderson, 2005.

The following example illustrates the complete design of the storage and handling system for one chemical.

Example 5-4. Design the coagulant chemical handling and storage system for Boiling Water, Arizona using the following design data:

Average daily design flow rate = 38,000 m³/d

Coagulant = ferric chloride

Maximum dosage = 50 mg/L as FeCl₃

Shipping time = 1 week

Summer temperature frequently exceeds 40°C

Solution:

a. Off-loading piping

From Table 5-5, select a 100 mm diameter schedule 80 PVC pipe with a notation to check manufacturer's data for temperature limitations.

b. Storage tank

(1) From Appendix A select FRP for tank material. The tank should be located indoors in a cool location.

(2) From Appendix A, note that ferric chloride is shipped as a 40% solution with 100% active ingredient. At the maximum dosage, the daily mass of ferric chloride used is

$$(50 \text{ mg/L})(38,000 \text{ m}^3/\text{d})(10^3 \text{ L/m}^3)(10^{-6} \text{ kg/mg}) = 1,900 \text{ kg/d}$$

and the mass of solution required is

$$\frac{1,900 \text{ kg/d}}{0.40} = 4,750 \text{ kg/d}$$

(3) Noting, from Table 5-1, that coagulants are noninterruptible, the volume to be held in two tanks for redundancy is 30-days supply plus two times the shipping time.

$$(4,750 \text{ kg/d})(30 \text{ d} + (2)(7\text{d})) = 209,000 \text{ kg}$$

(4) Using the density of ferric chloride from Appendix A, the volume of solution to be stored is

$$\frac{209,000 \text{ kg}}{1,440 \text{ kg/m}^3} = 145.14 \text{ or } 150 \text{ m}^3$$

c. Feeder

Two feeder pumps are required to meet redundancy requirements.

From Table 5-3, a piston metering pump with PVC or PE coated piston is selected. Checking the capacity

$$(4,750 \text{ kg/d}) \left(\frac{1}{24 \text{ h/d}} \right) \left(\frac{1}{1,440 \text{ kg/m}^3} \right) = 0.14 \text{ m}^3/\text{h}$$

where $1,440 \text{ kg/m}^3$ is the density of ferric chloride from Appendix A. This is in the operating range of 3×10^{-4} to $5 \text{ m}^3/\text{h}$.

d. Transfer piping

From Table 5-5, select a 50 to 100 mm diameter schedule 80 PVC pipe.

e. The arrangement of the system is shown in Figure 5-4.

5-7 DESIGNING FOR SAFETY AND HAZARDOUS CONDITIONS

Table 5-6 provides a general overview of safety requirements and protective measures for handling chemicals. Many of these measures are to be implemented by the operators, but several require design provisions. *Material Safety Data Sheets* (MSDS) provided by the manufacturer of the chemical provide more detailed information on its safe handling. Another general reference for chemical safety, exposure limits, and incompatibilities is *NIOSH Pocket Guide to Chemical Hazards* (NIOSH, 2003).

The Emergency Planning and Community Right-to-Know Act (EPCRA), also known as Title III of the Superfund Amendments and Reauthorization Act (SARA), requires facilities with chemicals above the thresholds given in Table 5-7 to report this to the State Emergency Response Commission (SERC) and coordinate with the appropriate Local Emergency Planning Commission (LEPC). Construction of a new facility exceeding these amounts requires that the owner notify the SERC and LEPC. Operating and maintenance manuals should address these issues.

In many communities, chlorine gas is **the** most hazardous substance in substantial quantity in the community. Not only is it a hazard because of potential accidental release from delivery through application to the water supply, but it also is a security hazard. Although it is more expensive, sodium hypochlorite (NaOCl) is being used to replace gaseous chlorine to reduce the hazard that gaseous chlorine poses. Many water treatment plants are using alternative disinfectants, such as ultraviolet (UV) radiation and ozone, to reduce the need for large amounts of chlorine. Wastewater treatment plants have implemented the use of UV for the same reason.

5-8 OPERATION AND MAINTENANCE

The major issues in operation and maintenance are safety programs and training, preventive maintenance, good housekeeping, and good record keeping.

Because the concentrated chemicals used in water and wastewater treatment are for the most part harmful to human health, formal safety programs are essential. This includes periodic hands-on training, provision of appropriate safety equipment in accessible locations, and provision of personal protective equipment (PPE).

TABLE 5-6
Protective measures for water & wastewater treatment chemicals

Chemical (D = dry; L = liquid; G = gas)	Protective equipment required											Remarks		
	Positive ventilation	Protective clothing	Neck cloths	Gloves	Rubber boots	Rubber gloves	Goggles	Face shields	Rubber aprons	Respirator	Gas mask		Avoid skin contact	Safety shower and eye baths
Activated alumina (D)	■													Store away from gasoline, mineral or vegetable oils, calcium hypochlorite (HTH), lime, sodium chlorite, or potassium permanganate
Activated carbon														
Powder (D)	■	■	■	■		■	■			■				
Granulate (D)	■		■										■	
Alum sulfate (D)	■	■	■	■			■			■		■		Similar to other acids
Alum sulfate (L)								■	■			■		
Ammonium hydroxide (L)	■											■	■	Moist NH ₃ reacts with many metals and alloys—liquid contact produces burns
Ammonium sulfate (D)	■	■	■	■			■			■		■	■	See alum sulfate above
Anhydrous ammonia (G)	■	■				■		■		■	■	■	■	Fire sprinklers and water hoses effective in removing gas
Bauxite (D)	■		■	■						■				
Bentonite (D)	■													
Calcium carbonate (D)	■													
Calcium hypochlorite (D)	■		■	■						■		■		
Carbon dioxide (G)	■									■		■		
Chlorine (G)	■			■				■		■	■	■		Avoid contact with hydrogen or organic compounds or other flammable materials
Chlorine dioxide (G)	■	■			■	■		■	■	■	■	■	■	Solution is corrosive
Copper sulfate (D)	■	■	■	■			■			■		■	■	Very corrosive
Ferric chloride (D)	■	■	■		■	■	■	■	■	■		■		Very corrosive
Ferric sulfate (D)	■	■	■		■	■	■	■	■	■		■		
Ferrous sulfate (D)	■	■	■	■			■			■		■		
Ferrous sulfate (L)		■				■		■	■			■	■	
Fluosilicic acid (L)		■	■	■	■	■	■	■	■	■		■	■	Have lime slurry on hand
Fluorspar (D)	■	■	■			■		■	■	■		■	■	Etches glass when moist

Chemical (D = dry; L = liquid; G = gas)	Protective equipment required													Remarks
	Positive ventilation	Protective clothing	Neck cloths	Gloves	Rubber boots	Rubber gloves	Goggles	Face shields	Rubber aprons	Respirator	Gas mask	Avoid skin contact	Safety shower and eye baths	
Hydrated lime (D)	■	■	■	■			■	■		■		■	■	Can burn eyes or skin
Hydrochloric acid (L)	■	■			■	■		■	■			■	■	
Iron-exchange resins (D)	■		■	■			■						■	Hydrogen cation resins are acidic
Ozone (G)	■											■	■	
Potassium permanganate (D)	■	■			■	■	■		■			■	■	Large quantities present fire hazard
Quicklime (D)	■	■	■	■			■	■				■	■	Can burn eyes or skin
Sodium aluminate (D)	■		■	■			■							
Sodium aluminate (L)				■		■	■					■		
Sodium bisulfate (D)	■			■			■							
Sodium carbonate (D)	■	■		■			■			■				
Sodium chloride (D)	■	■		■					■			■	■	Can dehydrate skin
Sodium chlorite (D)	■	■				■		■		■			■	Rinse any spills immediately with water
Sodium fluoride (D)	■	■	■	■			■			■		■	■	
Sodium polyphosphate, glassy (D)	■	■	■	■								■	■	
Sodium hydroxide (D)	■	■	■		■	■	■	■	■			■		
Sodium hydroxide (L)		■				■	■	■	■			■	■	
Sodium hypochlorite (L)	■	■				■	■	■	■	■		■	■	
Sodium silicate (D)	■													
Sodium fluorosilicate (D)	■	■	■	■			■	■		■			■	
Sodium sulfite (D)	■			■			■					■		
Sodium dioxide (G)	■							■		■	■	■		
Sulfuric acid (L)	■	■			■	■	■	■	■			■	■	

Adapted from Anderson, 2005.

TABLE 5-7
EPCRA threshold planning quantities

Chemical	Threshold planning quantity, kg
Chlorine	45
Chlorine dioxide	Not listed
Anhydrous ammonia	225
Aqua ammonia	Not listed
Hydrogen peroxide (52%)	450
Sulfuric acid	450
Ozone	45

Preventive maintenance includes regularly scheduled times for equipment to be taken out of service for replacement of worn parts, calibration, and so on. Frequently, this type of work is scheduled in the winter to take advantage of low flows. In addition, feeders, feed lines, and instrumentation are to be checked routinely during each shift.

Good housekeeping includes prompt cleaning of spills and removal of chemical dust.

Although regulatory agencies will dictate that certain records be kept, operation of the plant often requires more information than is reported. For example, the status of the chemical inventory and the operating performance of each piece of the chemical handling and feeding equipment should be logged and conveyed to the next shift operator (Kawamura, 2000).

Hints from the Field. Operation and maintenance personnel who have to live with the results of the engineer's design have offered the following suggestions:

- Schedule 80 PVC and CPCV are the most commonly used materials for sodium hypochlorite piping. Early installation of these systems failed because of leaks at the solvent welded joints. Special glues designed for use with NaOCl must be used to guard against this type of failure.
- Quicklime storage silos should always be cylindrical. Because of its hygroscopic nature, lime will invariably cake in the silo. In one case, the working volume of a 200 Mg square silo was effectively reduced to 35 Mg. Vibration and other attempts to loosen the caked material were ineffective. The additional expense of a cylindrical silo will be repaid many times by the reduced O&M costs of trying to loosen the caked lime.
- As shown in Figure 5-6, place the slaker directly beneath the lime storage silo to minimize dust in transporting the lime to the slaker.
- Grit in the lime can be removed after slaking by the simple expedient of placing a milk crate lined with hardware cloth in the exit stream (Figure 5-6).
- Transport the slaked lime to the mixing device with an eductor and flexible hose (Figure 5-6). Pumps will cake with lime, and rigid pipes will clog. The eductor eliminates moving parts, and the flexible pipe makes it easy to spot blockages and either break them in place or quickly replace a section for out-of-service cleaning.

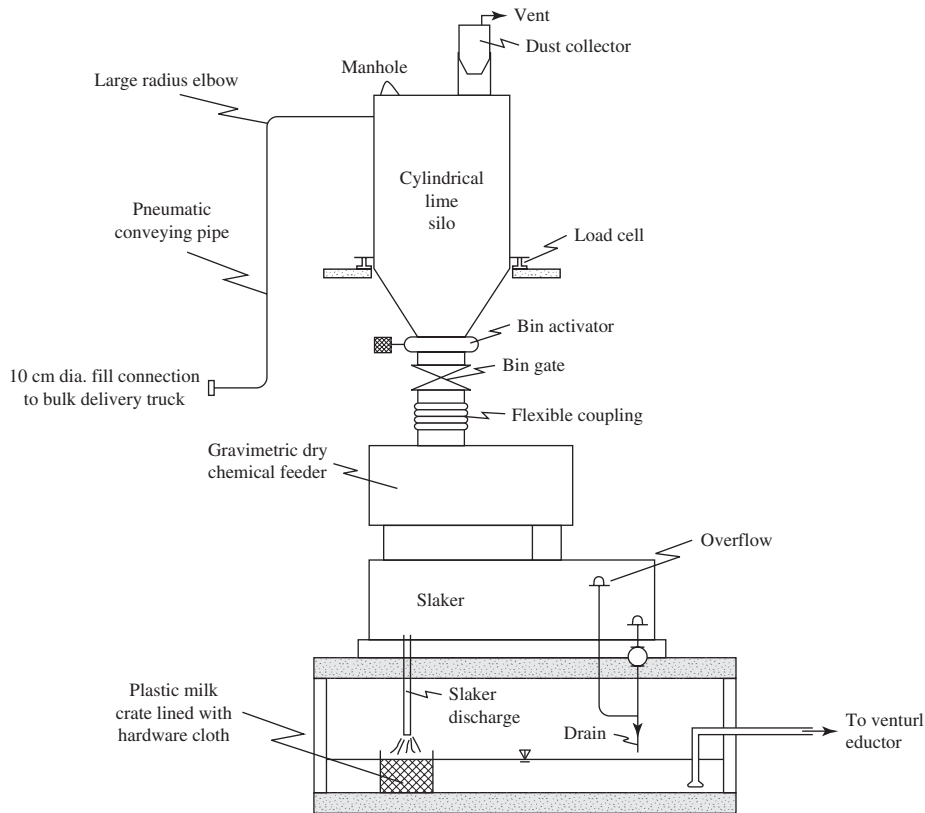

FIGURE 5-6

Lime materials storage, handling, and feed system. Two feeder slaker units are required for redundancy. Both may serve one silo. Transfer from the silo to day bins may also simplify measuring chemical usage.

Visit the text website at www.mhprofessional.com/wwe for supplementary materials and a gallery of photos.

5-9 CHAPTER REVIEW

When you have completed studying this chapter, you should be able to do the following without the aid of your textbooks or notes:

1. Given the plant capacity and/or the scenario for discharge, determine the number of feeders required.
2. Describe a method for covering the range of feed capacities required when the turn-down ratio of the feeder may not be sufficient.
3. Explain why the liquid chlorine level in chlorine tanks is nominally at 85 percent of the volume of the tank.
4. Explain the difference between interruptible and noninterruptible chemicals and give examples of each.

5. Describe a method to keep track of the inventory in a dry chemical silo.
6. Explain why the percent concentration of some liquid chemicals is important in handling and storage.
7. Given the plans for secondary containment of a storage area, identify the components that would need to be checked to meet acceptable design criteria.
8. Explain the purpose of a day tank.
9. Define MSDS.

With the use of this text, you should be able to do the following:

10. Design a chemical storage tank or silo.
11. Design a secondary containment system given the dimensions of a storage tank or silo.
12. Examine a set of drawings to verify safety features for a chlorine gas feed and storage system.
13. Select an appropriate feeder for a given chemical.
14. Given a chemical and material or two chemicals, use appropriate charts to determine whether or not they are incompatible.

5-10 PROBLEMS

- 5-1. Design a storage silo for lime for a water treatment plant with a design average day capacity of $0.23 \text{ m}^3/\text{s}$. The maximum dose is estimated to be 133 mg/L as CaO . The local supplier has current contracts with other municipalities that specify 85% purity and an average bulk density of 960 kg/m^3 . Shipping time is normally two weeks. Provide a dimensioned drawing of the silo with recommended appurtenances.
- 5-2. Design a storage silo for soda ash for a water treatment plant with a design average day capacity of $0.23 \text{ m}^3/\text{s}$. The maximum dose is estimated to be 106 mg/L as Na_2CO_3 . The local supplier has current contracts with other municipalities that specify 99% purity and an average bulk density of 800 kg/m^3 . Shipping time is normally 10 working days. Provide a dimensioned drawing of the silo with recommended appurtenances.
- 5-3. Mule Shoe is to provide fluoride to augment the natural fluoride in the water supply. The natural fluoride concentration is 0.25 mg/L . The design concentration is 1.0 mg/L . The flow rate is $0.057 \text{ m}^3/\text{s}$. The municipal water authority has decided to use 45 kg polyethylene kegs of fluorosilicic acid (H_2SiF_6) provided by the chemical supplier as their storage system. Commercial strength is 40% H_2SiF_6 . Estimate the number of kegs they must store if delivery is once a month.
- 5-4. For safety and security reasons, the city of Alum Rock has decided to replace its chlorine gas disinfection system with a sodium hypochlorite (NaOCl) system. You have been tasked with the design of the storage tank(s) for sodium hypochlorite that is to replace the gas cylinders. The existing storage system consists of twelve 900 kg

chlorine gas cylinders. These are housed in a room that is $11.5 \text{ m} \times 7 \text{ m} \times 3.3 \text{ m}$. Assume that the chlorine gas is 100% pure and that commercial NaOCl will provide 12% available chlorine. Specify the dimensions of the tank(s) and the materials for constructing an equivalent sodium hypochlorite storage system. Provide a dimensioned drawing of the tank(s) with recommended appurtenances and show how they will fit in the existing chlorine room. Assume the density of 12% NaOCl is $1,210 \text{ kg/m}^3$ and that a 1.0 m clearance between the top of the tank and the ceiling is required.

- 5-5.** Determine the size (in m^3/hour) and number of diaphragm pumps to feed ferric chloride for a $3,800 \text{ m}^3/\text{d}$ water treatment plant. The optimum dose selected is 50 mg/L . Ferric chloride may be obtained in a liquid form that is 40% pure. The density of this solution is 1.415 kg/L .
- 5-6.** Black Gold is to expand their water treatment plant because of a major increase in population due to the discovery of oil in the county. Lime is used to adjust the pH of their coagulation process. The estimated dosage range from the opening of the plant until it reaches its design life is 3 to 150 kg/h . The bulk density of lime is approximately 960 kg/m^3 . Select an appropriate type of feeder or combination of feeders from the list below.

Feeder type	Model	Capacity m^3/h	Turn-down ratio
Loss-in-weight	A-1	0.06	100:1
	A-2	2.0	100:1
Continuous belt	B-1	0.03	10:1
	B-2	0.06	10:1

- 5-7.** A chlorinator needs to be selected to complete the design of the disinfection facilities for Camp Verde. The average chlorine dose required is estimated to be 2.0 mg/L . The maximum dose required is estimated to be 10 mg/L . The average flow rate is $0.23 \text{ m}^3/\text{s}$. The available chlorinators are listed below. Each rotameter has a turn-down ratio of 20:1. Select the appropriate model and rotameter(s).

Model	Capacity, kg/d	Rotameter rating, kg/d
V-1	225	45
		90
		135
		180
		225
		225
V-2	900	45
		115
		225
		450

5-11 DISCUSSION QUESTIONS

- 5-1. A small batch coagulation plant did not receive the expected shipment of alum on time. However, they have lime (CaO) available, if they could use it. Can they use it as a substitute? Explain why or why not. Mention any safety precautions.
- 5-2. In Figure P-5-2, identify design items that are either wrong or that are missing.

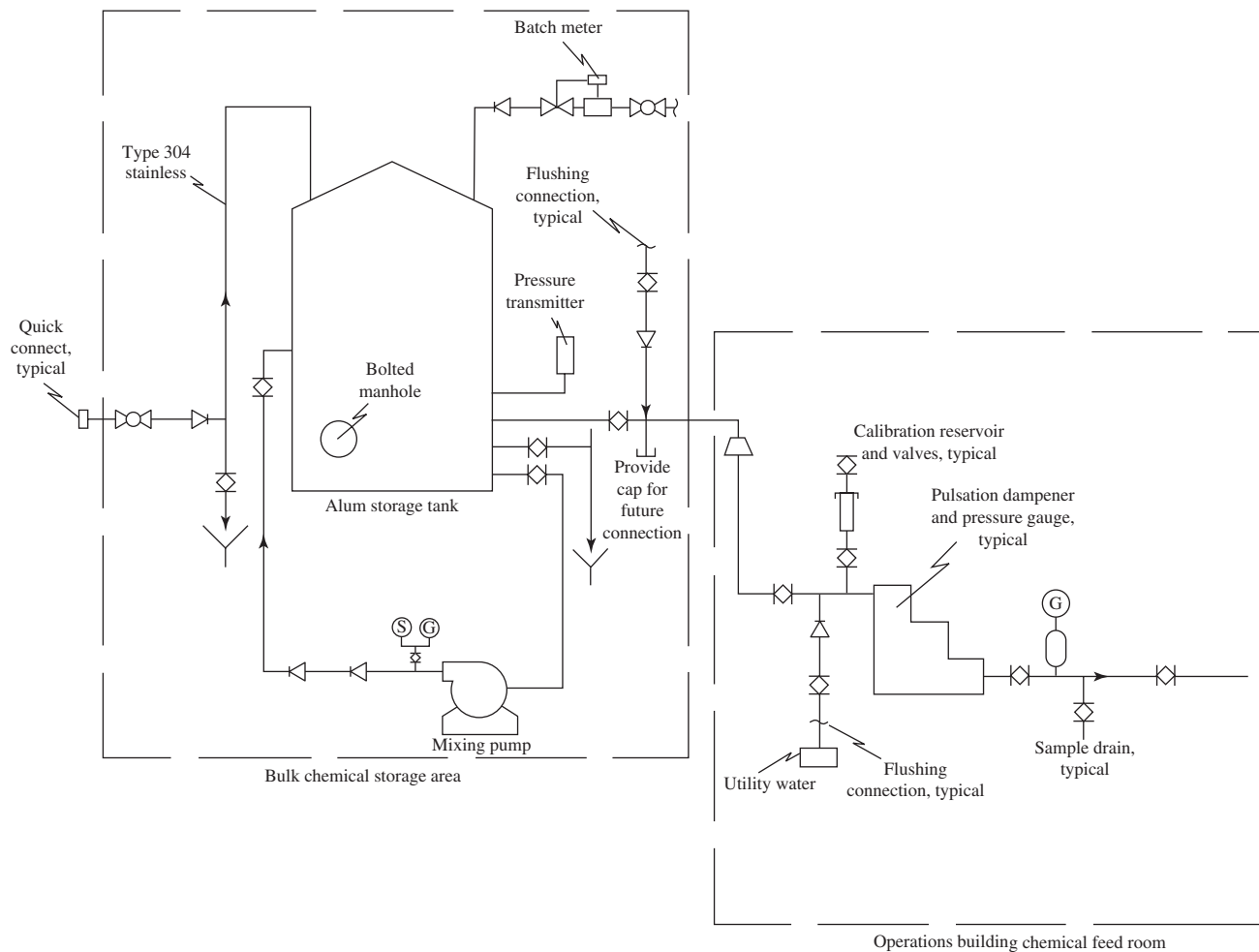

FIGURE P-5-2

5-12 REFERENCES

- Anderson, J. L. (2005) "Chemicals and Chemical Handling," in E. E. Baruth (ed.), *Water Treatment Plant Design*, McGraw-Hill, New York, pp. 15.1–15.53.
- GLUMRB (2003) *Recommended Standards for Water Works*, Great Lakes–Upper Mississippi River Board of State and Provincial Public Health and Environmental Managers, Health Education Services, Albany, New York.
- Hudson, H. E. (1978) "Chemical Handling and Feeding," in R. L. Sanks (ed.), *Water Treatment Plant Design for the Practicing Engineer*, Ann Arbor Science, Ann Arbor, Michigan, pp. 125–130.
- Hudson, H. E. (1981) *Water Clarification Processes*, Van Nostrand Reinhold, New York.
- Kawamura, S. (2000) *Integrated Design and Operation of Water Treatment Facilities*, 2nd ed., John Wiley & Sons, New York, pp. 358–361, 367–372.
- Metcalf & Eddy (2003) *Wastewater Engineering: Treatment and Reuse*, 4th ed., McGraw-Hill, Boston, MA, pp. 532–540.
- NIOSH (2003) *NIOSH Pocket Guide to Chemical Hazards*, Nostrand Reinhold, New York.
- U.S. EPA (1974) *Design Criteria for Mechanical, Electrical, and Fluid Systems and Component Reliability*, Supplement to *Federal Guidelines: Design, Operation, and Maintenance of Wastewater Treatment Facilities*, U.S. Environmental Protection Agency Report No. 430-99-74-001, Washington, D.C.

This page intentionally left blank

COAGULATION AND FLOCCULATION

6-1 INTRODUCTION

6-2 CHARACTERISTICS OF PARTICLES

6-3 COAGULATION THEORY

6-4 COAGULATION PRACTICE

6-5 FLOCCULATION THEORY

6-6 MIXING THEORY

6-7 MIXING PRACTICE

6-8 OPERATION AND MAINTENANCE

6-9 CHAPTER REVIEW

6-10 PROBLEMS

6-11 DISCUSSION QUESTIONS

6-12 REFERENCES

6-1 INTRODUCTION

Coagulation and flocculation are essential components of conventional water treatment systems that are designed to

- Remove infectious agents,
- Remove toxic compounds that have adsorbed to the surface of particles,
- Remove precursors to the formation of disinfection byproducts, and
- Make the water palatable.

Surface water supplies contain organic and inorganic particles. Organic particles may include algae, bacteria, cysts of protozoa, oocysts, and detritus from vegetation that has fallen into the water. Erosion produces inorganic particles of clay, silt, and mineral oxides. Surface water will also include particulate and dissolved organic matter, collectively referred to as *natural organic matter* (NOM), that is a product of decay and leaching of organic detritus. NOM is important because it is a precursor to the formation of disinfection byproducts.

Groundwater treated to remove hardness, or iron or manganese, by precipitation contains finely divided particles.

Both the precipitates and the surface water particles may, for practical purposes, be classified as suspended and colloidal. Suspended particles range in size from about 0.1 μm up to about 100 μm in diameter (Figure 6-1). Colloidal particles are in the size range between dissolved substances and suspended particles. They are in a solid state and can be removed from the liquid by physical means such as very high-force centrifugation or by passage of the liquid through filters with very small pore spaces. Colloidal particles are too small to be removed by sedimentation or by sand filtration processes.

The object of coagulation (and subsequently flocculation) is to turn the small particles into larger particles called *flocs*, either as precipitates or suspended particles. The flocs are readily removed in subsequent processes such as settling, dissolved air flotation (DAF), or filtration. For the purpose of this discussion *coagulation* means the addition of one or more chemicals to

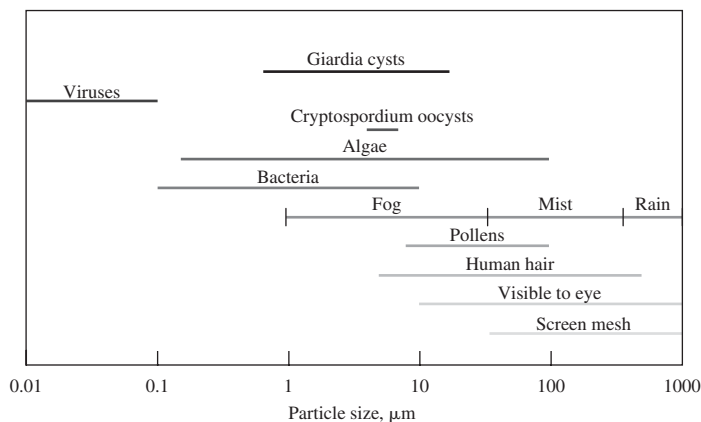

FIGURE 6-1
Particulates in water and miscellaneous other reference sizes.

condition the small particles for subsequent processing by flocculation.* *Flocculation* is the process of aggregation of the destabilized particles and precipitation products.

6-2 CHARACTERISTICS OF PARTICLES

Electrical Properties

The most important electrical property of the colloidal and suspended particles is their surface charge. This charge causes the particles to remain in suspension without aggregating for long periods of time. Surface water particle suspensions are thermodynamically unstable and, given enough time, they will flocculate and settle. However, the aggregation process is very slow, and the particles cannot be removed by sedimentation in a reasonable amount of time, that is, a short enough time that would allow production of a sufficient amount of water for a community of more than a few people.

For most particles in water the sign of the charge is negative (Niehof and Loeb, 1972; Hunter and Liss, 1979). This charge arises in four principal ways (Stumm and Morgan, 1970):

- *Ionization.* For example, silica has hydroxyl groups on its exterior surface. Depending on the pH, these can accept or donate protons:

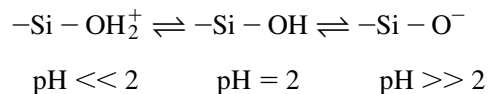

- *Adsorption.* In this case, a solute becomes bound to the solid surface, for example, a humic acid or natural color on a silica surface. These large macromolecules have carboxylic acid groups that dissociate at pH values greater than 5 to form negative ions.
- *Isomorphous replacement.* Under geologic conditions, the metal in a metal oxide is replaced by a metal atom with a lower valence. For example, if, in an array of solid SiO₂ tetrahedra, an Si atom is replaced by an Al atom (Al³⁺ has one less electron than Si⁴⁺), the lattice becomes negatively charged.
- *Structural imperfections.* In the formation of the mineral crystal, bonds are broken on the edge of the crystal. These lead to development of surface charge.

Electrical Double Layer. A colloidal dispersion in solution does not have a net charge. This is because the negatively charged particles accumulate positive counterions on and near the particle surface. Thus, as shown in Figure 6-2, a double layer forms. The adsorbed layer of cations (known as the *Helmholtz* layer or the *Stern* layer) is bound to the particle surface by electrostatic and adsorption forces. It is about 0.5 nanometers (nm) thick. A loose *diffuse layer* forms beyond the Helmholtz layer. The double layer (Helmholtz plus diffuse) has a net negative charge over the bulk solution. Depending on the solution characteristics, it can extend up to 30 nm into the solution (Kruyt, 1952).

Zeta Potential. When a charged particle is placed in an electric field, it will migrate to the pole of opposite charge. This movement is called *electrophoresis*. As the particle moves, a portion of the water near the surface moves with it. This movement displaces the ion cloud and gives it the

*Although the conditioning of colloidal and suspended matter is the primary function of the coagulation process, the precipitation of dissolved NOM is a concurrent objective.

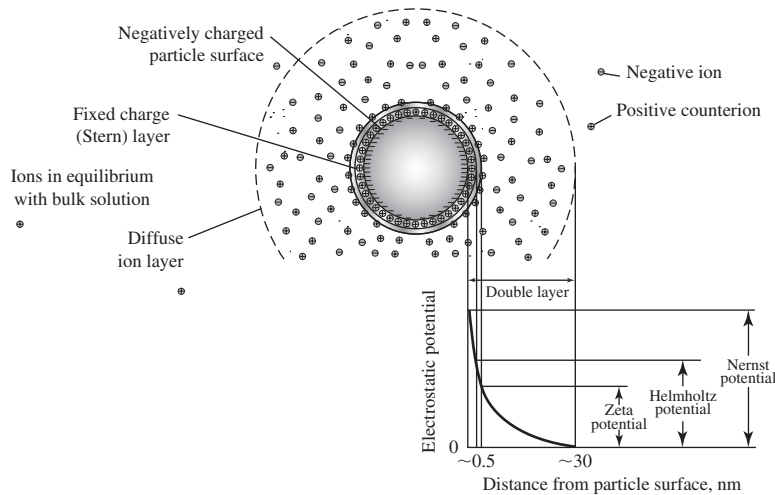

FIGURE 6-2
Surface charge on a particle in water.

shape shown in Figure 6-3. The electric potential between the shear plane and the bulk solution is called the *zeta potential*. It is noted in Figure 6-2. The zeta potential is calculated as

$$Z = \frac{v^0 k_z \mu}{\epsilon \epsilon_0} \tag{6-1}$$

where Z = zeta potential, mV

v^0 = electrophoretic mobility, $(\mu\text{m/s})/(\text{V/cm}) = v_E/E$

v_E = electrophoretic velocity of migrating particle, $\mu\text{m/s}$

E = electric field at particle, V/cm

k_z = shape constant of 4π or 6π

μ = dynamic viscosity of water, $\text{Pa} \cdot \text{s}$

ϵ = permittivity relative to vacuum

= 78.54 for water

ϵ_0 = permittivity in vacuum

= $8.854188 \times 10^{-12} \text{ N/V}^2$

The values for electrophoretic mobility for particles in natural water vary from about -2 to $+2$ $(\mu\text{m/s})/(\text{V/cm})$. The constant k_z is 4π if the extent of the diffuse layer is small relative to the curvature of the particle. It is 6π where the particle is much smaller than the thickness of the double layer (MWH, 2005).

Empirically, when the absolute value of the zeta potential is reduced below about 20 mV, rapid flocculation occurs (Kruyt, 1952).

Particle Stability. Particles in natural waters remain stable when there is a balance between the electrostatic force of the charged particles and attractive forces known as *van der Waals* forces. Because the particles have a net negative charge, the principal mechanism controlling stability is electrostatic repulsion.

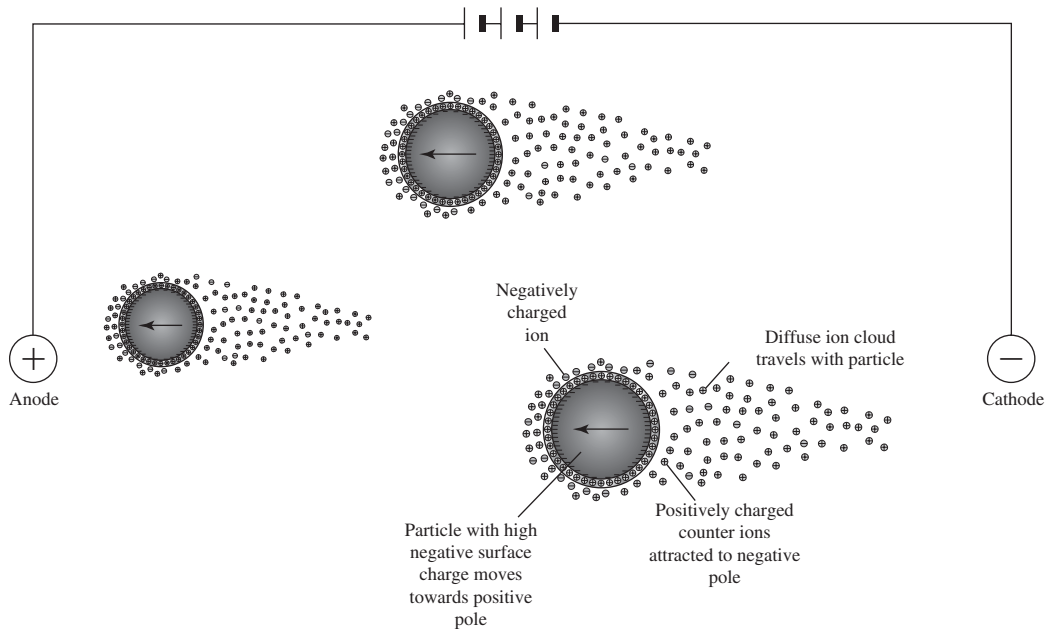
**FIGURE 6-3**

Schematic illustration of electrophoresis. Charged particle movement in an applied electric field. Note that each particle drags a cloud of ions with it.

Van der Waals forces arise from magnetic and electronic resonance when two particles approach one another. Because the double layer extends further into solution than the van der Waals forces, an energy barrier is formed that prevents particles from aggregating.

The theory of particle to particle interaction is based on the interaction of the attractive and repulsive forces as two particles approach each other. The theory is known as the DLVO theory after the individuals who developed it (Derjaguin and Landau, 1941; Verway and Overbeek, 1948).

The DLVO model concept is illustrated in Figure 6-4. The left and right ordinate represent the respective surfaces of two particles. The diagrams show the forces acting on the particles as they move toward each other. Two cases are shown. The van der Waals attractive force is the same in both cases. In case (a), the repulsive force from the electrostatic force exceeds the attractive force, and the net energy is repulsive. If the particles aggregate at all, it will be a loose aggregation at a distance of $4/k$, where k is the double layer thickness. This aggregation can be ruptured easily because the net force holding them together is weak. The particles will not aggregate strongly because of the energy barrier. In case (b), the repulsive force is less and the resultant net energy is zero. The particles will aggregate strongly because the resultant attractive forces become stronger as the particles close on one another.

6-3 COAGULATION THEORY

Coagulants

Inorganic coagulants used for the treatment of potable water exhibit the following characteristics:

- They are nontoxic at the working dosage.

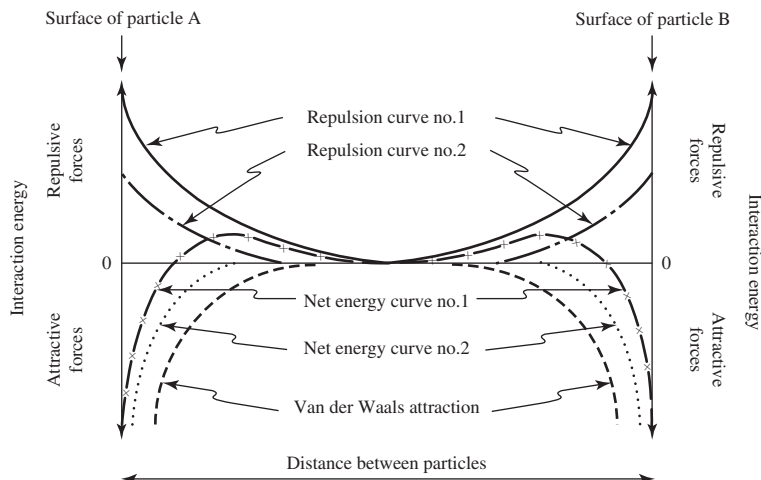

FIGURE 6-4

Attractive and repulsive forces that result when two particles are brought together. Repulsion curve no. 1 and net energy curve no. 1 result when no coagulant is present. Coagulant reduces the repulsion to curve no. 2.

- They have a high charge density.
- They are insoluble in the neutral pH range.

The inorganic chemicals commonly used in the United States are listed in Table 6-1. They are classified as hydrolyzable metal cations. In the United States, the predominant water treatment coagulant is aluminum sulfate or “alum.” It is sold in a hydrated form as $\text{Al}_2(\text{SO}_4)_3 \cdot x\text{H}_2\text{O}$ (where x is usually 14), because it is the least expensive coagulant (MWH, 2005).

Polyelectrolytes such as polydiallyldimethyl ammonium chloride (poly-DADMAC) and epichlorohydrin dimethylamine (epi-DMA) are the typical organic coagulants used in water treatment in the United States (MWH, 2005). Their chemical formulae are summarized in Table 6-2. They are water soluble and cationic.

Physics of Coagulation

There are four mechanisms employed to destabilize natural water suspensions:

- Compression of the electric double layer,
- Adsorption and charge neutralization,
- Adsorption and interparticle bridging, and
- Enmeshment in a precipitate.

Although these mechanisms are discussed separately, in practice several mechanisms are employed simultaneously.

TABLE 6-1
Frequently used inorganic coagulants

Coagulant	Chemical formula	Molecular weight, g/mole	Remarks
Aluminum sulfate	$\text{Al}_2(\text{SO}_4)_3 \cdot 14\text{H}_2\text{O}$	594	Hg contamination may be of concern
Sodium aluminate	$\text{Na}_2\text{Al}_2\text{O}_4$	164	Provides alkalinity and pH control
Aluminum chloride	AlCl_3	133.5	Used in blends with polymers
Polyaluminum chloride	$\text{Al}_w(\text{OH})_x(\text{Cl})_y(\text{SO}_4)_z$	Variable	“PACl” used when Hg contamination is a concern
Polyaluminum sulfate	$\text{Al}_w(\text{OH})_x(\text{Cl})_y(\text{SO}_4)_z$	Variable	“PAS” used when Hg contamination is a concern
Polyiron chloride	$\text{Fe}_w(\text{OH})_x(\text{Cl})_y(\text{SO}_4)_z$	Variable	
Ferric chloride	FeCl_3	162.5	
Ferric sulfate	$\text{Fe}_2(\text{SO}_4)_3$	400	

TABLE 6-2
Frequently used cationic organic coagulants

Coagulant	Chemical formula
Epichlorohydrin dimethylamine (epi-DMA)	
Polydiallyl dimethyl ammonium chloride (poly-DADMAC)	

Compression of the Double Layer. If the electric double layer is compressed, the repulsive force is reduced and particles will come together as a result of Brownian motion and remain attached due to van der Waals forces of attraction. Both the ionic strength and the charge of counterions are important in the compression of the double layer.

The DLVO model postulates that the van der Waals forces extend out into solution about 1 nm. If the double layer can be reduced to less than this, a rapidly flocculating suspension is formed. As shown in Figure 6-5a, increasing the ionic strength of the solution compresses the double layer. Although this method is effective, the ionic strength* is much greater than would be acceptable for potable water.

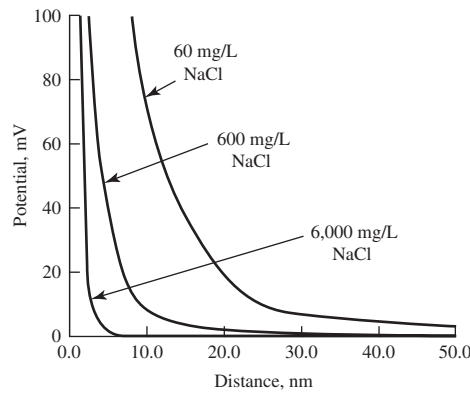

FIGURE 6-5a
Effect of solution concentration on double layer.

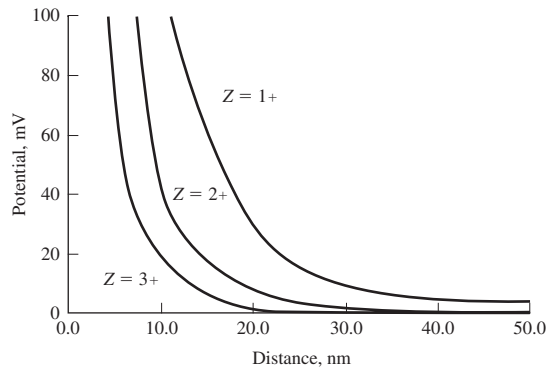

FIGURE 6-5b
Effect of charge on double layer. “Z” is the charge.

*Ionic strength is calculated as

$$I = 1/2 \sum C_i Z_i^2$$

where I = ionic strength, mole/L; C_i = concentration of species i , mole/L, and Z_i = number of replaceable hydrogen atoms or their equivalent (for oxidation-reduction, Z_i is equal to the change in valence).

As shown in Figure 6-5b, the charge of the counterions has a strong effect. In 1900, Hardy summarized a series of experiments with various coagulants in what is known as the *Schulze-Hardy rule*. They reported that for monovalent counterions, flocculation occurred at a concentration range of 25 to 15 millimoles/L; for divalent ions the range was 0.5 to 2 millimoles/L; for trivalent ions the range was 0.01 to 0.1 millimoles/L (Schulze, 1882, 1883; Hardy, 1900a, 1900b). For example, the ratio of $\text{Na}^+:\text{Ca}^{++}:\text{Al}^{+++}$ to achieve a given residual turbidity would be as shown in Figure 6-6 (O'Melia, 1972). According to the DLVO model, the ratios are $1:1/2^6:1/3^6$. Because coagulants are not "indifferent," they will undergo many interactions in addition to electrostatic attraction and repulsion. If, for example, phosphate is present, substantially more trivalent coagulant will be required because the coagulant will react with the phosphate. If multivalent ions comprise the fixed layer next to the negatively charged particle, the double layer will be reduced significantly and the critical coagulation concentration will be much lower than predicted by the Schulze-Hardy rule.

Adsorption and Charge Neutralization. Hydrolyzed metal salts, prehydrolyzed metal salts, and cationic polymers have a positive charge. They destabilize particles through charge neutralization.

Adsorption and Interparticle Bridging. Schematically, polymer chains such as poly-DADMAC and epi-DMA adsorb on particle surfaces at one or more sites along the polymer chain. The adsorption is a result of (1) coulombic, charge-charge interactions, (2) dipole interaction, (3) hydrogen bonding, and (4) van der Waals forces of attraction (Hunter, 2001). Other sites on the polymer chain extend into solution and adsorb on surfaces of other particles, thus creating a "bridge" between the particles. This bridge results in a larger particle that settles more quickly and forms a more dense sludge.

Enmeshment in a Precipitate. With doses exceeding saturation for the metal hydroxide, aluminum and iron salts form insoluble precipitates and particulate matter is entrapped in the precipitate. This type of destabilization has been described as *sweep coagulation* (Packham, 1965; Stumm

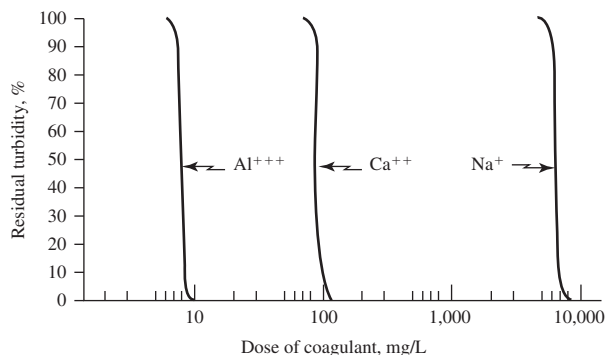

FIGURE 6-6

Schematic coagulation curves illustrating DLVO theoretical relationship between charge and dose to achieve a given turbidity reduction.

and O'Melia, 1968). In water treatment applications the mechanism is hypothesized to be nucleation of the precipitate on a particle surface followed by growth of an amorphous precipitate that entraps other particles.

CHEMISTRY OF COAGULATION

The chemistry of coagulation is extremely complex. The following discussion is limited to the basic chemistry. Because metal coagulants hydrolyze to form acid products that affect pH that in turn affects the solubility of the coagulant, it is useful to begin with a review of a few basic concepts that will help explain the interaction of coagulants and pH.

Buffer Solutions. A solution that resists large changes in pH when an acid or base is added or when the solution is diluted is called a buffer solution. A solution containing a weak acid and its salt is an example of a buffer. Atmospheric carbon dioxide (CO_2) produces a natural buffer through the following reactions:

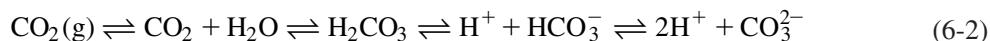

where H_2CO_3 = carbonic acid

HCO_3^- = bicarbonate ion

CO_3^{2-} = carbonate ion

This is perhaps the most important buffer system in water and wastewater treatment. It will be referred to several times in this and subsequent chapters as the *carbonate buffer system*.

As depicted in Equation 6-2, the CO_2 in solution is in equilibrium with atmospheric $\text{CO}_2(\text{g})$. Any change in the system components to the right of CO_2 causes the CO_2 either to be released from solution or to dissolve.

One can examine the character of the buffer system in resisting a change in pH by assuming the addition of an acid or a base and applying the law of mass action (Le Chatelier's principle). For example, if an acid is added to the system, it unbalances it by increasing the hydrogen ion concentration. Therefore, the carbonate combines with it to form bicarbonate. Bicarbonate reacts to form more carbonic acid, which in turn dissociates to CO_2 and water. The excess CO_2 can be released to the atmosphere in a thermodynamically open system. Alternatively, the addition of a base consumes hydrogen ions, and the system moves to the right with the CO_2 being replenished from the atmosphere. When CO_2 is bubbled into the system or is removed by passing an inert gas such as nitrogen through the liquid (a process called *stripping*), the pH will change more dramatically because the atmosphere is no longer available as a source or sink for CO_2 . Figure 6-7 summarizes the four general responses of the carbonate buffer system. The first two cases are common in natural settings when the reactions proceed over a relatively long period of time. In a water treatment plant, the reactions can be altered more quickly than the CO_2 can be replenished from the atmosphere. The second two cases are not common in natural settings. They are used in water treatment plants to adjust the pH.

In natural waters in equilibrium with atmospheric CO_2 , the amount of CO_2 in solution is quite small in comparison to the HCO_3^- in solution. The presence of Ca^{2+} in the form of limestone rock or other naturally occurring sources of calcium results in the formation of calcium

Case I

Acid is added to carbonate buffer system^a

Reaction shifts to the left as H_2CO_3^* is formed when H^+ and HCO_3^- combine^b

CO_2 is released to the atmosphere

pH is lowered slightly because of the availability of free H^+ (amount depends on buffering capacity)

Case II

Base is added to carbonate buffer system

Reaction shifts to the right

CO_2 from the atmosphere dissolves into solution

pH is raised slightly because H^+ combines with OH^- (amount depends on buffering capacity)

Case III

CO_2 is bubbled into carbonate buffer system

Reaction shifts to the right because H_2CO_3^* is formed when CO_2 and H_2O combine

CO_2 dissolves into solution

pH is lowered

Case IV

Carbonate buffer system is stripped of CO_2

Reaction shifts to the left to form more H_2CO_3^* to replace that removed by stripping

CO_2 is removed from solution

pH is raised

^aRefer to Equation 6-2.

^bThe asterisk * in the H_2CO_3 is used to signify the sum of CO_2 and H_2CO_3 in solution.

FIGURE 6-7

Behavior of the carbonate buffer system with the addition of acids and bases or the addition and removal of CO_2 . (Source: Davis and Cornwell, 2008.)

carbonate (CaCO_3), which is very insoluble. As a consequence, it precipitates from solution. The reaction of Ca^{2+} with CO_3^{2-} to form a precipitate is one of the fundamental reactions used to soften water.

Alkalinity. Alkalinity is defined as the sum of all titratable bases down to about pH 4.5. It is found by experimentally determining how much acid it takes to lower the pH of water to 4.5. In

most waters the only significant contributions to alkalinity are the carbonate species and any free H^+ or OH^- . The total H^+ that can be taken up by a water containing primarily carbonate species is

$$\text{Alkalinity} = [HCO_3^-] + 2[CO_3^{2-}] + [OH^-] - [H^+] \quad (6-3)$$

where $[\]$ refers to concentrations in moles/L. In most natural water situations (pH 6 to 8), the OH^- and H^+ are negligible, such that

$$\text{Alkalinity} = [HCO_3^-] + 2[CO_3^{2-}] \quad (6-4)$$

Note that $[CO_3^{2-}]$ is multiplied by two because it can accept two protons. The pertinent acid/base reactions are

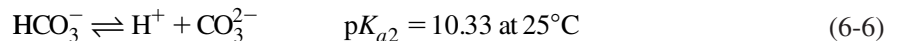
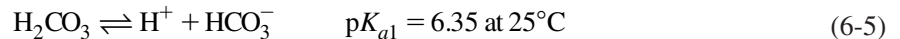

From the pK values, some useful relationships can be found. The more important ones are as follows:

1. Below pH of 4.5, essentially all of the carbonate species are present as H_2CO_3 , and the alkalinity is negative (due to the H^+).
2. At a pH of 8.3 most of the carbonate species are present as HCO_3^- and the alkalinity equals HCO_3^- .
3. Above a pH of 12.3, essentially all of the carbonate species are present as $[CO_3^{2-}]$ and the alkalinity equals $[CO_3^{2-}] + [OH^-]$. The $[OH^-]$ may not be insignificant at this pH.

Figure 6-8 schematically shows the change of species described above as the pH is lowered by the addition of acid to a water containing alkalinity. Note that the pH starts at above 12.3 and as acid is added the pH drops slowly as the first acid (H^+) addition is consumed by free hydroxide (OH^-), preventing a significant pH drop, and then the acid is consumed by carbonate (CO_3^{2-}) being converted to bicarbonate (HCO_3^-). At about pH 8.3 the carbonate is essentially all converted to bicarbonate, at which point there is another somewhat flat area where the acid is consumed by converting bicarbonate to carbonic acid.

From Equation 6-4 and the discussion of buffer solutions, it can be seen that alkalinity serves as a measure of buffering capacity. The greater the alkalinity, the greater the buffering capacity. We differentiate between alkaline water and water having high alkalinity. Alkaline water has a pH greater than 7, while a water with high alkalinity has a high buffering capacity. An alkaline water may or may not have a high buffering capacity. Likewise, a water with a high alkalinity may or may not have a high pH.

By convention, alkalinity is not expressed in molarity units as shown in the above equations, but rather in mg/L as $CaCO_3$. In order to convert species to mg/L as $CaCO_3$, multiply mg/L as the species by the ratio of the equivalent weight of $CaCO_3$ to the species equivalent weight:

$$\text{mg/L as } CaCO_3 = (\text{mg/L as the species}) \left(\frac{EW_{CaCO_3}}{EW_{\text{species}}} \right) \quad (6-7)$$

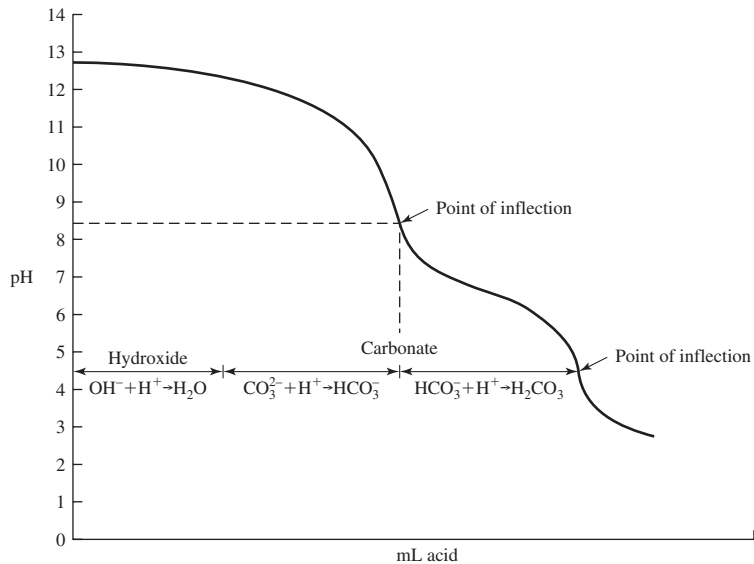

FIGURE 6-8

Titration curve for a hydroxide-carbonate mixture. (Source: Sawyer, McCarty, and Parkin, 1994.)

The alkalinity is then found by adding all the carbonate species and the hydroxide, and then subtracting the hydrogen ions. When using the units “mg/L as CaCO_3 ,” the terms are added directly. The multiple of two for CO_3^{2-} has already been accounted for in the conversion.

Example 6-1. A water contains 100.0 mg/L CO_3^{2-} and 75.0 mg/L HCO_3^- at a pH of 10. Calculate the alkalinity exactly at 25°C. Approximate the alkalinity by ignoring $[\text{OH}^-]$ and $[\text{H}^+]$.

Solution. First, convert CO_3^{2-} , HCO_3^- , OH^- , and H^+ to mg/L as CaCO_3 . The equivalent weights are

$$\text{CO}_3^{2-} : \text{MW} = 60, n = 2, \text{EW} = 30$$

$$\text{HCO}_3^- : \text{MW} = 61, n = 1, \text{EW} = 61$$

$$\text{H}^+ : \text{MW} = 1, n = 1, \text{EW} = 1$$

$$\text{OH}^- : \text{MW} = 17, n = 1, \text{EW} = 17$$

From the pH of 10, $[\text{H}^+] = 10^{-10}$ moles/L and the mg/L of the species is

$$\begin{aligned} \text{mg/L of species} &= (\text{moles/L})(\text{GMW})(10^3 \text{ mg/g}) \\ &= (10^{-10} \text{ moles/L})(1 \text{ g/mole})(10^3 \text{ mg/g}) = 10^{-7} \text{ mg/L of H}^+ \end{aligned}$$

The OH^- concentration is determined from the ionization of water, that is

$$K_w = [\text{OH}^-][\text{H}^+]$$

where $K_w = 10^{-14}$ ($pK_w = 14$):

$$[\text{OH}^-] = \frac{10^{-14}}{10^{-10}} = 10^{-4} \text{ moles/L}$$

and

$$\text{mg/L} = (10^{-4} \text{ moles/L})(17 \text{ g/mole})(10^3 \text{ mg/g}) = 1.7$$

Now, the mg/L as CaCO_3 is found by using Equation 6-7 and taking the equivalent weight of CaCO_3 to be 50:

$$\text{CO}_3^{2-} = 100.0 \left(\frac{50}{60} \right) = 167$$

$$\text{HCO}_3^- = 75.0 \left(\frac{50}{61} \right) = 61$$

$$\text{H}^+ = 10^{-7} \left(\frac{50}{1} \right) = 5 \times 10^{-6}$$

$$\text{OH}^- = 1.7 \left(\frac{50}{17} \right) = 5.0$$

The exact alkalinity (in mg/L) is found by

$$\text{Alkalinity} = 61 + 167 + 5.0 - (5 \times 10^{-6}) = 233 \text{ mg/L CaCO}_3$$

It is approximated by $61 + 167 = 228 \text{ mg/L}$ as CaCO_3 . This is a 2.2% error.

Aluminum. Aluminum can be purchased as either dry or liquid alum [$\text{Al}_2(\text{SO}_4)_3 \cdot 14\text{H}_2\text{O}$]. Commercial alum has an average molecular weight of 594. Liquid alum is sold as approximately 48.8 percent alum (8.3 percent Al_2O_3) and 51.2 percent water. If it is sold as a more concentrated solution, there can be problems with crystallization of the alum during shipment and storage. A 48.8 percent alum solution has a crystallization point of -15.6°C . A 50.7 percent alum solution will crystallize at $+18.3^\circ\text{C}$. The alternative is to purchase dry alum. However, dry alum costs about 50 percent more than an equivalent amount of liquid alum so that only users of very small amounts of alum purchase it in this form.

When alum is added to a water containing alkalinity, the following reaction occurs:

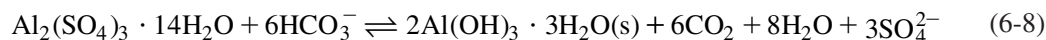

such that each mole of alum added uses six moles of alkalinity and produces six moles of carbon dioxide. The above reaction shifts the carbonate equilibrium and decreases the pH. However, as long as sufficient alkalinity is present and $\text{CO}_2(\text{g})$ is allowed to evolve, the pH is not drastically

reduced and is generally not an operational problem. When sufficient alkalinity is not present to neutralize the sulfuric acid production, the pH may be greatly reduced:

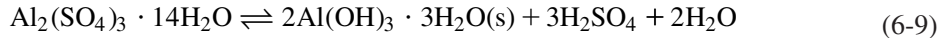

If the second reaction occurs, lime or sodium carbonate may be added to neutralize the acid formed because the precipitate will dissolve.

Example 6-2 illustrates the destruction of alkalinity.

Example 6-2. Estimate the amount of alkalinity (in mg/L) consumed from the addition of 100 mg/L of alum.

Solution:

- a. Using Equation 6-8, note that 6 moles of HCO_3^- are consumed for each mole of alum added.
- b. Calculate the moles/L of alum added.

$$\frac{100 \text{ mg/L of alum}}{\text{GMW of alum}} = \frac{100 \text{ mg/L}}{(594 \text{ g/mole})(10^3 \text{ mg/g})} = 1.68 \times 10^{-4} \text{ moles/L}$$

- c. Calculate the moles/L of HCO_3^- consumed.

$$6(1.68 \times 10^{-4} \text{ moles/L}) = 1.01 \times 10^{-3} \text{ moles/L}$$

- d. Convert to mg/L

$$(1.01 \times 10^{-3} \text{ moles/L})(\text{GMW of } \text{HCO}_3^-)$$

$$(1.01 \times 10^{-3} \text{ moles/L})(61 \text{ g/mole}) = 6.16 \times 10^{-2} \text{ g/L or } 61.6 \text{ mg/L as } \text{HCO}_3^-$$

Comment. A rule of thumb used to estimate the amount of the alkalinity consumed by alum is that 1 mg/L of alum destroys 0.5 mg/L of alkalinity as CaCO_3 .

An important aspect of coagulation is that the aluminum ion does not really exist as Al^{3+} , and that the final product is more complex than $\text{Al}(\text{OH})_3$. When the alum is added to the water, it immediately dissociates, resulting in the release of an aluminum ion surrounded by six water molecules. The aluminum ion starts reacting with the water, forming large $\text{Al} \cdot \text{OH} \cdot \text{H}_2\text{O}$ complexes. Some have suggested that $[\text{Al}_8(\text{OH})_{20} \cdot 28\text{H}_2\text{O}]^{4+}$ is the product that actually coagulates. Regardless of the actual species produced, the complex is a very large precipitate that removes many of the colloids by enmeshment as it falls through the water.

Iron. Iron can be purchased as either the sulfate salt ($\text{Fe}_2(\text{SO}_4)_3 \cdot x\text{H}_2\text{O}$) or the chloride salt ($\text{FeCl}_3 \cdot x\text{H}_2\text{O}$). It is available in various forms, and the individual supplier should be consulted for

the specifics of the product. Dry and liquid forms are available. The properties of iron with respect to forming large complexes, dose, and pH curves are similar to those of alum. An example of the reaction of FeCl_3 in the presence of alkalinity is

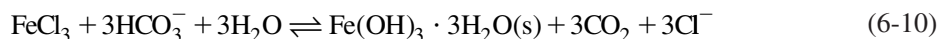

and without alkalinity

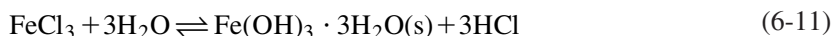

forming hydrochloric acid, which in turn lowers the pH.

pH and Dose

Two important factors in coagulant addition are pH and dose. The optimum dose and pH must be determined from laboratory tests. The optimum pH range for alum is approximately 5.5 to 7.7 with adequate coagulation possible between pH 5 and 9 under some conditions (Figure 6-9a).

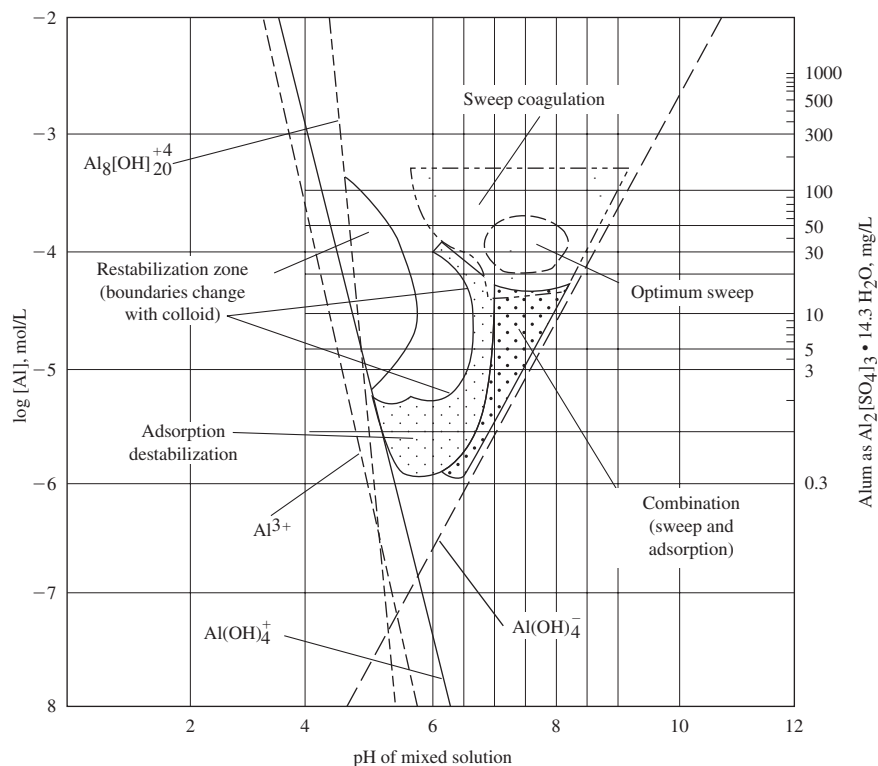
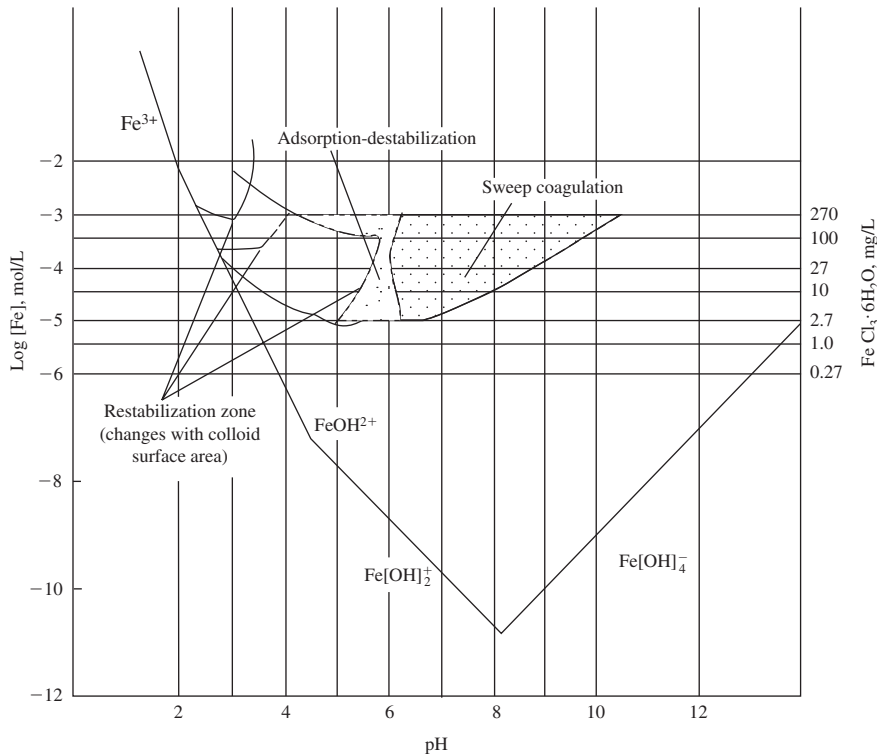

FIGURE 6-9a

Design and operation diagram for alum coagulation. (Source: Amirtharajah and Mills, 1982.)

**FIGURE 6-9b**

Design and operation diagram for Fe(III) coagulation. (Source: Johnson and Amirtharajah, 1983.)

Ferric salts generally have a wider pH range for effective coagulation than aluminum, that is, pH ranges from 4 to 9 (Figure 6-9b). The figures represent the alum dose and pH of the treated water after alum has been added. Prehydrolyzed metal salts (polyaluminum chloride, polyaluminum sulfate, and polyiron chloride) can be used over a pH range of 4.5 to 9.5 (MWH, 2005).

Because of the number and complexity of coagulant reactions, the actual dose and pH for a given water on a given day is generally determined empirically from a laboratory test. The test procedure is called a “jar test” based on the configuration of the test apparatus (Figure 6-10). It is illustrated in the next example.

Example 6-3. Six beakers are filled with the raw water, and then each is mixed and flocculated uniformly by identical paddle stirrers driven by a single motor (a *gang stirrer*). A typical test is conducted by first dosing each jar with the same alum dose and varying the pH in each jar. The test is then repeated in a second set of jars by holding the pH constant at the optimum pH and varying the coagulant dose.

In the example set of data below, two sets of such jar tests were conducted on a raw water containing 15 NTU and a HCO₃⁻ alkalinity concentration of 50 mg/L expressed as CaCO₃. The turbidity was measured after the mixture was allowed to settle for 30 minutes. The objective is to find the optimal pH, coagulant dose, and the theoretical amount of alkalinity that would be consumed at the optimal dose.

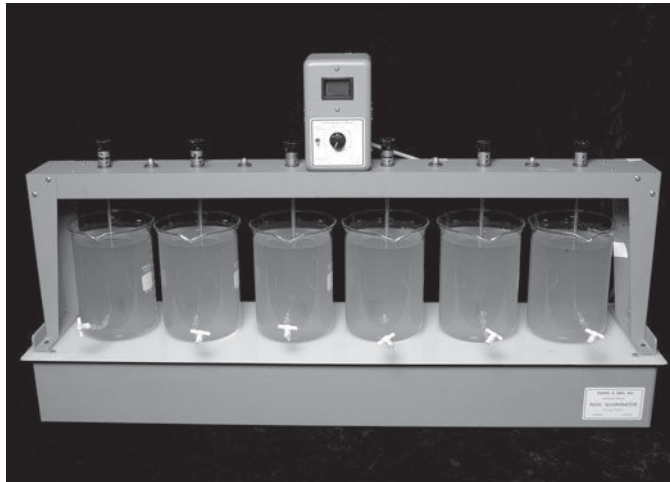

(a)

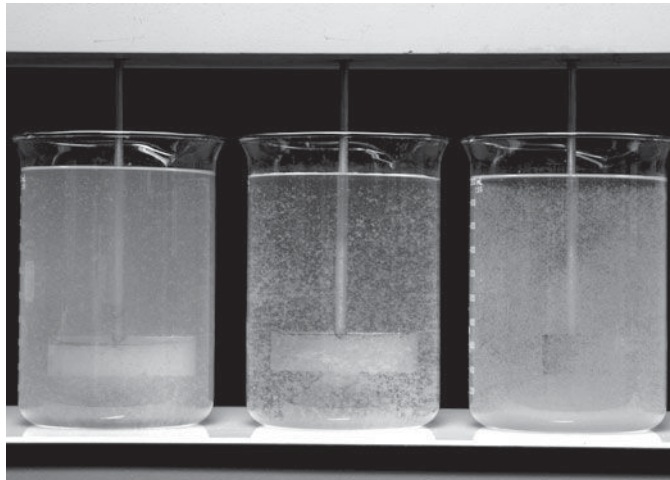

(b)

FIGURE 6-10

Jar test apparatus with turbid water (a) and three samples during flocculation (b).

(Source: Mackenzie L. Davis.)

Jar test I

	Jar numbers					
	1	2	3	4	5	6
pH	5.0	5.5	6.0	6.5	7.0	7.5
Alum dose (mg/L)	10	10	10	10	10	10
Turbidity (NTU)	11	7	5.5	5.7	8	13

Jar test II

	Jar numbers					
	1	2	3	4	5	6
pH	6.0	6.0	6.0	6.0	6.0	6.0
Alum dose (mg/L)	5	7	10	12	15	20
Turbidity (NTU)	14	9.5	5	4.5	6	13

Solution:

- a. The results of the two jar tests are plotted in Figure 6-11. In the first test, the optimal pH was chosen as 6.0, and this pH was used for the second jar test. From the second jar test, the optimal alum dose was estimated to be about 12.5 mg/L. In actual practice, the laboratory technician would probably try to repeat the test using a pH of 6.25 and varying the alum dose between 10 and 15 to pinpoint the optimal conditions.

From Figure 6-11, the optimum pH was estimated to be 6.0 and the optimum dose was estimated to be 12.5 mg/L.

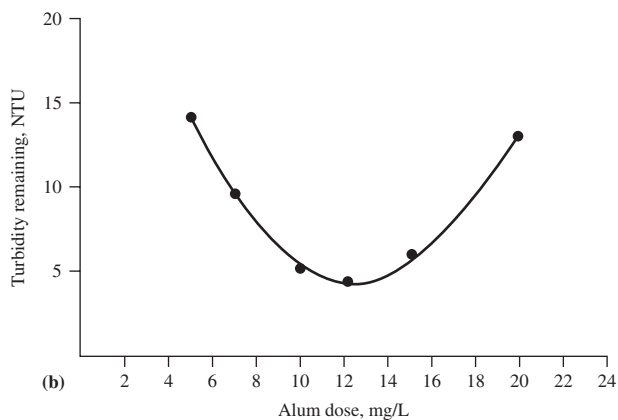
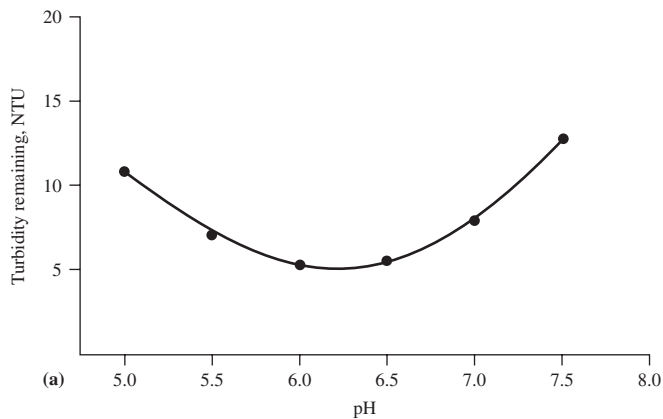
**FIGURE 6-11**

Results of jar test. (a) Constant alum dose, (b) constant pH.

- b. The amount of alkalinity that will be consumed is found by using Equation 6-8, which shows that one mole of alum consumes six moles of HCO_3^- . With the molecular weight of alum equal to 594, the moles of alum added per liter is:

$$\frac{12.5 \times 10^{-3} \text{ g/L}}{594 \text{ g/mole}} = 2.1 \times 10^{-5} \text{ moles/L}$$

which will consume

$$6(2.1 \times 10^{-5} \text{ moles/L}) = 1.26 \times 10^{-4} \text{ moles/L HCO}_3^-$$

The molecular weight of is 61, so

$$(1.26 \times 10^{-4} \text{ moles/L})(61 \text{ g/mole})(10^3 \text{ mg/g}) = 7.7 \text{ mg/L HCO}_3^-$$

are consumed, which can be expressed as CaCO_3 :

$$(7.7 \text{ mg/L HCO}_3^-) \frac{\text{E.W. CaCO}_3}{\text{E.W. HCO}_3^-}$$

$$(7.7 \text{ mg/L HCO}_3^-) \frac{50 \text{ g/equivalent}}{61 \text{ g/equivalent}} = 6.31 \text{ mg/L HCO}_3^- \text{ as CaCO}_3$$

As noted earlier, the lack of sufficient alkalinity will require the addition of a base to adjust the pH into the acceptable range. Lime (CaO), calcium hydroxide Ca(OH)_2 , sodium hydroxide (NaOH), and sodium carbonate (Na_2CO_3), also known as soda ash, are the most common chemicals used to adjust the pH. Table 6-3 illustrates the neutralization reactions.

TABLE 6-3
Neutralization reactions

To neutralize sulfuric acid with

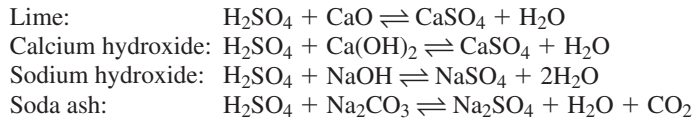

To neutralize hydrochloric acid with

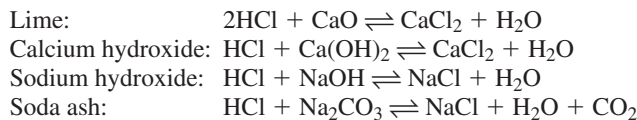

Note: a stoichiometric reaction will yield a pH of 7.0.

Example 6-4 illustrates the impact of the lack of alkalinity on the solution pH and the method for estimating the amount of base to bring the solution to a pH range that is satisfactory for coagulation.

Example 6-4. Estimate the pH that results from the addition of 100 mg/L of alum to a water with no alkalinity, and estimate the amount of sodium hydroxide (NaOH) in mg/L required to bring the pH to 7.0.

Solution:

- a. From Example 6-2, the number of moles of alum added is 1.68×10^{-4} moles/L.
- b. From Equation 6-9, note that 3 moles of sulfuric acid are produced for each mole of alum added. Therefore, the moles/L of sulfuric acid is

$$3(1.68 \times 10^{-4} \text{ moles/L}) = 5.04 \times 10^{-4} \text{ moles/L}$$

- c. Sulfuric acid dissociates to form two moles of H^+ for each mole of acid

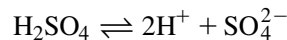

so the moles/L of H^+ formed is

$$2(5.04 \times 10^{-4} \text{ moles/L}) = 1.01 \times 10^{-3} \text{ moles/L}$$

- d. The estimated pH is

$$\text{pH} = -\log [\text{H}^+] = -\log [1.01 \times 10^{-3} \text{ moles/L}] = 3.00$$

- e. From Figure 6-9a, it is evident that this is out of the range of coagulation with alum.
- f. Using NaOH to neutralize the sulfuric acid, the reaction is

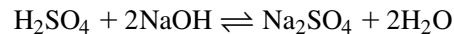

Therefore, 2 moles of sodium hydroxide are required to neutralize each mole of sulfuric acid

$$2(1.01 \times 10^{-3} \text{ moles/L}) = 2.02 \times 10^{-3} \text{ moles/L}$$

- g. Converting to mg/L

$$(2.02 \times 10^{-3} \text{ moles/L})(40 \text{ g/mole})(10^3 \text{ mg/g}) = 80.64 \text{ or } 81 \text{ mg/L}$$

Comments:

1. To determine if base needs to be added when alkalinity is present, estimate the amount of alkalinity present and calculate the amount of alkalinity “destroyed,” as in Example 6-2. If the amount destroyed exceeds the amount present, estimate the excess alum and use this amount to estimate the amount of base to add.

2. Because of the diversity of species that occur when alum and/or ferric chloride are hydrolyzed, and because natural waters will contain ions that will react with the base, it is not practical to calculate the dose. In actual practice, the dose is determined by titration of a water sample.
-

6-4 COAGULATION PRACTICE

The selection of the coagulant and the coagulant dose is a function of the characteristics of the coagulant (including its price), the concentration and type of particles, characteristics of NOM, water temperature, and other constituents of the raw water such as alkalinity and phosphorus. There is no formal approach to incorporate this collection of variables in the selection process. Jar test experiments and experience play a large role in the selection process. Some of the factors to be considered in the decision process are discussed in the following paragraphs.

Overview

High turbidity, high alkalinity water is the easiest to coagulate. Alum, ferric chloride, and high molecular weight polymers have been used successfully for these waters.

Control of the pH is of utmost importance in coagulating high turbidity, low alkalinity water. Polymers function well. Addition of a base may be required for alum and ferric chloride.

Alum and ferric chloride at high doses can coagulate low turbidity, high alkalinity waters. A combination of alum followed by polymer often works well. For this system, that is, low turbidity and high alkalinity, polymers cannot work alone. Coagulant aids may be required.

Low turbidity, low alkalinity waters are the most difficult to coagulate. Neither polymers nor alum/ferric chloride work alone when the turbidity and alkalinity are low. pH adjustment is required. Direct filtration should be considered for this type of water.

Coagulation of color is very pH dependent. Alum, ferric chloride, and cationic polymers are effective at pH values in the range of 4 to 5. The floc that are formed in coagulating color are very fragile.

Coagulant Selection

Metal Salts. As noted previously, the most common coagulants are alum, ferric chloride, and ferric sulfate. The predominant choice of coagulant is alum, followed by ferric chloride and ferric sulfate, respectively. While cost may be the overriding factor, the operating region, as noted in Figure 6-9, plays a significant role in coagulant selection. Ferric chloride is effective over a broader range. Polyaluminum chloride (PACl) is less sensitive to pH and can be used over a pH range from 4.5 to 9.5 (MWH, 2005).

The metal salt hydrolysis products react with SO_4^{2-} , NOM, F^- , and PO_4^{3-} to form both soluble and insoluble products. This will result in a requirement for increased dosage to achieve the desired destabilization.

Typical dosages of alum range from 10 to 150 mg/L. Ferric chloride and ferric sulfate dosages range from 5 to 150 mg/L and from 10 to 250 mg/L respectively (MWH, 2005).

NOM removal is a means of reducing disinfection byproducts. In the regulatory language of the U.S. EPA, *enhanced coagulation* is a recommended technique for removing NOM. Because NOM binds with metal ion coagulants, this is a consideration in selecting a coagulant and the dose to be applied. Of the metal salts and prehydrolyzed metal salts, the most effective for the removal of NOM, in order of increasing effectiveness, are iron, alum and PACl (MWH, 2005).

Polymer. In rare instances, usually when the turbidity and alkalinity are high, cationic polymers (poly-DADMAC and epi-DMA) have been used as primary coagulants, but their use typically has been in conjunction with a metal salt. The main advantage of using polymers in conjunction with metal salts is the ability to reduce the metal salt concentration and resulting sludge production by 40 to 80 percent.

The epi-DMA dose generally decreases as the pH increases. The dose for poly-DADMAC is only slightly affected by pH. Typical dosages are on the order of 1 to 10 mg/L.

Polymers are not effective in removing NOM.

Coagulant Aids

Insoluble particulate materials such as clay, sodium silicate, pure precipitated calcium carbonate, diatomite, and activated carbon have been used as coagulant aids. They are used in waters that have low concentrations of particles and, thus, have few nucleating sites to form larger floc. Because their density is higher than most floc particles, floc settling velocity is increased by the addition of coagulant aids. The dosage must be carefully controlled to avoid lowering the water quality.

Flocculant Aids

Uncharged and negatively charged polymers are used as flocculant aids. Their purpose is to build a stronger floc. They are added after the coagulants are added and the particles are already destabilized.

Activated silica and sodium silicate are common flocculant aids. In processes where these are added, called *ballasted flocculation*, micro-sand is added after chemical coagulation but before flocculation to act as a nucleus for floc formation. The sand has a higher density than the floc and increases its settling velocity (Willis, 2005).

6-5 FLOCCULATION THEORY

Smoluchowski (1917) observed that small particles undergo random Brownian motion due to collisions with fluid molecules and that these motions result in particle to particle collisions. Langelier (1921) observed that stirring water containing particles created velocity gradients that brought about particle collisions. These observations provide the basis for describing the mechanisms of flocculation.

Microscale Flocculation

The flocculation of small particles (less than 0.1 μm in diameter) is caused by diffusion. The rate of flocculation is relative to the rate at which the particles diffuse. Thus, the primary mechanism of aggregation is through Brownian motion. This aggregation is called microscale flocculation or *perikinetic flocculation*. After a period of seconds, the microflocs range in size from 1 to about 100 μm in diameter.

Macroscale Flocculation

Mixing is the major flocculation mechanism for particles greater than 1 μm in diameter. This mechanism is known as macroscale flocculation or *orthokinetic flocculation*. Mechanical mixing is employed to achieve orthokinetic flocculation.

Mechanical mixing causes unequal shearing forces on the floc, and some of the floc are broken up. After some period of mixing, a steady state distribution of floc sizes is achieved and formation and breakup become nearly equal.

Differential Settling

Because the floc particles are of different size, they settle at different rates. Differences in the settling velocities cause the particles to collide and flocculate.

Chemical Sequence

The addition of multiple chemicals to improve flocculation is common practice. The order of addition is important to achieve optimum results at minimum cost. Typically, the addition of a polymer after the addition of hydrolyzing metal salts is most effective. Ideally, the polymer addition should be made 5 to 10 minutes after the addition of the hydrolyzing metal salt. This allows for the formation of pinpoint floc that is then “bridged” by polymer. In conventional water treatment plant design this is rarely possible because of space limitations.

6-6 MIXING THEORY

The crux of efficient coagulation is the efficiency of mixing the coagulant with the raw water. Efficient flocculation requires mixing to bring the particles into contact with one another.

The following discussion includes the theoretical considerations in mixing coagulants, flocculation, and the practical aspects of selecting a mixing device. Many aspects of this discussion also apply to pH adjustment, softening (Chapter 7), and disinfection (Chapter 13).

Velocity Gradient

In the 1940s Kolmogorov (1941) and Camp and Stein (1943) independently developed a method of quantifying the energy dissipation in a vessel. Camp and Stein further proposed that the root-mean-square (RMS) of the velocity gradient (G) of the fluid, that is dv/dy in Figure 6-12, be used to estimate energy dissipation. They further proposed that the rate of flocculation is directly proportional to G . Subsequent research demonstrated that the proportionality also applied to coagulation with both metal ion coagulants and polymers (Harris, et al., 1966; Birkner and Morgan, 1968).

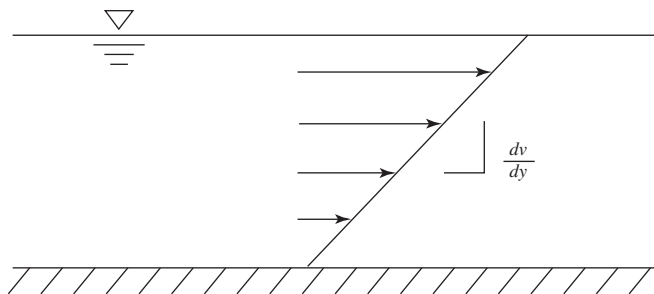

FIGURE 6-12
Velocity gradient.

The velocity gradient may be thought of as the amount of shear taking place; that is, the higher the G value, the more violent the mixing. The velocity gradient is a function of the power input into a unit volume of water. The RMS velocity gradient may be estimated as

$$G = \left(\frac{P}{\mu V} \right)^{1/2} \quad (6-12)$$

where G = global RMS velocity gradient, s^{-1}

P = power of mixing input to vessel, W

μ = dynamic viscosity of water, Pa · s

V = volume of liquid, m^3

Different velocity gradients are appropriate for different processes. Coagulation requires very high velocity gradients. Flocculation requires a velocity gradient high enough to cause particle contact and to keep the flocs from settling but low enough to prevent the flocs from tearing apart. In addition, different chemicals require different velocity gradients.

Mixing Time

Experimental work has revealed that coagulant reactions are very fast. Alum hydrolyzes to $Al(OH)^{2+}$ within 10^{-5} s (Base and Mesmer, 1976). Hahn and Stumm (1968) found the time to form mono- and polynuclear hydroxide species was on the order of 10^{-3} s, and the time of formation of polymer species was on the order of 10^{-2} s.

This work along with field observations implies that nearly instantaneous and intense mixing of metal salts is of critical importance. This is especially true when the metal salts are being used to lower the surface charge of the particles (adsorption and destabilization in Figure 6-9). Mixing times of less than 1 s are recommended in this case. The formation of the aluminum-hydroxide-precipitate is slower and occurs in the range of 1 to 7 s. Thus, in sweep coagulation (Figure 6-9) the extremely short mixing times are not as critical (Amirtharajah and Mills, 1982).

The time requirements for flocculation are more dependent on the requirements of downstream processes. For conventional treatment where settling follows flocculation the flocculation time ranges from 20 to 30 minutes. If direct filtration is to follow flocculation, shorter times on the order of 10 to 20 minutes are often selected (MWH, 2005).

For these time-dependent reactions, the time that a fluid particle remains in the reactor affects the degree to which the reaction goes to completion. In ideal reactors the average time in the reactor (the *theoretical detention* time also known as *hydraulic detention* time, *hydraulic residence* time, or *detention* time) is defined as

$$t = \frac{V}{Q} \quad (6-13)$$

where t = theoretical detention time, s

V = volume of fluid in reactor, m^3

Q = flow rate into reactor, m^3/s

Theoretically, given the desired detention time and the design flow rate, the liquid volume of the vessel to achieve the design detention time may be calculated. However, real reactors do not behave as ideal reactors because of density differences due to temperature or other causes, short

circuiting because of uneven inlet or outlet conditions, and local turbulence or dead spots in the reactor corners. The mean detention time in real tanks is generally less than the theoretical detention time calculated from Equation 6-13.

Selection of G and Gt Values

Both G and the product of the velocity gradient and time (Gt), serve as criteria for the design of mixing systems. The selection of G and Gt values for coagulation is dependent on the mixing device, the chemicals selected, and the anticipated reactions. As noted previously, coagulation occurs predominately by two mechanisms: adsorption of the soluble hydrolysis species on the colloid and destabilization or sweep coagulation where the colloid is trapped in the hydroxide precipitate. Jar test data may be used to identify whether adsorption/destabilization or sweep coagulation is predominant using the following procedure:

- Determine the optimum pH and dose from plots of settled turbidity (see, for example, Figure 6-11).
- Plot the optimum pH and dose on Figure 6-9.
- Determine which is the predominant mechanism from the plotted position.

G values in the range of 3,000 to 5,000 s^{-1} and detention times on the order of 0.5 s are recommended for adsorption/destabilization reactions. For sweep coagulation, detention times of 1 to 10 s and G values in the range of 600 to 1,000 s^{-1} are recommended (Amirtharajah, 1978).

6-7 MIXING PRACTICE

Although there are some instances of overlap, mixing equipment may be divided into two broad categories: equipment that is applicable to dispersion of the coagulant into the raw water and that used to flocculate the coagulated water. Dispersion of the coagulant into water is called *flash* mixing or *rapid* mixing.

Flash Mixing Design Criteria

This equipment is designed to produce a high G . The order of preference in selection of equipment type is based on effectiveness, reliability, maintenance requirements, and cost. Common alternatives for mixing when the mechanism of coagulation is adsorption/destabilization are:

1. Diffusion mixing by pressured water jets.
2. In-line mechanical mixing.
3. In-line static mixing.

Common alternatives for mixing when the mechanism of coagulation is sweep coagulation are:

1. Mechanical mixing in stirred tanks.
2. Diffusion by pipe grid.
3. Hydraulic mixing.

The focus of this discussion is on the following three mixing alternatives: in-line mechanical mixing, in-line static mixing, and mechanical mixing in stirred tanks.

In-Line Mechanical Mixing. Also known as an *in-line blender* (Figure 6-13), this in-line system overcomes some of the disadvantages of the static mixer.

The following design criteria may be used in selection of in-line mechanical mixers: (1) G in the range 3,000 to 5,000 s^{-1} , (2) t of about 0.5 s, and (3) headloss of 0.3 to 0.9 m (Amirtharajah, 1978).

An example of the information manufacturers provide for the selection of an in-line blender is given in Table 6-4 and Figure 6-14.

TABLE 6-4
Representative in-line blender data

Model	Weight kg	Motor ^a power, W	Dimensions ^b					
			A	B	C	D	E	F
AZ-1	65	350	85	12	11	30	64	23
AZ-2	85	550	90	15	17	35	68	30
AZ-3	140	750	95	17	22	40	68	30
AZ-4	230	750						
		1,000	110	20	27	50	71	30
AZ-5	300	1,100						
		1,500	125	23	32	55	76	30
AZ-6	325	1,500	130	25	36	60	76	30
AZ-7	400	1,500						
		2,250	135	27	41	65	76	30
AZ-8	425	2,250	140	30	46	70	76	30
AZ-9	500	2,250	145	33	51	80	76	30
AZ-10	600	3,700	150	33	51	70	88	44
AZ-11	750	7,500	160	38	61	90	88	53
AZ-12	1,200	15,000	190	48	71	120	95	58
AZ-13	1,600	22,000	210	56	91	125	95	68

^aWhere two values are given, alternate motors are available for the model.

^bThese are noted in Figure 6-14. All are in cm.

NOTE: these data are hypothetical and do not represent actual choices. Manufacturers' data must be used to select a blender.

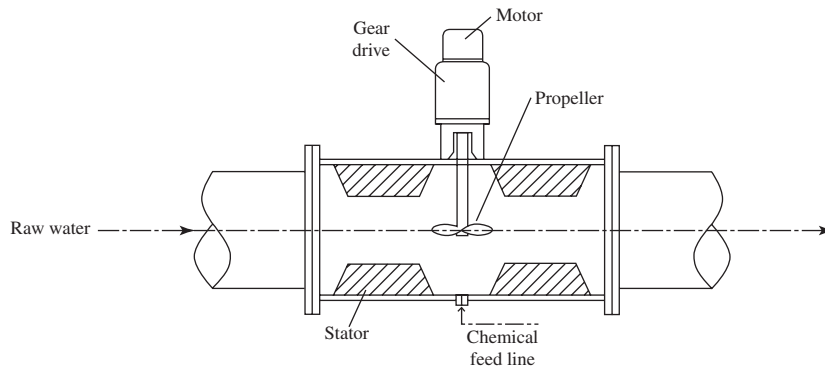

FIGURE 6-13
Typical in-line blender.

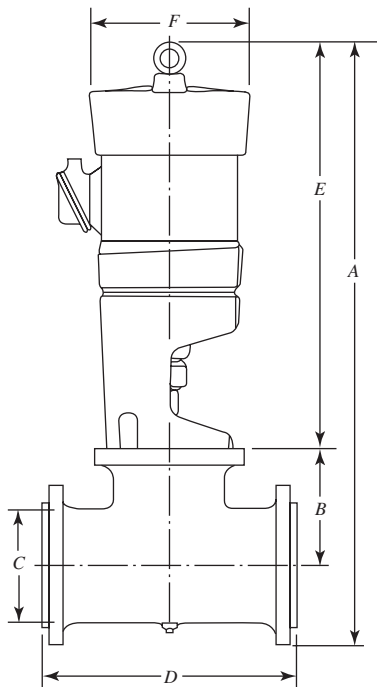

FIGURE 6-14
Dimension notation for in-line blenders given in Table 6-4.

Example 6-5. Using Table 6-4 select an in-line blender for an alum coagulant. The jar test data resemble that shown in Figure 6-11. The design flow rate is $383 \text{ m}^3/\text{h}$, and the design water temperature is 17°C .

Solution:

- Based on the jar test results, it appears that adsorption/destabilization is the predominant mechanism of coagulation. G values in the range of $3,000$ to $5,000 \text{ s}^{-1}$ and detention times on the order of 0.5 s are recommended for adsorption/destabilization reactions.
- As a first trial, select model AZ-6, with a reaction chamber diameter of 36 cm (dimension C in Table 6-4) and a length of 60 cm (dimension D in Table 6-4) and calculate the volume of the reaction chamber.

$$V = \frac{\pi(36 \text{ cm})^2}{4}(60 \text{ cm}) = 61,072 \text{ cm}^3$$

- Check the detention time using Equation 6-13

$$t = \frac{(61,072 \text{ cm}^3)(10^{-6} \text{ m}^3/\text{cm}^3)}{383 \text{ m}^3/\text{h}} = 1.59 \times 10^{-4} \text{ h or } 0.57 \text{ s}$$

This is sufficiently close to the 0.5 s guideline to be acceptable.

- Estimate the value of G assuming that the water power is 80% of the motor power. From Table 6-4 find the motor power is $1,500 \text{ W}$

$$P = (0.8)(1,500 \text{ W}) = 1,200 \text{ W}$$

Using Appendix A, find the viscosity of the water is $1.081 \times 10^{-3} \text{ Pa} \cdot \text{s}$ at 17°C .

From Equation 6-12

$$G = \left(\frac{1,200 \text{ W}}{(1.081 \times 10^{-3} \text{ Pa} \cdot \text{s})(61,072 \text{ cm}^3)(10^{-6} \text{ m}^3/\text{cm}^3)} \right)^{0.5} = 4,263 \text{ s}^{-1}$$

This meets the velocity gradient criteria.

Comment. If either the detention time or the velocity gradient criteria had not been met, another trial model would have been selected and checked. In an actual design, more than one manufacturer's models may have to be examined to find a satisfactory match.

In-Line Static Mixing. As shown in Figure 6-15, this mixer consists of a pipe with in-line helical vanes that rotate and split the flow to increase turbulence. The vanes are segmented so that the number of vanes may be adjusted to fit local conditions. These segments are called *elements*. The element size is specified in terms of the diameter of the pipe they are in, that is, the length of element divided by the pipe diameter (L/D). This is called the *aspect ratio*. Generally, the aspect ratio varies from 1.0 to 1.5 . The mixers come in sizes as small as 0.5 cm for research application

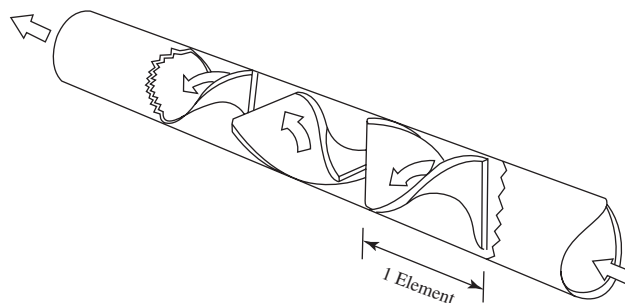

FIGURE 6-15
Static mixer.

to as large as 300 cm for industrial and water treatment use. Generally, they are made in standard pipe diameters.

These mixers have two advantages: (1) there are no moving parts and (2) no external energy source is required. They have the disadvantage that the degree of mixing and mixing time is a function of flow rate.

Although it applies to all mixers, a measure of the uniformity of the blend of the chemical and the water has been found to be particularly useful in selecting static mixers. The measure used is the coefficient of variation with time (COV) of the blended mixture. It is defined as

$$\text{COV} = \left(\frac{\sigma}{C} \right) (100\%) \quad (6-14)$$

where COV = coefficient of variation with time

σ = standard deviation of concentration, mg/L

C = average concentration over time, mg/L

The standard deviation is defined as

$$\sigma = \sqrt{\frac{\sum (C_t - C)^2}{n - 1}} \quad (6-15)$$

where C_t = concentration of sample, mg/L

n = number of samples

The following design criteria that may be used in selection are: (1) COV of 1 to 10 percent with an average of 5 percent, (2) Gt in the range 350–1700, (3) a mixing time of 1 to 3 s, and (4) a maximum headloss of 0.6 to 0.9 m. The design should specify that the mixing elements be removable so they may be cleared and/or cleaned (Bayer et al., 2003; Kawamura, 2000; MWH, 2005).

The selection process is highly dependent on the approach suggested by the manufacturer for their mixer. The following method is representative:

- Select the number of mixing elements to achieve the desired COV. Bayer et al. (2003) suggest that three elements will yield a COV of about 10 percent and that six elements will yield a COV of about 1 percent for mixers designed for turbulent flow (Reynolds number greater than 5,000). Turbulent flow may be assumed for water entering water treatment plants from pumped sources.

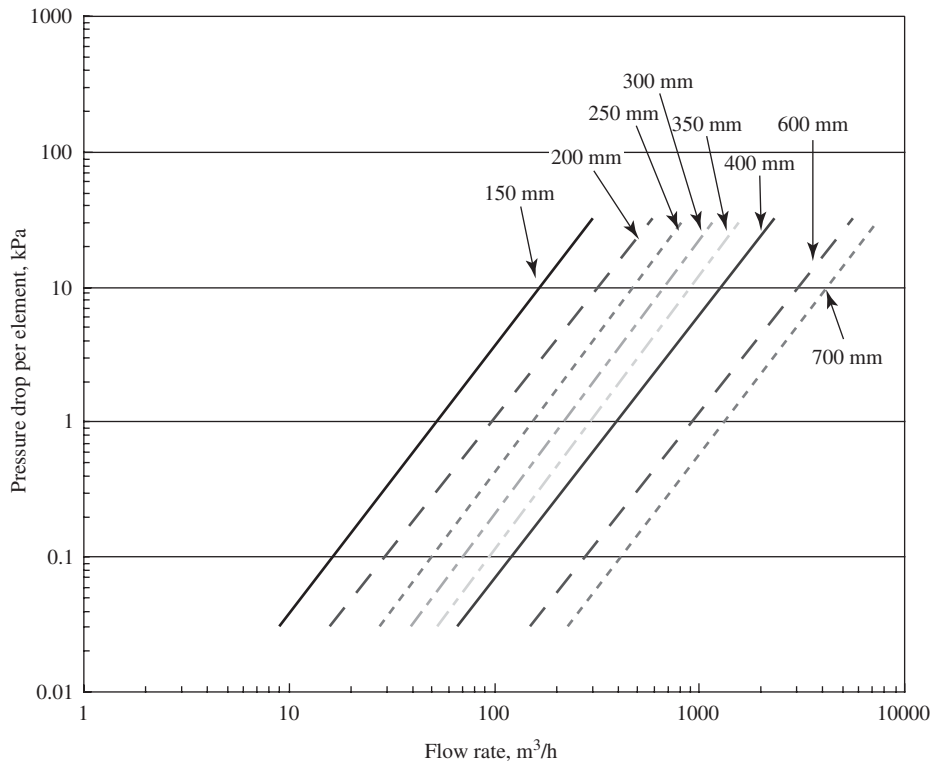

FIGURE 6-16

Typical static mixer pressure drop selection graph for pipe diameters from 150 mm to 700 mm.

- Using either an equation or a graph, such as that shown in Figure 6-16 provided by the manufacturer, determine the pressure drop per element.
- With the pressure drop per element and the number of elements, estimate the detention time, water power, and velocity gradient, and check these against the design criteria.

The detention time is calculated with Equation 6-13. The power imparted by static mixing devices may be computed using Equation 6-16. The velocity gradient is calculated with Equation 6-12.

$$P = \frac{\gamma QH}{\eta} \quad (6-16)$$

where P = water power, kW

γ = specific weight of fluid, kN/m³
 = 9.807 kN/m³ for water at 5°C

Q = flow rate, m³/s

H = total dynamic head, m

η = efficiency

Example 6-6. Design a static mixer for the following conditions:

- Design flow rate = 150 m³/h
- Minimum water temperature = 5°C
- Mixer aspect ratio = 1.5
- Design COV is 1%

Solution. This problem is solved by iteration; that is, a set of reasonable assumptions is made and then the calculations are performed to verify or correct the assumptions.

- a. Select a pipe diameter of 400 mm for the design flow rate.
- b. Select the number of elements to achieve a COV of 1%, that is, six elements.
- c. From Figure 6-16 determine the headloss per element is 0.16 kPa per element. The total headloss through the mixer is then

$$(6 \text{ elements})(0.16 \text{ kPa/element}) = 0.96 \text{ kPa}$$

- d. With six elements that have an aspect ratio of 1.5, the length of the mixer is

$$\begin{aligned} L &= (\text{no. of elements})(\text{aspect ratio})(\text{pipe diameter}) \\ &= (6)(1.5)(0.40 \text{ m}) = 3.6 \text{ m} \end{aligned}$$

- e. The volume of the mixer is

$$V = \frac{(\pi)(0.40 \text{ m})^2}{4}(3.6 \text{ m}) = 0.45 \text{ m}^3$$

- f. The detention time is

$$t = \frac{0.45 \text{ m}^3}{150 \text{ m}^3/\text{h}} = 3.0 \times 10^{-3} \text{ h or } 10.9 \text{ s}$$

- g. The water power imparted by the mixer is estimated using Equation 6-16 with $\eta = 1.00$:

$$P = \gamma QH = \frac{(9.807 \text{ kN/m}^3)(150 \text{ m}^3/\text{h})}{3,600 \text{ s/h}}(0.96 \text{ kPa})(0.102 \text{ m/kPa}) = 0.0400 \text{ kW}$$

where (0.102 m/kPa) is a conversion factor.

- h. Estimate the velocity gradient using Equation 6-12. Using the water temperature of 5°C and Appendix A, $\mu = 1.519 \times 10^{-3} \text{ Pa} \cdot \text{s}$

$$G = \left(\frac{40.0 \text{ W}}{(1.519 \times 10^{-3} \text{ Pa} \cdot \text{s})(0.45 \text{ m}^3)} \right)^{0.5} = 241.9 \text{ s}^{-1}$$

i. Estimate Gt .

$$Gt = (241.9 \text{ s}^{-1})(10.9 \text{ s}) = 2,636.7 \text{ or } 2,600$$

Comments:

1. The detention time and Gt criteria were not met. At this point in the design calculation, another trial would be attempted. The variables that can be explored are the diameter of the pipe and the number of elements (by assuming a less stringent COV). Alternatively, another manufacturer's mixer may be suitable under the assumptions given.
2. When the final design is selected, two mixers of this size would be provided for redundancy.
3. The failure of this design to meet the design criteria will be exacerbated when the flow rate is at the average and minimum flow rates. For this reason alone, static mixers have limited application in mixing coagulant.
4. Because this is an iterative problem, it is well suited to a spreadsheet solution.

Mechanical Mixing in Stirred Tanks. When the predominant coagulation mechanism is sweep coagulation, extremely short mixing times are not as important, as in adsorption-destabilization. A typical *completely mixed flow reactor (CMFR)* or *continuous-flow stirred tank reactor (CSTR)* as shown in Figure 6-17 will perform well for sweep coagulation. Detention times of 1 to 7 s and G values in the range of 600 to 1,000 s^{-1} are recommended (Letterman et al., 1973, and Amirtharajah, 1978).

The volume of a rapid-mix tank seldom exceeds 8 m^3 because of mixing equipment and geometry constraints. The mixing equipment consists of an electric motor, gear-type speed reducer, and either a radial-flow or axial-flow impeller as shown in Figure 6-18. The radial-flow impeller provides more turbulence and is preferred for rapid mixing. The tanks should be horizontally baffled into at least two and preferably three compartments in order to minimize short circuiting and thus provide sufficient residence time. They are also baffled vertically to minimize vortexing. Chemicals should be added below the impeller. Some geometric ratios for rapid mixing are shown in Table 6-5. These values can be used to select the proper basin depth and surface area and the impeller diameter. For rapid mixing, in order to construct a reasonably sized basin, often more depth is required than allowed by the ratios in Table 6-5. In this case the tank is made

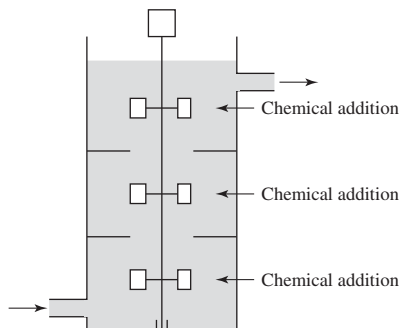
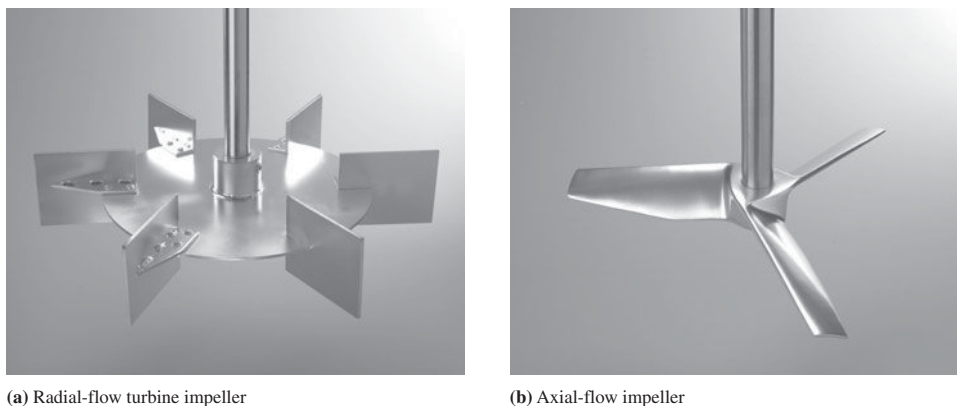

FIGURE 6-17

Completely mixed flow reactor (CMFR) or continuous-flow stirred tank reactor (CSTR). (Source: Davis and Cornwell, 2008.)

**FIGURE 6-18**

Basic impeller styles. (Source: SPX Process Equipment.)

TABLE 6-5
Tank and impeller geometries for mixing

Geometric ratio	Range
D/T (radial)	0.14–0.5
D/T (axial)	0.17–0.4
H/D (either)	2–4
H/T (axial)	0.34–1.6
H/T (radial)	0.28–2
B/D (either)	0.7–1.6

 D = impeller diameter

$$T = \text{equivalent tank diameter} = \left(\frac{4A}{\pi} \right)^{0.5}$$

 A = the plan area H = water depth B = water depth below the impeller

deeper by using two impellers on the shaft. When dual impellers are used, the top impeller is axial flow, while the bottom impeller is radial flow. When dual impellers are employed on gear-driven mixers, they are spaced approximately two impeller diameters apart. We normally assume an efficiency of transfer of motor power to water power of 0.8 for a single impeller.

The power imparted to the liquid in a baffled tank by an impeller may be described by the following equation for fully turbulent flow developed by Rushton (1952).

$$P = N_p(n)^3 (D_i)^5 \rho \quad (6-17)$$

where P = power, W N_p = impeller constant (also called power number)

- n = rotational speed, revolutions/s
 D_i = impeller diameter, m
 ρ = density of liquid, kg/m³

The impeller constant of a specific impeller can be obtained from the manufacturer. For the radial-flow impeller of Figure 6-18, the impeller constant is 5.7, and for the axial-flow impeller it is 0.31.

Example 6-7. Design a cylindrical flash mixing basin by determining the basin volume, tank diameter, dimensions, required input power, impeller diameter from manufacturer's data provided below, and its rotational speed using the following parameters:

- Design flow rate = 11.5×10^3 m³/d
 Rapid mix $t = 5$ s
 Rapid mix $G = 600$ s⁻¹
 Water temperature = 5°C
 Place impeller at one-third the water depth

From manufacturer's data, the following impellers are available:

Impeller type	Impeller diameters (m)			Power number (N_p)
Radial	0.3	0.4	0.6	5.7
Axial	0.8	1.4	2.0	0.31

Solution:

- a. Convert 11.5×10^3 m³/d to m³/s.

$$\frac{11.5 \times 10^3 \text{ m}^3/\text{d}}{(86,400 \text{ s/d})} = 0.133 \text{ m}^3/\text{s}$$

- b. Using Equation 6-13, determine the volume of the rapid mix basin.

$$V = Qt = (0.133 \text{ m}^3/\text{s})(5 \text{ s}) = 0.665 \text{ m}^3$$

- c. Using the radial impeller guidance from Table 6-5, assume $H/T = 2.0$, that is $H = 2T$. For a round mixing tank

$$V = \frac{\pi(T)^2}{4}(2T)$$

and

$$T = \left\{ \frac{(4)(0.665 \text{ m}^3)}{2\pi} \right\}^{1/3} = 0.751 \text{ or } 0.75 \text{ m}$$

and

$$H = 2(0.75 \text{ m}) = 1.5 \text{ m}$$

and because the impeller is at 1/3 water depth

$$B = (0.333)(1.5 \text{ m}) = 0.5 \text{ m}$$

- d. The required input water power can be calculated by using Equation 6-12. Using Table A-1 in Appendix A and the temperature of the water, find $\mu = 1.519 \times 10^{-3} \text{ Pa} \cdot \text{s}$.

$$P = (600 \text{ s}^{-1})^2 (1.519 \times 10^{-3} \text{ Pa} \cdot \text{s}) (0.665 \text{ m}^3) = 363.6 \text{ or } 360 \text{ W}$$

Because the efficiency of transfer of motor power to water power is about 80%, the motor power should be

$$\text{Motor power} = \frac{360 \text{ W}}{0.8} = 450 \text{ W}$$

- e. Using Table 6-5, evaluate the different size radial impellers using the geometric ratios. Below is a comparison of the ratios for the available sizes of radial impellers and the rapid mix basin dimensions.

Geometric ratio	Allowable range	Radial impeller diameter		
		0.3 m	0.4 m	0.5 m
D/T	0.14 – 0.5	0.4	0.53	0.67
H/D	2 – 4	5.0	3.8	3.0
H/T	0.28–2	2	2	2
B/D	0.7–1.6	1.7	1.3	1.0

Although the 0.4 m diameter impeller has a D/T slightly larger than the allowable range, it is satisfactory in all the other aspects and, therefore, is selected.

- f. The rotational speed is calculated by solving Equation 6-17 for n :

$$\begin{aligned} n &= \left[\frac{P}{N_p (D_i)^5 \rho} \right]^{1/3} \\ &= \left[\frac{450 \text{ W}}{(5.7)(0.4 \text{ m})^5 (1,000 \text{ kg/m}^3)} \right]^{1/3} \\ &= 1.976 \text{ rps or } 118.5 \text{ rpm or } 120 \text{ rpm} \end{aligned}$$

Comments:

1. To meet redundancy requirements, two rapid mix basins with this design are provided.
2. Because the average day and minimum flow rates will be less, the detention time at these flows will be longer than 5 s.
3. To account for variations in water height and wave action, as well as adding a factor of safety in the design volume, the tank is made deeper than the design water depth. This additional depth is called *freeboard*. The freeboard may vary from 0.45 to 0.60 m.

Flocculation Mixing Design Criteria

While rapid mix is the most important physical factor affecting coagulant efficiency, flocculation is the most important factor affecting particle-removal efficiency. The objective of flocculation is to bring the particles into contact so that they will collide, stick together, and grow to a size that will readily settle or filter out. Enough mixing must be provided to bring the floc into contact and to keep the floc from settling in the flocculation basin. Too much mixing will shear the floc particles so that the floc is small and finely dispersed. Therefore, the velocity gradient must be controlled within a relatively narrow range. Flexibility should also be built into the flocculator so that the plant operator can vary the G value by a factor of two to three. Heavier floc and higher suspended solids concentrations require more mixing to keep the floc in suspension. For example, softening floc is heavier than coagulation floc and, therefore, requires a higher G value to flocculate. This is reflected in the recommended G values shown in Table 6-6. An increase in the floc concentration (as measured by the suspended solids concentration) also increases the required G . Although GLUMRB (2003) specifies a minimum detention time of 30 minutes for flocculation, current practice is to use shorter times that are adjusted by temperature. With water temperatures of approximately 20°C, modern plants provide about 20 minutes of flocculation time at plant capacity. With lower temperatures, the detention time is increased. At 15°C the detention time is increased by 7 percent, at 10°C it is increased 15 percent, and at 5°C it is increased 25 percent.

Flocculation Basin. The flocculation basin should be divided into at least three compartments. The velocity gradient is tapered so that the G values decrease from the first compartment to the last and that the average of the compartments is the design value selected from Table 6-6. GLUMRB (2003) recommends flow through velocities be not less than 0.15 m/s nor greater than 0.45 m/s. Water depths in the basin range from 3 to 5 m (Kawamura, 2000). The velocity of flow from the flocculation basin to the settling basin should be low enough to prevent shear and breakup of the floc but high enough to keep the floc in suspension.

Baffle Wall. A baffle wall is used to separate the flocculation basin compartments (Figure 6-19). The top of the baffle is slightly submerged (1 to 2 cm), and the bottom should have a space of 2 to 3 cm above the floor to allow for drainage and sludge removal (Kawamura, 2000). Each baffle should have orifices that are uniformly distributed over the vertical surface. The size should be selected with the objective of providing a velocity gradient that does not exceed the gradient in the compartment immediately upstream.

TABLE 6-6
 Gt values for flocculation

Type	G, s^{-1}	Gt (unitless)
Low-turbidity, color removal coagulation	20–70	60,000 to 200,000
High-turbidity, solids removal coagulation	30–80	36,000 to 96,000
Softening, 10% solids	130–200	200,000 to 250,000
Softening, 39% solids	150–300	390,000 to 400,000

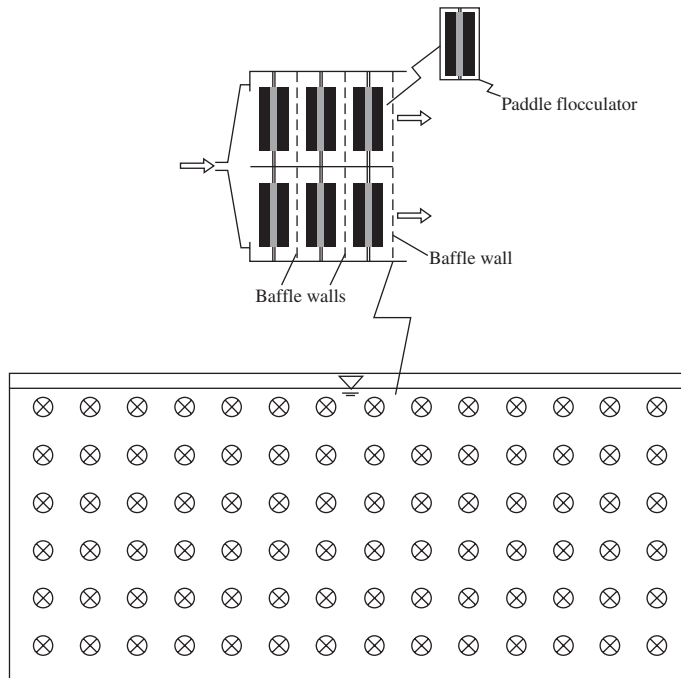

FIGURE 6-19 Baffle wall arrangement for three compartment flocculator. Note that there are two parallel treatment trains and that each baffle wall will have a different orifice arrangement.

The headloss through the orifice may be determined from the orifice (Reynolds and Richards, 1996):

$$Q = C_d A (2gh)^{1/2} \tag{6-18}$$

- where Q = flow rate through orifice, m^3/s
- C_d = coefficient of discharge
- A = area of orifice, m^2
- g = gravity acceleration = $9.81 m/s^2$
- h = headloss through the orifice, m

The coefficient of discharge varies from 0.60 to 0.80. Various authors have suggested that the orifices be 10 to 15 cm in diameter, the velocities be between 0.25 to 0.55 m/s, and the headloss range from 3 to 9 mm through each baffle orifice hole at the maximum flow rate. The higher velocity is found at the first baffle and the lower velocity at the last baffle (Kawamura, 2000; MWH, 2005).

Example 6-8. Design a baffle wall for one of a pair of flocculation basins using the following design parameters:

- $Q = 10,000 m^3/d$
- Diameter of orifices = 100 mm
- Orifice coefficient of discharge = 0.60

	A	B	C
3	Q =	10000	m ³ /d
4		0.116	m ³ /s
5	C _d =	0.6	
6	Diameter of each orifice =	100	mm
7		0.1	m
8	Area of each orifice =	0.00785	m ²
9	No. of orifices	58,448.63	
10	Q/orifice =	0.00198	m ³ /s
11			
12	Check orifice velocity =	0.25	m/s
13			
14	Headloss =	0.0090	m
15		9.0	mm

 Solver Parameters

 Set target cell:

 Equal to: Max. Min. Value of:

By changing cells:

Subject to the constraints:

\$B\$12 <= 0.55	<input type="button" value="Add"/>	
\$B\$12 >= 0.25	<input type="button" value="Change"/>	<input type="button" value="Reset all"/>
\$B\$15 <= 9	<input type="button" value="Delete"/>	<input type="button" value="Help"/>
\$B\$15 >= 3		

FIGURE 6-20

Example 6-8 spreadsheet with solver dialog box. The values in the spreadsheet are the final values not the starting values.

Solution:

- A Solver* program in a spreadsheet was used to perform the iterations for the solution of this problem. The spreadsheet cells are shown in Figure 6-20. The cell locations used in the figure are identified by brackets [] in the discussion below.
- Begin with the average design flow for one basin by setting the fixed parameters as follows:
 - [B3] $Q = 10,000 \text{ m}^3/\text{d}$
 - [B4] Write an equation to convert to m^3/s for use in the orifice equation

$$= \frac{[\text{B3}]}{86,400 \text{ s/d}} = \frac{10,000 \text{ m}^3/\text{d}}{86,400 \text{ s/d}} = 0.116 \text{ m}^3/\text{s}$$

[B5] $C_d = 0.60$

[B6] Diameter of orifice = 100 mm

*Solver is a "tool" in Excel®. Other spreadsheets may have a different name for this program.

- c. In cell [B7] write an equation to convert to m for use in the orifice equation

$$= \frac{[B6]}{1,000 \text{ mm/m}} = \frac{100 \text{ mm}}{1,000 \text{ mm/m}} = 0.1 \text{ m}$$

- d. In cell [B8] calculate the area of an individual orifice

$$= \frac{\pi[B7]^2}{4} = \frac{\pi(0.1)^2}{4} = 0.00785 \text{ m}^2$$

- e. In cell [B9] place a trial guess at the number of orifices

- f. In cell [B10] calculate the flow for an individual orifice

$$= \frac{[B4]}{[B9]}$$

- g. In cell [B12] check the velocity

$$= \frac{[B10]}{[B8]}$$

- h. In cell [B14] check the headloss by solving Equation 6-18 for h

$$= \left[\left(\frac{[B10]}{([B5] * [B8])} \right)^2 \right] * \left[\frac{1}{19.62} \right]$$

- i. In cell [B15] convert the result from [B14] to mm

$$= [B14] * 1000$$

- j. Activate the dialog box for Solver and designate the target cell [B12], that is, the one for the velocity.

- k. Set *Equal to* to “Max.”

- l. Set *By changing* to the cell containing the number of orifices, that is, [B9].

- m. Add the following four *constraints* in the dialog box:

- (1) Velocity

$$[B12] \leq 0.55$$

$$[B12] \geq 0.25$$

- (2) Headloss

$$[B15] \leq 9$$

$$[B15] \geq 3$$

- n. Execute solve to find the number of cells is 58.44863. Because this is not an integer, it is **NOT** the final answer. Acceptable answers are 59 or 60 orifices. The velocity and headloss may be checked by typing the integer in cell [B9].

Comments:

1. This design calculation lends itself to a spreadsheet because the design is iterative in selecting the appropriate number of orifices.
2. A scale drawing of the orifices on the cross section of the baffle will provide a visual check on the reasonableness of the design.

Mixer Alternatives. Flocculation is normally accomplished with one of the following systems: vertical turbine mixing similar to that used in flash mixing, a paddle flocculator (Figure 6-21), or a baffled chamber (Figure 6-22). Vertical turbine mixing with an axial-flow impeller (Figure 6-18) in a mixing basin is recommended over the other types of flocculators because they impart a nearly constant G throughout the tank (Hudson, 1981). However, the paddle flocculator has been the design choice for numerous plants. They are especially chosen for conventional treatment when a high degree of solids removal by sedimentation is desired. In addition, they are the unit of choice when very large volumes of water are to be treated and the number of vertical shaft units becomes excessive, that is >50 (Kawamura, 2000; MWH, 2005).

Vertical Turbine Mixing. Design recommendations include: using a nearly cubical shape for each compartment with the impeller located at a depth equal to two-thirds of the water depth (MWH, 2005), placing the shaft bearings above the water surface and providing a 1.2 m walkway space around the mixer for control panels, power connections, and space for maintenance work (Kawamura, 2000).

The design of the mechanical mixing system follows that used in flash mixing with appropriate substitution of constants for the axial flow impeller N_p and tank/impeller ratios from Table 6-5. The design process is illustrated in the following example.

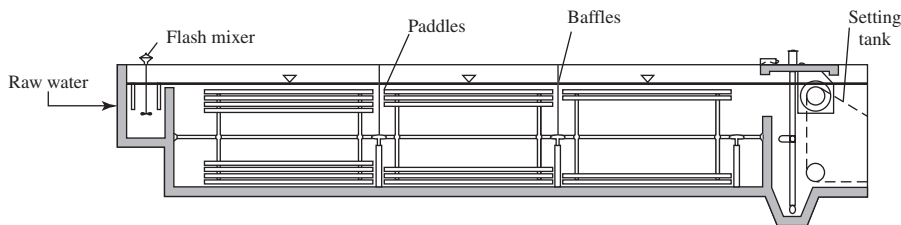
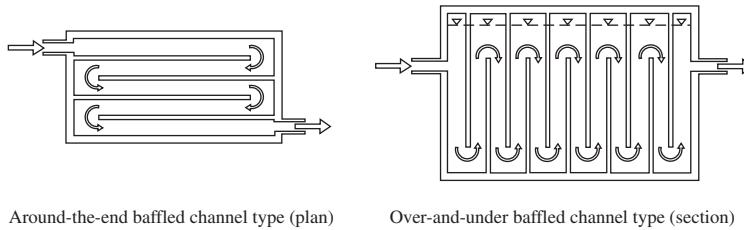

FIGURE 6-21

Paddle flocculator with paddle wheels arranged parallel to the flow.



Around-the-end baffled channel type (plan)

Over-and-under baffled channel type (section)

FIGURE 6-22

Baffled channel flocculation system.

Example 6-9. Design a flocculation basin by determining the basin volume, tank dimensions, required input power, impeller diameter, and its rotational speed using the following parameters and the manufacturer's data:

$$\text{Design flow rate} = 11.5 \times 10^3 \text{ m}^3/\text{d}$$

$$\text{Flocculation } t = 30 \text{ min}$$

$$\text{Three flocculator compartments with } G = 70, 50, 30 \text{ s}^{-1}$$

$$\text{Water temperature} = 5^\circ\text{C}$$

Place impeller at one-third the water depth

From manufacturer's data the following impellers are available:

Impeller type	Impeller diameters (m)			Power number (N_p)
Radial	0.3	0.4	0.6	5.7
Axial	0.8	1.4	2.0	0.31

Solution. Two flocculation basins are provided for redundancy at the design flow rate. The maximum day flow rate is assumed to be twice the average day flow rate.

- a. Convert $11.5 \times 10^3 \text{ m}^3/\text{d}$ to m^3/min .

$$\frac{11.5 \times 10^3 \text{ m}^3/\text{d}}{(1,440 \text{ min}/\text{d})} = 7.986 \text{ or } 8.0 \text{ m}^3/\text{min}$$

- b. With two flocculation basins, the maximum day flow through each will be

$$Q = \frac{8.0 \text{ m}^3/\text{min}}{2} = 4.0 \text{ m}^3/\text{min}$$

- c. Using Equation 6-13, determine the volume of the flocculation basin.

$$V = Qt = (4.0 \text{ m}^3/\text{min})(30 \text{ min}) = 120 \text{ m}^3$$

- d. Each basin is divided into three equal volume compartments or tanks

$$V_{\text{compartment}} = \frac{120 \text{ m}^3}{3} = 40 \text{ m}^3$$

- e. With the recommended water depth range of 3 to 4.5 m, assume water depth of 4.0 m. The surface area is then

$$A_{\text{surface}} = \frac{40 \text{ m}^3}{4.0 \text{ m}} = 10.0 \text{ m}^2$$

- f. With a rectangular plan, the length equals the width and

$$L = W = (10.0 \text{ m}^2)^{1/2} = 3.16 \text{ m}$$

- g. The equivalent diameter exist

$$T = \left\{ \frac{(4)(10.0 \text{ m}^2)}{\pi} \right\}^{1/2} = 3.57 \text{ m}$$

- h. The required input water power for each compartment can be calculated by using Equation 6-12. Using Table A-1 in Appendix A and the temperature of the water, find $\mu = 1.519 \times 10^{-3} \text{ Pa} \cdot \text{s}$.

$$P = (70 \text{ s}^{-1})^2 (1.519 \times 10^{-3} \text{ Pa} \cdot \text{s})(40.0 \text{ m}^3) = 297.7 \text{ or } 300 \text{ W}$$

$$P = (50 \text{ s}^{-1})^2 (1.519 \times 10^{-3} \text{ Pa} \cdot \text{s})(40.0 \text{ m}^3) = 151.9 \text{ or } 150 \text{ W}$$

$$P = (30 \text{ s}^{-1})^2 (1.519 \times 10^{-3} \text{ Pa} \cdot \text{s})(40.0 \text{ m}^3) = 54.7 \text{ or } 55 \text{ W}$$

Because the efficiency of transfer of motor power to water power is about 80%, the motor power for each compartment should be

$$\text{Motor power} = \frac{300 \text{ W}}{0.8} = 375 \text{ W}$$

$$\text{Motor power} = \frac{150 \text{ W}}{0.8} = 187.5 \text{ or } 190 \text{ W}$$

$$\text{Motor power} = \frac{55 \text{ W}}{0.8} = 68.75 \text{ or } 70 \text{ W}$$

- i. The impeller is located at $B = (0.333)(4.0 \text{ m}) = 1.587 \text{ or } 1.6 \text{ m}$ above the bottom of the tank.
- j. Using Table 6-5, evaluate the different size radial impellers using the geometric ratios. Below is a comparison of the ratios for the available sizes of radial impellers and the rapid mix basin dimensions.

Geometric ratio	Allowable range	Axial impeller diameter		
		0.8 m	1.4 m	2.0 m
D/T	0.17–0.4	0.22	0.39	0.56
H/D	2–4	5.0	2.9	2.0
H/T	0.34–1.6	1.12	1.12	1.12
B/D	0.7–1.6	1.7	0.95	0.67

The 1.4 m diameter impeller is satisfactory in all aspects.

- k. The tip speed is checked by first computing the rotational speed at $G = 70 \text{ s}^{-1}$.

$$\begin{aligned}
 n &= \left[\frac{P}{N_p (D_i)^5 \rho} \right]^{1/3} \\
 &= \left[\frac{300 \text{ W}}{(0.31)(1.4 \text{ m})^5 (1,000 \text{ kg/m}^3)} \right]^{1/3} \\
 &= 0.56 \text{ rps or } 33.87 \text{ rpm or } 34 \text{ rpm}
 \end{aligned}$$

The tip speed is then

$$\text{Tip speed} = (\text{rps})(\pi)(D_i) = (0.56)(\pi)(1.4 \text{ m}) = 2.46 \text{ or } 2.5 \text{ m/s}$$

This is less than the design criterion of a maximum tip speed of 2.7 m/s.

Comments:

1. The provision of two flocculation basins meets redundancy requirements.
2. An additional 0.60 m is added to the water depth as freeboard so the tank depth is 4.6 m.

Paddle Flocculator. The power input to the water by horizontal paddles may be estimated as

$$P = \frac{C_D A_p \rho v_p^3}{2} \quad (6-19)$$

where P = power imparted, W

C_D = coefficient of drag of paddle

A_p = cross-sectional area, m^2

v_p = relative velocity of paddles with respect to fluid, m/s

The velocity of the paddles may be estimated as

$$v_p = 2\pi k r n \quad (6-20)$$

where k = constant = 0.75

r = radius to centerline of paddle, m

n = rotational speed, rps

TABLE 6-7
Design recommendations for a paddle wheel flocculator

Parameter	Recommendation
G	$< 50 \text{ s}^{-1}$
Basin	
Depth	1 m > wheel diameter
Clearance between wheel and walls	0.3–0.7 m
Wheel	
Diameter	3–4 m
Spacing between wheels on same shaft	1 m
Spacing between wheel “rims” on adjacent shafts	1 m
Paddle board	
Width	10–15 cm
Length	2–3.5 m
Area of paddles/tank cross section	0.10–0.25
Number per arm	3
Spacing	at 1/3 points on arm
Tip speed	0.15–1 m/s
C_D $L/W = 5$	1.20
$L/W = 20$	1.50
$L/W \gg 20$	1.90
Motor	
Power	$1.5\text{--}2 \times$ water power
Turn down ratio	1:4

Sources: Kawamura, 2000; MWH, 2005; Peavy et al., 1985

Design recommendations for a paddle wheel flocculator are given in Table 6-7.

The maximum G for paddle flocculators is limited to about 60 s^{-1} with a recommended maximum value of 50 s^{-1} to avoid severe wear of the shaft bearings in a very short time. Each arm should have a minimum of three paddles so that the dead space near the shaft will be minimized (Kawamura, 2000).

Example 6-10. Design a paddle flocculator by determining the basin dimensions, the paddle configuration, the power requirement, and rotational speeds for the following parameters:

$$\text{Design flow rate} = 50 \times 10^3 \text{ m}^3/\text{d}$$

$$t = 22 \text{ min}$$

$$\text{Three flocculator compartments with } G = 40, 30, 20 \text{ s}^{-1}$$

$$\text{Water temperature} = 15^\circ\text{C}$$

Solution:

- a. To provide redundancy, the flow will be divided into two flocculation basins. The flow in each is

$$Q_{\text{each}} = \frac{50 \times 10^3 \text{ m}^3/\text{d}}{2} = 25 \times 10^3 \text{ m}^3/\text{d}$$

- b. Using Equation 6-13, calculate the volume of a flocculator basin as

$$V = \frac{(25 \times 10^3 \text{ m}^3/\text{d})}{1,440 \text{ min/d}} (22 \text{ min}) = 381.94 \text{ or } 382 \text{ m}^3$$

- c. With three compartments, each compartment volume is

$$V = \frac{382 \text{ m}^3}{3} = 127.33 \text{ m}^3$$

- d. Assuming a trial water depth of 4.0 m, the surface area of a compartment is

$$A_{\text{surface}} = \frac{127.33 \text{ m}^3}{4.0 \text{ m}} = 31.83 \text{ m}^2$$

- e. With a basin depth of 4.0 m and the design criterion of a basin depth 1 m greater than the diameter of the paddle wheel, the paddle wheel diameter is

$$4.0 \text{ m} - 1 \text{ m} = 3.0 \text{ m}$$

- f. The minimum length of a stage (compartment) is the diameter of the paddle wheel plus the design criterion of 1 m minimum between stages.

$$\text{Minimum length} = 3.0 \text{ m} + 1 \text{ m} = 4.0 \text{ m}$$

- g. The nominal width of a compartment is the surface area divided by the minimum length of a stage

$$W = \frac{31.83 \text{ m}^2}{4.0 \text{ m}} = 7.96 \text{ m}$$

- h. The required clearance is twice the minimum clearance from the walls plus 1 m between paddle wheels on a shaft.

$$\text{Required clearance} = 2(0.3 \text{ m}) + 1 \text{ m} = 1.60 \text{ m}$$

- i. The total length of the two paddle wheels is then

$$7.96 \text{ m} - 1.60 \text{ m} = 6.36 \text{ m}$$

j. Each paddle wheel is then

$$\frac{6.36 \text{ m}}{2} = 3.18 \text{ m long}$$

k. Place three paddle boards on each of four paddle arms with leading edge at 1/3 points, that is,

$$\frac{1.5 \text{ m}}{3} = 0.5 \text{ m}$$

The dimensions of each paddle board will be $15 \text{ cm} \times 3.18 \text{ m}$. A sketch of the layout of the paddle flocculator is shown below.

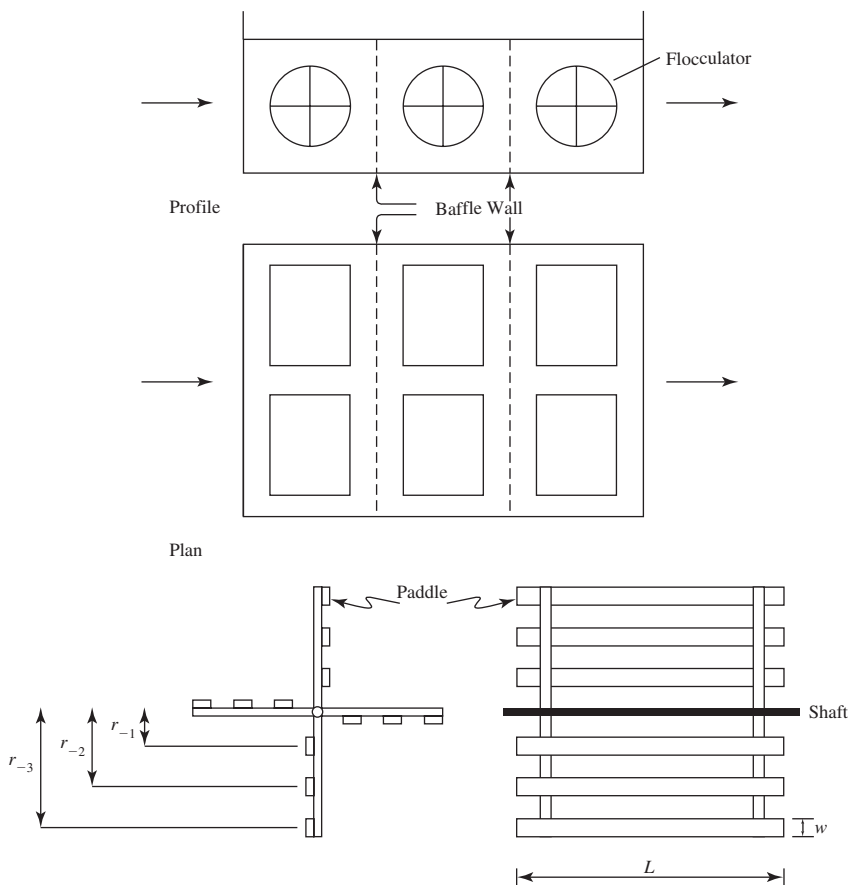

l. Solve Equation 6-12 for P to determine the water power required to achieve a $G = 40 \text{ s}^{-1}$ for the first chamber (compartment). Using Appendix A and a water temperature of 15°C find $\mu = 1.139 \times 10^{-3} \text{ Pa} \cdot \text{s}$.

$$P = G^2 \mu V = (40 \text{ s}^{-1})^2 (1.139 \times 10^{-3} \text{ Pa} \cdot \text{s}) (127.33 \text{ m}^3) = 232.04 \text{ or } 230 \text{ W}$$

- m. Determine the rotational speed required by the paddles using Equation 6-19. Note that the area of each paddle blade is the same, so the equation may be written

$$P = \frac{\rho C_D A_p}{2} [(v_{at\ r1})^3 + (v_{at\ r2})^3 + (v_{at\ r3})^3]$$

and substituting Equation 6-20 for the velocity term

$$P = \frac{\rho C_D A_p}{2} [2\pi(0.75)n]^3 [(r_1)^3 + (r_2)^3 + (r_3)^3]$$

The area of a paddle blade is

$$A_p = 0.15\text{ m} \times 3.18\text{ m} = 0.477\text{ m}^2$$

From the length to width ratio select the appropriate value for C_D .

$$\frac{L}{W} = \frac{3.18\text{ m}}{0.15\text{ m}} = 21.2$$

Select C_D of 1.5

Using $P = 232.04\text{ W}$, solve the rearranged equation for n with the radii for the paddle blades computed to the center of each blade.

$$r_1 = 0.5\text{ m} - \left(\frac{0.15\text{ m}}{2}\right) = 0.425\text{ m}$$

$$r_2 = 1.0\text{ m} - \left(\frac{0.15\text{ m}}{2}\right) = 0.925\text{ m}$$

$$r_3 = 1.5\text{ m} - \left(\frac{0.15\text{ m}}{2}\right) = 1.425\text{ m}$$

$$\begin{aligned} n &= \left(\frac{2P}{\rho C_D A_p [2\pi(0.75)]^3 [(r_1)^3 + (r_2)^3 + (r_3)^3]} \right)^{1/3} \\ &= \left(\frac{2(232.04\text{ W})}{(1,000\text{ kg/m}^3)(1.5)(0.477\text{ m}^2)(104.65)[(0.425)^3 + (0.925)^3 + (1.425)^3]} \right)^{1/3} \\ &= \left(\frac{464.08}{(78,877.07)(3.762)} \right)^{1/3} = (1.65 \times 10^{-3})^{1/3} = 0.116\text{ rps or } 6.96\text{ rpm or } 7\text{ rpm} \end{aligned}$$

- n. Assuming an efficiency of 0.65, the motor power required is

$$\text{Motor power} = \frac{232.04}{0.65} = 356.98\text{ or } 357\text{ W}$$

Comments:

1. Because G is tapered, n must be calculated for each of the following chambers as well as the first chamber.
 2. A motor power of $(1.5)(357 \text{ W}) = 535.5$ or 540 W or larger is recommended.
 3. Add 0.60 m to depth of tank for freeboard.
-

6-8 OPERATION AND MAINTENANCE

The most important operation and maintenance (O&M) task in coagulation is the selection of the appropriate chemicals and the adjustment of the dose to ever-changing raw water quality and plant flow. Frequent jar testing is the standard technique for adjusting the chemical dose. Because of the time delay in conducting the test, other techniques such as zeta potential measurements and the use of a *streaming current detector* (SCD) have been used to augment the jar test. None of these relieve the operator of the necessity of a significant amount of attention.

Monitoring of the chemical feed system to detect clogging of the lines and maintenance of the mixers ranks second in the need for close O&M oversight. Appropriate mixing energy is an important part of optimization of the chemical dose. Excess dosing with coagulant to compensate for inefficient mixing not only is uneconomical in terms of chemical usage, it is expensive in terms of sludge production.

Hints from the Field. Suggestions from operators include the following:

- All of the design calculations in this chapter were based on the design flow, that is, the maximum daily flow rate at the end of the design life. Because the minimum flow rate at start-up will probably be considerably less than the design flow, operational problems may be severe. It is highly recommended that the design be evaluated at minimum flow conditions.
- Most drive failures are caused when the unit is started at the top rotational speed. O&M manuals should note that mixers should be started at low speed to avoid very high torque force and a high power requirement.

Visit the text website at www.mhprofessional.com/wwe for supplementary materials and a gallery of additional photos.

6-9 CHAPTER REVIEW

When you have completed studying this chapter, you should be able to do the following without the aid of your textbooks or notes:

1. Explain what NOM is and why it may be one of the goals of coagulation/flocculation to remove it from drinking water.
2. Differentiate between the terms *coagulation* and *flocculation*.
3. Explain how colloidal particles become negatively charged.

4. Sketch a particle showing the charge of the Helmholtz layer and the diffuse layer.
5. Sketch the family of zeta potential curves under the influence of increasing ionic strength.
6. Sketch the family of zeta potential curves under the influence of increasing cationic charge of a coagulant.
7. Explain the Schulze-Hardy rule and why it is seldom achieved in natural waters.
8. Explain the physics of coagulation using the four mechanisms of coagulation.
9. Explain why the jar test is conducted in two steps.
10. Explain the purpose of enhanced coagulation and select appropriate coagulant(s) from a list.
11. Given a set of chemicals chosen for coagulation, select the order of addition.
12. In terms of the physics of coagulation, explain the difference between adsorption/destabilization and sweep coagulation.
13. From a list of mixing devices select appropriate mixers for either adsorption/destabilization or sweep coagulation.

With the use of this text, you should be able to do the following:

14. Estimate the alkalinity consumed by the addition of alum or ferric chloride to water with varying amounts of alkalinity including no alkalinity.
15. Estimate the pH from the addition of coagulant given the alkalinity.
16. Given the alkalinity, estimate the amount of base to neutralize an excess of coagulant over the available alkalinity.
17. Determine the optimum dose of coagulant from jar test data.
18. Select the appropriate coagulant and mixer system from jar test data.
19. Design an in-line blender, a static mixer, and a mechanical mixer in a stirred tank.
20. Design a baffle wall for a flocculation tank.
21. Design a vertical turbine mixer for flocculation or a paddle flocculator.

6-10 PROBLEMS

- 6-1. What is the “exact” alkalinity of a water that contains 0.6580 mg/L of bicarbonate, as the ion, at a pH of 5.66? No carbonate is present.
- 6-2. Calculate the “approximate” alkalinity (in mg/L as CaCO_3) of a water containing 120 mg/L of bicarbonate ion and 15 mg/L of carbonate ion.
- 6-3. Calculate the “exact” alkalinity of the water in Problem 6-2 if the pH is 9.43.

- 6-4.** Calculate the “approximate” alkalinity (in mg/L as CaCO_3) of a water containing 15 mg/L of bicarbonate ion and 120 mg/L of carbonate ion.
- 6-5.** A jar test has shown that the optimum dose of ferric chloride consumes all of the alkalinity. If the amount of ferric chloride that is in excess is 10 mg/L, how much lime ($\text{Ca}(\text{OH})_2$), in mg/L must be added to neutralize the acid formed?
- 6-6.** Shown below are the results of water quality analyses of the Thames River in London. If the water is treated with 60 mg/L of alum to remove turbidity, how much alkalinity will remain? Ignore side reactions with phosphorus and assume all the alkalinity is HCO_3^- .

Thames River, London

Constituent	Expressed as	Milligrams per liter
Total hardness	CaCO_3	260.0
Calcium hardness	CaCO_3	235.0
Magnesium hardness	CaCO_3	25.0
Total iron	Fe	1.8
Copper	Cu	0.05
Chromium	Cr	0.01
Total alkalinity	CaCO_3	130.0
Chloride	Cl	52.0
Phosphate (total)	PO_4	1.0
Silica	SiO_2	14.0
Suspended solids		43.0
Total solids		495.0
pH ^a		7.4

^aNot in mg/L.

- 6-7.** Shown below are the results of water quality analyses of the Mississippi River at Baton Rouge, Louisiana. If the water is treated with 30 mg/L of ferric chloride for turbidity coagulation, how much alkalinity will remain? Ignore the side reactions with phosphorus and assume all the alkalinity is HCO_3^- .

Mississippi River, Baton Rouge, Louisiana

Constituent	Expressed as	Milligrams per liter
Total hardness	CaCO_3	164.0
Calcium hardness	CaCO_3	108.0
Magnesium hardness	CaCO_3	56.0
Total iron	Fe	0.9
Copper	Cu	0.01
Chromium	Cr	0.03
Total alkalinity	CaCO_3	136.0

(continued)

Mississippi River, Baton Rouge, Louisiana (continued)

Constituent	Expressed as	Milligrams per liter
Chloride	Cl	32.0
Phosphate (total)	PO ₄	3.0
Silica	SiO ₂	10.0
Suspended solids		29.9
Turbidity ^a	NTU	12.0
pH ^a		7.6

^aNot in mg/L.

- 6-8.** Determine the size (liters/hour) of a proportioning pump to feed ferric chloride for a $0.438 \text{ m}^3/\text{s}$ water treatment plant. The optimum dose selected is 50 mg/L . Ferric chloride may be obtained in a liquid form that is 42% pure. The density of this solution is 1.797 kg/L .
- 6-9.** Using Table 6-4, select an in-line blender to mix alum with a design flow rate of $485 \text{ m}^3/\text{h}$. The design water temperature is 10°C . Verify that the detention time and velocity gradient meet the design criteria for adsorption/destabilization. Assume that the water power is 80% of the motor power, that the mixing time must be between 0.3 and 0.8 s, and that there will be a stand-by mixer for redundancy. Because this problem will require some iteration, a spreadsheet solution is highly recommended.
- 6-10.** Using Table 6-4, select a combination of in-line blenders to mix ferric chloride with a design flow rate that varies from a minimum of $8,200 \text{ m}^3/\text{d}$ in winter to a maximum of $49,200 \text{ m}^3/\text{d}$ in summer. The design water temperatures are 4°C in the winter and 15°C in the summer. The plant will operate 8 hours per day for seven days per week in the winter and 24 hours per day for seven days per week in the summer. Assume that the water power is 80% of the motor power and that the mixing time must be between 0.3 and 0.8 s. Because this problem will require some iteration, a spreadsheet solution is highly recommended.
- 6-11.** Rework Example 6-6 to find an appropriate static mixer from those shown in Figure 6-16 that conforms to the design criteria. Because this problem will require some iteration, a spreadsheet solution is highly recommended. The variables that may be adjusted include the number of mixing elements and the mixer diameter.
- 6-12.** Design a static mixer for the following conditions:
- Design flow rate = $350 \text{ m}^3/\text{h}$
 Minimum water temperature = 12°C
 Mixer aspect ratio = 1.0
- To complete this design, specify the following: number of static mixers, number of mixing elements, and mixer diameter.
- 6-13.** As a junior field engineer, you have been asked to assist the contractor on your job in resolving the following problem. A 4.9 kW motor and gear drive rated

at 175 rpm has been shipped with the four impellers described below. The baffled rapid mix tank into which it is to be installed is 3.0 m^3 in volume (1.56 m diameter by 1.56 m deep). Which impeller should be used? Assume a water temperature of 10°C , a $G = 1,000 \text{ s}^{-1}$, a water density of $1,000 \text{ kg/m}^3$, and that the motor power to water power efficiency is 80%. Show the calculations to justify your decision.

Impellers

- A. Propeller, pitch of 2, 3 blades, diameter = 0.48 m, $N_p = 1.0$
- B. Propeller, pitch of 2, 3 blades, diameter = 0.61 m, $N_p = 1.0$
- C. Turbine, 6 flat blades, vaned disc, diameter = 0.48 m, $N_p = 6.3$
- D. Turbine, 6 flat blades, vaned disc, diameter = 0.61 m, $N_p = 6.3$

6-14. The town of Eau Gaullie has requested proposals for a new coagulation water treatment plant. The design flow for the plant is $0.1065 \text{ m}^3/\text{s}$. The average annual water temperature is 19°C . The following design assumptions for a rapid-mix tank have been made:

1. Number of tanks = 1 (with 1 backup spare)
2. Tank configuration: circular with liquid depth = $2 \times$ diameter
3. Detention time = 10 s
4. Velocity gradient = 800 s^{-1}
5. Impeller type: turbine, 6 flat blades, $N_p = 5.7$
6. Available impeller diameters: 0.45, 0.60, and 1.2 m
7. Assume $B = (1/3)H$

Design the rapid-mix system by providing the following:

1. Water power input in kW
2. Tank dimensions in m
3. Diameter of the impeller in m
4. Rotational speed of impeller in rpm

6-15. Your boss has assigned you the job of designing a rapid-mix tank for the new water treatment plant for the town of Waffle. The design flow rate is $0.050 \text{ m}^3/\text{s}$. The average water temperature is 8°C . The following design assumptions for a rapid-mix tank have been made:

1. Number of tanks = 1 (with 1 backup)
2. Tank configuration: circular with liquid depth = 1.0 m
3. Detention time = 5 s

4. Velocity gradient = 750 s^{-1}
5. Impeller type: turbine, 6 flat blades, $N_p = 3.6$
6. Available impeller diameters: 0.25, 0.50, and 1.0 m
7. Assume $B = (1/3)H$

Design the rapid-mix system by providing the following:

1. Water power input in kW
 2. Tank dimensions in m
 3. Diameter of the impeller in m
 4. Rotational speed of impeller in rpm
- 6-16.** Rework Example 6-8 to find the orifice diameter using a headloss if one of the flocculation basins is out of service when the design flow rate occurs.
- 6-17.** Determine the number of orifices for a baffle wall with the following design parameters:
- Design flow rate = $0.11 \text{ m}^3/\text{s}$
 Orifice coefficient = 0.75
 Orifice diameter = 150 mm
- 6-18.** Using a spreadsheet program you have written, rework Example 6-8 for the following cases:
- a. Given velocities of 0.55, 0.45, and 0.35 m/s, find the corresponding diameters in cm and headlosses for 60 orifices.
 - b. Given headlosses of 3, 6 and 9 mm, find the corresponding diameters and velocities for 60 orifices.
- 6-19.** Continuing the preparation of the proposal for the Eau Gaullie treatment plant (Problem 6-14), design the flocculation tank by providing the following for the first two compartments only:
1. Water power input in kW
 2. Tank dimensions in m
 3. Diameter of the impeller in m
 4. Rotational speed of impeller in rpm
- Use the following assumptions:
1. Number of tanks = 2
 2. Tapered G in three compartments: 90, 60, and 30 s^{-1}
 3. $Gt = 120,000$

4. Compartment length = width = depth
 5. Impeller type: axial-flow impeller, three blades, $N_p = 0.31$
 6. Available impeller diameters: 1.0, 1.5, and 2.0 m
 7. Assume $B = (1/3)H$
- 6-20.** Continuing the preparation of the proposal for the Waffle treatment plant (Problem 6-15), design the flocculation tank by providing the following for the first two compartments only:

1. Water power input in kW
2. Tank dimensions in m
3. Diameter of the impeller in m
4. Rotational speed of impeller in rpm

Use the following assumptions:

1. Number of tanks = 1 (with 1 backup)
 2. Tapered G in three compartments: 60, 50, and 20 s^{-1}
 3. Detention time = 30 min
 4. Depth = 3.5 m
 5. Impeller type: axial-flow impeller, three blades, $N_p = 0.43$
 6. Available impeller diameters: 1.0, 1.5, and 2.0 m
 7. Assume $B = (1/3)H$
- 6-21.** Determine the required width of the paddle blade and recommend a motor power (in watts) and rotational speed (in rpm) for the horizontal shaft a cross-flow paddle flocculator for the first compartment of a three compartment flocculation basin shown in Figure P-6-23. (*Note:* there are three paddle wheels on one shaft.) Figure P-6-23 and the following assumptions are to be used in the design:

$$\text{Liquid volume} = 257.2 \text{ m}^3$$

$$\text{Velocity gradient} = 40 \text{ s}^{-1}$$

$$\text{Motor efficiency} = 80\%$$

$$\text{Paddle velocity} = 0.5 \text{ m/s}$$

$$\text{Water temperature} = 15^\circ\text{C}$$

$$\text{Drag coefficient} = 1.8$$

No stators are present*

*A stator is a vertical baffle.

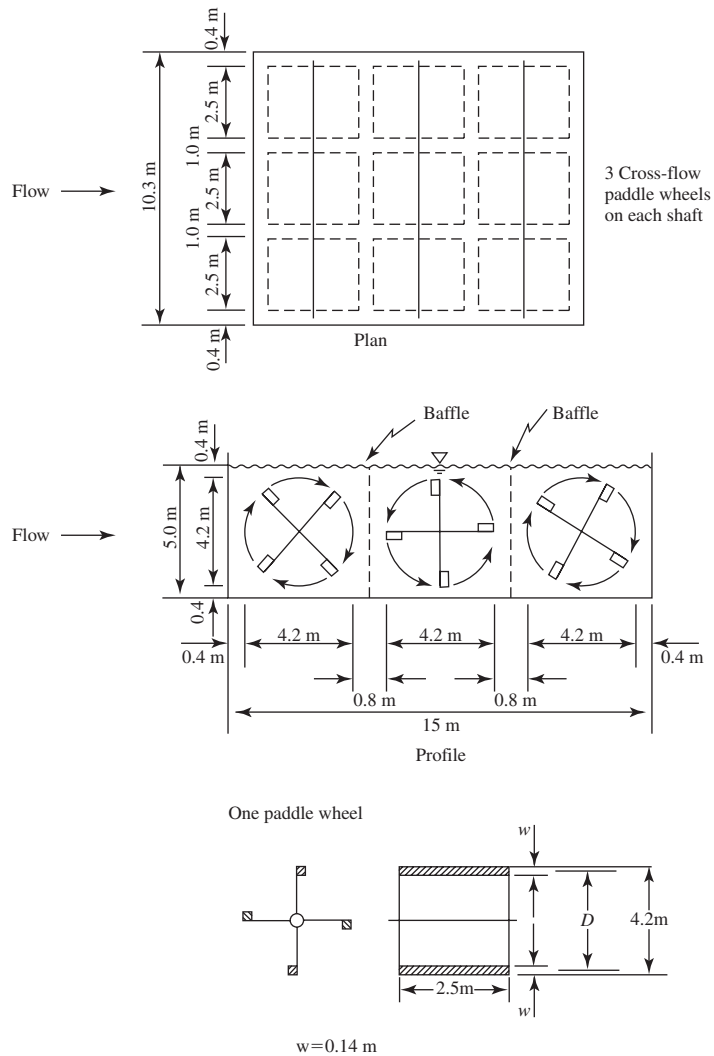

FIGURE P-6-23

(Source: Peavy et al., 1985.)

- 6-22. Design the first compartment of a cross-flow paddle flocculator for the city of None-such by determining the basin dimensions, the paddle configuration, the power requirement, motor power, and rotational speeds for the following parameters:

$$\text{Design flow rate} = 36 \times 10^3 \text{ m}^3/\text{d}$$

$$t = 23 \text{ min}$$

$$\text{Three flocculator compartments with } G = 40, 30, 20 \text{ s}^{-1}$$

For each compartment $L = W$

Water temperature = 10°C

Assume the design recommendations in Table 6-7 apply

To complete the design, provide a dimensioned sketch of the basin and wheels.

Hint: for a first trial assume a wheel diameter of 3.5 m.

- 6-23.** Design the first compartment of a cross-flow paddle flocculator for the city of Some- such by determining the basin dimensions, the paddle configuration, the power requirement, motor power, and rotational speeds for the following parameters:

Design flow rate = $28.8 \times 10^3 \text{ m}^3/\text{d}$

$t = 25 \text{ min}$

Three flocculator compartments with $G = 50, 40, 20 \text{ s}^{-1}$

For each compartment $L = W$

Water temperature = 5°C

Assume the design recommendations in Table 6-7 apply

To complete the design, provide a dimensioned sketch of the basin and wheels.

Hint: for a first trial assume a wheel diameter of 3.0 m.

6-11 DISCUSSION QUESTIONS

- 6-1.** The zeta potential of colloids measured in water from Lake Michigan would be *greater than*, *less than*, or *the same as* the zeta potential for the same colloidal dispersion measured in a water from the Atlantic ocean. Select the correct phrase.
- 6-2.** In Jar Test II in Example 6-3 the pH was held constant while the alum dose was varied. Explain why the settled turbidity varies from a high of 14 to a low of 4.5 and then rises again to 13.
- 6-3.** Which type of rapid mix (in-line blender or back mix reactor) would be selected for the jar test data shown below.

Jar No	1	2	3	4	5
Coagulant dose, mg/L	0	5	20	50	250
Final turbidity, (NTU)	8.35	8.26	7.92	7.51	6.49

Coagulant was Ferric Chloride

6-12 REFERENCES

- Amirtharajah, A. (1978) "Design of Raid Mix Units," in R. L. Sanks (ed.) *Water Treatment Plant Design for the Practicing Engineer*, Ann Arbor Science, Ann Arbor, MI, pp. 131–147.
- Amirtharajah, A. and K. M. Mills (1982) "Rapid-Mix Design for Mechanisms of Alum Coagulation," *Journal of American Water Works Association*, vol. 74, no. 4, pp. 210–216.
- Base, C. F. and R. E. Mesmer (1976) *The Hydrolysis of Cations*, Wiley-Interscience, New York.
- Bayer, T., K. Himmler, and V. Hessel (2003) "Don't Be Baffled by Static Mixers," *Chemical Engineering*, May, pp. 50–57.
- Birkner, F. and J. Morgan (1968) "Polymer Flocculation Kinetics of Dilute Colloidal Suspensions," *Journal of American Water Works Association*, vol. 60, no. 2, pp. 175–191.
- Camp, T. R. and P. C. Stein (1943) "Velocity Gradients and Hydraulic Work in Fluid Motion," *Journal of Hydraulics Division, American Society of Civil Engineers*, vol. 102, pp. 559–568.
- Davis, M. L. and D. A. Cornwell (2008) *Introduction to Environmental Engineering*, McGraw-Hill, Boston, Massachusetts, p. 205.
- Derjaguin, B. V. and L. D. Landau (1941) "Theory of Stability of Strongly Charged Lyophobic Soles and Coalescence of Strongly Charged Particles in Solutions of Electrolytes," *Acta Physicochim. URSS*, vol. 14, pp. 733–762.
- GLUMRB (2003) *Recommended Standards for Water Works*, Great Lakes–Upper Mississippi River Board of State and Provincial Public Health and Environmental Managers, Health Education Services, Albany, New York, p. 34.
- Hahn, H. H. and W. Stumm (1968) "Kinetics of Coagulation with Hydrolyzed Al(III)," *Journal of Colloidal Interface Science*, vol. 28, no. 1, pp. 457–467.
- Hardy, W. B. (1900a) *Proceedings of the Royal Society of London*, vol. 66, p. 110.
- Hardy, W. B. (1900b) *Z. physik Chem.*, vol. 33, p. 385.
- Harris, H. S., W. F. Kaufman, and R. B. Krone (1966) "Orthokinetic Flocculation in Water Purification," *Journal of Environmental Engineering Division, ASCE*, vol. 92, pp. 95–111.
- Hudson, H. E. (1981) *Water Clarification Processes, Practical Design and Evaluation*, Van Nostrand Reinhold, New York, pp. 115–117.
- Hunter, R. J. (2001) *Foundations of Colloid Science*, vols. 1 and 2, Oxford University Press, Oxford, United Kingdom.
- Hunter, R. J. and P. S. Liss (1979) "The Surface Charge of Suspended Particles in Estuarine and Coastal Waters," *Nature*, vol. 282, p. 823.
- Johnson, P. N. and A. Amirtharajah (1983) "Ferric Chloride and Alum as Single and Dual Coagulants," *Journal of American Water Works Association*, vol. 75, pp. 232–239.
- Kawamura, S. (2000) *Integrated Design and Operation of Water Treatment Facilities*, 2nd ed. John Wiley & Sons, New York, pp. 74–139.
- Kolmogorov, A. (1941) "Dissipation Energy in Locally Isotropic Turbulence," *Dokl. Akad. Nauk. SSSR*, vol. 32, pp. 19–21.
- Kruyt, H. R. (1952) *Colloid Science*, Elsevier, New York.
- Langelier, W. F. (1921) "Coagulation of Water with Alum by Prolonged Agitation," *Engineering News Record*, vol. 86, pp. 924–928.
- Letterman, R. D., J. E. Quon and R. S. Gemmill (1973) "Influence of Rapid-Mix Parameters on Flocculation," *Journal of American Water Works Association*, vol. 65, pp. 716–722.
- MWH (2005) *Water Treatment: Principles and Design*, John Wiley & Sons, Hoboken, New Jersey, pp. 658, 674–675, 686, 743, 750.
- Niehof, R. A. and G. I. Loeb (1972) "The Surface Charge of Particulate Matter in Sea Water," *Limnology Oceanography*, vol. 17, p. 7.
- O'Melia, C. R. (1972) "Coagulation and Flocculation," in W. J. Weber, Jr. (ed.), *Physicochemical Processes for Water Quality Control*, Wiley-Interscience, New York, pp. 68–69.

- Packham, R. F. (1965) "Some Studies of the Coagulation of Dispersed Clays with Hydrolyzing Salts," *Journal of Colloid Science*, vol. 20, pp. 81–92.
- Peavy, H. S., D. R. Rowe, and G. Tchobanoglous (1985) *Environmental Engineering*, McGraw-Hill, New York, pp. 147–151.
- Reynolds, T. D. and P. A. Richards (1996) *Unit Operations and Processes in Environmental Engineering*, PWS Publishing Company, Boston, pp. 181, 197, 268.
- Rushton, J. H. (1952) "Mixing of Liquids in Chemical Processing," *Industrial & Engineering Chemistry*, vol. 44, no. 12, p. 2, 931.
- Sawyer, C. N., P. L. McCarty and G. F. Parkin (1994) *Chemistry for Environmental Engineering*, 4th edition, McGraw-Hill, Inc., New York, p. 473.
- Schulze, H. (1882) *J. Prakt. Chem.*, vol 25, p. 431.
- Schulze, H. (1883) *J. Prakt. Chem.*, vol 27, p. 320.
- Smoluchowski, M. (1917) "Verversuch einer mathematischen Theorie der Koagulationskinetic Kolloider Losunger," *Zeit. Phys. Chemie*, vol. 92, pp. 129–168.
- Stumm, W. and C. R. O'Melia (1968) "Stoichiometry of Coagulation" *Journal of American Water Works Association*, vol. 60, pp. 514–539.
- Stumm, W. and J. J. Morgan (1970) *Aquatic Chemistry*, John Wiley & Sons, New York.
- Verway, E. J. W. and J. T. G. Overbeek (1948) *Theory of the Stability of Lyophobic Colloids*, Elsevier, Amsterdam.
- Willis, J. F. (2005) "Clarification," in E. E. Baruth (ed.), *Water Treatment Plant Design*, American Water Works Association and American Society of Civil Engineers, McGraw-Hill, New York, pp. 7-24–7-25.

This page intentionally left blank

LIME–SODA SOFTENING

- 7-1 HARDNESS**
- 7-2 LIME-SODA SOFTENING**
- 7-3 SOFTENING PROCESSES**
- 7-4 CHEMICAL DOSAGES BASED ON STOICHIOMETRY**
- 7-5 CONCURRENT REMOVAL OF OTHER CONSTITUENTS**
- 7-6 PROCESS CONFIGURATIONS AND DESIGN CRITERIA**
- 7-7 OPERATION AND MAINTENANCE**
- 7-8 STABILIZATION**
- 7-9 CHAPTER REVIEW**
- 7-10 PROBLEMS**
- 7-11 DISCUSSION QUESTIONS**
- 7-12 REFERENCES**

7-1 HARDNESS

The term *hardness* is used to characterize a water that does not lather well, causes a scum in the bath tub, and leaves hard, white, crusty deposits (scale) on coffee pots, tea kettles, and hot water heaters. The failure to lather well and the formation of scum on bath tubs is the result of the reactions of calcium and magnesium with the soap. For example:

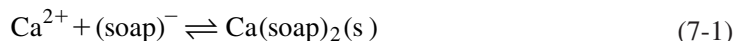

where (s) = a solid precipitate

As a result of this complexation reaction, soap cannot interact with the dirt on clothing, and the calcium-soap complex itself forms undesirable precipitates.

Hardness is defined as the sum of all polyvalent cations (in consistent units). The common units of expression are mg/L as CaCO₃ or milliequivalents per liter (meq/L). Qualitative terms used to describe hardness are listed in Table 7-1. The distribution of hard waters in the United States is shown in Figure 7-1.

Although all polyvalent cations contribute to hardness, the predominant contributors are calcium and magnesium. With the exception of a few other important polyvalent cations and *natural organic matter* (NOM), the focus of this discussion will be on calcium and magnesium.

Hardness in natural waters comes from the dissolution of minerals from geologic formations that contain calcium and magnesium. Two common minerals are *calcite* (CaCO₃) and *dolomite* [CaMg(CO₃)₂]. The natural process by which water becomes hard is shown schematically in Figure 7-2. As rainwater enters the topsoil, the respiration of microorganisms increases the CO₂ content of the water. As shown in Equation 6-2, the CO₂ reacts with the water to form H₂CO₃. Calcite and dolomite react with the carbonic acid to form calcium bicarbonate [Ca(HCO₃)₂] and magnesium bicarbonate [Mg(HCO₃)₂]. While CaCO₃ and CaMg(CO₃)₂ are not very soluble in water, the bicarbonates are quite soluble. Calcium chloride (CaCl₂), gypsum (CaSO₄), magnesium chloride (MgCl₂), and magnesium sulfate (MgSO₄) may also go into solution to contribute to the hardness.

Because calcium and magnesium predominate, the convention in performing softening calculations is to define the *total hardness* (TH) of a water as the sum of these elements

$$\text{TH} = \text{Ca}^{2+} + \text{Mg}^{2+} \quad (7-2)$$

The concentrations of each element are in consistent units (mg/L as CaCO₃ or meq/L). Two components of total hardness are: (1) that associated with the HCO₃⁻ anion (called *carbonate hardness* and abbreviated CH) and (2) that associated with other anions (called *noncarbonate hardness* and abbreviated NCH). Total hardness, then, may also be defined as

$$\text{TH} = \text{CH} + \text{NCH} \quad (7-3)$$

TABLE 7-1
Hard water classification

Hardness range (mg/L as CaCO ₃)	Description	Comment
0–50	Extremely soft	
50–100	Very soft	
100–150	Soft to moderately hard	Acceptable to most users
150–300	Hard	
>300	Very hard	

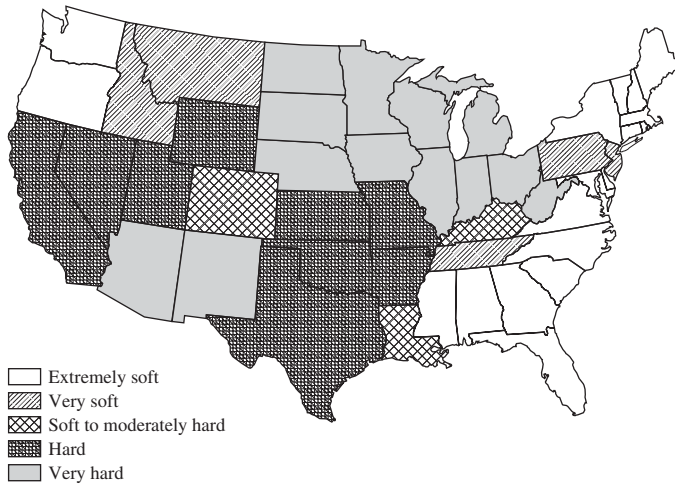
**FIGURE 7-1**

General distribution of hard water in untreated municipal water supplies.

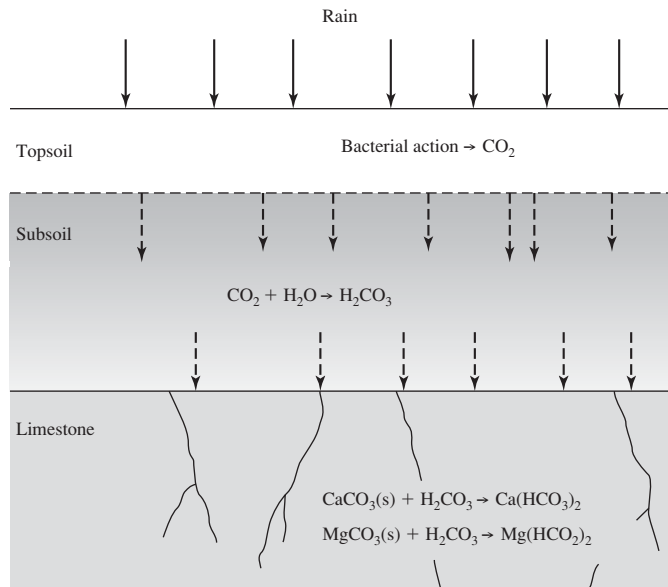
**FIGURE 7-2**

Natural process by which water is made hard. (Source: Davis and Cornwell, 2008.)

Carbonate hardness is defined as the amount of hardness equal to the total hardness or the total alkalinity, whichever is less. Carbonate hardness is often called *temporary hardness* because boiling the water removes it. Heating drives the CO_2 out of solution and the pH increases as shown in Equation 6-2 and Figure 6-7. The resulting reaction is

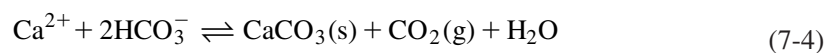

Noncarbonate hardness is defined as the total hardness in excess of the alkalinity. If the alkalinity is equal to or greater than the total hardness, then there is no noncarbonate hardness. Noncarbonate hardness is called *permanent hardness* because it is not removed when water is heated.

Bar charts of water composition are useful in understanding the process of softening. By convention, the bar chart is constructed with cations in the upper bar and anions in the lower bar. In the upper bar, calcium is placed first and magnesium second. Other cations follow without any specified order. The lower bar is constructed with bicarbonate placed first. Other anions follow without any specified order. Construction of a bar chart is illustrated in Example 7-1.

Example 7-1. Given the following analysis of a groundwater, construct a bar chart of the constituents, expressed as CaCO_3 .

Ion	mg/L as ion	EW CaCO_3 /EW ion ^a	mg/L as CaCO_3
Ca^{2+}	103	2.50	258
Mg^{2+}	5.5	4.12	23
Na^+	16	2.18	35
HCO_3^-	255	0.82	209
SO_4^{2-}	49	1.04	51
Cl^-	37	1.41	52

^aEquivalent weight of CaCO_3 /equivalent weight of ion.

Solution. The concentrations of the ions have been converted to CaCO_3 equivalents. The results are plotted in Figure 7-3.

The cations total 316 mg/L as CaCO_3 , of which 281 mg/L as CaCO_3 is hardness. The anions total 312 mg/L as CaCO_3 , of which the carbonate hardness is 209 mg/L as CaCO_3 . There is a

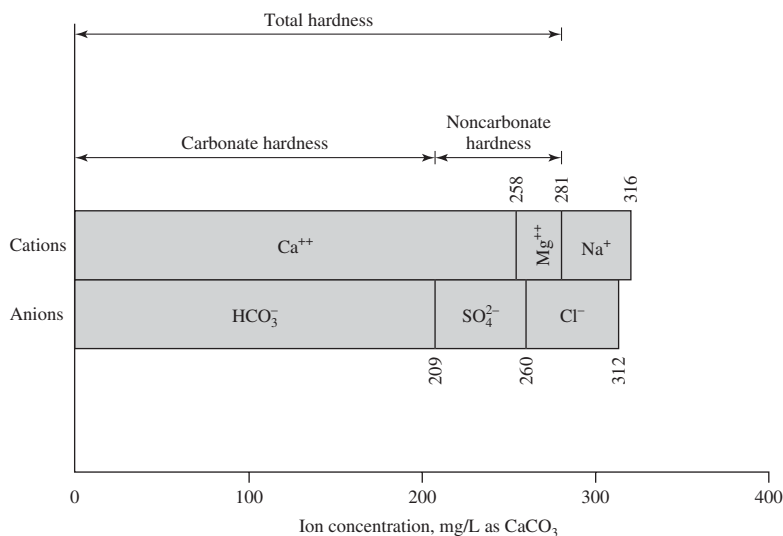

FIGURE 7-3

Bar graph of groundwater constituents. (Source: Davis and Cornwell, 2008.)

discrepancy between the cation and anion totals because there are other ions that were not analyzed. If a complete analysis were conducted, and no analytical error occurred, the equivalents of cations would equal exactly the equivalents of anions. Typically, a complete analysis may vary $\pm 5\%$ because of analytical errors.

The relationships between total hardness, carbonate hardness, and noncarbonate hardness are illustrated in Figure 7-4. In Figure 7-4a, the total hardness is 250 mg/L as CaCO_3 , the carbonate hardness is equal to the alkalinity $\text{HCO}_3^- = 200$ mg/L as CaCO_3 , and the noncarbonate hardness is equal to the difference between the total hardness and the carbonate hardness ($\text{NCH} = \text{TH} - \text{CH} = 250 - 200 = 50$ mg/L as CaCO_3). In Figure 7-4b, the total hardness is again 250 mg/L as CaCO_3 . However, because the alkalinity HCO_3^- is greater than the total hardness, and because the carbonate hardness cannot be greater than the total hardness (see Equation 7-3), the carbonate hardness is equal to the total hardness, that is, 250 mg/L as CaCO_3 .

With the carbonate hardness equal to the total hardness, then all of the hardness is carbonate hardness and there is no noncarbonate hardness. Note that in both cases it may be assumed that the pH is less than 8.3 because HCO_3^- is the only form of alkalinity present.

Example 7-2. A water has an alkalinity of 200 mg/L as CaCO_3 . The Ca^{2+} concentration is 160 mg/L as the ion, and the Mg^{2+} concentration is 40 mg/L as the ion. The pH is 8.1. Find the total, carbonate, and noncarbonate hardness.

Solution. The molecular weights of calcium and magnesium are 40 and 24, respectively. Because each has a valence of 2^+ , the corresponding equivalent weights are 20 and 12. Using Equation 6-7 to convert mg/L as the ion to mg/L as CaCO_3 and adding the two ions as shown in Equation 7-2, the total hardness is

$$\text{TH} = 160 \text{ mg/L} \left(\frac{50 \text{ mg/meq}}{20 \text{ mg/meq}} \right) + 40 \text{ mg/L} \left(\frac{50 \text{ mg/meq}}{12 \text{ mg/meq}} \right) = 567 \text{ mg/L as CaCO}_3$$

where 50 is the equivalent weight of CaCO_3 .

By definition, the carbonate hardness is the lesser of the total hardness or the alkalinity. Because, in this case, the alkalinity is less than the total hardness, the carbonate hardness (CH) is equal to 200 mg/L as CaCO_3 . The noncarbonate hardness is equal to the difference

$$\text{NCH} = \text{TH} - \text{CH} = 567 - 200 = 367 \text{ mg/L as CaCO}_3$$

Note that concentrations of Ca^{2+} and Mg^{2+} can only be added and subtracted if they are in equivalent units, for example, moles/L or milliequivalents/L or mg/L as CaCO_3 .

The removal of ions that cause hardness is called softening. The majority of treatment systems that employ softening are those using a groundwater source. There are, however, a number of surface water sources with a groundwater component that is hard that employ softening as part of their treatment process. Softening can be accomplished by the lime-soda process, ion exchange, nanofiltration, or reverse osmosis. Lime-soda softening is discussed in this chapter. The other methods are discussed in chapters 8 and 9.

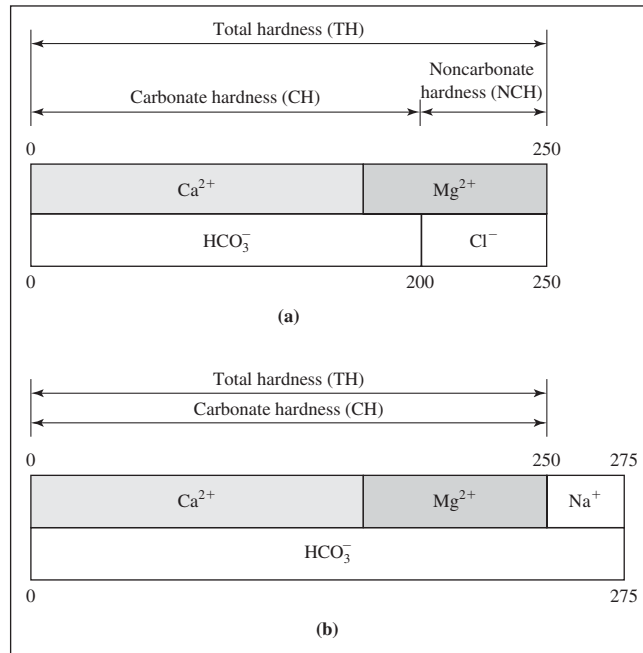

FIGURE 7-4 Relationships between total hardness, carbonate hardness, and noncarbonate hardness. (Source: Davis and Cornwell, 2008.)

7-2 LIME-SODA SOFTENING

Objectives

Prior to the mid-twentieth century, the primary purpose of lime-soda softening by municipal water treatment systems was to satisfy domestic consumer desire to reduce the aesthetic and economic impact of soap precipitation. The importance of this objective has been reduced by the introduction of synthetic detergents and home water softeners. Other benefits of lime-soda softening systems have been shown to be quite substantial. These include removal of heavy metals, NOM, turbidity, and pathogens as well as improving the water quality that reduces costs for distribution system corrosion, boiler and cooling water feed, and home water heater systems. The concurrent removal of arsenic, chromium, iron, lead, manganese, and mercury provides an additional benefit to the removal of hardness and, in some cases, may be the overriding reason for selection of the technology (Kawamura, 2000).

Lime-Soda Softening Chemistry

Solubility Product. Because all solids are soluble to some degree, there is an equilibrium between the ions in solution and the solid. This equilibrium can be expressed as

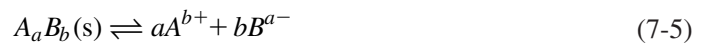

where (s) = solid precipitate.

The product of the activity of the ions (approximated by the molar concentration) is a constant for a given compound at a given temperature. In its most general form it is written as

$$K = \frac{[A]^a[B]^b}{[A_aB_b(s)]} \quad (7-6)$$

where [] = molar concentration, moles/L
(s) = solid state, that is the precipitate

Because the precipitate is a solid, $[A_aB_b(s)] = 1.0$ and the equation is conventionally expressed as

$$K_{sp} = [A]^a[B]^b \quad (7-7)$$

where K_{sp} = solubility product constant

This expression forms the fundamental basis for lime-soda softening. K_{sp} values are often reported as pK_{sp} where

$$pK_{sp} = -\log K_{sp} \quad (7-8)$$

A selected list of K_{sp} values is presented in Appendix A.

Le Chatelier's Principle. The lime-soda reactions are a direct application of *Le Chatelier's principle* or the *law of mass action*, which states that a reaction at equilibrium will adjust itself to relieve any force or stress that disturbs the equilibrium. To soften the water, an ion in common in the solubility equilibrium is selected to react with calcium or magnesium so the reaction forms more precipitate. The solubility product equilibrium provides a starting point for selecting the common ion. From Appendix A, it is apparent that several forms of calcium and magnesium will form a precipitate. The solubility product, as well as public health and economic criteria, are used as the criteria for selecting the form of precipitate. In the case of calcium, the desired precipitate is CaCO_3 . In the case of magnesium, the desired precipitate is $\text{Mg}(\text{OH})_2$. The solubility equilibrium reactions are

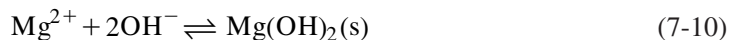

The concentration of CO_3^{2-} and/or OH^- is increased by the addition of chemicals, and the chemicals drive the reactions given in Equations 7-9 and 7-10 to the right. Insofar as possible, the naturally occurring bicarbonate alkalinity (HCO_3^-) is converted to carbonate (CO_3^{2-}) by the addition of hydroxyl ions (OH^-). Hydroxyl ions cause the carbonate buffer system (Equation 6-2) to shift to the right and, thus, provide the carbonate for the precipitation reaction (Equation 7-9).

The common source of hydroxyl ions is calcium hydroxide [$\text{Ca}(\text{OH})_2$]. Many water treatment plants find it more economical to buy *quicklime* (CaO), commonly called *lime*, than hydrated lime [$\text{Ca}(\text{OH})_2$]. The quicklime is converted to hydrated lime at the water treatment plant by mixing CaO and water to produce a slurry of $\text{Ca}(\text{OH})_2$, which is fed to the water for softening. The conversion process is called *slaking*:

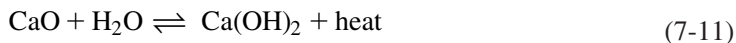

The reaction is exothermic. It yields almost 1 MJ per gram mole of lime. Because of this high heat release, the reaction must be controlled carefully. All safety precautions for handling a strong base should be observed. Because the chemical is purchased as lime, it is common to speak of chemical additions as additions of “lime,” when in fact the chemical added is hydrated lime (calcium hydroxide). When carbonate ions must be supplied, the most common chemical chosen is sodium carbonate (Na_2CO_3). Sodium carbonate is commonly referred to as *soda ash* or *soda*.

Softening Reactions. The softening reactions are regulated by controlling the pH. First, any free acids are neutralized. Then the pH is raised to precipitate the CaCO_3 ; if necessary, the pH is raised further to remove $\text{Mg}(\text{OH})_2$. Finally, if necessary, CO_3^{2-} is added to precipitate the non-carbonate hardness.

Six important softening reactions are discussed below. In each case, the chemical that is added to the water is printed in bold type. The notation (s) designates the solid form, and indicates that the compound has been removed from the water. The following reactions are presented sequentially, although in reality they occur simultaneously.

1. Neutralization of carbonic acid (H_2CO_3).

In order to raise the pH, free acids must be neutralized first. CO_2 is the principal acid present in unpolluted, naturally occurring water.* No hardness is removed in this step.

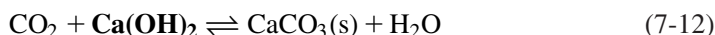

2. Precipitation of carbonate hardness due to calcium.

To precipitate calcium carbonate, all of the naturally occurring bicarbonate must be converted to carbonate. The carbonate then serves as the common ion for the precipitation reaction.



3. Precipitation of carbonate hardness due to magnesium.

To remove carbonate hardness that results from the presence of magnesium, more lime is added. The reaction may be considered to occur in two stages. The first stage occurs when the bicarbonate in step 2 above is converted to carbonate.



The hardness of the water does not change because MgCO_3 is soluble. With the addition of more lime, the hardness due to magnesium is removed.



* CO_2 and H_2CO_3 in water are essentially the same:

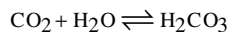

Thus, the number of reaction units (n) used to calculate the equivalents for CO_2 is two.

4. Removal of noncarbonate hardness due to calcium.

To remove noncarbonate hardness due to calcium, additional carbonate in the form of soda ash must be added

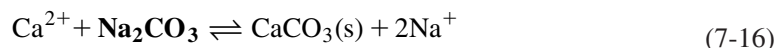

5. Removal of noncarbonate hardness due to magnesium.

To remove noncarbonate hardness due to magnesium, both lime and soda must be added. The lime provides the hydroxyl ion for precipitation of the magnesium.

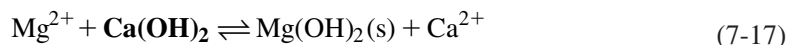

Although the magnesium is removed, there is no change in the hardness because the calcium is still in solution. To remove the calcium, soda ash must be added.

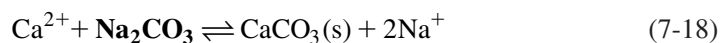

Note that this is the same reaction as the one to remove noncarbonate hardness due to calcium.

These reactions are summarized in Figure 7-5. Although the reactions shown above use lime and soda ash as sources of hydroxyl ion and carbonate ion, other sources may be used. For example, sodium hydroxide (NaOH) can be substituted for calcium hydroxide.

pH. Solubility relationships are generally more complex than implied by the discussion to this point. In addition to the solubility product, other equilibria affect the concentration of the ions present. Other ions may form salts with less solubility than the ones assumed to result from the solubility equilibrium. Reactions of the cation or anion with water to form hydroxide complexes or

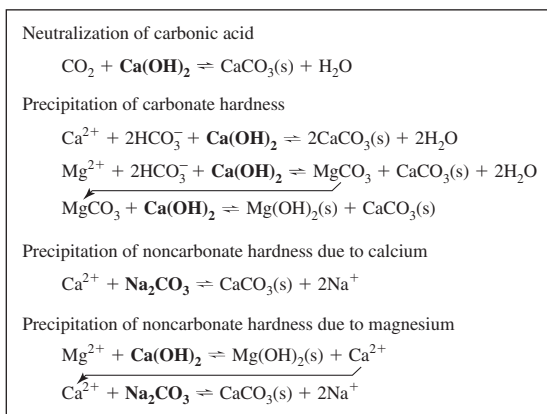

FIGURE 7-5

Summary of softening reactions. (Note: The chemical added is printed in bold type. The precipitate is designated by (s). The arrow indicates where a compound formed in one reaction is used in another reaction.) (Source: David and Cornwell, 2008.)

protonated anion species are common. In addition, the cations or anions may form complexes with other materials in solution, thus, reducing their effective concentration (Sawyer et al., 2003).

Of particular importance is the effect of solution pH on the solubility of cations. For example, assuming that there are no other compounds in solution to react with calcium hydroxide, the solubility product would be

$$K_{sp} = [\text{Ca}^{2+}][\text{OH}^-]^2 \quad (7-19)$$

or

$$\log [\text{Ca}^{2+}] = \log K_{sp} - 2 \log [\text{OH}^-] \quad (7-20)$$

However, $\log [\text{OH}^-]$ is a function of pH:

$$\text{pH} = \text{p}K_w - \text{pOH} = \text{p}K_w + \log [\text{OH}^-] \quad (7-21)$$

or

$$\log [\text{OH}^-] = \text{pH} - \text{p}K_w \quad (7-22)$$

So Equation 7-20 may be written

$$\log [\text{Ca}^{2+}] = \log K_{sp} - 2(\text{pH} - \text{p}K_w) \quad (7-23)$$

The pH not only affects the solubility of metal hydroxides, it also affects other equilibria, which in turn affects the solubility of the cation. Of particular importance is the relationship of the carbonate buffer system to pH. As noted in Equations 6-5 and 6-6, carbonate is an anion of the weak diprotic acid, H_2CO_3 . The carbonate species both influence and are influenced by the pH. The sum of the carbonate species may be specified as a total concentration of inorganic carbon:

$$C_T = [\text{H}_2\text{CO}_3] + [\text{HCO}_3^-] + [\text{CO}_3^{2-}] \quad (7-24)$$

If the pH is specified, the saturation value for $[\text{Ca}^{2+}]$ can be estimated for a given value of C_T . This is illustrated in Figure 7-6.

In lime-soda softening, the pH is controlled by the addition of lime. To precipitate CaCO_3 , the pH of the water must be raised to about 10.3. To precipitate magnesium, the pH must be raised to a range of about 11 to 11.3 (Horsley et al., 2005).

Process Limitations and Empirical Considerations. Lime-soda softening cannot produce a water completely free of hardness because of the solubility of CaCO_3 and $\text{Mg}(\text{OH})_2$, the physical limitations of mixing and contact, and the lack of sufficient time for the reactions to go to completion. Thus, the minimum calcium hardness that can be achieved is about 30 mg/L as CaCO_3 , and the minimum magnesium hardness is about 10 mg/L as CaCO_3 . Because of the slimy condition that results when soap is used with a water that is too soft, historically the goal for final total hardness has been set at between 75 and 120 mg/L as CaCO_3 . In recent years, many utilities have raised the target hardness to 120 to 150 mg/L as CaCO_3 to reduce chemical costs and *residuals** production (Horsley et al., 2005).

In order to achieve reasonable removal of hardness in a reasonable time period, an extra amount of $\text{Ca}(\text{OH})_2$ beyond the stoichiometric amount usually is provided. Based on empirical experience, the minimum extra amount is 20 mg/L of $\text{Ca}(\text{OH})_2$ expressed as CaCO_3 (or 0.40 meq).

*Residuals = precipitate in the lime-softening process and brine in ion exchange and reverse osmosis softening.

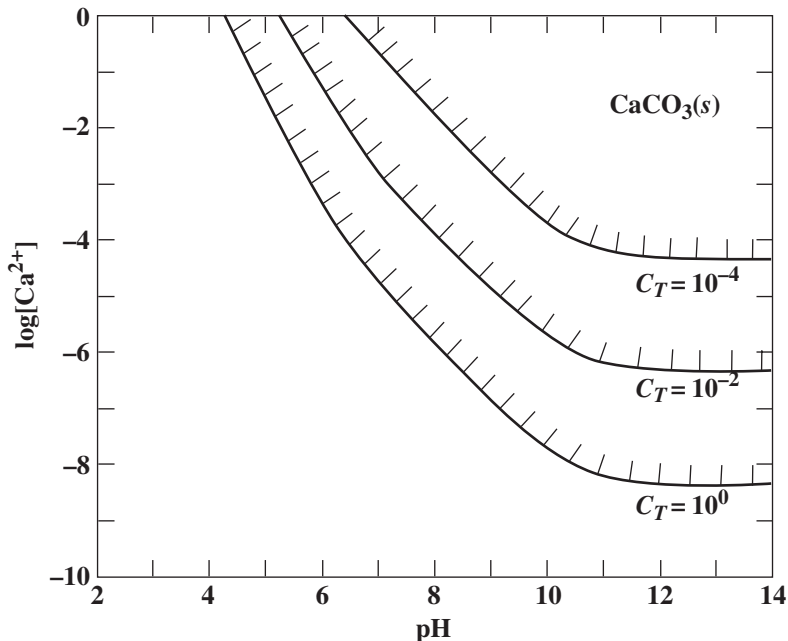

FIGURE 7-6

Logarithmic concentration diagram showing the relationship between pH, C_T (mol/L of inorganic carbon), and the equilibrium concentration of Ca^{2+} with respect to $CaCO_3(s)$. (Source: Sawyer et al., 2003.)

Magnesium in excess of about 40 mg/L as $CaCO_3$ (0.80 meq) forms scales on heat exchange elements in hot water heaters. Because of the expense of removing magnesium, normally only the magnesium that is in excess of 40 mg/L as $CaCO_3$ is removed. For magnesium removals less than 20 mg/L as $CaCO_3$, the basic extra amount of lime mentioned above is sufficient to ensure good results. For magnesium removals between 20 and 40 mg/L as $CaCO_3$, an extra amount of lime equal to the magnesium to be removed is added. For magnesium removals greater than 40 mg/L as $CaCO_3$, the extra lime added is 40 mg/L as $CaCO_3$. Addition of extra lime in amounts greater than 40 mg/L as $CaCO_3$ does not appreciably improve the reaction kinetics.

Because the excess lime adds hardness in the form of Ca^{2+} , it is removed in a subsequent process step called *recarbonation*. Recarbonation is discussed in detail in Section 7.3.

The sequence chemical additions (as $CaCO_3$) to soften water are summarized in Table 7-2:

7-3 SOFTENING PROCESSES

The selection of chemicals and their dosage depends on the raw water composition, the desired final water composition, operational convenience, sludge production, and cost. If a Mg^{2+} concentration of 40 mg/L as $CaCO_3$ is used as a product water criterion, then six cases illustrate the dosage schemes. Three of the cases occur when the Mg^{2+} concentration is less than 40 mg/L as $CaCO_3$ (Figure 7-7a, b, and c) and three cases occur when Mg^{2+} is greater than 40 mg/L as $CaCO_3$ (Figure 7-8a, b, and c).

The process alternatives described below are a selection of the many that may be implemented. The naming convention for the different process alternatives is not standardized and care should be taken to make sure that the process alternative is well understood by the design team and the client irrespective of the naming convention.

TABLE 7-2
Summary of chemical additions to soften water

Step	Chemical addition ^a	Reason
Carbonate hardness		
1.	Lime = CO ₂	Neutralize H ₂ CO ₃
2.	Lime = HCO ₃ ⁻	Raise pH; convert HCO ₃ ⁻ to CO ₃ ²⁻
3.	Lime = Mg ²⁺ to be removed	Raise pH; precipitate Mg(OH) ₂
4.	Lime = required excess	Drive reaction
Noncarbonate hardness		
5.	Soda = noncarbonate hardness to be removed	Provide CO ₃ ²⁻

^aThe terms "Lime" and "Soda" refer to mg/L of Ca(OH)₂ and Na₂CO₃ respectively, as CaCO₃ equal to mg/L of ion (or gas in the case of CO₂) as CaCO₃.

Removal of CO₂

Because CO₂ in the raw water behaves as H₂CO₃, its removal is the first step in raising the pH in lime-soda softening. It may be neutralized by the addition of lime, in which case it is not a "process" in the conventional meaning of the word. When the concentration exceeds 10 mg/L as CO₂ (22.7 mg/L as CaCO₃ or 0.45 meq/L), the economics of removal by aeration (*stripping*) are favored over removal by lime neutralization. Air stripping is a separate process. No hardness is removed in this process.

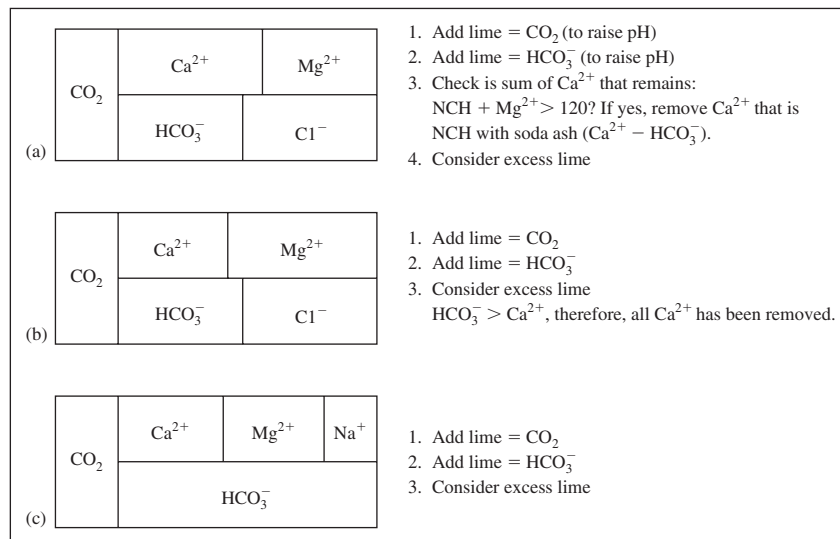
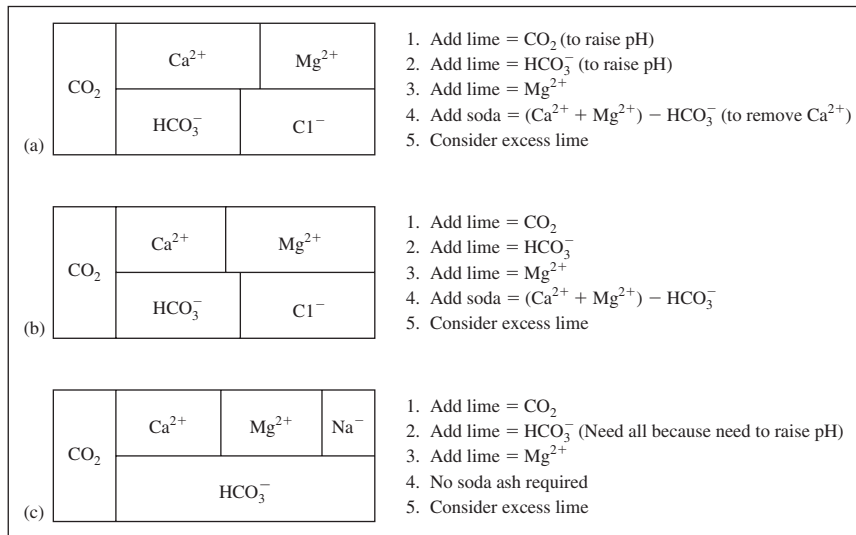

FIGURE 7-7

Dosage schemes when Mg²⁺ concentration is less than or equal to 40 mg/L as CaCO₃ and no split treatment is required. Note that no Mg²⁺ is removed and that reactions deal with CO₂ and Ca²⁺ only. (Source: Davis and Cornwell, 2008.)

**FIGURE 7-8**

Cases when Mg²⁺ concentration is greater than 40 mg/L as CaCO₃ and split treatment is required. Note that these cases illustrate softening to the practical limits in the first stage of the split-flow scheme. (Source: Davis and Cornwell, 2008.)

Lime Softening

Also called *selective calcium removal*, or *partial lime softening*, this alternative applies to cases (a), (b), and (c) in Figure 7-7. Only lime is added. The desired control pH is 10.3. This process removes only carbonate hardness caused by calcium.

Excess Lime Softening

This alternative applies to cases (b) and (c) in Figure 7-8. Only lime is added. The desired control pH is 11.3. This process removes only the carbonate hardness caused by calcium and magnesium.

Lime-Soda Softening

This alternative applies to cases (a), (b), and (c) in Figure 7-8. Both lime and soda ash are added. The desired control pH is 11.3. This process removes both carbonate and noncarbonate hardness caused by calcium and magnesium.

Softening to Practical Limits

One process to achieve a specified magnesium concentration or to achieve a given hardness is to treat a portion of the water to the practical limits and then blend the treated water with the raw water to achieve the desired magnesium concentration or hardness.* Stoichiometric amounts of lime and soda are added to remove all of the Ca²⁺ and Mg²⁺ to the practical limits of softening (that is, 0.60 meq/L or 30 mg/L as CaCO₃ of Ca²⁺ and 0.20 meq/L or 10 mg/L as CaCO₃ of Mg²⁺).

*Generally, it is not practical to attempt to achieve both a desired magnesium concentration and a specified final hardness with a single split, and it is not economical to have multiple splits.

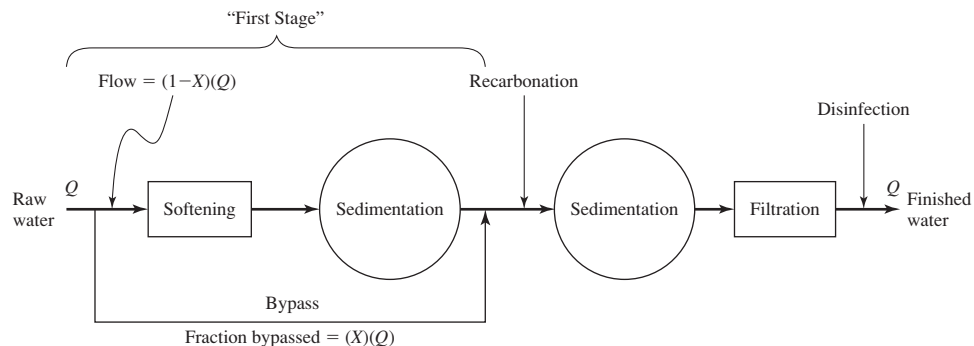

FIGURE 7-9
Split-flow treatment scheme. (Source: Davis and Cornwell, 2008.)

Split Treatment

As shown in Figure 7-9, in split treatment a portion of the raw water is bypassed around the softening reaction tank and the settling tank. This serves several functions. First, it allows the water to be tailored to yield a product water that has 0.80 meq/L or 40 mg/L as CaCO_3 of magnesium (or any other value above the solubility limit). Second, it allows for a reduction in capital cost of tankage because the entire flow does not need to be treated. Third, it minimizes operating costs for chemicals by treating only a fraction of the flow. Fourth, it uses the natural alkalinity of the water to lower the pH of the product water and assist in stabilization. In many cases a second sedimentation basin is added after recarbonation and prior to filtration to reduce the solids loading onto the filters.

The fractional amount of the split is calculated as

$$X = \frac{\text{Mg}_f - \text{Mg}_i}{\text{Mg}_r - \text{Mg}_i} \quad (7-25)$$

where Mg_f = final magnesium concentration, mg/L as CaCO_3

Mg_i = magnesium concentration from first stage (Figure 7-9), mg/L as CaCO_3

Mg_r = raw water magnesium concentration, mg/L as CaCO_3

The first stage is operated to soften the water to the practical limits of softening. Thus, the value for Mg_i is commonly taken to be 10 mg/L as CaCO_3 . Because the desired concentration of Mg is nominally set at 40 mg/L as CaCO_3 as noted previously, Mg_f is commonly taken as 40 mg/L as CaCO_3 .

Recarbonation

When the pH of the softened water is greater than the saturation pH, the pH must be reduced to stop the precipitation reaction that will deposit CaCO_3 in the filters and distribution system piping because this will cement them closed. CO_2 (which when dissolved in water forms H_2CO_3) has frequently been found to be the most economical chemical to use in reducing the pH. Alternatively, strong acids such as sulfuric acid may be employed. The *stabilization process* is discussed in detail in Section 7.8.

Five reactions that are employed in recarbonation are discussed below. In each case, the chemical that is added to the water is printed in bold type. The notation (s) designates the solid form and indicates that the compound has been removed from the water. The following reactions are presented sequentially, although in reality they occur simultaneously.

1. Recarbonation after selective calcium removal.

After selective calcium removal, the water will be supersaturated with calcium carbonate and the pH will be between 10.0 and 10.6. The addition of CO_2 lowers the pH to between 8.5 and 9.0 and converts the carbonate ions to bicarbonate ions.

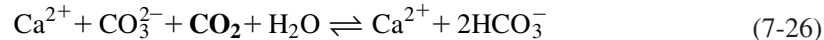

2. Recarbonation after the excess lime process.

After calcium and magnesium removal with excess lime, the pH will be above 11.0. Sufficient CO_2 is added to convert the excess hydroxyl ions to carbonate ions and then to convert the carbonate ions to bicarbonate. This will occur in the pH range of 10.0 to 10.5.

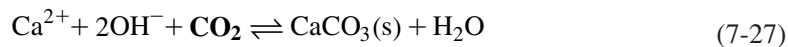

Additional CO_2 is added to lower the pH to about 8.4 to 8.6.

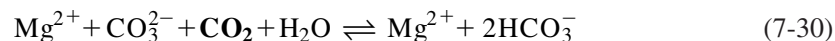
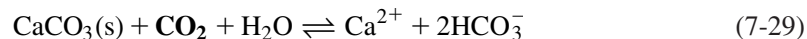

7-4 CHEMICAL DOSAGES BASED ON STOICHIOMETRY

The estimation of the chemical dosage is used to design the chemical storage silos, chemical feed systems, and sludge disposal facilities. In the following examples, it is assumed that the reactions go to completion, that the lime and soda ash are pure (100 percent of the chemical), and that the extra lime added to drive the reaction is removed by recarbonation.

Estimating CO_2 Concentration

CO_2 is of importance in two instances in softening. In the first instance, it consumes lime that otherwise could be used to remove Ca^{2+} and Mg^{2+} . In the second instance, CO_2 is used to neutralize the high pH of the effluent from the softening process. These reactions are an application of the concepts of the carbonate buffer system discussed in Chapter 6.

The approximate concentration* of CO_2 may be estimated using the equilibrium expressions for the dissociation of water and carbonic acid with the definition of alkalinity (Equation 6-3). The pH and alkalinity of the water must be determined to make the estimate. The equilibrium expressions for carbonic acid are

$$K_{a1} = \frac{[\text{H}^+][\text{HCO}_3^-]}{[\text{H}_2\text{CO}_3]} \quad \text{p}K_{a1} = 6.35 \text{ at } 25^\circ\text{C} \quad (7-31)$$

*A more accurate estimation technique is described by Benefield and Morgan (1999).

$$K_{a2} = \frac{[\text{H}^+][\text{CO}_3^{2-}]}{[\text{HCO}_3^-]} \quad \text{p}K_{a2} = 10.33 \text{ at } 25^\circ\text{C} \quad (7-32)$$

where [] = concentration in moles/L.

For water temperatures other than 25°C, the dissociation constants may be estimated as (Rossum and Merrill, 1983)

$$K_{a1} = 10^{14.8453 - 3404.71/T - 0.032786T} \quad (7-33)$$

$$K_{a2} = 10^{6.498 - 2909.39/T - 0.02379T} \quad (7-34)$$

where T = absolute temperature, K.

When the pH is less than 8.3, HCO_3^- is the dominant form of alkalinity, and total alkalinity is nominally taken to be equal to the concentration of HCO_3^- (Figure 6-8). For most natural waters this is a reasonable assumption. Thus, we can ignore the dissociation of bicarbonate to form carbonate. With this assumption, the procedure to solve the problem is:

- a. Calculate the $[\text{H}^+]$ from the pH.
- b. Correct the K_a value for temperature.
- c. Calculate the $[\text{HCO}_3^-]$ from the alkalinity.
- d. Solve the first equilibrium expression of the carbonic acid dissociation for $[\text{H}_2\text{CO}_3]$.
- e. Use the assumption that $[\text{CO}_2] = [\text{H}_2\text{CO}_3]$ to estimate the CO_2 concentration.

Example 7-3 illustrates a simple case where one of the forms of alkalinity predominates.

Example 7-3. What is the estimated CO_2 concentration of a water with a pH of 7.65 and a total alkalinity of 310 mg/L as CaCO_3 ? Assume the water temperature is 25°C.

Solution. When the raw water pH is less than 8.3, we can assume that the alkalinity is predominately HCO_3^- . Thus, we can ignore the dissociation of bicarbonate to form carbonate.

- a. The $[\text{H}^+]$ concentration is

$$[\text{H}^+] = 10^{-7.65} = 2.24 \times 10^{-8} \text{ moles/L}$$

- b. Because the alkalinity is reported as mg/L as CaCO_3 , it must be converted to mg/L as the species using Equation 6-7 before the molar concentration may be calculated. The ratio 61/50 is the ratio of the equivalent weight of HCO_3^- to the equivalent weight of CaCO_3 .

The $[\text{HCO}_3^-]$ concentration is

$$\begin{aligned} [\text{HCO}_3^-] &= (310 \text{ mg/L}) \left(\frac{61 \text{ mg/meq}}{50 \text{ mg/meq}} \right) \left(\frac{1}{(61 \text{ g/mole})(10^3 \text{ mg/g})} \right) \\ &= 6.20 \times 10^{-3} \text{ moles/L} \end{aligned}$$

- c. With $pK_{a1} = 6.35$, solve Equation 7-31 for $[H_2CO_3]$.

$$[H_2CO_3] = \frac{[H^+][HCO_3^-]}{K_{a1}}$$

$$K_{a1} = 10^{-6.35} = 4.47 \times 10^{-7} \text{ moles/L at } 25^\circ\text{C}$$

$$[H_2CO_3] = \frac{(2.24 \times 10^{-8} \text{ moles/L})(6.20 \times 10^{-3} \text{ moles/L})}{4.47 \times 10^{-7} \text{ moles/L}}$$

$$= 3.11 \times 10^{-4} \text{ moles/L}$$

- d. Assume that all the CO_2 in water forms carbonic acid. Thus, the estimated CO_2 concentration is

$$[CO_2] = 3.11 \times 10^{-4} \text{ moles/L}$$

In other units for comparison and calculation:

$$CO_2 = (3.11 \times 10^{-4} \text{ moles/L})(44 \times 10^3 \text{ mg/mole}) = 13.7 \text{ mg/L as } CO_2$$

and

$$CO_2 = (13.7 \text{ mg/L as } CO_2) \left(\frac{50 \text{ mg/meq}}{22 \text{ mg/meq}} \right) = 31.14 \text{ or } 31.1 \text{ mg/L as } CaCO_3$$

The equivalent weight of CO_2 is taken as 22 because it effectively behaves as carbonic acid (H_2CO_3) and thus $n = 2$.

Comment. This CO_2 concentration is high enough to warrant consideration of air stripping to remove it.

Selective Calcium Removal

When the magnesium concentration is less than 40 mg/L as $CaCO_3$, lime softening (also called *partial lime softening*) can produce the desired final hardness. The alternative dosing schemes are dependent on the amount of carbonate alkalinity as shown in Figure 7-7. In each instance CO_2 removal is shown by lime neutralization. This assumes that this is the economic alternative. In addition, it should be noted that lime must be added to the stoichiometric equivalent of the bicarbonate present regardless of the concentration of calcium. If the bicarbonate is not neutralized, the pH objective of 10.3 required to precipitate the calcium will not be achieved.

Example 7-4 illustrates one case of those shown in Figure 7-7, using both mg/L as $CaCO_3$ and milliequivalents/L (meq/L) as units of measure.

Example 7-4. Prepare a bar chart for Sweetwater's water analysis given below and determine the chemical dosage required for selective calcium removal. Estimate the dosage of quicklime (CaO) that needs to be added if the purity of lime is 90%.

Sweetwater water analysis^a

Constituent	mg/L
CO ₂	6.6
Ca ²⁺	80
Mg ²⁺	8.5
HCO ₃ ⁻	200.0
SO ₄ ²⁻	73

^aAssume that other ions in the water that are not reported account for the lack of an ion balance.

Solution:

- a. Begin by converting all the concentrations to CaCO₃ equivalents and meq.

Constituent, mg/L	EW	EW CaCO ₃ /EW ion	mg/L as		
			CaCO ₃	meq/L	
CO ₂	6.6	22.0	2.28	15.0	0.30
Ca ²⁺	80	20.0	2.50	200.0	4.00
Mg ²⁺	8.5	12.2	4.12	35.0	0.70
HCO ₃ ⁻	200.0	61.00	0.820	164.0	3.28
SO ₄ ²⁻	73	48.00	1.04	76	1.52

NOTE: meq/L = (mg/L as CaCO₃)/50 and meq/L = (mg/L)/EW.

The bar chart of the raw water in mg/L as CaCO₃ is shown below.

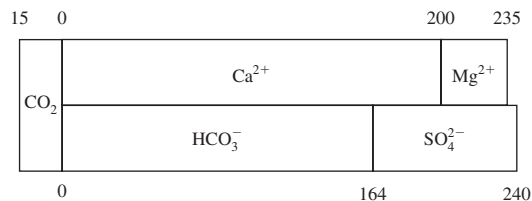

- b. Because Mg²⁺ is less than 40 mg/L as CaCO₃, removal of magnesium is unnecessary. The chemical additions are as follows:

Addition equal to:	Lime, mg/L as CaCO ₃	Lime, meq/L
CO ₂	15.0	0.30
HCO ₃ ⁻	164.0	3.28
	179.0	3.58

- c. Using the rule of thumb for extra lime, with Mg²⁺ < 40 mg/L as CaCO₃, the extra lime dosage should be about 20 mg/L as CaCO₃. The total amount of lime to be added is

179.0 mg/L as CaCO_3 + 20 mg/L as CaCO_3 = 199 mg/L as CaCO_3 . Lime is purchased and stored as CaO . The amount of 90% pure lime as CaO is

$$(199 \text{ mg/L as CaCO}_3) \left(\frac{28 \text{ meq/mg}}{50 \text{ meq/mg}} \right) \left(\frac{1}{0.90} \right) = 123.8 \text{ or } 124 \text{ mg/L as CaO}$$

where the equivalent weight of CaO = 28 meq/mg and the equivalent weight of CaCO_3 = 50 meq/mg.

- d. The total hardness of the finished water (after recarbonation) is

$$\begin{aligned} \text{Ca}^{2+} &= \text{Initial } 200 \text{ mg/L as CaCO}_3 - 164 \text{ mg/L as CaCO}_3 \text{ removed} \\ &\quad \text{with bicarbonate} \\ &= 36 \text{ mg/L as CaCO}_3 \end{aligned}$$

$$\text{Mg}^{2+} = 35 \text{ mg/L as CaCO}_3$$

$$\text{Total hardness} = 36 + 35 = 71 \text{ mg/L as CaCO}_3$$

- e. The changes in the water composition as illustrated by the changes in the bar chart are shown below.

Bar chart after removal of CO_2 (in mg/L as CaCO_3).

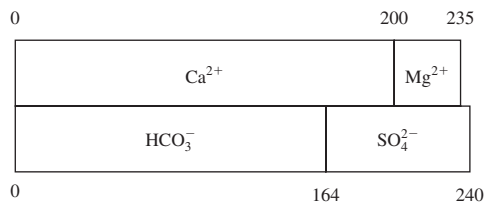

Bar chart of the finished water (in mg/L as CaCO_3).

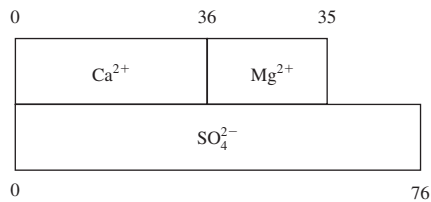

Comments:

1. Lime neutralization is used because the CO_2 is less than 10 mg/L as CO_2 .
 2. The finished water is quite soft and consideration should be given to splitting the flow to bypass some of the raw water to blend to a higher residual hardness. This would save capital costs by using smaller tanks and operating costs by reducing chemical usage as well as the amount of sludge that has to be disposed.
-

Softening to Practical Limits

Magnesium is more expensive to remove than calcium, so as much Mg^{2+} is left in the water as possible. It is more expensive to remove noncarbonate hardness than carbonate hardness because soda ash must be added to provide the CO_3^{2-} . Therefore, as much noncarbonate hardness is left in the water as possible. One way to achieve these objectives is to treat a portion of the water to the practical limits and then blend the treated water with the raw water to achieve the desired hardness. This form of split treatment does not control the final Mg^{2+} hardness.

Stoichiometric amounts of lime and soda are added to remove all of the Ca^{2+} and Mg^{2+} to the practical limits of softening, that is 0.60 meq/L or 30 mg/L as CaCO_3 of Ca^{2+} and 0.20 meq/L or 10mg/L as CaCO_3 of Mg^{2+} . Example 7-5 illustrates the technique using both mg/L as CaCO_3 and milliequivalents/L as units of measure.

Example 7-5. Prepare a bar chart for Mineral Wells water analysis given below and determine the chemical dosages to soften the water to the practical solubility limits. Assume that the lime and soda are 100% pure.

Mineral Wells water analysis^a

Constituent	mg/L
CO_2	9.6
Ca^{2+}	95.2
Mg^{2+}	13.5
Na^+	25.8
Alkalinity ^b	198
Cl^-	67.8
SO_4^{2-}	73

^aAssume that other ions in the water account for the lack of an ion balance.

^bmg/L as CaCO_3

Solution:

- a. Begin by converting all the concentrations to CaCO_3 equivalents and meq.

Constituent	mg/L	EW	EW CaCO_3 /EW ion	mg/L as CaCO_3	meq/L
CO_2	9.6	22.0	2.28	21.9	0.44
Ca^{2+}	95.2	20.0	2.50	238.0	4.76
Mg^{2+}	13.5	12.2	4.12	55.6	1.11
Na^+	25.8	23.0	2.18	56.2	1.12
Alkalinity				198	3.96
Cl^-	67.8	35.5	1.41	95.6	1.91
SO_4^{2-}	73	48.0	1.04	76	1.52

- b. Bar chart of raw water in mg/L as CaCO_3 .

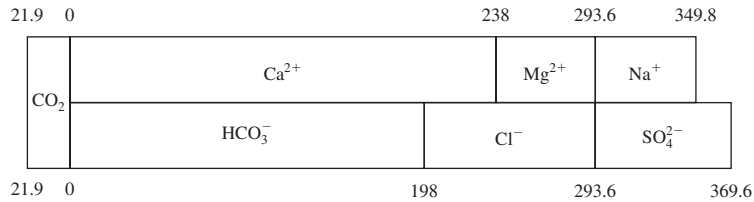

This is similar to the case shown in Figure 7-8a.

Solution:

- a. To soften to the practical solubility limits, lime and soda must be added as shown below.

Addition equal to:	Lime, mg/L as CaCO ₃	Lime, meq/L	Soda, mg/L as CaCO ₃	Soda, meq/L
CO ₂	21.9	0.44		
HCO ₃ ⁻	198.0	3.96		
Ca ²⁺ minus HCO ₃ ⁻			40	0.80
Mg ²⁺	55.6	1.11	55.6	1.11
Total	275.5	5.51	95.6	1.91

Because the difference $Mg^{2+} - 40 = 15.6$ mg/L as CaCO₃, the minimum excess lime of 20 mg/L as CaCO₃ is selected. The total lime addition is 295.5 mg/L as CaCO₃ or 165.5 mg/L as CaO. The soda addition is 95.6 mg/L as CaCO₃ or

$$95.6 \text{ mg/L as CaCO}_3 \left(\frac{53}{50} \right) = 101.3 \text{ or } 100 \text{ mg/L as Na}_2\text{CO}_3$$

Note that (53/50) is the equivalent weight of Na₂CO₃/equivalent weight of CaCO₃.

- b. The total hardness of the finished water is the sum of the practical solubility limits for calcium and magnesium, that is 30 mg/L as CaCO₃ + 10 mg/L as CaCO₃ = 40 mg/L as CaCO₃.
- c. The step-wise changes in the bar chart for each of the chemical additions is shown below.

Bar chart after removal of CO₂ (in mg/L as CaCO₃).

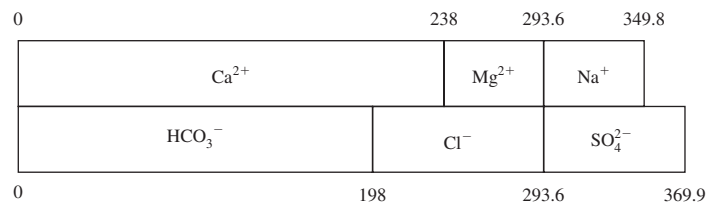

Bar chart after reaction with HCO_3^- (in mg/L as CaCO_3).

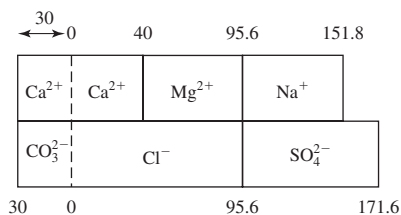

Bar chart after reaction of calcium with soda (in mg/L as CaCO_3).

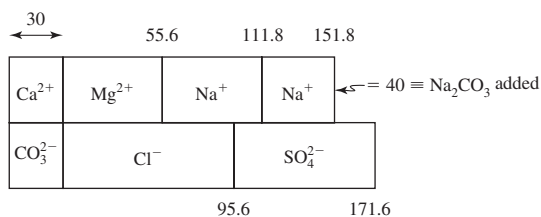

Bar chart after reaction of magnesium with lime and soda to yield the finished water (in mg/L as CaCO_3).

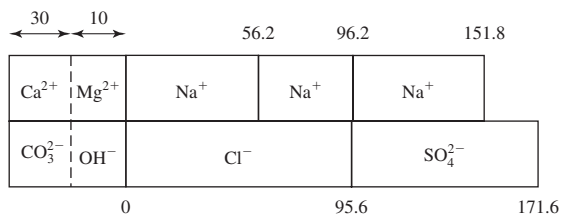

Comment: Lime neutralization of CO_2 is used because the CO_2 is less than 10 mg/L.

Split Treatment

When the magnesium concentration is greater than 40 mg/L as CaCO_3 , the flow is split to achieve a magnesium hardness of 40 mg/L as CaCO_3 as noted above. The portion of the flow that is treated is dosed to achieve the practical solubility limits for calcium and magnesium. The alternative dosing schemes are dependent on the amount of carbonate alkalinity as shown in Figure 7-8. In each instance CO_2 removal is shown by lime neutralization. This assumes that this is the economic alternative.

If the total hardness after blending is above the desired final hardness, then further softening in a second stage is required (Figure 7-10). Because the split is designed to achieve a desired Mg^{2+} of 40 mg/L as CaCO_3 , no further Mg^{2+} removal is required. Only treatment of Ca^{2+} is required. The dosing scheme for selective calcium removal is employed. Example 7-6 illustrates the dosing scheme.

Example 7-6. Prepare a bar chart for the Hard Times water analysis given below and determine the chemical dosages to soften the water to meet the following finished water criteria: maximum magnesium hardness of 40 mg/L as CaCO_3 and a total hardness in the range 80 to 120 mg/L as CaCO_3 .

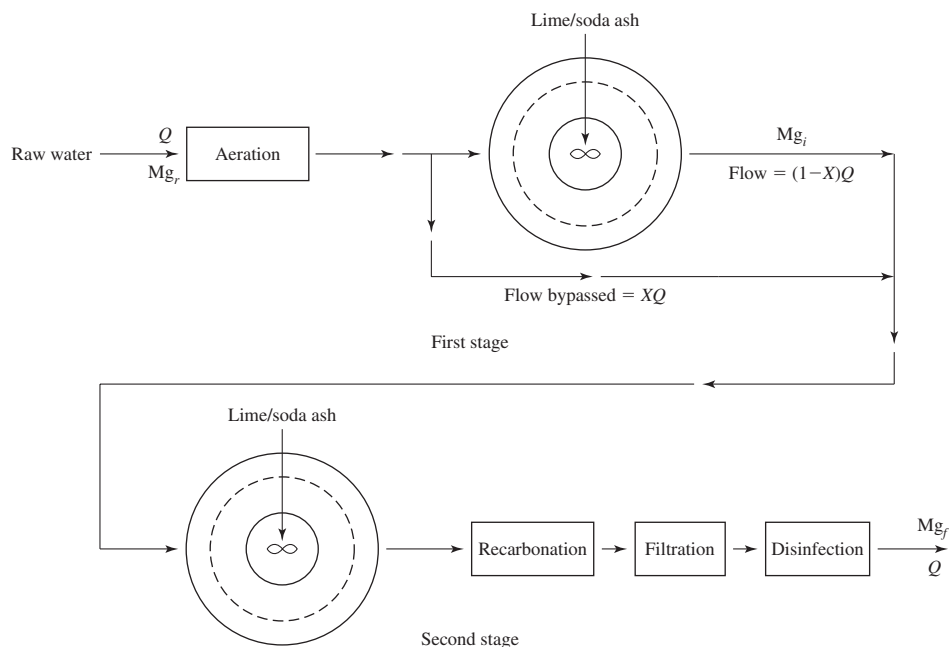

FIGURE 7-10
Flow diagram for a two stage split-treatment lime-soda ash softening plant.

Hard Times water analysis^a

Constituent	mg/L
CO ₂	5.5
Ca ²⁺	95.2
Mg ²⁺	22.0
Na ⁺	25.8
Alkalinity ^b	198
Cl ⁻	67.8
SO ₄ ²⁻	73

^aAssume that other ions in the water account for the lack of an ion balance.

^bmg/L as CaCO₃.

Solution:

- a. Begin by converting all the concentrations to CaCO₃ equivalents and meq.

Constituent	mg/L	EW	EW CaCO ₃ /EW ion	mg/L as CaCO ₃	meq/L
CO ₂	5.5	22.0	2.28	12.5	0.25
Ca ²⁺	95.2	20.0	2.50	238.0	4.76
Mg ²⁺	22.0	12.2	4.12	90.6	1.80
Na ⁺	25.8	23.0	2.18	56.2	1.12

continued

Constituent	mg/L	EW	EW CaCO ₃ /EW ion	mg/L as CaCO ₃	meq/L
Alkalinity				198.0	3.96
Cl ⁻	67.8	35.5	1.41	95.6	1.91
SO ₄ ²⁻	73	48.0	1.04	76	1.52

b. Bar chart of raw water in meq/L.

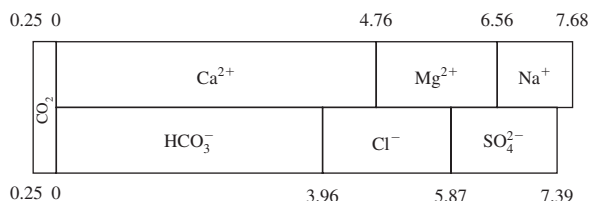

This is similar to the case shown in Figure 7-8a. Split treatment must be used to achieve a magnesium concentration goal of 40 mg/L as CaCO₃.

c. In the first stage the water is softened to the practical solubility limits; lime and soda must be added as shown below.

Addition equal to:	Lime, mg/L as CaCO ₃	Lime, meq/L	Soda, mg/L as CaCO ₃	Soda, meq/L
CO ₂	12.5	0.25		
HCO ₃ ⁻	198.0	3.96		
Ca ²⁺ minus HCO ₃ ⁻			40	0.80
Mg ²⁺	90.6	1.80	90.6	1.80
Total	301.1	6.01	130.6	2.60

d. The split is calculated in terms of mg/L as CaCO₃:

$$X = \frac{40 - 10}{90.6 - 10} = 0.372$$

The fraction of water passing through the first stage is then $1 - 0.372 = 0.628$.

e. The total hardness of the water after passing through the first stage is the sum of the practical solubility limits, that is, $30 + 10 = 40$ mg/L as CaCO₃. Because the total hardness in the raw water is $238 + 90.6 = 328.6$ mg/L as CaCO₃, the mixture of the treated and bypass water has a hardness of:

$$(0.372)(328.6 \text{ mg/L as CaCO}_3) + (0.628)(40 \text{ mg/L as CaCO}_3) = 147.4 \text{ mg/L as CaCO}_3$$

This is above the specified finished water criteria range of 80–120 mg/L as CaCO₃, so further treatment is required.

f. Because the split is designed to yield 40 mg/L as CaCO₃ of magnesium, no further magnesium is removed. To achieve the desired total hardness more calcium must be

removed. Removal of the calcium equivalent to the bicarbonate will leave 40 mg/L as CaCO_3 of calcium hardness plus the 40 mg/L as CaCO_3 of magnesium hardness for a total of 80 mg/L as CaCO_3 . The additions are as follows.

Constituent	Lime mg/L as CaCO_3	Lime meq/L
CO_2	12.5	0.25
HCO_3^-	198.0	3.96
	210.5	4.21

Addition of lime equal to CO_2 and HCO_3^- (even in the second stage) is necessary to achieve the control pH of 10.3.

- g. Excluding the extra lime to drive the reaction, the total chemical additions are in proportion to the flows:

$$\text{Lime} = 0.628(313.6) + 0.372(210.5) = 275.3 \text{ or } 275 \text{ mg/L as } \text{CaCO}_3$$

$$\text{Soda} = 0.628(130.6) + 0.372(0.0) = 82 \text{ mg/L as } \text{CaCO}_3$$

- h. Because the magnesium concentration is greater than 40 mg/L as CaCO_3 , the rule-of-thumb addition of extra lime to the first stage is 40 mg/L as CaCO_3 .

Comment. In this case the final hardness is at the low end of the acceptable range. Because the capital cost of installing a second stage is quite high, other alternative process schemes should be considered. For example, treating more water in the first stage would result in a total hardness in the acceptable range without the need for a second stage. The resulting water would have a magnesium concentration lower than the design goal of 40 mg/L as CaCO_3 . An economic analysis would have to be conducted because the capital cost would be less but the chemical and operating costs including sludge disposal might be higher.

Other Estimating Methods

The method of estimating dosages used here is a traditional technique that provides a direct link to the chemical reactions and, with the bar charts, provides a means of illustrating the chemical processes. An alternative to the stoichiometric approach is the solution of the simultaneous equilibria equations to estimate the dosage. A series of diagrams called the *Caldwell-Lawrence* diagrams have been developed to solve these equations graphically. Examples of their use may be found in AWWA (1978), Merrill (1978), Benefield et al. (1982), and Benefield and Morgan (1999).

The American Water Works Association has computer software for working with the *Caldwell-Lawrence* diagrams. It is called *The Rothberg, Tamburini, and Winsor Model for Corrosion Control and Process Chemistry*.

Use of Caustic Soda

Caustic soda (NaOH) is an alternative to the use of lime for softening. It has the advantages of decreased sludge production, reduction in dust generation, and the option of simpler storage and feed systems because it is purchased as a liquid. There are several disadvantages in using caustic

soda: the cost is four to six times higher than lime, the potential for hazardous chemical release is greater because it is a liquid, and freezing problems occur for 50 percent solutions at temperatures below 13°C (Kawamura, 2000). The choice of caustic over lime will fundamentally be driven by economic evaluation of the cost of caustic, the feed system, and sludge treatment and disposal.

The stoichiometric reactions may be derived by replacing Ca(OH)_2 with NaOH in Equations 7-12 through 7-15 and rebalancing the reactions. Because Ca^{2+} hardness is not substituted for Mg^{2+} , the reactions shown in Equations 7-16 and 7-18 are not required. The sodium carbonate formed in the reactions of caustic with carbonate hardness is available to precipitate calcium noncarbonate hardness.

7-5 CONCURRENT REMOVAL OF OTHER CONSTITUENTS

Arsenic

Arsenic removal ranging from 60 to 90 percent have been observed in softening plants that use excess lime for Mg^{2+} treatment. For single-stage softening plants that remove only Ca^{2+} , 0 to 40 percent removal has been observed (MWH, 2005). Removal effectiveness is highly dependent on the oxidation state of the arsenic. Arsenate (+5) is more readily removed than arsenite (+3). The major removal mechanism is by adsorption to the precipitate (MWH, 2005).

Iron and Manganese

The solubility diagrams shown in Figures 7-11 and 7-12 reveal that ferrous hydroxide [$\text{Fe(OH)}_2(\text{s})$] and manganese hydroxide [$\text{Mn(OH)}_2(\text{s})$] precipitate at high pH. Softening processes that achieve a pH greater than 9.6 remove 100 percent of the iron. Manganese is more difficult to remove. The pH must be greater than 9.8 to remove 100 percent of the manganese (Kawamura, 2000). Because the desired control pH for softening processes is 10.3 or greater, iron and manganese are effectively removed concurrently. The extra mass of lime added in the softening process is sufficiently great to provide an excess over the stoichiometric requirements to remove the iron and manganese.

Natural Organic Matter (NOM)

The concurrent removal of NOM in the softening process is of importance in preventing the formation of trihalomethanes (THM) and haloacetic acids (HAA5) when chlorine is used as a disinfectant. The effectiveness of lime-soda softening in reducing NOM is different for each water source. However, some generalizations may be made (Benfield and Morgan, 1999):

- Calcium carbonate precipitation generally removes from 10 to 30 percent of the color, total organic carbon, and disinfection byproduct precursors.
- Magnesium hydroxide precipitation generally removes from 30 to 60 percent of the total organic carbon and disinfection byproduct precursors, and 50 to 80 percent of the color.
- Addition of iron in the form of ferric sulfate generally removes an additional 5 to 15 percent of the color, total organic carbon, and disinfection byproduct precursors in either calcium or magnesium precipitation.

Alum hydroxide is an amphoteric hydroxide. That is, it is soluble at both low and high pH. Thus, at pH values normally encountered in lime-soda softening it is dissolved and is not effective in enhancing the removal of NOM.

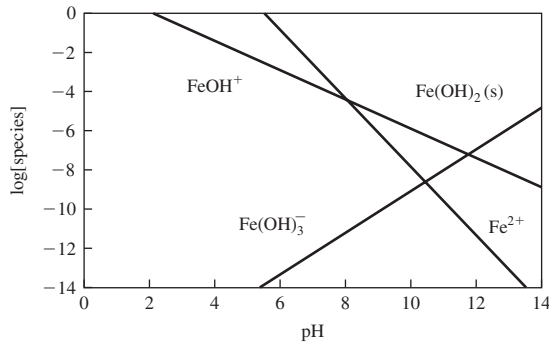

FIGURE 7-11
Solubility diagram for $\text{Fe}(\text{OH})_2$.

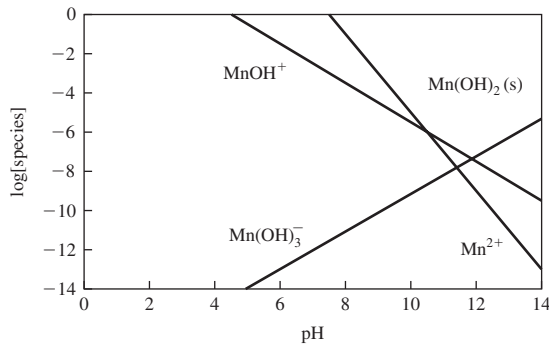

FIGURE 7-12
Solubility diagram for $\text{Mn}(\text{OH})_2$.

Turbidity

Although it is generally not of concern for groundwater sources, turbidity removal is a major objective in treating surface water. In those cases where the surface water is hard, softening by chemical precipitation will concurrently remove turbidity by sweep coagulation.

Other Contaminants

Sorg et al. (1977) identified a number of other contaminants that are removed concurrently by lime-soda softening or coagulation. These are listed in Table 7-3.

7-6 PROCESS CONFIGURATIONS AND DESIGN CRITERIA

The process flow diagrams for three common softening treatment schemes are shown in Figure 7-13 on page 7-29. Many other variations are possible including, for example, the use of blended raw water CO_2 to recarbonate and the use of coagulation and flocculation after the precipitation process to reduce the solids load to the filters. In the case of coagulation/flocculation, the high pH of the water coming from the precipitation process favors the use of ferric chloride as the coagulant because it is less soluble at higher pH than alum (see, for example, Figure 6-9).

TABLE 7-3
Effectiveness of lime softening and coagulation in removing inorganic contaminants

Contaminant	Method	Removal, %
Arsenic		
As ³⁺	Oxidation to As ⁵⁺ required	>90
As ⁵⁺	Ferric sulfate coagulation, pH 6–8	>90
	Alum coagulation, pH 6–7	>90
	Lime softening, pH 11	>90
Barium	Lime softening, pH 10–11	>90
Cadmium ^a	Ferric sulfate coagulation, pH > 8	>90
	Lime softening, pH > 8.5	>95
Chromium ^a		
Cr ³⁺	Ferric sulfate coagulation, pH 6–9	>95
	Alum coagulation, pH 7–9	>90
	Lime softening, pH > 10	>95
Cr ⁶⁺	Ferrous sulfate coagulation, pH 6.5–9 (pH may have to be adjusted after coagulation to allow reduction to Cr ³⁺)	>95
Fluoride	Lime-soda softening, pH 11–12	>55
Lead ^a	Ferric sulfate coagulation, pH 6–9	>95
	Alum coagulation, pH 6–9	>95
	Lime softening, pH 7–8.5	>95
Mercury ^a	Ferric sulfate coagulation, pH 7–8	>60
Selenium ^a (Se ⁴⁺)	Ferric sulfate coagulation, pH 6–7	70–80
Silver ^a	Ferric sulfate coagulation, pH 7–9	70–80
	Alum coagulation, pH 6–8	70–80
	Lime softening, pH 7–9	70–80

^aNo full scale evidence.

(Source: Benefield et al., 1982; Sorg et al., 1977)

Conventional Softening Basins

These basins are similar to conventional basins used for coagulation and flocculation. Rapid mixing either with paddle mixers or vertical turbines is followed with paddle mixers or vertical turbines for the reaction basin (also called the flocculation basin because of its analogy to the coagulation/flocculation process). When conventional basins are used, a portion of the precipitate is recycled to the head end of the process. Recycling accelerates the precipitation reactions, and the process more closely approaches true solubility limits when mixed with the previously formed precipitate crystals (Horsley et al., 2005).

Because they are similar to coagulation/flocculation systems, the design criteria are specified in a similar fashion. Flash mixing is generally provided by radial flow impellers though older plants may be using paddle wheels. The flash mixing velocity gradient (G) should be in the range 300 to 700 s⁻¹ and the minimum mixing time should be 10 to 30 s. With cold water found in most groundwater, rapid mixing for as long as 5 to 10 minutes may be required for dissolution

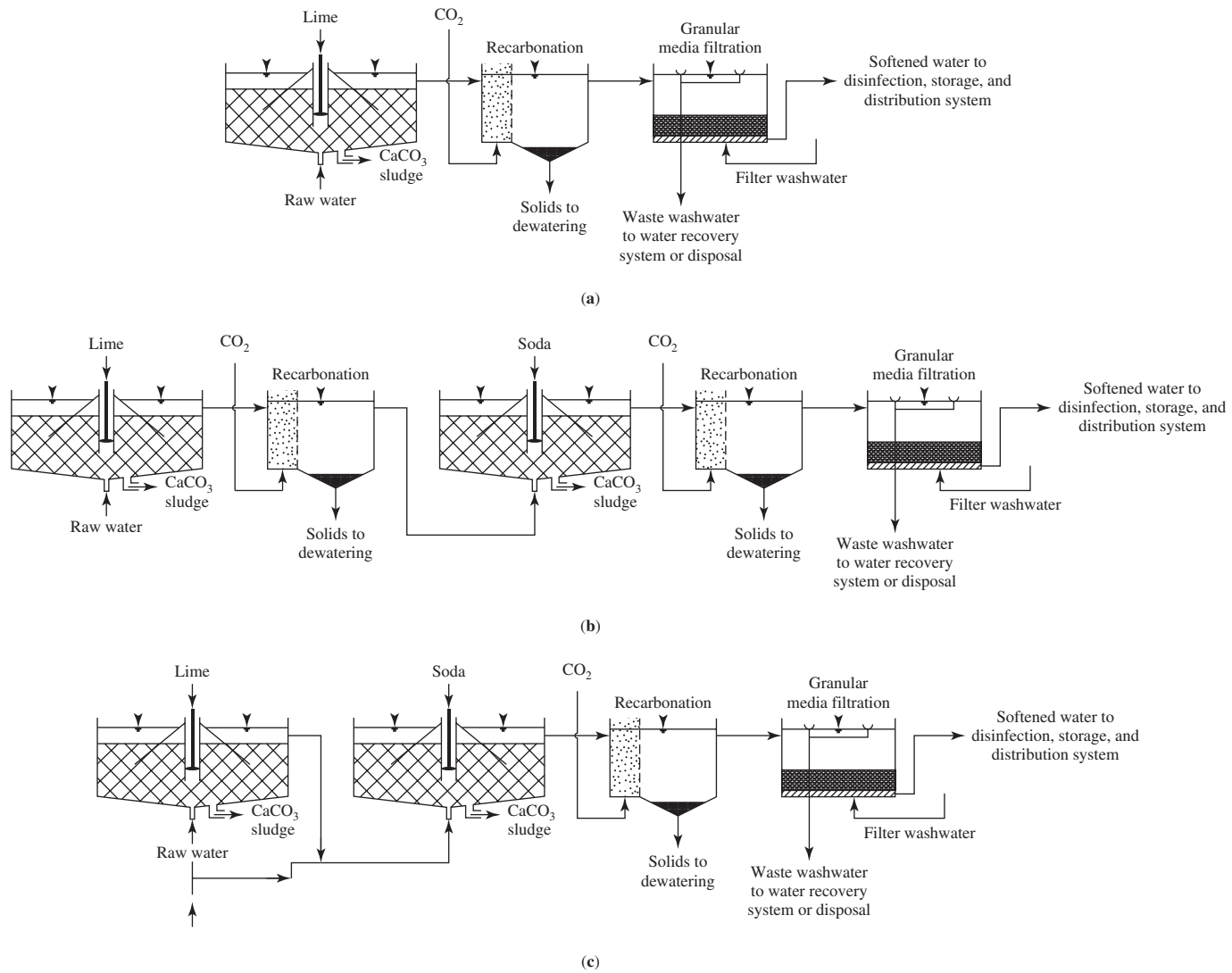

FIGURE 7-13

Process flow diagrams of common softening treatment techniques: (a) single-stage lime treatment; (b) two-stage excess lime-soda treatment; (c) split-flow lime treatment.

of the lime slurry. Flocculation mixing is provided by axial flow impellers or paddle wheels. The flocculation mixing velocity gradient is between 130 and 300 s^{-1} with a mixing time of 30 to 45 minutes, to achieve Gt values ranging from 200,000 to 400,000. The velocity through ports in the flocculation basin is in the range 0.15 to 0.36 m/s (Davis and Cornwell, 2008; Horsley et al., 2005; Kawamura, 2000).

The design process follows that shown in the Chapter 6 examples for vertical turbine and paddle mixers.

Upflow Solids Contact Basins

Conventional softening basins are mostly found at older facilities. They provide a high degree of process stability, but the size and number of basins result in a high capital cost. Since the late 1960s most new plants have been built with upflow solids contact basins as shown in Figure 7-14.

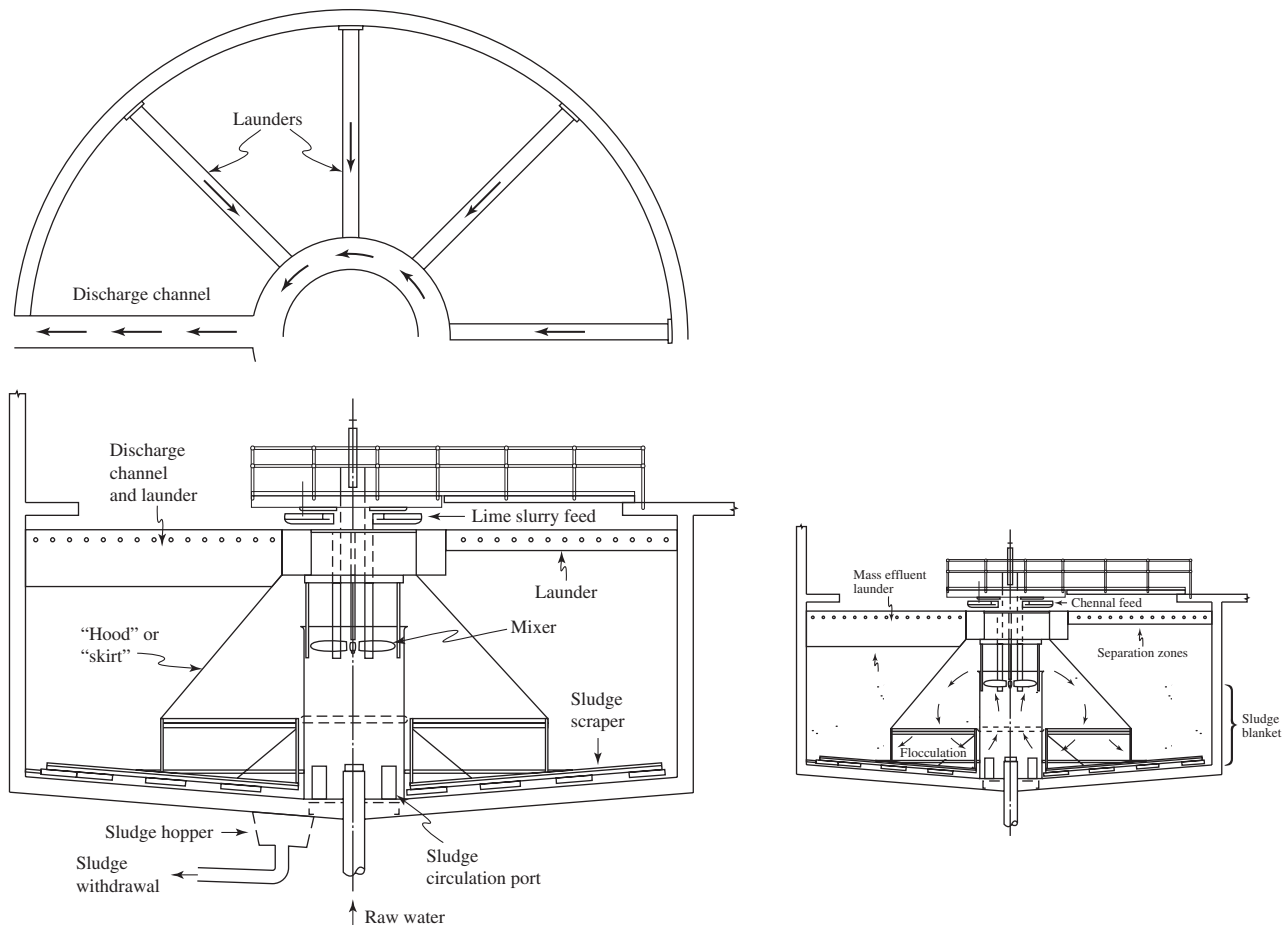

FIGURE 7-14
Upflow solids contact basin.

Although rapid mixing may be provided ahead of the solids contact unit, generally the softening chemicals are applied to the mixing zone of the contact unit. The mixing and recirculation zone is separated from the sedimentation zone by a conical baffle identified as the “hood” in Figure 7-14.

Effective solids contact units draw the settled precipitate from near the floor at the center of the basin with a large diameter turbine or impeller and recirculate it with the incoming water. When multiple units are used, the precipitate may be recirculated from one unit to another.

Because the units are sold as proprietary manufactured items, the designs are established by the manufacturer. Whenever possible, design requirements should be based on successful plants using the same or similar source water. The following information from Horsley et al. (2005) is provided for guidance in evaluating proprietary designs:

- The maximum recirculation rate is typically 10:1 based on the incoming raw water flow rate. The mixer is provided with a variable-speed drive to allow the operator to adjust the recirculation rate.
- The side water depth of the tank generally varies from 4.3 to 5.5 m. Contact time in the mixing zone is typically measured by the volume of water within and directly under the baffle cone.
- Overflow rate (that is, flow rate divided by the surface area, Q/A_s) is generally measured 0.6 m below the water surface, based on the surface area between the baffle wall and the basin wall.

GLUMRB (2003) recommends the following design criteria:

1. Flocculation and mixing period should not be less than 30 minutes.
2. Detention time should be two to four hours for solids contact clarifiers and softeners treating surface water.
3. Detention time should be one to two hours for solids contact clarifiers treating only groundwater.
4. Upflow rate (overflow rate) shall not exceed 2.4 cubic meters of flow per square meter of surface area per hour ($\text{m}^3/\text{h} \cdot \text{m}^2$ or m/h) at the slurry separation line for units used for clarifiers.
5. Upflow rate (overflow rate) shall not exceed $4.2 \text{ m}^3/\text{h} \cdot \text{m}^2$ or m/h at the slurry separation line for units used for softeners.
6. Weir loading shall not exceed $0.120 \text{ m}^3/\text{min} \cdot \text{m}$ of weir length for units used as clarifiers.
7. Weir loading shall not exceed $0.240 \text{ m}^3/\text{min} \cdot \text{m}$ of weir length for units used as softeners.

Table 7-4 provides information similar to that provided by manufacturers for selection of an upflow solids contact unit.

TABLE 7-4
Representative dimensions for upflow solids contact basin

Nominal diameter, m	Nominal SWD, ^a m	Nominal volume, m ³	Cone dimensions, m			Separation zone area, m ²	Column diameter, m	Motor power, kW	Number of weirs
			h	r ₁	r ₂				
6	3.7	109	2.5	3.8	1.2	25	0.6	0.5	8
9	4.3	288	3.1	5.3	1.5	60	1	1.5	8
12	4.8	580	3.6	6.5	2	100	1.3	2	8
15	5.3	970	4.1	7.5	2.7	160	1.7	3.5	8
18	5.5	1500	4.3	8.5	3.3	230	2	5.5	10
21	5.6	2140	4.4	9.5	4.2	300	2.3	7.5	10
24	5.8	2850	4.6	10	5	390	2.6	10	10
27	5.9	3730	4.7	10.5	6	480	3	15	10
30	6	4760	4.8	11.5	6.8	590	3.2	15	11

^aSWD = side water depth. This depth is measured at the wall of the basin.

Weirs extend radially from the column to wall of the basin. Both sides are used in evaluating weir length.

Note: These basins are representative but do not represent actual choices. Actual manufacturer's data must be used for real-world design.

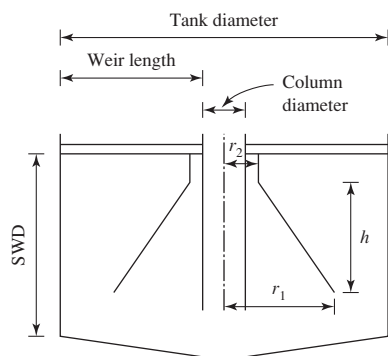

Example 7-7. Select and evaluate an upflow solids contact unit for the Sweetwater softening plant. The design flow rate is 7,400 m³/d. The data in Table 7-4 have been provided by the manufacturer. The tank is provided with eight radial weirs that are equal to the radius of the tank minus the radius of the top of the truncated cone (r_2).

Solution:

- a. Make a trial selection of the 12 m diameter tank and check the overflow rate using the separation zone area.

$$v = \frac{Q}{A_s} = \frac{7,400 \text{ m}^3/\text{d}}{100 \text{ m}^2} = 74 \text{ m/d or } 3.08 \text{ m/h}$$

The GLUMRB design guidance is less than 4.2 m/h. Therefore, the unit is acceptable for overflow rate.

- b. Next check the detention time for softening using the volume of the basin.

$$t = \frac{V}{Q} = \frac{580 \text{ m}^3}{7,400 \text{ m}^3/\text{d}} = 0.078 \text{ d or } 1.88 \text{ h}$$

The GLUMRB design guidance is one to two hours. Therefore, the unit is acceptable for detention time.

- c. The unit is next checked for mixing time by calculating the volume of the truncated cone and calculating the detention time in the cone. The volume of a truncated cone is

$$V = \frac{\pi h}{3} [(r_1)^2 + (r_1 r_2) + (r_2)^2]$$

where h = height of the truncated cone
 r_1 = radius at bottom of cone
 r_2 = radius at top of cone

For the trial tank the values of h , r_1 , and r_2 are taken from Table 7-4.

$$\begin{aligned} V &= \frac{\pi(3.6 \text{ m})}{3} [(6.5)^2 + (6.5 \text{ m})(2 \text{ m}) + (2 \text{ m})^2] \\ &= 223.4 \text{ m}^3 \end{aligned}$$

The mixing time in the cone is

$$t = \frac{223.4 \text{ m}^3}{7,400 \text{ m}^3/\text{d}} = 0.030 \text{ d or } 43.46 \text{ min}$$

The GLUMRB design guidance is a minimum of 30 minutes. Therefore, the unit is acceptable for mixing time.

- d. The weir length is checked by computing the length of the weir taking into account that there are eight weirs and that water enters both sides of each weir.

$$\begin{aligned} L &= (8 \text{ weirs})(2 \text{ sides/weir}) \left(\frac{12 \text{ m diameter} - 1.3 \text{ m diameter column}}{2} \right) \\ &= 85.6 \text{ m} \end{aligned}$$

With a flow rate of $7,400 \text{ m}^3/\text{d}$, the weir hydraulic loading rate is

$$WL = \frac{7,400 \text{ m}^3/\text{d}}{85.6 \text{ m}} = 86.45 \text{ m}^3/\text{d} \cdot \text{m} \text{ or } 0.060 \text{ m}^3/\text{min} \cdot \text{m}$$

The GLUMRB design guidance is a maximum of $0.240 \text{ m}^3/\text{min} \cdot \text{m}$ of weir length. Therefore the unit is acceptable for weir loading.

Because the trial unit meets all the criteria, it may be considered in the design evaluation.

Comment. If the trial selection did not meet the criteria, then iterative trials would be evaluated to see if any of this manufacturer's units is acceptable for the design.

7-7 OPERATION AND MAINTENANCE

The most important operation and maintenance task in softening is the selection of the appropriate chemicals and adjustment of the dose to changing raw water quality and plant flow. Monitoring of the chemical feed system to detect clogging of the lines and maintenance of the mixers ranks second in the need for close O&M oversight. Encrustation is a significant problem. Annual removal of calcium carbonate build-up during seasonal low-demand periods is customary.

Hints from the Field. Experience suggests the following:

- Open flumes are preferred over pipelines.
- Design of pipelines and flumes should include additional capacity for encrustation.
- Sludge scraper mechanisms should be kept in operation during low-flow periods when portions of the plant are off-line but are not to be drained. This prevents the sludge blanket from settling and “freezing” the scraper so that it cannot start moving again because the settled sludge is too dense for the torque that can be applied.
- Sludge withdrawal (called *blowdown*) **must** occur regularly to keep the draft tube in an upflow clarifier open so that recirculation occurs in the mixing portion of the clarifier.

7-8 STABILIZATION

A stable water is one that exhibits neither scale forming nor corrosion properties. In the water industry, a stable water is considered to be one that will neither dissolve nor deposit calcium. The original objective of water stabilization was to adjust the pH of the treated water to prevent corrosion of the water distribution system pipes by depositing a thin film of calcium carbonate as a protective coating. Numerous investigations have revealed that although the *Langelier index* (a method of calculating stability) is a reasonable predictor of the potential for CaCO_3 to precipitate or dissolve, it does not predict how much $\text{CaCO}_3(\text{s})$ will precipitate or whether its structure will provide resistance to corrosion (Schock, 1999).

Although its validity as a method of corrosion protection is limited, the Langelier index is still useful in predicting the potential for CaCO_3 to precipitate or dissolve. This is particularly valuable in designing the processes to reduce precipitation of CaCO_3 in the rapid sand filters and pipe network as well as those processes used to reduce the corrosivity of reverse osmosis/nanofiltration (RO/NF) treated water.

The Langelier Saturation Index (LSI)

Langelier (1936) developed the following relationship to predict whether or not a given water will deposit or dissolve CaCO_3 :

$$\text{LSI} = \text{pH} - \text{pH}_s \quad (7-35)$$

where pH is in the actual hydrogen ion concentration and pH_s is the pH at saturation. pH_s is further defined as

$$pH_s = pCa^{2+} + pAlk + C \quad (7-36)$$

where pCa^{2+} = negative logarithm of the calcium ion concentration, moles/L

$pAlk$ = negative logarithm of the total alkalinity, equiv/L

C = an empirical constant to correct for ionic strength and the temperature dependence of the solubility of $CaCO_3(s)$

The value of the constant for various ionic strengths (or total dissolved solids (TDS) concentrations) and temperatures is given in Table 7-5.

The state of saturation with respect to $CaCO_3$ depends on the LSI:

- If the LSI < 0, then the solution is undersaturated and $CaCO_3$ will dissolve.
- If the LSI = 0, the solution is at equilibrium.
- If the LSI > 0, then the solution is supersaturated and $CaCO_3$ will precipitate.

TABLE 7-5
Values of C for various ionic strengths and temperatures

		C									
Ionic strength	Total dissolved solids, mg/L	0°C	10°C	20°C	30°C	40°C	50°C	60°C	70°C	80°C	90°C
0.000		2.45	2.23	2.02	1.86	1.68	1.52	1.36	1.23	1.08	0.95
0.001	40	2.58	2.36	2.15	1.99	1.81	1.65	1.49	1.36	1.21	1.08
0.002	80	2.62	2.40	2.19	2.03	1.85	1.69	1.53	1.40	1.25	1.12
0.003	120	2.66	2.44	2.23	2.07	1.89	1.73	1.57	1.44	1.29	1.16
0.004	160	2.68	2.46	2.25	2.09	1.91	1.75	1.59	1.46	1.31	1.18
0.005	200	2.71	2.49	2.28	2.12	1.94	1.78	1.62	1.49	1.34	1.21
0.006	240	2.74	2.52	2.31	2.15	1.97	1.81	1.65	1.52	1.37	1.24
0.007	280	2.76	2.54	2.33	2.17	1.99	1.83	1.67	1.54	1.39	1.26
0.008	320	2.78	2.56	2.35	2.19	2.01	1.85	1.69	1.56	1.41	1.28
0.009	360	2.79	2.57	2.36	2.20	2.02	1.86	1.70	1.57	1.42	1.29
0.010	400	2.81	2.59	2.38	2.22	2.04	1.88	1.72	1.59	1.44	1.31
0.011	440	2.83	2.61	2.40	2.24	2.06	1.90	1.74	1.61	1.46	1.33
0.012	480	2.84	2.62	2.41	2.25	2.07	1.91	1.75	1.62	1.47	1.34
0.013	520	2.86	2.64	2.43	2.27	2.09	1.93	1.77	1.64	1.49	1.36
0.014	560	2.87	2.65	2.44	2.28	2.10	1.94	1.78	1.65	1.50	1.37
0.015	600	2.88	2.66	2.45	2.29	2.11	1.95	1.79	1.66	1.51	1.38
0.016	640	2.90	2.68	2.47	2.31	2.13	1.97	1.81	1.68	1.53	1.40
0.017	680	2.91	2.69	2.48	2.32	2.14	1.98	1.82	1.69	1.54	1.41
0.018	720	2.92	2.70	2.49	2.33	2.15	1.99	1.83	1.70	1.55	1.42
0.019	760	2.92	2.70	2.49	2.33	2.15	1.99	1.83	1.70	1.55	1.42
0.020	800	2.93	2.71	2.50	2.34	2.16	2.00	1.84	1.71	1.56	1.43

Source: T. E. Larson and A. M. Buswell, "Calcium Carbonate Saturation Index and Alkalinity Interpretations," *J. Am. Water Works Assoc.* 34 (1942): 1667. Copyright 1942 by the American Water Works Association, Inc.

Many modifications have been made to the basic equation to account for other alkalinity-contributing species, activity coefficients, and so forth. These are discussed in detail in Schock (1999). The basic equation will be used for the purpose of illustration of its use in design.

Stabilization Design for Lime-Soda Softened Water

As noted earlier in this chapter, recarbonation is the last step in the softening process. The purpose of the recarbonation step is to “stop” the precipitation reaction by lowering the pH. Carbon dioxide addition has been the method of choice for lowering the pH. Other chemicals may be used (for example, H_2SO_4) based on economic and operational considerations. Furthermore, split treatment of groundwater may bring sufficient CO_2 in the bypassed water to lower the pH without the addition of purchased chemicals.

The objective in stabilization is to achieve an LSI = 0. The reactions are given in Equations 7-27, 7-28, 7-29 and 7-30. The equilibrium equations for carbonic acid (7-31 and 7-32) are used to estimate the concentration of CO_2 that must be added. The estimation of the CO_2 dose is illustrated in the following example.

Example 7-8. Estimate the dose of CO_2 in mg/L to stabilize the water from split treatment softening. The bypass water has 1.37 meq/L of CO_2 . The estimated constituents and parameters of interest in the blended water are listed in the table below.

Constituent or parameter	Concentration, meq/L as $CaCO_3$ or units as shown
Ca^{2+}	1.38
Mg^{2+}	0.80
CO_3^{2-}	0.50
HCO_3^-	1.20
pH	9.95 units
TDS	320 mg/L
Temperature	10°C

Solution:

- a. Calculate the LSI.

Converting Ca^{2+} meq/L to moles /L,

$$\frac{(1.38 \text{ meq/L})(20 \text{ mg/meq})}{40,000 \text{ mg/mole}} = 6.90 \times 10^{-4} \text{ moles/L,}$$

where 20 mg/meq is the equivalent weight of Ca^{2+}

$$pCa = -\log (6.90 \times 10^{-4} \text{ moles/L}) = 3.16$$

The alkalinity is the sum of CO_3^{2-} and HCO_3^- . The units are given in meq/L. They must be in equiv/L

$$pAlk = -\log (0.50 \times 10^{-3} + 1.20 \times 10^{-3}) = 2.77$$

From Table 7-5 at a temperature of 10°C and a TDS of 320 mg/L, the correction factor is 2.56 and the LSI is

$$\text{LSI} = \text{pH} - \text{pH}_s = 9.95 - (3.16 + 2.77 + 2.56) = 9.95 - 8.49 = 1.46$$

As expected, this water is unstable and CaCO_3 will precipitate.

- b. To achieve stability, the pH must be lowered to pH_s . Using the second dissociation of carbonic acid (Equation 7-32), solve for the ratio $[\text{CO}_3^{2-}]/[\text{HCO}_3^-]$ with $[\text{H}^+] = \text{pH}_s$ in moles/L:

$$K_{a2} = \frac{[\text{H}^+][\text{CO}_3^{2-}]}{[\text{HCO}_3^-]}$$

$$\frac{[\text{CO}_3^{2-}]}{[\text{HCO}_3^-]} = \frac{K_{a2}}{[\text{H}^+]}$$

Correcting K_{a2} for temperature using Equation 7-34,

$$K_{a2} = 10^{6.498 - 2909.39/T - 0.02379T}$$

$$K_{a2} = 10^{6.498 - 2909.39/283 - 0.02379(283)}$$

$$= 3.05 \times 10^{-11}$$

$$\frac{[\text{CO}_3^{2-}]}{[\text{HCO}_3^-]} = \frac{3.05 \times 10^{-11}}{10^{-8.49}} = 0.0094$$

and

$$[\text{CO}_3^{2-}] = 0.0094 [\text{HCO}_3^-]$$

The total alkalinity will not change. Only the form of alkalinity will change. The total alkalinity is 0.50×10^{-3} equiv/L of CO_3^{2-} + 1.20×10^{-3} equiv/L of HCO_3^- . In moles/L these are

$$\frac{(0.50 \times 10^{-3} \text{ equiv/L of } \text{CO}_3^{2-})(30 \text{ g/equiv})}{60 \text{ g/mole}} = 2.50 \times 10^{-4} \text{ moles/L}$$

$$\frac{1.20 \times 10^{-3} \text{ equiv/L of } \text{HCO}_3^-)(61 \text{ g/equiv})}{61 \text{ g/mole}} = 1.20 \times 10^{-3} \text{ moles/L}$$

Thus

$$[\text{CO}_3^{2-}] + [\text{HCO}_3^-] = 2.50 \times 10^{-4} \text{ moles/L} + 1.20 \times 10^{-3} \text{ moles/L}$$

$$= 1.45 \times 10^{-3} \text{ moles/L}$$

This provides two simultaneous equations. Solving for $[\text{HCO}_3^-]$,

$$0.0094 [\text{HCO}_3^-] + [\text{HCO}_3^-] = 1.45 \times 10^{-3} \text{ moles/L}$$

and

$$[\text{HCO}_3^-] = \frac{1.45 \times 10^{-3} \text{ moles/L}}{1.0094} = 1.44 \times 10^{-3} \text{ moles/L}$$

and

$$[\text{CO}_3^{2-}] = 0.0094 (1.44 \times 10^{-3} \text{ moles/L}) = 1.35 \times 10^{-5} \text{ moles/L}$$

c. The dose of CO_2 is estimated assuming that $\text{CO}_2 = \text{H}_2\text{CO}_3$. The reaction is



Because one mole of CO_2 produces two moles of HCO_3^- , the dose of CO_2 to convert carbonate to bicarbonate is

$$\left(\frac{1.35 \times 10^{-5} \text{ moles/L}}{2} \right) (44 \times 10^3 \text{ mg/mole}) = 0.30 \text{ mg/L of CO}_2$$

The total concentration of bicarbonate after the conversion is

$$1.35 \times 10^{-5} \text{ moles/L} + 1.44 \times 10^{-3} \text{ moles/L} = 1.45 \times 10^{-3} \text{ moles/L}$$

Comments:

1. The small addition of CO_2 is the result of blending the raw water with the treated water. The raw water CO_2 converted the hydroxyl ion to carbonate. Otherwise, the high pH required to remove the magnesium (>11.3) would have resulted in a higher CO_2 requirement.
2. The fact that the water is “stable” does not mean that it is noncorrosive.
3. To estimate the concentrations from split treatment, assume $\text{Ca}^{2+} = 30 \text{ mg/L}$ as CaCO_3 and $\text{Mg}^{2+} = 10 \text{ mg/L}$ as CaCO_3 in the discharge from first stage of softening because the water has been softened to the practical solubility limits. Associated with this assumption are the related quantities of CO_2 and OH^- , that is $\text{CO}_2 = 30 \text{ mg/L}$ as CaCO_3 and $\text{OH}^- = 10 \text{ mg/L}$ as CaCO_3 .

The recarbonation basin should provide (GLUMRB, 2003):

- A detention time of 20 minutes.
- Two compartments with a diffuser depth not less than 2.5 m.
- One compartment (the mixing compartment) should have a detention time ≥ 3 minutes.

The practice of on-site generation of CO_2 is discouraged. Bulk pressurized or liquified CO_2 is commonly available and often used because it eliminates operation and maintenance problems associated with on-site generation by combustion.

Approximately 50 to 75 percent of the applied CO_2 goes into solution. The room housing the recarbonation basin must be ventilated to prevent the accumulation of the 25 to 50 percent of the

CO₂ that is not dissolved. Exposure to a 5 percent CO₂ concentration over a prolonged period may cause unconsciousness.

Visit the text website at www.mhprofessional.com/wwe for supplementary materials and a gallery of photos.

7-9 CHAPTER REVIEW

When you have completed studying this chapter, you should be able to do the following without the aid of your textbooks or notes:

1. Define hardness in terms of the chemical constituents that cause it and in terms of the results as seen by the users of hard water.
2. Using diagrams and chemical reactions, explain how water becomes hard.
3. Given the total hardness and alkalinity, calculate the carbonate hardness and noncarbonate hardness.
4. Explain the significance of alkalinity in lime-soda softening.
5. State the proper pH for removal of Ca²⁺ and Mg²⁺ and explain how the reactions “ensure” the proper pH.
6. Explain why the solubility relationships do not fully explain the pH required to achieve satisfactory precipitation of Ca²⁺ and Mg²⁺.
7. Explain to a client why lime-soda softening cannot produce a water completely free of hardness.
8. Explain to a client why a magnesium concentration of 40 mg/L as CaCO₃ is a design objective for lime-soda softening.
9. Describe to a client under what circumstances CO₂ in raw water is to be removed by precipitation or by stripping.
10. Given a water analysis, select an appropriate lime-soda softening process, that is, selective calcium removal, excess lime softening, or split treatment.
11. Explain the purpose of recarbonation.
12. Explain why the softening process may be of benefit in removing constituents of concern other than calcium and magnesium.

With the use of this text, you should be able to do the following:

13. Estimate the CO₂ concentration of a water given the pH, alkalinity, and water temperature.
14. Estimate the amount of lime and soda ash required to soften water of a stated composition.
15. Calculate the fraction of the “split” for a lime-soda softening system.
16. Draw bar graphs to describe a water during different stages of softening.

17. Show, by writing the chemical reactions, how caustic soda may be used instead of lime in softening.
18. Design an upflow solids contact basin from a manufacturer's data given the design flow rate.
19. Design a recarbonation system for lime/soda softening given the flow rate and treated water composition.

7-10 PROBLEMS

- 7-1. Using Equations 6-3, 7-31, 7-32, and the equilibrium constant expression for the ionization of water, derive two equations that allow calculation of the bicarbonate and carbonate alkalities in mg/L as CaCO₃ from measurements of the total alkalinity (A) and the pH.

Answers (in mg/L as CaCO₃):

$$\text{HCO}_3^- = \frac{50,000 \left\{ \left(\frac{A}{50,000} \right) + [\text{H}^+] - \left(\frac{K_W}{[\text{H}^+]} \right) \right\}}{1 + \left(\frac{2K_2}{[\text{H}^+]} \right)}$$

$$\text{CO}_3^{2-} = \left(\frac{2K_2}{[\text{H}^+]} \right) (\text{HCO}_3^-)$$

where A = total alkalinity, mg/L as CaCO₃
 K_2 = second dissociation constant of carbonic acid
 = 4.68×10^{-11} at 25°C
 K_W = ionization constant of water
 = 1×10^{-14} at 25°C
 HCO_3^- = bicarbonate alkalinity in mg/L as CaCO₃
 CO_3^{2-} = carbonate alkalinity in mg/L as CaCO₃

- 7-2. If a water has a carbonate alkalinity of 120.00 mg/L as the ion and a pH of 10.30, what is the bicarbonate alkalinity in mg/L as the ion?
- 7-3. Calculate the bicarbonate and carbonate alkalities, in mg/L as CaCO₃, of a water having a total alkalinity of 233.0 mg/L as CaCO₃ and a pH of 10.47.
- 7-4. What is the pH of a water that contains 120 mg/L of bicarbonate ion and 15mg/L of carbonate ion?
- 7-5. Calculate the bicarbonate and carbonate alkalities, in mg/L as CaCO₃, of the water described in the following mineral analysis for a water sample taken from Well No. 1 at the Eastwood Manor Subdivision near McHenry, Illinois (Woller and Sanderson, 1976a).

Well No. 1, Lab No. 02694, November 9, 1971

Iron	0.2	Silica (SiO ₂)	20.0
Manganese	0.0	Fluoride	0.35
Ammonium	0.5	Boron	0.1
Sodium	4.7	Nitrate	0.0
Potassium	0.9	Chloride	4.5
Calcium	67.2	Sulfate	29.0
Magnesium	40.0	Alkalinity	284.0 as CaCO ₃
Barium	0.5	pH	7.6 units

NOTE: All reported as "mg/L as the ion" unless stated otherwise.

- 7-6.** Determine the total, carbonate, and noncarbonate hardness in mg/L as CaCO₃ and in meq/L for the water analysis in Problem 7-5 using the predominant polyvalent cations.
- 7-7.** Calculate the total, carbonate, and noncarbonate hardness for the water analysis in Problem 7-5 in mg/L as CaCO₃ using all of the polyvalent cations. What is the percent error in using only the predominant cations as in Problem 7-6?
- 7-8.** The following mineral analysis was reported for a water sample taken from Well No. 1 at Magnolia, Illinois (Woller and Sanderson, 1976b). Determine the total, carbonate and noncarbonate hardness in mg/L as CaCO₃ and in meq/L using the predominant polyvalent cation definition of hardness.

Well No. 1, Lab No. B109535, April 23, 1973

Iron	0.42	Zinc	0.01
Manganese	0.04	Silica (SiO ₂)	20.0
Ammonium	11.0	Fluoride	0.3
Sodium	78.0	Boron	0.3
Potassium	2.6	Nitrate	0.0
Calcium	78.0	Chloride	9.0
Magnesium	32.0	Sulfate	0.0
Barium	0.5	Alkalinity	494.0 as CaCO ₃
Copper	0.01	pH	7.7 units

NOTE: All reported as "mg/L as the ion" unless stated otherwise.

- 7-9.** The following mineral analysis was reported for Michigan State University well water (MDEQ, 1979). Determine the total, carbonate, and noncarbonate hardness in mg/L as CaCO₃ and in meq/L using the predominant polyvalent cation definition of hardness.

Michigan State University Well Water

Fluoride	1.1	Silica (SiO ₂)	3.4
Chloride	4.0	Bicarbonate	318.0 mg/L as CaCO ₃
Nitrate	0.0	Sulfate	52.0
Sodium	14.0	Iron	0.5

(continued)

Michigan State University Well Water (continued)

Potassium	1.6	Manganese	0.07
Calcium	96.8	Zinc	0.27
Magnesium	30.4	Barium	0.2

NOTE: All units are mg/L as the ion unless stated otherwise

- 7-10.** An analysis of bottled water from the Kool Artesian Water Bottling Company is listed below. Determine the total, carbonate, and noncarbonate hardness in mg/L as CaCO_3 and in meq/L using the predominant polyvalent cation definition of hardness. (*Hint: use the solution to Problem 7-1 to find the bicarbonate concentration.*)

Kool Artesian Water

Calcium	37.0	Silica	11.5
Magnesium	18.1	Sulfate	5.0
Sodium	2.1	Potassium	1.6
Fluoride	0.1	Zinc	0.02
Alkalinity	285.0 mg/L as CaCO_3		
pH	7.6 units		

NOTE: All units are mg/L as the ion unless stated otherwise

- 7-11.** Prepare a bar chart of the Lake Michigan water analysis shown below. Because all of the constituents were not analyzed, an ion balance is not achieved.

Lake Michigan at Grand Rapids, MI Intake

Constituent	Expressed as	Milligrams per liter
Total hardness	CaCO_3	143.0
Calcium	Ca^{2+}	38.4
Magnesium	Mg^{2+}	11.4
Total iron	Fe	0.10
Sodium	Na^+	5.8
Total alkalinity	CaCO_3	119
Bicarbonate alkalinity	CaCO_3	115
Chloride	Cl^-	14.0
Sulfate	SO_4^{2-}	26.0
Silica	SiO_2	1.2
Total dissolved solids		180.0
Turbidity	NTU	3.70 ^a
pH	Units	8.4 ^a

^aNot in mg/L.

- 7-12.** Using K_{sp} , show why calcium is removed as a carbonate rather than a hydroxide in lime-soda softening.

- 7-13. Using K_{sp} , show why magnesium is removed as a hydroxide rather than a carbonate in lime-soda softening.
- 7-14. Estimate the CO_2 concentration in mg/L as CO_2 and in mg/L as CaCO_3 for the water analysis presented in Problem 7-5. Assume the water temperature was 4.4°C .
- 7-15. Estimate the CO_2 concentration in mg/L as CO_2 and in mg/L as CaCO_3 for the water analysis presented in Problem 7-8. Assume the water temperature was 6°C .
- 7-16. If the pH of the MSU water (Problem 7-9) was 8.0 and the water temperature was 5°C , what is the estimated CO_2 concentration in mg/L as CO_2 and as mg/L as CaCO_3 ?
- 7-17. Estimate the CO_2 concentration in mg/L as CO_2 and in mg/L as CaCO_3 for the water analysis presented in Problem 7-11. Assume the water temperature was 10°C . For the estimate of the CO_2 concentration, ignore the carbonate alkalinity.
- 7-18. Determine the lime and soda ash dose, in mg/L as CaCO_3 , to soften the following water to a final hardness of 90.0 mg/L as CaCO_3 . If the price of lime, purchased as CaO , is \$61.70 per megagram (Mg), and the price of soda ash, purchased as Na_2CO_3 , is \$172.50 per Mg, what is the annual chemical cost of treating $0.050 \text{ m}^3/\text{s}$ of this water? Assume the lime is 90% pure and the soda ash is 97% pure. The ion concentrations reported below are all mg/L as CaCO_3 .

$$\begin{aligned}\text{Ca}^{2+} &= 137.0 \\ \text{Mg}^{2+} &= 40.0 \\ \text{HCO}_3^- &= 197.0 \\ \text{CO}_2 &= 9.0\end{aligned}$$

- 7-19. What amount of lime and/or soda ash, in mg/L as CaCO_3 , is required to soften the Village of Lime Ridge's water to less than 120 mg/L hardness as CaCO_3 ?

Compound	Concentration, mg/L as CaCO_3
CO_2	4.6
Ca^{2+}	257.9
Mg^{2+}	22.2
HCO_3^-	248.0
SO_4^{2-}	32.1

- 7-20. Determine the lime and soda ash dose, in mg/L as CaO and Na_2CO_3 , to soften the following water to a final hardness of less than 130 mg/L as CaCO_3 . The ion concentrations reported below are all mg/L as CaCO_3 . Assume the lime is 90% pure and the soda ash is 97% pure.

$$\begin{aligned}\text{Ca}^{2+} &= 210.0 \\ \text{Mg}^{2+} &= 23.0 \\ \text{HCO}_3^- &= 165.0 \\ \text{CO}_2 &= 5.0\end{aligned}$$

- 7-21. Determine the lime and soda ash dose, in mg/L as CaO and Na₂CO₃, to soften the Thames River water to a final hardness of less than 125 mg/L as CaCO₃. Assume that all the alkalinity is bicarbonate and that the lime is 90% pure and the soda ash is 97% pure.

Thames River, London

Constituent	Expressed as	Milligrams per liter
Total hardness	CaCO ₃	260.0
Calcium hardness	CaCO ₃	235.0
Magnesium hardness	CaCO ₃	25.0
Total iron	Fe	1.8
Copper	Cu ²⁺	0.05
Chromium	Cr ⁶⁺	0.01
Total alkalinity	CaCO ₃	130.0
Chloride	Cl ⁻	52.0
Phosphate (total)	PO ₄ ³⁻	1.0
Silica	SiO ₂	14.0
Suspended solids		43.0
Total solids		495.0
pH	units	7.5
Temperature	°C	10.0

- 7-22. Determine the lime and soda ash dose, in mg/L as CaCO₃ to soften the following water to a final hardness of less than 120.0 mg/L as CaCO₃. If the price of lime, purchased as CaO, is \$61.70 per megagram (Mg), and the price of soda ash, purchased as Na₂CO₃, is \$172.50 per Mg, what is the annual chemical cost of treating 1.35 m³/s of this water? Assume the lime is 87% pure and the soda ash is 97% pure. The ion concentrations reported below are all mg/L as CaCO₃.

$$\begin{aligned} \text{Ca}^{2+} &= 293.0 \\ \text{Mg}^{2+} &= 55.0 \\ \text{HCO}_3^- &= 301.0 \\ \text{CO}_2 &= 5.0 \end{aligned}$$

- 7-23. Determine the lime and soda ash dose, in mg/L as CaCO₃, to soften the following water to a final hardness of less than 90.0 mg/L as CaCO₃. If the price of lime, purchased as CaO, is \$61.70 per megagram (Mg), and the price of soda ash, purchased as Na₂CO₃, is \$172.50 per Mg. What is the annual chemical cost of treating 0.050 m³/s of this water? Assume the lime is 90% pure and the soda ash is 97% pure. The ion concentrations reported below are all mg/L as CaCO₃.

$$\begin{aligned} \text{Ca}^{2+} &= 137.0 \\ \text{Mg}^{2+} &= 60.0 \\ \text{HCO}_3^- &= 197.0 \\ \text{CO}_2 &= 9.0 \end{aligned}$$

- 7-24.** Determine the lime and soda ash dose, in mg/L as CaCO_3 , to soften the Kool Artesian (Problem 7-10) water to a final hardness of ≤ 115 mg/L as CaCO_3 . Assume the water temperature as pumped from the ground is 10°C . If the price of lime, purchased as CaO , is \$100 per megagram (Mg), and the price of soda ash, purchased as Na_2CO_3 is \$200 per Mg, what is the annual chemical cost of treating $0.500 \text{ m}^3/\text{s}$ of this water? Assume all the alkalinity is bicarbonate, lime is 88% pure, and soda ash is 98% pure.
- 7-25.** Determine the lime and soda ash dose, in mg/L as CaCO_3 , to soften the Village of Galena's water to a final hardness of ≤ 130.0 mg/L as CaCO_3 . Assume the water temperature as pumped from the ground is 8.5°C . If the price of lime, purchased as CaO , is \$100 per megagram (Mg), and the price of soda ash, purchased as Na_2CO_3 is \$200 per Mg, what is the annual chemical cost of treating $0.500 \text{ m}^3/\text{s}$ of this water? Assume lime is 93% pure and soda ash is 95% pure.

Village of Galena

Constituent	Expressed as	Milligrams per liter
Calcium	Ca^{2+}	177.8
Magnesium	Mg^{2+}	16.2
Total iron	Fe	0.20
Lead ^a	Pb^{2+}	20 ^a
Sodium	Na^+	4.9
Carbonate alkalinity	CaCO_3	0.0
Bicarbonate alkalinity	CaCO_3	276.6
Chloride	Cl^-	0.0
Sulfate	SO_4^{2-}	276.0
Silica	SiO_2	1.2
Total dissolved solids		667
pH	units	8.2
Temperature	$^\circ\text{C}$	8.5

^aParts per billion.

- 7-26.** Rework Problem 7-21 using caustic soda instead of lime. Soften the water to the lowest hardness that can be achieved with caustic alone. Assume the caustic is 100% pure, CO_2 concentration = 9.96 mg/L, and that an excess of 40 mg/L of caustic will be added.
- 7-27.** Design an upflow solids contact basin for a softening plant treating groundwater. The plant has a maximum day design flow rate of $50,000 \text{ m}^3/\text{d}$ and average winter demand of $25,000 \text{ m}^3/\text{d}$. Verify that the design satisfactorily meets the GLUMRB guidance for flocculation and mixing period, detention time, upflow rate (overflow rate), and weir loading. Use Table 7-4 to select the upflow clarifier(s).
- 7-28.** Design an upflow solids contact basin for a softening plant treating groundwater. The plant has a maximum day design flow rate of $10,000 \text{ m}^3/\text{d}$ and average winter demand

of 5,000 m³/d. The primary softening clarifier is to be followed by a secondary clarifier that is to be used as settling tank for coagulation of the unsettled precipitate from the first tank. Verify that the design satisfactorily meets the GLUMRB guidance for side water depth, flocculation and mixing period, detention time, upflow rate (overflow rate), and weir loading. Use Table 7-4 to select the upflow clarifier(s).

- 7-29.** Estimate the dose of CO₂ in mg/L to stabilize the water from split treatment softening. The estimated constituents and parameters of interest in the blended water are listed in the table below.

Constituent or parameter	Concentration, mg/L as CaCO ₃ or units as shown
Ca ²⁺	63.0
Mg ²⁺	35.0
CO ₃ ²⁻	84.7
HCO ₃ ⁻	128.4
pH	10.1 units
TDS	240 mg/L
Temperature	4°C

- 7-30.** Estimate the dose of CO₂ in mg/L to stabilize the water from split treatment softening. The estimated constituents and parameters of interest in the blended water are listed in the table below.

Constituent or parameter	Concentration, mg/L as CaCO ₃ or units as shown
Ca ²⁺	53.65
Mg ²⁺	40.0
CO ₃ ²⁻	25.2
HCO ₃ ⁻	53.2
pH	9.89 units
TDS	560 mg/L
Temperature	12°C

7-11 DISCUSSION QUESTIONS

- 7-1.** Is the Lime Ridge water (Problem 7-19) a likely candidate for air stripping to remove CO₂ before lime-soda softening? Explain why or why not.
- 7-2.** Explain why many lime-soda softening utilities have raised their target hardness from between 75 and 120 mg/L as CaCO₃ to a target hardness between 120 and 150 mg/L as CaCO₃.
- 7-3.** A water that contains only carbonate hardness can be softened with NaOH alone. True or false?

7-12 REFERENCES

- AWWA (1978) *Corrosion Control by Deposition of CaCO₃ Films*, American Water Works Association, Denver.
- Benefield, L. D., J. F. Judkins, and B. L. Weand (1982) *Process Chemistry for Water and Wastewater Treatment*, Prentice-Hall, Englewood Cliffs, New Jersey, pp. 267–306, 418–419, 460.
- Benefield, L. D. and J. M. Morgan (1999) “Chemical Precipitation,” in R. D. Letterman (ed.) *Water Quality and Treatment*, 5th ed., American Water Works Association, McGraw-Hill, New York, pp. 9.1–9.91.
- Davis, M. L. and D. A. Cornwell (2008) *Introduction to Environmental Engineering*, McGraw-Hill, New York, pp. 236–259.
- GLUMRB (2003) *Recommended Standards for Water Works*, Great Lakes–Upper Mississippi River Board of State and Provincial Public Health and Environmental Managers, Health Education Services, Albany, New York, pp. 35–38, 66–80.
- Horsley, M. B., D. B. Elder, and L. L. Harms (2005) “Lime Softening,” in E. E. Baruth (ed.), *Water Treatment Plant Design*, McGraw-Hill, New York, pp. 11.1–11.20.
- Kawamura, S. (2000) *Integrated Design and Operation of Water Treatment Facilities*, 2nd ed, John Wiley & Sons, New York, pp. 74–139.
- Langelier, W. F. (1936) “The Analytical Control of Anticorrosion Water Treatment,” *Journal of American Water Works Association*, vol. 28, p. 1,500.
- MDEQ (1979) *Annual Data Summary*, Michigan Department of Public Health, Lansing, MI.
- Merrill, D. T. (1978) “Chemical Conditioning for Water Softening and Corrosion Control,” in R. L. Sanks (ed.) *Water Treatment Plant Design*, Ann Arbor Science, Ann Arbor, Michigan, pp. 497–565.
- MWH (2005) *Water Treatment: Principles and Design*, John Wiley & Sons, Hoboken, New Jersey, pp. 957, 1371, 1403, 1431, 1445, 1472, 1564.
- Rossum, J. R. and D. T. Merrill (1983) “An Evaluation of the Calcium Carbonate Saturation Indexes,” *Journal of the American Water Works Association*, vol. 69, no. 2, p. 95.
- Sawyer, C. N., P. L. McCarty, and G. F. Parkin (2003) *Chemistry for Environmental Engineering and Science*, McGraw-Hill, Boston, pp. 179, 564.
- Schock, M. R. (1999) “Internal Corrosion and Deposition Control,” in R. D. Letterman (ed.) *Water Quality and Treatment*, 5th ed., American Water Works Association, McGraw-Hill, New York, pp.17.1–17.109.
- Sorg, T. J., O. T. Love, Jr. and G. Logsdon (1977) *Manual of Treatment Techniques for Meeting the Interim Primary Drinking Water Regulations*, U.S. Environmental Protection Agency Report 600/8.77.005, MERL, Cincinnati, Ohio.
- Woller, D. M. and E. W. Sanderson (1976a) *Public Water Supplies in McHenry County*, Illinois State Water Survey, Publication No. 60–19, Urbana, IL.
- Woller, D. M. and E. W. Sanderson (1976b) *Public Water Supplies in Putnam County*, Illinois State Water Survey, Publication No. 60–15, Urbana, IL.

This page intentionally left blank

CHAPTER

8

ION EXCHANGE

8-1 INTRODUCTION

8-2 FUNDAMENTAL CONCEPTS OF ION EXCHANGE

8-3 PROCESS OPERATION

8-4 ION EXCHANGE PRACTICE

8-5 OPERATION AND MAINTENANCE

8-6 CHAPTER REVIEW

8-7 PROBLEMS

8-8 DISCUSSION QUESTION

8-9 REFERENCES

8-1 INTRODUCTION

Ion exchange* is a reversible reaction in which a charged ion in solution is exchanged for a similarly charged ion electrostatically attached to an immobile solid particle. The largest application of ion exchange in water treatment is for softening, where calcium, magnesium and other polyvalent cations are exchanged for sodium (Clifford, 1999). It is used both in individual homes [called *point-of-entry* (POE) or *point of use* (POU)] and in municipal systems. Ion exchange is also used to remove specific contaminants such as arsenic, barium, nitrate, and radium.

In common practice the raw water is passed through a bed of resin. The resin is made by polymerization of organic compounds into a porous matrix. Commercially available resins are selected for the bed. Typically, in water softening, sodium is exchanged for cations in solution. When the bed becomes saturated with the exchanged ion, it is shut down and regenerated by passing a concentrated solution of sodium back through the bed.

Because of its large application in softening water, the focus of this chapter is on this application.

8-2 FUNDAMENTAL CONCEPTS OF ION EXCHANGE

Ion Exchange Resins and Reactions

Ion Exchange Resins. The most common polymeric resin matrix is a cross-linked polystyrene to which charged *functional groups* are attached by covalent bonding. Divinylbenzene (DVB) is used as a cross-linking agent with the styrene. A higher DVB cross-linkage provides a more stable resin but will result in slower ion exchange kinetics. The common functional groups are in four categories: strongly acidic (for example, sulfonate, $-\text{SO}_3^-$); weakly acidic (for example, carboxylate, $-\text{COO}^-$); strongly basic (for example, quaternary amine, $-\text{N}^+(\text{CH}_3)_3$), and weakly basic (for example, tertiary amine, $-\text{N}(\text{CH}_3)_2$).

Figure 8-1 is a schematic representation of a resin bead and two typical functional groups. Cation exchange resins contain mobile positive ions, such as hydrogen (H^+) or sodium (Na^+), that are attached to immobile functional acid groups, such as sulfonic ($-\text{SO}_3^-$) and carboxylic ($-\text{COO}^-$) groups. The functional groups are fixed to the resin *matrix* or *backbone*. These are the cation ion exchange sites. The number of sites is finite, and when they all have been exchanged the ion exchange resin will no longer soften the water.

Strong Cation Exchange Reactions. The word “strong” in strong cation exchange does not refer to the physical strength of the resin but rather to the Arrhenius theory of electrolyte strength in which the functional group of the resin is dissociated completely in its ionic form at any pH. Equation 8-1 represents the exchange of sodium for calcium in the form of carbonate hardness and Equation 8-2 represents the exchange of sodium for noncarbonate hardness



*Often noted in the literature as *IX*.

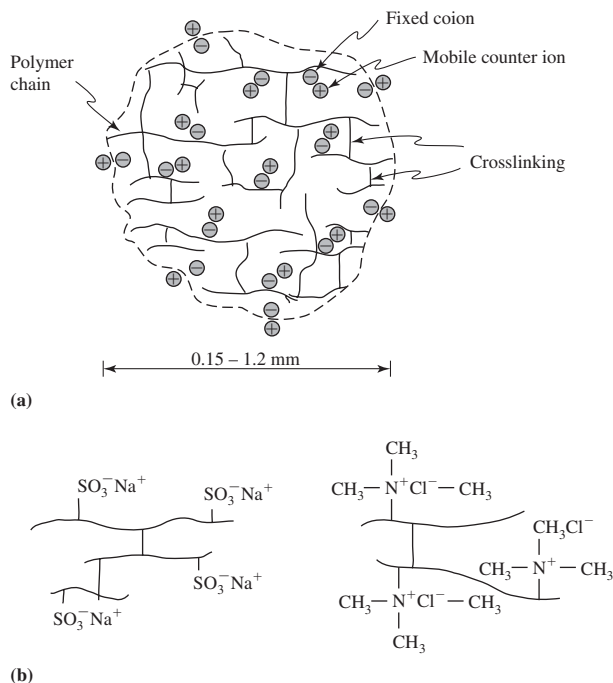

FIGURE 8-1

Schematic of organic cation-exchange bead (a). The bead is shown as a polystyrene polymer cross-linked with divinyl benzene with fixed coions (minus charge) balanced by mobile positively charged counterions (positive charge). (b) strong cation exchange resin on left (Na⁺ form) and strong-base on right (Cl⁻ form).

where ≡ denotes the resin and the **bold font** represents the solid resin phase. Magnesium and other polyvalent ions are removed by similar reactions. The sulfonic group provides a strong reactive site and the exchange resin readily removes all polyvalent cations. The reactions are reversible.

Weak Cation Exchange Reactions. The weak cation exchange resins can remove carbonate hardness as shown in Equation 8-3, but they cannot remove noncarbonate hardness.



The weak cation exchange resins are regenerated with a strong acid (HCl or H₂SO₄).

Ion Exchange Kinetics

The rate of ion exchange depends on the rates of the various transport mechanisms carrying the ion to be removed to the resin as well as the exchange reaction rate itself. The mechanisms are as follows (Reynolds and Richards, 1996): (1) movement of the ions from the bulk solution to the film or boundary layer surrounding the exchange solid, (2) diffusion of the ions through the film to the solid surface, (3) diffusion of the ions inward through the pores of the solid to the exchange

sites, (4) exchange of the ions by reaction, (5) diffusion of the exchanged ions outward through the pores to the solid surface, (6) diffusion of the exchanged ions through the boundary layer, and (7) movement of the exchanged ions into the bulk solution.

For a column of resin, the exchange reactions begin to saturate the upper levels before the lower levels. The progress of this saturation through the column results in a “wave” of saturation as shown in Figure 8-2a. If samples are taken at the bottom of the column, a curve of increasing concentration is detected as shown in Figure 8-2b. This curve is called the *breakthrough curve*. At some point in time the effluent concentration exceeds the design criteria, for example at concentration C_c in Figure 8-2b. The column is then taken out of service and regenerated.

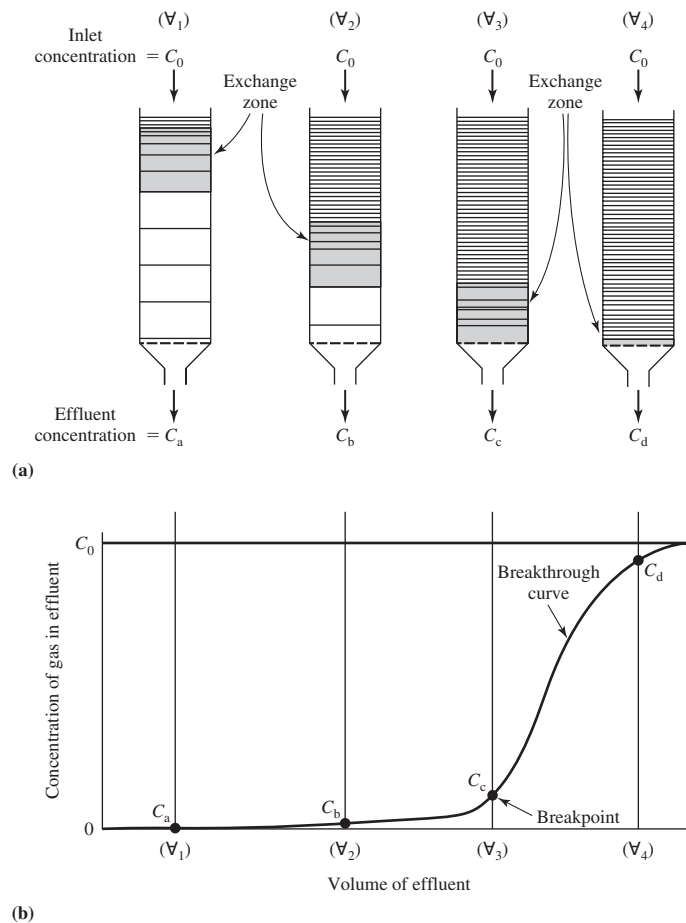

FIGURE 8-2

Ion exchange wave (a) and breakthrough (b). (Source: Treybal, 1968.)

Properties of Ion Exchange Resins

Exchange Capacity. One of the major considerations in selecting an ion exchange resin is the quantity of counterions that can be exchanged onto the resin. This quantity is called the *exchange capacity* of the resin. The total capacity is dependent on the quantity of functional groups on a resin bead. The exchange capacity may be reported as milliequivalents per gram of dry resin (meq/g) or as milliequivalents per milliliter of wet resin (meq/mL). The typical dry-weight capacity of a strong acid cation exchange resin falls in the range of 3.6 to 5.5 meq/g. Typical wet-volume capacity is 1.8 to 2.0 meq CaCO₃/mL.

Selectivity. Ion exchange resins have a variable preference or affinity for the ions in solution. This preference or affinity is called *selectivity*. Quantitatively, for a binary exchange, selectivity may be expressed as a selectivity coefficient (K_j^i). For the generalized cation reaction

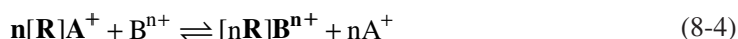

the equilibrium expression is

$$K_B^A = \frac{[\mathbf{A}^+]^n \{\mathbf{RB}^{n+}\}}{\{\mathbf{RA}\}^n [\mathbf{B}^{n+}]} \quad (8-5)$$

where K_B^A = apparent equilibrium constant or selectivity coefficient for cation (or anion) A exchanging with ion B onto resin
 $[\mathbf{A}^+]$ = aqueous-phase concentration of presaturant ion, eq/L
 $[\mathbf{B}^{n+}]$ = aqueous-phase concentration of counterion, eq/L
 $\{\mathbf{RA}\}, \{\mathbf{RB}^{n+}\}$ = activities of resin-phase presaturant ion and counterion, respectively
 n = valence of the exchanging ion

A similar expression can be written for anions. Although the activity terms are a function of ionic strength, concentrations are used in practice because they are measured more easily than activities. Thus, Equation 8-5 is conveniently expressed as

$$K_j^i = \frac{(C_j)^n q_i}{C_i (q_j)^n} \quad (8-6)$$

where K_j^i = equilibrium constant for cation (or anion) i exchanging with ion j
 C_j = aqueous phase concentration of presaturant ion j , meq/L
 q_i = resin phase concentration of counterion i , meq/L
 C_i = aqueous phase concentration of counterion i , meq/L
 q_j = resin phase concentration of presaturant ion j , meq/L
 n = valence of the exchanging ion

For the cation exchange of calcium and sodium expressed in Equation 8-2, the equilibrium constant would be expressed as

$$K_{\text{Na}}^{\text{Ca}} = \frac{(C_{\text{Na}})^2 q_{\text{Ca}}}{C_{\text{Ca}} (q_{\text{Na}})^2} \quad (8-7)$$

The greater the selectivity coefficient (K), the greater is the preference for the ion by the exchange resin. Commercial exchange resins used in water treatment tend to prefer (1) ions of higher valence, (2) ions with smaller solvated volume, (3) ions with greater ability to polarize, (4) ions that react strongly with the exchange sites on the resin, and (5) ions that do not form complexes (Helfferich, 1962).

For process design evaluation, separation factors are used rather than selectivity coefficients. The binary separation factor is a measure of the preference of one ion for another ion. It may be expressed as

$$\alpha_j^i = \frac{Y_i X_j}{X_i Y_j} \quad (8-8)$$

where α_j^i = separation factor

Y_i = resin phase equivalent fraction of counterions

X_j = equivalent fraction of presaturant ion in aqueous phase

X_i = equivalent fraction of counterion in aqueous phase

Y_j = resin phase equivalent fraction of presaturant ion

The equivalent fraction in the aqueous phase is calculated as

$$X_i = \frac{C_i}{C_T} \quad (8-9)$$

and

$$X_j = \frac{C_j}{C_T} \quad (8-10)$$

where C_T = total aqueous ion concentration

C_i = aqueous phase concentration of counter ion, eq/L

C_j = aqueous phase concentration of presaturant ion, eq/L

Similarly, for resin phase

$$Y_i = \frac{q_i}{q_T} \quad (8-11)$$

and

$$Y_j = \frac{q_j}{q_T} \quad (8-12)$$

where q_T = total exchange capacity of resin, eq/L.

Because a binary system involves only the presaturant ion and one other ion to be exchanged,

$$C_T = C_i + C_j \quad (8-13)$$

and

$$q_T = q_i + q_j \quad (8-14)$$

Separation factors for commercially available strong acid cation exchange resins are given in Table 8-1.

A combination of Equations 8-7 and 8-8 yields

$$\alpha_{\text{Na}}^{\text{Ca}} = K_{\text{Na}}^{\text{Ca}} \left(\frac{q_T Y_{\text{Na}}}{C_T X_{\text{Na}}} \right) \quad (8-15)$$

The implication of this equation is that, with q_T constant, divalent/monovalent exchange depends inversely on solution concentration and directly on the distribution ratio $Y_{\text{Na}}/X_{\text{Na}}$ between the resin and the water. The higher the solution concentration C_T , the lower the divalent/monovalent separation factor; that is, the selectivity tends to reverse in favor of the monovalent ion as ionic strength (that is, a function of C) increases. This is the theoretical basis for regeneration of the cation exchange resin by the application of a high concentration of sodium.

Rearrangement of Equation 8-8 with appropriate substitution of terms yields an expression that allows the calculation of the resin phase concentration of the counterion of interest if the binary separation factor and total resin capacity are known.

$$q_i = \frac{C_i q_T}{C_i + C_j \alpha_i^j} \quad (8-16)$$

where $\alpha_i^j = 1/\alpha_j^i$.

The use of this expression in estimating the maximum volume of water that can be treated by a given resin is illustrated in Example 8-1.

TABLE 8-1
Separation factors of ions for resins^a

Strong acid cation resins ^b		Strong base anion resins ^c	
Cation, i	α_{i/Na^+}	Anion, i	α_{i/Cl^-} ^d
Ra ²⁺	13.0	UO ₂ (CO ₃) ₃ ⁴⁻	3200
Ba ²⁺	5.8	ClO ₄ ^{-e}	150
Pb ²⁺	5.0	CrO ₄ ²⁻	100
Sr ²⁺	4.8	SeO ₄ ²⁻	17
Cu ²⁺	2.6	SO ₄ ²⁻	9.1
Ca ²⁺	1.9	HAsO ₄ ²⁻	4.5
Zn ²⁺	1.8	HSO ₄ ⁻	4.1
Fe ²⁺	1.7	NO ₃ ⁻	3.2
Mg ²⁺	1.67	Br ⁻	2.3
K ⁺	1.67	SeO ₃ ²⁻	1.3
Mn ²⁺	1.6	HSO ₃ ⁻	1.2
NH ₄ ⁺	1.3	NO ₂ ⁻	1.1
Na ⁺	1.0	Cl ⁻	1.0
H ⁺	0.67	BrO ₃ ⁻	0.9
		HCO ₃ ⁻	0.27
		CH ₃ COO ⁻	0.14
		F ⁻	0.07

^aAbove values are approximate separation factors for 0.005–0.010 *N* solution (TDS = 250–500 mg/L as CaCO₃).

^bSAC resin is polystyrene divinylbenzene matrix with sulfonate functional groups.

^cSBA resin is polystyrene divinylbenzene matrix with $-N^+(\text{CH}_3)_3$ functional groups (i.e., a Type 1 resin).

^dSeparation factors are approximate and are based on various literature sources and on experiments performed at the University of Houston.

^eClO₄/Cl⁻ separation factor is for polystyrene SBA resins; on polyacrylic SBA resins, the ClO₄/Cl⁻ separation factor is approximately 5.0.

(Source: Clifford, 1999.)

Example 8-1. Estimate the maximum volume of water per liter of resin that can be treated by a strong acid exchange resin in the sodium form if the resin has total capacity of 2.0 eq/L, the calcium concentration is 1.4 meq/L, and the sodium concentration is 2.6 meq/L. Assume no other cations are in the solution.

Solution:

- a. Calculate the separation factor for sodium over calcium using the separation factor from Table 8-1.

$$\alpha_j^i = 1.9$$

$$\alpha_j^i = 1/a_j^i = 1/1.9 = 0.53$$

- b. The maximum useful capacity of the resin for calcium is

$$q_{\text{Ca}} = \frac{C_{\text{Ca}} q_T}{C_{\text{Ca}} + C_{\text{Na}} \alpha_j^i}$$

$$= \frac{(1.4 \text{ meq Ca}^{2+}/\text{L})(2.0 \text{ eq/L of resin})(1,000 \text{ meq/eq})}{(1.4 \text{ meq Ca}^{2+}/\text{L}) + (2.6 \text{ meq Na}^+/\text{L})(0.53)}$$

$$= 1,008 \text{ or } 1,000 \text{ meq Ca}^{2+}/\text{L of resin}$$

- c. The maximum volume of water that can be treated per volume of resin per cycle is

$$V = \frac{q_{\text{Ca}}}{C_{\text{Ca}}} = \frac{1,000 \text{ meq Ca}^{2+}/\text{L of resin}}{1.4 \text{ meq Ca}^{2+}/\text{L of water}}$$

$$= 714.29 \text{ or } 710 \text{ L of water/L of resin}$$

Comments:

1. This is the maximum amount of Ca^{2+} that can be removed assuming 100% efficiency of transfer, 100% regeneration efficiency, and that sufficient contact time has been provided to achieve equilibrium. This seldom happens in actual practice because, as noted in Figure 8-2, complete breakthrough would have to occur to completely saturate the bed.
2. For multicomponent systems such as a hard water containing several polyvalent cations, Equation 8-16 must be expanded to take into account the concentrations and separation factors for each of the components. MWH (2005) provides an extensive discussion on the method.

Resin Particle Size. Particle size has two effects on the ion exchange process. The rate of ion exchange decreases with increasing particle size. In contrast, the headloss through the bed increases as the bead size decreases. Because excessive pressure drops through the bed have the

potential of causing physical damage to the resin beads, the hydraulic requirements of the resin rather than the kinetics for ion exchange govern the selection of the resin particle size.

Ion exchange resin beads are spherical. They are produced in particle diameters ranging from 0.04 to 1.0 mm. In the United States, the particle sizes are sold by standard sieve screen or “mesh” sizes. A table of U.S. Standard Screen sizes and their equivalent diameters is given in Appendix B. The common sieve size ranges used are 16 to 50 and 50 to 100. The smaller number is the largest diameter sieve, and the larger number is the smallest diameter sieve. The manufacturer’s specification is generally given the notation 16×50 or 50×100 . Thus, for a 16×50 resin, all of the resin beads will pass the number 16 sieve, and none will pass the number 50 sieve.

Other data provided by the manufacturer includes the *effective size* (d_{10}) and the *uniformity coefficient*. The effective size is the mesh size that passes 10 percent of a sieved sample. The uniformity coefficient is the ratio of the d_{60} to the d_{10} resin sizes. These data are provided to facilitate hydraulic design.

Structural Stability and Service Life. As noted above, high pressure drops through the bed have the potential to cause resin bead compression. This, in turn, can cause inadequate liquid distribution and reduced flow. In addition the resin beads are also susceptible to swelling, shrinking, and abrasion from excessive backwashing. These effects reduce the structural integrity of the resin and shorten its operating life.

Oxidation of the resin beads, especially strong acid sulfonated polystyrene-DVB resins, from chlorination prior to ion exchange will significantly reduce service life. If prechlorination is essential, resins with high cross-linking are recommended (MWH, 2005).

Excessive concentrations of iron and manganese, if oxidized, will form precipitates that will foul the resin. GLUMRB (2003) specifies that iron, manganese, or a combination of the two should not exceed 0.3 mg/L in the water applied to the resin. Organic compounds may foul the resin by irreversibly binding to strong base anion exchange resins.

Turbidity should not exceed 5 NTU in water applied to cation exchange softeners (GLUMRB, 2003).

Some of these issues are remedied with the selection of an appropriate resin and proper arrangement of the sequence of pretreatment processes.

8-3 PROCESS OPERATION

To contact the water with the ion exchange resin, it is passed through a columnar pressure vessel as shown in Figure 8-3. The water is passed through the column until the effluent no longer meets the treatment objective. The column is then regenerated. The two common methods for regeneration (cocurrent and countercurrent) are used to identify the operating schemes.

Cocurrent Operation

In this scheme the regeneration step is conducted in the same flow direction as the treatment flow. The direction of both flows is usually downward. For softening operations where some leakage of hardness in the effluent can be tolerated, this operational scheme is frequently chosen. It is usually the lowest cost design and the simplest to operate. The domestic water softener is a familiar example of this type of design (Brown, 1998).

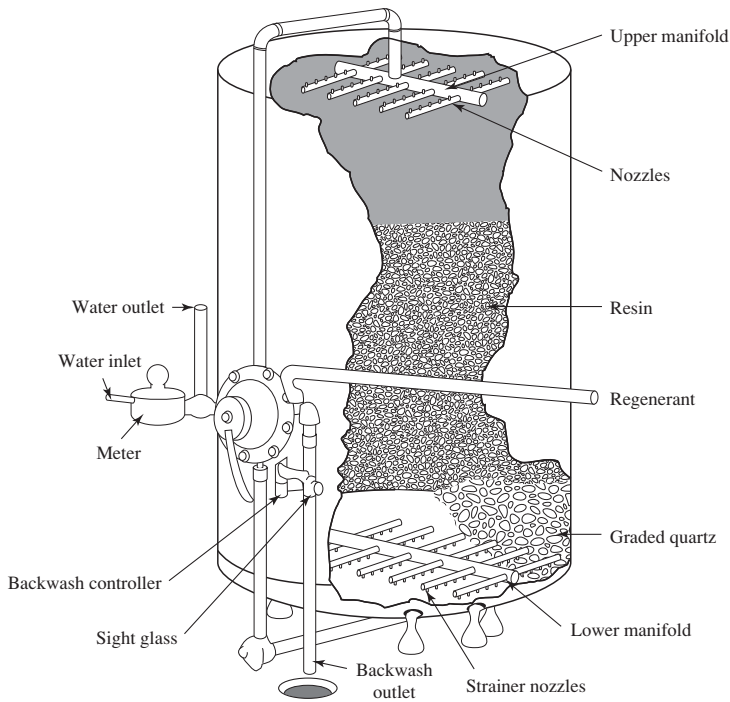

FIGURE 8-3

Typical ion exchange resin column.

(Source: U.S. EPA, 1981.)

The following steps are used in the ion exchange cycle :

- *Service.* The raw water is passed downward through the column until the hardness exiting the column exceeds the design limits. The column is taken out of service and another column is brought on line.
- *Backwash.* A flow of water is introduced through the underdrain. It flows up through the bed sufficient to expand the bed by 50 percent. The purpose is to relieve hydraulic compaction (Gottlieb, 2005), and to move the finer resin material and fragments to the top of the column and remove any suspended solids that have accumulated during the service cycle.
- *Regeneration.* The regenerating chemical, for example, sodium chloride, flows downward through the bed at a slow rate to allow the reactions to proceed toward complete regeneration.
- *Slow rinse.* Rinse water is passed through the column at the same flow rate as the regenerating flow rate to push the regenerating chemical through the bed.

- *Fast rinse.* This is a final rinse step. The fast rinse flows at the same flow rate as the service flow rate to remove any remaining regenerating solution.
- *Return to service.* The column is put back in use.

Countercurrent Operation

In this mode of operation the regenerant is passed through the resin in the opposite direction to that of the water being treated. Generally, the mode of operation is raw water flowing downward and regenerant flow upward. In most cases, countercurrent operation will result in lower leakage and higher chemical efficiency than cocurrent operation. However, countercurrent operation is a more expensive design and is more complicated to operate. Countercurrent operation is used where (1) high purity water is required, (2) chemical consumption must be minimized, or (3) waste volume must be minimized.

Bypass

As noted previously, there will be some leakage of hardness through the column because the passage of the saturation wave through the column is spread out, as shown in Figure 8-2, and because the high concentration of regenerant being released from the upper levels of the column will “regenerate” lower portions of the column where polyvalent ions were not completely removed in the regeneration cycle. The amount of leakage is usually less than 5 mg/L as CaCO₃ (Clifford, 1999). Thus, the treated water is softened far more than is necessary for normal consumer use. Thus, passing the entire flow to satisfy demand through the column results in a larger column than is necessary as well as consuming larger amounts of regeneration chemicals. In addition, very soft water is often corrosive.

To improve the stability of the water and make it less corrosive while reducing costs, a portion of the flow is bypassed around the column and blended with the treated water to achieve the design hardness. The bypass flow is calculated by solving the mass balance for hardness at the point where blending takes place. The mass balance of hardness is

$$Q_{\text{treated}}C_{\text{treated}} + Q_{\text{bypass}}C_{\text{bypass}} = Q_{\text{blended}}C_{\text{blended}} \quad (8-17)$$

and the flow balance is

$$Q_{\text{treated}} + Q_{\text{bypass}} = Q_{\text{blended}} \quad (8-18)$$

where Q_{treated} = flow rate of raw water entering column for treatment, m³/d
 Q_{bypass} = flow rate of water that is not treated, m³/d
 Q_{blended} = total design flow rate
 C_{treated} = concentration of hardness in the treated water, mg/L as CaCO₃
 C_{bypass} = hardness of the raw water, mg/L as CaCO₃
 C_{blended} = design final hardness, mg/L as CaCO₃

The bypass flow rate is determined by simultaneous solution of these two equations.

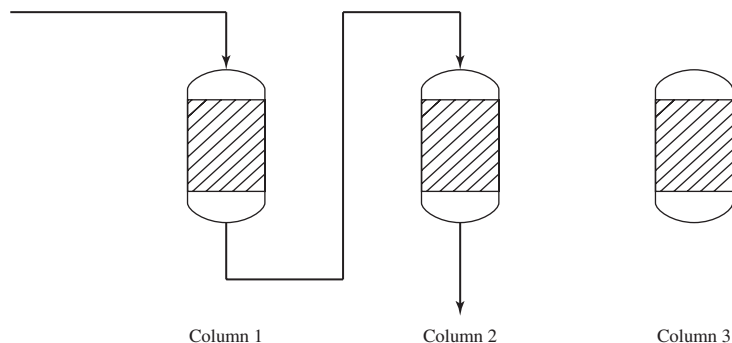

FIGURE 8-4

Two columns in series with one column as standby. After exhaustion of column 1, it will be taken out of service and regenerated. Column 2 will become “lead” and column 3 will follow in series. When column 2 is exhausted, it is taken out of service and column 3 becomes “lead.” Its effluent is passed through the regenerated column 1. This system has been called a “merry-go-round” system.

Multiple Columns

With the exception of home water softeners that may be shut down for a short period at night or that may be replaced by a service technician, the exhausted column that is taken out of service must be replaced by bringing another column on line. Although there are many alternate arrangements, three schemes are more common than others. They are (1) a standby column, (2) columns in series (known in the trade as the “merry-go-round” system), and (3) columns in parallel (the “carousel” system).

In the standby system there is a minimum of two columns. One is in service while the other is being regenerated and placed in standby. The operating time of each column must be long enough to allow for regeneration of the out-of-service column. This system does not provide any redundancy if only two columns are provided. A three column arrangement provides one extra column in the rotation and allows for backup during maintenance.

As show in Figure 8-4, the first column in the merry-go-round system serves as a roughing column and a second column serves as a polishing step.

In the carousel system, three columns are run in parallel while one is out of service. The three columns are in various stages of exhaustion: up to and including breakthrough, less than breakthrough, and substantially less than breakthrough. The water from the three columns is blended to achieve a consistent product water. This system is more likely to be used to meet an MCL requirement for a toxic constituent than for softening.

8-4 ION EXCHANGE PRACTICE

Typical design criteria for cation and anion exchange systems are summarized in Table 8-2. The following paragraphs elaborate on the design parameters.

Resin Selection

There are several hundred different resins available from United States and European manufacturers. Of these, the resins based on the polystyrene-DVB matrix are most widely used. The *operating capacity* (meq/mL as CaCO_3) serves as the primary selection criterion. This differs

TABLE 8-2
Typical ranges for design data and criteria for strong acid cation and strong base anion resins

Parameter	Strong acid cation resin	Strong base anion resin	Unit
Exchange capacity	3.6–5.5	1.8–2.0	meq/g as CaCO ₃
	1.6–2.2	0.8–1.4	meq/mL as CaCO ₃
Operating capacity ^a	50–70	40–60	% of exchange capacity
Moisture content	40–80	35–80	%
Shipping weight (moist)	640–930	670–720	kg/m ³
Screen size	16 × 50	16 × 50	
Service flow rate	200–2000	200–2000	m ³ /d · m ³ of resin
	8–40	8–40	BV/h
Surface loading rate	400–800	400–800	m ³ /d · m ² or m/d
Backwash rate	12–20	5–7.5	m ³ /h · m ² or m/h
Backwash duration	5–15	5–20	min
Bed expansion	50	50–75	%
Regenerant	NaCl	NaCl	
Regenerant concentration	5–10	2–15	%
Regenerant dose	80–320	80–320	kg NaCl/m ³ of resin
Regeneration flow rate	60–120	60–120	m ³ /d · m ² or m/d
	2–5	2–5	BV/h
Rinse volume	2–5	2–10	BV
pH range	0–14	0–14	units
Max. operating temp.	140	OH ⁻ form = 60;	°C
		C ⁻ form = 100	
Turbidity limit	5	5	NTU
Iron limit	5	0.1	mg/L as Fe
Total Fe + Mn	0.3	0.3	mg/L
Chlorine limit	1.0	0.1	mg/L of Cl ₂

^aOperating capacity depends on the method of regeneration and amount of regenerant applied.

Sources: Clifford, 1999; GLUMRB, 2003; MWH, 2005.

from the exchange capacity in that it is a measure of the actual performance of the resin under a defined set of conditions such as the raw water composition, *empty-bed contact time* (EBCT) or *service flow rate* (SFR), and degree of regeneration. The operating capacity is always less than the advertised exchange capacity because of incomplete regeneration, early leakage (break-through) that causes termination of the operational cycle to meet design limits, and efficiency of regeneration (measured as eq NaCl/eq CaCO₃).

Small laboratory columns (1.0 to 5.0 cm inside diameter) have been effective in analyzing alternative resins. These columns can be scaled directly to full scale design if the loading rate and EBCT are the same. Because the resin beads are small compared to the column diameter, the error due to channeling of the water down the walls is small. The hydraulics of full scale operation cannot be modeled by these small scale columns (MWH, 2005).

The larger the laboratory or pilot scale column, the better will be the results from scale-up. Although 60 cm long, 1 to 5 cm diameter columns are adequate for laboratory studies, larger diameter columns (for example, 10 cm) that have resin bed depths greater than 1 m are recommended (Reynolds and Richards, 1996; MWH, 2005).

Breakthrough curves are obtained from laboratory scale or pilot scale data such as that shown in Figure 8-5. The design breakthrough concentration, shown as V_b in Figure 8-5, may be used to estimate the capacity of the resin by calculating the area between the influent concentration (C_0) and the effluent concentration and dividing by the mass of resin in the column.

Flow Rates

The flow rate through the column affects the kinetics of the absorption bed. The longer the water is in contact with the resin, the greater is the opportunity for the mechanisms of the exchange process to come into play. Thus, the longer the contact time, the longer the time to reach breakthrough. There are two parameters used to control the contact time: (1) *empty-bed contact time* (EBCT) and (2) *service flow rate* (SFR) or *exhaustion rate*. The EBCT is calculated as the volume occupied by the resin (V_R) divided by the flow rate:

$$\text{EBCT} = \frac{V_R}{Q} \quad (8-19)$$

The service flow rate is

$$\text{SFR} = \frac{Q}{V_R} \quad (8-20)$$

The EBCT and SFR are used for ease of calculation. An actual detention time in the bed would have to account for the porosity. Typical EBCTs range from 1.5 to 7.5 min and SFRs range from 200 to 1,000 m^3 of water per day for each cubic meter of resin ($\text{m}^3/\text{d} \cdot \text{m}^3$). The SFR

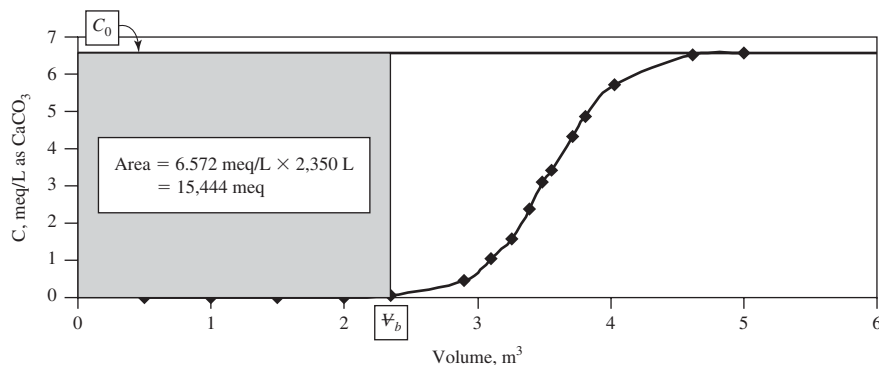

FIGURE 8-5
Ion exchange softening breakthrough curve.

may also be expressed as bed volumes of water per hour (BV/h). The usual range of values is 8 to 40 BV/h. EBCTs greater than 7.5 min and SFRs less than $200 \text{ m}^3/\text{d} \cdot \text{m}^2$ are acceptable because they provide greater time for the reactions. Shorter EBCTs and higher SFRs will result in earlier breakthroughs.

The *surface loading rate* (SLR) is limited to control the pressure drop across the bed and thereby control breakage of the resin beads. It is expressed as

$$\text{SLR} = \frac{Q}{A_c} \quad (8-21)$$

where A_c = the cross-sectional area of the resin bed, m^2 .

In general, the maximum allowable pressure drop across the bed is about 140 kPa. Because the pressure drop increases over time as the bed is operated, the design value for pressure drop is usually about 35 to 70 kPa less than this. This results in a maximum SLR of about 880 cubic meters per day per square meter of cross-sectional area ($\text{m}^3/\text{d} \cdot \text{m}^2$ or m/d). SLRs range from 175 to 880 m/d (Gottlieb, 2005). GLUMRB (2003) specifies that the rate should not exceed 400 m/d . Typical manufacturers' design curves for pressure drop are shown in Figure 8-6.

Backwashing

As noted previously, cocurrent beds are backwashed to relieve compression and remove particulate matter (often called "fines"). The backwash rate for strong acid cation resins is in the range $12\text{--}20 \text{ m}^3/\text{h} \cdot \text{m}^2$ of bed surface area. The backwashing period is on the order of 5 to 15 minutes. Bed expansion during backwash is typically assumed to be 50 percent, but some authors report expansions up to 100 percent of the operating depth (Reynolds and Richards, 1996; MWH, 2005).

Estimation of Resin Volume

There are several methods for estimating the required resin volume. The one that will be described here depends on the results of column studies. Column studies on the raw water provide a better estimate of the kinetic behavior of the resin to the actual constituents in the water than either synthetic water data or equilibrium data provided by manufacturers.

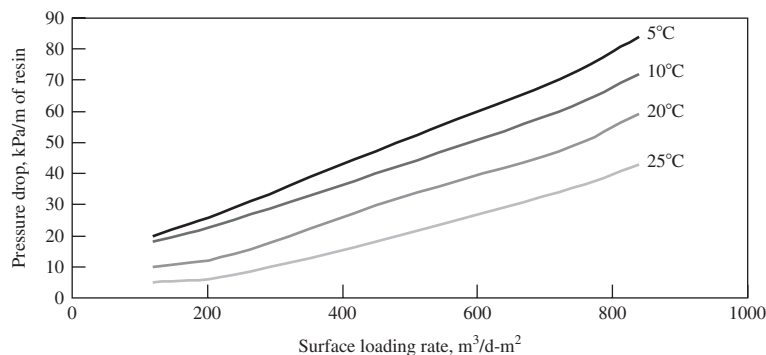

FIGURE 8-6

Typical ion exchange resin pressure drop curves at various water temperatures. Actual manufacturer's data should be used for design.

The column should be operated long enough to achieve complete saturation of the bed through several cycles of service and regeneration. To determine the optimum SFR, the flow rate must be varied during the saturation loading tests. The main goal in determining the optimum SFR is to reduce the capital cost of the column.

In the simplest expression, the resin volume required to treat a given flow rate of water is

$$V_R = \frac{Q}{\text{SFR}} \quad (8-22)$$

One method for estimating the resin mass is based on the principle of mass balance. It is illustrated in the following example.

Example 8-2. As part of the preliminary design for a softening plant, a sodium-based ion exchange column is to be evaluated. For the evaluation of alternatives, estimate the mass of moist resin required to soften the Hard Times water (Example 7-6) to a hardness of 80 mg/L as CaCO₃. The design flow rate is 275 m³/d. Assume that there is no leakage from the column, that is, $C_{\text{treated}} = 0.0$ mg/L as CaCO₃, that the moisture content of the resin is 44%, and the operating temperature is 10°C. Also assume that iron and turbidity concentrations are negligible. The manufacturer's resin operating capacity to breakthrough is 67% of the exchange capacity.

The laboratory scale column was 7.5 cm in diameter and the height of the resin in the column was 150.0 cm. The resin density on a moist basis is 0.85 g/cm³. The moisture content is the same as the full scale column. The flow rate through the column was 0.18 m³/h.

Solution:

- a. Begin by computing the meq of hardness removed per g of resin on a dry weight basis. The mass of dry resin in the column is computed from the column dimensions, the unit weight of the resin, and the moisture content of the resin.

$$\left[\frac{\pi(7.5 \text{ cm})^2}{4} \right] (150 \text{ cm})(0.85 \text{ g/cm}^3)(1 - 0.44) = 3,154.35 \text{ g}$$

- b. From the breakthrough curve of the laboratory column (Figure 8-5) the meq of hardness removed at breakthrough (V_b) was 15,444 meq.
- c. The meq/g of dry resin is

$$\frac{15,444 \text{ meq}}{3,154.35 \text{ g}} = 4.89 \text{ meq/g}$$

- d. The total hardness of the Hard Times water is equal to the sum of the Ca²⁺ and Mg²⁺ or 238 mg/L as CaCO₃ + 90.6 mg/L as CaCO₃ = 328.6 mg/L as CaCO₃.
- e. A material balance on the flow downstream of the ion exchange column is used to determine the bypass flowrate.

$$Q_{\text{treated}}C_{\text{treated}} + Q_{\text{bypass}}C_{\text{bypass}} = Q_{\text{blended}}C_{\text{blended}}$$

With no leakage $C_{\text{treated}} = 0.0$ mg/L and material balance equation is

$$\begin{aligned} Q_{\text{treated}}(0) + Q_{\text{bypass}}(328.6 \text{ mg/L as CaCO}_3) &= (275 \text{ m}^3/\text{d})(80 \text{ mg/L as CaCO}_3) \\ Q_{\text{bypass}} &= \frac{(275 \text{ m}^3/\text{d})(80 \text{ mg/L as CaCO}_3)}{328.6 \text{ mg/L as CaCO}_3} \\ &= 66.95 \text{ m}^3/\text{d} \end{aligned}$$

f. The flow rate passing through the ion exchange column is

$$275 \text{ m}^3/\text{d} - 66.95 \text{ m}^3/\text{d} = 208.05 \text{ m}^3/\text{d}$$

g. The meq/L of hardness to be removed is

$$(328.6 \text{ mg/L as CaCO}_3) \left(\frac{1}{50 \text{ meq/mg}} \right) = 6.572 \text{ meq/L}$$

where 50 meq/mg is the equivalent weight of CaCO_3 .

h. The meq of hardness to be removed in one day is

$$(6.572 \text{ meq/L})(208.05 \text{ m}^3/\text{d})(1,000 \text{ L/m}^3)(1\text{d}) = 1.37 \times 10^6 \text{ meq}$$

i. The mass of dry resin required is

$$(1.37 \times 10^6 \text{ meq}) \left(\frac{1 \text{ g}}{4.89 \text{ meq}} \right) (10^{-3} \text{ kg/g}) = 279.61 \text{ or } 280 \text{ kg}$$

j. The mass of resin on a moist basis is

$$(280 \text{ kg}) \left(\frac{1}{1-0.44} \right) = 500 \text{ kg}$$

k. To account for the manufacturer's operating capacity to breakthrough, increase the amount of resin to

$$\frac{1}{0.67}(500 \text{ kg}) = 746.27 \text{ or } 750 \text{ kg}$$

Comments:

1. The estimated resin was given in meq hardness/g of dry resin. This estimate could also be made as meq of hardness/mL of moist resin. The resin is shipped and installed moist. The

volume should be estimated in the test column after the test column has been backwashed and settled over several cycles.

2. The assumption of zero leakage is not realistic. As noted above, it will usually be some concentration less than 5 mg/L as CaCO₃.
 3. The estimate of the hardness removed by the resin is determined by computing the area under the breakthrough curve at the “design breakthrough.” For a two column system the design breakthrough is some hardness concentration above the leakage. For three columns in series, the design breakthrough may be as high as complete bed exhaustion. Likewise, in the parallel system with four columns, exhaustion of the bed may be selected as the design breakthrough.
-

Regeneration

Resins operated on the sodium cycle are usually regenerated with a 5 to 10% brine solution. The mass loading ranges from 80 to 320 kg NaCl/m³ of resin with 80 to 160 kg NaCl/m³ of resin being typical. The liquid flow rate is 60 to 120 m³/d · m² of surface area or in terms of bed volumes, about 2–5 BV/h (Reynolds and Richards, 1996; MWH, 2005).

Slow Rinse

The water rinse to push the regenerate through the bed is at the same flow rate as the regeneration.

Cycle Time

A minimum of two columns is recommended for redundancy: one in service and one in regeneration or standby. One column in service with storage is an alternative, but it provides no redundancy for mechanical or resin rehabilitation. Even with two columns, the out-of-service time must be less than the operating time for the in-service column to reach breakthrough. The following may be used to estimate the out-of-service time (Clifford, 1999):

$$t_{os} \leq t_{bw} + t_r + t_{sr} + t_{fr} \quad (8-23)$$

where t_{os} = out-of-service time
 t_{bw} = time for backwashing, 5 to 15 min
 t_r = time for regeneration, 30 to 60 min
 t_{sr} = time for slow rinse, 10 to 30 min
 t_{fr} = time for fast rinse, 5 to 15 min

Using the maximum estimate for each of these steps, the total out-of-service time is about two hours.

Example 8-3. An alternative three column design for Hard Times (Example 8-2) is to be evaluated. In this alternative, the columns will be in series and exhaustion of the resin is the “design breakthrough.” The total out-of-service time is estimated to be two hours.

Solution:

- a. The mass of resin is divided equally between the three columns.
- b. Using the total meq from step h in Example 8-2, the meq of hardness to be removed in one column at bed exhaustion is

$$\frac{1.37 \times 10^6 \text{ meq}}{3} = 4.57 \times 10^5 \text{ meq}$$

- c. The time for one bed to become exhausted at a flow rate of 208.5 m³/d (step f in Example 8-2) is

$$\frac{4.57 \times 10^5 \text{ meq}}{(6.572 \text{ meq/L})(208.05 \text{ m}^3/\text{d})(1,000 \text{ L/m}^3)} = 0.33\text{d or } 8 \text{ h}$$

- d. If breakthrough is 67% of the exchange capacity, the time to breakthrough is

$$\frac{(0.67)(4.57 \times 10^5 \text{ meq})}{(6.572 \text{ meq/L})(208.05 \text{ m}^3/\text{d})(1,000 \text{ L/m}^3)} = 0.22\text{d or } 5.4 \text{ h}$$

- e. The third column in the series can be regenerated in two hours. Therefore, this design will work because the third column can be brought on-line before breakthrough occurs in the second column.

Vessel Design

While pressurized tanks are used for small ion exchange columns, gravity flow is used in larger applications. Fiberglass and steel are the usual tank materials. Fiberglass tanks are generally limited to about 2.5 m in diameter, pressures under 1,000 kPa, and temperatures under 40°C. Prefabricated steel tanks may be up to 3.6 m in diameter. Steel tanks must be lined and often are more expensive than fiberglass.

Column heights are generally less than 4 m. Multiple columns in series are used if greater height is required. The height of the bed to diameter ratio is usually in the range of 0.2:1 to 3:1 (Clifford, 1999; Reynolds and Richards, 1996). Resin bed depths of less than 0.9 m are not recommended to avoid premature breakthrough due to nonideal resin bed behavior (GLUMRB, 2003). Resin bed depths greater than 4 m are generally avoided because of pressure drop limitations of the resin. The column height must be sufficient for expansion of the bed during backwashing. The dimensional limits of prefabricated units are usually governed by roadway constraints for underpasses and turning radii.

Table 8-3 summarizes the typical design criteria used in sizing the tank. Example 8-4 illustrates the design of the vessel.

TABLE 8-3
Typical range of design criteria used in sizing ion exchange columns and vessels

Parameter	Range of values	Comment
Pressure drop	35–70 kPa	135 kPa maximum
Diameter (D)	< 2.5 m	Fiberglass tanks
	< 3.6 m	Steel tanks
Height (H) of resin	≥ 0.9 m	To avoid premature breakthrough
	and ≤ 4 m	To limit pressure drop
$H:D$ of resin bed	1.5:1 to 3:1	
Expansion of resin bed	$\leq 100\%$	Typically < 50%
Height of column height	≤ 4 m	Use columns in series for greater height

Sources: GLUMRB, 2003; Gottlieb, 2005; Reynolds and Richards, 1996.

Example 8-4. Design the tank for the Hard Times (Examples 8-2 and 8-3) ion exchange column. The following design parameters have been established for the initial trial design:

$$\text{Resin shipping weight (moist)} = 800 \text{ kg/m}^3$$

Solution:

- a. The Solver* program in a spreadsheet was used to perform the iterations for solution of this problem. The spreadsheet cells are shown in Figure 8-7. **The values shown in the figure are the final solver solution.** The cell locations used in the figure are identified by brackets [] in the discussion below.
- b. Begin with the input data by setting the following:
 - [B5] $Q = 275 \text{ m}^3/\text{d}$ (from Example 8-2)
 - [B6] Resin mass = 750 kg (on moist basis from Example 8-2)
 - [B7] Shipping weight = 800 kg/m^3 (on moist basis given in the problem statement)
 - [B8] Surface loading rate = $408 \text{ m}^3/\text{d} \cdot \text{m}^2$ (Any rate between 400 and 800 may be selected as the starting point. The value shown here is the first guess. The value shown in the spreadsheet is the final Solver value.)
- c. Compute the volume of the media in cell [B13] as

$$= \frac{[\text{B6}]}{[\text{B7}]} = \frac{750 \text{ kg}}{800 \text{ kg/m}^3} = 0.94 \text{ m}^3$$

*Solver is a “tool” in Excel®. Other spreadsheets may have a different name for this program.

	A	B	C	D	E	F	G
1	Example 5-3 IX column dimensions						
2							
3	Input Data					Criteria	
4							
5	Q	275	m ³ /d				
6	Resin mass	750	kg	on moist basis			
7	Shipping weight	800	kg/m ³	on moist basis			
8	SLR	400	m ³ /d - m ²			>= 400 and <800	
9							
10							
11	<i>Compute volume of media</i>						
12							
13	V =	0.94	m ³				
14							
15	<i>Compute diameter of column</i>						
16							
17	Area =	0.69	m ²				
18							
19	Diameter =	0.94	m			< 3.6 m for steel tank	
20							
21	<i>Compute height of column</i>						
22							
23	H =	1.36	m			>0.9 m and <4.0 m	
24							
25	Check ratio						
26							
27	H:D =	1.46				>0.2 and < 3	
28							
29							
30	Solver parameters						
31							
32	Target cell	B27					
33	Equal to	min					
34	By changing	B8					
35	Subject to constraints						
36		B8	>=400				
37		B8	<=800				
38		B19	<= 3.6				
39		B23	<= 4.0				
40		B23	>=0.9				
41		B27	<=3				
42		B27	>=0.2				

Solver parameters

Set target cell:

Equal to: Max Min value of:

By changing cells:

B8

Subject to the constraints:

B19 <= 3.6

B23 <= 4.0

B23 >= 0.9

B27 <= 3.0

B27 >= 0.2

B8 <= 800

B8 >= 400

FIGURE 8-7
Example 8-4 spread sheet with Solver dialog box.

d. Compute the the area in [B17].

$$= \frac{[B5]}{[B8]} = \frac{275 \text{ m}^3/\text{d}}{408 \text{ m}^3/\text{d} \cdot \text{m}^2} = 0.67 \text{ m}^2$$

e. And then the diameter of the column in [B19].

$$= \left(\frac{[B17] \cdot 4}{3.1416} \right)^{0.5} = 0.93 \text{ m}$$

f. Compute the height of the column in cell [B23].

$$= \frac{[B13]}{[B17]} = \frac{0.94 \text{ m}^3}{0.67 \text{ m}^2} = 1.40 \text{ m}$$

g. Check the $H:D$ ratio.

$$= \frac{[B23]}{[B19]} = \frac{1.40 \text{ m}}{0.93 \text{ m}} = 1.50$$

h. Activate the dialog box for Solver and designate the target cell [B27], that is, the one for the height to diameter ratio ($H:D$).

i. Set *Equal to* to “Min.”

j. Set *By changing* to the cell containing the surface loading rate (SLR), that is, [B8].

k. Add the following four *constraints* in the dialog box:

(1) SLR

$$[B8] \leq 800$$

$$[B8] \geq 400$$

(2) Diameter

$$[B19] \leq 3.6 \text{ m}$$

(3) Height

$$[B23] \leq 4.0$$

$$[B23] \geq 0.9$$

(4) $H:D$ ratio

$$[B27] \leq 3$$

$$[B27] \geq 0.2$$

l. Execute solve to find the $\text{SLR} = 400 \text{ m}^3/\text{d} \cdot \text{m}^2$.

m. With resin column volume, check the EBCT.

$$\text{EBCT} = \frac{0.94 \text{ m}^3}{275 \text{ m}^3/\text{d}} = 0.0034 \text{ d or } 4.92 \text{ or } 4.9 \text{ min}$$

This is within the typical range of 1.5 to 7.5 min.

- n. Check the SFR

$$\text{SFR} = \frac{275 \text{ m}^3/\text{d}}{0.94 \text{ m}^3} = 292.55 \text{ or } 290 \text{ m}^3/\text{d} \cdot \text{m}^3 \text{ of water}$$

This is within the typical range of 200 to 1,000 $\text{m}^3/\text{d} \cdot \text{m}^3$.

- o. Check the pressure drop. Using Figure 8-6 and the operating temperature of 10°C from Example 8-2, the pressure drop at a surface loading rate of $400 \text{ m}^3/\text{d} \cdot \text{m}^2$ is about 37 kPa/m and the total pressure drop is $(1.36 \text{ m})(37 \text{ kPa/m}) = 50.3 \text{ kPa}$. This is within the typical range of 35 to 70 kPa and is less than the maximum of 140 kPa.
- p. Allowing for 50% expansion of the resin bed, the tank height will be

$$\text{Height of tank} = (1.5)(1.36 \text{ m}) = 2.04 \text{ or } 2.1 \text{ m}$$

This is less than the maximum of 3.6 m for prefabricated tanks and is acceptable.

Comment: Normally, one would not check both the EBCT and SFR as they are reciprocal of each other. The check is performed in this example for academic demonstration and to provide some experience with the the magnitude of the numbers and their relationship to one another.

Piping

PVC piping is most common for smaller systems. Either plastic-lined or stainless steel is used for larger systems.

Brine Disposal

Historically, brine has been disposed to the sanitary sewer system. For small household units, the impact on the wastewater treatment plant will not be significant. For larger municipal systems the problem is much more significant. Those communities near the ocean have it as an option for disposal. Deep well injection into a saline aquifer is another alternative as is evaporation. All of these options are highly site specific.

Because the issue of brine disposal is significant, the examination of the option of ion exchange as a treatment technology should consider the disposal alternatives and costs very early in the design process.

8-5 OPERATION AND MAINTENANCE

The major operational requirements in addition to routine monitoring are preparation of the regenerant and conducting the regeneration. Often these are automated.

In addition to routine maintenance of valves and pumps, periodic resin cleaning and/or replacement will be required. Resin cleaning may require eight or more hours of out-of-service time for the column. Extraordinary regeneration of the resin may be required after cleaning. The cleaning agents are hazardous and may be incompatible with the column materials.

Resin life for cation resins is on the order of 10 years for softening and 3 to 5 years for anion exchanger resins. Shorter resin life can be expected where the water fouls the resin.

Visit the text website at www.mhprofessional.com/wwe for supplementary materials and a gallery of photos.

8-6 CHAPTER REVIEW

When you have completed studying this chapter, you should be able to do the following without the aid of your textbooks or notes:

1. Explain the difference between a strong cation exchange resin and an weak cation exchange.
2. Given the separation factors for several cations, identify those that will be adsorbed in preference with respect to the others.
3. Explain why high pressure drops through the resin bed are detrimental to ion exchange performance and operating life.
4. Explain why multiple columns in series are preferred over a single column with the same resin mass.
5. Sketch a three-column “merry-go-round” bed arrangement and explain how it works to a client.
6. Select a softening ion exchange resin from breakthrough curves for several resins treating the same raw water source.
7. Define the following abbreviations: EBCT, SFR, SLR.
8. Explain why ion exchange may be of benefit in removing constituents of concern other than calcium and magnesium.

With the use of this text, you should be able to do the following:

9. Given a table of screen sizes and a manufacturer’s specification, identify the largest and smallest diameter resin particle that is being marketed.
10. Estimate the maximum volume of water per liter of resin that can be treated given the total capacity of the resin and the concentration of the ions to be treated.
11. Calculate the fraction of the “split” for an ion exchange softening system.
12. Calculate EBCT, SFR, and SLR given appropriate data.
13. Design an ion exchange column including estimating the resin volume to treat a water given the breakthrough data and the volume of water to be treated or the flow rate and cycle time for regeneration.
14. Determine the number of columns and sequence of their use given the cycle time of a single resin column.

8-7 PROBLEMS

- 8-1. Estimate the maximum volume of water per liter of resin that can be treated by a strong acid exchange resin in the hydrogen form if the resin has total capacity of 2.0 eq/L, the magnesium concentration is 1.4 meq/L, and the sodium concentration is 2.6 meq/L. Assume no other cations are in the solution.

- 8-2.** A pilot scale ion exchange column was used to develop design data for a softening system for the Village of Calcite. The data are shown below. The design flow rate is 4,000 m³/d. The design final hardness is 120 mg/L as CaCO₃. Regeneration is to be once per day. The manufacturer's operating capacity to breakthrough is 60%. Assume a two-column system: one in service and one in regeneration or standby. Also assume that there is no leakage before breakthrough. Use the mass balance technique to determine the mass of resin that will be required.

Raw water data:

$$\text{Ca}^{2+} = 444.5 \text{ mg/L as CaCO}_3$$

$$\text{Mg}^{2+} = 66.7 \text{ mg/L as CaCO}_3$$

$$\text{Operating temperature} = 10^\circ\text{C}$$

Iron and turbidity concentrations are negligible

Pilot scale column data:

$$\text{Column diameter} = 10.0 \text{ cm}$$

$$\text{Column height} = 150.0 \text{ cm}$$

$$\text{Resin density} = 0.70 \text{ g/cm}^3 \text{ on a moist basis}$$

$$\text{Moisture content} = 48\%$$

$$\text{Flow rate through the column} = 0.25 \text{ m}^3/\text{h}$$

Pilot scale breakthrough data for Calcite raw water

Volume, m ³	Effluent concentration, meq/L
0.5	0
1.0	0
1.5	0
2.0	0
2.1	0.05
3.0	0.46
3.5	1.05
4.0	2.00
4.5	3.20
5.0	4.90
5.35	6.00
5.45	6.40
5.5	6.70
5.6	7.00
5.7	7.40
5.8	7.80
5.9	8.20
6.0	8.50
6.4	9.00
7.0	9.70
7.5	10.0

- 8-3. Repeat Problem 8-2 assuming column leakage is 5.0 mg/L as CaCO₃.
- 8-4. Repeat Problem 8-2 assuming a three column system in series and operation of the “lead” column until the bed is exhausted. Assume the total out-of-service time is two hours.
- 8-5. A pilot scale ion exchange column was used to develop design data for a softening system for the Village of Dolomite. The data are shown below. The design flow rate is 7,000 m³/d. The design final hardness is 120 mg/L as CaCO₃. Regeneration is to be once per day. The manufacturer’s operating capacity to breakthrough is 50%. Assume a two-column system and that there is no leakage before breakthrough. Use the mass balance technique to determine the mass of resin that will be required.

Raw water data:

$$\text{Ca}^{2+} = 111.0 \text{ mg/L as CaCO}_3$$

$$\text{Mg}^{2+} = 131.8 \text{ mg/L as CaCO}_3$$

Operating temperature = 5°C

Iron and turbidity concentrations are negligible

Pilot scale column data:

Column diameter = 10.0 cm

Column height = 150.0 cm.

Resin density = 0.80 g/cm³ on a moist basis

Moisture content = 70%

Flow rate through the column = 0.25 m³/h

Pilot scale breakthrough data for Dolomite raw water

Volume, m ³	Effluent concentration, meq/L
0.0	0.0
0.1	0.0
0.25	0.0
0.50	0.0
1.0	0.0
2.0	0.0
2.25	0.0
2.5	0.0
3.0	0.1
3.3	0.6
3.4	1.05
3.5	1.58
3.6	2.37
3.7	3.09
3.8	3.49
4.0	4.33

- 8-6. Repeat Problem 8-5 assuming column leakage is 10.0 mg/L as CaCO₃.

- 8-7.** Repeat Problem 8-5 assuming a three-column system in series and operation of the “lead” column until the bed is exhausted. Assume the total out-of-service time is three hours.
- 8-8.** Continuing the design of the ion exchange column for the Village of Calcite, provide the following for the two-bed system that will operate in parallel with staggered regeneration cycles:
- Surface loading rate ($\text{m}^3/\text{d} \cdot \text{m}^2$)
 - Height and diameter of the resin bed
 - Empty bed contact time (min)
 - Service flow rate ($\text{m}^3/\text{d} \cdot \text{m}^3$)
 - Height and diameter of the column vessel
 - Pressure drop

Assume the density of the resin is 830 kg/m^3 (moist), a resin height less than or equal to 4.0 m, and that 50% expansion of the bed will be used during backwash. The pressure drop across the bed should be less than 140 kPa.

- 8-9.** Repeat Problem 8-8 using the three bed system designed in Problem 8-4.
- 8-10.** Continuing the design of the ion exchange column for the Village of Dolomite, provide the following for the two-bed system that will operate in parallel with staggered regeneration cycles:
- Surface loading rate ($\text{m}^3/\text{d} \cdot \text{m}^2$)
 - Height and diameter of the resin bed
 - EBCT
 - Service flow rate ($\text{m}^3/\text{d} \cdot \text{m}^3$)
 - Height and diameter of the column vessel
 - Pressure drop

Assume the density of the resin is 850 kg/m^3 (moist), a resin height less than or equal to 4.0 m, and that 50% expansion of the bed will be used during backwash. The pressure drop across the bed should be less than 140 kPa.

- 8-11.** Repeat Problem 8-10 using the three-bed system designed in Problem 8-7.

8-8 DISCUSSION QUESTION

- 8-1.** Two pilot ion exchange columns treating the same raw water in a parallel operation yielded the breakthrough curves shown below. Assuming the resins are equally priced, which resin would you choose? Explain your choice.

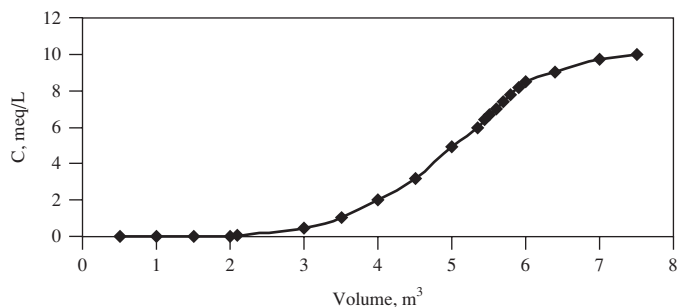

(a)

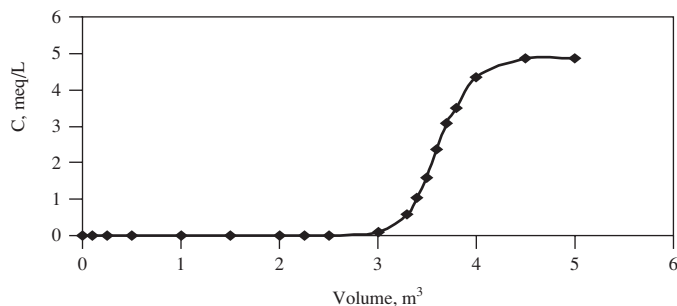

(b)

8-9 REFERENCES

- Brown, C. J. (1998) "Ion Exchange," in H. M. Freeman (ed.) *Standard Handbook of Hazardous Waste Treatment and Disposal*, McGraw-Hill, New York, pp. 6.57–6.85.
- Clifford, D. A. (1999) "Ion Exchange and Inorganic Adsorption," in R. D. Letterman (ed.) *Water Quality and Treatment*, 5th ed., American Water Works Association, McGraw-Hill, New York, pp. 9.1–9.91.
- GLUMRB (2003) *Recommended Standards for Water Works*, Great Lakes–Upper Mississippi River Board of State and Provincial Public Health and Environmental Managers, Health Education Services, Albany, New York, pp. 35–38, 66–80.
- Gottlieb, M. C. (2005) "Ion Exchange Applications in Water Treatment," in E. E. Baruth (ed.), *Water Treatment Plant Design*, McGraw-Hill, New York, pp. 12.1–12.61.
- Helferich, F. (1962) *Ion Exchange*, McGraw-Hill, New York.
- MWH (2005) *Water Treatment: Principles and Design*, John Wiley & Sons, Hoboken, New Jersey, pp. 957, 1371, 1403, 1431, 1445, 1472, 1564.
- Reynolds, T. D. and P. A. Richards (1996) *Unit Operations and Processes in Environmental Engineering*, PWS Publishing, Boston, pp. 379–380.
- Treybal, R. E. (1968) *Mass Transfer Operations*, McGraw-Hill, New York, pp. 253, 535.
- U.S. EPA (1981) *Development Document for Effluent Limitations: Guideline and Standards for the Metal Finishing Point Source Category*, U.S. Environmental Protection Agency Publication no. EPA/440/1-83-091, Washington, D.C.

This page intentionally left blank

REVERSE OSMOSIS AND NANOFILTRATION

9-1 INTRODUCTION

9-2 THEORY

9-3 PROPERTIES OF RO AND NF MEMBRANES

9-4 RO AND NF PRACTICE

9-5 ELECTRODIALYSIS

9-6 CHAPTER REVIEW

9-7 PROBLEMS

9-8 DISCUSSION QUESTION

9-9 REFERENCES

9-1 INTRODUCTION

Delineation of Membrane Processes

Reverse osmosis (RO), nanofiltration (NF), and electrodialysis are membrane processes that use the differences in permeability of water constituents as a separation technique. The membrane is a synthetic material that is *semipermeable*; that is, it is highly permeable to some constituents and less permeable to others. To remove a constituent from the water, the water is pumped against the surface of a membrane resulting in a separation of product and waste streams as shown in Figure 9-1.

Four types of pressure driven membranes are generally recognized: microfiltration (MF), ultrafiltration (UF), nanofiltration (NF), and reverse osmosis (RO). The hierarchy of the processes is identified by the types of materials rejected, operating pressures, and nominal pore sizes on an order-of-magnitude basis. These are shown schematically in Figure 9-2. Unlike NF/RO that are pressure driven, electrodialysis (ED) and electrodialysis reversal (EDR) processes are electrical voltage-driven.

The focus of the discussion for this chapter is RO and NF because they remove ions and have been used widely in softening water. MF and UF separate suspended particles (colloidal matter, microorganisms, and viruses) from the water. They are discussed in Chapters 12 and 26. ED/EDR are reviewed briefly.

In the past, there was a distinction made between RO and NF membranes based on their original manufactured properties and permeation capabilities. The differences have blurred with the introduction of new RO membranes. The new RO membranes, called “loose” RO, “softening membranes,” and “low-pressure” RO, have discriminating characteristics similar to the NF membranes. Although the distinctions are important from a theoretical point of view, the remainder of the discussion will treat NF/RO systems together for design and operational considerations.

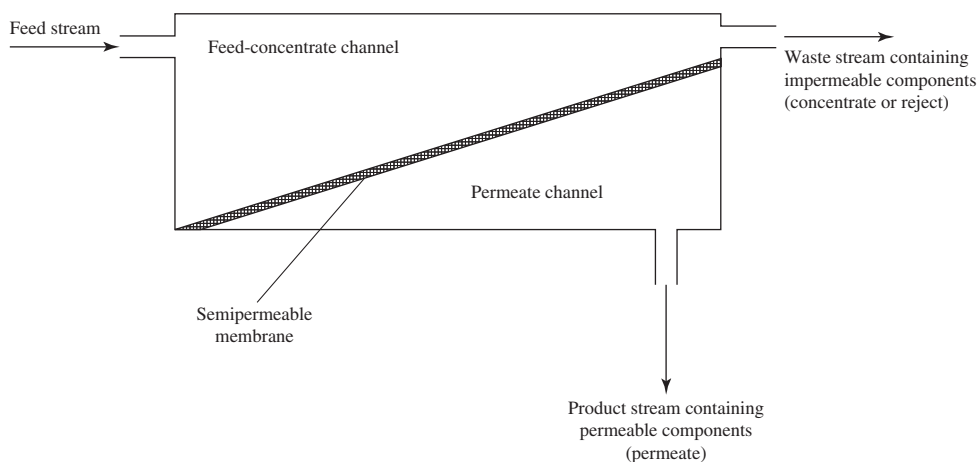
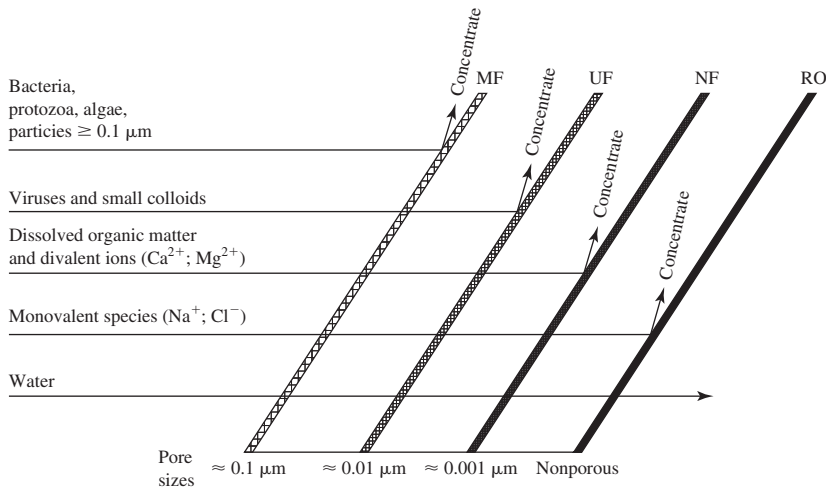

FIGURE 9-1

Schematic of separation process through reverse osmosis or nanofiltration membrane.

**FIGURE 9-2**

Common constituents removed by membrane processes.

MF = microfiltration;

UF = ultrafiltration;

NF = nanofiltration;

RO = reverse osmosis.

9-2 THEORY

Osmosis

Osmosis is defined as the spontaneous transport of a solvent (in this case, water) from a dilute solution to a concentrated solution across an ideal *semipermeable membrane* that impedes passage of the *solute* (ions in solution) but allows the *solvent* (water) to flow. This is shown schematically in Figure 9-3. The system will reach equilibrium when the hydrostatic pressure on the saline water side balances the force moving the water through the membrane. This is noted as the *osmotic pressure* in Figure 9-3b. If pressure is exerted to overcome the osmotic pressure, the solvent (pure water) will flow from the saline side to the fresh water side. The semipermeable membrane will not allow the passage of molecules other than water and gases. This is noted as *reverse osmosis* in Figure 9-3c.

Osmotic Pressure

The driving force for diffusion is typically described as a concentration gradient. A more rigorous explanation is a gradient in Gibbs energy. The general form of the Gibbs function is

$$\partial G = \forall \partial P - S \partial T + \sum u_i^\circ \partial n_i \quad (9-1)$$

where G = Gibbs energy, J

\forall = volume, m³

P = pressure, Pa

S = entropy, J/K

T = absolute temperature, K

u_i° = chemical potential of solute i , J/mole

n_i = amount of solute i in solution, moles

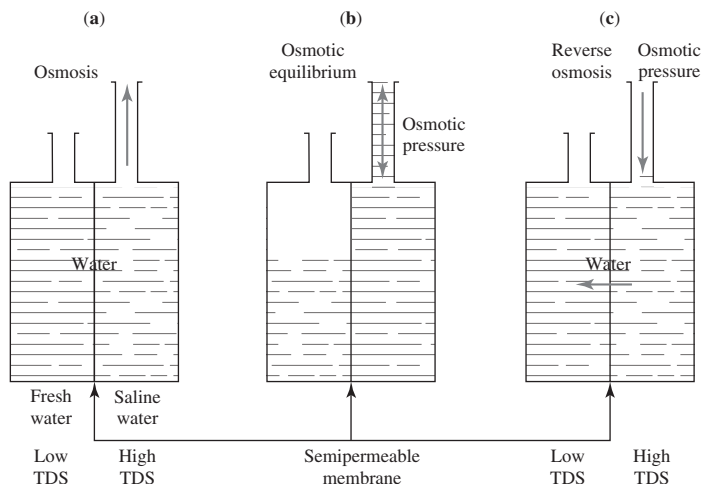
**FIGURE 9-3**

Direct and reverse osmosis. (Source: Davis and Cornwell, 2008.)

Chemical potential is defined as the change in Gibbs energy resulting from a change in the amount of component i when the temperature and pressure are held constant

$$u_i^\circ = \frac{\partial G}{\partial n_i} \quad (9-2)$$

Thus, under constant temperature conditions, equilibrium ($\partial G = 0$) will be achieved when

$$\forall \partial P = -\sum u_i^\circ \partial n_i \quad (9-3)$$

The pressure (∂P) to balance the difference in chemical potential of a solute is called the *osmotic pressure* (MWH, 2005). By convention it is given the symbol π . The equation for osmotic pressure can be derived thermodynamically using assumptions of incompressible and ideal solution behavior:

$$\pi = i\varphi CRT \quad (9-4)$$

where i = number of ions produced during dissociation of solute

φ = osmotic coefficient, unitless

C = concentration of all solutes, moles/L

R = universal gas constant, $8.314 \text{ kPa} \cdot \text{m}^3/\text{kg mole} \cdot \text{K}$

T = absolute temperature, K

The number of ions per mole, i , for example would be 2 for NaCl. The osmotic coefficient, φ , depends on the nature of the substance and its concentration. For NaCl it ranges from 0.93 to 1.03 over a concentration range of 10 to 120 g/L of salt. Seawater has an osmotic coefficient that varies from 0.85 to 0.95 for the same concentration range. Robinson and Stokes (1959) provide osmotic coefficients for a variety of electrolytes.

Flux

Several models have been developed to describe the flux of water ($\text{m}^3/\text{d} \cdot \text{m}^2$ of membrane surface area) and solutes ($\text{kg}/\text{m}^2 \cdot \text{d}$) through the RO membrane. Because there is some controversy about the mechanics of permeation, these are presented in summary here. For more details see MWH (2005). The models are:

- **Solution-diffusion model:** Permeation occurs through a dense membrane where the active layer is permeable but nonporous. Water and solutes dissolve into the solid membrane material, diffuse through the solid, and reemerge on the permeate side of the membrane. Separation occurs when the flux of the water is different from the flux of the solutes.
- **Pore flow model:** This model assumes the RO membranes have void spaces (pores) through which the liquid water travels. It considers the water and solute fluxes to be coupled. Rejection occurs because the solute molecules are “strained” at the entrance to the pores. Because the solute and water molecules are similar in size, the rejection mechanism is not a physical sieving but rather a chemical effect such as electrostatic repulsion.
- **Preferential sorption-capillary flow model:** This model assumes the membrane has pores. Separation occurs when one component of the feed solution (either solute or water) is preferentially adsorbed on the pore walls and is transported through the membrane by surface diffusion.

Ultimately, these models express flux as the product of a mass transfer coefficient and a driving force. The water flux is

$$J_w = k_w(\Delta P - \Delta\pi) \quad (9-5)$$

where J_w = volumetric flux of water, $\text{m}^3/\text{d} \cdot \text{m}^2$

k_w = mass transfer coefficient for water flux, $\text{m}^3/\text{d} \cdot \text{m}^2 \cdot \text{kPa}$

ΔP = net transmembrane pressure, kPa

$\Delta\pi$ = difference in osmotic pressure between the feed and the permeate, kPa

The driving force for the solute flux is the concentration gradient. The solute flux is

$$J_s = k_s(\Delta C) \quad (9-6)$$

where J_s = mass flux of solute, $\text{kg}/\text{d} \cdot \text{m}^2$

k_s = mass transfer coefficient for solute flux, $\text{m}^3/\text{d} \cdot \text{m}^2$

ΔC = concentration gradient across the membrane, kg/m^3

The flux of solutes through the membrane is

$$J_s = C_p J_w \quad (9-7)$$

where C_p = solute concentration in the permeate, kg/m^3 .

The *recovery* (r) is the ratio of permeate flow to feed water flow:

$$r = \frac{Q_P}{Q_F} \quad (9-8)$$

The flow balance and mass balance are

$$Q_F = Q_P + Q_C \quad (9-9)$$

$$C_F Q_F = C_P Q_P + C_C Q_C \quad (9-10)$$

where the subscripts refer to feed water (F), permeate (P), and concentrate (C).

Rejection is defined as

$$Rej = 1 - \frac{C_P}{C_F} \quad (9-11)$$

With an assumption that the rejection is close to 100 percent, these equations can be solved for the concentrate concentration:

$$C_C = C_F \left(\frac{1}{r} \right) \quad (9-12)$$

9-3 PROPERTIES OF RO AND NF MEMBRANES

Membrane Material

The materials most widely used in RO and NF are cellulosic derivatives and polyamide derivatives.

Cellulosic acetate (CA), the common commercial material, is not tolerant to temperatures above 30°C and tends to hydrolyze when the pH is less than 3 or greater than 8. It is susceptible to biological degradation and degrades with free chlorine concentrations above 1 mg/L. Most membrane manufacturers guarantee integrity of membranes if the chlorine concentration and contact time are within specified limits.

Polyamide (PA) membranes are generally resistant to biological degradation, are stable over a pH range of 3 to 11, and do not hydrolyze in water. Under similar pressure and temperature conditions, PA membranes can produce higher water flux and higher salt rejection than CA membranes. However, PA membranes are more susceptible to fouling and cannot tolerate free chlorine at any concentration (MWH, 2005).

Membrane Configuration

The membrane units are fabricated in either a spiral-wound configuration or a hollow-fiber configuration.

The spiral-wound configuration is shown in Figure 9-4. Two sheets of flat-sheet membrane are joined along three sides with the active membrane layer facing out. A spacer is placed between the membrane sheets to keep them from touching. The open end of the envelope formed by the two sheets is attached to a perforated central tube that collects the permeate. The spiral-wound elements are typically 1 m long and 0.3 m in diameter. The area for a 1 m long element would be about 30 m². Individual elements have a permeate recovery of 5 to 15 percent. To achieve higher recoveries, elements are placed in series. Typically, four to seven elements are arranged in series in a pressure vessel (MWH, 2005).

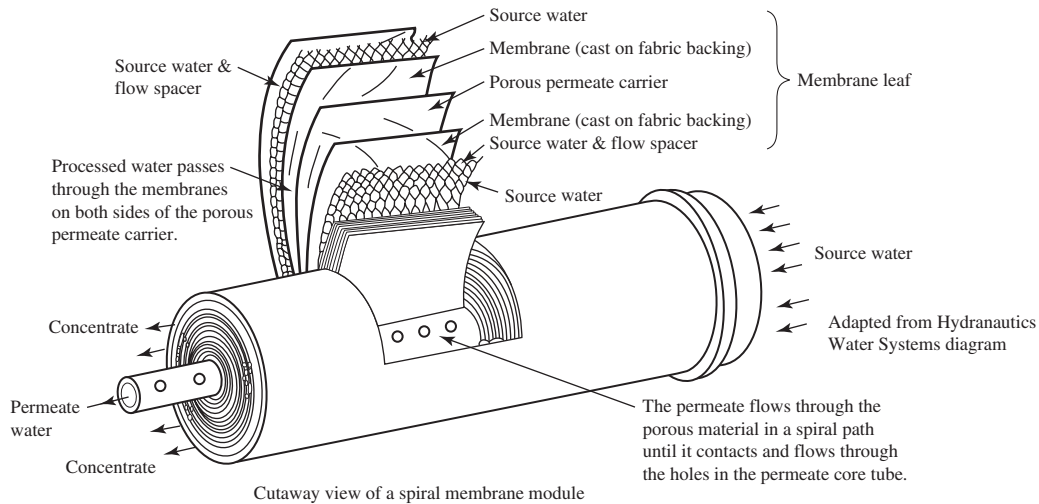
**FIGURE 9-4**

Typical spiral-wound RO membrane element.

(Source: U.S. AID, 1980.)

The hollow-fiber element has several hundred thousand fibers with outside diameters on the order of 0.085 mm suspended in a pressure vessel as shown in Figure 9-5. Permeate recovery is about 30 percent for each element.

The spiral-wound configuration is the most common for the production of drinking water from groundwater and surface water. The hollow-fiber configuration is used extensively for desalination of seawater in the Middle East (Taylor and Wiesner, 1999).

Temperature Effects

Temperature affects water viscosity and the membrane material. In general, the permeate flow increases as the temperature rises and the viscosity decreases. The relationship between membrane material, temperature, and flux is specific to individual products. Correction factors should be obtained from manufacturers (AWWA, 1999).

Service Life

Membrane fouling generally occurs by one of the following mechanisms (AWWA, 1999):

- Deposition of silt or other suspended solids.
- Inorganic scale deposits.
- Biological fouling.
- Interaction of organic constituents with the membrane.

Oxidation of the membrane from chlorination prior to ion exchange will significantly reduce the service life. This is especially true for PA membranes. If prechlorination is essential, CA resins are recommended (MWH, 2005).

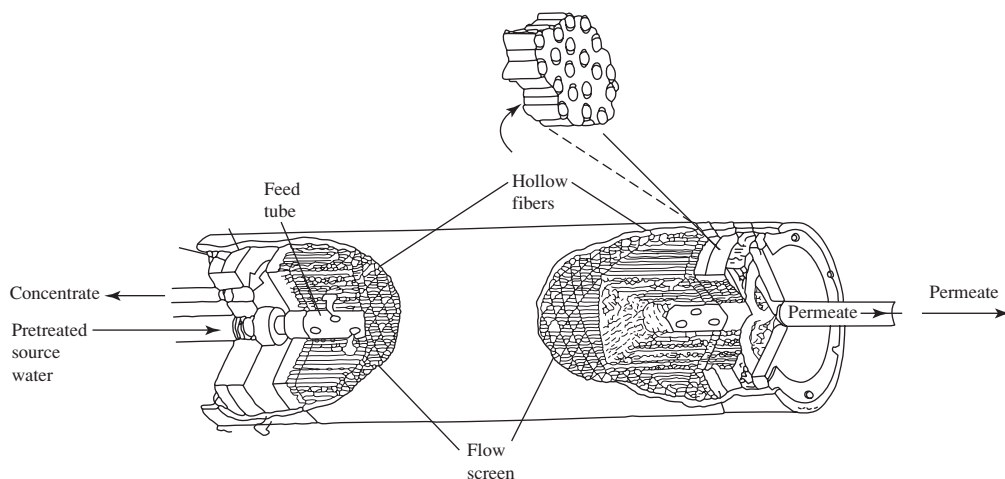

FIGURE 9-5
Typical hollow fiber NF/RO membrane module.
(Adapted from U.S. AID, 1980.)

Excessive concentrations of iron and manganese, if oxidized, will form precipitates that will foul the membrane. Scaling will also occur as a result of increasing recovery because the concentration of *limiting salts* will increase to their solubility limit, and they will precipitate. The most common scales of limiting salts are calcium carbonate and calcium sulfate. Others of concern are calcium fluoride, calcium orthophosphate, strontium sulfate, barium sulfate, and amorphous silica (MWH, 2005).

An additional negative impact is the result of the accumulation of solutes that form a boundary layer of high concentration at the membrane surface. The concentration at the surface of the membrane becomes higher than the concentration in the bulk feed water. This effect is called *polarization*. It has the following negative impacts (MWH, 2005):

- Water flux is lower because the osmotic pressure gradient is higher.
- Rejection is lower.
- Solubility limits of solutes are exceeded leading to precipitation and scaling.

These issues may be ameliorated by pretreatment of the raw water and operational procedures.

9-4 RO AND NF PRACTICE

Process Description

The smallest physical unit of production capacity is the *membrane element*. The membrane elements are enclosed in pressure vessels as shown in Figure 9-6. A group of pressure vessels operating in parallel is called a *stage*. The arrangement of one or more stages is called an *array*.

In a multistage process the stages are arranged in series. The number of pressure vessels decreases in each succeeding stage to maintain the water velocity in the feed channel as permeate is

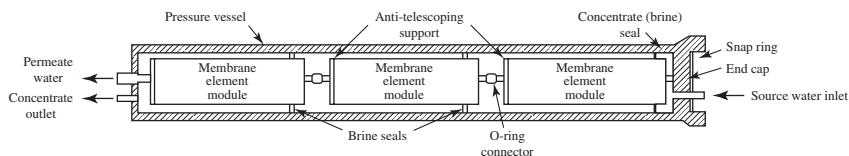
**FIGURE 9-6**

Cross section of pressure vessel with three spiral-wound RO elements.

(Source: U.S. AID, 1980.)

extracted. A two-stage arrangement is shown in Figure 9-7a and schematically in Figure 9-7b. A three-stage arrangement is shown schematically in Figure 9-7c.

A schematic of a typical RO or NF facility is shown in Figure 9-8.

Pretreatment

The first pretreatment is to prevent scaling by silica (SiO_2) and sparingly soluble salts such as calcium carbonate and calcium sulfate. Scale control consists of pH adjustment and/or addition of an antiscalant. Typically, the antiscalants are proprietary polymeric compounds.

Unlike ion exchange columns, RO/NF systems are not backwashed. Therefore, the second pretreatment process is filtration to remove particulate matter that will clog the feed channels or accumulate on the membrane surface. For surface water sources granular filtration or membrane filtration may be required. The minimum filtration requirement regardless of the water source is a cartridge filter rated in the 1 to 25 μm range with a typical rating of 5 μm . The maximum feed water turbidity recommended by manufacturers is 1 NTU with a preferred turbidity of less than 0.2 NTU (Bergman, 2005).

Disinfection may also be required to prevent biological fouling. Even though groundwater is expected to have a very low microbial population, when the membrane is out of service, the population on the membrane can quickly multiply. Chlorine solutions may be used for CA membranes, but other techniques such as ultraviolet irradiation, or chlorination followed by dechlorination are used for PA membranes.

Post-treatment

Because the RO/NF membranes do not remove gases, these are stripped after the RO/NF unit. The primary gases of concern are hydrogen sulfide and carbon dioxide. The removal of H_2S is to prevent odor complaints. CO_2 is removed because it forms carbonic acid.

The permeate has a low pH as a result of removal of alkalinity (buffering capacity) from the water and the addition of acid to prevent scaling. This water is corrosive to the distribution system. In addition to stripping CO_2 , addition of a base and corrosion inhibitor is generally required. Split treatment and blending may aid in corrosion control. Maximum Contaminant Limits (MCLs) for constituents such as arsenic must be considered if split treatment is part of the corrosion control strategy.

Concentrate Stream

The concentrate stream is under high pressure as it leaves the RO/NF unit. Energy recovery systems are often used in reducing the pressure.

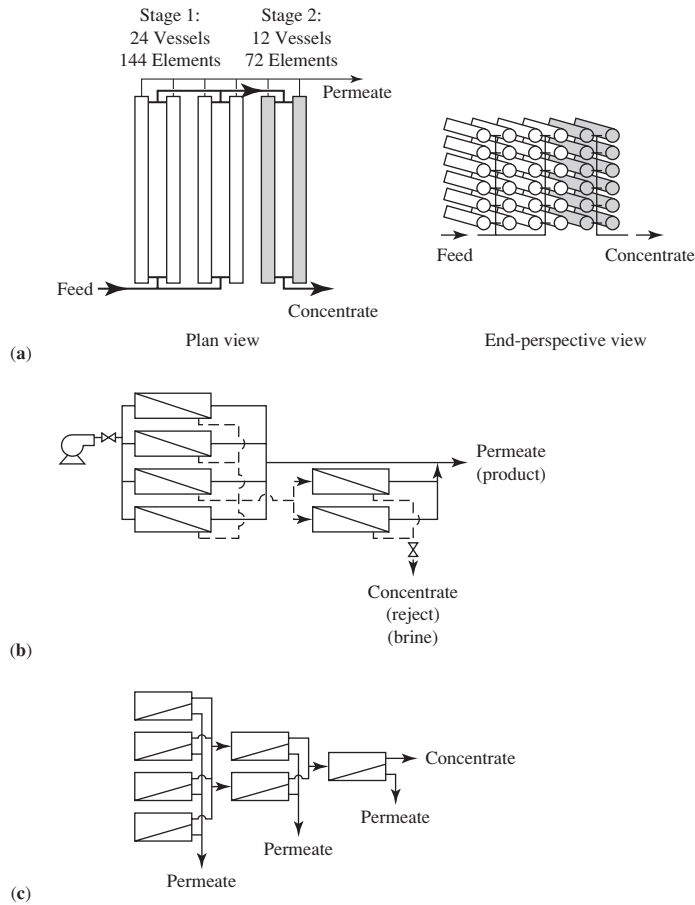

FIGURE 9-7
 Example array arrangements: (a) a 4×2 stage arrangement showing 12 pressure vessels, each with 6 elements per vessel; (b) a schematic of a 4×2 array; (c) a schematic of a $4 \times 2 \times 1$ array.

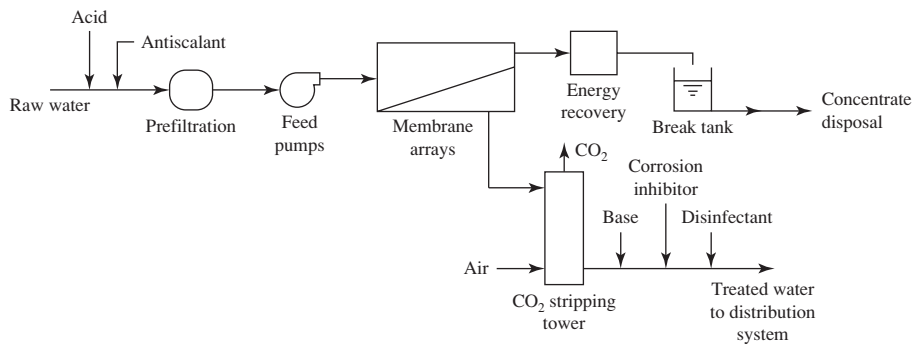

FIGURE 9-8
 Schematic of typical reverse osmosis facility.

TABLE 9-1
Typical NF/RO membrane process selections based on application

Raw water	Objective	Process
Groundwater	Softening	NF or “low-pressure” RO
Brackish water	Desalinization	RO, or “low-pressure” RO, NF
Seawater	Desalinization	RO
Surface water	NOM* removal	NF
Groundwater or surface water	Specific contaminant removal (i.e., arsenic, nitrate, radionuclides)	RO

*NOM = natural organic matter.

The concentrate itself is extremely high in total dissolved solids (TDS). Disposal methods include discharge to the municipal sewer system, ocean discharge, and deep well injection. In warm, dry climates evaporation ponds may be appropriate. As with ion exchange, disposal of the concentrate is a major issue in the selection of this technology and should be addressed early in the design process.

Process Design

Membrane Process Selection. As shown in Table 9-1 the initial choice of a conventional RO process or an NF (or low-pressure RO) is dependent on the raw water source and the product water quality objectives. Some preliminary design and economic analyses are required to refine the selection.

For water softening applications, the NF or low-pressure RO have some inherent advantages over conventional RO. As noted in Figure 9-2, these systems remove polyvalent ions (that is, those that cause hardness) but not monovalent ions. This results in a potential reduction in the TDS in the concentrate stream with a consequent amelioration of its disposal problems. In addition the operating pressures for NF and low-pressure RO are less than RO with a consequent reduction in energy operating costs.

If the feed water is not to be treated with chlorine, then a PA membrane is the typical membrane selected. If pretreatment with chlorine is required, then a CA membrane is more appropriate.

Side-by-side pilot testing of RO and/or NF units provides the best means of selecting an appropriate unit. Pilot testing will also provide information on chemical costs and concentrate disposal.

Operating Pressures. For NF membranes the feed water pressure ranges from 350 to 1,000 kPa. Low-pressure and brackish water RO units have feed water pressures in the range of 1,000 to 4,000 kPa. RO units treating seawater operate at pressures in the range of 5,500 to 8,500 kPa (Bergman, 2005).

Limiting Salt. The precipitation of salts as a result of concentrating the salt to its solubility limit is, in its simplest expression, a function of the permeate recovery rate (AWWA, 1999):

$$K_{sp} = \left[\frac{A^{p+}}{1-r} \right]^n \left[\frac{B^{q-}}{1-r} \right]^m \quad (9-13)$$

- where K_{sp} = solubility product
- A^{p+} = cation of salt, moles/L
- B^{q-} = anion of salt, moles/L
- n, m = number of moles
- r = permeate recovery ratio (also called “recovery rate”), decimal fraction

This expression is simplified because it does not account for activity coefficients. These, in turn, cannot be calculated until recovery is determined. Furthermore, carbonate and phosphate concentrations are dependent on pH. Equation 9-13 will be used for illustrative purposes here but, in actual design, computer programs supplied by manufacturers are used to perform the calculation.

Permeate recoveries can be improved by pretreating with acid and polymeric antiscalants. The estimation of the limiting salt and the improvement in recovery by pretreatment with acid is illustrated in the next two examples.

Example 9-1. Estimate the recovery rate for a groundwater with the following characteristics:

- $Ca^{2+} = 95.2 \text{ mg/L}$
- $CO_3^{2-} = 0.78 \text{ mg/L}$
- Alkalinity = 310 mg/L as $CaCO_3$
- pH = 7.65

Solution:

- a. From Appendix A, $K_{sp} = 4.95 \times 10^{-9}$.
- b. Convert the concentrations to moles/L.

$$\frac{95.2 \text{ mg/L}}{40 \times 10^3 \text{ mg/mole}} = 2.38 \times 10^{-3} \text{ moles/L of } Ca^{2+}$$

$$\frac{0.78 \text{ mg/L}}{60 \times 10^3 \text{ mg/mole}} = 1.3 \times 10^{-5} \text{ moles/L of } CO_3^{2-}$$

- c. Solve Equation 9-13 for r .

$$4.95 \times 10^{-9} = \left[\frac{2.38 \times 10^{-3} \text{ moles/L}}{1-r} \right]^2 \left[\frac{1.3 \times 10^{-5} \text{ moles/L}}{1-r} \right]$$

$$(1-r)^2 = \frac{3.09 \times 10^{-8}}{4.95 \times 10^{-9}} = 6.25$$

$$1-r = 2.5$$

$$r = -1.5$$

- d. This indicates that the solubility will be exceeded and no recovery is possible.

Comments:

1. As noted above, for an accurate answer, the activity must be taken into account. Recovery will increase the total dissolved solids (TDS) and, in turn, increase the ionic strength. Increasing the ionic strength increases the solubility (Taylor and Wiesner, 1999).

Example 9-2. Estimate the dose of sulfuric acid required to achieve a product water recovery rate of 75% for the water in Example 9-1. Assume the acid is a 100% solution.

Solution:

- a. Convert the alkalinity in Example 9-1 to moles/L.

$$(310 \text{ mg/L as CaCO}_3) \left(\frac{61 \text{ g/eq HCO}_3^-}{50 \text{ g/eq CaCO}_3} \right) = 378.2 \text{ mg/L as HCO}_3^-$$

$$\frac{378.2 \text{ mg/L as HCO}_3^-}{61,000 \text{ mg/mole}} = 6.2 \times 10^{-3} \text{ moles/L}$$

- b. Write the second dissociation of carbonic acid in terms of the carbonate. From Appendix A, the dissociation constant pK_2 is 10.33.

$$\text{CO}_3^{2-} = \frac{K_2[\text{HCO}_3^-]}{[\text{H}^+]}$$

$$K_2 = 10^{-10.33}$$

$$\text{CO}_3^{2-} = \frac{10^{-10.33}[6.2 \times 10^{-3} \text{ moles/L}]}{[\text{H}^+]}$$

- c. Substitute this expression for CO_3^{2-} in Equation 9-13:

$$4.95 \times 10^{-9} = \left[\frac{2.38 \times 10^{-3} \text{ moles/L}}{1-r} \right] \left[\frac{10^{-10.33}[6.2 \times 10^{-3} \text{ moles/L}]}{[\text{H}^+] (1-r)} \right]$$

With an assumed product water recovery rate of 75%, $r = 0.75$, and the equation may be rewritten as

$$4.95 \times 10^{-9} = \left[\frac{2.38 \times 10^{-3} \text{ moles/L}}{0.25} \right] \left[\frac{10^{-10.33}[6.2 \times 10^{-3} \text{ moles/L}]}{[\text{H}^+] 0.25} \right]$$

d. Solving for $[H^+]$,

$$\begin{aligned} [H^+] &= \frac{[9.52 \times 10^{-3} \text{ moles/L}][1.16 \times 10^{-12} \text{ moles/L}]}{4.95 \times 10^{-9}} \\ &= 2.23 \times 10^{-6} \end{aligned}$$

and the $\text{pH} = -\log [H^+] = 5.65$.

e. The acid dose must be sufficient to convert the bicarbonate to carbonic acid at a pH of 5.65. Using the equilibrium expression for the first dissociation of carbonic acid and finding $\text{p}K_{a1} = 6.35$ from Appendix A,

$$K_{a1} = \frac{[H^+][HCO_3^-]}{[H_2CO_3]}$$

where $K_{a1} = 10^{-6.35} = 4.47 \times 10^{-7}$.

Assuming the starting concentration of H_2CO_3 is negligible (that is, zero in the equation below) and with the recognition that each mole of carbonic acid formed reduces the bicarbonate by one mole, this expression becomes

$$K_{a1} = \frac{[H^+][HCO_3^- - X]}{[0 + X]}$$

where $X = [H^+]$ required to react with $[HCO_3^-]$.

The bicarbonate alkalinity (HCO_3^-) was calculated in step (a) as 6.2×10^{-3} moles/L.

$$\begin{aligned} 4.47 \times 10^{-7} &= \frac{[2.23 \times 10^{-6}][6.20 \times 10^{-3} \text{ moles/L} - X]}{[0 + X]} \\ X &= \frac{[2.23 \times 10^{-6}][6.20 \times 10^{-3} \text{ moles/L} - X]}{4.47 \times 10^{-7}} \\ X &= 3.09 \times 10^{-2} - 4.99X \\ X &= \frac{3.09 \times 10^{-2}}{5.99} = 5.16 \times 10^{-3} \text{ moles/L} \end{aligned}$$

f. Therefore, the sulfuric acid must supply 5.16×10^{-3} moles/L of H^+ . Because each mole of sulfuric acid dissociates to produce 2 moles of H^+ , the dose of sulfuric acid is

$$\frac{5.16 \times 10^{-3} \text{ moles/L}}{2} = 2.58 \times 10^{-3} \text{ moles/L}$$

In mg/L this is

$$(2.58 \times 10^{-3} \text{ moles/L})(98,000 \text{ mg/mole}) = 253 \text{ mg/L of pure acid}$$

Comments:

1. This dose is conservatively high because, as noted in Example 9-1, the activities were not considered.
 2. Commercial sulfuric acid is not pure. Commercial sulfuric acid is about 77% pure. The commercial acid dose would be $253 \text{ mg/L}/0.77 = 328.57$ or about 330 mg/L.
 3. Using sulfuric acid can increase the sulfate concentration enough to cause precipitation of calcium sulfate. If this is a problem, hydrochloric acid is used.
-

Membrane Element Design. Equations 9-5 and 9-6 are used to design a membrane element. The fluxes of water and solute cannot be calculated across the entire membrane because the net transmembrane pressure declines continuously along the length of the membrane element. This is a result of headloss in the feed channels and changes in osmotic pressure due to concentration of salts. Thus, fluxes of both water and solute are dependent on position in the element. To account for these changes, the design procedure is to numerically integrate Equations 9-5 and 9-6 along the element. Membrane manufacturers provide software to perform these calculations. This software includes temperature, osmotic pressure, limiting salt solubility, concentration polarization, mass transfer rates, and permeate water quality. It is specific to the manufacturer's product. These programs do not yield final design specifications. They are only tools for developing and testing various system configurations, and their output should not be regarded as completed designs.

Membrane Array Design. The membrane array design is based on the desired recovery. Membrane arrays are generally one to three stages with multiple elements connected in series in each stage. Typical permeate recovery rates for a one-, two-, or three-stage arrays with six 1 m long elements in series in a pressure vessel are as follows (AWWA, 1999; Bergman, 2005):

- One stage: $\leq 50\%$.
- Two stages: $> 50\%$ but $< 75\%$.
- Three stages: $< 90\%$.

To achieve 64 percent recovery of a 100 L/s feed water, for example, a 2:1 array could be used where the first stage has two pressure vessels, each operating at 50 L/s and 40 percent recovery, and the second stage has one pressure vessel operating at 60 L/s and 40 percent recovery. The permeate flow rate from the first stage would be $(50 \text{ L/s})(0.40)(2 \text{ pressure vessels}) = 40 \text{ L/s}$. The concentrate $(100 \text{ L/s} - 40 \text{ L/s} = 60 \text{ L/s})$ would flow to the second array. The permeate flow from the second stage would be $(60 \text{ L/s})(0.40)(1 \text{ pressure vessel}) = 24 \text{ L/s}$. The total permeate flow from the system would be $40 \text{ L/s} + 24 \text{ L/s} = 64 \text{ L/s}$. The recovery would be $(64 \text{ L/s}/100 \text{ L/s})(100\%) = 64\%$.

The design process is iterative in that a number of combinations are investigated to examine the most economical arrangement that yields the desired water quality objectives. In RO/NF softening systems, blending with bypassed water is common and should be considered in selecting the array arrangement.

Applying Manufacturer's Standard Conditions. The manufacturer's standard conditions for estimating the permeate flow rate (Q_p) can be corrected to local conditions for design estimates using the following equation (AWWA, 1999):

$$Q_p = (\text{PCF})(\text{TCF})(\text{MFRC}/\text{FF})(Q_i) \quad (9-14)$$

where Q_p = product water flow at operating conditions
 PCF = pressure correction factor
 TCF = temperature correction factor
 MFRC = membrane flux retention coefficient
 FF = fouling factor
 Q_i = initial product water flow at standard conditions

PCF is further defined as

$$\text{PCF} = P_F - 0.5(h_L) - P_P - \pi_{FC} + \pi_P \quad (9-15)$$

where P_F = feed pressure, Pa
 h_L = headloss through feed-concentrate channel, Pa
 P_P = permeate pressure, Pa
 π_{FC} = average feed concentrate osmotic pressure, Pa
 π_P = permeate osmotic pressure, Pa

TCF is specific to a given membrane product and should be obtained from the manufacturer. MFRC is taken to be about 0.65 to 0.85 over a 3 to 5 year operating period. FF is generally about 0.8 to 0.9 over 3 years (AWWA, 1999).

Stabilization Design for NF/RO Softened Water. Because the NF/RO membranes do not remove dissolved gases, the CO_2 in groundwater passes through the membrane. Acid pretreatment to prevent scaling results in the conversion of bicarbonate ion to CO_2 . Thus, the permeate has a low pH as a result of the formation of H_2CO_3 . It is very corrosive. In a typical NF/RO softened water, the raw water pH is decreased to between 5.5 and 7.0 (AWWA, 1999).

A common post-treatment process is air stripping to remove the CO_2 . The CO_2 concentration to achieve a design pH can be estimated using the carbonate equilibria. As demonstrated in the following example, the pH that can be achieved by air stripping the CO_2 is not high enough to make the permeate noncorrosive.

Example 9-3. Assuming that an air stripper can reduce the CO_2 in the permeate from an NF/RO unit to the theoretical limit of equilibrium with the CO_2 in the atmosphere, what will the pH of the permeate be? The atmospheric concentration of CO_2 in 2005, as measured at Mauna Loa, Hawaii, was 370 ppm.

Solution:

- a. The saturation value of dissolved CO_2 from the atmosphere can be determined using Henry's law with $K_H = 0.033363 \text{ mole/L} \cdot \text{atm}$.

$$[\text{CO}_2] = K_H P_g = (0.033363 \text{ mole/L})(370 \times 10^{-6} \text{ atm}) = 1.23 \times 10^{-5} \text{ moles/L}$$

- b. Using an expression derived from the equilibrium equations, determine the hydrogen ion concentration (Masters, 1998).

$$\begin{aligned} [\text{H}^+]^2 &= K_{a1}[\text{CO}_2(aq)] + 10^{-14} \\ &= (4.47 \times 10^{-7})(1.23 \times 10^{-5} \text{ moles/L}) + 10^{-14} \\ &= 5.53 \times 10^{-12} \end{aligned}$$

$$\text{and } [\text{H}^+] = 2.35 \times 10^{-6} \text{ moles/L.}$$

- c. The pH is

$$\text{pH} = -\log (2.35 \times 10^{-6} \text{ moles/L}) = 5.63$$

Comment. This pH is the theoretical limit, not a practical limit, that can be achieved by air stripping.

In addition to air stripping, some of the CO_2 can be converted to bicarbonate/carbonate alkalinity by raising the pH of the permeate before stripping using a strong base such as NaOH or $\text{Ca}(\text{OH})_2$. This step must precede air stripping to make use of the CO_2 in the permeate.

A third alternative, and one most likely to be practiced in softening, is to bypass a fraction of the raw water and blend it with the permeate. The raw water alkalinity will help stabilize the water.

Operation and Maintenance

Routine monitoring of the flow rate and pressure provides information on potential scale build up. A 10 to 15 percent decline in temperature- and pressure-normalized flux or about 50 percent increase in differential pressure may indicate fouling. Fouling requires chemical cleaning. Only agents approved by the membrane manufacturer in writing should be used. NF/RO systems are normally designed to operate for three months to one year between chemical cleanings (U.S. EPA, 2005). Pressure checks or mini-challenge tests with a surrogate particle are used to assure membrane integrity. The membrane must be free of breaks $\geq 3 \mu\text{m}$ in diameter.

Because RO/NF systems are pressure driven, special safety precautions should be emphasized. These include (AWWA, 1999):

- Do not overpressurize equipment.
- Assure that pressure vessels are suitably anchored.
- Be sure pressurized vessels are depressurized before working on them.
- Inspect pressure relief and shutdown devices regularly.
- Minimize equipment and piping vibrations and water hammer.

9-5 ELECTRODIALYSIS

Unlike NF/RO that are pressure driven, electrodialysis (ED) and electrodialysis reversal (EDR) processes are electrical voltage-driven. Alternating anion and cation transfer ion exchange membranes in flat-sheet form are placed between positive and negative electrodes. With the application of a direct current voltage, positively charged ions move toward the negative electrode (cathode), and negatively charged anions move toward the positive electrode (anode). This causes alternating compartments to become demineralized and the intervening compartments to become concentrated with ions.

ED and EDR do not remove electrically neutral substances such as silica, particulate matter, or pathogens. They are capable of removing the smallest charged contaminant ions. Although ED and EDR processes will soften water, they more often find special application in treating specific contaminants such as arsenic and sulfate and more general application in the treatment of brackish water with total dissolved solids less than 3,000 mg/L (Bergman, 2005).

Visit the text website at www.mhprofessional.com/wwe for supplementary materials and a gallery of photos.

9-6 CHAPTER REVIEW

When you have completed studying this chapter, you should be able to do the following without the aid of your textbooks or notes:

1. Define the following abbreviations: MF, UF, NF, RO.
2. Explain why NF/RO membranes are suitable for softening and MF/UF are not.
3. Using a diagram, explain to a lay audience what the terms *osmosis* and *reverse osmosis* mean.
4. Describe the two common configurations of membrane material and identify the one most frequently used for water softening.
5. List the four generally recognized mechanisms of membrane fouling.
6. Using a sketch you have drawn, identify the following terms that describe an NF/RO water treatment system: membrane element, stage, and array.
7. Sketch a NF/RO system including pretreatment and post-treatment processes.
8. Explain the the concept of “limiting salt” and the means to reduce its effect.
9. Explain how electrodialysis differs from NF/RO treatment.

With the use of this text, you should be able to do the following:

10. Calculate the osmotic pressure given the appropriate parameters.
11. Calculate the fraction of the “split” for an NF/RO softening system.
12. Calculate the rejection and concentration factors from a mass balance.
13. Estimate the recovery rate for a given set of water constituents.
14. Estimate the dose of sulfuric acid to achieve a given product recovery rate.

15. Design a membrane array to achieve a given permeate recovery rate.
16. Determine the pH that can be achieved by stripping CO₂.

9-7 PROBLEMS

- 9-1. Calculate the osmotic pressure for a seawater with a salinity of 35,000 mg/L. Assume 2 mole ions produced/mole of seawater, an osmotic coefficient of 0.85, a sea temperature of 25°C, and a molecular weight of 58.5 g/mole.
- 9-2. Calculate the total osmotic pressure for a groundwater with a calcium bicarbonate concentration of 720.0 mg/L and a magnesium bicarbonate concentration of 98.5 mg/L. Assume no other ions are present, 3 mole ions produced/mole of each compound, an osmotic coefficient of 1.0, and a groundwater temperature of 5°C.
- 9-3. A high-pressure RO system is being evaluated for producing pure water from seawater. It is to be blended with sea water for a drinking water supply. Make an order of magnitude estimate* of the required pressure differential (ΔP) if the difference in osmotic pressure must be 2,500 kPa. The mass transfer coefficient for water flux is $6.89 \times 10^{-4} \text{ m}^3/\text{d} \cdot \text{m}^2 \cdot \text{kPa}$ and the required volumetric flux of water is $170 \text{ L/h} \cdot \text{m}^2$.
- 9-4. A low pressure NF system is being evaluated for producing pure water from groundwater. It is to be blended with bypassed water for a softened drinking water supply. Make an order of magnitude estimate* of the required pressure differential (ΔP) if the difference in osmotic pressure must be 30 kPa. The mass transfer coefficient for water flux is $8.40 \times 10^{-4} \text{ m}^3/\text{d} \cdot \text{m}^2 \cdot \text{kPa}$ and the required volumetric flux of water is $30 \text{ L/h} \cdot \text{m}^2$.
- 9-5. Estimate the mass flux of solute (in $\text{kg/d} \cdot \text{m}^2$) for Problem 9-3 if the influent concentration is 35,000 mg/L and the effluent concentration is to be 0.0 mg/L. Assume the mass transfer coefficient for solute flux is $6.14 \times 10^{-4} \text{ m/h}$.
- 9-6. Estimate the mass flux of solute (in $\text{kg/d} \cdot \text{m}^2$) for Problem 9-4 if the influent concentration is 818.5 mg/L and the effluent concentration is to be 0.0 mg/L. Assume the mass transfer coefficient for solute flux is $6.14 \times 10^{-4} \text{ m/h}$.
- 9-7. Each pressure vessel in a proposed design for the desalinization of seawater is rated 35% recovery at flow rates between 850 to 1,300 m^3/d . Design an array system that will yield $\geq 2,000 \text{ m}^3/\text{d}$ of pure water for a town of 5,000 people at a permeate recovery of $\geq 50\%$.
- 9-8. Each pressure vessel in a proposed design for the softening of groundwater is rated 45% recovery at a flow rates between 750 and 1,000 m^3/d . Design an array system that will yield $\geq 4,000 \text{ m}^3/\text{d}$ of pure water for a town of 6,666 people at a permeate recovery of $\geq 80\%$.
- 9-9. Estimate the permeate recovery rate for a groundwater with the following characteristics:

$$\text{Calcium} = 67.2 \text{ mg/L}$$

$$\text{Carbonate} = 0.72 \text{ mg/L}$$

*Note that this is an “order of magnitude” estimate. As noted in the discussion, the performance of an NF/RO unit is computed by numerical integration of differential elements along the membrane.

Alkalinity = 284.0 mg/L as CaCO₃
 pH = 7.6 units

9-10. Estimate the permeate recovery rate for a groundwater with the following characteristics:

Calcium = 96.8 mg/L
 Carbonate = 1.67 mg/L
 Bicarbonate = 318.0 mg/L as CaCO₃
 pH = 8.0

9-11. Estimate the dose of sulfuric acid required to achieve a product water recovery rate of 75% for the water in Problem 9-9. Assume the acid is a 100% solution.

9-12. Estimate the dose of sulfuric acid required to achieve a product water recovery rate of 75% for the water in Problem 9-10. Assume the acid is a 100% solution.

9-8 DISCUSSION QUESTION

9-1. For the following water analysis select one of the following options for softening: lime-soda, ion exchange, NF.

Water A

Ca²⁺ = 111 mg/L as CaCO₃
 Mg²⁺ = 56 mg/L as CaCO₃
 Na⁺ = 63 mg/L as CaCO₃
 HCO₃⁻ = 110 mg/L as CaCO₃
 Turbidity = 4 NTU
 pH = 7.0
 Q_{design} = 85 m³/d

Water B

Ca²⁺ = 152 mg/L as CaCO₃
 Mg²⁺ = 114 mg/L as CaCO₃
 Na⁺ = 438 mg/L as CaCO₃
 HCO₃⁻ = 460 mg/L as CaCO₃
 Turbidity = 1 NTU
 pH = 7.7
 Q_{design} = 850 m³/d

9-9 REFERENCES

- AWWA (1999) *Reverse Osmosis and Nanofiltration*, American Water Works Association Manual M46, Denver, Colorado.
- Bergman, R. A. (2005) "Membrane Processes," in E. E Baruth (ed.), *Water Treatment Plant Design*, McGraw-Hill, New York, pp. 13.1–13.49.
- Davis, M. L. and D. A. Cornwell (2008) *Introduction to Environmental Engineering*, McGraw-Hill, New York, p. 876.

- Masters, G. M. (1998) *Introduction to Environmental Engineering and Science*, Prentice Hall, Upper Saddle River, New Jersey, p. 59.
- MWH (2005) *Water Treatment: Principles and Design*, John Wiley & Sons, Hoboken, NJ, pp. 1445, 1472, 1564.
- Robinson, R. A. and R. H. Stokes (1959) *Electrolyte Solutions: the Measurement and Interpretation of Conductance, Chemical Potential, and Diffusion in Solutions of Simple Electrolytes*, Butterworths, London.
- Taylor, J. S. and M. Wiesner (1999) *Membranes*, in R. D. Letterman (ed.) *Water Quality and Treatment*, 5th ed., American Water Works Association, McGraw-Hill, New York, pp. 11.1–11.71.
- U.S. AID (1980) *The U.S. Agency for International Development Desalinization Manual*, Denver, Colorado.
- U.S. EPA (2005) *Membrane Guidance Manual*, U.S. Environmental Protection Agency, Washington, D.C., pp. 7-7–7-8.

This page intentionally left blank

CHAPTER

10

SEDIMENTATION

10-1 INTRODUCTION

10-2 SEDIMENTATION THEORY

10-3 SEDIMENTATION PRACTICE

10-4 SEDIMENTATION BASIN DESIGN

10-5 OPERATION AND MAINTENANCE

10-6 CHAPTER REVIEW

10-7 PROBLEMS

10-8 DISCUSSION QUESTIONS

10-9 REFERENCES

10-1 INTRODUCTION

One of the objectives of the coagulation and flocculation processes is to enhance the size of particles so that they will settle in a reasonable period of time. The lime-soda softening process objective is to remove hardness by forming an insoluble precipitate. Once the particles and precipitate are formed, the most common means of removing them from the water is by gravitational settling in a *sedimentation basin* (also called a *clarifier* or *settling tank*). Other means, such as direct filtration or flotation, may also be employed. Gravitational settling is the subject of this chapter. The other processes are described in Chapters 11, 15, and 27.

10-2 SEDIMENTATION THEORY

In the design of an ideal sedimentation tank, one of the controlling parameters is the settling velocity (v_s) of the particle to be removed. For the purpose of discussion and illustration, the settling properties of particles are categorized into four classes: (1) discrete particle settling, (2) flocculant settling, (3) hindered settling, and (4) compression settling. By convention these categories have been labeled Type I, Type II, Type III, and Type IV settling, respectively. In actual settling tanks, it is not uncommon to see all of these types of settling. The value of separating the discussion into these categories is that it provides a means of understanding the relationship between variables in the design of the sedimentation basin.

Type I Sedimentation

Type I sedimentation is characterized by particles that settle discretely at a constant settling velocity. They settle as individual particles and do not flocculate during settling. Examples of these particles are sand and *grit* (a mixture of abrasive particles that may include sand, broken glass, etc.). Generally speaking, the only applications of Type I settling are during presedimentation for sand removal prior to coagulation in a potable water plant, in settling of sand particles during cleaning of rapid sand filters, and in grit chambers.

Stokes' Law. When particles settle discretely, the particle settling velocity can be calculated, and the basin can be designed to remove a specific size particle. In 1687, Sir Isaac Newton showed that a particle falling in a quiescent fluid accelerates until the frictional resistance, or drag, on the particle is equal to the gravitational force of the particle (Figure 10-1) (Newton, 1687). The three forces are defined as follows:

$$F_G = (\rho_s)gV_p \quad (10-1)$$

$$F_B = (\rho)gV_p \quad (10-2)$$

$$F_D = C_D A_p (\rho) \frac{v^2}{2} \quad (10-3)$$

where F_G = gravitational force

F_B = buoyancy force

F_D = drag force

ρ_s = density of particle, kg/m^3

ρ = density of fluid, kg/m^3

- g = acceleration due to gravity, m/s^2
 V_p = volume of particle, m^3
 C_D = drag coefficient
 A_p = cross-sectional area of particle, m^2
 v = velocity of particle, m/s

The driving force for acceleration of the particle is the difference between the gravitational and buoyant forces:

$$F_G - F_B = (\rho_s - \rho)g V_p \quad (10-4)$$

When the drag force is equal to the driving force, the particle velocity reaches a constant value called the *terminal settling velocity* (v_s).

$$F_G - F_B = F_D \quad (10-5)$$

$$(\rho_s - \rho)g V_p = C_D A_p (\rho) \frac{v^2}{2} \quad (10-6)$$

For spherical particles with a diameter = d ,

$$\frac{V_p}{A_p} = \frac{4/3(\pi)(d/2)^3}{(\pi)(d/2)^2} = \frac{2}{3}d \quad (10-7)$$

Using Equations 10-6 and 10-7 to solve for the terminal settling velocity:

$$v_s = \left[\frac{4g(\rho_s - \rho)d}{3 C_D \rho} \right]^{1/2} \quad (10-8)$$

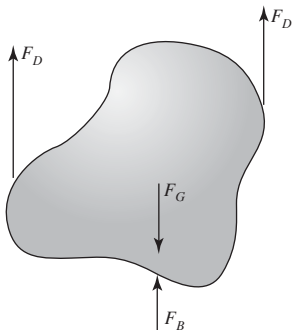

FIGURE 10-1

Forces acting on a free-falling particle in a fluid (F_D = drag force; F_G = gravitational force; F_B = buoyancy force). (Source: Davis and Cornwell, 2008.)

The drag coefficient takes on different values depending on the flow regime surrounding the particle. The flow regime may be characterized qualitatively as laminar, turbulent, or transitional. In laminar flow, the fluid moves in layers, or *laminae*, with one layer gliding smoothly over adjacent layers with only molecular interchange of momentum. In turbulent flow, the fluid motion is very erratic with a violent transverse interchange of momentum. Osborne Reynolds (1883) developed a quantitative means of describing the different flow regimes using a dimensionless ratio that is called the *Reynolds number*. For spheres moving through a liquid this number is defined as

$$\mathbf{R} = \frac{(d)v_s}{\nu} \quad (10-9)$$

where \mathbf{R} = Reynolds number
 d = diameter of sphere, m
 v_s = velocity of sphere, m/s
 ν = kinematic viscosity, $\text{m}^2/\text{s} = \mu/\rho$
 ρ = density of fluid, kg/m^3
 μ = dynamic viscosity, $\text{Pa} \cdot \text{s}$

Thomas Camp (1946) developed empirical data relating the drag coefficient to Reynolds number (Figure 10-2). For eddy resistance for spheres at high Reynolds numbers ($\mathbf{R} > 10^4$), C_D has a value of about 0.4. For viscous resistance at low Reynolds numbers ($\mathbf{R} < 0.5$) for spheres:

$$C_D = \frac{24}{\mathbf{R}} \quad (10-10)$$

For the transition region of \mathbf{R} between 0.5 and 10^4 , the drag coefficient for spheres may be approximated by the following:

$$C_D = \frac{24}{\mathbf{R}} + \frac{3}{\mathbf{R}^{1/2}} + 0.34 \quad (10-11)$$

Sir George Gabriel Stokes showed that, for spherical particles falling under laminar (quiescent) conditions, Equation 10-8 reduces to the following:

$$v_s = \frac{g(\rho_s - \rho)d^2}{18\mu} \quad (10-12)$$

where μ = dynamic viscosity, $\text{Pa} \cdot \text{s}$
 18 = a constant

Equation 10-12 is called *Stokes' law* (Stokes, 1845). Dynamic viscosity (also called *absolute viscosity*) is a function of the water temperature. A table of dynamic viscosities is given in Appendix A. Stokes' law is valid for spherical particles and laminar flow (Reynolds numbers ≤ 1).

The customary calculation procedure for Type I particles is to assume laminar conditions and to use Stokes' law to calculate a settling velocity. The Reynolds number is then checked using this velocity. If the Reynolds number is ≤ 1 , the calculation is complete. If the Reynolds

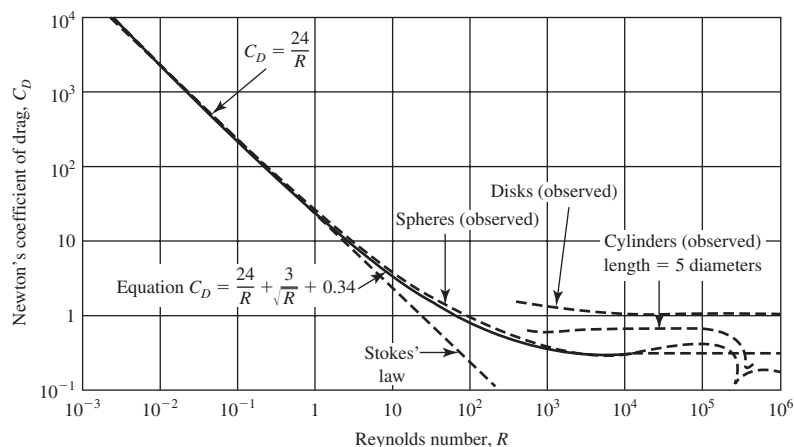

FIGURE 10-2
Newton's coefficient of drag as a function of Reynolds number. (Source: Camp, 1946.)

number is greater than 1, the appropriate equation for C_D is selected with this estimate of the Reynolds number, and Newton's equation is used to estimate the velocity. In turn, this velocity is used to check the Reynolds number. The process is iterated until a convergent solution is achieved; that is, the velocity yields a Reynolds number equal to that used in estimating the settling velocity.

Example 10-1. What is the settling velocity of a grit particle with a radius of 0.10 mm and a specific gravity of 2.65? The water temperature is 22°C.

Solution:

- a. From Appendix A, at a temperature of 22°C, find the water density to be 997.774 kg/m³. Use 1,000 kg/m³ as a sufficiently close approximation. Because the particle radius is given to only two significant figures, this approximation is reasonable. From the same table, find the viscosity to be 0.955 mPa · s. As noted in the footnote to the table in Appendix A, multiply this by 10⁻³ to obtain the viscosity in units of Pa · s (kg · m/m² · s).
- b. Using a particle diameter of 2.0×10^{-4} m, calculate the terminal settling velocity using Equation 10-12.

$$v_s = \frac{(9.81 \text{ m/s}^2)(2,650 \text{ kg/m}^3 - 1,000 \text{ kg/m}^3)(2.0 \times 10^{-4} \text{ m})^2}{18(9.55 \times 10^{-4} \text{ Pa} \cdot \text{s})} = 3.77 \times 10^{-2} \text{ m/s}$$

Note that the product of the specific gravity of the particle (2.65) and the density of water is the density of the particle (ρ_s).

- c. Check the Reynolds number. From the Appendix, the kinematic viscosity is 0.957 μm²/s. As noted in the footnote to the table in Appendix A, multiply this by 10⁻⁶ to obtain the viscosity in units of m²/s.

$$\mathbf{R} = \frac{(2.0 \times 10^{-4} \text{ m})3.77 \times 10^{-2} \text{ m/s}}{0.957 \times 10^{-6} \text{ m}^2/\text{s}} = 7.88$$

This is in the transition region and Stokes' law is not valid. An iterative solution using Newton's equation is required. Equation 10-11 is used to estimate the drag coefficient. The Reynolds number of 7.88 is used for the starting value of \mathbf{R} , and a new velocity is calculated. The resulting velocity is used to check the Reynolds number. The process is repeated until the value of the Reynolds number used to calculate the velocity matches the check of the Reynolds number.

- d. The Solver program* in a spreadsheet was used to perform the iterations. The spreadsheet cells are shown in Figure 10-3. The cell locations used in the figure are identified by brackets [] in the discussion below. For completeness, the spreadsheet solution begins by repeating the Stokes' law solution.

[B5] through [B10] are input values in the correct units.

- e. In cell [B14] write the Stokes' law solution for the settling velocity

$$= (9.81 * ([B6] - [B7]) * ([B5])^2) / (18 * [B9]) = 3.77E - 02$$

- f. In cell [B18] check the Reynolds number

$$= ([B5] * [B14]) / [B10] = 7.87E - 00$$

- g. Begin the set up for the Solver solution by entering the value of the Reynolds number that has just been computed in cell [B25]. **DO NOT** type in the cell reference.

- h. In cell [B29] calculate the Newton drag coefficient for \mathbf{R} between 0.5 and 10^4

$$= (24 / [B25]) + (3 / [B25]^{0.5}) + 0.34 = 4.46E - 00$$

- i. In cell [B31] enter Newton's equation for settling velocity

$$= ((4 * 9.81) * ([B6] - [B7]) * [B5]) / (3 * [B29] * [B7])^{0.5} = 3.11E - 02$$

- j. In cell [B35] check the Reynolds number

$$= ([B5] * [B31]) / [B10] = 6.50$$

- k. Activate the dialog box for Solver and designate the target cell [B35], that is, the last computation of the Reynolds number.

- l. Set *Equal to* to "Min."
- m. *By changing* the cell containing the the first estimate of Reynolds number, that is, [B25].
- n. Add the following *Constraint* in the dialog box: [B35] = [B25]
- o. Execute *solve* to find the settling velocity is 2.73E - 02 m/s as shown in Figure 10-3.

**Solver* is a "tool" in Excel®. Other spreadsheets may have a different name for this program.

	A	B	C	D	E	F	G
3	Input data						
4							
5	Diameter	2.00E-04	m				
6	Particle density	2650	kg/m ³				
7	Water density	1000	kg/m ³				
8	Temperature	22	°C				
9	Dynamic viscosity	9.55E-04	Pa · s				
10	Kinematic viscosity	9.57E-07	m ² /s				
11							
12	Stokes' settling velocity						
13							
14	v(s) =	3.77E-02	m/s				
15							
16	Check Reynolds number						
17							
18	R =	7.87E+00					
19							
20	Because R > 1 must use Newton's equation and iterate						
21							
22	Use solver						
23	Set up the equations shown below and enter the value of R from B18 as a first guess						
24							
25	R =	5.70E+00					
26							
27	Calculate Newton's drag coefficient for R between 0.5 and 10 ⁴						
28							
29	C _D =	5.81E+00					
30							
31	v(s) =	2.73E-02	m/s				
32							
33	Check the Reynolds number						
34							
35	R =	5.70E+00					
36							

Solver parameters

Set target cell:

Equal to: Max. Min. Value of:

By changing cells:

Subject to the constraints:

B35 = B25

FIGURE 10-3

Spreadsheet solution for Example 10-1. Note that the spreadsheet is a solution *after* the solver program has been run.

The Ideal Sedimentation Basin. Camp (1936) proposed a rational theory for removal of discretely settling particles in an ideal settling basin. The ideal settling basin theory assumes the following:

- Type I settling.
- Four zones in the basin: inlet, outlet, sludge, and settling.
- Even distribution of flow (uniform horizontal velocity) entering the settling zone.
- Even distribution of flow leaving the settling zone.
- Uniform distribution of particles through the depth of the inlet zone end of the settling zone.
- Particles that enter the sludge zone are captured and remain in the sludge zone.
- Particles that enter the outlet zone are not removed from the water.

Figure 10-4 is a schematic drawing of the zones in a horizontal flow clarifier and in an upflow clarifier.

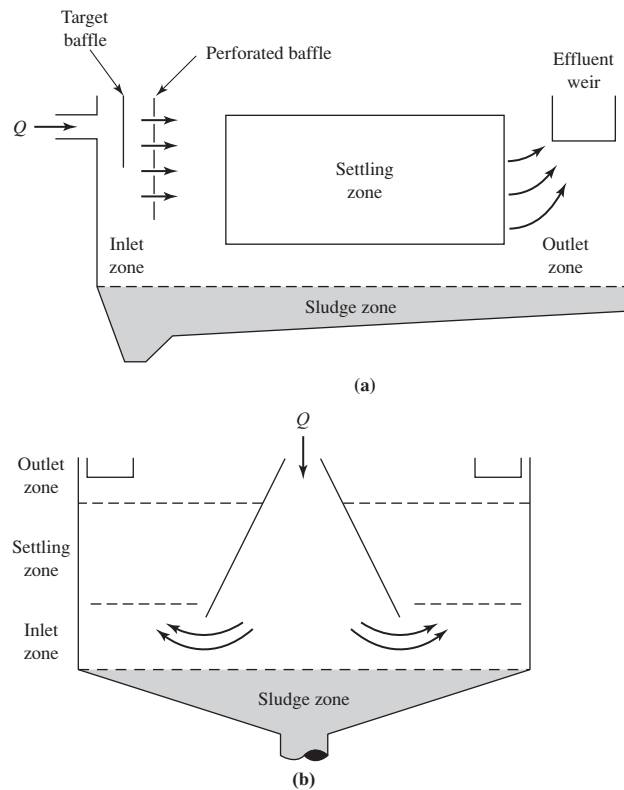

FIGURE 10-4 Zones of sedimentation: (a) horizontal flow clarifier; (b) upflow clarifier. (Source: Davis and Cornwell, 2008.)

In the upflow clarifier, particle-laden water enters the bottom of the clarifier as shown in Figure 10-5. As noted by the respective vector arrows, at the bottom of the clarifier the velocity of the rising water is greater than the settling velocity of the particle. As the water rises, the area through which it passes is increasing because of the cone shape of the clarifier. From the continuity principle the velocity of the water decreases as it rises:

$$v = \frac{Q}{A_c} \quad (10-13)$$

where v = velocity of water, m/s
 Q = flow rate of water, m³/s
 A_c = cross-sectional area through which the water flows, m²

However, the velocity of the particle remains the same. Given a large enough cross-sectional area, the upward water velocity vector will become less than the downward velocity vector of the particle. As a consequence, the particle will remain in the tank and the clear water will leave. In the design of the upflow clarifier, the area of the top of the cone that achieves the separation velocity sets the top of the cone and the placement of the weirs for overflow of the clear water. The upward water velocity that will enable the separation of the water from the particle is called the *overflow rate* because it is the rate at which water overflows the top of the tank into the weirs. The notation v_o is used to denote the overflow rate. It is also called the *hydraulic surface loading*, or the *surface loading*, because it has units of m³/d · m².

Theoretically, the efficiency of removal of discretely settling particles in a settling tank can be calculated based on the settling velocity of the particles and the overflow rate. For an upflow clarifier, 100 percent of the particles having a settling velocity greater than or equal to the overflow rate will remain in the settling tank (that is, they will be captured), and no particles with a settling velocity less than the overflow rate will be captured.

Camp (1936) demonstrated that particle removal in a horizontal flow settling tank is likewise dependent on the overflow rate. This can be shown using Figure 10-6 to illustrate the demonstration. In order to be removed from the water, a particle must have a settling velocity great enough so

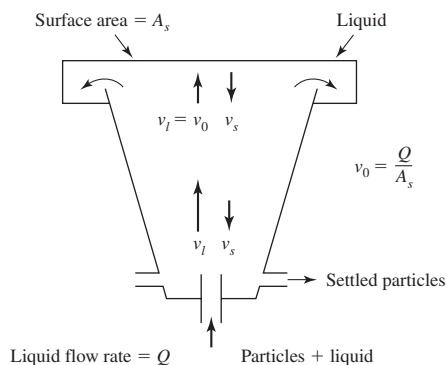

FIGURE 10-5

Settling in an upflow clarifier. (Legend: v_l = velocity of liquid; v_s = terminal settling velocity of particle.)

(Source: Davis and Cornwell, 2008.)

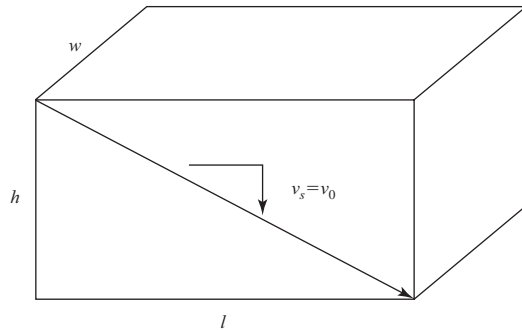

FIGURE 10-6
Dimensional definition of settling zone for Camp's derivation of overflow rate for a rectangular horizontal-flow sedimentation tank.

that it reaches the bottom of the tank during the time (t_o) the water spends in the tank (the *detention time*). That is, the settling velocity must equal the depth of the tank divided by t_o

$$v_s = \frac{h}{t_o} \quad (10-14)$$

where the detention time is defined as

$$t_o = \frac{V}{Q} \quad (10-15)$$

where V = volume of tank, m^3
 Q = flow rate, m^3/s

Using the definition of detention time from Equation 10-15 and substituting into Equation 10-14:

$$v_s = \frac{h}{(V/Q)} = \frac{hQ}{V} \quad (10-16)$$

Because tank volume is described by the product of the height, length, and width

$$v_s = \frac{hQ}{l \times w \times h} = \frac{Q}{l \times w} \quad (10-17)$$

The product ($l \times w$) is the surface area (A_s). Therefore,

$$v_s = \frac{Q}{A_s} \quad (10-18)$$

which is the overflow rate (v_o). From this, Camp proposed that the overflow rate is the critical design parameter that determines the removal efficiency of settling tanks. From a theoretical

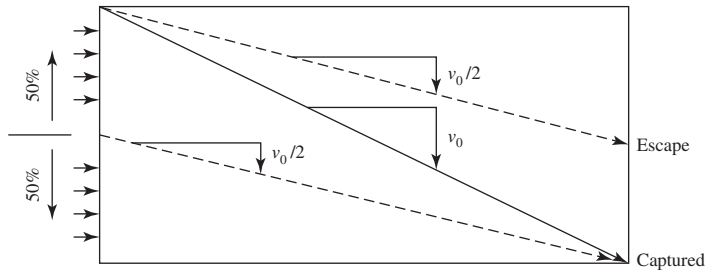

FIGURE 10-7
Partial particle removal in an ideal sedimentation tank. (Source: Davis and Cornwell, 2008.)

perspective, this implies that the removal efficiency is independent of depth and hydraulic detention time.

In a similar fashion to an upflow clarifier, if the settling velocity of a particle is equal to or greater than the overflow rate, 100 percent of the particles will be captured in a horizontal sedimentation tank. Unlike an upflow clarifier, some percentage of the particles with a v_s less than v_o will be removed. For example, consider particles having a settling velocity of $0.5 v_o$ entering uniformly into the settling zone. Figure 10-7 shows that 50 percent of these particles (those below half the depth of the tank) will be removed. Likewise, one-fourth of the particles having a settling velocity of $0.25 v_o$ will be removed. The percentage of particles removed, P , with a settling velocity of v_s in a horizontal flow sedimentation tank designed with an overflow rate of v_o is

$$P = \left(\frac{v_s}{v_o} \right) 100\% \quad (10-19)$$

Example 10-2. Sleepy Hollow has an existing horizontal-flow sedimentation tank with an overflow rate of $17 \text{ m}^3/\text{d} \cdot \text{m}^2$. What percentage removal should be expected for each of the following particle settling velocities in an ideal sedimentation tank: 0.1 mm/s, 0.2 mm/s, and 1 mm/s?

Solution:

- a. Begin by computing the overflow rate in compatible units.

$$\left(17 \text{ m}^3/\text{d} \cdot \text{m}^2 \right) \left(\frac{1,000 \text{ mm/m}}{86,400 \text{ s/d}} \right) = 0.197 \text{ or } 0.2 \text{ mm/s}$$

- b. For the 0.1 mm/s particles

$$P = \frac{0.1 \text{ mm/s}}{0.2 \text{ mm/s}} (100\%) = 50\%$$

- c. For the 0.2 mm/s particles

$$P = \frac{0.2 \text{ mm/s}}{0.2 \text{ mm/s}} (100\%) = 100\%$$

d. For the 1 mm/s particles

$$P = \frac{1 \text{ mm/s}}{0.2 \text{ mm/s}} (100\%) = 500\%$$

But the particle removal cannot be greater than 100%, so the particle removal is 100% for the particles settling at 1 mm/s.

Type II Sedimentation

Type II sedimentation is characterized by particles that flocculate during sedimentation. These types of particles occur in alum or iron coagulation, in wastewater primary sedimentation, and in settling tanks in trickling filtration.

There is no adequate mathematical relationship that can be used to describe Type II settling. The Stokes equation cannot be used because the flocculating particles are continually changing in size and shape. In addition, as water is entrapped in the floc, the specific gravity also changes.

Settling Column Model. Laboratory tests with settling columns serve as a model of the behavior of flocculant settling. These have value in evaluating of existing settling tanks and in developing data for plant expansion or modification of existing plants, but are not practical for the design of new settling tanks because of the difficulty in replicating the properties and concentrations of particles coming from the coagulation/flocculation process. The following discussion illustrates both the method of analyzing the column data and the behavior of the flocculant suspension.

A settling column is filled with the suspension to be analyzed. The suspension is allowed to settle. Samples are withdrawn from sample ports at different elevations at selected time intervals. The concentration of suspended solids is determined for each sample and the percent removal is calculated:

$$R\% = \left(1 - \frac{C_t}{C_0}\right) (100\%) \quad (10-20)$$

where $R\%$ = percent removal at one depth and time, %

C_t = concentration at time, t , and given depth, mg/L

C_0 = initial concentration, mg/L

Percent removal versus depth is then plotted as shown in Figure 10-8. The circled numbers are the calculated percentages. Interpolations are made between these plotted points to construct curves of equal concentration at reasonable percentages, that is, 5 or 10 percent increments. Each intersection point of an isoconcentration line and the bottom of the column defines an overflow rate (v_o):

$$v_o = \frac{H}{t_i} \quad (10-21)$$

where H = height of column, m

t_i = time defined by intersection of isoconcentration line and bottom of column (x -axis)

where the subscript, i , refers to the first, second, third, and so on intersection points

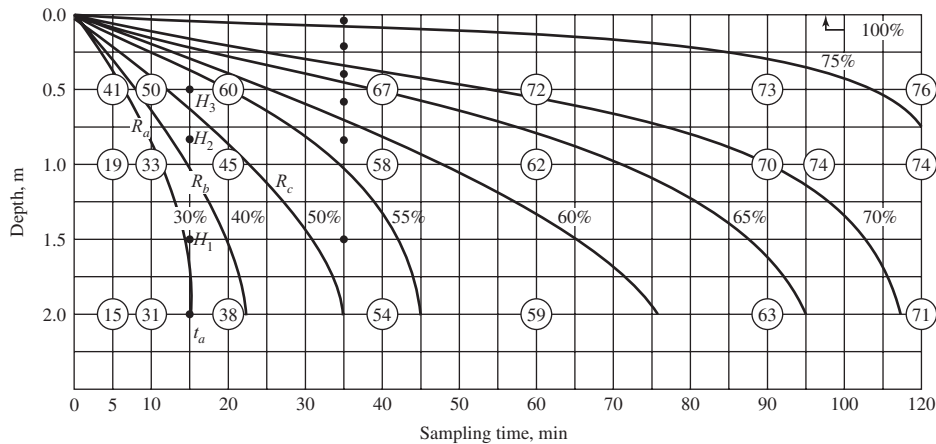

FIGURE 10-8
Isoconcentration lines for Type II settling test using a 2-m-deep column.

A vertical line is drawn from t_i to intersect all the isoconcentration lines crossing the t_i time. The midpoints between isoconcentration lines define heights H_1, H_2, H_3 , and so on used to calculate the fraction of solids removed. For each time, t_i , defined by the intersection of the isoconcentration line and the bottom of the column (x -axis), a vertical line is constructed and the fraction of solids removal is calculated:

$$R_{T_0} = R_a + \frac{H_1}{H}(R_b - R_a) + \frac{H_2}{H}(R_c - R_b) + \dots \quad (10-22)$$

where R_{T_0} = total fraction removed for settling time, t_a
 R_a, R_b, R_c = isoconcentration fractions a, b, c , etc.

The series of overflow rates and removal fractions are used to plot two curves. One of suspended solids removal versus detention time and one of suspended solids removal versus overflow rate. These can be used to size the settling tank. Eckenfelder (1980) recommends that scale-up factors of 0.65 for overflow rate and 1.75 for detention time be used to design the tank.

Example 10-3. The city of Stillwater is planning to install a new settling tank as an upgrade to their existing water treatment plant. Design a settling tank to remove 65% of the influent suspended solids from their design flow of $0.5 \text{ m}^3/\text{s}$. A batch-settling test using a 2.0 m column and coagulated water from their existing plant yielded the following data:

Percent removal as a function of time and depth

Depth, m	Sampling time, min						
	5	10	20	40	60	90	120
0.5	41	50	60	67	72	73	76
1.0	19	33	45	58	62	70	74
2.0	15	31	38	54	59	63	71

Solution. The plot is shown in Figure 10-8.

- a. Calculate the overflow rate for each intersection point. For example, for the 50% line,

$$v_o = \frac{2.0\text{m}}{35\text{min}}(1,440 \text{ min/d}) = 82.3 \text{ m}$$

- b. The corresponding removal percentage is

$$\begin{aligned} R_{T50} &= 50 + \frac{1.5}{2.0}(55 - 50) + \frac{0.85}{2.0}(60 - 55) \\ &\quad + \frac{0.60}{2.0}(65 - 60) + \frac{0.40}{2.0}(70 - 65) \\ &\quad + \frac{0.20}{2.0}(75 - 70) + \frac{0.05}{2.0}(100 - 75) \\ &= 59.5 \text{ or } 60\% \end{aligned}$$

- c. The corresponding detention time is taken from the intersection of the isoconcentration line and the x -axis used to define the overflow rate, that is, 35 minutes for the 50% line.
- d. This calculation is repeated for each isoconcentration line that intersects the x -axis, except the last ones for which data are too sparse, that is, 30, 40, 50, 55, 60, and 65%, but not 70 or 75%.
- e. Two graphs are then constructed (see Figures 10-9 and 10-10). From these graphs the bench-scale detention time and overflow rate for 65% removal are found to be 54 minutes and 50 m/d.

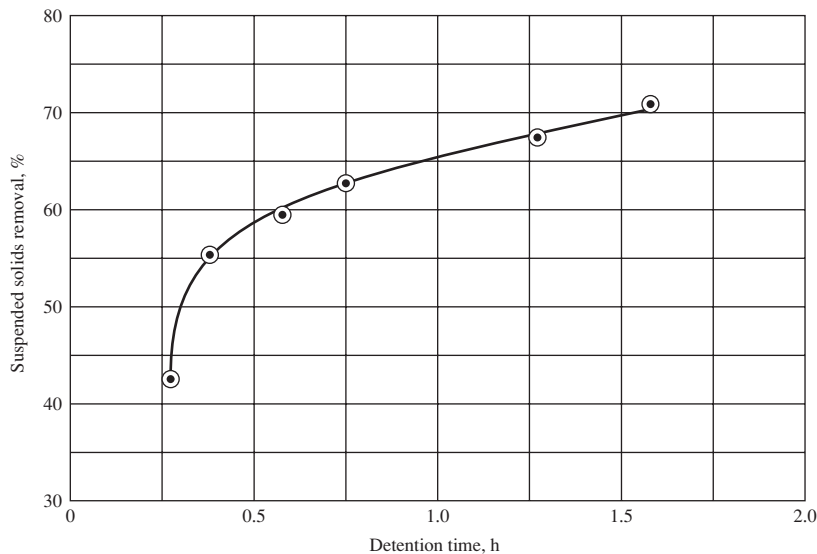

FIGURE 10-9 Suspended solids removal versus detention time. (Source: Davis and Cornwell, 2008.)

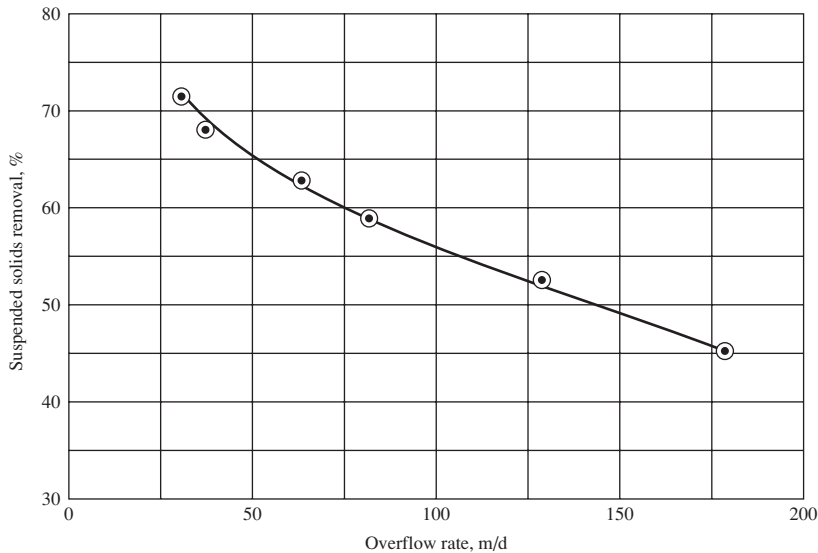

FIGURE 10-10
Suspended solids removal versus overflow rate. (Source: Davis & Cornwell, 2008.)

f. Applying the scale-up factors yields

$$t_o = (54 \text{ min})(1.75) = 94.5 \text{ or } 95 \text{ min}$$

$$v_o = (50 \text{ m/d})(0.65) = 32.5 \text{ m/d}$$

Comments:

1. As implied by the shape of the isoconcentration lines, and, conceptually, the trajectory of the particles, the settling velocity increases as the particles travel through the tank.
2. The depth of the tank is important because flocculant particles tend to grow in size. Thus, a greater depth facilitates the growth process.

Type III and Type IV Sedimentation

When the water contains a high concentration of particles (for example, greater than 1,000 mg/L) both Type III (*hindered* settling or *zone* settling) and Type IV (*compression* settling) occur along with discrete and flocculant settling. Zone settling occurs in lime-softening sedimentation, activated-sludge sedimentation, and sludge thickeners.

When a concentrated suspension of uniform concentration is placed in a column or graduated cylinder, Type II, III, and IV take place over time as illustrated in Figure 10-11. With a high particle concentration the free area between the particles is reduced. This causes greater interparticle fluid velocities that reduce the settling velocity below that of the individual particles. Because of the high concentration of particles, the liquid tends to move up through the interstices between the particles. As a result, the particles that are in contact with one another tend to settle as a zone or “blanket.” The particles in contact tend to maintain the same relative position. This results in a relatively clear layer above the settling mass of settling particles. This phenomenon is known as

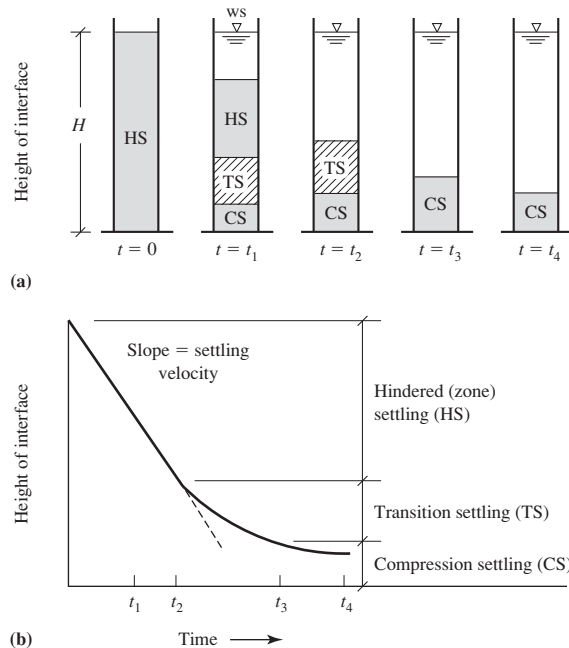
**FIGURE 10-11**

Idealized schematic of Type III and IV settling in a column (a) and a graph of the corresponding settling curve (b). (Source: Metcalf and Eddy, 2003.)

hindered settling. The rate of hindered settling is a function of the concentration of the particles and their characteristics.

As settling continues, a compressed layer of particles begins to form. The particles are in contact and do not really settle. A more correct way to visualize the phenomena is the flow of water out of a mat of particles that is being compressed. Thus, it is called *compression* settling.

As with Type II settling, the methods for analyzing hindered settling require settling test data. These methods are appropriate for plant expansions or modifications but have not found use in the design of small treatment plants. The methods are described in detail in Chapters 15 and 25.

High-Rate Settling. Increasing the particle density, or reducing the distance a particle must fall prior to removal, can accelerate the clarification process.

The specific gravity of alum floc is approximately 1.001 and that of lime floc is 1.002 (Kawamura, 2000). Several proprietary processes add a ballast (usually microsized sand 20 to 200 μm diameter) with a specific gravity on the order of 2.5 to 2.65 to the floc to increase its settling velocity. The sand is recovered and reused.

To reduce the distance the particle must fall, a series of inclined plates or tubes are placed in a rectangular horizontal flow settling basin. Three typical configurations are shown in Figure 10-12. The plates or tubes are inclined to a degree that allows the collected solids to slide down the surface to the sludge zone. Typically the tube is a square, about 5 cm on each side, and the angle is

about 60° . The configurations are named to reflect the direction of flow of water with respect to the direction that the particles will leave the plates or tubes: *countercurrent*, *cocurrent*, and *crosscurrent*. Thus, for example, the countercurrent configuration is one in which the flow of water is in the opposite direction to that of the particles.

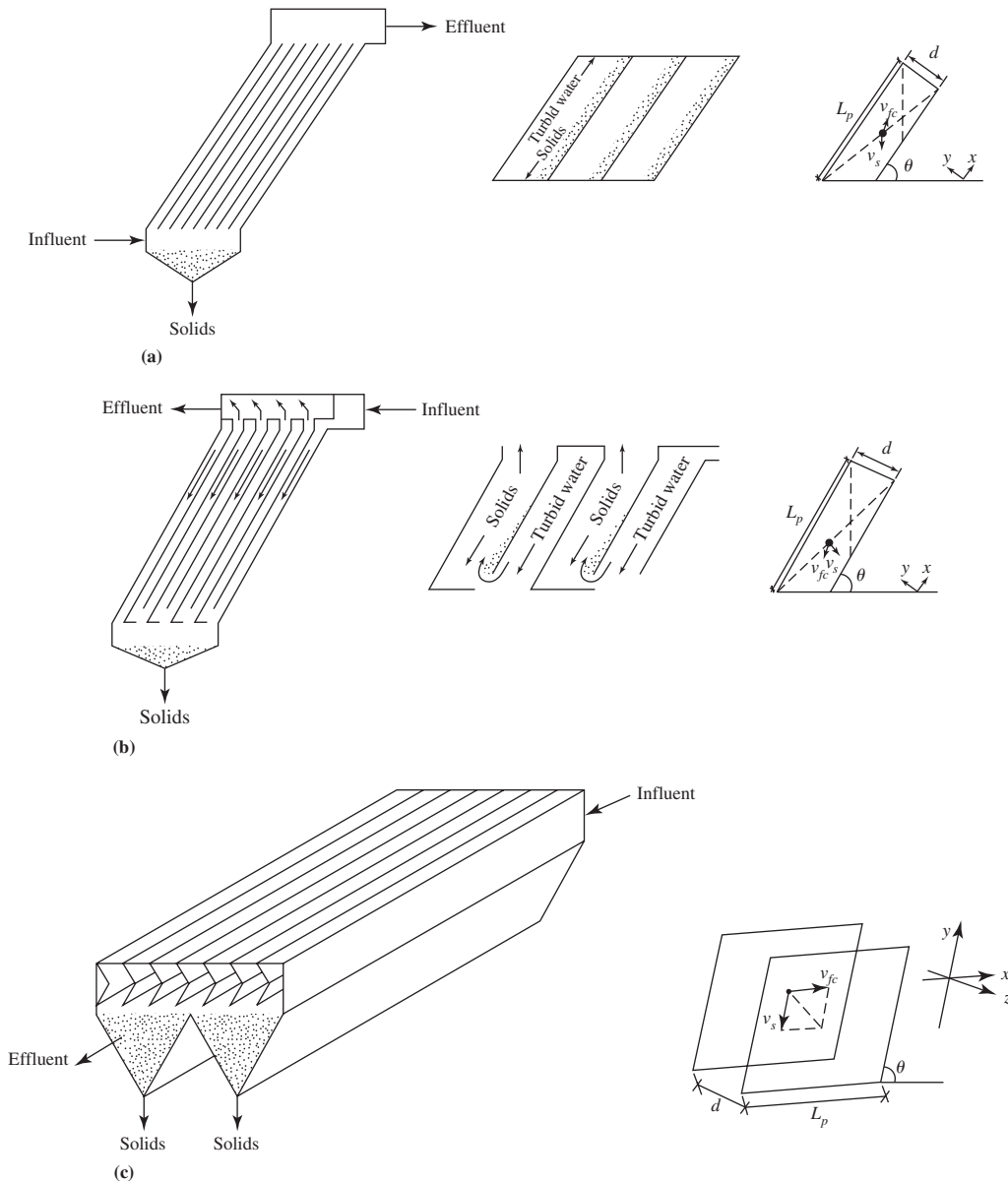

FIGURE 10-12 Flow patterns for inclined settling systems (a) countercurrent, (b) cocurrent, (c) crosscurrent.

The following theoretical development is from MWH (2005). The settling time for a particle to move between countercurrent parallel plates is

$$t = \frac{d}{v_s \cos \theta} \quad (10-23)$$

where t = settling time, s

d = distance between two parallel plates (as shown in Figure 10-12), m

v_s = particle settling velocity, m/s

θ = inclination angle of plates from horizontal, degrees

If a uniform velocity is assumed, then the particle travel time spent in the plates is

$$t_p = \frac{L_p}{v_{fc} - v_s \sin \theta} \quad (10-24)$$

where t_p = particle travel time spent in plates, s

L_p = length of plate, m

v_{fc} = fluid velocity in channel, m/s

If the trajectory of a particle that is shown in Figure 10-12 is considered, then all of the particles with a settling velocity v_s are removed. If Equation 10-23 is equated to Equation 10-24, t_p is equal to the settling time t . Those particles with a larger settling velocity are also removed, that is

$$v_s \geq \frac{v_{fc} d}{L_p \cos \theta + d \sin \theta} \quad (10-25)$$

The fluid velocity, v_{fc} , may be determined from the number of channels

$$v_{fc} = \frac{Q}{Ndw} \quad (10-26)$$

where Q = flow rate, m³/s

N = number of channels, dimensionless

w = width of channel, m

If one assumes that the surface area of the basin is comprised of plates and that the area occupied by the plates is ignored, then the fluid velocity, v_{fc} , is also related to the overflow rate of the basin

$$v_{fc} = \frac{Q}{Ndw} = \frac{Q}{A \sin \theta} \quad (10-27)$$

where A = top area of basin, m².

Depending on where they enter the plate, particles with settling velocities less than v_s may also be removed.

For cocurrent settling, the settling time for a particle to move between two parallel plates is given by Equation 10-23. The time that particles moving with the fluid spend in the plates is

$$t_p = \frac{L_p}{v_{fc} + v_s \sin \theta} \quad (10-28)$$

If Equation 10-23 is equated to Equation 10-28, t_p is equal to the settling time t . Those particles with a settling velocity v_s are removed. Those particles with larger settling velocity are also removed, that is

$$v_s \geq \frac{v_{fc} d}{L_p \cos \theta - d \sin \theta} \quad (10-29)$$

For crosscurrent settling, the settling time for a particle to move between two parallel plates is also given by Equation 10-23. The time that particles moving with the fluid spend in the plates is

$$t_p = \frac{L_p}{v_{fc}} \quad (10-30)$$

If t_p is equal to the settling time (equating Equation 10-23 and Equation 10-30), then the particles with settling time v_s are removed. Those particles with a larger settling velocity are also removed, that is

$$v_s \geq \frac{v_{fc} d}{L_p \cos \theta} \quad (10-31)$$

Non-Ideal Behavior of Settling Tanks

Numerous factors affect settling tank performance. These include turbulence, inlet energy dissipation, density currents, wind effects, outlet currents, and sludge equipment movement. In general, for most water treatment sedimentation basins, performance is primarily a function of turbulence, inlet energy dissipation, density currents, and wind effects rather than outlet currents and mechanical movement. Therefore, this discussion is focused on these effects.

Turbulence. In Camp's development of a theoretical basis for removal of discretely settling particles he assumed a uniform horizontal velocity in the settling zone. This assumption implies near laminar flow conditions (Reynolds number ≤ 1). This is rarely, if ever, achieved in actual settling tanks. However, this important assumption is considered in the design of the tank by evaluation of the Reynolds number and the Froude number. These dimensionless ratios are described in the next section of this chapter.

The Reynolds number is important as a measure of turbulence in flows that are influenced by viscous effects, such as internal flows and boundary layer flows. The Froude number is important in flows that are influenced by gravity, such as free surface flows.

Inlet Energy Dissipation. The performance of the sedimentation basin is strongly influenced by the effectiveness of energy dissipation at the inlet. Again using Camp's theory, the flow must

be uniform across the cross-sectional area of the tank as it enters the settling zone. The inlet pipe carrying solids to the clarifier often is designed to have velocities high enough to keep the particles from settling in the pipe. This high velocity must be reduced sufficiently to prevent jet effects in the basin. The design solution is to provide a diffuser wall and, perhaps, an inlet baffle (also known as a *target baffle*).

Density Currents. *Short-circuiting* is the term used to describe the effect of density currents on settling tank performance. Short-circuiting occurs when the flow through the tank is not uniform and a current carries the particulate matter to the effluent launders before the particles can settle. Temperature differentials and changes in solids concentration are major causes of density currents.

The addition of warm water to a sedimentation basin, or the warming of the surface water in a basin containing cooler water, leads to short circuiting because the warmer water rises to the surface and reaches the launders in a fraction of the theoretical detention time. Conversely, the cooler water tends to dive down, flow along the bottom, and rise at the tank outlet. Temperature density currents are commonly caused by exposure to sunlight, changing the mixing ratio of two or more water sources, switching from one source to another, and shifting the reservoir intake elevation.

A rapid increase in the influent solids concentration from floods or high winds on lakes and reservoirs will cause a higher density in the influent than in the basin. This will cause it to plunge as it enters the basin, flow along the bottom, and rise at the tank outlet. Intermediate diffuser walls have been used to counteract density current effects.

Wind Effects. Large, open tanks are susceptible to induced currents and, in sufficiently strong winds, waves along the top of the tank. An underflow current in the opposite direction to the surface current is also created. In addition to short circuiting, this may lead to scouring of the already settled particulate matter from the sludge zone. The design solutions include limiting the length of the tank and placing wave breakers along the tank surface.

10-3 SEDIMENTATION PRACTICE

Alternatives

Typical sedimentation tanks used in water treatment are listed in Table 10-1. Of those listed, the recommended order of preference for settling coagulation/flocculation floc is (1) a rectangular tank containing high-rate settler modules, (2) a long rectangular tank, and (3) a high-speed microsand clarifier (also known as *ballasted sand sedimentation*). For the lime-soda softening process, the upflow solids contact unit (also known as a *reactor clarifier* or *sludge blanket clarifier*) is preferred.

The upflow and upflow, solids-contact clarifiers are proprietary units that have their basic size and blueprints preestablished by the equipment manufacturers. They are not preferred for removing alum floc for the following reasons: (1) temperature fluctuations as small as 0.5°C can cause severe density flow short circuiting, and (2) there is a rapid loss of efficiency if there is hydraulic or solids overloading. There are circumstances when they may be appropriate. These are discussed in detail by Kawamura (2000). Horizontal flow with center feed, peripheral feed, and simple upflow clarifiers are not recommended because of their hydraulic instability (Kawamura, 2000).

TABLE 10-1
Alternative settling tank configurations

Nomenclature	Configuration or comment
Horizontal flow	Long rectangular tanks
Center feed	Circular, horizontal flow
Peripheral feed	Circular, horizontal flow
Upflow clarifiers	Proprietary
Upflow, solids contact	Recirculation of sludge with sludge blanket, proprietary
High-rate settler modules	Rectangular tank, parallel plates or tubes, proprietary
Ballasted sand	Addition of microsand, proprietary

Adapted from Kawamura, 2000.

With the exception of the upflow solids contact unit that was discussed in Chapter 7, the remainder of this discussion will focus on the preferred alternatives.

Rectangular Sedimentation Basins. Current design practice is shifting from rectangular sedimentation basins to high-rate settler modules or, in some cases, dissolved air flotation (DAF). The rectangular sedimentation basin design is presented here because, historically, it has been the most frequently used design and because it serves as the fundamental structure for high-rate settler modules.

A rectangular basin with horizontal flow is shown in Figure 10-13. To provide redundancy, two basins are placed longitudinally with a common wall. The inlet structure is designed to distribute flocculated water over the entire cross section. Outlet structures for rectangular tanks generally include launders placed parallel to the length of the tank. Cross baffles may be added to prevent the return of surface currents from the end of the tank back toward the inlet.

Generally, sludge is removed by mechanical collectors. The major types of mechanical collectors ranked in order of cost are: (1) a traveling bridge with sludge-scraping squeegees and a mechanical cross collector at the influent end of the tank, (2) a traveling bridge with sludge suction headers and pumps, (3) chain-and-flight collectors, and (4) sludge suction headers supported by floats and pulled by wires (MWH, 2005).

As may be implied from its title, the traveling bridge system consists of a bridge across the width of the tank that travels up and down the tank on wheels resting on the tank wall or side rails. Either scraper blades or a suction device is suspended from the bridge to the sludge zone. The suction system is equipped with either a pump or it makes use of a siphon effect from the differential head between water levels in the clarifier and the sludge line to remove the sludge. For water treatment systems, the pump system is preferred.

The chain-and-flight system consists of two strands of chain on either side of the collection area with “flights” running across the width of the collection area. The flights, formerly made of redwood, and now made of fiberglass reinforced composite, are attached at 3 m intervals. High density polyethylene (HDPE) wearing shoes are attached to the flights. These ride on T-rails cast into the concrete floor. The chain and sprocket drive, formerly made of steel, is now made of a high-strength composite material. Although the chains are corrosion free and require less maintenance, they have a tendency to stretch when first installed.

A *cross collector*, or hopper, is placed at the influent end of the tank. Sludge is scraped to the end of the tank and pushed into the hopper.

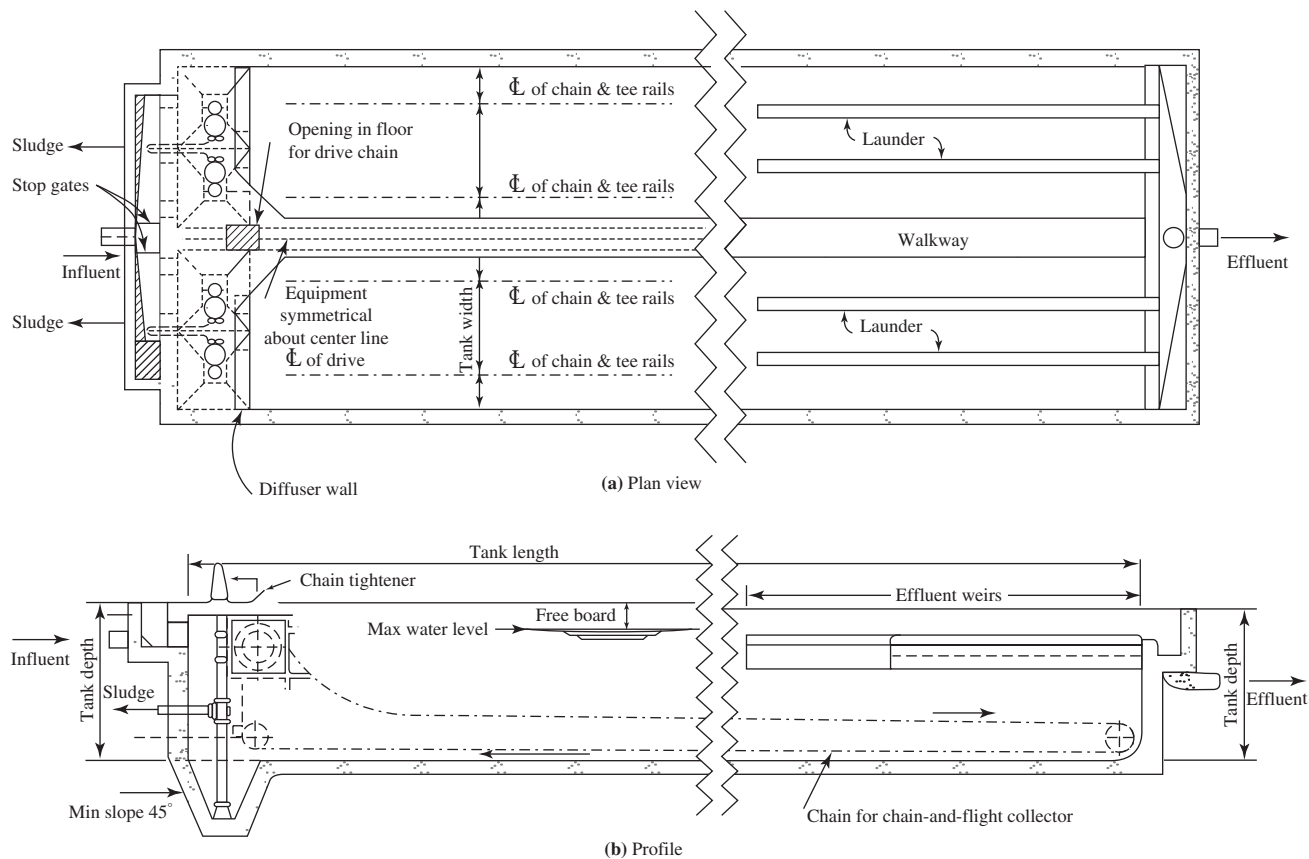
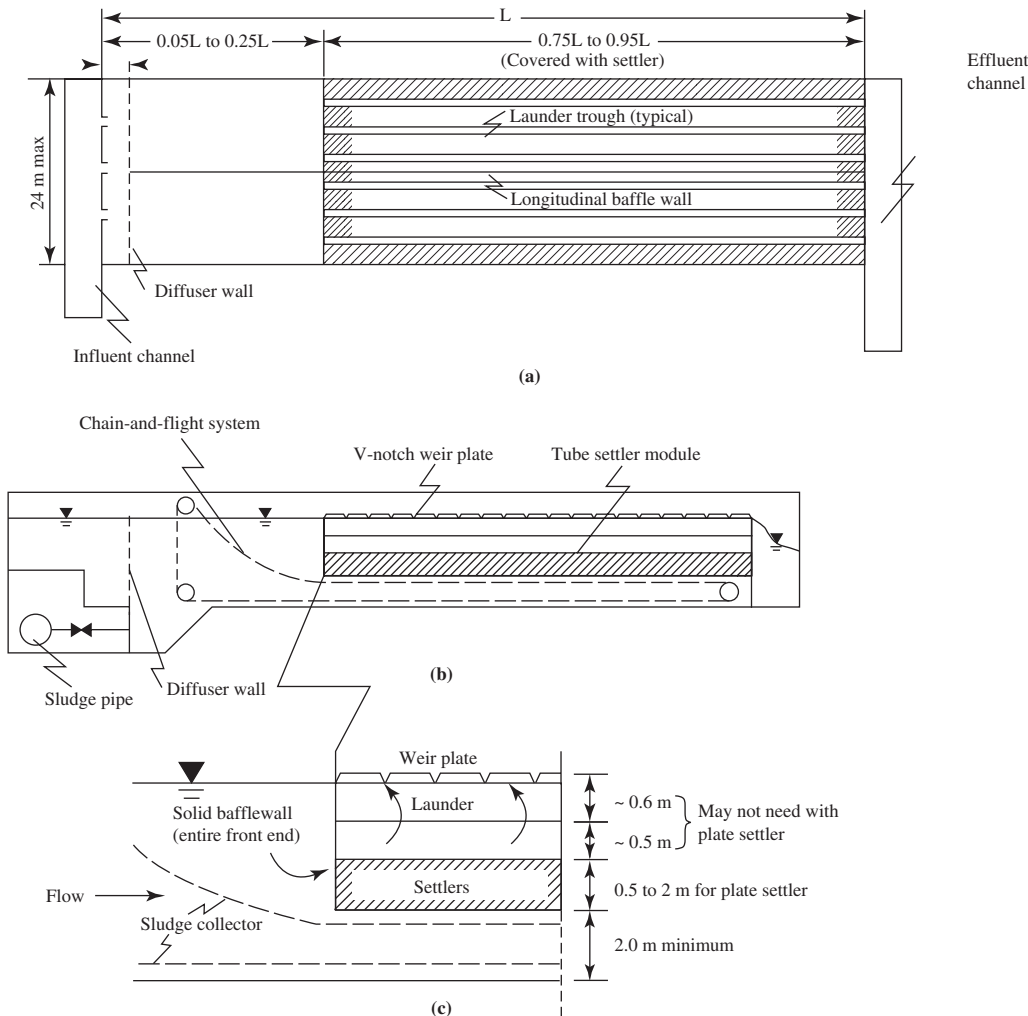

FIGURE 10-13
 (a) Plan and (b) profile of horizontal-flow, rectangular sedimentation basin.

High-Rate Settler Modules. The modules are placed in the downstream end of rectangular horizontal flow tanks below the launders as shown in Figure 10-14. They occupy approximately 75–95 percent of the tank area. The remaining area is left as open space. As with the rectangular sedimentation basin, a diffuser is placed at the inlet. A solid baffle wall covers the entire front end of the settler if the flow is countercurrent. Sufficient space is provided below the settler for the sludge collection mechanism.

Although special accommodations may be made for other types, the chain-and-flight or *indexing grid* sludge collection system is frequently employed because the settler modules would interfere with any of the other collection mechanisms. The indexing grid system (Figure 10-15) on page 10-24 consists of a series of concave-faced triangular blades rigidly connected to glide bars. The glide bars ride on top of polyethylene wear strips anchored to the floor of the tank. The system operates at the bottom of the sludge layer. The collector operates by gently pushing the grid system and the sludge in front of the grid at a speed between 0.6 and 1.2 m/min. When the hydraulic cylinder that drives the grid reaches the end of its stroke, the grid system reverses at two to three times the forward speed. During the return movement, the triangular shaped blades slide under the sludge so that there is minimum disturbance to the sedimentation process. The result is a continuous

FIGURE 10-14

Sedimentation tanks with tube settler modules: (a) plan; (b) elevator; (c) typical dimensions in m. Plate settlers may be deeper than tube settlers and in some proprietary types, may have an integrated launder.

movement of the sludge to a crosscollector at the end of the tank. The location of the drive system above the water and the minimization of moving parts in the sludge blanket are suggested operation and maintenance advantages of the indexing system.

Alternatively, the settler system may be designed to accommodate a traveling bridge if a traveling bridge is selected early in the design process. Because of the travel speed of the traveling bridge, only the pump type for removing the solids is appropriate.

Ballasted Sedimentation. These are proprietary units. A schematic of a typical unit is shown in Figure 10-16. Alum or ferric chloride is added in the first stage to form turbidity floc. Subsequently, a high-molecular-weight cationic polymer and microsand particles are added to the

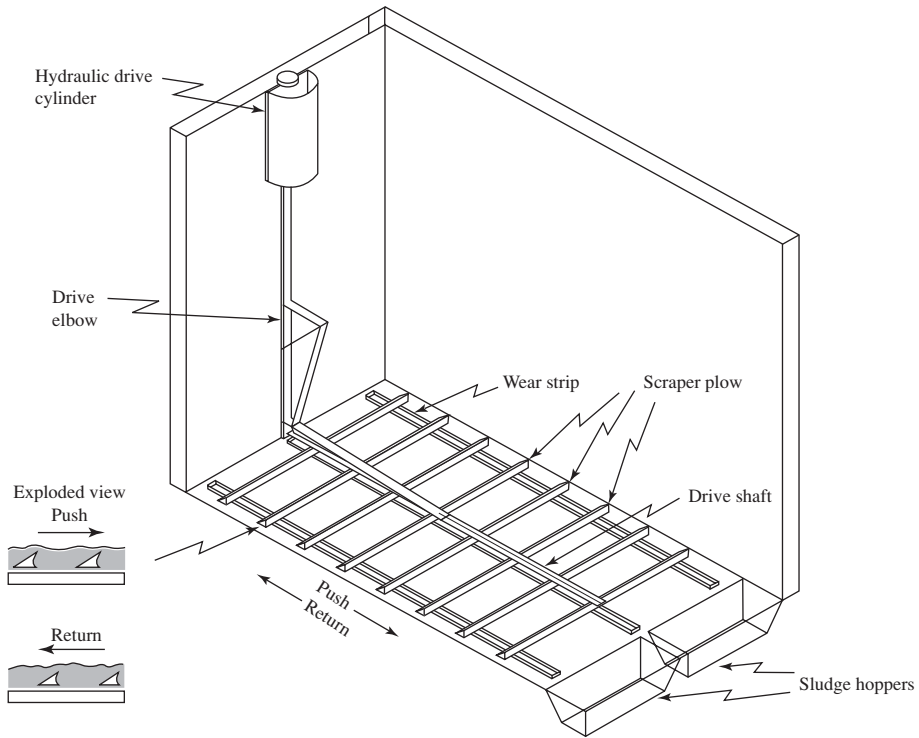

FIGURE 10-15
Indexing grid sludge scraper.

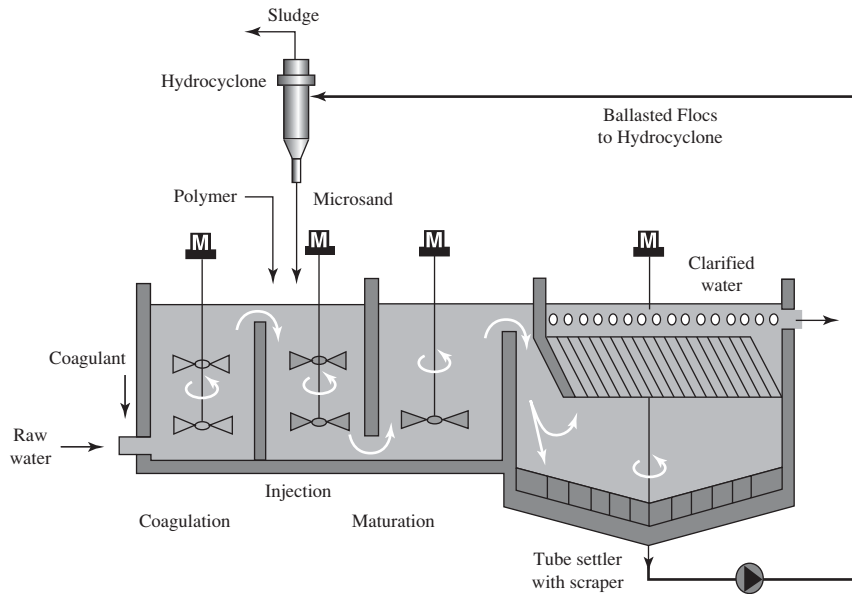

FIGURE 10-16
ACTIVFLO ballasted sedimentation process for water treatment. (Courtesy of Kruger Inc.)

second stage. These flocculate with the preformed turbidity floc. After flocculation, the ballasted floc is settled in a high-rate settler, and the sludge is pumped to a hydrocyclone where the microsand is recovered for reuse.

The surface loading rate ranges from 35 to 62 m/h. The floc settling velocities are 20 to 60 times greater than conventional sedimentation. This allows a reduction in detention time to between 9 and 10 minutes. The sludge contains 10 to 12 percent sand by weight.

10-4 SEDIMENTATION BASIN DESIGN

Rectangular tank and high-rate settlers are the primary focus of this discussion. Because ballasted sedimentation is a proprietary process, the design is under the control of the manufacturers. The design of this process will not be covered.

Rectangular Sedimentation Basins

At a minimum, to provide redundancy, two tanks are provided. These are placed together, in parallel, with a common wall. In general, four tanks are preferred (Willis, 2005). This provides maximum flexibility in operation over a wide range of flow rates with allowance for one unit being out of service at the maximum flow rate. Four tanks, however, may result in an unacceptable capital cost.

Inlet Zone. The preferred arrangement is a direct connection between the flocculation basin and the settling tank. The diffuser wall between the two tanks is designed using the same procedure that was used for baffle walls in flocculation tanks (Chapter 6).

When the flocculated water must be piped to the settling tank, the flow velocity commonly used is in the range of 0.15 to 0.6 m/s. This velocity must be reduced and the flow spread evenly over the cross section of the settling tank. A diffuser wall is the most effective way to accomplish this. The design process is the same as that used for baffle walls in flocculation tanks (Chapter 6).

The diffuser wall is placed approximately 2 m downstream of the inlet pipe. The headloss through the holes should be 4 to 5 times the velocity head of the approaching flow. Port velocities typically must be about 0.20 to 0.30 m/s for sufficient headloss. The holes are about 0.10 to 0.20 m in diameter spaced about 0.25 to 0.60 m apart. They are evenly distributed on the wall. The lowest port should be about 0.6 m above the basin floor (Willis, 2005).

Settling Zone. Overflow rate is the primary design parameter for sizing the sedimentation basin. Typical overflow rates are given in Table 10-2. These rates are usually conservative enough that the inlet zone does not have to be added to the length calculated for the settling zone. If the overflow rate is based on pilot studies, then the length of the inlet zone is added to the length calculated from the overflow rate.

In theory the sedimentation basin depth [also called *side water depth* (SWD)] should not be a design parameter because removal efficiency is based on overflow rate. However, there is a practical minimum depth required for sludge removal equipment. In addition, depth may be a controlling parameter to limit flow-through velocities and/or scour of particles from the sludge blanket. Basins with mechanical sludge removal equipment are usually between 3 and 5 m deep (MWH, 2005, and Willis, 2005).

To provide plug flow and minimize short circuiting, a minimum length to width ratio (L:W) of 4:1 is recommended. A preferred L:W is 6:1 (Kawamura, 2000).

TABLE 10-2
Typical sedimentation tank overflow rates^a

Application	Long rectangular and circular, m ³ /d · m ²	Upflow solids-contact, m ³ /d · m ²
Alum or iron coagulation		
Turbidity removal	40	50
Color removal	30	35
High algae	20	
Lime softening		
Low magnesium	70	130
High magnesium	57	105

^aThese rates are guides that are applicable at moderate water temperatures—not less than 10°C. For lower temperatures the rates should be reduced.

Source: Adapted from AWWA, 1990.

Open sedimentation tanks greater than 30 m in length are especially susceptible to wind effects. For longer tanks, wave breakers (launders or baffles) placed at 30 m intervals are recommended. The tank depth is usually increased by about 0.6 m to provide *freeboard* to act as a wind barrier.

Horizontal flow velocities must be controlled to avoid undue turbulence, backmixing, and scour of particles from the sludge. GLUMRB (2003) recommends that the velocity not exceed 0.15 m/min. Velocities of 0.6 to 1.2 m/min have been found to be acceptable for basin depths of 2 to 4.3 m (Willis, 2005). Reynolds and Froude numbers can be used to check on turbulence and backmixing. The Reynolds number is determined as

$$\mathbf{R} = \frac{v_f R_h}{\nu} \quad (10-32)$$

where \mathbf{R} = Reynolds number, dimensionless

v_f = average horizontal fluid velocity in tank, m/s

R_h = hydraulic radius, m

$= A_s/P_w$

A_s = cross sectional area, m²

P_w = wetted perimeter, m

ν = kinematic viscosity, m²/s = μ/ρ

μ = dynamic viscosity, Pa · s

ρ = density of fluid, kg/m³

The Froude number is determined as

$$\mathbf{Fr} = \frac{(v_f)^2}{g R_h} \quad (10-33)$$

where \mathbf{Fr} = Froude number, dimensionless

g = acceleration due to gravity, 9.81 m/s²

Recommended values for the settling zone design are $R < 20,000$ and $Fr > 10^{-5}$ (Kawamura, 2000). A large Reynolds number indicates a high degree of turbulence. A low Froude number indicates that water flow is not dominated by horizontal flow, and backmixing may occur. Like all design criteria, these values are based on experience. While the desired Reynolds number is relatively easy to achieve by modifying the tank shape, the recommended Froude number is very sensitive to the shape of the tank and is difficult to achieve while maintaining other design criteria when the flow rates are under $40,000 \text{ m}^3/\text{d}$.

The Reynolds number may be reduced and the Froude number increased by the placement of baffles parallel to the direction of flow. The baffles must be placed above the sludge collection equipment and should be about 3 m apart (MWH, 2005).

GLUMRB (2003) recommends a minimum of four hours detention time or an overflow rate not to exceed 1.2 m/h. This appears to be a carryover from the time when basins were manually cleaned and were designed with depths of 5 m or more to store large volumes of sludge between cleaning. Thus, more than half the volume could be filled with sludge before cleaning was required, and real detention times could vary from four hours when the tank was clean to less than two hours just before cleaning. Modern designs do not provide for this large of a storage zone, and detention times of 1.5 to 2.0 h have proven to provide excellent treatment (Willis, 2005).

Outlet Zone. The outlet zone is composed of launders running parallel to the length of the tank. The weirs should cover at least one-third, and preferably up to one-half, the basin length. As shown in Figure 10-17, they are spaced evenly across the width of the tank. If baffles are used, a launder is placed midway between the baffles. Long weirs have three advantages: (1) a gradual reduction of flow velocity toward the end of the tank, (2) minimization of wave action from wind, and (3) collection of clarified water located in the middle of the tank when a density flow occurs.

The water level in the tank is controlled by the end wall or overflow weirs. V-notch weirs are attached to the launders and broad-crested weirs are attached to the end wall. Submerged

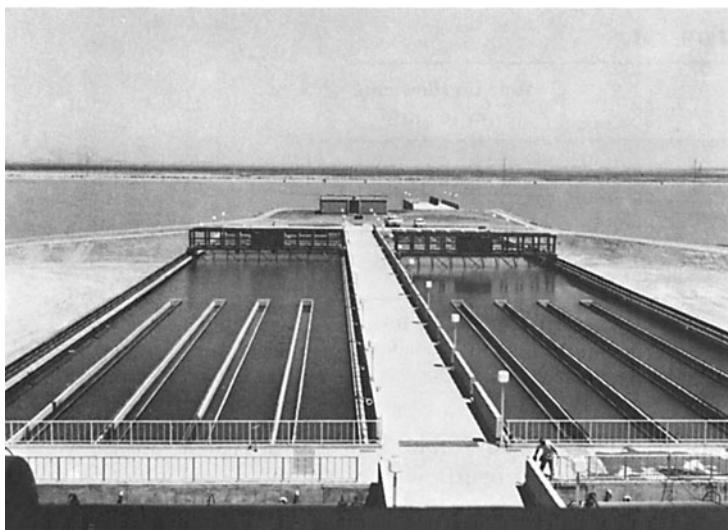

FIGURE 10-17

Launders in horizontal-flow rectangular sedimentation tanks.

orifices may be used on the launders. These have been used to avoid breakup of fragile floc when conventional rapid sand filters are used. For high-rate filter designs, there is less concern about breaking the floc because high-rate filters require a small strong floc, and filter aids are added prior to filtration to improve particle attachment in the filter.

Although the optimum weir hydraulic loading rate is dependent on the design of prior and subsequent processes, typical weir loading rates are given in Table 10-3. GLUMRB (2003) specifies that the hydraulic loading shall not exceed $250 \text{ m}^3/\text{d} \cdot \text{m}$ of outlet launder, that submerged orifices should not be located lower than 1 m below the flow line, and that the entrance velocity through submerged orifices shall not exceed 0.15 m/s. Research has shown that loading rates may be as high as $1,000 \text{ m}^3/\text{d} \cdot \text{m}$ of weir given a reasonable water depth (AWWA, 1990).

Sludge Zone. In selecting the depth of the sedimentation tank, an allowance of between 0.6 and 1 m is made for sludge accumulation and sludge removal equipment. If the overflow rate design is based on pilot studies, then the depth of the pilot settling column used to develop the data may be selected as the depth of the tank. In this case an additional 0.6 to 1 m is added to the column depth to account for the sludge zone.

To facilitate sludge removal, the bottom of the tank is sloped toward a sludge hopper at the head end of the tank. When mechanical equipment is used, the slope should be at least 1:600.

Chain-and-flight collectors are commonly employed to remove the sludge. Their length is limited to about 60 m. The flight widths are provided in 0.3 m increments and are limited to a 6 m width between the chains. However, up to three trains in parallel (24 m maximum width) may be placed in one settling basin (Kawamura, 2000). The velocity of chain-and-flight scrapers should be kept to less than 18 m/h to prevent resuspending settled sludge.

Unlike chain-and-flight collectors, traveling bridge collectors can service extremely long tanks. They are more cost effective if the basin length exceeds 80 to 90 m, and the width exceeds 12 m. They can span up to 30 m (Kawamura, 2000). For suction sludge removal units, the velocity can be as high as 60 m/h because the concern is disruption of the settling process, not the resuspension of sludge.

The cross collector is typically 1 to 1.2 m wide at the top and about 0.6 to 1.2 m deep. Either a helicoid screw or a chain-and-flight mechanism is used to move the sludge across the hopper to a hydraulic or pumping withdrawal. Traditionally, the hopper is steep-sided at an angle of about 60° (Willis, 2005).

TABLE 10-3
Typical weir hydraulic loading rates

Type of floc	Weir overflow rate, $\text{m}^3/\text{d} \cdot \text{m}$
Light alum floc (low-turbidity water)	140–180
Heavier alum floc (higher turbidity water)	180–270
Heavy floc from lime softening	270–320

Source: Davis and Cornwell, 2008.

Horizontal-Flow Rectangular Sedimentation Basin Design Criteria

Typical design criteria for horizontal-flow rectangular sedimentation basins in larger water treatment plants ($\geq 40,000 \text{ m}^3/\text{d}$) are summarized in Table 10-4. Some design criteria are quite rigid while others only provide guidance. For example, because of manufacturing constraints, the length of a chain-and-flight collection sets a firm maximum on the length of the settling basin. Although the maximum width is 6 m, multiple units may be mounted in parallel to achieve widths up to 24 m.

Example 10-4 illustrates the design of a horizontal-flow rectangular sedimentation basin based on the results of a pilot column study.

For design criteria for medium to small plants ($\leq 40,000 \text{ m}^3/\text{d}$) see the discussion following Example 10-4.

TABLE 10-4
Typical design criteria for horizontal-flow rectangular sedimentation basins

Parameter	Typical range of values	Comment
Inlet zone		
Distance to diffuser wall	2 m	
Diffuser hole diameter	0.10–0.20 m	
Settling zone		
Overflow rate	40–70 $\text{m}^3/\text{d} \cdot \text{m}^2$	See Table 10-2
Side water depth (SWD)	3–5 m	
Length	30 m	Wind constraint
	60 m	Chain-and-flight
	≥ 80 –90 m	Traveling bridge
Width	0.3 m increments	Chain-and-flight
	6 m maximum per train	Chain-and-flight
	24 m maximum = 3 trains per drive	Chain-and-flight
	30 m maximum	Traveling bridge
L:W	4:1 to 6:1	$\geq 6:1$ preferred
L:D	15:1	Minimum
Velocity	0.005–0.018 m/s	Horizontal, mean
Reynolds number	< 20,000	
Froude number	> 10^{-5}	
Outlet zone		
Launder length	1/3–1/2 length of basin	Evenly spaced
Launder weir loading	140–320 $\text{m}^3/\text{d} \cdot \text{m}$	See Table 10-3
Sludge zone		
Depth	0.6–1 m	Equipment dependent
Slope	1:600	Mechanical cleaning
Sludge collector speed	0.3–0.9 m/min	

Sources: AWWA, 1990; Davis and Cornwell, 2008; Kawamura, 2000; MWH, 2005; Willis, 2005.

Example 10-4. Design the settling tank(s) for the city of Stillwater's water treatment plant expansion using the design overflow rate found in Example 10-3. The maximum day design flow is $0.5 \text{ m}^3/\text{s}$. Assume a water temperature of 10°C .

Solution:

- a. Find the surface area.

First change the flow rate to compatible units:

$$(0.5 \text{ m}^3/\text{s})(86,400 \text{ s/d}) = 43,200 \text{ m}^3/\text{d}$$

Using the overflow rate from Example 10-3, the surface area is

$$A_s = \frac{43,200 \text{ m}^3/\text{d}}{32.5 \text{ m}^3/\text{d} \cdot \text{m}^2} = 1,329.233 \text{ or } 1,330 \text{ m}^2$$

- b. Select the number of tanks.

Two tanks is the minimum number. For this flow rate make trial calculations using six tanks.

$$\frac{1,330 \text{ m}^2}{6 \text{ tanks}} = 221.66 \text{ or } 222 \text{ m}^2/\text{tank}$$

- c. Select a trial width for calculation.

The maximum width for the chain-and-flight sludge collector is 6 m increments. Assume a width of 4 m.

- d. Check length-to-width ratio.

$$L = \frac{222 \text{ m}^2/\text{tank}}{4 \text{ m/tank}} = 55.5 \text{ m}$$

$$L/W = \frac{55.5 \text{ m}}{4 \text{ m}} = 13.8 \text{ or } 13.8:1$$

This is larger than the ratio of 6:1 and is acceptable.

- e. Select a trial depth.

Because the column depth used to calculate the overflow rate was 2 m, this is a starting point for setting the design depth. An allowance for the sludge depth of 1 m is added to this depth. In addition the tank should be provided with 0.6 m of freeboard. The total depth of the tank is then

$$2 \text{ m} + 1 \text{ m} + 0.6 \text{ m} = 3.6 \text{ m}$$

Side water depth (SWD) = 3.0 m.

If the sludge zone is not counted, the depth of the water is less than the design recommendation of 3 m.

- f. Check the length-to-depth ratios.

$$L/D = \frac{55.5 \text{ m}}{2 \text{ m}} = 27.75 \text{ or } 28:1$$

The L:D ratio is acceptable.

- g. Check the velocity and then check the Reynolds and Froude numbers.

$$\begin{aligned} v_f &= \frac{Q}{A} = \frac{0.5 \text{ m}^3/\text{s}}{(6 \text{ tanks})(2 \text{ m depth})(4 \text{ m width})} \\ &= 0.0104 \text{ m/s} \end{aligned}$$

This is within the acceptable range of 0.005 – 0.018 m/s.

$$R_h = \frac{A_x}{P_w} = \frac{(2 \text{ m deep})(4 \text{ m wide})}{2 \text{ m} + 4\text{m} + 2\text{m}} = 1.0 \text{ m}$$

From Appendix A at a temperature of 10°C, the viscosity is $1.307 \times 10^{-6} \text{ m}^2/\text{s}$ and the Reynolds number is

$$\mathbf{R} = \frac{(0.0104 \text{ m/s})(1.0 \text{ m})}{1.307 \times 10^{-6} \text{ m}^2/\text{s}} = 7,957.15 \text{ or } 8,000$$

This is less than 20,000 and is acceptable.

$$\mathbf{Fr} = \frac{(0.0104 \text{ m})^2}{(9.81 \text{ m/s}^2)(1.0 \text{ m})} = 1.1 \times 10^{-5}$$

This is greater than 10^{-5} and is acceptable.

- h. Design the launders.

Provide launders for 1/3 of the tank length

$$L_{\text{Launder}} = \frac{55.5 \text{ m}}{3} = 18.5 \text{ m}$$

Place them at 1 m intervals on center so that there are three in the tank.

- i. Check the weir loading rate.

$$WL = \frac{43,200 \text{ m}^3/\text{d}}{(6 \text{ tanks})(3 \text{ launders/tank})(18.5 \text{ m/launder})(2 \text{ sides})} = 64.86 \text{ or } 65 \text{ m}^3/\text{d} \cdot \text{m}$$

This is well below the limit of $250 \text{ m}^3/\text{d} \cdot \text{m}$ and is acceptable.

Summary:

$$Q_{\text{design}} = 43,200 \text{ m}^3/\text{d} = 0.5 \text{ m}^3/\text{s}$$

$$\text{Number of tanks} = 6$$

$$\text{Width of each tank} = 4 \text{ m}$$

$$\text{Length of each tank} = 55.5 \text{ m}$$

$$L:W = 13.8:1$$

$$\text{Depth including sludge} = 3.6 \text{ m}$$

$$L:D = 28:1 \text{ without sludge depth; } 18.5:1 \text{ with sludge depth}$$

$$v_f = 0.0104 \text{ m/s}$$

$$\text{Reynolds number} = 8,000$$

$$\text{Froude number} = 1.1 \times 10^{-5}$$

$$\text{Launders} = 3 \text{ spaced evenly}$$

$$\text{Launder length} = 18.5 \text{ m}$$

$$\text{Weir loading} = 65 \text{ m}^3/\text{d} \cdot \text{m}$$

$$\text{Sludge collector} = \text{chain-and-flight}$$

Comments:

1. Not all of the design recommendations were met. This is, in part, due to the use of the pilot column data to set the overflow rate and the water depth. In general, exceeding the guidelines is acceptable. When the guidelines are not met, consideration should be given to the importance of the guideline in the function of the tank. In this case the depth of the tank is quite shallow. Recognizing that deeper tanks are better for Type II settling, this would be a reason for another design iteration. Likewise, the weir length is excessive for the guideline, and an alternate scheme might be considered.
2. The design solution presented here is not the only one that is acceptable. For example, 4 tanks, 6 m wide, 3 m deep, divided into 2 channels with a baffle will also meet the design criteria. An economic analysis is required to select the best alternative.
3. Numerous iterations may be required to balance the number of tanks, width, various ratios and the Reynolds and Froude number recommendations. A spreadsheet is recommended for the iteration process.

Design Criteria for Small- to Medium-Sized Plants

Frequently, small to medium-sized plants will operate for only one or two 8-hour shifts and store water for the remaining period (Walker, 1978). Thus, the flow rates are higher than the estimated demand at the design life of the plant. For example, a 10,000 m³/d demand could be met by operating one 8-hour shift at a flow rate of $(24/8)(10,000 \text{ m}^3/\text{d}) = 30,000 \text{ m}^3/\text{d}$. The 30,000 m³/d flow rate would be used for setting the dimensions of the tank. The decision of the operating schedule is an economic one because the capital costs will be higher, but the operating cost for personnel and power will be less. If the operating schedule results in a flow rate above 40,000 m³/d, then the design criteria in Table 10-4 apply. The suggested design criteria in Table 10-5 may be used for flow rates less than 40,000 m³/d.

TABLE 10-5
Typical design criteria for small to medium horizontal-flow rectangular sedimentation basins

Parameter	Typical range of values	Comment
Number of tanks	1 + 1 spare ≥ 2	< 10,000 m ³ /d $\geq 20,000$ m ³ /d
Inlet zone		
Distance to diffuser wall	4% of length	up to 2 m
Diffuser hole diameter	0.10–0.20 m	
Settling zone		
Overflow rate	20 m ³ /d · m ² 40 m ³ /d · m ²	< 10,000 m ³ /d >10,000 m ³ /d
Side water depth (SWD)	3–5 m	
Length	30 m 60 m	Wind constraint Chain-and-flight
Width	0.3 m increments 6 m maximum per train	Chain-and-flight Chain-and-flight
L:W	minimum of 4:1	$\geq 6:1$ preferred
L:D	15:1	Minimum
Velocity	0.005–0.018 m/s	Horizontal, mean
Reynolds number	< 20,000	
Outlet zone		
Launder length	1/3–1/2 length of basin	Evenly spaced
Launder weir loading	≤ 250 m ³ /d · m of launder	
Sludge zone		
Depth	0.6–1 m	Equipment dependent
Slope	1:600	Mechanical cleaning
Sludge collector speed	0.3–0.9 m/min	

Sources: AWWA, 1990; GLUMRB, 2003; Kawamura, 2000; MWH, 2005; Walker, 1978; Willis, 2005.

High-Rate Settler Modules

The guidance provided for the number of tanks for rectangular horizontal flow sedimentation also applies to high-rate settler modules.

Inlet Zone. A diffuser is designed and placed in the tank inlet zone in the same fashion as it is for a plain rectangular horizontal flow clarifier.

Flow Pattern. The three flow patterns, countercurrent, cocurrent, and crosscurrent, in theory, have little difference in performance. In practice the countercurrent pattern is the one most commonly employed because cocurrent designs often have trouble with resuspended sludge and crosscurrent designs have trouble with flow distribution (MWH, 2005).

Plates versus Tubes. Although little difference has been reported for various tube shapes, the hexagon and v-shapes may have some advantage because the sludge can collect in the notch.

Current practice in Michigan is to use plates rather than tubes because of operation and maintenance issues with the tubes.

Angle of Inclination. Typically, the plate inclination angle is 55° and the tube inclination is 60° from the horizontal.

Overflow Rate. Based on the tank area covered by the settler, the recommended range of overflow rates is from 60 to $180 \text{ m}^3/\text{d} \cdot \text{m}^2$. In cold regions, the maximum rate should be limited to $150 \text{ m}^3/\text{d} \cdot \text{m}^2$ (MWH, 2005).

Based on the total projected area of the tubes, a typical overflow rate is $29 \text{ m}^3/\text{d} \cdot \text{m}^2$ with a range of 24 to $48 \text{ m}^3/\text{d} \cdot \text{m}^2$. For plate settlers, typical overflow rates range from 17 to $40 \text{ m}^3/\text{d} \cdot \text{m}^2$ (Willis, 2005).

Velocities. In the tube settler, an average velocity of approximately 0.0025 – 0.0033 m/s is normally used in settling alum floc. An approach velocity of 0.6 m/min in the tank upstream of the settler is recommended (Kawamura, 2000).

Depth. Because the sludge collection equipment must fit below the settler module, the minimum depth below the tubes is 2 m . This also creates low velocities approaching the settler (Willis, 2005). Module heights range from 0.5 to over 2 m . Typical tank depths range from 3.6 to 5 m (Kawamura, 2000, and MWH, 2005).

Placement. The module is placed in the downstream end of the tank. For tube settlers, it is common practice to have 75 percent of the tank area covered by the settler and the remaining 25 percent left as open space to settle heavy floc. For plate settlers, up to 95 percent of the tank area may be covered by the settler.

Detention Time. Tube settlers generally have a detention time of 3.5 to 5 minutes. The detention time in parallel plate modules is from 5 to 20 minutes (Kawamura, 2000).

Reynolds and Froude Numbers. As with horizontal flow rectangular tanks, the Reynolds number and Froude number are used as a check on turbulence and backmixing. Equations 10-32 and 10-33 apply. In lieu of manufacturer's data, a working estimate of tube diameter of 50 to 80 mm may be used. A Reynolds number < 50 and a Froude number $> 10^{-5}$ are recommended (Kawamura, 2005). Yao's (1970) theoretical analysis suggests the Reynolds number may be as high as 800 . In both cases, the velocity is that of the water flowing between the plates or in the tubes.

Outlet Zone. Launderers are placed above the settler module. Flow from tube settlers must be collected uniformly across the basin to equalize the flow through the tubes. Therefore, they are spaced at not greater than 1.5 m on centers.

To provide a transition to the launderers, a clear space of 0.6 to 1 m above tube settlers is provided. Flow is usually collected through submerged orifices (Willis, 2005).

A proprietary alternative plate settler uses an effluent tube at the top of each plate to collect the effluent. The launder is placed adjacent to the plate module.

Sludge Zone. The sludge zone extends along the length of the tank. Mechanical collection using chain-and-flight collectors is common.

Operation and Maintenance. To facilitate maintenance, modules must be sufficiently independent to allow removal of individual units. An overhead crane must be provided. Stainless steel modules are preferred.

High-Rate Settler Module Design Criteria

Typical design criteria for horizontal-flow rectangular sedimentation basins are summarized in Table 10-6. Example 10-5 illustrates the design of a high-rate settler in a rectangular sedimentation basin.

TABLE 10-6
Typical design criteria for high-rate settler modules

Parameter	Typical range of values	Comment
Inlet zone		
Distance to diffuser	≤ 2 m	
Diffuser hole diameter	0.10–0.20 m	
Settling zone		
Overflow rate	60–180 $\text{m}^3/\text{d} \cdot \text{m}^2$	Alum floc
Side water depth (SWD)	3–5 m	
Length	60 m	Chain-and-flight
Width	0.3 m increments	Chain-and-flight
	6 m maximum per train	Chain-and-flight
	24 m maximum = 3 trains per drive	Chain-and-flight
Settler		
Fraction of basin covered	< 0.75	For plates ≤ 0.95
Height	0.5–2.0 m	For plates ≥ 1.0 m
Plate angle	$\geq 55^\circ$	
Tube angle	$\geq 60^\circ$	
Tube hydraulic diameter	0.05–0.08 m	
Tube velocity	0.0025–0.0033 m/s	
Approach velocity	0.010 m/s	Horizontal, mean
Reynolds number	< 50	
Froude number	$> 10^{-5}$	
Outlet zone		
Launder length	Equal to length of settler	
Launder spacing	1.5 m on centers	
Launder elevation	0.6–1.0 m above top of settler	For plates = to top
Launder weir loading	$< 300 \text{ m}^3/\text{d} \cdot \text{m}$	
Sludge zone		
Depth	0.6–1 m	Equipment dependent
Slope	1:600	Mechanical cleaning
Sludge collector speed	0.3–0.9 m/min	

Sources: Kawamura, 2000, MWH, 2005, Willis, 2005.

Example 10-5. Design the settling tank(s) for the city of Stillwater's water treatment plant expansion using high-rate settlers. The maximum day design flow is $0.5 \text{ m}^3/\text{s}$. Assume a well settling alum floc, a water temperature of 10°C , that the angle of the settler tubes is 60° , and that the tubes have a hydraulic diameter of 50 mm.

Solution:

- a. Find the surface area of the settler.

First change the flow rate to compatible units:

$$(0.5 \text{ m}^3/\text{s})(86,400 \text{ s/d}) = 43,200 \text{ m}^3/\text{d}$$

Using an overflow rate of $150 \text{ m}^3/\text{d} \cdot \text{m}^2$, the surface area is

$$A_s = \frac{43,200 \text{ m}^3/\text{d}}{150 \text{ m}^3/\text{d} \cdot \text{m}^2} = 288 \text{ m}^2$$

- b. Select the number of tanks.

Two tanks is the minimum number. For this flow rate make trial calculations using two tanks.

$$\frac{288 \text{ m}^2}{2 \text{ tanks}} = 144 \text{ m}^2/\text{tank}$$

- c. Select a trial width for calculation.

The maximum width for the chain-and-flight sludge collector is 24 m in 0.3 m increments. Assume a width of 6 m. This is the maximum width per train.

- d. Check length-to-width ratio.

$$L_{\text{settler}} = \frac{144 \text{ m}^2/\text{tank}}{6 \text{ m/tank}} = 24 \text{ m}$$

Setting the settler at 75% of the length of the basin, the tank length is

$$L = \frac{24 \text{ m}}{0.75} = 32 \text{ m}$$

- e. Select a trial side water depth (SWD).

Assume a depth of settler of 0.6 m. Provide allowance above the settler for launder of 1.0 m (0.6 m clearance and 0.4 m depth of trough). Provide 2 m for sludge zone.

$$\text{SWD} = 0.6 + 1.0 + 2 = 3.6 \text{ m}$$

The depth of the water plus the sludge zone is greater than the minimum design recommendation of 3 m. With the addition of freeboard, the tank depth is 4.2 m.

- f. Check the approach velocity.

$$v_{\text{approach}} = \frac{Q}{A} = \frac{43,200 \text{ m}^3/\text{d}}{(2 \text{ tanks})(6 \text{ m})(3.6 \text{ m})(86,400 \text{ s/d})} = 0.0116 \text{ m/s}$$

This is slightly high but acceptable.

- g. Check the Reynolds and Froude numbers.

The angle of the settler tubes is 60° . The area of the settler module calculated in (b) above is 144 m^2 . The velocity in the settler is

$$v_{fc} = \frac{Q}{A \sin \theta} = \frac{0.5 \text{ m}^3/\text{s}}{(2 \text{ tanks})(144 \text{ m}^2)(\sin 60)} = 0.0020 \text{ m/s}$$

This is a little low but acceptable. Assuming a 50 mm (0.05 m) hydraulic diameter of the tube, the hydraulic radius is

$$R_h = \frac{A_x}{P_w} = \left(\frac{\pi d^2}{4} \right) \left(\frac{1}{\pi d} \right) = \frac{d}{4} = \frac{0.05 \text{ m}}{4} = 0.0125 \text{ m}$$

From Appendix A at a temperature of 10°C , the viscosity is $1.307 \times 10^{-6} \text{ m}^2/\text{s}$. Using Equation 10-32, the Reynolds number is

$$\mathbf{R} = \frac{(0.0020 \text{ m/s})(0.0125 \text{ m})}{1.307 \times 10^{-6} \text{ m}^2/\text{s}} = 19.12 \text{ or } 19$$

This is less than 50 and is acceptable. Using equation 10-33 with v_{fc} for the velocity, the Froude number is

$$\mathbf{Fr} = \frac{(0.0020 \text{ m})^2}{(9.81 \text{ m/s}^2)(0.0125 \text{ m})} = 3.26 \times 10^{-5}$$

This is greater than 10^{-5} and is acceptable.

- h. Design the launders.

Provide launders over the length of the settler. $L_{\text{Lauder}} = 24 \text{ m}$

Place them at 1 m intervals on center so that there are three in the tank.

- i. Check the weir loading rate.

$$\text{WL} = \frac{43,200 \text{ m}^3/\text{d}}{(2 \text{ tanks})(3 \text{ launders/tank})(24 \text{ m/lauder})(2 \text{ sides})} = 150 \text{ m}^3/\text{d} \cdot \text{m}$$

This is well below the limit of $300 \text{ m}^3/\text{d} \cdot \text{m}$ and is acceptable.

Summary:

$$Q_{\text{design}} = 43,200 \text{ m}^3/\text{d} = 0.5 \text{ m}^3/\text{s}$$

$$\text{Number of tanks} = 2$$

$$\text{Width of each tank} = 6 \text{ m}$$

$$L_{\text{settler}} = 24 \text{ m}$$

$$\text{Length of each tank} = 32 \text{ m}$$

$$\text{Side Water Depth including sludge} = 3.6 \text{ m}$$

$$v_{\text{approach}} = 0.0116 \text{ m/s}$$

$$v_{fc} = 0.0020 \text{ m/s}$$

$$\text{Reynolds number} = 19$$

$$\text{Froude number} = 3.26 \times 10^{-5}$$

$$\text{Launders} = 3 \text{ spaced evenly}$$

$$\text{Launder length} = 24 \text{ m}$$

$$\text{Weir loading} = 150 \text{ m}^3/\text{d} \cdot \text{m}$$

$$\text{Sludge collector} = \text{chain-and-flight}$$

Comments:

1. Not all of the design recommendations were met, but overall the design is satisfactory.
2. The number of tanks and their size is considerably less than in Example 10-4. Initially, this appears to be a very favorable alternative. However, the cost of the settler modules may offset the reduced cost for less tankage. In addition, there is no redundant settling basin at the maximum design flow, so an additional basin would have to be provided. An economic analysis is required to select the best alternative.

10-5 OPERATION AND MAINTENANCE

Perhaps the most important O&M activity is the optimization of the sludge withdrawal process. The proper sweep cycle and duration are determined by trial. The concentration and characteristics of solids are used to adjust the cycle. This is, of course, dependent on the turbidity and flow rate of the raw water, so a range of conditions must be investigated.

Other operational characteristics, such as turbidity in the tank, equal hydraulic loading in the tanks, and the number of tanks in service for a given flow rate must be observed with appropriate adjustments. Maintenance is primarily focused on preventive maintenance on the collector and observation for corrosion.

Hints from the Field. On new installations provided with plastic chain collection systems, frequent tension adjustment in the first year after installation should be expected. Stainless steel, (305 ss), or very heavy gauge plastic, is recommended for tube settlers to minimize corrosion and/or deformation.

Pierpont and Alvarez (2005) offer the following suggestions for optimizing ballasted sedimentation when surface water is characterized by high total organic carbon (TOC):

- Use larger tubes for the *lamella* settler: 90 mm instead of 40 mm.

- Use lower mixer speed (80 to 85 percent of maximum) and position the blades a full diameter from the floor.
- Use large sand grain sizes: 130–150 μm instead of 80 or 100–120 μm diameter.

Visit the text website at www.mhprofessional.com/wwe for supplementary materials and a gallery of additional photos.

10-6 CHAPTER REVIEW

When you have completed studying this chapter, you should be able to do the following without the aid of your textbooks or notes:

1. Describe the difference between Type I, II, III, and IV settling and give an example of where they are applied in water or wastewater treatment.
2. Show by derivation why overflow rate “controls” the efficiency of settling in both the upflow clarifier and the horizontal flow clarifier.
3. Calculate the percent removal of a discretely settling particle in a vertical or horizontal flow sedimentation basin.
4. Explain why a settling column study is probably not appropriate for design of a new water treatment plant.
5. Identify four potential causes that you would investigate to explain the poor performance of a settling tank.
6. Describe, for a client, the three types of sedimentation systems described in this text and the reasons you would recommend one over another.
7. Explain the reason for calculating the Reynolds number and Froude number in checking a horizontal-flow rectangular settling basin.
8. Given the dimensions of a horizontal-flow rectangular settling basin or high-rate settler, recommend a mechanical collector.

With the use of this text, you should be able to do the following:

9. Calculate the settling velocity of a discrete particle given its density, diameter, and the water temperature.
10. Analyze settling column data to determine an overflow rate and detention time to achieve a specified percent removal.
11. Calculate the settling time and particle travel time in a high-rate settler.
12. Design a rectangular horizontal-flow sedimentation basin.
13. Design a high-rate settler including the horizontal flow tank.

10-7 PROBLEMS

- 10-1.** Calculate the diameter of a discrete particle whose terminal settling velocity is 1.044 cm/s. The particle density is 2.65 g/cm^3 and the water temperature is 12°C . Assume Stokes' law applies and that the density of water is $1,000 \text{ kg/m}^3$.
- 10-2.** You have been asked to evaluate the ability of a horizontal flow gravity grit chamber to remove particles having a diameter of $1.71 \times 10^{-4} \text{ m}$. The depth of the grit chamber is 1.0 m. The detention time of the liquid in the grit chamber is 60 s. The particle density is 1.83 g/cm^3 . The water temperature is 12°C . Assume the density of water is $1,000 \text{ kg/m}^3$.
- 10-3.** If the settling velocity of a particle is 0.70 cm/s and the overflow rate of a horizontal flow clarifier is 0.80 cm/s, what percent of the particles are retained in the clarifier?
- 10-4.** If the settling velocity of a particle is 2.80 mm/s and the overflow rate of an up-flow clarifier is 0.560 cm/s, what percent of the particles are retained in the clarifier?
- 10-5.** If the settling velocity of a particle is 0.30 cm/s and the overflow rate of a horizontal flow clarifier is 0.25 cm/s, what percent of the particles are retained in the clarifier?
- 10-6.** If the flow rate of the original plant in Problem 10-3 is increased from $0.150 \text{ m}^3/\text{s}$ to $0.200 \text{ m}^3/\text{s}$, what percent removal of particles would be expected?
- 10-7.** If the flow rate of the original plant in Problem 10-4 is doubled, what percent removal of particles would be expected?
- 10-8.** If the flow rate of the original plant in Problem 10-5 is doubled, what percent removal of particles would be expected?
- 10-9.** If a $1.0\text{-m}^3/\text{s}$ flow water treatment plant uses 10 sedimentation basins with an overflow rate of $15 \text{ m}^3/\text{d} \cdot \text{m}^2$, what should be the surface area (m^2) of each tank?
- 10-10.** Assuming a conservative value for an overflow rate, determine the surface area (in m^2) of each of two sedimentation tanks that together must handle a flow of $0.05162 \text{ m}^3/\text{s}$ of lime softening floc.
- 10-11.** Repeat Problem 10-10 for an alum or iron floc.
- 10-12.** Two sedimentation tanks operate in parallel. The combined flow to the two tanks is $0.1000 \text{ m}^3/\text{s}$. The depth of each tank is 2.00 m and each has a detention time of 4.00 h. What is the surface area of each tank, and what is the overflow rate of each tank in $\text{m}^3/\text{d} \cdot \text{m}^2$?
- 10-13.** Determine the detention time and overflow rate for a settling tank that will reduce the influent suspended solids concentration from 33.0 mg/L to 15.0 mg/L . The following batch settling column data are available. The data given are percent removals at the sample times and depths shown.

Time, min	Depths, ^a				
	0.5	1.5	2.5	3.5	4.5
10	50	32	20	18	15
20	75	45	35	30	25
40	85	65	48	43	40
55	90	75	60	50	46
85	95	87	75	65	60
95	95	88	80	70	63

^aDepths from top of column, column depth = 4.5 m.

- 10-14.** The following test data were gathered to design a settling tank. The initial suspended solids concentration for the test was 20.0 mg/L. Determine the detention time and overflow rate that will yield 60% removal of suspended solids. The data given are suspended solids concentrations in mg/L.

Depth, ^a m	Time, min					
	10	20	35	50	70	85
0.5	14.0	10.0	7.0	6.2	5.0	4.0
1.0	15.0	13.0	10.6	8.2	7.0	6.0
1.5	15.4	14.2	12.0	10.0	7.8	7.0
2.0	16.0	14.6	12.6	11.0	9.0	8.0
2.5	17.0	15.0	13.0	11.4	10.0	8.8

^aDepths from top of column, column depth = 2.5 m.

- 10-15.** The following test data were gathered to design a settling tank. The initial turbidity for the test was 33.0 NTU. Determine the detention time and overflow rate that will yield 88% removal of suspended solids. The data given are suspended solids concentrations in NTU.

Depth, ^a m	Time, min			
	30	60	90	120
1.0	5.6	2.0		
2.0	11.2	5.9	2.6	
3.5	14.5	9.9	6.6	3.0

^aDepths from top of column, column depth = 4.0 m.

- 10-16.** Design a horizontal flow rectangular sedimentation basin for a maximum day design flow rate of 25,000 m³/d. Assume an overflow rate of 40 m³/d · m² and

a water temperature of 12°C. Provide the following in your summary of the design:

Q_{design}
 Number of tanks
 Width of each tank
 Length of each tank
 Side water depth
 Depth of sludge zone
 L:D
 v_f
 Reynolds number
 Number of launders
 Launder length
 Weir loading
 Type of sludge collector

- 10-17.** Design a horizontal flow rectangular sedimentation basin for a maximum day design flow rate of 15,000 m³/d. Assume an overflow rate of 50 m³/d · m² and a water temperature of 15°C. Provide the following in your summary of the design:

Q_{design}
 Number of tanks
 Width of each tank
 Length of each tank
 Side water depth
 Depth of sludge zone
 L:D
 v_f
 Reynolds number
 Number of launders
 Launder length
 Weir loading
 Type of sludge collector

- 10-18.** Design a horizontal flow rectangular sedimentation basin using high-rate settlers for a maximum day design flow rate of 25,000 m³/d. Assume a water temperature of 12°C, that the angle of the settler tubes is 60°, and that they have a hydraulic diameter of 0.05 m. Also assume the floc has excellent settling characteristics. Provide the following in your summary of the design:

Q_{design}
 Number of tanks

Width of each tank
 Length of settler
 Length of each tank
 Side water depth
 Depth of sludge zone
 v_{approach}
 v_{fc}
 Reynolds number
 Froude number
 Number of launders
 Launder length
 Weir loading
 Type of sludge collector

- 10-19.** Design a horizontal flow rectangular sedimentation basin using high-rate settlers for a maximum day design flow rate of $15,000 \text{ m}^3/\text{d}$. Assume a water temperature of 15°C , that the angle of the settler tubes is 60° , and that they have a hydraulic diameter of 0.05 m . Also assume the floc has excellent settling characteristics. Provide the following in your summary of the design:

Q_{design}
 Number of tanks
 Width of each tank
 Length of settler
 Length of each tank
 Side water depth
 Depth of sludge zone
 v_{approach}
 v_{fc}
 Reynolds number
 Froude number
 Number of launders
 Launder length
 Weir loading
 Type of sludge collector

10-8 DISCUSSION QUESTIONS

- 10-1.** Use a scale drawing to sketch a vector diagram of a horizontal-flow sedimentation tank that shows how 25 percent of the particles with a settling velocity one-quarter that of the overflow rate will be removed.

- 10-2.** Use a scale drawing to sketch a vector diagram that shows a plate settler with one plate located at half the depth of the tank will remove 100 percent of the particles that enter with a settling velocity equal to one-half that of the overflow rate.
- 10-3.** Describe design remedies for the following problems in a settling tank: jetting of the influent, density currents from cooler or warmer water, waves on the settling basin.
- 10-4.** What design alternative is available to increase the Froude number of a horizontal-flow rectangular sedimentation basin?

10-9 REFERENCES

- AWWA (1990) *Water Treatment Plant Design*, 2nd ed., American Water Works Association, Denver, Columbus, McGraw-Hill, New York, pp. 116, 125.
- Camp, T. R. (1936) "A Study of the Rational Design of Settling Tanks," *Sewage Works Journal*, vol. 8, no. 9, pp. 742–758.
- Camp, T. R. (1946) "Sedimentation and the Design of Settling Tanks," *Transactions of the American Society of Civil Engineers*, vol. 111, p. 895.
- Davis, M. L. and D. A. Cornwell (2008) *Introduction to Environmental Engineering*, McGraw-Hill, New York, pp. 269, 281.
- Eckenfelder, W. W. (1980) *Industrial Water Pollution Control*, McGraw-Hill, New York, 1989, p. 61.
- GLUMRB (2003) *Recommended Standards for Water Works*, Great Lakes–Upper Mississippi River Board of State and Provincial Public Health and Environmental Managers, Health Education Services, Albany, New York, pp. 34–35.
- Kawamura, S. (2000) *Integrated Design and Operation of Water Treatment Facilities*, 2nd ed., John Wiley & Sons, New York, pp. 139–189.
- Metcalf and Eddy (2003) *Wastewater Engineering: Treatment and Reuse*, 4th edition, McGraw-Hill, Boston, MA, p. 379.
- MWH (2005) *Water Treatment: Principles and Design*, John Wiley & Sons, Hoboken, New Jersey, pp. 811–814, 824–829.
- Newton, I. (1687) *Philosophiae Naturalis Principia Mathematica*.
- Pierpont, J. W. and M. Alvarez (2005) "Optimizing Ballasted Sedimentation for Organics-Laden Surface Water," *Opflow*, JUL, p. 15.
- Reynolds, O. (1883) "An Experimental Investigation of the Circumstances Which Determine Whether the Motion of Water Shall Be Direct or Sinuous and the Laws of Resistance in Parallel Channels," *Transactions of the Royal Society of London*, vol. 174.
- Stokes, G. G. (1845) *Transactions of the Cambridge Philosophical Society*, vol. 8, p. 287.
- Walker, J. D. (1978) "Sedimentation," in R. L. Sanks (ed.) *Water Treatment Plant Design for the Practicing Engineer*, Ann Arbor Science, Ann Arbor, Michigan, pp. 149–182.
- Willis, J. F. (2005) "Clarification," in E. E. Baruth, (ed.), *Water Treatment Plant Design*, American Water Works Association and American Society of Civil Engineers, McGraw-Hill, New York, p. 7.1–10-44.
- Yao, K. M. (1970) "Theoretical Study of High-Rate Sedimentation," *Journal of Water Pollution Control Federation*, vol. 42, p. 218.

GRANULAR FILTRATION

- 11-1 INTRODUCTION**
- 11-2 AN OVERVIEW OF THE FILTRATION PROCESS**
- 11-3 FILTER MEDIA CHARACTERISTICS**
- 11-4 GRANULAR FILTRATION THEORY**
- 11-5 THEORY OF GRANULAR FILTER HYDRAULICS**
- 11-6 GRANULAR FILTRATION PRACTICE**
- 11-7 OPERATION AND MAINTENANCE**
- 11-8 CHAPTER REVIEW**
- 11-9 PROBLEMS**
- 11-10 DISCUSSION QUESTIONS**
- 11-11 REFERENCES**

11-1 INTRODUCTION

Settled water turbidity is generally in the range from 1 to 10 NTU with a typical value being 2 NTU. Because these levels of turbidity interfere with the subsequent disinfection processes, the turbidity must be reduced. The Interim Enhanced Surface Water Treatment Rule (IESWTR) promulgated by the U.S. Environmental Protection Agency (EPA) requires that the treated water turbidity level be 0.3 NTU in 95 percent of monthly measurements with no sample to exceed 1 NTU. In order to reduce the turbidity to this level, a filtration process is normally used. The most common filtration process is granular filtration where the suspended or colloidal impurities are separated from water by passage through a porous medium. The medium is usually a bed of sand or other media such as coal, activated carbon, or garnet. In the last two decades, filters composed of membranes have been employed with increasing frequency. Granular filtration processes are the subject of this chapter. Membrane processes are discussed in Chapter 12.

11-2 AN OVERVIEW OF THE FILTRATION PROCESS

A number of classification systems are used to describe granular filters including media type, filtration rate, washing technique, and filtration rate control. This discussion is limited to slow sand, rapid sand, and high-rate filters with either multimedia or deep monomedium; the focus is on rapid sand and high-rate filters. Pressure filters (also called *precoat* filters) and automatic backwash filters are not discussed. Discussion of these types of filters may be found in Cleasby and Logsdon, 1999; Kawamura, 2000; MWH, 2005; Reynolds and Richards, 1996.

Granular filters are called *depth filters* because the particulate matter in the water penetrates into the filter as well as being caught on the surface. Figure 11-1 shows a cutaway drawing of a

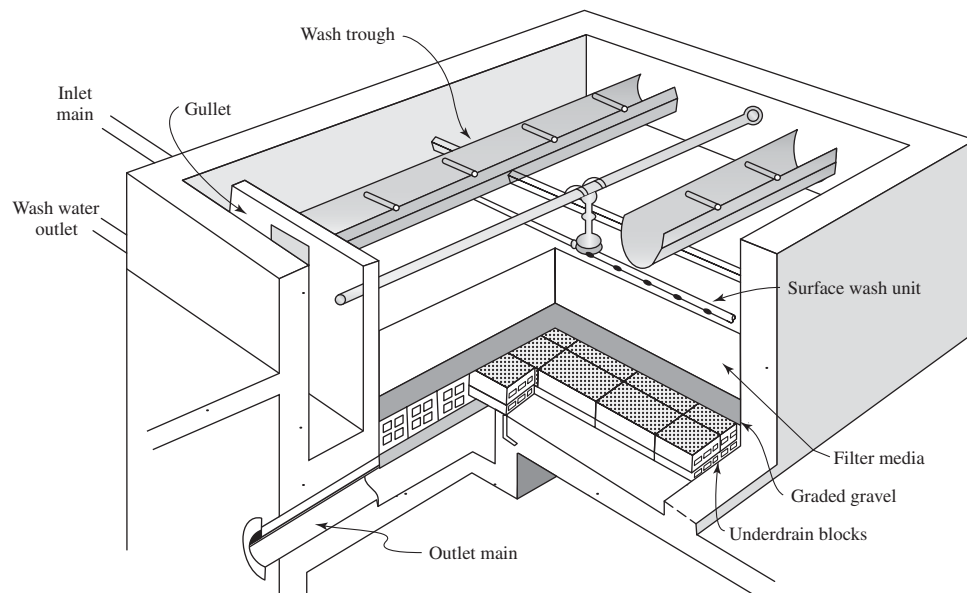

FIGURE 11-1
Typical gravity filter box. (Source: F. B. Leopold Co.)

conventional depth filter. The bottom of the filter consists of a support media and water collection system. The support media is designed to keep the filtration media (sand, coal, etc.) in the filter and prevent it from leaving with the filtered water. Layers of graded gravel (large on bottom, small on top) traditionally have been used for the support. The underdrain blocks collect the filtered water. In newer designs, integrated media support (IMS[®]) that combines a synthetic layer with a synthetic underdrain block is being used.

In a conventional filter, water containing the suspended matter is applied to the top of the filter. The suspended matter is filtered from the water. As material accumulates in the interstices of the granular medium, the headloss through the filter increases. When either the headloss or the effluent turbidity reaches a predetermined limit, filtration is terminated and the filter is cleaned. Under ideal conditions, the time required for headloss to reach the preselected value (called the *terminal headloss*) corresponds to the time when the turbidity in the effluent reaches its preselected value. In actual practice, one or the other will govern the cleaning cycle. The filter is cleaned by *backwashing*; that is, clean water is pumped backwards through the filter.

As illustrated in Figure 11-2, the efficiency of particle removal varies during the filtration cycle (called a *filter run*). The *ripening* or *maturation* stage occurs initially as the filter is put back

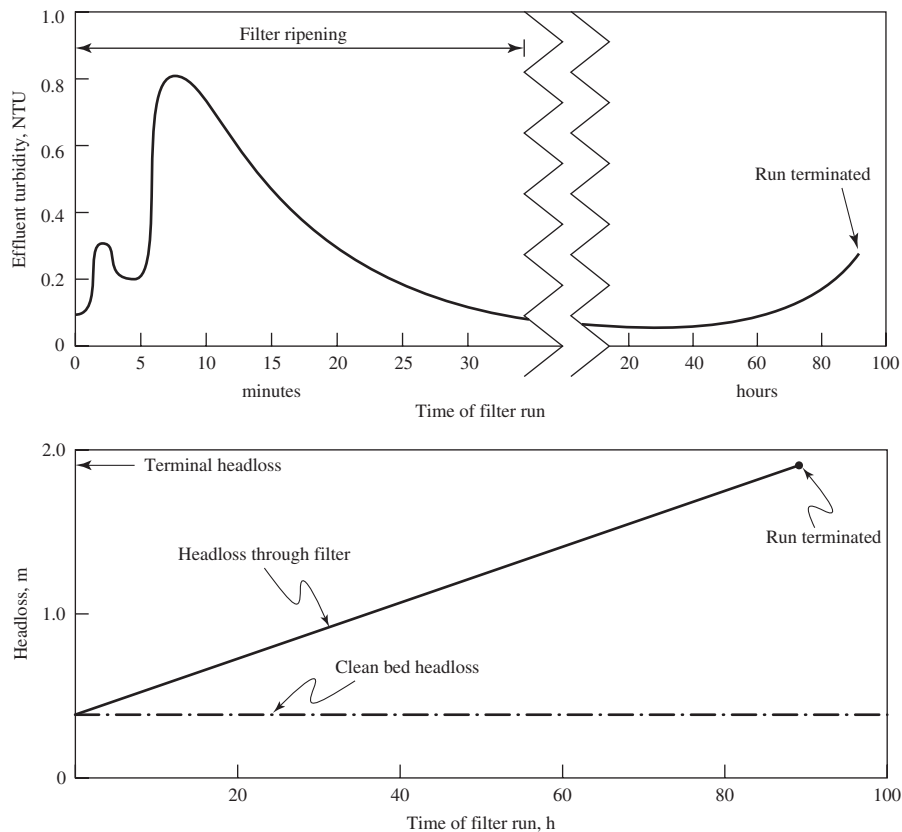

FIGURE 11-2
Idealized turbidity and headloss during a filter run. Note changes in time scale.

into service after cleaning. The peak occurs because of residual backwash water being flushed from the media, and from particles in the influent water that are too small to be captured. As the clean media captures particles, it becomes more efficient because the particles that are captured become part of the collector surface in the filter. Amirtharajah (1988) suggests that up to 90 percent of the particles that pass through a well-operating filter do so during the ripening stage.

After ripening, the effluent turbidity is essentially constant and, under steady-state conditions, can be maintained below 0.1 NTU. On the other hand, headloss continues to rise as particles collect in the filter. At some point the number of particles that can be effectively captured begins to decline and *breakthrough* occurs.

Nomenclature

There are several methods of classifying filters. One way is to classify them according to the type of medium used, such as sand, coal (called *anthracite*), *dual media* (coal plus sand), or *mixed media* (coal, sand, and garnet). Another common way to classify the filters is by nominal *filtration rate* or *hydraulic loading rate* (m^3 of water applied/d \cdot m^2 of surface area, or m/d). A third alternative is to classify the filters by the pretreatment level.

Based on the hydraulic rate, the filters are described as being slow sand filters, rapid sand filters, or high-rate filters.

Slow sand filters were first introduced in the 1800s. The water is applied to the sand at a loading rate of 3 to 8 $\text{m}^3/\text{d} \cdot \text{m}^2$. As the suspended or colloidal material is applied to the sand, the particles begin to collect in the top 75 mm and to clog the pore spaces. As the pores become clogged, water will no longer pass through the sand. At this point the top layer of sand is scraped off, cleaned, and replaced. Although slow sand filters require large areas of land and are labor intensive, the structures are inexpensive in comparison to the other types, and they have a long history of success.

In the late 1800s, health authorities began to understand that clean water was a major factor in preventing disease. The limitations of slow sand filters in meeting the need for filtration systems to serve large populations became readily apparent. *Rapid sand filters* were developed to meet this need. These filters have graded (layered) sand in a bed. The sand grain size distribution is selected to optimize the passage of water while minimizing the passage of particulate matter.

Rapid sand filters are cleaned in place by *backwashing*. The wash water flow rate is such that the sand bed is expanded and the filtered particles are removed from the bed. After backwashing, the sand settles back into place. The largest particles settle first, resulting in a fine sand layer on top and a coarse sand layer on the bottom. Rapid sand filters are the most common type of filter in service in water treatment plants today.

Traditionally, rapid sand filters have been designed to operate at a loading rate of 120 $\text{m}^3/\text{d} \cdot \text{m}^2$ (5 m/h). Filters now operate successfully at even higher loading rates through the use of proper media selection and improved pretreatment.

In the wartime era of the early 1940s, dual media filters were developed. They are designed to utilize more of the filter depth for particle removal. In a rapid sand filter, the finest sand is on the top; hence, the smallest pore spaces are also on the top. Therefore, most of the particles will clog in the top layer of the filter. In order to use more of the filter depth for particle removal, it is necessary to have the large particles on top of the small particles. This is accomplished by placing a layer of coarse coal on top of a layer of fine sand to form a *dual-media filter*. Coal has a lower specific gravity than sand, so, after backwash, it settles more slowly than the sand and ends up on top. Some dual-media filters are operated up to loading rates of 480 $\text{m}^3/\text{d} \cdot \text{m}^2$ (20 m/h).

In the mid-1980s, *deep-bed, monomedia* filters came into use. The filters are designed to achieve higher loading rates while at the same time producing lower turbidity in the finished water. They operate at loading rates up to $600 \text{ m}^3/\text{d} \cdot \text{m}^2$ (25 m/h).

When pretreatment of the water is by coagulant addition, flocculation, and clarification, the filter is classified as *conventional* filtration. If pretreatment consists of coagulation and flocculation but not clarification, the filtration process is called *direct* filtration. The process is called *in-line* or *contact* filtration when coagulant addition but only incidental flocculation is used. In some processes, coagulation is followed by two filtration steps: a roughing filter followed by another filter.

11-3 FILTER MEDIA CHARACTERISTICS

Grain Size

The grain size, or perhaps more correctly the grain size distribution, affects both the hydraulic performance of the filtration process and the efficiency of particle removal.

The size distribution, or variation, of a sample of granular material is determined by passing the sample through a series of standard *sieves* (screens). One standard series is the U.S. Standard Sieve Series. The U.S. Standard Sieve Series (Appendix B) is based on a sieve opening of 1 mm. Sieves in the “fine series” stand successively in the ratio of $(2)^{0.25}$ to one another, the largest opening in this series being 5.66 mm and the smallest 0.037 mm. All material that passes through the smallest sieve opening in the series is caught in a pan that acts as the terminus of the series (Fair and Geyer, 1954).

The grain size analysis begins by placing the sieve screens in ascending order with the largest opening on top and the smallest opening on the bottom. A sand sample is placed on the top sieve, and the stack is shaken for a prescribed amount of time. At the end of the shaking period, the mass of material retained on each sieve is determined. The cumulative mass is recorded and converted into percentages by mass equal to or less than the size of separation of the overlying sieve. Then a cumulative frequency distribution is plotted. For many natural granular materials, this curve approaches geometric normality. Logarithmic-probability paper, therefore, results in an almost straight-line plot. This facilitates interpolation. The geometric mean (X_g) and geometric standard deviation (S_g) are useful parameters of central tendency and variation. Their magnitudes may be determined from the plot. The parameters most commonly used, however, are the *effective size*, E , and the *uniformity coefficient*, U . The effective size is the 10 percentile size, that is, the media grain diameter at which 10 percent of the media by weight is smaller, d_{10} . The uniformity coefficient is the ratio of the diameter of media at which 60 percent by weight is smaller to the 10 percentile sizes, d_{60}/d_{10} . Use of the 10 percentile was suggested by Allen Hazen because he observed that resistance to the passage of water offered by a bed of sand within which the grains are distributed homogeneously remains almost the same, irrespective of size variation (up to a uniformity coefficient of about 5.0), provided that the 10 percentile remains unchanged (Hazen, 1892). Use of the ratio of the 60 percentile to the 10 percentile as a measure of uniformity was suggested by Hazen because this ratio covered the range in size of half the sand.* On the basis of logarithmic normality, the probability integral

*It would be logical to speak of this ratio as a coefficient of nonuniformity because the coefficient increases as the magnitude of nonuniformity increases.

establishes the following relations between the effective size, uniformity coefficient, geometric mean size, and geometric standard deviation:

$$E = P_{10} = (X_g)(S_g)^{-1.28} \quad (11-1)$$

$$U = P_{60}/P_{10} = (S_g)^{1.535} \quad (11-2)$$

Sand excavated from a natural deposit is called *run-of-bank* sand. Run-of-bank sand may be too coarse, too fine, or too nonuniform for use in filters. Within economical limits, proper sizing and uniformity are obtained by screening out coarse components and washing out fine components. In rapid sand filters, the removal of “fines” may be accomplished by stratifying the bed through backwashing and then scraping off the layer that includes the unwanted sand. In the United States, filter sand is purchased from commercial suppliers based on specifications provided by the engineer rather than processing the sand at the point of use.

Physical Properties

Standard requirements for filter media are described in ANSI/AWWA standard No. B100-01 (AWWA, 2001). This discussion is to highlight some of the properties.

Hardness. Hardness of the filter material is important as it is an indicator of the resistance to abrasion and wear that occurs during filter backwashing. Hardness is ranked on the Moh scale. Talc has a Moh hardness number of 1. Diamond has a Moh hardness number of 10. Sand, *garnet* and *ilmenite** are hard enough to resist abrasion. Anthracite coal and granular activated carbon (GAC) are friable and design specifications must specify the minimum acceptable hardness value. A minimum Moh hardness of 2.7 is often specified for anthracite (MWH, 2005). GAC hardness is evaluated using ANSI/AWWA standard B604-96 (AWWA, 1996).

Porosity. The porosity of the in-place media (not of the individual grains) affects the headloss and filtration efficiency of the media. It is defined as

$$\varepsilon = \frac{V_v}{V_T} = \frac{V_T - V_M}{V_T} \quad (11-3)$$

where ε = porosity, dimensionless

V_v = volume of voids, m^3

V_T = total volume of media bed, m^3

V_M = volume of media, m^3

Specific Gravity. The specific gravity of the media plays a role in both the arrangement of the filter media in multimedia filters and in the backwash flow requirements that are required to fluidize the bed. The selection of the media used in the design of dual- and tri-media filters is based on the specific gravity of the media.

**Garnet* is a generic term referring to several minerals that are silicates of iron, aluminum, and calcium mixtures. *Ilmenite* is an iron-titanium ore associated with hematite and magnetite, which are iron oxides.

TABLE 11-1
Typical properties of filter media

Property	Anthracite coal	GAC	Garnet	Ilmenite	Sand
Effective size, mm	0.45–0.55 ^a 0.8–1.2 ^b	0.8–1.0	0.2–0.4	0.2–0.4	0.3–0.6
Uniformity coefficient	≤ 1.65 ^a ≤ 1.85 ^b	1.3–2.4	1.3–1.7	1.3–1.7	1.3–1.8
Hardness, Moh	2–3	very low	6.5–7.5	5–6	7
Porosity	0.50–0.60	0.50	0.45–58	N/A	0.40–0.47
Specific gravity	1.5–1.75	1.3–1.7	3.6–4.2	4.2–5.0	2.55–2.65
Sphericity	0.46–0.60	0.75	0.60	N/A	0.7–0.8

^aWhen used alone.

^bWhen used as a cap on a dual media filter.

Sources: Castro et al., 2005; Cleasby and Logsdon, 1999; GLUMRB, 2003; MWH, 2005.

Summary. Typical properties of filter media are summarized in Table 11-1. Smaller effective sizes than those shown result in a product water that is lower in turbidity, but they also result in higher pressure losses in the filter and shorter operating cycles between each cleaning.

Example 11-1 illustrates how the media is tested to meet effective size and uniformity coefficient requirements.

Example 11-1. A sand filter is to be designed for the Ottawa Island’s new water treatment plant. A sieve analysis of the local island sand is given below. Using the sand analysis, find the effective size, E , and uniformity coefficient, U .

U. S. Standard Sieve No.	Analysis of Stock Sand (Cumulative Mass % Passing)
140	0.2
100	0.9
70	4.0
50	9.9
40	21.8
30	39.4
20	59.8
16	74.4
12	91.5
8	96.8
6	99.0

Solution. Begin by plotting the data on log-probability paper as shown in Figure 11-3. From this plot, find the effective size:

$$E = R_{10} = 0.30 \text{ mm}$$

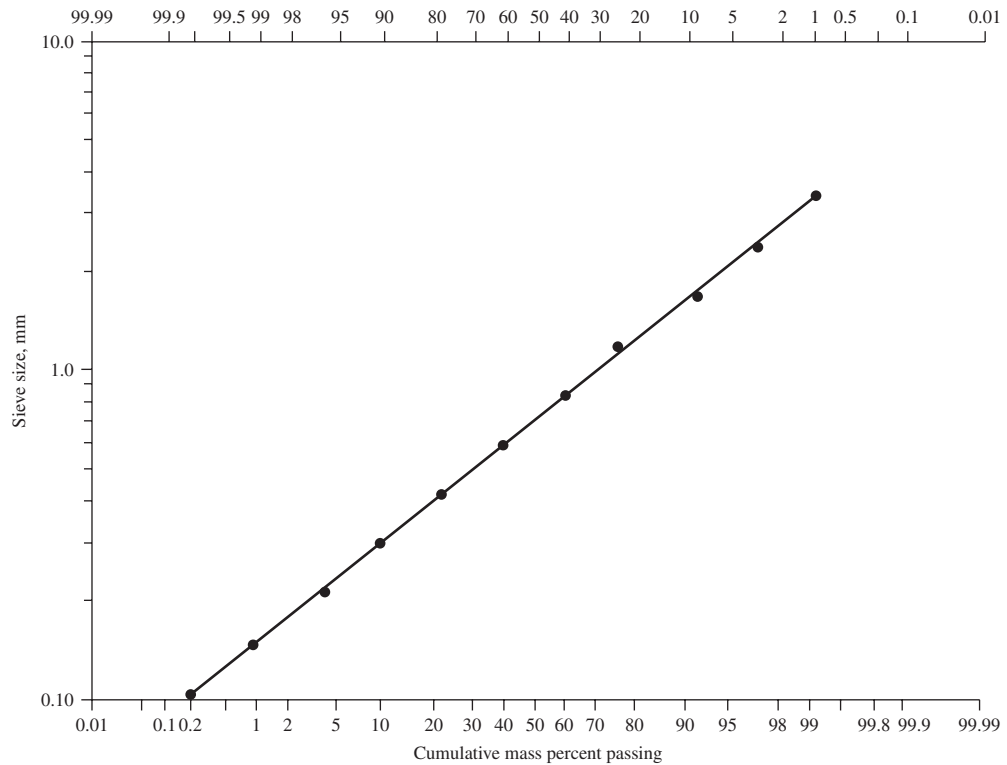

FIGURE 11-3
Grain size analysis of run-of-bank sand.

The uniformity coefficient is then

$$U = \frac{P_{60}}{P_{10}} = \frac{0.85 \text{ mm}}{0.30 \text{ mm}} = 2.8$$

Comments:

1. Obviously, this sand does not fall within the prescribed limits. Although this sand could be processed to meet the specifications, in the United States the sand would be rejected and the supplier would be required to provide a replacement.
2. Probability paper is not required to determine E and U . The x -axis scale may be arithmetic or any other scale that allows a smooth curve to be drawn through the data so the d_{10} and d_{60} sizes can be determined.
3. A spreadsheet plot with a curve fitting function is very useful in selecting the plotting axis and determination of the d_{10} and d_{60} sizes.

11-4 GRANULAR FILTRATION THEORY

Mechanisms of filtration

As shown in Figure 11-4a, some particles are removed by simple mechanical screening because the particle is larger than the smallest opening through which the water flows. This is the dominant mechanism for slow sand filters. Straining causes a cake to form at the surface of the filter. This improves the efficiency of particle removal but also increases the headloss.

In depth-filtration, particles smaller than the openings between the granular material are removed by a variety of mechanisms including sedimentation, flocculation, interception, and impaction.

The pore spaces between the grains of granular material are small, and the water velocity through the interstices is also small. If the mass and diameter of the particles is large enough, it will settle through the short distance from the water to the particle (Figure 11-4b). Because the streamlines of water flowing through the interstices bend as the water passes around the granular material, particles are brought into contact with one another. This mixing causes them to flocculate and grow larger in size (Figure 11-4c). The larger particles may then be captured by straining. Bending streamlines also cause smaller particles to pass near enough to the grains of filter material to be intercepted (Figure 11-4d). In some cases the particles have sufficient mass that they cannot follow the alteration in flow path with the streamlines, and their trajectory causes them to impact on the granular material of the filter (Figure 11-4e).

As the particles in the water come in contact with the granular filter material, the surface forces must be favorable for them to attach. They must sufficiently destabilized so that the electrostatic repulsive forces are minimized and the short range van der Waals forces result in a net attractive force.

Two approaches are used to provide models of fundamental filtration theory: microscopic and macroscopic (or phenomenologic). Although these models are not effective for predicting long-term filter performance, they are useful for evaluating the relative importance of the filtration mechanisms and the importance of several design and operating parameters. The models are based on several simplifying assumptions: spherical particles collide with spherical filter grains; hydrodynamic variability caused by angular media is not considered; changes in the filter media with time and depth in the filter are not considered; and changes in porosity and grain size as particles accumulate are not considered.

Microscopic Models of Filtration. Yao et al. (1971) developed a *transport and attachment* model that describes accumulation of particles on a single media grain “collector” by sedimentation, interception, and diffusion. This model underpredicts the number of collisions when compared to experimental data. A refinement of this model, called *trajectory analysis*, by Rajagopalan and Tien (1976) includes additional attractive forces due to van der Waals forces and reduced collisions due to viscous resistance. This model predicts filtration behavior better than the Yao model (Logan et al., 1995).

The Rajagopalan and Tien model can be used to demonstrate the effect of the uniformity coefficient (Figure 11-5) and dual-media filters (Figure 11-6) on filtration efficiency.

Macroscopic Models of Filtration. The phenomenological models make no attempt to describe the mechanisms of particle transport or attachment. They are based on a mass balance expression and an empirical rate expression to relate the duration of ripening, water quality, time to breakthrough, and time to terminal headloss.

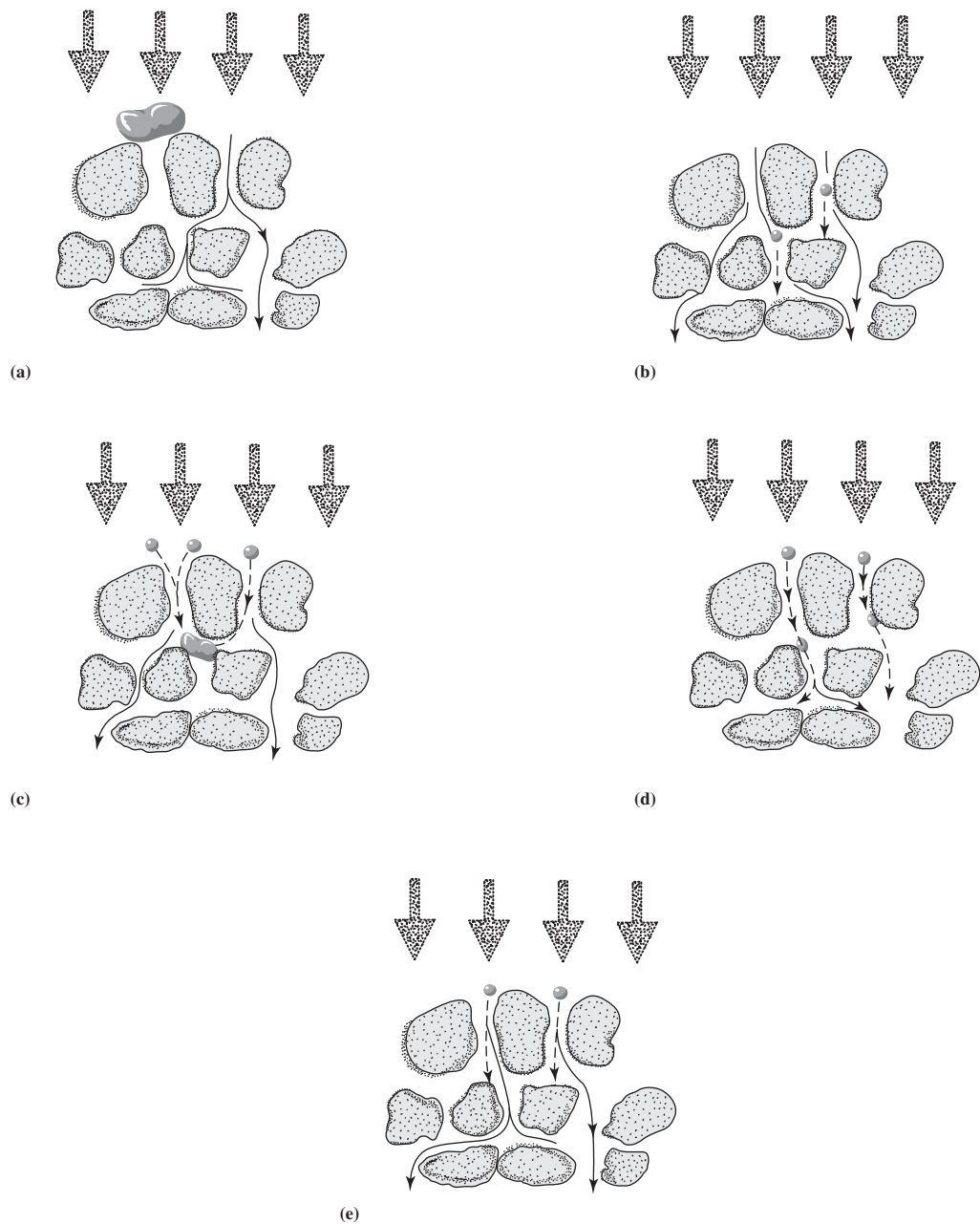

FIGURE 11-4 Mechanisms of granular filtration: (a) mechanical screening, (b) sedimentation, (c) flocculation, (d) interception, (e) impaction. Dashed line is particle trajectory. Solid line is water streamline (flow path).

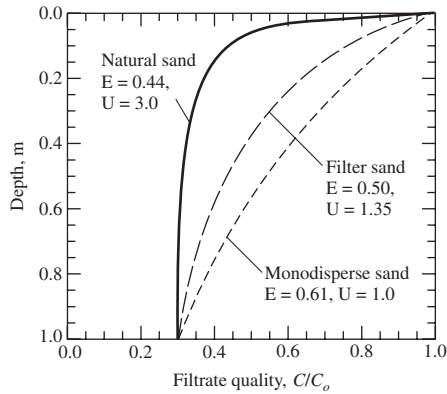

FIGURE 11-5
Effect of media uniformity on solids penetration in filter bed.
(Source: MWH, 2005.)

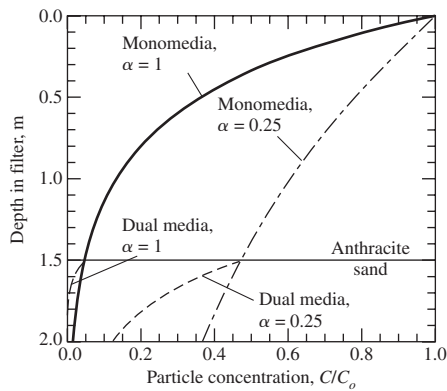

FIGURE 11-6
Effect of attachment efficiency on effluent from monomedia and dual-media filters.
(Source: MWH, 2005.)

The rate expression describes a first-order removal with depth proportional to the local particle concentration in the water:

$$\frac{\partial C}{\partial z} = -\lambda C \tag{11-4}$$

where C = concentration of particles in suspension, mg/L
 λ = filter coefficient, m^{-1}
 z = depth in filter, m

Based on laboratory and pilot scale studies, the filter coefficient is inversely proportional to the filtration rate, grain size, and the square of the viscosity (Cleasby and Logsdon, 1999).

The mass balance for a differential element may be expressed as

$$\frac{\partial \sigma}{\partial t} = -v_a \frac{\partial C}{\partial z} \quad (11-5)$$

where σ = specific deposit
 = mass of accumulated particles per filter bed volume, mg/L
 v_a = filtration rate, $\text{m}^3/\text{s} \cdot \text{m}^2$ of filter surface area, also m/s
 t = time, s

By combining Equations 11-4 and 11-5, the basic phenomenological model is

$$\frac{\partial \sigma}{\partial t} = \lambda v_a C \quad (11-6)$$

A simplified steady state model allows the computation of the time to breakthrough (t_B) and the time to the limiting head (t_{HL}):

$$t_B = \frac{\sigma_B D}{v_a (C_0 - C_E)} \quad (11-7)$$

$$t_{HL} = \frac{(H_T - h_L) D}{(k_{HL})(v_a)(C_0 - C_E)} \quad (11-8)$$

where σ_B = specific deposit at breakthrough, mg/L
 D = depth of filter bed, m
 C_0 = influent concentration of particles, mg/L
 C_E = effluent concentration of particles, mg/L
 H_T = limiting head, m
 h_L = initial clean bed headloss, m
 k_{HL} = headloss rate constant, $\text{L} \cdot \text{m}/\text{mg}$

A regression analysis of data collected from actual or pilot filters is used to estimate σ_B and k_{HL} . With these “constants,” the length of the filter run and the time to reach terminal headloss can be estimated. In addition, with pilot data, the optimum filter depth and run time can be estimated for a given solids loading.

11-5 THEORY OF GRANULAR FILTER HYDRAULICS

The hydraulic issues to be considered in the design of a filter system include: headloss through a clean filter bed, headloss resulting from the accumulation of particles in the bed, the fluidization depth of the bed during backwashing, and headloss in expanding the filter bed.

Clean Filter Headloss

Although the equations describing headloss are limited to clean filter beds, they provide an opportunity to examine the initial stages of filtration and the effects of design variables on headloss.

A number of equations have been developed to describe the headloss of clean water flowing through a clean porous medium, such as a granular filter. Several of these are summarized in Table 11-2. These are derived from the Darcy-Weisbach equation for flow in a closed conduit and

TABLE 11-2
Formulas used to compute the clean-water headloss through a granular porous medium

Equation	Definition of terms
Carmen-Kozeny (Carmen, 1937)	d = grain size diameter, m
$h_L = \frac{f}{\phi} \frac{1-\varepsilon}{\varepsilon^3} \frac{L}{d} \frac{v_a^2}{g}$	f = friction factor
$h_L = \frac{1}{\phi} \frac{1-\varepsilon}{\varepsilon^3} \frac{L v_a^2}{g} \sum f \frac{p}{d_g}$	g = acceleration due to gravity, 9.81 m/s ²
$f = 150 \frac{1-\varepsilon}{\mathbf{R}} + 1.75$	h_L = headloss, m
$\mathbf{R} = \frac{\phi d v_a \rho}{\mu}$	k = filtration constant, 5 based on sieve openings, 6 based on size of separation
Fair-Hatch (Fair and Hatch, 1933)	k_v = headloss coefficient due to viscous forces, dimensionless
$h_L = k_v S^2 \frac{(1-\varepsilon)^2}{\varepsilon^3} \frac{L}{d^2} \frac{v_a}{g}$	k_i = headloss coefficient due to inertial forces, dimensionless
$h_L = k_v \frac{(1-\varepsilon)^2}{\varepsilon^3} \frac{L v_a}{g} \left(\frac{6}{\phi} \right)^2 \sum \frac{p}{d_g^2}$	L = depth of filter bed or layer, m
Ergun (1952a)	\mathbf{R} = Reynolds number
$h_L = k_v \frac{(1-\varepsilon)^2}{\varepsilon^3} \frac{\mu L v_a}{\rho g d^2} + k_i \frac{1-\varepsilon}{\varepsilon^3} \frac{L v_a^2}{g d}$	p = fraction of particles (based on mass) within adjacent sieve sizes
	S = shape factor (varies between 6.0 for spherical particles and 8.5 for crushed materials)
	v_a = superficial (approach) filtration velocity, m/s
	ε = porosity
	μ = viscosity, Pa · s
	ν = kinematic viscosity, m ² /s
	ρ = density of water, kg/m ³
	ϕ = particle shape factor (1.0 for spheres, 0.82 for rounded sand, 0.75 for average sand, 0.73 for crushed coal and angular sand)

dimensional analysis. The Carmen-Kozeny, Fair-Hatch, and Rose equations are appropriate for sand filters when the Reynolds number does not exceed 6. For larger filter media, where higher velocities are used, the flow may be in the transitional range where these equations are not adequate. The Ergun equation is recommended for these cases (Cleasby and Logsdon, 1999).

The headloss through a clean stratified-sand filter with uniform porosity described by Rose (1945) serves as an example for illustration:

$$h_L = \frac{1.067(v_a)^2(D)}{(\varphi)(g)(\varepsilon)^4} \sum \frac{(C_D)(f)}{d_g} \tag{11-9}$$

where h_L = frictional headloss through the filter, m

v_a = approach velocity (also known as *face velocity*, *filtration rate*, or *loading rate*), m/s (or m³/s · m² of surface area)

D = depth of filter sand, m

C_D = drag coefficient

$$\begin{aligned}
 f &= \text{mass fraction of sand particles of diameter, } d_g \\
 d_g &= \text{geometric mean diameter of sand grains, m} \\
 \varphi &= \text{shape factor} \\
 g &= \text{acceleration due to gravity, m/s}^2 \\
 \varepsilon &= \text{porosity}
 \end{aligned}$$

The drag coefficient is defined in Equations 10-10 and 10-11. The Reynolds number is used to calculate the drag coefficient. The sand grain diameter is multiplied by the shape factor to account for nonspherical sand grains. The summation term is included to account for stratification of the sand grain sizes in the filter. The size distribution of the sand particles is found from a sieve analysis. The mean size of the material retained between successive sieve sizes is assumed to correspond the geometric mean size of successive sieves. It is calculated as

$$d_g = (d_1 d_2)^{0.5} \quad (11-10)$$

where d_g = geometric mean diameter of grain size distribution between sieves, mm
 d_1, d_2 = diameter of upper and lower sieve openings, mm

A cursory examination of the Rose equation reveals the following important relationships:

- The headloss is directly proportional to the square of the filtration or loading rate (m^3 of water/d \cdot m^2 of filter surface area or m/d or m/h), so small increases in loading rate are amplified.
- Headloss is inversely proportional to the diameter of the sand grains.
- The porosity, which is assumed constant through the bed, plays a very strong inverse role in the headloss.

From a design point of view, given the design flow rate (Q), the filtration rate (v_a) may be adjusted by adjusting the surface area of the filter box. The sand grain size distribution is specified by the effective size and uniformity coefficient. The headloss can be reduced by limiting the amount of fines in the distribution of sizes.

The porosity of the sand plays a significant role in controlling the headloss, and it is not in the control of the designer. Although other media, such as anthracite coal, provides an alternative means of adjusting the porosity, the range of porosities is not great. A further confounding factor is that all the headloss equations assume a uniform porosity through the depth of the bed—an unlikely occurrence once the bed is stratified.

A subtle but important variable that is not evident from a cursory examination of the equation is that of the water temperature. The viscosity is used in calculating the Reynolds number and it, in turn, is a function of the water temperature.

Example 11-2 illustrates the computation of the clean bed headloss for a stratified sand filter.

Example 11-2. Estimate the clean filter headloss in Ottawa Island's proposed new sand filter using the sand described in Example 11-1, and determine if it is reasonable. Use the following assumptions: loading rate is $216 \text{ m}^3/\text{d} \cdot \text{m}^2$, specific gravity of sand is 2.65, the shape factor is 0.82, the bed porosity is 0.45, the water temperature is 10°C , and the depth of sand is 0.5 m.

Solution. The computations are shown in the table below.

Sieve no.	% Retained	d , m	R	C_D	$\Sigma \frac{(C_D)(f)}{d}$
8-12	5.3	0.002	3.1370	9.684551	256.64
12-16	17.1	0.00142	2.2272	13.12587	1,580.7
16-20	14.6	0.001	1.5685	18.03689	2,633.4
20-30	20.4	0.000714	1.1199	24.60549	7,030.1
30-40	17.6	0.000505	0.79208	34.01075	11,853
40-50	11.9	0.000357	0.55995	47.21035	15,737
50-70	5.9	0.000252	0.39526	60.72009	14,216
70-100	3.1	0.000178	0.27919	85.96328	14,971
100-140	.7	0.000126	0.19763	121.4402	6,746.7
Total $(C_D)(f)/d =$					75,025

In the first two columns, the grain size distribution from Example 11-1 is rearranged to show the fraction retained between sieves. The third column is the geometric mean diameter of the sand grain computed from the upper and lower sieve size. The fourth column is the Reynolds number computed from Equation 10-9 with the correction for nonspherical sand grains. For the first row,

$$R = \frac{(\varphi)(d)(v_a)}{\nu} = \frac{(0.82)(0.002 \text{ m})(0.0025 \text{ m/s})}{1.307 \times 10^{-6} \text{ m}^2/\text{s}} = 3.137$$

The filtration velocity of 0.0025 m/s is the conversion of the filtration loading rate to compatible units:

$$v_a = \frac{216 \text{ m}^3/\text{d m}^2}{86,400 \text{ s/d}} = 0.0025 \text{ m/s}$$

The kinematic viscosity is determined from Appendix A using the water temperature of 10°C. The factor of 10^{-6} is to convert from $\mu\text{m}^2/\text{s}$ to m^2/s .

The drag coefficient is calculated in column 5 using either Equation 10-10 or 10-11, depending on the Reynolds number. For the first row,

$$\begin{aligned} C_D &= \frac{24}{R} + \frac{3}{R^{1/2}} + 0.34 \\ &= 7.6507 + 1.6938 + 0.34 = 9.6846 \end{aligned}$$

The final column is the product of the fractional mass retained and the drag coefficient divided by the diameter. For the first row,

$$\frac{(C_D)(f)}{d} = \frac{(9.6846)(0.053)}{0.002} = 256.64 \text{ m}^{-1}$$

The last column is summed and the headloss calculated using Equation 11-9:

$$\begin{aligned} h_L &= \frac{1.067(0.0025 \text{ m/s})^2(0.5 \text{ m})}{(0.82)(9.81 \text{ m/s}^2)(0.45)^4}(75,025 \text{ m}^{-1}) \\ &= (1.0119 \times 10^{-5} \text{ m}^2)(75,025 \text{ m}^{-1}) = 0.76 \text{ m} \end{aligned}$$

Comments:

1. This headloss is large for clean bed filtration. It should be less than 0.6 m for the specified loading rate. Comparison of the effective size and uniformity coefficient for this sand (from Example 11-1) with the typical values in Table 11-1 reveals that the uniformity coefficient is too high. As noted later in this chapter (see p. 11-22), the loading rate is high for a standard sand filter. Either the loading rate should be lowered, the fraction of fines should be reduced, or some combination of less fines and a lower loading rate should be employed.
2. Note that the equation used to calculate C_D changed when the Reynolds number dropped below 0.5.
3. As may be noted from the number of significant figures presented, this calculation was performed on a spreadsheet.

Terminal Headloss. As the filter clogs, the headloss will increase so that the results calculated using the clean bed equations are the minimum expected headlosses. There is no method to predict the increase in headloss as the filter becomes plugged with accumulated solids without full-scale or pilot plant data. The phenomenological model (Equations 11-7 and 11-8) provides a way to obtain estimates of the time to reach terminal headloss using pilot plant data. More typically, terminal headloss pressure is selected based on experience and the hydraulic profile of the entire treatment plant.

Backwashing Hydraulics

The expansion of the filter bed during backwash is calculated to provide a starting point in determining the placement of the backwash troughs above the filter bed. Fair and Geyer (1954) developed the following relationship to predict the depth of the expanded bed:

$$D_e = (1 - \varepsilon)(D) \Sigma \frac{f}{(1 - \varepsilon_e)} \quad (11-11)$$

where D_e = depth of the expanded bed, m

ε = porosity of the bed

D = depth the unexpanded bed, m

f = mass fraction of filter media with expanded porosity

ε_e = porosity of expanded bed

The conditions during backwash are turbulent. A representative model equation for estimating ε_e is that given by Richardson and Zaki (1954):

$$\varepsilon_e = \left(\frac{v_b}{v_s} \right)^{0.2247R^{0.1}} \quad (11-12)$$

where v_b is the backwash velocity and the Reynolds number is defined as

$$\mathbf{R} = \frac{(v_s)(d)}{\nu} \quad (11-13)$$

The expanded porosity is calculated for each fractional size of the media and summed for the entire bed. An approximation technique uses the 60th percentile diameter ($d_{60\%}$ in m) to calculate the Reynolds number,

$$\mathbf{R} = \frac{(v_s)(d_{60\%})}{\nu} \quad (11-14)$$

and then calculates the expanded porosity in one step for the entire bed depth (Cleasby, 1972). A more sophisticated model developed by Dharmarajah and Cleasby (1986) is also available.

The determination of D_e is not straightforward. From Equation 11-12, it is obvious that the expanded bed porosity is a function of the settling velocity. The particle settling velocity is determined by Equation 10-8 in Chapter 10. To solve Equation 10-8, the drag coefficient (C_D) must be calculated. The drag coefficient is a function of the Reynolds number, which, in turn, is a function of the settling velocity. Thus, the settling velocity is needed to find the settling velocity! To resolve this dilemma, the settling velocity must be estimated. Knowing the sand grain diameter and specific gravity, Figure 11-7 can be used to obtain a first estimate for the settling velocity to use in calculating the Reynolds number. The calculated value of the Reynolds number is compared to the estimate, and the procedure is iterated until the estimate and the calculated value of \mathbf{R} are the same.

Example 11-3 illustrates the calculation procedure to estimate D_e .

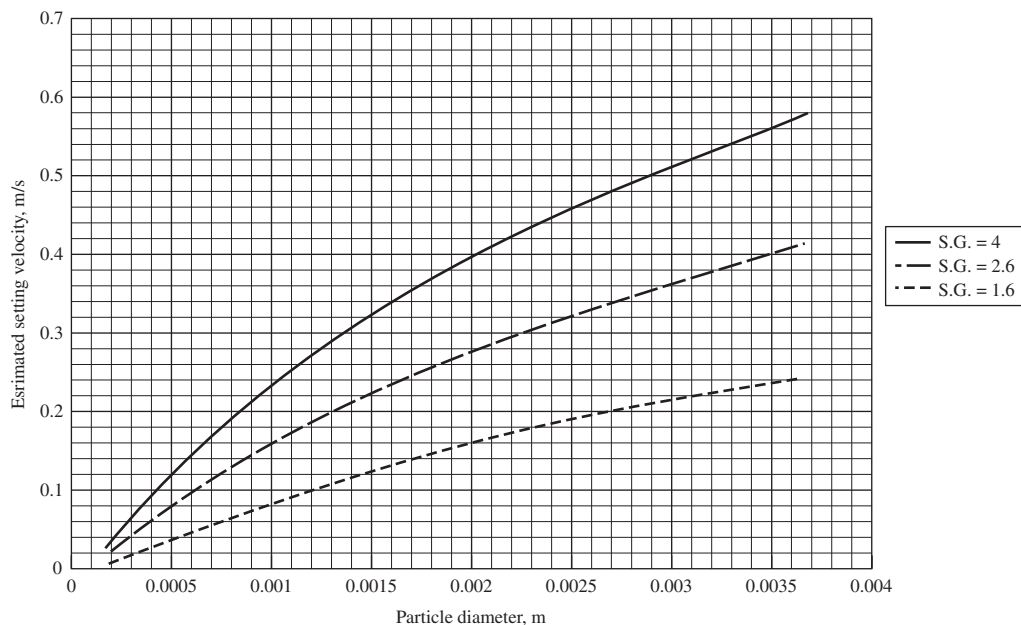

FIGURE 11-7
Particle settling velocity estimation chart. S. G. = specific gravity.

Example 11-3. Determine the depth of the expanded sand filter bed being designed for Ottawa Island (Example 11-2).

Solution. To begin, select a backwash rate. To retain the finest sand grains used in building the filter, the backwash rate must not wash out particles with a diameter of 0.000126 m (0.0126 cm). Using Figure 11-7, find that for a 0.0126 cm particle with a specific gravity of 2.65, the terminal settling velocity is approximately 1 cm/s (864 m/d).

The computations are shown below.

Sieve no.	Dia., m	Estimated v_s , m/s	Estimated Reynolds number	C_D	v_s , m/s	Fraction retained	Reynolds number	Exponent	Expanded porosity	$f/(1-\epsilon_e)$
8-12	0.002	0.3	376.43	0.56	0.277891	0.053	425.23	0.412	0.255	0.071
12-16	0.00142	0.2	178.18	0.70	0.209215	0.171	227.30	0.387	0.309	0.247
16-20	0.001	0.15	94.11	0.90	0.15441	0.146	118.14	0.362	0.371	0.232
20-30	0.000714	0.1	44.80	1.32	0.107828	0.204	58.91	0.338	0.448	0.369
30-40	0.000505	0.07	22.18	2.06	0.072715	0.176	28.10	0.314	0.537	0.380
40-50	0.000357	0.05	11.20	3.38	0.047723	0.119	13.04	0.290	0.635	0.326
50-70	0.000252	0.03	4.74	6.78	0.028313	0.059	5.46	0.266	0.758	0.244
70-100	0.000178	0.02	2.23	13.09	0.017121	0.031	2.33	0.245	0.877	0.252
100-140	0.000126	0.015	1.19	23.34	0.01079	0.007	1.04	0.226	0.983	0.412
					Sum =	0.966			Sum =	2.53

The estimated settling velocities in the third column were found from Figure 11-7. The Reynolds number was then computed with this estimated velocity. For the first row:

$$R = \frac{(\varphi)(d)(v_a)}{\nu} = \frac{(0.82)(0.002 \text{ m})(0.30 \text{ m/s})}{1.307 \times 10^{-6} \text{ m}^2/\text{s}} = 376.435$$

Note that the shape factor, sand particle diameter, and viscosity are all the same as in Example 11-2. The drag coefficient (C_D) is calculated in the same fashion as Example 11-2. The settling velocity is calculated using Equation 10-8 assuming the density of water is 1,000 kg/m³. For the first row:

$$v_s = \left[\frac{(4)(9.81 \text{ m/s}^2)(2,650 \text{ kg/m}^3 - 1,000 \text{ kg/m}^3)(0.002 \text{ m})}{(3)(0.55838)(1,000 \text{ kg/m}^3)} \right]^{1/2}$$

$$= 0.2778839 \text{ m/s}$$

The density of the sand grain is the product of the specific gravity (from Example 11-2) and the density of water:

$$\rho_s = (2.65)(1,000 \text{ kg/m}^3) = 2,650 \text{ kg/m}^3$$

The expanded bed porosity (next to last column) is calculated from Equations 11-12 and 11-13. For the first row $d = 0.002$ and

$$\mathbf{R} = \frac{(0.002) \text{ m} (0.2778839) \text{ m/s}}{1.307 \times 10^{-6} \text{ m}^2/\text{s}} = 425.22$$

$$\mathbf{R}^{0.1} = 1.83$$

and

$$0.2247 \mathbf{R}^{0.1} = 0.41$$

and

$$\varepsilon_e = \left(\frac{0.01 \text{ m/s}}{0.277884} \right)^{0.41} = 0.255$$

The first row of the last column is then

$$\frac{f}{1 - \varepsilon_e} = \frac{0.053}{(1 - 0.255)} = 0.0711$$

where 0.053 is the mass fraction of sand having a geometric mean diameter of 0.002 m, that is, between sieve numbers 8 and 12.

Using Equation 11-11 with a porosity of 0.45 and an undisturbed bed depth of 0.5 m from Example 11-2, the depth of the expanded bed is then

$$D_e = (1 - 0.45)(0.5 \text{ m})(2.53) = 0.696 \text{ or } 0.70 \text{ m}$$

Comments:

1. The expansion ratio is $D_e/D = 1.40$ or a 40% bed expansion.
2. The depth of the expanded bed is the starting point for setting the elevation of the backwash troughs. In this case it would be $D_e - D = 0.70 \text{ m} - 0.5 \text{ m} = 0.2 \text{ m}$ above the undisturbed bed surface plus a factor of safety.
3. The “one-step” calculation procedure yields a D_e of 0.60 m.

The hydraulic headloss that occurs during backwashing is calculated to determine the head required for the backwash pumps. The loss of head in expanding the filter is calculated as the gravitational force of the entire expanded bed:

$$F_g = mg = (\rho_s - \rho)(1 - \varepsilon_e)(a)(D_e)(g) \quad (11-15)$$

where F_g = gravitational force of the expanded filter bed, N

m = mass of bed, kg/m^3

g = acceleration due to gravity, 9.81 m/s^2

ρ_s = density of media, kg/m^3

ρ = density of water, kg/m^3

ε_e = porosity of expanded bed

a = cross-sectional area of filter bed, m^2

D_e = depth of expanded bed, m

Converting to pressure by dividing by the area of the bed and converting units of pressure (N/m^2) to units of head (m):

$$h_{Le} = \frac{F_g}{(a)(\rho)(g)} = \frac{(\rho_s - \rho)(1 - \varepsilon_e)(D_e)}{\rho} \quad (11-16)$$

11-6 GRANULAR FILTRATION PRACTICE

Filter Type

The selection of the type of filter is strongly influenced by the characteristics of the raw water and treatment processes that precede and follow the filter. Deep bed anthracite monomedia filters accumulate headloss at a low rate, and they have a high capacity for accumulating solids. This leads to long filter runs. However, when the water is not conditioned properly because of high variability in the raw water quality (Figure 11-8), improper chemical dosage, or lack of operator vigilance, the performance degrades dramatically. Dual-media filters provide a more robust

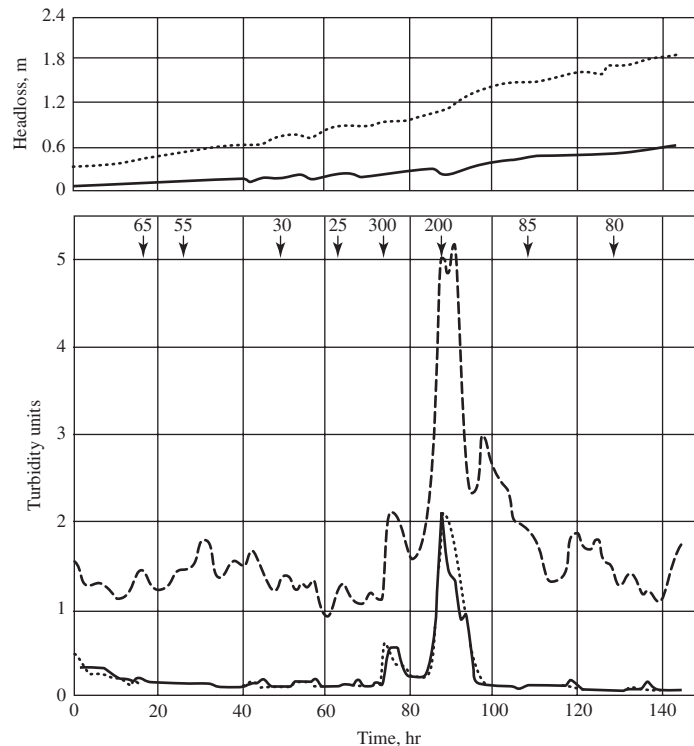

FIGURE 11-8

Turbidity values at filtration rates of 117 and $293 \text{ m}^3/\text{d} \cdot \text{m}^2$. In the upper graph, the dotted curve is for $293 \text{ m}^3/\text{d} \cdot \text{m}^2$; the solid, $117 \text{ m}^3/\text{d} \cdot \text{m}^2$. In the lower graph, the numbers at the top are the raw-water turbidity values at the time shown during the run; the dashed curve is for filter influent; the dotted for filter effluent at $117 \text{ m}^3/\text{d} \cdot \text{m}^2$; and the solid for filter effluent at $293 \text{ m}^3/\text{d} \cdot \text{m}^2$.

(Source: G. G. Robeck, K. A. Dostal, and R. L. Woodward, "Studies of Modification in Water Filtration," *Jour. AWWA*, 56(2), February 1964: 198.)

design when the raw water is improperly conditioned. Rapid sand filters have been in use for over a century. They have proven reliable but are limited in that the finest sand is on the top. As a result, the smallest pore spaces are also on the top. Therefore, most of the particles will clog in the top layer of the filter and only a small portion of the filter depth will be used. Because of the clogging of the small pore spaces, headloss is quickly accumulated and the length of the filter run is shorter than with the coarse media.

Softened groundwater has the most consistent water quality over long periods of time. In addition, the precipitate floc is very tough. Each of the three different media filters perform well.

Dual- or multimedia filters are favored when the raw water source is a large lake such as Lake Michigan. They are recommended for rivers with seasonal flooding, that results in large, rapid changes in turbidity over short periods of time.

Monomedia filters are preferred when the water source characteristics change only slowly with time and when chemical conditioning can keep pace with the changes.

Number

For smaller plants ($< 8,000 \text{ m}^3/\text{d}$), the minimum number of filters is two. For plants with a design capacity greater than $8,000 \text{ m}^3/\text{d}$, the minimum number of filters is four. A rule-of-thumb estimate for larger plants may be made using Kawamura's suggestion (2000):

$$N = 0.0195(Q)^{0.5} \quad (11-17)$$

where N = total number of filters

Q = maximum design flow rate, m^3/d

Example 11-4. Estimate the number of filters for Ottawa Island's new water treatment plant (Examples 11-1, 11-2, 11-3) if the maximum day design flow rate is $18,400 \text{ m}^3/\text{d}$.

Solution. Using Equation 11-17, the number of filters is

$$N = 0.0195(18,400)^{0.5} = 2.65$$

However, the design guidance for plants with a design capacity greater than $8,000 \text{ m}^3/\text{d}$ is a minimum of four filters.

Comment. Four filters provide more flexibility in operation.

Filtration Rate

When a plant has a small number of filters, the filtration rate in the remaining filters increases dramatically when one filter is taken off-line for backwashing or maintenance. A sudden increase in the filtration rate in those filters in service may result in particle detachment and an increase in turbidity in the effluent. This condition must be analyzed when the filtration rate is selected. If the design filtration rate is to be maintained, the nominal filtration with all units in service will be proportionally lower. GLUMRB (2003) specifies that the filters shall be capable of meeting the plant design capacity at the approved design filtration rate with one filter removed from service.

The capital cost of the filter is directly related to the filtration rate because higher filtration rates result in a smaller area for the filter bed. With proper coagulation, inclusion of polymer

addition, and good settling, dual-media filters can readily achieve satisfactory results at filtration rates up to $25 \text{ m}^3/\text{h} \cdot \text{m}^2$ of surface area (25 m/h or $600 \text{ m}^3/\text{d} \cdot \text{m}^2$). However, filter effluent quality tends to degrade at filtration rates above 12.5 m/h ($300 \text{ m}^3/\text{d} \cdot \text{m}^2$) with weak alum floc without polymer (MWH, 2005).

Generally, conservative design filtration rates are 7.5 m/h for rapid sand filters, 15 m/h for dual-media filters, and 25 m/h for deep, coarse monomedium filters that have polymer added as a filter aid. Approximate clean bed headlosses for common filter beds and filtration rates are given in Table 11-3.

Dimensions. The area of a filter bed may be estimated as

$$A = \frac{Q}{Nq} \tag{11-18}$$

- where A = area of a bed, m^2
- Q = maximum day flow rate, m^3/d
- N = number of beds
- q = filtration rate, $\text{m}^3/\text{d} \cdot \text{m}^2$

Although some extremely large plants may employ filter areas up to 200 m^2 , a common upper bound for large plants is 100 m^2 . The general range in area is 25 to 100 m^2 with an average of about 50 m^2 (Kawamura, 2000; MWH, 2005).

Filters are generally composed of two *cells* per *filter box* to form a *bed*. Generally, the *gullet* bisects the box to form the two cells. The width of a filter cell should be less than 6 m so that “off-the-shelf” wash water troughs may be used. The suggested length-to-width ratio of a cell is in the range of 2:1 to 4:1 (Kawamura, 2000).

The filter box depth is on the order of 4 to 8 m to provide space for the underdrain system, media, and headloss. Due to construction costs, filter designs rarely provide more than 2 to 3 m of available head through the filter bed. Experience indicates that effluent turbidity begins to increase when the net headloss is over 1.8 m for well-conditioned floc and dual-media filters, and may be less than 0.8 m for poorly conditioned floc (Cleasby and Logsdon, 1999; Kawamura, 2000; MWH, 2005).

TABLE 11-3
Approximate clean bed headlosses for common filter beds

Type of filter bed	Filtration rate, m/h	Headloss, m
Standard rapid sand	5	0.3
Standard rapid sand	7.5	0.45
Standard dual media	10	0.3
Standard dual media	12.5	0.45
Standard dual media	20	0.6
Standard dual media	25	0.75

(Source: Adapted from Kawamura, 2000.)

Example 11-5. In continuing the design of Ottawa Island's rapid sand filter, determine the area of each individual filter and the plan (horizontal) dimensions of a filter box. Use the filtration rate of $216 \text{ m}^3/\text{d} \cdot \text{m}^2$ from Example 11-2.

Solution:

- a. From Example 11-4, the initial estimate of number of filters is 4.
- b. Using Equation 11-18, with all beds in service, the area of a bed is

$$A = \frac{18,400 \text{ m}^3/\text{d}}{(4 \text{ filters})(216 \text{ m}^3/\text{d} \cdot \text{m}^2)} = 21.296 \text{ or } 21.3 \text{ m}^2/\text{filter}$$

- c. Redundancy capacity for the maximum day with one filter out of service must be provided. The choices are:
 1. Increase the number of beds to five and reduce the area.
 2. Increase the number of beds to six and reduce the area.
 3. Maintain the number of beds at four but make the area larger. This allows for a lower q during average conditions and meets the design loading rate with one bed out of service on the maximum day.
 4. Switch to a dual-media filter that would allow a higher loading rate.
- d. Because of construction and operational considerations, filters are built in pairs. Thus, alternative (1) is eliminated. Alternative (2) would be acceptable but would have a capital cost 50% greater than the four-filter system. Without switching to dual media, option 3 offers the most economical alternative.
- e. If each filter is increased by $1/3$, the filtration rate with one filter out of service would be

$$q = \frac{18,400 \text{ m}^3/\text{d}}{(3 \text{ filters})(1.333)(21.3 \text{ m}^2)} = 216.0 \text{ m}^3/\text{d} \cdot \text{m}^2$$

Therefore, for a trial calculation assume the area of one filter is $(1.3333)(21.3 \text{ m}^2) = 28.4 \text{ m}^2$.

- f. As a trial, select a total width of two cells = 5.2 m. Each cell has a width of 2.6 m. The length of each cell is then

$$L = \frac{28.4 \text{ m}^2}{(2)(2.6 \text{ m})} = 5.5 \text{ m}$$

This design meets two design criteria: the cell width is $< 6 \text{ m}$ and the L:W ratio (2.1:1) is within the recommended range of 2:1 to 4:1.

- g. An assumption of a gullet width of 0.6 m yields the plan view sketched below.

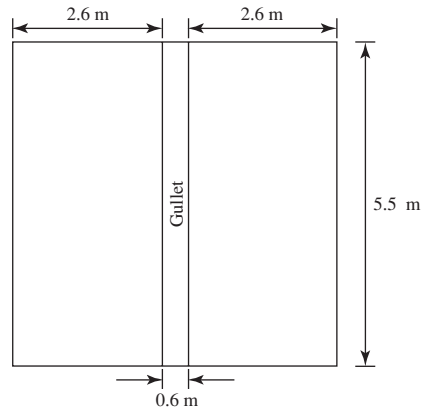

Comments:

1. The assumed gullet width will be checked in Example 11-7.
2. There are several lengths and widths that will meet the design criteria. The Solver tool* in a spreadsheet can be used to define the upper and lower bounds of the width per cell. The spreadsheet and dialog box are shown in Figure 11-9.
3. The vertical dimensions of the filter box depends on the media, underdrain and headloss through the filter. The depth of the filter box will be determined in Example 11-8.

Media

The selection of the filter type implicitly specifies the media type. The grain size distribution plays a strong role in the trade-off between headloss (larger media minimizes headloss) and filtration efficiency (smaller media captures particles better). The primary design criteria are the effective size (E) and the uniformity coefficient (U).

As shown in Figure 11-5, a low uniformity coefficient results in better utilization of the filter bed. The effective size plays a significant role in the headloss. The estimate of the clean bed headloss can be used to evaluate alternate media specifications. For example, because clean bed headlosses range from 0.3 to 0.6 m (Castro et. al., 2005), initial headlosses in excess of 0.6 m imply either that the filtration rate is too high or that the media has too large a proportion of fine grain sizes.

The media in multimedia filters must be matched to ensure that all the media fluidize at the same backwash rate so that one media is not washed out or fails to fluidize. The drag and gravitational forces of the smallest denser media grain size can be balanced with the largest lighter media grain size by equating the settling velocities of these particle sizes using Equation 10-8, and solving for the ratio of the diameters (Kawamura, 2000):

$$\frac{d_1}{d_2} = \left[\frac{\rho_2 - \rho}{\rho_1 - \rho} \right]^{0.667} \quad (11-19)$$

*Solver is a "tool" in Excel[®]. Other spreadsheets may have a different name for this program.

	A	B	C	D
1	Example 11-5			
2	Filter box dimensions for Ottawa Island			
3				
4				
5	Q_{\max}	18,400	m^3/d	
6	Filtration rate	216	$\text{m}^3/\text{d} - \text{m}^2$	
7	Number of filters	3		
8				
9	Area =	28.4	m^2	
10				
11	Width per cell =	2.66	m	
12				
13	Width per box =	5.33	m	
14				
15	L =	5.33	m	
16				
17	L:W =	2	:1	
18				
19				
20				
21	Solver dialog box inputs			
22				
23	Target cell	B11		
24	Equal to	min		
25	By changing	B11		
26	Subject to the constraints			
27		B11	< or =	6
28		B17	> or =	2
29		B17	< or =	4

FIGURE 11-9

Solver solution for length and width of filter box for Example 11-5.

where d_1 = diameter of lighter media, m

d_2 = diameter of denser media, m

ρ = density of water, kg/m^3

ρ_1 = density of medium with diameter d_1 , kg/m^3

ρ_2 = density of medium with diameter d_2 , kg/m^3

GLUMRB (2003) specifies the following effective sizes and uniformity coefficients:

- For sand, E of 0.45–0.55 mm and $U \leq 1.65$
- For anthracite coal as a monomedium, E of 0.45–0.55 mm and $U \leq 1.65$.
- For anthracite coal as a cap, E of 0.8–1.2 mm and $U \leq 1.85$.

TABLE 11-4
Suggested media depth as a function of effective size

Media depth (D) Effective size (E), or D/E	Applications
1,000	Ordinary monosand and dual-media beds
1,250	Typical tri-media beds (coal, sand, and garnet)
1,250–1,500	Coarse, deep, monomedium beds ($E = 1.2$ to 1.4 mm)
1,500–2,000	Very coarse, monomedium beds ($E = 1.5$ to 2.0 mm)

Data source: Kawamura, 2000.

Kawamura (2000) suggests that the depth of the filter bed follow the relationship shown in Table 11-4.

Filter Support and Underdrains

The underdrain system serves to support the filter medium, collect filtered water, and distribute backwash water and air scour if it is used.

Many filters use underdrain systems with openings larger than the filter medium to be supported. To prevent the medium from leaking into the underdrain system, several layers of graded gravel (called *filter support*) are placed between the underdrain and the medium. GLUMRB's specifications when graded gravel is required are given in Table 11-5.

There are five major categories of underdrain: manifold pipe system, blocks, screens, false bottom with nozzles, and porous bottom. A few of these are illustrated in Figure 11-10.

Pipe lateral underdrains were once popular because of their relatively low cost. Problems with relatively high headloss and poor wash water distribution has resulted in a decline in their use. Pipe lateral underdrains require support gravel.

One common type of block is made with 6 mm diameter orifices on the top of the block. Support gravel is required for this type of underdrain to keep the media from being washed out of the filter. Air scour may not be used with this system. A variation of this system uses polyethylene blocks. Air scour can be incorporated in this block.

TABLE 11-5
GLUMRB specifications for graded gravel

From the top layer down:	
Torpedo sand: 8 cm depth, $E = 0.8$ mm, $U \leq 1.7$	
Minimum of four gravel layers from the following:	
Size range, mm	Depth, mm
3–6	50–75
5–12	50–75
12–20	75–125
20–40	75–125
40–65	125–200

Source: Adapted from GLUMRB, 2003.

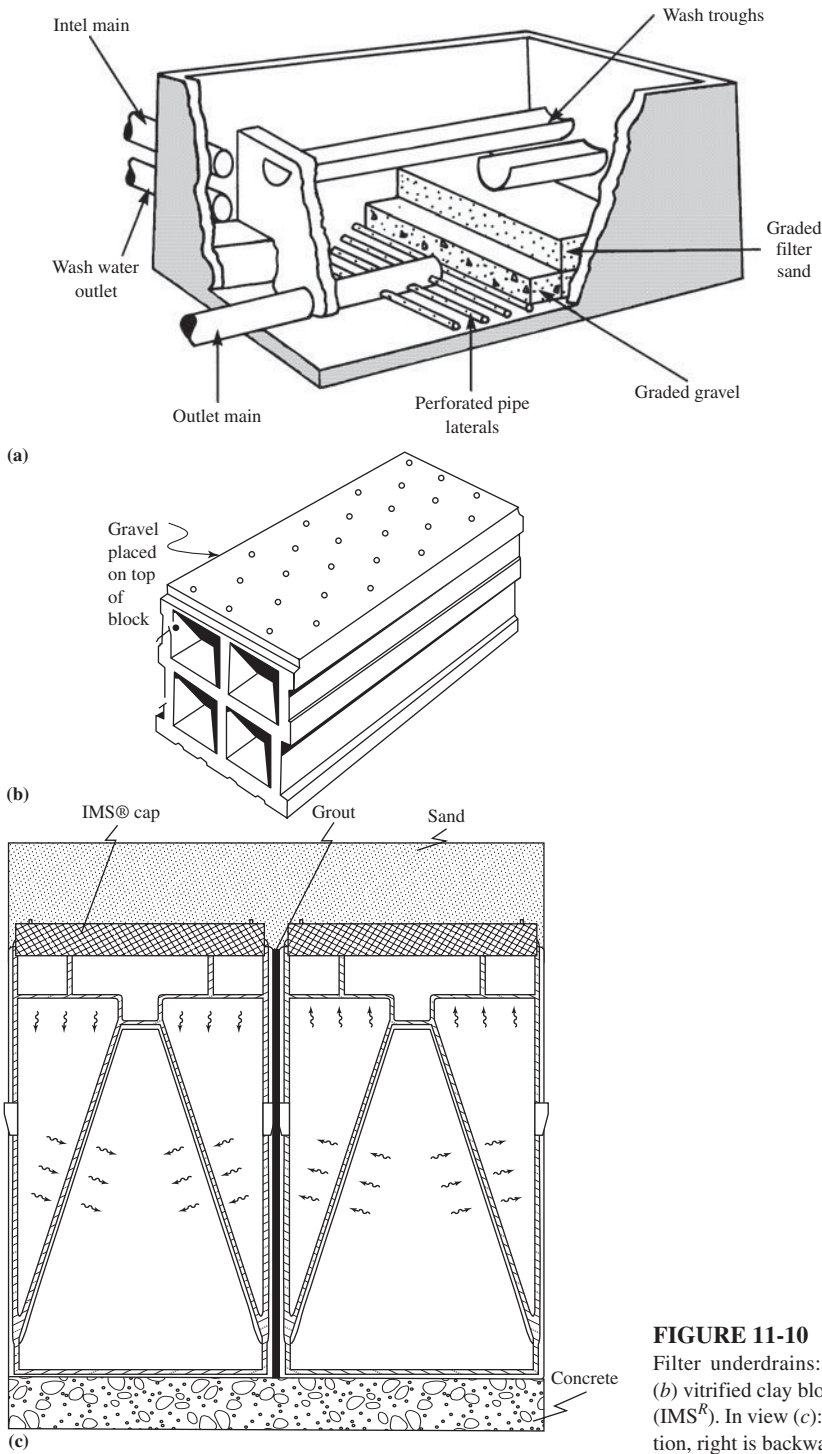

FIGURE 11-10
 Filter underdrains: (a) perforated pipe laterals, (b) vitrified clay block, (c) Integral Media Support (IMS^R). In view (c): left is water flow during filtration, right is backwash flow pattern.

Screens are designed to be used without support gravel. Air scour may not be used with this system.

The false bottom systems with nozzles are primarily used in filters using air/wash systems. Fine openings in the nozzles eliminate the need for support gravel. This reduces the required filter box depth in new designs and allows for deeper media depth in retrofit designs.

Porous bottom underdrains are constructed of aluminum oxide plates with very small pore sizes. The pores are susceptible to plugging and are not suitable for softening or iron/manganese removal plants.

The underdrain is a crucial feature of the filter design, and, in turn, it is crucial for the success of the plant in removing turbidity before disinfection. It needs to be physically strong as well as easy to install and maintain. None are free from disadvantages, but many problems can be avoided by selection of proven technology. Careful inspection during and after installation, but also before placement of filter media, is essential.

The headloss during filtration or backwashing is on the order of 0.1 to 0.3 m for modern underdrains. The pipe and lateral system headloss during backwash may be as large as 0.6 m (MWH, 2005). During filtration the conduit losses will be negligible because the conduits are sized to carry a backwash flow rate that is several times the filtration flow rate.

Backwashing

The need for backwash is indicated by one of three criteria:

- The headloss across the filter reaches the maximum design level or more customarily a preset limit in the range of 2.4 to 3.0 m;
- The filtrate turbidity reaches a set upper limit;
- Or, some maximum time limit, usually in the range of three or four days, has been reached.

The traditional backwash system in the United States is an upflow water wash with full bed fluidization. Backwash water is introduced into the bottom of the bed through the underdrain system. As the flow rate is increased, the entire bed expands. The backwash flow is continued until the wash water is reasonably clear. Figure 11-11 may be used to estimate an appropriate backwash rate. Each degree Celsius increase in water temperature requires about a 2 percent increase in the wash rate to prevent a reduction in bed expansion. The wash system should be designed for the warmest wash water temperature that may be expected (Castro et al., 2005). Typical wash volumes range from 4 to 8 m³ of wash water/m² of surface area of the bed (Cleasby and Logsdon, 1999). Storage capacity for two backwashes should be provided (Kawamura, 2000). GLUMRB (2003) specifies that not less than 15 minutes of wash of one filter at the design wash rate be provided.

For sand filters, backwash flow rates range between 30 and 60 m/h for periods from 10 to 20 minutes (MWH, 2005). The limiting factor in choosing a backwash rate is the terminal settling velocity of the smallest medium grains that are to be retained in the filter. Because the filter backwashing process is effectively an upflow clarifier, the backwash rate becomes the overflow rate that determines whether a particle is retained in the filter or is washed out through the backwash trough.

Another design criterion that is often used is to make sure that the largest, or the 90th percentile, largest diameter particles are fluidized. In a dual-media filter, the d_{90} of the anthracite is considered

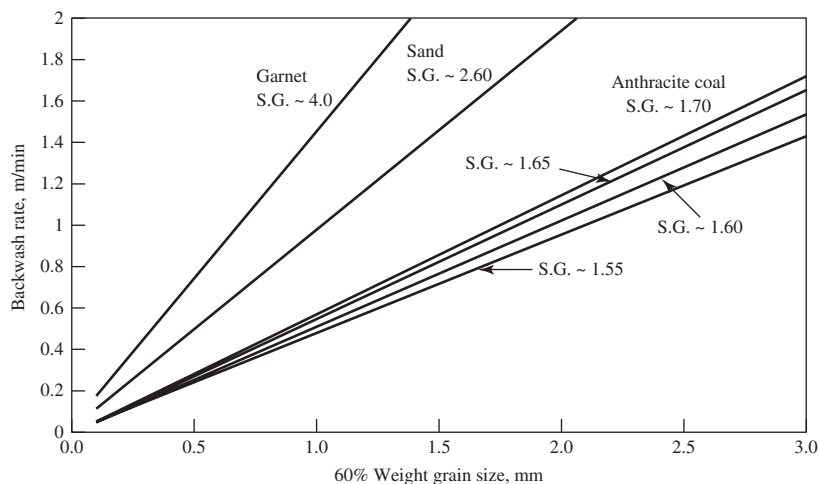

FIGURE 11-11

Guide for backwash rate, water temperature = 10°C. S.G. = specific gravity.

the largest-diameter particle. By fluidizing this particle during backwash, it will not “sink” to the bottom of the filter and will re-stratify after the backwash is complete.

GLUMRB (2003) specifies that provisions shall be made for washing filters as follows:

- A minimum rate of 37 m/h consistent with water temperatures and the specific gravity of the media or;
- A rate of 50 m/h or a rate necessary to provide 50 percent expansion of the filter bed is recommended or;
- A rate of 24 m/h for full depth anthracite or granular activated carbon media.

The alternatives for backwashing are (1) water-only backwash with a surface wash and (2) water and air backwash (also known as *air scour*). As shown in Figure 11-12, water backwash without surface scouring will not provide efficient cleaning of the bed.

Two basic types of surface wash systems are the fixed grid and rotating arms. Surface wash systems inject jets of water into the surface from about 2.5 to 5 cm above the surface. They are operated for one to two minutes before the upflow backwash, and continue to operate until about two to three minutes before the end of the upflow backwash. The surface wash systems have been used for over 50 years and have proven effective. GLUMRB (2003) specifies that the water pressure be at least 310 kPa and that the flow rate be 4.9 m/h with fixed nozzles or 1.2 m/h with revolving arms.

Air scour systems supply air through the underdrain system. Though highly touted, the air scour systems have not found universal favor. Kawamura (2000) reports that they agitate only the top 15 to 25 cm of the bed and are not recommended when the filter bed is less than 0.75 m deep because a surface wash system can provide adequate cleaning. The air scour system complicates the design and construction of the filter, requiring additional auxiliary equipment including air blowers, air piping, and controllers. Air scour systems require careful operation to avoid losing

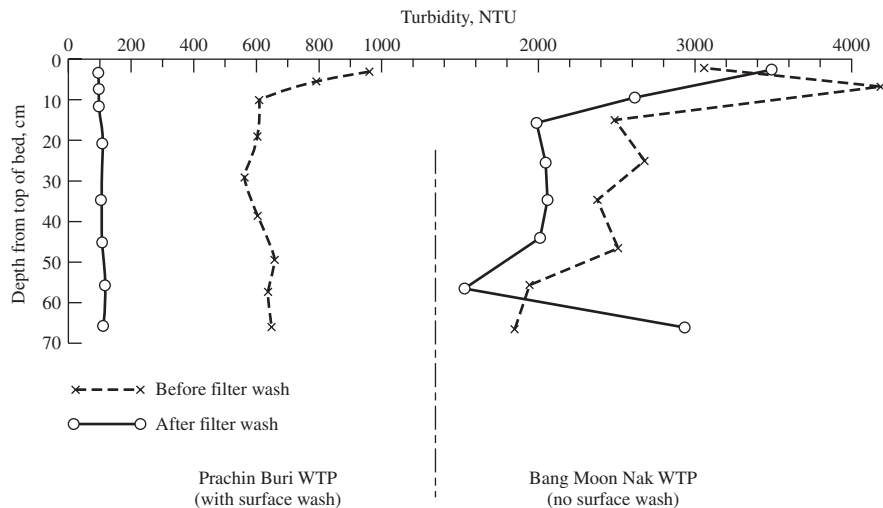

FIGURE 11-12 Sludge profile in filter beds. Amount of sludge is shown as turbidity (NTU).
(Source: Kawamura, 2000.)

filter medium and potential movement of the gravel support medium (Cleasby and Logsdon, 1999). Kawamura (2000) and MWH (2005) recommend air scour systems when the media depth exceeds 1 m.

For air scour systems, GLUMRB (2003) specifies an air flow of 0.9 to 1.5 m^3 of air/min $\cdot \text{m}^2$ of filter area. In addition, the backwash flow rate must be variable from 20 to 37 m/h so that a lower rate may be used when the air scour is on.

Backwash water has commonly been recovered and sent to the head end of the plant for treatment because it may represent 1 to 5 percent of the total plant production. Thus, it is a means of saving water resources as well as chemical and energy costs in its production. However, experimental evidence indicates that pathogenic cyst concentrations may build up to such levels that these organisms breakthrough the filter (Cornwell and Lee, 1994). Subsequent research has shown that treatment with polymers and settling at conventional overflow rates reduce the pathogen levels to those comparable with the raw water (Cornwell et al., 2001 and LeGouellec et al., 2004).

Wash Troughs

Troughs may be made of fiberglass-reinforced plastic (FRP), stainless steel, or concrete. Because they are less labor intensive to install, modern plants usually use manufactured “off-the-shelf” FRP or stainless troughs. They have semicircular bottoms to create smooth flow streamlines and to prevent accumulation of foam and solids under the trough. The required cross-sectional dimensions for a given wash water flow rate can be estimated from Figure 11-13.

The design elevation of the weir edge of the trough may be estimated by adding the depth required for maximum bed expansion* and the depth of the trough, plus a margin of safety of

*The targeted bed expansion for modern high-rate filters during backwash with surface wash is approximately 37 percent for a typical sand bed with a porosity of 0.45; the expansion for anthracite with a porosity of 0.5 is about 25 percent (Kawamura, 2000).

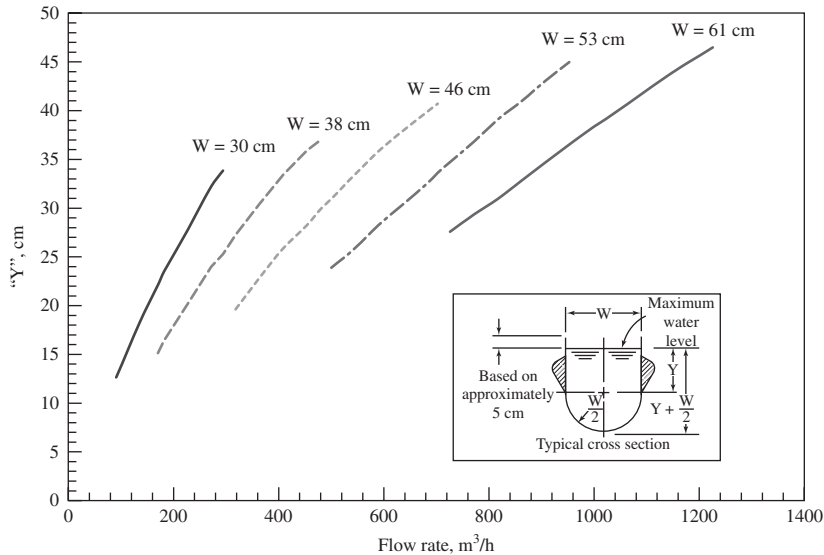

FIGURE 11-13
Wash trough sizing chart.

0.15 to 0.3 m (Castro et al., 2005). When anthracite is used, Cleasby and Logsdon (1999) recommend that the distance to the top of the troughs from the surface of the filter bed should be 1.1 to 1.2 m.

GLUMRB (2003) recommends that

- The bottom elevation of the trough be above the maximum level of the expanded media during washing;
- A 5 cm freeboard inside the trough be provided;
- The top edge be level and at the same elevation for all troughs;
- The troughs be spaced so that each trough serves the same number of square meters of filter area;
- The maximum horizontal travel of suspended particles to reach the trough not exceed 1 m.

For coal or dual media, troughs should be spaced 1.8 to 3 m apart (Kawamura, 2000).

It is critical that troughs be leveled uniformly to match a still water surface and that they be properly supported both vertically and horizontally so that their weirs remain absolutely level during backwashing. Center supports may be required for trough lengths over 4 m.

Example 11-6. Design the backwash system for Ottawa Island's rapid sand filter. Use the filter dimensions from Example 11-5. The backwash system includes the layout of the backwash troughs, backwash velocity, volume of backwash water per trough, the trough dimension (width and depth), trough elevation, volume of backwash tank, and elevation of the lowest water level in the backwash tank.

Solution:

- a. Using GLUMRB guidance, the wash troughs are to be spaced so that each trough serves approximately the same number of square meters of filter area and so that the maximum horizontal travel of suspended particles to reach the trough does not exceed 1 m.

Using the sketch from Example 11-5, place wash troughs at intervals as shown below to achieve an even spacing. As shown by the arrows, the maximum distance a suspended particle must travel to a trough is 1.1 m. This does not meet the GLUMRB recommendation but is acceptable.

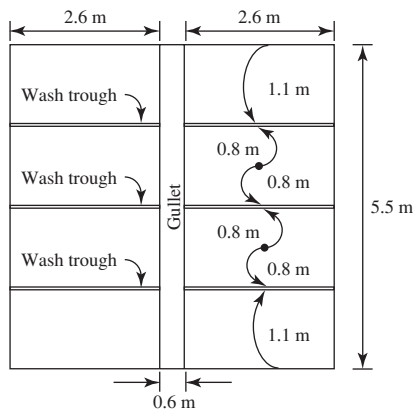

- b. From Example 11-3, the backwash velocity is 864 m/d. This is equivalent to

$$\frac{864 \text{ m/d}}{24 \text{ h/d}} = 36 \text{ m/h}$$

This is slightly less than the GLUMRB recommended minimum of 37 m/h, but as noted in Example 11-3, this rate will avoid washing out the finest sand.

- c. The maximum flow rate of backwash water per trough is at the end trough

$$(36 \text{ m/h})(2.6 \text{ m})(1.1 \text{ m} + 0.8 \text{ m}) = 177.8 \text{ or } 180 \text{ m}^3/\text{h}$$

The distance of 1.1 m is from the end of the filter cell to the center line of the trough; the distance 0.8 m is from the midpoint between the two troughs to the center line of the trough.

Using a backwash flow rate of 180 m³/h and Figure 11-13, select a trough with dimensions $W = 30 \text{ cm}$ and $Y = 23.5 \text{ cm}$. From the drawing in the figure, the depth of the trough is $23.5 \text{ cm} + (30 \text{ cm}/2) + 5 \text{ cm} = 43.5 \text{ cm}$

- d. The trough elevation is determined from the backwash expansion calculated in Example 11-3:

$$\begin{aligned} \text{Height to the weir edge above undisturbed media} &= D_e - D + \text{depth of trough} \\ &\quad + 0.15 \text{ m} \\ &= 0.7 \text{ m} - 0.5 \text{ m} + 0.435 \text{ m} \\ &\quad + 0.15 \text{ m} = 0.785 \text{ or } 0.8 \text{ m} \end{aligned}$$

- e. The volume of backwash water for 15 minutes (0.25 h) of backwash is

$$(36 \text{ m/h})(2 \text{ cells})(2.6 \text{ m})(5.5 \text{ m})(0.25 \text{ h}) = 257.4 \text{ m}^3$$

Provide two times this volume or 514.8 or about 520 m³.

- f. Assuming a gravity feed, the lowest level of water the backwash tank should be 11 m above the lip of the wash troughs (Kawamura, 2000).

Gullet

There are two gullets. The lower gullet carries the filtered water to the piping that leads to the clear well. It will not be discussed. The upper gullet is the one generally recognized and the one that is the focus of this discussion. It carries pretreated water to the filter and carries backwash water and filter-to-waste water away for treatment and recycling through the plant.

Flat-bottomed gullets (Figure 11-14) may be designed with the following equation (Camp, 1970; Hudson, 1981):

$$H = \left(h^2 + \frac{2(Q_{ww})^2}{gb^2h} \right)^{1/2} \tag{11-20}$$

- where H = depth at upstream end, m
- h = depth at distance x in Figure 11-14, m
- Q_{ww} = wash water discharge, m³/s
- x = length of gullet, m
- g = acceleration due to gravity, 9.81 m/s²
- b = width of gullet, m

The upper elevation of H , the depth of wash water at the upstream end, is set below the bottom of the wash troughs discharging into the gullet so that the wash trough discharge is a free fall. The elevation of the bottom of the gullet (the lower elevation of H) is highly variable. Various authors show it at the bottom of the underdrain, at the bottom of the media, at some elevation between the top and bottom of the media, and at the top of the media (Amirtharajah, 1978; Castro et al., 2005; Kawamura, 2000; MWH, 2005, Reynolds and Richards, 1996).

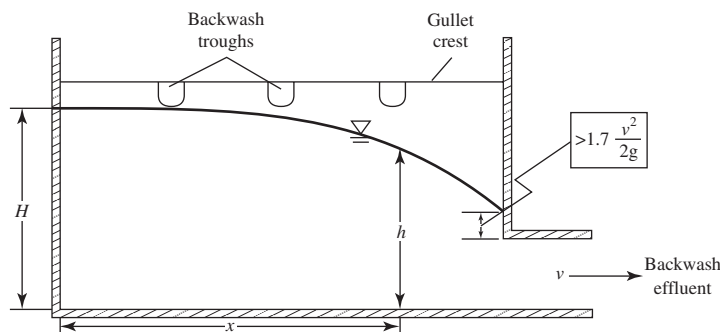

FIGURE 11-14
Illustration of terms used for gullet design (Equation 11-20).

As noted in Figure 11-14, the flow of backwash water out of the gullet controls the dimension h . The lowest feasible depth h at the outlet of the gullet is determined by the height of wash water required to overcome the entry headloss into the outlet pipe ($0.7 v^2/2g$) plus the velocity head that is lost in producing the desired velocity in the pipe. The backwash conduit velocity is generally in the range 1.2 to 2.4 m/s.

The wash water discharge, Q_{ww} , is determined from the backwash rate and the area of the filter.

The solution is iterative. A trial value of b is selected and the dimension H is calculated. Measuring from the bottom of the wash troughs, the depth is checked against one of the criteria noted above. If the depth is greater than the depth to the bottom of the underdrain, it is too deep. If the bottom of the gullet is above the media, the width may be too large. Depending on the size of the plant, with smaller plants having smaller gullets, trial widths in the range of 0.4 to 2 m are suggested.

Example 11-7. Determine the gullet dimensions for Ottawa Island's rapid sand filter. Use the filter dimensions from Example 11-5 and the backwash rate from Example 11-6. Assume a 450 mm diameter pipe from the gullet is to carry the wash water at a velocity of 1.8 m/s.

Solution:

- a. Estimate the velocity head in the effluent conduit.

$$\frac{v^2}{2g} = \frac{(1.8 \text{ m/s})^2}{2(9.81 \text{ m/s}^2)} = 0.165 \text{ or } 0.17 \text{ m}$$

- b. As shown in Figure 11-14, estimate the velocity plus entry headloss as

$$(1.7) \frac{v^2}{2g} = \frac{1.7(1.8 \text{ m/s})^2}{2(9.81 \text{ m/s}^2)} = 0.28 \text{ m}$$

- c. Calculate h .

$$h = \text{diameter of pipe} + (\text{velocity head} + \text{entrance headloss})$$

$$h = 0.45 \text{ m} + 0.28 \text{ m} = 0.73 \text{ m}$$

- d. From Example 11-5, assume a value of 0.6 m as a first trial for the width b and estimate H using Equation 11-20. Use the wash rate from Example 11-6 to estimate Q_{ww} .

$$Q_{ww} = \frac{36 \text{ m/h}(5.2 \text{ m})(5.5 \text{ m})}{3,600 \text{ s/h}} = 0.286 \text{ m}^3/\text{s}$$

$$H = \left[(0.73)^2 + \frac{2(0.286 \text{ m}^3/\text{s})^2}{(9.81 \text{ m/s}^2)(0.6 \text{ m})^2(0.73 \text{ m})} \right]^{1/2}$$

$$H = 0.7548 \text{ or } 0.8 \text{ m}$$

This is 0.8 m below the bottom of the wash troughs. Using the depth of the trough from Example 11-6, the initial estimate of the bottom elevation of the gullet is then

$$\begin{aligned} \text{Depth} &= H + \text{depth of trough} \\ &= 0.8 \text{ m} + 0.435 \text{ m} \\ &= 1.235 \text{ or about } 1.25 \text{ m below the lip of the wash trough} \end{aligned}$$

- e. Check depth using height of backwash troughs estimate (Example 11-6) and standard depths for sand, gravel, and underdrain blocks.
 - Height to the weir edge above undisturbed media = 0.8 m
 - Depth of sand = 0.6 m
 - Depth of gravel = 0.3 m
 - Depth of underdrain block = 0.3 m

From the sketch shown below, the bottom of the gullet will be approximately at the same elevation as the bottom of the gravel support. This is within the guidelines (between the top of the media and the bottom of the underdrains).

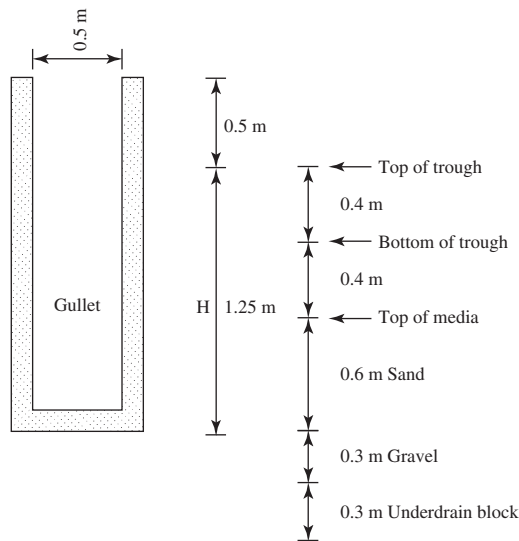

Comments:

1. The actual depth of the gullet will be a little deeper because the gullet wall surrounds the backwash trough and extends slightly above it to provide a firm support. This distance is on the order of 0.5 m.
2. The initial estimate of the width of the gullet of 0.6 m from Example 11-5 is the final width. The depth from the top edge to the bottom of the gullet is about 1.75 m

Flow Apportionment and Rate Control

The three basic methods for controlling the filtration rate and distributing the flow to the filters are a modulating control valve system, influent weir splitting, and declining-rate filtration.

The modulating control valve system is equipped with a flow meter and a control valve. Each filter has a flow meter, or a level transmitter and a controller. The control valve apportions the flow to balance the flows to each filter. As filters are taken out of service for backwashing or repair, the controller adjusts the flow. An advantage of this system is that it allows water to flow smoothly to the filters without weirs or orifices, thus, minimizing floc breakup. The disadvantage is that

without good maintenance they may overshoot the set point and “hunt” for the correct position, or possibly attempt to balance the flow in steps that result in surges to the filters that remain on line.

In the weir splitting system, water flows in through a common channel and is split equally to all operating filters by the weir. This system is the simplest method for splitting the flow, and rate changes are made gradually without the hunting of control valves.

In declining rate filtration no active control or apportionment is used. Each filter receives a different flow rate depending on the accumulated headloss. The cleanest filters receive the greatest flow, and the flow through each filter declines as solids accumulate. The advantage of this system is that it can be constructed without instrumentation or flow control. The disadvantages are that the operators have no indication of the flow rate or headloss, there is no method to control the filtration rate, and the rate at the beginning of filtration after cleaning may exceed the design filtration rate resulting in turbidity breakthrough.

Headloss Accommodation

The hydraulic gradient through the filter at various times during a filter run is illustrated in Figure 11-15. Negative head (less than atmospheric pressure) develops in a filter when the summation of headlosses from the media surface downward exceeds the depth of water to that point. It is not uncommon to have a meter or more of headloss in the upper 15 cm of a dirty sand filter bed (Cleasby, 1972). When shallow water operating depths are provided, negative head develops a short distance into the media. The negative pressure may cause bubbles of dissolved oxygen and nitrogen to come out of solution. If these bubbles are trapped in the bed (a phenomenon called *air binding*), they reduce the effective filtering area. This increases the filtration rate through the remaining filter area, which results in a more rapid turbidity breakthrough than otherwise would occur. In addition, the headloss rises dramatically.

The depth of water required to prevent a negative pressure in the filter can be estimated by solving Bernoulli’s equation for the headloss between the water surface on the filter and the centerline of the effluent pipe. Using the notation in Figure 11-16:

$$\frac{(v_1)^2}{2g} + \frac{p_1}{\gamma} + z_1 = \frac{(v_2)^2}{2g} + \frac{p_2}{g} + z_2 + h_L \tag{11-21}$$

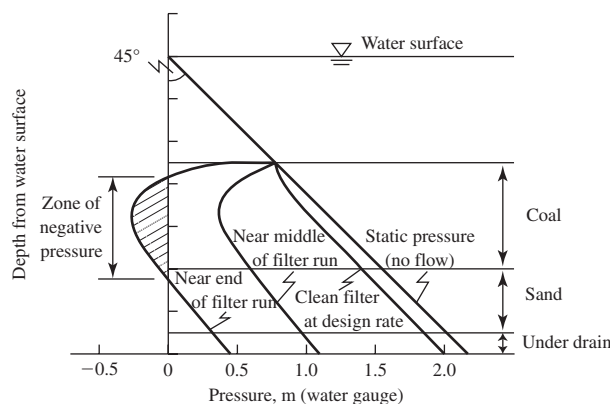

FIGURE 11-15 Pressure development within filter bed during filtration.

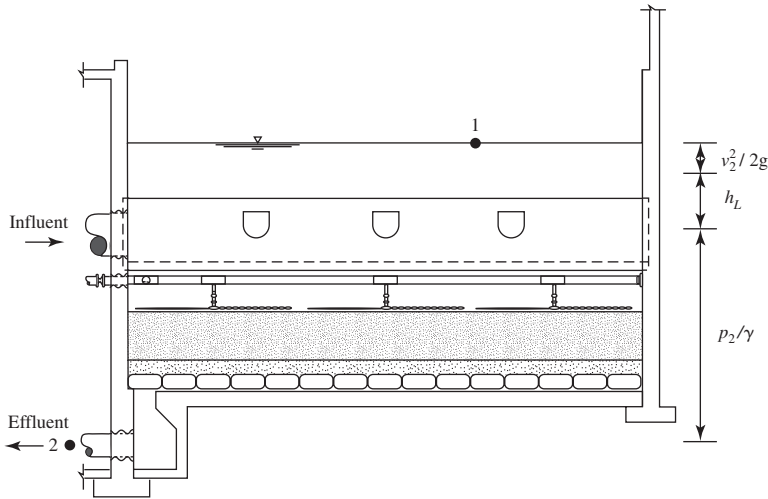

FIGURE 11-16
Schematic of granular filter during filtration. The Notation for Equation 11-22 is shown at right.

- where v_1, v_2 = velocities at points 1 and 2, m/s
- p_1, p_2 = pressures at points 1 and 2, kPa
- z_1, z_2 = elevation heads at points 1 and 2, m
- g = acceleration due to gravity, m/s^2
- γ = specific weight of water, kN/m^3
- h_L = headloss through filter media, and underdrain system, m

If relative pressure is used, $p_1 = 0$. The velocity at the surface of the water in the filter box may be assumed to be zero. The datum is selected so that $z_2 = 0$. Equation 11-21 may then be reduced to

$$\frac{p_2}{\gamma} = z_1 - \frac{(v_2)^2}{2g} - h_L \tag{11-22}$$

The depth of sand, gravel, underdrain, and the water above the media is equal to z_1 . The velocity in the effluent pipe is v_2 . The depth of water above the filter media is selected to maintain a positive value for p_2/γ .

It is natural for designers to make the filter box as shallow as possible. Deeper boxes are more expensive than shallow ones. Early in the 20th century it was common to design for media submergence of 1.2 to 1.5 m for rapid sand filters. A majority of these plants (up to 80 percent) reported air binding (Hudson, 1981).

The available headloss for gravity filters is generally designed to be 2.5 to 3 m. Kawamura (2000) recommends that a minimum depth of water above the filter bed of 1.8 m be provided and that a preferred depth is 2.4 m. He also notes that the turbidity of gravity filters often begins to increase when the net headloss is over 1.8 m. Consequently, the filter must be backwashed even though the headloss available may be 2.4 m or more.

Example 11-8 illustrates the headloss calculation.

Example 11-8. Determine the depth of the filter box for Ottawa Island's sand filter. Use the clean bed headloss from Example 11-2, and the velocity headloss and the media and underdrain depths from Example 11-7. Assume the minimum depth of water above the filter bed is 2.4 m.

Solution:

- a. Calculate z_1 using the assumed water depth and other depths from Example 11-7.

$$z_1 = \text{water depth} + \text{depth of sand, gravel, and underdrain}$$

$$z_1 = 2.4 \text{ m} + 0.6 \text{ m} + 0.3 \text{ m} + 0.3 \text{ m} = 3.6 \text{ m}$$

- b. The velocity headloss from Example 11-7 is

$$\frac{v^2}{2g} = \frac{(1.8 \text{ m/s})^2}{2(9.81 \text{ m/s}^2)} = 0.165 \text{ or } 0.17 \text{ m}$$

- c. Calculate p_2/γ at the beginning of a filter run using the clean bed headloss calculated in Example 11-2.

$$\frac{p_2}{\gamma} = 3.6 \text{ m} - 0.17 \text{ m} - 0.76 \text{ m} = 2.67 \text{ or } 2.7 \text{ m}$$

- d. Estimate the maximum allowable headloss.

$$\frac{p_2}{\gamma} = 3.6 \text{ m} - 0.17 \text{ m} - h_L = 3.43 \text{ m} - h_L$$

Thus, the maximum headloss that will cause a negative pressure in the filter is one that is $>3.43 \text{ m}$.

- e. The filter box depth is estimated as

$$D_{\text{box}} = \text{depth of water} + \text{depth of media} + \text{depth of underdrain}$$

$$+ \text{factor of safety} + \text{freeboard}$$

Assuming a factor of safety of 0.6 m and a freeboard depth of 0.6 m

$$D_{\text{box}} = 2.4 \text{ m} + 0.9 \text{ m} + 0.3 \text{ m} + 0.6 \text{ m} + 0.6 \text{ m} = 4.8 \text{ m}$$

Comments:

1. The elevation of the maximum water level in the filter box governs the hydraulic profile of the upstream processes in the plant. This, in turn, has a significant impact on the cost of the plant. This cost, as well as the cost of the filter itself, favor the design of shallower rather than deeper filter boxes.
2. The use of low profile drains and those that do not need gravel allow for the design of a shallower filter box.
3. Though more expensive, a deeper filter box provides for future expansion to deep bed monomedium.
4. The technique used here for establishing the depth of the filter box is conservative. Monk (1984) provides a detailed method for optimizing the depth of the filter box.

In addition to providing for a minimum depth of water, operational control must be provided to accommodate the increase in headloss during operation. Three methods are used to accommodate the increase in headloss during filtration: (1) maintaining a constant head in the filter effluent by the use of a modulating control valve, (2) maintaining a constant head in the filter effluent and allowing the water level to rise, and (3) maintaining a constant headloss and allowing the filtration rate to decline. These are discussed in detail by Castro et al. (2005), Monk (1987), and MWH (2005).

Some Important Appurtenances

Many features of the filter design are beyond the scope of this text, but a few are sufficiently noteworthy to identify them here.

As noted in Figure 11-2 the turbidity levels rise immediately after filter backwash and then drop off as the filter begins to clog. When this rise is averaged over the filter run, the change in turbidity is small. However, outbreaks of Giardiasis and Cryptosporidiosis caused by protozoan cysts that are very resistant to chlorine disinfection make even this “small” perturbation a potential health hazard (Hibler et al., 1987; Kramer et al., 1996). The design and operating solution is to provide for a “filter-to-waste” period immediately after backwashing. A diagram showing a method for the design to implement filter to waste is shown in Figure 11-17.

Because of outbreaks of Giardiasis and Cryptosporidiosis, filtration practice now includes a provision for monitoring the effluent turbidity from each filter. It is used to guide the length of

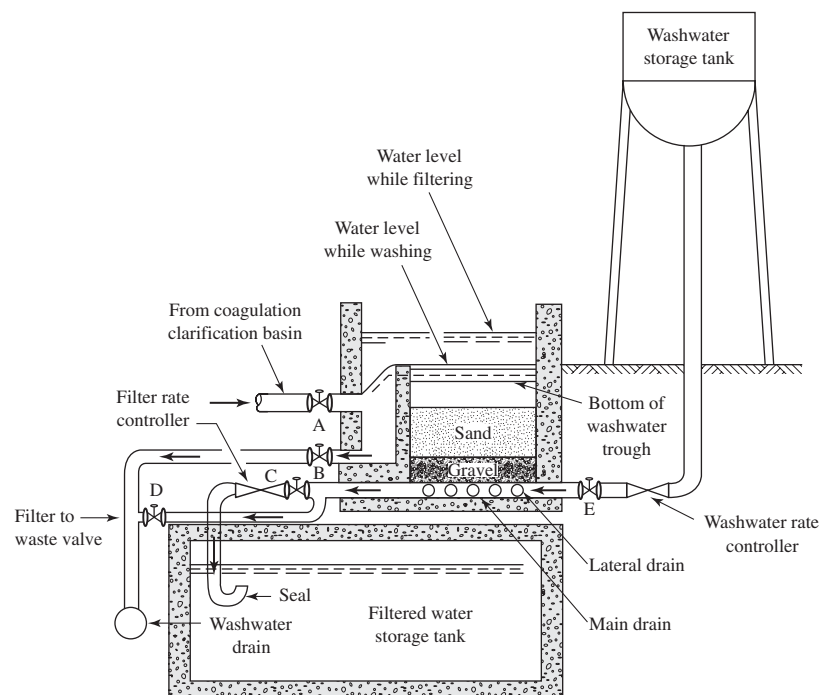

FIGURE 11-17

Diagrammatic section of a rapid sand gravity filter. A, B, C, D, and E are valves that may be hydraulically or pneumatically actuated. Valve D permits wasting filtered water. The seal in the effluent pipe keeps the pipe full at all times so that the rate controller will function.

time for filter effluent to be diverted to waste and to detect the onset of breakthrough of turbidity that signals the end of a filter run.

Many very small particles can exist in the water with turbidity less than 1 NTU. This implies that asbestos fibers, bacteria, viruses, and cysts may be passing through even with very low turbidities. Particle counters are used to detect these small particles and are recommended in conjunction with turbidimeters to address this issue (Cleasby and Logsdon, 1999).

Design Criteria

Along with Tables 11-1, 11-3, 11-4, and 11-5, Tables 11-6 through 11-13 provide a summary of the design guidance presented in this section.

TABLE 11-6
Pretreatment conditions for different operating modes

Operating mode	Pretreatment conditions
Conventional filtration	Coagulation with alum or ferric chloride and polymer followed by flocculation and sedimentation. Can treat turbidities up to 1,000 NTU.
Direct filtration	Coagulation with alum or ferric chloride and polymer followed by flocculation, but not sedimentation. Limited to raw water turbidities less than 15 NTU.
In-line filtration	Coagulation with alum or ferric chloride and polymer. Flocculation is incidental. Sedimentation is not provided. Limited to turbidities less than 10 NTU.

Source: Adapted from MWH, 2005.

TABLE 11-7
Recommended dimensions of ordinary gravity rapid filters

Parameter	Reported range of values	Comment
Area of filter	25–100 m ²	Very large plant maximum is 200 m ²
Width of cell	≤ 6 m	For “Off-the-shelf” troughs
L:W ratio	2:1 to 4:1	
Depth	4–8 m	Provide space for underdrain
Depth of water	≥ 1.8 m	
Gullet		
Width	0.4–2 m	
Depth	Varies from top of media to bottom of underdrain	Measured from the bottom of wash trough

Sources: Castro et al., 2005; GLUMRB, 2003; Kawamura, 2000.

TABLE 11-8
Design criteria for single-medium filters

Parameter	Reported range	GLUMRB recommendation	Recommended
Sand only			
Effective size	0.35–0.7 mm	0.45–0.55 mm	
Uniformity coefficient	1.3–1.8	≤1.65	
Shape factor (<i>f</i>)	0.7–0.95		
Porosity	0.4–0.47		
Specific gravity	2.65		
Depth of medium	0.6–0.75 m	≥0.6 m and ≤ .76 m	
Filtration rate	5–12 m/h		≤7.5 m/h
Backwash rate	30–60 m/h	≥37 m/h	
Backwash duration ^a	10–20 min	≥15 min	
Surface wash rate			
Revolving arms	1.2–1.8 m/h	≥1.2m/h	
Fixed arms	4.9–10 m/h	≥4.9 m/h	
Air scour	Staged or special baffle		
Anthracite coal only			
Effective size	0.70–0.75 mm	0.45–0.55 mm	
Uniformity coefficient	1.3–1.8	≤1.65	
Shape factor (<i>f</i>)	0.46–0.73		
Specific gravity	1.45–1.75		
Porosity	0.53–0.60		
Depth of medium	0.6–0.75 m		
Filtration rate	5–12 m/h		≤7.5 m/h
Backwash rate	37–45 m/h	≥24 m/h	
Backwash duration ^a	10–20 min	≥15 min	
Surface wash rate			
Revolving arms	1.2–1.8 m/h	≥1.2 m/h	
Fixed arms	4.9–10 m/h	≥4.9 m/h	
Underdrain			
Pipe lateral	Yes		
Block	Yes		
Air scour	No		
Air scour	Staged or special baffle		

^aActual off-line time will be ≥ 30 min because of the time required to drain the filter and gradually come up to the full backwash rate. An additional 30–40 minutes off-line is required for “filter-to-waste” to clear the bed of wash water and dislodged turbidity.

Sources: Castro et al., 2005; Cleasby and Logsdon, 1999; GLUMRB, 2003; Kawamura, 2000; MWH, 2005; Reynolds and Richardson, 1996.

TABLE 11-9
Design criteria for dual-media filters

Parameter	Reported range	GLUMRB recommendation	Recommended
Anthracite coal on top			
Effective size	0.9–1.4 mm	0.8–1.2 mm	
Uniformity coefficient	1.3–1.8	≤1.85	
Shape factor (<i>f</i>)	0.46–0.73		
Porosity	0.53–0.60		
Specific gravity	1.45–1.75		
Depth of medium	0.4–0.6 m		
Sand on bottom			
Effective size	0.35–0.7 mm	0.45–0.55 mm	
Uniformity coefficient	1.3–1.8	≤1.65	
Shape factor (<i>f</i>)	0.7–0.95		
Porosity	0.4–0.47		
Specific gravity	2.65		
Depth of medium	0.3–0.75 m	≥0.6 m and ≤0.76 m	
Filtration rate	7–20 m/h		≤ 15 m/h
Backwash rate	30–60 m/h	≥24 m/h	
Backwash duration ^a	10–20 min	≥15 min	
Surface wash rate			
Revolving arms	1.2–1.8 m/h	≥1.2 m/h	
Fixed arms	4.9–10 m/h	≥4.9 m/h	
Underdrain			
Pipe lateral	Yes		
Block	Yes		
Air scour	No—if total depth of medium ≤0.75 m		
Air scour	0.6–1.5 m ³ /min · m ² if total medium depth > 1 m		

^aActual off-line time will be ≥ 30 min because of the time required to drain the filter and gradually come up to the full backwash rate. An additional 30–40 minutes off-line is required for “filter-to-waste” to clear the bed of wash water and dislodged turbidity. If air scour is provided, the time will be even longer because of the necessity of sequencing the air scour and wash water.

Sources: Castro et al., 2005; Cleasby and Logsdon, 1999; GLUMRB, 2003; Kawamura, 2000; MWH, 2005; Reynolds and Richardson, 1996.

TABLE 11-10
Design criteria for tri-media filters

Parameter	Reported range	Recommended
Anthracite coal on top		
Effective size	0.9–1.4 mm	
Uniformity coefficient	1.4–1.75	
Shape factor (<i>f</i>)	0.46–0.73	
Porosity	0.53–0.60	
Specific gravity	1.45–1.75	
Depth of medium	0.4–0.5 m	
Sand in middle		
Effective size	0.45–0.55 mm	
Uniformity coefficient	1.4–1.65	
Shape factor (<i>f</i>)	0.7–0.95	
Porosity	0.4–0.47	
Specific gravity	2.65	
Depth of medium	0.15–0.3 m	
Garnet on bottom		
Effective size	0.20–0.35 mm	
Uniformity coefficient	1.2–2.0	
Shape factor (<i>f</i>)	0.6	
Specific gravity	3.6–4.2	
Depth of medium	0.075–0.15 m	
Filtration rate	10–25 m/h	≤15 m/h
Backwash rate	37–45 m/h	
Backwash duration ^a	10–20 min	≥15 min
Surface wash rate		
Revolving arms	1.2–1.8 m/h	
Fixed arms	4.9–10 m/h	
Underdrain		
Pipe lateral	Yes	
Block	Yes	
Air scour	No—if total depth of medium ≤0.75 m	
Air scour	0.6–1.5 m ³ /min · m ² if total medium depth > 1 m	

^aActual off-line time will be ≥30 min because of the time required to drain the filter and gradually come up to the full backwash rate. An additional 30–40 minutes off-line is required for “filter-to-waste” to clear the bed of wash water and dislodged turbidity. If air scour is provided, the time will be even longer because of the necessity of sequencing the air scour and wash water.

Sources: Castro et al., 2005; Cleasby and Logsdon, 1999; Kawamura, 2000; MWH, 2005; Reynolds and Richardson, 1996.

TABLE 11-11
Design criteria for deep-bed monomedium filters

Parameter	Reported range of values	Recommended
Anthracite coal		
Effective size	0.9–1.0 mm	
Uniformity coefficient	1.4–1.7	
Shape factor (<i>f</i>)	0.46–0.73	
Specific gravity	1.45–1.75	
Porosity	0.53–0.60	
Depth of medium	0.9–1.8 m	
Filtration rate	10–25 m/h	≤15 m/h
Backwash rate	37–45 m/h	
Backwash duration ^a	15 min	
Surface wash rate		
Revolving arms	1.2–1.8 m/h	≥1.2 m/h
Fixed arms	4.9–10 m/h	≥4.9 m/h
Underdrain		
Pipe lateral	No	
Block	Yes	
Air scour	Yes	
Air scour	0.6–1.5 m ³ /min · m ²	

^aActual off-line time will be ≥ 30 min because of the time required to drain the filter and gradually come up to the full backwash rate. An additional 30–40 minutes off-line is required for “filter-to-waste” to clear the bed of wash water and dislodged turbidity. If air scour is provided, the time will be even longer because of the necessity of sequencing the air scour and wash water.

Sources: Castro et al. 2005; Cleasby and Logsdon, 1999; Kawamura, 2000; MWH, 2005; Reynolds and Richardson, 1996.

TABLE 11-12
Wash trough design criteria

Parameter	Criterion
Length	≤6m
Interval	Particle travel distance ≤1 m
Height to weir edge	
Sand filter	Expansion + depth of trough + 0.15 to 0.3 m
Anthracite	1.1–1.2 m
Freeboard	5 cm
Installation	Weirs level

Sources: Castro et al., 2005; Cleasby and Logsdon, 1999; GLUMRB, 2003.

TABLE 11-13
Approximate flow velocities for filter channels and piping

Channel or pipe	Velocity, m/s
Influent conduit carrying flocculated water	0.3–0.6
Effluent conduit carrying filtered water	0.9–1.8
Backwash water conduit carrying clean wash water	2.4–3.5
Backwash water conduit carrying used wash water	1.2–2.4
Filter-to-waste connections	3.6–4.6

11-7 OPERATION AND MAINTENANCE

Under steady-state conditions, the operation and maintenance of the filter system is routine. Rapid sand filters following coagulation/flocculation are generally operated with filter run lengths between 12 and 96 hours with typical runs of about 24 hours. Some plants operate with longer cycles. Longer runs may make cleaning difficult because of compaction of the particulate matter (Cleasby and Logsdon, 1999; Castro et al., 2005). Baumann (1978) recommends that at peak solids and flow, run times should be greater than 15 hours and less than 24 hours. In the East Lansing water treatment plant, with softening floc, run times with a 2 NTU influent to the filter are limited to about 60 hours. With a more normal 0.5 NTU influent, filter runs are terminated at 120 hours to allow a 24-hour “float” for operational expediency. There is a general relationship between the influent particulate concentration, the filtration rate, and the filter run. It can be expressed as follows (Reynolds and Richards, 1996):

$$\frac{v_{a1}}{v_{a2}}(\text{run time at } v_{a1}) = \text{run time at } v_{a2}$$

$$\frac{C_{in2}}{C_{in1}}(\text{run time at } C_{in1}) = \text{run time at } C_{in2}$$

where v_{a1}, v_{a2} = filtration rates 1 and 2, m/h

C_{in1}, C_{in2} = influent particulate concentration, NTU

With changing raw water quality, equipment failure, power outages, and maintenance activities, rigorous attention to the filter system and upstream process is required. Three indicators are used in evaluating the performance of the filter: filtered water turbidity, length of the filter run, and the ratio of the volume of backwash water to the volume of filtered water.

After backwash, when steady-state is achieved, the turbidity should always be less than 0.1 NTU. Deviation from this level is an indication of need for adjustment of the coagulation/flocculation/settling system.

Shorter filter runs may imply one or more of several problems. Examples include air binding, accumulation of mud balls, and poorly settling floc.

Increases in the ratio of wash water to filtered water imply difficulty in cleaning the filter. This can result from deterioration (plugging) of the surface wash system or maldistribution of the backwash water.

These and many other issues are addressed in detail in Kawamura (2000) and the American Water Works Association’s *Filter Maintenance and Operations Guidance Manual* (2002).

Hints from the Field

Although the rise of turbidity during ripening of the filter results in only a small fraction of the filter run average turbidity, the potential for breakthrough of a significant dose of pathogens warrants significant operational consideration. This takes the form of diversion of the filtrate, that is, “filter-to-waste,” or, preferably, “filter-to-recycle” to the head end of the plant. The major sources of suspended solids responsible for the rise in turbidity after the filter is put back on line are the backwash water and the material released during interparticle collisions of the media on the closure of the backwash valve (Amirtharajah and Wetstein, 1980). The latter effect can be ameliorated approximately 20 percent by slow closure of the backwash valve (on the order of two minutes). The peak effluent turbidity during ripening may be in the range of three to seven times that of the steady state operation. It may take 30 to 40 minutes of diversion of the filtered water to waste before the steady state effluent turbidity is achieved. Real-time monitoring of turbidity during the filter-to-waste operation provides an efficient means of achieving a safe effluent quality while minimizing the “wasting” of treated water.

Visit the text website at www.mhprofessional.com/wwe for supplementary materials and a gallery of photos.

11-8 CHAPTER REVIEW

When you have completed studying this chapter, you should be able to do the following without the aid of your textbooks or notes:

1. Sketch and label a rapid granular filter identifying the following pertinent features: inlet main, outlet main, wash water outlet, gullet, support media (graded gravel), graded filter medium, and backwash troughs.
2. Define effective size and uniformity coefficient and explain their use in designing a rapid sand filter.
3. Compare the microscopic and macroscopic models of filtration with respect to explaining the mechanisms of filtration and the ability to predict the time to turbidity breakthrough and the time to reach the limiting headloss.
4. From a design point of view, explain the role of filtration rate, grain size distribution, and porosity in controlling headloss through a granular filter.
5. Explain the role of estimating the depth of the expanded bed in designing the rapid granular filter.
6. Compare the advantages and disadvantages in selecting the type of filter, that is, sand, dual media, or deep bed monomedium anthracite.
7. Qualitatively compare the effectiveness of bed expansion and surface wash in backwashing a filter.
8. Explain why it is important to provide for “filter-to-waste” or “filter to recycle” in the filter design.

With the use of this text, you should be able to do the following:

9. Perform a grain size analysis and determine the effective size and uniformity coefficient.
10. Calculate the headloss through a clean stratified filter bed and determine if it is excessive.
11. Calculate the depth of an expanded filter bed during backwash and locate the backwash trough elevation with respect to the top of the filter bed during filtration.
12. Calculate the number and size of filter beds given the maximum day flow rate and the filtration rate.
13. Calculate the equivalent diameter for a filter media having a specific gravity different from sand.
14. Design a backwash system including the layout for the placement of backwash troughs, size of the troughs, trough elevation, and the volume of backwash tank.
15. Determine gullet dimensions (depth and width) given the length, backwash flow rate, and wash water velocity in the effluent pipe.
16. Calculate the maximum headloss that can be achieved without creating a negative pressure in the filter media.

11-9 PROBLEMS

- 11-1. For a flow of $0.8 \text{ m}^3/\text{s}$, how many rapid sand filter boxes of dimensions $10 \text{ m} \times 20 \text{ m}$ are needed for a hydraulic loading rate of $110 \text{ m}^3/\text{d} \cdot \text{m}^2$?
- 11-2. If a dual-media filter with a hydraulic loading rate of $300 \text{ m}^3/\text{d} \cdot \text{m}^2$ were built instead of the standard filter in Problem 11-1, how many filter boxes would be required?
- 11-3. The water flow meter at the Troublesome Creek water plant is malfunctioning. The plant superintendent tells you the four dual media filters (each $5.00 \text{ m} \times 10.0 \text{ m}$) are loaded at a velocity of $280 \text{ m}/\text{d}$. What is the flow rate through the filters in m^3/s ?
- 11-4. A plant expansion is planned for Urbana. The new design flow rate is $1.0 \text{ m}^3/\text{s}$. A deep bed monomedia filter with a design loading rate of $600 \text{ m}^3/\text{d} \cdot \text{m}^2$ of filter is to be used. If each filter box is limited to 50 m^2 of surface area, how many filter boxes will be required? Check the design loading with one filter box out of service. Propose an alternative design if the design loading rate is exceeded with one filter box out of service.
- 11-5. The Orono Sand and Gravel Company has made a bid to supply sand for Eau Gaulie's new sand filter. The request for bids stipulated that the sand have an effective size in the range 0.35 to 0.55 mm and a uniformity coefficient in the range 1.3 to 1.7 . Orono supplied the following sieve analysis as evidence that their sand will meet the specifications. Perform a grain size analysis (semilog plot) and determine whether or not the sand meets the specifications. Use a spreadsheet program you have written to plot the data and fit a curve.

Sand analysis

U.S. Standard Sieve No.	Mass percent retained
8	0.0
12	0.01
16	0.39
20	5.70
30	25.90
40	44.00
50	20.20
70	3.70
100	0.10

- 11-6.** The Lexington Sand and Gravel Company has made a bid to supply sand for Laramie's new sand filter. The request for bids stipulated that the sand have an effective size in the range 0.35 to 0.55 mm and a uniformity coefficient in the range 1.3 to 1.7. Lexington supplied the following sieve analysis (sample size = 500.00 g) as evidence that its sand will meet the specifications. Perform a grain size analysis (log-log plot) and determine whether or not the sand meets the specifications. Use a spreadsheet program you have written to plot the data and fit a curve.

Sand analysis

U.S. Standard Sieve No.	Mass retained, g
12	0.00
16	2.00
20	65.50
30	272.50
40	151.0
50	8.925
70	0.075

- 11-7.** Rework Example 11-1 with the 70, 100, and 140 sieve fractions removed. Assume the original sample contained 100 g.
- 11-8.** The selection of an appropriate clean bed headloss equation is, in part, based on the acceptable upper bound of the Reynolds number that is appropriate for the equation. If the Rose equation (Equation 11-9) is suitable up to R of 6, determine the upper filtration rate for sand and anthracite beyond which it is not recommended. Use a spreadsheet program you have written, plot the Reynolds number versus the filtration rate for the following cases:

a. Sand

$$E = 0.5 \text{ mm}$$

$$v_a = 7.5 \text{ m/h; } 12 \text{ m/h; } 15 \text{ m/h; } 20 \text{ m/h; } 25 \text{ m/h}$$

$$\text{Water temperature} = 15^\circ\text{C}$$

b. Anthracite coal

$$\begin{aligned}
 E &= 1.1 \text{ mm} \\
 v_a &= 7.5 \text{ m/h; } 12 \text{ m/h; } 15 \text{ m/h; } 20 \text{ m/h; } 25 \text{ m/h} \\
 \text{Water temperature} &= 15^\circ\text{C}
 \end{aligned}$$

Use the following equation to calculate the Reynolds number.

$$R = \frac{(\rho)(v_a)(d)}{\mu} = \frac{(v_a)(d)}{\nu}$$

where ρ = density, kg/m^3
 v_a = approach velocity
 d = effective diameter of media (E)
 μ = dynamic viscosity, $\text{Pa} \cdot \text{s}$
 ν = kinematic viscosity, m^2/s

- 11-9.** The Ergun equation for calculating clean bed headloss (Table 11-2) has been proposed for use in cases where larger media and higher filtration rates are used such as deep bed monomedium filters. The first term in the Ergun equation accounts for viscous forces. The second term accounts for inertial forces. Calculate the ratio of the inertial term to the total headloss estimate for various filtration rates using a spreadsheet you have written. Assume the following values:

$$\begin{aligned}
 k_v &= 228 \\
 \varepsilon &= 0.50 \\
 \mu &= 1.14 \times 10^{-3} \text{ Pa} \cdot \text{s} \\
 L &= 1.5 \text{ m} \\
 \rho &= 999 \text{ kg/m}^3 \\
 d &= 1.1 \text{ mm} \\
 g &= 9.81 \text{ m/s}^2 \\
 k_i &= 4.4
 \end{aligned}$$

Identify the filtration rate at which the inertial term accounts for half of the clean bed headloss. See Trussell and Chang (1999) for more on k_v and k_i .

- 11-10.** The rapid sand filter being designed for Eau Gaullie has the characteristics and sieve analysis shown below. Using the Rose equation, determine the headloss for the clean filter bed in a stratified condition.

$$\begin{aligned}
 \text{Depth} &= 0.60 \text{ m} \\
 \text{Filtration rate} &= 120 \text{ m}^3/\text{d} \cdot \text{m}^2 \\
 \text{Sand specific gravity} &= 2.50 \\
 \text{Shape factor} &= 0.80 \\
 \text{Stratified bed porosity} &= 0.42 \\
 \text{Water temperature} &= 19^\circ\text{C}
 \end{aligned}$$

Sand analysis

U.S. Standard Sieve No.	Mass percent retained
8–12	0.01
12–16	0.39
16–20	5.70
20–30	25.90
30–40	44.00
40–50	20.20
50–70	3.70
70–100	0.10

- 11-11.** Determine the height of the expanded bed for the sand used in Problem 11-10 if the backwash rate is 1,000 m/d.
- 11-12.** The rapid sand filter being designed for Laramie has the characteristics shown below. Using the Rose equation, determine the headloss for the clean filter bed in a stratified condition.

Depth = 0.75 m
 Filtration rate = $230 \text{ m}^3/\text{d} \cdot \text{m}^2$
 Sand specific gravity = 2.80
 Shape factor = 0.80
 Stratified bed porosity = 0.50
 Water temperature = 5°C

Sand analysis

U.S. Standard Sieve No.	Mass percent retained
8–12	0.00
12–16	0.40
16–20	13.10
20–30	54.50
30–40	30.20
40–50	1.785
50–70	0.015

- 11-13.** Determine the maximum backwash rate and the height of the expanded bed for the sand used in Problem 11-12.
- 11-14.** As noted in Example 11-2, the headloss was too high. Rework the example without the 100–140 sieve fraction to see how much this would improve the headloss characteristics. Assume that the fraction above sieve size number 8 does not contribute to the headloss and that recalculation of the percentages is not required.

- 11-15.** What effect does removing the 100–140 sieve fraction have on the depth of the expanded bed in Example 11-3?
- 11-16.** Determine the number of filter beds for Eau Gaullie (Problem 11-10) if the maximum day design flow rate is $3,800 \text{ m}^3/\text{d}$.
- 11-17.** Determine the number of filter beds for Laramie (Problem 11-12) if the maximum day design flow rate is $55,000 \text{ m}^3/\text{d}$.
- 11-18.** In the continuing design of Eau Gaullie's rapid sand filter (Problems 11-10, 11-11, and 11-16), determine the area of each filter cell and the plan dimensions of a filter box. Assume a gullet width of 0.5 m.
- 11-19.** In the continuing design of Laramie's rapid sand filter (Problems 11-12, 11-13 and 11-17), determine the area of each filter cell and the plan dimensions of a filter box. Assume a gullet width of 0.8 m.
- 11-20.** Design the backwash system for Eau Gaullie's rapid sand filter. Use the filter dimensions from Problem 11-18. The backwash system includes the layout of the backwash troughs, backwash velocity, flow rate of backwash water per trough, the trough dimension (width and depth), trough elevation, volume of backwash tank, and elevation of the lowest water level in the backwash tank.
- 11-21.** Design the backwash system for Laramie's rapid sand filter. Use the filter dimensions from Problem 11-19. The backwash system includes the layout of the backwash troughs, backwash velocity, flow rate of backwash water per trough, the trough dimension (width and depth), trough elevation, volume of backwash tank, and elevation of the lowest water level in the backwash tank.
- 11-22.** Determine the gullet dimensions for Eau Gaullie's rapid sand filter. Use the filter dimensions from Problem 11-18 and the backwash rate from Problem 11-20. Assume a 250 mm diameter pipe from the gullet is to carry the wash water at a velocity of 0.9 m/s.
- 11-23.** Determine the gullet dimensions for Laramie's rapid sand filter. Use the filter dimensions from Problem 11-19 and the backwash rate from Problem 11-21. Assume a 700 mm diameter pipe from the gullet is to carry the wash water at a velocity of 1.2 m/s.
- 11-24.** Determine the depth of the filter box for Eau Gaullie's sand filter. Use the clean bed headloss from Problem 11-10 and velocity headloss from Problem 11-22. Assume the minimum depth of water above the filter bed is 2.4 m, that the gravel is 0.25 m deep, and that the depth of the underdrain is 0.25 m.
- 11-25.** Determine the depth of the filter box for Laramie's sand filter. Use the clean bed headloss from Problem 11-12 and velocity headloss from Problem 11-23. Assume the minimum depth of water above the filter bed is 2.4 m and that an IMS drain that is 30 cm deep is used.
- 11-26.** Design the structural components* of a rapid sand filter for the village of Waffle. The maximum day flow rate is $8,700 \text{ m}^3/\text{d}$. The design criteria and sand analysis are given

*These do not include the pipe gallery or control system.

below. Assume a 375 mm diameter pipe from the gullet is to carry the wash water at a velocity of 1.2 m/s. Verify that the sand meets the GLUMRB recommendations for E and U . Adjust the grain size distribution if the sand does not meet the specification.

- Depth = 0.50 m
- Filtration rate = $150 \text{ m}^3/\text{d} \cdot \text{m}^2$
- Sand specific gravity = 2.65
- Shape factor = 0.75
- Stratified bed porosity = 0.40
- Water temperature = 10°C
- Trial backwash velocity = 65 m/h
- Trial gullet width = 0.5 m
- Underdrain = 30 cm deep filter block with 1 mm orifice
- Gravel support = 32 cm in 4 layers
- Surface wash = revolving arms at GLUMRB recommended rate

Sand analysis

U.S. Standard Sieve No.	Mass percent retained
10–14	2.0
14–20	16.5
20–25	15.4
25–30	38.2
30–35	15.9
35–40	6.5
40–50	4.4
50–60	1.0

NOTE: geometric mean diameter of successive sieves is $d_g = (d_1d_2)^{0.5}$.

The following is to be provided to complete this portion of the filter design:

- Clean bed headloss
- Backwash velocity
- Depth of expanded bed
- Number of filter beds
- Area of an individual filter bed
- Plan dimensions
- Backwash trough layout
- Maximum backwash water trough flow rate
- Backwash trough dimensions
- Backwash trough weir elevation above undisturbed bed

- Gullet dimensions
- Backwash water volume
- Backwash tank volume
- Maximum allowable filtration headloss
- Depth of filter box
- Backwash tank low water elevation

11-27. Design the structural components of a dual-media rapid filter for the city of Apple Valley. The maximum day flow rate is 45,000 m³/d. The design criteria and media analyses are given below. Assume a 525 mm diameter pipe from the gullet is to carry the wash water at a velocity of 1.5 m/s. Verify that the sand meets the GLUMRB recommendations for *E* and *U*. Adjust the grain size distribution if the sand does not meet the specification. Also verify that largest grain size anthracite coal will have the same approximate settling velocity as the finest sand grain size.

- Filtration rate = 15 m/h
- Water temperature = 12°C
- Backwash = 85 m/h
- Trial gullet width = 0.8 m
- Underdrain = 30 cm deep fine screen
- Gravel support = none required
- Surface wash = revolving arms at GLUMRB recommended rate
- Air scour at GLUMRB recommended rate

Media characteristics

Parameter	Sand	Anthracite coal
Depth	0.30 m	0.50 m
Sand specific gravity	2.65	1.60
Shape factor	0.75	0.75
Stratified bed porosity	0.47	0.60

Media analysis

U.S. Standard Sieve No.	Sand mass percent retained	Anthracite coal mass percent retained
4-7		9.9
7-8		13.0
8-10		28.0
10-12		20.0
12-14		13.3
14-16		8.62

(continued)

Media analysis (continued)

U.S. Standard Sieve No.	Sand mass percent retained	Anthracite coal mass percent retained
16–18		4.22
18–20	10.60	2.96
20–25	41.50	
25–30	31.10	
30–35	9.70	
35–40	4.7	
40–45	2.4	

NOTE: geometric mean diameter of successive sieves is $d_g = (d_1 d_2)^{0.5}$.

The following is to be provided to complete this portion of the filter design:

- Clean bed headloss
- Backwash velocity
- Depth of expanded bed
- Number of filter beds
- Area of an individual filter bed
- Plan dimensions
- Backwash trough layout
- Maximum backwash water trough flow rate
- Backwash trough dimensions
- Backwash trough weir elevation above undisturbed bed
- Gullet dimensions
- Backwash water volume
- Backwash tank volume
- Maximum allowable filtration headloss
- Depth of filter box
- Backwash tank low water elevation

11-10 DISCUSSION QUESTIONS

- 11-1. Identify two design parameters that may be adjusted if the clean bed headloss in a granular filter is too large.
- 11-2. Which of the following granular filtration systems should be chosen if the quality of raw water is highly variable: (a) dual media, (b) monomedia?

- 11-3. Explain what air binding is, and describe the design method for avoiding it.
- 11-4. Explain the purpose of “filter-to-waste.”

11-11 REFERENCES

- Amirtharajah, A. (1978) “Design of Granular-Media Filter Units,” in R. L. Sanks (ed.), *Water Treatment Plant Design for the Practicing Engineer*, Ann Arbor Science, Ann Arbor, Michigan, pp. 675–737.
- Amirtharajah, A. and D. P. Wetstein (1980) “Initial Degradation of Effluent Quality During Filtration,” *Journal American Water Works Association*, vol. 72, no. 9, pp. 518–524.
- Amirtharajah, A. (1988) “Some Theoretical and Conceptual Views of Filtration,” *Journal American Water Works Association*, vol. 80, no. 12, pp. 36–46.
- AWWA (1996) ANSI/AWWA Standard No. B604-96, *Standard for Granular Activated Carbon*, American Water Works Association, Denver, Colorado.
- AWWA (2001) ANSI/AWWA Standard No. B100-01, *Standard for Filtering Material*, American Water Works Association, Denver, Colorado.
- AWWA (2002) *Filter Maintenance and Operations Guidance Manual*, AWWA and AWWA Research Foundation, Denver, Colorado.
- Baumann, E. R. (1978) in R. L. Sanks, ed., *Water Treatment Plant Design for the Practicing Engineer*, Ann Arbor Science, Ann Arbor, Michigan, pp. 231–281.
- Camp, T. R. (1970) “Water Treatment,” in V. Davis (ed.) *Handbook of Applied Hydraulics*, 3rd ed., McGraw-Hill, New York, p. 38–52.
- Carmen, P. C. (1937) “Fluid Flow through Granular Beds,” *Transactions of Institute of Chemical Engineers*, London, vol. 15, p. 150.
- Castro, K., G. Logsdon, and S. R. Martin (2005) “High-Rate Granular Media Filtration,” in E. E. Baruth (ed.), *Water Treatment Plant Design*, American Water Works Association and American Society of Civil Engineers, McGraw-Hill, New York, p. 8.1–8.41.
- Cleasby, J. L. (1972) “Filtration,” in W. J. Weber, Jr., (ed.) *Physicochemical Processes for Water Quality Control*, Wiley-Interscience, New York, pp. 173–174.
- Cleasby, J. L. and G. S. Logsdon (1999) “Granular Bed and Precoat Filtration, in R. D. Letterman (ed.) *Water Quality and Treatment*, 5th ed., American Water Works Association, McGraw-Hill, New York, pp. 8.1–8.99.
- Cornwell, D. A. and R. G. Lee (1994) “Waste Stream Recycling: Its Effect on Water Quality,” *Journal of the American Water Works Association*, November, p. 50.
- Cornwell, D. A. et al. (2001) *Treatment Options for Giardia, Cryptosporidium and Other Contaminants in Recycled Backwash Water*, American Water Works Association Research Foundation, Denver, Colorado.
- Dharmarajah, A. H., and J. L. Cleasby (1986) “Predicting the Expansion Behavior of Filter Media,” *Journal of the American Water Works Association*, December, pp. 66–76.
- Ergun, S. (1952) “Fluid Flow Through Packed Columns,” *Chemical Engineering Progress*, vol. 48, no. 2, p. 89.
- Fair, G. M. and J. C. Geyer (1954) *Water Supply and Waste-Water Disposal*, John Wiley & Sons, New York, p. 678.
- Fair, G. M. and L. P. Hatch (1933) “Fundamental Factors Governing the streamline Flow of Water Through Sand,” *Journal of American Water Works Association*, vol. 25, no. 11, p. 1551.
- Ferry, J. D. (1936) “Statistical Evaluation of Sieve Constants in Ultrafiltration,” *Journal of General Physiology*, vol. 20, pp. 95–104.
- GLUMRB (2003) *Recommended Standards for Water Works*, Great Lakes–Upper Mississippi River Board of State and Provincial Public Health and Environmental Managers, Health Education Services, Albany, New York, p. 40–54.

- Hazen, A. (1892) *Annual Report of the Massachusetts State Board of Health*, Boston.
- Hibler, C. P., C. M. Hancock, L. M. Perger, J. G. Wegrzyn, and K. D. Swabby (1987) *Inactivation of Giardia Cysts with Chlorine at 0.5°C to 5°C*, American Water Works Association Research Foundation, Denver, Colorado.
- Hudson, H. E. (1981) *Water Clarification Processes Practical Design and Evaluation*, Von Nostrand Reinhold, New York, 1981, pp. 180–182, 233–234.
- Kawamura, S. (2000) *Integrated Design and Operation of Water Treatment Facilities*, 2nd ed., John Wiley & Sons, New York, pp. 194–292.
- Kramer, M. H., B. L. Herwaldt, G. F. Craun, R. L. Calderon, and D. D. Juraneck (1996) “Waterborne Diseases 1993 and 1994,” *Journal of American Water Works Association*, vol. 88, no. 3, pp. 66–80.
- LeGouellec, Y. A., D. A. Cornwell, and M. J. MacPhee (2004) “Treating Microfiltration Backwash,” *Journal of American Water Works Association*, vol. 96, no. 1, pp. 72–83.
- Logan, B. E. et al. (1995) “Clarification of Clean-Bed filtration Models,” *Journal Environmental Engineering*, vol. 121, no. 12, pp. 869–873.
- Monk, R. D. G. (1984) “Improved Methods of Designing Filter Boxes,” *Journal of American Water Works Association*, vol. 76, no. 8, pp. 54–59.
- Monk, R. D. G. (1987) “Design Options for Water Filtration,” *Journal of American Water Works Association*, vol. 79, no. 9, pp. 93–106.
- MWH (2005) *Water Treatment: Principles and Design*, John Wiley & Sons, Hoboken, New Jersey, pp. 882, 892–894.
- Rajagopalan, R. and C. Tien (1976) “Trajectory Analysis of Deep-Bed Filtration with Sphere-in-Cell Porous Media Model,” *American Institute of Chemical Engineering Journal*, vol. 22, no. 3, pp. 860–868.
- Reynolds, T. D. and P. A. Richards (1996) *Unit Operations and Processes in Environmental Engineering*, PWS, Boston, pp. 287–288, 320.
- Richardson, J. F., and W. N. Zaki (1954) “Sedimentation and Fluidization, Part I,” *Transactions of the Institute of Chemical Engineers (Brit.)*, vol. 32, pp. 35–53.
- Robeck, G. G., K. A. Dostal, and R. L. Woodward (1964) “Studies of Modification in Water Filtration,” *Journal American Water Works Association*, vol. 56, no. 2, p. 198.
- Rose, H. E. (1945) “On the Resistance Coefficient–Reynolds Number Relationship of Fluid Flow through a Bed of Granular Material,” *Proceedings of the Institute of Mechanical Engineers*, vol. 153, p. 493.
- Trussell, R. R. and M. Chang (1999) “Review of Flow Through Porous Media as Applied to Headloss in Water Filters,” *Journal of Environmental Engineering*, vol. 125, pp. 998–1,006.
- Yao, K. M., M. T. Habibian and C.R. O’Melia (1971) “Water and Waste Water Filtration: Concepts and Applications,” *Environmental Science and Technology*, vol. 5, no. 11, pp 1,105–1,112.

CHAPTER

12

MEMBRANE FILTRATION

12-1 INTRODUCTION

12-2 MEMBRANE FILTRATION THEORY

**12-3 PROPERTIES OF MF AND UF
MEMBRANES**

12-4 MF AND UF PRACTICE

12-5 CHAPTER REVIEW

12-6 PROBLEMS

12-7 DISCUSSION QUESTIONS

12-8 REFERENCES

12-1 INTRODUCTION

The membrane used in membrane filtration is a synthetic material that is *semipermeable*; that is, it is highly permeable to some constituents and less permeable to others. To remove a constituent from the water, the water is pumped against the surface of a membrane, resulting in a separation of product and waste streams as shown in Figure 12-1.

Membranes can be described by a variety of criteria including (Jacangelo et al., 1997):

- Membrane pore size,
- *Molecular weight cutoff* (MWCO),
- Membrane material and geometry,
- Targeted materials to be removed,
- Type of water quality to be treated, and/or
- Treated water quality.

Along with these criteria, membrane processes can also be categorized broadly into pressure driven and electrically driven processes. This discussion is limited to pressure driven membrane processes. Figure 12-2 summarizes the various pressure driven membrane processes and selected materials removed by each. As used in water treatment, membranes are classified into two broad categories: (1) those that are used to separate ions from solution, that is, *reverse osmosis* (RO) and *nanofiltration* (NF) and (2) those that are used to separate suspended particles from water, that is, *microfiltration* (MF) and *ultrafiltration* (UF). RO and NF were presented in detail in Chapter 9. This chapter focuses on MF and UF.

A brief description of MF and UF provides a delineation of their differences.

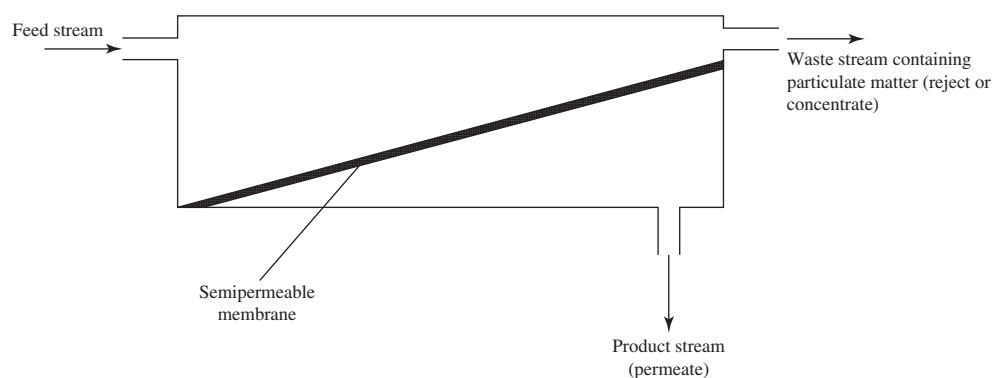

FIGURE 12-1
Schematic of separation process through semipermeable membrane.

Operating pressures (kPa)	700	200	70	35			
Size (micrometers)	0.001	0.01	0.1	1.0	10	100	1,000
Separation processes	Reverse osmosis	Nano-filtration	Ultrafiltration	Microfiltration	Conventional filtration processes		

FIGURE 12-2
Schematic comparison of selected separation processes.

- *Ultrafiltration (UF)*. UF membranes cover a wide range of MWCOs and pore sizes. Operational pressures range from 70 to 700 kPa, depending on the application. “Tight” UF membranes (MWCO = 1,000 daltons*) may be employed for removal of some organic materials from freshwater, while the objective of “loose” membranes (MWCO > 50,000 daltons, 70 to 200 kPa) is primarily for liquid/solid separation, that is, particle and microbial removal.
- *Microfiltration (MF)*. A major difference between MF and loose UF is membrane pore size; the pores of MF (= 0.1 μm or greater) are approximately an order of magnitude greater than those of UF. The primary application for this membrane process is particulate and microbial removal.

12-2 MEMBRANE FILTRATION THEORY

Mechanisms of Filtration

As shown in Figure 12-3a, some particles are removed by simple mechanical *screening* because the particle is larger than the smallest opening through which the water flows. This is the dominant mechanism for membrane filters. Additional mechanisms that remove particles are *adsorption* and *cake formation*.

Natural organic matter (NOM) adsorbs onto membrane surfaces as shown in Figure 12-3b (Jucker and Clark, 1994). In the early stages of filtration with a clean membrane this may be an important mechanism for removing soluble and insoluble materials that have dimensions that are much smaller than the membrane pore size. Although the adsorption capacity is quickly exhausted, the adsorbed material can reduce the size of the pores and, thus, increase the ability of the membrane to capture particles smaller than the nominal pore size.

*A dalton (Da) is a unit of mass equal to 1/16 the mass of the lightest and most abundant isotope of oxygen. Typical solutes used for the determination of MWCO are sodium chloride, magnesium sulfate, and dextrose.

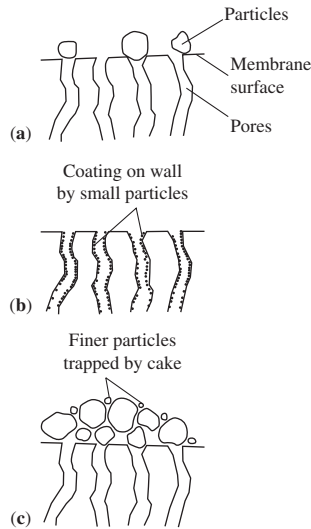

FIGURE 12-3
Mechanisms of membrane filtration: (a) Straining, (b) adsorption, (c) cake filtration.

Particles that are removed by straining build up a cake on the membrane surface (Figure 12-3c). The cake acts as a filtration medium. It improves the efficiency of the filter because it collects particles smaller than the nominal pore size of the membrane.

Models of Membrane Filtration

The basic models for describing membrane performance are based on the concept of *rejection*. The fraction of material removed from the permeate stream is described in the form of a simple efficiency equation:

$$R = 1 - \left(\frac{C_{\text{permeate}}}{C_{\text{feed}}} \right) \quad (12-1)$$

where R = rejection, dimensionless
 C_{permeate} = permeate concentration, mg/L or particles/L
 C_{feed} = feed water concentration, mg/L or particles/L

This equation may also be expressed in a logarithmic form (“log-removal”):

$$\text{LR} = \log \left(\frac{C_{\text{feed}}}{C_{\text{permeate}}} \right) \quad (12-2)$$

or as percent removal

$$\% \text{ removal} = 100 - \left(\frac{100}{10^{\text{LR}}} \right) \quad (12-3)$$

Ferry (1936) developed a model for straining based on the hypothesis that particles following a streamline near the edge of a pore opening impact the membrane surface and are captured, and those particles in the streamline near the center of the pore escape. Ferry's model is analogous to Yao's model (Yao et al., 1971). Based on a statistical analysis of this model, rejection is a function of the particle size (MWH, 2005):

$$R = 1 - 2 \left(1 - \frac{d_{\text{part}}}{d_{\text{pore}}} \right)^2 + \left(1 - \frac{d_{\text{part}}}{d_{\text{pore}}} \right)^4 \quad (12-4)$$

where d_{part} = particle diameter, m
 d_{pore} = effective pore diameter, m

Mathematical modeling of cake filtration results in equations similar to that for granular filtration such as those of Carmen (1937) and Rose (1945).

Theory of Membrane Filter Hydraulics

Flux. Pure water transport across a clean porous membrane is directly proportional to the *transmembrane pressure* (TMP) and inversely proportional to the dynamic viscosity. The volumetric flux ($\text{m}^3/\text{h} \cdot \text{m}^2$ of membrane surface area) is modeled using a modified form of Darcy's law (AWWA, 2005):

$$J = \frac{Q}{A} = \frac{\Delta P}{(\mu)(R_m)} \quad (12-5)$$

where J = volumetric water flux through membrane, $\text{m}^3/\text{h} \cdot \text{m}^2$ or m/h
 Q = volumetric flow rate of pure water, m^3/h
 A = surface area of clean membrane, m^2
 ΔP = transmembrane pressure, kPa
 μ = dynamic viscosity of water, $\text{Pa} \cdot \text{s}$
 R_m = membrane resistance coefficient, m^{-1}

This form differs from Darcy's law in that the absolute value of the pressure differential is used rather than the pressure gradient.

The volumetric flow rate of water across a single pore can be modeled using Poiseuille's law:

$$Q_{\text{pore}} = \frac{\pi r^4}{8(\mu)} \frac{\Delta P}{\Delta z} \quad (12-6)$$

where Q_{pore} = volumetric flow rate of pure water across a single pore, m^3/h
 r = radius of pore, m
 ΔP = transmembrane pressure, kPa
 μ = dynamic viscosity of water, $\text{Pa} \cdot \text{s}$
 Δz = pore length, m

Because pores in commercial water treatment membranes are not perfectly cylindrical, a dimensionless tortuosity factor is added to Equation 12-6. To represent the total flow rate,

Equation 12-6 is multiplied by the surface area and pore density per unit area (AWWA, 2005):

$$Q = A \rho_{\text{pore}} = \frac{\pi r^4}{8(\mu)\tau} \frac{\Delta P}{\Delta z} \quad (12-7)$$

where ρ_{pore} = pore density per unit area, number/m²
 τ = tortuosity factor, dimensionless

By analogy, the membrane resistance coefficient (R_m) can be expressed as

$$R_m = \frac{8(\mu)\tau\Delta z}{\pi r^4 \rho_{\text{pore}}} \quad (12-8)$$

This equation provides some insight into the factors that influence the design of a membrane filter. The flow rate is directly proportional to the pore density and inversely proportional to water viscosity, tortuosity, and thickness of the membrane. The most important factor affecting flow rate is the pore size because flow rate is directly proportional to the 4th power of pore radius. Therefore, small increases in pore radius can result in large increases in filtered water flow. Perhaps more importantly, because commercial membranes employed in water treatment have a distribution of pore sizes, the larger pores will transport a disproportionate quantity of water and particles.

Membrane Fouling. Fouling of MF/UF membranes may be defined as the gradual reduction in filtrate water flow rate at constant pressure, or an increase in transmembrane pressure to maintain a constant flux. Fouling may be caused by particulate matter, dissolved organic matter, or biological growth. It may be *reversible* or *irreversible*. The fouling is termed irreversible if the loss in flux cannot be recovered by backwashing and cleaning operations (Jacangelo and Buckley, 1996). These are illustrated in Figure 12-4. There are a number of models that have been developed in an attempt to describe the decline in permeate flux.

The first class of models is called *resistance-in-series*. These models apply a resistance value to each of three components thought to contribute to membrane fouling. It is assumed that each component contributes to hydraulic resistance and that they act independently from one another. The following two equations are typical of the form of the models:

$$J = \frac{\Delta P}{\mu(R_m + R_{ir} + R_r)} \quad (12-9)$$

$$J = \frac{\Delta P}{\mu(R_m + R_c + R_d)} \quad (12-10)$$

where J = volumetric water flux through membrane, m³/h · m² or m/h
 ΔP = transmembrane pressure, kPa
 μ = dynamic viscosity of water, Pa · s
 R_m = membrane resistance coefficient, m⁻¹
 R_{ir} = irreversible membrane resistance coefficient, m⁻¹

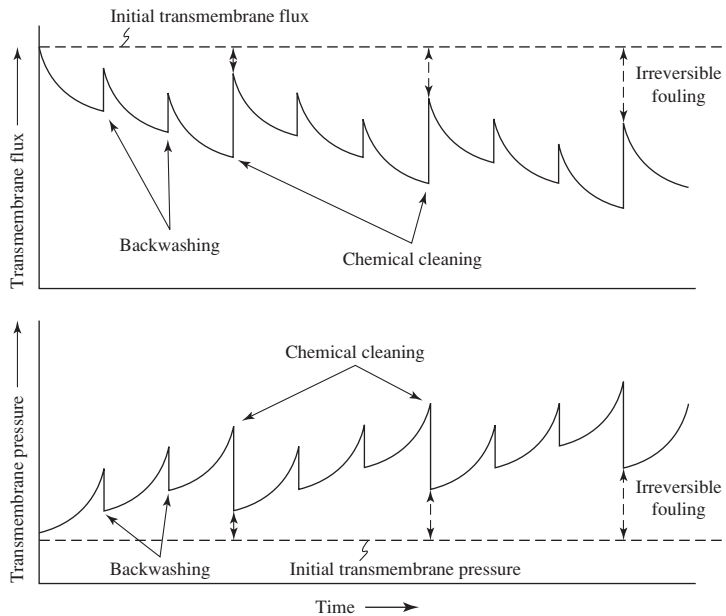
**FIGURE 12-4**

Schematic of partial restorations of transmembrane flux and pressure by chemical cleaning of MF membranes. The abscissa scale is compressed and the ordinate scale is expanded for illustration of the deterioration in performance.

$$R_r = \text{reversible membrane resistance coefficient, m}^{-1}$$

$$R_c = \text{cake layer membrane resistance coefficient, m}^{-1}$$

$$R_a = \text{adsorptive fouling membrane resistance coefficient, m}^{-1}$$

The second class of models is descriptive of the change in flux as a function of time. That is, they are equations developed to fit experimental data. In form, they represent the fact that flux declines toward a steady-state value. They are summarized in Table 12-1.

The third class of models is mechanistic. That is, they attempt to describe pore adsorption, pore blocking, or cake formation as function of time. Collectively they have been termed the *blocking laws*. They are summarized in Table 12-2.

12-3 PROPERTIES OF MF AND UF MEMBRANES

Membrane Material

The most common MF and UF membrane materials are organic polymers. The characteristics of the polymers are summarized in Table 12-3 on page 12-9.

Most synthetic membranes are hydrophobic. They must be stored wet or be filled with a wetting agent. If allowed to dry, they will experience a change in structure that will result in a reduction in potential flux.

Polysulfone membranes are one of the most widely used because of their high tolerance to pH and resistance to oxidants. They can withstand temperatures up to about 75°C. In addition,

TABLE 12-1
General forms of time-dependent membrane flux equations

Flux equation	Linearized form	Comments
(a) $J_t = J_0 e^{-kt}$	$\ln\left(\frac{J_t}{J_0}\right) = -kt$	Flux declines exponentially as foulants accumulate. Flux assumed to drop to zero at infinite time, which may not occur in practice.
(b) $J_t = J_{ss} + (J_0 - J_{ss})e^{-kt}$	$\ln\left(\frac{J_t - J_{ss}}{J_0 - J_{ss}}\right) = -kt$	Similar to Eq. (a), except flux drops to a steady-state flux J_{ss} at $t =$ infinite time.
(c) $J_t = J_0 (kt)^{-n}$	$\ln\left(\frac{J_t}{J_0}\right) = -n \ln(kt)$	Cannot be used for initial stages of filtration because infinite flux is predicted at time $t = 0$. Sometimes expressed as a function of the volume of permeate ($kt = V$) instead of as a function of time.
(d) $J_t = \frac{J_0}{(1 + kt)^n}$	$\ln\left(\frac{J_t}{J_0}\right) = -n \ln(1 + kt)$	The series resistance model can be written in this form with $n = 1$.

Source: Adapted from MWH, 2005.

TABLE 12-2
Blocking filtration laws

Flux equation	Major features and assumptions
Pore sealing (complete blocking filtration law) $J_t = J_0 e^{-(1.5CJ_0t/\rho_p d_p)}$ c = concentration of particles	<ul style="list-style-type: none"> Models blockage of the entrance to pores by particles retained at the membrane surface. Each retained particle blocks an area of the membrane surface equal to the particles cross-sectional area. Flux declines in proportion to the membrane area that has been covered. No superposition of particles occurs. Each particle lands on the membrane surface and not on other particles, so flux reaches zero when a monolayer of particles has been retained.
Internal pore constriction (standard blocking filtration law) $J_t = \frac{J_0}{(1 + CJ_0t/L\rho_p)^2}$ L = membrane thickness, m	<ul style="list-style-type: none"> Models the reduction of the void volume within the membrane. Assumes the membrane is composed of cylindrical pores of constant and uniform diameter. Particles deposit uniformly on the pore walls; pore volume decreases proportionally to the volume of particles deposited.

(continued)

Pore sealing with superposition (intermediate blocking filtration law)

$$J_t = \frac{J_0}{(1 + 1.5CJ_0t/\rho_P d_P)}$$

Cake filtration law

$$J_t = \frac{J_0}{(1 + 2\alpha_c C J_0 t / R_m)^{0.5}}$$

α_c = specific cake resistance

- Models blockage of the entrance to pores by particles retained at the membrane surface.
- Extension of the complete blocking filtration law.
- Relaxes the “monolayer” assumption in the complete blocking filtration law by allowing particles to land on previously retained particles or on the membrane surface by evaluating the probability that a particle will block a pore.
- Models the formation of a cake on the surface of a membrane using the resistance series model.
- The retained particles have no impact on the membrane itself, that is, no pore blocking or pore constriction.

Source: Adapted from MWH, 2005.

TABLE 12-3
Characteristics of selected membrane materials

Membrane material	Type	Hydrophobicity	Oxidant tolerance	pH range	Fouling resistance/cleanability
PVDF	MF/UF	Modified hydrophilic	Very high	2–11	Excellent
PP	MF	Slight hydrophobic	Low	2–13	Acceptable
Polyethersulfone (PES)	UF	Very hydrophilic	High	2–13	Very good
Polysulfone (PS)	UF	Modified hydrophilic	Moderate	2–13	Good
Cellulose acetate (CA)	UF	Naturally hydrophilic	Moderate	5–8	Good

(Source: AWWA, 2005.)

to polysulfone (PS), polyethersulfone (PES) and polyvinylidene difluoride (PVDF) are also in common use (AWWA, 2005).

Membrane Configuration

Hollow fiber membranes (Figure 12-5) are the most common configuration for MF and UF filtration applications (U.S. EPA, 2005). The fibers have an outside diameter ranging from 0.5 to 2 mm, and a wall thickness ranging from 0.07 to 0.6 mm. Unlike NF and RO membranes, the membrane filters operate over a repeating filtration cycle like granular filters. After filtration for a set duration, the accumulated solids are removed by backwashing with air and/or water. Once clean, the filter is put back into service.

All of the hollow fiber membranes fall into one of two categories: positive pressure driven and negative pressure (vacuum) driven. The positive pressure systems are configured in pressure vessels. The vacuum systems are submerged in basins containing the feed water.



FIGURE 12-5
Hollow fiber membranes

The hollow fiber membranes may be configured in one of four modes: (1) outside-in, (2) outside-in (cross-flow), (3) inside-out (dead-end), or (4) inside-out (cross-flow). For the outside-in system the flow pattern is against the outside of fiber and the permeate is in the *lumen* or inside the fiber. The inside-out arrangement may be either in the *dead-end* mode or the *cross-flow* mode. The advantages and disadvantages of each mode are summarized in Table 12-4. Positive pressure systems use either outside-in or inside-out modes. Vacuum systems use only the outside-in mode.

Temperature and Pressure Effects

Flux is inversely proportional to the viscosity. Viscosity changes due to changes in water temperature are an important design consideration in the treatment of surface water where the water temperature may range from 1°C to 20°C over the course of a year. The influence of viscosity may be estimated using tables such those found in Appendix A, or the following second-order polynomial that is valid over the temperature range 0°C to 35°C (AWWA, 2005):

$$\mu = 1.777 - 0.052T + 6.25 \times 10^{-4}(T)^2 \quad (12-11)$$

where μ = dynamic viscosity of water, mPa · s
 T = temperature, °C

Example 12-1 illustrates the effect of temperature change on permeate flux.

TABLE 12-4
Comparison of hollow-fiber membrane configurations

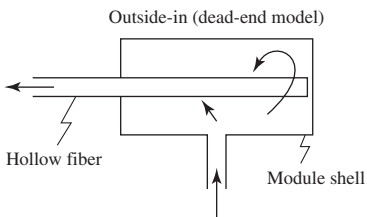
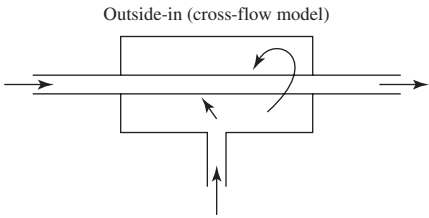
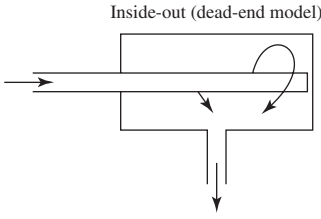
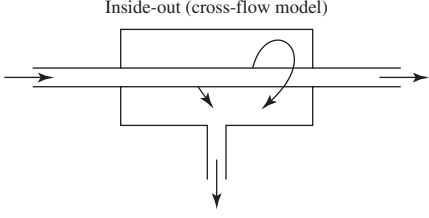
Configuration	Advantages	Disadvantages
 <p>Outside-in (dead-end model)</p>	<ul style="list-style-type: none"> • Can treat more water at same flux because outside of fiber has more surface area. • Less sensitive to presence of large solids in the feed water. 	
 <p>Outside-in (cross-flow model)</p>		
 <p>Inside-out (dead-end model)</p>	<ul style="list-style-type: none"> • Less expensive to operate than inside-out in cross-flow mode. 	<ul style="list-style-type: none"> • Large solids in feed water can clog lumen. • Can treat less water at same flux because inside of fiber has less surface area.
 <p>Inside-out (cross-flow model)</p>	<ul style="list-style-type: none"> • Can be operated at higher flux with high-turbidity feed water because cross-flow velocity flushes away solids and reduces impact of particles forming cake at membrane surface. 	<ul style="list-style-type: none"> • Large solids in feed water can clog lumen. • Can treat less water at same flux because inside of fiber has less surface area. • Pumping costs associated with recirculating feed water through lumen can be expensive.

Example 12-1. Estimate the percent change in permeate flux that will result from a temperature change from 15°C to 20°C if the TMP remains constant.

Solution:

a. Calculate the viscosity at 15°C and 20°C.

$$\mu = 1.777 - 0.052(15) + 6.25 \times 10^{-4}(15)^2 = 1.14 \text{ mPa} \cdot \text{s}$$

$$\mu = 1.777 - 0.052(20) + 6.25 \times 10^{-4}(20)^2 = 0.987 \text{ mPa} \cdot \text{s}$$

- b. Using Equation 12-5, determine the change in flux as a function of viscosity.

$$J_{15} = \frac{\Delta P}{(\mu_{15})(R_m)}$$

$$J_{20} = \frac{\Delta P}{(\mu_{20})(R_m)}$$

$$\frac{J_{20}}{J_{15}} = \left(\frac{(\mu_{15})(R_m)}{\Delta P} \right) \left(\frac{\Delta P}{(\mu_{20})(R_m)} \right)$$

$$J_{20} = J_{15} \frac{(\mu_{15})}{(\mu_{20})} = (J_{15}) \frac{1.14 \text{ mPa} \cdot \text{s}}{0.987 \text{ mPa} \cdot \text{s}} = 1.155 (J_{15})$$

- c. Calculate the percent change.

$$\% \text{ Change} = (1.155 - 1.000) 100\% = 15.5\% \text{ increase in flux}$$

In addition to the change in viscosity, temperature may also have an effect on the membrane material, such as swelling at higher temperature.

In certain instances, the resistance (R_m) of the polymeric membranes has been observed to increase with increasing transmembrane pressure (Chellam and Jacangelo, 1998). It has been hypothesized that this effect is a result of compaction of the membrane.

To account for different operating pressures when evaluating membrane alternatives, the *specific flux* is calculated. It is the flux at a standard temperature, normally 20°C, divided by the transmembrane pressure:

$$J_{\text{sp}} = \frac{J_{\text{st}}}{\Delta P} \quad (12-12)$$

where J_{sp} = specific flux, $\text{m}^3/\text{h} \cdot \text{m}^2 \cdot \text{kPa}$

J_{st} = flux at standard temperature, $\text{m}^3/\text{h} \cdot \text{m}^2$

The specific flux is called the *membrane permeability* when clean, reagent-quality water is being filtered through a new, unused membrane.

Service Life

Over time backwash cleaning is not sufficient, and more rigorous cleaning is required. This is achieved by chemical cleaning (Figure 12-4). Over long periods of time (5 to 10 years), the membranes degrade and they must be replaced (MWH, 2005).

12-4 MF AND UF PRACTICE

Process Description

The pressure vessel system consists of an array of pressure vessels (modules) on a rack (Figure 12-6). All the modules on a rack are operated in parallel. The racks are also operated in parallel. The modules are generally 100 to 300 mm in diameter and 1 to 6 m long. The racks may contain between 2 and 300 modules. One module typically contains between 8 and 70 m² of filter area.

The vacuum systems are open to the atmosphere (Figure 12-7). Multiple basins are employed to allow for flexible operation as demand varies, as well as placing units out of service for maintenance.

A schematic of a typical positive pressure MF or UF facility is shown in Figure 12-8.

Pretreatment

If the raw water turbidity and/or NOM concentration is high, pretreatment will include coagulation, flocculation, and sedimentation. Experience with coagulation is mixed with some researchers reporting improved performance (increased water production and higher flux, not better



FIGURE 12-6

A 9,500 m³/d pressure installation at Holliday Water Company, Utah.

(Source: AWWA, 2005.) Reprinted from M53: *Microfiltration and Ultrafiltration and Membranes for Drinking Water*, by permission. Copyright © 2005, Amerocam Water Works Association.

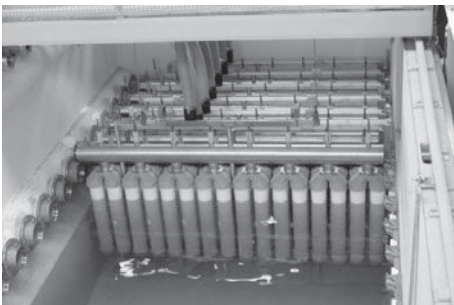

FIGURE 12-7

Submerged vacuum MF.

(Source: AWWA, 2005.) Reprinted from M53: *Microfiltration and Ultrafiltration and Membranes for Drinking Water*, by permission. Copyright © 2005, Amerocam Water Works Association.

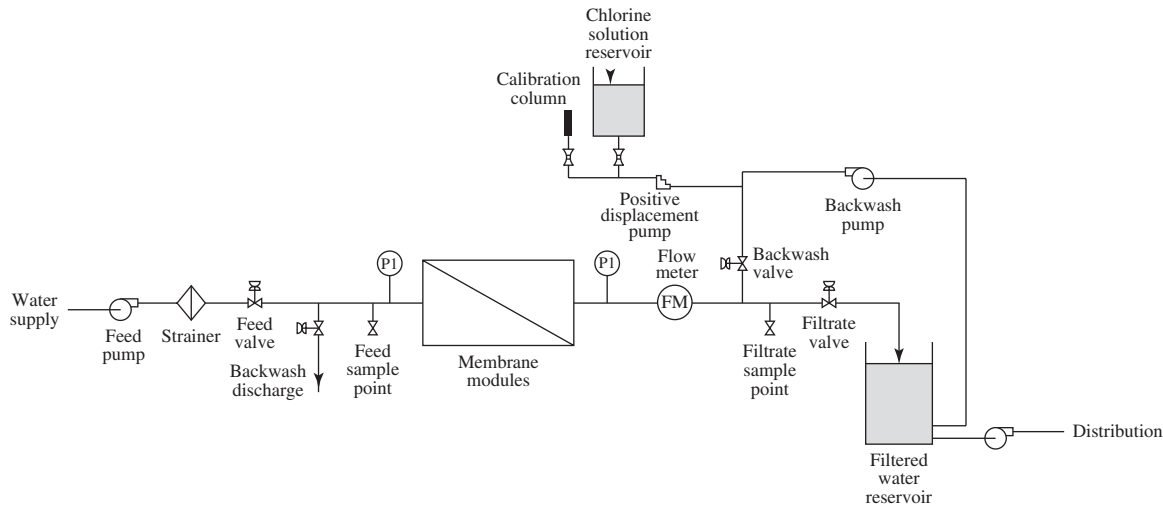

FIGURE 12-8

Schematic of typical pressure MF/UF facility.

(Source: U.S. EPA *Membrane Guidance Manual*, 2005.)

particle removal efficiency) and others reporting increased fouling. It appears that if the design of the coagulation system (including sedimentation) is to remove a significant fraction of the NOM (15 to 50 percent), MF membrane performance will be improved, but little improvement may be expected for UF membranes (Howe and Clark, 2006). The effect of coagulation is site specific due to the interactions between the coagulants, raw water components, and the membrane materials. In some cases, low doses may cause greater fouling than no coagulation, but higher coagulant doses for enhanced coagulation (for example, 25 to 50 mg/L of alum) frequently reduce fouling. In any event, performing pilot plant studies over a period of time to examine a variety of raw water conditions is recommended (Bergman, 2005; MWH, 2005).

Where iron and manganese are prevalent in the raw water, oxidation may be performed to form a precipitate that can be removed before the membrane treatment step. The common oxidants are chlorine, chlorine dioxide, ozone, and potassium permanganate. The use of oxidants requires careful selection of the membrane material, as well as precautions to remove excess residual oxidant before the membrane treatment step.

The minimum pretreatment requirements are established by the membrane manufacturer. In general, they will include strainers or bag filters rated in the 50 to 500 μm size range to protect the membrane from excessive solids loading (AWWA, 2005; Bergman, 2005).

Concentrate Stream

The primary concern in disposing the concentrate stream is suspended solids. Disposal methods include land application, discharge to the municipal sewer system, ocean discharge, and deep well injection. Disposal of the concentrate is a major issue in the selection of this technology and should be addressed early in the design process.

Process Design

Membrane Process Selection. The following factors should be considered in selecting the membrane and membrane process (Bergman, 2005):

- Source water.
- Pretreatment requirements.
- Product water quality requirements.
- Product water quantity requirements.
- Residuals disposal.
- Capital and operating cost.

UF membranes are favored over MF membranes if virus or dissolved organic compound removal without raw water pretreatment is a product water quality goal.

Because, at the time of this writing (2009), the use of MF and UF systems is relatively new to the municipal water treatment industry, consultation with manufacturers and pilot testing is highly recommended. This is particularly true because of the proprietary nature of the equipment. Facility design is frequently preceded by “preselection” of the equipment supplier because the facility is built around the special requirements of the proprietary design.

Operating Pressures. Transmembrane pressure is between 20 and 200 kPa for pressure systems and from -7 to -80 kPa for vacuum systems. The applied pressure ranges from 70 to 200 kPa. To minimize fouling the transmembrane pressure should be limited to 100 kPa (AWWA, 2005; Bergman, 2005; MWH, 2005).

For the direct filtration mode, the transmembrane pressure may be calculated as (AWWA, 2005):

$$\Delta P = P_i - P_p \quad (12-13)$$

where ΔP = transmembrane pressure, kPa

P_i = pressure at inlet to module, kPa

P_p = permeate pressure, kPa

When the system is operated in the cross-flow mode, the average transmembrane pressure is (AWWA, 2005):

$$\Delta P = \frac{P_i + P_o}{2} - P_p \quad (12-14)$$

where P_o = pressure at outlet of the module, kPa.

There is an accompanying pressure drop across the module (AWWA, 2005):

$$\Delta P_{\text{module}} = P_i - P_o \quad (12-15)$$

where ΔP_{module} = pressure drop across the module, kPa.

Membrane Element Design. Equations 12-5 and 12-11 are used to design the membrane module, rack, and total membrane system. Flux rates range from 0.034 to 0.170 m³/h · m² (m/h). In a fashion similar to granular filters, some excess capacity is provided to account for racks being off-line for backwashing and/or maintenance. The flux for MF/UF units treating backwash water may be as low as one-fourth of that for MF/UF units treating source water (Pressdee et al., 2006).

Although preliminary screening estimates of flux and membrane area can be made based on literature values, for any realistic design, results from pilot testing are required.

Backwashing. The backwash cleaning cycle is automatically controlled. All modules in a rack are washed simultaneously. Backwashing occurs at some preset interval ranging from 30 to 90 minutes and it lasts 1 to 5 minutes. The off-line time for a rack may be longer than 5 minutes because of the time inherent in valve sequencing for shut down and start up.

MF systems may be backwashed with either air or permeate water. UF systems are backwashed with permeate water. Because, in general, one rack at a time is backwashed, the design must ensure that there is sufficient time (plus a factor of safety) for all units to be washed in one backwash cycle. In general, the backwash supply (air or water) is from a single source, but multiple sources may be required to clean all racks in the allotted time.

Adding chlorine to the backwash water aids in reducing biofouling as shown in Figure 12-9. The test conditions shown were made with 45 s backwash with permeate water containing 3 mg/L chlorine (Jacangelo et al., 1992). Most systems use air scour during backwash.

Chemical Cleaning. Even with frequent backwashing, membrane performance will deteriorate over time. The cleaning procedure may take a few hours. The modules may be *cleaned in place* (CIP) or may be removed for cleaning. Sufficient excess capacity or redundancy must be provided to maintain production flow rates during the time units are off-line for chemical cleaning. In addition, the design must provide for storage and application of the chemicals and, in some cases, heating of the cleaning solutions to temperatures of 30°C to 40°C.

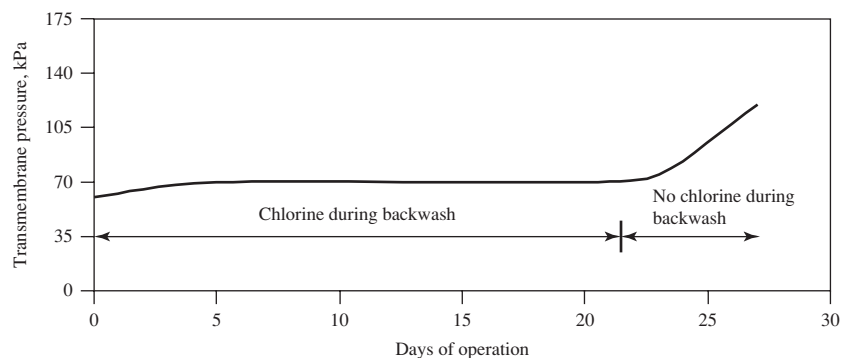

FIGURE 12-9
Effect of backwashing with chlorine on membrane fouling.

Example 12-2. Determine the number of modules per rack and the number of racks to provide uninterrupted flow for the following design conditions:

$$Q_{\max} = 10,000 \text{ m}^3/\text{d}$$

$$J = 0.100 \text{ m}^3/\text{h} \cdot \text{m}^2$$

$$\text{Membrane area per module} = 50 \text{ m}^2$$

$$\text{Backwash interval} = 60 \text{ min}$$

$$\text{Backwash time} = 8 \text{ min}$$

Solution:

- a. Estimate the total membrane area required.

$$\frac{10,000 \text{ m}^3/\text{d}}{(0.100 \text{ m}^3/\text{h} \cdot \text{m}^2)(24 \text{ h/d})} = 4,166.67 \text{ m}^2$$

- b. Estimate the number of modules.

$$\frac{4,166.67 \text{ m}^2}{50 \text{ m}^2/\text{module}} = 83.33 \text{ modules}$$

- c. Because cleaning is by racks, estimate the number of racks that must be cleaned in a backwash cycle.

$$\frac{60 \text{ min/backwash cycle}}{8 \text{ min/rack}} = 7.5 \text{ racks/backwash cycle}$$

To provide a safety factor of about 25%, provide treatment capacity in six racks.

- d. Estimate the number of modules per rack.

$$\frac{83.33 \text{ modules}}{6 \text{ racks}} = 13.88 \text{ or } 14 \text{ modules/rack}$$

- e. Design summary.

1. Provide: 6 racks + 1 spare for redundancy = 7 racks.
2. Check flux.

$$J = \frac{10,000 \text{ m}^3/\text{d}}{(6 \text{ racks})(14 \text{ modules/rack})(50 \text{ m}^2/\text{module})(24 \text{ h/d})} = 0.0992 \text{ m}^3/\text{d} \cdot \text{m}^2$$

Comments:

1. On the average day, the number of racks in service may be considerably less than six.
2. Because the maximum day demand generally occurs in the summer, a lower water viscosity coupled with a higher TMP may permit a less conservative design.

Design Criteria

Tables 12-3 and 12-5 provide a summary of range of design values for MF and UF membranes.

Operation and Maintenance

In addition to maintaining the mechanical system and providing chemical cleaning at appropriate times, the system must be carefully monitored to ensure the integrity of the membrane has not been breached. Routine testing for membrane integrity may be by air pressure tests or sonic monitoring. In the pressure-hold technique, the rate of decay of applied air pressure is monitored. In the sonic test, an acoustic sensor is placed against a module and the noise of air bubbling through a breach is detected.

Hints from the Field. The following hints are from Pressdee et al. (2006):

- Long-term pilot studies rather than short-term evaluations are preferred because the long testing period allows for identification of source water quality issues that may only occur a few times per year.

TABLE 12-5
Range of design values for membrane filters

Parameter	Range of values	Comment
Permeate flux		
Pressurized	30–170 L/m ² · h	
Vacuum	25–75 L/m ² · h	
Transmembrane pressure (TMP)		
Pressurized	20–100 kPa	
Vacuum	–7 to –80 kPa	
Area of membrane/module	8–70 m ² /module	
Modules/rack	2–300	
Module dimensions		
Diameter	100–300 mm	
Length	1–6 m	
Filter run duration	30–90 min	
Backwash		
Duration	1–5 min	
Pressure	35–350 kPa	
Flow rate	6 L/min/m ²	
Time between chemical cleaning	5–180 d	30–180 d common

- Prudent design suggests installation of excess membrane capacity to account for irreversible fouling, aging of membranes, unanticipated changes in water quality, and extreme low water temperatures in the winter.
- An allowance should be made when commissioning a new plant for an extended soaking time. A chemical solution recommended by the manufacturer is used to wet new membranes.

Visit the text website at www.mhprofessional.com/wwe for supplementary materials and a gallery of additional photos.

12-5 CHAPTER REVIEW

When you have completed studying this chapter, you should be able to do the following without the aid of your textbooks or notes:

1. Explain to a client the circumstances that favor the use of NF/RO membranes or MF/UF membranes.
2. Compare the mechanisms of filtration for granular filters and membranes.
3. Explain the role of the pore size and resistance coefficient in the design flux of an MF/UF membrane.
4. Draw a sketch of the flux or transmembrane pressure as a function of time that shows reversible and irreversible membrane fouling, and the effect of chemical cleaning.
5. Compare the typical membrane configuration for NF/RO systems with that used for MF/UF systems.
6. Discuss the effect of coagulation pretreatment on the performance of MF/UF filters.
7. Given water quality goals for viruses and dissolved organic matter, select the appropriate membrane, that is, either MF or UF.

With the use of this text, you should be able to do the following:

8. Calculate rejection, log removal, and percent removal of a constituent by a membrane filter.
9. Size a membrane system given the design flow rate and flux, or determine the flux from the transmembrane pressure, water temperature, and membrane resistance coefficient.
10. Determine the number of MF/UF membrane modules and rack arrangement given the design flow rate, design flux, membrane area per module, and backwash cycle.

12-6 PROBLEMS

- 12-1. What is the equivalent percent reduction for a 2.5 log reduction of *Giardia lamblia*?
- 12-2. What is the log reduction of *Giardia lamblia* that is equivalent to 99.96% reduction?

- 12-3.** Estimate the area of membrane required for Bar Nunn's new membrane filtration plant. The manufacturer of one of the membranes they have selected for testing has provided the following data:

$$\text{Maximum TMP} = 103 \text{ kPa}$$

$$R_m = 3.1 \times 10^{10} \text{ cm}^{-1}$$

Based on their pilot tests, Bar Nunn has selected the following operating parameters:

$$\text{Operating TMP} = 75\% \text{ of maximum TMP}$$

$$\text{Temperature} = 20^\circ\text{C}$$

$$Q_{\max} = 181.7 \text{ m}^3/\text{d}$$

- 12-4.** Bar Nunn has investigated an alternate manufacturer to the one identified in Problem 12-3. The alternate manufacturer offers a vacuum operated system that uses a maximum TMP of -55 kPa . With the exception of the TMP, the operating conditions are the same as those given in Problem 12-3. The capital cost of membrane is $\$1,100/\text{m}^2$ for both membranes, but the operating costs are less for the vacuum system because of the lower TMP. If the vacuum system operating costs are $\$16,500$ per year and those for the pressure system are $\$33,000$ per year and Bar Nunn uses 6.00% interest and a 10-year membrane life to evaluate alternatives, which system should be chosen based on these costs alone?
- 12-5.** Yeehaw's winter water demand is $10,400 \text{ m}^3/\text{d}$, and its summer demand is $15,600 \text{ m}^3/\text{d}$. If the membrane filtration system is designed for the winter demand, can the system meet the summer demand with the same area of membrane? The proposed winter and summer design conditions are:

$$\text{Maximum TMP} = 152 \text{ kPa}$$

$$\text{Operating TMP} = 75\% \text{ of maximum TMP}$$

$$R_m = 2.94 \times 10^{12} \text{ m}^{-1}$$

$$\text{Winter water temperature} = 4^\circ\text{C}$$

$$\text{Summer water temperature} = 20^\circ\text{C}$$

- 12-6.** Snowshoe's winter water demand is $7,600 \text{ m}^3/\text{d}$, and its summer demand is $10,200 \text{ m}^3/\text{d}$. If the membrane filtration system is designed for the winter demand, can the system meet the summer demand with the same area of membrane? The proposed winter and summer design conditions are:

$$\text{Maximum TMP} = 200 \text{ kPa}$$

$$\text{Operating TMP} = 75\% \text{ of maximum TMP}$$

$$R_m = 3.2 \times 10^{12} \text{ m}^{-1}$$

$$\text{Winter water temperature} = 1^\circ\text{C}$$

$$\text{Summer water temperature} = 15^\circ\text{C}$$

- 12-7.** A membrane manufacturer's data sheet reports the following:

$$\text{Initial specific flux} = 1.24 \text{ L/h} \cdot \text{m}^2 \cdot \text{kPa at } 20^\circ\text{C}$$

$$\text{Flux} = 33 \text{ L/h} \cdot \text{m}^2$$

$$R_m = 2.9 \times 10^{12} \text{ m}^{-1}$$

What is the TMP for these conditions?

- 12-8.** Determine the number of racks for the Spartanburg membrane filtration system for the “worst case scenario” of one rack off-line for CIP plus one rack off-line for backwash given the following design requirements:

$$Q_{\max} = 30,300 \text{ m}^3/\text{d}$$

$$J = 0.127 \text{ m}^3/\text{h} \cdot \text{m}^2$$

$$J_{\max \text{ allowable}} = 0.170 \text{ m}^3/\text{h} \cdot \text{m}^2$$

Cleaning cycle = 30 min
 Time off-line to clean = 150 s
 Membrane area per module = 15 m²
 Modules per rack = 90

- 12-9.** Determine the number of racks for the town of Agate’s membrane filtration system for the worst case scenario of one rack off-line for CIP plus one rack off-line for backwash given the following design requirements:

$$Q_{\text{winter}} = 7,600 \text{ m}^3/\text{d}$$

$$Q_{\text{summer}} = 10,200 \text{ m}^3/\text{d}$$

Winter water temperature = 1°C
 Summer water temperature = 15°C
 $J = 0.159 \text{ m}^3/\text{h} \cdot \text{m}^2$ for winter temperature
 $J_{\max \text{ allowable}} = 0.267 \text{ m}^3/\text{h} \cdot \text{m}^2$ for winter temperature
 Cleaning cycle = 30 min
 Time off-line to clean = 150 s
 Membrane area per module = 15 m²
 Modules per rack = 40

12-7 DISCUSSION QUESTIONS

- 12-1.** Because of the change in viscosity of water, a membrane design for cold water will have a higher flux and be able to treat a greater flow rate at a higher temperature. True or false?
- 12-2.** What is the difference between irreversible and reversible transmembrane membrane pressure?
- 12-3.** Describe the parameter values you would need to compare membranes from different manufacturers.

12-8 REFERENCES

- AWWA (2005) *Microfiltration and Ultrafiltration Membranes for Drinking Water*, AWWA Manual M53, American Water Works Association, Denver, Colorado.
- Bergman, R. A. (2005) “Membrane Processes,” in E. E Baruth (ed.), *Water Treatment Plant Design*, McGraw-Hill, New York, pp. 13.1–13.49.
- Carmen, P. C. (1937) “Fluid Flow through Granular Beds,” *Transactions of Institute of Chemical Engineers*, London, vol. 15, p. 150.
- Chellam, S. and J. G. Jacangelo (1998) “Existence of Critical Recovery and Impacts of Operational Mode on Portable Water Microfiltration,” *Journal of Environmental Engineering*, vol. 124, no. 12, pp. 1211–1219.

- Ferry, J. D. (1936) "Statistical Evaluation of Sieve Constants in Ultrafiltration," *Journal of General Physiology*, vol. 20, pp. 95–104.
- Howe, K. J. and M. M. Clark (2006) "Effect of Coagulation Pretreatment on Membrane Filtration Performance," *Journal of American Water Works Association*, vol. 98, no. 4, pp. 133–146.
- Jacangelo, J. and C. A. Buckley (1996) "Microfiltration," in J. Mallevalle, P. E. Odendaal, and M. R. Wiesner (eds.), *Water Treatment Membrane Processes*, American Water Works Association and McGraw-Hill, Denver, Colorado, p. 11.25.
- Jacangelo, J., N. Patania, J. M. Laîné, W. Booe, and J. Mallevalle (1992) *Low Pressure Membrane Filtration for Particle Removal*, American Water Works Association Research Foundation and American Water Works Association, Denver, Colorado.
- Jacangelo, J. G., S. Adham, and J. Laine (1997) *Membrane Filtration for Microbial Removal*, AWWA Research Foundation and American Water Works Association.
- Jucker, C. and M. M. Clark (1994) "Adsorption of Aquatic Humic Substances on Hydrophobic Ultrafiltration Membranes," *Journal Membrane Science*, vol. 97, pp. 37–52.
- MWH (2005) *Water Treatment: Principles and Design*, John Wiley & Sons, Hoboken, New Jersey, pp. 882, 892–894.
- Pressdee, J. R., S. Veerapaneni, H. L. Shorney-Darby, J. A. Clement, and J. P. Van der Hoek (2006) *Integration of Membrane Filtration into Water Treatment Systems*, American Water Works Association Research Foundation Report No. 91103.
- Rose, H. E. (1945) "On the Resistance Coefficient–Reynolds Number Relationship of Fluid Flow through a Bed of Granular Material," *Proceedings of the Institute of Mechanical Engineers*, vol. 153, p. 493.
- U. S. EPA (2005) *Membrane Guidance Manual*, U.S Environmental Protection Agency, Washington, D.C., pp. 2–15.
- Yao, K. M., M. T. Habibian, and C. R. O'Melia (1971) "Water and Waste Water Filtration: Concepts and Applications," *Environmental Science and Technology*, vol. 5, no. 11, pp. 1105–1112.

DISINFECTION AND FLUORIDATION

13-1 INTRODUCTION

13-2 DISINFECTION

13-3 EMERGENCY DISINFECTION

13-4 FLUORIDATION

13-5 OPERATION AND MAINTENANCE

13-6 CHAPTER REVIEW

13-7 PROBLEMS

13-8 DISCUSSION QUESTIONS

13-9 REFERENCES

13-1 INTRODUCTION

Disinfection is used in water treatment to reduce pathogens to an acceptable level. Disinfection is not the same as sterilization. Sterilization implies the destruction of all living organisms. Drinking water does not need to be sterile to be safe to drink.

Three categories of human enteric pathogens are of concern in drinking water: bacteria, viruses, and amebic cysts. Disinfection must be capable of destroying all three.

In the United States, five agents have found common use in disinfecting drinking water: (1) free chlorine, (2) combined chlorine, (3) ozone, (4) chlorine dioxide, and (5) ultraviolet irradiation. These are the subject of this chapter.

Fluoridation, which is also discussed in this chapter, refers to the addition or removal of fluoride from drinking water to maintain an optimum concentration to reduce tooth decay.

13-2 DISINFECTION

Disinfection Chemistry

Free Chlorine. Chlorine is the most common disinfecting chemical used. The term *chlorination* is often used synonymously with disinfection. Chlorine may be used as an element (Cl_2), as sodium hypochlorite (NaOCl), also known as bleach, as calcium hypochlorite [$\text{Ca}(\text{OCl})_2$], also known as HTH[®], or as chlorinated lime (CaOCl_2).

When chlorine is added to water, a mixture of hypochlorous acid (HOCl) and hydrochloric acid (HCl) is formed:

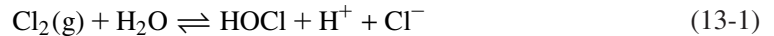

This reaction is pH dependent and essentially complete within a very few milliseconds. The pH dependence may be summarized as follows:

- In dilute solution and at pH levels above 1.0, the equilibrium is displaced to the right and very little Cl_2 exists in solution.
- Hypochlorous acid is a weak acid and dissociates poorly at levels of pH below about 6. Between pH 6.0 and 8.5 there occurs a very sharp change from undissociated HOCl to almost complete dissociation:

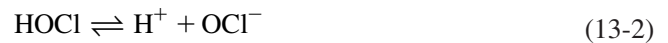

- Chlorine exists predominantly as HOCl at pH levels between 4.0 and 6.0.
- Below pH 1.0, depending on the chloride concentration, the HOCl reverts back to Cl_2 as shown in Equation 13-1.
- At 20°C, above about pH 7.5, and at 0°C, above about pH 7.8, hypochlorite ions (OCl^-) predominate.
- Hypochlorite ions exist almost exclusively at levels of pH around 9 and above.

Chlorine existing in the form of HOCl and/or OCl^- is defined as *free available chlorine* or *free chlorine*.

Example 13-1. If 15 mg/L of HOCl is added to a potable water for disinfection and the final measured pH is 7.0, what percent of the HOCl is not dissociated? Assume the temperature is 25°C.

Solution:

- a. The reaction is shown in Equation 13-2. From Appendix A, find that the $\text{p}K_a$ is 7.54 and

$$K_a = 10^{-7.54} = 2.88 \times 10^{-8}$$

- b. Writing the equilibrium constant expression

$$K_a = \frac{[\text{H}^+][\text{OCl}^-]}{[\text{HOCl}]}$$

and substituting the values for K_a and $[\text{H}^+]$

$$2.88 \times 10^{-8} = \frac{[10^{-7}][\text{OCl}^-]}{[\text{HOCl}]}$$

Solving for the HOCl concentration

$$[\text{HOCl}] = 3.47[\text{OCl}^-]$$

Because the fraction of HOCl that has not dissociated plus the OCl^- that was formed by the dissociation must, by the law of conservation of mass, equal 100% of the original HOCl added:

$$[\text{HOCl}] + [\text{OCl}^-] = 100\% \text{ (of the total HOCl added to the solution)}$$

then

$$3.47[\text{OCl}^-] + [\text{OCl}^-] = 100\%$$

$$4.47[\text{OCl}^-] = 100\%$$

$$[\text{OCl}^-] = \frac{100\%}{4.47} = 22.37\%$$

and

$$[\text{HOCl}] = 3.47(22.37\%) = 77.6\%$$

Comments:

1. Note that the concentration of HOCl was not used in the problem solution!
2. For different temperatures, the percentages will be different because K_a is a function of temperature.

Hypochlorite salts dissociate in water to yield hypochlorite ions:



The hypochlorite ions establish equilibrium with hydrogen ions (in accord with Equation 13-2). Thus, the same active chlorine species (HOCl and OCl^-) and equilibrium are established in water regardless of whether elemental chlorine or hypochlorites are used. The significant difference is in the resultant pH and its influence on the relative amounts of HOCl and OCl^- existing at equilibrium. Elemental chlorine tends to decrease pH; each mg/L of chlorine added reduces the alkalinity by up to 1.4 mg/L as CaCO_3 . Hypochlorites, on the other hand, always contain excess alkali to enhance their stability and tend to raise the pH somewhat. To optimize disinfecting action, the design pH is in the a range 6.5 to 7.5.

Free chlorine is relatively stable in pure water. It reacts slowly with naturally occurring organic matter (NOM) and rapidly with sunlight. The photolytic reaction is with hypochlorite. The reaction products are oxygen, chlorite ion, and chloride ion (Buxton and Subhani, 1971).

Chlorine/Ammonia Reactions. The reactions of chlorine with ammonia are of great significance in water chlorination processes. When chlorine is added to water that contains natural or added ammonia (ammonium ion exists in equilibrium with ammonia and hydrogen ions), the ammonia reacts with HOCl to form various *chloramines*. The reactions between chlorine and ammonia may be represented as follows (AWWA, 2006):

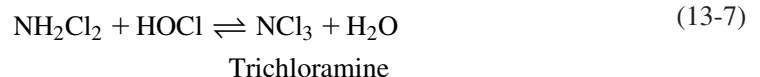
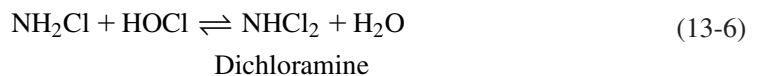
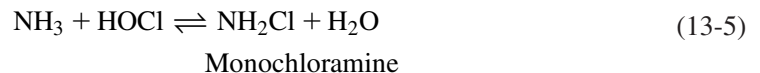

The distribution of the reaction products is governed by the rates of formation of monochloramine and dichloramine, which are dependent upon pH, temperature, time, and initial $\text{Cl}_2:\text{NH}_3$ ratio. In general, high $\text{Cl}_2:\text{NH}_3$ ratios, low temperatures, and low pH levels favor dichloramine formation.

Chlorine also reacts with organic nitrogenous materials, such as proteins and amino acids, to form organic chloramine complexes. Chlorine that exists in water in chemical combination with ammonia, or organic nitrogen compounds, is defined as *combined available chlorine* or *combined chlorine*. The sum of the concentrations of free chlorine and combined chlorine is called *total chlorine*.

The oxidizing capacity of free chlorine solutions varies with pH because of variations in the resultant $\text{HOCl}:\text{OCl}^-$ ratios. This is also true for chloramine solutions as a result of varying $\text{NHCl}_2:\text{NH}_2\text{Cl}$ ratios. Monochloramine predominates at high pH levels.

Chlorine Dioxide. Chlorine dioxide is a stable free radical that, at high concentrations, reacts violently with reducing agents. It is explosive with a *lower explosive limit** (LEL) reported variously between 10 and 39 percent. Thus, virtually all applications require synthesis on-site. Chlorine dioxide (ClO_2) is formed on-site by combining chlorine and sodium chlorite. One of three alternative reactions may be employed (MWH, 2005):

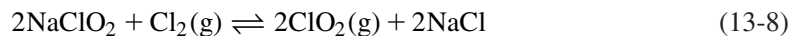

Under alkaline conditions chlorine dioxide forms chlorite (ClO_2^-) and chlorate (ClO_3^-) ions (Gordon et al., 1972):

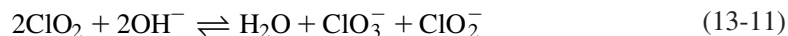

The typical reaction of chlorine dioxide in water is a one-electron reduction (Haas, 1999):



Ozone. Ozone is a pungent, unstable gas. It is a form of oxygen in which three atoms of oxygen are combined to form the molecule O_3 . Because of its instability, it is generated at the point of use. Ozone may be generated by photochemical, electrolytic, and radiochemical methods, but it is most commonly generated by a discharge electrode. Either pure oxygen, purchased as *liquid oxygen* (LOX), or the oxygen in the air, is dissociated by the impact of electrons from the discharge electrode. The atomic oxygen then combines with atmospheric oxygen to form ozone in the following reaction:



*Mixtures of gases with air that have concentrations above the LEL can be ignited.

When LOX is used, 5 to 8 percent by volume of the air exiting from the apparatus will be ozone. The resulting ozone-air mixture is then diffused into the water that is to be disinfected.

If ambient air is used as a source of oxygen (as opposed to liquid oxygen), trace levels of water can react with the nitrogen in the air to form nitric acid:

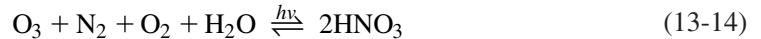

The nitric acid then corrodes the ozone generator. The implication for design of ozone systems is that the process must include a method for drying ambient air to a very low moisture content.

Redox Reactions. Chemical disinfectants are oxidants. Because they undergo oxidation-reduction reactions, this allows comparison of the disinfectants based on their oxidizing power. This is of particular interest in comparing chlorine compounds. The relative amount of chlorine present in these compounds may be expressed as *percent available chlorine*. The percent available chlorine of a compound is the electrochemical equivalent amount of Cl_2 . It is a measure of the oxidizing power of the compound in comparison to Cl_2 . It is calculated as

$$\% \text{ available chlorine} = \frac{\text{Equivalent weight of Cl}_2 \text{ in compound}}{\text{Equivalent weight of compound}} \quad (13-15)$$

The equivalent weight of a compound in an oxidation-reduction reaction is calculated using its oxidation-reduction half reaction. A selected list of half-reactions is given in Table 13-1. Example 13-2 demonstrates the calculation of percent available chlorine.

TABLE 13-1
Selected half reactions

Reaction
$\text{Ca}(\text{OCl})_2 + 2\text{H}^+ + 4\text{e}^- \rightleftharpoons 2\text{Cl}^- + \text{CaO} + \text{H}_2\text{O}$
$\text{CaOCl}_2 + 2\text{e}^- \rightleftharpoons 2\text{Cl}^- + \text{CaO}$
$\text{Cl}_2(\text{g}) + 2\text{e}^- \rightleftharpoons 2\text{Cl}^-$
$\text{ClO}_2 + 2\text{H}_2\text{O} + 5\text{e}^- \rightleftharpoons \text{Cl}^- + 4\text{OH}^-$
$\text{H}_2\text{O}_2 + 2\text{H}^+ + 2\text{e}^- \rightleftharpoons 2\text{H}_2\text{O}$
$\text{HOCl} + \text{H}^+ + 2\text{e}^- \rightleftharpoons \text{Cl}^- + \text{H}_2\text{O}$
$\text{MnO}_4^- + 8\text{H}^+ + 5\text{e}^- \rightleftharpoons \text{Mn}^{2+} + 4\text{H}_2\text{O}$
$\text{NaOCl} + \text{H}^+ + 2\text{e}^- \rightleftharpoons \text{Cl}^- + \text{NaOH}$
$\text{NH}_2\text{Cl} + \text{H}_2\text{O} + 2\text{e}^- \rightleftharpoons \text{Cl}^- + \text{NH}_3 + \text{OH}^-$
$\text{NHCl}_2 + 2\text{H}_2\text{O} + 4\text{e}^- \rightleftharpoons 2\text{Cl}^- + \text{NH}_3 + 2\text{OH}^-$
$\text{O}_3 + 2\text{H}^+ + 2\text{e}^- \rightleftharpoons \text{O}_2 + \text{H}_2\text{O}$
$\text{SO}_4^{2-} + 10\text{H}^+ + 8\text{e}^- \rightleftharpoons \text{H}_2\text{S}(\text{g}) + 4\text{H}_2\text{O}$

Sources: Weast, 1983; LaGrega et al., 2001; Snoeyink and Jenkins, 1980.

Example 13-2. Estimate the percent available chlorine in $\text{Ca}(\text{OCl})_2$.

Solution:

- a. The appropriate half reactions from Table 13-1 are

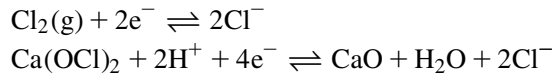

- b. From the half reactions calculate the equivalent weights of Cl_2 and $\text{Ca}(\text{OCl})_2$

$$\begin{aligned}\text{Equiv. Wt. of } \text{Cl}_2 &= \frac{\text{GMW of } \text{Cl}_2}{\text{No. of electrons consumed}} \\ &= \frac{2(35.45)}{2} = 35.45\end{aligned}$$

$$\begin{aligned}\text{Equiv. Wt. of } \text{Ca}(\text{OCl})_2 &= \frac{\text{GMW of } \text{Ca}(\text{OCl})_2}{\text{No. of electrons consumed}} \\ &= \frac{142.98}{4} = 35.745\end{aligned}$$

- c. The percent available chlorine is

$$\% \text{ available chlorine} = \frac{35.45}{35.745}(100\%) = 99.17\%$$

Comments:

1. Although the weight percent of chlorine in $\text{Ca}(\text{OCl})_2$ is barely half of the weight of the compound, the oxidizing power is virtually equivalent to chlorine gas.
2. It is possible for a compound to have a % available chlorine greater than 100%. For these compounds the implication is that they have greater oxidizing power than chlorine gas.

Ultraviolet (UV) Radiation. Table 13-2 outlines the spectral ranges of interest in photochemistry.

The energy associated with electromagnetic radiation may conceptually be thought of as photons. The energy is related to the wavelength of the radiation (Einstein, 1905):

$$E = \frac{hc}{\lambda} \quad (13-16)$$

TABLE 13-2
Spectral ranges of interest in photochemistry

Range name	Wavelength range (nm)
Near infrared	700–1,000
Visible	400–700
Ultraviolet	
UVA	315–400
UVB	280–315
UVC	200–280
Vacuum ultraviolet (VUV)	100–200

where E = energy in each photon, J
 h = Planck's constant, 6.6×10^{-34} J · s
 c = speed of light, m/s
 λ = wavelength of radiation, m

In general, the more energy associated with a photon of electromagnetic radiation, the more dangerous it is to living organisms.

Light photons with wavelengths longer than 1,000 nanometers (nm) have a photon energy too small to cause chemical change when absorbed, and photons with wavelengths shorter than 100 nm have so much energy that ionization and molecular disruptions characteristic of radiation chemistry prevail.

Little photochemistry occurs in the near infrared range except in some photosynthetic bacteria. The visible range is completely active for photosynthesis in green plants and algae. The ultraviolet range is divided into three categories connected with the human skin's sensitivity to ultraviolet light. The UVA range causes changes to the skin that lead to tanning. The UVB range can cause skin burning and is prone to induce skin cancer. The UVC range is extremely dangerous since it is absorbed by proteins and can lead to cell mutations or cell death.

UV electromagnetic energy is typically generated by the flow of electrons from an electrical source through ionized mercury vapor in a lamp. Several manufacturers have developed systems to align UV lamps in vessels or channels to provide UV light in the germicidal range for inactivation of bacteria, viruses, and other microorganisms. The UV lamps are similar to household fluorescent lamps, except that fluorescent lamps are coated with phosphorus, which converts the UV light to visible light.

Disinfection Byproducts. Chlorine reacts with natural organic matter (NOM) to form a number of carcinogenic byproducts. These include but are not limited to trihalomethanes (THMs), haloacetic acids (HAAs), haloacetonitriles, haloacetones, haloaldehydes, chloropicrin, cyanogen chloride, and chlorophenols. The THMs and HAAs occur most frequently and generally represent the highest concentrations of the organic contaminants.

Chloramines react with NOM to form byproducts similar to those formed by chlorination but at lower concentrations (U.S. EPA, 1994).

Chlorine dioxide and ozone can oxidize a number of organic constituents without producing THMs or HAAs. However, chlorine dioxide itself and the chlorite ion are toxic. Approximately 70 percent of the chlorine dioxide consumed by oxidation reactions is converted to chlorite under conditions typical in water treatment (Singer, 1992). In addition, if bromide is present, ozonation will form the hypobromite ion (OBr^-) which, in turn, forms, hypobromous acid that will react with NOM to form brominated byproducts.

There are no known disinfection byproducts that result from UV radiation (Haas, 1999).

Chemical Disinfectant Kinetics

Although more complex models are available, it is often assumed that decay of chlorine, combined chlorine, and chlorine dioxide can be modeled as a first order or pseudo-first order reaction, that is:

$$\frac{dC}{dt} = -k_d C \quad (13-17)$$

where C = disinfectant concentration, mg/L

k_d = first order decay rate constant, time^{-1}

t = time, complementary units to k_d

Example pseudo-first order decay rate constants are shown in Table 13-3.

TABLE 13-3
Pseudo-first order decay rate constants

Compound	k_d	Condition	Source
Ozone ^a	$1.5 \times 10^{-4} \text{ s}^{-1}$	Ground water low DOC ^b ; high alkalinity	Acero & von Gunten, 2001
Ozone ^a	$2.5 \times 10^{-3} \text{ s}^{-1}$	Surface water high DOC; low alkalinity	Acero & von Gunten, 2001
Ozone ^a	0.108 to 0.128 min^{-1}	Ozone contact chamber	Rakness, 2005
AOP ^c	$1.4 \times 10^{-3} \text{ s}^{-1}$	Ground water low DOC; high alkalinity	Acero & von Gunten, 2001
AOP	$5.8 \times 10^{-3} \text{ s}^{-1}$	Surface water high DOC; low alkalinity	Acero & von Gunten, 2001
Chloramine	0.01 to 0.02 d^{-1}	Surface water TOC ^d 1 to 2 mg/L	Wilczak et al., 2003
Chlorine	0.0011 to 0.0101 min^{-1}	Surface water TOC 2.3 to 3.8 mg/L	Sung et al., 2001
Chlorine	0.71 to 11.09 d^{-1}	Distrib. sys. pipe	Clark et al., 1993
Chlorine	0.36 to 1.0 d^{-1}	Distrib. sys. storage tank	Rossmann et al., 1995

^aNote that these authors presented these as first order approximations.

^bDOC = dissolved organic carbon.

^cAOP = advanced oxidation processes. These are combinations of disinfectants to produce hydroxyl radicals. Most noteworthy of the AOP processes is ozone plus hydrogen peroxide.

^dTOC = total organic carbon.

Hypochlorite and ozone decay are modeled as a second order reaction (Gordon et al., 1995; Gurol and Singer, 1982):

$$\frac{dC}{dt} = -k_{2d}C^2 \tag{13-18}$$

where k_{2d} = second order decay rate constant, L/mg · s
 t = time, s

Example 13-3. Using the following data adapted from Gurol and Singer (1982), estimate the rate constant for ozone decay at a pH of 2.2.

Ozone concentration, mg/L	Time, min
14.0	0
12.9	20
11.3	60
9.96	100
9.38	120

Solution:

a. Integration of Equation 13-18 yields

$$C_t = \frac{C_0}{1 + (k_{2d})(t)(C_0)}$$

b. A plot of

$$\left(\frac{1}{C_t} - \frac{1}{C_0} \right) \text{ versus time yields a straight line}$$

with a slope equal to k_{2d} as shown in Figure 13-1.

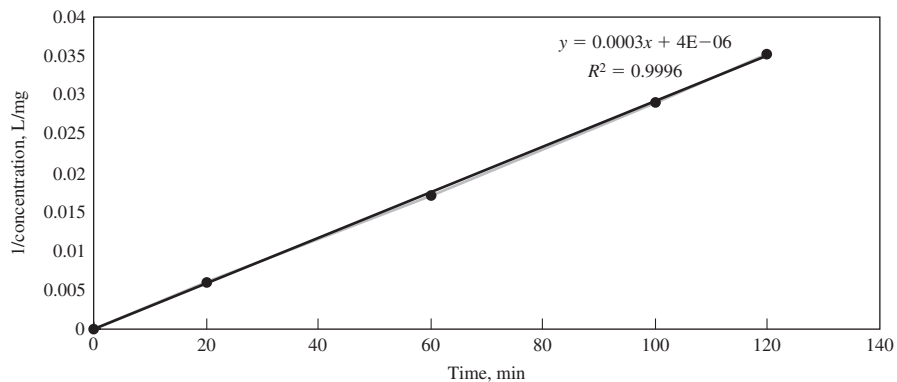

FIGURE 13-1
Ozone decay rate constant.

The transformed data are

$\left(\frac{1}{C_t} - \frac{1}{C_0}\right), \text{L/mg}$	Time, min
0	0
0.00609	20
0.01707	60
0.02897	100
0.03518	120

- c. From Figure 13-1, the equation of the line yields a slope (k_{2d}) of 0.0003 L/mg · min.

Comments:

1. The calculations, fit of the line to the data points, and equation of the line were performed with a spreadsheet.
2. Rate constants at other pH values will be substantially different.

Chemical Oxidant Demand

The *chlorine demand* of a water is the difference between the amount of chlorine added and the amount of free, combined or total chlorine remaining at the end of the contact period. A similar definition may be used for chlorine dioxide or ozone. The demand is a function of the water quality characteristics, pH, temperature of the water, amount of oxidant applied, and the time of contact.

Significant amounts of ammonia in the water react with chlorine to produce an unpleasant taste and odor (T&O). One method for removing T&O is by the addition of chlorine in a process called *breakpoint chlorination*. The reactions of chlorine and ammonia exhibited in breakpoint chlorination are an illustration of chlorine demand (Figure 13-2). The addition of chlorine results in the reactions with ammonia described in Equations 13-5, 13-6, and 13-7. With molar Cl_2 : NH_3 (as N), concentrations up to 1:1 (5:1 mass basis) monochloramine and dichloramine will be formed. The relative amounts of each depend on pH and other factors. Chloramine residuals generally reach a maximum at equimolar concentrations of chlorine and ammonia. Further increases in the Cl_2 : NH_3 ratio result in the oxidation of ammonia and reduction of chlorine. Sufficient time must be provided to allow the reaction to go to completion. Chloramine residuals decline to a minimum value, the *breakpoint*, when the molar Cl_2 : NH_3 ratio is about 2:1. At this point, the oxidation/reduction reactions are essentially complete. Further addition of chlorine produces free chlorine.

Other demand reactions are not so dramatic as breakpoint chlorination. Significant concentrations of strong reducing compounds that react rapidly will yield a demand curve such as that for sulfur dioxide (Figure 13-3). Lower concentrations of compounds such as NOM react slowly. The demand of these compounds is determined by comparison of their rate of decay to the rate of decay of the oxidant in pure water under identical conditions.

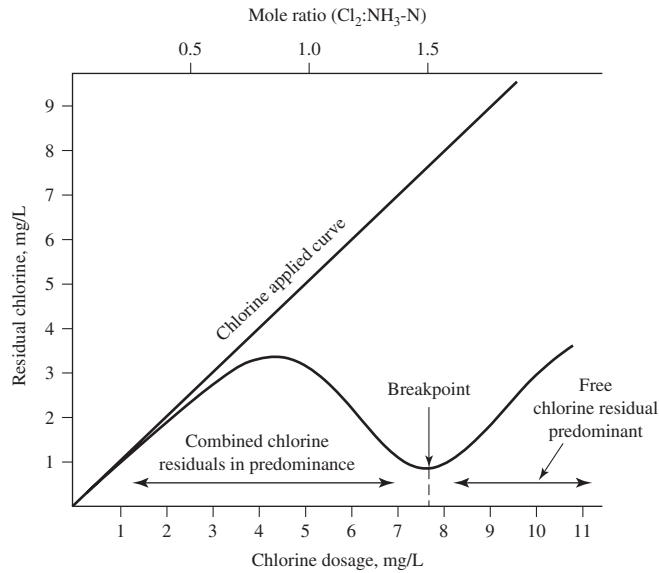

FIGURE 13-2
Breakpoint chlorination. (Source: AWWA, 1969.)

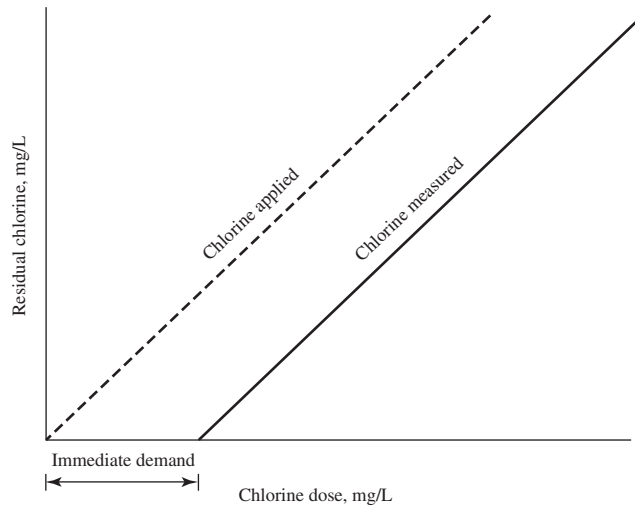

FIGURE 13-3
Chlorine demand exhibited by a very fast reaction such as that with sulfur dioxide.

Mechanisms of Disinfection

The mode of action by which disinfectants inactivate or kill microorganisms is dependent on a large number of variables. This brief overview is limited to some of the common water disinfectants and two broad classes of microorganisms: bacteria and viruses.

Chlorine. The chlorine must penetrate into the bacterial cell to cause inactivation. In bacteria, respiratory, transport, and nucleic acid activity are all adversely affected (Haas and Engelbrecht, 1980). In bacteriophage, the mode of action appears to be disruption of the viral nucleic acid, while in poliovirus the protein coat is affected (Dennis et al., 1979; Fujioka et al., 1985).

Chlorine Dioxide. The physiological mode of inactivation is attributed to disruption of protein synthesis (Benarde et al., 1967). Disruption of capsid functions inactivates viruses (Noss et al., 1985).

Ozone. Although complicated by measurement difficulties, physicochemical damage to DNA appears to be the mechanism of inactivation of both bacterial cells and poliovirus (Hammelin and Chung, 1978; Roy et al., 1981). This includes attack on the bacterial membrane, disruption of enzymatic activity, and nucleic acids. The first site for virus inactivation is the virion capsid (U.S. EPA, 1999).

UV Radiation. UV radiation causes specific deleterious changes in microorganism nucleic acids. (Jagger, 1967). DNA absorbs light in the ultraviolet range—primarily between 200 and 300 nanometers (nm). UV light is most strongly absorbed by DNA at 253.7 nm. If the DNA absorbs too much UV light, it will be damaged and will be unable to replicate. It has been found that the energy required to damage the DNA is much less than that required to actually destroy the organism (Setlow, 1967). The effect is the same. If a microorganism cannot reproduce, it cannot cause an infection.

Disinfection Kinetics

Chick's Law. Using disinfectants like phenol, mercuric chloride, and silver nitrate and organisms like *Salmonella typhi*, *Escherichia coli*, *Staphylococcus aureus*, and *Bacillus anthracis*, Dr. Harriet Chick demonstrated that disinfection could be modeled as a pseudo-first order reaction with respect to the concentration of organisms (Chick, 1908). In a thoroughly mixed batch reactor or a perfect plug flow reactor, Chick's law takes the form

$$\frac{dN}{dt} = -k_c N \quad (13-19)$$

where N = number of organisms per unit volume
 k_c = rate constant of inactivation, s^{-1} , or min^{-1}
 t = time, s, or min

In integrated form the equation is

$$\ln\left(\frac{N}{N_0}\right) = -k_c t \quad (13-20)$$

where N_0 = number of organisms per unit volume at time zero

A common method of graphing the data for Chick's law is to plot the log of the survival ratio versus time on a semilog graph (Figure 13-4).

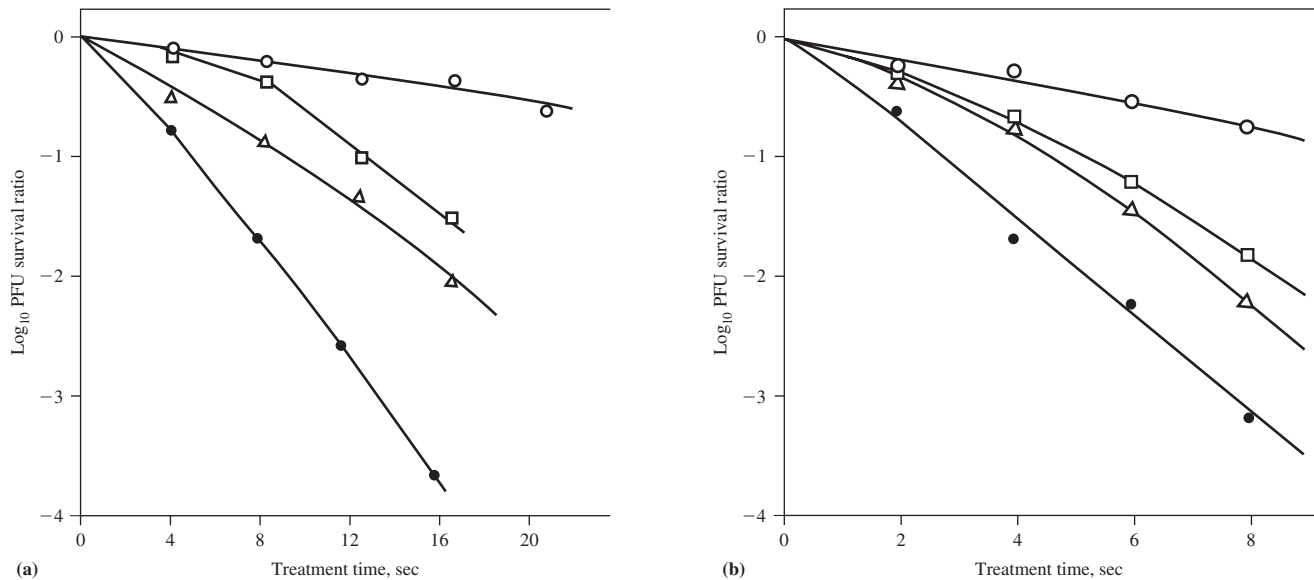

FIGURE 13-4 Inactivation of single poliovirus particles by HOCl (a) at 10°C, pH 6.0: (○) 1.5 μM, (□) 11 μM, (△) 20 μM, and (●) 41 μM; (b) at 20°C, pH 6.0: (○) 2.2 μM, (□) 11 μM, (△) 22 μM, and (●) 35 μM. (Source: Floyd, et al., 1979.)

Chick-Watson Law. Chick’s law does not take into account the concentration of the disinfectant. From Figure 13-4, it is obvious that the disinfectant concentration has a marked effect. Recognizing this, Watson (1908) proposed an alternative expression to describe a given level of inactivation:

$$C^n t = \text{constant} \tag{13-21}$$

where C = disinfectant concentration, mg/L
 n = coefficient of dilution
 t = time

Chick’s law and Watson’s equation are combined by relating the rate constant of inactivation to the disinfectant concentration:

$$k_c = k_{cw} C^n \tag{13-22}$$

where k_{cw} = rate constant of inactivation independent of concentration, time⁻¹

The Chick-Watson law in integrated form is then

$$\ln\left(\frac{N}{N_0}\right) = -k_{cw} C^n t \tag{13-23}$$

Example 13-4. The data for HOCl disinfection of poliovirus at a concentration of 1.8 mg/L is shown below (adapted from Floyd et al., 1979). The temperature was 20°C, the pH was 6.0. Determine the rate constant of inactivation assuming the Chick-Watson model applies with an n value of 1.0.

Time, s	Number of PFU ^a
0	6,152
2	3,000
4	1,200
6	710
8	300

^aPFU = plaque forming units.

Solution:

- a. Compute $\ln(N/N_0)$ and Ct for each time.

Time, s	$\ln(N/N_0)$	Ct
0	0.0	0
2	-0.718	3.6
4	-1.63	7.2
6	-2.16	10.8
8	-3.02	14.4

- b. A “trendline” fit of $\ln(N/N_0)$ versus Ct yields a straight line with a slope equal to k_{cw} as shown in Figure 13-5.
- c. From a spreadsheet, the equation of the trend line yields a slope of -0.2078 and k_{cw} of 0.2078 L/mg · s.

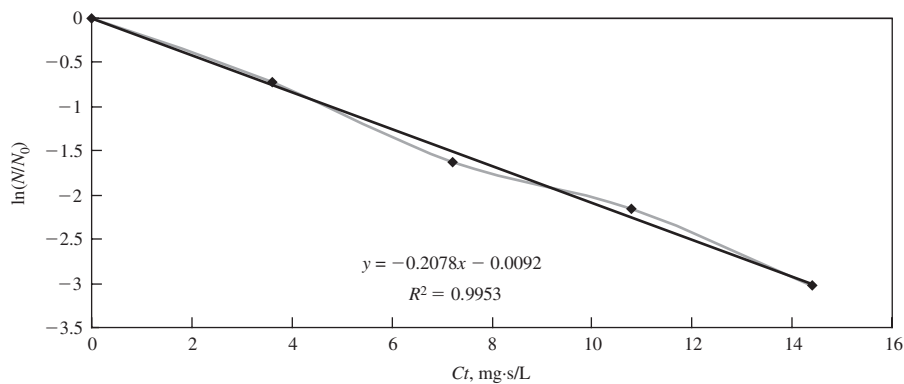

FIGURE 13-5
Poliovirus decay rate.

The Chick-Watson law assumes that the concentration of disinfectant remains constant. As noted above, even without reaction with other constituents in the water, the disinfectant concentration decays with time. Even if the concentration is kept constant during inactivation of microorganisms, the results do not always follow Equation 13-23. "Tailing," "shoulders," and time lags may occur with different microorganism and disinfectant combinations. Different temperatures and pH values for the same organism and disinfectant will result in different curves as shown in Figures 13-4a and 13-4b.

In many cases the exponent "n" in Equation 13-22 is close to 1.0 (Hoff, 1986). Thus, a fixed value of the product Ct results in a fixed degree of inactivation.

Plotting combinations of disinfectant concentration and time to a fixed percent inactivation for a given temperature yields curves that follow the form of $C^n t = \text{constant}$. The constant is a function of the organism, temperature, and pH. The curves are linear on a log-log scale (Figures 13-6A, 13-6B, and 13-6C).

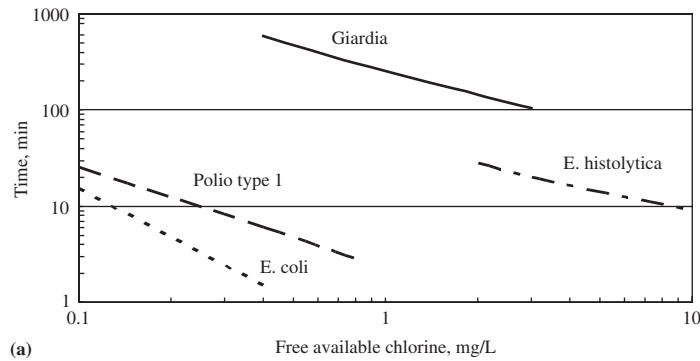

FIGURE 13-6A

Free available chlorine disinfection. Time to achieve 99.6 to 100 percent kill at water temperature of 0°C to 5°C.

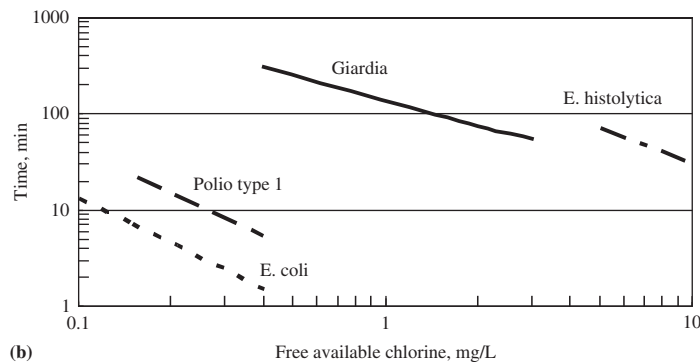

FIGURE 13-6B

Free available chlorine disinfection. Time to achieve 99.6 to 100 percent kill at water temperature of 10°C.

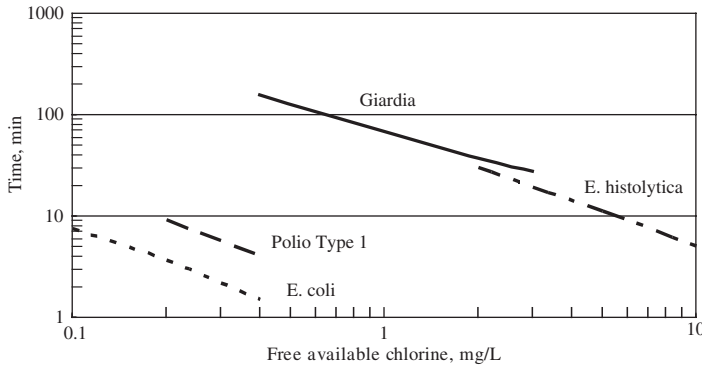

FIGURE 13-6C

Free available chlorine disinfection. Time to achieve 99.6 to 100 percent kill at water temperature of 20°C to 24°C.

Hom-Haas Model. This model of disinfection accounts for both changes in chemical disinfectant concentration and microorganism survival. The integrated form of the model is (Hom, 1972; Haas and Joffe, 1994):

$$\ln\left(\frac{N}{N_0}\right) = -k_{HH}C^n t^m \quad (13-24)$$

where k_{HH} = die-off coefficient, consistent units, for example: L/mg · s
 n, m = empirical constants, dimensionless

Multiple linear regression using survival as the dependent variable and disinfectant concentration and time as the independent variables produces an intercept equal to k_{HH} and slopes equal to n and m . This computation can be solved with the aid of a spreadsheet program.

UV Disinfection Kinetics. A modified form of the Chick-Watson law that includes the effects of the wavelength of light can be used to describe survival of microorganisms exposed to UV radiation (Linden and Darby, 1997; MWH, 2005):

$$\left\{\frac{dN}{dt}\right\}_\lambda = I_\lambda N \quad (13-25)$$

where I_λ = effective germicidal intensity of UV radiation for wavelength λ , mW/cm².

For multiple wavelengths, I_λ must be integrated over the spectrum of wavelengths. A plot of the relationship between log survival of MS2 phage and effective *germicidal dose* [that is the product of energy per unit area and time (mW/cm²)(t)] is shown in Figure 13-7.

The inactivation of microorganisms by UV is directly related to UV dose. This is a concept similar to Ct used for other common disinfectants, including chlorine and ozone. The average UV dose is calculated as follows:

$$D_{UV} = It \quad (13-26)$$

where D_{UV} = UV dose

I = average intensity, mW/cm²

t = average exposure time, s

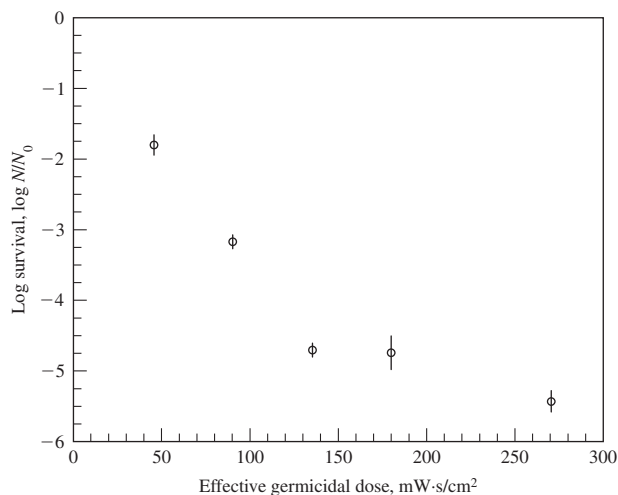
**FIGURE 13-7**

Relationship between log survival of MS2 phage and effective germicidal dose as determined in low pressure UV lamp collimated beam system. (95 percent confidence interval shown.) (Source: Linden and Darby, 1997.)

Disinfection Practice

To be of practical use, disinfectants must possess the following properties:

1. They must destroy the kinds and numbers of pathogens that may be introduced into water within a practicable period of time over an expected range in water temperature.
2. They must meet possible fluctuations in composition, concentration, and condition of the water to be treated.
3. They must be neither toxic to humans and domestic animals nor unpalatable or otherwise objectionable in the concentrations required for disinfection.
4. Their strength or concentration in the treated water must be determined easily, quickly, and, preferably, automatically.
5. Their cost must be reasonable.

Ideally, disinfectants should also possess the following characteristics:

1. They should be safe and easy to store, transport, handle, and apply.
2. They should persist in a sufficient concentration to provide reasonable residual protection against possible recontamination before use, or—because this is not a normally attainable property—the disappearance of residuals must be a warning that recontamination may have taken place.

Regulatory Context. Selection of an appropriate disinfection strategy for water treatment requires a balance among three driving forces:

- Providing water free of pathogens. The regulatory focus for pathogen removal is on coliform bacteria, heterotrophic plate counts, *Cryptosporidium* oocysts, *Giardia* cysts, *Legionella*, and viruses.
- Avoiding production of disinfection byproducts (DBPs). Trihalomethanes (THMs), haloacetic acids (HAAs), other halogenated organic compounds, ozone DBPs, oxidation byproducts, and disinfectant residuals present a health risk. They must be limited in drinking water.
- Maintaining a disinfectant residual in the distribution system. Residual disinfectant is provided to maintain the bacteriological quality, provide a rapid means for detection of system contamination, and prevent regrowth of microorganisms.

The disinfectant strategy consists of two parts: primary disinfection and secondary disinfection. *Primary disinfection* refers to the first disinfectant used to achieve microbial inactivation. *Secondary disinfection* refers to the second disinfectant used in a treatment system. Its objective is to provide disinfection residual in the distribution system.

The selection of the primary disinfectant is bounded by four factors: (1) preceding treatment, (2) *total organic carbon* (TOC) concentration, (3) bromide ion concentration, and (4) ability to meet microbial inactivation requirements. If the upstream water treatment processes do not include filtration, the U.S. Environmental Protection Agency strongly discourages the use of ozone or ozone/peroxide systems because of the potential production of ozone byproducts and *biodegradable organic matter* (BOM) that promotes regrowth in the distribution system (U.S. EPA, 1999). The presence of TOC concentrations above 2 mg/L favors selection of a primary disinfectant that will not produce DBPs. The reactions of ozone and ozone/peroxide with bromide ion produces hypobromous acid and bromate ion. If the concentration of bromide ion exceeds 0.10 mg/L, ozone and ozone/peroxide may not be used (U.S. EPA, 1999).

U.S. EPA uses the *Ct* concept to determine the ability of the primary disinfectant to inactivate three target organisms: *Cryptosporidium* oocysts, *Giardia* cysts, and viruses. The target inactivation is based on inactivation expressed in a logarithmic form (“log-inactivation”):

$$LI = \ln\left(\frac{N}{N_0}\right) = kCt \quad (13-27)$$

where LI = log inactivation, dimensionless

N = number of surviving microorganisms per unit volume

N_0 = original number of organisms per unit volume

k = rate constant for inactivation, min^{-1}

C = disinfectant concentration, mg/L

t = contact time, min

LI can be converted to percent removal:

$$\% \text{ removal} = 100 - \left(\frac{100}{10^{LI}}\right) \quad (13-28)$$

TABLE 13-4
Additional *Cryptosporidium* log-inactivation requirements for filtered water

Raw water <i>Cryptosporidium</i> oocysts concentration, oocysts/L	Additional conventional filtration treatment requirements including softening ^a	Additional direct filtration requirements ^a
< 0.075	No additional treatment	No additional treatment
≥0.075 and <1.0	1 log treatment	1.5 log treatment
≥1.0 and <3.0	2 log treatment	2.5 log treatment
≥3.0	2.5 log treatment	3 log treatment

^aAdditional treatment requirements reflect a *Cryptosporidium* removal credit of 3 log for conventional, slow sand, or diatomaceous earth filtration plants, and a 2.5 log credit for direct filtration plants.

Source: Code of Federal Regulations, 40 CFR 141.711, 2006.

EPA's *Long Term Enhanced Surface Water Treatment Rules* (LT1ESWTR and LT2ESWTR) target log-inactivation values are ≥ 3.0 for *Giardia* cysts and ≥ 4.0 for viruses. The log-inactivation required for *Cryptosporidium* oocysts is a function of the raw water *Cryptosporidium* oocyst concentration as shown in Table 13-4.

These credits assume a treated water turbidity ≤ 0.5 NTU for conventional and direct filtration and ≤ 1 NTU for slow-sand and diatomaceous earth filtration (Lin, 2001).

In some cases, where the degree of contamination is high, greater log removals may be appropriate. EPA (1991) recommends the overall treatment requirement be adjusted based on the degree of contamination as shown in Table 13-5.

The selection of a secondary disinfectant depends on the selected primary disinfectant. Of concern are the *assimilable organic carbon* (AOC) concentration, *DBP formation potential* (DBPFP), and distribution system retention time. AOC is produced when a strong oxidant such as ozone is used as a primary disinfectant with a high TOC concentration in the water. Without further treatment, the finished water has a high potential to stimulate regrowth of microorganisms in the distribution system. High AOC is defined as a concentration exceeding 0.10 mg/L after filtration. DBPFP is an indication that organic byproducts can be expected to form in the distribution system if chlorine is used. A high DBPFP is defined as a water meeting one of the following:

- THM seven-day formation exceeds the MCL of 0.08 mg/L.
- HAA5 seven-day formation exceeds the MCL of 0.06 mg/L.

TABLE 13-5
Recommended overall disinfection^a as a function of raw water quality

Microorganism removal/inactivation	Raw water concentration, microorganisms/100 L		
	<1	>1 and <10	<10
<i>Giardia</i> cyst	3 log	4 log	5 log
Virus	4 log	5 log	6 log

^aOverall disinfection includes removal credits for treatment as well as inactivation by disinfectants.

Water that spends a long time in the distribution system allows for the reactions that form THMs to proceed toward completion. A distribution system retention time is considered high if it exceeds 48 hours (U.S. EPA, 1999).

Selection of Disinfectant. Although there are other disinfectants and combinations of disinfectants, this discussion is limited to chlorine gas, liquid sodium hypochlorite, chloramines, chlorine dioxide, ozone, and UV radiation.

A summary of disinfectant properties and considerations in their selection are summarized in Tables 13-6 and 13-7.

TABLE 13-6
Summary of disinfectant properties (based on typical disinfectant application)

Condition	Chlorine	Ozone	Chlorine dioxide	Permanganate	Chloramine	Ozone/peroxide	Ultraviolet
Produce THM with TOC	y	s	n	n	y	s	n
Produce oxidized organics	s	y	s	s	n	y	s
Produce halogenated organics	y	s	n	n	y	s	n
Produce inorganic byproducts	n	s	y	n	n	s	n
Produce BOM	s	y	s	n	n	y	n
MRDL applies	y	n	y	n	y	n	n
Lime softening impacts	y	n	n	n	y	n	y
Turbidity impacts	n	s	n	n	n	s	y
Meet <i>giardia</i> - <2.0 log	y	y	y	n	n	n	y
Meet <i>giardia</i> - >2.0 log	n	y	y	n	n	n	y
Meet <i>crypto</i> - <2.0 log	n	y	y	n	n	n	y
Meet <i>crypto</i> - >2.0 log	n	y	y ^a	n	n	n	y
Meet virus - <2.0 log	y	y	y	n	n	n	y
Meet virus - >2.0 log	y	y	y	n	n	n	y
Secondary disinfectant	y	n	s	n	y	n	n
Operator skill (1 = low; 5 = high)	1	5	5	1	2	5	3
Applicable to large utilities	y	y	y	y	y	y	n
Applicable to small utilities	y	y	y	y	y	y	y

y = yes, n = no, s = sometimes

^a*Ct* values to achieve >2.0 log inactivation are very high at common water temperatures.

TABLE 13-7
Consideration for selecting disinfectant

Consideration	Cl ₂	NaOCl	O ₃	ClO ₂	Chloramine	UV
Residual persistence	Low	Low	None	Moderate	Very low	None
pH dependence	Yes	Yes	Some	Some	Yes	None
Safety concerns	Very high	Moderate	High	Very high	Moderate	Moderate
Complex equipment	Yes	No	Very	Yes	Yes	Yes

(continued)

TABLE 13-7 (continued)
Consideration for selecting disinfectant

Consideration	Cl ₂	NaOCl	O ₃	ClO ₂	Chloramine	UV
Equipment reliability	Good	Very good	Good	Good	Good	Moderate
Process control	Well developed	Well developed	Developing	Developing	Well developed	Developing
O&M requirements	Low	Low	High	High	Low	Low

Sources: Haas, 1999; Hesby, 2005; MWH, 2005.

Figures 13-8 and 13-9 provide a means for narrowing the choices of primary and secondary disinfectant, respectively. The selection flow diagrams do not address the role of microbial growth in settling tanks and filters or the presence of manganese, iron, and sulfides in the raw water.

Where biological growth is a problem in settling tanks and filters, some alternative means of reducing DBPs include reducing NOM, the use of chlorine dioxide as a pretreatment followed by chlorine and chloramine, and ozonation followed by DBP removal with anthracite biofilters or granular activated carbon (GAC).

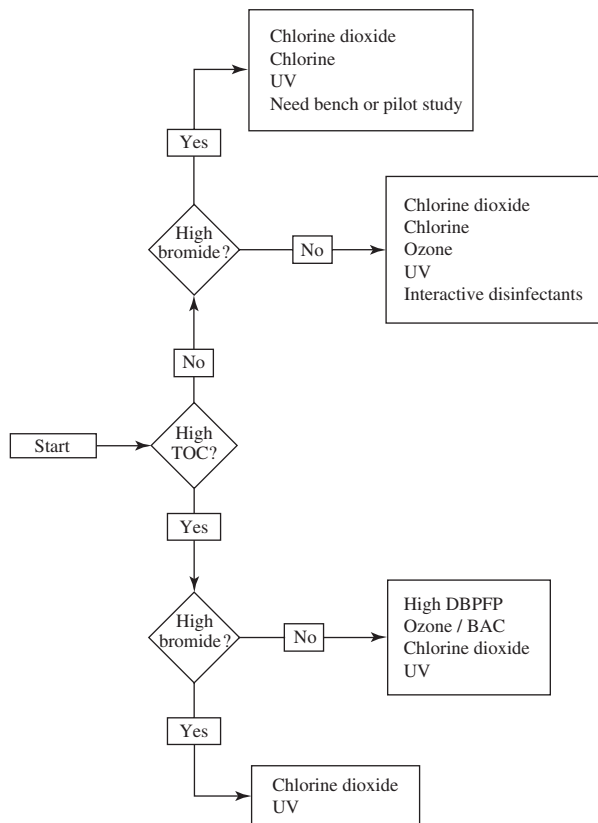
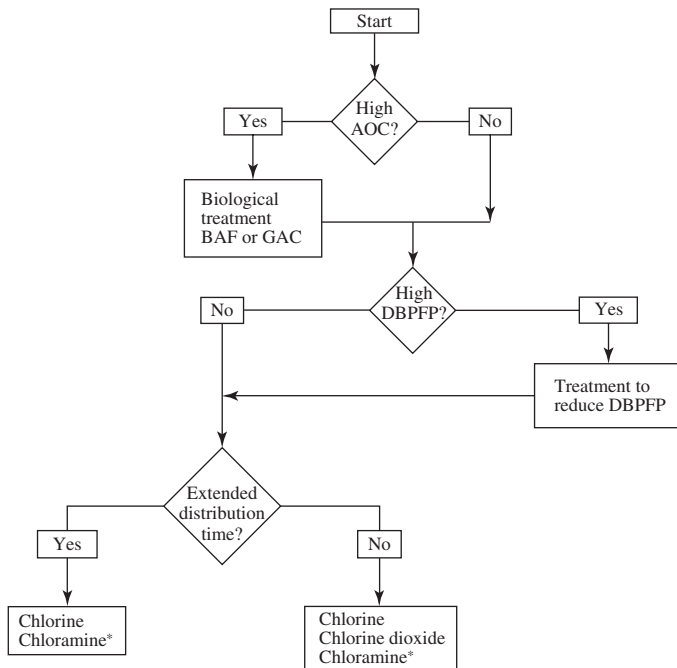

FIGURE 13-8
 Flow diagram to narrow selection of a new primary disinfectant for systems that filter.
 (Source: Adapted from U.S. EPA, 1999.)



*Chloramine is a potential problem because NH_3 promotes regrowth and because of chloramine reactions that release Pb and Cu from pipes.

FIGURE 13-9

Flow diagram to narrow selection of a new secondary disinfectant.

(Source: Adapted from U.S. EPA, 1999.)

Iron, manganese, and sulfides exert an oxidant demand and, in the case of iron and manganese, will form precipitates as a result of oxidation. The precipitates, in addition to being an aesthetic problem, will interfere with the disinfection process.

The use of the flow charts and boundary conditions in selecting primary and secondary disinfectants is illustrated in Example 13-5.

Example 13-5. Select the primary and secondary disinfectants for the town of Stillwater which uses the Noir River for its water supply. The design flow rate is $18,500 \text{ m}^3/\text{d}$. The water is treated by conventional coagulation, sedimentation, and filtration. The time for water to reach the most distant customer at the minimum demand flow rate is 31 hours. The Noir River water analysis is shown below.

Noir River water analysis

Constituent	Concentration
TOC	5 mg/L
Bromide	Not detected
Turbidity	10–500 NTU
<i>Giardia</i> cysts	< 1/100 L
Virus	< 1/100 L
<i>Cryptosporidium</i> oocysts	1.1–2.0/L

Solution:

- a. The concentration of TOC is greater than 2 mg/L so it is considered high. Bromide was not detected. From Figure 13-8, the primary disinfectant alternatives are ozone, chlorine dioxide, and UV.
- b. A comparison of ozone, chlorine dioxide, and UV in Table 13-6 reveals the following highlights:
 - Neither ozone nor ClO_2 are clearly superior with respect to production of byproducts (THM, oxidized organic matter, halogenated organic matter, inorganic byproducts, and BOM). UV is clearly superior.
 - Ozone and UV do not have MRDLs (Maximum Residual Disinfectant Level) while ClO_2 does.
 - All three can achieve > 2.0 log *Giardia* inactivation and > 2.0 virus inactivation. From Table 13-5, the required log removal for *Giardia* cysts and virus when the concentration is $< 1/100$ L is 3 and 4 logs, respectively. The conventional filtration credit for *Giardia* cyst removal is 2.5 and 2 for viruses. Therefore, all can meet the additional disinfection inactivation required.
 - The concentration of ClO_2 or UV dose to meet a 2.0 log inactivation for *Cryptosporidium* oocysts that is required for the concentration found in the Noir River is very high (See Table 13-4 and *Ct* tables*). At the required dose, the potential for exceeding both the ClO_2 MRDL of 0.8 mg/L and chlorite DBP limit of 1.0 mg/L is high.
- c. From Table 13-7, with the exception of safety concerns, ozone and ClO_2 are very comparable. UV has moderate safety concerns and moderate equipment reliability concerns.
- d. Based on this analysis, ozone is selected as the primary disinfectant with the understanding that there will be no residual and that AOC will be a problem.
- e. From Figure 13-9, the flow path leads to a requirement for biological treatment and a high DBPFP.
- f. The distribution system time is 31 hours. This is less than the 48-hour criterion. This leads to ClO_2 or chloramines as the secondary disinfectant choices. Because chloramine is rated as (yes) and ClO_2 is rated s (sometimes) as a secondary disinfectant in Table 13-6, chloramine is selected.

Comments:

1. Over time, with improvements in reliability and O&M, the UV alternative will become more attractive than the ozone option selected here.
2. Other strategies may be more appropriate. For example:
 - Removal of NOM may permit consideration of alternative disinfectants.
 - An improved watershed management program to lower the *Cryptosporidium* discharges from agricultural runoff may lower the overall log removal/inactivation requirement and thus open consideration of other disinfectants.

**Ct* tables may be found at www.mhprofessional.com/wwe or in the Code of Federal Regulations.

Weight Percent Chlorine. Chlorine in one of its forms is the most common disinfectant used in the United States. It is available commercially in pressurized vessels that contain both liquified and gaseous fractions. Sodium hypochlorite (NaOCl), also known as bleach, is a liquid form. Calcium hypochlorite ($\text{Ca}(\text{OCl})_2 \cdot 4\text{H}_2\text{O}$), also known as HTH[®], is sold as a granule, powder, and tablet.

The relative amount of chlorine present in these compounds may be expressed as *weight percent chlorine*. The weight percent chlorine is a measure of the amount of chlorine being purchased or being supplied. It is used to calculate the feed rate to produce the desired dose of chlorine for compounds other than chlorine gas as well as the storage volume required and equivalent operating cost for chemicals. It is defined as

$$\text{Weight \% chlorine} = \frac{\text{GMW of chlorine in compound}}{\text{GMW of compound}}(100\%) \quad (13-29)$$

Example 13-6. Estimate the weight percent chlorine in HTH[®].

Solution. Using the molecular weights of Cl_2 and HTH[®], the weight percent chlorine is

$$\text{Weight \% chlorine} = \frac{2(35.45)}{214.90}(100\%) = 32.99 \text{ or } 33\%$$

Comment. If HTH[®] is selected to supply the required chlorine dose, the mass of HTH[®] to be provided must be (1/0.3299) or about three times the mass of chlorine required assuming the HTH[®] is 100% pure.

Safety Precautions and Chemical Handling. Gaseous chlorine is most often employed by larger utilities. It is normally stored in its shipping container. The recommended standards for chlorine are provided here in detail because of the extreme hazard of the gas and the wide use of chlorine gas for disinfection (GLUMRB, 2003):

- Chlorine gas feed and storage shall be enclosed and separated from other operating areas. The chlorine room shall be:
 - provided with a shatter resistant inspection window installed in an interior wall,
 - constructed in such a manner that all openings between the chlorine room and the remainder of the plant are sealed, and
 - provided with doors equipped with panic hardware, assuring ready means of exit and opening outward only to the building exterior.
- The room shall be constructed to provide the following:
 - each room shall have a ventilating fan with a capacity that provides one complete air change per minute,

- the ventilating fan shall take suction near the floor as far as practical from the door and air inlet,
 - air inlets should be through louvers near the ceiling,
 - separate switches for the fan and lights shall be located outside the chlorine room and at the inspection window,
 - vents from the feeders and storage shall discharge to the outside atmosphere through chlorine gas collection and neutralization systems,
 - floor drains are discouraged. Where provided, the floor drains shall discharge to the outside of the building and shall not be connected to other internal or external drainage systems.
- Chlorinator rooms should be heated to 15°C and be protected from excessive heat.
 - Pressurized chlorine feed lines shall not carry chlorine gas beyond the chlorinator room.
 - A continuous chlorine sensor and alarm is recommended.

A scrubber system that is activated in the event of a chlorine leak is recommended. Section 80.303 of Article 80 of the Uniform Fire Code provides design guidance. The scrubber system uses sodium hydroxide to neutralize the chlorine gas (AWWA, 2006).

Because of safety and security concerns, many utilities have switched to hypochlorite. The decision to switch is a complex management decision because the cost of NaOCl is significantly higher than the cost of gaseous chlorine.

Sodium hypochlorite (also called liquid bleach) may be stored in the original shipping containers or in compatible containers. Fiber-glass reinforced plastic (FRP) tanks, specific polyethylene fabricated for NaOCl storage, and carbon steel tanks lined with rubber or polyvinyl chloride (PVC) are recommended (Hesby, 2005; MWH, 2005). Most small to medium-sized plants feed hypochlorite with positive displacement diaphragm metering pumps or peristaltic metering pumps. The peristaltic pumps are preferred because they operate without vapor lock. Schedule 80 PVC piping provides good service if it is not exposed to sunlight. When sunlight exposure is unavoidable, chlorinated polyvinyl (CPVC) is recommended (MWH, 2005). Ball valves should not be used because they lock down, trap NaOCl off-gases, and explode.

A major design issue with the storage of NaOCl is its stability. Commercial bleach is generally shipped as 12 to 15 percent available Cl_2 at a $\text{pH} \geq 12$. If the pH is held above 11, the rate of decay is very low (Gordon et al., 1997). Concentration and temperature are important considerations in storage. For example, if a 15 weight percent solution is diluted to 7.5 percent, its half-life will increase from 50 to about 140 days if it is stored at 25°C. If it is stored at 7.5 weight percent and 15°C, its half-life will be on the order of 500 days (Gordon et al., 1997; MWH, 2005). At the other end of the spectrum, the crystallization temperatures are: -22°C for a 15 *trade percent* (weight per unit volume so that 1 percent corresponds to a weight of 10 g of available chlorine per liter) solution; -17°C for a 12.5 percent solution; -12°C for a 10 percent solution. The implications for design of a NaOCl storage facility are that it should be protected from sunlight, kept at an ambient temperature less than 20°C but greater than -12°C, and the NaOCl should be diluted on receipt from 15 to 7.5 weight percent. Because

it is delivered at a pH of about 12, dilution induced low-pH decay is normally not a problem (MWH, 2005). However, the dilution water should be soft because the high pH of NaOCl will precipitate hardness from a hard water.

A proprietary system for on-site generation of hypochlorite was introduced in the United States in the 1980s. It uses electrolytic decomposition of NaCl to produce a NaOCl feed solution. Because the hypochlorite solution is generated on demand, it has the safety advantages of hypochlorite without the problem of degradation while the NaOCl solution is in storage. However, power consumption is significant.

Ozone at concentrations greater than 23 percent is explosive. At ambient temperature and pressure, it rapidly decays. Unlike chlorine, it cannot be stored under pressure but must be generated on-site. The corona discharge method of generation is commonly used for drinking water disinfection. In this method, oxygen is passed through an electric field that is generated by applying a high voltage across electrodes separated by a dielectric material. As oxygen passes through the electric field, it is broken down to oxygen singlets ($O\bullet$). These react with oxygen to form O_3 . The source of oxygen is either ambient air or commercially supplied liquid oxygen (LOX). Air-fed ozone systems were used widely prior to the mid-1990s. The LOX-fed systems have become the system of choice since about 1995 (Rakness, 2005). Regardless of the source, the feed gas must be prepared. The system design goals for the feed gas are: temperature $\leq 30^\circ\text{C}$; 100 percent removal of particulate matter ≥ 0.3 micrometers (μm) in diameter, 95 percent removal of particulate matter ≥ 0.1 μm ; hydrocarbons ≤ 4 to 5 ppm, dew point in the range -65°C to -100°C (Dimitriou, 1990). Typical components include: air compressor, after-cooler, refrigerative drying, vapor/liquid separator, prefilters, desiccant dryer, particulate after-filter, and controls. Even with gas transfer efficiencies of 90 to 99 percent, the off-gas from the ozone reactor may have ozone concentrations on the order of 500–1600 ppm (v/v). This exceeds the occupational exposure limit of 0.10 ppm (v/v). The ozone in the off-gas can be destroyed thermally with or without a catalyst. Without a catalyst the required temperature is 300°C – 350°C at a 5 second residence time. The use of a catalyst lowers the required temperature to between 30°C and 70°C (AWWARF, 1991).

Chlorine dioxide cannot be stored because it is not safe. The pure gas may explode as a result of high temperatures, exposure to light, changes in pressure, or exposure to organic contaminants (Hesby, 2005). Therefore, it is generated on-site. Most generation techniques use a chlorine/sodium chlorite mixture. GLUMRB (2003) recommends that sodium chlorite be stored by itself in a separate room and preferably in a separate building detached from the water treatment facility. The storage structure must be of noncombustible materials. Positive displacement feeders are used.

Chloramine is formed on-site by reacting ammonia with chlorine as shown in Equations 13-5 through 13-7. Monochloramine is the desired compound for chloramine disinfection. Dichloramine is a disinfectant, but it also produces undesirable tastes and odors. In addition to being poorly soluble, nitrogen chloride is a foul smelling gas. Monochloramine is formed until the mass ratio of Cl_2/NH_3 exceeds 4 (Hesby, 2005). The recommended mass ratio is in the range between 4.5:1 and 5:1 because this minimizes the concentration of unreacted ammonia (AWWA, 2006). The rate of the reaction is strongly influenced by pH with the highest rate at pH 6 or lower. However, at this pH the amount of dichloramine formed is significant. At pH 8 and above the amount of dichloramine is not significant. A pH between 7 and 8 appears to be the best compromise.

Ammonia is available commercially in three forms: anhydrous ammonia (liquified gas), aqueous ammonia (NH_3 dissolved in water = NH_4OH), and ammonia sulfate crystals. Anhydrous ammonia and aqueous ammonia are the forms most commonly used. With minor modification, the equipment used to feed anhydrous ammonia is the same as that used for chlorine. Although anhydrous ammonia injector systems are available, direct ammonia gas feeder designs are common. Aqueous ammonia is commercially available as a 19 percent by weight solution. Diaphragm metering pumps are used to deliver aqueous ammonia. The recommended piping is carbon or stainless steel. Because it reacts violently with copper, brass, bronze, or other copper alloys, they must not be used in the aqueous ammonia feed system. Ammonia vapors are extremely toxic and appropriate venting must be supplied.

A few of GLUMRB's (2003) recommended safety precautions for aqueous ammonia (also called aqua ammonia) are as follows:

- A closed unpressurized tank with lockout provisions to prevent accidental addition of incompatible chemicals shall be provided for storage. It shall be vented through an inert liquid trap to a high point outside.
- The storage tank shall be fitted with either cooling/refrigeration and/or provision for adding dilution water without opening to prevent ammonia vapor pressure from exceeding atmospheric pressure.
- An exhaust fan shall be installed to withdraw air from high points in the room and makeup air shall be allowed to enter at a low point in the room.

A scrubber system that is activated in the vent of an ammonia leak is recommended. Section 80.303 of Article 80 of the Uniform Fire Code provides design guidance.

For anhydrous ammonia, GLUMRB (2003) recommends safety precautions similar to those specified for chlorine gas. Two notable exceptions are that the air exhaust system shall have an elevated intake and that heaters shall be provided. The complete list of GLUMRB (2003) recommendations should be consulted for design compliance.

Operator Safety. Operators should have Occupational and Safety Administration (OSHA) training on the use of personal protective equipment (PPE). Provisions for PPE and safety equipment include the following (GLUMRB, 2003):

- Full face mask (gas mask) respiratory protection equipment that meets the requirements of the National Institute for Occupational Safety and Health (NIOSH) shall be available but not stored inside any room where gaseous chemicals are used or stored. The units shall use compressed air and have at least a 30 minute capacity. These units are termed *self-contained breathing apparatus* (SCBA).
- Continuous leak detection equipment with an audible alarm and warning light is recommended.
- A deluge shower and eyewash should be installed in the room where disinfection chemicals are used or stored.
- Each operator shall be provided with appropriate protective clothing including rubber gloves, face shields, and rubber aprons appropriate for the chemicals being handled.

The American Water Works Association Manual of Practice M20 (AWWA, 2006) provides detailed recommendations for evaluating safety equipment and the appropriate personal protective equipment (PPE) for tasks involving potential exposure to chlorine compounds.

Sources of Ultraviolet Radiation. Both low-pressure and medium-pressure lamps are available for disinfection applications. Low-pressure lamps emit their maximum energy output at a wavelength of 253.7 nm, while medium-pressure lamps emit energy with wavelengths ranging from 180 to 1370 nm. The intensity of medium-pressure lamps is much greater than low-pressure lamps. Thus, fewer medium-pressure lamps are required for an equivalent dosage. For small systems, the medium-pressure system may consist of a single lamp. Although both types of lamps work equally well for inactivation of organisms, low-pressure UV lamps are recommended for small systems because of the reliability associated with multiple low-pressure lamps (U.S. EPA, 1996).

Contact Facilities. The Chick-Watson law provides the theoretical basis for the EPA's approach to regulation of drinking water disinfection, that is, the provision of adequate chemical dose and contact time (Ct). Prior to the recognition and regulation of THMs, adequate contact time was provided by addition of the primary disinfectant early in the treatment process. Since 1980, when the EPA began to regulate THM, many existing and newly proposed facilities locate the point of addition at the end of the process. This is the approach that will be discussed here.

The disinfection reactors, also called *disinfection chambers* or *contact chambers*, fall into three categories: pipelines, longitudinal-serpentine basins, and cross-baffled serpentine basins. The ideal reactor for chlorine, combined chlorine, and chlorine dioxide is one that exhibits ideal plug-flow, that is, one with no longitudinal dispersion so that the contact time is equal to the hydraulic residence time. The gases Cl_2 , NH_3 , and ClO_2 are metered into a *slip stream* (a portion of the water that has undergone coagulation, settling, filtration, or other treatment) that is then injected into the main flow of water passing into the contact chamber.

A long pipeline, preferably without bends and restrictions, provides the most ideal reactor. For example, a pipeline that provides 30 minutes of contact time at a flow rate greater than $0.044 \text{ m}^3/\text{s}$ and a velocity greater than 0.6 m/s will be nearly ideal, that is, a pipeline about 1 km long (MWH, 2005). Unfortunately, real pipelines generally reach the first customer through a much shorter distance with a less than ideal flow path. However, for that portion of the line that approaches the ideal setting, calculation of the dispersion number provides an estimate of the performance of the reactor. The dispersion number may be estimated as (Sjenitzer, 1958):

$$d_{\#} = 89,500 f^{3.6} \left(\frac{D}{L} \right)^{0.859} \quad (13-30)$$

where $d_{\#}$ = dispersion number, dimensionless
 f = Darcy-Weisbach friction factor, unitless
 D = diameter of pipe, m
 L = length of pipe, m

A goal of the pipeline design is a dispersion number of about 0.01. Lower dispersion numbers add little increase in kill efficiency, while dispersion numbers above about 0.05 drop off rapidly in kill efficiency (Trussell and Chao, 1977).

In the absence of a suitable long pipeline, a longitudinal-serpentine basin is generally the most cost-effective means of providing a contact chamber approaching ideal plug flow (MWH, 2005). Because the serpentine flow results in flow separation and dead spots as a result of the 180° flow reversal, the alternative devices shown in Figure 13-10 have been proposed to correct these problems. Marske and Boyle (1973) recommend a minimum length to width ratio of at least 40:1. It is measured as the width of the flow path to the length of the flow path. In addition, they recommend a sharp crested weir the width of the flow path at the end of the chamber. Height-of-channel to width-of-channel ratios are generally in the range of 1 to 3.

Because no reactor provides ideal plug flow, the contact time is generally less than ideal. To account for nonideal reactors, EPA has adopted a requirement that the Ct value be calculated with the time that 90 percent of the water will be exposed in the disinfection chamber. This time is called t_{10} (U.S. EPA, 1991). Although tracer studies are recommended to determine t_{10} for design, an alternative approach using a baffling classification system is provided. Examples of the various baffle classifications are shown in Figure 13-11. EPA's assumed ratio of t_{10} to the theoretical hydraulic detention time (t_0) for each of the classifications is given in Table 13-8. Figure 13-12 shows the effect of L:W ratio on the t_{10}/t_0 ratio. The use of the baffle classifications in the design of a contact chamber is illustrated in Example 13-7.

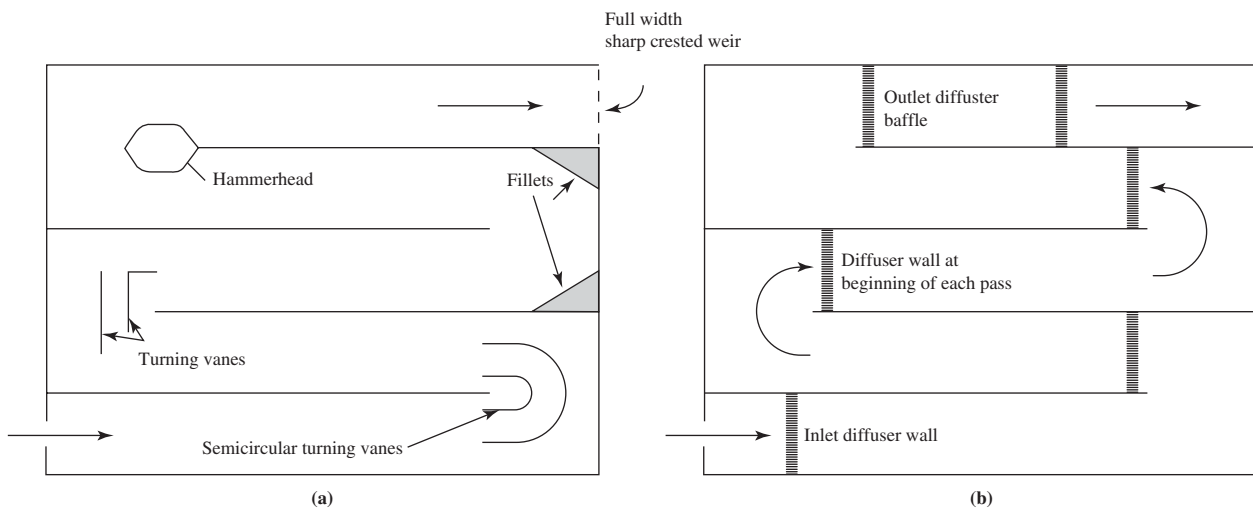

FIGURE 13-10

Controlling flow separation in serpentine basins using various devices.

Note: Do not put in diffuser wall before a turn or halfway through a turn.

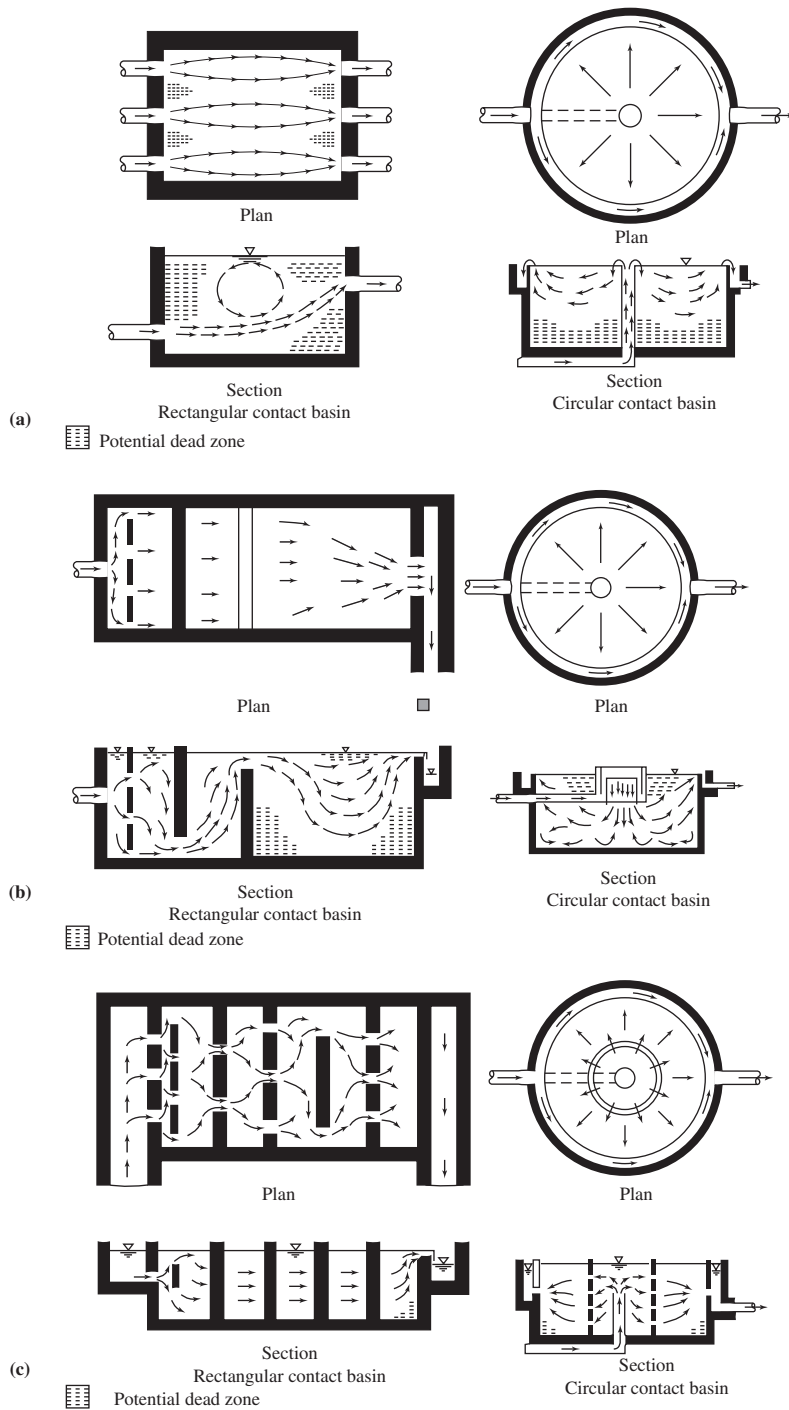

FIGURE 13-11
 Baffling condition examples.
 (a) Poor baffling, (b) average
 baffling, (c) superior baffling.
 (Source: U.S. EPA, 1991.)

TABLE 13-8
Baffle classification

Performance	t_{10}/t_0	Baffling description
Very poor	0.1	Unbaffled (mixed flow), agitated, very low length-to-width ratio, high inlet and outlet flow velocities
Poor	0.3	Single or multiple unbaffled inlets and outlets, no intrabasin baffles
Average	0.5	Baffled inlet or outlet with some intrabasin baffles
Superior	0.7	Perforated inlet baffle, serpentine or perforated intrabasin baffles, outlet weir or perforated launders
Perfect	1.0	Very high length-to-width ratio (pipeline flow), perforated inlet, outlet, and intrabasin baffles

Source: Adapted from U.S. EPA, 1991.

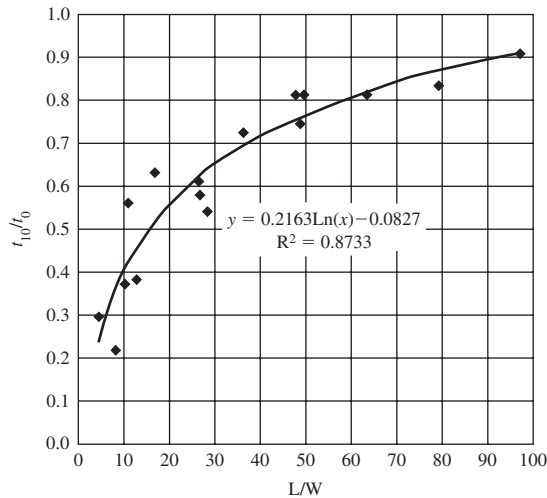

FIGURE 13-12
Impact of L/W on t_{10}/t_0 ratio.

Source: Crozes et al., 1999.

Example 13-7. Design a longitudinal-serpentine chlorine contact chamber for a design flow of 18,400 m³/d. The required t_{10} to achieve a Ct of 200 is 100 min. The design must provide superior performance, that is $t_{10}/t_0 = 0.7$.

Solution:

- a. Calculate the required hydraulic detention time.

$$\frac{100 \text{ min}}{t_0} = 0.7$$

$$t_0 = 142.86 \text{ or about } 145 \text{ min}$$

- b. From the definition of hydraulic detention time, the volume of the reactor is then

$$t_0 = \frac{V}{Q}$$

$$V = (t_0)(Q) = (145 \text{ min})(18,400 \text{ m}^3/\text{d}) \left(\frac{1}{1,440 \text{ min/d}} \right)$$

$$V = 1852.78 \text{ m}^3$$

- c. As recommended, assume a value for $L \geq 40W$ and $H = 3W$. Using Figure 13-3 at $t_{10}/t_0 = 0.7$, find $L:W$ is a little less than 40:1. Therefore, select $L:W = 40:1$.

$$L = 40W$$

$$H = 3W$$

$$\text{width of channel} = W$$

- d. Solve for the width of the channel:

$$V = (W)(3W)(40W) = 120 W^3$$

$$W = \left(\frac{V}{120} \right)^{1/3} = \left(\frac{1852.78 \text{ m}^3}{120} \right)^{1/3} = 2.49 \text{ or } 2.5 \text{ m}$$

- e. The channel dimensions are then

$$L = 40(2.5 \text{ m}) = 100 \text{ m}$$

$$H = 3(2.5 \text{ m}) = 7.5 \text{ m}$$

$$W = 2.5$$

- f. A sketch of the contact chamber plan with devices to control flow separation is shown below.

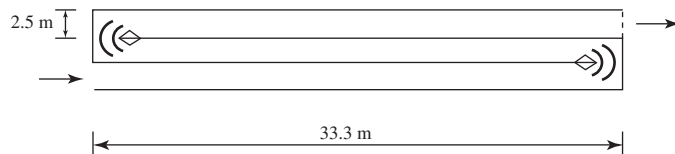

Comment:

1. For ease of construction, the dimensions would be $100 \text{ m} \times 7.5 \text{ m} \times 2.5 \text{ m}$. This provides a volume of $1,875 \text{ m}^3$, which is greater than the $1,852.78 \text{ m}^3$ required.
2. To meet redundancy requirements, two contact chambers of this size must be provided.

When ozone is bubbled into the contact chamber rather than a slip stream, a cross-baffled serpentine chamber is used (Figure 13-13). The number and size of the cells depends on the ozonation objective. For oxidation only (no disinfection), two or four cells are used. For disinfection to achieve *Giardia* and virus inactivation, six or eight cells are common. *Cryptosporidium* inactivation calls for 10 or more cells (Rakness, 2005). Normal operation is to use diffusers in

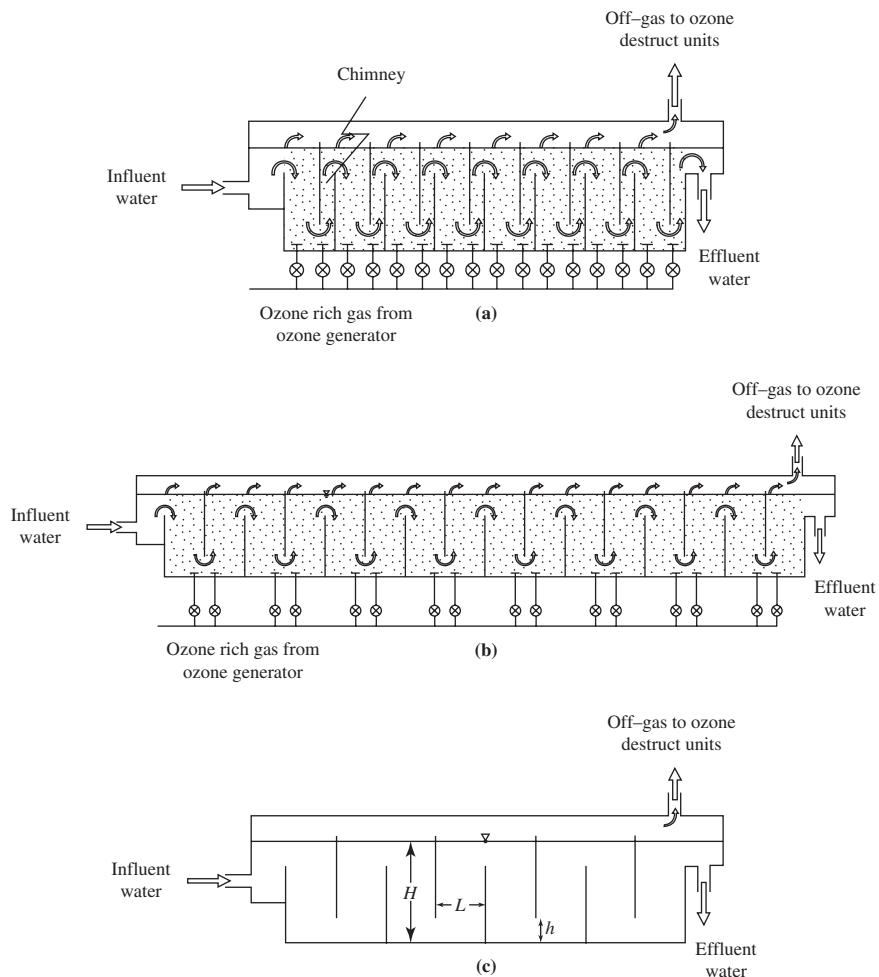
**FIGURE 13-13**

Schematics cross-sectional views of two alternate designs for an eight-chamber, over-under contact chamber: (a) with chimneys and (b) without chimneys. Figure (c) provides dimension definitions.

the first cell of contact chamber as shown in the figure. However, if the initial diffusers cannot meet the ozone demand, then the piping system is designed with the ability to place diffusers in several cells or, in the extreme, in every cell. This allows for ozone injection to maintain the required concentration, C , at the desired level. Pilot scale testing is used to determine the need for diffusers in more than one cell. Porous diffusers that provide fine bubbles provide a higher ozone transfer efficiency than perforated pipe. Using computational fluid dynamic (CFD) modeling, Henry and Freeman (1996) found that the ratio of fluid depth (H) to the longitudinal width (W) and the ratio of the depth of the opening under the baffle to the longitudinal width can be used to maximize the t_{10}/t_0 ratio. Their work showed that at $H:L = 4:1$ and $W:L = 1:1$, a t_{10}/t_0 ratio of 0.65 was achieved. H ranged from 6 to 7.5 m.

Ideally the dose and contact time for ozonation is determined from bench and/or pilot scale data using actual raw water samples. Although the maximum practical concentration of ozone in

solution is 40 mg/L (U.S. EPA, 1986), normal dose values are less than 10 mg/L for drinking water applications. Ozone gas transfer rates are on the order of 85 percent for air-fed ozone systems and 95 percent for liquid oxygen-fed systems. Thus, for a 10 mg/L dose, the transferred dose will be on the order of 8.5 to 9.5 mg/L.

Most conventional UV reactors are available in two types: closed vessel and open channel. For drinking water applications, the closed vessel is generally the preferred UV reactor for the following reasons (U.S. EPA, 1996):

- Smaller footprint.
- Minimized pollution from airborne material.
- Minimal personnel exposure to UV.
- Modular design for installation simplicity.

Figure 13-14 shows a conventional closed-vessel UV reactor.

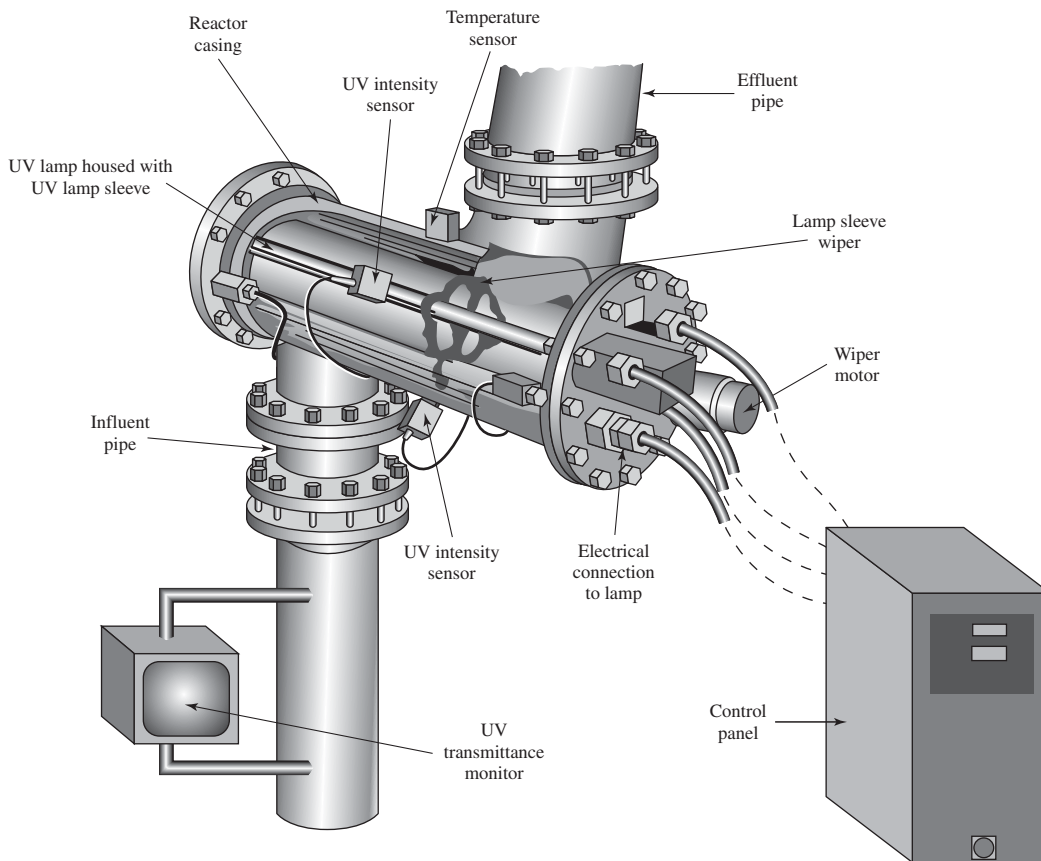

FIGURE 13-14
UV disinfection system schematic. (Source: Aquionics.)

Ballasts (i.e., transformers) that control the power of the UV lamps are either electronic or electromagnetic. Electronic ballasts offer several potential advantages including lower lamp operating temperatures, higher efficiencies, and longer ballast life.

The equation for UV dose indicates that dose is directly proportional to exposure time and thus inversely proportional to system flow rate. UV intensity (I) is a function of water UV transmittance and UV reactor geometry as well as lamp age and fouling. UV intensity can be estimated by mathematical modeling and verified by bioassay. Exposure time is estimated from the UV reactor specific hydraulic characteristics and flow patterns.

The major factor affecting the performance of UV disinfection systems is the influent water quality. Particles, turbidity, and suspended solids can shield pathogens from UV light or scatter UV light to prevent it from reaching the target microorganism, thus reducing its effectiveness as a disinfectant. Some organic compounds and inorganic compounds (such as iron and permanganate) can reduce UV transmittance by absorbing UV energy or coating the lamps. When this occurs, higher levels of UV are required to achieve the same dose. Therefore, it is recommended that UV systems be installed downstream of the filters so that removal of particles and organic and inorganic compounds is maximized upstream of UV.

Water turbidity and UV transmittance are commonly used as process controls at UV facilities. The UV percent transmittance of a water sample is measured by a UV-range spectrophotometer set at a wavelength of 253.7 nm using a 1-cm-thick layer of water. The water UV transmittance is related to UV absorbance (A) at the same wavelength by the equation:

$$\text{Percent transmittance} = 100\% \times 10^{-A} \quad (13-31)$$

For example, a water UV absorbance of 0.022 per cm corresponds to a water percent transmittance of 95 (i.e., at 1 cm from the UV lamp, 95 percent of lamp output remains). Similarly, a UV absorbance of 0.046 per cm is equivalent to 90 percent UV transmittance.

EPA's Ct Tables. The EPA's tables (Code of Federal Regulations, 40 CFR 141.74 and 40 CFR 720) provide the simplest approach for establishing a design strategy for disinfection. The tables are provided in Appendix D. The tables set disinfection credits for *Giardia*, *Cryptosporidium*, and viruses when chlorine, chloramine, chlorine dioxide, ozone, or UV is used. Water temperature and pH are addressed in the tables.

Chlorine Dose Guidance. Michigan's rules for chlorine residuals provide guidance on dosage. They require that the minimum free chlorine residual at active points in a water distribution system be 0.2 to 0.5 mg/L and that combined chlorine residuals be 1.0 to 2.0 mg/L. The rules also suggest that it is desirable to have a trace of free chlorine at distant points in the distribution system.

Disinfection Design

Ultimately the agency that administers drinking water regulations will determine the required Ct requirements and the credits that will be given for various treatment steps. The following steps can be taken to determine the probable credits (adapted from Hesby, 2005):

1. Determine the total removal/inactivation required.
 - Tables 13-4 and 13-9 provide guidance for standard removal/inactivation credits.
 - For vulnerable sources, higher removal/inactivation may be required (Table 13-5).

TABLE 13-9
Log-removal/inactivation requirements for filtered water

Microorganism	Log removal/inactivation	Remarks
<i>Giardia</i> cysts	≥ 3	
Viruses	≥ 4	
<i>Cryptosporidium</i> oocysts	0 to 2.5	See Table 13-4

2. Determine the credits for physical removal.
 - Table 13-10 provides guidance for standard treatment credits.
3. Determine the credits required for inactivation by disinfection.
 - The difference between the removal/inactivation required and the physical removal credits is the required inactivation.
4. Select the disinfectant.
 - Using the boundary conditions (TOC, AOC, DBPFP, and distribution detention time), select the primary and secondary disinfectant.
5. Determine the required Ct to achieve the required inactivation for the design conditions (pH, temperature).
6. Compute t_{10} for the water to reach the first customer.
7. Compute the Ct credit at the first customer and the credit required for the contact chamber.
8. Establish the contact chamber's hydraulic efficiency using Figure 13-11 or Figure 13-12 and find t_{10}/t_0 from Table 13-8 or Figure 13-12.
9. Compute the required hydraulic detention time (t_0).
10. Design the contact chamber.
11. Iterate the design for alternate disinfectants, contact times, temperatures, flow rates, and pH values.

Example 13-8 illustrates the design process through step 9.

TABLE 13-10
Standard log-removal credits for treatment

Process	Log removal credit		
	<i>Giardia</i> cysts	Viruses	<i>Cryptosporidium</i> oocysts
Conventional filtration plants	2.5	2	3
Direct filtration plants	2	1	2.5

Example 13-8. Continue the design of the ozone disinfection system for Stillwater (Example 13-5). The pH and temperature selected for the design analysis are 7.0 and 5°C respectively. For the design of the contact chamber assume $t_{10}/t_0 = 0.65$. From bench-scale test data, the second order rate constant was determined to be 3.5 L/mol · s. Assume a transferred dose of 2.0 mg/L.

Solution:

- a. The difference between the removal/inactivation required and the physical removal credit is the required inactivation. From Example 13-5 for the Noir River:

	Required log removal/inactivation	Treatment log removal credit	Disinfectant log inactivation required to meet standard
<i>Giardia</i> cysts	3	2.5	0.5
Viruses	4	2	2
<i>Cryptosporidium</i> oocysts	5	3	2

The last column in this table (Disinfectant log inactivation required to meet standard) is the difference between the removal/inactivation required and the values found in the first two columns, that is, (Required log removal/inactivation) – (Treatment log removal credit). The “Required log removal/inactivation” for *Cryptosporidium* is based on the raw water concentration of 1.1 to 2.0 oocysts/L given in Example 13-5, and the additional log-inactivation requirements given in Table 13-4. In the footnote to Table 13-4 it is noted that the additional treatment reflects a credit of 3 log credit for conventional treatment. Therefore, 2 log is added to the 3 log credit given in the footnote for a total of 5 log required.

- b. From Example 13-5, the primary disinfectant is ozone.
- c. Using the EPA’s *Ct* tables in Appendix D, the *Ct* to achieve the required log inactivation for each microorganism at a temperature of 5°C is

<i>Giardia</i> cysts	1.9 mg · min/L
Viruses	4 log inactivation will occur at the <i>Ct</i> of 1.9 mg · min/L
<i>Cryptosporidium</i> oocysts	32 mg · min/L

Therefore, the *Cryptosporidium Ct* governs.

- d. Determine the required hydraulic residence time. With the bench-scale test dose of 2.0 mg/L transferred dose, the required t_{10} is

$$\frac{Ct}{C} = \frac{32 \text{ mg} \cdot \text{min/L}}{2.0 \text{ mg/L}} = 16 \text{ min}$$

and if the ozone concentration remains constant throughout the contact chamber, the theoretical hydraulic detention time with the assumed t_{10}/t_0 of 0.65 is

$$\frac{t_{10}}{t_0} = \frac{16 \text{ min}}{t_0} = 0.65$$

$$t_0 = \frac{16 \text{ min}}{0.65} = 24.6 \text{ min}$$

- e. Because ozone generating capacity is expensive and the energy consumption is high, Rakness (2005) recommends an optimized design that takes the decay into account by numerical integration. To perform the numerical integration, the concentration leaving each chamber must be estimated. This requires the decay rate constant in compatible units for Ct calculation. The conversion is

$$\frac{(3.5 \text{ L/mole} \cdot \text{s})}{(48,000 \text{ mg/mole of ozone})} = 7.29 \times 10^{-5} \text{ L/mg} \cdot \text{s}$$

or $4.38 \times 10^{-3} \text{ L/mg} \cdot \text{min}$

- f. An iterative solution is required. Based on Rakness (2005), assume 10 cells. The spreadsheet solution is shown below. **Note that this is a solution, not the first trial.** The first trial with 2.0 mg/L did not achieve the desired Ct of 32 mg · min/L.

Cell no.	Concentration at cell influent, mg/L	HDT, min	Residual at cell effluent, mg/L	t_{10} , min	Ct , mg-min/L
1	2.30	2.46	2.24	1.60	N/A
2	2.24	2.46	2.19	1.60	3.50
3	2.19	2.46	2.14	1.60	3.42
4	2.14	2.46	2.09	1.60	3.35
5	2.09	2.46	2.05	1.60	3.27
6	2.05	2.46	2.00	1.60	3.20
7	2.00	2.46	1.96	1.60	3.13
8	1.96	2.46	1.92	1.60	3.07
9	1.92	2.46	1.88	1.60	3.01
10	1.88	2.46	1.84	1.60	2.95
11	1.84	2.46	1.81	1.60	2.89
				Sum =	31.79 or 32

Explanation of computations:

For the first cell, 2.30 is the initial dose; 2.46 min is the hydraulic detention time (HDT) based on a total HDT of 24.6 min calculated in step d divided into 10 cells that provide contact (the need for the 11 cells shown is discussed below); 2.24 is the calculated concentration of the influent dose after 2.46 min using the second order decay

equation from Example 13-3; t_{10} is the effective contact time using $t_{10}/t_0 = 0.65$ for the efficiency of contact; Ct is the product of 2.24×1.60 . Using the first cell, the residual at the cell effluent is calculated as follows:

$$C = \frac{2.30 \text{ mg/L}}{1 + (4.38 \times 10^{-3} \text{ L/mg} \cdot \text{min})(2.46 \text{ min})(2.30 \text{ mg/L})} = 2.24$$

The Ct for this cell is not counted because the influent water has no ozone. The effluent ozone concentration is a first approximation based on the decay assuming the ozone concentration at the inlet was 2.30 mg/L. A more rigorous solution requires integration of the ozone profile based on the kinetics of ozone dissolving into solution and the decay.

For the second and subsequent cells, the calculations are identical except the influent concentration is the effluent concentration from the previous cell. The 11th cell is added to achieve the required Ct of 32 mg · min/L.

g. Design the contact chamber.

The volume of the chamber is calculated from the hydraulic detention time and the design flow rate (Example 13-4).

$$V = t_0 Q = (24.6 \text{ min})(18,500 \text{ m}^3/\text{d}) \left(\frac{1}{1,440 \text{ min/d}} \right) = 316.04 \text{ or } 316 \text{ m}^3$$

Using the Henry and Freeman (1996) optimum ratios, a depth of 6.0 m and an assumed $H = 4L$:

$$L = \frac{H}{4} = \frac{6}{4} = 1.5 \text{ m/cell}$$

$$V = (H)(L/\text{cell})(\text{number of cells})(\text{width of cell})$$

$$316 \text{ m} = (6 \text{ m deep})(1.5 \text{ m long/cell})(10 \text{ cells})(\text{width of cell})$$

$$\text{width of cell} = \frac{316 \text{ m}^3}{(6 \text{ m})(1.5 \text{ m/cell})(10 \text{ cells})}$$

$$= 3.51 \text{ or } 3.5 \text{ m}$$

The final contact chamber dimensions must include 11 chambers to account for the first chamber. Therefore, the final dimensions are 6 m deep \times 3.5 m wide \times 16.5 m long.

Comments:

1. Two contact chambers of the size designed must be provided for redundancy.
 2. Because the initial estimate of t_0 was based on a dose of 2.0 mg/L rather than 2.3 mg/L the calculated t_0 is a little high. However, the effluent concentration from the first cell is an approximation, so the extra detention time provides a small safety factor.
 3. The effluent concentration used for contact assumed that it was constant while the water passed through the cell. This is conservative because the average was slightly higher.
-

Multiple Contact Reactors. When sequential contactors are used to provide the required contact time to meet the Ct requirements, the calculation procedure is modified by the following stepwise procedure:

1. Calculate the Ct value at the exit of each sequential reactor using the residual disinfectant concentration at that point.
2. Find the the 3 log (99.9%) or 4 log (99.99%) Ct required from the appropriate EPA Ct table based on water temperature and pH.
3. Compute the inactivation ratio, that is, $Ct_{\text{calc.}}/Ct_{99.9}$ or $Ct_{\text{calc.}}/Ct_{99.99}$.
4. Calculate the estimated log inactivation by multiplying the ratio computed in step 3 by 3 for *Giardia* and by 4 for viruses because of the requirement for 3 log and 4 log inactivations, respectively.
5. Sum the segment inactivations to determine the total system log inactivation.

This process is demonstrated in Example 13-9.

Example 13-9. Estimate the total log inactivation for *Giardia* for disinfection contact in a contact basin followed by a pipeline as described below. The water temperature is 5°C and the pH is 7.5 for both reactors.

Reactor	t_{10} contact time	Chlorine residual, mg/L
Clearwell	67 min	1.0
Pipe	53 min	0.6

The chlorine residual was measured at the exit from the reactor.

Solution:

- a. Calculate Ct for the clearwell.

$$Ct_{\text{calc.}} = (1.0 \text{ mg/L})(67 \text{ min}) = 67 \text{ mg} \cdot \text{min} / \text{L}$$

- b. Find the $Ct_{99.9}$ for *Giardia* from Appendix D. At a temperature of 5°C, pH = 7.5, and $C = 1.0 \text{ mg/L}$, $Ct_{99.9}$ is 179 mg · min/L.
- c. Calculate $Ct_{\text{calc.}}/Ct_{99.9}$.

$$\frac{Ct_{\text{calc.}}}{Ct_{99.9}} = \frac{67 \text{ mg} \cdot \text{min/L}}{179 \text{ mg} \cdot \text{min/L}} = 0.374 \text{ or } 0.37$$

- d. Calculate Ct for the pipe.

$$Ct_{\text{calc.}} = (0.6 \text{ mg/L})(53 \text{ min}) = 31.8 \text{ mg} \cdot \text{min/L}$$

- e. Find the $Ct_{99,9}$ for *Giardia* from Appendix D. At a temperature of 5°C, pH = 7.5 and $C = 0.6$ mg/L, $Ct_{99,9}$ is 171 mg · min/L.
- f. Calculate $Ct_{\text{calc.}}/Ct_{99,9}$.

$$\frac{Ct_{\text{calc.}}}{Ct_{99,9}} = \frac{31.8 \text{ mg} \cdot \text{min/L}}{171 \text{ mg} \cdot \text{min/L}} = 0.186 \text{ or } 0.19$$

- g. The sum of $Ct_{\text{calc.}}/Ct_{99,9}$ is $0.37 + 0.19 = 0.56$. The equivalent log reduction is then

$$(3 \log)(Ct_{\text{calc.}}/Ct_{99,9}) = (3)(0.56) = 1.7 \log \text{ *Giardia* inactivation.}$$

Comment. Note that the time is t_{10} and not the hydraulic residence time.

13-3 EMERGENCY DISINFECTION

When disasters such as floods, tornadoes, and hurricanes occur or when the water treatment plant disinfection system fails, emergency precautions are required to prevent widespread disease.

In the case of disruption of the water treatment plant disinfection system, loss of water pressure due to a break in the water main, or similar circumstances, the water utility will announce a boil water advisory notice. This means that water to be used for consumption, food preparation, and brushing teeth should be boiled vigorously (rolling boil) for 5 minutes.

In the case of natural disasters, the boil water advisory should also be given. In addition, treatment of other water for washing hands and utensils is also recommended. Clear water may be obtained by filtering through clean cloth. Disinfection of the clear water can be accomplished with household bleach. In general, commercial household bleach contains 5.2 percent (52,000 mg/L) NaOCl. Two to four drops of household bleach per liter of water will provide a measure of protection. Boiled water should be stored in containers cleaned with boiled water or disinfected water.

For extended durations without public water supply, advisories should also include instructions to bury fecal waste and to wash hands in disinfected or boiled water. Epidemics that follow natural disasters often claim more lives than the disaster because these simple measures are not implemented.

13-4 FLUORIDATION

Introduction

When the concentration of naturally occurring fluoride is too low to prevent tooth decay, it is added into the water supply. When it produces mottling because it is too high, it is removed from the water. The discussion in this chapter is focused on increasing the concentration to prevent tooth decay.

Fluoridation Chemistry

The three most commonly used fluoride compounds are sodium fluoride (NaF), fluorosilicic acid (H_2SiF_6), and sodium fluorosilicate (Na_2SiF_6). The American Water Works Association (AWWA) standards for these compounds are:

- AWWA Standard B701 for sodium fluoride.

- AWWA Standard B702 for sodium fluorosilicate.
- AWWA Standard B703 for fluorosilicic acid.

Sodium Fluoride. When added to water, NaF dissociates into sodium and fluoride ions:



At temperatures commonly found in water treatment, its solubility is 4 g/100 mL of water. Standard grade NaF has a solution pH of approximately 7.6. Commercial grade NaF has a nominal purity of 98 percent (AWWA, 2004).

Fluorosilicic Acid. The most common concentration of H_2SiF_6 used in water treatment is 23–25 percent aqueous solution. In water it dissociates virtually 100 percent to form hydrofluoric acid and silicon tetrafluoride:



Hydrofluoric acid strongly dissociates:



At high concentration, SiF_4 will volatilize out of solution. At normal water treatment doses it reacts with water to form silicic acid (H_2SiO_3) or silicon dioxide (SiO_2):

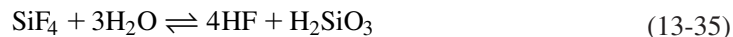

All solutions of fluorosilicic acid exhibit a pH of approximately 1.2. Commercial grade fluorosilicic acid has a nominal purity of 23 percent and a freezing point of -16°C (AWWA, 2004).

Sodium Fluorosilicate. When dissolved in water, Na_2SiF_6 dissociates:



The most common reaction of SiF_6^- is hydrolysis:

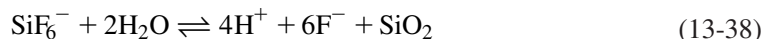

An alternate pathway is the slow dissociation to form F^- and silicon tetrafluoride:



The pH values of the solutions are generally about 3.6. Commercial grade sodium fluorosilicate has a nominal purity of 98.5 percent (AWWA, 2004).

Available Fluoride Ion. The *available fluoride ion* is the weight fraction of fluoride in the compound:

$$\text{AFI} = \frac{\text{GMW F}^-}{\text{GMW of Compound}} \quad (13-40)$$

The available fluoride as a percent of the commercial grade compound is

$$\text{Available \%} = (\text{AFI})(\% \text{ Purity}) \quad (13-41)$$

Fluoridation Practice

Dosage. The dosage is the amount of fluoride chemical to achieve the optimum fluoride level to prevent tooth decay. Initially, the level was obtained by examination of the teeth of thousands of children living in various places with different fluoride levels. Early in the investigation the variation was linked to the local air temperature, which had a direct bearing on the amount of water children consumed at different ages (Reeves, 1999). The Division of Oral Health of the Centers for Disease Control and Prevention (CDC) developed an optimum scheme based on the five-year annual average of maximum daily temperatures. The following expression, when calculated to one decimal point, summarizes the tabular presentation that may be found in AWWA Manual M4:

$$\text{Dosage} = 8 \times 10^{-4}(T)^2 - 5.82 \times 10^{-2}(T) + 1.7432 \quad (13-42)$$

where Dosage = fluoride concentration, mg/L

T = annual average of maximum daily temperatures, °C

The range of acceptable concentrations is from 0.1 mg/L below to 0.4 mg/L above the dosage (AWWA, 2004). The applied dosage is the dose calculated using Equation 13-40 minus the naturally occurring fluoride concentration.

Feed Systems. The simplest fluoridation system is based on fluorosilicic acid. The acid is supplied in carboys. These are set on a platform scale, which is used to monitor the dose. Piston, diaphragm, or peristaltic pumps made of polyvinyl chloride (PVC) or polypropylene are used to inject the fluorosilicic acid into the main water flow. A vacuum breaker is used to prevent water from the main being siphoned into the feed system.

A sodium fluoride saturator (Figure 13-15) is a simple system that may be used for plants up to 50,000 m³/d. Sodium fluoride from bags is transferred into the tank and dissolved. The pump selection and use of a vacuum breaker is the same as that for fluorosilicic acid. The mixing tank must be corrosion resistant. The water supply will have to be softened because precipitation of the fluoride as CaF will reduce the dose.

Dry feeding of sodium fluorosilicate or sodium fluoride may be by either gravimetric or volumetric feeder to a dissolving tank. The solution is then transported to the main water flow by either gravity or a pump.

For the smallest plants (< 3,000 m³/d), solution feed from carboys is usually selected. For plants in the intermediate range (3,000 to 10,000 m³/d), manual or automatic fluoride solution preparation in a saturator is generally selected. Dry feed systems are generally found in plants

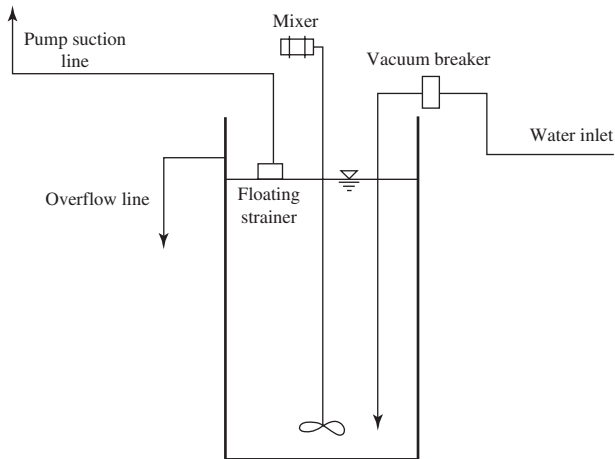

FIGURE 13-15

Sodium fluoride saturator. NaF is added manually from bags to prepare the solution. The Polyethylene tank has a volume of about 200 L.

(Source: AWWA, 2004.)

having higher flow rates. Volumetric feeders will provide satisfactory service for flows as low as 500 m³/d but are more commonly employed when sodium fluorosilicate is the source of fluoride and the flow rates are over 10,000 m³/d. For large plants (>10,000 m³/d) using sodium fluoride, gravimetric feeders are appropriate (AWWA, 2004).

Feed Point. Fluoride compounds must be fed after conventional filtration or softening. Feeding fluoride compounds upstream of coagulation/flocculation, settling, and filtration results in a significant decrease in TOC removal, clarifier performance, overloading of the filter and loss of up to 40 percent of the applied fluoride dose ((Pommerenk and Schafran, 2002). In softening plants the fluoride will precipitate as CaF if it is introduced before filtration of the softened water.

Safety Precautions. The greatest chance for exposure to dry fluoride chemicals comes from the inhalation of dust generated when feeder hoppers are being filled. The fumes from fluorosilicic acid are extremely toxic. During filling operations, operators must wear a respirator approved by the National Institute for Occupational Safety and Health (NIOSH), splash-proof safety goggles, an apron, and rubber gloves. A deluge shower and eyewash should be installed in the room where fluoridation chemicals are used or stored. Air exhausted from the fluoride handling equipment shall discharge through a dust filter to the outside atmosphere of the building (GLUMRB, 2003).

Fluorosilicic acid should not be stored out of doors. Exposure to the sun will cause build up of pressure in the containers. Exposure to temperatures below -16°C will result in freezing and potential container rupture.

The state solid waste division should be consulted for proper procedures for disposal of empty fluoride containers and/or bags. Fluorosilicic acid containers should not be reused (AWWA, 2004).

Example 13-10. Determine the chemical feed rate for sodium fluorosilicate in g/min as the compound and in mL/min of the saturated solution for the following conditions:

Average maximum daily air temperature = 18°C
 Naturally occurring fluoride concentration = 0.2 mg/L
 Commercial purity of Na₂SiF₆ = 95%
 Solubility = 0.762 g/100 mL
 Flow rate = 158 m³/h

Solution:

- a. Determine the optimum fluoride level using Equation 13-42.

$$\text{Dosage} = 8 \times 10^{-4}(18)^2 - 5.82 \times 10^{-2}(18) + 1.7432 = 0.955 \text{ or } 1.0 \text{ mg/L}$$

- b. Determine the dosage to be added to the natural background concentration.

$$\text{Dosage} = 1.0 \text{ mg/L} - 0.2 \text{ mg/L} = 0.8 \text{ mg/L}$$

- c. Calculate the available fluoride ion in Na₂SiF₆.

$$\text{AFI} = \frac{(6)(19 \text{ g/mole})}{(2)(23 \text{ g/mole}) + 28 \text{ g/mole} + (6)(19 \text{ g/mole})} = \frac{114}{188} = 0.606 \text{ or } 0.61$$

- d. Calculate the mass feed rate.

$$\begin{aligned} \text{Feed rate} &= \frac{(0.8 \text{ mg/L})(158 \text{ m}^3/\text{h})(1,000 \text{ L/m}^3)}{(0.61)(0.95)} \\ &= 218,119 \text{ mg/h or } 218 \text{ g/h or } 3.6 \text{ g/min} \end{aligned}$$

- e. The solution feed rate:

$$\text{Solution feed rate} = \frac{3.6 \text{ g/min}}{7.62 \times 10^{-3} \text{ g/mL}} = 472 \text{ mL/min}$$

Comments:

1. The factor of 0.95 in step (d) is the purity.
2. The solution feed rate is the mass feed rate divided by the solubility of sodium fluorosilicate.

13-5 OPERATION AND MAINTENANCE

The following O&M activities are typical:

- Routine measurement of residuals both in the plant and the distribution system to ensure compliance with applicable regulations.
- Daily, weekly, and monthly preventive maintenance is essential as the chemicals are corrosive and materials failure can result in catastrophic injury and damage to facilities.

- Corrective action drills and maintenance of response equipment and materials for chemical leakage.
- Periodic “hands-on” safety training.

Visit the text website at www.mhprofessional.com/wwe for supplementary materials and a gallery of photos.

13-6 CHAPTER REVIEW

When you have completed studying this chapter, you should be able to do the following without the aid of your textbooks or notes:

1. Identify the chemical species that are included in the terms *free available chlorine*, *chloramine*, and *total chlorine*.
2. Explain why sodium hypochlorite is replacing chlorine as a disinfectant and why it is equally effective.
3. Explain why light in the ultraviolet range of wavelengths is effective in disinfection while light in other wavelengths is not.
4. Discuss the role of NOM and each of the common disinfectants (Cl_2 , chloramines, ClO_2 , O_3 , and UV) in forming disinfection byproducts.
5. Explain the implications of the Chick-Watson law in the design of disinfection facilities.
6. Identify the target microorganisms used by the U.S. Environmental Protection Agency to establish regulations for disinfection.
7. Identify the four factors that bound the selection of a primary disinfectant.
8. Select an appropriate reactor configuration to provide superior contacting performance.
9. Explain why temperature is used to govern the concentration of fluoride in drinking water.
10. Select an appropriate chemical form of fluoride given the design water flow rate for a community.

With the use of this text, you should be able to do the following:

11. Given the pH and chlorine or hypochlorous acid concentration in water, determine the fractions that are HOCl and OCl^- .
12. Calculate the masses of ammonia and Cl_2 or HOCl required to achieve a given concentration of monochloramine for a given water plant flow rate.
13. Calculate the percent available chlorine or the relative oxidation potential of compounds given a table of half-reactions.
14. Determine the decay rate constant for first and second order reactions of a disinfectant from a set of data.
15. Determine the decay rate constant for a Chick-Watson reaction given a set of Ct data and an assumption about the value of n .

16. Given a set of data of contact times and corresponding chlorine doses to achieve a given percent inactivation, determine a Ct value.
17. Select a primary and a secondary disinfectant for a given set of water quality data.
18. Calculate the weight percent of a chlorine compound.
19. Design a contact chamber for disinfection by chlorine compounds given the required Ct .
20. Design a contact chamber for ozone disinfection given the required Ct .
21. Determine the appropriate Ct value required for a given water quality, pre-disinfection treatment, and disinfectant.
22. Determine the appropriate fluoride dose for a given temperature.
23. Calculate the feed rate of a given fluoride compound to achieve a given fluoride dose in a given water flow rate.

13-7 PROBLEMS

- 13-1. What is the pH of a water at 25°C that contains 0.50 mg/L of hypochlorous acid? Assume equilibrium has been achieved. Neglect the dissociation of water. Although it may not be justified by the data available, report the answer to two decimal places.
- 13-2. If the pH in Problem 13-1 is adjusted to 7.00, what would be the OCl^- concentration in mg/L?
- 13-3. Estimate the mass feed rate (g/min) of HOCl and of NH_3 to achieve a monochloramine residual of 1.8 mg/L in a flow rate of 38,000 m³/d.
- 13-4. Estimate the mass feed rate (g/min) of Cl_2 and of NH_3 to achieve a monochloramine residual of 2.0 mg/L in a flow rate of 1,700 m³/d.
- 13-5. Estimate the percent available chlorine in chlorinated lime (CaOCl_2).
- 13-6. Estimate the percent available chlorine in monochloramine.
- 13-7. Estimate the percent available chlorine in dichloramine.
- 13-8. Based on a hydraulic analysis, the town of Longview has determined that the travel time for water to be carried to the most distant customer is 26 hours. A laboratory study of the decay of chlorine in the filtered water yielded the results shown below. What dose of chlorine is required to maintain a residual of 0.5 mg/L of chlorine at the most distant customer's tap? Use a spreadsheet program you have written to determine the decay constant.

Laboratory study

Time, h	Chlorine residual, mg/L
0	1.1
1	1.02
3	0.90
6	0.76

- 13-9.** Because of high TOC in the raw water, the town of Nome has asked your firm to evaluate the feasibility of using chlorine dioxide as a primary disinfectant. The concern of the utility is the potential for odor complaints that are reported to occur at concentrations greater than 0.1 mg/L (Hoehn et al., 2003). The following data have been provided by the utility. What is the maximum dose they can apply without causing odor complaints? Use a spreadsheet program you have written to determine the decay constant and use it to estimate the maximum dose. Ignore the initial ClO_2 demand in determining the decay constant.

Contact chamber detention times

100 min at Q_{\min}
42 min at Q_{\max}

Laboratory study

Time, min	Chlorine dioxide residual, mg/L
15	1.15
30	0.79
60	0.41
90	0.24

Initial dose = 3.0 mg/L

- 13-10.** Two options are available in the design of the storage tank for sodium hypochlorite: one tank to hold a 60-day supply or two tanks, each to hold a 30-day supply. The room housing the tanks will have a maximum temperature of 25°C in the summer. The supplier will provide either 15.89% NaOCl or 7.93% NaOCl. The unit cost (\$/Mg of available chlorine) of the more dilute solution is higher than that of the more concentrated solution. The client has indicated that, from an operational point of view, a 60-day resupply schedule is preferable. The decay data for the two solutions has been prepared by a reputable independent laboratory. It is shown below. Use a spreadsheet program you have written to determine the rate constants, and determine the concentration of each solution at 60 days. Analyze the data and make a design recommendation to your client.

NaOCl decay data in mg/L at 25°C

Time, d	15.89%	7.93%
0	1.589×10^5	7.930×10^4
10	1.40×10^5	7.75×10^4
20	1.25×10^5	7.58×10^4
40	1.03×10^5	7.26×10^4

Adapted from Gordon et al., 1995.

- 13-11.** Using the U.S. EPA's Ct tables, plot a Ct line on a copy of Figure 13-5 for the following conditions: *Giardia* inactivation by free chlorine, 99.9% inactivation, 10°C, pH = 7.0.
- 13-12.** The Code of Federal Regulations provides tables of Ct values for 99.9% inactivation at various temperatures and pH values (10 CFR 141.74 and 10 CFR 141.720). To determine the Ct value for another inactivation percentage, the following equation is suggested in the *Guidance Manual* (U.S. EPA, 1991):

$$Ct \text{ required} = \left(\frac{\log \text{ inactivation required}}{3 \log} \right) (Ct_{99.9})$$

Another method to determine log inactivation credits at intermediate or extrapolated values is with the use of the Chick-Watson law. Using a spreadsheet you have written and the following data from the *Guidance Manual*, determine the inactivation rate constant and determine the percent error in estimating Ct for a 94.38% inactivation of *Giardia* with chlorine at a temperature of 10°C and a pH of 7.0. The following data were extracted from the *Guidance Manual* at a temperature of 10°C, a pH of 7.0, and a chlorine dose of 1.6 mg/L.

***Giardia* inactivation**

Log inactivation	Ct , mg-min/L
0.5	20
1.0	40
1.5	60
2.0	79
2.5	99
3.0	119

- 13-13.** The Lakeview water treatment plant is considering the use of chlorine dioxide as a primary disinfectant because of high TOC in the raw water. The plant requires a log credit of 1.0 to meet the *Cryptosporidium* inactivation requirements. To avoid taste and odor problems, the dose of chlorine must not exceed 2.3 mg/L. The ClO_2 will be dosed at the head end of the plant to achieve a detention time of 150 min.
- Your boss has asked you to check the ClO_2 dose at the average raw water temperature of 10°C, and at the minimum winter temperature of 1.5°C, and advise him on the potential for odor problems. Assume the flow rate and detention time is the same at both temperatures.
- 13-14.** Select the primary disinfectant for the village of Sleepy Hollow, which uses groundwater for its water supply. The design flow rate is 7,600 m³/d. The water is softened

by ion exchange. The time for water to reach the most distant customer at the minimum demand flow rate is six hours. The groundwater analysis is shown below.

Sleepy Hollow groundwater analysis

Constituent	Concentration
Raw water	
TOC	<0.2 mg/L
Bromide	Not detected
Turbidity	<2 NTU
<i>Giardia</i> cysts	<1/100 L
Virus	<1/100 L
<i>Cryptosporidium</i> oocysts	<0.075/L
Treated water	
Turbidity	<0.3 NTU

- 13-15.** Select the primary and secondary disinfectants for the town of Hard Times, which uses the Verde River for its water supply. The design flow rate is 30,600 m³/d. The water is treated by conventional coagulation, sedimentation, and filtration. The time for water to reach the most distant customer at the minimum demand flow rate is 62 hours. The Verde River water analysis is shown below.

Verde River water analysis

Constituent	Concentration
TOC	10–20 mg/L
Bromide	0.010 mg/L
Turbidity	10–500 NTU
Total coliforms	100–1,000/100 mL
<i>Giardia</i> cysts	5/100 L
Virus	2/100 L
<i>Cryptosporidium</i> oocysts	>3.0/L

The potential AOC and DBPFP are rated high.

- 13-16.** Design a longitudinal-serpentine chlorine contact chamber for a design flow of 38,400 m³/d. The required t_{10} to achieve a Ct of 165 is 82.8 min. Assume that Figure 13-12 applies and that the design criterion is a performance $t_{10}/t_0 = 0.8$. Use $H = 3W$ for the height estimate.
- 13-17.** Rework Problem 13-16 with the assumption that the chlorine contact chamber is followed by a distribution pipe that can be used as a contact chamber. It is a straight pipe 300 mm in diameter, and it has no service connections for 1.0 km. Assume $t_{10}/t_0 = 1.0$ for the pipe.

- 13-18.** Design a cross-baffled serpentine ozone contact chamber for a design flow of $38,400 \text{ m}^3/\text{d}$. The required t_{10} to achieve a Ct of 30 is 15 min, and the second order rate constant was determined to be $3.5 \text{ L/mol} \cdot \text{s}$. Assume that Figure 13-12 applies and that the design criterion is a performance $t_{10}/t_0 = 0.8$. Also assume a depth of 6.0 m and $H = 4L$.
- 13-19.** Using fluoride as a tracer, the following data were gathered to determine t_{10} for the clearwell storage that follows a treatment plant. The raw water concentration of fluoride was 0.2 mg/L . The fluoride dose for the tracer study was 2.0 mg/L . Correct the measured fluoride tracer concentrations to account for the raw water concentration, and calculate the ratio C/C_0 for each data point. Using a spreadsheet program, plot C/C_0 versus time, and determine t_{10} by reading the graph at $C/C_0 = 0.10$.

Time, minutes	Measured F^- concentration, mg/L
0	0.20
3	0.20
6	0.20
9	0.20
12	0.29
15	0.67
18	0.94
21	1.04
24	1.44
27	1.55
30	1.52
33	1.73
36	1.93
39	1.85
42	1.92
45	2.02
48	1.97
51	1.84
54	2.06

- 13-20.** The village of Match Box is using a slow sand filter followed by chlorination. The filter effluent has a turbidity in the range 0.4 to 0.6 NTU. Chlorine is added to a 265 m^3 clearwell. The 100 mm diameter pipeline to the first customer is 500 m long. The residual chlorine concentrations in the clearwell and the pipeline are 1.6 and 1.0 mg/L, respectively. The clearwell is considered to have a very poor performance rating because it lacks baffling. The pipeline is considered to have a nearly perfect performance rating. Determine the *Giardia* log-inactivation at a temperature of 10°C and a pH of 7.5. The peak flow rate is $0.38 \text{ m}^3/\text{min}$ (adapted from Lin, 2001).

- 13-21.** The town of Wallowa has asked your firm to evaluate their water treatment facility for compliance with the requirements of the rules for surface water treatment (LT2ESWTR) for *Cryptosporidium*, *Giardia*, and viruses. The plant design capacity is 3,800 m³/d. The winter conditions have been selected as critical. From plant data, the pH is 8.0 and the temperature is 5°C. The water is treated at the intake structure with chlorine dioxide to oxidize organic matter. There is no residual chlorine dioxide after the demand is satisfied. Gaseous chlorine is added at the intake and at the effluent line from filtration before the water enters the clearwell. Ammonia is added at the inlet to the clearwell to form chloramine. The first service connection is immediately adjacent to the plant. The following data are representative of the raw water quality for the microorganisms of concern:

Wallowa River water analysis

Microorganism	Concentration
<i>Cryptosporidium</i>	<0.075 oocysts/L
<i>Giardia</i>	<1/100 mL
Virus	<1/100 mL

The following data were obtained from a survey of the plant:

Wallowa water treatment plant

Treatment unit	Volume, m ³	Outlet residual Cl ₂ , mg/L	Baffling conditions
Rapid mix	0.91	0.4	Baffled at inlet and outlet
Flocculator	68.1	0.3	Baffled at inlet and outlet with horizontal paddles
Clarifier	568	0.2	Baffled only at outlet
Filters	25.0	0.1	Assumed performance rating = 0.5
Clearwell	1,817	0.3 free 1.6 combined	No baffling

Adapted from Lin, 2001.

- 13-22.** The village of Sleepy Hollow (Problem 13-14) has selected sodium hypochlorite as its disinfectant. The regulating agency has given them credit for 3-log *Cryptosporidium* oocyst, 2-log *Giardia* cyst, and 2-log virus removal by the treatment process. The NaOCl is to be added prior to a 300 m³ clearwell. The clearwell is unbaffled. The treated water has a pH of 7.5 and a winter temperature of 5°C. The first service connection is adjacent to the plant. Design a disinfection system for Sleepy Hollow. Assume a chlorine dose of 1.2 mg/L and a client preference for a contact chamber with superior performance. Provide the following for the design: (1) additional *Ct* required to meet LT2ESWTR, (2) contact chamber design to achieve *Ct*, (3) plan view with dimensions.

- 13-23.** The town of Hard Times (Problem 13-15) has selected ozone as the primary disinfectant and chloramine ($\text{NaOCl} + \text{NH}_3$) as the secondary disinfectant. The pH of the water entering the contact chamber will be 7.0, and the winter water temperature will be 5°C . Design a disinfection system for Hard Times. Assume a trial ozone dose of 2.5 mg/L and a second order rate constant of $6.0 \times 10^{-3} \text{ L/mg} \cdot \text{min}$ and a client preference for a contact chamber with superior performance. Provide the following for the design: (1) additional Ct required to meet LT2ESWTR, (2) contact chamber design to achieve Ct , (3) plan view with dimensions, and (4) feed rate of NaOCl and ammonia (g/min) to achieve a dichloramine dose of 1.6 mg/L .
- 13-24.** The city of Ten Sleep proposes to use Crater Lake for its water supply. The plan is to treat $3,500 \text{ m}^3/\text{d}$ by direct filtration. The first customer is adjacent to the plant. The raw water analysis is shown below. The city council is concerned about safety and the lack of skilled operating personnel. The available space at the site is restricted.
1. Determine the total removal/inactivation required.
 2. Determine the credits for physical removal.
 3. Determine the credits required for inactivation by disinfection.
 4. Select the primary disinfectant.
 5. Determine the required Ct to achieve the required inactivation for the design conditions (pH, temperature).

Crater Lake water analysis

Constituent	Concentration
Raw Water	
TOC	<1.0 mg/L
Bromide	Not detected
Turbidity	<5 NTU
<i>Giardia</i> cysts	<1/100 L
Virus	<1/100 L
<i>Cryptosporidium</i> oocysts	<0.075/L
Treated Water	
Turbidity	<0.3 NTU
pH	7.5
Temperature	5°C

- 13-25.** A $76,000 \text{ m}^3/\text{d}$ direct filtration plant is applying free chlorine as a disinfectant at a dose of 2.0 mg/L . Their low flow is $19,000 \text{ m}^3/\text{d}$. Their water analysis is the same as that for Crater Lake (Problem 13-24). To save money, they would like to reduce the chlorine dose at low flow. The t_{10} of their contact chamber is 27.5 minutes under peak flow conditions (pH = 7.0 and 5°C). Check the plant operation to confirm that they are meeting the LT2ESWTR disinfection requirements, and determine what dose they should use at low flow.

13-26. Determine the chemical feed rate for fluorosilicic acid in mL/min for the following conditions:

Average maximum daily air 10°C

Naturally occurring fluoride concentration = 0.1 mg/L

Flow rate = 794 m³/h

Assume the specific gravity of fluorosilicic acid is 1.27.

13-27. Determine the chemical feed rate for sodium fluoride from a saturator in mL/min for the following conditions:

Average maximum daily air temperature 25°C

Naturally occurring fluoride concentration = 0.2 mg/L

Flow rate = 318 m³/h

Assume the sodium fluoride solubility is 42 g/L and the purity is 93%.

13-8 DISCUSSION QUESTIONS

- 13-1.** Using the EPA's *Ct* tables at a temperature of 10°C and a pH of 7.0, discuss the relative effectiveness of chlorine, chloramines, chlorine dioxide, and ozone as a *Giardia* disinfectant.
- 13-2.** One proposal for treating water in developing countries is for individual families to use a small, home-made slow sand filter followed by storage of the filtered water in a clear plastic bottle exposed to the sun for a day. Explain the purpose of the sand filter and the mechanism that disinfects the water.
- 13-3.** Based on reactor mass balance principles, explain why plug flow is preferred over a completely mixed reactor for disinfection.
- 13-4.** A new employee has proposed using a vertical serpentine flow chlorine disinfection chamber rather than a longitudinal-flow serpentine chlorine chamber in order to save space. Do you agree with this proposal? Explain your reasoning.

13-9 REFERENCES

- Acero, J. L. and U. von Gunten (2001) "Characterization of Oxidation Processes: Ozonation and the AOP O₃/H₂O₂," *Journal of American Water Works Association*, vol. 93, no. 10, pp. 90–100.
- AWWA (2004) *Water Fluoridation Principles and Practices*, American Water Works Association Manual of Practice M4, Denver, Colorado.
- AWWA (2006) *Water Chlorination/Chloramination Practices and Principles*, American Water Works Association Manual of Practice M20, Denver, Colorado.
- AWWARF (1991) *Ozone in Water Treatment: Application and Engineering*, American Water Works Research Foundation, Denver, Colorado.
- Benarde, M. A. et al. (1967) "Kinetics and Mechanism of Bacterial Disinfection by Chlorine Dioxide," *Applied Microbiology*, vol. 15, no. 2, p. 257.
- Buxton, G. and M. Subhani (1971) "Radiation Chemistry and Photochemistry of Oxychlorine Ions," *Transactions of the Faraday Society*, vol. 68, no. 5, pp. 958–971.
- Chick, H. (1908) "An Investigation of the Laws of Disinfection," *Journal of Hygiene*, vol. 8, pp. 92–158.

- Clark, R. M., W. M. Grayman, R. M. Males, and A. F. Hess (1993) "Modeling Contaminant Propagation in Drinking Water Distribution Systems," *Journal of Environmental Engineering*, vol. 119, no. 2, pp. 349–364.
- Crozes, G. F., J. P. Hagstrom, M. M. Clark, J. Ducoste, and C. Burns (1999) *Improving Clearwell Design for CT Compliance*, AWWA Research Foundation, Denver, Colorado.
- Dennis, W. H. et al. (1979) "Mechanism of Disinfection: Incorporation of ^{36}Cl into f2 Virus," *Water Research*, vol. 13, p. 363.
- Dimitriou, M. A. (1990) *Design Guidance Manual for Ozone Systems*, International Ozone Association, Norwalk, Connecticut, pp. 16–17.
- Einstein, A. (1905) "Über einen die Erzeugung und Verwandlung des Lichtes betreffenden huristischen Gesichtspunkt," *Ann. Der Physik*, vol. 17, no. 3, pp. 131–148.
- Floyd, R., D. G. Sharp, and J. Johnson (1979) "Inactivation by Chlorine of Single Poliovirus Particles in Water," *Environmental Science and Technology*, vol. 13, no. 4, pp. 438–442.
- Fujioka, R., K. Tenno, and P. Loh (1985) "Mechanism of Chloramine Inactivation of Poliovirus: A Concern for Regulators," in R. Jolley (ed.) *Water Chlorination: Environmental Impact and Impact and Health Effects*, Lewis Publishers, Chelsea, Michigan.
- GLUMRB (2003) *Recommended Standards for Water Works*, Great Lakes–Upper Mississippi River Board of State and Provincial Public Health and Environmental Managers, Health Education Services, Albany, New York, pp. 77–79, 93–96.
- Gordon, G. et al. (1972) "The Chemistry of Chlorine Dioxide," *Progress in Inorganic Chemistry*, vol. 15, p. 201.
- Gordon, G., L. Adam, and B. Bubnis (1995) "Minimizing Chlorate Ion Formation," *Journal of American Water Works Association*, vol. 87, no. 6, pp. 97–106.
- Gordon, G. L., L. Adam, B. Bubnis, C. Kao et al. (1997) "Predicting Liquid Bleach Decomposition," *Journal of American Water Works Association*, vol. 89, no. 4, pp. 142–149.
- Gurol, M. D. and P. C. Singer (1982) "Kinetics of Ozone Decomposition," *Environmental Science and Technology*, vol. 16, no. 7, pp. 377–383.
- Haas, C. N. and R. S. Engelbrecht (1980) "Chlorine Dynamics During Inactivation of Coliforms, Acid-Fast Bacteria and Yeasts," *Water Research*, vol. 14, pp. 1,749–1,757.
- Haas, C. N. and J. Joffe (1994) "Disinfection Under Dynamic Conditions: Modification of Hom's Model for Decay," *Environmental Science & Technology*, vol. 28, no. 7, pp. 1,367–1,369.
- Haas, C. N. (1999) "Disinfection," in R. D. Letterman (ed.) *Water Quality and Treatment*, 5th ed., American Water Works Association, McGraw-Hill, New York, pp. 14.1–14.60.
- Hammelin, C. and Y. Chung (1978) "Role of the POL, REC, and DNA Gene Products in the Repair of Lesions Produced in *E. coli* by Ozone," *Studia* (Berlin), vol. 68, p. 229.
- Henry, D.J. and E.M. Freeman (1996) "Finite Element Analysis and T10 Optimization of Ozone Contactors," *Ozone Science Engineering*, vol. 17, pp. 587–606.
- Hesby, J. C. (2005) "Oxidation and Disinfection," in E. E. Baruth, (ed.), *Water Treatment Plant Design*, American Water Works Association and American Society of Civil Engineers, McGraw-Hill, New York, p. 10.1–10.61.
- Hoehn, R. C., C. S. Ellenberger, D. L. Gallagher, E. V. Wiseman, Jr., R. W. Benninger, and A. Rosenblatt (2003) "ClO₂ and By-product Persistence in a Drinking Water System," *Journal of American Water Works Association*, vol. 95, no. 4, pp. 141–150.
- Hoff, J. (1986) *Inactivation of Microbial Agents by Chemical Disinfectants*, U.S. Environmental Protection Agency Publication EPA/600/2-86/067, Washington, D.C.
- Hom, L. (1972) "Kinetics of Chlorine Disinfection in an Ecosystem," *Journal of Environmental Engineering*, vol. 98, no. 1, pp. 83–94.
- Jagger, J. (1967) *Introduction to Research in Ultraviolet Photobiology*, Prentice Hall, Inc. Engelwood Cliffs, New Jersey.

- LaGrega, M. D., P. L. Buckingham, and J. C. Evans (2001) *Hazardous Waste Management*, 2nd ed., McGraw-Hill, Boston, Massachusetts, pp. 510–511.
- Lin, S. (2001) *Water and Wastewater Calculations Manual*, McGraw-Hill, New York, pp. 451–469.
- Linden, K. G. and J. L. Darby (1997) “Estimating Effective Germicidal Dose from Medium Pressure UV Lamps,” *Journal of Environmental Engineering*, vol. 123, no. 11, pp. 1142–1149.
- Marske, D. M. and J. D. Boyle (1973) “Chlorine Contact Chamber Design—A Field Evaluation,” *Water and Sewage Works*, vol. 120, no. 1, pp. 70–77.
- MWH (2005) *Water Treatment: Principles and Design*, John Wiley & Sons, Hoboken, New Jersey, pp. 1103, 1109, 1137.
- Noss, C., W. Dennis, and V. Olivieri (1985) “Reactivity of Chlorine Dioxide with Nucleic Acids and Proteins,” in R. Jolley (ed.) *Water Chlorination: Environmental Impact and Impact and Health Effects*, Lewis Publishers, Chelsea, Michigan.
- Pommerenk, P. and G. C. Schafran (2002) “Effects of Prechlorination on Removal of Particles and Organic Matter,” *Journal of American Water Works Association*, vol. 94, no. 2, pp. 99–108.
- Rakness, K. L. (2005) *Ozone in Drinking Water: Process Design, Operation, and Optimization*, American Water Works Association, Denver, Colorado, pp. 109–187.
- Rakness, K. L. and G. F. Hunter (2000) *Advancing Ozone Optimization During Pre-Design, Design, and Operation*, AWWA Research Foundation and American Water Works Association, Denver, Colorado.
- Reeves, T. G. (1999) “Water Fluoridation,” in R. D. Letterman (ed.) *Water Quality and Treatment*, 5th ed., American Water Works Association, McGraw-Hill, New York, pp. 15.1–15.19.
- Rossmann, L. A., J. G. Uber, and W. M. Grayman (1995) “Modeling Disinfectant Residual in Drinking Water Storage Tanks,” *Journal of Environmental Engineering*, vol. 121, no. 10, pp. 752–756.
- Roy, D., R. S. Engelbrecht, and E. S. K. Chian (1981) “Kinetics of Enteroviral Inactivation by Ozone,” *Journal of the Environmental Engineering Division*, ASCE, vol. 107, EE5, pp. 887–899.
- Setlow, J. (1967) “The Effects of Ultraviolet Radiation on Photoactivation,” *Comprehensive Biochemistry*, vol. 27, pp. 157–209.
- Singer, P. C. (1992) “Formation and Characterization of Disinfection Byproducts,” Presented at the First International Conference on the Safety of Water Disinfection: Balancing Chemical and Microbial Risks.
- Sjenitzer, F. (1958) “How Much Do Products Mix in a Pipeline?” *Pipeline Engineering*, vol. 12, pp. D31–D34.
- Snoeyink, V. and D. Jenkins (1980) *Water Chemistry*, John Wiley and Sons, New York, pp. 328–329.
- Sung, W., J. Levenson, T. Toolan and D. K. O’Day (2001) “Chlorine Decay Kinetics of a Water Reservoir,” *Journal of American Water Works Association*, vol. 93, no. 10, pp. 101–110.
- Trussell, R. R. and J. L. Chao (1977) “Rational Design of Chlorine Contact Facilities,” *Journal of Water Pollution Control Federation*, vol. 49, no. 4, pp. 659–667.
- U.S. EPA (1986) *Design Manual: Municipal Wastewater Disinfection*, U.S. Environmental Protection Agency Publication EPA 625/1-86/021, Washington, D.C.
- U.S. EPA (1989) “Filtration and Disinfection: Turbidity, *Giardia Lamblia*, Viruses, *Legionella*, and Heterotrophic Plate Count Bacteria. Final Rule,” *Federal Register*, vol. 68, pp. 27486–27541.
- U.S. EPA (1991) *Guidance Manual for Compliance with Filtration and Disinfection Requirements for Public Water Systems Using Surface Water Sources*, U.S. Environmental Protection Agency, Washington, D.C.
- U.S. EPA (1994) “National Primary Drinking Water Regulations; Disinfectants and Disinfection Byproducts: Proposed,” *Federal Register*, vol. 59, pp. 38,668–38,829.
- U.S. EPA (1996) *Ultraviolet Light Disinfection Technology in Drinking Water Application—An Overview*, U.S. Environmental Protection Agency Office of Ground Water and Drinking Water, Pub. No. 811-R-96-002.

- U.S. EPA (1999) *Alternative Disinfectants and Oxidants Guidance Manual*, U.S. Environmental Protection Agency Publication EPA 815-R-99-014, Washington, D.C.
- U.S. EPA (2006) *Ultraviolet Disinfection Guidance Manual for the Final Long Term 2 Enhanced Surface Water Treatment Rule*, U.S. Environmental Protection Agency Publication EPA 815-R-06-007, Washington, D.C.
- Watson, H. (1908) "A Note on the Variation of the Rate of Disinfection with Change in Concentration of the Disinfectant," *Journal of Hygiene*, vol. 8, p. 536.
- Weast, R. C. (1983) *CRC Handbook of Chemistry and Physics*, CRC Press, Boca Raton, Florida, pp. 16–163.
- Wilczak, A., L. L Hoover, and H. H. Lai, (2003) "Effects of Treatment Changes on Chlorine Demand and Decay," *Journal of American Water Works Association*, vol. 95, no. 7, pp. 94–106.

REMOVAL OF SPECIFIC CONSTITUENTS

- 14-1 INTRODUCTION**
- 14-2 ARSENIC**
- 14-3 CARBON DIOXIDE**
- 14-4 FLUORIDE**
- 14-5 IRON AND MANGANESE**
- 14-6 NITRATE**
- 14-7 NATURAL ORGANIC MATTER (NOM)**
- 14-8 PERCHLORATE**
- 14-9 PHARMACEUTICALS AND ENDOCRINE-DISRUPTING COMPOUNDS (EDCs)**
- 14-10 RADIONUCLIDES**
- 14-11 SYNTHETIC ORGANIC CHEMICALS (SOCs) AND VOLATILE ORGANIC CHEMICALS (VOCs)**
- 14-12 TASTE AND ODOR (T&O)**
- 14-13 CHAPTER REVIEW**
- 14-14 PROBLEMS**
- 14-15 DISCUSSION QUESTIONS**
- 14-16 REFERENCES**

14-1 INTRODUCTION

The focus of the previous chapters has been on removal of broad classes of constituents: turbidity, color, hardness, and pathogens. The focus of this chapter is a selected list of specific constituents that are not addressed in the previous chapters. They were selected because of their impact on the potability and palatability of water. These include arsenic, iron and manganese, fluoride, nitrate, NOM, pharmaceuticals, radionuclides, taste and odor (T&O), synthetic organic chemicals (SOCs) and volatile organic compounds (VOCs). In addition, because of its economic impact on the softening process, treatment to remove carbon dioxide is included.

14-2 ARSENIC

Arsenic is almost exclusively a groundwater contaminant. Therefore, this discussion is limited to a few selected processes deemed reasonable for treating groundwater at a centralized facility. A more thorough discussion may be found in the *Arsenic Treatment Technology Handbook* (U.S. EPA, 2003).

Arsenic can occur in four oxidation states in water: +5, +3, 0, -3. The most common states are trivalent arsenite [As(III)] and pentavalent arsenate [As(V)]. Most As(III)-containing water in the pH range of 6 to 9 will have As in the form of H_3AsO_3 . Arsenate will be in the form HAsO_4^{2-} in the pH range 7 to 11.5. At pH values less than 7.0, arsenate will be in the form H_2AsO_4^- .

Treatment Strategies

Preoxidation Processes. Reduced inorganic arsenite cannot be removed effectively. Preoxidation to form As(V) at the head end of all of the unit processes described in the following paragraphs is essential. Chlorine, permanganate, and ozone are highly effective. Chlorine dioxide, monochloramine, and UV are ineffective as stand-alone oxidants for As(III).

Side reactions with iron, manganese, and sulfide must be accounted for in determining the dose for oxidation (Ghurye and Clifford, 2001).

The oxidation-reduction reaction with chlorine is

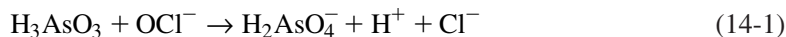

This reaction is relatively independent of pH in the range 6.3 to 8.3. In a laboratory study, at an excess of three times the stoichiometric amount of chlorine, 95 percent of the As(III) was converted to As(V) in 42 seconds (Ghurye and Clifford, 2001).

The oxidation-reduction reaction with permanganate is

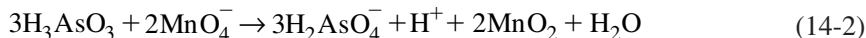

Like the chlorine reaction, this reaction is relatively independent of pH in the range 6.3 to 8.3. At a similar threefold stoichiometric excess, 95 percent of the As(III) was converted to As(V) in 36 seconds. As with chlorine oxidation, side reactions with iron, manganese, and sulfide must be accounted for in determining the dose (Ghurye and Clifford, 2001).

Permanganate is difficult to handle. It is commercially available as a crystal that is corrosive and stains nearly everything purple. Manganese particles are produced as a result of permanganate oxidation reactions. Therefore, postoxidation filtration is essential to prevent accumulation of deposits in the distribution system.

The oxidation-reduction reaction with ozone is

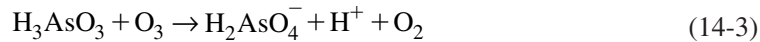

Like the chlorine reaction, this reaction is relatively independent of pH in the range 6.3 to 8.3. Using an excess of three times the stoichiometric dose, 95 percent of the As(III) was converted to As(V) in 18 seconds (Ghurye and Clifford, 2001).

A comparison of preoxidation alternatives is shown in Table 14-1.

TABLE 14-1
Comparison of Preoxidation alternatives

Criteria	Liquid sodium hypochlorite system	On-site hypochlorite generation system	Permanganate solution feed system	Ozone generation
Safety and regulatory issues	<ul style="list-style-type: none"> • HazMat regulations for safety and handling apply • Potential for corrosive vapors in the presence of moisture • Emergency response plan required with local fire department • Secondary containment required 	<ul style="list-style-type: none"> • Below 1% threshold for hazardous classification • Exempt from HazMat regulations • No secondary containment requirements 	<ul style="list-style-type: none"> • Solid permanganate poses dust and inhalation hazard • Liquid is very corrosive 	<ul style="list-style-type: none"> • Poisonous and reactive gas
Space requirements	<ul style="list-style-type: none"> • Space requirements are small, assuming the Uniform Fire Code (UFC) exempt criteria are met 	<ul style="list-style-type: none"> • Space requirements are large. There must be room for salt storage, brine tanks, hypochlorite holding tanks, electrolytic equipment, as well as instrumentation & control and power. 	<ul style="list-style-type: none"> • Space requirements are small. Additional space may be required for storage of solid permanganate. 	<ul style="list-style-type: none"> • Space requirements are small
Chemical characteristics	<ul style="list-style-type: none"> • 5¼ or 12½% sodium hypochlorite solution. Degrades over time. • Decay of solution creates chlorate byproduct • Increases pH of water slightly 	<ul style="list-style-type: none"> • Stable sodium hypochlorite solution (0.8%) • Constant application concentration • Chlorate formation low to none • Increases pH of water slightly 	<ul style="list-style-type: none"> • Stable permanganate solution, generally 3–4% • Reacts rapidly with dissolved organics 	<ul style="list-style-type: none"> • Gas • Very strong oxidizer
Chemical delivery	<ul style="list-style-type: none"> • Liquid hypochlorite delivered by tanker truck, 55-gal drum, or 5-gal pail 	<ul style="list-style-type: none"> • Salt delivered in 50-lb bags or 2000-lb totes 	<ul style="list-style-type: none"> • Solid permanganate available in 25-kg pails, 50-kg kegs, and 150-kg drums 	<ul style="list-style-type: none"> • N/A
Labor	<ul style="list-style-type: none"> • Periodic delivery • Dilution procedures 	<ul style="list-style-type: none"> • Salt delivery • Weekly loading of salt into brine tank 	<ul style="list-style-type: none"> • Load dry feeder • Dilution procedures 	<ul style="list-style-type: none"> • N/A

(continued)

TABLE 14-1 (continued)
Comparison of Preoxidation alternatives

Criteria	Liquid sodium hypochlorite system	On-site hypochlorite generation system	Permanganate solution feed system	Ozone generation
Operation and maintenance	<ul style="list-style-type: none"> • Low day-to-day O&M. Long-term material maintenance could be a problem because of corrosive effects of liquid hypochlorite. 	<ul style="list-style-type: none"> • Moderate O&M, mainly associated with salt handling. Change electrode cells every five years. 	<ul style="list-style-type: none"> • Low day-to-day O&M for automated systems • Stains everything purple 	<ul style="list-style-type: none"> • Low day-to-day O&M
Off-normal operation	<ul style="list-style-type: none"> • A temporary bleach solution can be mixed in the storage tank 	<ul style="list-style-type: none"> • A temporary bleach solution can be mixed in the day tank 	<ul style="list-style-type: none"> • N/A 	<ul style="list-style-type: none"> • N/A
Community relations	<ul style="list-style-type: none"> • HazMat signage required 	<ul style="list-style-type: none"> • No HazMat regulations. Hydrogen byproduct vented to atmosphere. 	<ul style="list-style-type: none"> • N/A 	<ul style="list-style-type: none"> • N/A

Adapted from U.S. EPA, 2003.

Example 14-1. Estimate the stoichiometric amount of hypochlorite in mg/L required to oxidize arsenic in groundwater with the following constituents:

$$\begin{aligned} \text{As(III)} &= 50 \mu\text{g/L} \\ \text{Fe(II)} &= 1.2 \text{ mg/L} \end{aligned}$$

Solution:

1. The redox reaction for oxidizing As(III) is given in Equation 14-1.



Note that one mole of hypochlorite reacts with one mole of arsenic.

2. The redox reaction for oxidizing Fe(II) is

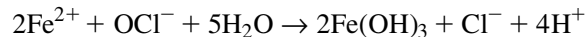

Note that one mole of hypochlorite reacts with two moles of iron.

3. Calculate the molar concentrations of arsenic and iron:

$$\text{Moles/L of As} = \frac{50 \mu\text{g/L}}{(74.92 \text{ g/mole})(10^6 \mu\text{g/g})} = 6.67 \times 10^{-7} \text{ moles/L}$$

$$\text{Moles/L of Fe} = \frac{1.2 \text{ mg/L}}{(55.85 \text{ g/mole})(10^3 \text{ mg/g})} = 2.15 \times 10^{-5} \text{ moles/L}$$

4. The required stoichiometric addition is

$$6.67 \times 10^{-7} \text{ moles/L} + (0.5)(2.15 \times 10^{-5} \text{ moles/L}) = 1.141 \times 10^{-5} \text{ moles/L of OCl}^-$$

5. In mg/L

$$(1.141 \times 10^{-5} \text{ moles/L of OCl}^-)(51.45 \text{ g/mole}) = 5.871 \times 10^{-4} \text{ g/L or } 0.59 \text{ mg/L}$$

Comment. According to Ghurye and Clifford (2001), three times this dose is required to oxidize 95 percent of the arsenic in less than one minute.

Ion Exchange. Limitations to the use of ion exchange are the concentration of total dissolved solids (TDS) and sulfate. If the TDS is less than 500 mg/L (Wang et al., 2000) and the sulfate concentration is less than 50 mg/L (U.S. EPA, 2003), strong-base ion exchange is effective and economical. Iron, manganese, or a combination of the two, should not exceed 0.3 mg/L because the oxidized forms will plug the ion exchange resin (GLUMRB, 2003).

Designs generally employ empty bed contact times (EBCTs) of 1.5 to 3 minutes. Downflow cocurrent regeneration has been shown to be more effective than countercurrent regeneration (Clifford, 1999).

Activated Alumina. Activated alumina (AA) is a porous, granular material with ion exchange properties. It is a mixture of amorphous and gamma aluminum oxide prepared by low-temperature (300 to 600°C) dehydration of $\text{Al}(\text{OH})_3$. The media is placed in columns that are designed and operated in the same fashion as ion exchange columns.

The pH must be tightly controlled in the range 5.5 to 6.0. The alumina capacity is significantly reduced in the presence of sulfate ions. Arsenic is difficult to remove from alumina. A 4 percent NaOH solution is recommended for regeneration (Clifford, 1999). Because of the high pH of the regeneration process approximately 2 percent of the media dissolves during each regeneration cycle.

Iron-Based Sorbents (IBS). Adsorption on IBS is considered an emerging technology by the EPA. The processes are proprietary. They are based on sorption on iron-impregnated media. The process is described as irreversible chemisorption. The media is placed in columns that are designed in the same fashion as ion exchange columns. The media is discarded when it becomes saturated. Appropriate media disposal procedures are discussed in Chapter 15.

Reverse Osmosis (RO). Conventional RO design and operation results in highly effective arsenic removal. While chlorine may be used to control biological growth, it is not necessary to preoxidize the raw water to remove significant amounts of arsenic. Some membranes are damaged by chlorine and may be damaged by other oxidants as well. RO is capable of achieving over 97 percent removal of As(V) and 92 percent removal of As(III) (NSF, 2001a and 2001b). Because As(III) removal is inconsistent, U.S. EPA (2002) recommends preoxidation. Careful selection of the membrane material is essential if chlorine preoxidation is considered a necessary part of the process. Manufacturers should be consulted to obtain information on material warranty requirements.

Enhanced Lime Softening. For those water systems employing lime softening, the adjustment of the pH to values above 10.5 is effective in removing As(V) by coprecipitation.

Oxidation/Filtration. For those water systems employing oxidation and filtration for iron removal, As(V) adsorbs onto the iron hydroxide precipitate. The removal efficiency is highly dependent on the initial iron concentration and ratio of iron to arsenic. In general, if the Fe:As mass ratio is greater than 20:1, the removal efficiency will be on the order of 80 to 95 percent (U.S. EPA, 2003).

Modified Iron Removal (MIR). Several alternatives are available when the iron-to-arsenic ratio is less than 20:1. These systems work in a fashion similar to conventional iron removal systems but use either a proprietary media or add iron (in the Fe^{3+} form) to maximize the iron removal efficiency. These systems use either manganese greensand or other manganese dioxide based systems.

Decision Trees and Technology Comparison. Figure 14-1 is an adaptation of EPA's decision trees for selecting a new treatment technology for arsenic removal. Figure 14-2 is an additional aid in process selection. Tables 14-2 and 14-3 on pages 14-9, 14-10, and 14-11 summarize a comparison of the technologies and some typical design and operating parameters.

14-3 CARBON DIOXIDE

Removing CO_2 will improve neither the potability nor the palatability of the water. Its removal is an economic issue in the lime-soda softening process and in posttreatment of NF/RO treated water. As noted in Chapter 7, CO_2 and H_2CO_3 in water are essentially the same. Carbon dioxide is the principal acid present in unpolluted, naturally occurring water. Raw water CO_2 concentrations in surface water are generally negligible. In groundwater, concentrations ranging from a few mg/L to nearly 100 mg/L have been reported (AWWA, 1990). Concentrations in the range of 20 to 40 mg/L are not uncommon. Carbon dioxide must be removed or neutralized before the pH can be raised to precipitate hardness. When the concentration exceeds 10 mg/L as CO_2 (22.7 mg/L as CaCO_3 or 0.45 meq/L), the economics of removal by aeration (*stripping*) are favored over removal by lime neutralization (AWWA, 1990). In NF/RO treated water, air stripping in conjunction with other treatment is used to increase the stability of the permeate.

Stripping

Air stripping of CO_2 may be accomplished by a variety of devices: spray aerators, multiple-tray aerators, cascade aerators, cone aerators, and packed columns. Of these types, multiple-tray aerators have found wide use in stripping CO_2 . The multiple-tray aerators consist of a series of trays with slatted, perforated, or wire-mesh bottoms. The raw water is distributed at the top, flows down over a series of trays, and is collected in a basin at the base of the unit. Although natural ventilation may be used, artificial ventilation is more common because the units are housed in buildings. This is especially true in colder climates where freezing temperatures occur. Blowers force air from the bottom of the tray system countercurrent to the flow of water. Scroll panels provide good cross-ventilation, and the roof is open except directly over the distributing trays.

Design Equation. The following empirical equation may be used to estimate the number of trays (Scott, 1955):

$$C_n = C_0 10^{-kn} \quad (14-4)$$

where C_n = concentration of carbon dioxide after passing through n trays, mg/L

C_0 = raw water concentration of carbon dioxide, mg/L

n = number of trays including distribution tray at top

k = coefficient dependent on ventilation, temperature, turbulence, installation

The value of k ranges from 0.12 to 0.16.

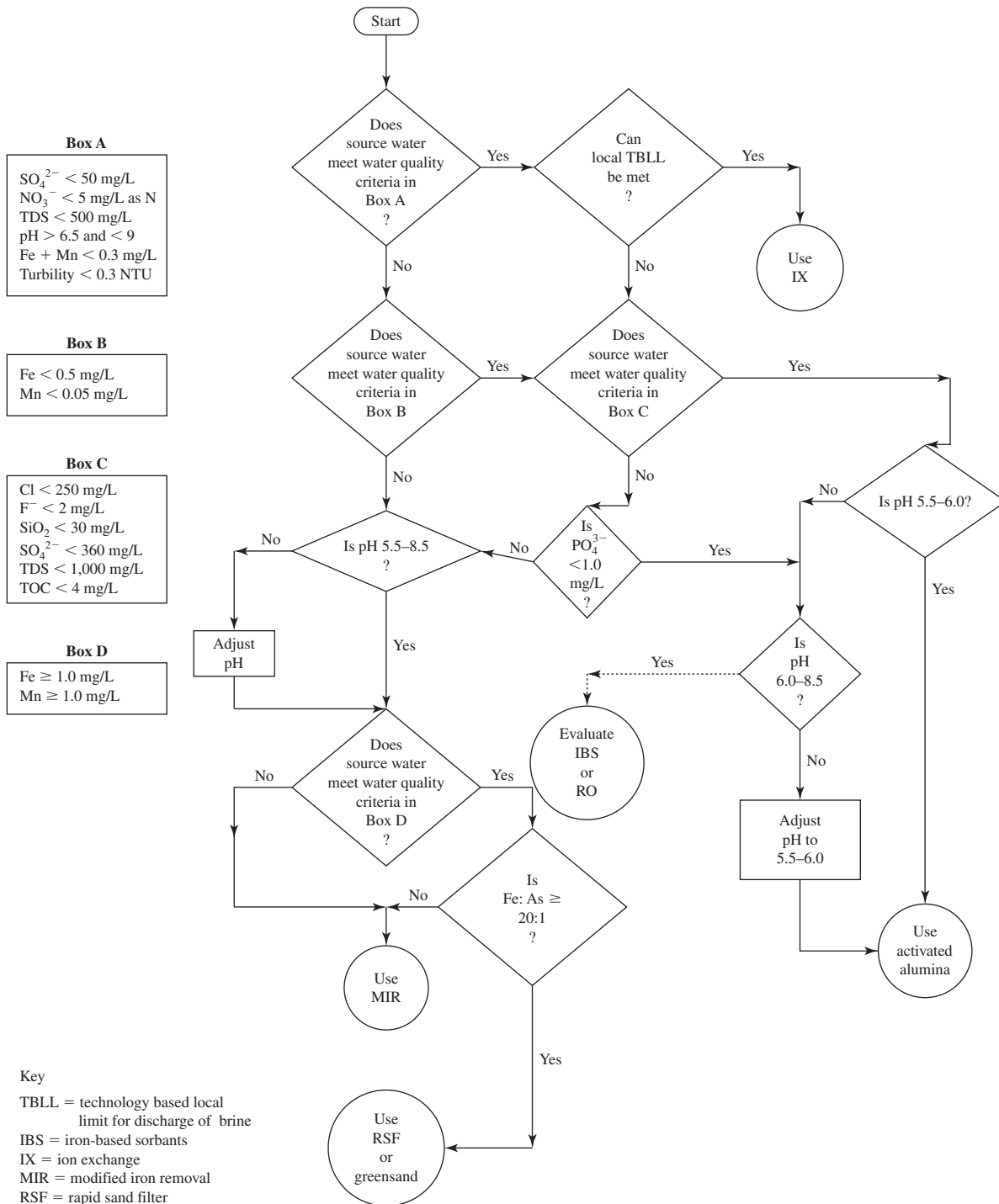

FIGURE 14-1

Decision tree for treatment to remove arsenic.

(Note: The tree assumes oxidation to As(V) before all of the selections.)

(Adapted from U.S. EPA, 2003.)

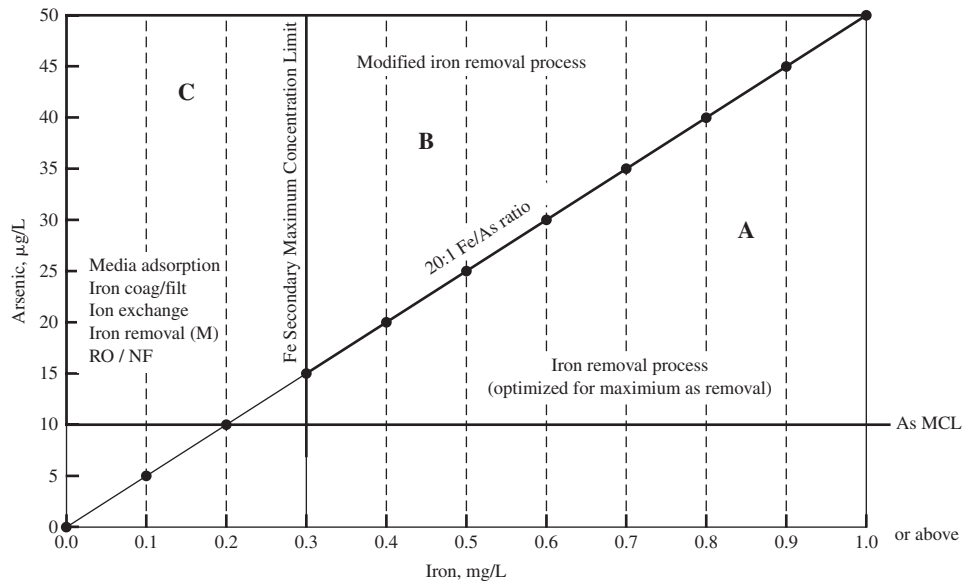

FIGURE 14-2
Arsenic treatment process selection guide.
(Source: Cook, 2005.)

Design Practice. Multiple-tray aerators are typically designed with three to nine trays. These are spaced about 300 to 750 mm apart. The footprint of the structure ranges from 2 to 6 m²/1,000 m³ of design capacity. The water application rates range from 60 to 75 m³/d · m² (Dyksen, 2005).

14-4 FLUORIDE

When the raw water fluoride concentration exceeds the recommended limits (see Chapter 13 for limits), fluoride removal is required. Activated alumina is an excellent medium for fluoride removal. It is far superior to synthetic organic ion exchange resins (Clifford, 1999). The design fundamentals are similar to those used for ion exchange columns with synthetic resins. Unlike typical ion exchange column behavior, the breakthrough curve is not sharp and the design must account for substantial leakage. Although countercurrent regeneration is the most efficient way to minimize the leakage problem, most plants are designed with cocurrent regeneration because of its simplicity.

A typical fluoride-removal plant utilizing activated alumina consists of two or more adsorption beds. The raw water pH is adjusted to 5.5 to 6.0, and it is passed downward through a 1 to 1.5 m deep bed of medium. The medium is specified by *mesh size*. For example 8 × 30 mesh means that the activated alumina particles will pass a number 8 sieve and will be retained on a number 30 sieve. Activated alumina medium is generally 28 × 48 mesh.

Following exhaustion, the medium is backwashed and then treated in a two-step regeneration. Backwashing with raw water is to remove entrained particles, break up clumps of alumina,

TABLE 14-2
Arsenic treatment technologies summary comparison

Factors	Sorption processes				Membrane processes
	Ion exchange IX	Activated alumina ^a AA	Iron-based sorbents IBS	Modified iron removal MIR	Nanofiltration or reverse osmosis NF/RO
USEPA BAT ^a	Yes	Yes	No ^c	No	Yes
USEPA SSCT ^b	Yes	Yes	No ^c	No	Yes
System size ^{b,d}	25–10,000	25–10,000	25–10,000	25–10,000	501–10,000
Removal efficiency	95% ^e	95% ^e	Up to 98% ^e	Up to 95%	> 95% ^e
Total water loss	1–2%	1–2%	1–2%	< 5%	15–75%
Preoxidation required ^f	Yes	Yes	Yes ^g	Yes	Likely ^h
Optimal water quality conditions	pH 6.5–9 ^e < 5 mg/L NO ₃ ⁻¹ < 50 mg/L SO ₄ ²⁻¹ < 500 mg/L TDS ^k < 0.3 NTU Turbidity	pH 5.5–6 ⁱ pH 6–8.3 ^l < 250 mg/L Cl ⁻¹ < 2 mg/L F ⁻¹ < 360 mg/L SO ₄ ^{2- k} < 30 mg/L Silica ^m < 0.5 mg/L Fe ^{+3 i} < 0.05 mg/L Mn ^{+2 i} < 1,000 mg/L TDS ⁱ < 4 mg/L TOC ^k < 0.3 NTU Turbidity	pH 6–8.5 < 1 mg/L PO ₄ ⁻³ < 0.3 NTU Turbidity	pH 5.5–8.5 < 0.3 NTU turbidity	No particulates
Operator skill required	Medium	Low ^a	Low	Low	Medium
Waste generated	Spent resin, spent brine, backwash water	Spent media, backwash water	Spent media, backwash water	Spent media, backwash water	Reject water, CIP water
Other considerations	Possible pre & post pH adjustment Prefiltration required Potentially hazardous brine waste Nitrate peaking Carbonate peaking affects pH	Possible pre & post pH adjustment Prefiltration may be required Modified AA available	Media may be very expensive. ^o Prefiltration may be required	Media may be expensive. Prefiltration may be required	High water loss (15–75% of feed water)
Centralized cost	Medium	Medium	Medium	Medium	High

^aActivated alumina is assumed to operate in a nonregenerated mode.

^bU.S. EPA, (2002). Implementation Guidance for the Arsenic Rule, EPA Pub. No 816K02018.

^cIBS's track record in the United States was not established enough to be considered as Best Available Technology (BAT) or Small System Compliance Technology (SSCT) at the time the rule was promulgated.

^dAffordable for systems with the given number of people served.

^eU.S. EPA, 2000.

^fPreoxidation only required for As(III).

^gSome iron based sorbents may catalyze the As(III) to As(V) oxidation and therefore would not require a pre-oxidation step.

^hRO will remove As(III), but its efficiency is not consistent and pre-oxidation will increase removal efficiency.

ⁱAwwaRF, 2002.

^jKempic, 2002.

^kWang, et al., 2000.

^lAA can be used economically at higher pHs, but with a significant decrease in the capacity of the media.

^mGhurye and Clifford, 2001.

ⁿTumab, 2002.

^oWith increased domestic use. IMS cost will significantly decrease.

Adapted from U.S. EPA, 2003.

TABLE 14-2 (continued)
Arsenic treatment technologies summary comparison

Factors	Precipitative Processes				
	Enhanced lime softening LS	Enhanced (conventional) coagulation filtration CF	Coagulation-assisted micro-filtration CMF	Coagulation-assisted direct filtration CADF	Oxidation filtration OxFilt
Best available technology (BAT) ^a	Yes	Yes	No	Yes	Yes
Small System Compliance Technologies (SSCT) ^a	No	No	Yes	Yes	Yes
System size ^{a,b}	25–10,000	25–10,000	500–10,000	500–10,000	25–10,000
Removal efficiency ^c	90%	95% (w/FeCl ₃) < 90% (w/Alum)	90%	90%	50–90%
Total water loss	0%	0%	5%	1–2%	1–2%
Preoxidation required ^d	Yes	Yes	Yes	Yes	Yes
Optimal water Quality conditions	pH 10.5 – 11 ^e > 5 mg/L Fe ³⁺ ^e	pH 5.5 – 8.5 ^f	pH 5.5 – 8.5 ^f	pH 5.5 – 8.5 ^f	pH 5.5 – 8.5 > 0.3 mg/L Fe Fe:As Ratio > 20:1
Operator skill required	High	High	High	High	Medium
Waste generated	Backwash water, Sludge (high volume)	Backwash water, Sludge	Backwash water, Sludge	Backwash water, Sludge	Backwash water, Sludge
Other considerations	Treated water requires pH adjustment.	Possible pre & post pH adjustment.	Possible pre & post pH adjustment.	Possible pre & post pH adjustment.	None.
Centralized cost	Low ^g	Low ^g	High	Medium	Medium

^aU.S. EPA, 2002.

^bAffordable for systems with the given number of people served.

^cDepends on arsenic and iron concentrations.

^dPreoxidation only required for As(III).

^eAwwaRF, 2002.

^fFields, et al., 2000.

^gCosts for enhanced LS and enhanced CF are based on modification of an existing technology. Most small systems will not have this technology in place.

TABLE 14-3
Typical sorption treatment design and operating parameters

Parameter	IX	AA	IBS	MIR
Media bulk density, kg/m ³	640–700	640–750	1,100–1,200	N/A
Minimum column layers				
Freeboard, %	90 ^{a, b}	50 ^c	50	N/A
Media, m	1–1.5 ^b	1–1.5 ^c	0.8–1.0	0.8–1.0
Operating conditions				
Hydraulic loading rate m ³ /d · m ²	470–700 ^b	230–530 ^c	300–470	300–600
Empty bed contact time min	1.5–5	3–12 ^c	3.5	2–8
Downflow pressure drop, ^d kPa/m ²	50–100 ^e	10 ^f	N/A	N/A
Maximum pressure differential, kPa	100	35	24	N/A
Backwash conditions				
Backwashing flow rate, m ³ /d · m ²	180–230 ^b	400 ^c		N/A
Backwashing duration, min	5–20 ^b	10 ^c		N/A
Regeneration conditions^a				
Brine strength, wt %	6–10	—	—	—
Downflow rate m ³ /d · m ²	120–350	—	—	—
Regenerant volume m ³ /m ³ resin	2.7	—	—	—
Rinsing conditions				
Slow rinse rate, m ³ /d · m ²	25–270	—	—	—
Fast rinse rate, m ³ /d · m ²	120–1,200	—	—	—
Displacement requirements, BV	4–6	—	—	—

^aThis will be very resin specific. Check with the resin manufacturer before design. Assumes AA is not regenerated.

^bRubel, 2001.

^cRubel, 2003.

^dThis depends on temperature, type of media, and hydraulic loading rate.

^eFor strong base anion exchange resin at 20 °C and 25 m³/h · m²

^fFor AA at 5 m³/h · m²

N/A—Not Available.

Source: Clifford, 1999; Cook, 2007; U.S. EPA, 2003.

and reclassify the medium. Following a 5 to 10 minute backwash, a 60 to 75 minute slow rinse (0.020 m³/min · m²) with a 1 to 4 percent NaOH solution is used. The NaOH is followed by a slow rinse with water. A slow acid rinse follows the base (nominally 2 percent H₂SO₄ or HCl) that, in turn, is followed by a slow water rinse before putting the unit back in service. Detailed instructions on this complex regeneration process and schematic drawings are provided in the AWWA manual (2004) as well as in Rubel and Woosley (1979). Typical design criteria are shown in Table 14-4.

If lime-soda softening is practiced, fluoride can be removed by suitable pH adjustment.

14-5 IRON AND MANGANESE

Iron and manganese often occur together, and the treatment technologies are similar, so they are grouped together for this discussion. They are removed from water for aesthetic reasons. In oxidized form [Fe(III) and Mn(IV)], they impart color to water and stain fixtures and clothing.

TABLE 14-4
Typical design criteria for removal of fluoride by activated alumina

Parameter	Typical range or value
Treatment	
Media	
Capacity	3,000 to 5,000 g/m ³
Size	28 × 48 mesh
Depth	1 to 1.5 m
Filtration rate	90 to 400 m ³ /d · m ²
Volume concentration	1,000 to 1,500 bed volumes depending on the F ⁻
Backwash flow rate	470 to 550 m ³ /d · m ²
Backwash time	5 to 10 minutes
Regeneration	
Regenerant	1% NaOH
Flow rate	30 m ³ /d · m ²
Volume	5 bed volumes
Time	60 to 75 min
Rinse volume	2 bed volumes
Rinse flow rate	30 m ³ /d · m ²
Regenerant	2% H ₂ SO ₄
Flow rate	30 m ³ /d · m ²
Volume	1.5 bed volumes typically ^a
Rinse volume	2 bed volumes
Rinse flow rate	30 m ³ /d · m ²

^aTo neutralize the bed to pH 5.5.

Adapted from Clifford, 1999; Kawamura, 2000.

Iron stains are a red or rust color. Manganese stains are brown or black. For these reasons, the U.S. EPA set secondary drinking water MCLs of 0.3 mg/L for iron and 0.05 mg/L for manganese.

While quite insoluble in their oxidized form, they are very soluble in their reduced forms [Fe(II) and Mn(II)]. They are commonly associated with anoxic groundwater and hypolimnetic water in eutrophic lakes. Although more commonly found in the low mg/L range, in groundwater with low alkalinity, total iron concentrations may reach 10 mg/L or more. Concentrations of Mn²⁺ are on the order of 0.1 to 2.0 mg/L (Kawamura, 2000; MWH, 2005).

Treatment Strategies

Preoxidation. The most common method of removing iron and manganese is based on the conversion of the soluble forms to insoluble forms by oxidation. Oxidation with air, chlorine, chlorine dioxide, and permanganate are common in the United States. Ozone has been used successfully in Europe.

The oxidation-reduction reactions with air are (AWWA, 1990):

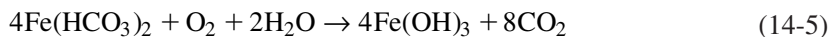

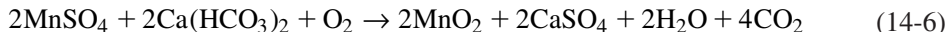

These reactions are quite slow. At a pH of 7.5 to 8.0, the iron reaction may take between 15 minutes and one hour (Hand et al., 1999; MWH, 2005). GLUMRB (2003) recommends a minimum detention time of 30 minutes after aeration. At a pH of 9.5, manganese oxidation requires an hour. At lower pH values, manganese oxidation with air is not practical.

The oxidation-reduction reactions with chlorine are (AWWA, 1990):

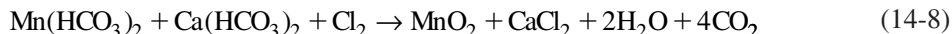

At a pH of 8.0 to 8.5, the oxidation time is about 15 to 30 minutes for iron. Oxidation of Mn^{2+} requires two to three hours at this pH. If ammonia is present it will consume chlorine and significantly increase the time for oxidation (MWH, 2005).

The oxidation reactions with chlorine dioxide are (AWWA, 1990):

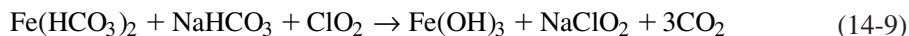

With a pH of 5.5, in the absence of natural organic matter (NOM), the oxidation time for iron is about 5 seconds and about 20 seconds for manganese. At higher pH values the reaction rate is faster. NOM does not interfere with the oxidation of Mn^{2+} but inhibits the oxidation of Fe^{2+} almost completely (MWH, 2005).

The oxidation reactions with permanganate are (AWWA, 1990):

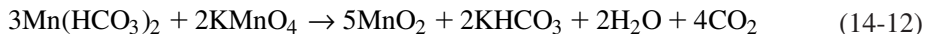

Both Fe^{2+} and Mn^{2+} are oxidized in less than 20 seconds at pH values greater than 5.5. Oxidation of iron complexed with NOM requires over an hour. The applied dose of permanganate must be controlled carefully because residual permanganate on the order of 0.05 mg/L results in an easily detectable pink color to the water.

Filtration. Traditional iron and manganese removal is by filtration of the preoxidized constituents. All of the media types are similar with respect to particle size distribution. The media differs from rapid sand filter media in that it is treated with KMnO_4 to provide a manganese oxide (MnO_2) coating.

The common media is called *greensand* because of the color of the media. Greensand is a dull green iron potassium silicate called *glaucinite*. For iron and manganese removal, it is synthetically coated with a thin layer of MnO_2 . Glaucinite exhibits an ion exchange capacity that allows the surface to be saturated with manganous ions. Following saturation, the glaucinite is soaked in a strong oxidizing solution (KMnO_4) that converts the manganous ion to $\text{MnO}_2(\text{s})$. As with ion exchange, the greensand may be regenerated periodically by backwashing, or it may be continuously regenerated with a low oxidant dose. Commercially available greensand has an effective size of 0.30–0.35 mm, a uniformity coefficient of less than 1.6, and a specific gravity of 2.4 (Sommerfeld, 1999).

Silica sand and/or anthracite treated to provide a coating of manganese oxide have been used as filter media. In addition, membrane (MF) filtration has been used to remove the precipitate after preoxidation.

Ion Exchange. Ion exchange may be suitable for raw water with iron and manganese concentrations less than 0.5 mg/L, but this is not a common treatment technology. It is not recommended for higher concentrations because the media becomes coated with oxides. The coated media cannot be regenerated.

Nanofiltration. NF membranes are very efficient for the removal of soluble Fe^{2+} and Mn^{2+} . However, a very small concentration of oxidized iron and manganese will foul the membrane. If the raw water is anaerobic and great care is taken to prevent oxidation of the iron and manganese, NF can be highly effective (MWH, 2005).

Lime-Soda Softening. As noted in Chapter 7 (Figures 7-11 and 7-12) at the high pH values required for lime-soda softening, iron and manganese are effectively removed.

Complexed Iron and Manganese. Preoxidation, followed by sedimentation and filtration is ineffective for complexed iron and manganese. Typical circumstances that result in complexed iron and manganese are (Sommerfeld, 1999):

- Shallow wells adjacent to rivers, streams, and lakes.
- Total organic carbon (TOC) concentrations greater than 2.0 to 2.5 mg/L.
- Presence of ammonia in the raw water.
- Presence of hydrogen sulfide in the raw water.

Pretreatment to remove NOM, NH_3 , and H_2S is one method to make the iron and manganese oxidation removal processes effective. Alternative means of iron and manganese removal such as ion exchange or NF may become competitive with oxidation/filtration when the complexes are encountered.

Decision Trees. Figures 14-3 and 14-4 illustrate methods to select alternative treatment trains to deal with constituents that may interfere with the iron and manganese removal. Pilot testing of alternatives is highly recommended.

14-6 NITRATE

High levels of nitrate are of concern because it is a precursor to nitrite, which causes *methemoglobinemia*, also known as “blue baby syndrome.” The nitrate is converted to nitrite in the stomach. It complexes with hemoglobin which reduces its capability to carry oxygen. The U.S. EPA has set an MCL of 10 mg/L as nitrate.

Of the several processes that can remove nitrate (biological denitrification, RO, and ion exchange), ion exchange is generally the most economical. Strong base anion exchange (SBA)

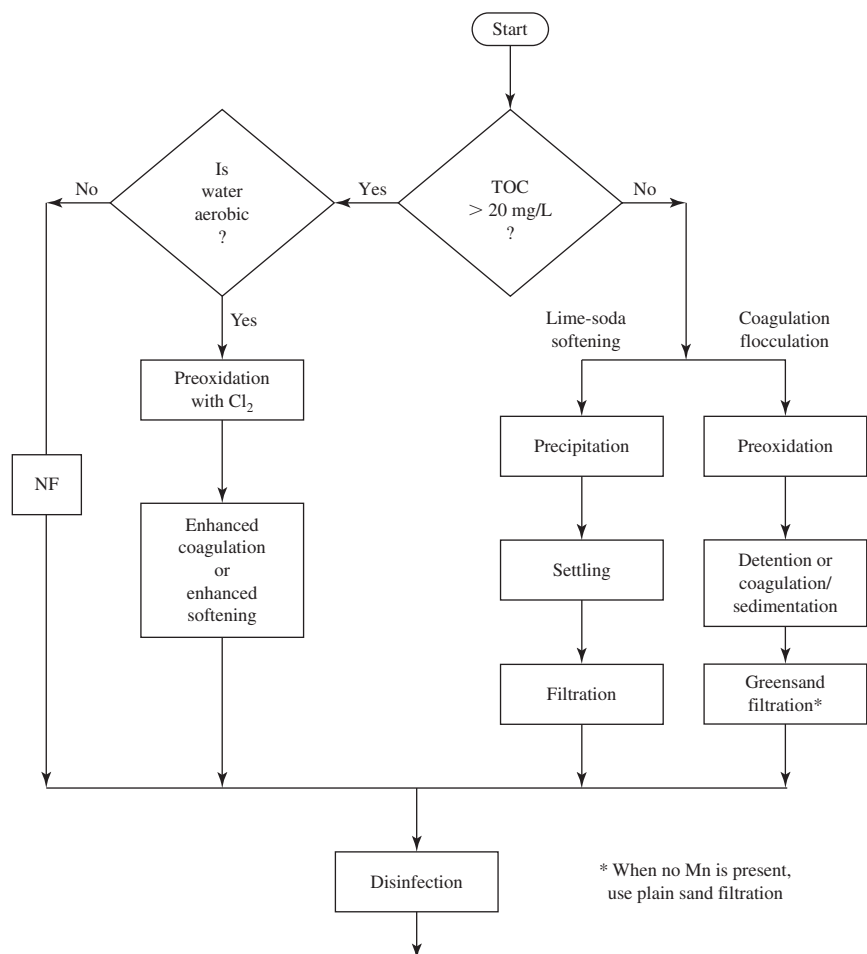
**FIGURE 14-3**

Decision tree for treatment to remove iron/manganese at larger water treatment plants (> ~ 40,000 m³/d).

resins are effective in removing nitrate. The preference for anion exchange for standard SBA resins is sulfate > nitrate > bicarbonate > chloride. When the sulfate concentration is high, nitrate-specific resins are selected.

14-7 NATURAL ORGANIC MATTER (NOM)

NOM is of concern because its reaction with chlorine forms carcinogenic disinfection byproducts and complexes with other constituents to inhibit their removal from water. One method of quantifying the presence of NOM is by measuring the total organic carbon (TOC) in the water. Unless they are under the influence of surface water, most groundwaters have TOC concentrations less than 2 mg/L. Surface water TOC concentrations range from 1 to 20 mg/L (MWH, 2005).

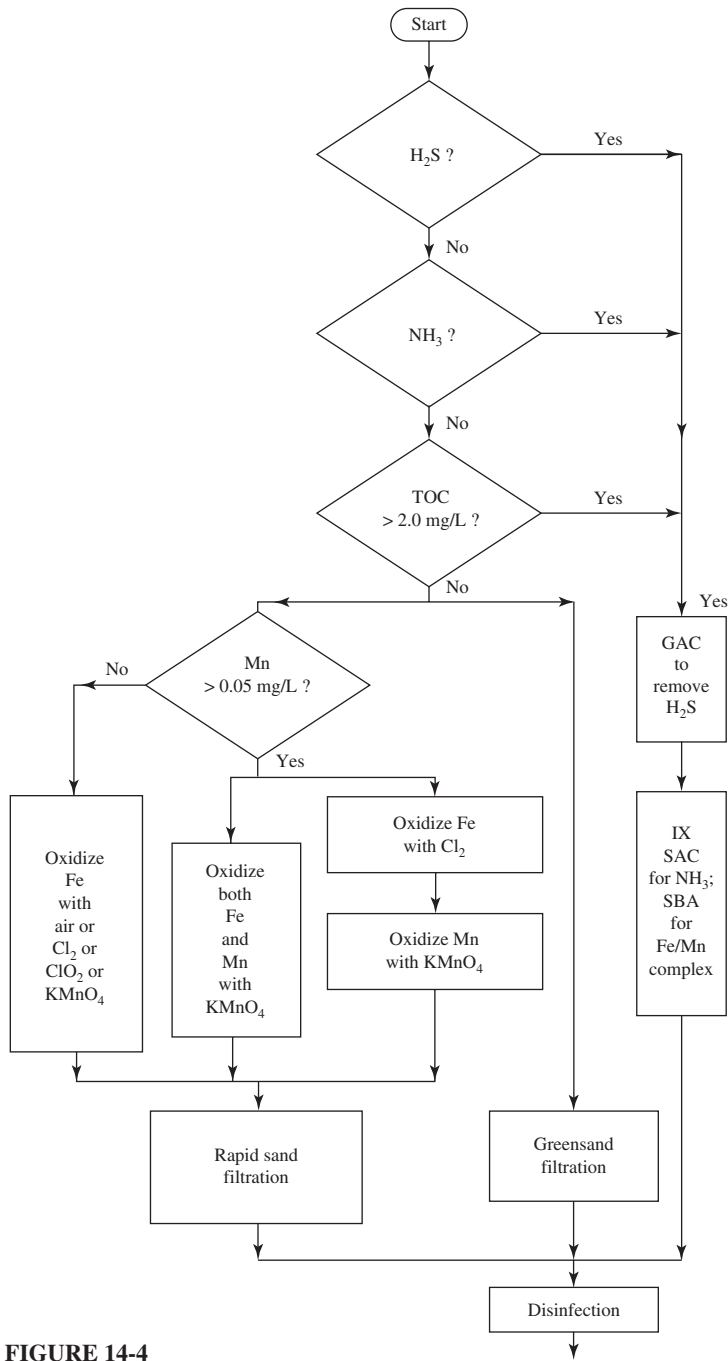

FIGURE 14-4

Decision tree for treatment to remove iron/manganese at smaller water treatment plants ($< \sim 30,000 \text{ m}^3/\text{d}$).

GAC = granular activated carbon

SAC = strong-acid cation exchange resin

SBA = strong-base anion exchange resin

Treatment Strategies

The primary methods of NOM removal are enhanced coagulation, adsorption on activated carbon, ion exchange, and NF/RO. As noted in Chapter 7, lime-soda softening is also effective in removing NOM.

Enhanced Coagulation. Alum or ferric chloride coagulation removes NOM by NOM-metal ion interaction. The conventional coagulation/flocculation/sedimentation/filtration treatment train is “enhanced” by adjusting the dose based on TOC removal rather than on turbidity removal. In general, this implies higher doses of coagulant. Adjustment of the pH to the range of 5.5 to 6.5 results in the optimum NOM removal for a given dose of alum. With the adjustment of pH and alum doses on the order of 50 to 100 mg/L, TOC removal on the order of 30 to 50 percent can be achieved (MWH, 2005).

The U.S. EPA (2006) established requirements for TOC removal compliance as shown in Table 14-5.

Adsorption. Although activated carbon is effective in NOM removal, a large amount of activated carbon is required to remove a little NOM (MWH, 2005). Dvorak and Maher (1999) suggest that carbon usage rates can be minimized by blending effluent from parallel columns. For operational end-points of 0.75 and 1.5 mg/L TOC and empty bed contact times (EBCTs) of 5.25 and 10.5 minutes, the most dramatic improvement in carbon usage occurs by using two columns. The usage rate decreases slightly with the addition of a third and fourth column and then levels off. Increasing the EBCT from 5.25 minutes to 10.5 minutes reduces the usage dramatically for one column but only slightly for two columns. They do not recommend increasing the EBCT to 21 minutes based on their study.

Ion Exchange. Anion exchange resins are effective in removing NOM because it is highly ionized in water. TOC reductions on the order of 50 percent can be achieved with conventional packed bed ion exchange columns.

Magnetic ion exchange (MIEX) uses a magnetized bead that is added to water as a slurry (Figure 14-5). The exchange reaction is faster than in a column that allows a shorter contact time. The magnetized beads coalesce during settling, which increases the settling rate.

NF and RO. While NF and RO systems have been used successfully for removing NOM from groundwater while it was being softened, their use for surface water is limited because of fouling problems.

TABLE 14-5
Enhanced coagulation TOC removal requirements

Source water TOC, mg/L	Source water alkalinity, mg/L as CaCO ₃		
	0 – 60	> 60–120	> 120
0–2.0	No action	No action	No action
> 2.0–4.0	35%	25%	15%
> 4.0–8.0	45%	35%	25%
> 8.0	50%	40%	30%

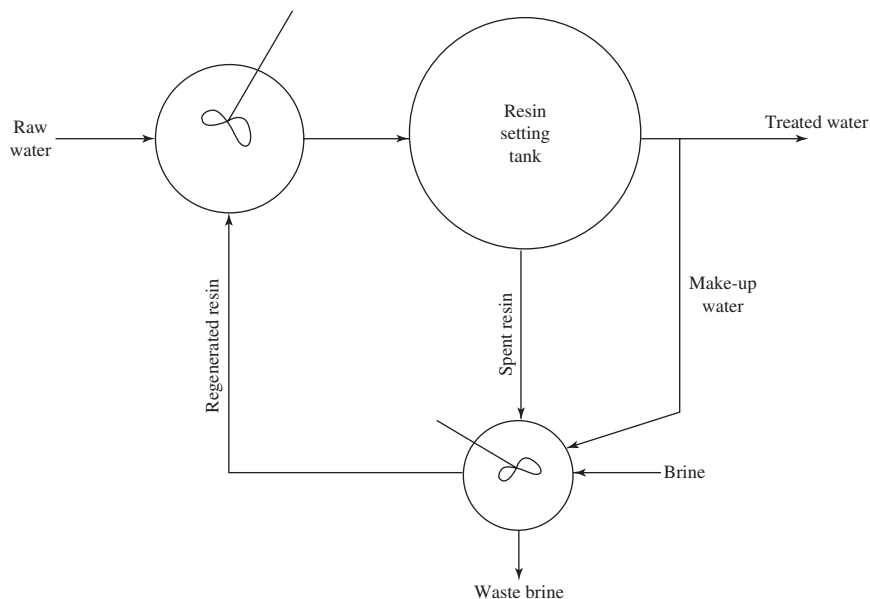

FIGURE 14-5
Magnetic ion exchange (MIEX[®]) process flow diagram.

14-8 PERCHLORATE

Perchlorate (ClO_4^-) contamination has become a major concern since the U.S. Environmental Protection Agency (EPA) reported that its presence in drinking water poses a health hazard because of its effect on thyroid hormone production. Although EPA has placed perchlorate on the Contaminant Candidate List 2, a maximum contaminant level (MCL) has not been set. However, several states have set their own advisory levels. These range from 1 to 14 $\mu\text{g}/\text{L}$. In 2006, Massachusetts set an MCL of 2 $\mu\text{g}/\text{L}$, and in 2007, California set an MCL of 6 $\mu\text{g}/\text{L}$.

Numerous technologies for removing perchlorate from drinking water have been investigated. These include ion exchange, biological reduction, reverse osmosis, granular activated carbon adsorption, and chemical reduction. Of these, strong-base anion exchange (SBA) and biological reduction have shown favorable results.

The presence of nitrate, sulfate, and uranium in the raw water require careful consideration in the selection of an appropriate resin for ion exchange. The perchlorate-chloride separation factors of commercially available resins vary over almost three orders of magnitude.

From limited research results with ion exchange resins, the following general conclusions may be made (Tripp and Clifford, 2006):

- Polyacrylic resins prefer sulfate over perchlorate and nitrate.
- Polystyrene SBA resins prefer sulfate over nitrate, but not over perchlorate.
- Resins with high perchlorate selectivity (for example tripropyl and bifunctional triethyl-trihexyl) prefer perchlorate and nitrate over sulfate.

In each of these instances, the regenerant brine is a significant disposal issue. As an aid to process selection, Tripp and Clifford (2006) presented the decision criteria outlined in Table 14-6.

Even at low concentrations ($< 10 \mu\text{g/L}$), the presence of naturally occurring uranium [U(VI)] complicates the decision process because SBA resins concentrate the uranium. The regeneration of SBA with high concentrations of adsorbed uranium may result in the production of a hazardous waste. Gu et al. (2005) concluded that bifunctional resins can be used effectively to treat water contaminated with both uranium and perchlorate. To minimize the generation of hazardous waste, the adsorbed U(VI) may be separated from the ClO_4^- by using a dilute acid wash to remove the U(VI) prior to the regeneration of the spent resin loaded with ClO_4^- .

Large pilot-scale ($270 \text{ m}^3/\text{d}$) fluidized bed bioreactor (FBR) results have demonstrated that perchlorate concentrations on the order of $1,000 \mu\text{g/L}$ can be reduced to less than $5 \mu\text{g/L}$ (Webster et al., 2009). Granular activated carbon (GAC) is suspended or fluidized by the upward flow of water through a column. The GAC acts as the medium for attached microbial growth. An electron donor such as acetic acid is fed to the column. Under anoxic conditions, the microorganisms perform an oxidation-reduction reaction in consuming all of the dissolved oxygen, nitrate, and perchlorate. The byproducts of the process are nitrogen gas, chloride ions, carbon dioxide, heat, and additional biomass. The FBR is self-inoculated by the natural flora of the incoming groundwater. As with typical biological processes, an acclimation period is required after start-up to achieve sufficient biomass to be effective. In this pilot study, the start-up period was about one month. Although the system required careful monitoring during start-up, the performance was reliable even with simulated failures of power and pumps after the start-up period.

TABLE 14-6
Ion exchange process recommendations for perchlorate-contaminated groundwater

SO_4^{2-} mg/L	NO_3^- mg/L	Brine disposal available	Suggested treatment process
< 250	Any	Yes	Option 1: Use standard polyacrylic gel resin with low perchlorate selectivity and operate until nitrate breakthrough with partial exhaustion and partial countercurrent regeneration without mixing. Use 6% NaCl at 320 kg/m^3 , and no temperature adjustment. Consider biological or chemical treatment of perchlorate and reuse of brine.
< 500	$< 5.0^a$	Yes	Option 2: Use standard polystyrene gel resin with medium-high perchlorate selectivity run to sulfate breakthrough with partial countercurrent regeneration at ambient temperature or elevated temperature of 50 to 60°C .
< 500	$< 5.0^a$	No	Option 3: Use highly perchlorate selective resin, run to perchlorate breakthrough, with resin regeneration offsite.

^aFeed water nitrate as nitrogen concentrations as high as the 10 mg/L MCL are acceptable as long as several ion exchange columns are operated in parallel at different stages of exhaustion. This is to dilute the the nitrate peak to less than the MCL when peaking occurs.

14-9 PHARMACEUTICALS AND ENDOCRINE-DISRUPTING CHEMICALS (EDCs)

Pharmaceutical compounds, such as sulfamethoxazole, carbamazepine, and ibuprofen, and endocrine-disrupting compounds, such as 17 β -estradiol, testosterone, and bisphenol-A, have been identified in the surface waters of the United States. Figure 14-6 shows the most frequently detected pharmaceuticals and EDCs. Typical concentrations are low. For example, in surface water supplies they are generally less than 1 $\mu\text{g/L}$ (Hullman, 2009).

Although research on removal of pharmaceuticals and EDCs is in its infancy, some early results are useful in pointing to potential technologies. For a selected set of pharmaceuticals (bezafibrate, clofibrac acid, carbamazepine, and diclofenac), Ternes et al. (2002) reported the following:

- Conventional sand filtration and coagulation with ferric chloride provide no significant removal,
- Ozonation was effective for some compounds, and
- Ozonation followed by granular activated carbon filtration was very effective for all compounds investigated but clofibrac acid.

For selected sets of pharmaceuticals (sulfamethoxazole, carbamazepine, diclofenac, and ibuprofen) and EDCs (estradiol, estrone, testosterone, and progesterone), several authors

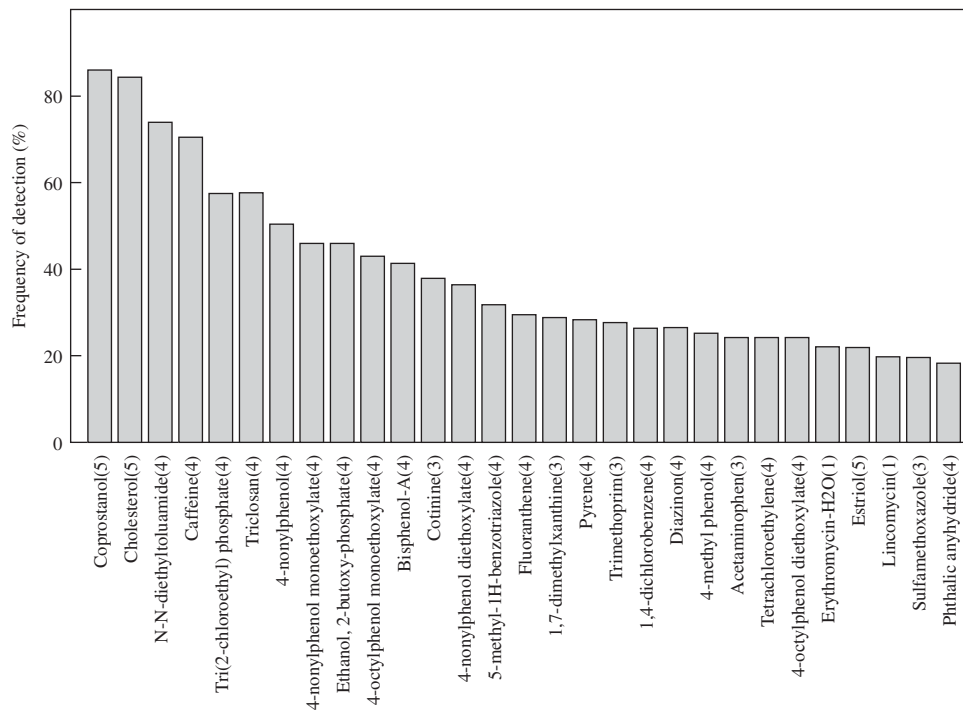

FIGURE 14-6

Most frequently detected pharmaceuticals and endocrine-disrupting compounds. (Source: U.S.G.S., 2002.)

(Drewes et al., 2005; Nghiem et al., 2004 and 2005) indicate NF and RO are highly effective in removing these compounds. Ozonation also appears to be highly effective for the destruction of these compounds (Westerhoff et al., 2005). UV irradiation of pharmaceuticals appears to be only effective in the presence of hydrogen peroxide (Rosenfeldt and Linden, 2004).

14-10 RADIONUCLIDES

The most common radionuclides of concern in natural waters are radium-226 (^{226}Ra) radium-228 (^{228}Ra), radon-222 (^{222}Rn), and uranium-234 (^{234}U). In groundwater, ^{226}Ra and ^{228}Ra exist primarily as divalent cations. Radon-222 is a volatile gas. Uranium-234 exists as uranyl ion. It readily complexes with carbonate and hydroxide. The revised Radionuclide Rule outlining the concentration limits for these compounds was published on December 8, 2003.

The U.S. EPA has designated the following as best available technologies (BAT) for removal of the radionuclide shown (U.S. EPA, 2005):

- Radon-222: air stripping.
- Radium-226 and radium-228 together: coagulation/flocculation/sedimentation/filtration.
- Radium-226 and radium-228 separately: ion exchange, RO or lime-soda softening.
- Uranium-234: ion exchange; coagulation/flocculation/sedimentation/filtration.

Table 14-7 summarizes the performance of specific technologies for specific radionuclides. Sludge and resin disposal alternatives are discussed in Chapter 15.

TABLE 14-7
Performance of specific technologies for specific radionuclides

Technology	Removal efficiency, %		
	Radon	Radium	Uranium
Activated alumina			up to 99
Aeration, diffused bubble	to 99 +		
Aeration, spray	70–95 +		
Air stripping, packed tower	to 99 +		
Coagulation-filtration			85–95
GAC adsorption	62–99 +		
Greensand		19 to 82 ^a	
Anion exchange			up to 95
Cation ion exchange		81–97	
Lime-soda softening		75–90	16 to 97 ^b
Reverse osmosis		90–95 +	90

^a19 to 63% for radium-226 and 23 to 82% for radium-228.

^bpH of at least 10.6.

Adapted from Lowery and Lowery, 1988; U.S. EPA, 2005.

14-11 SYNTHETIC ORGANIC CHEMICALS (SOCs) AND VOLATILE ORGANIC CHEMICALS (VOCs)

Synthetic organic chemicals include pesticides, polycyclic aromatic hydrocarbons, and polychlorinated biphenyls. SOC is considered a regulatory term rather than a chemical description. Some of the SOCs are volatile organic chemicals. The term *volatile organic chemical* (VOC) refers to a compound with a high vapor pressure that causes it to evaporate readily. In water treatment practice, they are classified into three broad groups:

- Those found in petroleum products (e.g., benzene, toluene, and xylene).
- Halogenated compounds used as solvents, degreasers, and intermediates (e.g., tetrachloroethylene and methylene chloride).
- Disinfection byproducts like the trihalomethanes.

With the exception of the THMs, these compounds enter the water from industrial waste discharge, leaking fuel storage tanks, and uncontrolled waste disposal sites.

Treatment Strategies

The U.S. EPA designated air stripping and granular activated carbon (GAC) as best available technology (BAT) for treatment of VOCs except for vinyl chloride and methylene chloride. For these two chemicals, only air stripping is recognized as BAT. As a rule of thumb, chemicals having a dimensionless Henry's law coefficient $\geq 7.5 \times 10^{-4}$ at 20°C can be removed by packed tower stripping (54 FR 22062). Air stripping is more economical than GAC for removal of VOCs if the off-gas can be directly discharged without treatment (Ball and Edwards, 1992; Gross and TerMaath, 1985; Hand et al., 1986). The economic advantage of air stripping over GAC diminishes when off-gas treatment is required and other strategies should be investigated (Ball and Edwards, 1992).

For SOCs that cannot be stripped, GAC is the BAT technology.

Stripping. Although there are a number of air stripping systems available, packed towers (Figure 14-7) serve as a primary method for removal of VOCs. The relevant equations are (LaGrega et al., 2001):

$$Z = (\text{HTU})(\text{NTU}) \quad (14-13)$$

$$\text{HTU} = \frac{Q}{(A)(K_L a)} \quad (14-14)$$

$$\text{NTU} = \left(\frac{S}{S-1} \right) \ln \left[\frac{(C_{\text{in}}/C_{\text{eff}})(S-1) + 1}{S} \right] \quad (14-15)$$

$$S = \frac{(H)(Q_a)}{Q} \quad (14-16)$$

where Z = packing height, m
 HTU = height of transfer unit, m
 Q = flow rate of water, m^3/s

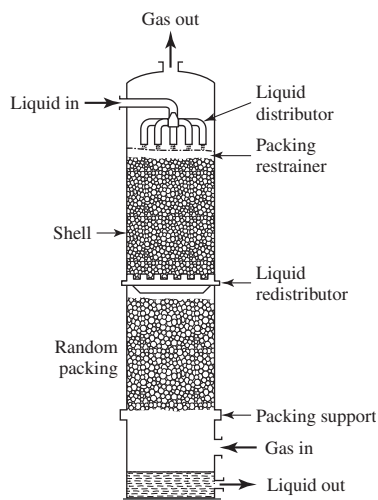

FIGURE 14-7
Packed tower stripping column.

- A = cross-sectional area of column, m^2
- K_{La} = overall transfer rate constant, s^{-1}
- NTU = number of transfer units
- S = stripping factor
- C_{in} = influent concentration, mg/L
- C_{eff} = effluent concentration, mg/L
- H = Henry's constant, dimensionless
- Q_a = flow rate of air, m^3/s

The overall transfer rate constant (K_{La}) is a complex function of the diffusion coefficients, liquid mass loading, liquid viscosity, and packing size. The Sherwood and Holloway equation and the Onda correlations (see LaGrega et al., 2001) are two techniques for estimating K_{La} . However, for design purposes, K_{La} should be determined experimentally. A factor of safety is required for both the pilot scale data and the estimating techniques because they overestimate K_{La} . They are between 33 percent and 47 percent high (Djebbar and Narbaitz, 1995; MWH, 2005).

Dimensionless Henry's constants for selected compounds are given in Appendix A.

Air-to-water ratios (Q_a/Q) range from 5:1 to 300:1 (Kavanaugh and Trussel, 1980; LaGrega et al., 2001). For chemicals with dimensionless Henry's law coefficients from 0.003 to 0.3, the air-to-water ratio that provides the minimum tower volume and power requirement is approximately 3.5 times the minimum air-to-water ratio needed to meet a treatment objective concentration of C_{eff} (Hand et al., 1986; MWH, 2005). The minimum air-to-water ratio is calculated with the following equation:

$$\frac{Q_a}{Q} = \frac{C_{in} - C_{eff}}{(H)(C_{in})} \quad (14-17)$$

- where Q_a/Q = air-to-water ratio
- C_{in} = influent liquid concentration, mg/L
 - C_{eff} = effluent liquid concentration, mg/L
 - H = Henry's law coefficient, dimensionless

For VOC stripping, the ratio should be selected to achieve the desired concentration of VOC in the effluent while maintaining a height-to-diameter ratio greater than 1:1. In general, it is more economical to provide higher air-to-water ratio because it lowers the tower height. The trade-off is between the operating cost for the blower to provide air and the capital cost for a taller tower.

The pressure drop per unit of tower height ($\Delta P/Z$) in the packed tower is a function of the superficial gas velocity and the friction factor for dry packing (F_p). The proportionality expression is:

$$\frac{\Delta P}{Z} \propto (F_p)(v_g)^2 \quad (14-18)$$

where $\Delta P/Z$ = pressure drop per unit length of packed column, Pa/m
 F_p = friction factor or, more commonly, packing factor, dimensionless
 v_g = superficial gas velocity, m/s

The *packing factor* is specific to the shape and size of the packing. A few examples are shown in Table 14-8.

The cross-sectional area of the column (A) is estimated using the Eckert pressure drop curves shown in Figure 14-8 (Eckert, 1961).

The estimating procedure is

1. Specify the water temperature, packing factor (F_p), air-to-water ratio (Q_a/Q), and gas pressure drop ($\Delta P/Z$).
2. Compute the value of the ratio G_m/L_m using the following expression:

$$\frac{G_m}{L_m} = \left(\frac{Q_a}{Q} \right) \left(\frac{\rho_g}{\rho_w} \right) \quad (14-19)$$

TABLE 14-8
Selected packing factors and specific surface area

Type	Nominal diameter, mm	Packing factor, F_p
Plastic saddles ^a	50	20.0
	75	16.0
Plastic tripacks ^b	50	15.0
	90	14.0
Flexring ^c	50	24.0
	90	20.0
IMPAC ^{d TM}	85	15.0
	140	6.0
LANPAC ^{d TM}	60	21.0
	90	14.0

^aNorton Co., Akron, OH.

^bJaeger Co., Houston, TX.

^cCeilcote Co., Cleveland, OH.

^dLANTEC Co., Los Angeles, CA.

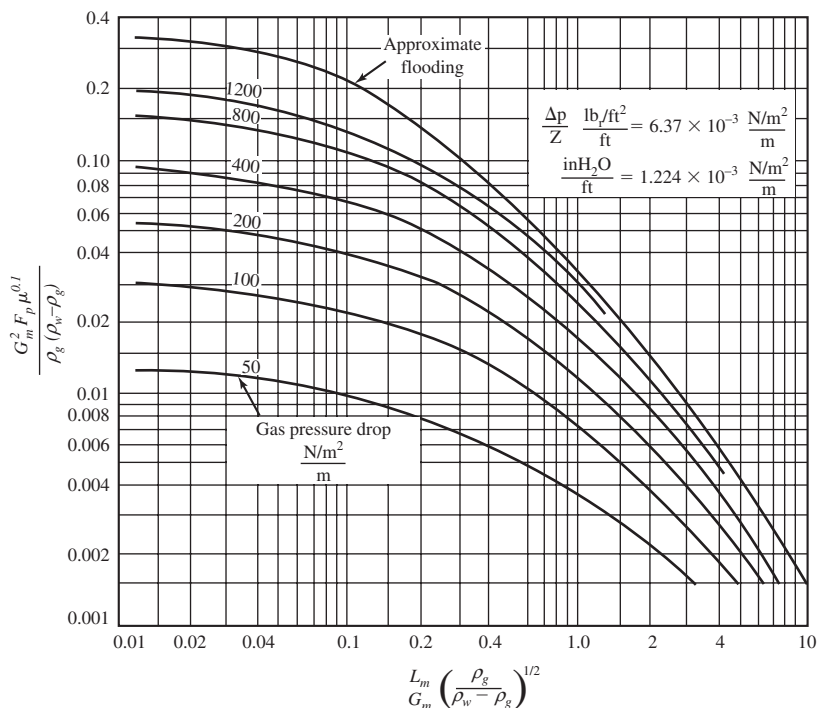
**FIGURE 14-8**

Flooding and pressure drop in randomly packed towers.

(Source: Treybal, R. E. 1980. *Mass Transfer Operations*. New York: Chem. Engrg. Series, McGraw-Hill, 3rd ed.)

Reproduced with permission of The McGraw-Hill Companies.

where G_m = air mass loading rate, $\text{kg/m}^2 \cdot \text{s}$
 L_m = water mass loading rate, $\text{kg/m}^2 \cdot \text{s}$
 ρ_g = air density, kg/m^3
 ρ_w = water density, kg/m^3

3. Compute the value of x on the x -axis of the Eckert curve using

$$x = \left[\frac{1}{(G_m/L_m)} \right] \left[\frac{\rho_g}{\rho_w - \rho_g} \right]^{0.5} \quad (14-20)$$

4. Determine y on Figure 14-8 using the computed value of x and the specified pressure drop.
5. With the value of y , solve the following expression for G_m :

$$G_m = \left[\frac{(y)(\rho_g)(\rho_w - \rho_g)}{(F_p)(\mu)^{0.1}} \right]^{0.5} \quad (14-21)$$

where y = numerical value on y -axis found in step 4
 F_p = packing factor, dimensionless
 μ = dynamic viscosity of water, $\text{Pa} \cdot \text{s}$

TABLE 14-9
Typical packed column design ranges

Parameter	Value	Comment
Tower height	1.5 to 9 m	Prefab will be sized to fit on flat bed trailer
Diameter	0.3 to 3.6 m	Restriction to 3.6 m for transport of prefab units
Height:diameter	> 1:1	Without liquid redistribution use > 4:1 for proper liquid distribution
Pressure drop	50 to 100 Pa/m of packing	Economics favor 50 Pa/m
Q_a/Q	5:1 to 300:1	
Ratio of diameter to packing size	8:1 to 15:1	> 15:1 preferred

Sources: Dyksen, 2005; Hand et al., 1999; LaGrega et al., 2001; MWH, 2005; Treybal, 1980.

6. Determine the water mass loading rate.

$$L_m = \frac{G_m}{(Q_a/Q)(\rho_g/\rho_w)} \quad (14-22)$$

7. Determine the cross-sectional area of the packed tower.

$$A = \frac{(Q)(\rho_w)}{L_m} \quad (14-23)$$

Typical design ranges are given in Table 14-9.

Prefabricated tower dimensions are limited by highway transportation clearances. Multiple towers in series are used to meet height requirements when tower heights exceed 9 m. Multiple towers in parallel are used when tower diameters exceed 3.6 m. The tower height is greater than the height of the packing. Approximately 1 to 2 m may be added to the packing height for support structures and internal distribution piping. Prefabricated units are generally built in 0.3 m increments.

Potential operating problems arise when the water contains appreciable quantities of iron, manganese, and/or hardness. The aeration will oxidize the iron/manganese, which will then precipitate on the packing and foul it. Preoxidation and filtration may be used to avoid this problem. Because CO₂ is being stripped, the pH of the water will rise. This may lead to calcium carbonate precipitation in the packing. Using a larger packing diameter (> 50 mm), careful monitoring, and periodic cleaning of the packing may be required. A design with capability to periodically acid wash the packing has also been used when high iron/manganese/calcium was encountered (Ball and Edwards, 1992).

Example 14-2. Springfield has a well field that is contaminated with trichloroethylene (TCE). The design flow rate is 8,200 m³/d. A packed tower has been selected to remove the TCE. A treatment objective of 95 percent removal of TCE has been selected. Design a packed tower to strip TCE from the water. The following design data have been provided:

Raw water TCE = 72.0 $\mu\text{g/L}$

Temperature = 10°C

$K_L a = 0.0128 \text{ s}^{-1}$

Packing = plastic tripack with diameter of 50 mm

$\Delta P/Z = 50 \text{ Pa/m}$

$\rho_g = 1.2 \text{ kg/m}^3$

$\rho_w = 1,000 \text{ kg/m}^3$

H at 10°C = 0.116

Determine the following to complete the design:

Q_a/Q

Q_a

Column diameter

Stripping factor

Height of packing

Overall height of packed tower

Solution:

- a. Determine the minimum air to water ratio (Q_a/Q) from Equation 14-17. At 95 percent removal, the effluent concentration of TCE is 3.60 $\mu\text{g/L}$.

$$\frac{Q_a}{Q} = \frac{72.0 \mu\text{g/L} - 3.60 \mu\text{g/L}}{(0.116)(72.0 \mu\text{g/L})} = 8.19$$

To achieve the air-to-water ratio that provides the minimum tower volume and power requirement, multiply the minimum air-to-water ratio by 3.5.

$$\frac{Q_a}{Q} = (8.19)(3.5) = 28.66 \text{ or } 30$$

- b. Determine the diameter of the column

- (1) Compute the value of the ratio G_m/L_m .

$$\frac{G_m}{L_m} = (30) \left(\frac{1.2 \text{ kg/m}^3}{1,000 \text{ kg/m}^3} \right) = 0.0360$$

- (2) Compute the value of x on the Eckert curve using Equation 14-20.

$$x = \left[\frac{1}{0.0360} \right] \left[\frac{1.2 \text{ kg/m}^3}{1,000 \text{ kg/m}^3 - 1.2 \text{ kg/m}^3} \right]^{0.5} = 0.96$$

- (3) Find y on Figure 14-8 using $x = 0.96$ and the $\Delta P/Z = 50 \text{ Pa/m}$ curve:

$$y = 0.0039$$

- (4) With the value of y , solve Equation 14-21 for G_m . The packing factor of 15.0 for 50 mm tripacks is found in Table 14-8.

$$G_m = \left[\frac{(0.0039)(1.2 \text{ kg/m}^3)(1,000 \text{ kg/m}^3 - 1.2 \text{ kg/m}^3)}{(15.0)(1.307 \times 10^{-3})^{0.1}} \right]^{0.5} = 0.778 \text{ kg/m}^2 \cdot \text{s}$$

(5) Determine the water mass loading rate.

$$L_m = \frac{0.778 \text{ kg/m}^2 \cdot \text{s}}{(30)(1.2 \text{ kg/m}^3/1,000 \text{ kg/m}^3)} = 21.61 \text{ kg/m}^2 \cdot \text{s}$$

(6) Determine the cross-sectional area of the packed tower.

$$A = \frac{(8,200 \text{ m}^3/\text{d})(1,000 \text{ kg/m}^3)}{(21.61 \text{ kg/m}^2 \cdot \text{s})(86,400 \text{ s/d})} = 4.39 \text{ m}^2$$

(7) Determine the diameter of the column.

$$D = \left(\frac{(4.39 \text{ m}^2)(4)}{\pi} \right)^{0.5} = 2.36 \text{ or } 2.4 \text{ m}$$

c. The height of a transfer unit (HTU) is a function of the area of the column. Using the area of 4.39 m^2

$$\text{HTU} = \frac{8,200 \text{ m}^3/\text{d}}{(4.39 \text{ m}^2)(0.0128 \text{ s}^{-1})(86,400 \text{ s/d})} = 1.69 \text{ m}$$

d. With the Henry's law constant of 0.116, the stripping factor is

$$S = (0.116)(30) = 3.48$$

e. The number of transfer units (NTU) is

$$\text{NTU} = \left(\frac{3.48}{3.48 - 1} \right) \ln \left[\frac{(72.0 \text{ } \mu\text{g/L}/3.60 \text{ } \mu\text{g/L})(3.48 - 1) + 1}{3.48} \right] = 3.76$$

f. The height of the packing (Z) is then

$$Z = (1.69 \text{ m})(3.76) = 6.35 \text{ m}$$

The height to diameter ratio is greater than 1:1 so this design is acceptable.

g. The estimated overall height of the tower will be $6.35 \text{ m} + 1.0 \text{ m}$ for distribution piping, etc. = 7.35 m . Because prefabricated units are usually constructed in 0.3 m increments, the actual final dimensions will be about 2.4 m in diameter and 7.5 m in height.

Comments:

1. The overall tower height meets the $\leq 9 \text{ m}$ criterion for prefab units. If it did not, alternative designs would be considered including increasing the air-to-water ratio and/or splitting the tower into two sections and using them in series.
2. The K_{La} for this problem was selected arbitrarily. It is not based on experimental data for the water or packing specified and should NOT be used for actual design.

3. A spreadsheet was used to perform the computations and explore several variables. Other solutions provide acceptable answers.

Granular Activated Carbon (GAC). The removal of a chemical from solution by activated carbon is a mass-transfer process in which the chemical is bonded to the solid. This process is called *adsorption*. The chemical (the *adsorbate*) penetrates into the pores of the solid (the *adsorbent*), but not into the lattice itself. The bond may be physical or chemical. Electrostatic forces hold the chemical when physical binding is predominant. Chemical bonding is by reaction with the surface. Activated carbon (the adsorbate) is made from various materials such as wood, coconut shells, coal, and lignite. The manufacturing process is essentially a carbonization of the solid followed by activation using hot air or steam. Like ion exchange resins, the number of active sites is finite and the carbon becomes saturated with use over time. It is regenerated by heating with hot air or steam.

Adsorption isotherms are used to select one of the manufactured activated carbons for removing the SOCs of concern in the water supply. The isotherms are prepared from experimental data. The selected activated carbon is placed in a solution containing the chemical or chemicals of interest. The solution is agitated to provide adequate contact between the granules of carbon and the chemical. The slurry is mixed until equilibrium is achieved. In general, this will take about one to four hours. The initial concentration will decrease to an equilibrium value. By employing a series of slurry tests, a plot can be made that describes the relationship between the equilibrium concentration and the mass of SOC (x) adsorbed per unit mass of activated carbon (m). Because the adsorption phenomenon is very temperature and pH dependent, the experimental temperature is controlled, that is, the experiment is *isothermal*, and the pH must be the same as that used in the full-scale treatment process. As a consequence, the data are only relevant for the temperature and pH at which the experiment is conducted.

Freundlich (1906) developed an empirical equation that is used to describe the results of the adsorption isotherm experiment. A form of the equation is

$$q_e = \frac{x}{m} = K(C_e)^{1/n} \quad (14-24)$$

where q_e = mass of solute adsorbed per mass of activated carbon, mg/g
 K = Freundlich adsorption capacity parameter, (mg/g)(L/mg)^{1/n}
 C_e = equilibrium concentration of solute, mg/L
 $1/n$ = Freundlich adsorption intensity parameter, dimensionless

The linear form of the Freundlich equation is

$$\log(q_e) = \log K + \left(\frac{1}{n}\right) \log C_e \quad (14-25)$$

A log-log plot will yield a straight line with a slope of $1/n$. With C_e equal to 1.0, $K = q_e$.

EPA has published isotherm data for individual chemicals that may be used for preliminary feasibility studies (Dobbs and Cohen, 1980). For actual selection of a manufactured carbon, isotherm experiments with the actual raw water are necessary because there are usually multiple chemicals that compete for adsorption sites and many other constituents that are not SOCs will adsorb.

Example 14-3. Determine the Freundlich isotherm constants K and n for the following experiment (adapted from LeGrega et al., 2001).

One hundred milliliters of a 600 mg/L xylene solution is placed in each of five containers with different amounts of activated carbon and agitated for 48 hours. The samples are filtered, and the amount of xylene is determined as shown below.

Container	1	2	3	4	5
Carbon, mg	600	400	300	200	50
Xylene remaining, mg/L	25	99	212	310	510

Solution.

a. Calculate q_e .

m , g	C_e , mg/L	x , mg	q_e , mg/g
0.6	25	57.5	95.8
0.4	99	50.1	125.3
0.3	212	38.8	129.3
0.2	310	29.0	145.0
0.05	510	9.00	180.0

The quantity in the column marked “ m ” is the mass of carbon in grams instead of mg given in the data set. C_e is given in the data set. The value of “ x ” is computed as follows:

$$x = (C_0 - C_e)(V)$$

where C_0 is the initial concentration and V is the volume of solution in liters. In this case, that is 0.100 L. The value $q_e = x/m$.

b. A spreadsheet is used to plot C_e versus q_e and find the trendline equation,

$$q_e = 51.3 (C_e)^{0.187}$$

With the isotherm data, a feasibility comparison of several carbon types can be made. The feasibility estimate must assume a batch reaction that comes to equilibrium at the same temperature used for the isotherm.

Example 14-4. Use the isotherm data from Example 14-3 to make a gross estimate of the daily carbon usage required to treat a highly contaminated well serving a small village. The demand is 380 m³/d. The water is contaminated with 60 mg/L of xylene. The MCL is 10 mg/L. Assume that a batch reactor will be used that will operate at the same temperature and pH as the laboratory experiment and that the slurry will be mixed until equilibrium is achieved.

Solution:

- a. From the Freundlich equation developed in Example 14-3 with $C_e = 10$ mg/L,

$$q_e = 51.3 (10)^{0.187} = 78.9 \text{ mg xylenes/g carbon}$$

- b. Mass of xylene to be removed per day:

$$(60 \text{ mg/L} - 10 \text{ mg/L})(380 \text{ m}^3/\text{d})(1,000 \text{ L/m}^3) = 1.90 \times 10^7 \text{ mg/d}$$

- c. Mass of carbon required:

$$\frac{1.90 \times 10^7 \text{ mg/d of xylene to be removed}}{78.9 \text{ mg xylenes/g carbon}} = 2.41 \times 10^5 \text{ g/d or 240 kg/d of activated carbon}$$

Actual designs should be based on column studies using the actual raw water because the behavior of the GAC column will not reach equilibrium in normal practice. The mass balance method presented for designing ion exchange columns (Chapter 8) can be used to evaluate the column data and develop a design.

The usual systems to contact the water with the carbon are fixed beds and countercurrent moving beds (also called *pulsed beds*). The fixed beds may be operated in either the upflow or downflow configuration. The upflow, fixed bed is more efficient in carbon use but requires a relatively high influent clarity (< 2–3 NTU). The downflow configuration may also serve as a filter for suspended solids. The countercurrent moving beds have a lower labor cost and higher utilization of the adsorption capacity of the carbon. Both the fixed beds and the moving beds may use gravity or pressure liquid flow. A typical fixed-bed column with liquid downflow is shown in Figure 14-9. In practice, multiple beds in series, parallel, or a combination of series and parallel are used. A minimum of two in series is recommended to optimize carbon use and prevent premature breakthrough.

The particle size of the GAC affects pressure drop, filtration efficiency, and the rate at which equilibrium is reached. Smaller particles yield a higher pressure drop but reach equilibrium more rapidly. Selection of the GAC particle size is then a matter of balancing these competing issues.

Table 14-10 provides a guide to selection for the various possible column configurations. Typical design criteria are listed in Table 14-11 on page 14-34.

Carbon regeneration is a major consideration in the selection and design of GAC facilities. An extensive discussion of the options and operational considerations is given in Clark and Lykins (1989).

14-12 TASTE AND ODOR (T&O)

Taste and odor are grouped together because they are inextricably linked. Although taste and odor are not classified as “specific constituents,” they arise from specific constituents and are, therefore, included in this chapter. The major water treatment issue with T&O is palatability rather than potability.

Decaying vegetation and metabolites of microorganisms are the most universal sources of disagreeable taste and odors in surface water. T&O problems are more common in surface water than groundwater because of the presence of algae in surface water. The rotten egg odor of hydrogen sulfide occurs in groundwater, and in some distribution systems, as a result of the

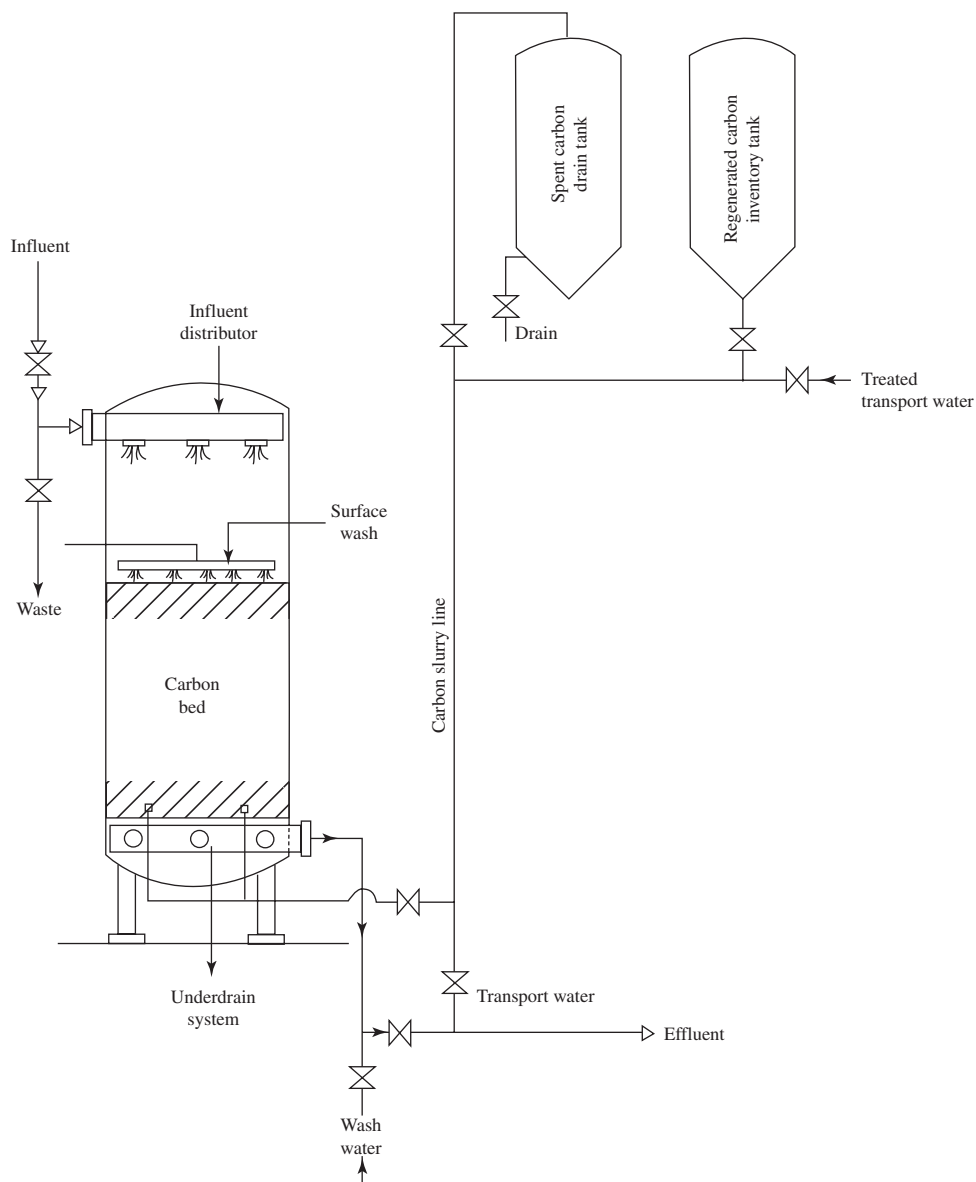

FIGURE 14-9
Single column, fixed bed carbon adsorption system.

anaerobic conversion of sulfates. Other sources of taste and odor are metals (zinc, copper, iron, and manganese) and solvents.

Treatment Strategies

Chemical oxidation and activated carbon adsorption are the most common methods of reducing T&O.

TABLE 14-10
Guide to selection of GAC adsorption system configuration

System configuration	Use when:
Single fixed bed; downflow	Low carbon use rate (CUR) is anticipated because of low contaminant concentrations and low flow rate
Fixed bed in series; ^a downflow	High CUR anticipated; high effluent quality required
Fixed beds in parallel; ^b downflow	Large total flow rate; pressure drop minimization is required
Expanded beds; upflow	Suspended solids are to be removed in subsequent process; low CUR is anticipated because of low contaminant concentrations and low flow rate
Moving or pulsed beds; upflow	High CUR anticipated; high effluent quality required; either some carbon fines can be tolerated in effluent or carbon adsorption is followed by filtration

^aCapital cost generally limits number of columns to four or less.

^bMost appropriate for large plants; spare column is provided to allow carbon regeneration at design capacity; CUR is increased by staggered start and blending of effluent which allows beds to operate until exhausted.

Sources: Brady, 2005; Fornwalt and Hutchins, 1966; Rizzo and Sheperd, 1977; Zanitach, undated.

Chemical Oxidation. Chlorine is effective in oxidizing odors associated with reduced sulfur compounds. It is less effective in destroying odors resulting from phenolic and other organic compounds. In addition, chlorination of organic compounds may result in the formation of disinfection byproducts.

Chlorine dioxide, ozone, and permanganate have been used successfully to reduce T&O. Because of the great variety of sources of T&O, careful experimentation with these oxidants is warranted as the oxidation products may be more odorous than the original compound.

Activated Carbon. Both granular and powdered activated carbon (GAC and PAC) have been used successfully for T&O control. In a 1989 survey, Suffet et al. (1996) found 63 percent of the water treatment plants used PAC for T&O control. The majority of surface water episodes are of one to two weeks duration. The convenience of PAC is that it can be added periodically in a conventional surface water treatment plant when T&O arises due to algal bloom. PAC is generally added in one of four locations: at the water intake, in the rapid mix tank, at the filter inlet, and in a separate slurry mixing tank. The intake addition provides a long contact time but may interfere with preoxidation for NOM removal. The rapid mix tank provides good mixing, but the coagulant may interfere with the adsorption of the T&O. Addition of the PAC just ahead of the filter makes efficient use of the PAC but may result in filter breakthrough of the fines. Doses range from a few to 100 mg/L with typical doses in the 0.5 to 18 mg/L range (Graham et al., 2000). Experiments conducted by Huang et al. (1996) on the reduction of 2-methylisoborneol (MIB) and geosmin, two common sources of T&O in

TABLE 14-11
Typical design ranges for GAC columns for water treatment

Parameter	Value	Comment
Carbon mesh size	8 × 30	Downflow beds and upflow packed beds
	12 × 40	Upflow expanded beds
Hydraulic loading rate		
Single fixed column	60 to 230 m ³ /d · m ²	
Parallel fixed column	60 to 230 m ³ /d · m ²	
Series columns	175 to 400 m ³ /d · m ²	
Moving bed	290 to 600 m ³ /d · m ²	
EBCT	10 to 60 min	There is a diminishing return on time to exhaustion and CUR at EBCTs greater than 30 min. Pilot tests are essential.
Carbon use rate (CUR)	20 to 100 kg/1,000 m ³	Lower CURs are associated with longer EBCTs
Column height	1 to 5 m	Prefab will be sized to fit on flat bed trailer.
Diameter	< 3.6 m	Restriction to 3.6 m for transport of prefab units
Height:Diameter	> 1:1	Without liquid redistribution use > 4:1 for proper liquid distribution
Pressure drop	0.2 to 8 kPa/m of carbon	
Backwash rate	600 to 1,200 m ³ /d · m ²	
Backwash expansion	10 to 50%	

Sources: Clark and Lykins, 1989; Culp et al., 1978; Reynolds and Richards, 1996; U.S EPA, 1971.

surface water, demonstrate the need to examine alternative carbon sources and contact times (Figures 14-10 and 14-11).

GAC is placed in a packed bed. GAC is used in about 7 percent of the plants for T&O control (Suffet et al., 1996). For continuous T&O control from groundwater, GAC is preferred because much less is required than if PAC is used. Because of the wide variety of experience in the sources of T&O, pilot scale data are the best resource for design data. A rapid small-scale column test (RSSCT) has been developed that can be used to predict pilot-scale GAC performance (Crittenden et al., 1987). An extensive discussion of the use of RSSCT and the care required in using it for scale up are discussed in MWH (2005).

A few anecdotal data illustrate the order of magnitude design criteria (Clark and Lykins, 1989; Dvorak and Maher, 1999; MWH, 2005):

- Bed depths of 1 m are too short.
- Bed depths of 2–3 m are effective.

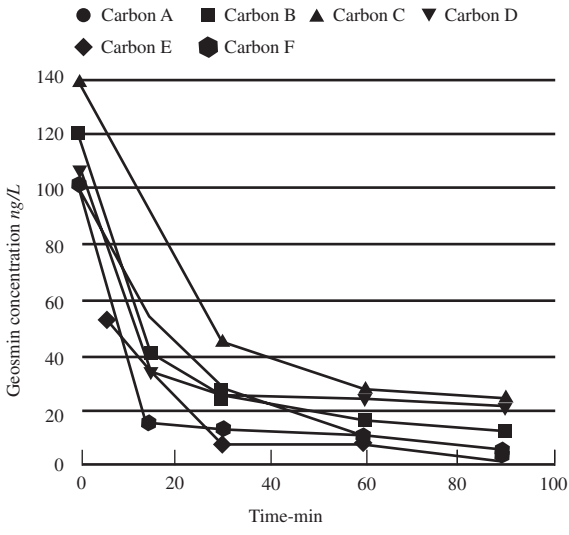

FIGURE 14-10
Kinetic test results for adsorption of MIB for various PACs. (Source: Huang et al., 1996).

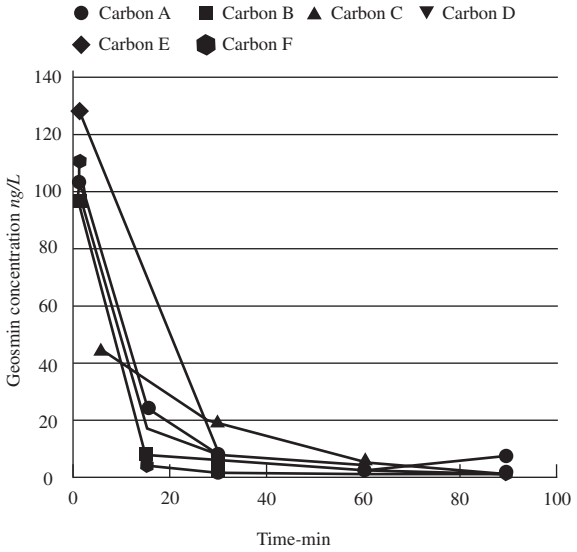

FIGURE 14-11
Kinetic test results for adsorption of geosmin for various PACs. (Source: Huang et al., 1996.)

- Effective empty bed contact times (EBCTs) are on the order of 10 to 15 minutes but may be up to one hour.
- Normal service life is on the order of 2 to 5 years.
- Regeneration periods from 6 to 36 years have been reported with filter volume to water flow rate ratios of 4.6 to 10.6 m³ of carbon/1,000 m³ of the design flow rate.

Visit the text website at www.mhprofessional.com/wwe for supplementary materials and a gallery of photos.

14-13 CHAPTER REVIEW

When you have completed studying this chapter, you should be able to do the following without the aid of your textbooks or notes:

1. Identify the oxidation state of arsenic required for it to be removed effectively.
2. Explain why it is of benefit to strip CO₂ from water that is to be softened by the lime-soda process.
3. Identify the medium most likely to be selected to reduce the fluoride concentration in a water supply.
4. Explain why iron and manganese are removed from a water supply.
5. Explain why nitrate is removed from a water supply.
6. Explain why NOM is removed from a water supply.
7. Define the following abbreviations: EDC, SOC, VOC.
8. Explain why PAC is chosen more frequently than GAC for T&O control in plants with surface water as their source of supply.

With the use of this text, you should be able to do the following:

9. Estimate the dose of a given arsenic oxidant for a water that has one or more of the following constituents in addition to arsenic: iron, manganese, sulfide.
10. Select an appropriate arsenic treatment scheme given the raw water constituents and their concentrations.
11. Design a stripping tower to remove CO₂ to a specified level given the water temperature.
12. Evaluate an activated alumina column design with respect to typical design criteria.
13. Select an appropriate iron and/or manganese treatment scheme given the raw water constituents and their concentrations.
14. Evaluate alternative treatment processes to remove NOM for a given TOC concentration in a raw water and existing treatment train.
15. Recommend several alternatives to evaluate for removal of radon, radium, or uranium in a raw water.

16. Evaluate a preliminary design of a GAC column for T&O control in groundwater.
17. Design a stripping tower to remove a VOC to a specified level given the Henry's law constant, overall transfer rate constant, and water temperature.
18. Compute the Freundlich equation constants using experimental data.

14-14 PROBLEMS

- 14-1. Estimate the stoichiometric amount of permanganate in mg/L required to oxidize arsenic in groundwater with the following constituents:

$$\text{As(III)} = 50 \mu\text{g/L}$$

$$\text{Fe(II)} = 2.0 \text{ mg/L}$$

$$\text{Mn(II)} = 0.5 \text{ mg/L}$$

Note: Redox half reactions are given in Table 13-1.

- 14-2. Estimate the stoichiometric amount of ozone in mg/L required to oxidize arsenic in groundwater with the following constituents:

$$\text{As(III)} = 100 \mu\text{g/L}$$

$$\text{Fe(II)} = 12.0 \text{ mg/L}$$

$$\text{H}_2\text{S} = 0.2 \text{ mg/L}$$

Note: Redox half reactions are given in Table 13-1.

- 14-3. Select an arsenic treatment system for a groundwater with the following characteristics:

$$\text{As}^{5+} = 48 \mu\text{g/L}$$

$$\text{Cl}^- = 102 \text{ mg/L}$$

$$\text{F}^- = 1.0 \text{ mg/L}$$

$$\text{Fe}^{3+} = 0.3 \text{ mg/L}$$

$$\text{H}_2\text{S} = \text{N/D}^*$$

$$\text{Mn}^{4+} = 0.01 \text{ mg/L}$$

$$\text{NO}_3^- = \text{N/D}^*$$

$$\text{pH} = 7.0$$

$$\text{PO}_4^{3-} = \text{N/D}^*$$

$$\text{Silica} = 12 \text{ mg/L}$$

$$\text{SO}_4^{2-} = 20 \text{ mg/L}$$

$$\text{TDS} = 225 \text{ mg/L}$$

$$\text{TOC} = 0.1 \text{ mg/L}$$

* N/D = not detected

- 14-4. Select an arsenic treatment system for groundwater with the following characteristics:

$$\text{As}^{5+} = 88 \mu\text{g/L}$$

$$\text{Cl}^- = 260 \text{ mg/L}$$

$$\text{F}^- = 1.0 \text{ mg/L}$$

$$\text{Fe}^{3+} = 1.2 \text{ mg/L}$$

$$\text{H}_2\text{S} = 0.3 \text{ mg/L}$$

$$\text{Mn}^{4+} = 0.2 \text{ mg/L}$$

$$\text{NO}_3^- = 1.0 \text{ mg/L}$$

$$\text{pH} = 6.3$$

$$\text{PO}_4^{3-} = \text{N/D}^*$$

$$\text{Silica} = 24 \text{ mg/L}$$

$$\text{SO}_4^{2-} = 100 \text{ mg/L}$$

$$\text{TDS} = 412 \text{ mg/L}$$

$$\text{TOC} = 3.0 \text{ mg/L}$$

* N/D = not detected

- 14-5.** Determine the number of trays for a multiple tray aerator to reduce the CO_2 concentration in Eastwood Manor's raw water supply from 20.9 mg/L to 6.2 mg/L as CO_2 . The following design criteria have been developed for this project: $Q = 5,450 \text{ m}^3/\text{d}$, temperature = 5°C .
- 14-6.** Determine the number of trays for a multiple tray aerator to reduce the CO_2 concentration in Magnolia's raw water supply from 27.8 mg/L to 4.0 mg/L as CO_2 . The following design criteria have been developed for this project: $Q = 10,600 \text{ m}^3/\text{d}$, temperature = 5°C
- 14-7.** Select an iron/manganese removal system for the village of Ferric. The design flow rate is $3,800 \text{ m}^3/\text{d}$. The raw water characteristics are:

$$\text{Fe(II)} = 5.0 \text{ mg/L}$$

$$\text{Mn(II)} = 0.0 \text{ mg/L}$$

$$\text{H}_2\text{S} = \text{N/D}^*$$

$$\text{NH}_3 = \text{N/D}^*$$

$$\text{TOC} = \text{N/D}^*$$

* N/D = not detected

- 14-8.** Select an iron/manganese removal system for the town of Many Farms. The design flow rate is $7,600 \text{ m}^3/\text{d}$. The raw water characteristics are:

$$\text{Fe(II)} = 15.0 \text{ mg/L}$$

$$\text{Mn(II)} = 0.1 \text{ mg/L}$$

$$\text{H}_2\text{S} = 1.0 \text{ mg/L}$$

$$\text{NH}_3 = 1.3 \text{ mg/L}$$

$$\text{TOC} = 4.0 \text{ mg/L}$$

$$\text{Dissolved oxygen} = \text{N/D}^*$$

* N/D = not detected

- 14-9.** Design a stripping column to reduce the trichloroethylene concentration in Oil City's raw water supply from 6.0 mg/L to $1.5 \mu\text{g/L}$. The following design criteria have been developed for this project.

$$Q = 6,500 \text{ m}^3/\text{d}$$

$$\text{Temperature} = 10^\circ\text{C}$$

Packing = 90 mm tripacks

$H = 0.237$

$K_L a = 0.72 \text{ min}^{-1}$

$\Delta P/Z = 50 \text{ Pa/m}$

$\rho_g = 1.2 \text{ kg/m}^3$

$\rho_w = 1,000 \text{ kg/m}^3$

Determine the following to complete the design:

Q_a/Q

Q_a

Column diameter

Stripping factor

Height of packing

Overall height of packed tower

- 14-10.** Design a stripping column to reduce the tetrachloroethylene concentration in Carbon Hill's raw water supply from $56.9 \mu\text{g/L}$ to $5.0 \mu\text{g/L}$. The following design criteria have been developed for this project.

$Q = 6,500 \text{ m}^3/\text{d}$

Temperature = 10°C

Packing = 90 mm tripacks

$H = 0.364$

$K_L a = 1.3 \text{ min}^{-1}$

$\Delta P/Z = 50 \text{ Pa/m}$

$\rho_g = 1.2 \text{ kg/m}^3$

$\rho_w = 1,000 \text{ kg/m}^3$

Determine the following to complete the design:

Q_a/Q

Q_a

Column diameter

Stripping factor

Height of packing

Overall height of packed tower

- 14-11.** Determine the Freundlich isotherm constants for the following experimental data for methylene chloride. The initial concentration was $8.4 \mu\text{g/L}$ and the sample volume was 1.0 L.

Container	1	2	3	4	5	6
Carbon, mg	45	120	360	1,100	1,400	1,600
CH ₂ Cl ₂ remaining, $\mu\text{g/L}$	7.1	5.5	2.9	0.89	0.75	0.60

- 14-12.** The following Freundlich isotherm constants were obtained for adsorption of toluene on activated carbon. Plot the isotherm curves for each, and determine which of these appears to be the better choice for further examination in column studies.

Manufacturer	K	$1/n$
A	6.3	0.37
B	8.7	0.45

K is in units of (mg/g)(L/mg).

14-15 DISCUSSION QUESTIONS

- 14-1. A community of 70,000 has solicited proposals for a lime-soda softening plant to treat their groundwater. Your company has proposed air stripping CO_2 as one of the process steps. The city engineer has asked why CO_2 has to be removed as it does not contribute to hardness. Explain.
- 14-2. One of the treatment alternatives for removing iron and manganese from a groundwater is NF. To use this process, the raw water must not have any dissolved oxygen in it. Explain why.
- 14-3. Explain why a GAC column cannot be designed based on the results from an isotherm experiment to determine the Freundlich constants.

14-16 REFERENCES

- AWWA (1990) *Water Treatment Plant Design*, 2nd ed. American Water Works Association, Denver, Colorado, McGraw-Hill, New York, pp. 68–74.
- AWWA (2004) *Water Fluoridation Principles and Practices*, American Water Works Association Manual of Practice M4, Denver, Colorado.
- AwwaRF (2000) *Arsenic Treatability Options and Evaluation of Residuals Management Issues*, Awwa Research Foundation, Denver, Colorado.
- AwwaRF (2002) Implementation of Arsenic Treatment Systems-Part 1. Process Selection, Awwa Research Foundation, Denver, Colorado.
- Ball, B. R. and M. D. Edwards (1992) “Air Stripping VOCs from Groundwater: Process Design Considerations,” *Environmental Progress*, vol. 11, no. 1, pp. 39–48.
- Brady, R. D. (2005) “Activated Carbon Processes,” in E. E Baruth (ed.), *Water Treatment Plant Design*, McGraw-Hill, New York, pp. 14.1–14.38.
- Clark, R. M. and B. W Lykins (1989) *Granular Activated Carbon: Design, Operation, and Cost*, Lewis Publishers, Chelsea, Michigan.
- Clifford, D. A. (1999) “Ion Exchange and Inorganic Adsorption,” in R. D. Letterman (ed.), *Water Quality and Treatment*, 5th ed. American Water Works Association, McGraw-Hill, New York, pp. 9.1– 9.91.
- Cook, P. (2005) “Arsenic Removal Technologies for Drinking Water Treatment,” *Emerging Issues in Water Treatment*, Michigan Section of American Water Works Association Research and Technical Practice Seminar, Lansing, Michigan, May 17.
- Cook, P. (2007) Michigan Department of Environmental Quality, personal communication.
- Crittenden, J. C. et al. (1987) “Design of Rapid Fixed-Bed Adsorption Tests for Nonconstant Diffusivities,” *Journal of Environmental Engineering Division*, vol. 113, no. 2, pp. 243–259.
- Culp, R. L. and G. L. Culp (1971) *Advanced Wastewater Treatment*, Van Nostrand Reinhold, New York, pp. 145–157.
- Culp, R. L., G. Wesner, and G. L. Culp (1978) *Handbook of Advanced Wastewater Treatment*, Van Nostrand Reinhold, New York, p. 185.

- Djebbar, Y. and R. M. Narbaitz (1995) "Mass Transfer Correlations for Air Stripping Towers," *Environmental Progress*, vol. 14, no. 3, pp. 137–145.
- Dobbs, R. A. and J. M. Cohen (1980) *Carbon Adsorption Isotherms for Toxic Organics*, U.S. Environmental Protection Agency, Publication No. EPA-600/8-80-023, Cincinnati, Ohio.
- Drewes, J. E., C. Bellona, M. Oedekoven, P. Xu, et al. (2005) "Rejection of Wastewater-Derived Micropollutants in High-Pressure Membrane Applications Leading to Indirect Potable Reuse," *Environmental Progress*, vol. 24, no. 4, pp. 400–415.
- Dvorak, B. I. and M. K. Maher (1999) "GAC Contactor Design for NOM Removal: Implications of EBCT and Blending," *Journal of Environmental Engineering*, vol. 125, no. 2, pp. 161–165.
- Dyksen, J. E. (2005) "Aeration and Air Stripping," in E. E. Baruth (ed.), *Water Treatment Plant Design*, American Water Works Association and American Society of Civil Engineers, McGraw-Hill, New York, p. 5.1–5.24.
- Eckert, J. S. (1961) "Design Techniques for Sizing Packed Towers," *Chemical Engineering Progress*, vol. 57, no. 9, pp. 54–58.
- Fields, K., A. Chen, and L. Wans (2000) *Arsenic Removal from Drinking Water by Iron Removal Plants*, U.S. EPA 600/R00063, Washington, D.C.
- Fornwalt, H. J. and R. A. Hutchins (1966) "Purifying Liquids with Activated Carbon," in *Chemical Engineering*, vol. 73, no. 8, pp. 179–184.
- FR (1989) *Federal Register* 54 FR 22062.
- Freundlich, H. (1906) "Über die Adsorption in Lösungen," *Z. Phys. Chem. A*, vol. 57, pp. 385–470.
- Ghurye, G. and D. A. Clifford (2001) *Laboratory Study on Oxidation of As(III) to As(V)*, U.S. Environmental Protection Agency Publication EPA 600-R-01-021, Washington, D.C.
- GLUMRB (2003) *Recommended Standards for Water Works*, Great Lakes–Upper Mississippi River Board of State and Provincial Public Health and Environmental Managers, Health Education Services, Albany, New York, pp. 75–77, 82.
- Graham, M., I. Najm, M. Simpson, B. MacLeod et al. (2000) *Optimization of Powdered Activated Carbon Application for Geosmin and MIB Removal*, American Water Works Association Research Foundation, Denver, Colorado.
- Gross, R. L. and S. G. TerMaath (1985) "Packed Tower Aeration Strips Trichloroethene from Groundwater," *Environmental Progress*, vol. 4, no. 2, pp. 119–124.
- Gu, B., Y. K. Ku, and G. M. Brown (2005) "Sorption and Desorption of Perchlorate and U(VI) by Strong-Base Anion Exchange Resins," *Environmental Science and Technology*, vol. 39, no. 3, pp. 901–907.
- Hand, D. W., J. C. Crittenden, J. L. Gehin, and B. W. Lykins (1986) "Design and Evaluation of an Air-Stripping Tower for Removing VOCs from Groundwater," *Journal of American Water Works Association*, vol. 78, no. 9, pp. 87–97.
- Hand, D. W., D. R. Hokanson, and J. C. Crittenden (1999) "Air Stripping and Aeration," in R. D. Letterman (ed.), *Water Quality and Treatment*, 5th ed. American Water Works Association, McGraw-Hill, New York, pp. 5.1–5.68.
- Huang, C., J. E. Van Benschoten, and J. N. Jensen (1996) "Adsorption Kinetics of MIB and Geosmin," *Journal of American Water Works Association*, vol. 88, no. 4, pp. 116–128.
- Hullman, R. (2009) *Fate of Pharmaceuticals in Drinking Water Utilities*, M.S. thesis, Michigan State University.
- Kavanaugh, M. C. and R. R. Trussel (1980) "Design of Aeration Towers," *Journal of American Water Works Association*, vol. 72, no. 12, pp. 684–692.
- Kawamura, S. (2000) *Integrated Design and Operation of Water Treatment Facilities*, 2nd ed. John Wiley & Sons, New York, pp. 523.
- LaGrega, M. D., P. L. Buckingham, and J. C. Evans (2001) *Hazardous Waste Management*, McGraw-Hill, Boston, Massachusetts, pp. 463–476.

- Lowery, J. D. and S. B. Lowery (1988) "Radionuclides in Drinking Water," *Journal of American Water Works Association*, vol. 80, no. 7, pp. 50–64.
- MWH (2005) *Water Treatment: Principles and Design*, John Wiley & Sons, Hoboken, New Jersey, pp. 1194, 1220, 1222, 1330–1339, 1522–1526, 1568–1592.
- Nghiem, L. D., A. I. Schäfer, and M. Elimelech (2004) "Removal of Natural Hormones by Nanofiltration Membranes: Measurement, Modeling, and Mechanisms," *Environmental Science & Technology*, vol. 38, no. 6, pp. 1,888–1,896.
- Nghiem, L. D., A. I. Schäfer, and M. Elimelech (2005) "Pharmaceutical Retention Mechanisms by Nanofiltration Membranes," *Environmental Science & Technology*, vol. 39, no. 19, pp. 7,698–7,705.
- NSF (2001a) *Environmental Technology Verification Report: Removal of Arsenic in Drinking Water—Hydranautics ESPSA2-4040 Reverse Osmosis Membrane Element Module*, NSF International 0120 EPADW395.
- NSF (2001b) *Environmental Technology Verification Report: Removal of Arsenic in Drinking Water—KOCH Membrane Systems TFC-ULP4 Reverse Osmosis Membrane Module*, NSF International 0125 EPADW395.
- Perry, R. H. and C. H. Chilton (1973) *Chemical Engineer's Handbook*, p. 18–44.
- Reynolds, T. D. and P. A. Richards (1996) *Unit Operations and Processes in Environmental Engineering*, PWS Publishing, Boston, Massachusetts, p. 353–355.
- Rizzo, R. L. and A. R. Sheperd (1977) "Treatment of Industrial Wastewater with Activated Carbon," *Chemical Engineering*, vol. 84, no. 1, pp. 95–100.
- Rosenfeldt, E. J. and K. G. Linden (2004) "Degradation of Endocrine Disrupting Chemicals Bisphenol A, Ethinyl Estradiol, and Estradiol During UV Photolysis and Advanced Oxidation Processes," *Environmental Science and Technology*, vol. 38, pp. 5,476–5,483.
- Rubel, F. (2001) *Design Manual—Removal of Arsenic from Drinking Water Supplies by Ion Exchange*, U.S. EPA Draft Document, Washington, D.C.
- Rubel, F. (2003) *Design Manual—Removal of Arsenic from Drinking Water Supplies by Adsorptive Media*, EPA 600-R-03-019, Washington, D.C.
- Rubel, F. and R. D. Woosley (1979) "The Removal of Excess Fluoride from Drinking Water by Activated Alumina," *Journal of American Water Works Association*, vol. 71, no. 1, p. 45.
- Scott, G. R. (1955) "Committee Report: Aeration of Water," *Journal of American Water Works Association*, vol. 44, no. 4, p. 873.
- Sommerfeld, E. O. (1999) *Iron and Manganese Removal Handbook*, American Water Works Association, Denver, Colorado.
- Suffet, I. H., A. Corado, D. Chou, M. J. McGuire et al. (1996) "AWWA Taste and Odor Survey," *Journal of American Water Works Association*, vol. 88, no. 4, 168–180.
- Ternes, T. A., M. Meisenheimer, D. McDowell, F. Sacher et al. (2002) "Removal of Pharmaceuticals During Drinking Water Treatment," *Environmental Science & Technology*, vol. 36, no. 17, pp. 3,855–3,863.
- Treybal, R. E. (1980) *Mass Transfer Operations*, 3rd ed., McGraw-Hill, New York.
- Tripp, A. R. and D. A. Clifford (2006) "Ion Exchange for the Remediation of Perchlorate-Contaminated Drinking Water," *Journal of American Water Works Association*, vol. 98, no. 4, pp. 105 – 114.
- U.S. EPA (1971) *Process Design Manual for Carbon Adsorption*, U.S. Environmental Protection Agency.
- U.S. EPA (2000) *Technologies and Costs for Removal of Arsenic from Drinking Water*, EPA 815R00028, Washington, D.C.
- U.S. EPA (2002) *Implementation Guidance for the Arsenic Rule—Drinking Water Regulations for Arsenic and Clarifications to Compliance and New Source Contaminants Monitoring*, EPA 816K02018.
- U.S. EPA (2003) *Arsenic Treatment Technology Evaluation Handbook for Small Systems*, U.S. Environmental Protection Agency Publication EPA 816-R-03-014, Washington. D.C.

- U.S. EPA (2005) *A Regulator's Guide to the Management of Radioactive Residuals from Drinking Water Technologies*, U.S. Environmental Protection Agency Publication No. 816RO5004.
- U.S. EPA (2006) *Source Water Monitoring Guidance Manual for Public Water Systems for the Final Long Term 2 Enhanced Surface Water Treatment Rule*, EPA 815-R06-005, U.S. Environmental Protection Agency, Office of Water, Washington, D.C.
- U.S. G.S. (2002) <http://toxics.usgs.gov/pubs/OFR-02-94>.
- Wang, L., A. Chen, and K. Fields (2000) *Arsenic Removal from Drinking Water by Ion Exchange and Activated Alumina Plants*, U.S. Environmental Protection Agency Publication EPA 600-R-00-088, Washington, D.C.
- Webster, T. S., W. J. Guarini, and H. S. Wong (2009) "Fluidized Bed Bioreactor Treatment of Perchlorate-Laden Groundwater to Potable Standards," *Journal of American Water Works Association*, vol. 101, no. 5, pp.137–151.
- Westerhoff, P., Y. Yoon, S. Shane, and E. Wert (2005) "Fate of Endocrine-Disruptor, Pharmaceutical, and Personal Care Products During Simulated Drinking Water Treatment Processes," *Environmental Science and Technology*, vol. 39, pp. 6,649–6,663.
- Zanitach, R. H. (undated) "Application and Engineering Design Considerations" in *Calgon Adsorption Handbook*, Calgon Corporation, Pittsburgh, Pennsylvania.

This page intentionally left blank

WATER PLANT RESIDUALS MANAGEMENT

- 15-1 INTRODUCTION**
- 15-2 SOLIDS COMPUTATIONS**
- 15-3 SOLIDS PRODUCTION AND CHARACTERISTICS**
- 15-4 MINIMIZATION OF RESIDUALS GENERATION**
- 15-5 RECOVERY OF TREATMENT CHEMICALS**
- 15-6 RESIDUALS CONVEYANCE**
- 15-7 MANAGEMENT OF SLUDGES**
- 15-8 MANAGEMENT OF LIQUID RESIDUALS**
- 15-9 DISPOSAL OF SPECIFIC RESIDUAL CONSTITUENTS**
- 15-10 ULTIMATE DISPOSAL**
- 15-11 CHAPTER REVIEW**
- 15-12 PROBLEMS**
- 15-13 DISCUSSION QUESTIONS**
- 15-14 REFERENCES**

15-1 INTRODUCTION

The precipitated chemicals and other materials removed from raw water to make it potable and palatable are termed *residuals*. Satisfactory treatment and disposal of water treatment plant residuals can be the single most complex and costly operation in the plant.

Residuals withdrawn from coagulation and softening plants are composed largely of water, and the residuals are often referred to as *sludge*. As much as 98 percent of the sludge mass may be water. Thus, for example, 20 kg of solid chemical precipitate is accompanied by 980 kg of water. Assuming equal densities for the precipitate and water (a bad assumption at best), approximately 1 m³ of sludge is produced for each 20 kg of chemicals added to the water. For even a small plant (say 4,000 m³/d) this might mean up to 800 m³/y of sludge.

Water treatment plants and the residuals they produce can be broadly divided into four general categories. First are those treatment plants that coagulate, filter, and oxidize surface water for removal of turbidity, color, bacteria, algae, some organic compounds, and sometimes iron and/or manganese. These plants generally use alum or iron salts for coagulation and produce two waste streams. The majority of the waste produced from these plants is sedimentation basin (or clarifier) sludge and spent filter backwash water (SFBW). The second type of treatment plants are those that practice softening for the removal of calcium and magnesium by the addition of lime, sodium hydroxide, and/or soda ash. These plants produce clarifier basin sludges and SFBW. On occasion, plants practice both coagulation and softening. Softening plant wastes can also contain trace inorganic compounds such as radium that could affect their proper handling. The third type of plants are those that are designed to specifically remove trace inorganic compounds such as nitrate, fluoride, radium, arsenic, and so on. These plants use processes such as ion exchange, nanofiltration, and reverse osmosis. They produce liquid residuals (*concentrate*) or solid residuals such as spent ion exchange resin. The fourth category of treatment plants includes those that produce air-phase residuals during the stripping of volatile compounds. The major types of treatment plant residuals produced are shown in Table 15-1.

Most of the coagulants and the impurities they remove settle to the bottom of the settling basin where they become part of the sludge. These sludges are referred to as alum, iron, or polymeric sludge according to which primary coagulant is used. These wastes account for approximately 70 percent of the water plant residuals generated in the United States. The sludges produced in treatment plants where water softening is practiced using lime or lime and soda ash account for an additional 25 percent of the industry's residuals production. It is therefore apparent that most of the waste generation involves water treatment plants using coagulation or softening processes. Because 95 percent of the residuals produced are coagulants or softening sludge, they will be stressed in this chapter.

The most logical residual management program attempts to use the following approach in sludge disposal:

1. Minimization of residual generation.
2. Recovery of treatment chemicals.
3. Residual treatment to reduce volume.
4. Ultimate disposal in an environmentally safe manner.

With a short digression to explain some fundamental solids computations and to identify the sources of water plant residuals and their production rates, this chapter is organized along these lines.

TABLE 15-1
Major water treatment plant residuals

Solid/Liquid Residuals

1. Alum sludges
2. Iron sludges
3. Polymeric sludges
4. Softening sludges
5. Spent filter backwash water
6. Spent granular activated carbon or powdered activated carbon
7. Slow sand filter cleaning residue
8. Residuals from iron and manganese removal plants
9. Spent precoat filter media

Liquid-Phase Residuals

10. Ion exchange regenerant brine
11. Waste regenerant from activated alumina
12. Nanofiltration/reverse osmosis concentrate
13. MF and UF membrane concentrate

Gas-Phase Residuals

14. Air stripping off-gases
 15. Ozone off-gas
-

15-2 SOLIDS COMPUTATIONS

Volume-Mass Relationships

Because most water treatment plant (WTP) sludges are primarily water, the volume of the sludge is primarily a function of the water content. Thus, if the percent solids and the specific gravity of the solids are known, one can estimate the volume of the sludge. The solid matter in water treatment (and wastewater treatment) sludge is composed of fixed (mineral) solids and volatile (organic) solids. The volume of the total mass of solids may be expressed as

$$V = \frac{M_s}{S_s \rho} \quad (15-1)$$

where M_s = mass of solids, kg
 S_s = specific gravity of solids
 ρ = density of water = 1,000 kg/m³

Because the total mass is composed of fixed and volatile fractions, Equation 15-1 may be rewritten as:

$$\frac{M_s}{S_s \rho} = \frac{M_f}{S_f \rho} + \frac{M_v}{S_v \rho} \quad (15-2)$$

where M_f = mass of fixed solids, kg
 M_v = mass of volatile solids, kg
 S_f = specific gravity of fixed solids
 S_v = specific gravity of volatile solids

The specific gravity of the solids may be expressed in terms of the specific gravities of the fixed and solid fractions by solving Equation 15-2 for S_s :

$$S_s = M_s \left[\frac{S_f S_v}{M_f S_v + M_v S_f} \right] \quad (15-3)$$

The specific gravity of sludge (S_{sl}) may be estimated by recognizing that, in a similar fashion to the fractions of solids, the sludge is composed of solids and water so that

$$\frac{M_{sl}}{S_{sl}\rho} = \frac{M_s}{S_s\rho} + \frac{M_w}{S_w\rho} \quad (15-4)$$

where M_{sl} = mass of sludge, kg
 M_w = mass of water, kg
 S_{sl} = specific gravity of sludge
 S_w = specific gravity of water

It is customary to report solids concentrations as percent solids, where the fraction of solids (P_s) is computed as

$$P_s = \frac{M_s}{M_s + M_w} \quad (15-5)$$

and the fraction of water (P_w) is computed as

$$P_w = \frac{M_w}{M_s + M_w} \quad (15-6)$$

Thus, it is more convenient to solve Equation 15-1 in terms of the solids fraction. If each term in Equation 15-4 is divided by $(M_s + M_w)$ with the recognition that $M_{sl} = M_s + M_w$, then Equation 15-4 may be expressed as

$$\frac{1}{S_{sl}\rho} = \frac{P_s}{S_s\rho} + \frac{P_w}{S_w\rho} \quad (15-7)$$

If the specific gravity of water is taken as 1.0000, as it can be without appreciable error, then solving for S_{sl} yields

$$S_{sl} = \frac{S_s}{P_s + (S_s)(P_w)} \quad (15-8)$$

With these expressions, the volume of sludge (V_{sl}) can be calculated with the following equation:

$$V_{sl} = \frac{M_s}{(\rho)(S_{sl})(P_s)} \quad (15-9)$$

Volume Reduction Relationships

In the simplest, approximate terms, if one assumes that the mass of sludge (M_s), density of water (ρ), and specific gravity of the sludge (S_{sl}) do not change as water is removed, the volume after *dewatering* is

$$V_{\text{dewatered}} = (V_{\text{wet}}) \frac{P_{s \text{ wet}}}{P_{s \text{ dewatered}}} \quad (15-10)$$

From the previous derivation of the equation for the volume of sludge, it may be noted that the specific gravity of the sludge is a function of the percent water in the sludge (Equation 15-8). Thus, Equation 15-10 is only a rough estimation of the reduction in sludge volume. A more rigorous estimate of the resultant volume from dewatering is given by:

$$V_{\text{dewatered}} = \frac{(V_{\text{wet}})(P_{s \text{ wet}})(\rho)(S_{\text{wet sludge}})}{(\rho_{\text{cake}})(P_{s \text{ filter cake}})} \quad (15-11)$$

where the terms are as noted previously with subscripts added to indicate before dewatering and after dewatering. The name given to the dewatered sludge is *cake*. The density of the cake is calculated as

$$\rho_{\text{cake}} = (S_{\text{cake}})(\rho) \quad (15-12)$$

where S_{cake} = specific gravity of the cake.

The specific gravity of the cake may be calculated with Equation 15-8 with appropriate substitution of the subscript cake for the subscript *sl*.

Example 15-1. Compare the estimate of sludge volume using the approximate and rigorous forms of the equation for estimating the volume using the following data:

- Specific gravity of solids = 2.5
- Solids fraction of wet sludge = 15%
- Solids fraction of dewatered sludge = 25%
- Volume of wet sludge = 6.0 m³/d

Solution:

- a. Volume of dewatered sludge using Equation 15-10.

$$V_{\text{dewatered}} = (6.0 \text{ m}^3/\text{d}) \frac{0.15}{0.25} = 3.60 \text{ m}^3/\text{d}$$

- b. Volume of dewatered sludge using Equation 15-11.

- (1) Compute the specific gravity of the sludge before dewatering and the specific gravity of the cake after dewatering using Equation 15-8.

$$S_{\text{wet sludge}} = \frac{2.5}{0.15 + (2.5)(0.85)} = 1.099$$

$$S_{\text{cake}} = \frac{2.5}{0.25 + (2.5)(0.75)} = 1.176$$

(2) Compute the volume of dewatered sludge.

$$V_{\text{dewatered}} = \frac{(6.0 \text{ m}^3/\text{d})(0.15)(1,000 \text{ kg/m}^3)(1.099)}{(1.176)(1,000 \text{ kg/m}^3)(0.25)} = 3.36 \text{ m}^3/\text{d}$$

c. Comparison of volume estimates.

$$\% \text{ error} = \frac{3.60 \text{ m}^3/\text{d} - 3.36 \text{ m}^3/\text{d}}{3.36 \text{ m}^3/\text{d}}(100\%) = 7.14\%$$

In one year's time the estimated volume of sludge is 1,314 m³ by the approximate method. The more rigorous method yields an estimated annual sludge volume of 1,226 m³.

Comment. For dilute concentrations of light solids the percent error decreases to a negligible amount. For high concentrations of heavy solids the percent error is significant.

15-3 SOLIDS PRODUCTION AND CHARACTERISTICS

In water treatment plants, sludge is most commonly produced in the following treatment processes: presedimentation, sedimentation, and filtration (filter backwash).

Presedimentation

When surface waters are withdrawn from watercourses that contain a large quantity of suspended materials, presedimentation prior to coagulation may be practiced. The purpose of this is to reduce the accumulation of solids in subsequent units. The settled material generally consists of fine sand, silt, clay, and organic decomposition products.

Coagulation Sedimentation Basin

On a theoretical basis the dry mass of sludge produced from the addition of alum may be estimated from the reaction chemistry described by Equation 6-8 in Chapter 6, which is reproduced here:

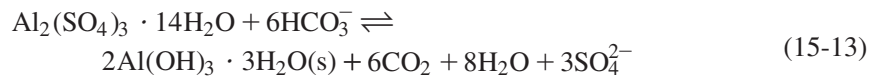

With a gram molecular weight of 594 for $\text{Al}_2(\text{SO}_4)_3 \cdot 14\text{H}_2\text{O}$, the addition of 1 mg/L of alum is equivalent to

$$\frac{1 \text{ mg/L}}{(594 \text{ g/mole})(1,000 \text{ mg/g})} = 1.684 \times 10^{-6} \text{ moles/L}$$

Noting that 1 mole/L of alum yields 2 moles/L of the aluminum precipitate and that the gram molecular weight of the precipitate is 132.05 g/mole, then the mass of dry solids is

$$2(1.684 \times 10^{-6} \text{ moles/L})(132.05 \text{ g/mole}) = 4.446 \times 10^{-4} \text{ g/L or } 0.44 \text{ mg/L}$$

Thus, on a theoretical basis, each mg/L of alum yields 0.44 mg/L of sludge on a dry basis. Suspended solids present in the water will produce an amount of sludge equal to the mg/L of suspended solids. The amount of sludge produced per turbidity unit is not as obvious; however, in many waters a correlation does exist. Carbon, polymers, and clay will produce about 1 kg of sludge per kg of chemical addition. The sludge production for alum coagulation may then be approximated by (Davis and Cornwell, 2008):

$$M_s = 86.4 Q(0.44A + SS + M) \quad (15-14)$$

where M_s = mass of dry sludge produced, kg/d

Q = plant flow, m³/s

A = alum dose, mg/L

SS = suspended solids in raw water, mg/L

M = miscellaneous chemical additions such as clay, polymer, and carbon, mg/L

In a similar fashion, the dry mass of sludge produced from the addition of iron may be estimated from the reaction chemistry described by Equation 6-10 in Chapter 6 which is reproduced here:

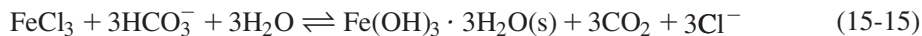

The sludge production for ferric chloride coagulation may be approximated by:

$$M_s = 86.4 Q(2.9 \text{ Fe} + SS + M) \quad (15-16)$$

where Fe is the iron dose in mg/L expressed as mg/L of Fe, and the other terms are as described in the preceding equation. Because the units of expression are different, it appears that iron produces several times the amount of sludge that alum produces. Based on the molecular weights of the product, in coagulating equivalent, one mole of iron produces about 20 to 25 percent more dry-weight sludge than one mole of aluminum. When iron is purchased as ferric chloride (FeCl₃) and the dose is as equivalent dry weight without waters of hydration, about 1.0 mg of solids is produced for each milligram of FeCl₃ added.

The calculation of polyaluminum chloride (PACl) doses to solids production is not as straight forward as alum and iron calculations because there is no uniform strength measurement. A typical PACl liquid contains about 30 to 35 percent PACl and about 10 percent Al₂O₃. A very rough estimate of the dry solids production is about 0.8 mg for each mg of PACl added expressed as PACl.

Solids concentrations from horizontal flow settling basins using continuous collection equipment for alum and iron sludges resulting from coagulation of low- to moderate-turbidity raw water will be in the range of 0.5 to 2 percent. It is often less than 1 percent. Coagulant sludges from highly turbid water may be in the 2 to 4 percent range (Cornwell, 1999). Twenty to 40 percent of the solids are organic constituents; the remainder are inorganic constituents or silts. The specific gravity of alum coagulated solids is typically in the range of 1.2 to 1.5. The range of specific gravity for iron coagulated sludge solids is 1.2 to 1.8 (MWH, 2005). The pH of alum sludge is normally in the 5.5 to 7.5 range. Alum sludge from sedimentation basins may include large numbers of microorganisms, but it generally does not exhibit an unpleasant odor. The sludge flow rate is often in the range of 0.3 to 1 percent of the treatment plant flow.

Softening Sedimentation Basin

The residues from softening by precipitation with lime $[\text{Ca}(\text{OH})_2]$ and soda ash (Na_2CO_3) will vary from a nearly pure chemical to a highly variable mixture. The softening process discussed in Chapter 7 produces a sludge containing primarily CaCO_3 and $\text{Mg}(\text{OH})_2$.

Theoretically, each mg/L of calcium hardness removed produces 1 mg/L of CaCO_3 sludge; each mg/L of magnesium hardness removed produces 0.6 mg/L of sludge; and each mg/L of lime added produces 1 mg/L of sludge. The theoretical sludge production can be estimated as (Davis and Cornwell, 2008):

$$M_s = 86.4 Q(2\text{CaCH} + 2.6 \text{MgCH} + \text{CaNCH} + 1.6 \text{MgNCH} + \text{CO}_2) \quad (15-17)$$

where M_s = mass of dry sludge production, kg/d
 Q = plant flow, m^3/s
 CaCH = calcium carbonate hardness removed as CaCO_3 , mg/L
 MgCH = magnesium carbonate hardness removed as CaCO_3 , mg/L
 CaNCH = noncarbonate calcium hardness removed as CaCO_3 , mg/L
 MgNCH = noncarbonate magnesium hardness removed as CaCO_3 , mg/L
 CO_2 = carbon dioxide removed by lime addition, as CaCO_3 , mg/L

When surface waters are softened, or when the softening process is followed by coagulation and flocculation to remove the fine precipitate, this equation does not account for all of the solids production. There will be additional sludge from coagulation of suspended materials and precipitation of metal coagulants. Equations 15-14 and/or 15-16 may be used to estimate the additional mass of solids that will be produced.

The specific gravity of lime softening sludge solids is about 1.9 to 2.5. The sludge pH will be in the range 10.5 to 11.5. The solids content of lime softening sludge in the sedimentation basin ranges between 2 and 15 percent. A nominal value of 10 percent solids is often used.

Spent Filter Backwash Water

All water treatment plants that practice filtration produce a large volume of wash water containing a low suspended solids concentration. The volume of backwash water is usually 2 to 3 percent of the treatment plant flow. Spent filter backwash water (SFBW) will typically contain 10 to 20 percent of the total solids production. It will have a suspended solids concentration in the range of 30 to 400 mg/L depending on the applied turbidity and the ratio of backwash water to production water volume (Cornwell, 1999; Peck and Russell, 2005). From limited data, solids production can range from less than 3 kg/1,000 m^3 to more than 16 kg/ m^3 of production water (Cornwell, 2006). The solids in backwash water resemble those found in sedimentation units. Because filters can support biological growth, the spent filter backwash water may contain a larger fraction of organic solids than do the solids from the sedimentation basins. SFBW will contain substantial concentrations of microorganisms. It has been identified as a source of microorganisms that increases the concentration of *Cryptosporidium* and *Giardia* in the water applied to filters when it is recycled. This may result in an undesirable breakthrough of these organisms into the water supply (Le Gouellec et al., 2004).

Iron and Manganese Precipitates

The oxidation products that are formed in the removal of iron and manganese are principally ferric hydroxide, ferric carbonate, and/or manganese dioxide. For each mg/L of iron or manganese in

solution, 1.5 to 2 mg/L of sludge is produced (Peck and Russel, 2005). Because the iron and manganese concentrations found in natural water is typically low, the sludge volumes are much less than coagulant and softening sludge volumes. The iron and manganese oxides are captured on the filters, and the solids are found in the spent backwash water.

Membrane Process Residuals

The constituents that do not pass through the membrane are termed *reject*, *concentrate*, or *brine*. The volume of reject can be estimated as

$$Q_c = Q_f(1 - R) \quad (15-18)$$

where Q_c = reject or concentrate flow rate, m³/d
 Q_f = feed water flow rate, m³/d
 R = recovery rate

The recovery rate is dependent on the source water quality, fouling, feed rate, operating pressure, and type of membrane. Typical recovery rates and backwash or concentrate flow rates as a percent of the feed water flow rate are shown in Table 15-2.

If an ion or particle is completely rejected by a NF/RO membrane, the concentration factor, that is, the concentration in the residual waste stream compared to that in the feed stream, may be estimated as (Peck and Russel, 2005):

$$CF = \frac{1}{1 - R} \quad (15-19)$$

In addition to the concentrate, clean in place (CIP) residuals must be disposed. While the reject volume may range from 10 to 60 percent of the feed flow, CIP chemicals are typically less than 0.1 percent of the treated flow (AWWA, 2004).

For low pressure membranes (MF and UF), backwash water represents about 95 to 99 percent of the residual waste. The remainder is chemically enhanced backwash (CEB) and CIP chemicals. The volume of backwash residuals is on the order of 2 to 15 percent of the plant feed

TABLE 15-2
Typical recovery rates for membrane processes

Process	Feed water recovery rate, %	Backwash or concentrate flow, ^a % of feed rate
Microfiltration	85 to 98	2 to 15
Ultrafiltration	85 to 98	2 to 15
Nanofiltration	75 to 90	10 to 25
Brackish water RO	60 to 85	15 to 40
Seawater RO	20 to 50	50 to 80

^aBackwash does not include chemically enhanced backwash (CEB) or clean in place (CIP) chemicals.

Sources: AWWA, 1996; AWWA, 2005; Peck and Russel, 2005.

TABLE 15-3
Typical constituents of ion exchange brine

Constituent	Range of concentration, mg/L
Calcium	3,000 to 6,000
Magnesium	1,000 to 2,000
Sodium	2,000 to 5,000
Chloride	9,000 to 20,000
Total dissolved solids (TDS)	15,000 to 35,000
Total hardness (as CaCO ₃)	11,000 to 24,000

Sources: Mickey, 1993; MWH, 2005.

flow rate (AWWA, 2003). CEB and CIP chemicals range from 0.2 to 0.4 percent of the feed water flow rate (AWWA, 2005). The total solids in the wash water is in the range of 100 to 1,000 mg/L. The specific gravity of the wash water is in the range 1.00 to 1.025 (MWH, 2005).

Ion Exchange Residuals

The residual waste streams from ion exchange are liquid. The production rate varies from 1.5 to 10 percent of the water treated. The typical constituents and their ranges are shown in Table 15-3.

The ion exchange resin itself will leach 30 to 300 mg/L of BOD and 30 to 5,000 mg/L of COD. In addition, it is solid waste that will have to be replaced approximately every five to ten years.

Mass Balance Analysis

Clarifier sludge production can be estimated by a mass balance analysis of the sedimentation basin. Because there is no reaction taking place, the mass balance equation reduces to the form:

$$\text{Accumulation Rate} = \text{Input Rate} - \text{Output Rate} \quad (15-20)$$

The input rate of solids may be estimated using Equations 15-14, 15-16, or 15-17 for the appropriate chemical addition. An estimate of the concentration of solids and the flow rate is required to estimate the mass flow (output rate) of solids leaving the clarifier through the weir. With these estimates, the mass flow out through the weir is then

$$\text{Weir solids mass output rate} = (C_{\text{effluent}})(Q_{\text{effluent}}) \quad (15-21)$$

where C_{effluent} = concentration of solids in effluent, g/m³
 Q_{effluent} = flow rate through the weir, m³/d

Example 15-2 illustrates the calculations to estimate the sludge production.

Example 15-2. A coagulation treatment plant with a flow of 0.5 m³/s is dosing alum at 23.0 mg/L. No other chemicals are being added. The raw water suspended solids concentration is 37.0 mg/L. The effluent suspended solids concentration is measured at 12.0 mg/L. The sludge solids content is 1.00% and the specific gravity of the sludge solids is 1.2. What volume of sludge must be disposed of each day?

Solution. The mass balance diagram for the sedimentation basin is

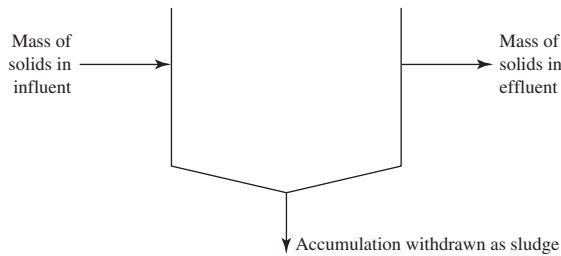

- a. Compute the accumulation of sludge in the clarifier. The mass of solids (sludge) flowing into the clarifier is estimated from Equation 15-14:

$$\begin{aligned} M_s &= 86.4(0.50 \text{ m}^3/\text{s})[(0.44)(23.0 \text{ mg/L}) + 37.0 \text{ mg/L} + 0] \\ &= 2,035.58 \text{ kg/d} \end{aligned}$$

Recognizing that $\text{g/m}^3 = \text{mg/L}$, the mass of solids leaving the weir is

$$\begin{aligned} \text{Weir output rate} &= (12.0 \text{ g/m}^3)(0.50 \text{ m}^3)(86,400 \text{ s/d})(10^{-3} \text{ kg/g}) \\ &= 518.4 \text{ kg/d} \end{aligned}$$

The accumulation of sludge in the clarifier is then

$$\text{Accumulation} = 2,035.58 - 518.4 = 1,517.18 \text{ or } 1,517 \text{ kg/d}$$

- b. Using the specific gravity of the sludge solids, compute the specific gravity of the sludge.

$$S_{sl} = \frac{1.2}{0.01 + (1.2)(0.99)} = 1.002$$

- c. Estimate the volume of sludge produced that must be disposed of each day.

$$V_{sl} = \frac{1,517 \text{ kg/d}}{(1,000 \text{ kg/m}^3)(1.002)(0.01)} = 151.4 \text{ or } 150 \text{ m}^3/\text{d}$$

15-4 MINIMIZATION OF RESIDUALS GENERATION

Coagulation

The sludge production rate may be reduced by 30 to 80 percent from the amount produced by conventional complete treatment using alum or iron if either of two methods is employed: simultaneous use of polymer and coagulant or the adoption of a direct filtration alternative (Kawamura, 2000). While the use of polymer has been adopted widely, the direct filtration techniques (direct filtration and in-line filtration) are limited by the raw water turbidity.

Frequent assessment of coagulant dosage by jar testing has been shown to reduce the generation of sludge because it minimizes the potential for overdosing with coagulant.

Softening

Blending softened water and raw water to achieve a final hardness greater than the practical solubility limits will significantly reduce the amount of sludge produced. Customers that have been consuming water with a hardness over 300 mg/L as CaCO₃ will be pleased to have a water with 130 to 150 mg/L as CaCO₃ hardness. Not only will there be a savings in sludge production, there will be associated cost savings in sludge disposal and chemical purchases that can be passed on to the customer. Each 10 mg/L of hardness as CaCO₃ left in the water reduces the sludge quantity by about 1,200 kg/y per m³/s of flow.

Air stripping of carbon dioxide rather than neutralization with lime is another method for reducing sludge production. Because there is a cost associated with building and operating the stripping column, a careful economic analysis is required. Suggestions for a starting point in investigation of stripping based on the CO₂ concentration are given in Chapter 7.

In softening plants where a significant fraction of hardness is attributable to magnesium, split flow lime softening can reduce the total sludge production compared with excess lime softening (Peck and Russell, 2005).

Spent Backwash Water

Filter design criteria that are relevant to determining waste wash water frequency in granular filters are the unit filter run volume (UFRV) and the unit backwash volume (UBWV). The UFRV is the volume of water that passes through a unit area of the filter during a run. The UBWV is the volume per unit area required to backwash the filter.

The efficiency of water production is called the *recovery*. It is defined as the ratio of the net to total water filtered:

$$\text{Recovery} = \frac{\text{UFRV} - \text{UBWV} - \text{UFWV}}{\text{UFRV}} \quad (15-22)$$

where UFWV = unit filter to waste volume, m³/m² of filter area.

Filters designed to achieve a recovery of 95 percent or more will generate less spent backwash water. To achieve 95 percent recovery, UFRV will have to be at least 200 m³/m² of filter area, and a filter run will have to be at least 1,000 minutes between backwash cycles. (MWH, 2005).

Recycling

Recycling both saves product water and minimizes the volume of residuals. Possible streams that may be recycled include (Cornwell, 1999):

1. Filter to waste.
2. Spent filter backwash water.
 - a. With the solids from filtration.
 - b. Without the solids from filtration (after settling).
3. Clarifier or settling basin sludge from softening.
4. Sludge thickener supernatant.

5. Sludge lagoon overflow.
6. Dewatering operation liquid waste.
 - a. From filter press.
 - b. From centrifuge.
 - c. Leachate from sand drying beds.

Recycling must be evaluated carefully. These wastes may upset the treatment processes and affect the quality of the finished water. The principal constituents that may be of concern include (Cornwell, 1999):

- Microbiological contaminants.
- Total organic carbon.
- Disinfection byproducts.
- Turbidity and suspended solids.
- Metals.
- Taste and odor causing compounds.

High concentrations of many of these constituents can be removed by coagulation, sedimentation, and other treatment processes. As the composition of the waste stream is unique for each plant, careful on-site analysis, including laboratory and pilot experiments, is recommended.

15-5 RECOVERY OF TREATMENT CHEMICALS

Although not widely practiced, the technologies for recovery of alum and iron coagulant and lime have been available in the United States for over 40 years. The low cost of virgin chemicals, as well as the availability of several sludge disposal options, has made the economics of chemical recovery unfavorable except in some special localized cases. The specialized cases will become more numerous as local circumstances reduce the options for sludge disposal.

Alum Recovery

Four methods are available for recovery of alum: acidification, liquid ion exchange, alkaline recovery, and Donnan dialysis.

Acid Recovery. This process consists of three steps:

- Thickening of the sludge.
- Acidification of the sludge to a pH between 1.0 and 3.0.
- Decanting the dissolved aluminum for reuse.

Aluminum recoveries range from 60 to 80 percent. The reaction of about 1 kg of sulfuric acid with 0.5 kg of aluminum hydroxide yields approximately 1 kg of alum. Other metals such as

chromium and copper can be converted to a soluble form during acidification. This has raised concerns for the potential buildup of toxic metals.

Liquid Ion Exchange (LIX). The process steps for liquid ion exchange are the same as those used for acid recovery except that the aluminum is extracted into the LIX medium. The LIX is immiscible in water and is separated by flotation. The aluminum is recovered from the LIX by adjusting the pH of the solution. The LIX can then be reused. Unlike the acid recovery process, the LIX process is selective for aluminum (Westerhoff and Cornwell, 1978). In laboratory studies this process achieved 95 percent recovery of alum.

An example of a specialized case of the application of this technique is one where a nearby wastewater treatment plant can use the recovered alum to remove phosphorus from the wastewater. This approach increases the potential for favorable economics while reducing the potential for recycling and concentrating toxic metals.

Alkaline Recovery. If sodium aluminate can be used as coagulant, then the aluminum can be dissolved by raising the pH from about 12 to 12.5 with sodium hydroxide. This converts the aluminum hydroxide to sodium aluminate. Aluminum recoveries of 90 to 95 percent are reported (Peck and Russell, 2005).

Donnan Membrane Process. Also known as *Donnan dialysis*, this process is driven by an electrochemical potential gradient across a semipermeable ion exchange membrane. In the Donnan membrane cell, the feed side of the membrane contains coagulant acidified to a pH in the range of 3 to 3.5. The recovery side contains a 10 percent sulfuric acid solution. In laboratory experiments, a 70 percent alum recovery was obtained, and the recovered alum was essentially free of particulate matter and NOM. Concentrations of metals that were examined were low but not zero: As = 0.5 mg/L, Cu = 1 mg/L, Zn = 7 mg/L. While these data were obtained at laboratory scale, they show promise for future development (Prakash and Sengupta, 2003).

Iron Coagulant Recovery

In a process similar to the acid recovery process for alum, this process requires a pH of 1.5 to 2.0 to recover 60 to 70 percent of the iron. Because of the expense and poor dewatering characteristics of the sludge, there has been little interest in this process.

The laboratory scale Donnan process has also been used to recover iron coagulant with similar success to alum recovery (Prakash and Sengupta, 2003).

Lime and Magnesium Recovery

Recalcining. Lime sludge that is predominantly CaCO_3 can be subjected to high heat in a process similar to that used to form quicklime (CaO) from CaCO_3 that has been mined. This heating process is called *recalcining*. This process is energy intensive and requires cheap energy and substantial quantities of sludge to achieve a scale that can be economical.

Magnesium Carbonate. Black and Thompson (1975) developed a method that softens the water while coagulating turbidity. Magnesium carbonate is used as the coagulant. Lime is added to precipitate the magnesium. The resulting sludge is composed of CaCO_3 , $\text{Mg}(\text{OH})_2$, and the coagulated turbidity. The sludge is carbonated by injecting CO_2 gas, which selectively dissolves

the $\text{Mg}(\text{OH})_2$. The carbonated sludge is filtered and soluble magnesium bicarbonate is recovered as filtrate. The lime is recovered by recalcining the CaCO_3 .

15-6 RESIDUALS CONVEYANCE

With appropriate selection of materials to deal with the corrosive nature of the sludge, waste backwash water, reject from membrane processes, brine from ion exchange processes, and sludges with solids concentrations less than 1 percent may be conveyed by standard pump and pipe systems used for water. As shown in Example 27-2, the Hazen-Williams equation may be used for pipe design.

Sludges with concentrations above 1 percent behave as non-Newtonian fluids. There is no simple relationship that can be used to predict headloss. There is no readily available method for calculating headloss in chemically generated sludges from water treatment processes. The graphs that are available for calculating headloss in pumping sludge are based on experiments with biological sludges found in wastewater treatment systems. Peck and Russell (2005) suggest that these may be used with appropriate safety factors. These are discussed in Chapter 27.

In addition to the difficulties in predicting headloss, conventional centrifugal pumps are ineffective in moving sludge with solids concentrations greater than about 3 or 4 percent. Progressive cavity pumps, peristaltic pumps, and diaphragm pumps have been used for pumping residuals from clarifiers and thickeners. As an alternative to screw or conveyor systems, progressive cavity pumps and high-pressure piston pumps have been used to move dewatered residuals (Peck and Russell, 2005). The selection and application of various alternatives for moving sludges and dewatered residuals are discussed in Chapter 27.

15-7 MANAGEMENT OF SLUDGES

The treatment of solid/liquid wastes produced in water treatment processes involves the separation of the water from the solid constituents to the degree necessary for the selected disposal method. Therefore, the required degree of treatment is a direct function of the ultimate disposal method. In turn, the ultimate disposal method is a function of regulatory constraints and the economics of the disposal method.

There are several sludge treatment methodologies that have been practiced in the water industry. Figure 15-1 shows the most common sludge handling options available, listed by the categories of thickening, dewatering, and disposal. In choosing a combination of the possible treatment process trains, it is best to first identify the available disposal options and their requirements for a final cake solids concentration. Most landfill applications will require a “handleable” sludge, and this may limit the type of dewatering devices that are acceptable. Methods and costs of transportation may affect the decision how dry is dry enough? The criteria should not be to simply reach a given solids concentration, but rather to reach a solids concentration that has the properties for handling, transport, and disposal. The required properties are a function of the management options that are available.

Table 15-4 shows a generalized range of results that have been obtained for final solids concentrations from different dewatering devices for coagulant and lime sludges.

To give you an appreciation of these solids concentrations, a sludge cake with 35 percent solids would have the consistency of butter, while a 15 percent sludge would have a consistency much like rubber cement.

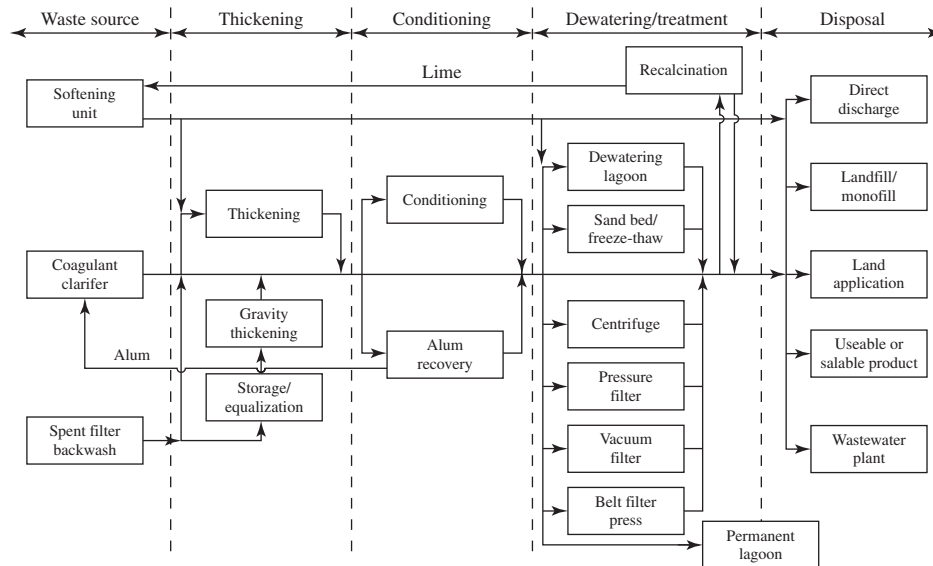

FIGURE 15-1 Sludge handling options. (Source: Davis and Cornwell, 2008.)

The conventional sludge handling options shown in Figure 15-1 are discussed in the following paragraphs.

Thickening

After removal of the sludge from the clarifier or sedimentation basin, the first treatment step is usually thickening. Thickening assists the performance of any subsequent treatment, gets rid of a lot of water quickly, and helps to equalize flows to the subsequent treatment device.

TABLE 15-4
Range of obtainable cake solid concentrations

	Lime sludge, %	Coagulation sludge, %
Gravity thickening	15–30	2–4
Dissolved air flotation	3–5	3–5
Basket centrifuge	N/A ^a	10–15
Solid bowl, scroll centrifuge	55–65	20–25
Belt filter press	25–60	15–30
Vacuum filter	45–65	N/A ^a
Pressure filter	55–70	30–40
Sand drying bed	50	20–25
Storage lagoon	50–60	7–15

^aN/A = not advised.

(Sources: Davis and Cornwell, 2008; MWH, 2005.)

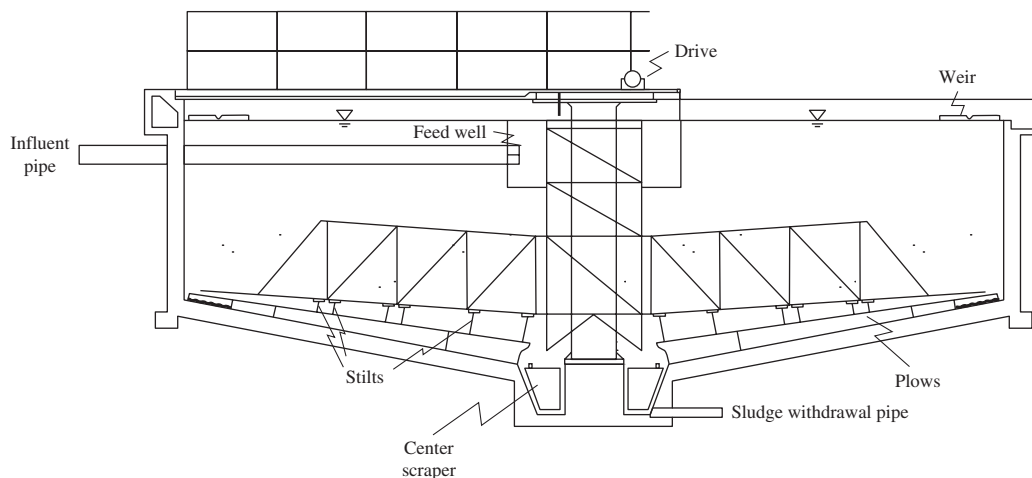

FIGURE 15-2
Continuous-flow gravity thickener.

Thickening may be accomplished by gravity settling or flotation. Gravity thickening is usually accomplished by using circular settling basins similar to a clarifier (Figure 15-2). Dissolved air flotation (DAF) thickeners typically are rectangular as shown in Figure 15-3. Thickeners can be designed based on pilot evaluations or using data obtained from similar plants.

The addition of polymer significantly improves the performance of thickeners (Peck and Russell, 2005).

Gravity Thickening. As noted in Chapter 10, when the water contains a high concentration of particles (for example, greater than 1,000 mg/L), both Type III (*hindered settling* or *zone settling*) and Type IV (*compression settling*) occur along with discrete and flocculant settling. Zone settling and compression settling occurs in sludge thickeners.

As with Type II settling, the methods for analyzing hindered settling require settling test data. These methods are appropriate for plant expansions or modifications, but have not found

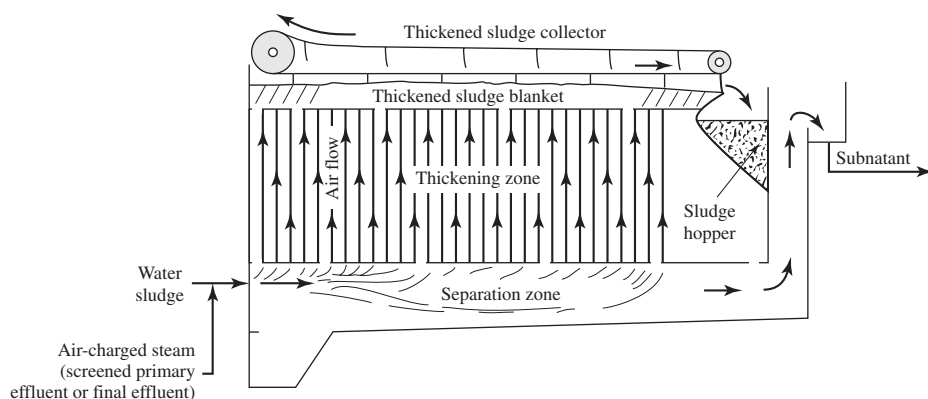

FIGURE 15-3
Dissolved air flotation (DAF) thickener.

use in the design of treatment plants where process sludges from treating the actual raw water are not available. However, they are useful in explaining the behavior of thickeners and demonstrating the controlling design variables.

Dick has described a graphical procedure for sizing gravity thickeners using a *batch flux curve** (Yoshioka et al., 1957; Dick, 1970). *Flux* is the term used to describe the rate of settling of solids. It is defined as the mass of solids that pass through a horizontal unit area per unit of time ($\text{kg}/\text{m}^2 \cdot \text{d}$). This may be expressed mathematically as follows:

$$\begin{aligned} F_s &= (C_u)(v) \\ &= (C_s)(\text{zone settling velocity}) \end{aligned} \quad (15-23)$$

where F_s = solids flux, $\text{kg}/\text{m}^2 \cdot \text{d}$

C_u = concentration of solids in underflow, that is, the sludge withdrawal pipe, kg/m^3

C_s = suspended solids concentration, kg/m^3

v = underflow velocity, m/d

The sizing procedure begins with a batch settling curve such as that shown in Figure 15-4. The data for the settling curve are obtained by filling a transparent cylinder with sludge that is well mixed to distribute the solids. At time zero, the mixing intensity is reduced and the solids are allowed to settle. Type III settling produces a distinct interface so the measurement of the height of the interface at various time intervals allows the calculation of a settling velocity. This experiment is conducted at several different sludge concentrations that are obtained by diluting the sludge.

Vesilind (1979) has outlined some of the critical factors in conducting the test. These include:

- A cylinder diameter as large as possible, but not less than 20 cm in diameter,
- An initial height that is, preferably, the same as the thickener, but not less than 1 m,
- Filling the cylinder from the bottom, and
- Stirring the cylinder very slowly at a speed of 0.5 rpm during the test.

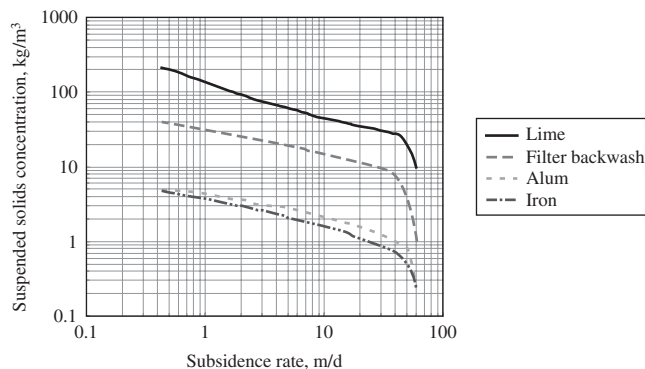

FIGURE 15-4
Batch settling curves.

*The original development of this method was by N. Yoshioka and others.

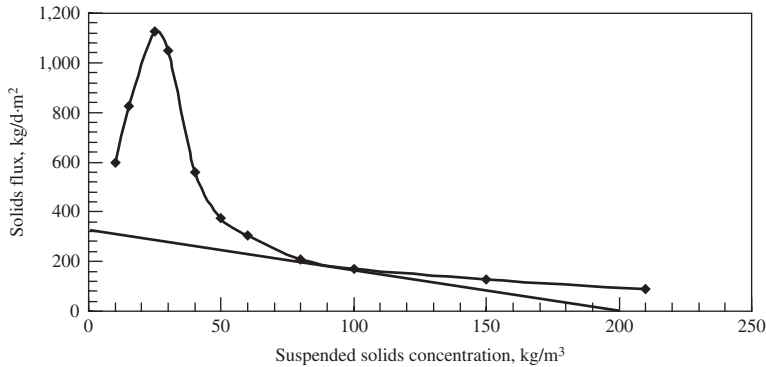

FIGURE 15-5
Batch flux curve.

Data from the batch settling curve are used to construct a batch flux curve (Figure 15-5). Knowing the desired underflow concentration, a line through the desired concentration and tangent to the batch flux curve is constructed. The extension of this line to the ordinate axis yields the design flux. From this flux and the inflow solids concentration, the surface area may be determined. Example 15-3 illustrates the procedure and the application of the controlling design variables.

Example 15-3. A gravity thickener is to be designed to thicken a lime softening sludge from a conventional settling basin. The sludge flow rate is $171.2 \text{ m}^3/\text{d}$, and the solids mass loading is $4.28 \times 10^3 \text{ kg/d}$. The limiting overflow rate to prevent carryover of solids is 0.4 m/h . The thickened sludge should have an underflow solids concentration of 20.0% . Assume that the sludge yields a batch settling curve such as that shown in Figure 15-4. Determine the required surface area and diameter of the thickener for thickening, and verify that the hydraulic loading rate is acceptable.

Solution:

- a. Begin by calculating solids flux (F_s) and plotting the solids flux curve. The explanation of the computations is given below the table.

SS, kg/m ³	v , m/d	F_s , kg/d m ²
210	0.43	90.3
150	0.86	129
100	1.7	170
80	2.6	208
60	5.1	306
50	7.5	375
40	14	560
30	35	1,050
25	45	1,125
15	55	825
10	60	600

The suspended solids concentrations (SS) in the first column were selected arbitrarily. The data in the second column were read from Figure 15-4 at the abscissa points noted in the first column. The data in the third column are the products of the first and second column; that is, $210.0 \times 0.43 = 90.3$, $150.0 \times 0.86 = 129$, and so on.

Converting the first column to percent and plotting the SS in kg/m^3 versus the last column yields the batch flux curve (Figure 15-5).

- b. As shown in the figure, the tangent line from the desired underflow solids concentration of 20% yields a solids flux of $320 \text{ kg/d} \cdot \text{m}^2$. (The percent solids concentration is 0.10 times the SS in kg/m^3 .) With safety factor of 0.667, the design solids flux is

$$F_{s \text{ design}} = (320 \text{ kg/d} \cdot \text{m}^2)(0.667) = 213.44 \text{ kg/d} \cdot \text{m}^2$$

- c. The solids mass loading is given as $4.28 \times 10^3 \text{ kg/d}$. Therefore, the required surface area of for thickening is

$$A_s = \frac{4.28 \times 10^3 \text{ kg/d}}{213.44 \text{ kg/d} \cdot \text{m}^2} = 20.05 \text{ or } 20 \text{ m}^2$$

- d. The diameter of the thickener is then

$$D = \left(\frac{(4)(20 \text{ m}^2)}{\pi} \right)^{1/2} = 5.05 \text{ or } 5 \text{ m}$$

- e. Check the hydraulic loading criterion by calculating the overflow rate with this surface area.

$$v_0 = \frac{171.2 \text{ m}^3/\text{d}}{20 \text{ m}^2} = 8.56 \text{ m/d or } 0.36 \text{ m/h}$$

This overflow rate is acceptable because it is below the design criterion of 0.4 m/h.

Comments:

1. If the hydraulic loading criterion is exceeded, then the surface area of the thickener is governed by the hydraulic loading criterion, and the surface area and diameter are recalculated using the overflow rate criterion.
2. This is a small thickener. It may not be economical to build a thickener this small because the savings in disposal cost may not be recovered by the end of the design life of the thickener.

Gravity Thickening Practice. Typical gravity thickener design parameters are summarized in Table 15-5. Wasting to the thickener may or may not be continuous, depending upon the size of the WTP. Frequently, smaller plants will waste intermittently because of work schedules and lower volumes of sludge. Typically, the supernatant suspended solids levels are quite high. Thus,

the supernatant must be returned to the head end of the WTP. This is a particular problem for surface water plants because it results in an increase in the concentration of *Cryptosporidium* and *Giardia*.

The primary design elements are the diameter, depth, and required drive torque. In the absence of an operating facility that is generating sludge for laboratory development of design data, typical values for the solids loading and design overflow rate (initial settling velocity) are used to estimate the tank diameter. The calculation is the same as that shown in Example 15-3 starting at step (c).

The depth of the tank is typically divided into three parts for conceptual design: (1) the free-board above the sludge liquid surface, (2) a settling zone where the particulate matter separates

TABLE 15-5
Range of typical gravity thickener design parameters

Parameter	Typical range				Remarks
	Alum	Iron	Lime	Filter backwash	
Specific gravity of solids	1.2–1.5	1.2–1.8	1.9–2.4	1.0–1.025	For both granular and microfiltration filter backwash
Specific gravity of sludge	1.025–1.1	1.05–1.2	1.01–1.2	N/A ^a	
Percent solids from settling tank	0.1–2%	0.1–2%	2 and 15%	30–400 mg/L	Nominal value for lime = 10%
	2–4%	2–4%			Highly turbid water
Sludge volume	0.1–3%	0.1–3%	0.3–5%	3–10%	% of water treated
Initial settling velocity	2.2–5.5 m/h	1–5 m/h	0.4–3.6 m/h	<0.12 m/h	No coagulant for filter backwash
				0.2–0.7 m/h	With coagulant for filter backwash
Solids loading	15–80 kg/d · m ²	15–80 kg/d · m ²	100–300 kg/d · m ²	N/A	
Percent solids from thickener	3–4%	3–4%	15–30%	70–90%	Recovery of applied solids in mg/L
Safety factor for solids flux	0.667	0.667	0.667	0.667	When based on lab data
Thickener diameter ^b	3–50 m	3–50 m	3–50 m	N/A	In 0.3 m increments for small tanks In 1.5 m increments for large tanks
Thickener SWD	3–6 m	3–6 m	4–6 m	N/A	For tanks 3 to 50 m in diameter

^aN/A = not available.

^bAlthough diameters up to 180 m are advertised in manufacturers' literature, they are rarely used for water treatment plant sludges. Sources: Cornwell, 1999; Kawamura, 2000; MWH, 2005; Peck and Russell, 2005.

from the liquid, and (3) the thickening zone at the bottom of the tank. Typical values for the freeboard and settling zone are 0.6 and 2 m respectively. The thickening zone is calculated as (U.S. EPA, 1979):

$$H_{\text{thickening}} = \frac{(M_s)(t)}{(P_{s \text{ average}})(\rho)(A_s)} \quad (15-24)$$

where $H_{\text{thickening}}$ = height of thickening zone, m
 M_s = mass of solids applied, kg
 t = storage period for thickened sludge, d
 $P_{s \text{ average}}$ = average solids fraction in zone
 ρ = density of water, kg/m³
 A_s = surface area of thickener, m²

For continuous underflow thickeners, one to two day's storage is typically provided. The average solids fraction ($P_{s \text{ average}}$) is estimated as the average of the influent solids fraction and the underflow solids fraction.

The required running torque drive may be estimated as (Boyle, 1978):

$$T = (W)(r^2)(g) \quad (15-25)$$

where T = running torque, J
 W = truss arm load, kg_f/m
 r = radius of scraper arm, m
 g = gravitational acceleration, 9.81 m/s²

Example values for the truss arm load for water treatment sludges are 15 kg_f/m for coagulant sludge and 22 kg_f/m for lime sludge (WEF, 1998). Manufacturers should be consulted for design estimates. In addition to the running torque, the alarm torque (120 percent of running torque), shut-off torque (140 percent of running torque), and peak torque (the torque that will cause imminent failure, 200 percent of running torque) must be specified. Manufacturers have advertised running torque capability of greater than 1 MJ for 45 m diameter thickeners.

Example 15-4. Complete the design of the thickener by calculating the depth and running torque of the solids rake in Example 15-3 with the following assumptions:

Solids from the settling tank = 3%
 Thickener underflow solids = 20%
 Truss arm load = 22 kg_f/m

Solution:

a. Calculate the average solids fraction in the thickening zone.

$$P_{s \text{ average}} = \frac{0.03 + 0.20}{2} = 0.115$$

- b. Estimate the height of the thickening zone using the mass of solids applied in one day (4.28×10^3 kg/d) and the surface area of the thickener area (20 m^2) from Example 15-3.

$$H_{\text{thickening}} = \frac{(4.28 \times 10^3 \text{ kg/d})(1 \text{ d})}{(0.115)(1,000 \text{ kg/m}^3)(20 \text{ m}^2)}$$

$$= 1.86 \text{ or } 1.9 \text{ m}$$

- c. The side water depth (SWD) of the thickener is then

$$\text{SWD} = \text{freeboard} + \text{settling zone} + H_{\text{thickening}}$$

$$= 0.6 \text{ m} + 2 \text{ m} + 1.9 \text{ m} = 4.5 \text{ m}$$

- d. Using the radius of the thickener from Example 15-3 for the rake radius, the running torque is estimated as

$$\text{Torque} = (22 \text{ kg}_f/\text{m})(2.5 \text{ m})^2(9.81 \text{ m/s}^2) = 1,348.87 \text{ or } 1,300 \text{ J}$$

Comment: The depth of the thickener does not take into account the additional depth that results from the slope of the floor toward the sludge withdrawal point. A typical slope is about 25%. For this design the center of the thickener would be about 0.6 m deeper than the side water depth.

Dissolved Air Flotation (DAF). In the DAF thickening process air is pressurized to 200–800 kPa and injected into the sludge as 10 to 100 μm diameter microbubbles (Gregory, Zabel, and Edzwald, 1999). The bubbles adhere to the sludge solids particles or are enmeshed in the solids matrix. Because the average solids-air density is less than that of water, the agglomerate floats to the surface. The sludge forms a layer at the top of the tank; this layer is removed by a skimming mechanism for further processing.

DAF is generally most effective in the following applications (MWH, 2005):

- Low-density particulate matter such as algae.
- Dissolved organic matter such as natural color.
- Low-to moderate turbidity water that produces low density floc.
- Low temperature water.

Coagulant residuals can be thickened by flotation to about 2,000 to 3,000 mg/L at a solids flux rate of 50 to 150 $\text{kg/m}^2 \cdot \text{d}$. This is higher than can be achieved by simple settling but less than can be achieved by gravity thickening (Peck and Russell, 2005).

Recent applications include clarification of granular filter waste wash water and membrane filter backwash (Shorney-Darby et al., 2007).

Dewatering

Following thickening of the sludge, dewatering can take place by either mechanical or nonmechanical means. In nonmechanical devices, sludge is spread out with the free water draining

and the remaining water evaporating. Sometimes the amount of free water available to drain is enhanced by natural freeze-thaw cycles. In mechanical dewatering, some type of device is used to force the water out of the sludge. Table 15-4 provides a method for screening the selection of an alternative from those that are discussed in the following paragraphs.

In the following discussion the desirability of conducting pilot tests to develop design data is mentioned in several instances. Cornwell (2006) provides some general, as well as specific, guidance on conducting pilot tests.

Nonmechanical Dewatering

Lagoons. Lagoons can be constructed as either permanent storage lagoons or dewatering lagoons. Permanent storage lagoons are designed to act as a final disposal site. They will not be discussed. Some authors (for example, Cornwell, 1999) consider a lagoon to be a dewatering lagoon only if it has a sand underdrain bottom. Others (for example, Kawamura, 2000, and MWH, 2005) consider the underdrain an optional feature. The difference in concept is critical in selection of the method for determining the design dimensions. If an underdrain system is provided, then the design methodology is the same as that used for a sand drying bed. This method is discussed in the next section. In this discussion the term dewatering lagoon is used with the understanding that an underdrain will not be provided.

Lagoons are generally operated in a cyclic fashion: fill, settle, decant. This cycle is repeated until the lagoon is full or the decant can no longer meet discharge limitations. The solids are then removed for final disposal. The standing water is removed by decanting or pumping to facilitate drying. To recover the water, the decant is often returned to the head end of the plant. As noted for thickening, this may be a problem because it increases the concentration of *Cryptosporidium* and *Giardia*.

Coagulant sludges can only be expected to reach a 7 to 10 percent solids concentration in dewatering lagoons. The remaining solids must be cleaned out wet. Evaporation to dryness is generally not practical. Depending upon the depth of the wet solids, evaporation can take years. The top layers will often form a crust, preventing evaporation of the bottom layers of sludge.

Lime-soda softening sludges dewater more readily than coagulant sludges. Typical values vary from 30 to more than 50 percent. For these sludges it is important to design the lagoon so that the sludge does not remain submerged after initial filling because it does not compact well under water.

Dewatering lagoons, which are generally earthen basins, have no size limitations but have been designed with surface areas from 2,000 to 60,000 m², and depths ranging from 2 to 10 m. Typically, several lagoon cells are provided to allow for a drying period after the lagoon is full. Dewatering lagoons should be equipped with inlet structures designed to dissipate the velocity of the incoming sludge. This minimizes turbulence in the lagoons and helps prevent carryover of solids in the decant. The lagoon outlet structure is designed to skim the settled supernatant.

When land is readily available, lagoons may serve as both thickeners with continuous decanting and drying beds. A common approach for coagulant sludges is to provide sufficient volume for three months of filling and three months of dewatering. For lime softening sludges, a three-year cycle for filling and concurrent dewatering has been used.

Lagoon Design. The required area and depth of the lagoon are a function of the maximum daily flow of sludge (m^3/d) and the mass of solids to be dewatered. For conceptual design, the lagoon may be considered as a series of layers:

- A solids holding layer,
- A dewatering layer, and
- A liquid layer that is removed by decanting.

The area of the lagoon is based on the area required for the dewatering layer. It is calculated as

$$A_s = \frac{V}{(N)(D_i)} \quad (15-26)$$

where A_s = surface area of lagoon, m^2

V = volume of sludge, m^3/y

N = number of uses of the lagoon per year

D_i = initial depth of the dewatering layer, m

The preferred depth for filling is 1.2 m with a recommended maximum of 1.8 m (Kawamura, 2000). In locations with a wet climate these depths should probably be lower.

An alternative design approach is to use a design criteria based on solids loading rate (MWH, 2005):

$$A_s = \frac{(M_s)(t)}{M_L} \quad (15-27)$$

where M_s = mass of solids, kg/d

t = duration of filling cycle, d

M_L = sludge loading rate, kg dry solids/ m^2

Typical solids loading rates range from 40 to 80 kg dry solids/ m^2 of surface area, with the lower value being applied in wet regions and the higher value in dry regions.

In the absence of specific geometric design, a multiplier of 1.5 times the area (A_s) is used to account for berms and access roads in estimates of the required land.

GLUMRB (2003) suggests that coagulation sludge lagoons volume be sized based on the total chemicals used plus a factor for turbidity. For lime softening sludge, GLUMRB suggests that for a lagoon depth of 1.5 m, an area of 0.75 m^2 per m^3 of water treated per day per 100 mg/L of CaCO_3 hardness removed be provided. This should provide about 2.5 years storage (GLUMRB, 2003).

Obviously, the sizing of a sludge lagoon involves a large number of assumptions. In the interest of providing sufficient capacity, the design is often very conservative. Thus, it is not uncommon to find that the lagoons have been oversized.

The inlet structure should have an isolation valve. It should be located at the source of sludge rather than at the lagoon and, in cold climates, be protected from freezing. The outlet structure for decanting should be capable of withdrawal at multiple levels. An example is shown in Figure 15-6.

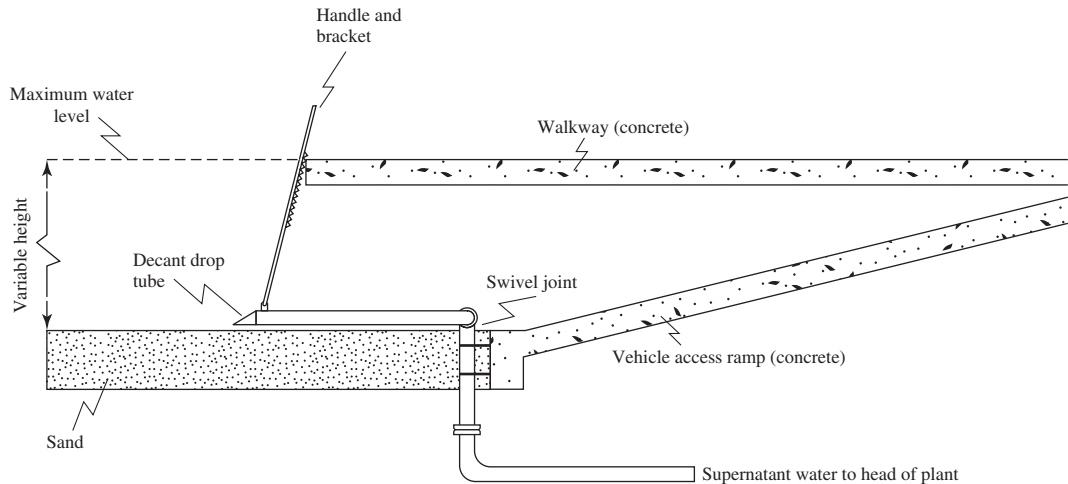

FIGURE 15-6
Lagoon decant structure. Shown with no sludge in lagoon.

Lagoons should be equipped with sealed bottoms to protect the groundwater. A lined lagoon will have two or three layers. In the three-layer system, the bottom layer will be about 30 cm of compacted clay with a low hydraulic conductivity ($\leq 1 \times 10^{-7}$ cm/s), an intermediate impermeable synthetic membrane (1.25 to 2.5 mm thick high density polyethylene—HDPE—is common), and a final granular layer (run of bank sand) about 30 cm deep. In a two layer system the synthetic membrane is eliminated. The clay and membrane are to prevent leakage to the groundwater. The granular layer is to protect the clay and/or membrane from abrasion by heavy equipment used to remove the sludge. In sensitive cases, local circumstances may require a leachate collection system.

Typical design criteria are given in Table 15-6.

TABLE 15-6
Range of typical sludge lagoon design parameters

Parameter	Range of values	Remarks
Operating cycle	N/A	Fill, settle, decant
Number	3	Minimum, 4 preferred
Loading		
Wet climate	40 kg/m ²	
Dry climate	80 kg/m ³	
Solids feed		
Coagulant	0.1 to 2%	
	2 to 4%	Highly turbid water
Lime	2 to 15%	Nominal value = 10%

(continued)

Solids dewatered		
Coagulant	7 to 10%	
Lime	30 to > 50%	
Capacity	3 to 4 months	If depth is provided for storage, may be as long as 3 years
Depth of liquid sludge	1.2 to 1.8 m	During filling, 1.2 m preferred
Length to width	4:1	
Inlet to outlet distance	30 m	Minimum
Lining	Clay and/or HDPE	Local regulations may require leachate collection
Berms		
Slope	3:1	Horizontal to vertical
Access road	≥5 m wide	Wide enough for excavation equipment and double bottom trailers to maneuver

Sources: Kawamura, 2000; Peck and Russell, 2005.

Example 15-5. Design a sludge lagoon to dewater a coagulation sludge. The sludge flow rate is $85.6 \text{ m}^3/\text{d}$, and the solids concentration from a thickener is 2.5%. Assume a wet climate, a four lagoon system with a six-month cycle for each lagoon, and an applied depth of 0.40 m.

Solution:

- a. Using a six-month cycle, the number of lagoon uses per year will be

$$N = \frac{12 \text{ mo/y}}{6 \text{ mo/cycle}} = 2 \text{ cycles/year}$$

- b. The total area of the four lagoons is estimated as

$$A_s = \frac{(85.6 \text{ m}^3/\text{d})(365 \text{ d/y})}{(2 \text{ cycles/y})(0.80 \text{ m})(4 \text{ lagoons})} = 4,881.88 \text{ or } 5,000 \text{ m}^2$$

Comments:

1. This is a fairly conservative design because of the assumption of a wet climate.
2. If the lagoon is also to be used for thickening, the area may have to be increased substantially.

Sand Drying Beds. Sludge is dewatered on a sand drying bed by three mechanisms: drainage, decanting, and evaporation. First, the water is drained from the sludge, into the sand, and out the underdrains. This process may last a few days until the sand is clogged with fine particles or until all the free water has drained away. Decanting can occur once a supernatant layer has formed. Decanting for removal of rain water can also be particularly important with sludges that do not crack.

The water that does not drain or is not decanted must evaporate. Climate plays a significant role in the feasibility of using this drying technique. Phoenix would be a more efficient area for a sand bed than Seattle!

Drying bed options may be roughly described as follows:

- Conventional rectangular beds have side walls and a layer of sand on gravel with under-drain piping to carry away the liquid. They have been built either with or without provisions for mechanical removal of the dried sludge, and with or without a roof or a greenhouse-type covering. In the United States, the capital cost of roofing over a sand drying bed of any appreciable size probably precludes it from being built. The cost of labor is such that mechanical sludge removal will, in all likelihood, be more economical than manual removal.
- Paved rectangular drying beds are built with a center sand drainage strip with or without heating pipes buried in the paved section, and with or without covering to prevent incursion of rain.
- “Wedge-water” drying beds include a wedge wire septum incorporating provision for an initial flood with a thin layer of water. This is followed by introduction of liquid sludge on top of the water layer, controlled formation of cake, and provision for mechanical cleaning.
- Rectangular vacuum-assisted drying beds are built with provision for application of vacuum to assist gravity drainage.

Operational procedures common to all types of drying beds involve the following steps (ASCE, 1990):

1. Pump sludge onto the drying bed surface.
2. Add chemical conditioners continuously by injection into the sludge as it is pumped onto the bed. Anionic, cationic, and nonionic polymer have all been used successfully in individual application. However, a combination of polymers may give the best dewatering characteristics (Ayol, Dentel, and Filibeli, 2005). Polymer doses fall in the range of 1 to 10 g/kg of sludge solids (MWH, 2005).
3. When the bed is filled to the desired level, allow the sludge to drain and dry to the desired final solids concentration. This concentration can vary from 15 to 30 percent for coagulant sludge and 50 to 70 percent for lime sludge.
4. Remove the dewatered sludge either mechanically or manually.
5. Repeat the cycle.

Periodically, sand that is inadvertently picked up when the dewatered sludge is removed must be replaced.

The filtrate from the sand drying beds can be either recycled, treated, or discharged to a watercourse depending on its quality.

Ideally, pilot testing is conducted prior to design of the sand drying bed. The pilot tests provide data on the loading depth, initial solids concentration, and polymer use that maximizes the drained solids concentration. Some example data are shown in Table 15-7. Although similar data for lime sludges are not available, typical loading depths of 0.3 to 1.2 m have been reported (ASCE, 1990). From the data trends it is apparent that there is a general trend of diminishing return in drained solids concentration with increased loading.

Laboratory testing of the filtrate from the pilot tests provides data for the decision on the final disposition of the filtrate and decant.

Sand Drying Bed Design. Current United States practice is to make drying bed cells rectangular with dimensions of 4 to 20 m by 15 to 60 m, with vertical side walls 1 to 1.5 m above the sand surface. For mechanical sludge removal, the dimensions should be selected to accommodate the removal equipment, that is, multiples of the loader bucket width. In a typical design, 0.3 to 0.46 m of sand is placed over 0.3 to 0.46 m of graded gravel or stone. The sand is specified with an effective diameter that ranges from 0.3 to 1.2 mm and a uniformity coefficient from 3.5

TABLE 15-7
Example pilot test results

Sludge type	Initial solids concentration, %	Loading, kg/m ²	Initial depth, m	Drained solids concentration, %	Polymer dose, g/kg
Alum	1.1	5	0.44	8.5	1.0 N
		10	0.88	7.3	
		15	1.31	6.9	
		20	1.75	5.8	
Alum	6.5	10	1.48	16.2	1.55 A
		20	2.95	19.1	
		30	4.42	11.8	
Polyaluminum chloride	1.7	10	0.57	12.2	1.2 C
		20	.45	10.0	
		30	1.13	12.1	
Ferric chloride	1.9	5	0.25	6.3	4.2 C
		10	0.50	6.3	
		20	1.0	3.2	
Ferric chloride	6.5	10	1.48	23.2	1.25 A
		15	2.20	21.7	
		20	4.42	20.3	

N = nonionic polymer

A = anionic polymer

C = cationic polymer

Adapted from Cornwell and Vandermeijden, 1999.

to 5.0. Gravel is normally graded from 3 to 25 mm in effective diameter. Underdrain piping has normally been of vitrified clay, but plastic piping is also acceptable. The pipes should be no less than 100 mm in diameter, should be spaced 2 to 6 m apart, and should have a minimum slope of 1 percent.

Mechanical equipment such as a front end loader is used to remove the dried sludge. Bed runners consisting of 10 by 30 cm concrete pads provide a drive way for the wheels of the front end loader, so the loader does not compact the sand. In addition, they serve as a guide for buckets to rest on as sludge is picked up. This minimizes the amount of sand that is picked up by the loader when it removes the sludge. A typical layout is shown in Figure 15-7.

Cornwell and Vandermeijden (1999) proposed a model for developing the sand bed design based on a monthly mass balance of water. The working equations for the model are as follows:

$$D_d = (D_i) \left(\frac{P_s \text{ initial}}{P_s \text{ drained}} \right) \quad (15-28)$$

$$\Delta D_e = D_d - \left(\frac{(D_d)(P_s \text{ drained})}{P_s \text{ final}} \right) \quad (15-29)$$

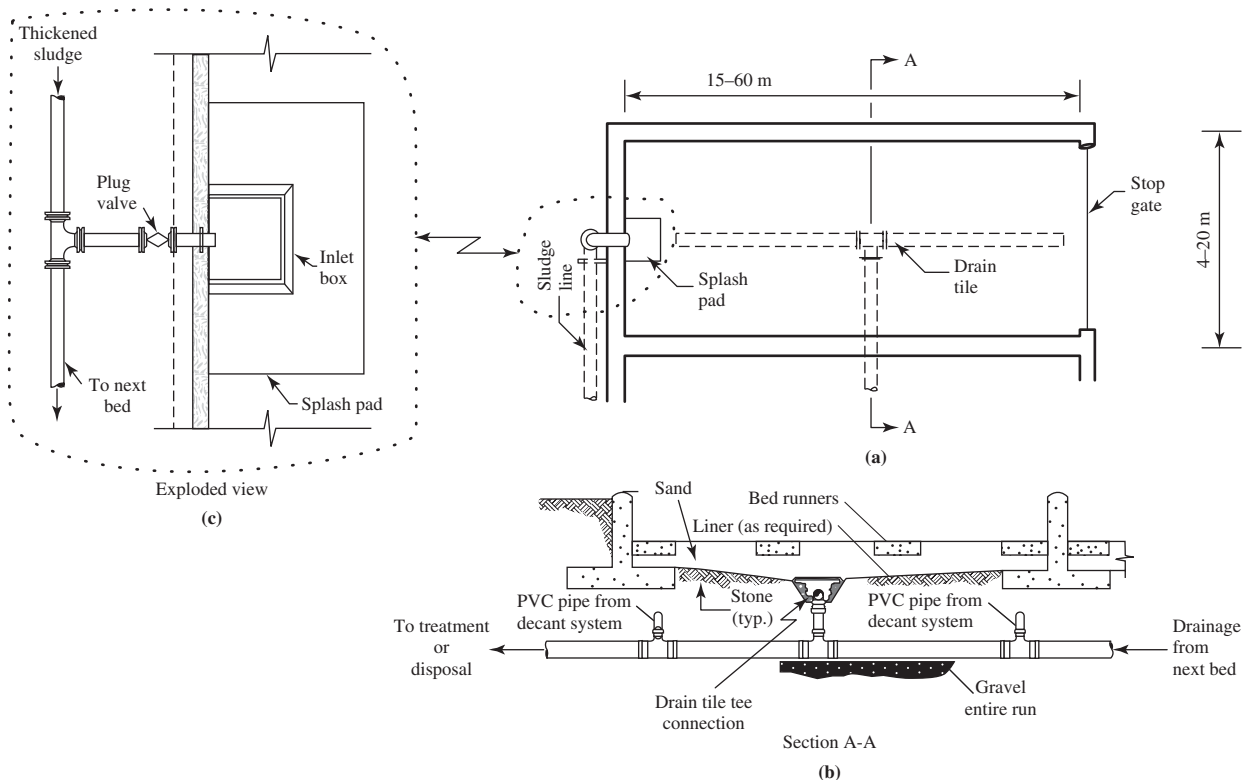

FIGURE 15-7 Sand drying bed. (a) Plan view, (b) cross section, (c) exploded view of inlet.

$$L = (D_i)(P_{\text{initial}})(\rho) \quad (15-30)$$

$$A_s = \frac{M_{s(t)}}{L} \quad (15-31)$$

where D_d	= drained residuals depth after free water is removed, m
D_i	= initial residuals depth, m
P_s initial	= initial solids fraction
P_s drained	= solids fraction after drain and decant
ΔD_e	= required depth change to be caused by evaporation, m
P_s final	= desired final solids fraction
L	= loading, kg/m ²
ρ	= density of water = 1,000 kg/m ³
A_s	= surface area of sand bed, m ²
$M_{s(t)}$	= mass of dry solids produced per unit of time, kg/month

The following steps outline the design procedure:

1. On a monthly basis, estimate the solids production.
2. Compute the monthly **net** evaporation rate, that is, the pan evaporation rate minus the precipitation, for the location of the sand drying bed. Sources for the pan evaporation rate and precipitation data include the National Weather Service and State Climatology Offices. While precipitation data are widely available, pan evaporation data are sparse. For academic purposes, U.S. Army Corps of Engineers monthly maps of pan evaporation isopleths (Appendix H, EM 1110-2-5027, 1987) have been reproduced in the Chapter 15 folder at www.mhprofessional.com/wwe.
3. Select a loading rate (L) and calculate a drained/decanted depth (D_d) using Equation 15-28 and data from pilot testing or similar treatment facilities. In the absence of pilot testing, the data in Table 15-7 may provide a basis to make an estimate.
4. Calculate the required evaporative drying (ΔD_e) in terms of meters of evaporation using Equation 15-29.
5. Using Equation 15-31, calculate the area required (A_s) for the selected loading rate (L).
6. Using the net evaporation data, determine the number of months, rounded to the next highest integer number, to achieve ΔD_e .
7. On a monthly basis, repeat steps 1 through 7 for an annual cycle.
8. Construct a mass balance accounting table of the area required for drying (A_s) for each month taking into account the number of months required to dry a bed.

The most convenient way to calculate the mass balance is to begin with a month following that which has no “carryover” of solids. Carryover is when more than one month is required for the net evaporation to equal or exceed the required evaporation. In subsequent months, when

more than one month's evaporation is required, there will be a "carryover" bed area. This area is carried forward. In other months, more evaporation is available than is required. This area is "used" to reduce the carryover. The maximum area carried forward is the required bed area.

The calculation process is illustrated in the following example problem.

Example 15-6. For the alum solids production and net evaporation rate shown below, determine the total bed area required.

Month	Solids production, kg/d	Net evaporation, cm/mo
Jan	3,519	2.5
Feb	3,724	4.8
Mar	4,115	8.9
Apr	4,208	11.9
May	2,369	14.7
Jun	1,528	17.5
Jul	1,458	17.8
Aug	2,196	16.5
Sep	1,415	11.4
Oct	1,856	8.9
Nov	1,642	6.6
Dec	2,012	4.6

Based on pilot data in Table 15-7, the following design assumptions were made:

Initial sludge depth = 0.875 m

Initial solids concentration = 1.1%

Drained solids concentration = 7.3%

Desired final solids concentration = 20%

(Note: from the pilot data, an initial sludge depth of 0.875 m implies a loading of 10 kg/m².)

Solution: The spreadsheet solution is shown below. The explanation of the column calculations is given below the table.

- The original solids production and net evaporation data are reproduced in columns 2 and 4. To begin, with the exception of the last two columns, the mass balance was computed starting in January. Then, by observation, a convenient starting point was selected so that the evaporation exceeded ΔD_e and thus resulted in no carryover of solids into the following month. October met this requirement and also was convenient in that it preceded the wet season when increased bed area is anticipated. The table was then rearranged so that it started with October.
- The data in column 3 is the product of column 2 and the number of days in the month. For example, for the first row:

$$(1,871 \text{ kg/d})(31 \text{ d/mo}) = 58,001 \text{ kg/mo}$$

(1)	(2)	(3)	(4)	(5)	(6)	(7)	(8)	(9)	(10)	(11)
Month	Solids production, kg/d	Solids production, kg/mo	Net evaporation, cm/mo	Net evaporation, m/mo	$D(d)$, m	Delta $D(e)$, m	L , kg/m ²	A_s , m ²	Time to dry, mo	Total bed area required, m ²
OCT	1871	58001	8.9	0.089	0.132	0.084	10.00	5,800	1	5800
NOV	1656	49680	6.6	0.066	0.132	0.084	10.00	4,968	2	4968
DEC	2028	62868	4.6	0.046	0.132	0.084	10.00	6,287	3	11255
JAN	3547	109957	2.5	0.025	0.132	0.084	10.00	10,996	3	17283
FEB	3753	105084	4.8	0.048	0.132	0.084	10.00	10,508	2	27791
MAR	4148	128588	8.9	0.089	0.132	0.084	10.00	12,859	1	34333
APR	4241	127230	11.9	0.119	0.132	0.084	10.00	12,723	1	12723
MAY	2388	74028	14.7	0.147	0.132	0.084	10.00	7,403	1	7403
JUN	1540	46200	17.5	0.175	0.132	0.084	10.00	4,620	1	4620
JUL	1470	45570	17.8	0.178	0.132	0.084	10.00	4,557	1	4557
AUG	2214	68634	16.5	0.165	0.132	0.084	10.00	6,863	1	6863
SEP	1427	42810	11.4	0.114	0.132	0.084	10.00	4,281	1	4281
Sum =		918650	kg	1.261	m					

- c. The data in column 5 is a conversion to consistent units, that is, m/mo.
- d. Column 6 is the computation of the drained depth. For example, for the first row, where $D_i = 0.875$ m, $P_{s \text{ initial}} = 0.011$, and $P_{s \text{ drained}} = 0.073$:

$$D_d = (0.875) \left(\frac{0.011}{0.073} \right) = 0.1318 \text{ or } 0.132$$

- e. Column 7 is the computation of ΔD_e , the required depth change to be caused by evaporation. For the first row, where $D_d = 0.132$, $P_{s \text{ drained}} = 0.073$, and $P_{s \text{ final}} = 0.20$:

$$\Delta D_e = 0.132 - \left(\frac{(0.1318)(0.073)}{0.20} \right) = 0.0839 \text{ or } 0.084 \text{ m}$$

- f. Column 8 is the sludge loading based on the note given in the problem statement.
- g. Column 9 is the area required for the sludge. For the first row, with the October sludge production of 58,0001 kg, this is:

$$A_s = \frac{(58,001 \text{ kg})(1 \text{ mo})}{10 \text{ kg/mo} \cdot \text{m}^2} = 5,800 \text{ m}^2$$

- h. The time to dry is computed in column 10. This is best illustrated for the second row (NOV):

Total required evaporation = 0.084 m from column 7. The net evaporation for each month is given in column 5.

November net evaporation = 0.066 m. This is less than 0.084 m so another month of drying is required.

December net evaporation = 0.046 m. The total for NOV and DEC = 0.112 m. This is greater than 0.084 m so the total time to dry is then two months, that is, NOV and DEC.

Although only a fraction of December would be required to complete drying, a conservative estimate of a whole month is used to allow for abnormal weather and time to remove the sludge.

- i. The total bed area is a running accumulation of the required bed area with an assumption that the sludge drying begins the month that it is placed. Another spreadsheet was developed for these computations. It is shown below.

(1)	(2)	(3)	(4)	(5)	(6)	(7)
Month	Bed area required for month	Carry/over m ² NOV	Carry/over m ² DEC	Carry/over m ² JAN	Carry/over m ² FEB	Total bed area required m ²
OCT	5,800					5,800
NOV	4,968					4,968
DEC	6,287	4968				11,255
JAN	10,996		6287			17,283
FEB	10,508		6287	10,996		27,791
MAR	12,859			10,966	10508	34,333
APR	12,723					12,723
MAY	7,403					7,403
JUN	4,620					4,620
JUL	4,557					4,557
AUG	6,863					6,863
SEP	4,281					4,281

The second column is the bed area calculated as A_s in column 9 of the first spreadsheet. The “carryover” columns (3 through 6) indicate the area occupied in subsequent months from the month the sludge was placed. The number of months that carryover on the sludge drying beds was calculated as in step h and is listed in column 9 of the first spreadsheet. For example, sludge placed in NOV requires two months to dry. Therefore, it appears in the month it was placed and in the row for DEC. The total area occupied in the month of DEC is the sum of that placed in DEC and the carryover from NOV.

- j. The maximum total bed area required occurs in MAR. It is 34,333 m² or 35,000 m².

Comments:

1. The total area of the sand drying beds should be divided into cells that allow the operation and maintenance personnel flexibility in loading and unloading.
2. An estimate of the area based on the annual net evaporation may yield very misleading results. This is particularly true if high sludge production occurs when the net evaporation

is low as shown in this example. A typical occurrence is when rains bring high turbidity. Thus, the sludge production goes up while the rains reduce the net evaporation.

3. In climates where there is a season with little or no evaporation, either storage is provided or sufficient beds are provided to store the sludge until evaporative drying can take place. These climates may be cold enough to take advantage of additional dewatering by freezing and thawing of the sludge.
-

Freeze Treatment. Dewatering sludge by either of the nonmechanical methods may be enhanced by physical conditioning of the sludge through alternate natural freezing and thawing cycles. The freeze-thaw process dehydrates the sludge particles by freezing the water that is closely associated with the particles. The dewatering process takes place in two stages. The first stage reduces sludge volume by selectively freezing the water molecules. Next, the solids are dehydrated when they become frozen. When thawed, the solid mass forms granular-shaped particles. This coarse material readily settles and retains its new size and shape. This residue sludge dewateres rapidly and makes suitable landfill material.

The supernatant liquid from this process can be decanted, leaving the solids to dewater by natural drainage and evaporation. Pilot-scale systems can be utilized to evaluate this method's effectiveness and to establish design parameters. Elimination of rain and snow from the dewatering system by the provision of a roof will enhance the process considerably.

The potential advantages of a freeze-thaw system are

1. Insensitivity to variations in sludge quality.
2. No conditioning required.
3. Minimum operator attention.
4. Natural process in cold climates (winter).
5. Solids cake more acceptable at landfills.
6. Sludge easily worked with conventional equipment.

Several natural freeze-thaw installations are located in New York state. At the alum coagulation plant of the Metropolitan Water Board of Oswego County, SFBW is discharged to lagoons that act as decant basins. Thickened sludge is pumped from the lagoons to special freeze-thaw basins in layers about 450 mm thick. The sludge has never been deeper than 300 mm during freezing because of additional water losses. The 300 mm sludge layer reduces to about 75 mm of dried material after freeze-thaw (Davis and Cornwell, 2008).

Solar Drying Beds. These beds are similar in construction and operation to conventional sand drying beds. They differ in that they are constructed with sealed bottoms. Thus, there is no provision for water to be removed through drainage. Because they rely primarily on evaporation, they typically have lower solids loading rates and filling depths of liquid sludge are less. These beds are cheaper to build and operate than conventional sand drying beds because there is no cost for underdrains and cleaning with front-end loaders is quicker without incurring sand loss. Most solar beds are located in the southern and southwestern parts of the United States where evaporation rates are high (Cornwell, 1999).

Mechanical Dewatering

Centrifuging. A centrifuge uses centrifugal force to speed up the separation of sludge particles from the liquid. In a typical unit (Figure 15-8), sludge is pumped into a horizontal, cylindrical bowl, rotating at 800 to 2,000 rpm. This results in an applied force of 1,500 to 4,000 times the force of the acceleration due to gravity. Polymers used for sludge conditioning also are injected directly into the centrifuge. The solids are spun to the outside of the bowl where they are scraped out by a screw conveyor. The liquid, or *centrate*, is returned to the treatment plant. Two types of centrifuges are currently used for sludge dewatering: the solid bowl and the basket bowl. For dewatering water treatment plant sludges, the solid-bowl scroll centrifuge has proven to be more successful than the basket bowl.

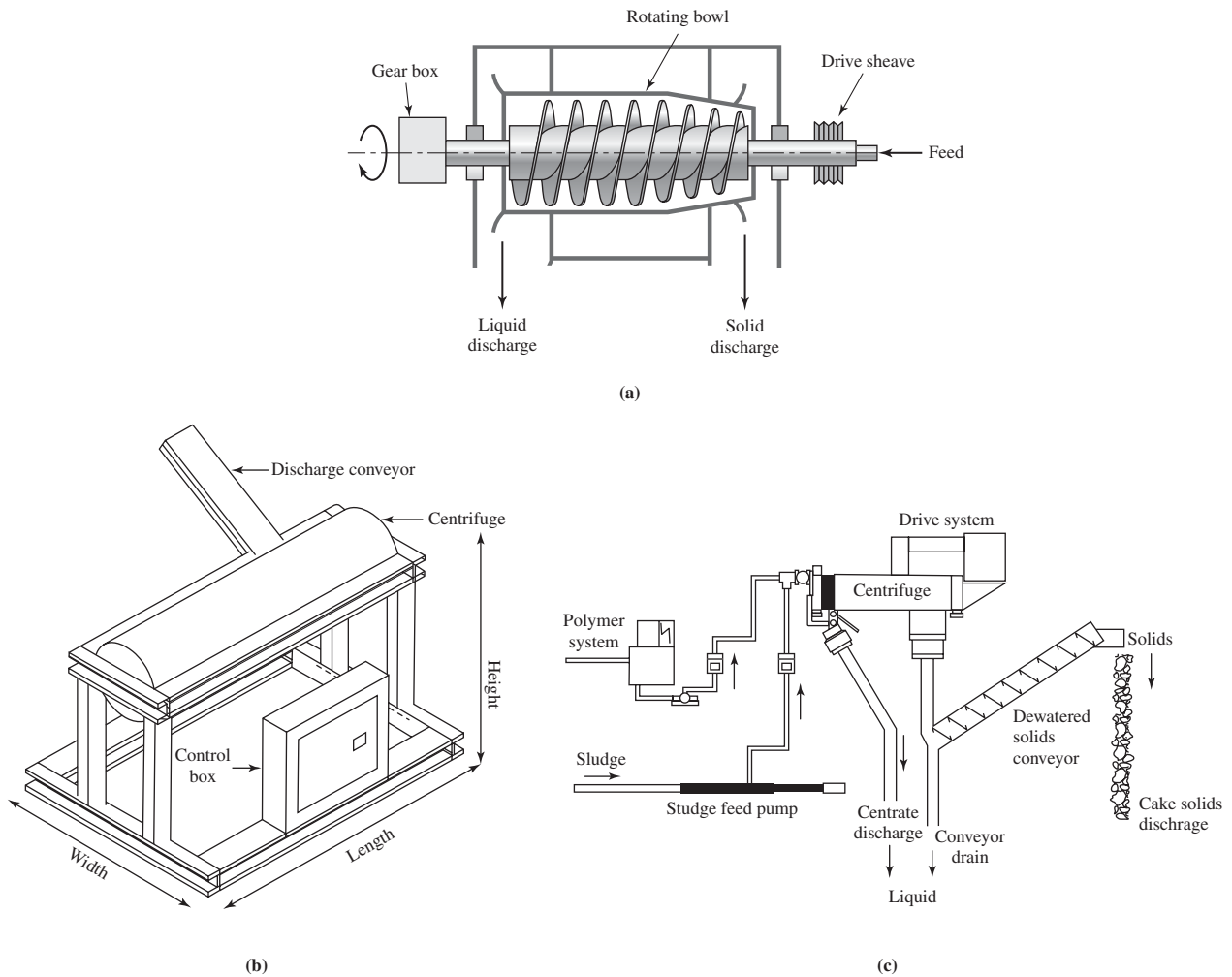

FIGURE 15-8 Solid bowl centrifuge. (a) Schematic, (b) isometric, (c) process layout. (Schematic Courtesy Bird Machine Company.)

TABLE 15-8
Typical selection of centrifuges

Model	Flow rate, ^a m ³ /h	Bowl diameter, cm	Length, m	Width, m	Height, m	Weight, kg
25	4.5	25	2.1	1.1	0.8	1,300
30	9	30	2.4	1.1	0.9	1,500
35	18	35	2.8	1.4	1.0	2,500
45	30	45	3.2	1.5	1.0	3,500
55	60	55	3.7	1.6	1.1	4,500
65	70	65	4.4	2.0	1.2	7,500
75	110	75	5.9	2.7	1.3	13,000

^aMaximum solids concentration = 4%

Note: These centrifuges are representative but do not represent actual choices. Actual manufacturers' data must be used for real world design.

Centrifuges are very sensitive to changes in the concentration or composition of the sludge, as well as to the amount of polymer applied. Thus, the best way to evaluate centrifugation is by using pilot tests. Cornwell (2006) provides a detailed procedure for scaling up pilot results to full scale. The best indicators of performance are the cake solids concentration and the centrate suspended solids concentration.

For new plants without production sludge to test, similar facilities treating similar water are the only option in evaluating this alternative for sludge dewatering.

Centrifuge Selection Considerations. Centrifuges can handle sludge solids concentrations up to about 4 percent. Centrifuges are often located on upper floors of the sludge building so that the cake may be discharged into trucks or hoppers below. Because of the mass and vibration of the centrifuge, special attention should be given to the structural requirements to handle the load and vibration in evaluating the cost of this option.

The best performance data for centrifuges have been obtained at 75 to 80 percent of the manufacturer's hydraulic or solids capacity. A typical selection of centrifuges is shown in Table 15-8.

Example 15-7. Select a centrifuge to dewater a coagulation sludge that has been thickened to 2.5%. The initial sludge flow rate is estimated to be 128.4 m³/d, and the design sludge flow rate is 171.2 m³/d. The plant managers wish to operate on a two-shift basis, that is, 16 h/d to minimize labor costs. Using Table 15-8, select an appropriate centrifuge system.

Solution:

- a. Calculate the hourly sludge flow rate for a 16-hour operation at the initial and design sludge flow rates.

$$Q_{\text{sludge initial}} = \frac{128.4 \text{ m}^3/\text{d}}{16 \text{ h/d}} = 8.025 \text{ or } 8 \text{ m}^3/\text{h}$$

$$Q_{\text{sludge design}} = \frac{171.2 \text{ m}^3/\text{d}}{16 \text{ h/d}} = 10.7 \text{ or } 11 \text{ m}^3/\text{h}$$

- b. From Table 15-8, the Model 30 centrifuge rated at $9 \text{ m}^3/\text{h}$ appears to be satisfactory for the initial sludge flow rate, but not the the design flow rate. Using the 75 to 80% rule of thumb as a safety factor,

$$(0.75)(9 \text{ m}^3/\text{h}) = 6.75 \text{ m}^3/\text{h}$$

would provide the best performance for this centrifuge. This is not satisfactory.

- c. An alternate design that would also provide redundancy would be to provide two centrifuges rated at $9 \text{ m}^3/\text{h}$. This scheme would allow for an operational time of

$$\frac{128.4 \text{ m}^3/\text{d}}{(2 \text{ centrifuges})(6.75 \text{ m}^3/\text{h})} = 9.511 \text{ or } 9.5 \text{ h/d}$$

The capacity of the two centrifuges at the design sludge flow rate would allow for operation

$$\frac{171.2 \text{ m}^3/\text{d}}{(2 \text{ centrifuges})(6.75 \text{ m}^3/\text{h})} = 12.68 \text{ or } 13 \text{ h/d}$$

- d. Another scheme would be to provide one centrifuge rated at $18 \text{ m}^3/\text{h}$. While this scheme would provide the same operating hours as the two centrifuge option, it would not provide any redundancy.

Comments:

1. Among the many other alternatives to be considered are redesign of the thickener to yield a higher solids loading at a lower flow rate, or other manufacturers' products with a different selection of sizes.
2. For the two centrifuge option, the initial operating schedule should alternate the centrifuges' use to both extend their life and make use of the manufacturer's warranty.
3. As may be noted, at the design life, there is no redundant centrifuge. Either sludge storage or the provision of space for the addition of another centrifuge when the capacity of the two centrifuges does not allow for redundant operation are options that might be considered.

Vacuum Filtration. A vacuum filter consists of a cylindrical drum covered with a filtering material or fabric, which rotates partially submerged in a vat of conditioned sludge. A vacuum is applied inside the drum to extract water, leaving the solids, or *filter cake*, on the filter medium. In practice, a differential pressure of about 70 kPa is applied. As the drum completes its rotational cycles, a blade scrapes the filter cake from the filter and the cycle begins again. Two basic types

of rotary drum vacuum filters are used in water treatment: the *traveling medium* and the *precoat medium* filters. The traveling medium filter is made of fabric or stainless steel coils. This filter is continuously removed from the drum, allowing it to be washed from both sides without diluting the sludge in the sludge vat. The precoat medium filter is coated with 50 to 75 mm of inert material, which is shaved off in 0.1 mm increments as the drum moves.

Vacuum filters are not recommended for coagulation sludges.

Continuous Belt Filter Press (CBFP). The belt filter press operates on the principle that bending a sludge cake contained between two filter belts around a roll introduces shear and compressive forces in the cake, allowing water to work its way to the surface and out of the cake, thereby reducing the cake moisture content. The device employs double moving belts to continuously dewater sludges through one or more stages of dewatering (Figure 15-9). Typically the CBFP includes the following stages of treatment:

1. A reactor/conditioner to remove free-draining water.
2. A low pressure zone of belts with the top belt being solid and the bottom belt being a sieve; here further water removal occurs, and a sludge mat having significant dimensional stability is formed.
3. A high pressure zone of belts with a serpentine or sinusoidal configuration to add shear to the pressure dewatering mechanisms.

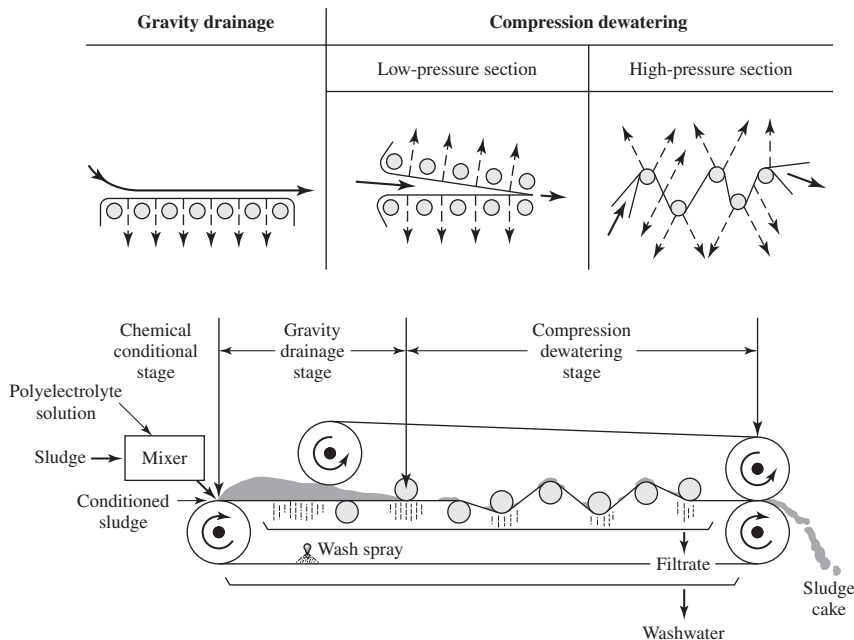

FIGURE 15-9
Continuous belt filter press.

(Source: U.S. EPA, 1979.)

The design and selection of a belt filter press is often based on the “throughput” of the press. *Throughput* is the rate at which residuals can be dewatered. The throughput can be either hydraulically or solids limited. A belt press having a particular type and width of belt has a maximum loading capacity for a given type of residual. The solids loading is considered the most critical factor, and throughput is expressed in terms of solids loading: kg/meter of belt width per hour. For coagulant sludges the typical loading rate is about 150 kg/m · h, but sludges thickened to 4 percent may be loaded at a rate of 400 to 570 kg/m · h (Cornwell, 2006). Lime sludges up to 30 percent solids have been dewatered to 60 percent solids (MWH, 2005). Typical belt widths are 1.0, 1.5, 2.0, and 3.0 m.

Discharge from the press may be directly to a truck. Other options include conveyors and hoppers or roll-off boxes.

The belt press has a relatively low energy requirement compared to other mechanical dewatering devices. To achieve acceptable solids concentrations, the sludge fed to the CBFP must be conditioned. Polymers are often used for conditioning. In addition, belt wash water must be provided. This wash water represents another disposal issue as it will be high in suspended solids.

Plate and Frame Filter Press. The basic component of a filter press is a series of recessed vertical plates. Each plate is covered with cloth to support and contain the sludge cake. The plates are mounted in a frame consisting of two head supports connected by two horizontal parallel bars. Conditioned sludge is pumped into the pressure filter and passes through feed holes in the filter plates along the length of the filter and into the recessed chambers. As the sludge cake forms and builds up in the chamber, the pressure gradually increases to a point where further sludge injection would be counterproductive. At this time the injection ceases. A variation of the standard plate and frame filter press is the diaphragm filter press. The construction is similar to the standard recessed chamber, but the drainage surfaces on the face of the plates are flexible membranes or diaphragms. After the filtration cycle is completed and the recessed chambers are filled with solids, and before the press is opened, air or water pressure is applied behind the diaphragms causing them to flex outward to exert additional pressure on the filter cake. This squeezes the cake and further reduces any remaining moisture.

The diaphragm filter press yields a higher cake solids and has a shorter cycle time than the standard plate and frame press. Although the filter press may be highly automated, the operation will require significant operator attention. Current models are provided with “cake breakers” to dislodge the cake from the press. These may need operator attention to ensure that the cake is completely dislodged. The operation and schematic cross sections are illustrated in Figure 15-10.

A typical pressure filtration cycle begins with the closing of the press to the position shown on Figure 15-10a. Sludge is fed for a 20- to 30-minute period until the press is effectively full of cake. The pressure at this point is generally the designed maximum (700 to 1,700 kPa) and is maintained for one to four hours, during which more filtrate is removed and the desired cake solids content is achieved. The filter is then mechanically opened, and the dewatered cake is dropped from the chambers onto a conveyor belt or hopper for removal. Cake breakers are usually required to break up the rigid cake into conveyable form. Because plate pressure filters operate at high pressures and because many units use lime for conditioning, the cloths require routine washing with high-pressure water, as well as periodic washing with acid.

While filter presses work well for lime sludges, they require large quantities of conditioning agents, including lime and fly ash, to produce a dry cake from coagulation sludges. In either case, thickening before filtration is typical.

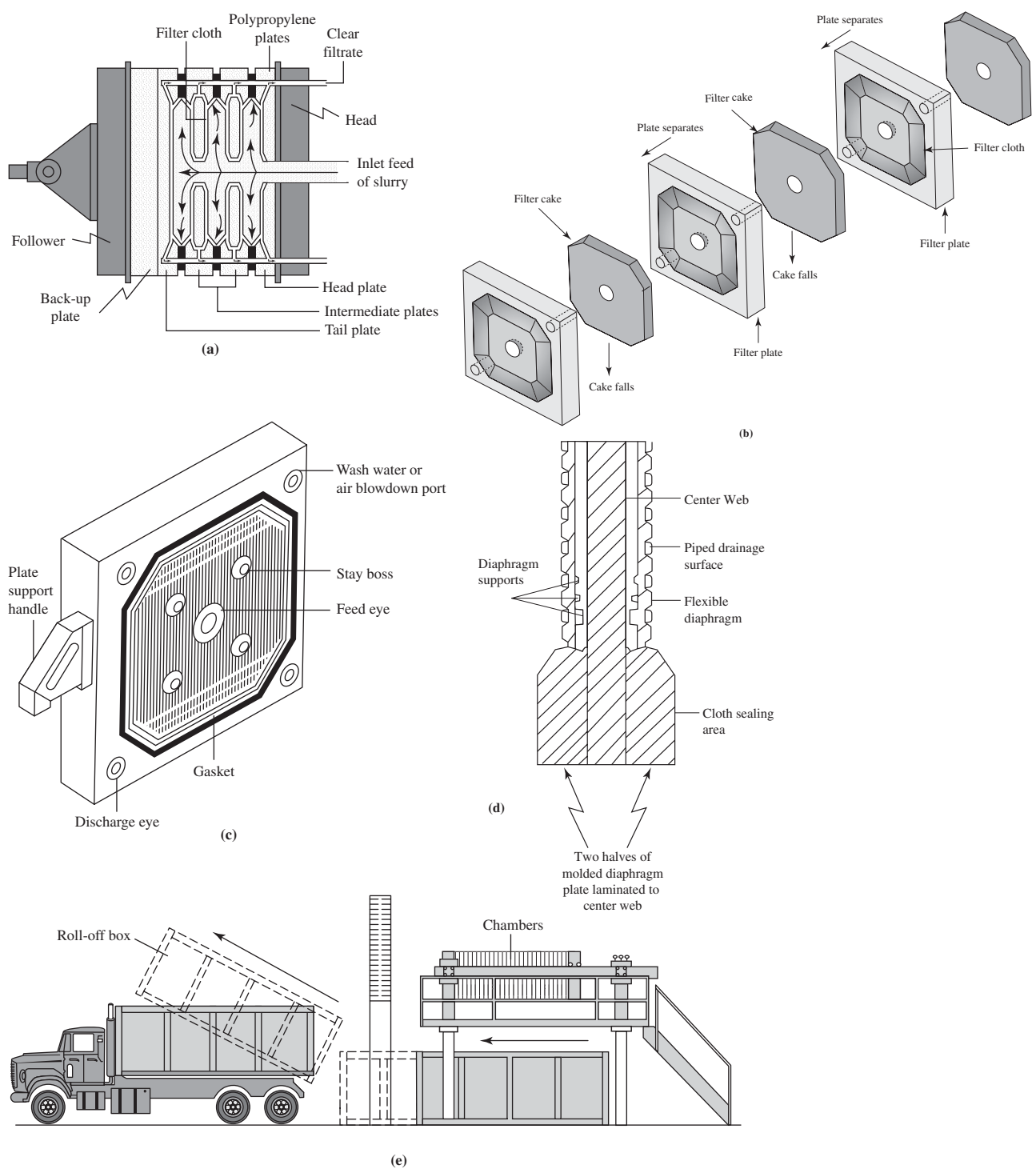

FIGURE 15-10 Plate and frame filter press. (a) Filling the press, (b) cake breaking, (c) plate details for recessed plate, (d) diaphragm plate details, (e) plate and frame solids off-loading system.

Alum sludges are conditioned using lime and/or fly ash. Lime dosage is typically in the range of 10 to 15 percent of the sludge solids. Fly ash is applied at dosage of about 100 percent of the sludge solids. Polymers are dosed in the range of 1 to 2 g/kg. While cake solids may be between 45 and 50 percent dry solids, as much as 30 percent of the dry solids may be conditioning chemicals and/or fly ash. To reduce the volume of sludge, only polymer may be used for conditioning. This is an economic issue as well as an operational issue. The cost of polymer, which is very expensive, must be weighed against the cost of disposing of a larger volume of solids.

Example 15-8 illustrates the method for selecting an appropriate size filter press from manufacturer's data like that shown in Table 15-9.

TABLE 15-9
Typical filter press manufacturer's data

Press size	Volume, L	No. of chambers	Length, m
<i>H</i> = 3.5 m			
<i>W</i> = 2.7 m			
	3,500	64	7.7
	4,300	77	8.7
	5,000	90	9.5
	5,700	103	10.4
	6,400	115	11.2
	7,100	128	12.1
	7,800	141	13.0
<i>H</i> = 4.2 m			
<i>W</i> = 2.7 m			
	5,700	74	8.4
	6,500	84	9.1
	7,000	91	9.6
	7,700	100	10.2
	8,500	110	10.9
	9,300	120	11.6
	10,000	130	12.2
<i>H</i> = 3.9 m			
<i>W</i> = 3.9 m			
	8,500	89	9.5
	9,600	100	10.2
	10,600	110	10.9
	11,500	120	11.6
	12,500	130	12.2
	13,400	140	12.9
	14,400	150	133.6

Note: These presses are representative but do not represent actual choices. Actual manufacturer's data must be used for real world design.

Example 15-8. A lime softening water treatment plant with a design capacity of 30,000 m³/d is being designed. A filter press has been selected as the method of dewatering the sludge for landfilling. The calculated removals of hardness and the design characteristics of the sludge are given below. Based on experience, a cycle time of four hours is anticipated. This includes filling, pressing, and discharging the sludge. From Table 15-9 select an appropriate press.

$$\text{CaCH} = 198 \text{ mg/L as CaCO}_3$$

$$\text{MgCH} = 15 \text{ mg/L as CaCO}_3$$

$$\text{CaNCH} = 0.0 \text{ mg/L as CaCO}_3$$

$$\text{MgNCH} = 55 \text{ mg/L as CaCO}_3$$

$$\text{CO}_2 = 18 \text{ mg/L as CaCO}_3$$

$$\text{Specific gravity of sludge} = 1.1$$

$$\text{Specific gravity of dewatered sludge} = 1.176$$

$$\text{Percent solids delivered to the filter press} = 10\%$$

$$\text{Dewatered solids} = 25\%$$

Solution:

- a. Begin by estimating the daily dry solids sludge production using Equation 15-17. The flow rate in appropriate units is

$$Q = \frac{30,000 \text{ m}^3/\text{d}}{86,400 \text{ s/d}} = 0.3472 \text{ m}^3/\text{s}$$

Using Equation 15-17, the estimated mass of dry solids is

$$M_s = 86.4(0.3472 \text{ m}^3/\text{s})[2(198 \text{ mg/L}) + 2.6(15 \text{ mg/L}) + 0.0 + 1.6(55 \text{ mg/L}) + 18 \text{ mg/L}] = 16,229 \text{ kg/d}$$

- b. Estimate the volume of sludge using Equation 15-9.

$$V_{sl} = \frac{16,229 \text{ kg/d}}{(1,000 \text{ kg/m}^3)(1.1)(0.10)} = 147.5 \text{ m}^3/\text{d} \text{ or } 147,500 \text{ L/d}$$

- c. The volume of the filter press in liters is estimated using Equation 15-11.

$$V_{\text{dewatered}} = \frac{(147,500 \text{ L/d})(0.10)(1,000 \text{ g/L})(1.1)}{(1.176)(1,000 \text{ g/L})(0.25)} = 55,187 \text{ or } 55,200 \text{ L/d}$$

- d. At four hours per cycle, the volume of the press must be

$$\frac{(55,200 \text{ L/d})(4 \text{ h/cycle})}{24 \text{ h/d}} = 9,200 \text{ L/cycle}$$

- e. From Table 15-9 two models will work:

$$H = 4.2 \text{ m and } W = 2.7 \text{ m with 120 plates has a capacity of 9,300 L}$$

$$H = 3.9 \text{ m and } W = 3.9 \text{ m with 100 plates has a capacity of 9,600 L}$$

Comments:

1. Of the two possible choices, the larger press ($H = 3.9$ m and $W = 3.9$ m) has the advantage of using fewer plates. Fewer plates means a smaller number of things that can go wrong. The shorter length will also result in a better distribution of solids. Because the frame for the larger plates can be expanded to 150 plates, this press also offers the possibility of expansion by adding plates.
2. Not addressed here is redundancy and staff management, which are issues that also must be considered.

15-8 MANAGEMENT OF LIQUID RESIDUALS

Conventional methods of disposal of liquid residuals from ion exchange and membrane processes include discharge to surface water bodies, dilution and spray irrigation, deep well injection, drain fields, and discharge to municipal sewers. Table 15-10 summarizes the regulatory and other environmental requirements with these disposal methods. Decision trees for selection of a management alternative for MF/UF and NF/RO residuals are shown in Figures 15-11 and 15-12 on pages 15-45 and 15-46.

TABLE 15-10
Concerns and requirements associated with conventional disposal methods

Disposal method	Regulatory concerns	Other requirements
Disposal to surface water	Receiving stream limitations Radionuclides Odors (hydrogen sulfide) Low dissolved oxygen levels Sulfide toxicity Low pH	Mixing zone Possible pretreatment Multiple-port diffusers Modeling of receiving stream
Deep well injection	Confining layer Upconing to drinking water wells Injection well integrity Corrosivity	Well liner Monitoring well Periodic integrity test Water quality of concentrate must be compatible with the water quality in the injection zone
Spray irrigation	Groundwater protection	Monitoring wells Possible pretreatment Backup disposal method Need for irrigation water Availability of blend waters
Drainfield or borehole	Groundwater protection	Monitoring wells Proper soil conditions and/or rock permeability
Sanitary sewer collection systems	Effect on local wastewater treatment plant performance (toxicity to biomass or inhibited settleability in clarifiers)	None

Source: AWWA, 1996.

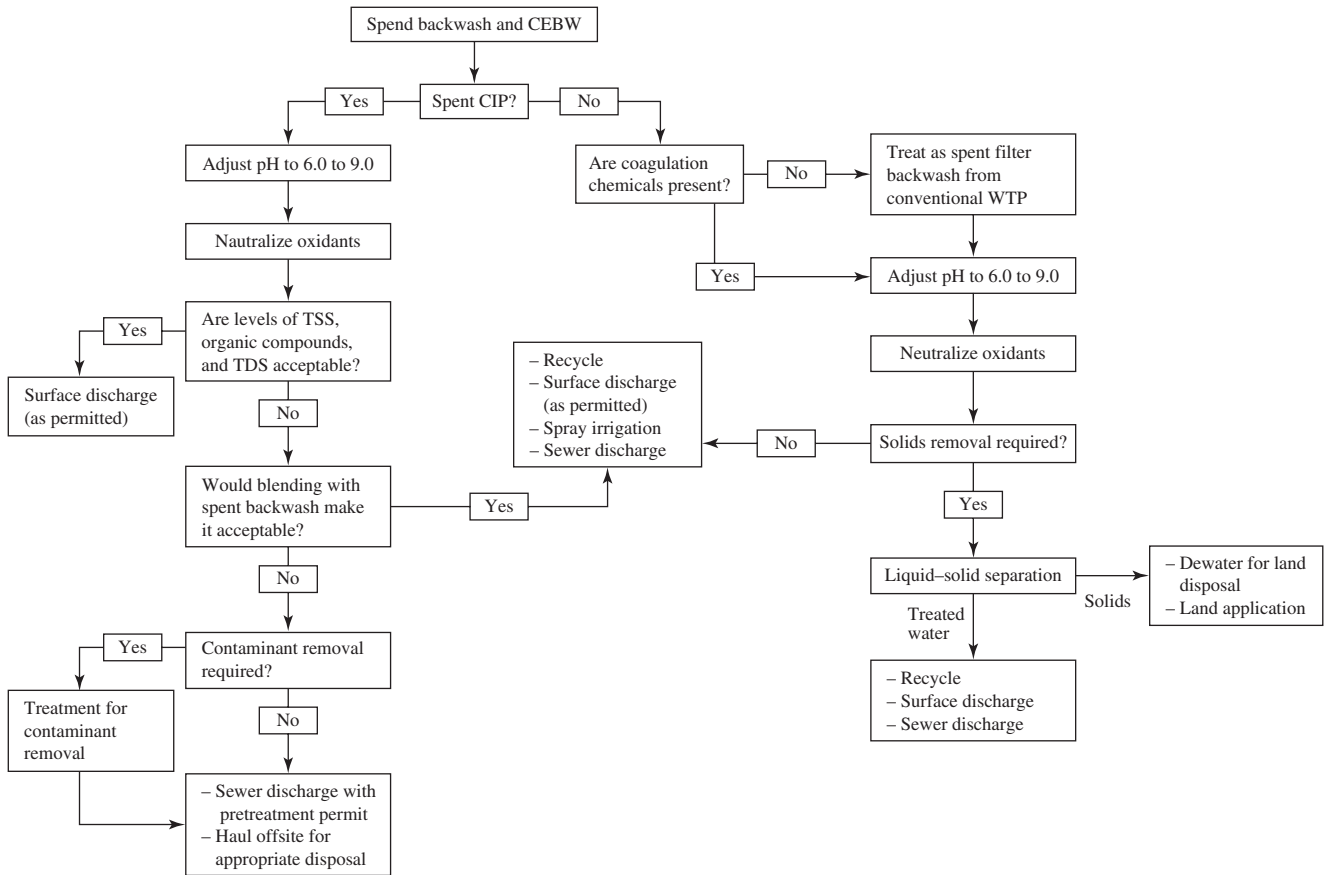

FIGURE 15-11

Decision tree for MF/UF residuals. (CIP—clean in place chemicals, CEBW—chemically enhanced backwash, TSS—total suspended solids, TDS—total dissolved solids.)

15-9 DISPOSAL OF SPECIFIC RESIDUAL CONSTITUENTS

Arsenic Residuals

Unless the arsenic concentration is less than 5.0 mg/L, regenerant from ion exchange, activated alumina and modified iron removal (MIR) plants, as well as reject from reverse osmosis will exceed the toxicity characteristic and must be disposed of as a hazardous waste at an approved hazardous waste treatment facility. Iron-based sorbents and sludges from iron and aluminum coagulation as well as enhanced lime softening must be tested using the toxicity characteristic leaching procedure (TCLP) or, in the case of California, the waste extraction test (WET) to determine if they are classified as a hazardous waste. Testing of sludges has resulted in the conclusion that sludges do not qualify as a hazardous waste because the TCLP levels are under 5.0 mg/L (Cornwell et al., 2003). However, these sludges may not pass the WET, so individual evaluation is warranted.

The potential regulatory requirements are shown in Figure 15-13. A decision tree for handling and disposal of arsenic residuals is shown in Figure 15-14 on page 15-47.

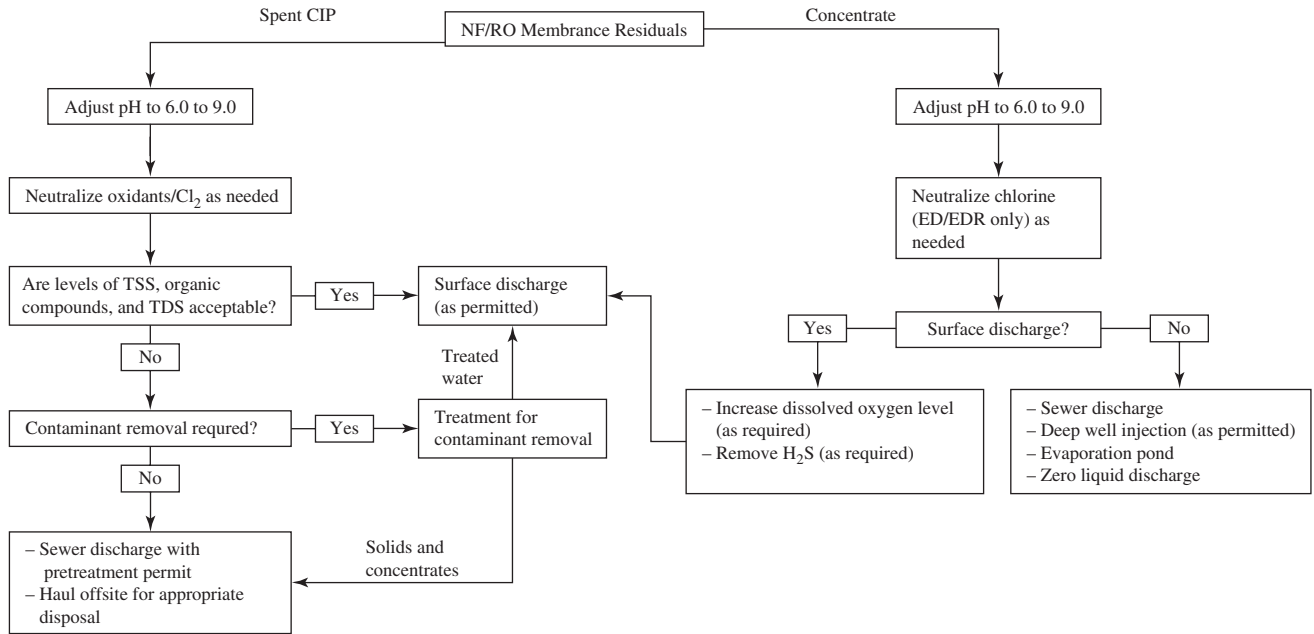

FIGURE 15-12 Decision tree for NF/RO membrane residuals management. (CIP—clean in place chemicals, TSS—total suspended solids, TDS—total dissolved solids.)

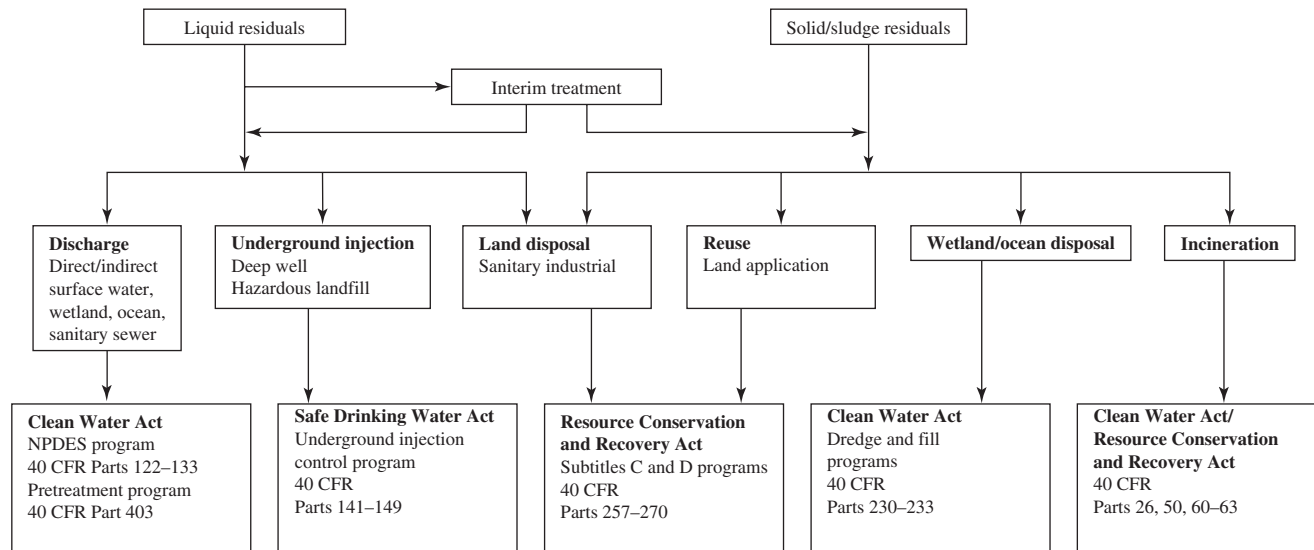
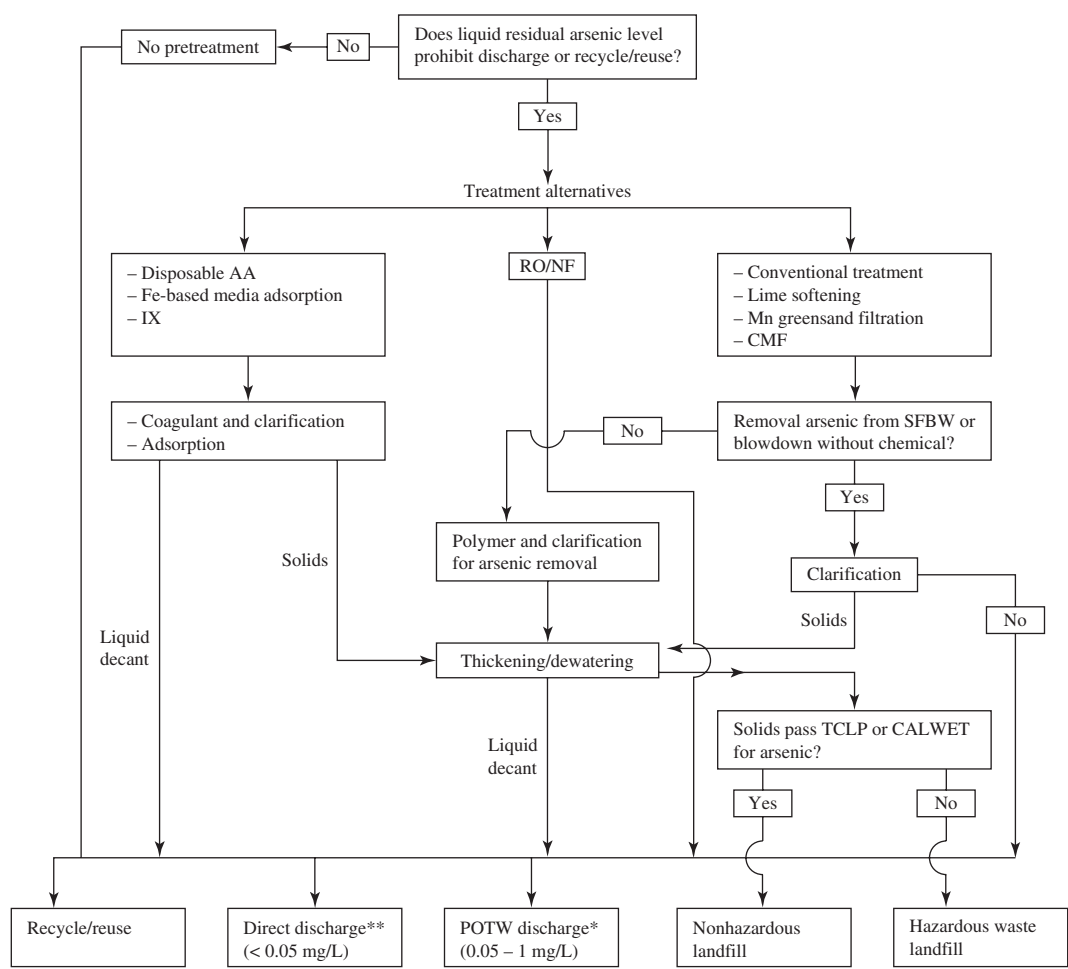

FIGURE 15-13 Arsenic residuals disposal—federal regulations. (Adapted from U.S. EPA, 2000.)



Notes: Spent media disposed of in nonhazardous waste landfill. AA and Iron-based media adsorption backwash waters are expected to meet POTW direct discharge or recycle arsenic criteria.

*Depends on backwash analysis
**Depends on state regulations

AA—Activated Alumina
CALWET—California Waste Extraction Test
CMF—Coagulation Microfiltration
IX—Ion Exchange
TCLP—Toxicity Characteristic Leaching Procedure
POTW—Publicly Owned Treatment Works

FIGURE 15-14
Arsenic residuals handling and disposal decision tree.

Fluoride Residuals

The liquid streams from activated alumina (AA) regeneration or reverse osmosis (RO) treatment to remove fluoride may be disposed of in the same manner as other AA and RO residuals summarized in Figures 15-12 and 15-13.

Iron and Manganese Residuals

Waste filter wash water can be disposed of by dewatering the solids on sand drying beds and landfilling the solids. GLUMRB recommends that the sand be 30 cm deep with an effective size of 0.3 to 0.5 mm and a uniformity coefficient of less than 3.5. The sand should have a supporting layer consisting of 10 cm of torpedo sand and 20 cm of gravel. The area of the sand drying bed should be sufficient to allow the entire volume of wash water for one day to be placed at a depth of less than 0.60 m, unless production filters are washed on a rotating schedule (GLUMRB, 2003). The sand drying beds need to be located at some distance from drinking water wells so they do not become “under the influence of a surface water source.”

Nitrate Residuals

The liquid streams from ion exchange treatment to remove nitrate may be disposed of in the same manner as other ion exchange residuals summarized in Table 15-10. See “Perchlorate Residuals” for a recycling option.

Perchlorate Residuals

The destruction of perchlorate and nitrate in regenerant brines can be accomplished by either microbial or chemical processes. Destruction by chemical means generally requires high temperature (50°C–60°C) and pressure. If polystyrene or polyvinylpyridine resin is used, the heated brine can be used directly in regeneration of the resin. Although large amounts of NaCl are required to strip perchlorate from the exhausted resin, because of the relatively small fraction of sites occupied by perchlorate, only a small fraction of the chloride applied is actually used to replace perchlorate. By destroying the perchlorate and nitrate in the spent brine, the available chloride salt can be recycled for many regeneration cycles (Tripp and Clifford, 2006).

Radioactive Residuals

Although other radioisotopes are of concern, radium is the radionuclide of primary concern. The U.S. Environmental Protection Agency suggested alternatives for disposal of water treatment plant liquid and solid wastes are illustrated in Figures 15-15 and 15-16 on pages 15-49 and 15-50.

Synthetic Organic Chemical (SOC) Residuals

Granular activated carbon (GAC) that becomes saturated is usually regenerated. Thermal regeneration destroys the SOC. Regeneration may be on-site for large facilities or off-site for smaller plants.

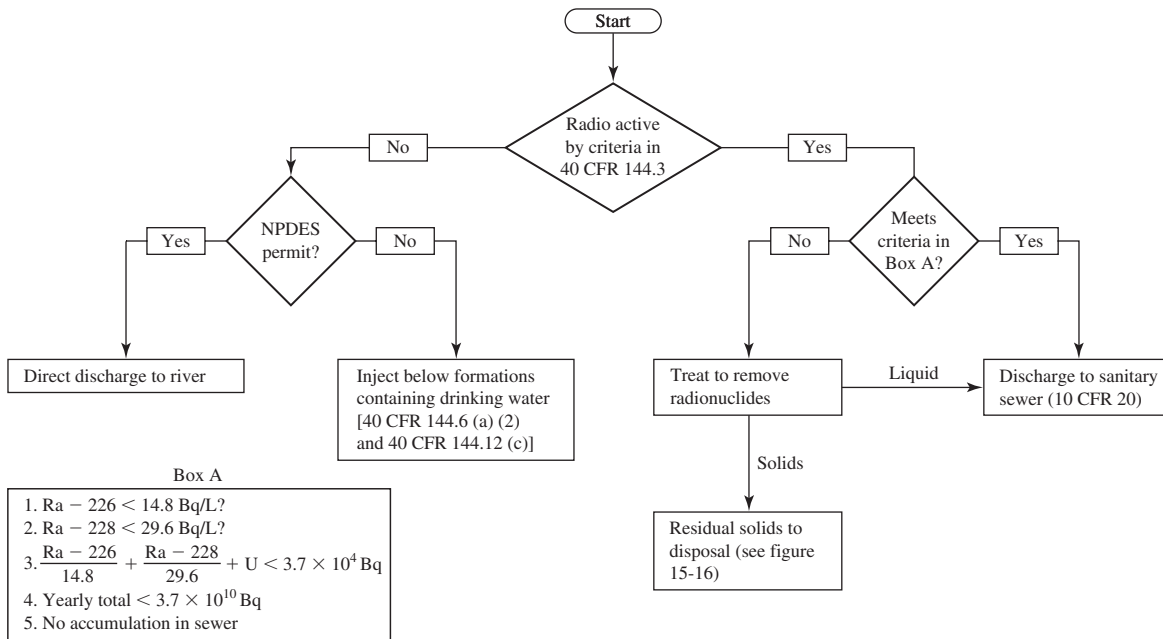
**FIGURE 15-15**

U.S. EPA suggested disposal alternatives for water treatment plant liquid wastes containing natural radioactivity. (NPDES = National Pollution Discharge Elimination System)

15-10 ULTIMATE DISPOSAL

After all possible sludge treatment has been accomplished, a residual sludge remains, which must be sent to ultimate disposal or used in a beneficial manner. Of the many theoretical alternatives for ultimate disposal, only four are of practical interest:

- Land spreading.
- Other beneficial use.
- Codisposal with sewage sludge.
- Landfilling.

Land Spreading

Land application of water treatment plant residuals is regulated in the United States under the Resource Conservation and Recovery Act (RCRA) as well as state and local agencies. RCRA rules require that the residuals pass the TCLP test.

Residuals that have been land applied include coagulant sludges, lime softening sludges, nanofiltration concentrate, and slow sand filter washings (Novak, 1993). Depending on local soil conditions, application of lime sludges may have beneficial effects on the soil and crop yields. This is especially true when nitrogen fertilizers are used because they typically lower the soil pH,

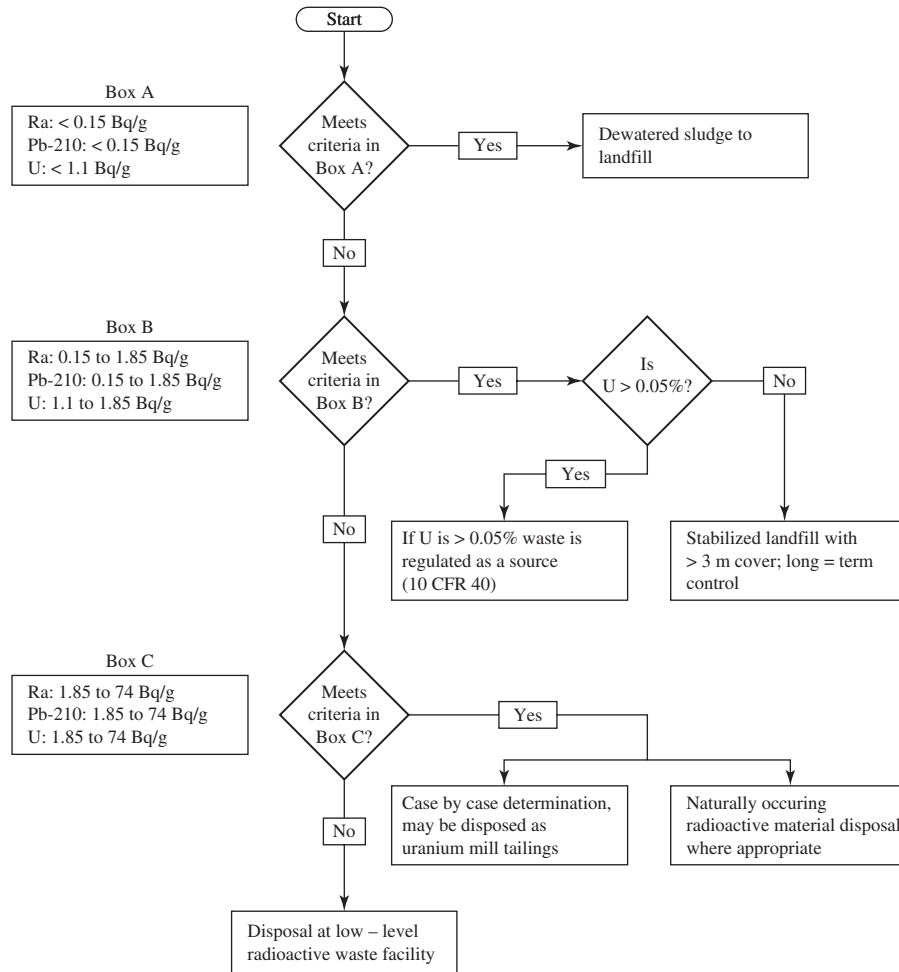

FIGURE 15-16 U.S. EPA suggested disposal alternatives for water treatment plant solid wastes containing natural radioactivity.

which results in a decrease in calcium availability. The addition of lime sludge raises the soil pH to a level comparable to commercially available agricultural limestone. In contrast, the addition of aluminum or iron coagulant sludge may have a negative impact by reducing the availability of phosphorus and increasing compaction. Iron application to grazing land may result in a negative effect on copper metabolism in sheep (Marshall, 2002).

Other Beneficial Uses

Turf grass has a relatively low nutrient demand, but requires significant moisture levels. Dewatered sludge applied to a turf farm at the beginning of the seeding process can improve water retention (Cornwell, 1999).

Commercial producers of topsoil use a raw soil blended with some organic material to form their product. Sludge can be blended during the production process to increase nutrient value and water retention. The quality of the sludge must meet metal limits of the topsoil producer (Vandermeijden and Cornwell, 1993).

Many other beneficial uses such as cement manufacturing, brick manufacturing, road sub-grade, landfill cover, and flue gas desulfurization are discussed in *Water Treatment Residuals Engineering* (Cornwell, 2006).

Codisposal with Sewage Sludge

Water treatment plant sludge can be mixed with biosolids from wastewater treatment prior to disposal. For a utility that operates both the water and wastewater facilities, this option allows permitting and monitoring for “one” solid waste. In addition, the water plant residuals will often lower the metal concentrations in the biosolids product because the water treatment residuals dilute the residuals from the wastewater treatment plant.

Landfilling

When the beneficial options cannot be exercised, landfilling becomes the alternative of choice. The landfill can be either a monofill, with only the water treatment residuals, or it can be co-disposed with municipal solid waste.

The design of a monofill is more appropriately covered in other texts such as *Water Treatment Residuals Engineering* (Cornwell, 2006). However, it should be noted that a major requirement is that the sludge be capable of supporting excavating equipment that will be working at the landfill site.

Codisposal with municipal solid waste is generally limited by the permit limits of the landfill site, and the requirement that the sludge pass the TCLP test so that it is not considered to be a hazardous waste. Typically, there is also a requirement that the sludge release no free water during transport and placement. A typical requirement is 30 percent solids (Cornwell, 2006).

Visit the text website at www.mhprofessional.com/wwe for supplementary materials and a gallery of photos.

15-11 CHAPTER REVIEW

When you have completed studying this chapter, you should be able to do the following without the aid of your textbook or notes:

1. Outline the logical steps in implementing a residual management program.
2. On a process flow diagram, label the sources of residuals.
3. Explain the difference between coagulation sludges and lime softening sludges with respect to their specific gravity and solids concentration.
4. State one method of minimization of residuals generation for each of the following: coagulation, lime-soda softening, and spent backwash water.

5. Given the characteristics of a sludge, select the appropriate thickening process.
6. Explain the climatic factors that favor lagoons and sand drying beds for dewatering sludges.
7. Given the characteristics of a sludge, select an appropriate mechanical dewatering process.
8. Identify three alternatives for management of liquid residuals.
9. Explain the major regulatory limitation on the disposal of arsenic residuals.
10. Compare the four generic categories of ultimate disposal of water treatment plant residuals with respect to constraints, ease of implementation, and sustainability.

With the aid of this text, you should be able to do the following:

11. Calculate the specific gravity of sludge given the specific gravity of the solids and the fraction that is solids.
12. Calculate the volume of sludge given the mass of solids, specific gravity of the solids, and the percent solids or the mass of solids given the specific gravity and percent solids.
13. Estimate the volume of dewatered sludge by either the approximate or rigorous method.
14. Estimate the mass of dry solids produced by either coagulation or lime softening.
15. Compute a mass balance for solids for a sedimentation basin.
16. Design a gravity thickening tank using the batch flux method given the appropriate batch settling data.
17. Design a dewatering lagoon given the general climate scenario, that is, wet or dry.
18. Design a sand drying bed given the appropriate precipitation, pan evaporation, and pilot data or similar data.
19. Select a centrifuge using manufacturers' data and anticipated operating conditions.
20. Select a plate filter press using manufacturers' data and anticipated operating conditions.
21. Select a liquid residuals management technique given the appropriate data.
22. Select an arsenic residuals management technique given the appropriate data.
23. Select a radium residuals management technique given the appropriate data.

15-12 PROBLEMS

- 15-1. Estimate the specific gravity of a lime softening sludge with a solids specific gravity of 1.9 and a solids concentration of 10%.
- 15-2. If the sludge in Problem 15-1 is dewatered to achieve 35% solids, what is the specific gravity of the filter cake?
- 15-3. If the volume of 1.0% sludge is 151.4 m^3 , what is the mass of dry solids? Assume the specific gravity of the sludge is 1.0.

- 15-4.** If the mass of dry solids in 171.2 m^3 of a sludge is 4,280 kg, what is the percent solids? Assume the specific gravity of the sludge is 1.0.
- 15-5.** What mass of water must be removed from the sludge in Problem 15-4 to achieve 25% solids?
- 15-6.** Dr. Cornwell derived Equation 15-16 based on the stoichiometric chemistry of iron. Using Equation 6-10, show how Dr. Cornwell arrived at the coefficient of 2.9 for the iron dose in Equation 15-16.
- 15-7.** An alternate form of Equation 15-14 is one based on the stoichiometric chemistry of ferric chloride assuming that the ferric chloride is purchased in solution and that there are no waters of hydration. Use Equation 6-10 to derive the coefficient for FeCl_3 assuming the ferric chloride dose in Equation 15-16 is mg/L as FeCl_3 instead of Fe; that is, find “ x ” in the following equation:

$$M_s = 86.4 Q(x \text{ (Ferric chloride)} + \text{SS} + \text{M})$$

- 15-8.** Compare the approximate form for estimating sludge volume reduction and the rigorous method by computing the percent error for the following conditions:
- Specific gravity of solids = 1.2
 - Solids fraction of wet sludge = 1%
 - Solids fraction of dewatered sludge = 25%
 - Volume of wet sludge = $66.0 \text{ m}^3/\text{d}$
- 15-9.** Compare the approximate form for estimating sludge volume reduction and the rigorous method by computing the percent error for the following conditions:
- Specific gravity of solids = 2.4
 - Solids fraction of wet sludge = 10%
 - Solids fraction of dewatered sludge = 50%
 - Volume of wet sludge = $66.0 \text{ m}^3/\text{d}$
- 15-10.** Using a spreadsheet you have written, plot a graph of percent error versus the wet sludge solids concentrations of 1, 2, 3, and 4% for the data in Problem 15-8.
- 15-11.** Using a spreadsheet you have written, plot a graph of percent error versus the wet sludge solids concentrations of 2, 5, 10, and 15% for the data in Problem 15-9.
- 15-12.** The city of Pherric’s coagulation treatment plant sedimentation tank is being designed to treat a flow of $20,000 \text{ m}^3/\text{d}$. Based on jar tests, the design dose of ferric chloride is estimated to be 18.0 mg/L and the polymer dose is estimated to be 0.1 mg/L. The design raw water suspended solids concentration is 19.4 mg/L. The design effluent suspended solids concentration from the settling tank is 3.0 mg/L. The following sludge characteristics have been selected for the design: sludge solids content = 0.010%, specific gravity of the sludge solids = 1.2. What volume of sludge from the settling tank must be disposed of each day? Assume that the ferric chloride is fed as FeCl_3 .
- 15-13.** The city of Calcareous’ upflow solids contact tank design flow is $30,000 \text{ m}^3/\text{d}$. The water source is the Raccoon River. The plant will remove 114 mg/L of calcium carbonate hardness as CaCO_3 by the addition of lime. No other hardness removal is

required. The maximum turbidity of the Raccoon River at flood stage is 71 mg/L. Ferric chloride is to be added at a dose of 25 mg/L as FeCl_3 in the coagulation step following softening. Based on experience with similar plants, an effluent suspended solids concentration of 2.0 mg/L is being used for the design. The design sludge solids content is 10% and the design specific gravity of the sludge solids is 1.9. What volume of sludge from the upflow solids contact unit must be disposed of each day during flood stage?

- 15-14.** A MF membrane filter has been selected for providing 136,000 m³/d of treated water for the city of Tumanipharmz. The design recovery rate is 90%. The suspended solids concentration in the raw water is 29.1 mg/L. Estimate the feed flow rate to produce 136,000 m³/d of treated water, the reject flow rate, the suspended solids concentration of the concentrate, the sludge production (kg/d), and the percent solids concentration.
- 15-15.** A small RO plant will be used to soften water for Saline. The design flow rate is 3,800 m³/d. The design recovery rate is 75%. The TDS of the feed water is 2,800 mg/L. Estimate the feed flow rate required to produce 3,800 m³/d, the reject flow rate, and TDS concentration of the concentrate.
- 15-16.** The treated water (3,800 m³/d) from Saline's RO plant (Problem 15-15) is blended with raw water for delivery to the customers so that the water has a TDS of 250 mg/L. Determine the flow rate (m³/d) of raw water to blend with the RO water to achieve a TDS of 250 mg/L.
- 15-17.** Because the settled water from Pherric (Problem 15-12) has a very low percent solids, a thickener is being considered for treatment of the sludge before dewatering. Using the following batch settling curve data, design three alternative sludge thickeners with the following underflow solids concentrations: 0.30%, 0.40%, and 0.50%. An overflow rate of 2.5 m/h has been selected for the design.

A completed design will include the tank diameter, tank depth, and the running torque for the rake. Assume two day's storage at an average P_s of 0.004.

Batch settling data for Pherric's coagulation sludge

v_s , m/d	SS, kg/m ³
0.5	4.6
1.7	3.9
2.6	2.7
5.5	2.0
7.9	1.75
14	1.4
24	1.0
38	0.75
50	0.5
60	0.3

Note: you will need the solution from Problem 15-12 to solve his problem.

15-18. The reject from the MF membrane filter at Tumanipharmz (Problem 15-14) is to be treated with polymer and thickened. Because the potential for *Cryptosporidium* concentration in the backwash water, an overflow rate equal to or less than 0.2 m/h is required (Cornwell, 1999). Design three alternative sludge thickeners with the following underflow solids concentrations: 3%, 4%, and 5%. The following batch settling curve data are assumed to be representative.

A completed design will include the tank diameter, tank depth, and the running torque for the rake. Assume two day's storage at an average P_s of 0.04.

Batch settling data for Tumanipharmz's backwash water solids

v_s , m/d	SS, kg/m ³
0.5	38
1.7	26
2.6	23
5.5	19
7.9	16
14	13
24	10.2
38	8
50	4
60	1

Note: you will need the solution from Problem 15-14 to solve his problem.

- 15-19.** Rework Example 15-5 using Equation 15-27 and compare the result. Assume the specific gravity of the sludge is 1.3 and a sludge loading rate of 80 kg dry solids/m².
- 15-20.** Using the GLUMRB guidance, estimate the surface area of a lagoon to store the sludge from Calcareous (Problem 15-13).
- 15-21.** Compare the area calculated in Problem 15-20 with the area estimated using Equations 15-26 and 15-27. Use the following assumptions: a 1.5 m depth, one use per year, specific gravity of sludge = 2.0, 10% solids, a dry climate.
- 15-22.** In the continuing management of Pherric's coagulant treatment sludge (Problems 15-12 and 15-17), your firm has been asked to perform a preliminary design of a sand drying bed. The sludge from a thickener at 2% solids is to be applied to the bed at a loading rate of 10 kg/m². A drained solids concentration of 6.3%, an initial residuals depth of 0.50 m, and a final solids concentration of 20% have been selected for the design. The following precipitation and pan evaporation data were obtained in the general geographic region of Pherric. For this preliminary design, estimate the area required for the sand drying beds. Assume the sludge will be stored on the beds even when there is no evaporation.

Hydrologic and sludge production data for Pherric

Month	Precipitation, cm	Pan evaporation, cm	Sludge production, kg/d
JAN	1.3	1.1	194
FEB	1.0	1.0	150
MAR	1.6	1.8	240
APR	2.3	10.8	345
MAY	4.5	14.4	690
JUN	4.6	16.8	690
JUL	3.4	20.8	510
AUG	3.2	19.6	480
SEP	2.7	12.4	405
OCT	1.6	10.8	240
NOV	1.2	10.2	180
DEC	1.2	9.6	180

- 15-23.** In the continuing management of Tumanipharmz's backwash solids (Problems 15-14 and 15-18), your firm has been asked to perform a preliminary design of a sand drying bed. The sludge from a thickener at 4% solids is to be applied to the bed at a loading rate of 15 kg/m². A drained solids concentration of 18%, an initial residuals depth of 2.20 m, and a final solids concentration of 30% have been selected for the design. The following precipitation and pan evaporation data were obtained in the general geographic region of Pherric. For this preliminary design, estimate the area required for the sand drying beds. Assume the sludge will be stored on the beds even when there is no evaporation.

Hydrologic and sludge production data for Tumanipharmz

Month	Precipitation, cm	Pan evaporation, cm	Sludge production, kg/d
JAN	8.0	0.0	3,320
FEB	5.9	0.0	2,450
MAR	8.0	0.0	3,320
APR	5.9	25.3	2,450
MAY	10.2	29.9	4,230
JUN	10.6	31.9	4,400
JUL	10.0	32.4	4,150
AUG	7.3	29.0	3,030
SEP	6.7	25.1	2,780
OCT	5.4	24.2	2,240
NOV	6.3	14.4	2,610
DEC	5.9	5.4	2,450

- 15-24.** In the continuing management of Pherric's coagulant treatment sludge, your firm has been asked to perform a preliminary selection of a centrifuge. The sludge from a thickener at 2% solids is to be pumped to the centrifuge. Using Table 15-8, select an

appropriate centrifuge system. Assume a two-shift basis, that is, 16 h/d to minimize labor costs. Use the approximate method for estimation for sludge volume reduction.

- 15-25.** In the continuing management of Tumanipharmz's backwash solids (Problems 15-14 and 15-18), your firm has been asked to perform a preliminary selection of a centrifuge. The sludge from a thickener at 3% solids is to be pumped to the centrifuge. Using Table 15-8, select an appropriate centrifuge system. Assume a two-shift basis, that is, 16 h/d to minimize labor costs.
- 15-26.** In the continuing management of Pherric's coagulant treatment sludge, your firm has been asked to perform a preliminary selection of a CBFP. The sludge from a thickener (Problem 15-17) at 4% solids is to be pumped to the CBFP. Determine the appropriate belt width for the press. Assume a two-shift basis, that is, 16 h/d to minimize labor costs.
- 15-27.** In the continuing management of Tumanipharmz's backwash solids, your firm has been asked to perform a preliminary selection of a CBFP, that is, loading rate and belt width. The sludge from a thickener at 3% solids is to be pumped to the CBFP. Determine the appropriate belt width for the press. Assume a two-shift basis, that is, 16 h/d to minimize labor costs.
- 15-28.** In the continuing management of Calcareous's lime softening solids, your firm has been asked to perform a preliminary selection of a diaphragm filter press. The sludge from the upflow solids contact tank at 10% solids is to be pumped to the press. Using Table 15-9, select an appropriate filter press system. Assume a two-shift basis, that is, 16 h/d to minimize labor costs. Also assume the specific gravity of the dewatered sludge is 1.2 and that it is to be dewatered to 35% solids with an 8-hour press time.
- 15-29.** Assuming a three lagoon system for the area estimated for the lagoons in Problem 15-20, prepare a scale drawing of a typical lagoon (plan and profile) and an overall arrangement of the lagoons including access roads. Estimate the total area (in ha) required for the lagoons and access roads.
- 15-30.** For the sand drying bed area calculated for Pherric (Problem 15-22), prepare a dimensioned scale drawing of a typical bed (plan and profile) and an overall arrangement of the number of beds including access roads. Assume bed runners will be provided. Show these in the scale drawing of a typical bed. Estimate the total area (in ha) required for the beds and access roads. *Note:* you will have to do some research to find the dimensions of a front-end loader to establish the stop gate entrance width and placement of bed runners.

15-13 DISCUSSION QUESTIONS

- 15-1.** Match the following residual characteristics with the type of residual.
- | | | |
|----|-----------------|---------------------------|
| a. | 10% solids | () Coagulation sludge |
| b. | 1% solids | () Lime sludge |
| c. | 400 mg/L solids | () Spent filter backwash |

- 15-2.** A lime softening plant located in Michigan has space available for either lagoons or sand drying beds. Which is more likely to be selected? Explain why.
- 15-3.** A lime softening plant located in a highly developed urban area has little space for sludge dewatering. Ultimately the sludge will be hauled to agricultural land for application. Which of the following mechanical dewatering processes is favored: basket centrifuge, CBFP, or plate and frame filter press? Explain why.
- 15-4.** The TCLP test is specified for regulatory control of arsenic treatment residuals. Describe the test in general terms and what a failure to pass the test implies for the disposal of the residuals.

15-14 REFERENCES

- ASCE (1990) *Water Treatment Plant Design*, American Society of Civil Engineers, McGraw-Hill, New York, pp. 336–338.
- AWWA (1996) *Management of Water Treatment Plant Residuals*, American Water Works Association, Denver, Colorado.
- AWWA (2003) “Committee Report: Residuals Management for Low-Pressure Membranes,” *Journal of American Water Works Association*, vol. 95, no. 6, pp. 68–82.
- AWWA (2004) “Committee Report: Current Perspectives on Residuals Management for Desalting Membranes,” *Journal of American Water Works Association*, vol. 96, no. 12, pp. 73–87.
- AWWA (2005) *Microfiltration and Ultrafiltration Membranes for Drinking Water*, AWWA Manual M53, American Water Works Association, Denver, Colorado.
- Ayol, A., S. K. Dentel, and A. Filibeli (2005) “Dual Polymer Conditioning of Water Treatment Residuals,” *Journal of Environmental Engineering*, vol. 131, no. 8, pp. 1,132–1,138.
- Black, A. P. and C. G. Thompson (1975) *Plant Scale Studies of the Magnesium Carbonate Water Treatment Process*, U.S. Environmental Protection Agency Publication No. EPA-660/2-75-006, Cincinnati, Ohio.
- Boyle, W. H. (1978) “Ensuring Clarity and Accuracy in Torque Determinations,” *Water and Sewage Works*, vol. 125, no. 3, p. 76.
- Cornwell, D. A. (1999) “Water Treatment Plant Residuals Management,” in R. D. Letterman (ed.) *Water Quality and Treatment*, 5th ed., American Water Works Association, McGraw-Hill, New York, pp. 16.1–16.51.
- Cornwell, D. A. (2006) *Water Treatment Residuals Engineering*, AWWA Research Foundation, Denver, Colorado.
- Cornwell, D. A. and C. Vandermeiden (1999) “Sizing Residuals Drying Beds,” *Journal of American Water Works Association*, vol. 91, no. 11, pp. 94–105.
- Cornwell, D. A., M. J. MacPhee, R. Muter, J. Novak, M. Edwards, J. L. Parks, and C. Itle (2003) *Disposal of Waste Resulting from Arsenic Removal Processes*, AWWA Research Foundation and American Water Works Association, Denver, Colorado.
- Davis, M. L. and D. A. Cornwell (2008) *Introduction to Environmental Engineering*, McGraw-Hill, Dubuque, Iowa, pp. 311–324.
- Dick, R. I. (1970) “Thickening,” in E. F. Gloyna and W. W. Eckenfelder (eds.), *Advances in Water Quality Improvement—Physical and Chemical Processes*, University of Texas Press, Austin, p. 380.
- Gregory, R., T. F. Zabel, and J. K. Edzwald (1999) “Sedimentation and Flotation,” in R. D. Letterman (ed.) *Water Quality and Treatment*, 5th ed., American Water Works Association, McGraw-Hill, New York, pp. 7.47–7.80.
- GLUMRB (2003) *Recommended Standards for Water Works*, Great Lakes–Upper Mississippi River Board of State and Provincial Public Health and Environmental Managers, Health Education Services, Albany, New York, pp. 34, 119–123.

- Kawamura, S. (2000) *Integrated Design and Operation of Water Treatment Facilities*, 2nd ed., John Wiley & Sons, New York, p. 387.
- Le Gouellec, Y. A., D. A. Cornwell, and M. J. MacPhee (2004) "Treating Microfiltration Backwash," *Journal of American Water Works Association*, vol. 96, no. 1, pp. 72–83.
- Marshall, T. (2002) "Sweeter Soil with Substantial Savings," *Ohio's Country Journal*, vol. 11, no. 5, pp. 21–22.
- Mickey, M. (1993) "Membrane Concentrate Disposal Issues," *Proceedings of the 4th Joint WEF and AWWA Conference on Biosolids and Residuals Management*, Water Environment Federation, Alexandria, Virginia.
- MWH (2005) *Water Treatment: Principles and Design*, John Wiley & Sons, Hoboken, New Jersey, pp. 844, 927, 926, 1661, 1665, 1666, 1669, 1686.
- Novak, J. T. (1993) *Demonstration of Cropland Application of Alum Sludges*, American Water Works Association Research Foundation, Denver, Colorado.
- Parrotta, M. J. (1991) "Radioactivity in Water Treatment Wastes: A USEPA Perspective," *Journal of American Water Works Association*, vol. 83, no. 4, pp. 134–140.
- Peck, B. E. and J. S Russell (2005) "Process Residuals," in E. E. Baruth, (ed.), *Water Treatment Plant Design*, American Water Works Association and American Society of Civil Engineers, McGraw-Hill, New York, pp. 17.1–17.70.
- Prakash, P. and A. K. Sengupta (2003) "Selective Coagulant Recovery from Water Treatment Plant Residuals Using Donnan Membrane Process," *Environmental Science & Technology*, vol. 37, no. 19, pp. 4,468–4,474.
- Shorney-Darby, H., G. Dias, P. Ryan, C. Hidahl, R. Henderson, and K. Abrahm (2007) "Expanding a Conventional Water Treatment Plant with Low-Pressure Membranes," *Journal of American Water Works Association*, vol. 99, no. 12, pp. 52–60.
- Tripp, A. R. and D. A. Clifford (2006) "Ion Exchange for the Remediation of Perchlorate-Contaminated Drinking Water," *Journal of American Water Works Association*, vol. 98, no. 4, pp. 105–114.
- U.S. EPA (1979) *Process Design Manual: Sludge Treatment and Disposal*, U.S. Environmental Protection Agency Publication No. 625/1-79-011, Cincinnati, Ohio, pp. 5.1–5.15.
- U.S. EPA (2000) *Regulations on the Disposal of Arsenic Residuals from Drinking Water Treatment Plants*, U.S. Environmental Protection Agency Publication No. EPA/600/R-00/25, Washington, D.C.
- Vandermeijden, C. and D. A. Cornwell (1993) "A U.S. Perspective of Beneficial Use Programs for Water Treatment Plant Residuals," in *Proceedings of WEF Biosolids Conference*, Water Environment Federation, Washington, D.C.
- Vesilind, P. A. (1979) *Treatment and Disposal of Wastewater Sludges*, Ann Arbor Science, Ann Arbor, Michigan.
- WEF (1998) *Design of Municipal Wastewater Plants*, 4th ed.
- Westerhoff, G. P. and D. A. Cornwell (1978) "A New Approach to Alum Recovery," *Journal of American Water Works Association*, vol. 70, no. 12, p. 709.
- Yoshioka, N., et al. (1957) "Continuous Thickening of Homogenous Flocculated Slurries," *Chemical Engineering*, Tokyo (in Japanese).

This page intentionally left blank

**DRINKING WATER PLANT PROCESS SELECTION
AND INTEGRATION**

16-1 INTRODUCTION

16-2 PROCESS SELECTION

16-3 PROCESS INTEGRATION

16-4 SECURITY

16-5 CHAPTER REVIEW

16-6 PROBLEMS

16-7 DISCUSSION QUESTIONS

16-8 REFERENCES

16-1 INTRODUCTION

The primary goal of municipal water treatment is to supply an adequate quantity of potable water to the public. A secondary but essential goal is to make the water palatable. Since 1899, when George Warren Fuller demonstrated the efficacy of combining coagulation, flocculation, settling, and filtration to produce consistently high quality water from the Ohio River—despite its exceedingly high variations in raw water quality—environmental engineers have assembled a “train” of processes to achieve a desired water quality. Because no single process is 100 percent efficient and because processes fail, the *treatment train* concept is now recognized as the best means to provide *multiple barriers* to protect the water supply from intrusion of contaminants.

The treatment train/multiple barrier concept is illustrated in the arrangement of the conventional surface water coagulation plant beginning at the end of the treatment process.

- Although disinfection is quite effective in destroying vegetative pathogens, it is not very effective in destroying spore-forming organisms. Furthermore, the presence of turbidity interferes with disinfection of vegetative organisms by shielding them from the disinfectant as well as consuming excessive amounts of disinfectant to achieve a prescribed level of disinfection.
- By preceding the disinfection process with a filtration process, both the excess turbidity and the organisms resistant to disinfection can be removed. However, the filtration systems are expensive to build and operate. In addition, they can become overloaded with a resultant breakthrough of both turbidity and pathogens.
- By preceding the filtration process with settling, a majority of the turbidity can be removed. This allows for a reduction in the filter size as well as improving its overall performance. Because of the very low settling velocity of the turbidity, as well as the turbulence in real settling tanks, they do not achieve high efficiency.
- The introduction of the coagulation/flocculation process ahead of the settling tank results in the production of large floc that settles better than individual turbidity particles. This improves the efficiency of the settling tanks.

Thus, the overall objective of the coagulation treatment train is to make the disinfection process more efficient. In addition, multiple barriers to the pathogens are put in place because pathogens are removed in each of the processes that precede disinfection.

The objectives of this chapter are to provide an approach to process selection to form treatment trains and to summarize the essential factors to be considered in selecting water treatment processes. Ancillary topics include plant layout, plant hydraulics, supervisory control and data acquisition (SCADA), and security.

16-2 PROCESS SELECTION

Fundamental Precepts

Experience has taught us the following fundamental precepts in process selection (MWH, 2005):

1. The raw water quality of every source is different.
2. Raw water quality is variable.

3. There is no standard water treatment plant design that is applicable to all sources.
4. For every source, a number of treatment process alternatives are available.
5. Site conditions often limit the types of treatment process that can be used.
6. Retrofitting and upgrading of existing plants requires creative solutions that are not presented in standard textbooks such as this one.
7. Pilot plant testing is highly recommended in the selection of retrofit and upgrade alternatives.
8. Pilot plant testing requires careful planning and execution to obtain useful design and operating criteria.
9. It is essential that the multibarrier concept be a feature of all designs.
10. Operator experience is invaluable in developing a design.

Evaluation of Process Options

While experts with a large body of knowledge gained from experience will often be able to screen the universe of available processes to select a set of options for study and evaluation, the sorting process they use is not intuitively obvious. In simplified form, the sorting process may be represented as a matrix table in which all the relevant treatment processes are listed on one axis and the factors related to process selection are listed on another axis. Each process is given a rating or ranking for each of the factors. In addition, a weighting system may be employed to account for greater influence of more important aspects of some of the factors than others.

For academic purposes, Tables 16-1, 16-2, and 16-3 illustrate some matrices that provide information for initial screening. Other aids for initial screening are Figure 16-1 and the tables in previous chapters that are summarized in Table 16-4.

A number of other tables and decision trees are available in the literature to aid in making selections. Some of these are very useful in refining screening selections. For example Monk (1987) provides comparisons of rapid sand filter media, underdrain systems, backwash systems, auxiliary scour, and filter control systems.

Factors that should be included in decisions on water treatment processes include (Logsdon, Hess, and Horsley, 1999):

- Contaminant removal
- Source water quality
- Reliability
- Existing conditions
- Process flexibility
- Utility capabilities
- Costs
- Environmental compatibility

TABLE 16-1
Appropriateness of water treatment processes for removing primary contaminants

Contaminant categories	Acration and stripping	Coagulation, sedimentation or DAF, filtration	Lime softening	Chemical oxidation and disinfection	Membrane processes		
					Microfiltration—0.1 μm pores	Ultrafiltration—0.01 μm pores	Nanofiltration—0.001 μm pores
Inorganic chemicals							
Antimony							A ^a
Arsenic (3+)		AO ^b	AO				A
Arsenic (5+)		A	A				A
Barium			A				A
Beryllium		A	A				A
Cadmium		A	A				A
Chromium (3+)		A	A				A
Chromium (6+)							A
Cyanide				A			
Fluoride			A				
Mercury			A				A
Nickel			A				A
Nitrate							A
Nitrite							A
Selenium (4+)		A					A
Selenium (6+)							A
Thallium							A
Organic contaminants							
VOCs	A						
SOCs							
Pesticides & herbicides							A
DOC		A					A
Radionuclides							
Radium (226 & 228)			A				A
Uranium							A
Microorganisms							
Algae		A	A		A	A	
Bacteria		A	A	A	A	A	
Protazoa		A	A	A	A	A	
Virus				A		A	
Turbidity		A	A		A	A	

^aA = appropriate process.

^bAO = appropriate when used in conjunction with oxidation.

Adapted from NRC, 1997.

Contaminant categories	Reverse osmosis— nonporous	Electrodialysis/ ED reversal	Ion exchange		Adsorption		
			Anion	Cation	Granular activated carbon (GAC)	Powdered activated carbon (PAC)	Activated alumina (AA)
Inorganic chemicals							
Antimony	A						
Arsenic (3+)	A	A	A				A
Arsenic (5+)	A	A	A				A
Barium	A	A		A			
Beryllium	A	A					
Cadmium	A	A		A			
Chromium (3+)	A	A		A			
Chromium (6+)	A	A	A				
Cyanide							
Fluoride	A	A					A
Mercury	A	A					
Nickel	A	A		A			
Nitrate	A	A	A				
Nitrite	A	A	A				
Selenium (4+)	A	A	A				A
Selenium (6+)	A	A	A				A
Thallium	A	A					A
Organic contaminants					A	A	
VOCs	A				A	A	
SOCs	A				A	A	
Pesticides & herbicides	A				A	A	
DOC							
Radionuclides							
Radium (226 & 228)	A	A	A				
Uranium							
Microorganisms							
Algae							
Bacteria							
Protazoa							
Virus							
Turbidity							

TABLE 16-2
Appropriateness of water treatment processes for removing secondary contaminants

Contaminant categories	Acratation and stripping	Coagulation, sedimentation or DAF, filtration	Lime softening	Chemical oxidation and disinfection	Membrane processes		
					Microfiltration—0.1 μm pores	Ultrafiltration—0.01 μm pores	Nanofiltration—0.001 μm pores
Chloride							
Color		A		A			A
Hardness			A				A
Iron		AO	A				ANDO ^a
Manganese		AO	A				ANDO
Sulfate							A
TDS							A
Taste & odor	A			A			
Zinc			A				A

^aANDO = appropriate when no dissolved oxygen enters the process.
 Adapted from NRC, 1997

TABLE 16-3
Summary of membrane process applications for drinking water regulations

Rule	Membrane process					
	EDR	RO	NF	UF	MF	
SWTR/ESWTR ^a	no	yes	yes	yes	yes	
CR ^b	no	yes	yes	yes	yes	
LCR ^c	yes	yes	yes	no	no	
IOC ^d	yes	yes	yes	no	no	
SOC ^e	no	yes	yes	yes (+PAC)	yes (+PAC)	
Radionuclides	yes (no radon)	yes (no radon)	yes (no radon)	no	no	
DBPR ^f	no	yes	yes	yes(+ coagulation)	yes (+ coagulation)	
GWDR ^g	no	yes (expected)	yes (expected)	yes (expected)	yes (expected)	
Arsenic	yes	yes	yes	yes (+ coagulation)	yes (+ coagulation)	
Sulfates	yes	yes	yes	no	no	

^aSWTR/ESWTR—Surface water treatment rule/enhanced surface water treatment rule.

^bCR—Coliform rule.

^cLCR—Lead and copper rule.

^dIOC—Inorganic chemicals.

^eSOC—Synthetic organic chemicals.

^fDBPR—Disinfection by-product rule.

^gGWDR—Ground water rule.

Source: Taylor and Wiesner, 1999.

Contaminant categories	Reverse osmosis—nonporous	Electrodialysis/ED reversal	Ion exchange		Adsorption		
			Anion	Cation	Granular activated carbon (GAC)	Powdered activated carbon (PAC)	Acitvated alumina (AA)
Chloride	A	A					
Color	A				A	A	
Hardness	A	A		A			
Iron	ANDO			A			
Manganese	ANDO			A			
Sulfate	A	A					
TDS	A	A					
Taste & odor					A	A	
Zinc	A	A		A			

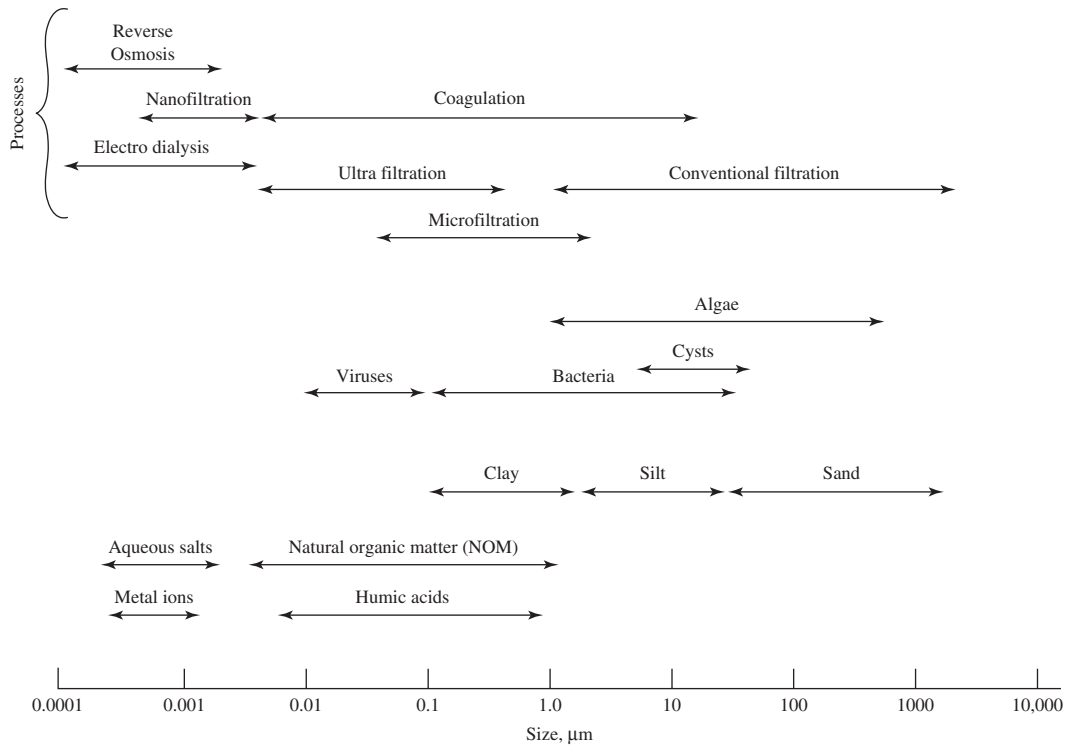

FIGURE 16-1
Aid for initial screening of processes based on size of contaminants.

TABLE 16-4
Summary of tables and figures to aid in screening alternatives

Process or contaminant	Table or figure number	Remarks
Arsenic	Tables 14-1, 14-2, 14-3 Figures 14-1 & 14-2	Decision tree & graph
Disinfection	Tables 13-4, 13-5, 13-6, 13-7, 13-9, 13-10 Figures 13-9, 13-10	Decision trees
GAC	Table 14-10	
Iron & Manganese	Figures 14-5 & 14-6	Decision trees
NF/RO membranes	Table 9-1	
MF/UF membranes	Table 12-1	
Radium	Table 14-7	
Residuals		
Arsenic	Figures 15-13 & 15-14	Decision trees
Liquid	Table 15-10 Figures 15-11 & 15-12	Decision trees
Radioactive	Figures 15-15 & 15-16	Decision trees
Sludges	Table 15-4	Lime & coagulation

These factors are discussed in the following paragraphs.

Contaminant Removal. Removal of contaminants is the primary purpose of most treatment processes. In the United States, the regulations promulgated by the U.S. Environmental Protection Agency set the maximum allowable contaminant levels (MCLs). Obviously, processes that cannot achieve the MCL for a single contaminant or group of contaminants can be quickly eliminated. For example, if arsenic is the sole contaminant constituent of concern, a quick review of Table 16-1 reveals that MF and UF membranes are not an option that should be considered. However, Table 16-1 is not the be all, end all in the screening process. While the table shows seven other options that should be considered, the tables and decision trees in Chapter 14 provide a much more refined list of options and guidance in making choices for arsenic removal.

Many utilities choose to produce water that is much better in quality than that required to comply with the regulations. This includes improving the aesthetic characteristics of the water. Many of the processes that are needed to provide the water quality required to meet the regulations may be operated in a manner that yields a higher quality than is required by the regulations. One way to get higher quality is to operate at lower loading rates than the customary norms. Another way is to provide additional treatment processes.

Source Water Quality. In the simplest view, a comparison of the source water quality and the desired finished water quality set the required degree of treatment. The variation in the source water quality must be within the range of quality that the treatment plant can successfully treat.

In some cases, the characteristics of the raw water suggest the need for a particular treatment process. An example is the use of dissolved air flotation (DAF) in treating algae laden water or greensand to treat groundwater with high concentrations of iron.

Often a community will use multiple sources for their water supply. While this makes the decision process even more complex, it offers opportunities for blending to dampen fluctuations in raw water quality as well as improving reliability of the source.

Reliability. As used here, the term *reliability* includes robustness as well as mean time between failures. Robustness includes the ability to handle changes in raw water quality, on-off cyclic operations, normal climatic changes, adverse weather events, and the degree of maintenance required to maintain efficient operation. Although minimum redundancy requirements (e.g., Table 1-3) help to ensure reliability, they do not take into account failures because the equipment is operated outside of its normal operating range or failure to meet water quality goals because of frequent or very long down time for repairs.

Existing Conditions. Upgrades and expansion of existing facilities requires careful evaluation of the existing process and the constraints of the site. Hydraulic requirements may often limit the choices in process selection and design configuration.

Process Flexibility. The ability of the operator to mix and match various processes to adapt to variations in demand ranging from minimum demand at initial start-up of the plant to maximum demand at the design life is essential to providing consistently good quality water. In addition, the ability to “work around” scheduled out-of-service maintenance requirements as well as unscheduled maintenance for repair of failures should be planned in the selection of process options. Both the plant layout and the hydraulics of the plant play a role in providing this flexibility. These are discussed later in this chapter.

A more difficult requirement is the flexibility to meet changing regulatory requirements (which, generally, will become more stringent rather than less stringent) or changes in the source water characteristics. For a given set of site characteristics, planning for future expansion is one logical way to provide flexibility. In some cases it may be possible to provide extra space in the hardened facilities (i.e., concrete structures) to allow for addition of equipment when the need arises. Providing access doors or roof structures to the space is also a good idea. There is, of course, the risk that the space will never be needed.

Utility Capabilities. The water utility must be able to operate the plant once it is built. This includes repairs as well as day-to-day adjustments, ordering supplies, taking samples, and so on. Processes should be selected that can be operated and maintained by available personnel or personnel that can be trained. The plant management must be informed of the complexities and requirements of the treatment process before plans are adopted. Staff training, as well as availability and access to service, are important considerations in selecting a process.

For many small (501 to 3,300 people) and very small (25 to 500 people) communities and even some medium (3,301 to 10,000) to very large (>100,000 people) communities, there are economies of scale in joining with others to provide treated water. The economies of scale are found primarily in capital cost, outside services, and materials. Energy and, to a lesser extent,

labor costs do not exhibit as significant an economy of scale (Shih et al., 2006). Based on survey data, Shih et al. found that the median unit production cost (operating cost plus depreciation in $\$/\text{m}^3$ of water delivered) for a very small plant was 135 percent greater than that for a very large plant. On the other hand, 20.7 percent of very small plants and 22.0 percent of medium-sized plants had a unit cost lower than the median unit cost of very large plants. Thus, larger size does not guarantee lower costs. In addition to the political issues of local control, a careful economic evaluation of the alternative of joining with another community is warranted.

Costs. The capital cost may be the key factor in selection of a process. As noted in Chapter 1, the operating cost is, in all likelihood, equally relevant. It may be even more important than capital cost in the decision process because of the rising cost of energy and labor.

Environmental Compatibility. The issues included under this heading range from residuals disposal to the wastage of water in the treatment process. Advanced processes that generate residuals with high concentrations of materials that are difficult to dispose of may be sufficient reason to reject them. Likewise, processes that reject large quantities of water with respect to the quantity of water produced should be reviewed carefully. This is especially true in areas where water supplies are limited.

Process Selection Examples

The following three case studies were selected from the literature to demonstrate the wide range of choices and some of the logic that was used in making the choices. The cited references provide more detail. A literature review of the many other examples that are reported in the *Journal American Water Works Association* and *Opflow* (also published by the American Water Works Association) should be part of any study to evaluate process alternatives.

Case Study 16-1

Groundwater sources that are hydraulically connected to a surface water source must comply with EPA's rules under the category called "groundwater under the influence of surface water," more frequently cited as "groundwater under the influence." Although this designation imposes requirements for water quality that are not normally applied to groundwater, the use of wells "under the influence" may have significant advantages over direct withdrawal from surface water. This source of water is often referred to as *river bank filtration* or just *bank filtration*.

The effectiveness of bank filtration has long been recognized in Europe. Many utilities are interested in bank filtration in the United States because it has the potential to remove pathogenic microorganisms and reduce disinfection byproduct precursors.

Discussion. The paper by Weiss et al. (2003) was selected to illustrate a comparison of three sources for a water supply: a river, a horizontal collector well, and a vertical well located 122 m from the river.

The river is the Wabash River at Terre Haute, Indiana. The site is sketched in Figure 16-2. The characteristics of the collector well and the individual well are as shown in Table 16-5.

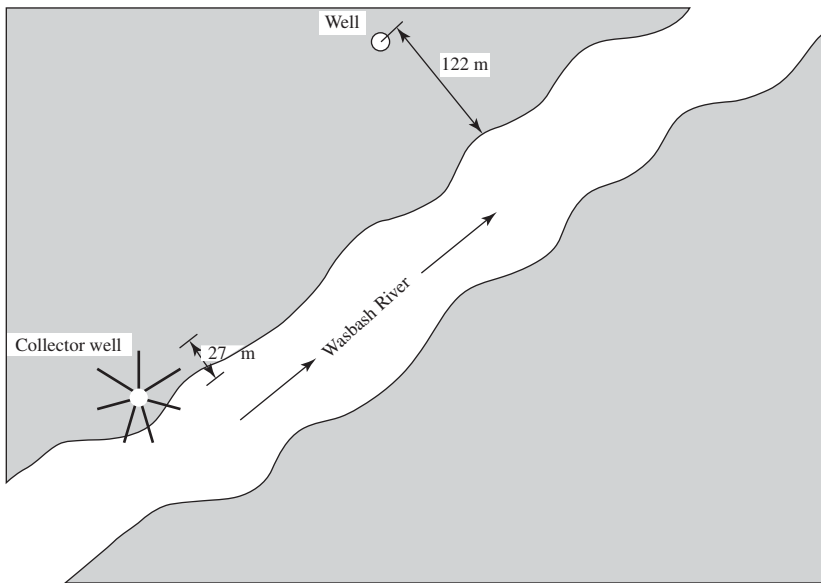

FIGURE 16-2
Wabash River at Terre Haute, Indiana.

TABLE 16-5
Characteristics of the wells at Terre Haute, Indiana

Well ID	Depth to well screen, m	Well screen length, m	Well capacity, m ³ /d
Collector	24	480 ^a	45,500
Well No. 3	45	14	3,760

^a Ranney screen.

The average total organic carbon (TOC) and dissolved organic carbon (DOC) for each source are shown in Figure 16-3.

The *Clostridium* and *E. coli* C bacteriophage concentrations for each source are given in Table 16-6.

Both the collector well and the vertical well achieved a remarkable improvement in the source water quality over direct withdrawal from the river.

Comments:

1. Not investigated in the paper by Weiss et al. were several other potential effects of bank filtration (Tufenkji, Ryan, and Elimelech, 2002):
 - a. When there is intense microbial activity in the river bed sediments, the oxygen is depleted and anoxic conditions result.
 - b. Microbial activity under anoxic conditions results in reduction of the nitrate concentration.

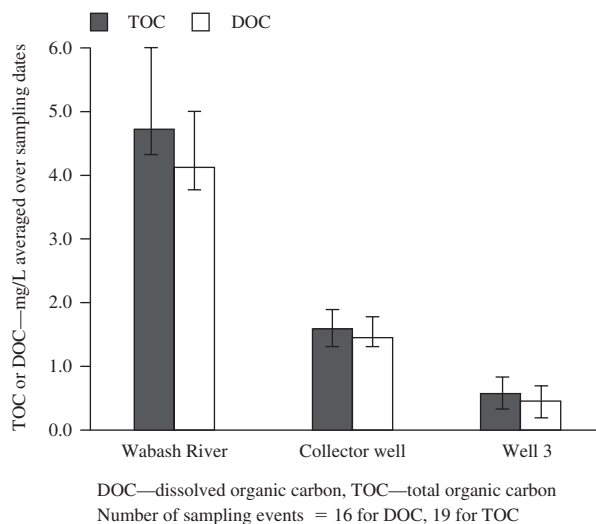

FIGURE 16-3
Average TOC and DOC concentrations at Terre Haute, Indiana.
(Source: Weis et al., 2003.)

TABLE 16-6
Clostridium and *E. Coli* concentrations at Terre Haute, Indiana

Location	<i>Clostridium</i> average counts/100 mL	<i>E. coli</i> C pfu/100 mL
Wabash River	183	147
Collector well	0.07	< 0.07
Well 3	< 0.07	< 0.07

- c. If the aquifer becomes highly reduced, manganese and iron are mobilized, which may result in a deterioration of the water quality. If the well system is at the outer limit of the surface water–groundwater interface, oxidation results in precipitation of these metals.
 - d. Microbial degradation of organic matter mobilizes metals such as copper and cadmium.
 - e. Excessive microbial growth may decrease hydraulic conductivity at the surface water–groundwater interface as a result of biofilm formation.
2. The effects of groundwater dilution as well as the subsurface filtration aspects of river bank filtration are assessed in a paper by Partinoudi and Collins (2007).

Case Study 16-2

The Milwaukee *Cryptosporidium* outbreak in 1993 had a major impact on process selection for both new construction and upgrades. This coupled with U.S. EPA's increasingly stricter drinking water regulations is influencing utilities to consider low-pressure membrane (MF and UF) as part of their multibarrier treatment train.

Discussion. Shorney-Darby et al. (2007) present a detailed explanation of the evaluation of MF membranes for expansion of the Modesto Regional Water Treatment Plant (MRWTP) in central California. The existing 136,000 m³/d plant was a conventional system that employed ozone disinfection, alum coagulation, flocculation, sedimentation, and deep-bed monomedium filtration to treat water from the Modesto Reservoir. The plant was commissioned in 1995 and has operated well. The original design incorporated features for expansion to 273,000 m³/d using the same processes of conventional treatment. Table 16-7 summarizes the raw water and filter effluent quality. In the summer months, when there are few rain events in central California, turbidity and TOC concentrations are stable and low in the raw water supply (5 NTU and 1.3 mg/L, respectively). During the rainy winter months, the turbidity can reach 20 NTU and TOC concentrations can double.

The screening process for the expansion project was limited to two choices: replication of the existing plant and construction of a parallel MF plant. Because the conventional plant was well known, the study focused on the implications of a new MF plant. The particular concern was the higher turbidity and TOC in the winter.

A pilot study was conducted to see if pretreatment (e.g., coagulation, flocculation, and settling) would be required to achieve satisfactory operation. The main conclusions from the pilot testing were the following:

- Low-pressure membranes can effectively treat Modesto Reservoir water at a reasonable water flux with reasonable cleaning intervals;
- No pretreatment upstream of the membranes is necessary; and
- The membrane train can operate for several months each year without coagulant but low dosages of alum (< 8mg/L) may have to be used to lower TOC concentrations in the rainy season.

The 20-year present worth cost estimates for the conventional plant and the MF plant differed by less than 10 percent. This fact, coupled with favorable pilot testing led to the decision to proceed with the MF option. This decision was facilitated by the recognition that the MF plant would allow for future expansion while the construction of a parallel conventional plant would use all of the available land.

The final treatment train arrangement is shown in Figure 16-4.

TABLE 16-7
Range of MRWTP water quality data: January to April, 2007

Parameter	Raw water	Filter effluent
Turbidity, NTU	1.5 to 19.4	0.015 to 0.130
Total organic carbon mg/L	1.1 to 3.4	0.78 to 2.2
Total coliform, MPN/100 mL	0 to 1,733	0
Fecal coliform, MPN/100 mL	0 to 300	0
<i>Cryptosporidium</i> , counts/100 mL	0 to 0.05	N/A
<i>Giardia</i> , counts/100 mL	0 to 0.02	N/A
Algae, cells/ mL	625 to 38,750	N/A
pH	5.9 to 7.4	8.1 to 9.0 (finished water)
Temperature, °C	4.5 to 21	

Adapted from Shorney-Darby et al., 2007.

Residuals handling in the new plant configuration required careful planning. Because the polymers used in thickening the conventional treatment residuals potentially could damage the membrane via the recycled decant water, separate handling systems were used (Figure 16-5). In

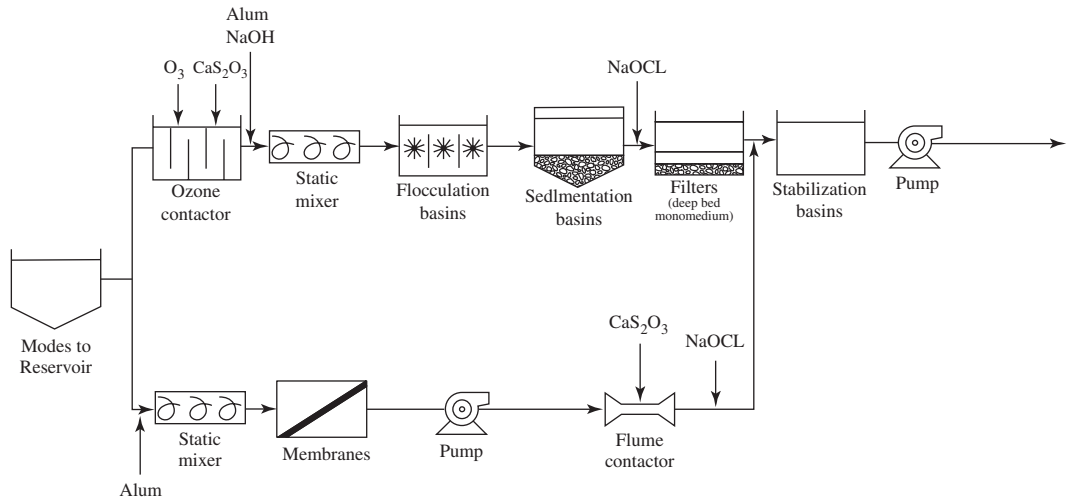

FIGURE 16-4 Parallel conventional (top) and membrane (bottom) treatment trains for expanded Modesto Regional Water Treatment Plant.

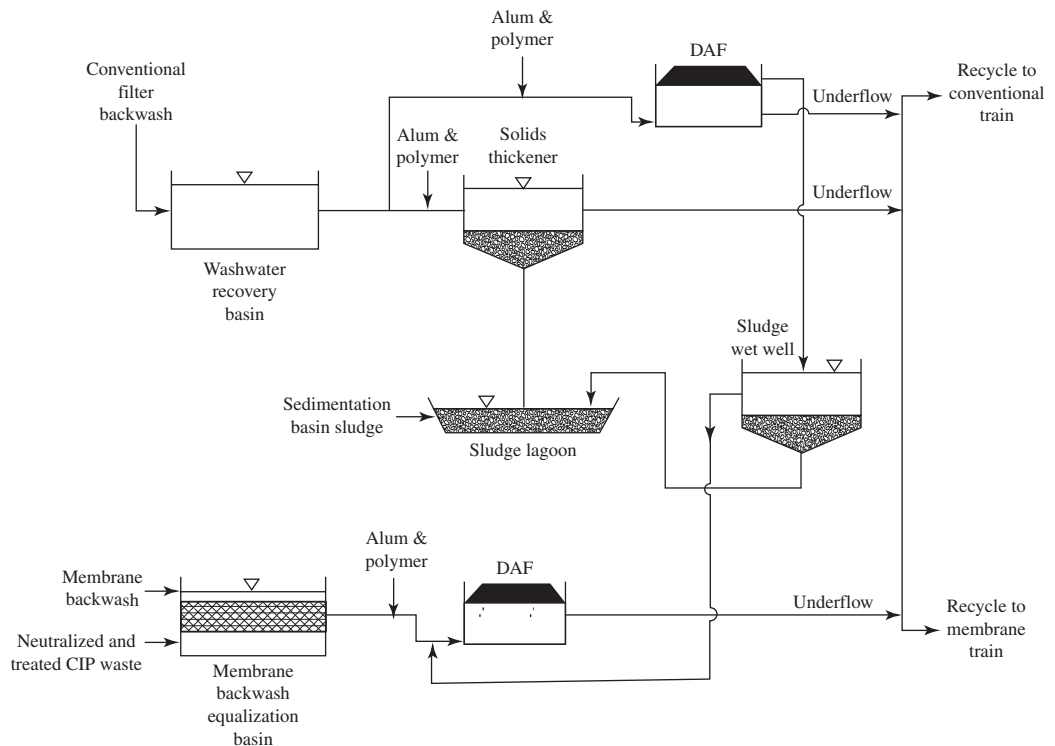

FIGURE 16-5 Residuals treatment trains for expanded Modesto Regional Water Treatment Plant.

addition, recycling of MF clean-in-place (CIP) chemicals was found to disrupt the coagulation and sedimentation processes. Some of the CIP chemicals will be neutralized and returned to the head end of the plant. Others will be hauled off-site for disposal.

Comment. A major disadvantage of using the MF for the expansion is that, in effect, there are two plants to operate: a conventional plant and a MF plant. This implies that operators with exceptionally diverse skills must be employed or two, almost independent staffs have to be provided. In addition, with the exception of alum, two different sets of chemicals must be stored and maintained.

Case Study 16-3

As noted in Chapter 2, groundwater has many characteristics that make it preferable as water supply. But it is not without drawbacks, including high concentrations of manganese, iron, hydrogen sulfide, or ammonia.

Discussion. Sled and Pierson (2007) describe the treatment objectives and processes selected for the upgrade of the Renton, Washington water treatment plant. The raw water quality characteristics are described in Table 16-8.

The treatment objectives for the new treatment plant were:

- Eliminate customer complaints about manganese staining of clothes and fixtures.
- Produce treated water with a free chlorine residual.
- Improve the taste and odor of the water.
- Eliminate hydrogen sulfide odor in the ambient air that occurred with the previous air stripping process.
- Increase the dissolved oxygen to match that of the city's other water supplies.
- Meet the pH requirements for continued compliance with the Lead and Copper Rule.

The treatment objectives were quantified by selecting the water quality objectives shown in Table 16-9.

The major components of the new treatment process are granular activated carbon (GAC) for hydrogen sulfide removal, greensand for manganese and iron removal, and breakpoint

TABLE 16-8
Renton, Washington raw water quality characteristics

Parameter	Range of values
Ammonia, free, mg/L	0.35 to 0.55
TOC, mg/L	0.46 to 1.9
Total iron, mg/L	0.0 to 0.04
Total manganese, mg/L	0.07 to 0.12
Sulfide, mg/L	0.06 to 0.20
pH	7.6 to 8.0

Adapted from Sled and Pierson, 2007.

TABLE 16-9
Renton, Washington treated water quality objectives

Parameter	Treatment objective
Ammonia, free, mg/L	< 0.025
Total iron, mg/L	< 0.05
Total manganese, mg/L	< 0.01
Sulfide, mg/L	< 0.0003
pH	7.6 to 8.0

Adapted from Sled and Pierson, 2007.

chlorination for ammonia reduction. Three 3.6 m diameter GAC columns and three 3.6 m diameter greensand filters are used in the plant. This provides a capacity of 16,000 m³/d. Space is provided to add two more GAC columns and two more greensand filters to bring the capacity to 30,000 m³/d. Sodium hypochlorite is used for breakpoint chlorination. Contact is provided in an underground clearwell that is provided with serpentine baffle walls.

Comments:

1. The translation of the treatment objectives into quantitative measures is an excellent way to assess the capability of alternative processes.
2. The provision of “hardened” space for expansion gives Renton flexibility for the future.
3. The paper presents many worthwhile lessons learned for consideration in start-up of a new facility of this type as well as suggestions for training programs with new equipment.

16-3 PROCESS INTEGRATION

Plant Layout

The available land area and topography dictate the plant layout. The conceptual framework for the plant layout begins with the *process flow diagram* (Figure 16-6). The process flow diagram should include the following items (Kawamura, 2000):

1. All the unit processes in the correct sequence.
2. All the major pipe connections with flow directions.
3. All the chemicals that are to be used and the application points of each.
4. All the major sampling points.
5. The location and size of all major flow meters, valves, and connecting pipes.
6. The location of all major pumps, blowers, and screens.
7. The control points for pressure, water level, flow rate, and water quality.

The basic styles of plant layout are the linear style, compact style, and campus style (Figure 16-7). In general, the linear and campus styles have several advantages over the compact

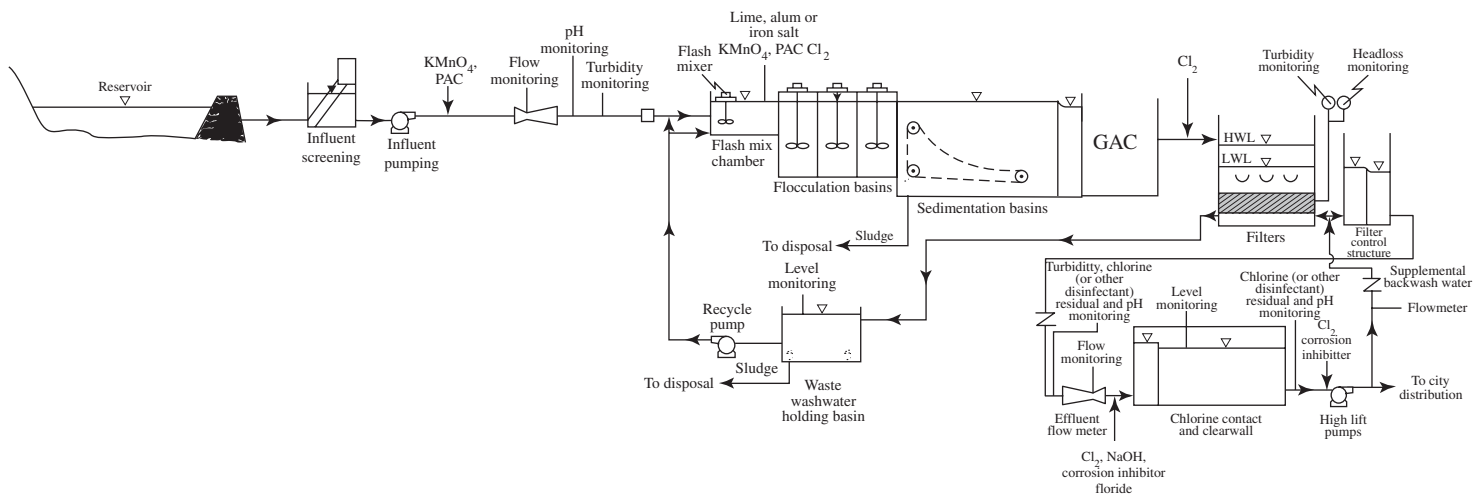

FIGURE 16-6
Example of a process flow diagram.

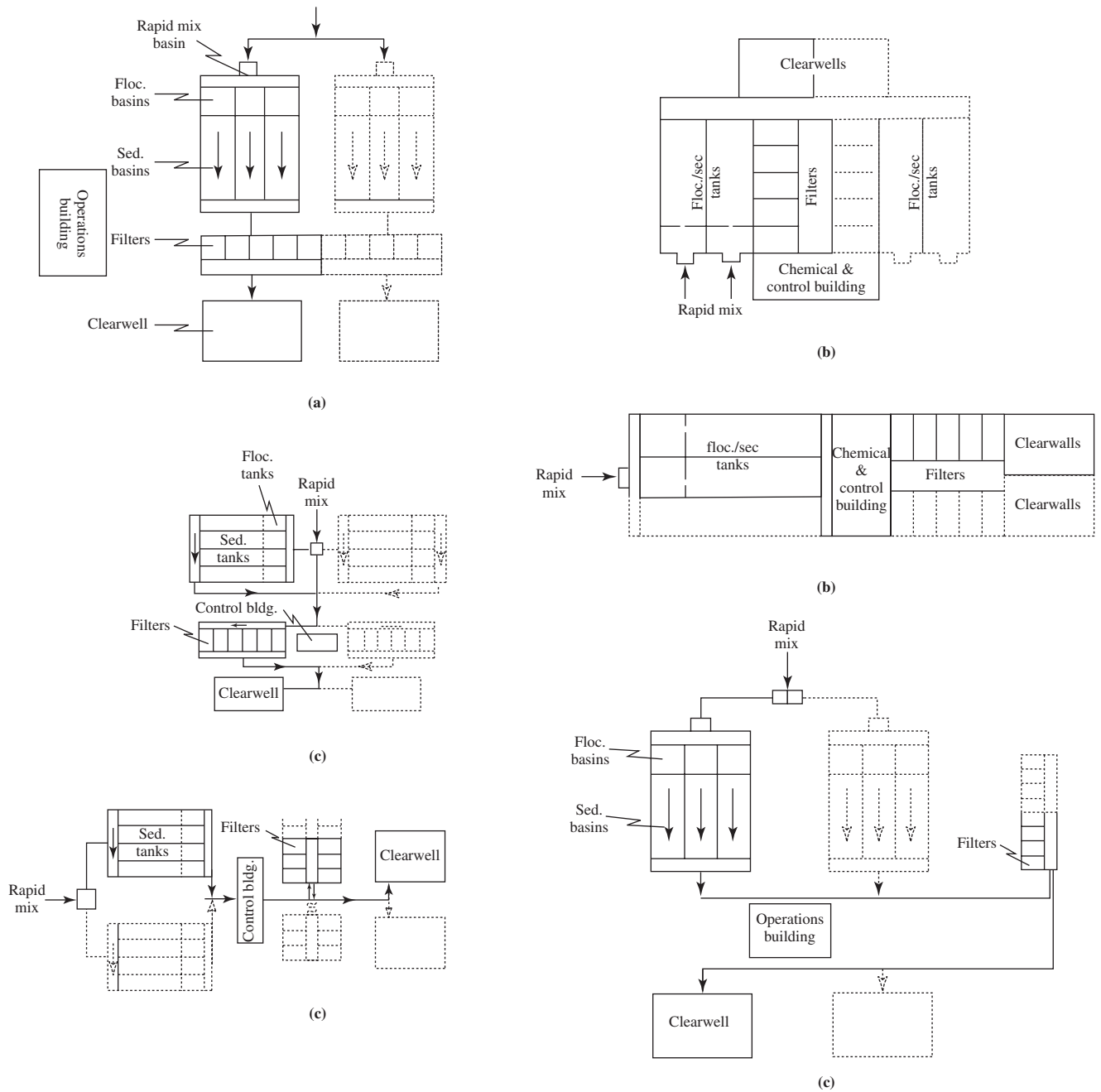

FIGURE 16-7 Basic styles of plant layout. Linear (a), Compact (b), and Campus (c). Future plans shown by dotted lines.

layout. These include: (1) easier construction because each treatment process is easily accessible, (2) less potential for structural damage between different processes because of differential settling, (3) upgrading with new technology between units is relatively easy, (4) if the site is not flat, there is a potential savings in earthwork, and (5) an inherent increase in safety is realized because of separation from chemical spills and/or fire.

The disadvantages of the linear and campus styles are (1) larger plant site requirements, (2) more yard piping, (3) operators must travel greater distance between each process, and (4) construction costs may be greater.

When space is not a constraint, a linear layout generally allows the maximum flexibility for expansion. Redundancy and flexibility are enhanced if the units are interconnected in such a way that the flow through the plant can be shuttled from one treatment train to another as shown in Figure 16-8. Because chemicals must be delivered to the plant, connection to the transportation net becomes an integral part of the layout. Likewise, because residuals are generally transported offsite, the residuals handling system is an integral part of the plant layout.

Kawamura (2000) emphasizes two points in laying out the plant. The first is to provide a single application point for all the pretreatment chemicals. The second is to provide a single chemical feed point to the filter influent for all the filters and use this scheme for the combined filter water prior to the clearwell. The single point application scheme is recommended because it simplifies the chemical feed system and provides uniform water quality control.

Plant Hydraulics

The plant hydraulics are represented by a drawing that shows the hydraulic grade line across the treatment plant. The drawing must show the elevations of the walkway (top of the structure), the water level, and the bottom elevation of each unit process as well as the invert and crown of all the connecting pipes and the invert of all the channels. An example hydraulic profile is shown in Figure 16-9.

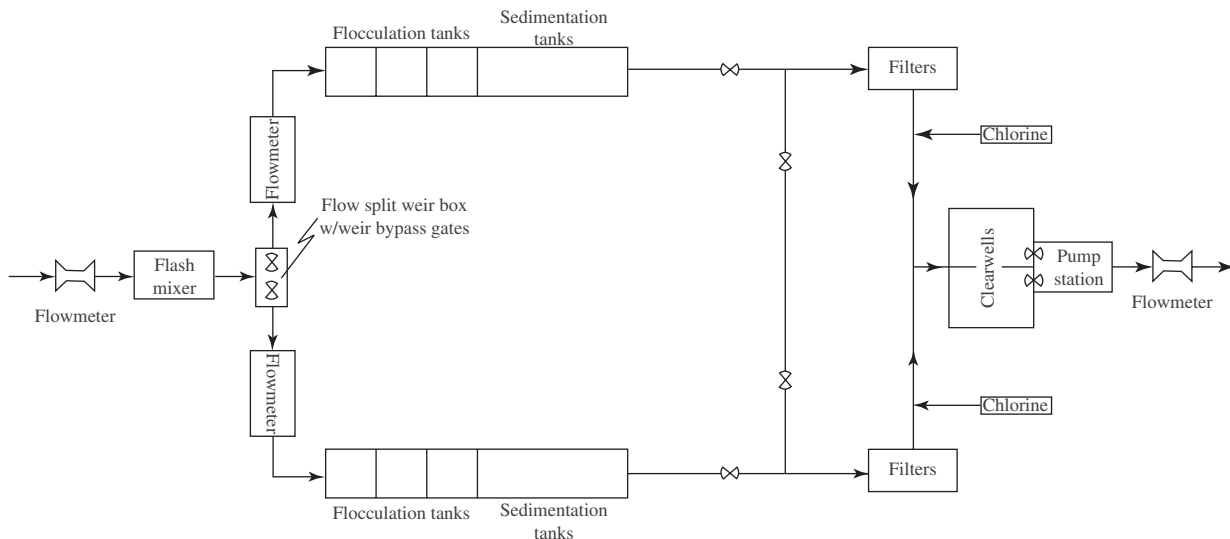

FIGURE 16-8
Process train scheme to improve treatment flexibility.

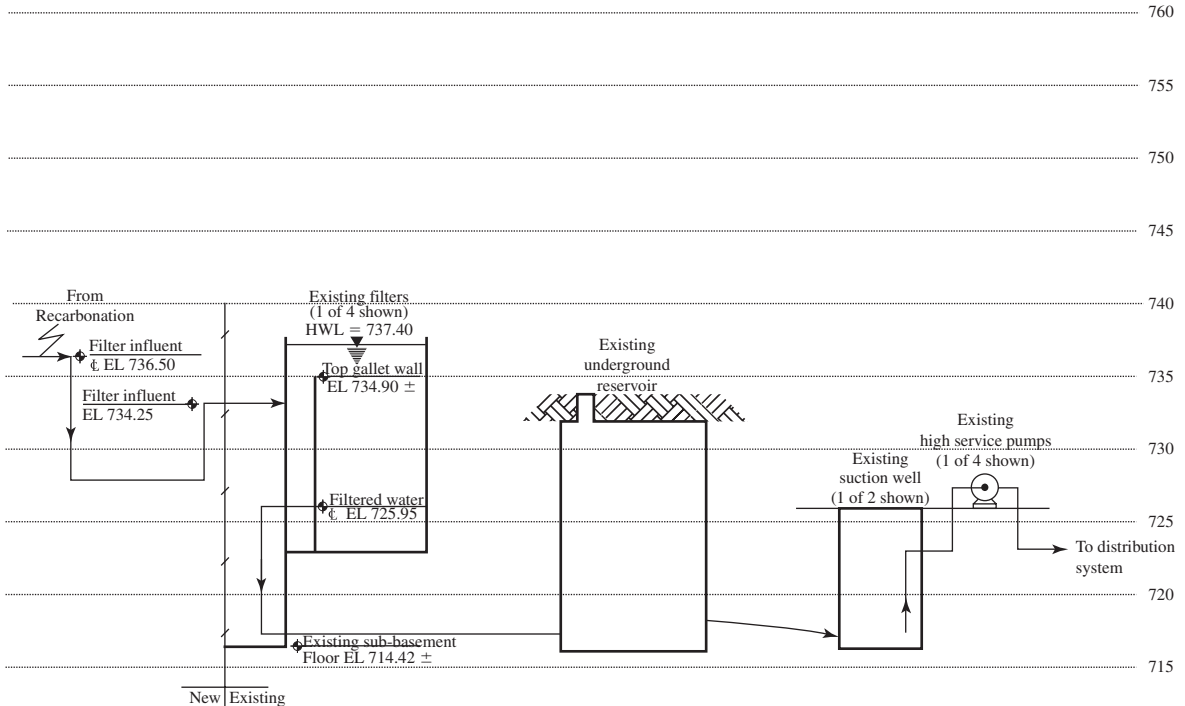
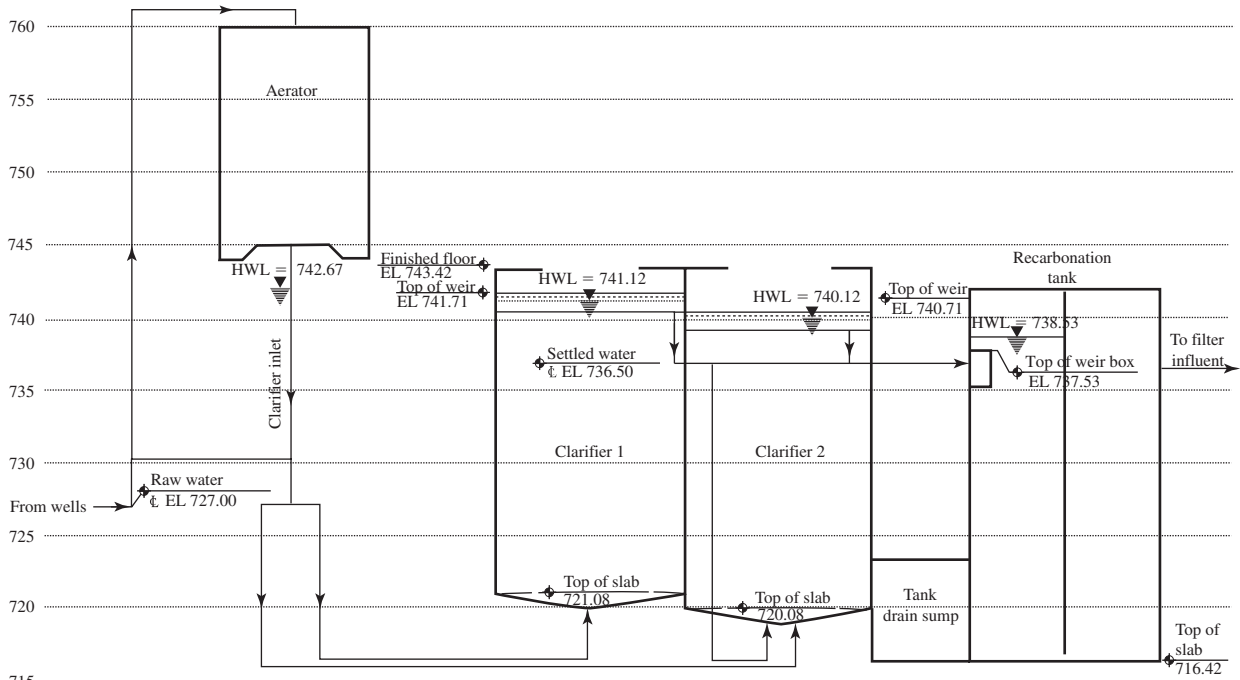

FIGURE 16-9
Typical hydraulic grade line for a softening plant.

Ideally, the water flows through the plant by gravity after it is pumped to the head end of the plant. This minimizes the number of pumps to move the water through the plant. The elevation of the surface of the water as it flows through the plant follows the hydraulic grade line. These elevations are set by the design based on calculations of headloss through the various structures of the plant. Once the headlosses are known, the elevations of the surface water are set by working from a selected elevation for the discharge from the rapid sand filter or from a selected elevation for the influent to the plant. The elevation of the water surface in each process upstream is set to overcome the headloss in moving the water to the next downstream process.

Some of the headloss calculations have already been demonstrated (e.g., for pipes, baffle walls, and the rapid sand filter in Chapters 3, 6, and 11, respectively). Other headlosses that need to be estimated are the losses in the orifice weir from settling tanks and the losses in channels leading from one process to another. The losses in the orifice weir may be estimated with Equation 6-18, repeated here:

$$Q_{\text{orifice}} = C_d A (2gh)^{1/2} \quad (16-1)$$

where Q = flow rate through orifice, m^3/s

C_d = coefficient of discharge

A = area of orifice, m^2

g = gravity acceleration = 9.81 m/s^2

h = headloss through the orifice, m

The coefficient of discharge varies from 0.60 to 0.80. The estimate of orifice headloss is illustrated in Example 16-1.

Example 16-1. Design the orifice for Stillwater's launders (Example 7-4). Assume the orifices are 5 cm in diameter and that they are placed 0.30 m on centers. From Example 7-4, there are six tanks for the design flow rate of $43,200 \text{ m}^3/\text{d}$ and each tank has 55.5 m of launder.

Solution:

- a. Estimate the number of orifices per tank.

$$(55.5 \text{ m of launder})(2 \text{ sides per launder}) = 111.0 \text{ m}$$

At 0.30 m intervals, the number of orifices is

$$\frac{111.0 \text{ m}}{0.30 \text{ m/orifice}} = 370 \text{ orifices}$$

- b. Determine the flow rate per tank in compatible units with Equation 16-1, i.e. in m^2/s .

$$\frac{43,200 \text{ m}^3/\text{d}}{(6 \text{ tanks})(86,400 \text{ s/d})} = 0.0833 \text{ m}^3/\text{s per tank}$$

- c. Estimate the flow rate per orifice.

$$\frac{Q}{N} = \frac{0.0833 \text{ m}^3/\text{s per tank}}{370 \text{ orifices per tank}} = 2.25 \times 10^{-4} \text{ m}^3/\text{s} \cdot \text{orifice}$$

- d. Calculate the area of each orifice.

$$A = \frac{\pi(0.05 \text{ m})^2}{4} = 1.963 \times 10^{-3} \text{ m}^2$$

- e. Calculate the headloss for one orifice using a coefficient of discharge of 0.60.

$$h = \frac{1}{2(9.81 \text{ m/s}^2)} \left(\frac{2.25 \times 10^{-4} \text{ m}^3/\text{s}}{(0.60)(1.963 \times 10^{-3} \text{ m}^2)} \right)^{1/2}$$

$$= 0.022 \text{ m or } 2.2 \text{ cm or } 2 \text{ cm}$$

Because the orifices are all at the same elevation, this is the headloss for water flowing out of the sedimentation tank into the launder. A sketch of the cross section of the launder and the water levels in the tank and launder are shown below.

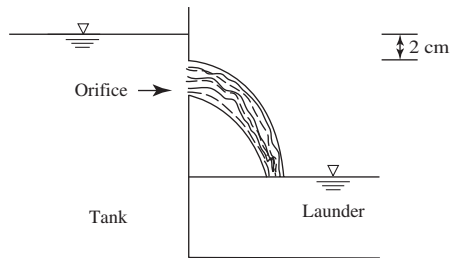

Comment. This is a theoretical estimate. Corrosion or encrustation of the orifice will change the diameter and, thus, the headloss. A safety factor of 2 in the estimated headloss is not unreasonable. This would yield an estimate of 4 cm headloss.

The headloss in the fall of the water from the orifice to the surface level of the water in the launder requires an estimate of the depth of water in the launder. This is, in essence, a design of the launder width and depth. This is an open channel flow problem. The flow in an open channel may be estimated using Manning's equation:

$$Q_{\text{channel}} = \frac{1.00}{n} (A)(R)^{2/3} S^{1/2} \tag{16-2}$$

- where Q_{channel} = flow rate in channel, m^3/s
 n = Manning's coefficient, dimensionless
 A = cross-sectional area of flow, m^2
 R = hydraulic radius, m
 = A/P
 P = wetted perimeter, m
 S = slope of bottom of the channel, m/m

The coefficient 1.00 has implicit units of $\text{m}^{1/3}/\text{s}$. The wetted perimeter is the perimeter where the water is in contact with walls and floor of the channel. Manning's n is taken as 0.012 for finished concrete and 0.018 for steel. The estimate of the surface water level in a launder is illustrated in Example 16-2.

Example 16-2. Estimate the cross-sectional dimensions of a launder for Stillwater's (Examples 7-4 and 16-1) settling tank and estimate the maximum depth of water in the channel. Assume the launder channel is steel and has a slope of 0.002 m/m and a freeboard of 10 cm above the water level in the settling tank.

Solution:

- An iterative solution is required because neither the depth or width of the flow in the channel is known. The approach used here is to assume a channel width in the range of nominal values (i.e., 0.30 to 0.60 m) and use a spreadsheet tool such as Solver* to determine the height of the water for a solution to Manning's equation.
- From Example 7-4, the design flow rate is 43,200 m³/d for six tanks and there are three launders per tank. The flow rate at a launder exit is then:

$$Q_{\text{channel}} = \frac{43,200 \text{ m}^3/\text{d}}{(6 \text{ tanks})(3 \text{ launders})(86,400 \text{ s/d})} = 0.02778 \text{ m}^3/\text{s}$$

- Using the sketch below and assuming a channel width of 0.45 m, the cross-sectional area of the water flow is

$$A = (0.45 \text{ m})(y)$$

where y is the depth of flow.

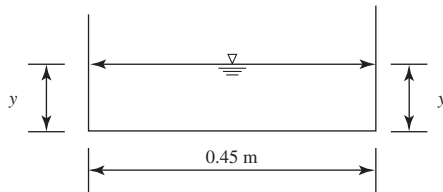

- The wetted perimeter is then

$$P = 0.45 \text{ m} + 2(y)$$

- The hydraulic radius is

$$R = \frac{(0.45 \text{ m})(y)}{0.45 \text{ m} + 2(y)}$$

- For steel, Manning's $n = 0.018$.
- With the variables defined, Manning's equation is

$$0.0278 \text{ m}^3/\text{s} = \frac{1.00}{0.018} [(0.45 \text{ m})(y)] \left[\frac{(0.45 \text{ m})(y)}{0.45 + 2(y)} \right]^{2/3} (0.002)^{1/2}$$

*Solver is a tool in Excel®. Other spreadsheets may have a different name for this program.

h. Simplifying in terms of the variable y ,

$$\frac{(0.0278 \text{ m}^3/\text{s})(0.018)}{(1.00)(0.45 \text{ m})(0.002)^{1/2}} = 0.0248 = (y) \left[\frac{(0.45 \text{ m})(y)}{0.45 + 2(y)} \right]^{2/3}$$

- i. The right-hand side of the equation was entered in a spreadsheet with a starting value of $y = 0.30$ and goal value of 0.0248. The Solver solution is $y = 0.22219 \text{ m}$ or 0.22 m.
- j. Combining the results from Example 16-1 and the width and depth found here yields a cross section as shown in the following sketch:

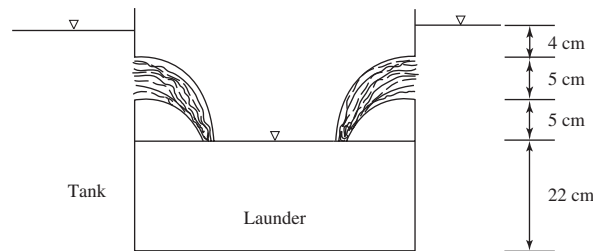

k. Using the sketch above, the headloss for the settling tank outlet is then:

$$4 \text{ cm} + 5 \text{ cm} + 5 \text{ cm} = 14 \text{ cm or } 0.14 \text{ m}$$

Comment. This is an approximate solution because it ignores the fact that there will be a back-water curve in the launder. A more exact solution may be found using the techniques described by Reynolds and Richards (1996).

Example 16-3 illustrates the construction of the hydraulic grade line.

Example 16-3. Estimate the elevations and plot the hydraulic grade line for a small softening plant given the dimensions and headloss data shown below. The top of the clearwell storage tank is at an elevation of 180.88 m above mean sea level. The weir controlling the water level in the clearwell is set 2.00 m below the top of the tank.

Tank vertical dimensions and headloss data

Tank	Overall height, m	Water depth, m	Headloss, m
Upflow solids contact	7.50	6.87	0.14
Recarbonation	3.50	2.50	0.14
Rapid sand filter	4.80	3.50 ^a	3.50

^a Water depth is measured from the filter floor, i.e., the bottom of the drainage blocks.

Solution:

- a. Begin with the top of the tank (elev. 180.88 m). The weir is set 2.00 m below the top of the clearwell at elevation 178.88 m.

- b. The bottom of the rapid sand filter is level with the weir at elevation 178.88. At the maximum head on the filter, the water level is 3.50 m above the bottom of the filter box. This water level is at an elevation of 182.38 m. The filter box is 4.80 m deep, so the top of the filter box is at an elevation of $178.88 + 4.80 = 183.68$ m.
- c. The headloss across the recarbonation chamber is 0.14 m. The water surface in the recarbonation chamber is placed 0.14 m above the maximum water level in the rapid sand filter. This yields a water elevation of $182.38 \text{ m} + 0.14 \text{ m} = 182.52$ m. The overall height of the recarbonation chamber is 3.50 m and the water depth is 2.50 m. Thus, the water surface is 1.00 m below the top of the chamber. This places the top of the chamber at an elevation of $182.52 \text{ m} + 1.00 \text{ m} = 183.52$ m and the bottom of the chamber at an elevation of $182.52 \text{ m} - 3.50 \text{ m} = 180.02$ m.
- d. The headloss across the upflow solids contact basin is 0.14 m. The water surface in the upflow solids contact basin is placed 0.14 m above the maximum water level in the recarbonation chamber. This yields a water elevation of $182.52 \text{ m} + 0.14 \text{ m} = 182.66$ m. The overall height of the upflow solids contact basin is 7.50 m and the water depth is 6.87 m. Thus, the water surface is 0.63 m below the top of the upflow solids contact basin. This places the top of the upflow solids contact basin at an elevation of $182.66 \text{ m} + 0.63 \text{ m} = 183.29$ m and the bottom of the chamber at an elevation of $183.29 \text{ m} - 7.50 \text{ m} = 175.79$ m.
- e. The profile of the hydraulic grade line is shown in Figure 16-10.

Comments:

1. Losses in pipes and conduits were ignored in this example. Although the distances between process units is generally not very large, significant losses can occur if the pipes are too small or if minor losses due to valves (especially those not fully open) are not taken into consideration.
2. V-notch weirs may be used instead of orifices.

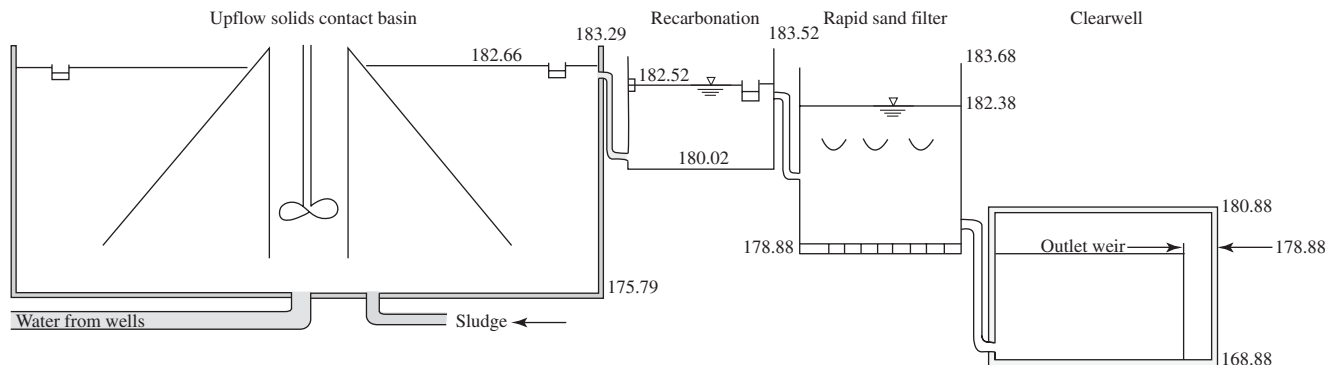

FIGURE 16-10

Hydraulic grade line for a small softening plant. Elevations are above mean sea level. See Example 16-3 for calculations.

Supervisory Control and Data Acquisition (SCADA)

Until the 1960s, almost all control of the operation of a water treatment plant was by manual methods either by direct operator intervention or by hard-wired electronic switches. The advent of modern computing technology has radically changed the design of process instrumentation and controls.

The current generation of control system software has evolved from the original *distributed control system* (DCS) that was developed for in-plant applications where high-speed networking was available to the SCADA systems that were originally developed for connection over low-speed data lines. Over time, the SCADA system and DCS have developed very similar capabilities. In the current literature, the SCADA terminology prevails. It will be used in this discussion with the understanding that it applies equally well to DCS.

This discussion is an overview. In keeping with the second canon of the code of ethics, the design of the instrumentation and control system must be conducted by instrumentation and control system engineers. Instrumentation, programming, configuration, and other details of the SCADA system will not be covered in this discussion. The chapter by Kubel (2005) and publications of AWWA (1993, 2001) provide a more comprehensive discussion of instrumentation and controls.

For convenience, a glossary of abbreviations and terms used in describing SCADA is presented in Figure 16-11.

Driving Forces for Implementing SCADA. There are a number of engineering and business reasons for implementing a SCADA system (Kubel, 2005):

- *A need for improved treatment quality.* Modern automation and control allows closer and more consistent water treatment than is possible with manual operation.
- *Tighter regulatory requirements.* As sampling and record keeping requirements increase, significant labor savings can result from adding on-line instruments with automatic data logging.
- *A need to reduce costs.* Some cost savings through automation include reduced chemical usage, reduced equipment wear, and optimization of energy usage.

Field bus—digital communication to field devices
GUI—graphical user interface
HOA—three-way switch (Hand-Off-Auto) that allows manual (Hand) operation, turns the unit off, and automatically (Auto) runs the operation
LOI—local operator interface
MCC—motor control center
PDA—pocket computer (personal data acquisition)
PI—proportional control algorithm
PID—proportional/integral/derivative control algorithm
PLC—programmable logic controller
RTU—remote terminal unit
SP—set point
UPS—uninterruptible power supply

FIGURE 16-11
Glossary of SCADA terms.

- *Improved labor efficiency.* Labor savings are achieved by automating tasks and providing data that allows operators to anticipate equipment failure and perform preventive maintenance.
- *Quicker response to emergencies.* Centralized control can reduce the time to make changes in water production during a crisis.

Hierarchy of Control. Water treatment plants often use a combination of manual, semiautomatic, and fully automatic control. The hierarchy generally includes *local control* and *computer control*.

The local control includes, for example, manual controls on motor starters, valve actuators, and pumps. Operators can set such things as variable-frequency drive (VFD) motor speeds and chemical flow rates. It also includes hard-wired interlocks to function when the computer systems are not in service and to protect personnel while they work on equipment.

Computer control generally includes all fully automatic operations, manual operation from the computer keyboard, and optimization by computer algorithms.

Types of Control Algorithms. Some example algorithms include sequencing for start-up and shut-down of processes and continuous control of process operation. The common algorithms are *feed-forward*, *feed-back*, *proportional*, and *compound control*.

An example of a feed-forward system is the polymer feed shown in Figure 16-12. The polymer flow is maintained at a fixed ratio to the main flow into the mixing tank. The rate controller [$F(\text{flow})$] continuously computes the required polymer flow based on the main line flow.

An example of the feed-back system is the level controller shown in Figure 16-13. The operator enters a level *set point*. The controller continuously measures the level in the tank. If the tank level is higher than the set point, the controller adjusts the valve to reduce the flow. If the tank level is low, the controller opens the valve.

Proportional control adjusts the controlled device as a proportion of the measured process variable. In contrast to the ratio system, the change in the controlled device rises or falls with a change in the measured variable according to some mathematical relationship (e.g., rate of change, power law, exponential, or cubic spline). The PID offers integration or differentiation algorithms to refine the control process. For example, if the process variable changes rapidly, controller output is reduced by an amount proportional to the rate of change.

Compound control is a combination of techniques. A common combination is feed-forward plus feed-back. In a highly nonlinear system such as pH control, feed-forward plus feed-back and a proportional nonlinear algorithm reduces overshoot and hunting by the feed pumps. Chlorination systems with compound control are also favored to maintain adequate residuals without over-dosing.

Typical Water Treatment Control Strategies. The following outline provides examples of control of some generic water treatment processes (Kubel, 2005).

- *Raw water pump control.* Typically the operator sets the desired plant influent flow. This becomes a flow set point to a feed-back flow controller.
- *Coagulation.* Coagulant and polymers are fed using flow or flow/turbidity feed-forward control. Alternatively, feed-back from a streaming current detector is used.

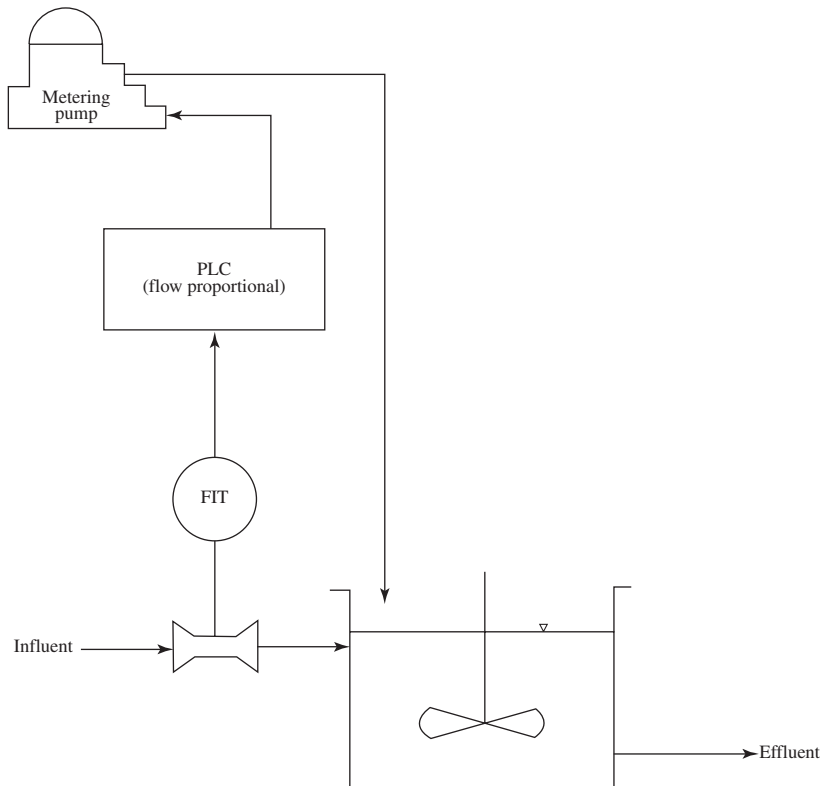

FIGURE 16-12
Feed-forward control example: polymer dosing.

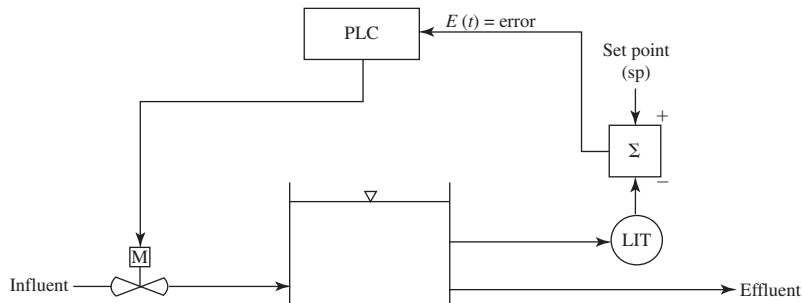

FIGURE 16-13
Feed-back control example: tank level control. FIT = flow indicating transducer; LIT = level indicating transducer.

- *Filtration.* The number of filters required online is determined by the plant flow and the optimum flow per filter. In a cascade level flow control, a level signal from the influent channel is transmitted to a PI level controller. The controller output adjusts the flow set points for the individual filter flow controllers.

A schematic diagram of the principal functions of a monitoring and control system are shown in Figure 16-14.

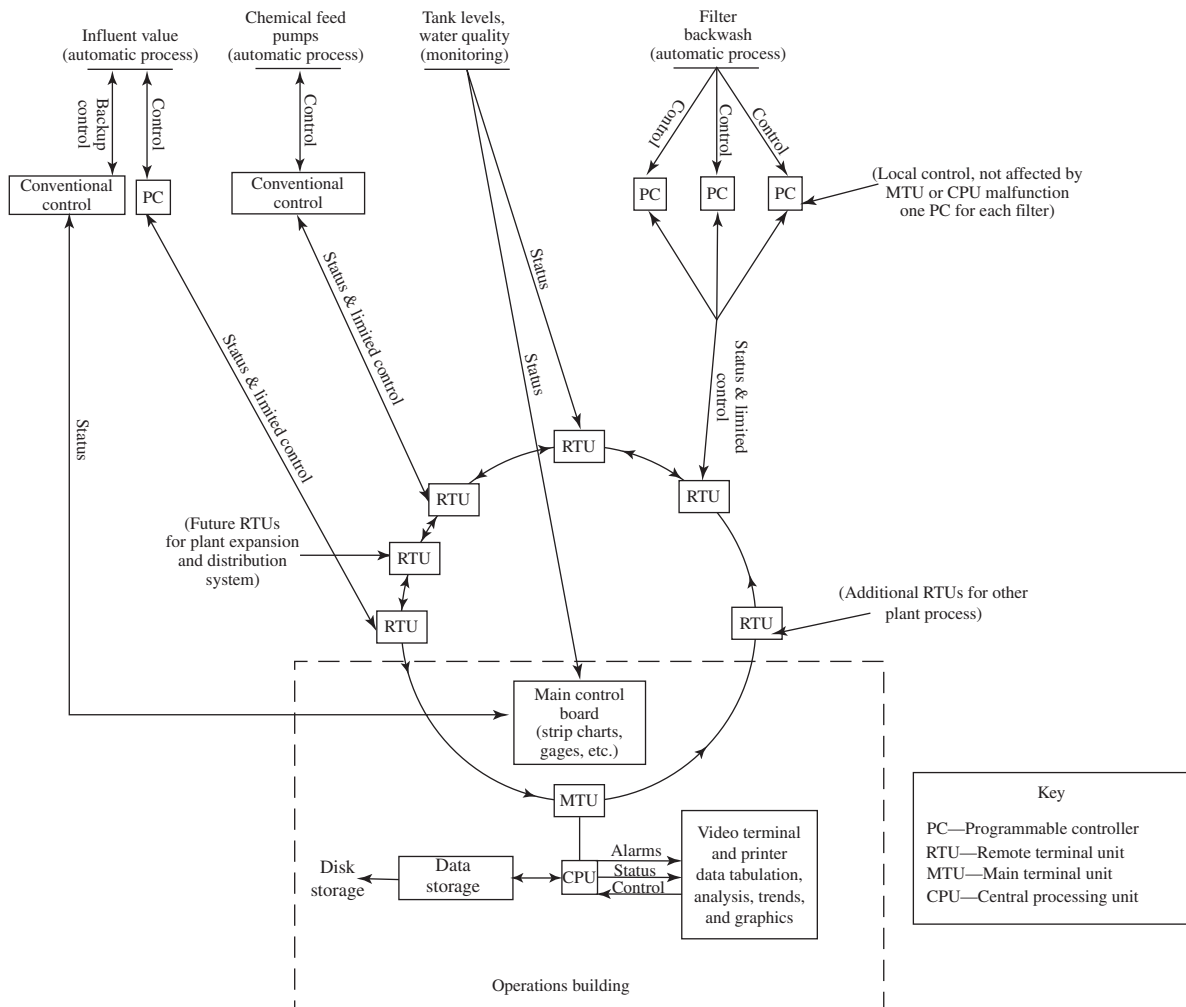

FIGURE 16-14
Schematic diagram of principal functions of a monitoring and control system.

Control System Hardware. Of the many pieces of hardware involved in a SCADA system, three have been selected for discussion here because of their widespread application.

- *PLCs.* Programmable logic controllers are industrial-grade special-purpose microcomputers with input/output (I/O) subsystems for monitoring and controlling process equipment.
- *RTUs.* Remote terminal units were originally designed to be installed at remote sites and linked to a central station by low-speed telephone or radio. They originally were designed to gather status data and had limited or no control capability. As of 2005, RTUs have become more sophisticated. They have better communications capability than PLCs, such as multiple communications port access from multiple other sites. The differences between RTUs and PLCs has diminished over the past few years and will continue to do so.

- *Field bus.* This technology provides digital communication technology to field devices. The use of this technology has been driven by the desire to reduce cabling cost. The data speed ranges from 1.2 kb/s to 31.25 kb/s and maximum distances range from 100 m to 1,900 m.

System Design Considerations. The process flow diagram prepared by the project engineer is the basis for the instrumentation and controls engineer to begin the design. In the design process, the following documents are usually produced in the sequence listed below (Kawamura, 2000):

1. Process and instrumentation diagram (P&ID).
2. Process control diagram (PCD).
3. Instrumentation input-output summaries (IIOs).
4. Instrumentation specification sheets (ISSs).
5. Logic diagrams.
6. Panel layout drawings.
7. Loop interconnection drawings (LIDs).
8. Instrumentation installation details (IIDs).

Because of the rapidity with which computer technology changes, designs that are made two or three years before the project is built may be obsolete before they are installed. For that matter, just a few years after the project is built, the technology will have advanced and obsolescence will begin to set in. There is no particular strategy that is completely acceptable in solving this dilemma. In so far as possible, open-ended systems capable of expansion should be specified. The owner/operator must be realistic in expectations and be prepared for upgrades and renovation as part of the operation and maintenance budget.

Uninterruptible power supplies (UPSs) are essential because failure of the commercial power supply during critical operations will have catastrophic results on plant performance. The UPS capability should be such that it can last until the plant generator backup comes online. Conversely, the UPS should have a bypass switch to allow commercial power to feed directly to the load if the UPS electronics fail.

The control system is a weak link in the plant's security unless specific measures are taken to protect it. These are discussed in the next section.

Hints from the Field. The following hints are offered by those who have to live with SCADA systems:

- Existing facilities should, over several years, phase in SCADA in conjunction with capital improvement projects such as new pumps and feeders.
- Design redundancy into various aspect of the system in addition to the most critical plant and remote station processes. PLC/RTU units that archive files in flash memory ensure maximum data integrity in the event of a SCADA communication network failure.
- Establish a field instrument database for every field instrument and keep it maintained.
- Design a system that is not proprietary.

- Purchase PLC and computer control systems that can be expanded. Although current projects do not forecast appreciable growth in demand, increasing regulatory requirements, business requirements for better asset management, and data for capital improvement programs will become routine if they are not already routine.
- The life cycle of SCADA systems is about 7 to 10 years. Five years into the life of the system an assessment of the behavior of the SCADA system is warranted to address downtime frequency and duration, data holes, and failures that result from upgrades.

16-4 SECURITY

Introduction

Nothing can be made 100 percent secure, but security enhancement and risk reduction are possible. The challenge for the water utility and the design engineer is to provide an appropriate level of security by accounting for risk while balancing vulnerability, available capital, operating resources, and operation and maintenance issues. While this chapter focuses on the water treatment plant design, security issues for the utility are much broader and the techniques for addressing security go far beyond the fixed facilities provided in a design.

Like the discussion of SCADA, this discussion is an overview. Some of the pertinent issues will be highlighted, but many details will be left for other texts such as *Water Supply Systems Security* (Mays, 2004a). In a very broad sense, water supply security encompasses three areas: critical infrastructure; preparedness, response, and recovery; and communication and information. This discussion will, for the most part, be limited to critical infrastructure.

The Threats

The probability of a terrorist threat to drinking water is very low; however, the consequence could be extremely severe for exposed populations (Mays, 2004b). The threats to a water supply are summarized as:

- *Cyber threats.* These threats include disruption of the SCADA system.
- *Physical threats.* Destruction of elevated storage tanks, water mains, pumping stations, and chlorine storage facilities that either reduces water pressure and compromises fire fighting capabilities or releases toxic chlorine gas.
- *Chemical threats.* The injection of a wide variety of toxic compounds (either chemical warfare agents or industrial chemicals) that result in death or poisoning of large numbers of the population.
- *Biological threats.* Numerous pathogens common in developing countries but unseen in the United States for decades could, in very small doses, start an epidemic in an unprotected population.

Vulnerability Assessment

Title IV of PL 107-188 (Public Health, Security, and Bioterrorism Preparedness and Response Act, “Bioterrorism Act of 2002”) required community water systems serving populations greater

than 3,300 to conduct vulnerability assessments and submit them to the U.S. EPA by 2004. Assuming that these communities all did so, the assessments are available for review for renovation and expansion projects. Review of these assessments should be part of the planning process for new projects. For those projects where vulnerability assessments do not exist, the need for the plan should be discussed with the client as part of the planning process.

A number of assessment tools have been developed to assist communities in making the assessment. The U.S. EPA and the National Rural Water Association developed a self-assessment guide titled *Security Self-Assessment Guide for Small Systems Serving Between 3300 and 10,000*. These checklists and others are included in Mays (2004c). Commercial software tools such as Risk Assessment Methodology for Water Utilities (RAM-WSM), Vulnerability Self-Assessment Tool (VSAT), and ASSET are also available.

The assessment tools address the following areas of vulnerability:

1. Raw water source (surface or groundwater).
2. Raw water channels and pipelines.
3. Raw water reservoirs.
4. Treatment facilities.
5. Connections to distribution systems.
6. Pump stations and valves.
7. Finished water tanks and reservoirs.

Figure 16-15 illustrates a qualitative method for assessing asset-based vulnerability. In addition, especially for distribution systems, modeling is a proven method for assessing the systems response to an intrusion.

Layered Security

The strategy for providing security for the water treatment plant is called *layered security* based on the concept of “security in depth.” A typical water treatment plant may include four or five security access control levels (Booth et al., 2004):

Level 1 : Public zone.

The area outside of the perimeter fence. It is accessible to the public.

Level 2 : Clear zone.

The area between the fence and the locked building exterior.

Level 3 : Building lobby.

The area within the building, prior to access the circulation areas in the building.

Level 4 : Interior circulation area.

All the interior areas in the building that are readily accessible.

Level 5 : High value area.

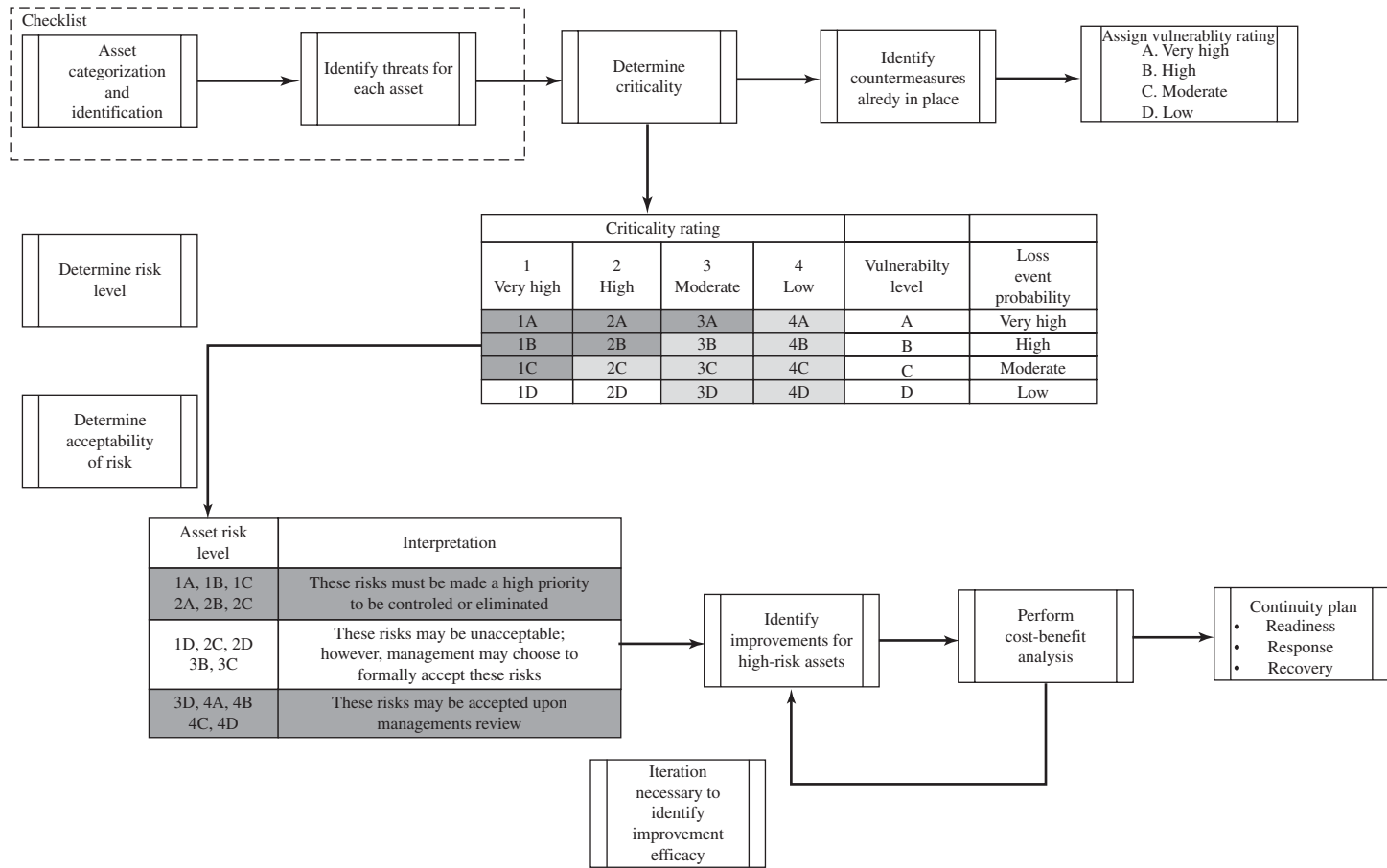

FIGURE 16-15
 Asset-based vulnerability analysis and response planning approach.

Interior areas that are restricted to those that need access. Examples include chemical storage and SCADA rooms.

Access control systems are based on something the individual possesses, something the individual knows, a physical attribute, or a combination of the three. Possession can be the simple act of having a key or identification card. Knowledge implies restricted information such as personal identification numbers (PIN) or passwords. Physical attributes include such biometrics as fingerprint scanning and iris mapping.

Physical Security. Fencing and controlled access gates at the boundary of the plant property provide the first layer of security. Although these can be easily breached, they do two things: (1) they inhibit random vandalism and (2) they make potential intruders aware that the facility is being protected and that other less obvious security measures are in place.

Locked doors and the absence of windows at ground level provide another layer of security. Key locks, key pads, and electrified locks that must be actuated internally each have their advantages and disadvantages.

Warning Systems. Another layer of security is provided by systems that alert personnel that individuals are seeking access. These include closed circuit television (CCTV) and access control systems (ACS). These may be coupled with speaker phone systems to make queries or motion detectors to alert the staff where access has been made.

Action Implementation. The effectiveness of the response to an intrusion is time dependent. Fully automated systems will lock down and alert appropriate authorities. Typical systems will require individuals to respond appropriately.

SCADA Security. Panguluri, Phillips, and Clark (2004) provide lists of observed SCADA vulnerabilities and steps to improve SCADA security. In general SCADA security guidance identifies the following design factors:

- SCADA control components should be in locked, access-controlled sites.
- Remote access for maintenance personnel and vendors should be tightly controlled.
- Multiple layers of access controls (filters, firewalls, etc.) should be built between business computing networks and the SCADA system.
- Network architecture should be reviewed by a certified security professional prior to design completion.
- Access to the SCADA operating system should be limited.
- System backups and restoration should be specified to recover from disasters.
- Connection between the SCADA system and the Internet should be limited or prohibited.

Table 16-10 is an example of layered access control.

TABLE 16-10
Water system—layered access control (example)

Security access zone	Affected areas	Access control process	Other complementary security measures
Level 1	Public areas outside perimeter fence	N/A—Public Zone	No trespassing signage, guard house with security officer checking vehicles
Level 2	Clear zone	N/A	High visibility site lighting Perimeter CCTV surveillance
Level 3	Building lobby area	Visual inspection by security officer (or staff member) Badge display Inspection of parcels, packages	CCTV surveillance of incoming personnel (body size and facial features) Hardened blast-resistant exterior doors, with electronic mortise locks Interlocked exterior and interior lobby doors Door switch devices
Level 4	Interior circulation corridor General mechanical spaces	Card access	Interior motion detection
Level 5	Chlorine storage areas SCADA workstation areas Laboratory areas Security equipment room	Card access + PIN	CCTV surveillance of high value areas

Adapted from Booth et al., 2004.

Visit the text website at www.mhprofessional.com/wwe for supplementary materials and a gallery of photos.

16-5 CHAPTER REVIEW

When you have completed studying this chapter, you should be able to do the following without the aid of your textbook or notes:

1. Explain the concepts of a treatment train and multiple barrier in designing a water treatment plant.
2. Given a precept of process selection, provide an example to explain it to a client.
3. Given a process flow sheet and source water characteristics, identify the water quality characteristics or upstream processes that point to the selection of each of the processes.
4. Define the terms DCS and SCADA and explain how they relate to the engineering and business decisions for water treatment system design.
5. Explain the difference between local control and computer control of processes.
6. Explain the difference between feed-forward, feed-back, and proportional control systems.

7. Given a simple process description such as pump control or reservoir volume, select an appropriate algorithm for controlling it from the following four choices: feed-forward, feed-back, proportional, and compound control.
8. Define the terms PLC and RTU.
9. List the three broad areas included in providing water system security.
10. Explain the need for a vulnerability assessment and describe a simple qualitative assessment strategy.
11. Explain the concept of layered security and give some examples.

With the aid of this text, you should be able to do the following:

12. Given a process flow sheet and source water characteristics, identify alternative processes that may have or should have been considered.
13. Given a source water quality characteristics and design criteria, perform a screening analysis to select an initial set of processes for further evaluation.
14. Given a selected list of processes, organize them into a treatment train and draw and label a process flow diagram.
15. Design an orifice weir for a launder.
16. Design the launder cross section.
17. Sketch and label the hydraulic gradient given the elevations and headlosses for each of the processes.

16-6 PROBLEMS

- 16-1. In Case Study 16-2, DAF was selected as part of the residuals treatment process. Explain what water quality characteristic points to the selection of this process.
- 16-2. In the water treatment flow sheet from the Chino Basin in California shown in Figure P-16-2, identify the possible water quality characteristics that point to the following selected processes:
 1. Ion exchange.
 2. RO.
 3. Air stripping following RO.
- 16-3. In the water treatment flow sheet from the Chino Basin in California shown in Figure P-16-3 on page 16-38, identify the possible water quality characteristics that point to the following selected processes:
 1. Air stripping at the beginning of the plant.
 2. Bypass of the other treatment processes after air stripping.
 3. Ion exchange.
 4. RO.
 5. Air stripping following RO.

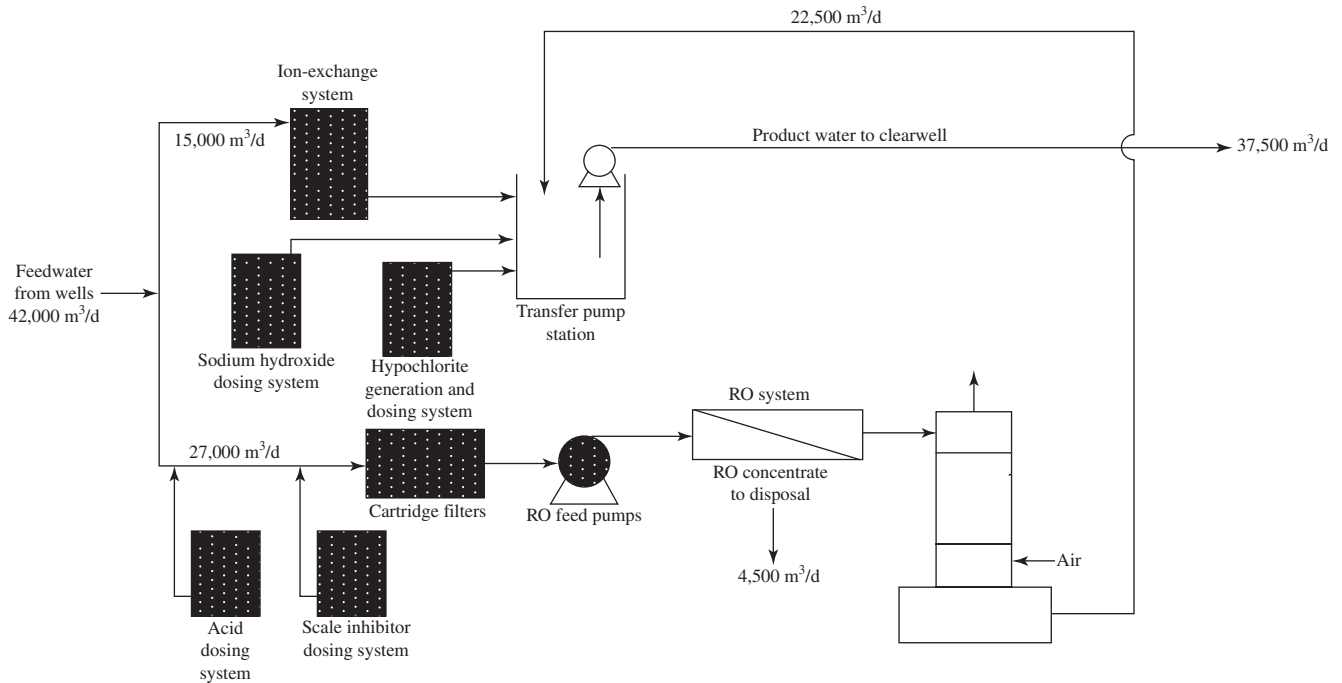

FIGURE P-16-2
Chino II WTP.

- 16-4.** The Minneapolis Water Works (MWW) operates two plants rated at 360,000 m³/d and 265,000 m³/d. Both plants draw water from the Mississippi River. Upstream discharges in the watershed include agricultural runoff, power plant cooling water, and wastewater treatment plant discharges. The raw water quality often changes rapidly. This is particularly true during spring snow melt. The table below summarizes the raw water quality.

Mississippi River water quality at Minneapolis, Minnesota

Parameter	Maximum	Minimum	Average
Color, apparent color units	115	17	40
Turbidity, NTU	52.5	1.5	9.8
Total organic carbon, mg/L	15	8	10
Hardness, mg/L as CaCO ₃	236	89	170
Total dissolved solids, mg/L	200	800	150
pH	8.9	7.7	8.3
Temperature, °C	30.7	0	11.7

Adapted from Pressdee, Rezania, and Hill (2005).

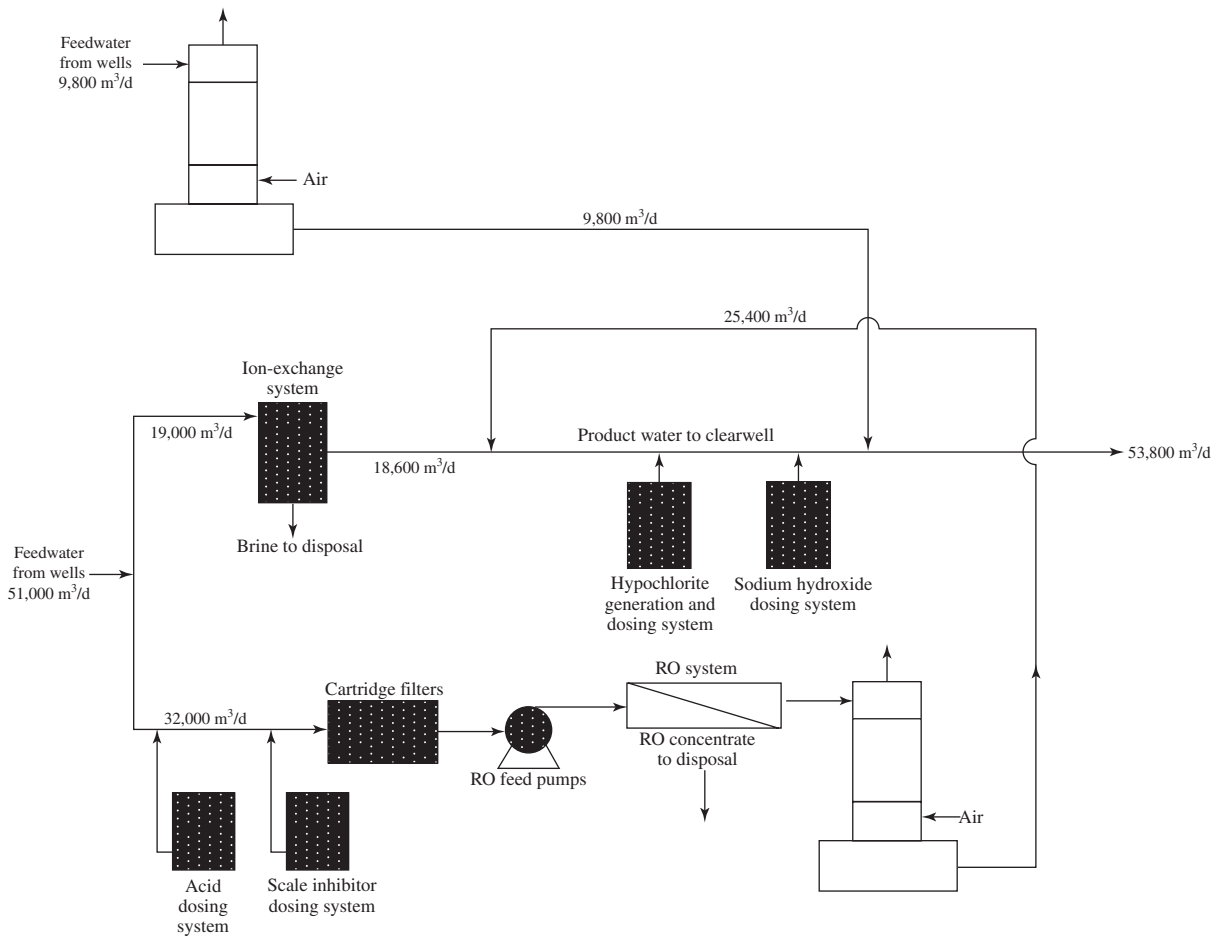

FIGURE P-16-3
Chino I WTP.

MWW established the following criteria for evaluation of alternatives to upgrading the plant:

- Compliance with current and future regulations.
- Reliability to produce a high-quality water free of taste and odor and *Cryptosporidium*.
- Compatibility with future regulatory changes and technological developments with particular emphasis on *Cryptosporidium*.
- Increased use of technology to compensate for reduced staffing levels.
- Costs that were commensurate with the levels of reliability of the alternative.

The process flow diagram for the existing process is shown in Figure P-16-4.

As part of the initial screening process, develop a short list (six or less) of process alternatives to be considered.

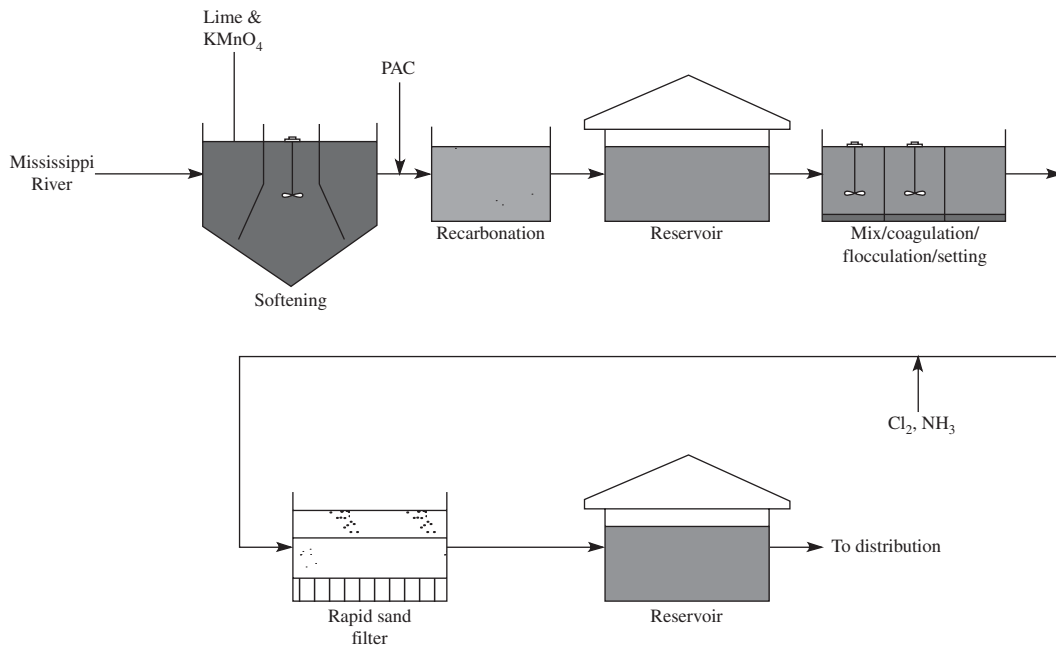

FIGURE P-16-4
MWW WTP.

- 16-5.** In Case Study 16-2, DAF was selected for dewatering in the residuals treatment train. Suggest two other appropriate alternatives that might appear on a preliminary screening list.
- 16-6.** Propose a screening list of treatment options for a community supply, including treatment trains for the following surface water quality characteristics. Assume a population of 10,000.

Parameter	Value, mg/L as CaCO_3
Calcium	111
Magnesium	56
Sodium	63
Potassium	5
Bicarbonate	110
Sulfate	100
Chloride	15
Nitrate	10
Phosphate	1
pH	7.0
Temperature	4–26°C
TOC	10 mg/L
Turbidity	7 NTU

- 16-7.** Propose a screening list of treatment options for a community supply including treatment trains for the following well water quality characteristics. Assume a population of 35,000.

Parameter	Value, mg/L as CaCO ₃
Calcium	153
Magnesium	115
Sodium	438
Potassium	32
Bicarbonate	460
Carbonate	20
Sulfate	15
Chloride	239
Nitrate	1.8
Fluoride	0.4
Carbon dioxide	22.6
Iron	0.15 mg/L
Manganese	0.20 mg/L
pH	7.8
Temperature	5–12°C
TOC	7.2 mg/L
Turbidity	1.5 NTU

- 16-8.** Propose a screening list of treatment options for a community supply including treatment trains for the following well water quality characteristics. Assume a population of 3,000.

Parameter	Value, mg/L as CaCO ₃
Calcium	318
Magnesium	51
Sodium	198
Potassium	12
Bicarbonate	200
Sulfate	151
Chloride	239
Nitrate	29
Fluoride	1.0
Carbon dioxide	2.0
Iron	0.13 mg/L
Manganese	0.01 mg/L
pH	7.5–8.3
Temperature	4–8°C
TOC	1.0 mg/L
Turbidity	1.0 NTU

- 16-9.** The city of Des Moines obtains its water from three sources: the Des Moines River, the Raccoon River, and an infiltration gallery. The source water is seasonally high in nitrate as shown in Figure P-16-9.

2006 Source water nitrate

Nitrate levels in water from the infiltration gallery are much less than those found in the rivers.

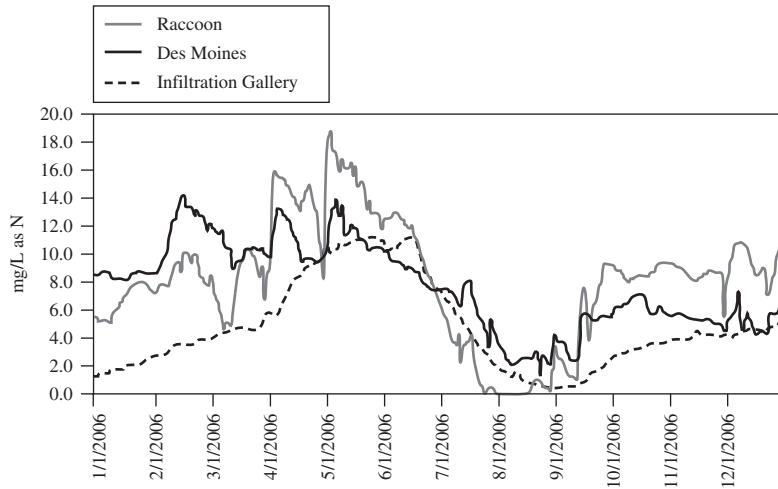

FIGURE P-16-9

Des Moines source waters.

(Source: Jones, Hill, and Brand.)

Suggest a treatment scheme, including a new ion exchange treatment process, and operational plan to keep the treated water nitrate concentration less than 10 mg/L as N while minimizing treatment costs. Assume that the ion exchange facility operating and amortization costs are three times that of the other facilities. The average demand is 113,000 m³/d. Use the following “worst case” production and nitrate assumptions:

Source	Q_{\max} , m ³ /s	Nitrate, mg/L as N
Des Moines River	2.2	14.0
Infiltration gallery	1.0	12.0
Raccoon River	1.0	18.0
Ion exchange	0.4	0.0

- 16-10.** Flint’s proposed process flow diagram is shown in Figure P-16-10. Identify the items missing from Kawamura’s list and mark where they should be on a copy of the process flow diagram.

City of Flint
Proposed water treatment
plant process schematic

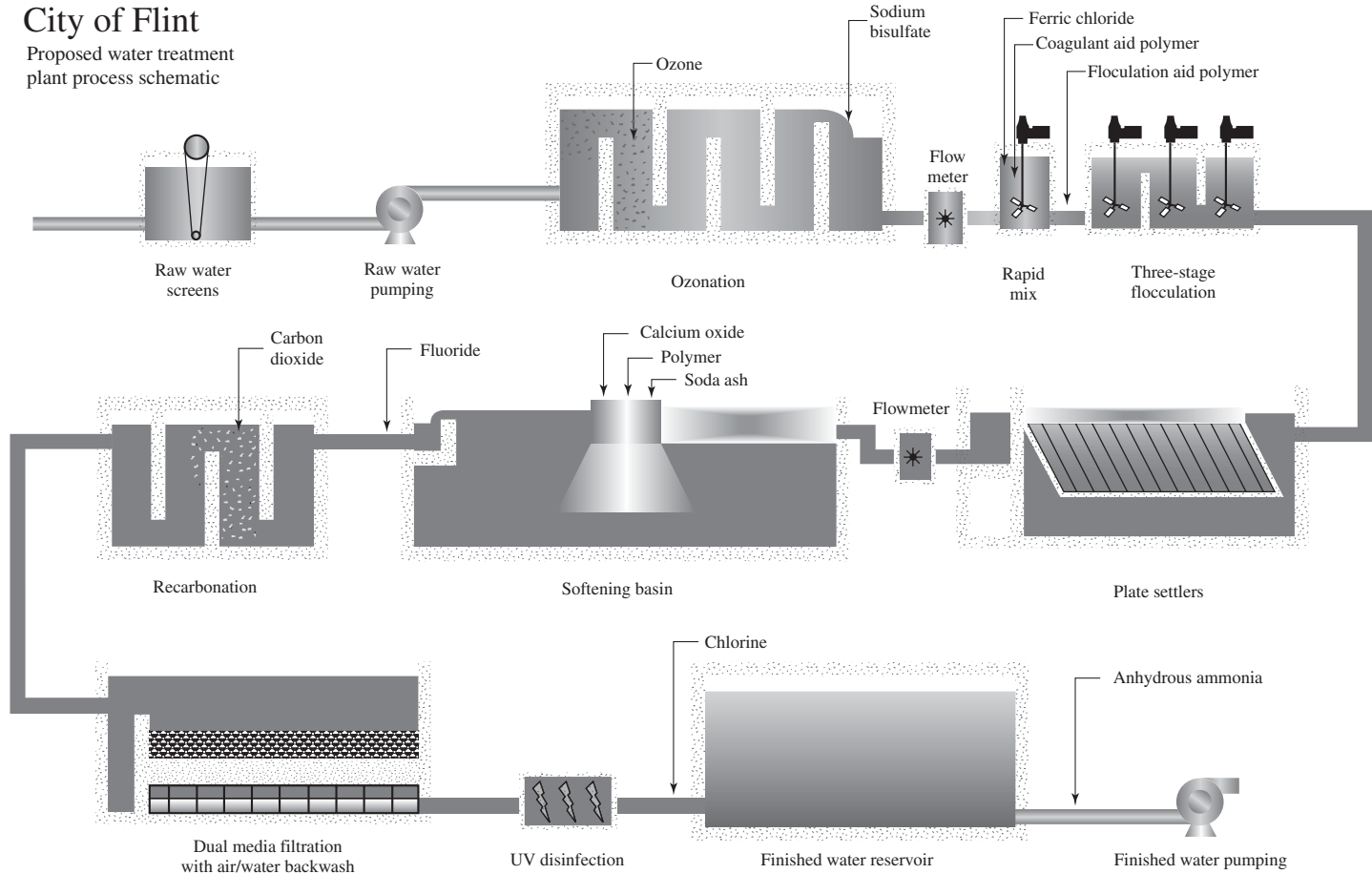

FIGURE P-16-10
Flint's WTP.

16-11. Thornton's process flow diagram is shown in Figure P-16-11. Identify the items missing from Kawamura's list and mark where they should be on a copy of the process flow diagram.

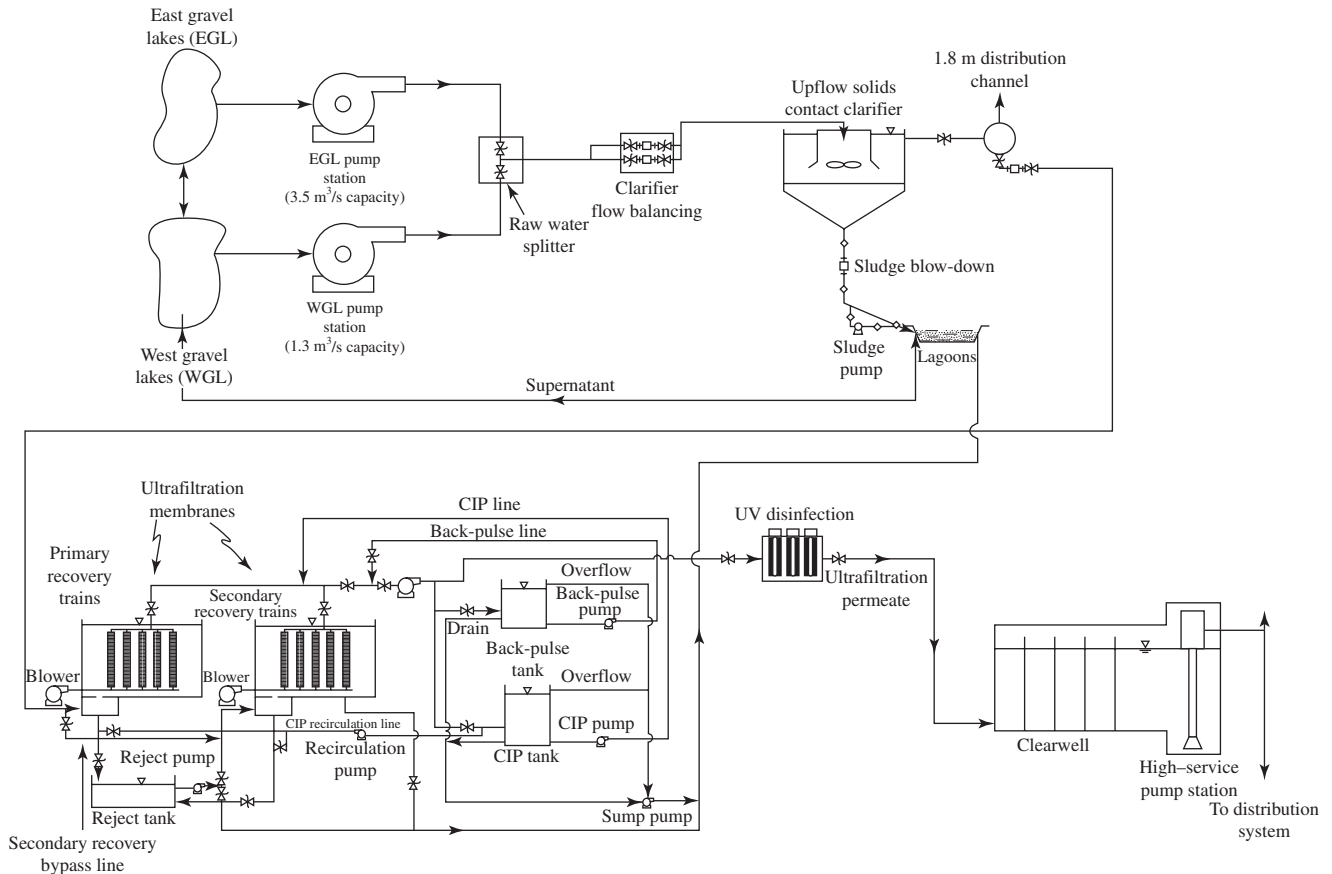

FIGURE P-16-11
Thornton's WTP.

16-12. Erie County Water Authority's Sturgeon Point Plant residuals handling process flow diagram is shown in Figure P-16-12. Identify the items missing from Kawamura's list and mark where they should be on a copy of the process flow diagram.

16-13. Des Moines residuals handling process flow diagram is shown in Figure P-16-13. Identify the missing items and mark where they should be on a copy of the process flow diagram.

16-14. Estimate the headloss in Stillwater's launder orifices (Example 16-1) assuming that the orifices become encrusted and are actually only 4.0 cm in diameter.

16-15. Design the orifice for Sweetwater's upflow clarifier weirs. The flow rate is $7,400 \text{ m}^3/\text{d}$. There are eight radial weirs. The center column of the upflow clarifier is 1.3 m in diameter. The tank is 12.0 m in diameter. Assume the orifices are 5.0 cm in diameter.

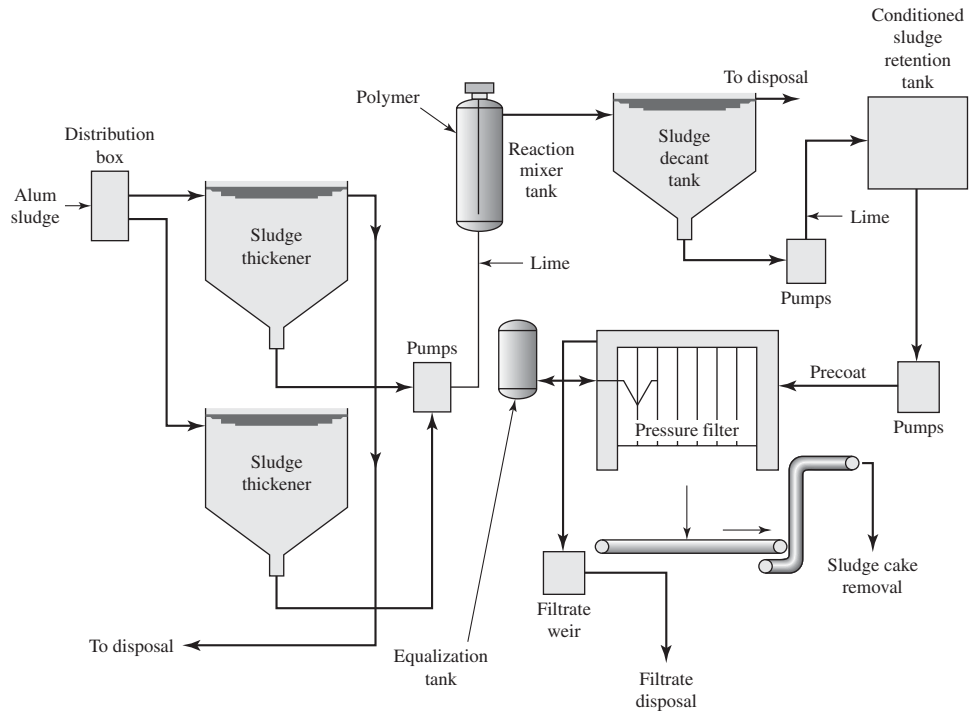

FIGURE P-16-12
Sturgeon Point WTP residuals handling.
(Source: Davis and Cornwell, 2008.)

- 16-16.** Determine the cross-sectional dimensions of the launders for Stillwater’s upflow clarifier (Problem 16-15).
- 16-17.** Determine the cross-sectional dimensions for the launders for a rectangular settling basin with a flow rate of 12,500 m³/d. There are three launders in the tank.
- 16-18.** Estimate the elevations to plot the hydraulic grade line for a small coagulation plant given the dimensions and headloss data shown below. The ground surface slopes from an elevation of 485.0 m to an elevation of 481.0 m above mean sea level. The top of the clearwell storage tank is 2.00 m below the ground surface. The weir controlling the water level in the clearwell is set 2.00 m below the top of the tank.

Tank profile dimensions and headloss data

Tank	Overall height, m	Water depth, m	Profile length, m	Headloss, m
Upflow solids contact	5.90	5.30	15.0	0.14
Recarbonation	5.18	4.57	24.0	0.14
Rapid sand filter	3.39	2.39 ^a	4.90	2.39

^a Water depth is measured from the filter floor, that is, the bottom of the drainage blocks.

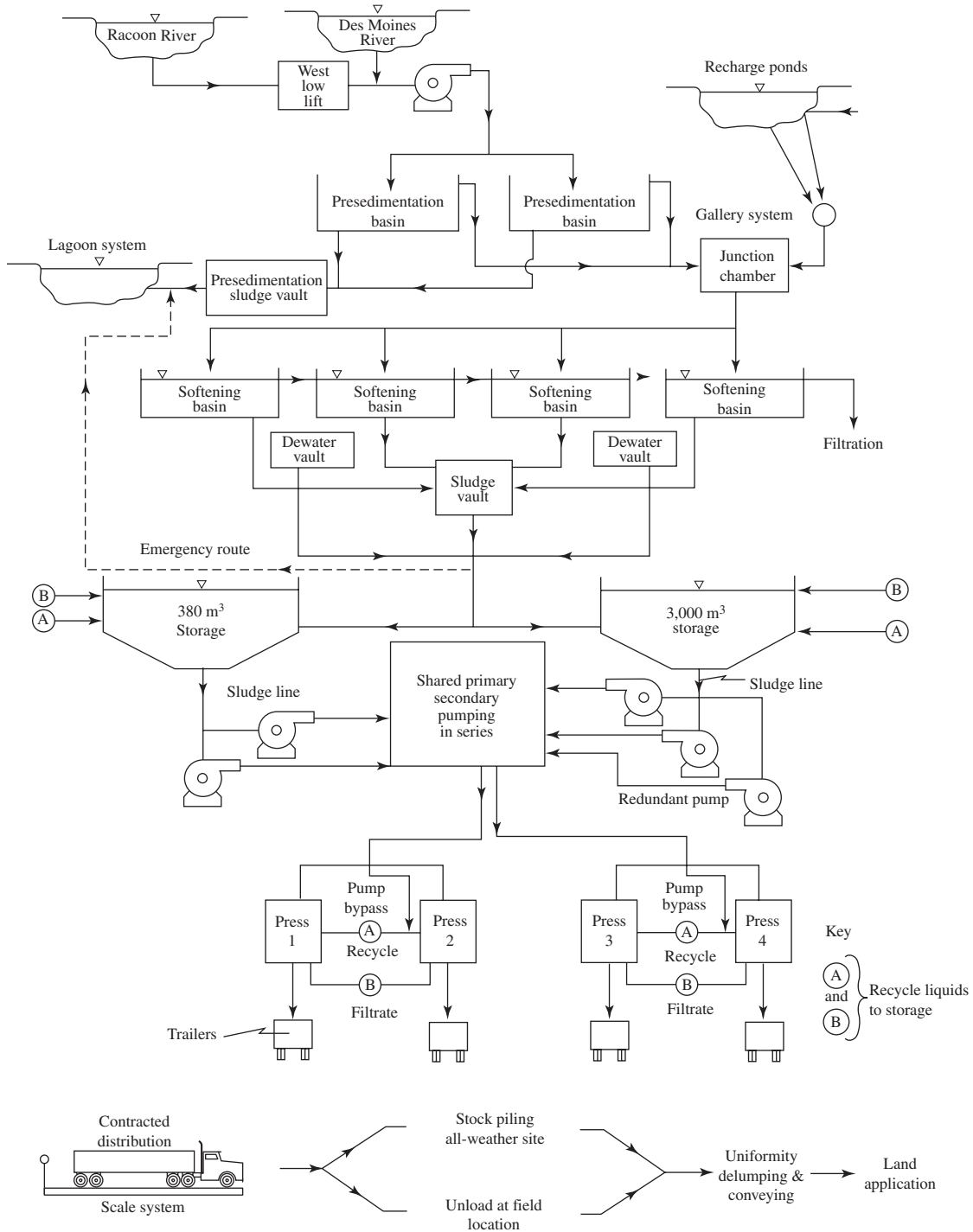

FIGURE P-16-13
Des Moines WTP residuals handling. Supernatant from storage is recycled to head end of plant.

Prepare a sketch drawing showing the hydraulic profile for the waster treatment plant with the vertical dimensions and headlosses.

- 16-19.** Locate the water treatment plant on the topographic map shown in Figure P-16-19 and estimate the elevations used to plot the hydraulic grade line for a small softening plant given the dimensions and headloss data shown below. Prepare a sketch showing the hydraulic profile for the waster treatment plant with the vertical dimensions and elevations. The 100 year flood elevation is 804 m. Water is to be pumped from the bottom of the filters to an elevated storage tank.

Tank profile dimensions and headloss data

Tank	Overall height, m	Water depth, m	Profile length, m	Headloss, m
Flash mix	3.00	2.20	1.0	0.05
Flocculation	7.50	6.87	25.0	0.45
Settling	3.50	2.50	33.5	0.14
Rapid sand filter	4.30	3.00 ^a	9.75	3.00

^aWater depth is measured from the filter floor, that is, the bottom of the drainage blocks.

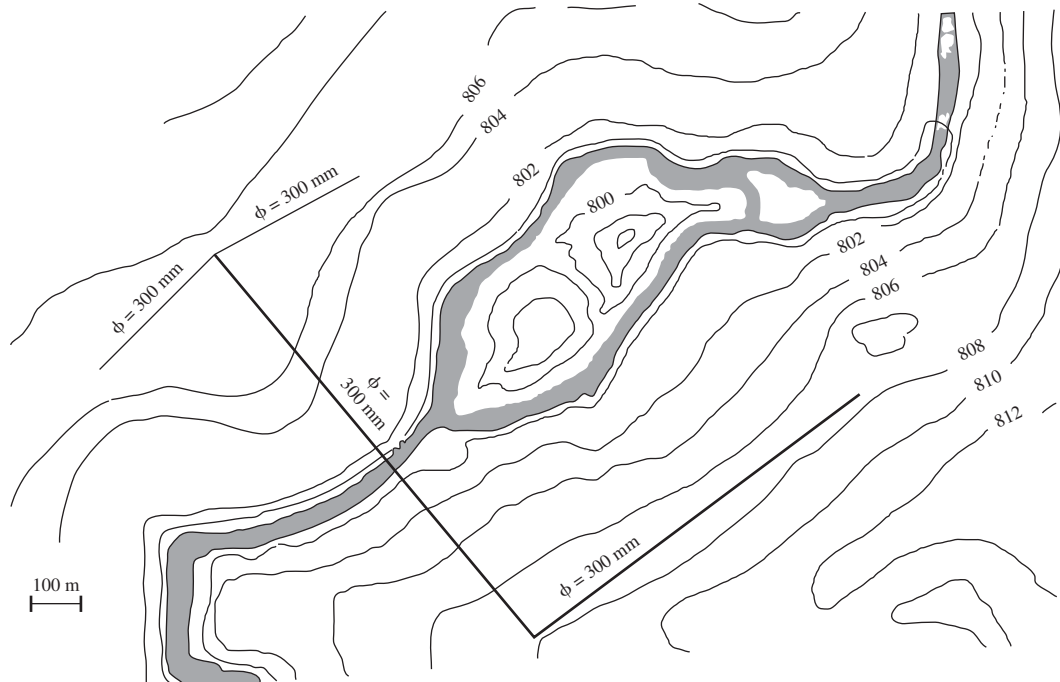

FIGURE P-16-19
Topographic map.

16-7 DISCUSSION QUESTIONS

- 16-1. In the Chino WTP processes (Problems 16-2 and 16-3), there is a cartridge filter upstream of the RO feed pump. Explain its purpose and why it is placed where it is.
- 16-2. The mayor has asked you to explain to the city council members how a SCADA system can save money. Prepare a written explanation with examples.
- 16-3. Match the following processes with the appropriate control algorithm.
 - a. Hypochlorite chlorinator Feed-forward
 - b. pH Compound
 - c. Alum feed Feed-forward plus feed-back with nonlinear algorithm
- 16-4. Explain why a PLC for a pump should have HOA capability.
- 16-5. What security access zone and access control should be recommended for the SCADA system?

16-8 REFERENCES

- AWWA (1993) *Instrumentation and Computer Integration of Water Utility Operations*, American Water Works Association, Denver, Colorado.
- AWWA (2001) *Instrumentation and Control*, Manual M2, American Water Works Association, Denver, Colorado.
- Barthuly, P. J. (2005) "Hydraulics," in E. E. Baruth (ed.), *Water Treatment Plant Design*, American Water Works Association and American Society of Civil Engineers, McGraw-Hill, New York, p. 16.1–16.15.
- Booth, R., A. Bowman, F. Gist, J. R. Ringold (2004) "Security Hardware and Surveillance Systems for Water Supply Systems," in L. W. Mays (ed.), *Water Supply Systems Security*, McGraw-Hill, New York, pp. 12.1–12.37.
- Christianson, M. and D. Origer (2007) "Going Wireless with SCADA Technology," *Opflow*, vol. 33, no. 7, pp. 10–12.
- Corbin, D. J. (2005) "Site Selection and Plant Arrangement," in E. E. Baruth (ed.), *Water Treatment Plant Design*, American Water Works Association and American Society of Civil Engineers, McGraw-Hill, New York, p. 23.1–23.37.
- Davis, M. L. and D. A. Cornwell (2008) *Introduction to Environmental Engineering*, McGraw-Hill, New York, p. 323.
- Fischer, P., M. Lichwardt, J. Dye, and B. Hart (2006) "Quenching Thornton's Thirst," *Civil Engineering*, vol. 76, no. 12, pp. 60–65.
- Jones, C. S., D. Hill, and G. Brand (2007) "Use a Multifaceted Approach to Manage High Source-Water Nitrate," *Opflow*, vol. 33, no. 6, pp. 20–22.
- Kawamura, S. (2000) *Integrated Design and Operation of Water Treatment Facilities*, 2nd ed., John Wiley & Sons, New York, pp. 65–72, 330–331.
- Kubel, D. (2005) "Process Instrumentation and Controls," in E. E. Baruth (ed.), *Water Treatment Plant Design*, American Water Works Association and American Society of Civil Engineers, McGraw-Hill, New York, p. 20.1–20.42.
- Logsdon, G., A. Hess, and M. Horsley (1999) "Guide to Selection of Water Treatment Processes," in R. D. Letterman (ed.), *Water Quality and Treatment*, 5th ed., American Water Works Association, McGraw-Hill, New York, pp. 3.1–3.26.
- Mays, L. W. (2004a) *Water Supply Systems Security*, McGraw-Hill, New York.

- Mays, L. W. (2004b) "Water Supply Security: An Introduction," in L. W. Mays (ed.) *Water Supply Systems Security*, McGraw-Hill, New York, p. 1.6.
- Mays, L. W. (2004c) "Vulnerability Assessment, Emergency Response Planning: Summary of What's Available," in L.W. Mays (ed.) *Water Supply Systems Security*, McGraw-Hill, New York, 3.1–3.42.
- McAllister, D. and R. Beavers (undated) "A New Approach to Lime Sludge Disposal," Des Moines Water Works, unpublished manuscript.
- Miller, C. L., S. Burton, and K. Manning (2007) "Preserving the Chino Basin," *Civil Engineering*, May, pp. 56–60.
- Monk, R. D. G. (1987) "Design Options for Water Filtration," *Journal of American Water Works Association*, vol. 79, no. 9, pp. 93–106.
- MWH (2005) *Water Treatment: Principles and Design*, John Wiley & Sons, Hoboken, New Jersey, p. 1860.
- NRC (1997) *Safe Drinking Water from Every Tap*, National Research Council, National Academy Press, Washington, D.C.
- Panguluri, S., W. R. Phillips, and R. M. Clark (2004) "Cyber Threats and IT/SCADA System Vulnerability," in L.W. Mays (ed.) *Water Supply Systems Security*, McGraw-Hill, New York, p. 5.8–5.9.
- Partinoudi, V. and M. R. Collins (2007) "Assessing RBF Reduction/Removal Mechanisms for Microbial and Organic DBP Precursors," *Journal of American Water Works Association*, vol. 99, no. 12, pp. 61–71.
- Pressdee, J., S. Rezania, and C. Hill (2005) "Minneapolis Water Works' Ultrafiltration Plant Gets Off to a Big Start," *Journal of American Water Works Association*, vol. 97, no. 12, pp. 56–63.
- Reynolds, T. D. and P. A. Richards (1996) *Unit Operations and Processes in Environmental Engineering*, PWS, Boston, pp. 311–313.
- Shih, J., W. Harrington, W. A. Pizer, and K. Gillingham (2006) "Economies of Scale in Community Water Systems," *Journal of American Water Works Association*, vol. 98, no. 9, pp. 100–108.
- Shorney-Darby, H., G. Dias, P. Ryan, C. Hidahl, R. Henderson, and K. Abraham (2007) "Expanding a Conventional Water Treatment Plant with Low-Pressure Membranes," *Journal of American Water Works Association*, vol. 99, no. 12, pp. 52–60.
- Sled, R. and G. Pierson (2007) "Teeing Off with a New Treatment Plant," *Opflow*, vol. 33, no. 8, pp. 26–29.
- Taylor, J. S. and M. Wiesner (1999) "Membranes," in R. D. Letterman (ed.), *Water Quality and Treatment*, 5th ed., American Water Works Association, McGraw-Hill, New York, pp. 11.1–11.68.
- Tufenkji, N., J. N. Ryan, and M. Elimelech (2002) "Bank Filtration," *Environmental Science & Technology*, vol. 36, November, pp. 423A–428A.
- Weiss, W. J., E. J. Bouwer, W. P. Ball, C. O'Melia, M. W. LeChevallier, H. Arora, and T. F. Speth (2003) "Riverbank Filtration—Fate of DBP Precursors and Selected Microorganisms," *Journal of American Water Works Association*, vol. 95, no. 10, pp. 68–81.

STORAGE AND DISTRIBUTION SYSTEMS

17-1 INTRODUCTION

17-2 DEMAND ESTIMATES

17-3 SERVICE PRESSURES

17-4 PIPE NETWORK DESIGN

17-5 STORAGE TANK DESIGN

17-6 PUMP SELECTION

17-7 NETWORK ANALYSIS

17-8 SANITARY PROTECTION

17-9 CHAPTER REVIEW

17-10 PROBLEMS

17-11 DISCUSSION QUESTIONS

17-12 REFERENCES

17-1 INTRODUCTION

Planning and design of a typical distribution system includes the following elements:

- Demand estimates including fire demand.
- Service pressures.
- Pipe network design.
- Storage tank design.
- Pump selection.
- Network analysis.
- Sanitary protection.

These are the topics of discussion for this chapter.

17-2 DEMAND ESTIMATES

The terms used in water distribution planning and design are defined in Table 17-1.

Demand estimating techniques were discussed in Chapter 2. These apply to the distribution system as well as the water treatment plant. The demand estimate for the distribution system differs in that, in addition to the total demand of the water distribution system, the individual demand of segments of the community must be estimated. Where the type of demand is similar, for example, domestic or commercial or industrial, broad *zones* or *districts* may be defined to establish the demand. If a decision has been made to provide water for fire protection, this demand must also be considered as part of the demand estimate. In larger distribution systems,

TABLE 17-1
Terms used in water distribution planning and design

Terms	Definition
Average day demand	The total annual quantity of water production for a municipality divided by 365.
Maximum day demand	The highest water demand of the year during any 24-hour period.
Peak hour demand	The highest water demand of the year during any one-hour period.
Peaking factor	The increase above the average annual demand experienced during a specified time period. Customarily, these are multipliers of the average day demand. Some examples are maximum day/average day and peak hour/average day.
Distribution main	A smaller diameter pipe that serves a relatively small area.
Trunk line	A large diameter pipe that serves a relatively large area.
Transmission main	A larger diameter pipe that is designed to transport large quantities of water. Water services for small individual customers are normally not placed on trunk lines.

Adapted from Ysusi, 2000.

the additional requirement of providing fire protection has a marginal effect on sizing decisions, but in smaller systems, the requirement to provide fire protection will have a significant impact on sizing.

Fire Flow Requirements

Community Governance. The decision of whether or not to size distribution system components for fire protection must be made by the governing body of the community. There is no legal requirement that the governing body must size the distribution system for fire protection. In some instances, it may be prohibitively expensive (AWWA, 1998).

An approach that has proven more economical for large cities is to establish codes and ordinances that require condemnation or upgrading of unsafe buildings to meet fire codes, including mandatory automatic sprinkler systems (AWWA, 1998). This approach works for two reasons. The first is that if buildings that have activities conducive to rapidly burning fires are eliminated, the water demand to provide fire protection is reduced. The second is that the fire flow requirements for the municipal system are less if buildings are provided with automatic sprinklers. This approach is not viable for suburban residential communities.

Automatic Fire Sprinkler Systems. Automatic sprinklers have been the single most important system for automatic control of fires in buildings for more than a century. Among the benefits of automatic sprinklers is the fact that they operate directly over a fire. Smoke, toxic gases, and reduced visibility do not affect their operation. In addition, much less water is used because only those sprinklers fused by the heat of the fire operate, especially if the building is compartmented (Coté and Linville, 1997). Of all the tools available to facilitate and promote fire protection, none offers such a wide variety of benefits to the building owner, developer, fire service, water supplier, and the general public as the widespread use of automatic sprinkler systems (AWWA, 1998).

Sprinklers are designed to control fires, but to completely extinguish a fire, hose streams are required. The National Fire Protection Association (NFPA) recommended automatic sprinkler flow rate per unit area is shown in Figure 17-1. The total hose-stream allowance and fire flow duration are shown in Table 17-2. The determination of the hazard group noted in the figure and table is a multifaceted process that is described in the several publications of the NFPA. A broad average description of the hazard groups is as follows (AWWA, 1998):

- *Ordinary group 1:* retail stores, offices, hotels, and institutional buildings.
- *Ordinary group 2 or 3:* warehouses and manufacturing activities.
- *Extra hazard groups:* occupancies with highly flammable products or processes.

The pressure required to operate the sprinklers varies depending on the manufacturer. The NFPA pressure may be specified at every sprinkler, for example, 50 kPa, or at the base of the sprinkler riser, for example, a pressure equivalent to 100 kPa at the highest sprinkler. For domestic sprinkler systems, the required operating pressure ranges from 140 to 275 kPa. For all of these sprinkler systems, the pressure at the street may have to be considerably higher to overcome friction and elevation losses.

Fire sprinkler designers must be appraised of the minimum pressures that may be available at the water main in the street. The selection of the pressure to be used for the sprinkler system

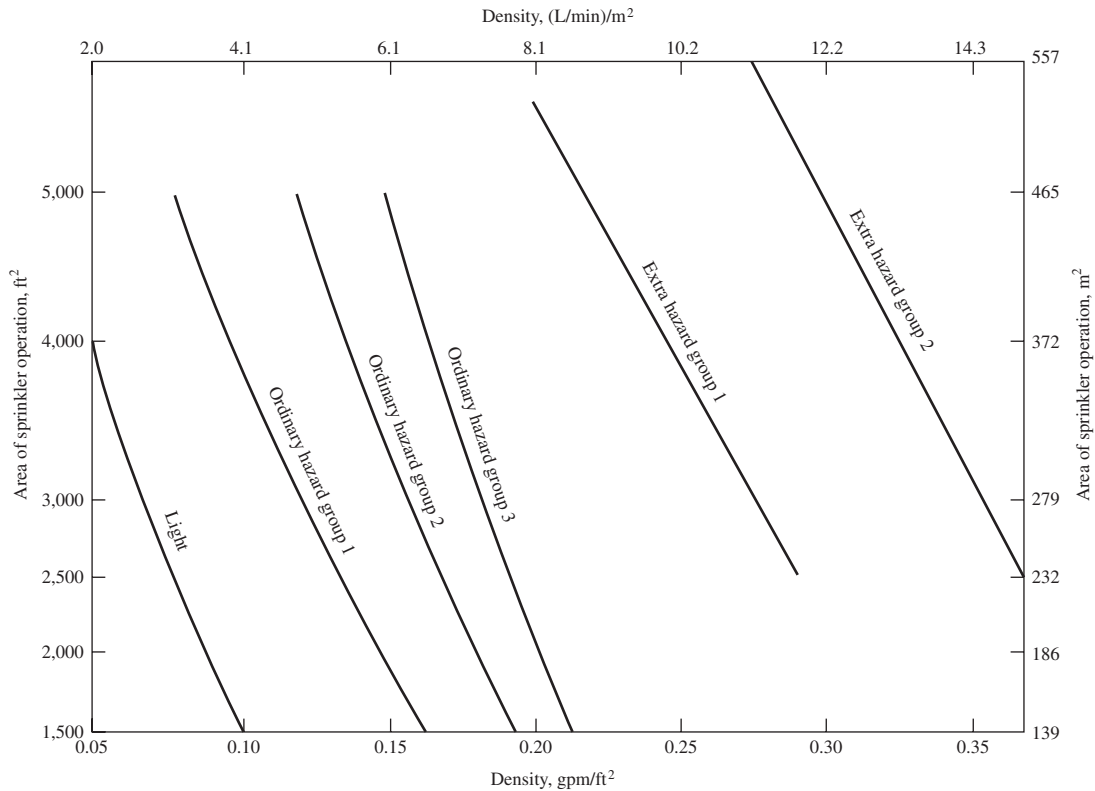

FIGURE 17-1
 Sprinkler system design curves. Reprinted with permission from NFPA, 13-1987.
 (Source: NFPA, 1987.)

TABLE 17-2
Hazard classification schedule for hose-stream allowance

Hazard classification	Hose-stream allowance, m ³ /min	Duration, min
Light	3.8	30
Ordinary group 1	9.5	60–90
Ordinary group 2	9.5	60–90
Ordinary group 3	19	60–120
Extra hazard group 1	19	90–120
Extra hazard group 2	38	120

Adapted from AWWA, 1998.

depends on the level of risk that the owner is willing to accept and the related cost. The lower the design pressure used to size the sprinkler, the lower the risk of failure due to inadequate pressure.

In designing the water system, the design engineer does not design the individual sprinkler systems for every building. Instead, representative requirements for portions of the town are used. For example, one hotel sprinkler system may be designed to represent a hotel district, or one commercial establishment's sprinkler system may be designed to represent a district. In special cases, the client may require a more detailed design, as in the design of a mall water supply system.

Example 17-1 illustrates the estimate of fire flow for a sprinkler system and a hose-stream in a commercial establishment.

Example 17-1. A representative sprinkler plus hose-stream fire flow is desired for a motel district. Based on a review of the plans for several motels, the following assumptions have been made:

1. Area of a representative motel = 1,500 m².
2. Four compartments are used for the sprinkler system.
3. The motels are classified as Ordinary group 1.

Solution:

- a. Because four compartments are used, the floor area for sprinkler demand is estimated as

$$\frac{1,500 \text{ m}^2}{4} = 375 \text{ m}^2$$

- b. Using Figure 17-1 and 375 m², the flow rate per unit area is estimated to be 3.8 L/min · m² or 0.0038 m³/min · m².
- c. The sprinkler flow rate is then estimated to be

$$Q_{\text{sprinkler}} = (375 \text{ m}^2)(0.0038 \text{ m}^3/\text{min} \cdot \text{m}^2) = 1.4 \text{ m}^3/\text{min}$$

- d. From Table 17-2, hose-stream rate is 9.5 m³/min.
- e. The total fire demand is then estimated to be

$$Q_{\text{fire demand}} = 1.4 \text{ m}^3/\text{min} + 9.5 \text{ m}^3/\text{min} = 10.9 \text{ m}^3/\text{min}$$

Comments:

1. The fire demand would apply to the entire motel district because there is a basic assumption that only one fire will occur at a time.
 2. As noted in the next section, the fire flow requirement is added to the maximum day demand in the design of the system for the motel district.
-

TABLE 17-3
Typical fire flow requirements

Land use	Fire flow requirement, m ³ /h
Single family residential	115–455
Multifamily residential	340–680
Commercial	570–1,100
Industrial	800–2,300
Central business district	570–3,400

Adapted from Ysusi, 2000.

Needed Fire Flow (NFF). The range of fire flow requirements is quite broad (Table 17-3).

A rule of thumb is that the minimum amount of water that can safely and effectively control a fire when a sprinkler system is not available is 115 m³/h at a residual pressure of 140 kPa. This represents the amount of water for two standard hose streams on a given fire. Above this minimum, it is recommended that at any given point in the distribution system, the system be able to provide the required design flow by using one of three methods for determining the NFF: (1) Insurance Services Office, (2) Illinois Institute of Technology Research Institute, or (3) Iowa State University. The Insurance Services Office (ISO) method is most likely to yield realistic requirements (AWWA, 1998). GLUMRB (2003) recommends that the requirements of the State Insurance Services Office be followed.

The ISO method was developed for use during an evaluation for insurance purposes. It is based on the following empirical equation:

$$\text{NFF}_i = (C_i)(O_i)(1.0 + X_i + P_i) \quad (17-1)$$

where NFF_i = needed fire flow

C_i = construction factor

O_i = occupancy factor

X_i = exposure factor

P_i = communication factor

The construction factor (C_i) takes into account materials of construction (e.g., frame, masonry, or fire resistant). In SI units, it is approximated as

$$C_i \approx 18(F)(A_i)^{0.5} \quad (17-2)$$

where F = construction class factor

A_i = effective area, m²

The effective area is the total area of the largest floor, plus a percentage of other floors.

The occupancy factor (O_i) takes into account the combustibility of the materials or processes inside the structure. The exposure factor (X_i) depends on the construction and the length-height value (length of wall times height in stories) of the exposed building, the distance between facing walls of the subject building (the one to have a sprinkler system), and the exposed building (a nearby building that might catch fire). The communications factor (P_i) depends on the protection for communicating wall openings and the length of the communication between fire divisions. ISO has prepared tables for selection of these variables.

TABLE 17-4
Needed fire flow (NFF) for one- and two-family dwellings^a

Distance between buildings, m	Needed fire flow, m ³ /h
Greater than 30	115
10–30	170
3–10	230
Less than 3	340

^aDwellings not to exceed two stories.
 Adapted from AWWA, 1998.

For one and two family dwellings, the ISO procedure is simplified to the requirements listed in Table 17-4.

Example 17-2 illustrates the calculation procedure using the ISO equations and tables.

Example 17-2. For comparison, compute the NFF for the representative motel in Example 17-1 assuming sprinklers are not provided. Use the following assumptions:

1. Area of a representative motel = 1,500 m².
2. One-story high.
3. Joisted masonry construction.
4. Occupancy classification = C2.
5. Distance to exposure building 20 m.
6. Exposure building is a blank wall.
7. Exposure building wall is masonry with no windows.

Solution:

- a. Calculate C_i . For joisted masonry construction, $F = 1.0$.

$$C_i \approx 18(1.0)(1,500 \text{ m}^2)^{0.5} = 697.14 \text{ m}^3/\text{h}$$

By rule, this is rounded to nearest 60 m³/h, so $C_i = 720 \text{ m}^3/\text{h}$.

- b. For the occupancy classification of C2, $O_i = 0.85$.
- c. Because the exposure building is a blank masonry wall, the values for X_i and P_i are both zero.
- d. The NFF is then

$$\text{NFF} = (720 \text{ m}^3/\text{h})(0.85)(1.0 + 0 + 0) = 612 \text{ m}^3/\text{h}$$

By rule, this is rounded to nearest 60 m³/h, so NFF = 600 m³/h or 10 m³/min.

Comments:

1. This is slightly less than the required sprinkler plus hose-stream fire flow found in Example 17-1. Given the approximations and assumptions, these estimates are the same. This is because this building was treated as a “stand-alone” building.
 2. If the proximity of another building with less than fire resistant construction was within 10 m, the sprinkler system would require less water.
 3. Regardless of the economy or lack thereof in supplying water for fire suppression, some places require fire suppression. For example, motels and similar structures, where a high fraction of the occupants are not employees, will be provided with automatic sprinklers for preservation of human life and reduction of human injury.
-

It is not unusual to determine the NFF in consultation with the local fire marshal or fire chief. In the absence of a realistic estimate, the ISO (for structures without sprinklers) or NFPA (for structures with automatic sprinklers) is used to estimate the NFF. As is in the case of sprinkler systems, every building is **not** evaluated for NFF. Instead, a representative structure for a district is evaluated.

Good engineering judgement is required in establishing the NFF. In general, it would not be reasonable for the fire demand of a few isolated structures in a residential community to drive the selection of the NFF for the whole community. An exception might be if that structure provided most of the jobs in the community. Involvement of the community in the decision in these special cases is warranted.

Peak Hour Demand

Most systems are quite capable of meeting the average day conditions. It is only when the system is stressed that deficiencies become apparent. The peak hour demand estimate is used to evaluate the distribution system response to stress. It does not include fire demand, which is considered localized rather than systemwide. The peak hour demand may be considered as communitywide demand because of normal community use under special circumstances such as widespread lawn watering on a hot summer day.

The range of peaking factors used in the United States varies from 2.0:1 to 7.0:1 (Ysusi, 2000). Figure 2-1, in Chapter 2, provides a means of selecting an appropriate peaking factor based on the community population. Example 17-3 illustrates the calculation of the peaking factor when no actual data are available.

Example 17-3. Estimate the peak hour demand for a community of 8,000 people. Assume the average demand is equal to the United States public supply use of 580 Lpcd.

Solution:

- a. The estimated average day demand is

$$(580 \text{ Lpcd})(8,000 \text{ people})(10^{-3} \text{ m}^3/\text{L}) = 4,640 \text{ m}^3/\text{d}$$

- b. Using Figure 2-1 and the population of 8,000, the peaking factor is about 3.2.

c. The peak hour demand is then estimated to be

$$(3.2)(4,640 \text{ m}^3/\text{d}) = 14,848 \text{ or } 15,000 \text{ m}^3/\text{d}$$

Comment. For volume calculations, it should be recognized that the calculated peak hour demand has a duration of one hour, that is, the volume of water is about $(15,000 \text{ m}^3/\text{d})(1\text{h}/24\text{h}/\text{d}) = 625 \text{ m}^3$

Maximum Day

The range of peaking factors used for the maximum day in the United States is from 1.5:1 to 6:1 with the common range being 1.8:1 to 2.8:1 (Ysusi, 2000). The U.S national average in 1967 was 2.2 (Linaweaver et al., 1967). The distribution system is tested (by calculation) at various locations with the community maximum day estimate set as a “background” plus the NFF for the zone or district.

Determining the Design Flow

The design flow is usually determined in the following stepwise fashion:

1. Estimate the average daily demand.
2. Estimate the maximum daily demand.
3. Estimate the maximum hourly demand.
4. Estimate the required fire flow if fire protection is to be provided.
5. Select a design flow.

Normally the distribution design flow rate is either the sum of the required fire flow rate for the most stringent situation plus the maximum daily demand or just the peak hour demand, whichever is greater. Current design practice assumes that the coincidence of fire demand and the peak hour demand are sufficiently rare, and that the cost of meeting such an event is so high that it is not a reasonable criterion for the design of the distribution system.

17-3 SERVICE PRESSURES

Water pressures in the mains must fall into a range of values. If the pressure is too low, fixtures will not operate satisfactorily. If the pressure is too high, fixtures may leak, valve seats will wear out, and hot water heater pressure relief valves may discharge.

Design Criteria

GLUMRB (2003) specifies that the system shall be designed to maintain a minimum pressure of 140 kPa at ground level at all points in the distribution system under all conditions of flow. The normal working pressure in the distribution system should be approximately 410 to 550 kPa and not less than 240 kPa.

TABLE 17-5
Typical service pressure criteria

Condition	Service pressure, kPa	Service pressure, m of water
Maximum pressure	450–550	46–56
Minimum pressure during maximum day	240	24.5
Minimum pressure during peak hour	170	17.3
Minimum pressure during fires	140	14.3

Adapted from Ysusi, 2000.

The Uniform Plumbing Code requires that water pressures not exceed 550 kPa at service connection unless the service is provided with a pressure-reducing valve. Some typical service pressure criteria are summarized in Table 17-5.

Hints from the Field

Experience has shown the following:

- Pressures under 350 kPa will not supply adequate working pressure (150 kPa) at faucets located at the top floor of a six-story building, and pressures under 200 kPa are unable to supply the upper floors of a four-story building.
- Booster stations should be located such that the minimum inlet pressure to the pump is above 240 kPa and preferably above 275 kPa.

17-4 PIPE NETWORK DESIGN

The design of the pipe network in a distribution system is an iterative process based on the desired pressure in the system under different demand conditions. Trial pipe diameters are selected for the network of pipes, and a hydraulic analysis is performed for the range of conditions. Of the numerous issues that must be addressed in the network design, the following will be presented in this section:

- Pipe material selection.
- Pipe diameter and spacing.
- Design equations.
- Simple network evaluation.
- Valve selection and spacing.
- Hydrant spacing.
- Minor loss calculation.

Pipe Material Selection

Standards and specifications for pipes are available from the American National Standards Institute (ANSI) and the American Water Works Association. These should be obtained for actual design specifications.

Common pipe materials for water distribution systems are ductile iron pipe (DIP), polyvinyl chloride (PVC) pipe, high density polyethylene (HDPE) pipe, reinforced concrete pressure pipe (RCPP), steel pipe, and asbestos-cement pipe (ACP). ACP has not been used in the last 20–30 years because of health concerns related to asbestos even though research has shown no association between water delivered by ACP and disease (Ysusi, 2000). Steel pipe is rarely used for pipelines smaller than 400 mm. It is widely used in the western United States for transmission pipelines in sizes larger than 600 mm. RCPP is not commonly used for water distribution and serves as an alternative material for transmission lines. It has the disadvantage that it is attacked by soft water, acids, sulfides, sulfates, and chlorides. It may be cracked by water hammer. The more common pipe materials are DIP, PVC, and HDPE.

Ductile Iron Pipe (DIP). This is the most common water distribution pipe used in the United States for water mains 400 mm in diameter or smaller. The standard length is 5.5 m. Sizes range from 100 to 1,350 mm. Current practice is to use cement mortar lining and an asphaltic outer coating. DIP manufacturers recommend that the pipe be encased in a loose-fitting flexible polyethylene tube (0.2 mm thick) in corrosive soils. These are commonly known as “baggies.”

Rubber push-on and mechanical joints are used to connect the pipes. These joints allow for about 2 to 5 degrees of deflection. Flanged joints are used for fitting and valve connections in locations where the pipe is not buried. Service connections, known as *corporation stops*, may be installed either before or after pipe installation. DIP is favored because service connections can be made while the pipe is in service without shutting off the water supply to other customers.

AWWA Manual M41 (AWWA, 2003) provides detailed information on design criteria for earth loads, truck loads, railroad crossings, fittings, thrust restraint, and corrosion protection, as well as procedures for installation.

Polyvinyl Chloride (PVC) Pipe. This is the most common plastic pipe used in the United States. Although it is manufactured in sizes up to 900 mm, the commonly used sizes for water distribution systems are 300 mm and smaller. It is rated for pressure capacity at 23°C. As the operating temperature rises above 23°C, the pressure rating decreases. There are two AWWA specifications for PVC pipes depending on the size. For the 100 to 300 mm sizes, pressure ratings are in three classes. These ratings include an allowance for hydraulic transients (pressure surges or waves). The larger sizes are not rated in the same fashion, and they do not provide an allowance for pressure surges.

Rubber gasket bell and spigot type joints are used to connect the pipes. Ductile iron fittings are used. PVC is corrosion resistant, and no coating or lining is provided.

High-Density Polyethylene (HDPE). Although it is manufactured in sizes from 100 to 1,200 mm, this pipe has primarily served as a transmission line. Like PVC, it is rated for pressure capacity at 23°C. It is rated for pressure transients not exceeding two times the nominal pressure class.

Thermal butt-fusion is the most widely used method for joining HDPE pipe. This procedure uses portable equipment to hold the pipe or fittings in close alignment, while opposing ends are faced, cleaned, heated, melted, fused, and cooled. The pipe is normally joined above ground and

then placed in the trench. This method of joining requires a much higher skill level than push joints. This joint does not allow for deflection. HDPE is not to be joined by solvent cements, adhesives, or threaded connections.

Ductile iron fittings are used. HDPE is corrosion resistant, and no coating or lining is provided.

Pipe Diameter and Spacing

GLUMRB (2003) specifies that the minimum size of water main that provides fire protection and serves fire hydrants shall be 150 mm diameter. Larger size mains will be required to allow withdrawal of the fire flow while maintaining minimum pressures. In Michigan, the minimum size for fire protection is 200 mm. The pipe diameter where fire protection is not to be provided should be a minimum of 75 mm diameter.

The AWWA (1998) provides the more detailed suggestions shown in Table 17-6.

Within these guidelines and commensurate with the demand estimates, a trial set of pipe diameters must be selected. One method of making the initial selection is by using a table such as that shown in Appendix C.

Pipes are normally placed in the right-of-way (ROW) alongside a public road, so the road net sets the spacing. The pipes should not be placed under the pavement, except in crossings and unusual circumstances, because this makes repairs more difficult and expensive. House connections on the side of the street opposite the pipeline are made by boring under the roadway.

The depth of the pipe in the ground is a function of the climate (it should be placed below the frost line), soil load, and wheel loading from vehicles. These considerations are beyond the scope of this text. An extensive treatise on the subject is presented in *Buried Pipe Design* edited by Moser (2001).

Design Equations

The objective of the hydraulic analysis of the trial set of pipe diameters is to ensure that the desired pressure and flow rate is achieved at specific locations in the system. The hydraulic analysis is based on an extended version of the Bernoulli equation. It may be expressed as:

$$\frac{p_1}{\gamma} + \frac{(v_1)^2}{2g} + z_1 = \frac{p_2}{\gamma} + \frac{(v_2)^2}{2g} + z_2 + h_f \quad (17-3)$$

TABLE 17-6
Typical distribution piping criteria

Appurtenance	Typical minimum values
Smallest pipes in network	150 mm
Smallest branching pipes (dead ends)	200 mm
Largest spacing of 150 mm grid ^a	180 m
Smallest pipes in high-value district	200 mm
Smallest pipes on principal streets in central district	300 mm
Largest spacing of supply mains or feeders	900 m

^a 200 mm pipe is used for larger spacing.

Adapted from AWWA, 1998.

where p_1, p_2 = pressure at points 1 and 2, m of water
 v_1, v_2 = velocities at points 1 and 2, m³/s
 z_1, z_2 = elevations of points 1 and 2, m
 h_f = headloss due to friction, m
 γ = specific weight of fluid, kN/m³
 g = gravitational acceleration = 9.81 m/s²

It is common to express the terms of Equation 17-3 in elevation of equivalent water height so that p/g , and $(v)^2/2g$ have units of meters.

Energy losses due to friction are taken into account by the headloss term on the right-hand side of Equation 17-3. The headloss is calculated using the Hazen-Williams equation (Equation 3-5) reproduced here for convenience:

$$h_f = 10.7 \left(\frac{Q}{C} \right)^{1.85} \left(\frac{L}{D^{4.87}} \right) \quad (17-4)$$

where h_f = headloss, m
 Q = flow rate, m³/s
 L = equivalent length of pipe, m
 C = Hazen-Williams coefficient of roughness
 D = diameter of pipe, m

Velocities are calculated based on the continuity equation:

$$Q = vA \quad (17-5)$$

where Q = flow rate, m³/s
 v = velocity of flow, m/s
 A = cross-sectional area of flow, m²

Mass balance is used to account for flows into and out of junctions.

To verify that the service pressure meets the design criteria, Equation 17-3 is solved for p_2/γ .

Simple Network Evaluation

At this point in the discussion, a simplified network evaluation is useful in illustrating the steps of the pipe network design process.

A small distribution system at a camp has been selected for this illustration (Figure 17-2). Fire protection is not included. Water is supplied to the system by a well pumping to an elevated storage tank. Water from the storage tank supplies the pressure to the distribution system. The peak hour demand at various points in the distribution system and the corresponding elevations are given in Table 17-7.

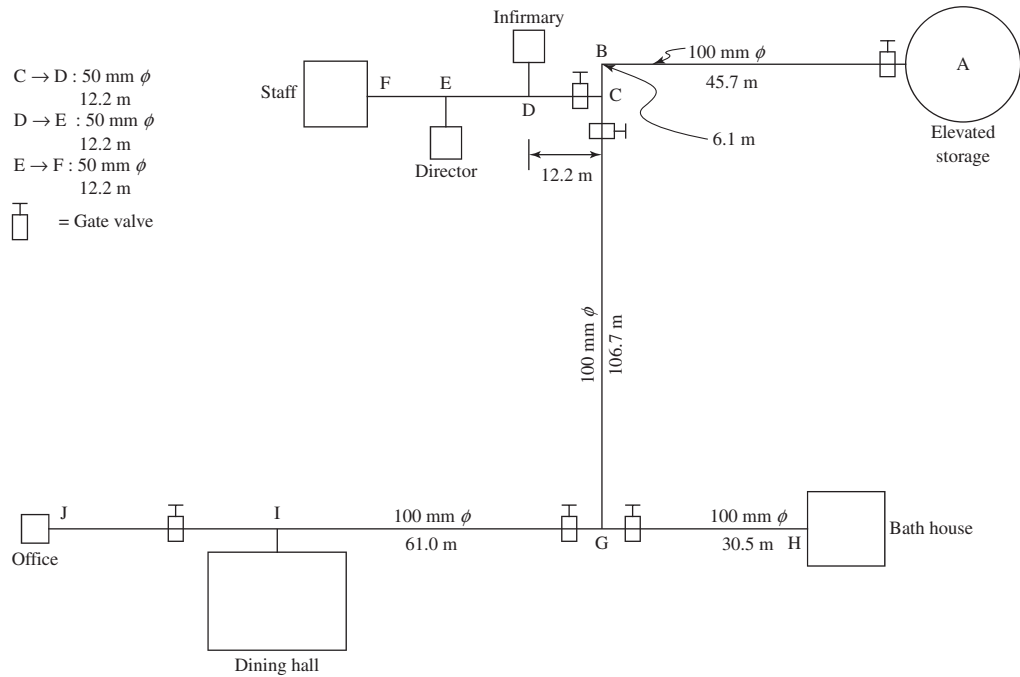

FIGURE 17-2
Camp distribution system layout for Example 17-4.

TABLE 17-7
Peak hour demand and elevations for Example 17-4

Point	Peak hour demand, m ³ /h	Elevation, of pipe, m
Bottom of storage tank (A)	50.0	200.0
B	50.0	177.14
C	-	177.14
D	10.0	176.53
E	6.00	176.23
F	3.00	175.62
G	40.0	174.74
H	25.0	175.04
I	15.0	175.04

Example 17-4. Perform a hydraulic analysis to determine if the water pressure at Point H of the pipe network shown in Figure 17-2 meets a design criterion of 207 kPa. Ignore the velocity headloss and minor losses for this example.

Solution:

- a. The hydraulic analysis was performed in a tabular fashion. The resulting table is shown below. The calculations are explained below the table.

Example 17-4, hydraulic analysis of camp

Distance		Flow, m ³ /h	Pipe size, mm	Head available, m				Headloss, m/100 m	Total headloss, m	Head remaining		
From	To			Meters	Initial	Fall (+)	Rise (-)			Total	m	kPa
A	C	51.8	50	100	0.00	22.86	0.00	22.86	5.8	3.00	19.86	194.72
C	D	12.2	10	50	19.86	0.61	0.00	20.47	8.6	1.05	19.42	190.41
C	G	106.7	40	100	19.86	2.40	0.00	22.26	3.8	4.05	18.20	178.49
G	H	30.5	25	100	18.20	0.00	0.30	17.90	1.6	0.49	17.41	170.76

Note: (m of water)*(9.8067) = kPa.

- b. The starting point for the run of pipe from A to C is at the bottom of the water tower. The head available is that just before the water tower becomes empty. This is the lowest head that will be available. At this starting point (A) the head available is the “Initial” head of 0.00 m shown in column 4 in the row labeled “A to C.”
- c. The “Fall” is the elevation difference between A and C. That is 200.0 m – 177.14 m = 22.86 m, as shown in column 5 in the row labeled “A to C.”
- d. There is no “Rise” in elevation between A and C.
- e. The “Total” head available is then 0.00 m + fall – rise = 0.00 + 22.86 m – 0.00 m = 22.86 m.
- f. The “Headloss” is the friction loss per 100 m of pipe. Using the table in Appendix C, the loss is estimated as 5.8 m/100 m of pipe. For the 51.8 m run of pipe, the “Total headloss” is

$$\left(\frac{5.8 \text{ m}}{100 \text{ m}}\right)(51.8 \text{ m}) = 3.00 \text{ m}$$

- g. The “Head remaining” is the difference between the Total head available and the Total headloss:

$$22.86 \text{ m} - 3.00 \text{ m} = 19.86 \text{ m}$$

- h. Converting the Head remaining in m to kPa,

$$(19.86 \text{ m})(9.8067 \text{ kPa/m of water}) = 194.8 \text{ kPa}$$

This is below the design goal of 207 kPa.

- i. The head remaining (19.86 m) at point C becomes the “Initial” head for the next reach of pipe (C to D and C to G).
- j. The water flow around the junction labeled “C” must balance. The flow into the junction is $50 \text{ m}^3/\text{h}$. The flow to D is $10 \text{ m}^3/\text{h}$, so the flow to G must be $50 \text{ m}^3/\text{h} - 10 \text{ m}^3/\text{h} = 40 \text{ m}^3/\text{h}$.
- k. The head remaining at H is shown in the last column in the last row. It is 170.76 kPa.

Comments:

1. While it might seem appropriate to stop the calculation at the end of the first row and adjust the design selections, the computations are continued to point H. This is done to illustrate that further losses in the system up to point H must also be considered. So rather than stop and readjust at each point, the adjustment is made for the system as a whole.
2. One alternative adjustment would be to raise the bottom tank elevation $[(207 \text{ kPa} - 170.76 \text{ kPa})/9.8067 = 3.70 \text{ m}]$. Another would be to select larger diameter pipes. These alternatives would have to be evaluated based on cost.
3. The Bernoulli equation is related to the tabular calculation as follows:

$$\frac{p_2}{\gamma} = \frac{p_1}{\gamma} + \frac{(v_1)^2}{2g} + z_1 - \frac{(v_2)^2}{2g} - z_2 - h_f$$

The pressure at the bottom of the tank is zero so $p_1 = 0$. As noted in the assumptions, the velocity head is ignored so v_1 and $v_2 = 0$. There is no rise, so $z_2 = 0$. $z_1 = 22.86 \text{ m}$. $h_f = 3.00 \text{ m}$. The Bernoulli equation is then

$$\frac{p_2}{\gamma} = 0 + 0 + 22.86 - 0 - 0 - 3.00 = 19.86 \text{ m}$$

4. The calculations were performed on a spreadsheet. This allows for adjustment of one value, such as the height of the bottom of the storage tank, to see its implications on other parts of the system. The headloss was obtained from the appendix, but it can easily be calculated in the spreadsheet.
5. This system has no loops. This is not common design practice. However, the inclusion of loops requires flow balancing. This process is commonly carried out using a computer program. It will be discussed in Section 17-7.

Valve Selection

Valves are a significant component of any water distribution system. They are commonly used for isolating a section of pipeline for maintenance or repairs, controlling the flow rate, releasing air, and preventing backflow. Two elements are considered in selecting valves for a distribution system design. The first is headloss as the water passes through the valve. The second is the method of controlling the flow. The headloss characteristics are intrinsically related to the method of control.

Four basic closure methods are used for flow control (AWWA, 2006):

- A disc or plug moves against or into an opening. Examples are *globe* and *piston* valves.
- A flat, cylindrical, or spherical surface slides across an opening. An example is a *gate* valve.
- A disc or ellipse rotates across the diameter of the pipe. Examples are *plug*, *ball*, *butterfly*, and *cone* valves.
- A flexible material moves into a flow passage. Examples are *diaphragm* and *pinch* valves.

Gate valves (Figure 17-3) are the most commonly used type of valve for isolating portions of a distribution system for pipes in the range 150 to 400 mm. Resilient seat gate valves are favored because the resilient material (e.g., vulcanized rubber) seats against the prismatic body

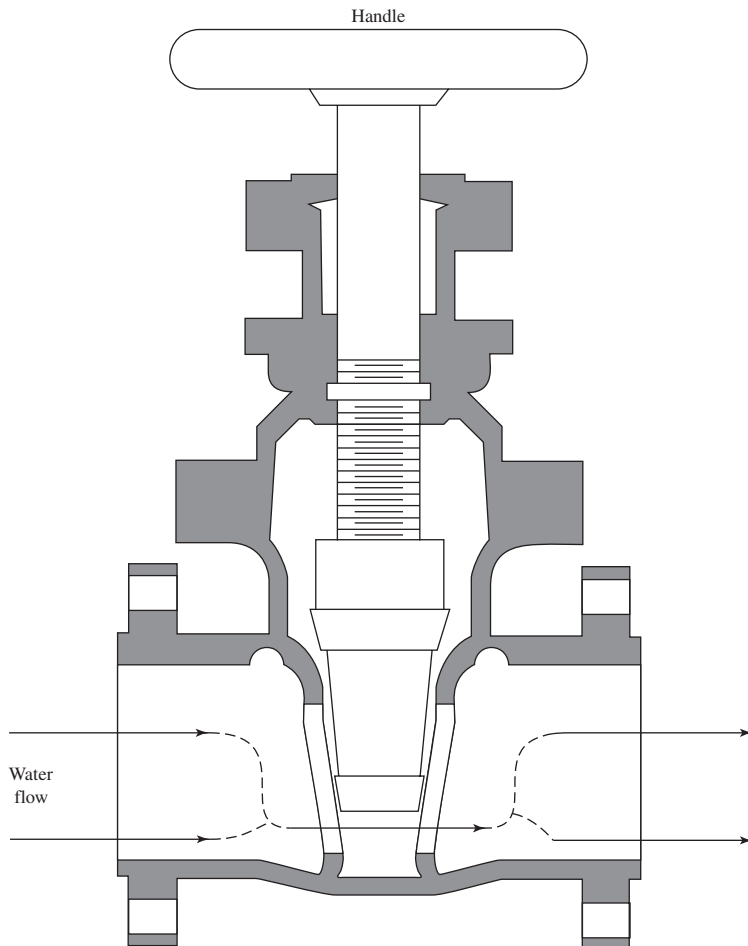

FIGURE 17-3
Gate valve.

of the valve. There is no pocket at the bottom of the valve to collect grit. They are not suited for precise flow control because flow reduction is not proportional to travel of the closure disc. The characteristics and applications of this and other types of valves are given in Manual M44 (AWWA, 2006).

Special Purpose Valves. For specific system applications, special valves are available to make operation simpler, more efficient, or automatic. These include:

- *Check valves.* This is a single-direction valve (Figure 17-4) that allows flow in one direction and stops reverse flow. They cause significant pressure loss and are recommended for use only where reverse flow operation would be catastrophic. An example is the discharge from a pump where flow reversal might damage the pump.
- *Air release valves.* An air release valve is a self-actuated valve that automatically vents small pockets of air that accumulate at the high point in a water line.
- *Altitude valves.* These are frequently globe-type or piston valves that are installed in storage tank inlet-outlet lines. They remain open as the tank is filled. They close during normal flow conditions. They open again when the pressure in the distribution system becomes less than the static head of the height of water in the tank.
- *Pressure relief valves.* These are used to protect against excessive pressure in the water line (Figure 17-5).
- *Pressure reducing valves.* These are used to provide water to a pressure district or zone of lower elevation from a district of higher elevation. They are often globe valves similar to those of altitude valves. By design, they have a very high pressure drop.
- *Reduced pressure zone backflow prevention valve.* This valve (Figure 17-6) is used to prevent the reversal of flow that might cause contaminated water to flow into the water line.

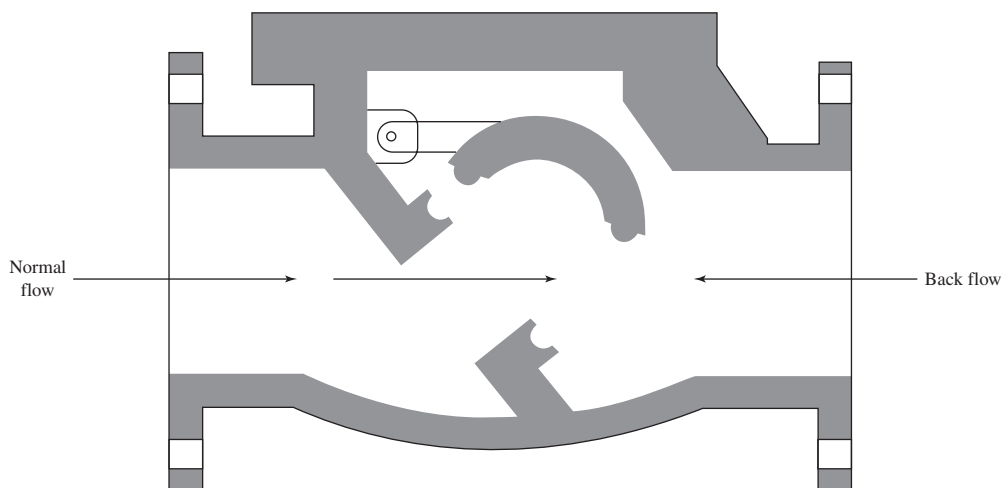

FIGURE 17-4
Swing-type check valve shown in the open position.

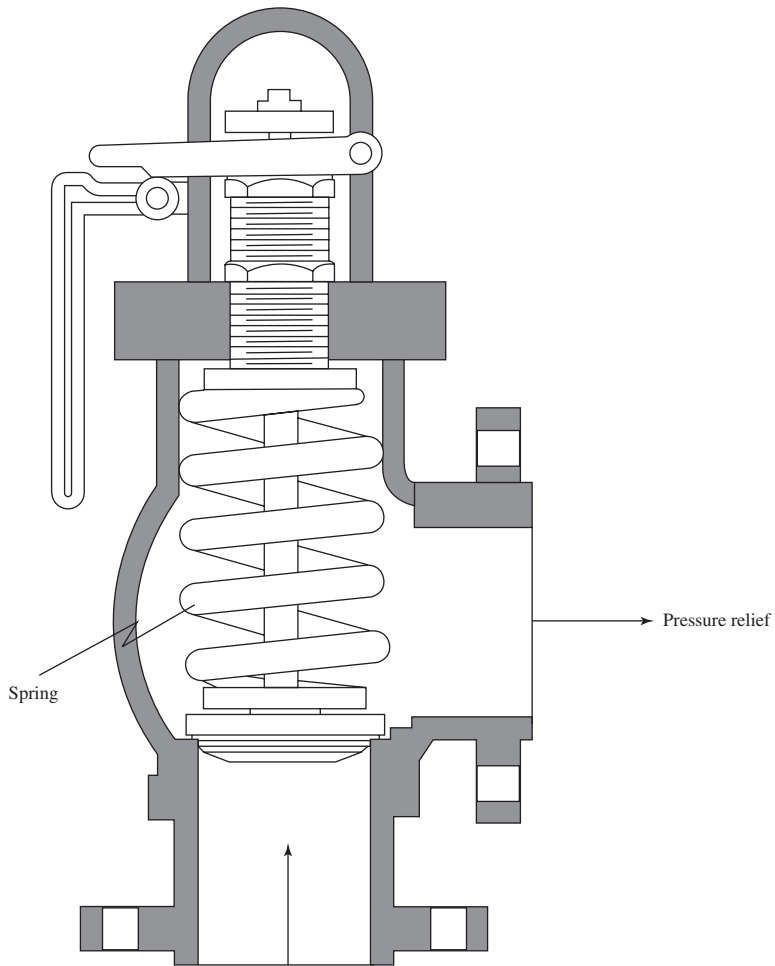

FIGURE 17-5
Pressure relief valve. When pressure reaches a critical limit, valve opens to release pressure.

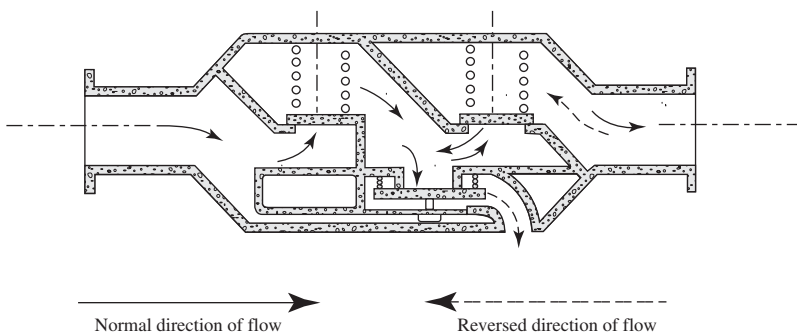

FIGURE 17-6
Reduced pressure zone backflow preventer.
(Source: U.S. PHS, 1963.)

An example application would be a multistory hospital or laboratory connection to a water main. The water main could potentially have a lower pressure than the building because of fire demand, and water from instrument washing sinks could flow into the water main.

Valve Placement. GLUMRB (2003) recommends that distribution system valves be located at not more than 150 m intervals in commercial districts and at not more than one block or 250 m in other districts. It is common to place valves so that sections may be isolated for repairs while continuing to provide service to other segments of the system. An example is illustrated in Figure 17-7.

Hydrant Spacing

GLUMRB (2003) recommends that hydrants be placed at each street intersection and at intermediate points recommended by the State Insurance Services Office. This placement ranges from 70 to 300 m. Fire departments normally require a maximum linear distance between hydrants of 90 m in congested areas and 180 m in light residential districts AWWA (1998). The actual distance between hydrants is dependent on the amount of hose the local fire department normally carries.

Minor Losses

The headlosses that occur due to bends, elbows, joints, valves, and so on are often referred to as *minor losses*. In some instances this is a misnomer because they may be greater than the losses due to pipe friction. The general equation for estimating these losses is Equation 3-6, repeated here for convenience:

$$h_f = K \frac{v^2}{2g} \quad (17-6)$$

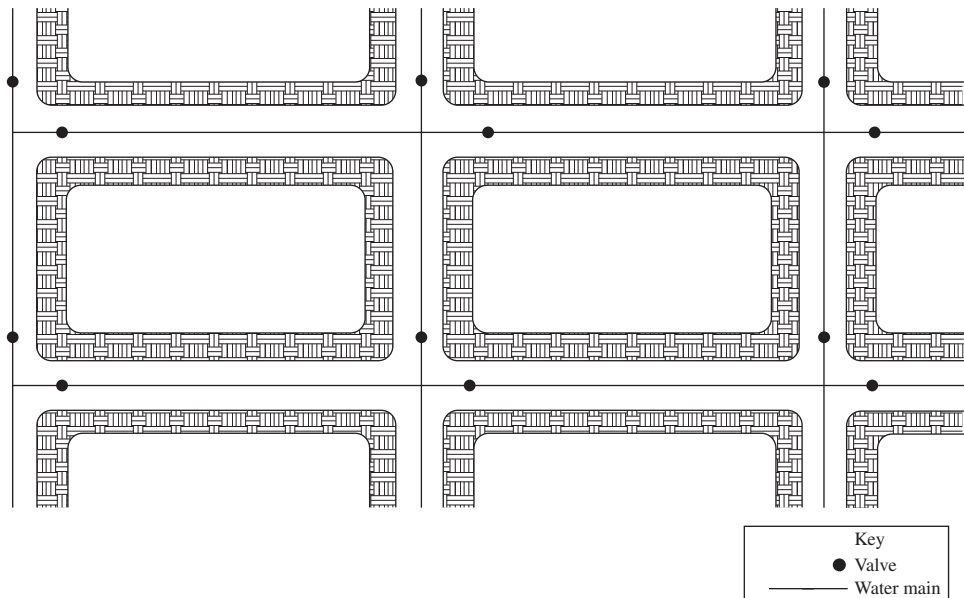
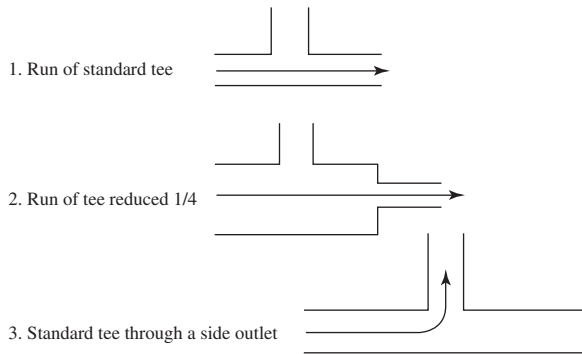

FIGURE 17-7
Location of valves in a distribution system.

**FIGURE 17-8**

Nomograph nomenclature.

where K = energy loss coefficient.

Energy loss coefficients are given in Appendix C. The values are for pipes greater than or equal to 300 mm. For each decrement of 25 mm less than 300 mm, increase K by 5 percent.

An alternate method of expressing the minor losses is in terms of the *equivalent length of pipe* that has the same headloss for the same flow rate. The equivalent length is then added to the actual pipe length for calculation of the headloss for the run of pipe. A nomograph given in Appendix C provides a convenient method for making the headloss estimate. Figure 17-8 provides an explanation of some of the vocabulary used in the nomograph.

Example 17-5 illustrates the equivalent length of pipe method for estimating minor losses.

Example 17-5. Using Figure 17-2 and the data from Example 17-4, estimate the equivalent length of pipe and the total headloss for the pipe run from A to C and from C to D. Assume the valves are fully open gate valves and all elbows are medium sweep.

Solution:*From A to C*

- Using the nomograph in Appendix C, plot a line starting at the 100 mm nominal diameter to the dot on the vertical line that is connected to “fully open” gate valve. Read the equivalent length of pipe to be 0.8 m.
- Using the nomograph in Appendix C, plot a line from the 100 mm nominal diameter to the dot on the vertical line that is connected to the medium sweep elbow. Read the equivalent length of pipe to be 2.6 m.
- Add these lengths to the length of pipe from A to C.

$$0.8 \text{ m} + 2.6 \text{ m} + 45.7 \text{ m} + 6.1 \text{ m} = 55.2 \text{ m}$$

- Using the headloss per 100 m from Example 17-4, estimate the headloss for the pipe run to be:

$$\frac{5.8 \text{ m}}{100 \text{ m}}(55.2 \text{ m}) = 3.2 \text{ m}$$

From C to D

1. The tee at Point C is a standard tee through a side outlet. It is followed by a sudden contraction from 100 mm to 50 mm. This contraction is followed by a fully open gate valve and 12.2 m of 50 mm pipe.
2. Using the nomograph in Appendix C, starting at the 100 mm nominal diameter, plot a line to the dot on the vertical line that is connected to the standard tee through a side outlet. Read the equivalent length of pipe to be 5.6 m.
3. Using the nomograph again, noting the instructions at the top of the figure, plot a line from the 50 mm diameter to the dot on the vertical line that is connected to the sudden contraction ($d/D = 50 \text{ mm}/100 \text{ mm} = 1/2$). Read the equivalent length of pipe to be 0.6 m.
4. Using the nomograph again, plot a line to the dot on the vertical line that is connected to the fully open gate valve. Read the equivalent length of pipe to be 0.35.
5. Add these lengths to the length of pipe from C to D.

$$12.2 \text{ m} + 5.6 \text{ m} + 0.6 \text{ m} + 0.35 \text{ m} = 18.75 \text{ m}$$

6. Using the headloss per 100 m from Example 17-4, estimate the headloss for the pipe run to be:

$$\frac{8.6 \text{ m}}{100 \text{ m}} (18.75 \text{ m}) = 1.6 \text{ m}$$

Comments:

1. Note that in the case of the sweep elbow, the error that results from ignoring the minor losses is on the order of 5% while the sequence of “minor losses” in going from C to D amounts to an error of more than 35% if the minor losses are ignored.
2. Whether the estimate is performed using equations or the nomograph, it is an estimate. Sanks (2006) warns that the minor loss estimate may vary from –20 to +30% or more.

17-5 STORAGE TANK DESIGN**Tank Terminology**

The terms *tank* and *reservoir* are used interchangeably. *Hydropneumatic tanks* are pressurized by placing air in the tanks (Figure 17-9). They are suitable for very small populations (< 600 people) when storage for fire protection is not provided. When fire protection is required, a separate fire pump is used. Hydropneumatic tanks cannot supply the required volume of water for fire fighting. They also may be used at a booster station that provides a pressure boost in the system. If the tank is constructed so that the bottom is at or near ground level, the tank is referred to as a *ground level tank* or just a *ground storage tank*. If the ground storage tank is significantly taller than it is wide, it is usually referred to as a *standpipe*. The classic “water tower” is referred to as an *elevated storage tank*.

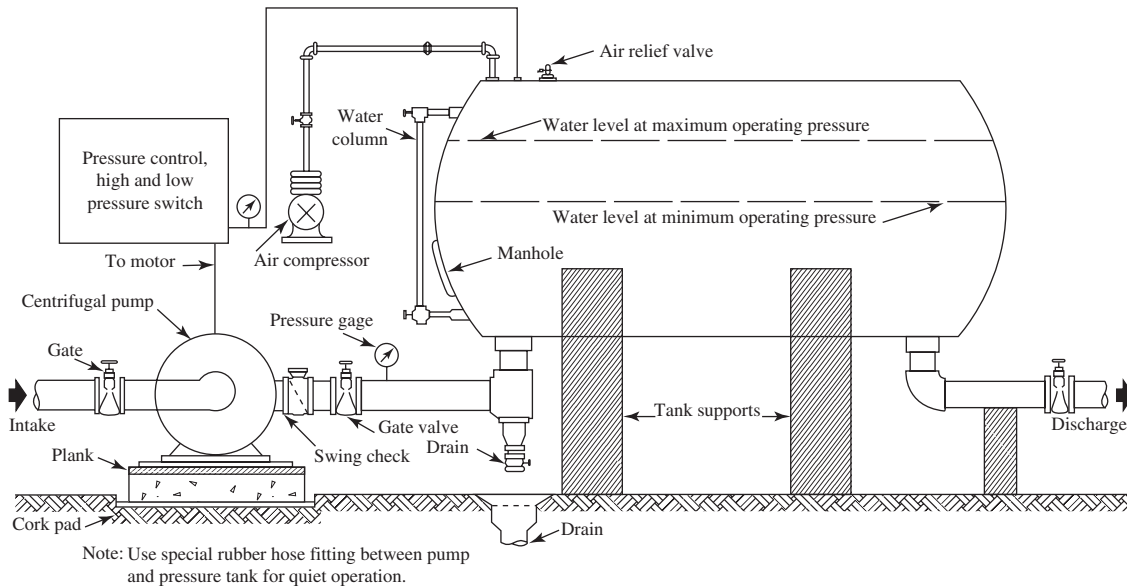

FIGURE 17-9

Typical installation of pressure storage tank and centrifugal pump for a small water supply.

(Source: *Environmental Sanitation* by Joseph A. Salvato, Jr., published by John Wiley & Sons, Inc., New York, 1958.)

Pumped storage refers to water that is stored below the hydraulic grade line in ground tanks or below ground tanks. The water can leave the tank only by being pumped. Tanks that *float-on-the-system* have storage located at elevations such that the hydraulic grade line outside of the tank is virtually the same as the water level in the tank. Figure 17-10 illustrates the tank terminology.

Clearwell storage is provided at the end of the water treatment plant. If located at ground level or below ground level, this is pumped. It may serve the multiple functions of storage, contact for disinfection, and supply for backwash water.

Location

One of the purposes of providing storage is for *equalization*, that is, to provide a mechanism to level out the production of the water treatment plant while the customer demand varies widely over the course of the day. Elevated storage is a common means of providing equalization both in capacity and pressure. Another reason for providing elevated storage is that it is a means of storing energy. Because there are extra charges for electricity to pump during high electrical demand (and high water demand), the elevated storage can offset this charge by filling the tank when demand is low. In addition, some utilities have time-of-day pricing that allows for lower rates at night when demand is low for both power and water. Water stored at night when water demand and electric pricing are low can be used during the day to reduce energy usage and cost.

The location of the storage tank with respect to the location of the water treatment plant and the center of demand is a major consideration in the design of the storage tank. Three generic locations are (1) at the source (well or water treatment plant), (2) between the source and the

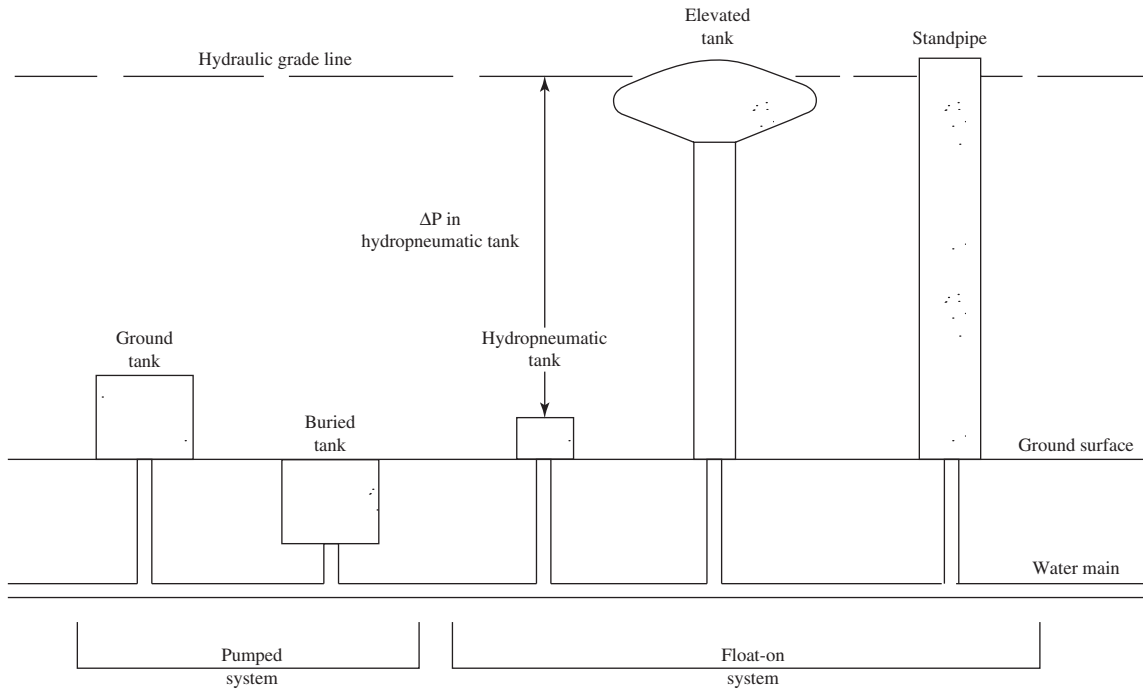

FIGURE 17-10
Tank terminology.

demand center, and (3) on the downstream side of the demand center. These are illustrated in Figure 17-11. The height and location of the tank may require a Federal Aviation Administration (FAA) permit.

Very large communities (> 100,000 people) may not provide elevated storage. Because the variation in demand is small compared to the average demand, the relatively small changes in demand are met with pumping from underground storage.

At the Source. For small communities (< 3,300 people), where little or no treatment is provided and the distance from the source to the demand center is small, elevated storage located at or near the source may be an appropriate economic decision (Figure 17-11a). Although placing the tank at the source is the easiest arrangement for hydraulic analysis, it is the least useful placement in terms of fire fighting or equalization of pressure.

Elevated storage at the source may also be appropriate for larger systems where multiple tanks will be used because the elevated storage at the source may be used to provide head for backwashing the filters.

On the Downstream Side of the Demand Center. This is generally the best place to locate an elevated storage tank. For routine operation, this arrangement allows flow to reach the center of demand from two directions (Figure 17-11b). The flow carried by any individual pipe will be lower and pipe sizes may be smaller. In addition, during fires water can flow from more than one direction toward the fire location.

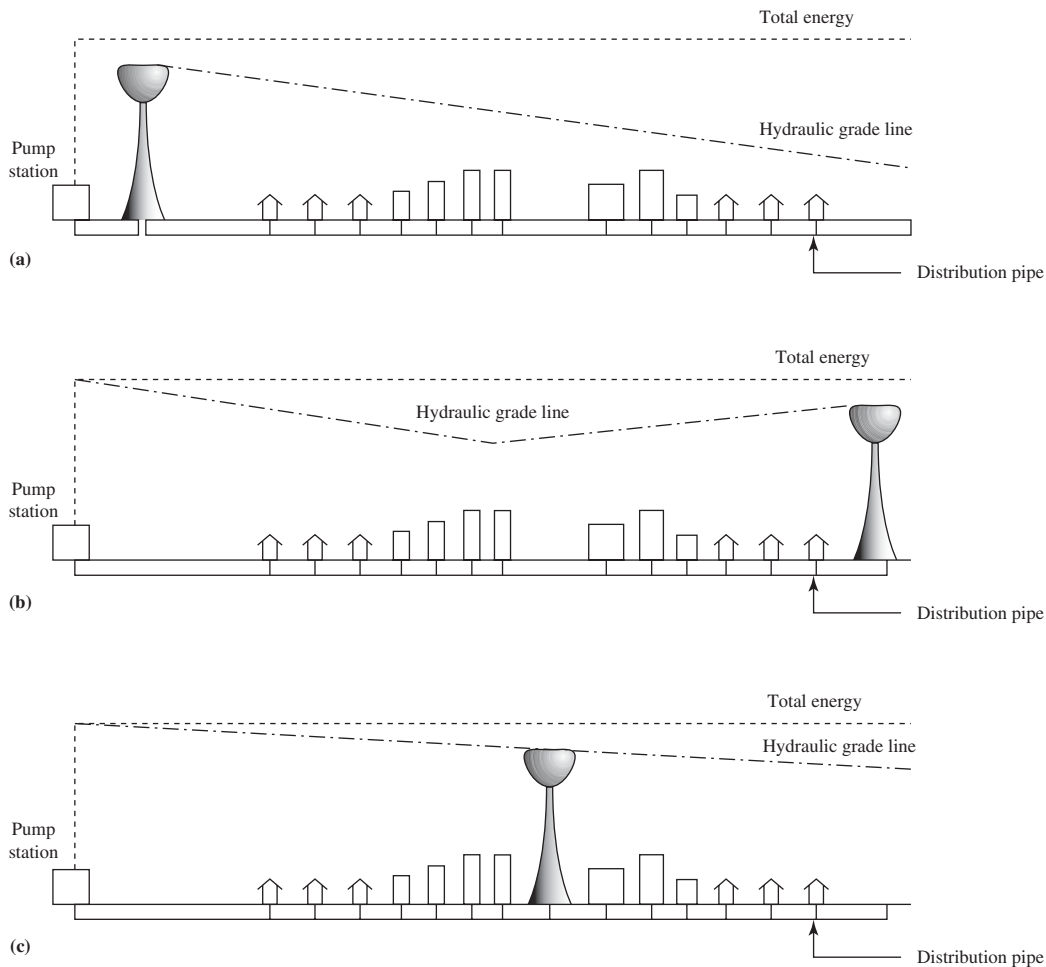
**FIGURE 17-11**

Generic locations of elevated storage: (a) at the source, (b) downstream of the demand center, (c) intermediate location.

Between the Source and the Demand Center. This is an intermediate choice in terms of desirability. Terrain, land availability, and cost considerations may make this the most logical location. The location decision should be based on a thorough hydraulic analysis.

Multiple Tanks in the Pressure Zone. If multiple tanks are required in a pressure zone, they should be placed at approximately the same distance from the source. If one tank is close to the source and the other tanks are far away, it may be difficult to fill the remote tanks without shutting off or overflowing the tank that is close to the source unless it is provided with an altitude valve. For the same reason, it is essential that all of the tanks have virtually the same overflow elevation.

Multiple Pressure Zones. When multiple pressure zones are required, sufficient storage volume should be placed in each zone. It is a waste of energy to pump water from a lower pressure zone to storage in a higher pressure zone and then have it flow back down to the lower zone because of lack of storage in the lower pressure zone.

Tank Levels

The most significant decision about a tank in terms of distribution system design is its overflow elevation. This elevation and the minimum, average-day, bottom of the tank will determine the size and boundary of the pressure zone that can be served from the tank, as well as the layout of the transmission mains and the required pumping head (Walski, 2000b). GLUMRB (2003) recommends that the maximum variation between high and low levels in the storage tank not exceed 10 m ($\Delta \approx 100$ kPa).

The pressure zone is located on a contour map by plotting the overflow elevation and the highest and lowest elevations of customers that can be served within the design pressure boundaries (e.g., 240 kPa to 550 kPa). In general, pressure zone hydraulic grade lines should differ by about 30 m from one pressure zone to the next (Walski, 2000b).

Volume

For small systems not providing fire protection, GLUMRB (2003) specifies that the minimum storage capacity shall be equal to the average daily consumption. A historically more conservative rule-of-thumb is to provide capacity equal to two to three days average daily consumption. This may be excessive with the recognition that a long storage time results in increased formation of disinfection byproducts, as well as decay of chlorine residual.

For those communities that elect to provide fire protection, the sizing of the tank requires a more complex evaluation. For the purpose of this evaluation, the volume of the storage tank may be conceptually divided into three layers:*

1. Domestic water demand is fed to the distribution system from the top 3 to 5 m. As the water level drops, the tank controls open, and the high service pumps start pumping to fill the tank. This is called *equalization storage*.
2. The next layer, amounting to 30 to 50 percent, is reserved for fire demand.
3. The bottom layer is termed *emergency storage*. It can still supply a minimum pressure of 140 kPa.

Equalization Storage. The design of this storage is to enable the source to operate at a predetermined rate. The fraction of daily water production that must be stored depends on the individual community and the operational mode selected. Table 17-8 shows how the type of operation affects the volume required.

TABLE 17-8
Operation effects on equalization storage

Type of operation	Equalization volume required as a fraction of maximum daily demand
Constant pumping	0.10 to 0.25
Follow demand	0.05 to 0.15
Off-peak pumping	0.25 to 0.50
Variable speed pumps	0

Source: Walski, 2000b.

*Although stratification may occur, the water is not, or perhaps more correctly, should actually not be in layers.

TABLE 17-9
Required duration for fire flow

Required fire flow, m ³ /h	Required duration, h
570 or less	2
680–790	3
900–1,000	4
1,100–1,250	5
1,360–1,475	6

Adapted from ISO.

Fire Storage. The flow from fire storage required in excess of the equalization storage is given by (Walski, 2000b):

$$SSR = NFF + MDD - PC - ES - SS - FDS \quad (17-7)$$

where SSR = storage supply required, m³/h
 NFF = needed fire flow, m³/h
 MDD = maximum daily demand, m³/h
 PC = production capacity, m³/h
 ES = emergency supply, m³/h
 SS = suction supply, m³/h
 FDS = fire department supply, m³/h

The emergency supply is the water that can be brought to the system through connection with other systems. The suction supply is the supply that can be taken from nearby open water bodies. The fire department supply is water that can be brought to the fire by trucks.

The SSR in flow units is converted to volume by using the ISO assumed duration of a fire. A selection of duration values from the ISO is given in Table 17-9.

Emergency Storage. Storage that is located below the tank level that provides a minimum of 240 kPa but above the minimum fire pressure of 140 kPa is sometimes referred to as *emergency storage* because a utility would only allow the pressure to fall to this level during an emergency. There is no formula to estimate this volume. If a utility has a single source without auxiliary power and a relatively unreliable distribution system, a significant amount of emergency storage should be provided. In contrast, if a utility has multiple sources and treatment facilities with an auxiliary power supply, the amount of emergency storage that should be provided is minimal.

Example 17-6. Using the data in Example 17-3, estimate the required storage volume assuming it is a rural residential community of single family dwellings that will supply fire protection. Assume that the production capacity of the well system is twice the average day demand and that off-peak pumping will be used to equalize the storage. Auxiliary generator power is available. There is no ES, SS, or FDS.

Solution:

- a. The NFF is estimated from Table 17-3. A conservative estimate is 455 m³/h. By rule, round to the nearest 60 m³/h or 480 m³/h.
- b. The MDD is estimated using the average daily demand from Example 17-3 (4,640 m³/d) and a peaking factor of 2.2 × average day from Chapter 2.

$$(2.2)(4,640 \text{ m}^3/\text{d}) = 10,208 \text{ m}^3/\text{d} \text{ or } 425.3 \text{ m}^3/\text{h}$$

- c. The PC is twice the average daily demand from Example 17-3.

$$2(4,640 \text{ m}^3/\text{d}) = 9,280 \text{ m}^3/\text{d} \text{ or } 387 \text{ m}^3/\text{h}$$

- d. The SSR is then

$$\text{SSR} = 480 \text{ m}^3/\text{h} + 425.3 \text{ m}^3/\text{h} - 387 \text{ m}^3/\text{h} = 518.3 \text{ m}^3/\text{h}$$

- e. From Table 17-9, the required duration is 2 h. The fire storage required is

$$(2\text{h})(518.3 \text{ m}^3/\text{h}) = 1036.6 \text{ m}^3$$

- f. Because off-peak pumping will be used to equalize the storage, from Table 17-8 one-half the maximum daily demand will need to be stored.

$$(0.5 \text{ d})(10,208 \text{ m}^3/\text{d}) = 5,104 \text{ m}^3$$

- g. Because there are two wells, auxiliary power, and storage is provided for fire flow, no emergency storage will be provided.

- h. The total storage volume required is

$$V = 1036.6 \text{ m}^3 + 5,104 \text{ m}^3 = 6,140.6 \text{ m}^3$$

Comments:

1. The actual storage tank volume selected would be the next standard size larger than the calculated volume.
2. This is quite a large tank for a small community. A different mode of operation, for example, constant pumping, a less conservative estimate of the off-peak pumping storage (25% rather than 50%), or the provision of another well might result in a more reasonable and economical size.

Appurtenances

Appurtenances are subordinate or adjunct parts of an apparatus—in this case the water tank. Of the several appurtenances to the water tank, the following have been selected for discussion: riser pipe, overflow pipe, and vents. These are illustrated in Figure 17-12

Riser Pipe. This pipe is connected to the distribution system and the bottom of the tank. Water flows into the storage tower and drains from the tank back into the distribution system through this pipe. For tanks that float on the system, the tank will drain only if the hydraulic grade line outside of the tank falls below the water level in the tank. When the water level reaches a predetermined lower elevation, a signal is sent to the pumping facility and pumping is increased to raise the hydraulic grade line and pump water into the tank.

Overflow Pipe. The overflow pipe is a pipe that discharges water from the top capacity line in an emergency when the pumps fail to shut off. GLUMRB (2003) specifies that the pipe be brought down to an elevation between 0.30 and 0.60 m from the ground surface and discharge over a drainage inlet structure or a splash plate. No overflow may be connected directly to a sewer or a storm sewer. The overflow pipe must be screened with a twenty-four mesh noncorrodible screen at its discharge point.

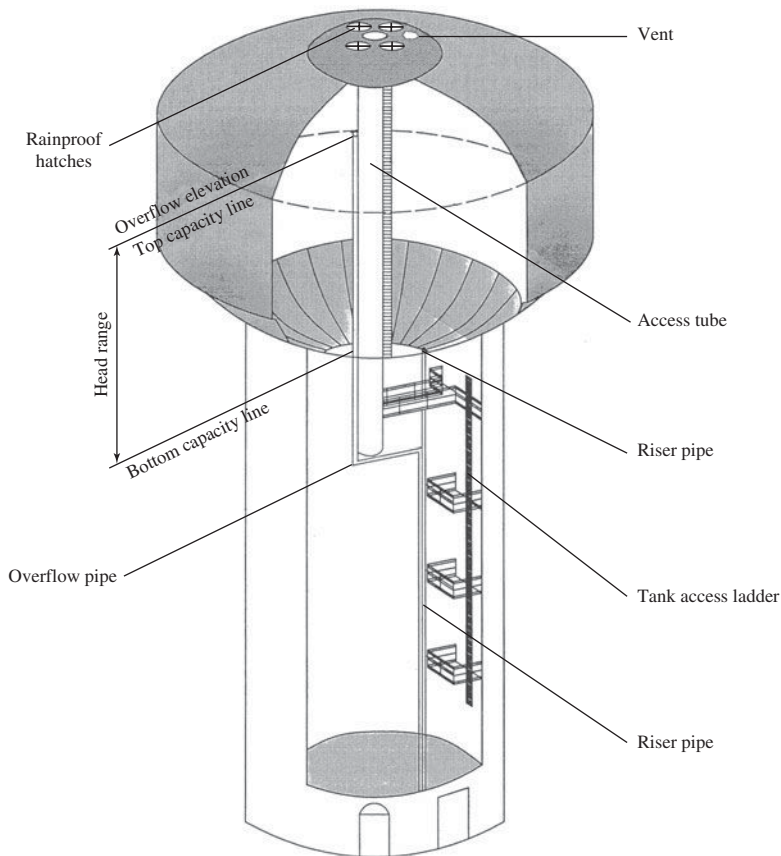

FIGURE 17-12
Water tower appurtenances.

Vents. The vents are to prevent the tank from becoming pressurized. GLUMRB (2003) specifies that the vent shall open downward, exclude surface and rainwater, birds and animals, insects, and dust. A twenty-four mesh noncorrodible screen is required.

Water Quality

Studies in the 1990s (Clark et al., 1993; Kirmeyer et al., 1999) found that long residence times in storage tanks resulted in decay of disinfectant residuals to levels that were extremely low to non-existent. In addition, it has been recognized that longer detention times in storage tanks normally leads to increases in the formation of disinfection by-products.

Through physical scale models, actual tank tests and computational fluid dynamics, Grayman et al. (2004) developed the following design and operating criteria to improve mixing and reduce water quality deterioration:

- The storage tank should be designed to encourage good mixing rather than plug flow.
- Baffles should not be used.
- Mixing should be enhanced. This can be accomplished by utilizing the jet flow as water enters the tank.
- For a tank operating on a fill-and-draw mode, mixing occurs primarily during the fill cycle. Therefore, the mixing time must be less than the fill time for the tank.
- Although the inlet configuration is secondary compared with the previous factors, the arrangements shown in Figure 17-13 have a greater potential for causing poor mixing.
- Long detention times lead to decay of the disinfectant residual. Estimates of the detention time and the disinfectant decay rate can be used to establish an acceptable detention time.

For jet flow to accomplish mixing, it must be turbulent. For circular jets, the Reynolds number remains constant throughout the jet structure and is equal to that of the flow exiting the riser into the tank. Fully turbulent jets have Reynolds numbers greater than 3,000. Thus, the design must incorporate a riser pipe that achieves this Reynolds number.

Mixing time may be estimated using the following equation (Grayman et al., 2004):

$$t_{\text{mixing}} = 10.2 \left[\frac{(\Psi)^{2/3}}{(M)^{1/2}} \right] \quad (17-8)$$

where t_{mixing} = mixing time, s

Ψ = volume of water in tank at start of fill, m^3

M = momentum = $(u)(Q)$, m^4/s^2

u = inflow velocity, m/s

Q = flow rate, m^3/s

With the requirement that, for good mixing, the fill time must exceed the mixing time, Equation 17-8 may be rewritten in terms of the required change in water volume during the fill cycle as a fraction of the volume at the start of the fill period:

$$\frac{\Delta\Psi}{\Psi} > \frac{9.03 d}{(\Psi)^{1/3}} \quad (17-9)$$

where d = inlet diameter, m

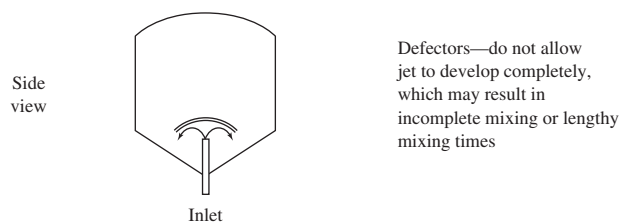

Deflectors—do not allow jet to develop completely, which may result in incomplete mixing or lengthy mixing times

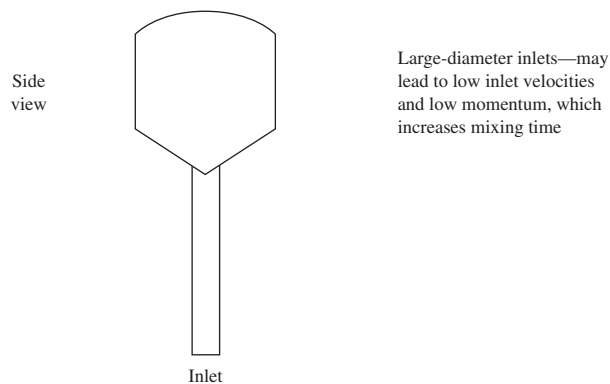

Large-diameter inlets—may lead to low inlet velocities and low momentum, which increases mixing time

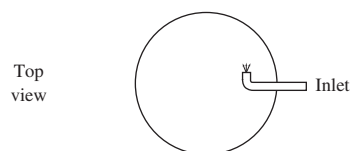

Tangential inlet—can lead to swirling flow, which may result in dead spot in center of tank

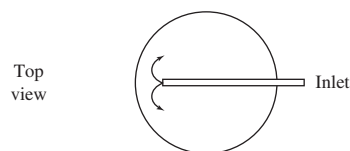

Inlet directed at wall—does not allow jet to develop completely, which may result in incomplete mixing or lengthy mixing times

FIGURE 17-13
Example inlet configurations that may lead to mixing problems.

The theoretical average residence time in the tank is

$$t_{\text{residence}} = \frac{V_{\text{max}}}{(V_{\text{max}} - V_{\text{min}})(N)} \quad (17-10)$$

where V_{max} = maximum daily volume, m^3
 V_{min} = average minimum daily volume, m^3
 N = number of fill and draw cycles per day

Hints from the Field

Cellular Antennas. In many locations, Federal Aviation Administration (FAA) and local zoning restrictions have limited the ability of cellular companies to build towers. Because of these restrictions, elevated water storage tanks have become prime sites for installation of antennas.

The money from leasing sites on the water tower has become a welcome source of revenue. While the revenue is certainly worth considering, care must be taken to avoid the adverse effects of these installations. Some installations have resulted in structural damage, coating and corrosion damage, restriction to access ladders, and contamination through improperly sealed penetrations. The following recommendations are provided in considering the installation of antennas (Dixon, 2008):

- The cellular company should provide drawings of its installation. These should include site utilities, ground structures, cable routing, and antenna mounting structures.
- A qualified engineering firm with experience with both storage tanks and antenna installation should review the plans.
- Structural analysis should be performed to ensure that the tank can support the antennas.
- Inspection of the completed installation should be performed by a qualified engineer.

17-6 PUMP SELECTION

The fundamentals of pump selection were addressed in Chapter 3. This discussion is limited to the type of pump, piping arrangements, parallel and series operation, a summary of the steps in pump selection, and a typical operational procedure.

Type of Pump

Pumps used to supply the distribution system are called *high-service pumps*. High-service pumps are selected with the objective of providing a high enough pressure to make water flow at a high rate through service connections at various elevations throughout the distribution system. The place where the high-service pumps are located is called a *pump station*. The location and configuration of the pump station governs the type of pump construction. If the intake structure is located below the pump station, for example, in a clear well below the plant, the common choice is a vertical turbine pump. This type of pump was described in Chapter 3. In many cases, the pump station is located downstream of a reservoir where the water level is at an elevation above the pump station. In these cases, a horizontal centrifugal pump is a more logical selection. Horizontal centrifugal pumps of split case design (Figure 17-14) are commonly used because the rotating element can be removed without disturbing the suction and discharge piping.

Variable Speed Pumps. As noted in Chapter 3, variable speed drives, especially the adjustable frequency drive (commonly referred to as a *variable frequency drive* or just *VFD*), have become common. The VFD adds both flexibility in operation and a potential for savings in energy costs.

Piping Arrangements. A typical piping system for a high-service pump is shown in Figure 17-15 on page 17-34. Table 17-10 on page 17-35 identifies the elements along with typical *K* values for

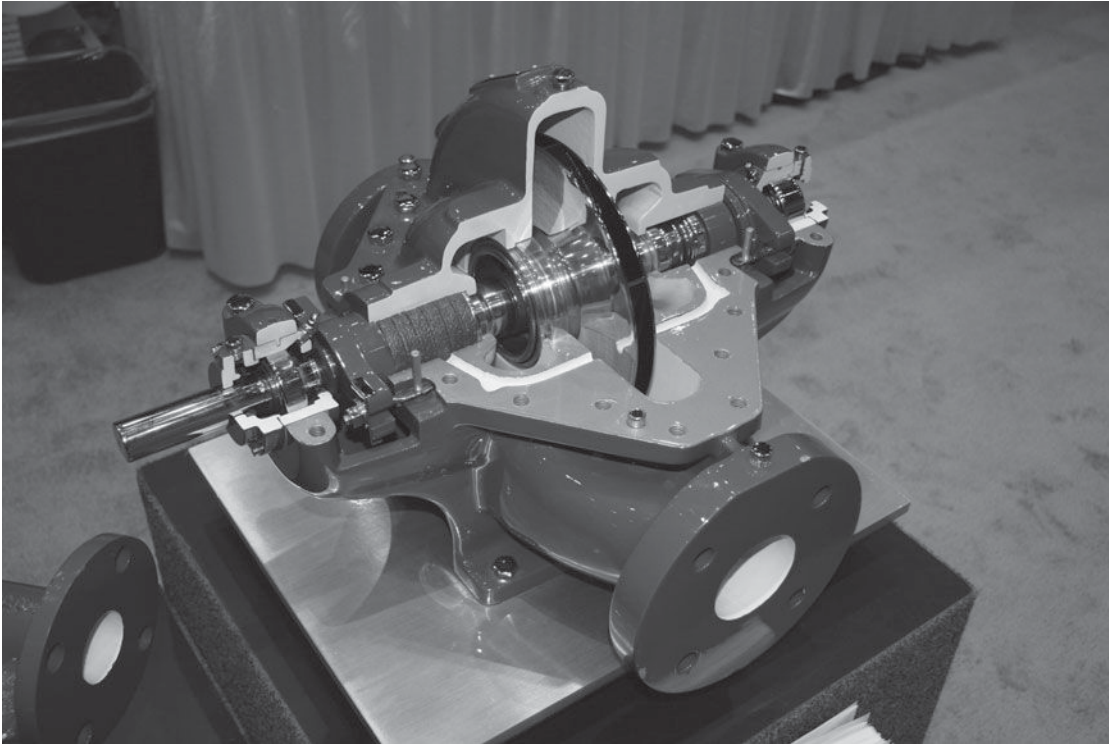

FIGURE 17-14

Horizontal pump with axially split casing.

(Source: Mackenzie L. Davis.)

calculating minor losses. In order to minimize headloss and turbulence, long radius bends in both the suction and discharge piping are recommended. Either resilient wedge gate valves or butterfly valves that meet American Water Works Association specifications are recommended for use as isolation valves on both the suction and discharge piping. Additionally, a check valve should be provided on the discharge pipe to prevent backflow through the pump when the pump is shut down or if there is a power failure. Although many types of check valves have been used satisfactorily, cone valves are recommended because the regulated opening and closing times have proven effective in minimizing surges (Honeycutt and Clopton, 1976). Cone valves are the “Cadillac” of valves. Other valves can be designed to minimize surge.

Parallel and Series Operation

Parallel Operation. The use of multiple pumps in parallel is common practice. Each pump’s discharge is connected to a common manifold as shown in Figure 17-16 on page 17-35. The principle on which the design is based is that the total station discharge is determined by adding the individual pump discharges at a particular head with the largest pump out of service.

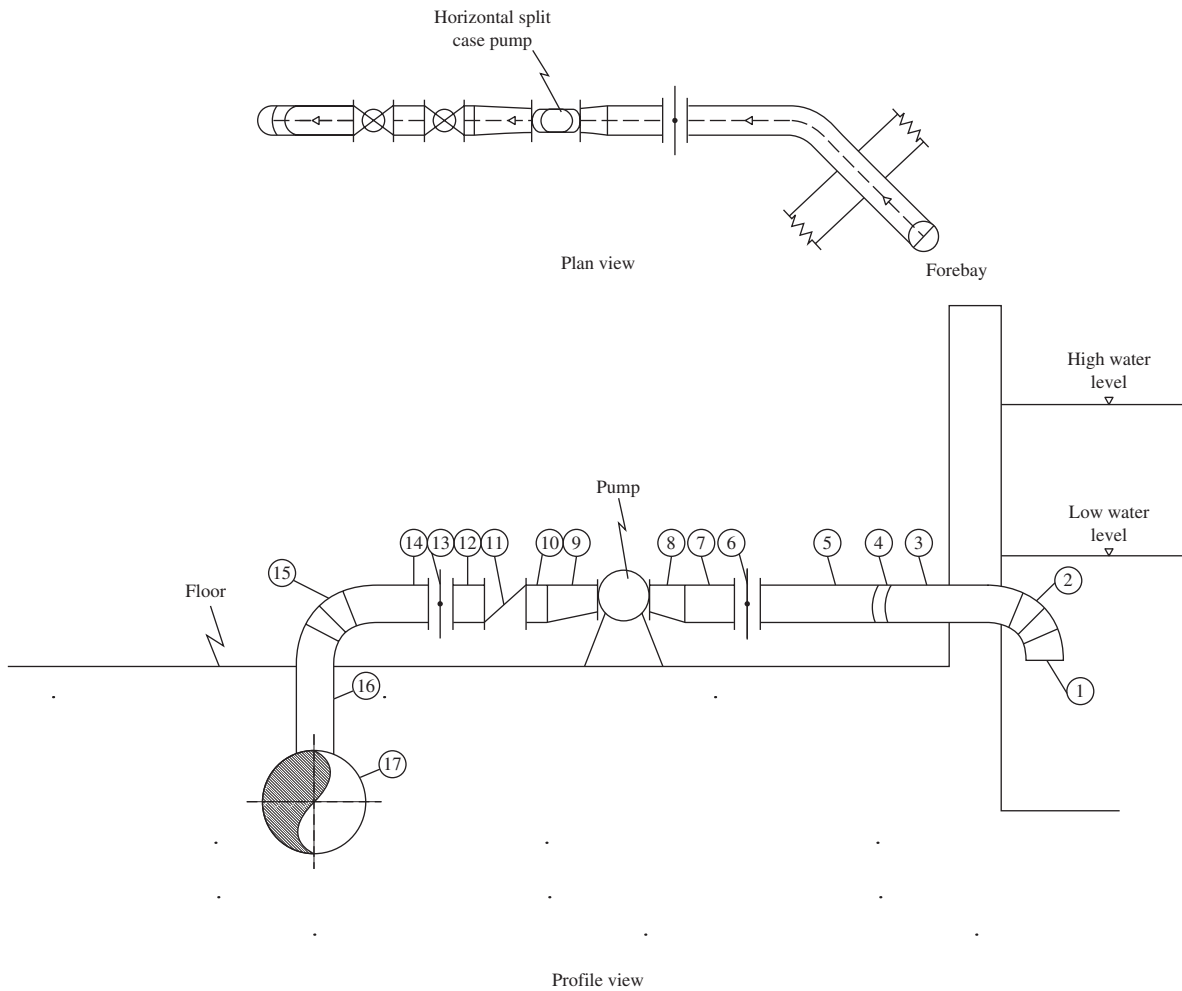

FIGURE 17-15
High-service pump piping system. See Table 17-10 for key to numbered components.

Because the system head curve rises with increasing flow, the simultaneous operation of two identical pumps in parallel will not produce a discharge equal to twice the capacity of one pump (Figure 17-17 on page 17-36).

Series Operation. For two identical pumps placed in series operation, the heads are added, but the flow rate is not increased. This arrangement is not common for a given pumping station. However, pumps placed in the distribution system to increase pressure (*booster stations*) are, in effect, pumps operating in series.

If more head is required for a given flow rate at a single pumping station, either multistage centrifugal pumps or vertical turbine pumps are used.

TABLE 17-10
Typical minor loss factors (K) and Hazen-Williams friction factors (C) for high-service pumping system

Item in Figure 17-15	Description	Pipe size		Friction factor	
		mm	m	K^a	C^b
1	Entrance (ordinary)	300	0.30	1.0	
2	90° elbow	300	0.30	0.30	
3	4.5 m of straight pipe	300	0.30		140
4	30° elbow	300	0.30	0.20	
5	2 m of straight pipe	300	0.30		140
6	Butterfly valve	300	0.30	0.46	
7	1.2 m of straight pipe	300	0.30		140
8	300 mm × 200 mm reducer	200	0.20	0.25	
9	150 mm × 250 mm increaser	250	0.25	0.25	
10	1 m of straight pipe	250	0.25		140
11	Pump check valve	250	0.25	0.80	
12	1 m of straight pipe	250	0.25		140
13	Butterfly valve	250	0.25	0.46	
14	0.60 m of straight pipe	250	0.25		140
15	90° elbow	250	0.25	0.30	
16	1.5 m of straight pipe	250	0.25		140
17	Tee connection	250	0.25	0.50	

^aTypical K values. Different publications present other values.

^bReasonable value for mortar-lined steel pipe. Value can range from 130 to 145.

Source: Bosserman, 2000.

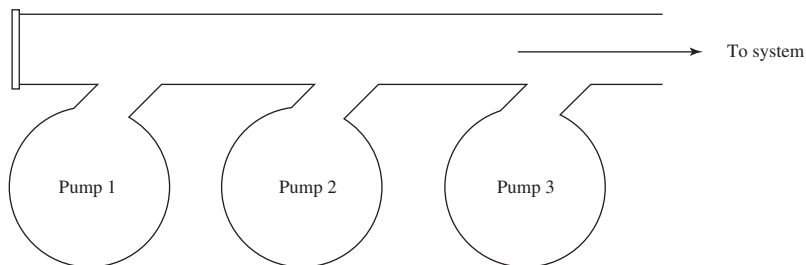

FIGURE 17-16
Pump manifold.

Summary of Pump Selection

The following steps summarize the pump selection process:

1. Plot the system head curves.
2. Modify the manufacturer's head-discharge curve by subtracting the minor losses in the pump suction and discharge piping.

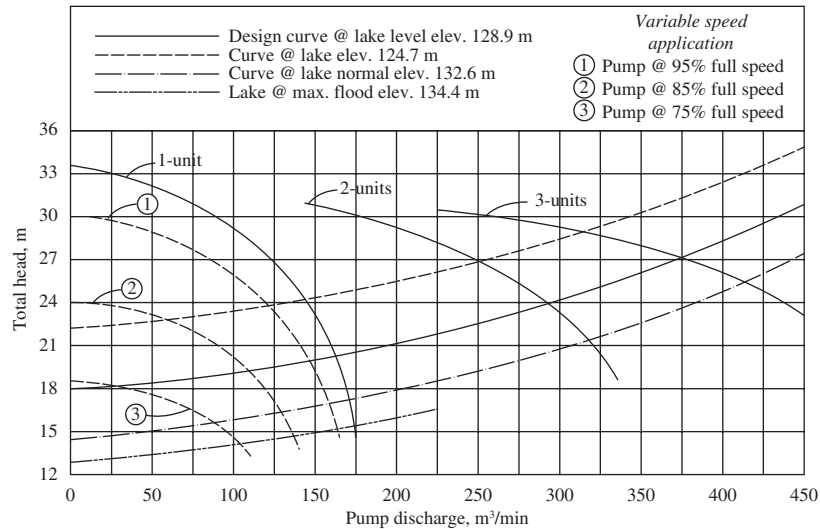

FIGURE 17-17
System head curve for raw-water pump station.

3. Select a pump so that the initial operating point occurs to the right of the BEP.*
4. In multiple pump operations, check the operating point with each combination of pumps that may operate together.
5. Check that the $NPSH_A^*$ exceeds the $NPSH_R^*$ for all hydraulic considerations including run-out.

Typical Operating Procedure

A typical operating procedure for a pumping station with two variable speed (VFD) pumps and one or more constant speed pumps is as follows:

1. If the demand flow rate is less than the capacity of one VFD pump, operate one pump.
2. If the demand flow rate is between one and two times the capacity of a single unit, operate both VFD pumps in lieu of operating one unit at full speed and one unit at a speed less than that required to produce the minimum allowable flow to stay within the preferred operating range (POR).*
3. If the demand flow rate is more than two times the design capacity of a single unit, operate two VFD pumps and as many constant speed pumps as required to ensure operation of all pumps at speeds that will produce flows exceeding the lower bound of the POR.

17-7 NETWORK ANALYSIS

In all but the smallest systems, the pipe network includes loops. That is, the pipe system forms a grid connected at multiple points. The number of dead ends is minimized in order to provide

*See Chapter 3 for definitions and discussion of these terms.

increased reliability of service and to reduce headloss. Reliability of service is increased with loops because interruption of service by a break in the main may be readily circumvented by the water taking an alternate route to downstream users.

The classical pipe-network flow problem asks what flows and pressures are in a network of pipes subject to a known set of inflows and outflows. Two sets of equations are needed to solve this problem. The first set requires conservation of flow to be satisfied at each pipe junction. The second specifies a nonlinear relationship between flow and headloss at each pipe. The Hazen-Williams equation is an example of this relationship. When the network contains loops, as is the case in most instances, these equations form a coupled set of nonlinear equations. These can be solved only by using iterative methods. For all but the simplest cases, a computer is used for the solution (Rossman, 2000).

At a minimum, preliminary selection of each of the elements of the design discussed to this point in the chapter must be resolved before the computer program can be used. Once the model is set up, the selected parameters may be adjusted to improve the model solution.

An example computer program that serves as a basis for the following discussion is EPANET2. EPANET2 is a public domain water distribution modeling package developed by the U.S. Environmental Protection Agency. The program can be downloaded from <http://www.epa.gov/NRMRL/wswrd/dw/epanet.html>.

Network Representation

The vocabulary used in representing the network is summarized as follows:

- *Network*. The distribution system is represented by a collection of links connected together at their end points, which are called *nodes*.
- *Links*. Pipes, pumps, and control valves are represented by links.
- *Junctions*. These are nodes where pipes connect and water consumption occurs.
- *Reservoirs*. These represent fixed head boundaries.
- *Tanks*. These are variable volume storage facilities.

In addition, some informational objects are also used to represent the distribution system. These include:

- Time patterns to model diurnal water demand.
- Head-discharge curves for pumps.
- Operational controls that change link status depending on tank levels, nodal pressures, and time.
- Hydraulic analysis options that include the type of headloss equation, units, viscosity, and specific gravity.
- Water quality options, including compounds, and reaction rate coefficients
- Time parameters, including the duration of the simulation, time steps, and time interval for output results.

Skeletonization

The process of representing only selected pipes in the model is called *skeletonization*. This process is begun by deciding on the smallest diameter of pipe to include in the model. The advantages of a skeletonized network are reduced data handling and easier comprehension of the output. The disadvantages include the need to use engineering judgement in which pipes to include and the difficulty in aggregating demand from individual users.

A highly skeletonized model may be appropriate for capital improvement planning or pump scheduling studies. It would not be appropriate for water quality modeling or for fire flow analysis.

17-8 SANITARY PROTECTION

A number of features in the design and installation of the storage and distribution system are required to protect the water from contamination. Some of these have already been discussed, for example, screens on openings to storage tanks. They will not be repeated here.

Sanitary Protection of Storage

Location. GLUMRB (2003) specifies the following in siting storage tanks:

- The bottom of ground level reservoirs and standpipes should be placed at the normal ground surface, and shall be above the 100-year flood or the highest flood of record.
- If the bottom elevation of a storage reservoir must be below normal ground surface, it must be placed above the groundwater table. At least 50 percent of the water depth should be above grade. Sewers, drains, standing water, and similar sources of possible contamination must be kept at least 15 m from the reservoir. Gravity sewers constructed of water main quality pipe, pressure tested in place without leakage, may be used at distances greater than 6 m, but less than 15m.
- The top of a partially buried storage structure must be not less than 0.60 m above normal ground surface.

In Michigan, placing any portion of the tank below grade is discouraged.

Disinfection. Finished water storage structures must be disinfected in accordance with AWWA Standard C652 using Methods 1 or 2. Method 3 is not recommended. In Method 1 a liquid chlorine or sodium hypochlorite solution is fed such that the chlorine concentration after six hours is 10 mg/L if the solution is fed uniformly. If it is mixed into the tank, the time period is 24 hours. In Method 2, the tank is sprayed or brushed with a solution of 200 mg/L available chlorine. Bacteriological testing after disinfection is used to confirm that disinfection is complete.

The air space in the tank will have a substantial concentration of chlorine gas during treatment. Workers should wear appropriate breathing apparatus and protective clothing including eye protection to avoid chlorine poisoning and burns. A self-contained breathing apparatus (SCBA) should be used.

Sanitary Protection of Water Mains

Location. GLUMRB (2003) specifies that water mains shall be laid at least 3 m horizontally from any existing or proposed gravity sewer, septic tank, or subsoil treatment system. Water mains crossing sewers shall be laid to provide a minimum vertical distance of 0.45 m between the outside of the water main and the outside of the sewer. It is preferable that the water main be located above the sewer. At crossings, one full length of water pipe shall be located so both joints will be as far from the sewer as possible.

For above water crossings, the pipe must be protected from damage and freezing. Typically, the pipe is hung from a bridge. In extremely cold climates, this practice is problematic. If the water crossing is to be made under water, a minimum cover of 0.60 m above the lowest dredged bottom must be provided. In addition, the pipe must have flexible, restrained, or welded watertight joints. Valves are to be placed at both ends to isolate the section of pipe. Some provision must be made to allow determination of potential leakage as well as sampling for water quality analysis.

Disinfection. Finished water mains must be disinfected in accordance with AWWA Standard C651. The three methods are summarized here (Walski, 2000a).

- *Tablet method.* This method can be used if the pipes have been kept clean. Some manufacturers are offering to ship the pipe with plugs to keep out dirt, debris, and animals. The method involves placing hypochlorite granules or tablets in the pipes during installation at intervals no greater than 150 m. The number of 5 g tablets per length of pipe can be estimated using the following equation:

$$N = (6.4 \times 10^{-6})(L)(D)^2 \quad (17-11)$$

where N = number of 5 g tablets

L = length of pipe, m

D = diameter of pipe, mm

Using this method the average concentration of chlorine during the test should be about 25 mg/L. The water must fill the main slowly. A velocity of less than 0.3 m/s is recommended. If the water temperature is higher than 5°C, the water must be kept in the main for at least 24 hours. If the temperature is less than 5°C, the water must be kept in the pipe for 48 hours. This method is appropriate for small mains.

- *Continuous feed method.* The mains must be flushed at a velocity greater than 0.76 m/s to remove sediment and air pockets. Chlorine is fed at a rate that maintains a concentration of 25 mg/L for 24 hours. At the end of 24 hours, the free chlorine residual must be greater than 10 mg/L.
- *Slug method.* This method consists of placing hypochlorite tablets as in the first method and then flushing the main as in the second method. Then a slug of 100 mg/L chlorinated water is placed in the main for at least three hours. The concentration must not drop below 50 mg/L. This method is appropriate for large mains.

In each of these methods, highly chlorinated water must be disposed of in an environmentally responsible manner. This may require treatment with a reducing chemical such as sodium sulfite.

Research by Haas et al. (2002) has demonstrated that lined and unlined DIP requires larger chlorine doses than PVC pipe to achieve a 25 mg/L residual after 24 hours. The demand for chlorine is larger for smaller diameter pipes than larger ones. For example: the dose of calcium hypochlorite to achieve a residual of 25 mg/L after 24 hours is 44.0 mg/L for 100 mm diameter versus 31.7 mg/L for 300 mm diameter.

Visit the text website at www.mhprofessional.com/wwe for supplementary materials and a gallery of photos.

17-9 CHAPTER REVIEW

When you have completed studying this chapter, you should be able to do the following without the aid of your textbook or notes:

1. Under the two common distribution systems design strategies (i.e., with and without fire protection), describe the components of demand that must be estimated.
2. Explain why fire sprinkler systems reduce fire demand.
3. Explain why it is not necessary to calculate the NFF for each building in a distribution system.
4. State the normal range of pressures for a distribution system and the allowable minimum pressure in units of kPa.
5. Identify the following abbreviations that are used for describing distribution pipe material: DIP, PVC, HDPE, RCPP, ACP.
6. Explain the closure mechanism for the following valves: globe, gate, plug, butterfly.
7. Select the appropriate valve type for isolating pipe section and for regulating flow.
8. Explain the difference between pumped storage and float-on-the-system storage.
9. Explain why very large communities frequently do not have elevated storage tanks.
10. Explain the difference between the riser pipe and overflow pipe in terms of function and location of its terminal point in the water tower.
11. Explain why mixing of water in a storage tank is desirable.
12. Describe one method for mixing the contents of storage tank.

With the aid of this text, you should be able to do the following:

13. Estimate the sprinkler and hose-stream fire flow for a given structure given a description of the type of occupant and the floor area.
14. Estimate the NFF for a building given the appropriate ISO tables or citations.
15. Estimate the demand for a distribution network district.
16. Perform a pipe network design and analysis for a small system that does not have any loops.

17. On a pipe network, locate the points where valves and hydrants should be placed.
18. Calculate minor losses in terms of headloss using either appropriate equations or equivalent length of pipe.
19. Given a community plan and scenario for growth and fire protection, locate a water tower.
20. Given a community plan and scenario for growth and fire protection, determine the volume for a water tower.
21. Calculate the required inlet velocity to achieve a mixing time given the riser diameter and the water temperature.
22. Calculate the required inlet volume (ΔV) to achieve a mixing time that is less than the fill time.
23. Calculate the minor losses for a given piping arrangement for a pump.
24. Perform a network analysis using EPANET.

17-10 PROBLEMS

- 17-1. Estimate the sprinkler and hose-stream fire flow for a warehouse that is used to store books. The warehouse is one story with dimensions of $10\text{ m} \times 100\text{ m}$.
- 17-2. A sprinkler system is to be designed for the Southern Cross Mall. The mall consists of four corridors that join at the center as shown in Figure P-17-2. The anchor store at the end of each corridor occupies $1,000\text{ m}^2$. The stores on both sides of the corridor are of varying frontage, but each is 10 m in length. Determine the size of the sprinkler districts to form the minimum number of districts and mark them on a copy of the mall plan. Estimate the sprinkler and hose-stream fire flow for a sprinkler district.

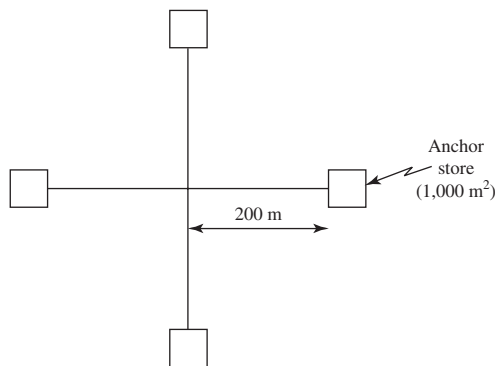

FIGURE P-17-2
Southern Cross Mall.

- 17-3. Estimate the NFF for a subdivision of duplex buildings that are centered on lots that are $30\text{ m} \times 30\text{ m}$. The duplexes are $26\text{ m} \times 8\text{ m}$. They are set on the lots so the long dimension faces the street and the short dimensions face each other.

- 17-4. A client has requested that your firm examine the implications of building materials on the motel model in Example 17-2. Using the following coefficients from the ISO tables, calculate the NFF and plot the NFF versus the construction class (F). Explain the cost implications for capital cost versus the annual insurance cost.

Frame construction: $F = 1.5$
 Joisted masonry construction: $F = 1.0$
 Masonry, noncombustible: $F = 0.8$
 Fire resistive: $F = 0.6$

- 17-5. Estimate the demand for the Village of Sunfield distribution network shown in Figure P-17-5. The population estimate is 1,380 people. No fire protection will be provided. Assume the average daily withdrawal is the same as that for Nevada (Table 2-6).

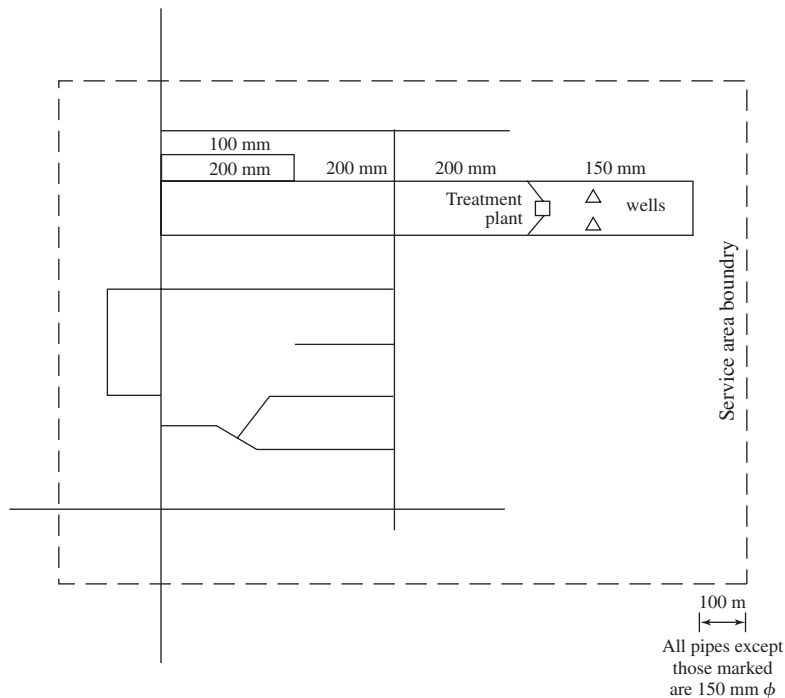
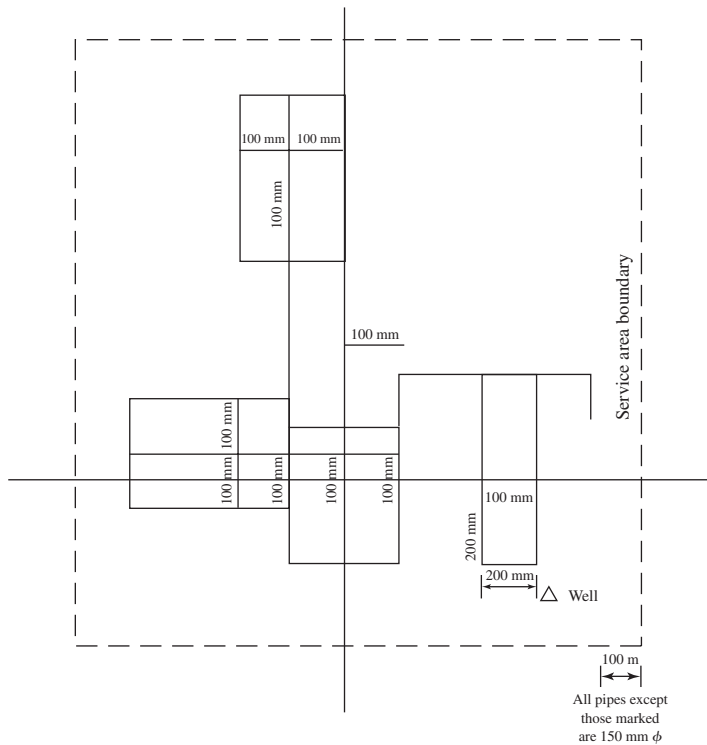

FIGURE P-17-5
 Village of Sunfield distribution system.

- 17-6. Rework Problem 17-5 assuming fire protection will be provided. Assume only residential housing and a distance of 15 m between houses.
- 17-7. Estimate the demand for the Village of Webster distribution network shown in Figure P-17-7. The population estimate is 1,690 people. No fire protection will be provided. Assume the average daily withdrawal is the same as that for Connecticut (Table 2-6).

**FIGURE P-17-7**

Village of Webster distribution system.

- 17-8.** Rework Problem 17-7 assuming fire protection will be provided. Assume only residential housing and a distance of 3 m between houses.
- 17-9.** Rework Example 17-4 by adjusting the pipe sizes rather than the elevation of the storage tank to achieve a pressure of 207 kPa at Point H.
- 17-10.** Perform a hydraulic analysis on the camp in Example 17-4 to find the pressure at Point F.
- 17-11.** A water distribution system is being designed to supply a valley community as shown in Figure P-17-11. Assuming that minor losses and friction can be ignored, does the pressure at the critical points B and C in the system meet specification norms?
- 17-12.** Determine the losses (total of friction and minor in meters of head) in the pipe shown in Problem 17-11 for the following conditions: pipe diameter = 200 mm, flow rate = $227 \text{ m}^3/\text{h}$, pipe length = 170.7 m; pipe has one ordinary entrance, one gate valve fully open, two long sweep elbows.
- 17-13.** In order to reduce its insurance rate, a country club has proposed that they build a water line from the city trunk line as shown in Figure P-17-13. As the city engineer, you must verify that there is enough pressure in the trunk line to ensure that the required fire flow

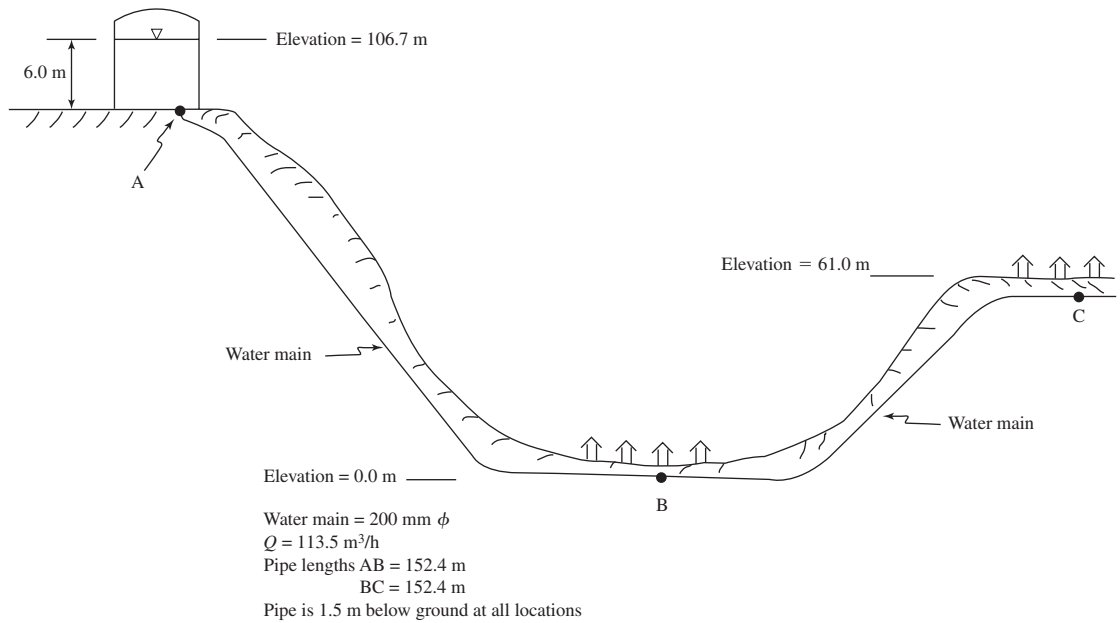

FIGURE P-17-11
Valley water distribution system.

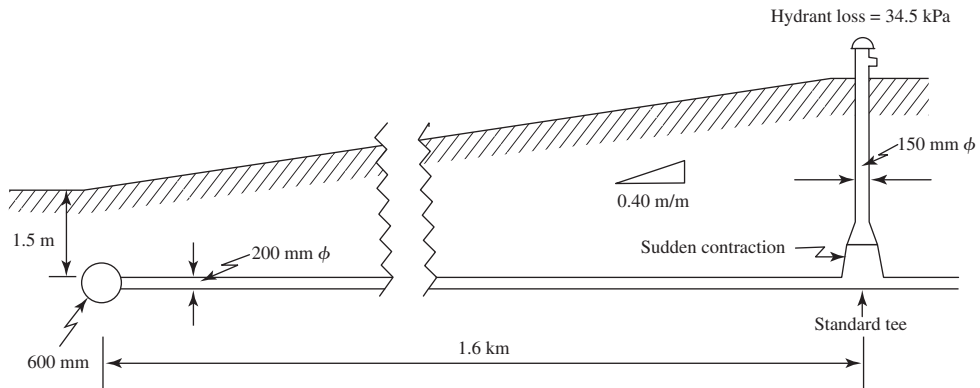

FIGURE P-17-13
Water main for fire flow.

of $136 \text{ m}^3/\text{h}$ can be delivered at a pressure of 206 kPa after it leaves the hydrant. Calculate the required pressure in the trunk line. Show all work. Include minor losses.

- 17-14.** In anticipation of a commitment to provide fire protection, on a copy of the map of Sunfield's distribution system (Problem 17-5), mark the locations where valves and fire hydrants should be placed.
- 17-15.** In anticipation of a commitment to provide fire protection, on a copy of the map of Webster's distribution system in Problem 17-7, mark the locations where valves and fire hydrants should be placed.

- 17-16.** On a copy of the map of Sunfield's distribution system (Problem 17-5), mark the location where an elevated storage tank should be placed. Assume that the village anticipates growth to the west that will double the population in 20 years.
- 17-17.** On a copy of the map of Webster's distribution system (Problem 17-7), mark the location of an elevated storage tank. Assume that the village anticipates no growth in the foreseeable future.
- 17-18.** Lotta Doubts has estimated that an elevated water storage tank for the Village of Doom should have a capacity of $4,540 \text{ m}^3$. Doom has a population of 5,000. Based on historic records, the average daily demand is 380 Lpcd and the maximum daily demand is estimated to be two times the average daily demand. Neither the population nor the demand is expected to change over the next 25 years. The fire demand is estimated at $570 \text{ m}^3/\text{h}$ for a two-hour fire. The village is supplied by two well pumps. Each can pump at $90 \text{ m}^3/\text{h}$. As the senior engineer, you are to check Lotta's work. Show by calculation that she is either correct or incorrect. Assume that there is no other storage tank, no emergency supply, and no nearby water body or fire department tanker truck.
- 17-19.** Determine the volume of an elevated water storage tank required for the Village of Sunfield (Problem 17-5). Assume backup power and additional wells will be constructed as the population doubles to 2,760 people. Fire protection is to be provided and off-peak pumping will be provided for equalization. Select an appropriate tank from Figure P-17-19. On a copy of the tank drawing, annotate the drawing for missing appurtenances and/or appurtenance specifications.
- 17-20.** Determine the volume of an elevated water storage tank required for the Village of Webster (Problem 17-7). Assume there is backup power and a constant population. Fire protection is to be provided and off-peak pumping will be provided for equalization. Select an appropriate tank from Figure P-17-19. On a copy of the tank drawing, annotate the drawing for missing appurtenances and/or appurtenance specifications.
- 17-21.** Determine whether or not the fill time for the Village of Sunfield's storage tank (Problem 17-19) exceeds the mixing time using the following assumptions:
1. One pump can meet the maximum day demand in 12 hours.
 2. The diameter of the inlet is 300 mm.
- 17-22.** Determine whether or not the fill time for the Village of Webster's storage tank (Problem 17-20) exceeds the mixing time using the following assumptions:
1. One pump can meet the maximum day demand in 12 hours.
 2. The diameter of the inlet is 300 mm.
- 17-23.** Design a water distribution system for the Bastogne Retirement Center (Figure P-17-23). The specific design requirements of the client are as follows:
- a. Fire protection to be provided by the water distribution system.
 - b. Minimum water pressure at the top of the apartment building is to be 240 kPa.
 - c. Maximum system pressure is to be 550 kPa.

**Standard sizes
Watersphere tanks**

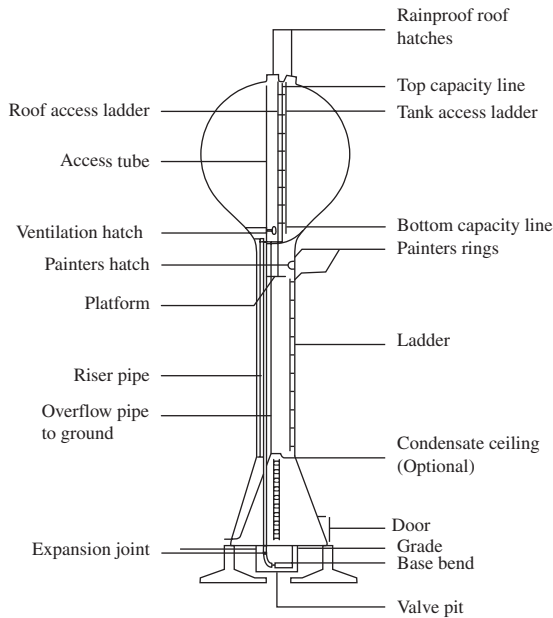

Capacity m ³	Diameter of sphere m	Range of head m
95	5.80	5.02
114	6.15	5.38
151	6.74	6.05
189	7.21	6.60
284	8.24	7.68
379	9.02	8.69
473	9.71	9.33
568	10.32	9.95

Waterspheroid tanks

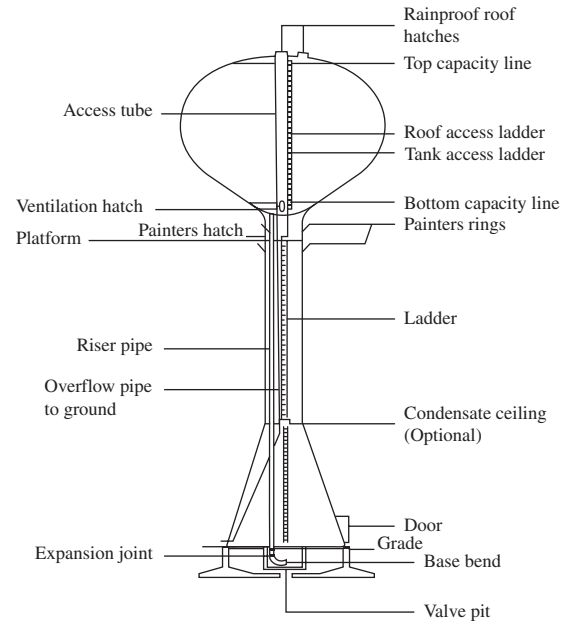

Capacity m ³	Diameter of sphere m	Range of head m
757	12.35	8.76
946	13.31	9.53
1,135	14.18	9.91
1,515	15.71	10.68
1,890	16.93	11.43
2,840	19.70	12.20
3,785	22.55	12.20
4,730	24.04	13.42
5,680	26.37	14.02
7,570	28.58	15.85

FIGURE P-17-19
Typical elevated storage tanks.

The following assumptions may be used in the design:

- a. Each of the three apartment buildings is occupied by 50 residents. Each apartment building is four stories high. Each story is 3 m high.
- b. Each duplex is occupied by four residents.
- c. Average daily demand for the Center is 500 Lpcd.
- d. Peaking factor is 6.8 for peak hour demand.
- e. Needed fire flow for the duplexes is 230 m³/h.
- f. Needed fire flow for an apartment building is 500 m³/h.

- g.** System pressure is to be provided from the elevated storage tank.
- h.** Other than static lift, pressure losses in buildings may be ignored.
- i.** The distribution system will not contain any loops.

To satisfactorily complete the design, you must provide the following:

- a.** A design table similar to that used in Example 17-4 showing the pipe diameters and pressures at critical points (e.g., high and low elevations, and end of pipe).
- b.** A standard size storage tank from Figure P-17-19, the volume of the storage tank, the minimum and maximum elevations (above MSL and above grade) of water in the storage tank.
- c.** Locate fire hydrants and valves on a copy of the water line map (Figure P-17-23).

17-24. Design a water distribution system for the Village of Waffle (Figure P-17-24 on page 17-49). The specific design requirements of the client are as follows:

- a.** Fire protection to be provided by the water distribution system.
- b.** Minimum water pressure at top of apartment building is to be 240 kPa.
- c.** Maximum system pressure is to be 550 kPa.

The following assumptions may be used in the design:

- a.** Each of the four apartment buildings is occupied by 50 residents. Each apartment building is four stories high. Each story is 3 m high.
- b.** Each house is occupied by three residents.
- c.** Average daily demand for the Village is 500 Lpcd.
- d.** Peaking factor is 6.2 for peak hour demand.
- e.** Needed fire flow for the houses is 230 m³/h.
- f.** Needed fire flow for an apartment building is 500 m³/h.
- g.** System pressure is to be provided from the elevated storage tank.
- h.** Other than static lift, pressure losses in buildings may be ignored.
- i.** The distribution system will not contain any loops.

To satisfactorily complete the design, you must provide the following:

- a.** A design table similar to that used in Example 17-4 showing the pipe diameters and pressures at critical points (e.g., high and low elevations, and end of pipe).
- b.** A standard size storage tank from Figure P-17-19, the volume of the storage tank, the minimum and maximum elevations (above mean sea level (MSL) and above grade) of water in the storage tank.
- c.** Locate fire hydrants and valves on a copy of the water line map (Figure P-17-24).

17-25. Using EPANET, determine the pressure at point G in the skeletonized system shown in Figure P-17-25 on page 17-50. The flow rate shown is the fire demand plus the domestic flow. Is the pressure adequate for fire supply? Assume that the elevations at all of the junctions are the same.

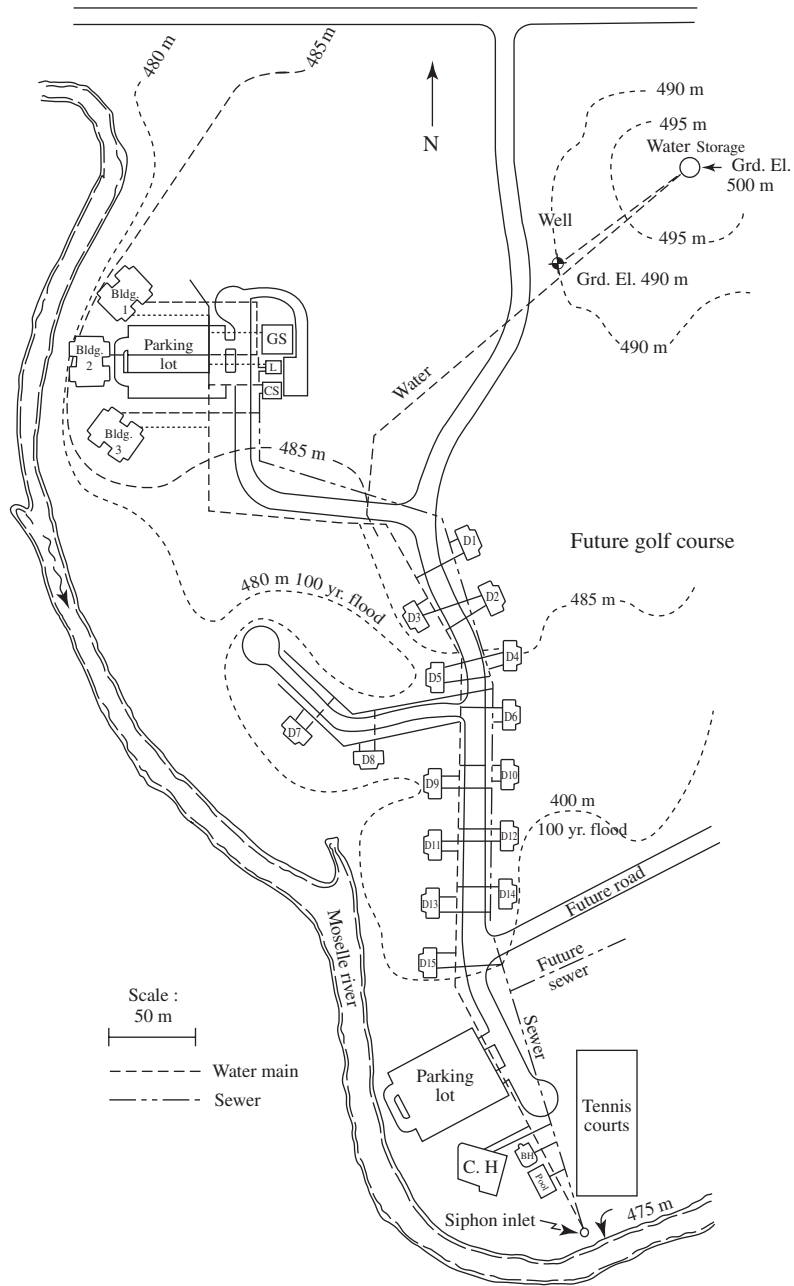

FIGURE P-17-23
Bastogne Retirement Center.

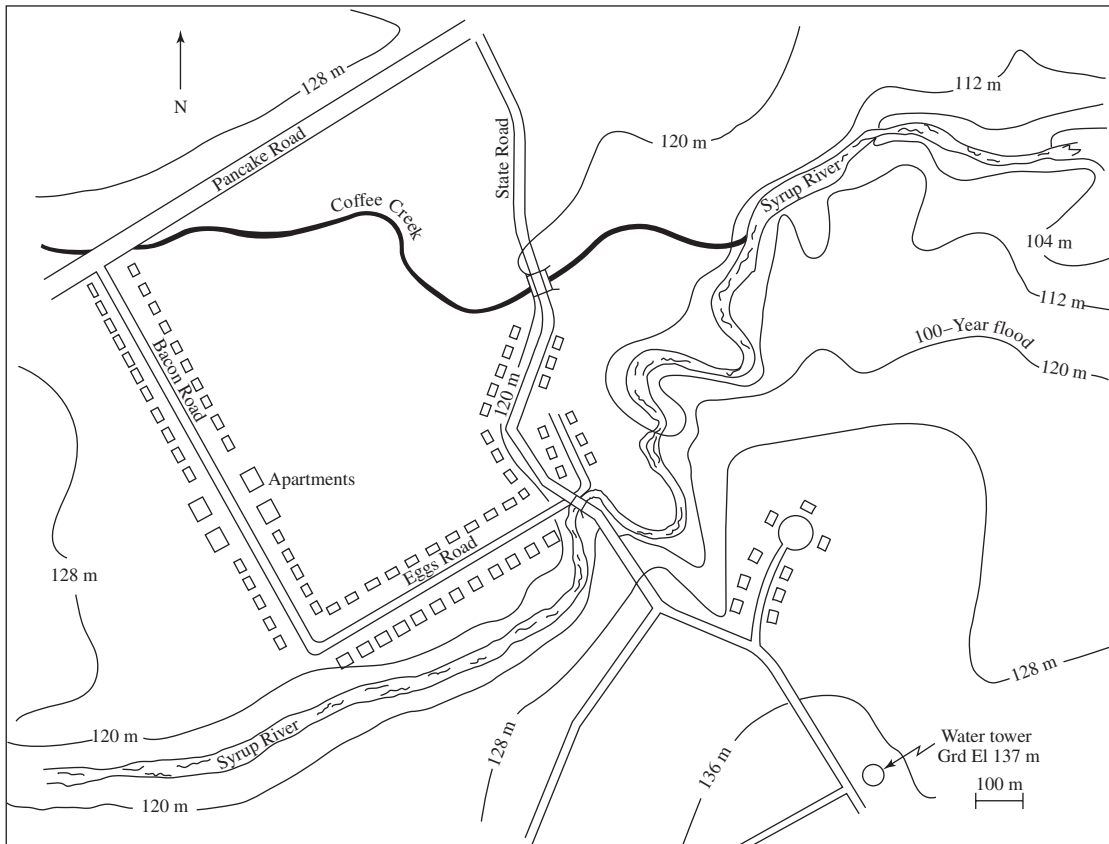

FIGURE P-17-24
Village of Waffle.

- 17-26.** Using EPANET, determine the pressure at point A in the skeletonized system shown in Figure P-17-26. The flow rate shown is the fire demand plus the domestic flow. Is the pressure adequate for fire supply? Assume that the elevations at all of the junctions are the same.
- 17-27.** Estimate the total minor losses for the pipe and pump system shown in Figure 17-15 and Table 17-10. Assume the flow rate is $15.1 \text{ m}^3/\text{min}$. Use the loss coefficient method (K) to make the estimate. Use gate valves in place of the butterfly valves. Assume a Hazen-Williams C of 140 for the pipe sections.
- 17-28.** Repeat Problem 17-23 using the equivalent length of pipe method.

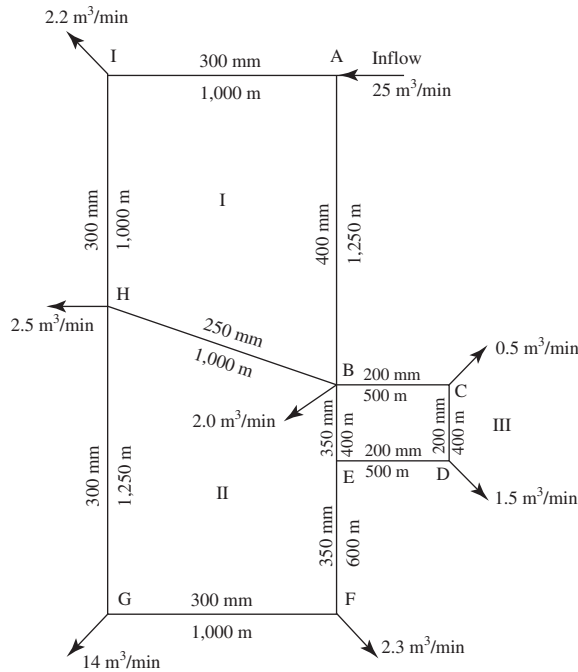

FIGURE P-17-25
Distribution network analysis with fire.
Adapted from Steel and McGhee, 1979.

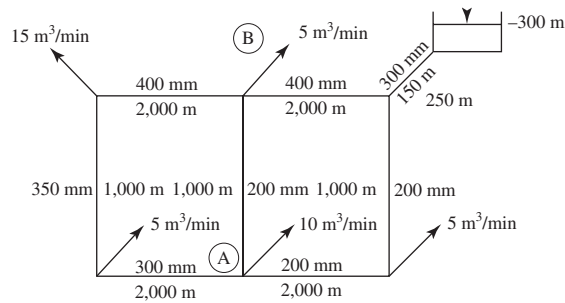

FIGURE P-17-26
Distribution network analysis with elevated storage.
Adapted from Steel and McGhee, 1979.

17-11 DISCUSSION QUESTIONS

- 17-1. The design of a water distribution system requires that the engineer compute a NFF for each building in the district. True or false? If the answer is false, correct it in a nontrivial manner.
- 17-2. Why is a storage tank that is wider than it is tall preferred over a narrow tall tank?

- 17-3.** You have been asked to enter a water storage tank to complete an inspection punch list after construction because you have had confined space training. The work crew is swabbing the interior with 200 mg/L of chlorine. The following personal protective equipment (PPE) has been provided. Is anything missing or incorrect?
- Hard hat
 - Work boots
 - Protective coveralls

17-12 REFERENCES

- AWWA (1998) *Distribution System Requirements for Fire Protection*, Manual M31, American Water Works Association, Denver, Colorado.
- AWWA (2003) *Ductile-Iron Pipe and Fittings*, Manual M41, American Water Works Association, Denver, Colorado.
- AWWA (2006) *Distribution Valves: Selection, Installation, Field Testing, and Maintenance*, Manual 44, American Water Works Association, Denver, Colorado.
- Bosserman, B. E. (2000) "Pump System Hydraulic Design," in L. W. Mays (ed.), *Water Distribution Systems Handbook*, McGraw-Hill, New York, pp. 5.1–5.40.
- Clark, R. M., W. M. Grayman, R. M. Males, and A. F. Hess (1993) "Modeling Contaminant Propagation in Drinking Water Distribution Systems," *Journal of Environmental Engineering*, vol. 119, no. 2, pp. 349–361.
- Coté, A. E. and J. L. Linville (eds.) (1997) *Fire Protection Handbook*, 18th ed., National Fire Protection Association, Quincy, Massachusetts.
- Dixon Engineering Inc. (2008) *Dixon Digest*, Lake Odessa, Michigan.
- GLUMRB (2003) *Recommended Standards for Water Works*, Great Lakes–Upper Mississippi River Board of State and Provincial Public Health and Environmental Managers, Health Education Services, Albany, New York, pp. 103–118.
- Grayman, W. M., L. A. Rossman, R. A. Deininger, C. Smith, C. N. Arnold and J. F. Smith (2004) "Mixing and Aging of Water in Distribution System Storage Facilities," *Journal of American Water Works Association*, vol. 96, no. 9, pp. 70–80.
- Haas, C. N., M. Gupta, R. Chitluru, and G. Burlingame (2002) "Chlorine Demand in Disinfecting Water Mains," *Journal of American Water Works Association*, vol. 94, no. 1, pp. 97–102.
- Honeycutt, F. G. and D. E. Clopton (1976) "Water Supply," in I. J. Karassik, W.C. Krutzsch, W. H. Fraser, and J. P. Messina (eds.) *Pump Handbook*, McGraw-Hill, New York, pp.10-6–10-13.
- Kirmeyer, G. K., L. Kirby, B. M. Murphy, P. F. Noran et al. (1999) *Maintaining Water Quality in Finished Water Storage Facilities*, America Water Works Association Research Foundation, Denver, Colorado.
- Linaweaver, F. P., J. C. Geyer, and J. B. Wolff (1967) "Summary Report on the Residential Water Use Research Project," *Journal of the American Water Works Association*, vol. 59, p. 267.
- Moser, A.P. (ed.) (2001) *Buried Pipe Design*, 2nd ed., McGraw-Hill, New York.
- NFPA (1987) *Standard for the Installation of Sprinkler Systems*, National Fire Protection Association, Standard No. NFPA 13-1987, Quincy, Massachusetts.
- Rossman, L. A. (2000) "Computer Models/EPANET," in L.W. Mays (ed.), *Water Distribution Systems Handbook*, McGraw-Hill, New York, pp. 12.1–12.23.
- Sanks, R. L. (2006) "Data for Flow in Pipes, Fittings, and Valves," in G. M. Jones (ed.), *Pump Station Design*, Elsevier, New York, p. B11.
- Steel, E. W. and T. J. McGhee (1979) *Water Supply and Sewerage*, 5th ed., McGraw-Hill, New York, pp. 124, 151.
- U.S. PHS (1963) *Water Supply and Plumbing Cross-connections*, U.S. Department of Health Education and Welfare, Public Health Service, Washington, D.C., p. 30.

- Walski, T. M. (2000a) "Water-Quality Aspects of Construction and Operation," in L.W. Mays (ed.) *Water Distribution Systems Handbook*, McGraw-Hill, New York, pp. 8.1–8.11.
- Walski, T. M. (2000b) "Hydraulic Design of Water Distribution Storage Tanks," in L.W. Mays (ed.), *Water Distribution Systems Handbook*, McGraw-Hill, New York, pp. 10.1–10.20.
- Ysusi, M. A. (2000) "System Design: Overview," in L.W. Mays (ed.), *Water Distribution Systems Handbook*, McGraw-Hill, New York, pp. 3.1–3.49.

**GENERAL WASTEWATER COLLECTION AND
TREATMENT DESIGN CONSIDERATIONS**

**18-1 WASTEWATER SOURCES AND FLOW
RATES**

18-2 WASTEWATER CHARACTERISTICS

18-3 WASTEWATER TREATMENT STANDARDS

18-4 SLUDGE DISPOSAL REGULATIONS

18-5 PLANT SIZING AND LAYOUT

18-6 PLANT LOCATION

18-7 CHAPTER REVIEW

18-8 PROBLEMS

18-9 DISCUSSION QUESTIONS

18-10 REFERENCES

18-1 WASTEWATER SOURCES AND FLOW RATES

Like with water supply design, a fundamental prerequisite to begin the design of wastewater facilities is a determination of the design capacity. This, in turn, is a function of the wastewater flow rates. The determination of wastewater flow rates consists of five parts: (1) selection of a design period, (2) estimation of the population and commercial and industrial growth, (3) estimation of wastewater flows, (4) estimation of infiltration and inflow, and (5) estimation of the variability of the wastewater flow rates.

Design Period

The constraints in selecting a design period (design life) are very similar to those discussed at length in Chapter 2 and will not be repeated here. Design periods that are commonly employed in practice and commonly experienced life expectancies are shown in Table 18-1.

Components of Wastewater

Wastewater may be classified into the following components:

- *Domestic or sanitary wastewater.* Wastewater discharged from residences, commercial (e.g., banks, restaurants, retail stores), and institutional facilities (e.g., schools and hospitals).
- *Industrial wastewater.* Wastewater discharged from industries (e.g., manufacturing and chemical processes).
- *Infiltration and inflow (I/I).* Water that enters the sewer system from groundwater infiltration and storm water that enters from roof drains, foundation drains, and submerged man-holes.
- *Storm water.* Runoff from rainfall and snow melt.

TABLE 18-1
Design periods for wastewater works

Type of facility	Characteristics	Design period, y	Life expectancy, y
Treatment plants			
Fixed facilities	Difficult and expensive to enlarge/replace	20–25	50+
Equipment	Easy to refurbish/replace	10–15	10–20
Collection systems			
Trunk lines and interceptors > 60 cm	Replacement is expensive and difficult	20–25	60+
Laterals and mains ≤ 30cm	Easy to refurbish/replace	To full development ^a	40–50

^aFull development (also called “build-out”) means that the land area being serviced is completely occupied by houses and/or commercial and institutional facilities.

Domestic Wastewater Flows

Residential Districts. When the proposed project is in a community with an existing wastewater collection system, the community's historic records provide the best estimate of wastewater production. Conversion of total wastewater flow to a per capita basis allows for the separation of population growth from the growth in unit production of wastewater. In the absence of existing data for the client community, installation of temporary flow meters or nearby communities with similar demographics are good alternative sources of data. When the demographics differ in some particular aspect such as a higher or lower density of commercial facilities or a major industrial component, adjustment in the total wastewater production will be appropriate. Gross estimates of unit demand may be made using statewide data. Hutson et al. (2001) have estimated water use by state, and the United States Bureau of Census (Census, 2006) maintains a population database by state. Great care should be used in making estimates from generalized data. All the water withdrawn for use does not end up in the sewer. A rough estimate of 60 to 90 percent of the domestic water-withdrawal rate may be used to estimate the production of residential wastewater. The higher percentages apply to northern states in cold weather. In warm, dry climates where water is used for evaporative cooling of homes and landscape irrigation, the lower percentage is more likely (Metcalf & Eddy, 2003).

GLUMRB (2004) recommends that the sizing of facilities receiving flows from new wastewater collection systems be based on an average domestic daily flow of 380 liters per capita per day (Lpcd) plus wastewater flows from commercial, institutional, and industrial facilities.

Regulations requiring the use of water saving devices (Table 2-5) can significantly reduce the wastewater flow.

Commercial Districts and Institutional Facilities. Estimates for commercial wastewater flows range from 7.5 to 14 m³/ha · d (cubic meters per hectare per day)(Metcalf & Eddy, 2003). For small districts with a limited number of well-defined businesses and institutions, Tables 2-2 and 2-3 in Chapter 2 can provide a basis for estimating commercial and institutional flows.

Industrial Wastewater Flows

If the water requirements of the industries are known, estimates of wastewater flow may be made by assuming about 85 to 95 percent of the water used becomes wastewater when internal recycle is not practiced. A typical design value for estimating the flows from industrial districts that have few wet processes is in the range 7.5 to 14 m³/ha · d for light industrial development and 14 to 28 m³/ha · d for medium industrial development (Metcalf & Eddy, 2003).

To reduce charges for wastewater, many industries have implemented water conservation programs. These programs may result in significant reductions from typical values. Special investigation of industrial sources to obtain realistic estimates is warranted.

Infiltration and Inflow

The extraneous flows in sewers are defined as follows (Federal Register, 1974):

- *Infiltration.* The water entering a sewer system, including sewer service connections and from the ground through foundation drains, defective pipes, pipe joints, connections, or manhole walls. Infiltration does not include inflow.

- *Inflow*. The water discharged into a sewer system, including service connections from such sources as roof downspouts (also called *leaders*); basement, yard, and area drains; cooling-water discharges; drains from springs and swampy areas; manhole covers; cross connections from storm sewers and combined sewers; catch basins; storm water; surface runoff; street wash water; or drainage. This category is further subdivided as:
 - *Steady inflow*. This category includes water from basement and footing drains, cooling water discharges, and drains from springs and swampy areas. It is not distinguishable from infiltration when hydraulic measurements are taken in the sewer.
 - *Direct inflow*. These are inflows that cause an almost immediate increase in wastewater flows. Sources of direct inflow include roof downspouts; basement, yard, and area drains; footing drains; manhole covers; cross connections from storm sewers and combined sewers; catch basins; storm water; surface runoff; street wash water; or drainage.

Storm Water

Historically, many communities elected to collect storm water and wastewater in *combined sewers* and convey the peak dry weather flow to the wastewater treatment plant while large surges of storm water were diverted directly to surface water bodies. The resulting mixture of sewage and storm water has major adverse impacts on the receiving bodies of water. Current regulations prohibit this combination in new facilities.

The estimation of storm water flows and the treatment of storm water is a major subject that is beyond the scope of this text.

Variability of Wastewater Flow Rates

Wastewater flow rates vary over several time scales ranging from diurnal to the design period. The use of these data in design and operation of the collection system and treatment plant are outlined in Table 18-2.

Variation of Domestic Wastewater Flows

Water consumption and wastewater production change with the seasons, the days of the week, and the hours of the day. Fluctuations are greater in small communities than in large communities, and during short rather than long periods of time. The variation in wastewater flow rate is normally reported as a factor of the average day. As noted above, when the proposed project is in a community with an existing community wastewater collection and treatment system, the community's historic records provide the best estimate of wastewater production. This includes its variability. Figure 2-1 in Chapter 2 and Figure 18-1 provide alternative methods of estimating the variability.

Variation of Commercial, Institutional, and Industrial Wastewater Flows

If the commercial, institutional, and industrial wastewater flows make up a significant portion of the average flows (i.e., ≥ 25 percent excluding infiltration), peaking factors for each category should be estimated separately.

TABLE 18-2
Principal flow rate terms and their use in design and operation

Flow rate	Use in design and operation
Average daily	Base for development of flow rate ratios and for estimating pumping, sludge quantities, and chemical costs; identification of sewers where flows will not achieve minimum velocities
Minimum hour	Estimating turndown ratio ^a for pumping facilities and low range for plant flow metering
Minimum day	Sizing of plant components (influent channels, biological treatment systems including recycle requirements for trickling filters)
Minimum month	Selection of minimum operating units required during low flow periods (especially at start-up of new facility); scheduling shutdown for maintenance
Peak hour	Sizing of sanitary sewers; sizing pumping facilities and channels; sizing of physical unit operations including bar racks and screens, grit chambers, sedimentation tanks, filters, and chlorine contact tanks
Maximum day	Sizing equalization basins and sludge pumping systems
Maximum month	Sizing chemical storage facilities

^aThe ratio of the highest operating flow rate to the lowest operating flow rate.

Adapted from Metcalf & Eddy, 2003.

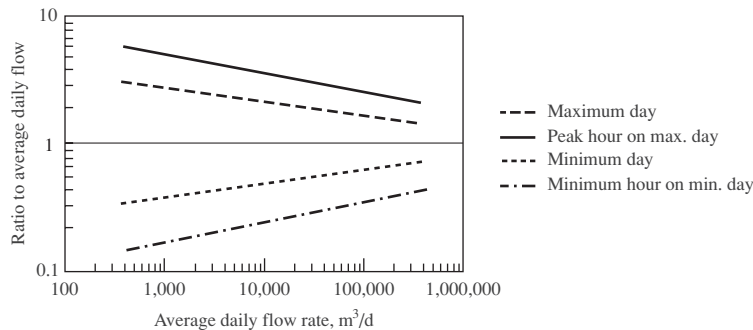

FIGURE 18-1

Ratio of extreme flows to average daily flow.

Variation of Infiltration Flows

The amount of groundwater flowing from a given area varies from a negligible amount for a highly impervious area to 25 to 30 percent of the rainfall for a pervious area with a sandy subsoil. The infiltration of groundwater into the sewer may range from 0.01 to more than $1.0 \text{ m}^3/\text{d} \cdot \text{mm} \cdot \text{km}$ (cubic meters per day per mm diameter of sewer per km length of sewer).

For existing sewer systems, flow measurement provides the best estimate of infiltration/inflow. Metcalf & Eddy (1981) provides a detailed discussion of these techniques. For new sewers, average rates from similar existing sewers, corrected for differences in materials, construction methods, and anticipated future conditions provide another source of data.

TABLE 18-3
Typical infiltration allowances

Pipe diameter, mm	Infiltration Permitted	
	$m^3/d \cdot km$	$L/d \cdot mm \cdot km$
Regulations prior to 1980		
200	8 to 12	40 to 60
300	10.5 to 13.5	35 to 40
600	24 to 27	40 to 45
New pipe		
		10 to 40

Adapted from ASCE, 1982.

In the absence of actual measurements, past practice and regulatory agency requirements, such as those shown in Table 18-3, may be considered as a basis for an estimation (ASCE, 1982). Alternatively, Figure 18-2 may serve as a means of estimating peak infiltration flows. These curves may be considered conservative for most sewer designs. The category of “new sewers” includes those recently constructed in which precast concrete manholes were used and in which pipe joints were sealed with compression gaskets or rubber or rubber-like materials (Metcalf & Eddy, 1981).

Based on examination of 20 data sets from the midwestern and central United States, Lyon and Nelson (2002) found that the average dry weather flow allowance of 380 Lpcd needs to be increased to better account for actual infiltration. For small tributary systems ($<6,000 m^3/d$)

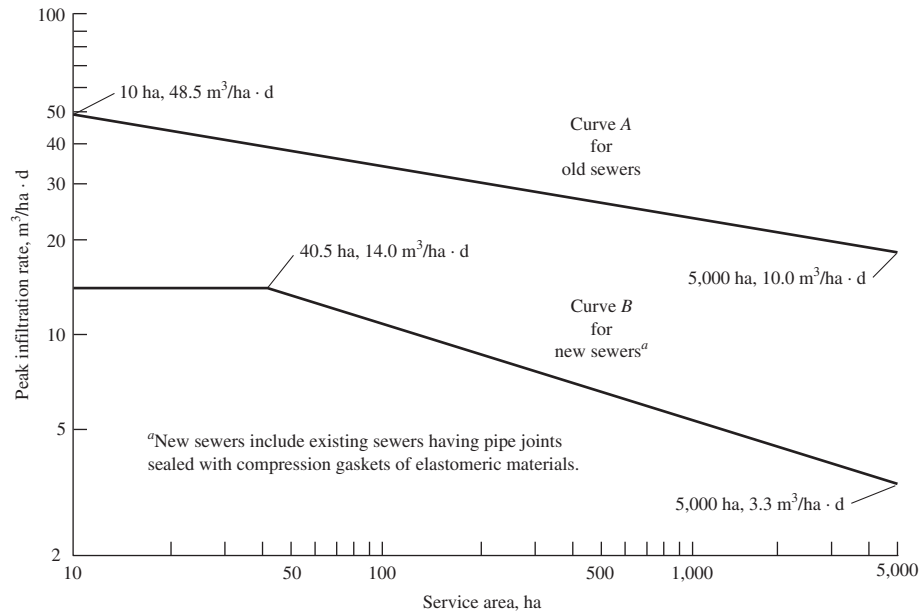

FIGURE 18-2
Peak infiltration allowances. *Source:* Metcalf & Eddy, 1981.

the peaking factors in Figures 2-1 and 18-1 are not conservative enough. Based on the Lyon and Nelson (2002) data, an average dry weather flow allowance of 440 to 500 Lpcd appears to be more appropriate. For very small, extremely leaky sanitary sewer systems, a peaking factor as high as 15 is possible. Very leaky systems may have a peaking factor as high as 10. Moderately leaky systems may have a peaking factor as high as 5.

18-2 WASTEWATER CHARACTERISTICS

Characteristics of Domestic Wastewater

Physical Characteristics of Domestic Wastewater. Fresh, aerobic, domestic wastewater has been said to have the odor of kerosene or freshly turned earth. Aged, septic sewage is considerably more offensive to the olfactory nerves. The characteristic rotten-egg odor of hydrogen sulfide and the mercaptans is indicative of septic sewage. Fresh sewage is typically gray in color. Septic sewage is black.

Wastewater temperatures normally range between 10°C and 20°C. In general, the temperature of the wastewater will be higher than that of the water supply. This is because of the addition of warm water from households and heating within the plumbing system of the structures.

One cubic meter of wastewater weighs approximately 1,000,000 grams. It will contain about 500 grams of solids. One-half of the solids will be dissolved solids such as calcium and sodium salts as well as and soluble organic compounds. The remaining 250 grams will be insoluble. The insoluble fraction consists of about 125 grams of material that will settle out of the liquid fraction in 30 minutes under quiescent conditions. The remaining 125 grams will remain in suspension for a very long time. The result is that wastewater is highly turbid.

Chemical Characteristics of Domestic Wastewater. Because the number of chemical compounds found in wastewater is almost limitless, we normally restrict our consideration to a few general classes of compounds. These classes often are better known by the name of the analytical procedure used to measure them than by what is included in the class. The biochemical oxygen demand (BOD₅) test is a case in point. Another closely related test is the *chemical oxygen demand* (COD) test.

The COD test is used to determine the oxygen equivalent of the organic matter that can be oxidized by a strong chemical oxidizing agent (potassium dichromate) in an acid medium. The COD of a waste, in general, will be greater than the BOD₅ because more compounds can be oxidized chemically than can be oxidized biologically and because BOD₅ does not equal ultimate BOD.

The COD test can be conducted in about three hours. If it can be correlated with BOD₅, it can be used to aid in the operation and control of the wastewater treatment plant (WWTP).

Total Kjeldahl nitrogen (TKN) is a measure of the total organic and ammonia nitrogen in the wastewater.* TKN gives a measure of the availability of nitrogen for building microbial cells, as well as the potential nitrogenous oxygen demand that will have to be satisfied.

Phosphorus may appear in many forms in wastewater. Among the forms found are the orthophosphates, polyphosphates, and organic phosphate. Together, these are referred to as “total phosphorus (as P)”.

The broad categories of BOD, COD, TKN, and suspended solids are divided into subcategories. The current nomenclature used to characterize wastewater constituents used in the design of biological wastewater treatment processes and their shorthand designations are shown in Table 18-4.

*Pronounced “kell dall” after J. Kjeldahl, who developed the test in 1883.

TABLE 18-4
Definition of terms used to characterize important wastewater constituents used for the analysis and design of biological wastewater treatment processes

Constituent ^{a, b}	Definition
BOD	
BOD or BOD ₅	Total 5-d biochemical oxygen demand
sBOD	Soluble 5-d biochemical oxygen demand
UBOD or BOD _u	Ultimate biochemical oxygen demand
COD	
COD	Total chemical oxygen demand
bCOD	Biodegradable chemical oxygen demand
pCOD	Particulate chemical oxygen demand
sCOD	Soluble chemical oxygen demand
nbCOD	Nonbiodegradable chemical oxygen demand
rbCOD	Readily biodegradable chemical oxygen demand
rbsCOD	Readily biodegradable soluble chemical oxygen demand
sbCOD	Slowly biodegradable chemical oxygen demand
bpCOD	Biodegradable particulate chemical oxygen demand
nbpCOD	Nonbiodegradable particulate chemical oxygen demand
nbsCOD	Nonbiodegradable soluble chemical oxygen demand
Nitrogen	
TKN	Total Kjeldahl nitrogen
bTKN	Biodegradable total Kjeldahl nitrogen
sTKN	Soluble (filtered) total Kjeldahl nitrogen
ON	Organic nitrogen
bON	Biodegradable organic nitrogen
nbON	Nonbiodegradable organic nitrogen
pON	Particulate organic nitrogen
nbpON	Nonbiodegradable particulate organic nitrogen
sON	Soluble organic nitrogen
nbsON	Nonbiodegradable soluble organic nitrogen
Suspended Solids	
TSS	Total suspended solids
VSS	Volatile suspended solids
nbVSS	Nonbiodegradable volatile suspended solids
iTSS	Inert total suspended solids

^aNote: b = biodegradable; i = inert; n = non; p = particulate; s = soluble.

^bMeasured constituent values, based on the terminology given in this table, will vary depending on the technique used to fractionate a particular constituent.

Source: Metcalf & Eddy, 2003.

TABLE 18-5
Typical composition of untreated domestic wastewater

Constituent	Weak	Medium	Strong
	(all mg/L except settleable solids)		
Alkalinity (as CaCO ₃) ^a	50	100	200
Ammonia (free)	10	25	50
BOD ₅ (as O ₂) ^b	100	200	300
Chloride ^a	30	50	100
COD (as O ₂)	250	500	1,000
Total suspended solids (TSS)	120	210	400
Volatile (VSS)	95	160	315
Fixed	25	50	85
Settleable solids, mL/L	5	10	20
Sulfates ^a	20	30	50
Total dissolved solids (TDS)	200	500	1,000
Total Kjeldahl nitrogen (TKN) (as N)	20	40	80
Total organic carbon (TOC) (as C)	75	150	300
Total phosphorus (as P)	5	10	20

^aTo be added to amount in domestic water supply. Chloride is exclusive of contribution from water-softener backwash.

^bFor newer, tighter collection systems, or where water conservation is practiced, these numbers may be considerably higher.

Adapted from Metcalf & Eddy, 2003.

Three typical compositions of untreated domestic wastewater are summarized in Table 18-5. Because there is no “typical” wastewater, it should be emphasized that these data should only be used as a guide. The pH for all of these wastes will be in the range of 6.5 to 8.5, with a majority being slightly on the alkaline side of 7.0.

Characteristics of Industrial Wastewater

Industrial processes generate a wide variety of wastewater pollutants. The characteristics and levels of pollutants vary significantly from industry to industry. The Environmental Protection Agency (EPA) has grouped the pollutants into three categories: conventional pollutants, nonconventional pollutants, and priority pollutants. The conventional and nonconventional pollutants are listed in Table 18-6. The priority pollutants are listed in Table 2-11 in Chapter 2.

TABLE 18-6
EPA's conventional and nonconventional pollutant categories

Conventional	Nonconventional
Biochemical oxygen demand (BOD ₅)	Ammonia (as N)
Total suspended solids (TSS)	Chromium VI (hexavalent)
Oil and grease	Chemical oxygen demand (COD)
Oil (animal, vegetable)	COD/BOD ₇
Oil (mineral)	Fluoride

(continued)

TABLE 18-6 (continued)
EPA's conventional and nonconventional pollutant categories

Conventional	Nonconventional
pH	Manganese Nitrate (as N) Organic nitrogen (as N) Pesticide active ingredients (PAI) Phenols, total Phosphorus, total (as P) Total organic carbon (TOC)

Source: 40 CFR §413.02, 464.02, 467.02, and 469.12.

Because of the wide variety of industries and levels of pollutants, only a snapshot view of the characteristics can be presented. A sampling of a few industries for two conventional pollutants is shown in Table 18-7.

A similar sampling for nonconventional pollutants is shown in Table 18-8.

TABLE 18-7
Examples of industrial wastewater concentrations for BOD₅
and suspended solids

Industry	BOD ₅ , mg/L	Suspended solids, mg/L
Ammunition	50–300	70–1,700
Fermentation	4,500	10,000
Food processing	100–6,900	30–3,500
Pulp and paper (kraft)	100–350	75–300
Slaughterhouse (cattle)	400–2,500	400–1,000
Tannery	700–7,000	4,000–20,000

TABLE 18-8
Examples of industrial wastewater concentrations for nonconventional pollutants

Industry	Pollutant	Concentration, mg/L
Coke by-product (steel mill)	Ammonia (as N)	200
	Organic nitrogen (as N)	100
	Phenol	2,000
Metal plating	Chromium VI	3–550
Nylon polymer	COD	23,000
	TOC	8,800
Plywood-plant glue waste	COD	2,000
	Phenol	200–2,000
	Phosphorus (as PO ₄)	9–15

18-3 WASTEWATER TREATMENT STANDARDS

In Public Law 92-500, the Congress required municipalities and industries to provide *secondary treatment* before discharging wastewater into natural water bodies. The U.S. Environmental Protection Agency (EPA) established a definition of secondary treatment based on three wastewater characteristics: BOD₅, suspended solids, and hydrogen ion concentration (pH). The definition is summarized in Table 18-9.

PL 92-500 also directed that the EPA establish a permit system called the *National Pollutant Discharge Elimination System* (NPDES). Under the NPDES program, all facilities that discharge pollutants from any point source into waters of the United States are required to obtain a NPDES permit. Although some states elected to have EPA administer their permit system, most states administer their own program. Before a permit is granted, the administering agency will model the response of the receiving body to the proposed discharge to determine if the receiving body is adversely affected. To maintain the quality of the receiving body of water, the permit may require lower concentrations than those specified in Table 18-9.

In addition, the states may impose additional conditions in the NPDES permit. For example, in Michigan, a limit of 1 mg/L of phosphorus is contained in permits for discharges to surface waters that do not have substantial problems with high levels of nutrients. More stringent limits are required for discharges to surface waters that are very sensitive to nutrients.

CBOD₅ limits are placed in the NPDES permits for all facilities that have the potential to contribute significant quantities of oxygen-consuming substances. The nitrogenous oxygen demand from ammonia nitrogen is typically the oxygen demand of concern from municipal discharges. It is computed separately from the CBOD₅ and then combined to establish a discharge limit. Ammonia is also evaluated for its potential toxicity to the stream's biota.

The limits for BOD₅ and nitrogen are often seasonally adjusted in colder climates because cold water has a higher dissolved oxygen (DO) saturation value and because the biological activity is

TABLE 18-9
U.S. Environmental Protection Agency definition of secondary treatment ^{a, b}

Characteristic of discharge	Units	Average monthly concentration ^c	Average weekly concentration ^c
BOD ₅	mg/L	30 ^d	45
Suspended solids	mg/L	30 ^d	45
Hydrogen ion concentration	pH units	Within the range 6.0–9.0 at all times ^e	
CBOD ₅ ^f	mg/L	25	40

^aSource: 40 CFR §133.102.

^bPresent standards allow stabilization ponds and trickling filters to have higher 30-day average concentrations (45 mg/L) and 7-day average concentrations (65 mg/L) of BOD and suspended solids as long as the water quality of the receiving body of water is not adversely affected. Other exceptions are also permitted. The CFR and the *NPDES Permit Writers' Manual* (U.S. EPA, 1996) should be consulted for details on the exceptions.

^cNot to be exceeded.

^dAverage removal shall not be less than 85 percent.

^eOnly enforced if caused by industrial wastewater or by in-plant inorganic chemical addition.

^fCBOD₅ = carbonaceous BOD₅. May be substituted for BOD₅ at the option of the permitting authority.

lower in cold water. In Michigan, the limits from May through November are more strict than from December through April. For example, a BOD₅ limit in the winter may be 10 mg/L and 4 mg/L in the summer while the NH₃ limit in the winter is set at 2 mg/L in the winter and 0.5 mg/L in the summer.

To avoid anoxic conditions that might result from mixing a wastewater discharge with a very low dissolved oxygen (DO) concentration with a river flow with a marginal DO level, the permit may require the facility provide a minimum DO in the discharged wastewater. For example, DO levels of 5 to 8 mg/L have been specified (Metcalf & Eddy, 2003).

Bacterial effluent limits may also be included in the NPDES permit. For example, municipal wastewater treatment plants in Michigan must comply with limits of 200 fecal coliform bacteria (FC) per 100 mL of water as a monthly average and 400 FC/100 mL as a 7-day average. More stringent requirements are imposed to protect waters that are used for recreation. Total-body-contact recreation waters must meet limits of 130 *Escherichia coli* per 100 mL of water as a 30-day average and 300 *E. coli* per 100 mL at any time. Partial-body-contact recreation is permitted for water with less than 1,000 *E. coli* per 100 mL of water.

For thermal discharges such as cooling water, temperature limits may be included in the permit. Michigan rules state that the Great Lakes and connecting waters and inland lakes shall not receive a heat load that increases the temperature of the receiving water more than 1.7°C above the existing natural water temperature after mixing. For rivers, streams, and impoundments the temperature limits are 1°C for cold-water fisheries and 2.8°C for warm-water fisheries.

An example of NPDES limits is shown in Table 18-10. Note that in addition to concentration limits, mass discharge limits are also established.

Total Maximum Daily Load

Under Section 303(d) of the 1972 Clean Water Act, states, territories, and authorized tribes are required to develop lists of *impaired waters*. Impaired waters are those that do not meet water quality standards that the states, territories, and authorized tribes have established for them. This assessment is made after assuming that point sources of pollution have installed minimum levels

TABLE 18-10
NPDES limits for the city of Hailey, Idaho^{a, b, c}

Parameter	Average monthly limit	Average weekly limit	Instantaneous maximum limit
BOD ₅	30 mg/L 43 kg/d	45 mg/L 64 kg/d	N/A
Suspended solids	30 mg/L 43 kg/d	45 mg/L 64 kg/d	N/A
<i>E. coli</i> bacteria	126 colonies/100 mL	N/A	406 colonies/100 mL
Fecal coliform bacteria	N/A	200 colonies/100 mL	N/A
Total ammonia as N	1.9 mg/L 4.1 kg/d	2.9 mg/L 6.4 kg/d	3.3 mg/L 7.1 kg/d
Total phosphorus	6.8 kg/d	10.4 kg/d	N/A
Total Kjeldahl nitrogen	25 kg/d	35 kg/d	N/A

^aThis table outlines only the quantitative limits. The entire permit is 22 pages long.

^bRenewal announcement, 7 February 2001.

^cSource: U.S. EPA, 2005a.

of pollution control technology. The law requires that these jurisdictions establish priority rankings for waters on the lists and develop *total maximum daily loads* (TMDL) for these waters. A TMDL specifies the maximum amount of pollutant that a water body can receive and still meet water quality standards. In addition, the TMDL allocates pollutant *loadings* (that is, the mass of pollutant) that may be contributed among point and nonpoint sources. The TMDL is computed on a pollutant-by-pollutant basis for a list of pollutants. Additional categories include acids/bases (measured as pH), pesticides, and mercury. The TMDL computation is defined as:

$$\text{TMDL} = \Sigma \text{WLA} + \Sigma \text{LA} + \text{MOS} \quad (18-1)$$

where WLA = waste load allocations, that is, portions of the TMDL assigned to existing and future point sources

LA = load allocations, that is, portions of the TMDL assigned to existing and future nonpoint sources

MOS = margin of safety

The MOS is to account for uncertainty about the relationships between loads and water quality. A software system called *Better Assessment Science Integrating Point and Nonpoint Sources* (BASINS) that integrates a *geographic information system* (GIS), national watershed and meteorological data, and state-of-the-art environmental assessment and modeling tools may be used to develop the TMDL (Ahmad, 2002; U.S. EPA, 2005b).

Pretreatment of Industrial Wastes

Industrial wastewaters can pose serious hazards to municipal systems because the collection and treatment systems have not been designed to carry or treat them. The wastes can damage sewers and interfere with the operation of treatment plants. They may pass through the wastewater treatment plant (WWTP) untreated or they may concentrate in the sludge, rendering it a hazardous waste.

The Clean Water Act (CWA) gives the EPA the authority to establish and enforce pretreatment standards for discharge of industrial wastewaters into municipal treatment systems. Specific objectives of the pretreatment program are:

- To prevent the introduction of pollutants into WWTPs that will interfere with their operation, including interference with their use or with disposal of municipal sludge.
- To prevent the introduction of pollutants to WWTPs that will pass through the treatment works or otherwise be incompatible with such works.
- To improve opportunities to recycle and reclaim municipal and industrial wastewaters and sludge.

EPA has established “prohibited discharge standards” (40 CFR 403.5) that apply to all non-domestic discharges to the WWTP and “categorical pretreatment standards” that are applicable to specific industries (40 CFR 405-471). Congress assigned the primary responsibility for enforcing these standards to local WWTPs.

In the General Pretreatment Regulations, industrial users (IUs) are prohibited from introducing the following into a WWTP:

1. Pollutants that create a fire or explosion hazard in the municipal WWTP, including, but not limited to, waste streams with a closed-cup flash point of less than or equal to 60°C, using the test methods specified in 40 CFR 261.21.

2. Pollutants that will cause corrosive structural damage to the municipal WWTP (but in no case discharges with a pH lower than 5.0) unless the WWTP is specifically designed to accommodate such discharges.
3. Solid or viscous pollutants in amounts that will cause obstruction to the flow in the WWTP resulting in interference.
4. Any pollutant, including oxygen-demanding pollutants (such as BOD), released in a discharge at a flow rate and/or concentration that will cause interference with the WWTP.
5. Heat in amounts that will inhibit biological activity in the WWTP and result in interference, but in no case heat in such quantities that the temperature at the WWTP exceeds 40°C unless the approval authority, on request of the *publicly owned treatment works* (POTW), approves alternative temperature limits.
6. Petroleum oil, nonbiodegradable cutting oil, or products of mineral oil origin in amounts that will cause interference or will pass through.
7. Pollutants that result in the presence of toxic gases, vapors, or fumes within the POTW in a quantity that may cause acute worker health and safety problems.
8. Any trucked or hauled pollutants, except at discharge points designated by the POTW.

18-4 SLUDGE DISPOSAL REGULATIONS

Current terminology distinguishes between sludge and biosolids. *Sludge* is defined as solids removed from wastewater during treatment. Solids that are treated further are called *biosolids*. Biosolids are primarily organic, semisolid products that remain after biodegradable solids are stabilized biologically or chemically. They are suitable for beneficial use.

The regulations for the disposal of sewage sludge in municipal solid waste landfills is codified as 40 CFR Part 258. Because municipal wastewater residuals typically represent a small percentage of the waste at a codisposal site, they are not discussed here.

On February 19, 1993, the EPA promulgated risk-based regulations that govern the use or disposition of biosolids. These regulations are codified as 40 CFR Part 503 and have become known as the “503 Regulations.” The regulations apply to sewage sludge generated from the treatment of domestic sewage that is land-applied, placed on a surface disposal site, or incinerated in an incinerator that accepts only sewage sludge. The regulations do not apply to sludge generated from treatment of industrial process wastes at an industrial facility, hazardous sewage sludge, sewage sludge with polychlorinated biphenyl (PCB) concentrations of 50 mg/L or greater, or drinking water sludge. The 503 regulations are “self-implementing.” This means that permits are not required. However, conformance to the regulation is required for facilities that land-apply their sewage sludge. Violations of the regulations are violations of the law. The following discussion is limited to the land application of bulk biosolids. The regulation should be consulted for biosolids that are sold or given away.

Figure 18-3 summarizes the sludge quality requirements for use or disposal. The regulation establishes two levels of sewage sludge quality with respect to heavy-metal concentrations: ceiling concentration limits and pollution concentration limits. To be land-applied, bulk sewage sludge must meet the pollutant ceiling concentration limits *and* cumulative pollutant loading rates (CPLR) *or* the pollutant concentration limits (Table 18-11). Bulk sewage sludge applied to lawns and home gardens must meet the pollutant concentration limits. Sewage sludge sold

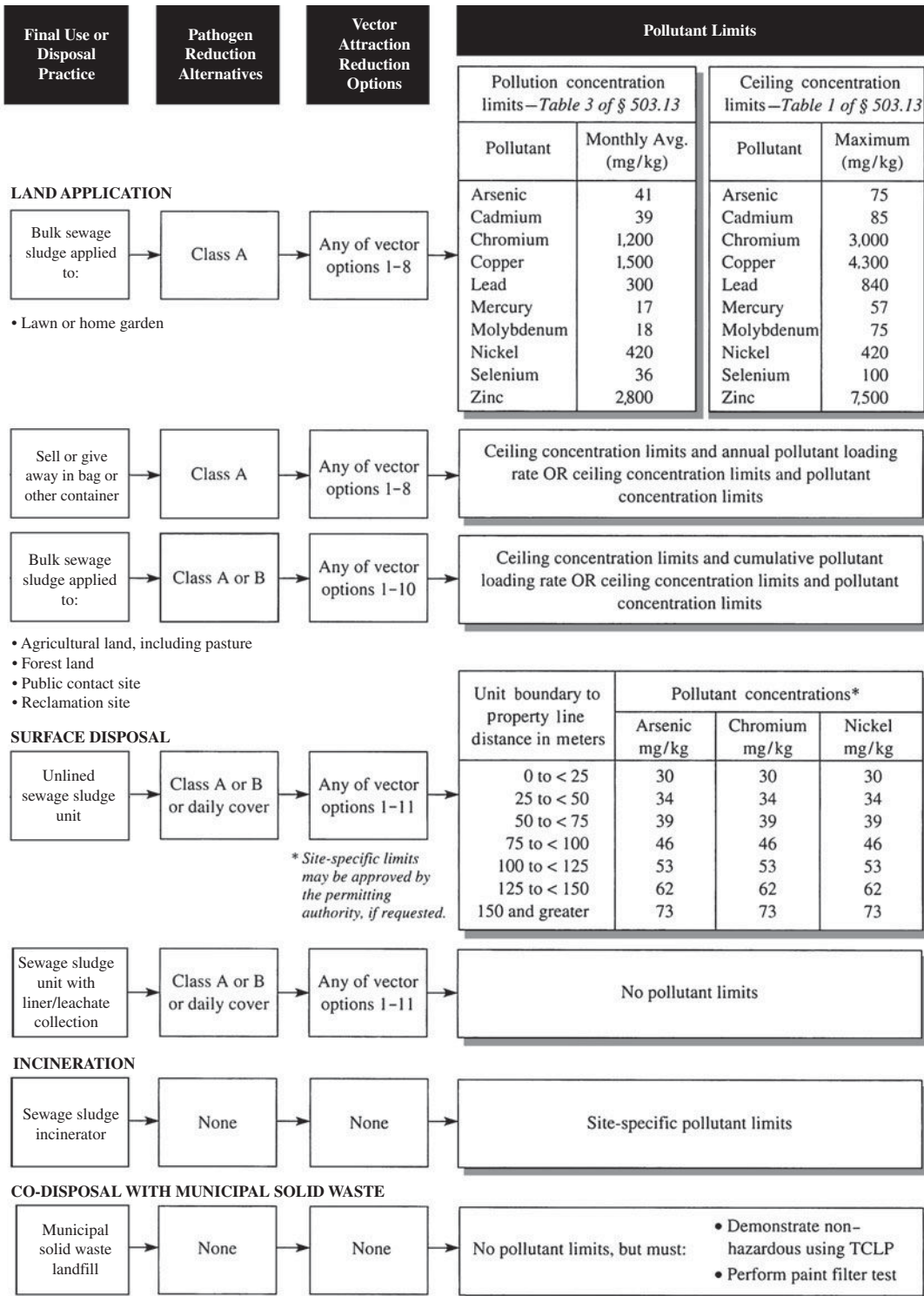

FIGURE 18-3
Sludge quality requirements for use or disposal practices.

TABLE 18-11
Land application limits for heavy metals^{a, b}

Pollutant	Ceiling concentration limits, mg/kg	Cumulative pollutant loading rates, kg/ha	Pollutant concentration limits, mg/kg	Annual pollutant loading rates, kg/ha · y
Arsenic	75	41	41	2.0
Cadmium	85	39	39	1.9
Chromium	3,000	3,000	1,200	150
Copper	4,300	1,500	1,500	75
Lead	840	300	300	15
Mercury	57	17	17	0.85
Molybdenum	75	18	18	0.90
Nickel	420	420	420	21
Selenium	100	100	36	5.0
Zinc	7,500	2,800	2,800	140

^aConcentrations are on a dry-weight basis.

^bSource: 40 CFR Part 503.13.

or given away in bags must meet the pollutant concentration limits *or* the annual sewage sludge product application rates that are based on the annual pollutant loading rates.

Land Application Management Practices

The general management practices that must be followed for bulk biosolids are summarized in Table 18-12.

TABLE 18-12
Land-application management practices for bulk biosolids under U.S. EPA Part 503.12 rule

Bulk biosolids cannot be applied to flooded, frozen, or snow-covered agricultural land, forests, public contact sites, or reclamation sites in such a way that the biosolids enter a wetland or other waters of the United States (as defined in 40 CFR Part 122.2), except as provided in a permit issued pursuant to Section 402 (NPDES permit) or Section 404 (Dredge and Fill Permit) of the Clean Water Act, as amended.

Bulk biosolids cannot be applied to agricultural land, forests, or reclamation sites that are 10 m or less from U.S. waters, unless otherwise specified by the permitting authority.

If applied to agricultural lands, forests, or public contact sites, bulk biosolids must be applied at a rate that is equal to or less than the agronomic rate for the site. Biosolids applied to reclamation sites may exceed the agronomic rate if allowed by the permitting authority.

Bulk biosolids must not harm or contribute to the harm of a threatened or endangered species or result in the destruction or adverse modification of the species' critical habitat when applied to the land. Threatened or endangered species and their critical habitats are listed in Section 4 of the Endangered Species Act. Critical habitat is defined as any place where a threatened or endangered species lives and grows during any stage of its life cycle. Any direct or indirect action (or the result of any direct or indirect action) in a critical habitat that diminishes the likelihood of survival and recovery of a listed species is considered destruction or adverse modification of a critical habitat.

Pathogen Reduction Alternatives

Two levels of quality for pathogen densities (Class A and Class B) are defined in the regulation. The implicit requirements for Class A pathogen reduction are that:

- *Salmonella* bacteria be less than 3 most probable number (MPN) of organisms per four grams of total solids;
- Enteric viruses be less than 1 per four grams of total solids; and
- Viable helminth ova be less than 1 per four grams of total solids.

The Class B pathogen standard requires that the sludge have less than 2 million fecal coliforms per gram of sludge or that it be treated in a process to significantly reduce pathogens (PSRP).

The Class A and Class B treatment alternatives are outlined in Table 18-13. Processes to further reduce pathogens (PFRPs) are summarized in Table 18-14. Processes to significantly reduce pathogens (PSRP) are described in Table 18-15.

TABLE 18-13
Pathogen reduction alternatives

Class A:

In addition to meeting the requirements in one of the six alternatives listed below, fecal coliform or *Salmonella* sp. bacterial levels must meet specific densities at the time of biosolids use or disposal, when prepared for sale or giveaway in a bag or other container for application to the land, or when prepared to meet the requirements in 503.10(b), (c), (e), or (f).

Alternative 1	Thermally treated biosolids: use one of four time-temperature regimes
Alternative 2	Biosolids treated in a high pH-high temperature process: specifies pH, temperature, and air-drying requirements
Alternative 3	For biosolids treated in other processes: demonstrate that the process can reduce enteric viruses and viable helminth ova. Maintain operating conditions used in the demonstration
Alternative 4	Biosolids treated in unknown processes: demonstration of the process is unnecessary. Instead, test for pathogens— <i>Salmonella</i> sp. bacteria, enteric viruses, and viable helminth ova—at the time the biosolids are used or disposed of or are prepared for sale or giveaway in a bag or other container for application to the land, or when prepared to meet the requirements in 503. 10(b), (c), (e), or (f)
Alternative 5	Use of PFRP: Biosolids are treated in one of the processes to further reduce pathogens (PFRP)
Alternative 6	Use of a process equivalent to PFRP: biosolids are treated in a process equivalent to one of the PFRPs, as determined by the permitting authority

(continued)

TABLE 18-13 (continued)
Pathogen reduction alternatives

Class B:

The requirements in one of the three alternatives below must be met in addition to Class B site restrictions for the application of biosolids to land.

Alternative 1	Monitoring of indicator organisms: test for fecal coliform density as an indicator for all pathogens at the time of biosolids use or disposal
Alternative 2	Use of PSRP: biosolids are treated in one of the processes to significantly reduce pathogens (PSRP)
Alternative 3	Use of processes equivalent to PSRP: biosolids are treated in a process equivalent to one of the PSRPs, as determined by the permitting authority

Source: U.S. EPA (1992).

TABLE 18-14
Processes to further reduce pathogens (PFRPs) listed in Appendix B of 40 CFR Part 503

1. Composting

Using either the within-vessel composting method or the static aerated pile composting method, the temperature of the sewage sludge is maintained at 55°C (131°F) or higher for 3 days.

Using the windrow composting method, the temperature of the sewage sludge is maintained at 55°C (131°F) or higher for 15 days or longer. During the period when the compost is maintained at 55°C (131°F) or higher, there shall be a minimum of five turnings of the windrow.

2. Heat drying

Sewage sludge is dried by direct or indirect contact with hot gases to reduce the moisture content of the sewage sludge to 10% or lower.

Either the temperature of the sewage sludge particles exceeds 80°C (176°F) or the wet bulk temperature of the gas in contact with the sewage sludge as the sewage sludge leaves the dryer exceeds 80°C (176°F).

3. Heat treatment

Liquid sewage sludge is heated to a temperature of 180°C (356°F) or higher for 30 minutes.

4. Thermophilic aerobic digestion

Liquid sewage sludge is agitated with air or oxygen to maintain aerobic conditions and the mean cell residence time (i.e., the solids retention time) of the sewage sludge is 10 days at 55°C (131°F) to 60°C (140°F).

5. Beta ray irradiation

Sewage sludge is irradiated with beta rays from an electron accelerator at dosages of at least 1.0 megarad at room temperature (ca. 20°C [68°F]).

6. Gamma ray irradiation

Sewage sludge is irradiated with gamma rays from certain isotopes, such as Cobalt 60 and Cesium 137, at dosages of at least 1.0 megarad at room temperature (ca. 20°C [68°F]).

7. Pasteurization

The temperature of the sewage sludge is maintained at 70°C (158°F) or higher for 30 minutes or longer.

Source: U.S. EPA (1992).

TABLE 18-15

Processes to significantly reduce pathogens (PSRPs) listed in Appendix B of 40 CFR Part 503**1. Aerobic digestion**

Sewage sludge is agitated with air or oxygen to maintain aerobic conditions for a specific mean cell residence time (i.e., solids retention time) at a specific temperature. Values for the mean cell residence time and temperature shall be between 40 days at 20°C (68°F) and 60 days at 15°C (59°F).

2. Air drying

Sewage sludge is dried on sand beds or on paved or unpaved basins. The sewage sludge dries for a minimum of 3 months. During 2 of the 3 months, the ambient average daily temperature is above 0°C (32°F).

3. Anaerobic digestion

Sewage sludge is treated in the absence of air for a specific mean cell residence time (i.e., solids retention time) at a specific temperature. Values for the mean cell residence time and temperature shall be between 15 days at 35°C (95°F) to 55°C (131°F) and 60 days at 20°C (68°F).

4. Composting

Using either the within-vessel, static aerated pile, or windrow composting methods, the temperature of the sewage sludge is raised to 40°C (104°F) or higher and remains at 40°C (104°F) or higher for 5 days. For 4 hours during the 5-day period, the temperature in the compost pile exceeds 55°C (131°F).

5. Lime stabilization

Sufficient lime is added to the sewage sludge to raise the pH of the sewage sludge to 12 after 2 hours of contact.

Source: U.S. EPA (1992).

Sludges meeting the Class A pathogen densities may be land-disposed immediately. Time restrictions are placed on harvesting crops, grazing of animals, and public access to sites on which Class B sludge is applied. These are summarized in Table 18-16.

TABLE 18-16

Site restrictions for Class B biosolids**Restrictions for the harvesting of crops and turf**

1. Food crops with harvested parts that touch the biosolids/soil mixture and are totally above ground shall not be harvested for 14 months after application of biosolids.
2. Food crops with harvested parts below the land surface where biosolids remains on the land surface for 4 months or longer prior to incorporation into the soil shall not be harvested for 20 months after biosolids application.
3. Food crops with harvested parts below the land surface where biosolids remains on the land surface for less than 4 months prior to incorporation shall not be harvested for 38 months after biosolids application.
4. Food crops, feed crops, and fiber crops whose edible parts do not touch the surface of the soil shall not be harvested for 30 d after biosolids application.
5. Turf grown on land where biosolids are applied shall not be harvested for 1 year after application of the biosolids when the harvested turf is placed on either land with a high potential for public exposure or a lawn, unless otherwise specified by the permitting authority.

(continued)

TABLE 18-16 (continued)
Site restrictions for Class B biosolids

Restriction for the grazing of animals

1. Animals shall not be grazed on land for 30 d after application of biosolids to the land.

Restrictions for public contact

1. Access to land with a high potential for public exposure, such as a park or ball field, is restricted for 1 year after biosolids application. Examples of restricted access include posting with no trespassing signs or fencing.
 2. Access to land with a low potential for public exposure (e.g., private farmland) is restricted for 30 d after biosolids application. An example of restricted access is remoteness.
-

Source: U.S. EPA, 1992.

Vector Attraction Reduction

Vectors are insects (or other animals) that transmit disease. The organic nature of sludge often attracts vectors after the sludge is land-applied. The 503 regulations provide 11 alternatives to reduce vector attraction. These are described in Table 18-17.

18-5 PLANT SIZING AND LAYOUT

Once the preliminary selection of the wastewater treatment unit operations and processes has been made (the screening process discussed in Chapter 1), rough calculations are made to determine sizes to be used in examining feasibility of site locations and cost. The elements to be considered in plant sizing include: (1) number and size of process units and (2) number and size of ancillary structures. The layout should include: (1) provision for expansion, (2) connection to the transportation net, (3) connection to the wastewater collection system, (4) effluent discharge location, and (5) residuals handling system.

Number and Size of Process Units

To ensure the provision of wastewater treatment, in general, a minimum of two units is provided for redundancy. When only two units are provided, each shall be capable of meeting the plant design capacity. There are actually two design capacities. The first is the design process flow capacity that is used to design processes such as activated sludge. The second is the hydraulic flow capacity that is used to size pumping facilities and physical facilities such as bar racks and screens. The EPA's design guidance is summarized in Table 1-4 in Chapter 1. Consideration should also be given to the efficiency/effectiveness of the process units with the low flows at start-up of the facility and other low flow periods. Nighttime flows and loss of a major contributor because of relocation or failure of a business are other examples of low flow conditions that frequently occur.

Number and Size of Ancillary Units

The ancillary units include: administration building, laboratory space, storage tanks, mechanical building for pumping facilities, roads, and parking. The size of these facilities is a function of the

TABLE 18-17
Summary of requirements for vector attraction reduction under Part 503

Requirement	What is required?	Most appropriate for:
Option 1 503.33(b)(1)	At least 38% reduction in volatile solids during sewage sludge treatment	Sewage sludge processed by: <ul style="list-style-type: none"> • Anaerobic biological treatment • Aerobic biological treatment • Chemical oxidation
Option 2 503.33(b)(2)	Less than 17% additional volatile solids loss during bench-scale anaerobic batch digestion of the sewage sludge for 40 additional days at 30°C to 37°C (86°F to 99°F)	Only for anaerobically digested sewage sludge that cannot meet the requirements of Option 1
Option 3 503.33(b)(3)	Less than 15% additional volatile solids reduction during bench-scale aerobic batch digestion for 30 additional days at 20°C (68°F)	Only for aerobically digested sewage sludge with 2% or less solids that cannot meet the requirements of Option 1—e.g., sewage sludges treated in extended aeration plants
Option 4 503.33(b)(4)	SOUR at 20°C (68°F) is ≤ 1.5 mg oxygen/hr/g total sewage sludge solids	Sewage sludges from aerobic processes (should not be used for composted sludges)
Option 5 503.33(b)(5)	Aerobic treatment of the sewage sludge for at least 14 days at over 40°C (104°F) with an average temperature of over 45°C (113°F)	Composted sewage sludge (Options 3 and 4 are likely to be easier to meet for sludges from other aerobic processes)
Option 6 503.33(b)(6)	Addition of sufficient alkali to raise the pH to at least 12 at 25°C (77°F) and maintain a pH ≥ 12 for 2 hours and a pH ≥ 11.5 for 22 more hours	Alkali-treated sewage sludge (alkalies include lime, fly ash, kiln dust, and wood ash)
Option 7 503.33(b)(7)	Percent solids $\geq 75\%$ prior to mixing with other materials	Sewage sludges treated by an aerobic or anaerobic process (i.e., sewage sludges that do not contain unstabilized solids generated in primary wastewater treatment)
Option 8 503.33(b)(8)	Percent solids $\geq 90\%$ prior to mixing with other materials	Sewage sludges that contain unstabilized solids generated in primary wastewater treatment (e.g., any heat-dried sewage sludges)
Option 9 503.33(b)(9)	Sewage sludge is injected into soil so that no significant amount of sewage sludge is present on the land surface 1 hour after injection, except Class A sewage sludge, which must be injected within 8 hours after the pathogen reduction process.	Sewage sludge applied to the land or placed on a surface disposal site. Domestic septage applied to agricultural land, a forest, or a reclamation site, or placed on a surface disposal site
Option 10 503.33(b)(10)	Sewage sludge is incorporated into the soil within 6 hours after application to land or placement on a surface disposal site, except Class A sewage sludge, which must be applied to or placed on the land surface within 8 hours after the pathogen reduction process.	Sewage sludge applied to the land or placed on a surface disposal site. Domestic septage applied to agricultural land, a forest, or a reclamation site, or placed on a surface disposal site
Option 11 503.33(b)(11)	Sewage sludge placed on a surface disposal site must be covered with soil or other material at the end of each operating day.	Sewage sludge or domestic septage placed on a surface disposal site

Source: U.S. EPA, 1992.

size of the plant. In small- to medium-sized facilities, particularly in cold climates and when land is expensive, administration, laboratory, pumping and storage are housed in one building.

The storage tanks include those for chemicals and, in some instances, fuel. Space for storage of chemical residuals must also be provided.

Plant Layout

When space is not a constraint, a linear layout generally allows the maximum flexibility for expansion. Redundancy is enhanced if the units are interconnected in such a way that the flow through the plant can be diverted from one treatment train to another. Because chemicals must be delivered to the plant, connection to the transportation net becomes an integral part of the layout. Likewise, because residuals are generally transported offsite, the residuals handling system is an integral part of the plant layout. The plant layout should minimize in-plant pumping.

18-6 PLANT LOCATION

Ideally a site comparison study will be performed after alternatives have been screened and rough sizing of the processes is complete. Many factors may preclude the ideal situation. For example, in highly urbanized areas the availability of land may preclude all but one site. In some cases the availability of land may force the selection of processes that fit into the available space.

Given that more than one site is available, there are several major issues to be considered. As noted in Chapter 1, cost is a major element in the selection process. The site should allow for expansion. The location of the plant relative to the receiving water for disposal of the treated wastewater, the service area, and the transportation net should be weighed carefully. The physical characteristics of the site alternatives that must be evaluated include the potential for flooding, foundation stability, groundwater intrusion, and the difficulty in preparing the site. Because the hydraulics of the collection system is primarily governed by the ground slope, the treatment facility is often placed at the lowest possible elevation. The soils and groundwater table at these sites should be examined carefully for foundation stability. Other issues to be considered include wetland infringement, the availability of alternate, independent sources of power, waste disposal options, public acceptance (particular attention must be paid to odor control), and security.

Visit the text website at www.mhprofessional.com/wwe for supplementary materials and a gallery of photos.

18-7 CHAPTER REVIEW

When you have completed studying this chapter, you should be able to do the following without the aid of your textbook or notes:

1. Explain why wastewater flow estimates for the components of wastewater flow should be made separately.
2. Explain the difference between infiltration and inflow to a citizen's group.
3. Explain why infiltration rates for new sewers are expected to be lower than for old existing sewers.

4. Compare the physical characteristics of fresh sewage and septic sewage.
5. Distinguish between conventional and nonconventional pollutants.
6. State the BOD₅, suspended solids, and fecal coliform concentrations that are often cited as a definition of secondary treatment.
7. Explain why industries are required to pretreat wastewater before discharging to municipal sewers.
8. Discuss a design strategy to address the issue of low flow at the start-up of a new wastewater treatment plant.
9. Discuss the conflicting desirability of locating the wastewater treatment plant at a low elevation and the potential soil and groundwater problems in construction at such a site.

With the aid of this text, you should be able to do the following:

10. Estimate the wastewater flow from commercial, institutional, and recreational facilities based on characteristic units such as occupancy, seats, guests, beds, and so on.
11. Estimate the wastewater flow reduction that may be obtained by requiring the use of water saving devices.
12. Estimate the average daily, maximum day, peak hour, and minimum flow for domestic wastewater production.
13. Estimate the infiltration flow rate for a given area with old or new sewers.
14. Estimate the infiltration flow rate for a given length of pipe.
15. Using topographic maps, select likely locations for a wastewater treatment plant.

18-8 PROBLEMS

- 18-1.** Estimate the average and peak hour wastewater flow rate for Camp Swampy. State all assumptions. The facility composition is shown below.
- a. Camp with central toilet and bath facilities—350 campers
 - b. Staff cottages with private bath, two people per cottage—40 staff members
 - c. Dining hall serves three meals per day to campers and staff
- 18-2.** A proposal to build Hotel California is being evaluated to estimate wastewater flow rates. Two proposals are being considered. Estimate the average and peak hour wastewater flow rate for each proposal. State all assumptions. The owner has asked two questions:
- (1) What is the impact on wastewater flow rate of having a bar with the restaurant?
 - (2) With respect to wastewater flow, are there any economies of scale?

The proposals are outlined in the table below. Assume an average occupancy of 80%, 1.5 people per room, and a maximum occupancy of 100%, 2 people per room.

Unit	Proposal A	Proposal B
Guest rooms	120	240
Number of employees	12	17
Self-service laundry machines	2	4
Restaurant, no bar, seats	80	120
Restaurant, with bar, seats	100	160

- 18-3.** Repeat Problem 18-1 assuming the following water saving features are introduced:
- Low-flush toilets that reduce flow from 73 to 35 L/capita · d.
 - Limiting flow shower head that reduces flow from 50 to 42 L/capita · d.
 - Energy-saver dishwasher that saves 10 L/meal.
- 18-4.** Repeat Problem 18-2 assuming the following water saving features are introduced:
- Low-flush toilets that reduce flow from 73 to 35 L/capita · d.
 - Limiting flow shower head that reduces flow from 50 to 42 L/capita · d.
- 18-5.** Analyze Xenia's wastewater flow rate data to estimate the following: average daily flow rate, estimated maximum day, estimated peak hour, minimum day, and dry weather flow. Assume the dry season occurs from the beginning of May to the end of September. (Data from Metcalf & Eddy, 2003.)

Xenia's flow data, m³/d

Year	2006	2007
Population	8,690	9,400
Month		
January	8,800	13,900
February	6,200	9,900
March	6,800	8,100
April	4,000	4,200
May	4,000	5,700
June	3,600	3,600
July	2,400	2,600
August	2,000	1,500
September	2,800	2,000
October	3,200	4,800
November	4,800	3,200
December	5,200	6,700

- 18-6.** Analyze Eau Gaullie's wastewater flow rate data to estimate the following: average daily flow rate, estimated maximum day, estimated peak hour, minimum day, and

dry weather flow. Assume the dry season occurs from the beginning of May to the end of September. (Data from Metcalf & Eddy, 2003.)

Eau Gaullie's flow data, m³/d

Year	2008	2009
Population	11,030	12,280
Month		
January	8,300	10,000
February	11,800	18,400
March	9,400	13,000
April	6,500	5,000
May	5,300	7,600
June	4,800	4,600
July	3,300	3,800
August	3,800	3,100
September	2,800	2,200
October	4,400	4,400
November	6,000	6,500
December	7,300	8,600

- 18-7.** Use Figure 2-1 to estimate the peak hour flow rate for the data from Problem 18-5.
- 18-8.** Use Figure 2-1 to estimate the peak hour flow rate for the data from Problem 18-6.
- 18-9.** The town of Aulwaze has asked your firm to begin preliminary planning for a new wastewater treatment plant. Based on current records, the following data have been provided to you. The population density has been and is expected to continue to be 16 people/ha. For the purpose of infiltration estimates, the sewer system after 1978 is considered to be new. Estimate the average daily and peak flow rates at the beginning of the design life in 2011 and at the design life of 15 years after start-up. Use a spreadsheet program you have written to graph the data, fit trend lines, and derive curve fitting equations for population and for wastewater flow.

Village of Aulwaze population estimates and wastewater flow rates

Year	1978	1999	2009
Population	10,400	14,600	16,800
Wastewater flow rate, Lpcd	401	464	494

- 18-10.** The Village of Royalflush has asked your firm to begin preliminary planning for a new wastewater treatment plant. Based on current records, the following data have been provided to you. The population density has been and is expected to continue to be 16 people/ha. For the purpose of infiltration estimates, the sewer system after

1980 is considered to be new. Estimate the average daily and peak flow rates at the beginning of the design life in 2011 and at build out in 2030. The build-out population is estimated to be about 1,700. Use a spreadsheet program you have written to graph the data, fit trend lines, and derive curve fitting equations for population and for wastewater flow.

Village of Royalflush population estimates and wastewater flow rates

Year	1973	1980	1990	2000	2009
Population	1,400	1,380	1,420	1,510	1,630
Wastewater flow rate, Lpcd	380	385	475	580	680

18-11. On a copy of the map for LaNeige Fondue and vicinity, identify potential sites for a new WWTP. The WWTP will treat wastewater from the village, the biofuel plant, and the retirement center. The 100-year flood elevation is along the 480 m contour.

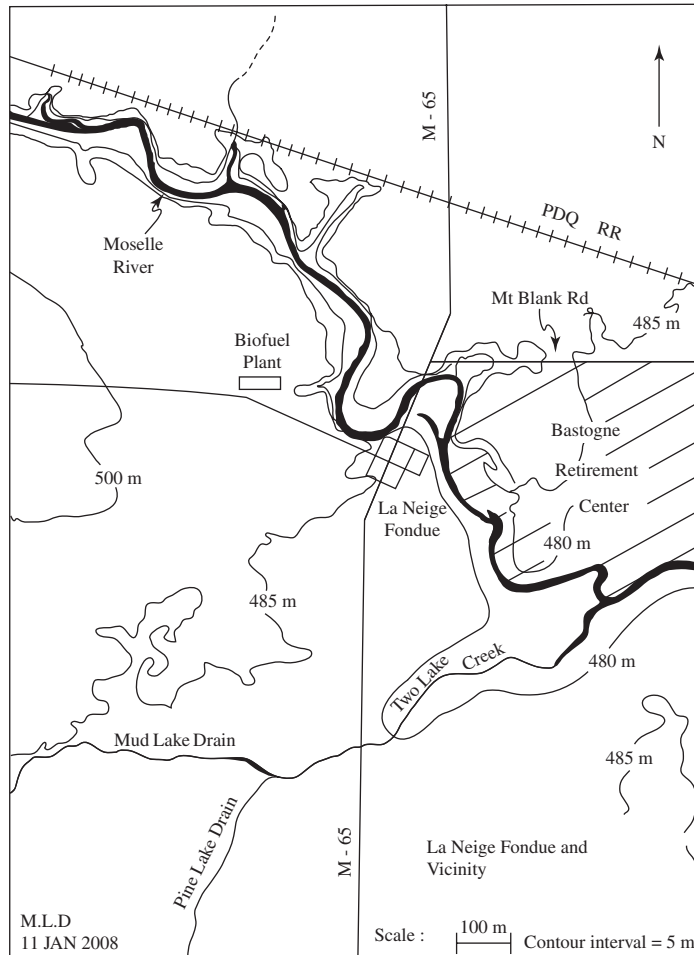

FIGURE P-18-11

18-12. On a copy of the map for Waffle and vicinity, identify potential sites for a new WWTP. The WWTP will treat wastewater from the village and the brewery. The 100-year flood elevation is along the 120 m contour.

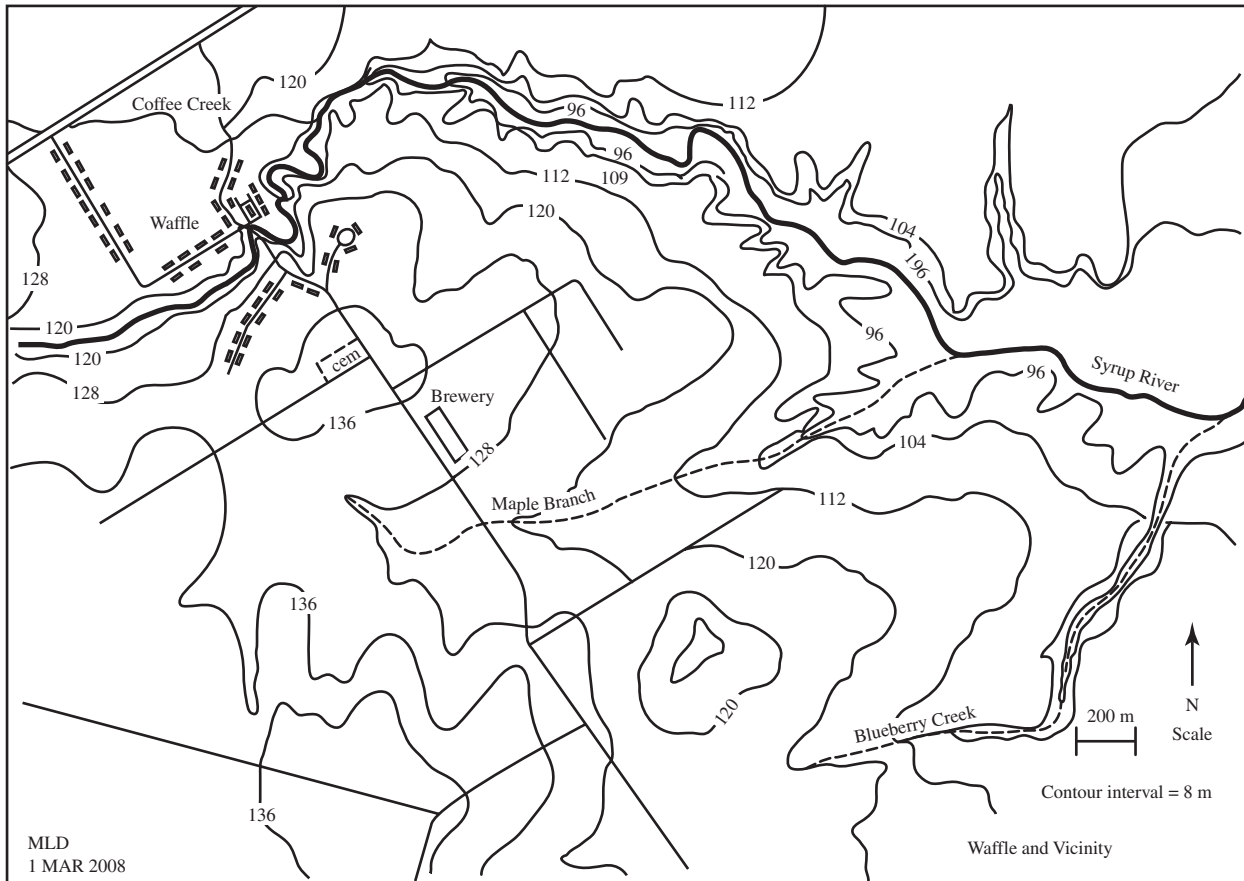

FIGURE P-18-12

18-9 DISCUSSION QUESTIONS

- 18-1.** A local service organization has asked you to make a presentation about a city proposal to address the issue of combined sewer overflow. Prepare one or two PowerPoint graphics that you will use to show the difference between infiltration and inflow.
- 18-2.** In the following list of pollutants mark those that are conventional with a “C” and those that are nonconventional with “NC.”
- Chromium VI
 - pH
 - TSS
 - Phenol
 - Oil and grease

- 18-3.** The town of Northfield provides wastewater treatment for a community of 10,000 and two colleges, each with a population of 5,000. In examining the flow data, what time periods in the annual cycle of flows will be important for identifying extreme flow rates?

18-10 REFERENCES

- Ahmad, R. (2002) "Watershed Assessment Power for Your PC," *Water Environment & Technology*, April, pp. 25–29.
- ASCE (1982) *Gravity Sewer Design and Construction*, American Society of Civil Engineers and Water Pollution Control Federation, Reston, Virginia, pp. 37, 123.
- Census (2006) at <http://www.census.gov>.
- Federal Register* (1974), vol. 39, no. 29, section 35.905, February 11th.
- GLUMRB (2004) *Recommended Standard for Wastewater Facilities*, Great Lakes–Upper Mississippi River Board of State and Provincial Public Health and Environmental Managers, Health Education Services, Albany, New York.
- Hutson, S. S., N. L. Barber, J. F. Kenny et al. (2001) *Estimated Use of Water in the United States in 2000*, U.S. Geological Survey Circular 1268, Washington, D.C., <http://www.usgs.gov>.
- Lyon, T. and R. Nelson (2002) "Sewer Design Practices," *Water Environment and Technology*, March, pp. 21–25.
- Metcalf & Eddy (1981) *Wastewater Engineering: Collection and Pumping of Wastewater*, McGraw-Hill, New York, pp. 61–95.
- Metcalf & Eddy (2003) *Wastewater Engineering: Treatment and Reuse*, McGraw-Hill, Boston, pp. 154–170, 452.
- U.S. EPA (1992) *Environmental Regulations and Technology: Control of Pathogens and Vector Attraction in Sewage Sludge*, U.S. Environmental Protection Agency Publication No. EPA/625/R-92/013, pp. 18–30.
- U.S. EPA (2005a) <http://www.epa.gov>. Search: Region 10 => Homepage => NPDES Permits => Current NPDES Permits in Pacific Northwest and Alaska => Current Individual NPDES Permits in Idaho.
- U.S. EPA (2005b) <http://www.epa.gov/owow/tmdl/intro.html> and <http://www.epa.gov/waterscience/models/allocation/def.html>.

CHAPTER

19

SANITARY SEWER DESIGN

- 19-1 INTRODUCTION
- 19-2 PREDESIGN ACTIVITIES
- 19-3 GRAVITY SEWER COLLECTION SYSTEM DESIGN
- 19-4 ALTERNATIVE SEWERS
- 19-5 PUMP STATION DESIGN
- 19-6 OPERATION AND MAINTENANCE
- 19-7 SEWER SAFETY
- 19-8 CHAPTER REVIEW
- 19-9 PROBLEMS
- 19-10 DISCUSSION QUESTIONS
- 19-11 REFERENCES

19-1 INTRODUCTION

The design of a sewer system generally includes the following steps: preliminary investigations, a detailed survey, the actual design, and preparation of final drawings. With the addition of a discussion of sewer nomenclature, appurtenances, and confined space safety issues, these topics form the outline of this chapter.

Nomenclature

The various types of sewers in a typical wastewater collection system are described in Table 19-1 and are illustrated in Figures 19-1 and 19-2.

The nomenclature of a typical sewer pipe with a bell and spigot joint is shown in Figure 19-3 on page 19-5.

Appurtenances

Manholes. Manholes are the most familiar appurtenance of a wastewater collection system. Although they have been built of brick and cast in place, current practice is to use precast concrete. The standard manhole (Figure 19-4 on page 19-5) and the drop manhole (Figure 19-5 on page 19-6) are the typical configurations. The drop manhole is used when the inflow and outflow sewers differ in elevation by more than 0.6 m. This protects the workers who must enter from inadvertently taking a shower while they work. It also reduces volatilization of odoriferous compounds. The entire outside of the drop connection is encased in concrete to minimize differential settlement pressures between the drop pipe and the manhole that may fracture the connection.

The manhole cover is always round to prevent it from falling into the manhole. Current practice is to use a solid cast iron or ductile iron cover. The cover should not be perforated because of the potential for inflow from storm water. This also minimizes escape of odors. When there is potential for the manhole to be submerged, the cover is provided with a gasket and is bolted down. Alternatively, if the manhole is not in a roadway, the manhole may be constructed so that the top is above flood level.

TABLE 19-1
Nomenclature of sewers in a typical collection system

Name	Description
Lateral	Lateral sewers form the first element of a wastewater collection system. They collect the wastewater from buildings and convey it to a main sewer.
Main	The main sewer conveys wastewater to trunk sewers or intercepting sewers.
Force main	This term is used to describe a pressurized pipe that is used to convey wastewater.
Trunk	Trunk sewers are large diameter sewers that are used to convey wastewater from main sewers to treatment facilities or to intercepting sewers.
Interceptor	The interceptors are very large diameter sewers that are used to intercept a number of main or trunk sewers and convey wastewater to treatment facilities.

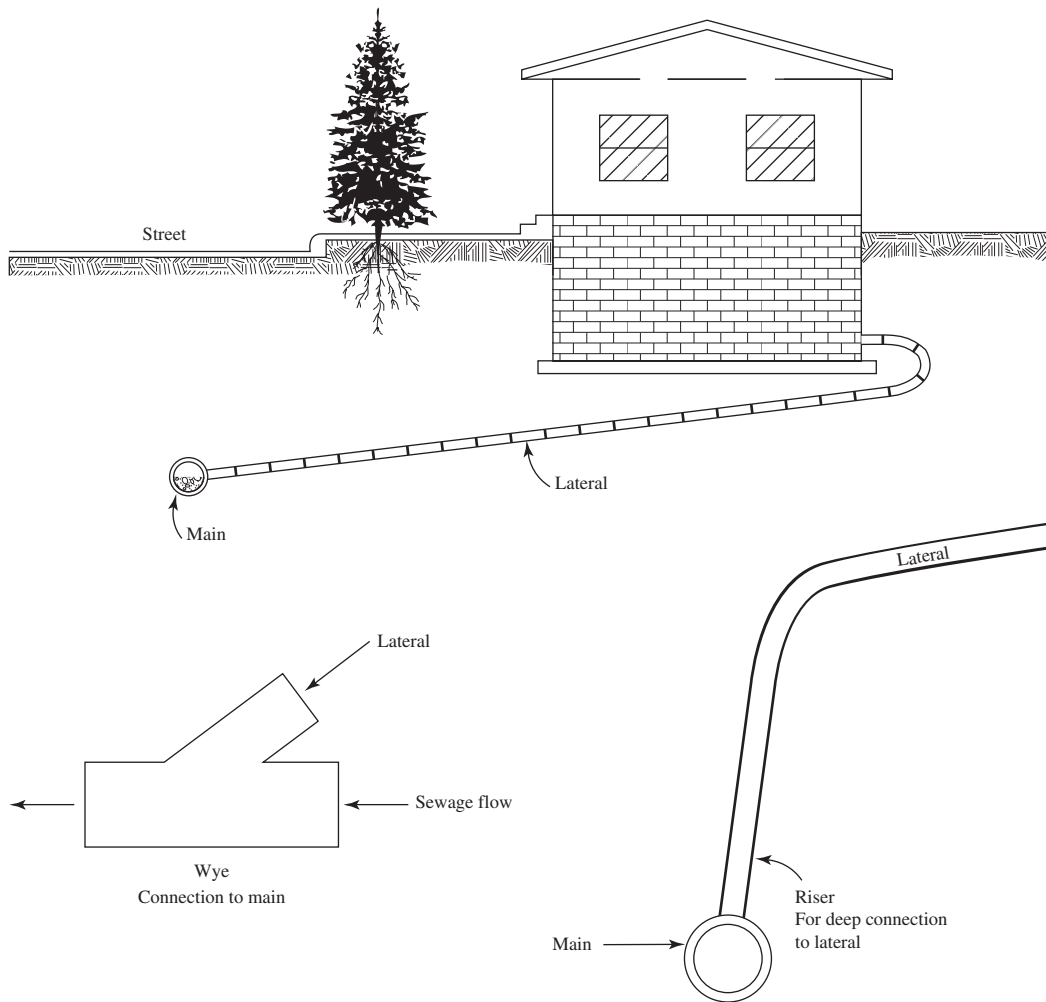
**FIGURE 19-1**

Lateral with exploded view of wye connection to main and an alternative connection for a deep main.

Lift Stations and Pumping Stations. Several conditions result in the necessity to pump sewage in a gravity collection system. These include but are not limited to the following cases:

- *Flat terrain.* Long pipe runs to reach the wastewater treatment plant may result in sewers that are very deep. At some point, either the angle of repose of the soil limits the excavation perpendicular to the sewer because of available space or the cost of further excavation is prohibitive.
- *Hilly terrain.* When hills present an obstacle that cannot be circumvented by gravity flow, the wastewater may be pumped over the obstacle.

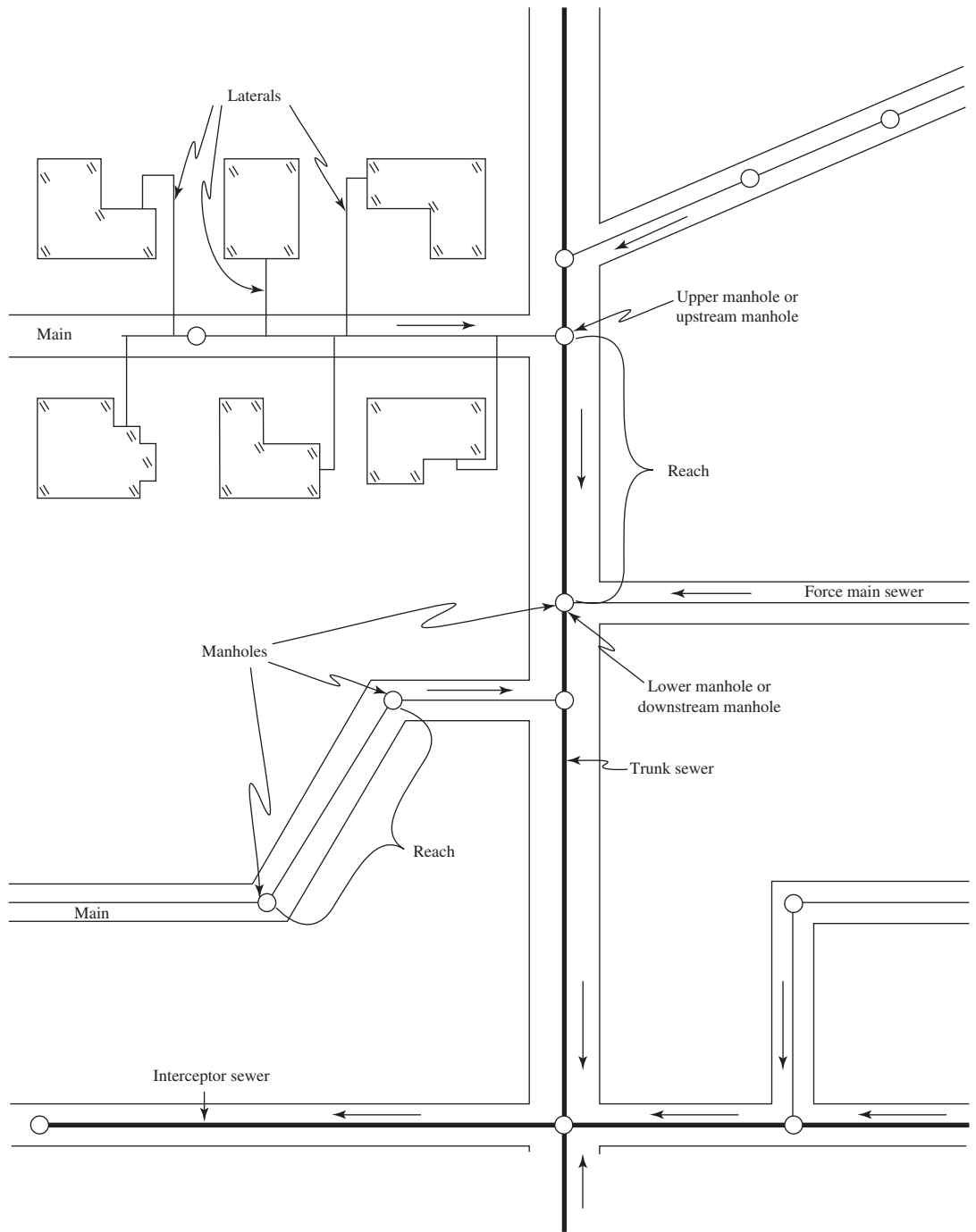

FIGURE 19-2
Nomenclature of sewers.

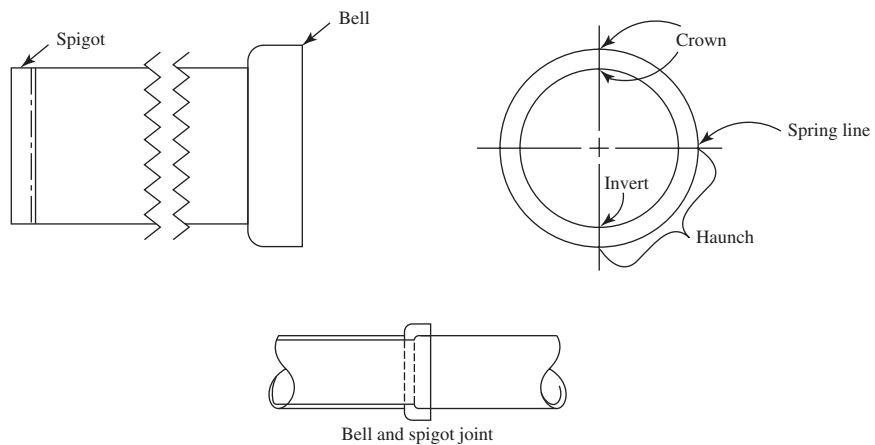

FIGURE 19-3
Nomenclature of a sewer pipe.

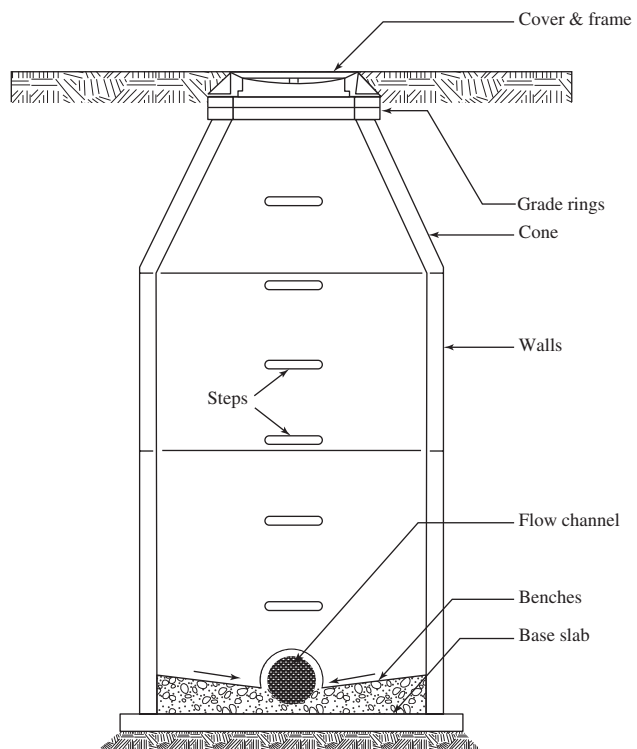

FIGURE 19-4
Manhole nomenclature.

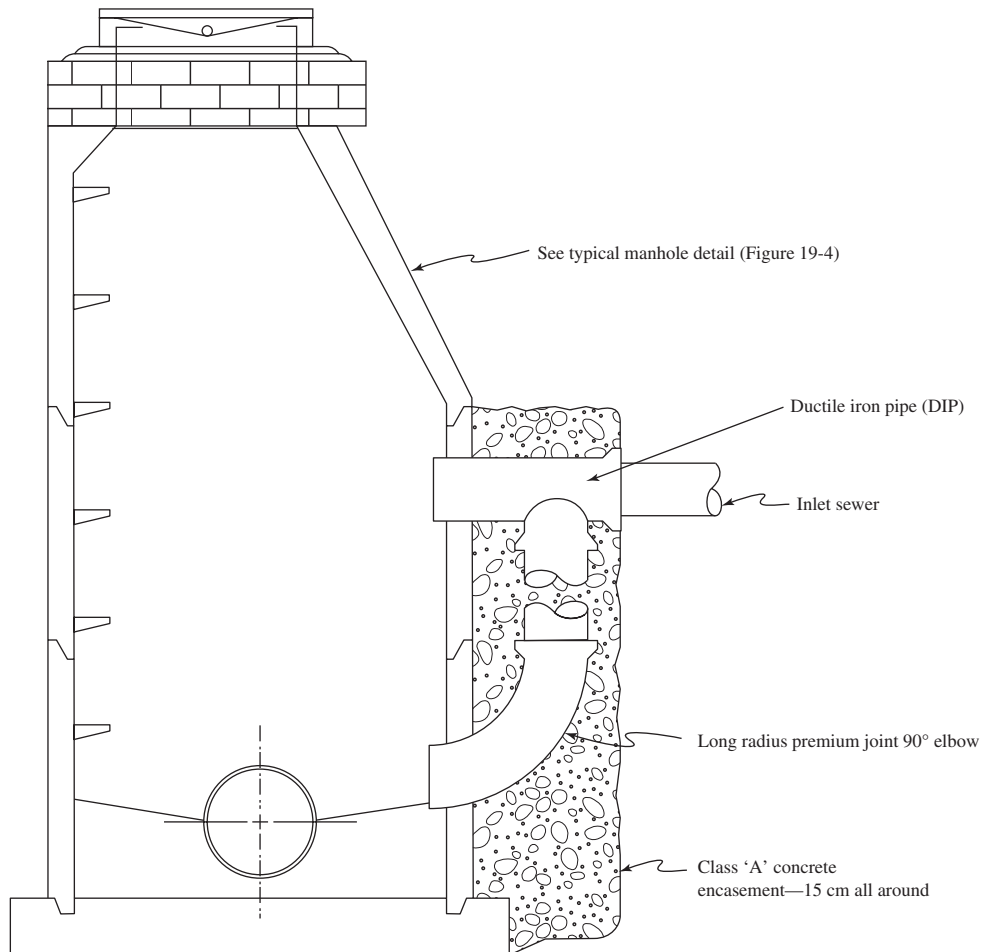
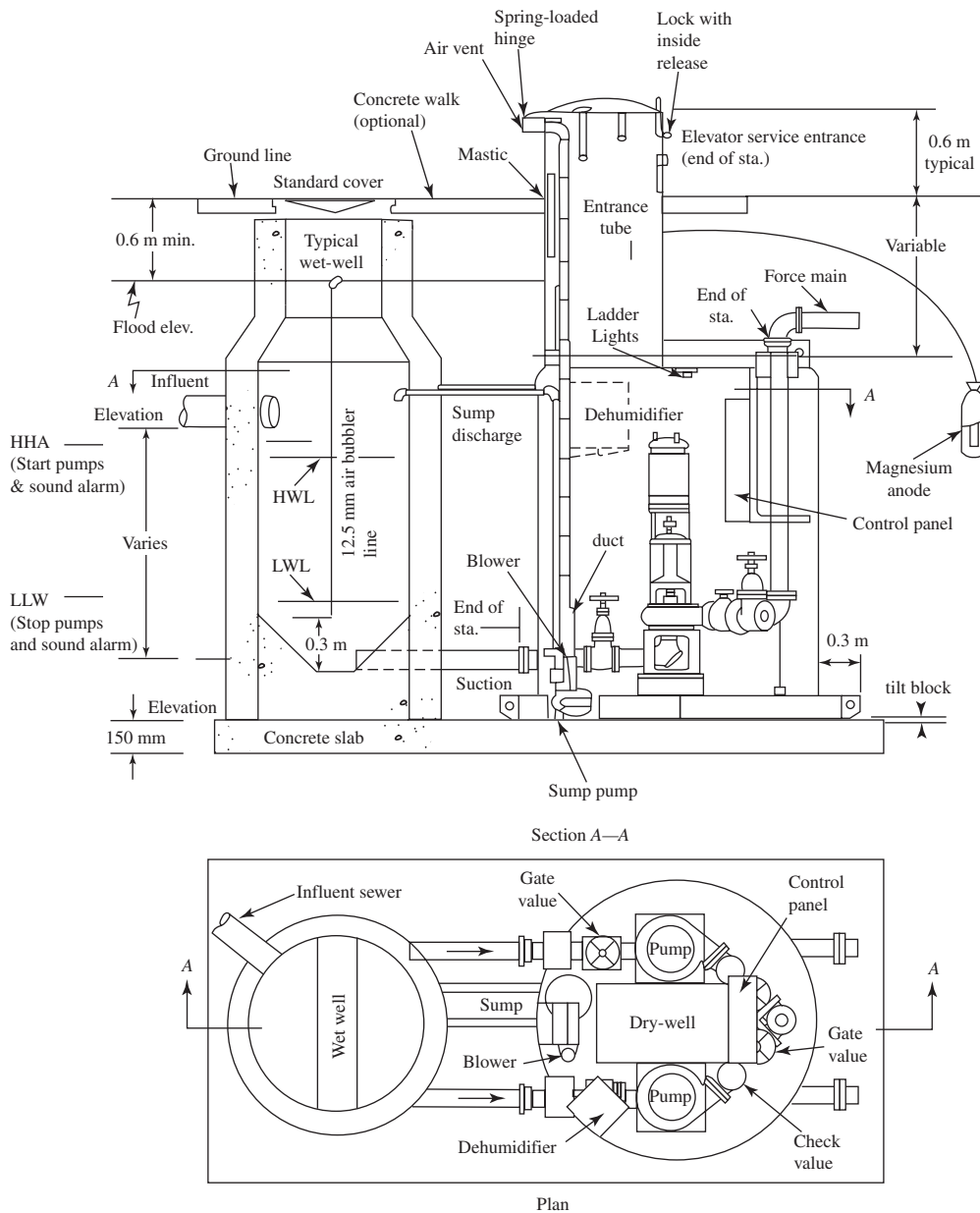

FIGURE 19-5
Drop manhole detail.

- *Obstacles.* Bedrock, for example, may limit the depth of the sewer.
- *Groundwater.* When the depth of the sewer places it below the groundwater table, it may be desirable to raise the sewer grade by pumping. This condition is often encountered when sewers are to be provided for lakefront property.

In these instances, the sewage may be lifted to a higher elevation by pumping. Thus, these pumping stations are called *lift stations*. Conventional pumping stations similar to those used for low service water pumping are constructed when the flow rates are high or where the wastewater must be screened. Factory-assembled, or package pumping stations, such as that shown in Figure 19-6 are used for smaller flows.

The discharge from the pumping station may be to either another gravity sewer with a higher invert than the incoming sewer or to a *force main*.

**FIGURE 19-6**

Factory-assembled lift station with two pumps. Wet well is on left; dry wall is on right. HWL = high water level; LWL = low water level; HHA = high, high alarm; LLW = low, low water. (Adapted from Metcalf & Eddy, 1981.)

Inverted Siphons. When it is necessary for a sewer to pass under structures such as depressed highways, under a river, or across a valley floor, the pipe falls below the hydraulic grade line. This portion of the sewer is called a *depressed sewer* or, more commonly, an *inverted siphon*. Although it is always full of sewage under pressure, at times there may be little flow.

The inverted siphon consists of two or more pipes (often called *barrels*), an inlet chamber, and an outlet chamber (Figure 19-7). They are designed to maintain velocities greater than 1 m/s to minimize sedimentation of solids. To maintain reasonable velocities for various flows, the pipes are arranged so that additional pipes are brought into service as the wastewater flows increase.

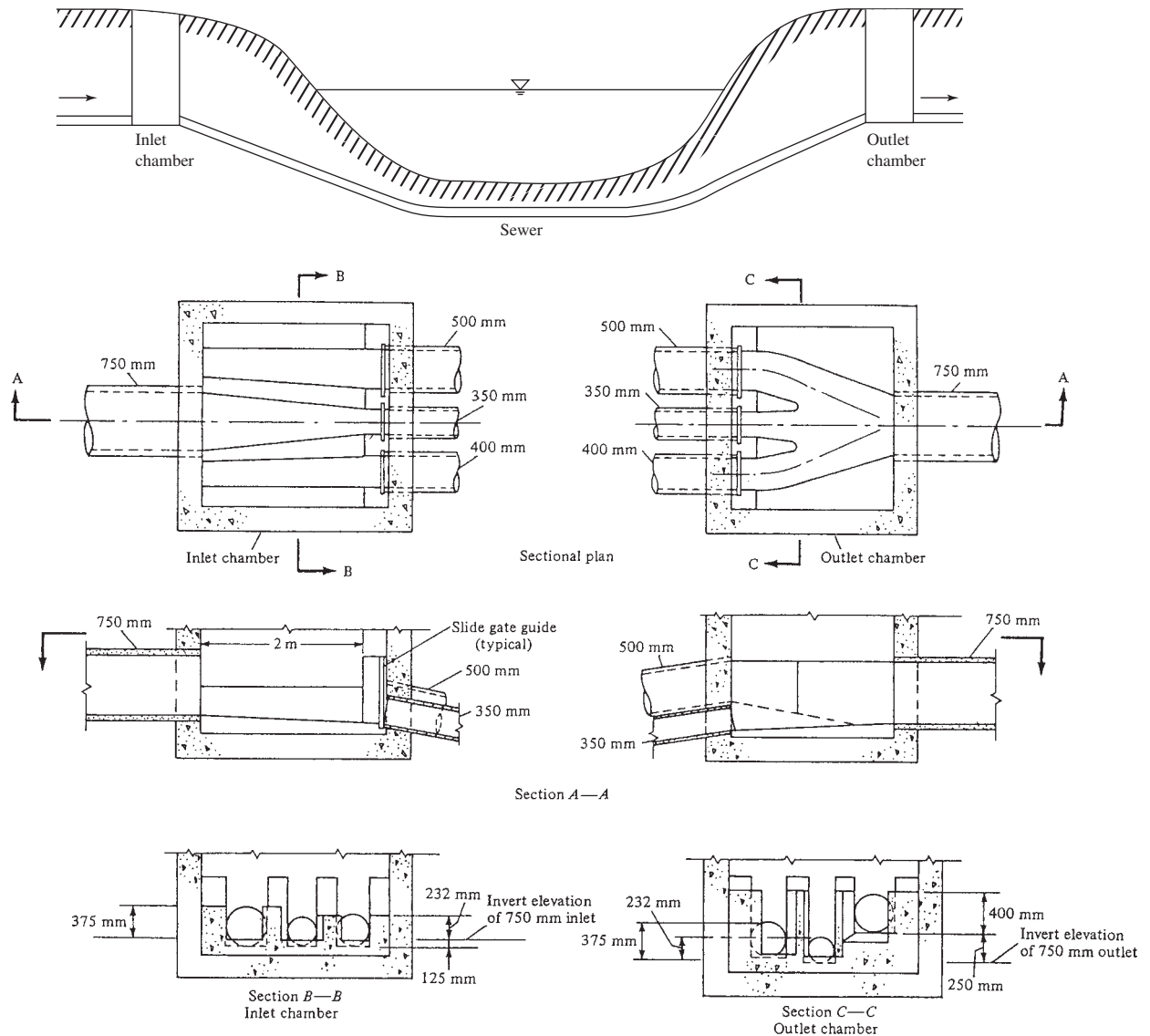

FIGURE 19-7
Inverted siphon with detailed views of inlet and outlet chambers. (Adapted from Metcalf & Eddy, 1981.)

Because the sewer is under pressure, it will be subject to tensile stresses. For this reason, sewers are usually constructed of ductile iron pipe or other pressure rated pipe.

The design of inverted siphons is beyond the scope of this text. Metcalf & Eddy (1981) provides a detailed worked example.

19-2 PREDESIGN ACTIVITIES

Preliminary Investigations

The preliminary investigations include gathering of data such as demographics, wastewater production estimates (as discussed in Chapter 18), and maps. It also includes an underground survey to locate obstacles such as existing sewers, water mains, gas lines, electrical and telephone lines, and similar features. An environmental review will be conducted to identify potential soil contamination from abandoned waste disposal sites and service stations. Geologic and hydrologic investigations may also be appropriate.

Surveying and Mapping

In order to prepare construction drawings, the following survey work must be conducted: location of streets, right-of-ways (ROW), basements and their elevations (usually estimated for residences), location of natural features such as streams and ditches, and construction of elevation profiles. In addition, benchmarks must be established for use during construction.

For sewer system layout, the map scale used is on the order of 1:1,000 to 1:3,000. For construction drawings, the map scale is on the order of 1:480 to 1:600. When there is significant relief, contours are shown at intervals ranging from 250 mm to 3 m. Elevations of street intersections, abrupt changes in grade, building foundations, and existing structures (sewers, lift stations, etc.) that new construction must connect with are included on the map. For projects encompassing more than one or two streets, aerial photogrammetry is often used.

19-3 GRAVITY SEWER COLLECTION SYSTEM DESIGN

The design of the sewer network in a collection system is an iterative process based on the required capacity of the system for the anticipated flow rates. Trial pipe diameters are selected for the network of pipes, and a hydraulic analysis is performed for the anticipated range of conditions. Of the numerous issues that must be addressed in the network design, the following will be presented in this section:

- Estimation of wastewater flow rates.
- Pipe material selection.
- Design criteria.
- Design equations.
- Collection system layout.
- Design of a lateral or branch.

Estimation of Wastewater Flow Rates

The required wastewater flow rates at the beginning of the service life and at the design life are the average daily flow rate, peak hour flow rate, and the peak infiltration allowance. These were discussed in detail in Chapter 18.

Pipe Material Selection

The principal sewer material for pipes with small or medium diameters is polyvinyl chloride (PVC). For larger pipe diameters, ductile iron pipe (DIP), high density polyethylene (HDPE) pipe, or reinforced concrete pipe (RCP) may be specified. Truss pipes are becoming more common for larger pipe diameters.

Vitrified Clay Pipe (VCP). This classic pipe material has demonstrated its durability in use in the United States for over a century. It has a high resistance to corrosion and abrasion. Its major disadvantage is its high mass per unit length that makes it more difficult to handle and increases installation costs. It is rarely installed today.

This pipe is made of clay or shale that has been ground, wet, molded, dried, and fired in a kiln. Near the end of the burning process, sodium chloride is added to the kiln. It vaporizes to form a hard waterproof glaze by reacting with the pipe surface. The firing of the clay produces a vitrification of the clay that makes it very hard and dense (Steel and McGhee, 1979).

The pipe is manufactured with integral bell and spigot ends fitted with polymeric rings. It is available in diameters from 75 mm through 1,050 mm and lengths up to 3 m (ASCE, 1982). Pipes are typically joined with push-on gasket joints.

Polyvinyl Chloride Pipe (PVC). This pipe is made by extrusion of polyvinyl chloride. It is available in diameters from 10 mm through 1.2 m and lengths up to 6 m (ASCE, 1982). Rubber gasket bell and spigot type joints are used to connect the pipes.

This pipe has been in use for over half a century. It is almost exclusively the material of choice for pressure and vacuum sewers. Its advantages are corrosion resistance and low mass per unit length. It is subject to attack by certain organic chemicals and excessive deflection if improperly bedded. The low mass per unit length gives it some cost advantage in installation.

Ductile Iron Pipe (DIP). This pipe material was discussed in Chapter 17. Its primary application for sewers is for force mains. Because wastewater is often corrosive, current practice is to use a cement mortar lining and an asphaltic outer coating. Epoxy coating may be used in trunk sewers. DIP manufacturers recommend that the pipe be encased in a loose-fitting flexible polyethylene tube (0.2 mm thick) when the pipe is to be placed in corrosive soils.

High-Density Polyethylene (HDPE). This pipe material was discussed in Chapter 17. Its primary use is as an alternative pressure pipe for force mains.

Reinforced Concrete Pipe (RCP). Precast RCP is manufactured by a variety of techniques including centrifugation, vibration, packing, and tamping for consolidating the concrete in forms. Adjustment of the wall thickness, concrete strength, and reinforcing allow for a wide variety of strengths.

The pipe is manufactured with integral bell and spigot ends. It is available in diameters from 300 mm through 5.0 m, and lengths up to 7.5 m (ASCE, 1982). These pipes are typically joined with push-on gasket joints.

The normal service for RCP is for trunk lines and interceptor sewers. Its major limitations are its high mass per unit length and its susceptibility to *crown corrosion*.

Truss Pipe. This pipe is made of PVC or acrylonitrile butadiene styrene (ABS). It consists of dual walls with a truss system between the walls. Sometimes the space between the walls is filled with cement. It is more rigid than PVC pipe but shares the same ease of construction.

Crown Corrosion. The corrosion of the crown of a sewer is the result of biochemical reactions in the sewage and in the condensed moisture at the crown of the sewer. With long sewer reaches and little oxygen transfer from the air in the sewer, or when sewage sits for long periods between pumping in force mains (e.g., in residential areas with little or no nighttime flow), the sewage becomes anoxic or anaerobic. Under these conditions, the sulfate in the sewage is reduced to sulfide. At the usual pH level of domestic sewage, the sulfide is converted to hydrogen sulfide. In poorly ventilated sewers, moisture collects on the walls and the crown. Hydrogen sulfide dissolves in this moisture. As such it does no harm.

Bacteria capable of oxidizing hydrogen sulfide, in particular those of the genus *Thiobacillus*, are always present in sewage. At high flows, these bacteria are brought to the walls and crown where they adhere after the high flows recede. They oxidize the hydrogen sulfide to sulfuric acid by the following reaction (Sawyer et al., 2003):



This strong acid attacks acid soluble materials such as concrete, iron, or steel. The corroded crown fails under the load of soil above it. These processes are summarized in Figure 19-8.

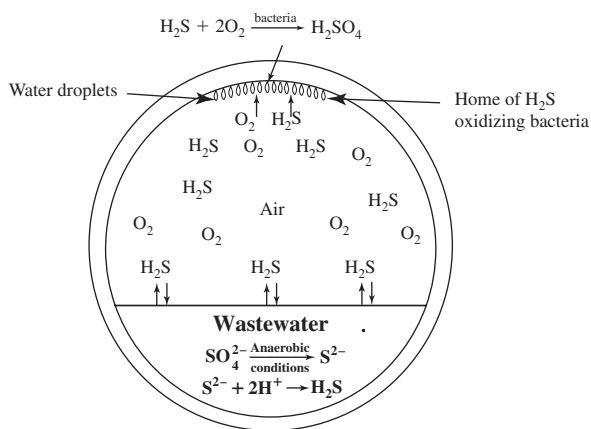

FIGURE 19-8

Formation of hydrogen sulfide in sewers and "crown" corrosion resulting from oxidation of hydrogen sulfide to sulfuric acid.

(Source: Sawyer et al., 2003.)

Where wastewater temperatures are high, detention times in the sewer are long, and the sulfate concentrations in the sewage are high, this is a particularly serious problem that must be considered in the selection of pipe materials. Because they are not susceptible to crown corrosion, VCP and PVC pipe are frequently chosen for these applications. When very large diameters require the use of RCP pipe, it should be lined with corrosion resistant material.

Design Criteria

The design criteria discussed in this section apply to gravity flow sewers. Other criteria are used for *alternative sewer systems* such as pressure and vacuum sewers.

Location. In the construction for new residential areas, the sewer is commonly placed on one side of the roadway in the right-of-way (ROW). Connections to the sewer from buildings on the opposite side of the street may be made by boring under the street. In established communities (or where local codes require), it may be found in alley ways behind the residence or in the street.

Sewers should be at such a depth that they can receive the contributed flow by gravity. Where houses have basements, the invert of the sewer is placed a minimum of 3.0 to 3.5 m below grade. Where there is no basement, it is placed to provide sufficient cover to protect the pipe from live load and dead load damage. Moser (2001) provides guidance on design to prevent live and dead load damage. Where building codes are in place, they should be consulted for the appropriate depth. In the absence of other guidance, a rule of thumb is to use a sewer invert depth of 1.8 to 2.4 m below grade when basements are not present.

Building codes may prohibit gravity service from the basement. If sewage is to be removed from the basement level, grinder pumps are installed.

When sewers cannot be placed at a depth sufficient to prevent freezing, for example, when bedrock is near the surface, they must be insulated (GLUMRB, 2004). Countermarsh (1998) discusses alternative designs for these conditions.

Maximum sewer depth is approximately 8 to 9 m. When the depth exceeds 8 to 9 m, a lift station is provided. In exceptional circumstances, the sewer may reach a practical construction limit of 10 to 12 m depth before a lift station is constructed.

GLUMRB (2004) specifies that gravity sewers shall be laid at least 3 m horizontally (edge to edge) from any existing or proposed water mains. Sewers crossing water mains shall be laid to provide a minimum vertical distance of 0.45 m between the outside of the water main and the outside of the sewer. It is preferable that the water main be located above the sewer. At crossings, one full length of water pipe shall be located so both joints will be as far from the sewer as possible. The sewer shall be designed and constructed equal to water pipe, and shall be pressure tested at 1,035 kPa to assure water tightness.

Pipe Size. No public gravity sewer conveying raw wastewater shall be less than 200 mm in diameter (GLUMRB, 2004). This size has been selected to minimize clogging when extraneous material enters the sewer.

Some engineers design sewer pipes to flow half full at the design capacity to provide a factor of safety. This practice is favored when designing laterals or branches that have the potential to be extended to accommodate growth. It is not justified for mains, trunk lines, or interceptors (Steel and McGhee, 1979).

Slope. All sewers shall be designed and constructed to give mean velocities, when flowing full, of not less than 0.6 m/s based on Manning's formula using an "n" value of 0.013 (GLUMRB, 2004). Manning's formula is discussed in the next section.

Slopes are commonly calculated using the depth of the invert of the pipe. Minimum slopes to achieve 0.6 m/s are shown in Table 19-2. Slopes greater than these may be desirable to maintain self-cleansing velocities at all rates of flow, for construction, or to control sewer gases. A mean velocity of 0.3 m/s is usually sufficient to prevent the deposition of the organic solids in wastewater. To prevent deposition of mineral matter, a mean velocity of 0.75 m/s is required. Slopes that result in mean velocities of 0.5 m/s have been used, but these require frequent cleaning (Metcalf & Eddy, 1981).

Sewers 1.2 m and larger should be designed and constructed to give mean velocities, when flowing full, of not less than 0.9 m/s based on Manning's formula and an "n" value of 0.13.

Oversizing sewers to justify flatter slopes is prohibited. The use of larger pipes at flatter slopes will reduce the velocity well below the self-cleaning velocity.

The erosive action of the material suspended in the wastewater depends on the nature of the material and the velocity at which it is carried along. The erosive action determines the maximum safe velocity of the wastewater. In general, maximum mean velocities of 2.5 to 3.0 m/s at the design depth of flow will not damage the sewer (Metcalf & Eddy, 1981).

Where velocities greater than 4.6 m/s are anticipated, special provision must be made to protect against displacement by erosion and impact. Sewers on slopes greater than 20 percent must be securely anchored.

The slope between manholes must be uniform.

Alignment. In general, sewers less than or equal to 600 mm in diameter must be laid with straight alignment between manholes. Curvilinear alignment of sewers large than 600 mm may be permitted if compression joints are specified. Slopes must be increased with curvilinear alignment to maintain a minimum velocity above 0.6 m/s. The recommended practice is to use extra manholes and straight alignment between manholes.

TABLE 19-2
Recommended minimum slopes for gravity flow sewers^a

Nominal diameter, mm	Minimum slope, m/m <i>n</i> = 0.013	Minimum slope, m/m <i>n</i> = 0.010	Capacity, flowing full, m ³ /s
200	0.0033	0.0020	0.019
250	0.0025	0.0015	0.029
300	0.0019	0.0011	0.042
350	0.0016	0.0009	0.058
375	0.0014	0.0008 ^b	0.066
400	0.0013	0.0008 ^b	0.075
450	0.0011	0.0007 ^b	0.095
500	0.0010	0.0006 ^b	0.118
600	0.0008 ^b	0.0005 ^b	0.170

^aCalculated using Manning's equation with nominal pipe diameter and $v = 0.6$ m/s.

^bThe minimum practicable slope for construction is about 0.0008 m/m.

Changes in Pipe Size. When a smaller pipe joins a larger one, the invert of the larger sewer should be lowered sufficiently to maintain the same energy gradient. An approximate method for securing this result is to place the 0.8 depth point of both sewers at the same location.

In no instance should a larger pipe discharge into a smaller pipe. Even though a smaller pipe at a steeper slope may be able to carry the larger flow, there is the potential for objects that will travel freely in the larger pipe to obstruct the smaller pipe.

Manholes. Manholes are placed at the junction of two or more sewers, at changes in vertical or horizontal alignment, at changes in sewer size, and at the end of each line. The spacing for straight runs is shown in Table 19-3.

Drop manholes are used when the inflow and outflow sewers differ in elevation by more than 0.6 m. They may also be used to reduce the slope when the velocities exceed erosive velocities (2.5–3.0 m/s).

The manholes in small sewers are typically about 1.2 m in diameter. A minimum access diameter of 0.6 m is provided. Although the same size manhole barrel is used for both small and large manholes, the base will be larger for sewers larger than 600 mm.

Although the American Society of Civil Engineer's manual on sewer design (ASCE, 1982) suggests that it is unnecessary, current practice is to provide an arbitrary minimum drop of 30 mm across the standard manhole. Otherwise, the grade through the manhole should match the energy grade line for larger diameters or with size change.

Hints from the Field. Experience has yielded the following useful rules of thumb. These are not design criteria but rather practical considerations in applying the design criteria.

- In normal practice, the ground slope is used as a first trial for selecting the slope. However, there are a number of exceptions. For example:
 - a. If the ground is flat, select the minimum slope to achieve a velocity of 0.6 m/s with the sewer flowing full.
 - b. If there is a slight upgrade for a short distance, select the minimum slope to achieve a velocity of 0.6 m/s with the sewer flowing full.
 - c. If the ground slope yields a velocity greater than 2.5 m/s, then select a lower slope.

TABLE 19-3
Typical manhole spacing for straight runs^a

Pipe diameter	Spacing
375 mm or less	120 m or less
450 to 750 mm	150 m
or	
450 to 750 mm	180 m with adequate cleaning equipment
825 to 1,200 mm	180 m
1,200 mm or greater	460 m

^a The actual spacing is highly dependent on local conditions and client preference.

- A drop manhole may be used to minimize excessive velocity in a steep sewer. Alternatively, consider designing the sewer as a *gravity force main* or pressure pipe with energy dissipation at the downstream end of the pipe (Orsatti, 1996).
- Because lift stations are expensive to build, operate, and maintain, avoid them to the maximum extent possible by considering alternative routing.
- Because drop manholes are expensive to build and often become plugged or fail structurally, avoid them to the maximum extent possible by considering the alternative of extra excavation.
- In the upper reaches of the collection system (e.g., in residential subdivisions), there will seldom be enough flow at average or, perhaps, even at maximum discharge rates to achieve a minimum velocity of 0.6 m/s in a 200 mm diameter sewer at minimum slope. This means that a regular maintenance program that includes cleaning the sewer will be required.

Summary. The design criteria for sewers are summarized in Table 19-4.

Design Equations

Two equations serve in the design of sewers: the Hazen-Williams equation introduced in Chapter 3 (Equation 3-2) and Manning's equation. Of these two, the Manning equation has found wide application in sewer design because it applies both to sewers flowing full and those flowing partially full—the latter being the condition most frequently encountered. Three useful forms of Manning's equation are:

$$v = \frac{1}{n} R^{2/3} S^{1/2} \quad (19-2)$$

$$S = \frac{(v^2)(n^2)(6.3448)}{(D^{1.333})} \quad (19-3)$$

$$Q = \frac{1}{n} R^{2/3} S^{1/2} A \quad (19-4)$$

where v = velocity, m/s
 n = coefficient of roughness, unitless
 R = hydraulic radius, m
 $= \frac{\text{cross-sectional area of flow, m}^2}{\text{wetted perimeter, m}}$
 S = slope of energy grade line, m/m
 D = diameter of pipe, m
 Q = flow rate, m³/s
 A = cross-sectional area of flow, m²

The selection of an appropriate value for n is typically based on the pipe material and its condition. There is a large body of work that has been devoted to the determination of n for various surfaces. Selected values from the literature are shown in Table 19-5 on page 9-17.

TABLE 19-4
Typical design criteria for gravity sewers

Parameter	Recommendation	Comment
Pipe material	PVC	For main sewers
Pipe diameter	200 mm minimum Size to carry peak flow rate	Nominal diameter See Table 19-2
Slope	To achieve 0.6 m/s	Flowing full, Manning's $n = 0.013$, see Table 19-2
Maximum velocity	2.5 to 3.0 m/s	
Depth to invert	3.0 to 3.5 m minimum 1.8 to 2.4 m 8 to 9 m maximum	When basements are present or 0.6 m below the lowest basement When no basements are present
Depth to crown	$H = D/6$ minimum	For dead load; granular soil For live load see Moser (2001)
Location with respect to water mains	3.0 m horizontally 0.45 m vertically When crossing	Edge to edge Outside to outside; water above sewer Full length to joint for water main or encased sewer
Alignment	Straight between manholes	600 mm or less
Manholes	Place at: junction of two sewers change in vertical alignment change in horizontal alignment change in pipe size at end of each line Spacing for straight runs Effluent elev. = Influent elev. - 0.03 m	See Table 19-3 To account for entrance and exit losses
Drop manholes	When inflow and outflow inverts differ by more than 0.6 m	
Manhole diameter	1.2 m minimum	Access ≥ 0.6 m

As noted above, GLUMRB (2004) specifies that $n = 0.013$ for the calculation of minimum velocity. Designers typically use $n = 0.013$ for PVC because, once the pipe is in use, this n is more realistic.

For a pipe flowing full, the hydraulic radius is defined as

$$R = \frac{(\pi/4)(D)^2}{\pi D} = \frac{D}{4} \quad (19-5)$$

TABLE 19-5
Typical values of n that are used with the Manning equation

Pipe material	Condition		
	Good	Fair	Deteriorated
DIP (lined)	0.011	0.013 ^a	0.015
HDPE	0.010 ^a	0.011	0.013
PVC	0.010 ^a	0.011	0.013
RCP	0.013	0.015 ^a	0.018
VCP	0.013 ^a	0.015 ^a	0.017

^aValues commonly used in design.

where D = diameter of pipe in meters. Similarly, for a pipe flowing half-full, $R = D/4$. **For pipes flowing full or half-full**, other useful forms of Manning's equation are:

$$v = \frac{0.397}{n}(D)^{2/3}S^{1/2} \quad (19-6)$$

$$Q = \frac{0.312}{n}(D)^{8/3}S^{1/2} \quad (19-7)$$

$$S = \frac{10.3(n^2)(Q^2)}{(D)^{16/3}} \quad (19-8)$$

For other fractional flows, the estimate of R is quite complex. Camp (1946) developed a graphical solution procedure. Camp's graph (adapted in Figure 19-9) depicts the nonlinear behavior of several variables in the Manning equation. To begin with the obvious, the curves are based on the value of the variable when the pipe is flowing full. In common notation, a capital letter is used for the value of the variable when the pipe is flowing full, that is, D , V , and Q . A lower case letter is for the value of the variable when the pipe is flowing partially full, that is, d , v , q .

Research on asbestos-cement, DIP, VCP, and RCP pipe has revealed that Manning's n varies with depth as shown on the left-hand side of Figure 19-9 (Bloodgood and Bell, 1961; Pomeroy, 1967). The functional form is as follows (ASCE, 1982):

$$n \approx k^{(m/2)}D^{(1-3m)/6} \quad (19-9)$$

where n = Manning's n

k = effective absolute roughness, or height of wall roughness, m

m = proportionality factor

D = diameter of pipe, m

The value of m is slightly less than 1/3 for turbulent flow.

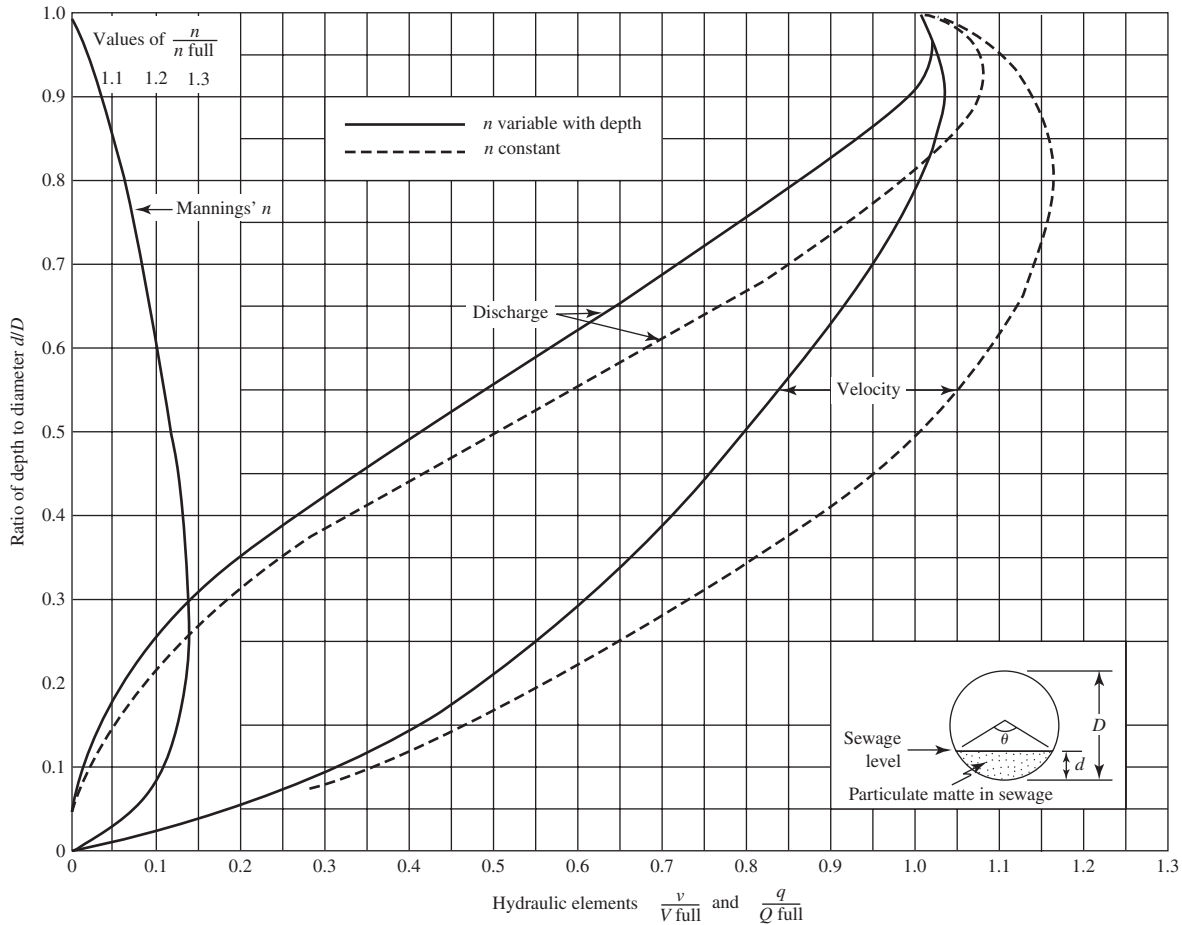

FIGURE 19-9
Hydraulic properties of circular sewers. (Adapted from Camp, 1946.)

In contrast to the pipes noted above, PVC pipe with flows from $0.2D$ to full do not indicate a significant variation in n with depth. Data for discharge and velocity approximate the curves that are obtained using an assumption of a constant n (Neale and Price, 1964).

The shape of the velocity ratio curve is primarily a function of the change in the hydraulic radius with depth of flow. From simple geometric relationships, for pipes flowing partially full, this can be shown to be:

$$R = \left(\frac{D}{4} \right) \left(1 - \frac{180 \sin \theta}{\pi \theta} \right) \quad (19-10)$$

where R = hydraulic radius, m

D = pipe diameter, m

θ = angle subtended by the segment of the pipe diameter occupied by the wastewater (see inset in Figure 19-9), degrees

Note that $\cos 1/2 \theta = 1 - 2d/D$. The shape of the discharge ratio curve is a function of the change in both the area and hydraulic radius as a function of depth. The behavior of the area as a function of depth is described by Equation 19-11:

$$A = \frac{D^2}{4} \left(\frac{\pi \theta}{360} - \frac{\sin \theta}{2} \right) \quad (19-11)$$

Example 19-1 illustrates the use of Figure 19-9 in estimating the velocity of sewage flowing in a partially full sewer.

Example 19-1. Determine the velocity of $0.0081 \text{ m}^3/\text{s}$ flow in a 200 mm diameter sewer at a slope of 0.0040 m/m . The pipe is new VCP.

Solution.

- a. Estimate the velocity and flow rate for the sewer flowing full. The hydraulic radius for flowing full is $D/4$ and $n = 0.013$ for new VCP (Table 19-5). Using Equation 19-6:

$$\begin{aligned} v_{\text{full}} &= \frac{0.397}{0.013} (0.200 \text{ m})^{2/3} (0.0040 \text{ m/m})^{1/2} \\ &= (30.53)(0.3420)(0.0632) = 0.66 \text{ m/s} \end{aligned}$$

Using Equation 19-7:

$$\begin{aligned} Q_{\text{full}} &= \frac{0.312}{0.013} (0.200 \text{ m})^{8/3} (0.0040 \text{ m/m})^{1/2} \\ &= (24.00)(0.0137)(0.0632) = 0.0208 \text{ m}^3/\text{s} \end{aligned}$$

- b. Calculate Q/Q_{full} .

$$\frac{Q}{Q_{\text{full}}} = \frac{0.0081 \text{ m}^3/\text{s}}{0.0208 \text{ m}^3/\text{s}} = 0.39$$

- c. Enter Figure 19-9 on the abscissa at $Q/Q_{\text{full}} = 0.39$ and draw a vertical line to the discharge curve labeled “ n variable with depth.” From the intersection point, draw a horizontal line to the velocity curve labeled “ n variable with depth.” From this intersection point, draw a vertical line down to the abscissa and read $v/v_{\text{full}} = 0.78$.
- d. The velocity flowing partially full is then

$$v = 0.78 v_{\text{full}} = (0.78)(0.66 \text{ m/s}) = 0.51 \text{ m/s}$$

Comments:

1. The specification of new VCP pipe was used to select $n = 0.013$ and to select the “ n variable with depth” curves. For plastic pipe, the value for n is 0.010 , and the curves selected would be “ n constant.”
 2. The use of the graphs for estimating v/v_{full} implies that calculated velocities should have no more than two significant figures. In all likelihood, given the inherent errors in estimating flow rates and Manning’s n , as well as the use of the nominal pipe diameter, one might argue that velocities should be limited to one significant figure.
-

Layout of a Collection System

The collection system may be viewed as a dendritic network of sewers. The layout begins with a detailed map that shows the contours. A line is drawn to represent the proposed sewer for each street. An arrow is placed near the line to indicate the direction of flow. Except in special cases, the sewers should slope with the ground surface. The plan that provides the most direct route is often the most economical, provided that pumping is not required.

Manholes are located on the sewer lines in accordance with the design criteria for spacing. Each manhole is numbered. The numbering system is not prescribed. The author's preference is to have the lowest number at the termination of the system and the higher numbers at the extremities of the system, with sewage flowing from higher numbers to lower numbers.

The service area for each lateral is sketched on the map. Generally, the service area limits will be midway between the streets where the sewer is to be placed.

Figure 19-10 illustrates the layout technique.

Design of a Main

The design of a sewer main is the starting point for computations for a network. The flow chart shown in Figure 19-11 provides an introduction to the process. Experience and circumstances will reveal a number of alternative methods for solving the problem.

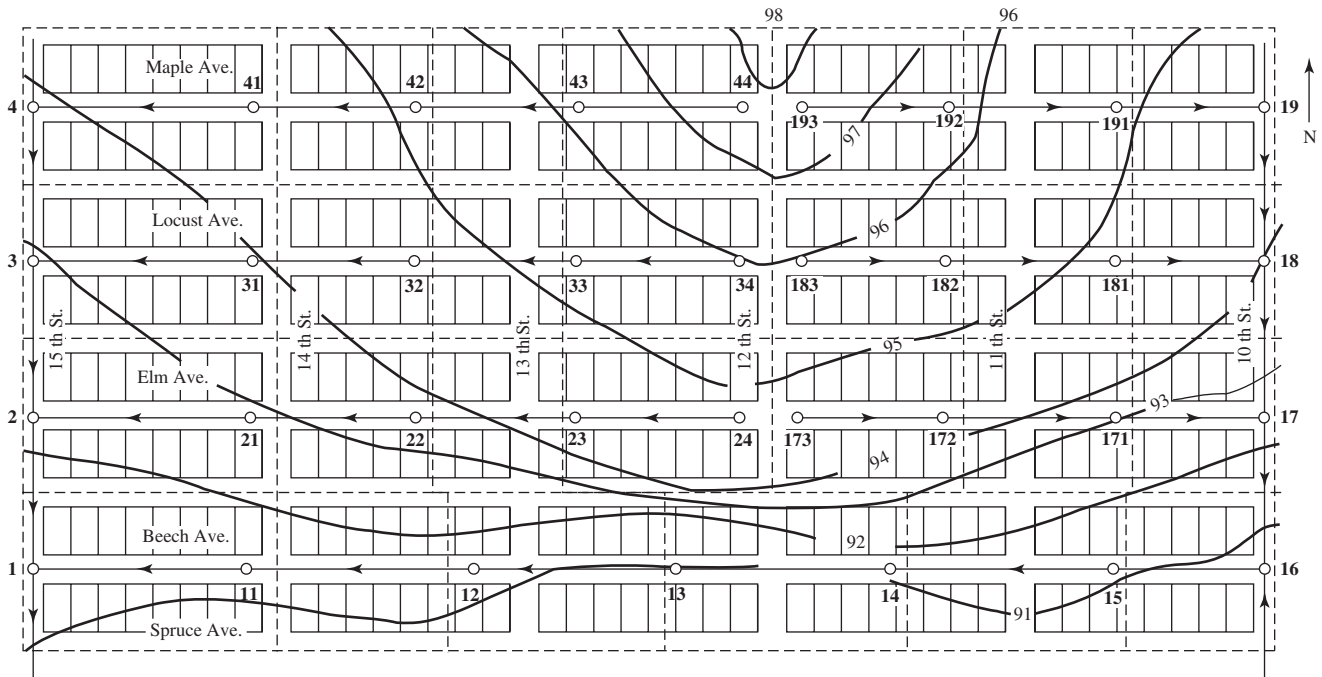

FIGURE 19-10

Layout of a sanitary sewer for a replacement project. The sewers are placed in alleys behind houses. The dashed lines indicate the service area for each sewer. The contour lines are in meters. (Adapted from Steel and McGhee, 1979.)

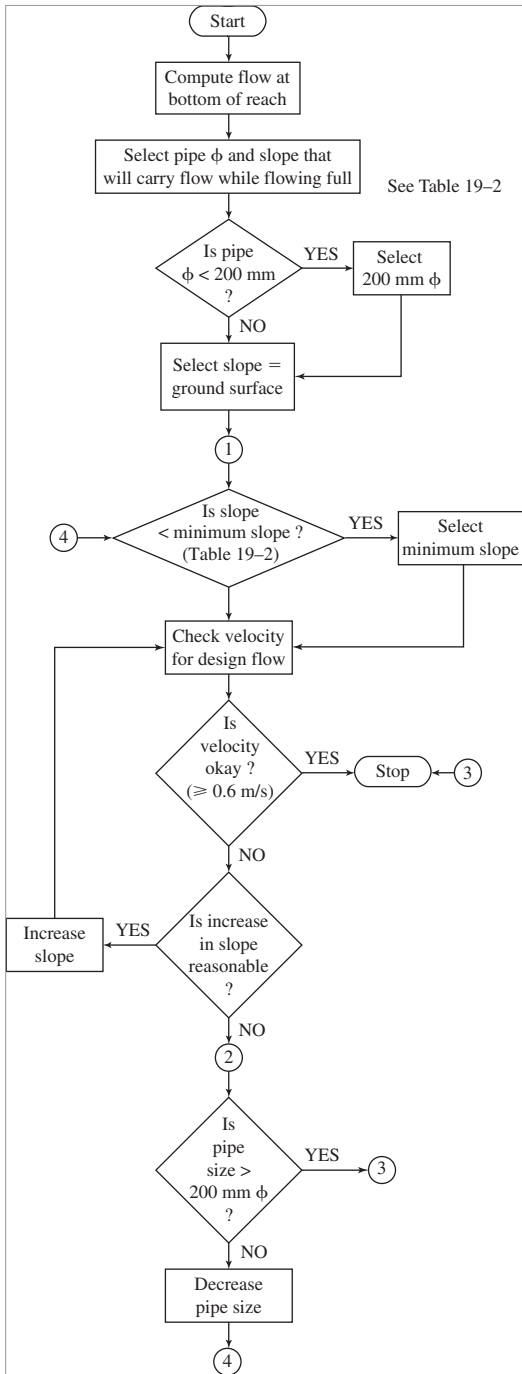

FIGURE 19-11
Sewer design flow chart for selecting pipe size for a reach between manholes.

The check of the velocity at the design capacity is to evaluate whether or not the velocity at the design flow rate will be self-cleaning.

The decision point in the flow chart that requires an evaluation of the question “Is increase in slope reasonable?” requires some judgement and experience to make a choice. A beginning criterion is that if the velocity is less than or equal to 0.45 m/s, it is unlikely that increasing the slope to achieve 0.6 m/s is reasonable. This is because the required slope will be so steep that it will drive the sewer into the ground and ultimately require numerous lift stations. In the event that the desired velocity cannot be achieved, the client should be advised of the likelihood that frequent cleaning will be required.

Example 19-2 illustrates the design of a main.

Example 19-2. Design a sewer to connect two businesses (Koffee Au Noir and Elsie’s Dairy Kreamer) to an existing sewer main. The plan view of the proposed sewer line is shown in Figure 19-12. The distance between manholes is marked on the plan. It was selected based on an expectation that the sewer pipe diameter would be less than 375 mm. Surface elevations are given at each manhole. The proposed sewer must connect to the existing sewer at MH No. 48 at an invert elevation of 177.98 m. Assume that Koffee Au Noir and Elsie’s Dairy Kreamer both have basements. The peak flow rates for Koffee Au Noir and Elsie’s Dairy Kreamer are 20.2 L/s

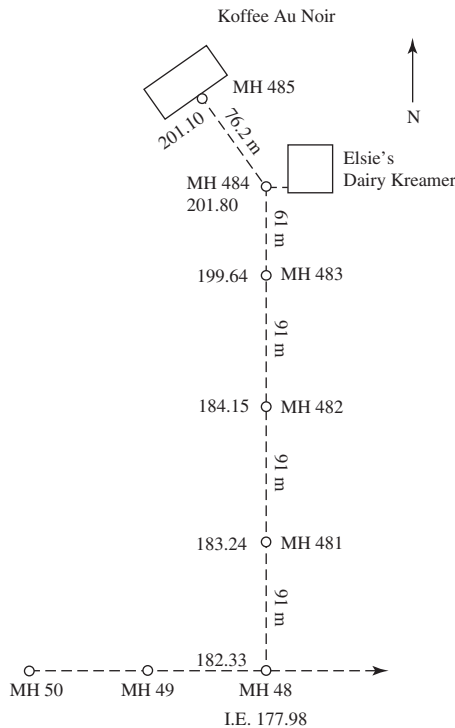

FIGURE 19-12 Plan view of sewer for Example 19-2. MH = manhole. Elevations on the left of the MH are surface elevations.

and 14.5 L/s, respectively. Infiltration and inflow are assumed to be negligible for this sewer main. A maximum velocity criterion of 2.5 m/s has been established by the local authority. No other establishments will connect to this line above MH 482. VCP has been selected as the pipe material. Ignore the customary 0.03 m drop through the manholes.

Solution:

- a. Using the surface elevations from Figure 19-12, plot the ground surface profile on a scale drawing as shown in Figure 19-13.
- b. The calculations were performed on the spreadsheet shown below. Row and column calculations are explained below the table.
- c. The first four columns are self-explanatory.

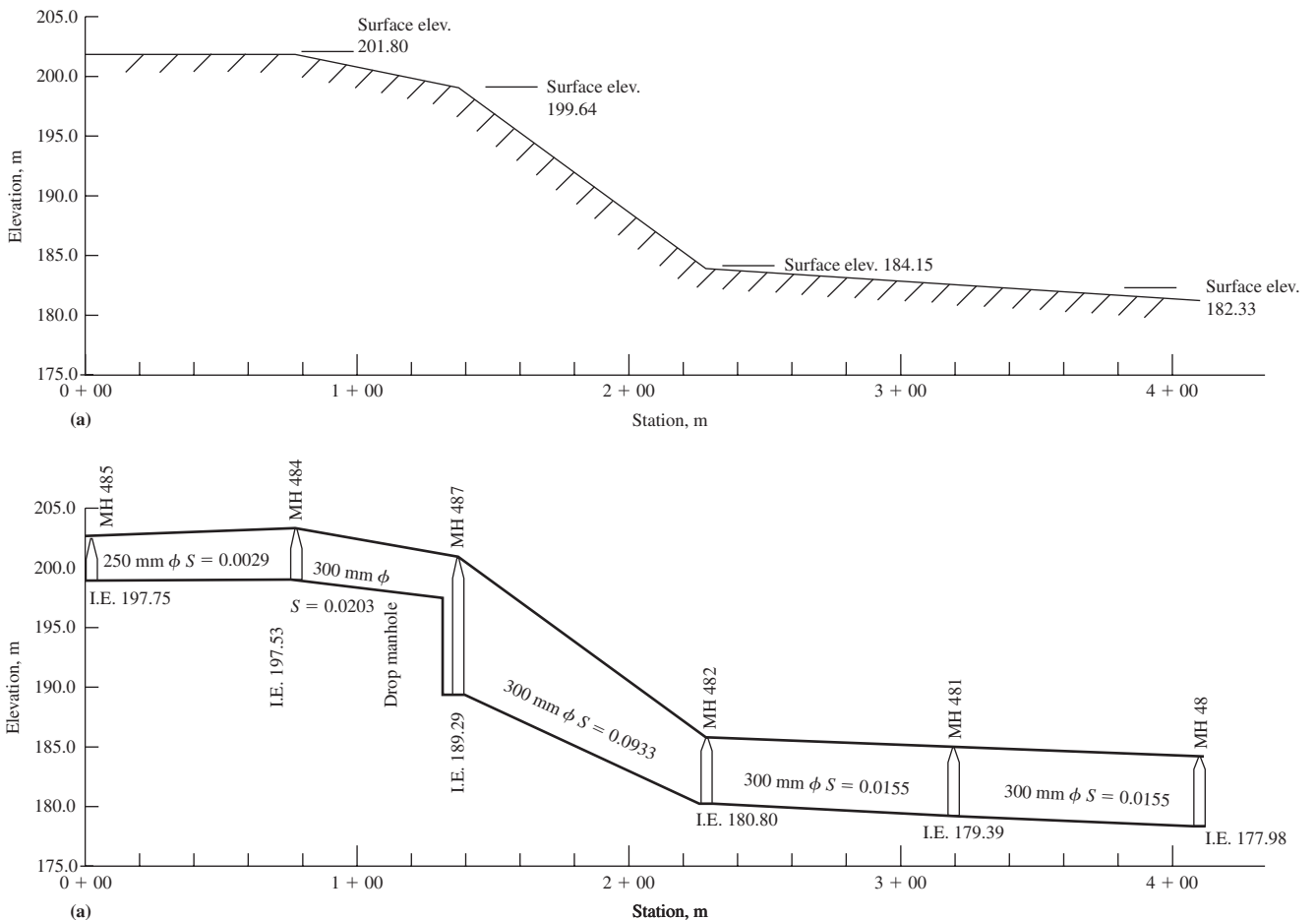

FIGURE 19-13
 Profiles for Example 19.2. (a) Surface profile. (b) Sewer profile.
 Note: drop through manhole has been ignored.

Example 19-2

Line (1)	From MH (2)	To MH (3)	Length of line, m (4)	Flow, m ³ /s (5)	Pipe diameter, m (6)	Ground elevations		Grade of surface, m/m (9)	Grade of sewer, m/m (10)	Velocity flowing full, m/s (11)
						Upper MH, m (7)	Lower MH, m (8)			
1	485	484	76.2	0.0202	0.250	201.10	201.80	-0.0092	0.0029	0.65
2	484	483	61.0	0.0347	0.300	201.80	199.64	0.0354	0.0203	1.95
3	483	482	91.0	0.0347	0.300	199.64	184.15	0.1702	0.1702	5.65
3 revised	483	482	91.0	0.0347	0.300	199.64	184.15	0.1702	0.0933	4.18
4	482	481	91.0	0.0347	0.300	184.15	183.24	0.0100	0.0155	1.70
5	481	48	91.0	0.0347	0.300	183.24	182.33	0.0100	0.0155	1.70

Notes: Drop through manhole (MH) was ignored. Column numbers (in parentheses) continue in the table on p. 19-25.

- d. The flow rate in column 5, line 1 is the flow rate from Koffee Au Noir converted to compatible units for later calculations:

$$\frac{20.2 \text{ L/s}}{1,000 \text{ L/m}^3} = 0.0202 \text{ m}^3/\text{s}$$

- e. Column 6, line 1: Using Table 19-2, select a 250 mm diameter pipe because it will carry 0.029 m³/s flowing full at a minimum slope of 0.0025 m/m.
- f. Columns 7 and 8, line 1: These are the surface elevations given on the plan map (Figure 19-12).
- g. Column 9, line 1: The ground slope is calculated using the two manhole elevations and the distance between them:

$$\frac{201.10 \text{ m} - 201.80 \text{ m}}{76.2 \text{ m}} = -0.0092$$

The negative sign means that the slope is uphill.

- h. Because the uphill slope is slight, the minimum slope from Table 19-2 for a 250 mm diameter VCP pipe was selected and entered in column 10, line 1: 0.0025 m/m.

This slope resulted in a velocity of 0.56 m/s when flowing partially full. The slope was adjusted to 0.0029 m/m to achieve a velocity of 0.60 m/s when flowing partially full.

- i. Column 11, line 1: Using Equation 19-6 because the pipe is flowing full, the velocity at a slope of 0.0029 m/m and a Manning's $n = 0.013$ is:

$$\begin{aligned} v &= \frac{0.397}{n} (D)^{2/3} S^{1/2} \\ &= \frac{0.397}{0.013} (0.250 \text{ m})^{2/3} (0.0029)^{1/2} \\ &= 0.65 \text{ m/s} \end{aligned}$$

Note: Manning's $n = 0.013$ because the pipe is new VCP.

Q_{full} , m^3/s (12)	Q/Q_{full} (13)	v/v_{full} (14)	Velocity, m/s (15)	Fall of sewer, m (16)	Invert elevations		Depth of lower MH, m (19)	
					Upper MH, m (17)	Lower MH, m (18)		
0.0321	0.63	0.92	0.60	0.22	197.75	197.53	4.27	
0.1379	0.25	0.71	1.38	1.24	197.53	196.29	3.35	Picked depth of 3.35 m and calculated slope of 0.0203
0.3993	0.09	0.52	2.94	15.49	196.29	180.80	3.35	
0.2957	0.12	0.58	2.42	8.49	189.29	180.80	3.35	Drop MH = 7.0 m
0.1205	0.29	0.72	1.23	1.41	180.80	179.39	3.85	
0.1205	0.29	0.72	1.23	1.41	179.39	177.98	4.35	

- j. Column 12, line 1: Using Equation 19-7 because the pipe is flowing full, the flow rate at a slope of 0.0029 m/m and a Manning's $n = 0.013$ is:

$$\begin{aligned} Q &= \frac{0.312}{n} (D)^{8/3} S^{1/2} \\ &= \frac{0.312}{0.013} (0.25)^{8/3} (0.0029)^{1/2} \\ &= 0.0321 \text{ m}^3/\text{s} \end{aligned}$$

- k. Column 13, line 1: computation of Q/Q_{full} using Q from column 5 and Q_{full} from column 12:

$$\frac{0.0202}{0.0321} = 0.63$$

- l. Column 14, line 1: Using Figure 19-9 and the procedure outlined in step c in Example 19-1, find v/v_{full} :

$$\frac{v}{v_{\text{full}}} = 0.92$$

- m. Column 15, line 1: Calculate the velocity for the pipe flowing 92 percent full:

$$v_{\text{full}} = (0.92)(0.65 \text{ m/s}) = 0.60 \text{ m/s}$$

Note: The ratio (0.92) was computed in column 14, and the velocity was computed in column 11.

- n. Column 16, line 1: Calculate the change in elevation from the upper MH to the lower MH (called the *fall*) using the distance between manholes from column 4 and the slope from column 10:

$$(76.2 \text{ m})(0.0029 \text{ m/m}) = 0.22 \text{ m}$$

- o. Column 17, line 1: The elevation of the upper MH is the difference between the surface elevation and the invert of the sewer, which is 3.35 m below the ground surface because Koffee Au Noir and Elsie's Dairy Creamer have basements (see Table 19-4):

$$201.10 \text{ m} - 3.35 \text{ m} = 197.75 \text{ m}$$

- p. Column 18, line 1: The elevation of the lower MH invert is the difference between the upper MH invert (column 17) and the fall (column 16):

$$197.75 \text{ m} - 0.22 \text{ m} = 197.53 \text{ m}$$

Note: This elevation is copied to column 17, line 2.

- q. Column 19, line 1: This column is a check to make sure that the depth at the lower MH is equal to or greater than the required depth for basements. It is calculated as the surface elevation (column 8) minus the invert of the lower MH (column 18):

$$201.80 \text{ m} - 197.53 \text{ m} = 4.27 \text{ m}$$

Now working on Line 2

- r. Column 5, line 2: The flow rate is the sum of that from Koffee Au Noir and Elsie's Dairy Creamer:

$$0.0202 \text{ m}^3/\text{s} + \frac{14.5 \text{ L/s}}{1,000 \text{ L/m}^3} = 0.0347 \text{ m}^3/\text{s}$$

Note: Because there are no additional flows for the remainder of the lateral, this flow rate is repeated in the remaining lines of this column.

- s. Column 6, line 2: Because $0.0347 \text{ m}^3/\text{s}$ is greater than the flowing full capacity of the 250 mm diameter pipe at the minimum slope, use Table 19-2 and select a 300 mm diameter pipe to carry the flow.
- t. Column 10, line 2: Because the slope is steep, a trial calculation places the invert elevation of the lower MH at the minimum depth of 3.35 m. The logic in making this choice was to minimize excavation. Thus, the invert elevation at MH 483 is:

$$199.64 \text{ m} - 3.35 \text{ m} = 196.29 \text{ m}$$

The lower MH elevation is then entered in column 18.

The slope is then computed from the invert elevations in columns 17 and 18 and the distance between the MHs (column 4):

$$\frac{197.53 \text{ m} - 196.29 \text{ m}}{61.0 \text{ m}} = 0.0203$$

- u. Columns 11 through 19, line 2: follow the same logic as in line 1.

Now working on Line 3

- v. Columns 1 through 9: follow the logic in lines 1 and 2. Note that the distance in column 4, MH 483 to MH 482, is the horizontal distance. This is the distance to calculate the slope. The actual required pipe length is obviously longer.

- w. Column 10, line 3: The slope of the ground surface was selected for this trial.
- x. Columns 11 through 19, Line 3: follow the same logic as in Line 1.

Note: The velocity in column 15 exceeds the allowable velocity of 2.5 m/s.

Now working on Line 3 revised

- y. Because of the excessive velocity, a drop manhole at MH 483 was selected to reduce the slope of the sewer. After several trials, using the velocity criterion of 2.5 m/s to determine acceptability, a drop of 7.0 m was selected. The upper MH elevation is:

$$196.29 \text{ m} - 7.0 \text{ m} = 189.29 \text{ m}$$

- z. Column 10, line 3 revised: Keeping the lower MH elevation at the same value as in the first trial for line 3, the slope is then:

$$\frac{189.29 \text{ m} - 180.80 \text{ m}}{91.0 \text{ m}} = 0.0933$$

- aa. Columns 11 through 19 for line 3 revised are calculated as in Line 1.
- bb. Lines 4 and 5: Because the grade is uniform from MH 482 to MH 48, the slope was computed from the invert at MH 482 to the invert specified for connection at MH 48, that is, 177.98 m. It is

$$\frac{180.80 \text{ m} - 177.98 \text{ m}}{2(91.0 \text{ m})} = 0.0155$$

Note: The factor of 2 in the denominator is to account for the two manhole distances between MH 482 and MH 48.

- cc. Assuming that the slope remains constant, it is entered in column 10 for lines 4 and 5. The computations in columns 11 through 19 for lines 4 and 5 are calculated as in line 1. The depth of the lower MH is checked to make sure that it is equal to or greater than 3.35 m. This satisfies the requirements for the sewer and completes the computations for this lateral.
- dd. The final sewer profile is shown in Figure 19-13b.

Comments:

1. The long, tedious explanation belies the ease with which the computations and design may be completed with the aid of a spreadsheet. The length of the solution is also exacerbated by several issues that were introduced to provide an example for instructional purposes.
2. The weakness of the spreadsheet solution used here is that it requires the user to determine the v/v_{full} ratio graphically. A complex polynomial equation can be resolved to fit a large portion of the graphical solution.
3. This solution is only one of several alternatives. Some others include the following:
 - a. On a larger scale, another route that does not include the steep grade may be available.

- b. The selection of the diameter of the sewer based on the minimum slope introduced some complexities that may be avoided by picking a smaller diameter pipe placed at a steeper grade from the starting point at Koffee Au Noir.
 - c. A gravity force main may be a more economical alternative.
 4. From a construction point of view, microtunneling may be a cost-effective alternative to conventional excavation for construction. As a general rule, microtunneling is often cost effective when the depth of cover is equal to or greater than 7.5 m. Trenchless construction is not always effective with high ground water as there is still a need to handle the water. Nominal drive lengths are 90 to 215 m (Staheli and Hermanson, 1996). Other trenchless methods, such as jack and bore, may be more appropriate than microtunneling. Directional drilling is not typically used for gravity flow sewers because of the lack of grade control. It may be appropriate for building services.
 5. As with water distribution systems, commercially available computer programs provide rapid solutions for large pipe networks. In the more sophisticated programs, there are optimization routines that lay out routing based on specified criteria as well as performing all the calculations.
-

Final Drawings

Computer-aided design (CAD) facilitates the preparation of final drawings. CAD drawings are often used in conjunction with aerial photogrammetry to produce the final drawings. Figure 19-14 is an example of a typical drawing.

19-4 ALTERNATIVE SEWERS

The most common alternative sewer systems are small-diameter gravity (SDG), pressure, and vacuum sewers. Although these systems are predominately used for very small, remote areas providing service to populations less than 200 people, they have found special application with significantly larger populations (Guertin, 2007). The following paragraphs compare these systems and outline their design. For detailed guidance on their design the reader is referred to the Water Environment Federation publication entitled *Alternative Sewer Systems* (WEF, 1986) and commercial literature from companies supplying these systems.

System Descriptions

Small-Diameter Gravity (SDG). The SDG sewers may be either constant gradient or variable gradient. Both use small diameter pipes to carry septic tank effluent to a treatment facility. The septic tanks are an essential part of the system as they provide a place for removal of heavy solids, grease, and grit that would otherwise plug the pipe.

The advantages of SDG sewers over conventional sewers include lower capital cost because of reduced pipe and installation costs; clean-outs instead of manholes; reduced lift station costs because of pretreatment and flow attenuation by the septic tanks; and reduced I/I. Another potential advantage is reduction in treatment costs because of septic tank pretreatment. Disadvantages of SDG sewers include maintaining and pumping the septic tanks, odors, and corrosion because of the anaerobic conditions in the septic tank that result in hydrogen sulfide production.

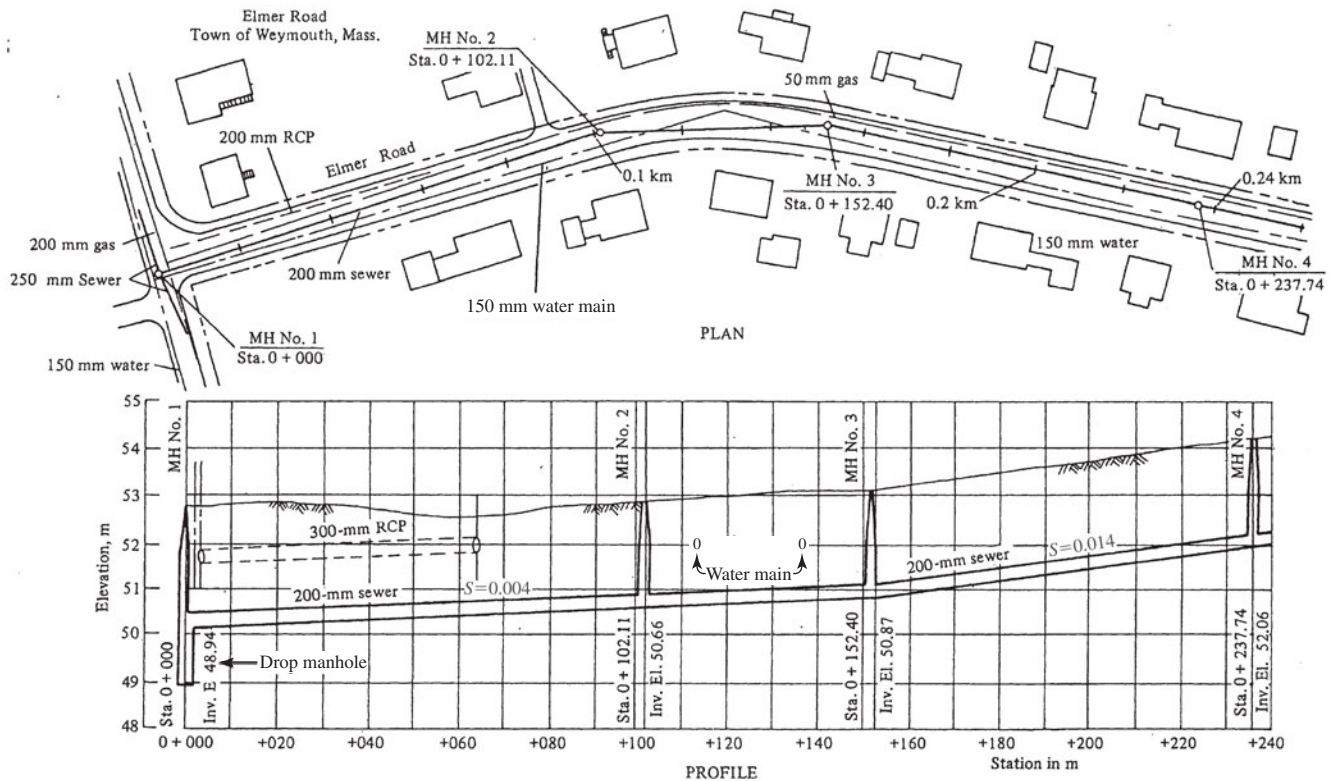

FIGURE 19-14

Typical sewer contract drawing. (Adapted from Metcalf & Eddy, 1981.)

Pressure Sewers. The two major types of pressure sewer systems are the septic tank effluent pump (STEP) system and the grinder pump (GP) system. The STEP system, like the SDG system, requires a septic tank for the same reasons as the SDG system. The GP system grinds the solids in a small tank on the residence property and pumps the wastewater into the pressure pipe system.

The benefits of pressure sewers primarily relate to installation costs because the sewer uses small diameter pipe that is laid just below the frost penetration depth. Some site conditions particularly favor pressure pipe systems. These include hilly terrain, rock outcropping, high water tables, and lakefront property that lacks a natural slope for a gravity sewer. Because the pipe is pressurized, I/I is not a problem.

Potential disadvantages include higher operation and maintenance cost because of the need to maintain the numerous pumps in the system. Severe corrosion of the electrical and mechanical equipment, particularly from the STEP system, may be encountered.

Vacuum Sewers. These systems depend on a central vacuum source. A valve is used to separate the gravity portion of the waste system from the vacuum at the source. When the valve opens, a slug of wastewater followed by a slug of air enters the pipe system. The slug of wastewater is propelled into the main by the differential pressure of the vacuum and the air slug. The

wastewater in the main flows to the lowest local elevation by gravity. When the next upstream valve opens, the new slug pushes the downstream slug further downstream. After a number of these sequential valve openings, the wastewater arrives at a central vacuum source and a transfer device, such as a pump, moves the wastewater to a treatment plant or an interceptor sewer.

The advantages of the vacuum system are similar to those for the pressure system. In addition, higher dissolved oxygen in the wastewater, central power usage at the vacuum station, and reduced concern for exfiltration of waste are beneficial.

The disadvantages include higher energy and operating costs, the need for exact grade alignment, greater infiltration potential, and less tolerance to flows exceeding the design flow. In addition, vacuum systems are limited in their capability to lift sewage.

Comparison with Conventional Sewers. Table 19-6 summarizes the relative characteristics of alternative and conventional sewers.

General Design Considerations

Small-Diameter Gravity Sewers. The preliminary considerations in the design of SDG sewers are the same as those for a conventional gravity sewer, that is, mapping, flow rate estimation, and so on. SDG sewers have a minimum recommended diameter of 50 mm. Pressure-rated pipe materials such as PVC are recommended. Manning's equation is used for the design.

An item of concern in the design is to ensure that the maximum hydraulic gradient does not cause backflow into an individual or group of septic tanks. Backflow prevention valves may be required. Pump discharge lines should have check valves to prevent drawback backwater entry from the sewer. Manholes should be avoided because they result in additional water, grit, and other debris.

Pressure Pipe. Flow design values are commonly based on the number of houses being served. WEF (1986) provides graphical estimating guides based on research conducted in the 1970s and 1980s. Pipe materials will be subject to a constant variation in working pressures. Therefore, the

TABLE 19-6
Relative characteristics of alternative sewers

Sewer type	Ideal topography	Construction cost in rocky, high ground water sites	Sulfide potential	Minimum slope or velocity required	O/M requirements	Ideal power requirements
SDG	Downhill	Moderate	High	No	Low-mod.	None
STEP	Uphill	Low	High	No	Mod.-high	Low
GP	Uphill	Low	Mod.-high	Yes	Mod.-high	Moderate
Vacuum	Flat	Low	Low	Yes	High	High
Conventional	Downhill	High	Moderate	Yes	Moderate	None
SDG—STEP	Undulating	Low-mod.	High	No	Moderate	Low
Conv.—GP	Undulating	Mod.-high	Moderate	Yes	Mod.-high	Low-mod.
Conv.—Vac.	Undulating	Mod.-high	Low-mod.	Yes	High	Mod.-high

Source: WEF, 1986.

pipng system should be designed based on cyclic surging. Fatigue failure must be considered in the design. Pressure rated PVC has generally been the pipe material of choice.

In contrast to pressure water distribution systems, in GP systems the layout of the collection system is dendritic. STEP systems may have loops with valves to provide predicable flow directions. The looping provides alternative routing when repairs need to be made. Either Manning's equation or the Hazen-Williams equation is used for design. The Hazen-Williams equation is most often used. The value of C usually varies between 140 and 160 for PVC pipe. When using the GP system, the design velocity should be greater than 0.6 m/s. A velocity of 0.3 m/s is adequate for the STEP system because the septic tank removes a majority of the grit and grease.

Pumping "uphill" is usually the preferred practice. In some cases "downhill" pumping is unavoidable. When downhill situations occur, air enters the pipeline. This results in two-phase flow and high headlosses.

Vacuum Sewers. The pipe materials used for pressure sewers are suitable for vacuum systems. Pipe diameters are on the order of 75 to 100 mm. The difficulty in design is the fact that the flow regime is two phase and cyclic. WEF (1986) provides design equations.

19-5 PUMP STATION DESIGN

Wastewater pumping stations are generally classified as one of the following types: wet well/dry well; submersible; suction lift; and screw pump. Only the first two will be discussed here.

Pump station design includes the following elements: force main design, pump selection, and station layout. These are the topics of this section.

Force Main Design

As noted earlier in this chapter, a force main is a pipeline designed to carry wastewater under pressure from the pump station to one of the following discharge points: a gravity sewer, a storage tank, or a wastewater treatment plant. The internal pressure of a force main is usually at a maximum at the pumping station. It decreases to, or nearly to, atmospheric pressure at the point of discharge.

The force main is an integral part of the pumping system, as its design and the system head-capacity curve are required to size the pump(s).

Design Equation. The Hazen-Williams equation (Equation 3-5, Chapter 3) is usually used to determine friction losses in the force main. To avoid pump cavitation in newly installed pipe, it is recommended that system head-capacity curves be developed using Hazen-Williams C values for both new pipe and design year pipe (Metcalf & Eddy, 1981). Suggested values are listed in Table 19-7.

Force Main Velocities. Because the flow rate of sewage is highly variable, particularly in small districts where nighttime flows may be zero, the design criteria for force mains is fundamentally based on velocity. From observations, it has been recognized that velocities equal to or greater than 0.6 m/s are required to prevent solids from settling out. It has also been observed that velocities greater than or equal to 1.1 m/s are required to resuspend deposited solids (Metcalf & Eddy, 1981).

TABLE 19-7
Suggested Hazen-Williams C values for force main design

Pipe material	Age	C
Lined DIP	New	140
	Design year	120
Plastic pipe	New	≥ 150
	Design year	120

Source: Data extracted from Metcalf & Eddy, 1981.

For a small-or medium-sized pumping station that pumps intermittently, the recommended minimum velocity is 1.1 m/s. A desirable velocity is 1.5 m/s. In larger pump stations where pumping is continuous because the influent flow rate is large and continuous, velocities on the order of 0.7 to 1.5 m/s are recommended.

Pipe Materials. The pipe materials that are suitable for water distribution systems are also suitable for force mains (Chapter 17). The potential for crown corrosion, especially when pumping is intermittent, must be considered in selecting the pipe material.

Depth of Cover. In comparison to gravity sewers, force mains are laid at a comparatively shallow depth. A minimum cover of 0.9 m is used to minimize the impact of live loads. In cold climates, the depth should be sufficient to protect against freezing.

Appurtenances. Two appurtenances that are not encountered in water distribution systems, but are particular to force mains, are air and vacuum valves. A *blowoff* is a controlled outlet that permits the draining or flushing of the pipe. They may be found at long depressed sections. They consist of a manhole and an appropriate valve.

Air valves are used at high points in the force main to allow trapped air and other gases to be released. The gas bubbles become trapped at the high points because intermittent pumping allows the release of entrained and dissolved gases.

Pump Selection

Sewage is commonly pumped using specially designed centrifugal pumps. Of the three types of centrifugal pumps, *axial flow pumps* are not recommended for use with untreated wastewater.

Nonclog, radial-flow pumps are designed to handle untreated wastewater. Common design features include enclosed impellers with less than four vanes for very large pumps and, usually, less than three for smaller sizes. Because a 70 mm diameter solid can pass through most toilet bowls (e.g., toy fire engines and baby dolls), GLUMRB (2004) specifies that pumps handling untreated wastewater must be capable of passing a sphere at least 80 mm in diameter and that pump suction and discharge openings be at least 100 mm in diameter.

Mixed-flow volute pumps may also be used to pump untreated wastewater. These pumps operate at higher speeds than radial flow, nonclog pumps. They are usually of lighter construction,

and the size of solid that can pass a mixed-flow pump is smaller than a comparable nonclog radial flow pump. The lighter construction often means a lower cost.

The pump shafts may be horizontal or vertical. The vertical pumps are often preferred because of space limitations. They require less floor space, eliminate high points in suction lines, and permit vertical separation of the pump and motor. A typical vertical shaft, radial-flow wastewater pump is shown in Figure 19-15.

Conventional Pump Station Design

Conventional pump stations are required for larger flows ($> 0.2 \text{ m}^3/\text{s}$) or where the wastewater must be screened to protect the pumps. Conventional stations are custom-designed for a particular location.

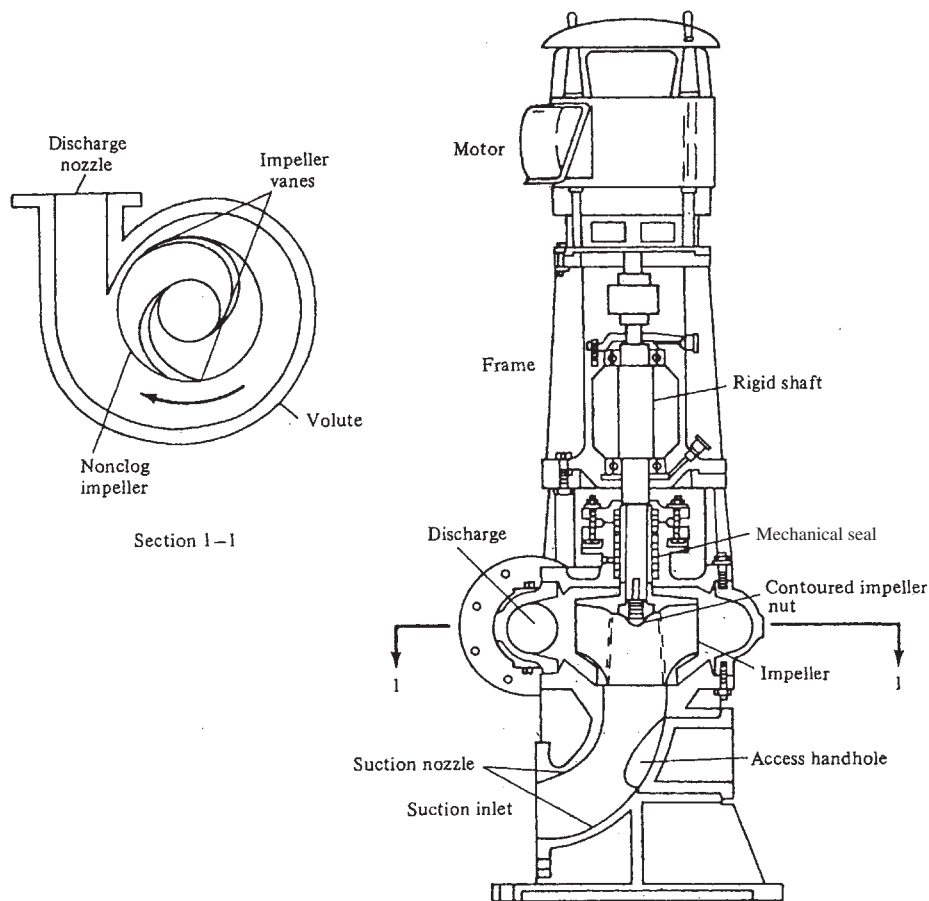

FIGURE 19-15
Typical vertical shaft radial-flow wastewater pump. (Source: Metcalf & Eddy, 1981.)

General Features. Typical schematic views of a conventional pump station are shown in Figure 19-16. When located in residential neighborhoods, the building exterior should blend in with the character of the residential buildings. However, actual window openings are normally omitted to increase security of the building. False windows and architectural features are provided to enhance the characteristics to blend in with the surrounding buildings.

Doors must be wide enough to remove and replace equipment. In large stations, overhead bridge cranes are provided. Floor openings and hatches are provided for removing equipment from lower floors.

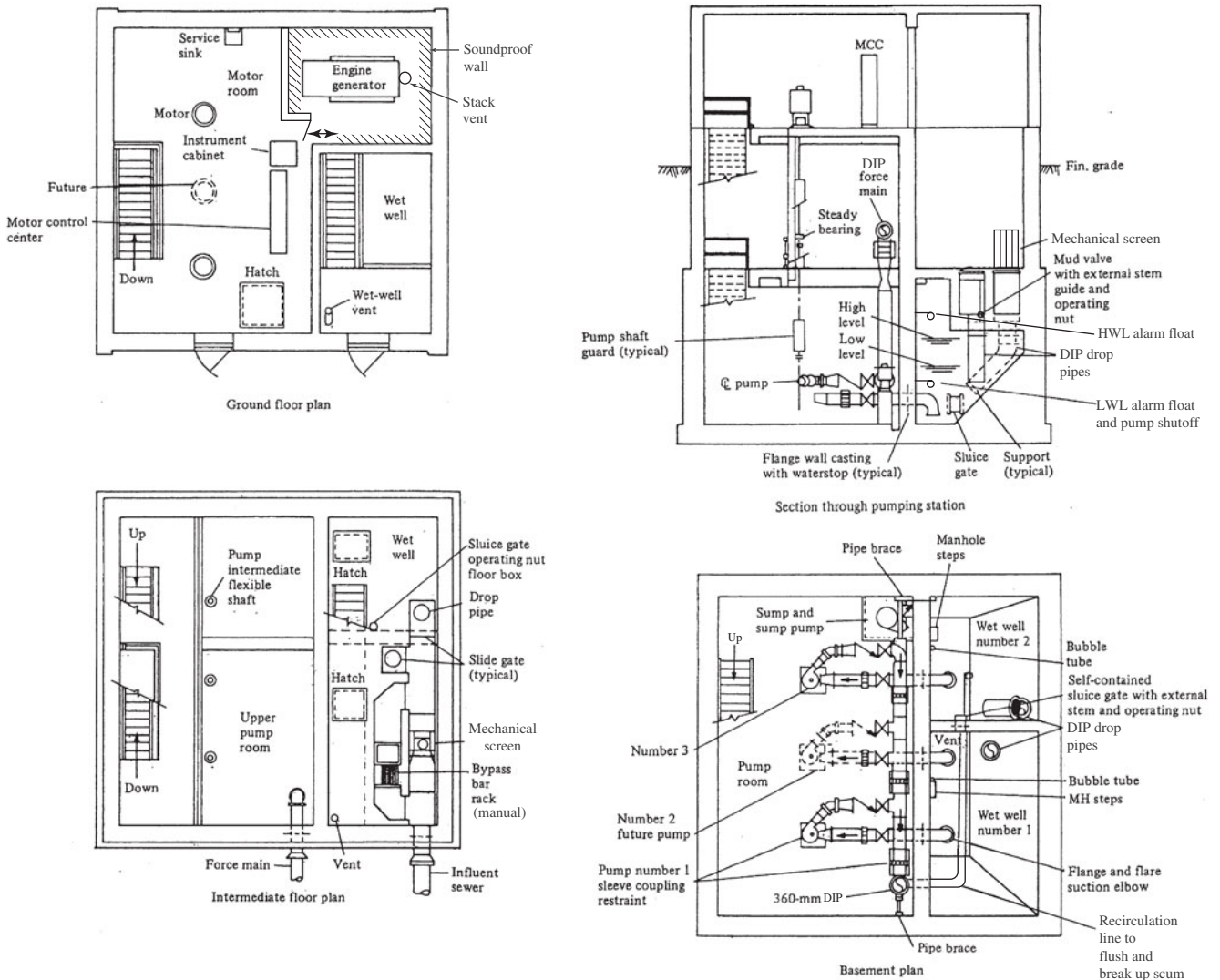

FIGURE 19-16 Typical, conventional wastewater pumping station. (Source: Metcalf & Eddy, 1981.)

The ground floor must be set above the flood plain of the surrounding area. In both the substructure and superstructure, the wet well and dry well must be isolated from each other. This isolation must be vapor tight to ensure that volatile and poisonous gases (CH_4 and H_2S , respectively, from anaerobic decomposition of the sewage) cannot move from the wet well to the dry well.

Backup power is provided by a generator or secondary power with automatic switching. It must be properly vented. Fuel storage must meet local fire codes. Alternatively, natural gas may be used as fuel.

Wet Well. The fundamental purposes of the wet well are storage of wastewater and the provision of sufficient submergence of the pump suction inlet to prevent vortexes from forming and air entrainment that will cause pump cavitation. In addition, space is often provided in the wet well for bar racks to protect the pumps from clogging.

GLUMRB (2004) specifies that bar racks shall be provided for pumps handling wastewater from sewers that are 750 mm or larger. The bar rack spacing varies from 25 to 150 mm between bars. It is suggested that distance between bars be one-third the size of the maximum solid diameter that the pump can pass (Metcalf & Eddy, 1981). The screenings from the bar rack must either be removed from the pumping station for disposal or be ground up and returned to the flow.

GLUMRB (2004) specifies that the effective volume of the wet well shall be based on the design average flow and a filling time not to exceed 30 minutes. An effective way to design the volume is to base it on the method of pump operation, keeping in mind that short cycling times between pump starts will wear out the pump and motor. When a variable speed drive (also known as a *variable frequency drive* or *VFD*) or a magna drive is used, the required storage volume is small. To prevent short-cycling, constant speed pumps require a large volume. The suggested time between starts is a function of the motor size (Metcalf & Eddy, 1981):

- For motors less than 15 kW: 15 minutes is recommended;
- For motors between 15 and 75 kW: ≥ 15 minutes;
- For motors between 75 and 200 kW: ≥ 20 to 30 minutes.

The volume of the wet well between start and stop elevations for a single pump or a single-speed pump control step for multiple-speed operation is given by (BSCE, 1961):

$$V = \frac{Qt}{4} \quad (19-12)$$

where V = required capacity, m^3

Q = pump capacity, m^3/min or increment in pumping capacity where one pump is already operating and a second pump is started or where pump speed is increased

t = minimum time in minutes of one pumping cycle (time between successive starts or changes in speed of a pump)

The derivation of this equation is provided in Metcalf & Eddy (1981). The current trend is to use variable frequency drives (VFD) to match incoming flow. This allows for a reduction in the volume of the wet well and minimizes the peak discharge to downstream sewers or the wastewater treatment plant.

In small pumping stations where one pump is designed to meet the capacity, the pump capacity (Q) is the peak hour flow rate flowing into the wet well. If two identical pumps are provided,

one of which is a standby pump, the volume computed by Equation 19-12 can be reduced by half by alternating the pumps.

In very large lift stations, the required wet well volume is provided using two or more compartments. Each section should be provided with a slide gate so that it can be isolated when it is out of service for maintenance. Submersible pumps may be used for deep systems. They eliminate long shafts, bearings, guards, and maintenance headaches.

Alternative suction bell piping arrangements are shown in Figure 19-17. The submergence depths are shown in Table 19-8. Inlet velocities should be in the range of 1.2 to 1.8 m/s. Discharge velocities range from 1.8 to 2.4 m/s.

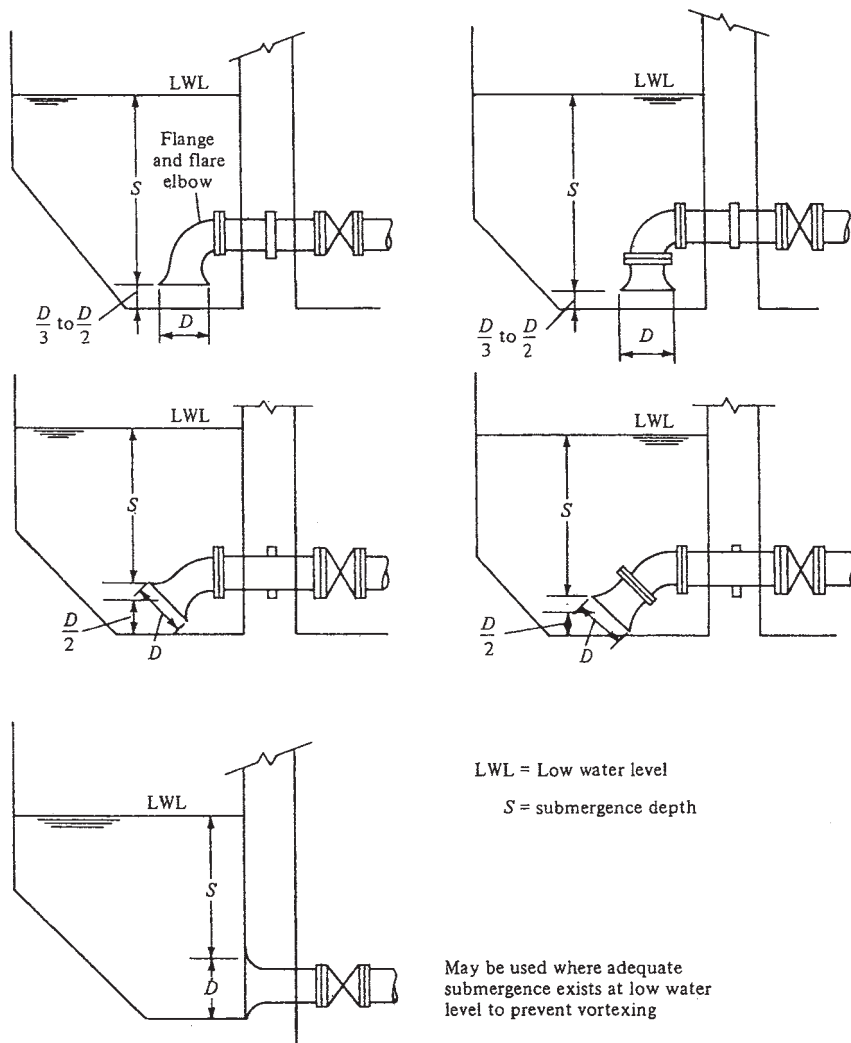

FIGURE 19-17

Pump suction connections to wet well. Diameters (D) and submergence (S) are given in Table 16-8.

(Source: Metcalf & Eddy, 1981.)

TABLE 19-8
Submergence depth required to prevent vortexing in pump suction connection

Velocity at diameter D m/s	Required submergence depth, S m
0.6	0.3
1.0	0.6
1.5	1.0
1.8	1.4
2.1	1.7
2.4	2.15
2.7	2.6

Source: Metcalf & Eddy, 1981.

The shape of the wet well is important to minimize the deposition of solids. It is recommended that the floor be level from a point 0.3 to 0.4 m beyond the outermost edge of the suction bell. It should then slope up to the opposite wall at a slope of 1:1 or greater.

Ventilation requirements are specified by the Occupational Safety and Health Administration (OSHA). These are based on maintaining flammable and toxic gas levels at 50 percent of their hazard level (29 CFR 1910.146 (c)(5)(I)). These requirements supersede the GLUMRB (2004) guidance.

A common problem in large stations is that of obtaining sufficient wet-well volume at a reasonable cost. If the pump start elevation is above the invert of the incoming sewer, sewer storage is available. The storage is computed based on the backwater curve in the sewer. If the pump start elevation is below the invert of the incoming sewer, no sewer storage is available. The disadvantage of this design is that odor control will probably be necessary.

Dry Well. The pumps are housed in the dry well. A gutter is provided along the wall between the wet well and the dry well. Seepage, pump drainage, and floor wash down is carried to the gutter by sloping the floor 10 mm/m. The gutter drains to a sump with a sump pump discharge.

Stairs, not ladders, are provided to move between floors. In deep pump stations, pump motors are separated from the pump by placing them on the top floors. Alternatively, submersible pumps are used.

Adequate clearance around the pump and motor should be provided to allow a crew to work. The recommended spacing is 0.9 to 1.1 m from all piping and flanges (not just the pump base). The pump discharge connection should be made on the side of the manifold (Jones, 2000). Connecting to the underside invites plugging of valves and piping. For the same reason, check valves should be located in a horizontal pipe—never in a vertical pipe (GLUMRB, 2004).

Ventilation in the dry well, based on the volume below grade, should be a minimum of 15 air changes per hour if the fan operates intermittently and six air changes per hour if it operates continuously (GLUMRB, 2004). Additional ventilation may be required to remove heat generated by the pump motors.

Factory-Assembled Pump Stations

Also known as *prefabricated lift stations*, factory-assembled pump stations (Figure 19-6) are used in collection systems with low flows and where the need to protect the pump from clogging

with debris is minimal. Of the three types, pneumatic ejection, dry pit, and wet pit, only the latter two will be discussed here.

Major Physical Features. The prefab stations are manufactured in components that can be shipped by truck. All of the equipment and appurtenances are mounted and connected permanently within the module. The dry pit prefab stations use a modified manhole as the wet pit (Figure 19-6). The wet pit prefab stations (Figure 19-18) use submersible pumps to avoid the need for a dry pit.

As with the conventional lift stations, provision must be made to prevent flooding. Frequently, this is accomplished by elevating the top above the flood level. In addition, because the lift

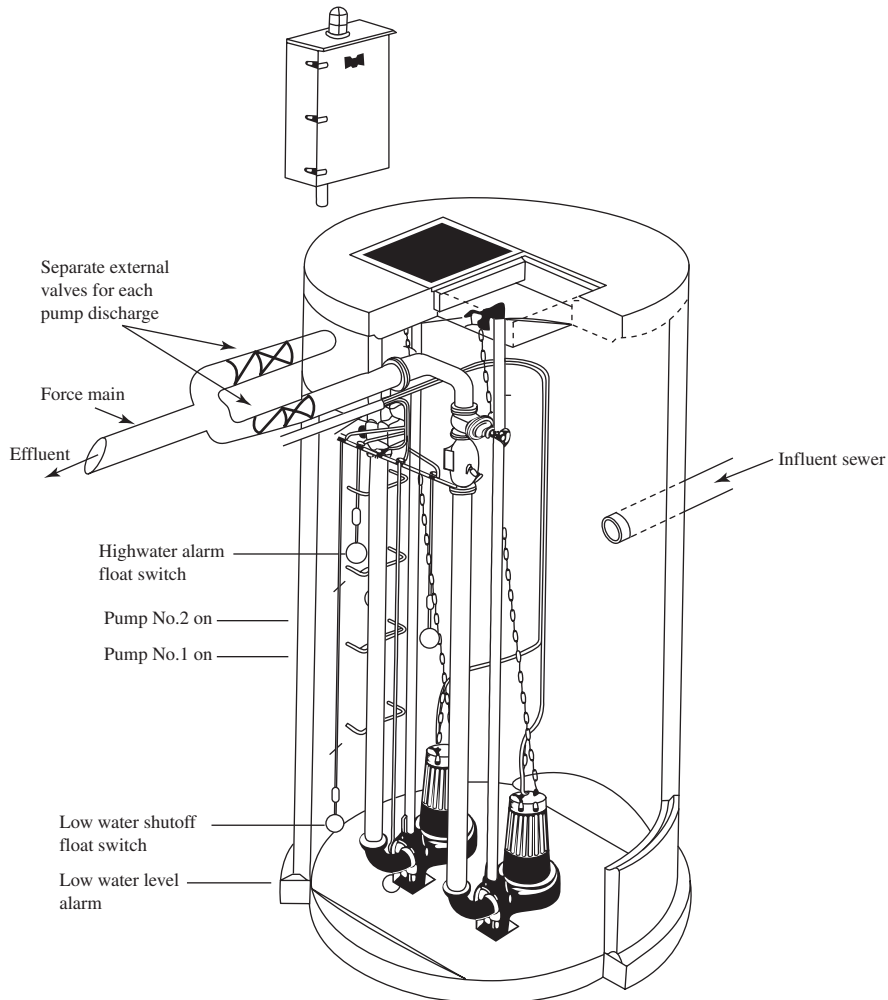

FIGURE 19-18 Factory-assembled lift station with submersible pumps. The external valves are placed in a chamber that allows access without entering a confined space. (Adapted from Steel and McGhee, 1979.)

station is located at a low point, there is a potential for flotation when the groundwater table is high. Anchors or increases in the mass of the slab beyond carrying the structural load may be employed to prevent flotation.

Prefab stations are provided with a minimum of two pumps. Each pump must have sufficient capacity to handle the design peak hourly flow (GLUMRB, 2004).

Dry Pit Station. The wet well that is part of this pumping station is an oversized manhole or pipe sections with a sloped bottom. The low water level elevation is set so that no air can enter the suction pipe by the formation of a vortex. The top of the pump volute must be below the low water level of the wet well to avoid air binding of the pump. The effective volume of the wet well is between the low and high wastewater levels. It is estimated using Equation 19-12.

The blower is an essential safety feature. It provides ambient air. It should be sized using the same criteria that are specified for the conventional dry pit. Ventilation for the wet well is to be provided by portable blowers.

Wet Pit Station. This station may be a steel factory-assembled station, or it may consist of factory-assembled pumps and hardware installed in a conventional concrete manhole. The effective volume is between the high and low wastewater levels. It is estimated using Equation 19-12.

Hints from the Field. To extend the life and, coincidentally, make use of the pump warranty, stations with two pumps should be designed to operate the pumps alternately. This has the additional benefit of being able to size the wet well for half the volume because the time between pump starts will be doubled.

In so far as it is technically possible, pump stations should be located to minimize their impact on the community. Consideration and funding should be provided for landscaping, architectural conformity, noise control, and odor control. The facility must have appropriate safeguards for security.

19-6 OPERATION AND MAINTENANCE

The O&M of sewers consists principally of pump station service, removal or prevention of stoppages, cleaning, and repairs.

When the sewer is filled to capacity and wastewater backs up into manholes, it is said to be *surcharged*. This condition is often accompanied by backups into basements. This may be the result of stoppages or flows greater than the sewers were designed for. Control of excess flow is enhanced by local ordinances that prohibit connection of sump pumps and down spouts to the sewer as these increase inflow and the potential for surcharging the sewer as well as *sanitary sewer overflows* (SSOs). As much as 30 percent of excessive flow may result from downspouts and sump pump connections (Peters et al., 2007). If the surcharge is excessive, sewage will flow out of the top of the manhole causing a SSO.

In some cases, as much as 76 percent of I/I may be a result of breaks in connection between the lateral and the main. Grouting may be an alternative to excavation and replacement for repair of the connection, but new technologies employing cast-in-place lining are more effective.

At the extremities of the collection system where flows are low or in flat terrain, sewer cleaning is a prudent measure to prevent SSO and/or backups into residences and buildings. This may be accomplished by flushing and the use of a vacuum truck.

Periodic video surveillance of the sewer is one method to establish the condition of the sewer. When repairs are performed before failure of the sewer, cured-in-place pipe (CIPP) may be appropriate. Typically, installing CIPP involves introducing a nonwoven-fiber felt liner tube impregnated with a thermosetting resin into an existing pipe. No excavation is required (Lindsey, 2007).

19-7 SEWER SAFETY

The Occupational Safety and Health Administration (OSHA) defines a *confined space* as one that has limited or restricted means for entry or exit, is large enough for an employee to enter and perform work, and is not designed for continuous occupancy by the employee. The following are classified as confined spaces: a sewer manhole, a lift station wet well, a prefab pumping station dry well. They are a safety hazard primarily because of the potential for accumulation of toxic and explosive gases. The list of specific toxic gases includes but is not limited to carbon dioxide (in quantities sufficient to displace oxygen and cause asphyxiation), carbon monoxide, chlorine, hydrogen sulfide, and sulfur dioxide. The explosive gases include carbon monoxide, gasoline, hydrogen, hydrogen sulfide, methane, and ammonia (Macy et al., 1980).

OSHA specifies the rules for entering a confined space. Table 19-9 lists appropriate equipment for entering a manhole. Among the many precautions for working in a sewer manhole, a lift station wet well, or a prefab pumping station dry well, the following three are held up as vital:

- *Never work alone.* Preferably, the crew should consist of three people, one of whom stays topside at all times.
- *Check the atmosphere before entering*—even if there has never been a problem before or “It is always ok.” At least one fatality occurs each year because of this assumption.
- *Use a safety harness and have a tripod and hoist topside.* Entrance and egress are difficult enough without injury or incapacitation. It is virtually impossible for a rescue person to carry another individual out.
- *Man-lift.* If the dry well is 7.5 to 9m deep, a powered man-lift should be part of the design.

Another safety issue is manhole covers. The standard manhole cover has a mass between 110 and 135 kg. A heavy duty manhole cover may have a mass up to 300 kg. Improper handling may result in a lower back disorders, muscle injury, or in the worst instances crushed or severed fingers and toes. Although a pry bar and J-hook are normal components of the work crew’s gear, another useful tool is a long-handle, round-blade shovel with about 5 cm of the tip removed. With the shovel blade placed between the manhole and the frame, the long lever arm of the shovel makes it easy to release the manhole from the frame. The manhole cover should **never** be carried by hand or otherwise maneuvered with one’s hands. The pry bar or J-hook should be used to drag it away from the manhole. Likewise, in returning the cover, it should be maneuvered back near the manhole with the pry bar or J-hook and then maneuvered over the manhole with the heel of the worker’s steel-toed boots. It should **never** be maneuvered with one’s hands. There is no need to be concerned about it falling in the manhole. It is round. It will not fall in.

TABLE 19-9
Personal protective equipment (PPE)

1. Hard hats
 2. Rain suits
 3. Hip boots
 4. Rubber gloves
 5. Leather gloves
 6. Overalls
 7. Goggles
 8. Chest harness belt with safety rope
 9. Extra rope
 10. First-aid kit with blanket
 11. Fire extinguisher
 12. Tripod and hoist
 13. Ladder
 14. Combustible gas and oxygen content detector.
 15. Toxic gas monitor and oxygen content detector.
 16. Air packs, air tanks, hose
 17. Forty-five-minute self-contained air packs for emergency rescue
 18. Five-minute egress escape air pack
 19. Portable air blower, 3 hp. 1,750 cfm
 20. Portable electric generator, four outlets
 21. Electric lamp
 22. Portable lamp
 23. Flashlights
 24. Tool hoisters
 25. "Men working" signs
 26. Traffic cones
 27. Vehicle beacon warning light
 28. Barricade with beacon
 29. Reflective traffic vests
 30. Mirrors
 31. Steel toed boots
 32. J-hook
 33. Long handle shovel
 34. Cell phone/radio
-

Adapted from Macy et al., 1980.

Visit the text website at www.mhprofessional.com/wwe for supplementary materials and a gallery of photos.

19-8 CHAPTER REVIEW

When you have completed studying this chapter, you should be able to do the following without the aid of your textbook or notes:

1. Name the types of sewers (lateral, main, etc.) on a map with a sewer plan layout.
2. Name the parts (bell, spigot, etc.) of a sewer pipe.

3. Name the parts of a manhole.
4. Sketch a drop manhole and explain why and where it may be used.
5. Explain the purpose of a lift station and give examples of when it is appropriate to use them.
6. Explain the purpose of an inverted siphon and give examples of when it is appropriate to use one.
7. Define the following abbreviations and terms: ROW, MH, SDG, STEP, GP, force main, wet well, dry well.
8. Explain what crown corrosion is, the circumstances that promote its occurrence, and design techniques to minimize it.
9. Explain the logic behind the following design criteria: minimum pipe size, minimum velocity.
10. Explain the need for estimating the velocity of wastewater in a pipe that is flowing less than full or half full.
11. Explain what an alternative sewer is and the circumstances that warrant their consideration.
12. List the three vital safety precautions for entering sewers.
13. Describe safe techniques for removing and/or replacing a manhole cover.

With the aid of this text, you should be able to do the following:

14. Sketch the layout of a sewer on a topographic map.
15. Use Manning's equation to estimate the slope, velocity, or capacity of a pipe given the other appropriate variables.
16. Estimate the velocity of flow in a pipe flowing partially full.
17. Given a topographic map and sewage flow rates, design a sequence of reaches of a sewer main.
18. Design a force main and select an appropriate pump for a small lift station.
19. Design the wet well volume of a wastewater pumping station given the pump characteristics and peak hourly flow rate.

19-9 PROBLEMS

- 19-1. Table 19-2 suggests that the minimum slope for a flow rate of $0.019 \text{ m}^3/\text{s}$ is 0.0033 using Manning's equation with $n = 0.013$. Show by computation that this wastewater flow rate in a 350 mm diameter VCP on the minimum slope for the 350 mm diameter will not achieve $0.6 \text{ m}^3/\text{s}$.
- 19-2. It has been proposed that the low velocity in Problem 19-1 can be raised to the minimum velocity of 0.6 m/s by switching to PVC pipe. Show by calculation whether or not this is true.

- 19-3.** Write an equation that will allow calculation of v/v_{full} from a value of Q/Q_{full} rather than reading from Camp's hydraulic elements graphs for the condition when $n = \text{constant}$. The equation is to be for the region Q/Q_{full} from 0.02 to 0.988. The R^2 value for the equation must be ≥ 0.999 for a satisfactory solution. Use the data from Fair and Geyer (1954) given below.

Q/Q_{full}	v/v_{full}
0.988	1.14
0.838	1.12
0.671	1.072
0.500	1.00
0.337	0.902
0.196	0.776
0.088	0.615
0.021	0.401

- 19-4.** Write an equation that will allow calculation of v/v_{full} from a value of Q/Q_{full} rather than reading from Camp's hydraulic elements graphs for the condition when $n = \text{variable}$. The equation is to be for the region Q/Q_{full} from 0.017 to 0.879. The R^2 value for the equation must be ≥ 0.999 for a satisfactory solution. Use the data adapted from Fair and Geyer (1954) given below.

Q/Q_{full}	v/v_{full}
0.87932	1.0146
0.7123	0.952
0.55022	0.87904
0.400	0.800
0.26623	0.71258
0.15288	0.60528
0.06952	0.48585
0.01701	0.32481

- 19-5.** Rework Example 19-1 using PVC pipe.
- 19-6.** Rework Example 19-2 using PVC pipe.
- 19-7.** In Example 19-2, check the actual distance between MH 482 and MH 483 to see if it complies with GLUMRB requirement for distance between manholes.
- 19-8.** Determine the total length of pipe that must be purchased for the sewer in Example 19-2. Assume it can be purchased in 3.0 m lengths.
- 19-9.** Lay out the sewer lines (placement, direction of flow, and manhole locations) for the residential area that includes Oak, Maple, Alpine, and Walnut Streets in Figure P-19-9 below. The laterals are to connect to a sewer main that connects to a trunk line along Main Street. The trunk line discharges into the WWTP at the junction of Bull Run and Main Street.

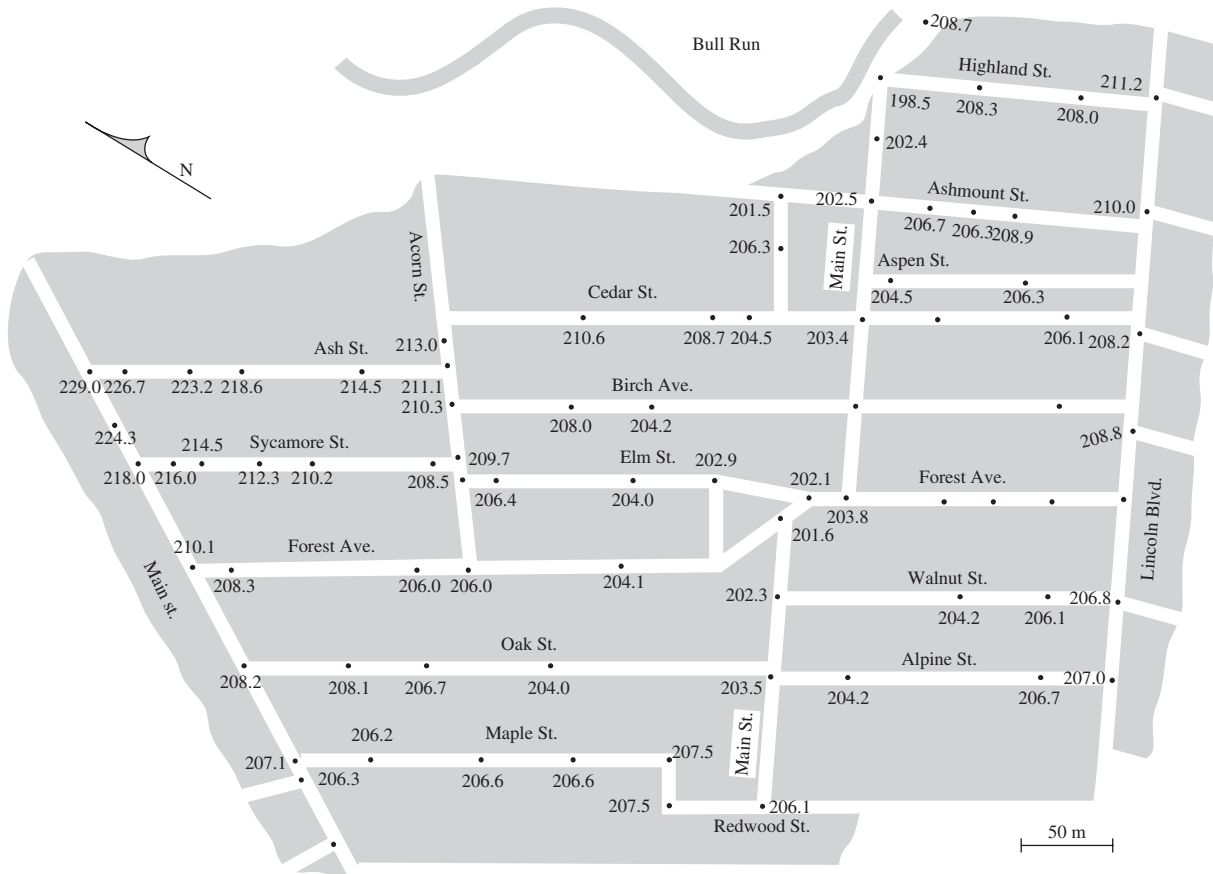

FIGURE P-19-9
Map for sewer layout. Elevations are in meters above mean sea level at points noted by dots. These are *not* manhole locations.
(Adapted from Metcalf & Eddy, 1981.)

- 19-10. Using Figure P-19-9, lay out the sewer lines (placement, direction of flow, and manhole locations) for the residential area that includes the following streets: Ash, Sycamore, Forrest, Cedar, Birch, Elm, and Acorn. The mains may connect either to a trunk line that connects to an intercepting sewer along Main Street or directly to the intercepting. The trunk line discharges into the WWTP at the junction of Bull Run and Main Street.
- 19-11. Design a VCP main for the Bastogne Retirement Center (Figure P-17-23) by preparing a sewer design table similar to that shown in Example 19-2 and a profile drawing similar to Figure 19-13b. Mark and number the manhole locations on a copy of Figure P-17-23 in Chapter 17. The sewer design is to terminate at

an inverted siphon that will carry the sewage under the Moselle River to a lift station. Use the following assumptions: population is 210 people, average daily flow is 500 Lpcd, peaking factor for peak hourly flow is 6.8 and I/I of 40 L/d · mm · km. Interpolate linearly between contour lines to estimate elevations of the ground surface. This problem **does not** include the design of the siphon or the lift station.

- 19-12.** Design a VCP lateral sewer for the Village of Waffle (Figure P-17-24) by preparing a sewer design table similar to that shown in Example 19-2 and a profile drawing similar to Figure 19-13b. The sewer will be beside Bacon Road and Eggs Road starting at Pancake Road and ending at State Road. Mark and number the manhole locations on a copy of Figure P-17-24 in Chapter 17. The sewer design is to terminate at an inverted siphon that will carry the sewage under the Syrup River to a lift station. Use the following assumptions: wastewater production is equal to water demand and is the same as that given in Problem 17-24; peaking factor for peak hourly flow is 6.2; I/I is 40 L/d · mm · km. Interpolate linearly between contour lines to estimate elevations of the ground surface. This problem **does not** include the design of the siphon or the lift station.
- 19-13.** Design a VCP gravity flow sewer main starting at the intersection of 4th and G Streets and ending at the intersection of 2nd and B Streets (Figure P-19-13). Prepare a sewer design table similar to that shown in Example 19-2 and a profile drawing similar to Figure 19-13b. Use the following assumptions: minimum invert depth is 3.0 m, the invert of the sewer entering the main from G Street (east and west) is at an elevation of 102.13 m. Contributing flows, including I/I, from mains are given below. (Adapted from Metcalf & Eddy, 1981.)

Peak hour lateral flow rates including I/I

Street	Flow rate, m ³ /s
G St.	0.0143
F St.	0.0115
E St.	0.0095
D St. via 3rd St.	0.0083
C St.	0.0053
Jefferson Blvd.	0.0052
Washington St.	0.0065

- 19-14.** Design a VCP gravity flow sewer main along Pierce Street to serve the mains from the cross streets starting at the intersection with Madison Avenue and ending at Harrison Avenue (Figure P-19-14 on page 19-47). Prepare a sewer design table similar to that shown in Example 19-2 and a profile drawing similar to Figure 19-13b. Use the following assumptions: minimum invert depth is 3.0 m; the invert of the sewer entering the main from Madison Avenue is at an elevation of 16.91 m. Contributing flows, including I/I, from mains are given below (adapted from Metcalf & Eddy, 1981).

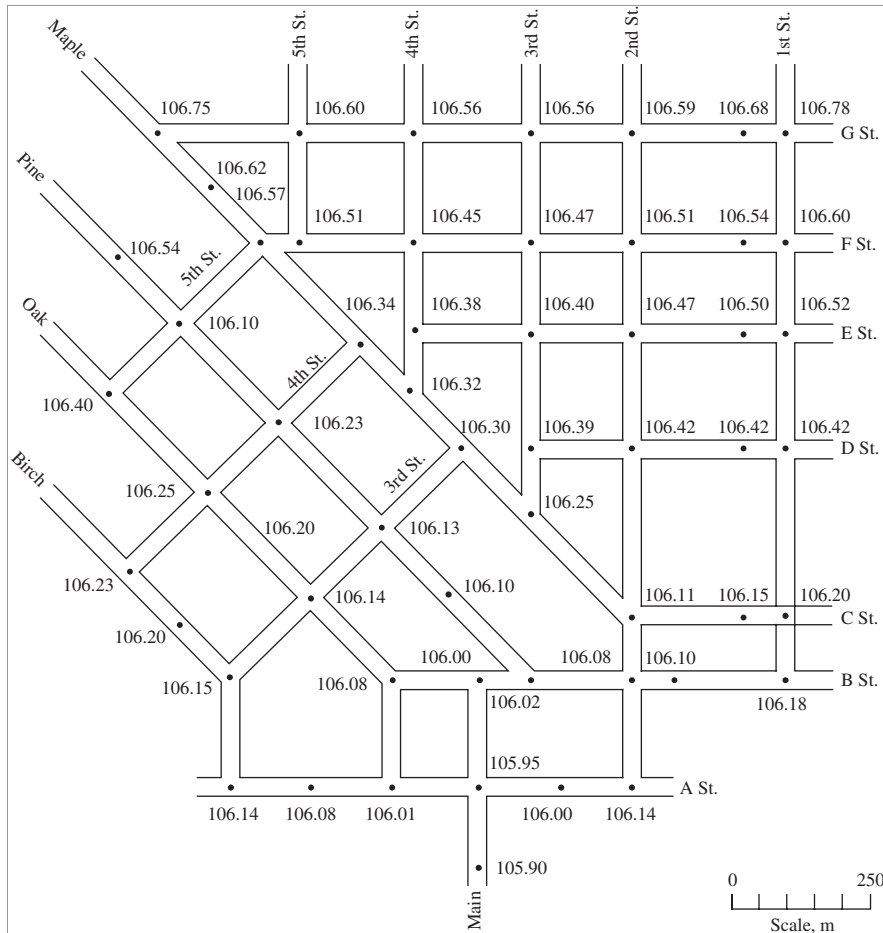

FIGURE P-19-13
 Map for Problem 19-13. Elevations are in meters at points noted by dots. These are also manhole locations.
 (Adapted from Metcalf & Eddy, 1984.)

Peak hour lateral flow rates including I/I

Street	Flow rate, m ³ /s
Madison Ave.	0.0075
Taylor Ave.	0.0087
Coolidge Ave.	0.0072
Grant Ave.	0.0068
Adams Lane	0.0200
Jefferson Blvd.	0.0052
Washington St.	0.0065

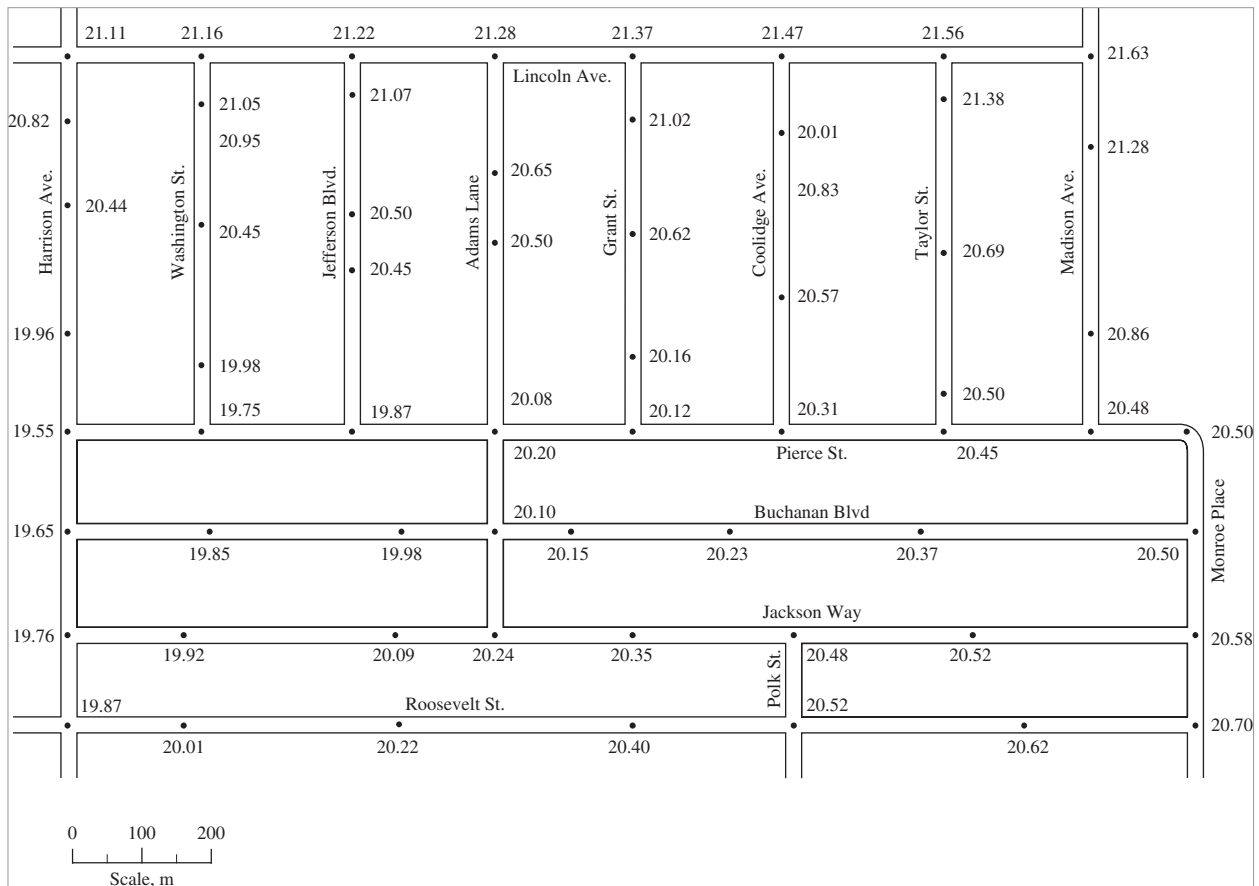

FIGURE P-19-14
 Map for Problem 19-14. Surface elevations are in meters at points noted by dots. Intermediate manholes between street intersections are *not* shown. These must be added. Interpolate between elevations shown for additional elevations.
 (Source: Metcalf & Eddy, 1981.)

- 19-15.** Estimate the volume of the wet well for a lift station for wastewater flowing from the Bastogne Retirement Center (Problem 19-11).
- 19-16.** Estimate the volume of the wet well for a lift station for wastewater flowing from the Village of Waffle (Problem 19-12).
- 19-17.** Design a force main and select a pump for the Bastogne Retirement Center lift station (Problem 19-15). Assume that the invert of the pipe entering the lift station is at an elevation 470.03 m and will have to deliver the wastewater to the WWTP 279 m from the lift station at an invert elevation of 481.83 m. Use DIP for the force main.

- 19-18.** Design a force main and select a pump for the lift station at Waffle (Problem 19-15). Assume that the invert of the pipe entering the lift station is at an elevation 114.08 m and will have to deliver the wastewater to the WWTP 286 m from the lift station at an invert elevation of 125.00 m. Use DIP for the force main.

19-10 DISCUSSION QUESTIONS

- 19-1.** Describe a fundamental difference between the design of force mains and water distribution mains.
- 19-2.** Draw a sketch to show a client the condition known as a “surcharged sewer” and give two conditions that might cause it to occur.
- 19-3.** Prepare an outline of the safety issues to be addressed in entering a sewer.
- 19-4.** Prepare a set of instructions outlining the safe procedure for removing and replacing a manhole cover.

19-11 REFERENCES

- ASCE (1982) *Gravity Sanitary Sewer Design and Construction*, American Society of Civil Engineers Manual of Practice No. 60, Reston, Virginia, pp. 100, 153–165.
- Bloodgood, D. E. and J. M. Bell (1961) “Manning’s Coefficient Calculated from Test Data,” *Journal of Water Pollution Control Federation*, vol. 33, p. 176.
- BSCE (1961) *Pumps, Measuring Devices, Hydraulic Controls*, Seminar Papers on Wastewater Treatment and Disposal, Boston Society of Civil Engineers.
- Camp, T. R. (1946) “Design of Sewers to Facilitate Flow,” *Sewage Works Journal*, vol. 18, p. 3.
- Countermarsh, B. A. (1998) “Precious Pipe,” *Water Environment & Technology*, August, pp. 55–57.
- Fair, G. M. and J. C. Geyer (1954) *Water Supply and Disposal*, John Wiley & Sons, New York, p. 403.
- GLUMRB (2004) *Recommended Standards for Wastewater Facilities*, Great Lakes–Upper Mississippi River Board of State and Provincial Public Health and Environmental Managers, Health Education Services, Albany, New York, pp. 30-1–30-11, 40-1–40-8.
- Guertin, D. (2007) “Minimal Disruption,” *Water Environment & Technology*, vol. 19, May, pp. 50–55.
- Hannan, P., R. Lovett, and T. Ralston (1996) “Lateral Packers, Grout Close in on Infiltration,” *Water Environment & Technology*, vol. 9, March, pp. 45–47.
- Jones, G. M. (2000) “System Design for Wastewater Pumping,” in G. M. Jones (ed.), *Pump Station Design*, Elsevier, New York, p. 17.9.
- Lindsey, S. E. (2007) “What Every Owner Should Know About CIPP,” *Water Environment & Technology*, vol. 19, January, pp. 59–62.
- Macy, M. S., R. D. Miller, and S. A. Kacmar (1980) “Safety in Sanitary Sewers,” *Deeds and Data*, Water Pollution Control Federation, May.
- Metcalf & Eddy (1972) *Wastewater Engineering: Collection, Treatment and Disposal*, McGraw-Hill, New York, p. 107.
- Metcalf & Eddy (1981) *Wastewater Engineering: Collection and Pumping of Wastewater*, McGraw-Hill, New York, pp. 100–126, 170–176, 342–389.
- Moser, A. P. (2001) *Buried Pipe Design*, 2nd ed., McGraw-Hill, New York, pp. 33–46.
- Neale, L. C. and R. E. Price (1964) “Flow Characteristics of PVC Sewer Pipe,” *Journal of Sanitary Engineering Division*, American Society of Civil Engineers, vol. 90, SA3, p. 109.
- Orsatti, B. (1996) “Sewer Design on the Slant,” *Water Environment & Technology*, vol. 8, March, pp. 39–43.

- Peters, J., E. G. Malter, and B. Schaef (2007) "Lateral Moves," *Water Environment & Technology*, vol. 19, January, pp. 63–66.
- Pomeroy, R. D. (1967) "Flow Velocities in Small Sewers," *Journal of Water Pollution Control Federation*, vol. 39, p. 1,525.
- Sawyer, C. N., P. L. McCarty, and G. F. Parkin (2003) *Chemistry for Environmental Engineering and Science*, McGraw-Hill, Boston, pp. 672–673.
- Staheli, K. and G. E. Hermanson (1996) "Microtunneling," *Water Environment & Technology*, vol. 8, March, pp. 31–36.
- Steel, E. W. and T. J. McGhee (1979) *Water Supply and Sewerage*, 5th ed., McGraw-Hill, New York, pp. 331, 381–382, 392–399, 418–425.
- WEF (1986) *Alternative Sewer Systems*, Water Environment Federation, Alexandria, Virginia.

This page intentionally left blank

HEADWORKS AND PRELIMINARY TREATMENT

20-1 INTRODUCTION

20-2 PUMP STATION

20-3 FLOW MEASUREMENT

20-4 BAR RACKS AND SCREENS

20-5 COARSE SOLIDS REDUCTION

20-6 GRIT REMOVAL

20-7 FLOW EQUALIZATION

**20-8 ALTERNATIVE PRELIMINARY PROCESS
ARRANGEMENTS**

20-9 CHAPTER REVIEW

20-10 PROBLEMS

20-11 DISCUSSION QUESTIONS

20-12 REFERENCES

20-1 INTRODUCTION

Headworks refers to the unit operations that are placed at the upstream end of the wastewater treatment plant (WWTP). These include the pumping station, flow measurement, and a group of unit operations commonly referred to as *preliminary treatment*.

Typically WWTPs are designed so that flow through the plant is by gravity. The wastewater frequently is carried to the WWTP by gravity and, consequently, it is at a substantial depth below grade. Thus, a pumping station is required to raise the sewage to an appropriate level to facilitate gravity flow through the plant. Flow measurement is an essential component of the operation and management of the WWTP.

Preliminary treatment typically serves three important functions: removal of untreatable solid materials; protection of subsequent treatment units; and improvement of the performance of subsequent treatment units. Preliminary treatment unit operations include: screens, shredders or grinders, grit removal, and flow equalization.

20-2 PUMP STATION

The design of the pump station (or lift station) at the WWTP is to a great extent similar to those placed in the collection system. The major differences are that the building components are incorporated into the WWTP facility and that an alternative to the nonclog centrifugal pump may be appropriate. The alternative is a *screw pump* (often called an *Archimedes screw*).

Screw pumps (Figure 20-1) are high volume, nonclog, atmospheric head devices that can pump a variety of solids and debris in raw wastewater without screening. There are two general types: the open screw that rotates in a trough and the enclosed screw, in which both the screw and the enclosing cylinder rotate. A major advantage of these pumps is variable pumping at constant speed, because the output, up to the design capacity, is controlled by the sump level and equals the influent flow rate. Operators like screw pumps because the good ones, when properly installed, are nearly trouble free (Garbus, 2006).

The overall efficiency of the pumping system may be as high as 80 percent at design flow. At approximately 30 percent of design capacity, the efficiency of the open screw drops to about

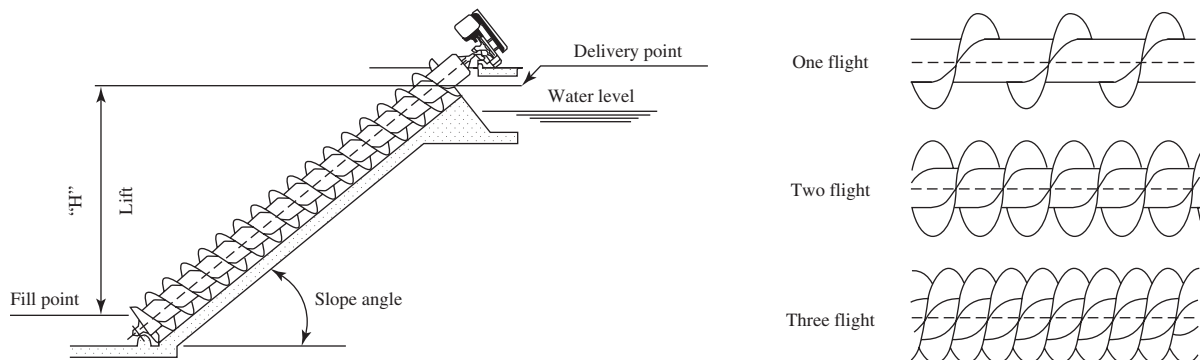

FIGURE 20-1
Screw pump arrangement with diagram of multiple flights.

TABLE 20-1
Typical screw pump selection chart^a

Screw diameter, m	Maximum rpm	Maximum capacity at 30° slope, m ³ /h			Maximum height at 30° slope, m		
		1-flight	2-flight	3-flight	1-flight	2-flight	3-flight
0.30	110	34	42	52	2.4	2.2	2.1
0.41	91	66	83	103	2.9	2.7	2.5
0.51	79	112	140	175	3.4	3.0	3.0
0.61	70	168	210	262	4.0	3.7	3.7
0.76	60	288	360	451	4.2	3.9	3.7
0.91	53	434	542	678	4.8	4.4	4.2
1.07	48	621	776	970	5.3	5.0	4.6
1.22	44	881	1,101	1,376	4.7	4.3	4.1
1.37	41	1,132	1,415	1,769	5.6	5.2	4.9
1.52	38	1,486	1,858	2,322	5.2	4.7	4.4
1.68	35	1,774	2,216	2,771	5.9	5.5	5.1
1.83	33	2,230	2,788	3,484	5.6	5.1	4.7
2.03	31	2,791	3,488	4,360	5.1	4.6	4.3
2.13	30	3,219	4,023	5,029	5.8	5.3	4.9

^aFor academic use. Use actual manufacturers' data for design.

60 percent because of friction and backflow (called *slippage*) of fluid between the flights and the trough. There is no slippage with the enclosed screw (Garbus, 2006). Major disadvantages of screw pumps are the large area (*footprint*) of the pumping station because of the angle of the slope of the screw and limited head (about 10 m) that can be achieved.

Design Considerations. For redundancy, the pump station must have adequate capacity to handle the peak hydraulic flow rate with the largest pumping unit out of service. Centrifugal pump selection is made based on the system head curve. Screw pump selection is made from manufacturers' data such as that shown in Table 20-1. The static lift height is determined based on the difference in elevation between the low flow into the plant wet well and the required elevation to overcome headlosses as wastewater flows through the plant (i.e., the hydraulic grade line).

Example 20-1 illustrates the procedure for selecting an appropriate screw pump.

Example 20-1. Design a screw pumping system for Waterloo's WWTP that has the following characteristics:

Interceptor sewer

Minimum sewage elevation = 514.75 m

Maximum sewage elevation = 515.00 m

Discharge elevation to stilling well = 519.17 m

Average flow rate at design capacity = 37,000 m³/d

Solution:

- a. Calculate the maximum height the screw pump must lift the sewage. This is the discharge elevation minus the minimum sewage elevation.

$$519.17 \text{ m} - 514.75 \text{ m} = 4.42 \text{ m}$$

- b. Calculate the minimum flow rate at start-up and the peak hour flow rate at design capacity. Using Figure 18-1 from Chapter 18, find the ratio of the minimum hour on the minimum day to the average flow to be 0.28 and the ratio of the peak hour flow rate at design capacity to the average flow to be 2.8. The flow rates are then

$$\text{Minimum flow rate} = (0.28)(37,000 \text{ m}^3/\text{d}) = 10,360 \text{ or } 10,400 \text{ m}^3/\text{d}$$

$$\text{Peak hour flow rate} (2.8)(37,000 \text{ m}^3/\text{d}) = 103,600 \text{ or } 104,000 \text{ m}^3/\text{d}$$

- c. Convert the flow rates to m^3/h to be compatible with the selection charts.

$$\text{Minimum flow rate} = \frac{10,400 \text{ m}^3/\text{d}}{24 \text{ h/d}} = 433.3 \text{ or } 433 \text{ m}^3/\text{h}$$

$$\text{Average flow rate} = \frac{37,000 \text{ m}^3/\text{d}}{24 \text{ h/d}} = 1,541.67 \text{ or } 1,540 \text{ m}^3/\text{h}$$

$$\text{Peak hour flow rate} = \frac{104,000 \text{ m}^3/\text{d}}{24 \text{ h/d}} = 4,333.3 \text{ or } 4,330 \text{ m}^3/\text{h}$$

- d. Review the choices from Table 20-1. Based on the maximum required lift height (4.42 m), the screw diameters for 1 and 2 flights $\geq 0.91 \text{ m}$ and $\geq 1.07 \text{ m}$ for 3 flights will work.
- e. The selection process is iterative. Begin by assuming that the smallest acceptable screw pump is one that will pump at 30% of capacity at a reduced efficiency of 60%.

$$\frac{433 \text{ m}^3/\text{h}}{0.30} = 1,443 \text{ m}^3/\text{h}$$

From Table 20-1, the standard size screw pump that will pump at this rate is a 1-flight screw that is 1.52 m in diameter rated at 1,486 m^3/h .

- f. Estimate the number of screw pumps required to meet the maximum flow rate.

$$\frac{4,330 \text{ m}^3/\text{h}}{1,486 \text{ m}^3/\text{h per pump}} = 2.91 \text{ or } 3 \text{ pumps}$$

- g. At the average flow rate, two pumps operating at

$$\frac{1,540 \text{ m}^3/\text{h}}{2} = 770 \text{ m}^3/\text{h}$$

or

$$\frac{770 \text{ m}^3/\text{h}}{1,486 \text{ m}^3/\text{h}} = 0.52 \text{ or } 52\% \text{ capacity}$$

will work.

- h. To meet the redundancy requirement to have adequate capacity for the peak hour flow rate with one pump out of service, a total of four pumps rated at $1,486 \text{ m}^3/\text{h}$ will be required.

Comments:

1. Other combinations will also work. Note that 2 and 3 flights with 1.32 m diameter will not work.
2. Consultation with the manufacturer may reveal that alternate slopes are available that may be a better fit.
3. Other manufacturers may have pumps that are a better fit.

20-3 FLOW MEASUREMENT

The two most common flow measuring devices used for wastewater are the *Parshall flume* and the *magnetic flow meter*.

Parshall Flume

The Parshall flume (Figure 20-2) is an empirically rated measuring device. It was developed by R. L. Parshall (1926a, 1926b, 1941) under the auspices of the U.S. Department of Agriculture. The dimensions of the flume are fixed so that there is a flow transition from subcritical to supercritical flow. The transition is caused by designing the flume to narrow to the *throat* dimension (W) while dropping the channel bottom. At critical flow depth, energy is minimized and there is a direct relationship between water depth and velocity. This allows the flume, like a weir, to be used as a measuring device. The weir crest throat width (W) is used to set the other dimensions of the flume. The Parshall flume dimensions are now specified by standard setting organizations such as ISO (1992) and ASTM (1991). Weir crest widths vary from 25 mm to 15 m to measure flows from $1 \text{ m}^3/\text{h}$ to more than $300,000 \text{ m}^3/\text{h}$. A list of dimensions for a limited range of flow measuring capacities is shown in Table 20-2.

When the flume is operating under free flow conditions, a hydraulic jump is visible at the throat. Under these conditions, the downstream discharge is not submerged at H_b , and a depth reading at the upstream point H_a can be used to gage the flow. If the downstream discharge at H_b

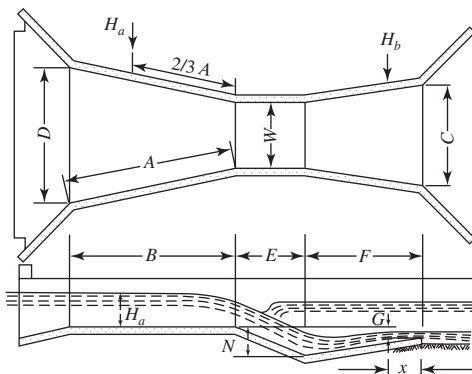

FIGURE 20-2

Parshall flume with identification of measurement locations noted in Table 20-2.

TABLE 20-2
Parshall flume dimensions

Minimum flow rate, m ³ /h	Maximum flow rate, m ³ /h	W, m	A, m	B, m	C, m	D, m	E, m	F, m	G, mm	N, mm	x, mm
5	300	0.15	0.61	0.61	0.40	0.40	0.30	0.61	76	114	51
10	520	0.23	0.88	0.86	0.38	0.57	0.30	0.46	76	114	51
40	1,630	0.30	1.37	1.34	0.61	0.84	0.61	0.91	76	229	51
50	2,450	0.46	1.45	1.42	0.76	1.03	0.61	0.91	76	229	51
70	3,360	0.61	1.52	1.50	0.91	1.21	0.61	0.91	76	229	51
100	5,100	0.91	1.68	1.64	1.22	1.57	0.61	0.91	76	229	51
130	6,900	1.22	1.83	1.79	1.52	1.94	0.61	0.91	76	229	51

Adapted from Parshall in nominal SI equivalent to U.S. customary units. For actual design see Parshall, 1926a and 1926b.

is submerged, then a correction factor must be applied. Stevens (1998) provides tables for converting the gage reading to flow rate and corrections for submergence.

LMNO (2008) has developed an equation and graphs that may be used for free flow conditions:

$$Q = CH_a^n \tag{20-1}$$

- where Q = flow rate, m³/s
- H_a = depth of water at point “a,” m
- C and n = coefficients to be obtained from Figures 20-3A and 20-3B

This equation is valid for $H_a \leq 2$ m and $0.152 \leq W \leq 15.24$ m.

The Parshall flume is limited to measurement of gravity flow rate. However, the flume is favored as a flow measuring device because it will pass a wide variety of solids such as rags, sand, and large objects that potentially will foul other flow measuring devices. Another reason the Parshall flume is favored is that the flow rate can be determined manually by measuring the water depth. This provides an independent method for calibrating the flume, and it provides

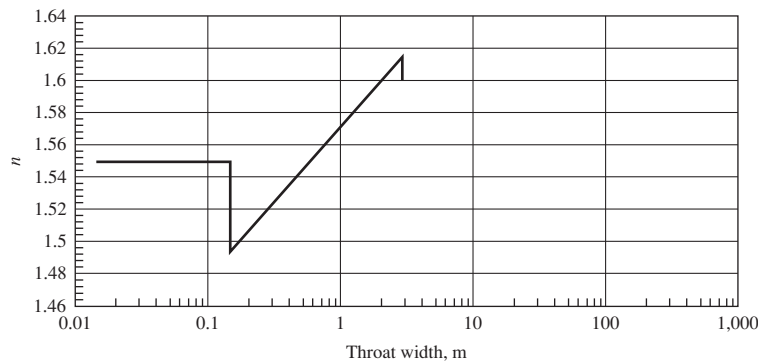
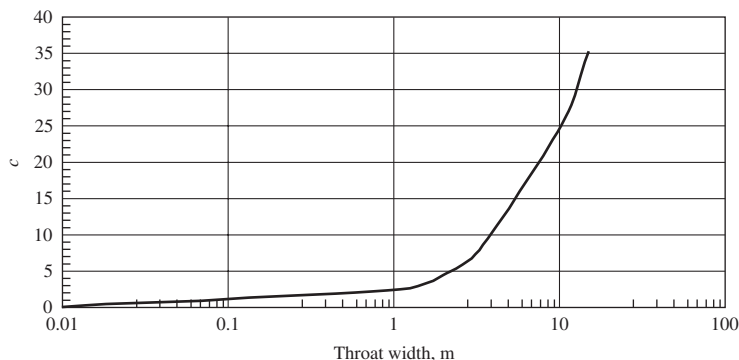

FIGURE 20-3A
Parshall flume coefficient n .

**FIGURE 20-3B**Parshall flume coefficient, C .

redundancy when the electronics fail. A given size of Parshall flume is capable of measuring a wide range of flow rates. When the flow range from minimum at plant start-up to maximum at design capacity exceeds the range of a standard flume, a removable prefabricated insert may be used to accommodate the low flows at start-up.

The major disadvantage of the flume is the comparatively large footprint for the structure and the additional space required to achieve uniform flow into and out of the flume.

Example 20-2 illustrates the selection of a Parshall flume.

Example 20-2. Continuing with the head works design for Waterloo (Example 20-1), design a Parshall flume by specifying the throat width and estimating the maximum depth of the flume. Assume free flow conditions and 0.6 m freeboard above the maximum depth.

Solution:

- Using Table 20-2, select a throat width of 0.91 m with a maximum range of flows from $100 \text{ m}^3/\text{h}$ to $5,100 \text{ m}^3/\text{h}$. This range encompasses the range found in Example 20-1: $433 \text{ m}^3/\text{h}$ to $4,330 \text{ m}^3/\text{h}$.
- Calculate the depth of flow at $4,330 \text{ m}^3/\text{h}$. Use Figures 20-3A and 20-3B to find the coefficients for Equation 20-1. For a throat width of 0.91 m, $n = 1.57$, and $C = 2.5$, convert the peak hour flow rate to appropriate units and solve Equation 20-1 for H_a .

$$\frac{104,000 \text{ m}^3/\text{d}}{86,400 \text{ s/d}} = 1.20 \text{ m}^3/\text{s}$$

$$H_a = \left(\frac{Q}{C} \right)^{1/n} = \left(\frac{1.20 \text{ m}^3/\text{s}}{2.5} \right)^{1/1.57} = 0.628 \text{ or } 0.63$$

- Add the freeboard to the depth of flow to yield

$$0.63 + 0.6 = 1.2 \text{ m depth for the flume.}$$

Comments:

1. The selection of the throat width fixes the other dimensions of the flume as specified in Table 20-2 and Figure 20-2.
 2. Although there is no redundancy requirement for the measuring device, it would be prudent to provide some method for bypassing the device to allow maintenance activities to be performed.
-

Magnetic Flow Meter

Faraday's law is the theoretical basis for the operation of the magnetic flow meter (also known as a *mag meter*). It may be summarized as follows:

When an electrical conductor passes through an electromagnetic field, an electromotive force or voltage is induced in the conductor that is proportional to the velocity of the conductor. The voltage thus generated is mutually perpendicular to both the velocity of the conductor and the magnetic field (Metcalf & Eddy, 1972).

This may be expressed as:

$$E \propto (v)(B)(L_{\text{conductor}}) \quad (20-2)$$

where E = voltage generated, volts
 v = velocity of the conductor, m/s
 B = magnetic field, Wb
 $L_{\text{conductor}}$ = length of conductor, m

In actual operation the liquid in the pipe serves as the conductor. The electromagnetic field is generated by placing coils around the pipe (Figure 20-4). The induced voltage is measured by electrodes placed on either side of the pipe. If the pipe is a conductor, the electrodes do not have to penetrate the wall of the pipe. The output signal must be calibrated to provide a flow reading.

The mag meter has the advantage that it can be located on a force main from a centrifugal pump. It can pass objects that can travel in the pipe. The major disadvantage is the dependence on the conductivity of the wastewater, which may vary widely and thus affect the calibration.

Location

To measure the flow accurately, both the Parshall flume and the mag meter require uniform flow upstream and downstream of the measuring point. For the Parshall flume a straight uniform channel should be maintained for a reasonable distance. An approach equal to at least 10 times the throat width (W) is desirable. Downstream changes in direction must be sufficiently distant so that the resulting backwater curve does not reach the flume (Steel and McGhee, 1979). The requirements for the mag meter are illustrated in Figure 20-4b.

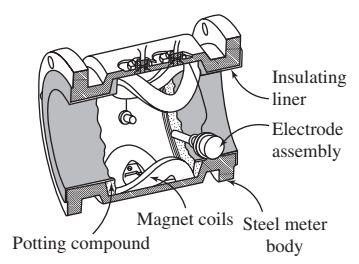

(a)

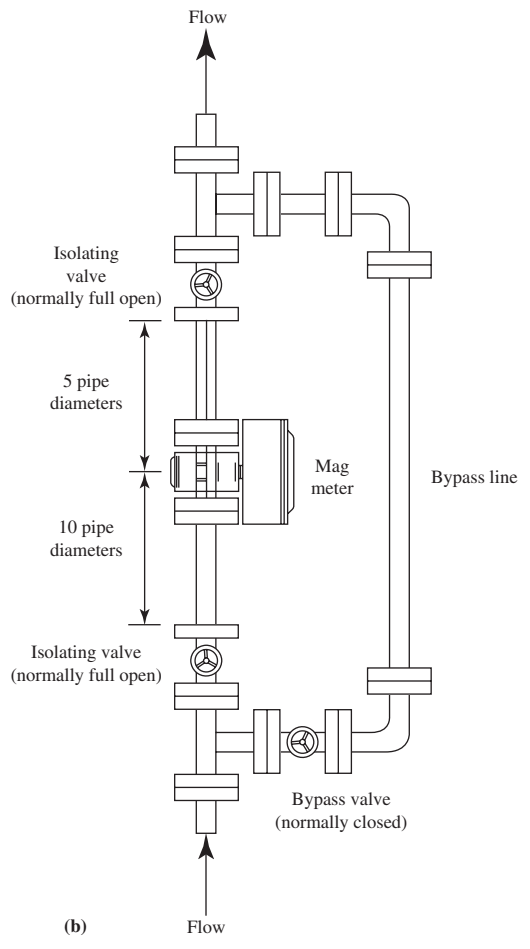

(b)

FIGURE 20-4
 (a) Schematic of magnetic flowmeter and (b) correct installation locations. (Schematic courtesy of Fisher & Porter.)

20-4 BAR RACKS AND SCREENS

The nomenclature of racks and screens is typically based on their purpose and the size of the openings. Table 20-3 provides a summary of the types. The size range of the openings as a means of differentiation is not well defined.

TABLE 20-3
Nomenclature of racks and screens

Type	Typical opening	Typical use
Trash racks	40–150 mm	To prevent logs, stumps, and large heavy debris from entering treatment processes. Principally used in combined sewers ahead of pumping units. In WWTPs, frequently followed by coarse screens.
Bar racks or coarse screens	6–75 mm	To remove large solids, rags, and debris. Typically used in WWTP.
Fine screens	1.5–6 mm	To remove small solids. Typically follows a coarse screen.
Very fine screens	0.25–1.5 mm	To reduce suspended solids to near primary treatment level. Typically follow a coarse screen and/or fine screen. May be used when downstream processes do not include primary treatment.
Microscreens	1 μ m–0.3 mm	Used in conjunction with very fine screens for effluent polishing.

Sources: Daukss, 2006, WEF, 1998.

Bar Rack Cleaning Mechanisms

Although manually cleaned racks are often provided in bypass lines, mechanically cleaned screens are typically used in the United States. These fall into four categories: chain-driven, reciprocating rake, catenary, and continuous belt. These are illustrated in Figure 20-5. Advantages and disadvantages of each type are presented in Table 20-4 on page 20-12.

Chain-Driven. In general, front-cleaned, front-return chain-driven screens are more efficient in retaining captured solids, but they are less rugged and are susceptible to jamming. They are seldom used for plants receiving combined sewage. Back-cleaned screens are more rugged but are more susceptible to carryover of solids to the downstream side. Both types suffer from the disadvantage of submerged sprockets that require frequent operator attention and are difficult to maintain.

Reciprocating Rake. The reciprocating rake or *climber screens* imitate the motion of a person raking the screen. They are front cleaned, front return. Thus, they are effective in capture and discharge of screenings without carryover. They have the advantage that all parts requiring maintenance are above the water line. The disadvantages are that a single rake may limit capacity to handle high loadings of screenings, and they have a requirement for a high overhead clearance to accommodate the raking mechanism.

Catenary Screen. The catenary screen is a front-cleaned, front-return chain-driven screen. In contrast to the chain-driven screens, it has no submerged sprockets. It can handle heavy objects. It has a large footprint.

Continuous Belt. The continuous belt can handle both fine and coarse solids. It has no submerged sprocket.

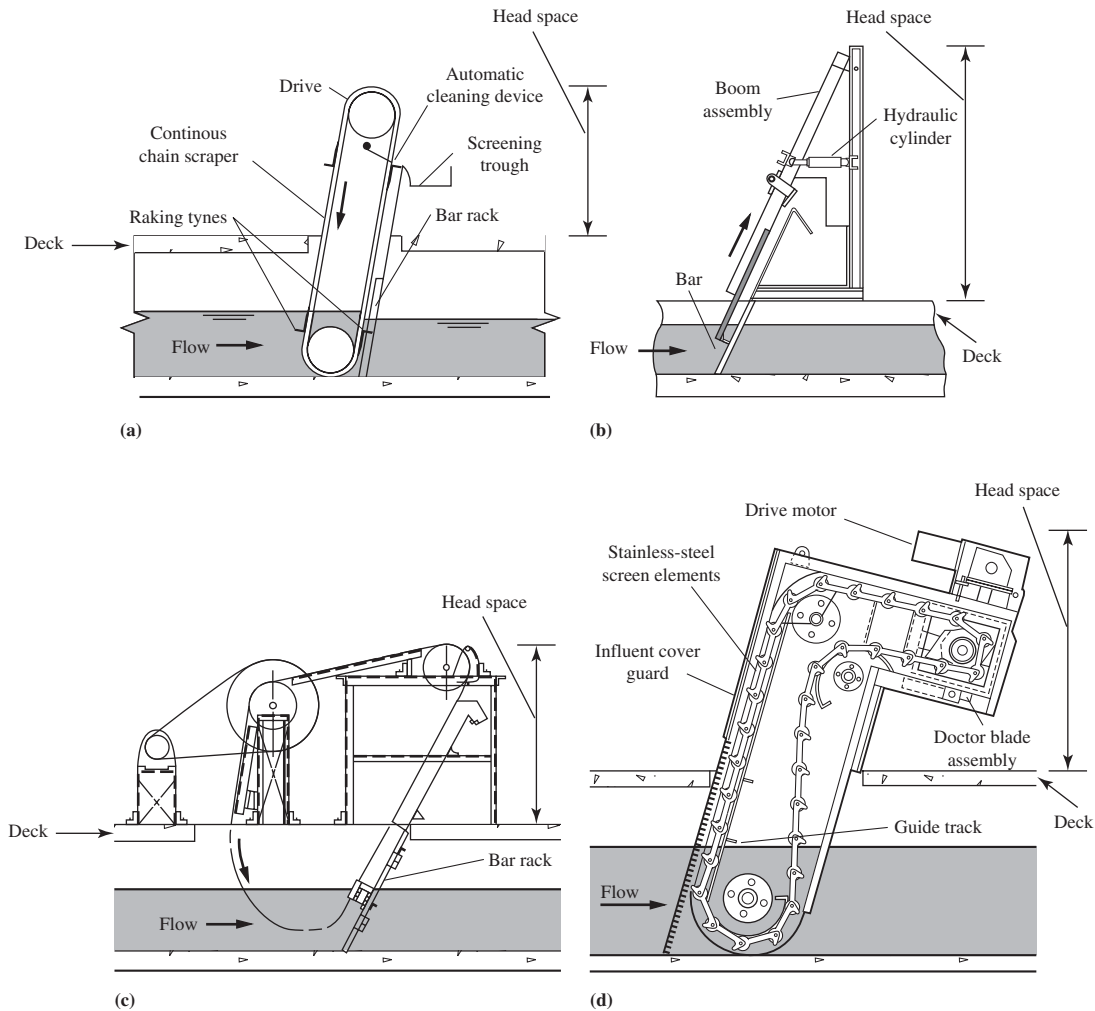
**FIGURE 20-5**

Mechanically cleaned coarse screens: (a) front-cleaned, front-return chain driven, (b) reciprocating rake, (c) catenary, and (d) continuous belt. (Source: Metcalf & Eddy, 2003.)

Bar Rack Design Practice

Capacity and Redundancy. Two or more mechanically cleaned screens are provided so that one unit may be taken out of service without impairing performance. Each should have adequate capacity to pass the peak hydraulic flow rate with the largest unit out of service. The design should provide that each unit can be isolated from the others.

In very small plants, a single unit may be installed with a bypass channel. The bypass channel will have a manually cleaned screen.

TABLE 20-4
Advantages and disadvantages of various types of bar screens

Type of screen	Advantages	Disadvantages
Chain-driven screen		
Front clean/ back return	Multiple cleaning elements (short cleaning cycle) Used for heavy-duty applications	Unit has submerged moving parts that require channel dewatering for maintenance Less efficient screenings removal, i.e., carryover of residual screenings to screened wastewater channel
Front clean/ front return	Multiple cleaning elements (short cleaning cycle) Very little screenings carryover	Unit has submerged moving parts that require channel dewatering for maintenance Submerged moving parts (chains, sprockets, and shafts) are subject to fouling Heavy objects may cause rake to jam
Back clean/ back return	Multiple cleaning elements (short cleaning cycle) Submerged moving parts (chains, sprockets, and shafts) are protected by bar rack	Unit has submerged moving parts that require channel dewatering for maintenance Long rake teeth are susceptible to breakage Some susceptibility to screenings carryover
Reciprocating rake	No submerged moving parts; maintenance and repairs can be done above operating floor Can handle large objects (bricks, tires, etc.) Effective raking of screenings and efficient discharge of screenings Relatively low operating and maintenance costs Stainless-steel construction reduces corrosion High flow capacity	Unaccounted for high channel water level can submerge rake motor and cause motor burnout Requires more headroom than other screens Long cycle time; raking capacity may be limiting Grit accumulation in front of bar may impede rake movement Relatively high cost due to stainless-steel construction
Catenary	Sprockets are not submerged; most maintenance can be done above the operating floor Required headroom is relatively low Multiple cleaning elements (short cleaning cycle) Can handle large objects Very little screenings carryover	Because design relies on weight of chain for engagement of rakes with bars, chains are very heavy and difficult to handle Because of the angle of inclination of the screen (45 to 75°), screen has a large footprint Misalignment and warpage can occur when rakes are jammed May emit odors because of open design
Continuous belt	Most maintenance can be done above operating floor Unit is difficult to jam	Overhaul or replacement of the screening element is a time-consuming and expensive operation

(Source: Metcalf & Eddy, 2003.)

Location. In nearly all cases, screens should be installed ahead of the grit chambers to prevent fouling of the grit chamber equipment.

Velocities. The approach velocity should be at least 0.4 m/s to minimize deposition of solids in the channel. The velocity through the screen should be less than 0.9 m/s at peak flow rates to minimize forcing of material through the screen (GLUMRB, 2004).

One of several alternatives are employed to regulate the velocity through the screen. Placement of a control structure such as a Parshall flume downstream of the screen or control of the wet well operating levels can be used. Sizing the channel for velocity control by widening the channel at the screen is another technique that may be employed.

Channels. Dual channels must be provided. Typically they are constructed of concrete. They must be capable of being isolated by the use of slide gates or recesses in the channel walls for the insertion of *stop plates* or *stop logs*. The term *stop log* is derived from the early use of wooden logs set in a groove to stop the water flow. Modern stop plates are made of extruded aluminum. The channel invert should be 75 to 150 mm below the invert of the incoming sewer (GLUMRB, 2004).

The channel dimensions are selected to achieve the approach velocity constraints. The floor of the channel should be level, or should slope downward through the screen without pockets that may trap solids. Fillets (Figure 20-6) are provided to minimize the accumulation of solids. The channel approach to the screen should be straight and perpendicular to the screen for a distance equal to 10 times the depth of flow (Metcalf & Eddy, 1972).

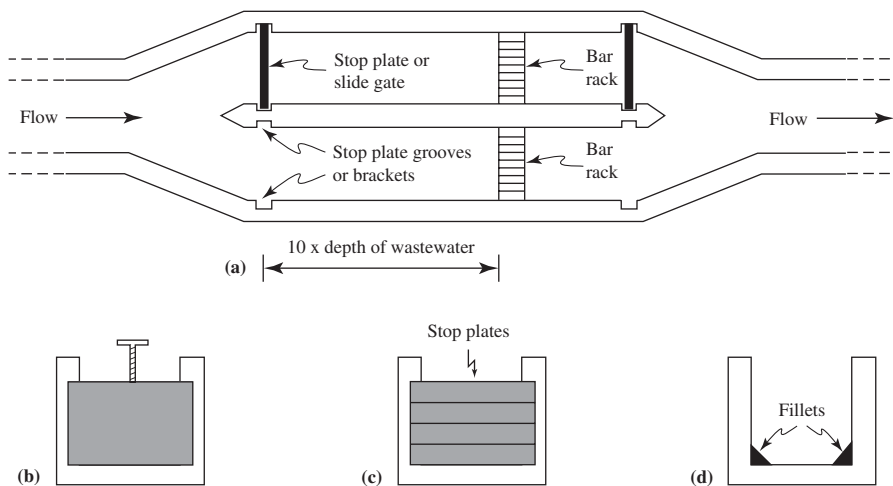

FIGURE 20-6

Two channels with bar racks. (a) Top channel is isolated by stop plate or slide gate. (b) Slide gate. (c) Stop plates in channel. (d) Channel fillets.

The velocity of the open channel flow in the channel may be described by Manning's equation:

$$v = \frac{1}{n} R^{2/3} S^{1/2} \quad (20-3)$$

$$Q = \frac{1}{n} R^{2/3} S^{1/2} A \quad (20-4)$$

where v = velocity, m/s
 n = coefficient of roughness, unitless
 R = hydraulic radius, m
 $= \frac{\text{cross-sectional area of flow, m}^2}{\text{wetted perimeter, m}}$
 S = slope of energy grade line, m/m
 A = cross sectional area of flow, m²

A typical coefficient of roughness (n) for smooth concrete is 0.012. Because the channel slope is horizontal or nearly so, a very small slope is used in the calculation. At first glance, the solution appears to be indeterminate because both the width of the channel and the depth of flow are unknown. However, the width of the channel may be assumed based on either the width of the screen or the Parshall flume inlet.

Although the continuity equation ($Q = vA$) is a satisfactory starting point for estimating the area and, from it, the depth, the open channel flow conditions described by Manning's equation include the area in a nonlinear form because the area is used to compute the hydraulic radius. In this case an iterative solution is required.

Example 20-3 illustrates a channel design using Manning's equation and a spreadsheet with the *Solver** tool.

Example 20-3. Design the channel for the bar rack for Waterloo (Examples 20-1 and 20-2). Assume the following:

1. Approach velocity at average flow rate ≥ 0.4 m/s.
2. Approach velocity at peak hour flow rate at design capacity ≤ 0.9 m/s.
3. Slope of channel is 0.0001 m/m.
4. Width of channel is equal to Parshall flume inlet.
5. Two channels will be provided for redundancy, but one channel must handle the flow for the peak hydraulic flow rate.
6. Freeboard = 0.6 m.

Solution:

- a. Use the Solver program* in a spreadsheet to perform the iterations to solve this problem. The spreadsheet cells are shown in Figure 20-7. The cell locations used in the figure are identified by the brackets [] in the discussion below.

**Solver* is a "tool" in Excel®. Other spreadsheets may have a different name for this program.

	A	B	C	D	E
4	Average Q				
5	n =	0.012		for smooth concrete	
6	Q =	0.4282	m ³ /s		
7	S =	0.0001	m/m		
8	Width =	1.60	m		
9	Depth =	0.64	m		
10					
11					
12	Calculate velocity				
13					
14		A=	1.024	m ²	
15		P=	2.879867		
16		R=	0.355535		
17		R ^{0.6667} =	0.501849		
18		S ^{0.5} =	0.01		
19					
20		v=	0.42	m/s	
21					
22		Q/v=	1.024	m ²	

(a)

Solver parameters

Set target cell:

Equal to: Max. Min. Value of:

By changing cells:

Subject to the constraints:

\$C\$14 = \$C\$22

\$C\$20 > = 0.4

(b)

FIGURE 20-7
(a) Spreadsheet cells and (b) dialog box for “solver” parameters.

b. Begin with the average design flow rate and set the fixed parameters as follows:

$$[B5] \quad n = 0.012$$

$$[B6] \quad \text{From Example 20-1: } Q = \frac{37,000 \text{ m}^3/\text{d}}{86,400 \text{ s/d}} = 0.4282 \text{ m}^3/\text{s}$$

$$[B7] \quad S = 0.0001 \text{ m/m}$$

$$[B8] \quad \text{Width } (W) = 1.6 \text{ m}$$

c. Make a first-trial estimate of the depth by using the continuity solution.

$$A = \frac{Q}{v}$$

$$A = \frac{0.4282 \text{ m}^3/\text{s}}{0.4 \text{ m/s}} = 1.07 \text{ m}^2$$

and

$$D = \frac{A}{W} = \frac{1.07 \text{ m}^2}{1.6 \text{ m}} = 0.67 \text{ m}$$

Enter this value in cell [B9] as the initial trial value.

- d. Write an equation for the cross-sectional area of flow (A) using the width of the channel and the depth of the flow in the channel, that is, $B8*B9$ (see cell [B14]).
- e. Set up the equation for v .

$$= \frac{1}{n} R^{2/3} S^{1/2} \text{ in cell [B20]}$$

with

$$R = \frac{(W)(D)}{W + (2D)}$$

- f. Set up the equation to compute the area from:

$$\frac{Q}{v} \text{ in cell [B22].}$$

- g. Activate the dialog box for solver and designate the target cell [B20], that is, the one containing the computation of the velocity.
- h. Set *Equal to* to “Min.”
- i. Set *By changing* to the cell containing the depth of the flow in the channel [B9].
- j. Add the following two constraints in the dialog box:

- (1) Cell with area computed from $Q/v =$ area computed from “width \times depth.”

$$[C14] = [C22]$$

- (2) Velocity computed in step (e) above ≥ 0.4 m/s.

$$[C20] \geq 0.4$$

- k. Execute solver to find: depth = 0.64 m and a velocity of 0.42 m/s.
- l. Repeat the solution process for the peak flow to find: depth = 1.4 m and the velocity = 0.53 m/s.
- m. Repeat the solution process for the minimum flow to find: depth = 0.265 m and the velocity = 0.28 m/s.
- n. The channel depth is the depth at maximum flow plus the freeboard. The channel dimensions are then:

$$\text{Width} = 1.6 \text{ m}$$

$$\text{Depth} = 1.4 \text{ m} + 0.6 \text{ m} = 2.0 \text{ m}$$

Comments:

- 1. The primary constraints on the approach velocity at average design flow and peak flow were met with only one channel in service. The velocity at the minimum flow

at start-up is low. This will be an operation and maintenance issue early in the life of the plant. The channels may have to be dewatered and cleaned more frequently than otherwise may have been anticipated. Because there are two channels, this will be possible without undue interruption in operation.

2. The commercially available widths of bar racks may be a more appropriate point for selecting a starting width.
3. The arrangement of the spreadsheet cells shown in this example is presented for the convenience of explaining the solution. Other arrangements may be more convenient and/or efficient.

Bar Design. Typical design ranges for bar racks are summarized in Table 20-5.

Materials. Current practice is to use corrosion-resistant materials such as stainless steel and plastics for the bar rack. Though much more expensive, the stainless-steel systems are preferred because of their better maintenance history.

Headloss. The headloss through mechanically cleaned coarse screens is a key design parameter. Based on an assumption of steady, two-dimensional flow, the clean water headloss through a bar screen can be calculated using the Bernoulli equation. The headloss created by a clean screen may be estimated based on the flow and the effective area of the screen openings.

For clean and partially clogged bar screens, the Bernoulli equation yields (WEF, 1998):

$$H_L = \frac{k[(v_{\text{thru}})^2 - (v_{\text{approach}})^2]}{2g} \quad (20-5)$$

where H_L = headloss, m

k = empirical discharge coefficient

v_{thru} = velocity through the bar screen, m/s

v_{approach} = approach velocity, m/s

g = gravitational acceleration = 9.81 m/s²

TABLE 20-5
Typical bar design ranges

Parameter	Cleaning method	
	Manual	Mechanical
Bar size		
Width	5–15 mm	5–15 mm
Depth	25–40 mm	25–40 mm
Clear spacing between bars	25–50 mm	6–75 mm
Slope from vertical	30–45°	0–30°

Sources: Daukss, 2006; Metcalf & Eddy, 2003; WEF, 1998.

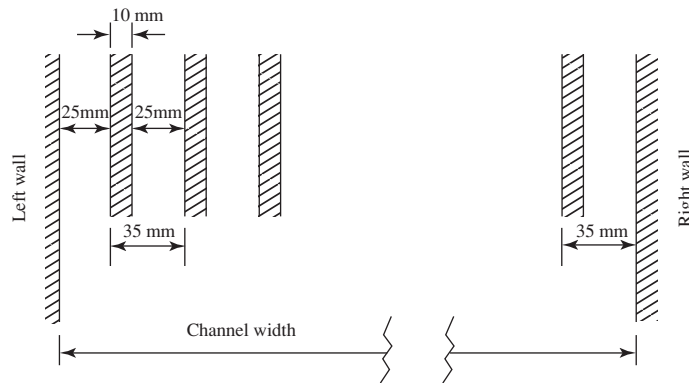

FIGURE 20-8
Example of bar arrangement for coarse screen.

The discharge coefficient is typically taken to be 1.67 for a clean screen and 1.43 for a partially clogged screen (Metcalf & Eddy, 2003). The approach velocity is calculated for the channel upstream of the bar rack. The velocity through the bar rack is based on the effective area of the screen openings. It is estimated as the sum of the vertical projections of the screen openings (WEF, 1998). The screen opening may be approximated by assuming a bar arrangement like the one shown in Figure 20-8. The approximate number of bars is:

$$N_{\text{bars}} = \frac{\text{Width of channel} - \text{bar spacing}}{\text{Bar width} + \text{bar space}} \quad (20-6)$$

The number of bar spaces is $N_{\text{bars}} + 1$.

Headloss through mechanically cleaned bar racks is typically limited to 150 mm by operational controls. The controls activate the raking mechanism based on measurement of the difference in head upstream and downstream of the screen. Alternatively, the raking mechanism may be operated by a time clock. A cycle length of 15 to 30 minutes is typical. For the timed cycle system, either a high water or high differential override switch should be provided that places the rake mechanism in continuous operation when excessive loads are encountered (Metcalf & Eddy, 2003). Increases in flow rate that indicate wet weather flow should activate the screens to run continuously (Spangler, 2006).

Example 20-4 illustrates the use of the headloss equation to select a bar arrangement and estimate the headloss with partial blockage of the screen.

Example 20-4. Estimate the headlosses for a bar rack for Waterloo (Examples 20-1, 20-2, and 20-3) with a clean bar rack and with partial blockage of the screen. Use the following assumptions:

1. Mechanically cleaned bar rack.
2. Bar width = 15 mm.
3. Bar spacing = 20 mm.
4. Angle from vertical = 30°.

5. Differential headloss for activation of the cleaning rakes is 150 mm.
6. Maximum flow area blockage to initiate continuous operation of rakes is 50%.

Solution:

- a. Begin by checking the velocity through one bar rack at the peak hour flow rate at design capacity.
- b. Estimate the number of bars and openings. From Example 20-3, the channel width is 1.6 m. Using Equation 20-6, the approximate number of bars is:

$$\frac{1,600 \text{ mm} - 20 \text{ mm}}{15 \text{ mm} + 20 \text{ mm}} = 45.14 \text{ or } 45 \text{ bars}$$

The number of bar spaces is $45 + 1 = 46$.

- c. Determine the effective area of the screen openings by calculating the projected total open area. Use the depth of flow in the channel at the peak hour flow rate at design capacity from Example 20-3.

$$\text{Area} = (46 \text{ spaces})(20 \text{ mm/space})(10^{-3} \text{ m/mm})(1.4 \text{ m}) = 1.29 \text{ m}^2$$

- d. From Example 20-1, the peak hour flow rate at design capacity is $104,000 \text{ m}^3/\text{d}$. The velocity through the bar rack is

$$v_{\text{thru}} = \left(\frac{104,000 \text{ m}^3/\text{d}}{86,400 \text{ s/d}} \right) \left(\frac{1}{1.29 \text{ m}^2} \right) = 0.93 \text{ m/s}$$

This is slightly above the recommended velocity of 0.9 m/s.

- e. Using Equation 20-5 and the approach velocity of 0.53 m/s from Example 20-3, the headloss through the clean bar rack is

$$\begin{aligned} H_L &= \frac{1.67[(0.93 \text{ m/s})^2 - (0.53 \text{ m/s})^2]}{2(9.81 \text{ m/s}^2)} \\ &= \frac{0.98}{19.62} = 0.05 \text{ m or } 50 \text{ mm} \end{aligned}$$

- f. If the bar rack is 50% clogged, the area of flow is reduced by 50% and the velocity through the bar rack is doubled to 1.86 m/s. The headloss is then

$$\begin{aligned} H_L &= \frac{1.43[(1.86 \text{ m/s})^2 - (0.53 \text{ m/s})^2]}{2(9.81 \text{ m/s}^2)} \\ &= \frac{4.55}{19.62} = 0.23 \text{ m or } 230 \text{ mm} \end{aligned}$$

This headloss is greater than that set to initiate cleaning. In addition, the velocity constraint is exceeded.

- g. Check the velocity and headloss at the average flow rate at design capacity of 37,000 m³/d. From Example 20-3, the depth is 0.64 m and the approach velocity is 0.42 m/s.

$$\text{Area} = (46 \text{ spaces})(20 \text{ mm/space})(10^{-3} \text{ m/mm})(0.64 \text{ m}) = 0.59 \text{ m}^2$$

$$v_{\text{thru}} = \left(\frac{37,000 \text{ m}^3/\text{d}}{86,400 \text{ s/d}} \right) \left(\frac{1}{0.59 \text{ m}^2} \right) = 0.73 \text{ m/s}$$

This meets the recommended velocity through the bars.

$$H_L = \frac{1.67[(0.73 \text{ m/s})^2 - (0.42 \text{ m/s})^2]}{2(9.81 \text{ m/s}^2)}$$

$$= \frac{0.595}{19.62} = 0.03 \text{ m or } 30 \text{ mm}$$

- h. Two bar racks are required to meet redundancy requirements.

Comments:

1. The 50% blockage at peak flow conditions is extreme. This condition warrants an alarm to the operator and initiation of continuous cleaning when the headloss becomes excessive.
2. The clean bar rack headloss is acceptable.
3. Typically, manufacturers will provide standard bar rack bar sizes and spacing as well as headloss curves or tables.

Screenings Handling. Screenings from the rake are usually discharged directly into a hopper or movable container. The design must provide head space above the deck for the discharge as well as the screen return and motor assembly (see Figure 20-5). The spacing required is particular to the manufacturer's model that is selected.

Finer spacing results in wetter screenings. Wetter screenings create handling and transport issues. The design practice for treating and disposing of the screenings is discussed in Chapter 27.

Hints from the Field. Operational experience has yielded the following observations:

1. If material is left on the screen too long it will work through to the downstream side. To avoid this, one of the following alternatives is recommended:
 - Typically, timed screen cleaning should be on for about 5 minutes and off for 25 minutes.
 - Flow-based screen cleaning uses a system that changes the timing of cleaning to increase the frequency of cleaning for high flows.
 - Headloss across the screen plus a minimum cleaning cycle appears to be the system that works best to control the activation of the rakes.

2. Sensors for headloss should have nothing in the channel that may be fouled by debris, rags, and other flotsam. Differential bubbler, radar, and ultrasonic devices to measure the depth of the wastewater are acceptable alternatives.
3. The stop log grooves or channels may become a serious corrosion problem. A *chain fall* to raise and lower each stop log plate is recommended. Operators prefer slide gates rather than stop logs.

Fine Screen Options

There are a number of options in the selection of fine screens and very fine screens. The screen size (opening) is often based on the downstream processes to be employed. There is no definitive classification scheme, but several broad categories may be defined. These include the following:

- **Band screens.** Perforated panels attached to a drive chain act as the screening mechanism. The flow pattern may be through the front and back side of the panel. In this configuration a brush and spray bar clean the back side of the screen.
In an alternate configuration, the center-feed band, wastewater enters through the center of the screen and exits out the sides.
- **Bar screens.** These are similar to bar racks but with finer openings. They are front clean/back return.
- **Drum screens.** The screening medium is mounted on a cylinder that rotates in a flow channel. The flow may be from inside the drum to the outside with screenings captured on the interior surface, or the flow may be from the outside in.
- **Step Screens®.** This design consists of two step-shaped sets of thin vertical plates. One is fixed and one is movable. They alternate across the screen face. The movable plates rotate in a vertical motion to carry the solids up to the next step and ultimately to the top where they are discharged.

The advantages and disadvantages of these screens are summarized in Table 20-6. In general, fine screens can be rotated out of the screening channel for service.

TABLE 20-6
Advantages and disadvantages of types of fine screens

Type of screen	Advantages	Disadvantages
Band (center feed)	Minimal screenings carryover	Channel must be widened at screen; perforation prone to clogging with grease
Bar	Multiple cleaning elements	Not as efficient as other screens
Drum	Minimal screenings carryover Low headloss	Perforation prone to clogging with grease
Step	Handles grease	High headloss; shallow or wide channel required

Sources: Forstner, 2007; Keller et al., 2006; Metcalf & Eddy, 2003.

TABLE 20-7
Characteristics to consider in selecting a fine screen

Screen type	Typical range of openings, mm	Capture ^a efficiency	Hydraulic capacity	Deep channel suitability	FOG ^b suitability	Combined screening and washing
Band, perforated—center feed	1–10	High	Good	Suitable	Poor	No
Bar	2–15	Low	Very good	Suitable	Suitable	No
Drum	0.2–6	High	Very good	Not suitable	Poor	Yes
Step Screen [®]	1–6	Medium	Good	Suitable	Suitable	No

^aAssessed at low range of openings

^bFats, oils, and grease

Sources: Forstner, 2007; Keller et al., 2006; Makie and Oyler, 2007.

Some of the characteristics to be considered in selecting a fine screen are summarized in Table 20-7.

Fine Screen Design Practice

The capacity and redundancy requirements for fine screens are the same as those for coarse screens.

Location. Fine screens are placed downstream of coarse screens. When a facility receives only wastewater that has already been screened, such as from a force main or from a screened lift station, then the fine screen may be the only screen in the plant.

Velocities. The average approach velocity should be in the range 0.6 to 1.2 m/s. It should be greater than 0.3 m/s at low flow and less than 1.4 m/s at peak flow (Keller et al., 2006).

Channels. The channel dimensions are selected to achieve the approach velocity constraints. They generally are limited to depths of 7.5 to 9 m. Because the approach velocities are higher than those specified for coarse screens, some adaptation of the channel width may be required. Baffles or concrete fillets in the lower portions of the upstream channel have been suggested as a means of reducing the area and increasing the velocity at low flow while providing greater cross-sectional area during peak flow events (Keller et al., 2006).

As with the coarse screen channel, the channel approach to bar and step screens should be straight and perpendicular to the screen for a distance equal to 10 times the depth of flow.

Materials. The screens are typically made of stainless steel (bars, mesh, or wedge-wire) or perforated plates made of synthetic material.

Headloss. The headloss through a fine screen may be estimated using the orifice equation (Metcalf & Eddy, 2003):

$$H_L = \left(\frac{1}{2g} \right) \left(\frac{Q}{CA} \right)^{1/2} \quad (20-7)$$

where H_L = headloss, m

Q = flow rate through the screen, m^3/s

g = acceleration due to gravity = 9.81 m/s^2

C = coefficient of discharge for the screen

A = effective open area of submerged screen, m^2

A typical value of C for a clean screen is 0.6. Actual values of C and A depend on the screen design. These factors include the size and milling of slots, or, in the case of wire, the diameter and weave. The percent open area is of particular importance. The values must be determined experimentally. They should be obtained from the manufacturer of the screen. Some typical fine screen openings and effective open areas are listed in Table 20-8.

As with coarse screens, the important determination is the headloss during operation when the screen is partially clogged. Many manufacturers recommend that the screen be operated at a condition of being blinded 50 to 70 percent to improve capture efficiency.

Screenings Handling. The amount of solid material collected by fine screens is considerably greater than with coarse screens because of the the smaller screen openings. Capture rates are a function of the screen opening. Some examples are 87 to 93 percent for 3 mm band screens, 78 to 81 percent for 6 mm band screens. Other fine screens have similar relationships: 84 percent for 3 mm and 71 to 76 percent for 6 mm (Makie and Oyler, 2007). A screw conveyor or belt conveyor should be used to collect and transport the screenings to a washer and compactor.

The design practice for treating and disposing of the screenings is discussed in Chapter 27.

20-5 COARSE SOLIDS REDUCTION

An alternative to capturing coarse solids on bar racks and/or screens is to use a mechanical device to shred or grind the solids and return them to the flow. Three of the most common devices are comminutors, macerators, and grinders.

There is a divergence of views on the desirability of using this technique for handling coarse solids. One view is that the coarse solids should be removed from the wastewater early in the flow scheme to eliminate downstream problems. Another view is that the shredded material is easily handled by downstream processes. Of particular concern are rag and plastic materials that form strings or ropes that wrap around pump impellers, accumulate on clarifier mechanisms and air diffusers, clog sludge pipelines, and foul heat exchangers. Plastic limits the potential for land application of biosolids. For certain processes, such as membrane bioreactors (MBRs), or the requirement to produce Class A biosolids, coarse solids reduction is not an option. Fine screens must be used.

TABLE 20-8
Fine-screen openings and effective open areas

Hole spacing, mm	Open area, %
9	55
6	40
3	35
1	31

Adapted from Keller et al., 2006.

Comminutors

A typical comminutor uses a stationary horizontal screen to intercept the solids in the flow and a rotating or oscillating cutting bar to shear the material. The solids are reduced in size to between 6 and 20 mm. They pass downstream. Although they were commonly used in the past, most new facilities use screens, macerators, or grinders.

Macerators

Macerators are slow-speed grinders that typically use two sets of counterrotating blade assemblies (Figure 20-9). The tolerance on the macerator blades assemblies is small enough (typically, 6 to 9 mm) that the material passing through is effectively chopped. This chopping action reduces the potential for producing ropes of rags and plastic.

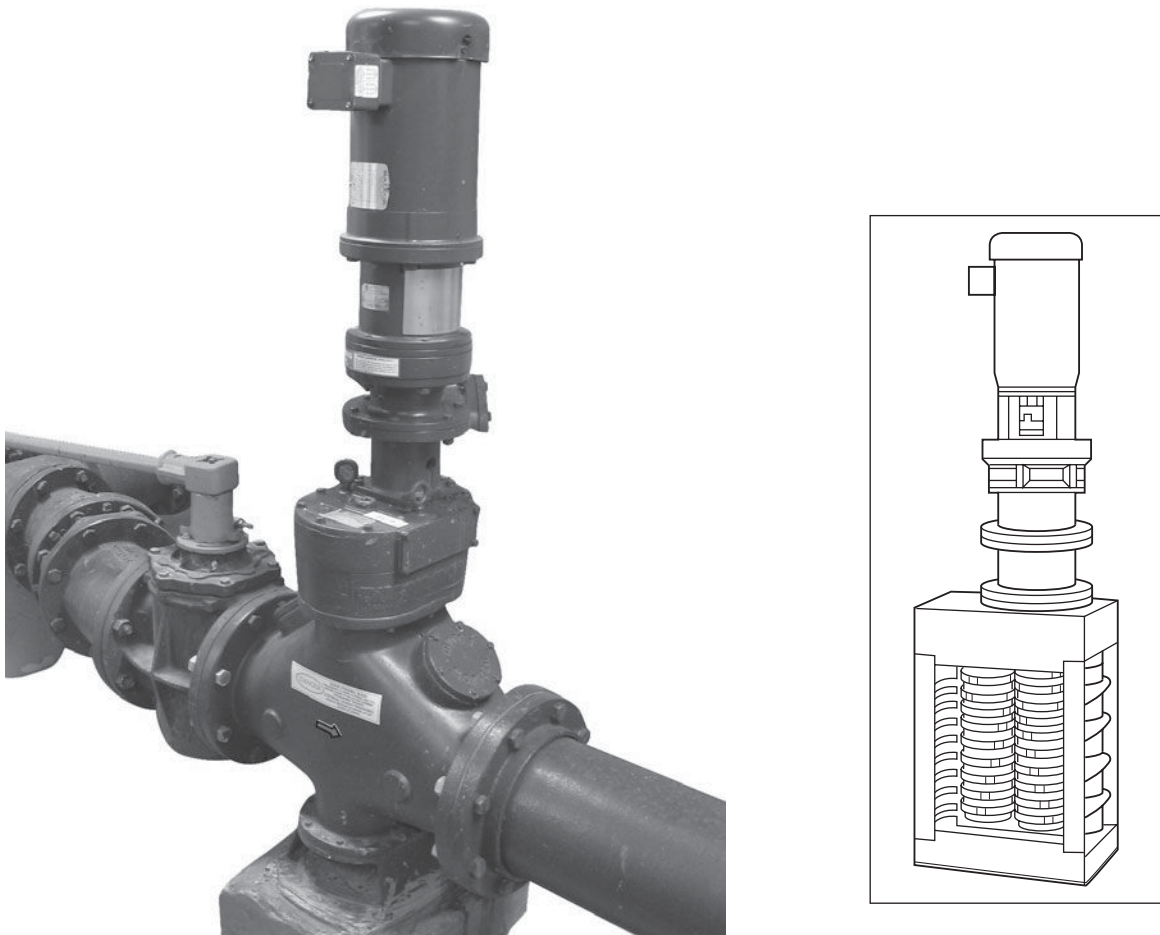

FIGURE 20-9

Photo and isometric drawing of a macerator.

(Sources: Mackenzie L. Davis; Metcalf & Eddy, 2003.)

Grinders

Grinders pulverize the solids by a high-speed rotating assembly. The cutting blades force the material through a stationary grid that encloses the assembly.

Design Considerations

The capacity and redundancy requirements for solids reduction devices are the same as those for coarse screens. They may be located downstream of grit chambers to reduce wear on the cutting mechanism, but typically they are placed ahead of grit chambers to prevent rags, bags, and other debris from fouling the grit removal equipment. As with the screens, channels are constructed with a bypass and provisions for isolating the channel and dewatering it when maintenance is required.

Typical headloss through these devices is 100 to 300 mm and can approach 900 mm in large units at maximum flows.

Because these units are sold as stand-alone devices, no detailed design is required. However, manufacturers' data must be consulted for data on recommended channel dimensions, capacity, headloss, submergence, and power requirements. In evaluating alternatives, the ratings should be decreased by about 80 percent because the manufacturers use clean water to establish the ratings (Metcalf & Eddy, 2003).

Hint from the Field. Once you take it out, do **not** put it back in (Pugh, 2008).

20-6 GRIT REMOVAL

Sand, gravel, broken glass, egg shells, and other material having a settling velocity substantially greater than the organic material in wastewater is called *grit*. Grit removal is provided to protect mechanical equipment from abrasion and wear; reduce the formation of deposits in pipelines and channels; and reduce the frequency of digester cleaning that is required because of accumulated grit.

A secondary, but none-the-less extremely desirable goal of the grit removal system is to separate the grit from the organic material in the wastewater. This separation allows the organic material to be treated in subsequent processes.

Theory

At its most fundamental level, the controlling parameter in grit removal is the settling velocity of the particle. The behavior of settling particles in a grit chamber is commonly described as Type I (discrete particle) sedimentation. This phenomenon is described in Chapter 10.

To separate the inert grit material from organic particles, grit removal devices depend on the difference in specific gravity between organic and inorganic solids. In standard gravity separation all particles are assumed to settle in accord with Newton's equation (Equation 10-8), repeated here for convenience,

$$v_s = \left[\frac{4g(\rho_s - \rho)d}{3 C_D \rho} \right]^{1/2} \quad (20-8)$$

and, by Camp’s equation (1942), to be scoured at a velocity

$$v_{\text{scour}} = \left[\frac{8\beta(\rho_s - \rho)gd}{1,000(f)} \right]^{1/2} \tag{20-9}$$

- where v_s = settling velocity of particle, m/s
- g = acceleration due to gravity = 9.81 m/s²
- ρ_s = density of particle, kg/m³
- ρ = density of water, kg/m³
- d = particle diameter, m
- C_D = drag coefficient, dimensionless
- v_{scour} = scour velocity, m/s
- β = dimensionless constant
- f = dimensionless Darcy-Weisbach friction factor

The dimensionless constant (β) ranges from 0.04 to 0.06. The Darcy-Weisbach friction factor is taken to be in the range 0.02 to 0.03.

In a horizontal-flow grit chamber, to assure removal of the grit and scour of organic matter that settles, three conditions must be met (Steel and McGhee, 1979):

1. The overflow rate of the chamber must be equal to the settling velocity of the inert grit particle.
2. The horizontal velocity must be less than the scour velocity of the inert particles.
3. The horizontal velocity must be greater than the scour velocity of the organic particles.

By the 1950s, a design philosophy had evolved specifying that horizontal-flow grit chambers should capture sand particles with a diameter of 200 μm and a specific gravity of 2.65 (Fair and Geyer, 1954). The solution of Newton’s equation and the scour equation using these assumptions yields an overflow rate of 0.021 m/s and a horizontal velocity between 0.056 m/s and 0.23 m/s.

Unfortunately, this specification ignored observations made in the 1920s that the specific gravity of grit was in the range of 1.4 to 1.6 (Metcalf & Eddy, 1930). As shown in Figure 20-10, subsequent work has revealed a range of specific gravities from about 1.1 to 2.7 (Eutek, 2008; Metcalf & Eddy, 2003). In addition, it is recognized that grease and other organic matter frequently

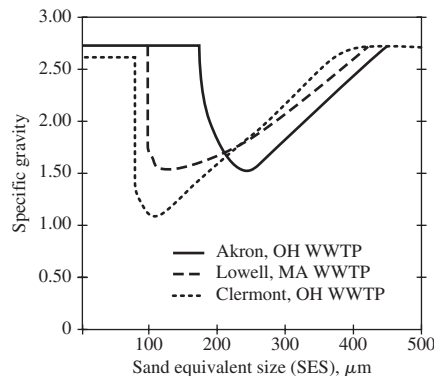

FIGURE 20-10
Variation in specific gravity of grit.
(Source: Courtesy of Eutek, 2008.)

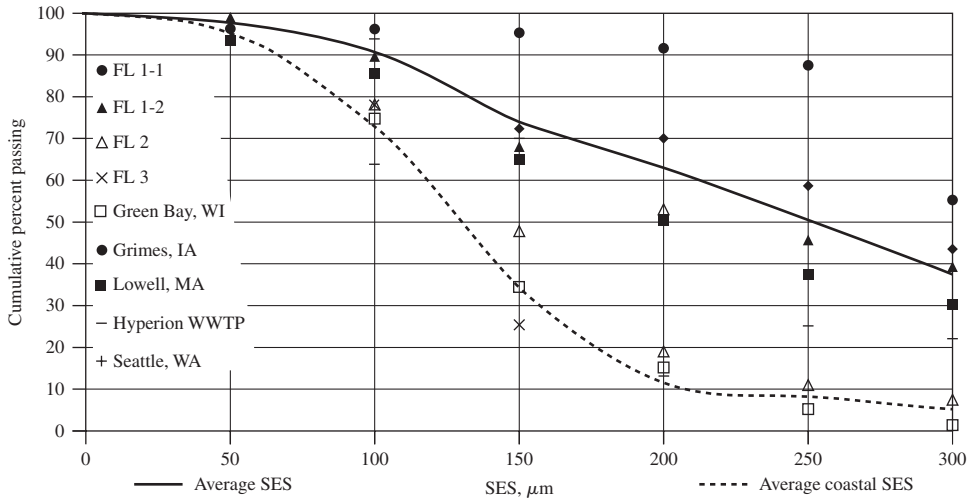

FIGURE 20-11

Grit SES particle size distributions.

(Source: Courtesy of Eutek, 2008.)

coats the inorganic grit particle. Thus, neither the specific gravity nor the size of a grit particle can be described in terms of a sand grain alone. A more realistic measure called the *sand equivalent size* (SES) is preferred (Wilson et al., 2007a). SES is the size of a clean sand particle that settles at the same rate as a grit particle.

The selection of the 200 μm particle diameter for removal appears to be arbitrary. Typical particle size distributions of particles are shown in Figure 20-11. From the figure it is obvious that a large fraction of the grit has a SES less than 200 μm diameter. As noted in 1971 and illustrated in Figure 20-11, the grit in wastewater of coastal cities often contains a large fraction of particles less than 200 μm in diameter (WPCF, 1971).

With peak flows and/or combined sewer systems, particles as large as gravel may be transported to the wastewater treatment plant. The implication of this high variability in the character of the grit is that the design of the grit chamber, while based on fundamental settling theory, must provide sufficient operational flexibility to adjust to local circumstances.

Grit Removal Alternatives

There are four general types of grit removal systems: horizontal-flow grit chambers, detritus tanks, aerated grit chambers, and vortex-flow grit chambers. The horizontal-flow grit chamber is, fundamentally, a velocity-controlled channel. The velocity is controlled by a proportional weir or Parshall flume. The detritus tank is a square horizontal-flow grit chamber. The tank is basically a sedimentation basin with a very short detention time. The flow is directed across the tank by a series of gates or weirs and discharges over a weir that runs the length of the opposite side of the tank. In aerated grit chambers, air is introduced along one side of the tank near the bottom and causes a spiral roll pattern perpendicular to the flow through the tank (Figure 20-12). The vortex systems rely on a mechanically induced vortex to capture grit (Figure 20-13).

While they have been used for many decades, horizontal-flow grit chambers and detritus tanks are no longer favored in the United States. The remainder of this discussion focuses on the preferred alternatives: aerated grit chambers and vortex chambers.

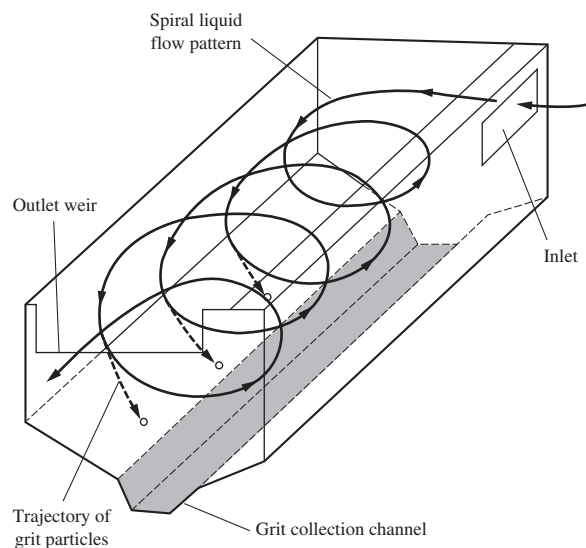
**FIGURE 20-12**

Spiral roll pattern in an aerated grit chamber. (Source: Metcalf & Eddy, 2003.)

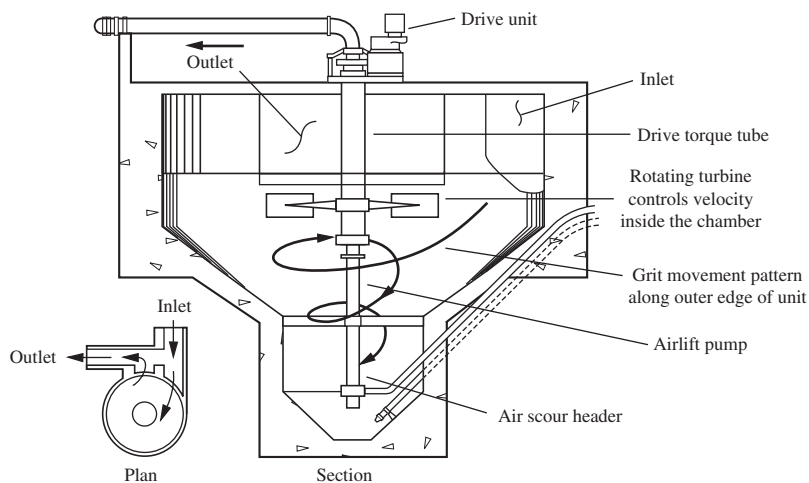
**FIGURE 20-13**

Vortex grit chamber. (Source: Metcalf & Eddy, 2003.)

Aerated Grit Chamber. As the wastewater moves through the chamber in a spiral pattern (Figure 20-12), heavier grit particles settle to the bottom of the tank. Lighter particles that are principally organic remain in suspension and are carried out of the tank. The velocity of roll of water across the bottom of the tank controls the size of particles of a given specific gravity that will settle out (Albrecht, 1967; Sawicki, 2004). The rolling action induced by the air diffusers is independent of flow through the tank. The rate of air diffusion and the tank shape govern the

rate of velocity of the roll. The particles that are settled out are moved by the spiral flow of the water across the bottom of the tank to a grit hopper or trough. The grit is removed from the hopper with one of the following: chain and bucket collectors, screw augers, clamshell buckets, or recessed impeller or air lift pumps.

The advantages and disadvantages of aerated grit chambers are summarized in Table 20-9.

Vortex Grit Chamber. Wastewater is brought into the chamber tangentially (Figure 20-13). At the center of the chamber a rotating turbine with adjustable-pitch blades along with the cone-shaped floor produces a spiraling, doughnut-shaped flow pattern. This pattern tends to lift the lighter organic particles and settle the grit into a grit sump. The effluent outlet has twice the width of the influent flume. This results in a lower exit velocity than the influent velocity and thus prevents grit from being drawn into the effluent flow. It should be noted that centrifugal acceleration does not play a significant role in removing the particles. The velocities are too low.

Solids are removed from the sump by a grit pump or an air lift pump. Typically, air or water scour is used to loosen the compacted grit just before it is removed from the chamber.

The advantages and disadvantages of vortex grit chambers are summarized in Table 20-10.

Aerated Grit Chamber Design Practice

A cross section of the chamber is shown in Figure 20-14. The bottom slope is set at a 45 degree angle. The collection channel (also called a *sump* or *hopper*) for grit is sized based on the anticipated quantity of grit. Air is introduced along one side near the bottom of the tank to induce a spiral roll velocity pattern perpendicular to the flow through the tank. The rate of air diffusion and the tank shape govern the rate of roll and, thereby, the size of the particle with a given specific

TABLE 20-9
Advantages and disadvantages of aerated grit chambers

Advantages	Disadvantages
Efficiency constant over wide range of flow	Power consumption is high
Headloss is minimal	Labor required for air system maintenance
Organic content can be controlled by air rate	Volatile organic compounds may be released
Chamber can be used to add and mix chemicals	Odor may be an issue
Slight pre-aeration may reduce septic conditions	Labor for grit removal equipment maintenance

Sources: WEF, 1998, and Spangler, 2006.

TABLE 20-10
Advantages and disadvantages of vortex grit chambers

Advantages	Disadvantages
Efficiency constant over wide range of flow	Proprietary design
Energy efficient	Compaction of grit
Headloss is minimal	Turbine blades may collect rags
Small footprint	
No submerged bearings	

Adapted from WEF, 1998, and Spangler, 2006.

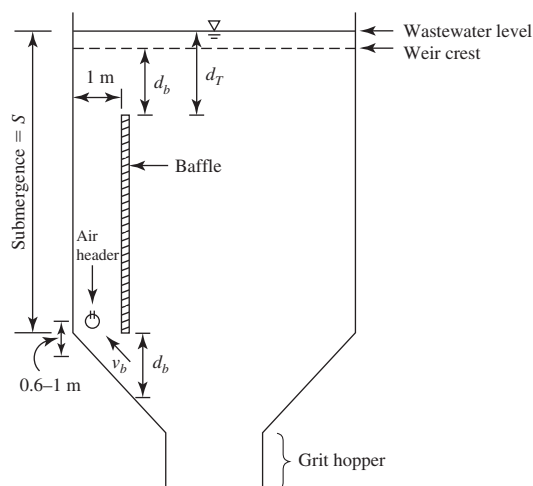

FIGURE 20-14

Aerated grit chamber with dimension notations. The distance of the air header to the sloped wall of the grit chamber is noted as 0.6–1 m.

gravity that will be removed. A large number of variables affect the air lift pumping energy and its effect on the roll pattern in the tank.

Although there are no formal arguments for the required efficiency of grit removal, typically it has been assumed that a properly functioning aerated grit chamber should remove 100 percent of the sand fraction greater than $200\ \mu\text{m}$ in diameter and 65 to 75 percent of the sand fraction between 100 and $200\ \mu\text{m}$. In addition, the organic content of the captured grit should not exceed 10 percent (Imhoff and Imhoff, 1979).

Modern treatment technology such as fine bubble diffused aeration and membrane filtration (Chapters 23 and 26) appear to warrant higher efficiency. Wilson et al. (2007b) suggest that 95 percent removal of the SES $60\ \mu\text{m}$ diameter is required to prevent inert grit from settling in fine bubble aeration systems. From Figure 20-11, it appears that about 95 percent removal of particles greater than $50\ \mu\text{m}$ SES virtually eliminates grit from the wastewater.

Capacity and Redundancy. Aerated grit chambers must be able to pass the extreme peak hydraulic flow rate with the largest unit out of service. In addition, the grit handling equipment (collection channel and mechanical equipment) must be able to handle the highest grit loading at the highest flow rate.

Location. Typically, the grit chamber is placed downstream of coarse screens or mechanical coarse solids reduction devices. They may be placed upstream of fine screens to protect the fine screen from excessive wear.

Detention Time. Experience has shown that a detention time of 2 to 5 minutes at peak hourly flow is sufficient to achieve greater than 95 percent removal of the traditional design particle size ($200\ \mu\text{m}$ diameter, specific gravity of 2.65). Typically, the detention time is set at 3 minutes at peak hourly flow (Metcalf & Eddy, 2003; WEF, 1998). Detention times ranging from 3.6 to 7.8 minutes at average flow conditions have been reported to achieve efficiencies ranging from 94 to 98.8 percent (Morales and Reinhart, 1984). Longer detention times improve grit removal and may be necessary to capture smaller grit particles (WEF, 1998).

Geometry. The shape of the grit chamber is designed to enhance the spiral roll of the wastewater as it passes through the chamber. Although some aerated grit chambers have been formed to a

bulb shape to provide this geometry (see, for example, the cross sections for Gdansk and Gdynia in Poland—Sawicki, 2004), the complexity of the shape would appear to be very expensive to construct. The more conventional approach is to use dimensions and dimensional ratios that have proven successful.

There is no typical geometry. Chambers have depths of 2 to 5 m. The width to liquid depth ratio ranges from 1:1 to 5:1 with a typical value of 2:1. The length-to-width ratio ranges from 2.5:1 to 5:1 (WEF, 1998). Lengths range from 7.5 to 27.5 m (Metcalf & Eddy, 2003, Morales and Reinhart, 1984).

Square chambers are not recommended. They require careful placement of baffles to work properly without short circuiting. Long, narrow tanks appear to provide the best process efficiency, grit quality, and ease of operation (Morales and Reinhart, 1984).

Baffles. Four types of baffles have been used in aerated grit chambers: inlet, outlet, intermediate, and longitudinal. The first three types of baffle are used to prevent short circuiting of the flow through the tank. The longitudinal baffle is used in conjunction with the air supply to control the roll pattern.

If the flow enters the chamber perpendicular to the flow through a long, narrow tank (Figure 20-12), inlet and outlet baffles may not be required. The common use of inlet and outlet baffles is to turn the direction of flow to induce a spiral roll and reduce short circuiting. The baffles are placed perpendicular to the spiral roll pattern (Morales and Reinhart, 1984; WEF, 1998).

WEF (1998) suggests that a good design should include an intermediate baffle across the width of the tank to prevent short circuiting through the center of the roll pattern.

The longitudinal baffle (Figure 20-14) is placed approximately 1 m from the wall next to the air diffusers (WEF, 1998). It is an essential ingredient in controlling the roll pattern and velocity of the flow across the bottom of the tank. The dimension d_b is sized to achieve a design velocity across the bottom of the tank. Neither d_b nor d_T have been specified in the literature. Albrecht (1967) proposed an empirical method for determining the velocity through the slot at the bottom of the baffle. It includes selection of a design value for d_b . This is discussed later in this section.

Air Supply. The shape of the grit chamber is not the only key to good design; diffuser placement, air source, and adequate baffling all affect performance (Morales and Reinhart, 1984). Coarse bubble diffusers are recommended for supplying the air. They are typically placed 0.6 to 1 m above the bottom of the chamber. The air supply should be isolated from other treatment plant aeration requirements to facilitate process control. The plant process air supply may provide the air, but separate dedicated blowers are preferred (WEF, 1998). Adequate control, including valves and flow meters for each bank of diffusers, is essential. In order to maintain effective grit removal over a wide range of flows and grit loadings, the operators must be able to adjust the aeration rate over a wide range of air flow rates and to taper the aeration rate along the tank.

The air supply and control system should be able to provide air over the range 0.0019 to 0.0125 m³/s · m of tank length (GLUMRB, 2004; Sawaki, 2004; WEF, 1998).

Velocities. Unlike the horizontal-flow grit chamber, neither the overflow rate nor the velocity of flow through the tank are design criteria. The primary design criterion for the aerated grit chamber is the velocity of flow across the bottom of the tank (Albrecht, 1967; Sawicki, 2004). This velocity controls the SES diameter particle that will be removed. Based on theoretical calculations and experimental evidence, for efficient removal of grit the velocity across the bottom of the tank should be less than 0.15 m/s (Sawicki, 2004). Other experimental evidence is that a range of 0.03 to 0.40 m/s for the bottom velocity provides efficient removal (Morales and Reinhart, 1984).

WEF (1998) recommends that the velocity measured 150 mm below the surface be tapered from 0.6 m/s at the inlet to 0.45 m/s at the tank outlet.

Because the geometry of the tank is fixed by the design, the only mechanism available for the operator to control the velocity is to adjust the air flow rate. Thus, not only is it imperative that operational control and flexibility be provided, but it is also advisable that a means of measuring the velocity be made available. Morales and Reinhart (1984) used a portable water current meter for their observations.

Quantities and Characteristics of Grit. The type of sewer system (separate or combined), and characteristics of the drainage area, including soil type, industry type, use of garbage grinders, and so on, will affect both the quantity and character of the grit. Based on U.S. EPA data, the range in grit quantities varies from 0.004 to 0.037 m³/1000 m³ of wastewater for separate sewers and from 0.004 to 0.18 m³/1000 m³ for combined sewers.

Grit solids content will vary from 35 to 80 percent with a volatile content of 1 to 55 percent (U.S. EPA, 1979). Grit from a properly operating aerated grit chamber should have a volatile content no greater than 10 percent (Imhoff and Imhoff, 1979; Sawicki, 2004). The moisture and volatile content is influenced by the efficiency of washing.

Grit Sump. The volume of the grit sump at the bottom of the grit chamber should be designed based on the anticipated maximum load, efficiency of collection, and grit removal frequency. The failure of grit removal systems often is not a function of the sedimentation of the particles, but rather the inability of the removal equipment to keep up with the load. As a result, settled grit is scoured out of the grit chamber.

The sump side walls are set at a steep angle. Angles of 60° to 90° from the horizontal are shown in the literature.

Grit Removal Equipment. The four methods of removing grit from the sump are: inclined screw or tubular conveyors, chain and bucket elevators, clamshell buckets, and pumping. Currently, chain and bucket systems are seldom installed. They will not be discussed here.

The inclined screw or tubular conveyors may provide some washing of the grit as it is removed. These systems discharge a very dry grit (Morales and Reinhart, 1984). They have a relatively large footprint and are sensitive to wear. The motor must be sized to handle sudden high peak loads.

Clamshell buckets are moved by an overhead crane. This system provides inconsistent grit removal and requires discontinuing flow to the chamber during grit removal. It lacks effective dewatering and washing.

Pumping systems offer the advantage of a small footprint. However, the piping and valves require intensive maintenance. In particular, the piping may become plugged. Dislodging the compacted grit is a major undertaking.

Residuals Management. The design practice for treating and disposing of grit is discussed in Chapter 27.

Design Criteria for Aerated Grit Chambers. Table 20-11 summarizes the design criteria for aerated grit chambers.

Design Tools. Based on the theoretical concept that energy delivered to the liquid by air bubbles is equal to the local work performed by each bubble, Sawicki (2004) developed a method for determining the transverse circulation in the aerated grit chamber. This equation is solved

TABLE 20-11
Typical design criteria for aerated grit chambers

Parameter	Typical range	Comment
Detention time at peak flow rate	120–300 s	Typical = 180 s
Dimensions		
Depth	2–5 m	Liquid depth
Width	2.5–7 m	
Width:depth	1:1–5:1	Typical = 1.5:1
Length	7.5–27.5 m	
Length:width	2.5:1–5:1	
Baffles		
Inlet and outlet		Required when flow enters parallel to tank Placed perpendicular to spiral roll
Intermediate		Across width
Longitudinal		Placed 1 m from wall
Air supply		
Flow rate	0.0019–0.0125 m ³ /s · m	Adjustable over full range
Diffuser	0.6–1 m above bottom	Coarse bubble
Velocities		
Transverse roll	0.6–0.45 m/s	Tapered, measured 150 mm below surface
Across bottom	0.03–0.45 m/s	Measured at bottom of longitudinal baffle
Quantity of grit	0.004–0.20 m ³ /1,000 m ³ of flow	

Sources: Morales and Reinhart, 1984; Metcalf & Eddy, 2003; Sawicki, 2004; WEF, 1998.

numerically to determine the circulation discharge. This can then be used to estimate the trajectories of individual grit particles.

Computational fluid dynamics (CFD) modeling has been used to evaluate and optimize alternative baffle arrangements in the design of aerated grit chambers (Burbano, et al., 2009).

Albrecht (1967) developed an empirical equation that, except for the lack of a definitive value for the empirical constant (K), can be helpful in exploring alternative designs. It provides a means of estimating the velocity across the bottom of the chamber:

$$v_b = \left[\frac{(S)(A_{f\text{-total}})}{(K)(L)(d_b)} \right]^{1/2} \quad (20-10)$$

where v_b = velocity across bottom of chamber, m/s
 S = submergence, m
 $A_{f\text{-total}}$ = total air flow rate for the chamber, m³/s
 K = dimensional coefficient, m · s
 L = length of chamber, m
 d_b = opening under the baffle, m

The dimensions are shown in Figure 20-14. The equation may be simplified slightly if the air flow rate is given in units of $\text{m}^3/\text{s} \cdot \text{m}$ of chamber length so that the form is:

$$v_b = \left[\frac{(S)(A_f)}{(K)(d_b)} \right]^{1/2} \quad (20-11)$$

where A_f = air flow rate per unit length, $\text{m}^3/\text{s} \cdot \text{m}$.

With an appropriate value of K , the velocity across the bottom of the tank may be approximated by adjusting the dimensions. Based on an exploration of a number of designs using the design criteria noted above, a value of $K = 0.7 \text{ m} \cdot \text{s}$ appears to be a workable starting point for examination of design options.

Example 20-5 illustrates the design of an aerated grit chamber using the design criteria and the modified Albrecht equation.

Example 20-5. Using the data from Examples 20-1 through 20-4, design an aerated grit chamber for the Waterloo WWTP. Assume a design velocity through the slot of $\leq 0.15 \text{ m/s}$ and that two grit chambers will be provided but the peak hourly flow rate must be met with one out of service. Also assume a worst case for design of the grit channel.

Solution:

- a. The design is iterative. Initial selections are made for dimensions from the design criteria in Table 20-11. The spreadsheet shown below was used to adjust the design values using Albrecht's modified equation with $K = 0.7 \text{ m} \cdot \text{s}$ as a guide. An explanation of the selections and calculations is shown below the spreadsheet.

$Q =$	37,000	m^3/d	
Peaking factor	2.8		
$Q_p =$	103,600	m^3/d	
$Q =$	1.20	m^3/s	
$t =$	180.00	s	
Volume =	215.83	m^3	
Depth =	3.00	m	
Width =	4.00	m	
Length =	17.99	m	
Air rate =	0.0019	$\text{m}^3/\text{s}\cdot\text{m}$	
$K =$	0.7	m-s	
Assume a value for d_b and calculate v_{slot}			
$d_b =$	0.65	m	
$A_F =$	0.0019	$\text{m}^3/\text{s}\cdot\text{m}$	
$S =$	2.35	m	
$v_{\text{slot}} =$	0.15	m/s	
W:D =	1.33		
L:W =	4.50		
L:D =	6.00		

- b. Using the peak hour flow rate from Example 20-1 and a detention time of 180 s from Table 20-11, estimate the volume of the aerated grit chamber as

$$V = \left(\frac{103,600 \text{ m}^3/\text{d}}{86,400 \text{ s/d}} \right) (180 \text{ s}) = 215.83 \text{ m}^3$$

- b. Using Table 20-11 as a guide, select a wastewater depth = 3 m and a width = 4 m.
c. Calculate length.

$$L = \frac{215.83 \text{ m}^3}{(3 \text{ m})(4 \text{ m})} = 17.99 \text{ m}$$

This is greater than 7.5 m and less than 27.5 m and, therefore, meets the criterion.

- d. Check ratios.

W:D = 1:1.33. This meets the criterion.

L:W = 1: 4.5. This meets the criterion.

- e. Assume initial values for $A_f = 0.0125 \text{ m}^3/\text{s} \cdot \text{m}$ and $d_b = 0.60 \text{ m}$ and calculate the velocity using Equation 20-10 with $K = 0.7 \text{ m} \cdot \text{s}$. Note that submergence (S) is the depth of the tank minus the slot height (d_b).
f. Adjust the air flow rate and/or the slot height (d_b) until the design velocity is achieved.
g. After a number of iterations, a final slot size of 0.65 m and an air flow rate of $0.0019 \text{ m}^3/\text{s} \cdot \text{m}$ were selected to meet the velocity criterion.
h. For the worst case grit load ($0.20 \text{ m}^3/1000 \text{ m}^3$ of flow), the grit channel and removal equipment must handle:

$$V_{\text{grit}} = \left(\frac{0.20 \text{ m}^3 \text{ grit}}{1,000 \text{ m}^3} \right) (103,600 \text{ m}^3/\text{d}) = 20.7 \text{ m}^3 \text{ of grit}$$

- i. The grit channel is 18 m long. Assume the channel is 1 m wide with vertical sides. The depth of the channel to hold the grit removed in one day is

$$D_{\text{grit channel}} = \frac{20.7 \text{ m}^3}{(1 \text{ m})(18 \text{ m})} = 1.15 \text{ m}$$

Comments:

1. Additional depth will have to be added to the wastewater depth to account for volume expansion due to the addition of air and to provide freeboard.
2. This design method does not address the conditions during average flow or, for that matter, the use of two chambers during the peak hour.
3. Other dimensions, or more than two channels, may be more appropriate to address the wide range of flows. However, more chambers will be more expensive.

4. The width and depth of the grit channel will have to accommodate standard manufacturers' dimensions.
 5. The grit channel does not have to hold all of the grit from one day if the cleaning mechanism can operate while the channel is in use.
 6. The solver function in the spreadsheet can be employed to optimize the air flow rate and slot width.
 7. The use of the Albrecht equation is an **aid** to the design process. **It is not** a design equation. The assumed value of K has not been verified by experiment or experience. Engineering judgement is required to determine if the results are practical or even possible.
-

Vortex Grit Chamber Design Practice

Currently, two vortex grit systems are on the market: chambers with flat bottoms and a small opening to collect grit and chambers with sloping bottoms and a large opening to collect grit. Both systems are proprietary. Because the manufacturers provide the complete unit, no detailed design is necessary.

Typical detention times at peak hour flow rates are 20 to 30 seconds. Units are generally sized to handle peak flow rates up to about $0.3 \text{ m}^3/\text{s}$.

Hint from the Field. Because manufacturers' equipment is specified based on flow rate, consideration must be given to the impact of variable flow and, in particular, low flow on the efficiency of particle removal.

20-7 FLOW EQUALIZATION

Wastewater does not flow into a municipal wastewater treatment plant at a constant rate. Even in dry weather, the flow rate varies from hour to hour, reflecting the living habits of the area served and variable process flows from industrial customers. Above-average sewage flows and strength occur in mid-morning. Low flows occur from 11 PM to 5 AM. In wet weather, inflow and infiltration result in a surge in flow rate and dramatic changes in the concentration of suspended solids and biochemical oxygen demand (BOD_5). The constantly changing amount and strength of wastewater to be treated make it difficult to operate the treatment processes efficiently. Also, many treatment units must be designed for the maximum flow conditions encountered, which actually results in their being oversized for average conditions. The purpose of flow equalization is to dampen these variations so that the wastewater can be treated at a nearly constant flow rate. Flow equalization can significantly improve the performance of an existing plant and increase its useful capacity. In new plants, flow equalization can reduce the size and cost of the treatment units.

Theory

A typical variation in daily wastewater flow is shown in Figure 20-15a. Ideally, the fluctuation in diurnal flow rate may be visualized as a sinusoidal wave as shown in Figure 20-15b. From a design and operating point of view, the ideal flow rate would be constant at the average value

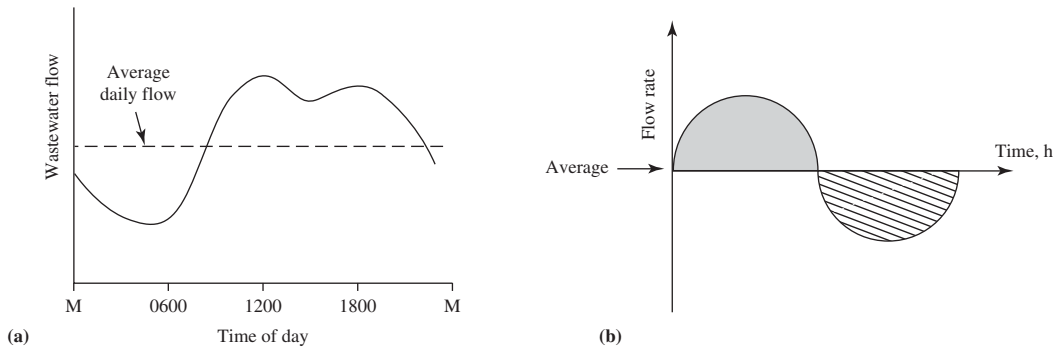
**FIGURE 20-15**

(a) Typical and (b) highly idealized hypothetical flow patterns.

shown in the figure. The reduction in the amplitude of the wave, called *equalization* or *damping*, may be accomplished by storing the wastewater that is in excess and delivering it downstream during the time that the flow rate is below the average flow rate.

In the idealized scenario shown in Figure 20-15b, the shaded area above the average flow rate is equal to the cross-hatched area below the average flow rate. Each of these areas is a volume. This volume is the basis for the design of an equalization basin. It may be determined by a volume balance analysis of the diurnal flow rate where

$$\frac{dS}{dt} = Q_{in} - Q_{out} \quad (20-12)$$

or for a time interval of Δt

$$dS = (Q_{in})(\Delta t) - (Q_{out})(\Delta t) \quad (20-13)$$

where dS is the change in storage for the time increment Δt , and the quantities $(Q_{in})(\Delta t)$ and $(Q_{out})(\Delta t)$ are volumes. The analysis is made for the case where Q_{out} is a constant equal to Q_{avg} . The diurnal variation is integrated numerically and the maximum value of ΣdS is the required storage.

Equalization Design Practice

The principal factors that must be considered in the design of equalization basins are: (1) location and configuration, (2) volume, (3) basin geometry, (4) mixing and air requirements, (5) appurtenances, and (6) pumping facilities. These are discussed in the following paragraphs.

Location and Configuration. The basins are normally located near the head end of the treatment works, preferably downstream of pretreatment facilities such as bar screens and grit chambers. Two typical WWTP configurations are in-line equalization and off-line equalization (Figure 20-16). Considerable damping of constituent mass loadings, as well as flow rate, may be achieved with in-line equalization.

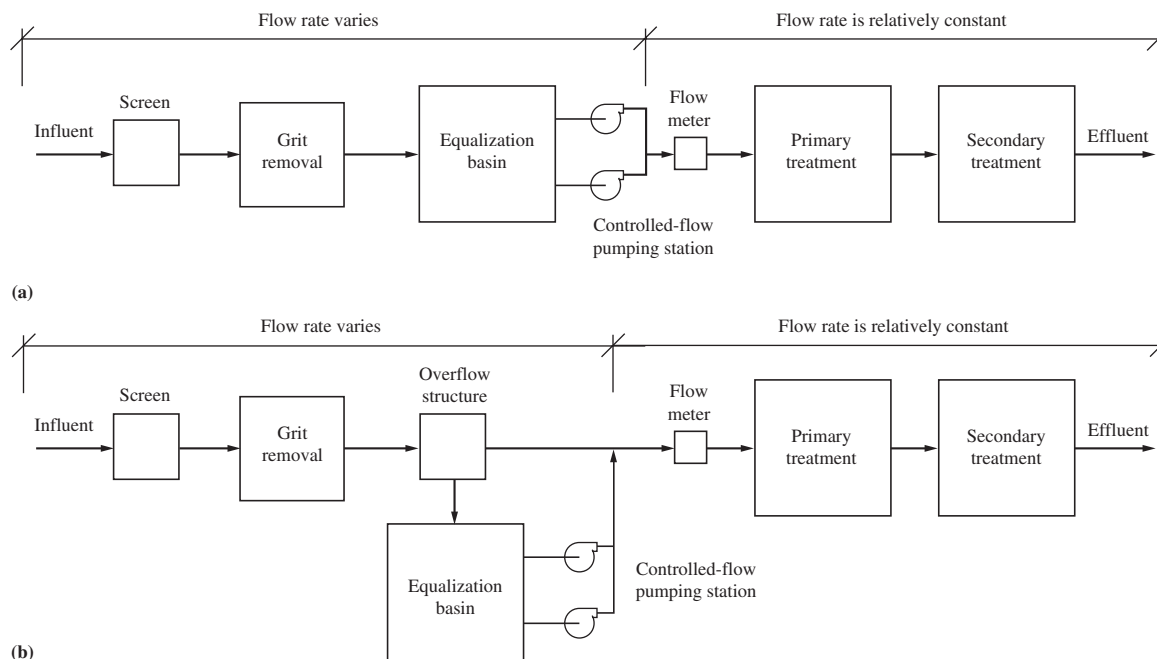

FIGURE 20-16

Typical wastewater-treatment plant flow diagram incorporating flow equalization: (a) in-line equalization and (b) off-line equalization. Flow equalization can be applied after grit removal, after primary sedimentation, and after secondary treatment where advanced treatment is used.

(Source: Metcalf & Eddy, 2003.)

The off-line arrangement is typically used to attenuate wet weather flow. In this arrangement, only the flow above some predetermined flow rate is diverted to the equalization basin. This dampens the flow rate but is not effective in damping the diurnal variation in constituent concentration.

Volume. As noted above, the required volume is estimated from diurnal flow data by performing a volume balance to determine the maximum storage volume required. In practice the volume will be larger than the theoretical value to account for the following:

1. Operation of aeration and mixing equipment will not permit complete dewatering of an in-line basin.
2. If recycle streams are brought to the mixing basin, this volume must be accommodated.
3. Contingency for variations beyond the diurnal flow pattern.

Additional volume is provided for these contingencies. The contingency multipliers range from 1.1 to 1.25 times the theoretical estimate.

Example 20-6 illustrates the estimation of the volume required for in-line equalization using the mass balance technique and the concurrent damping of the BOD_5 load.

Example 20-6. Determine the equalization basin volume required for the following cyclic flow pattern. Provide a 25% excess capacity for equipment, unexpected flow variations, and solids accumulation. Evaluate the impact of equalization on the mass loading of BOD₅.

Time, h	Flow, m ³ /s	BOD ₅ , mg/L	Time, h	Flow, m ³ /s	BOD ₅ , mg/L
0000	0.0481	110	1200	0.0718	160
0100	0.0359	81	1300	0.0744	150
0200	0.0226	53	1400	0.0750	140
0300	0.0187	35	1500	0.0781	135
0400	0.0187	32	1600	0.0806	130
0500	0.0198	40	1700	0.0843	120
0600	0.0226	66	1800	0.0854	125
0700	0.0359	92	1900	0.0806	150
0800	0.0509	125	2000	0.0781	200
0900	0.0631	140	2100	0.0670	215
1000	0.0670	150	2200	0.0583	170
1100	0.0682	155	2300	0.0526	130

Solution. Design of the equalization basin volume.

- Because of the repetitive and tabular nature of the calculations, a spreadsheet is ideal for this problem. The spreadsheet solution is easy to verify if the calculations are set up with judicious selection of the initial value. If the initial value of the first flow rate is greater than the average after the sequence of nighttime low flows, then the last row of the computation should result in a storage value of zero for a perfect sinusoidal flow pattern.
- The first step is to calculate the average flow. In this case it is 0.05657 m³/s. Next, the flows are arranged in order beginning with the time and flow that first exceeds the average. In this case it is at 0900 h with a flow of 0.0631 m³/s. The tabular arrangement is shown in Table 20-12. An explanation of the calculations for each column is given in the following steps.
- In the third column, the flows are converted to volumes using the time interval between flow measurements:

$$V = (0.0631 \text{ m}^3/\text{s})(1 \text{ h})(3,600 \text{ s/h}) = 227.16 \text{ m}^3$$

- The average volume that leaves the equalization basin is calculated in the fourth column. It is the average flow rate computed on an hourly basis.

$$V = (0.05657 \text{ m}^3/\text{s})(1 \text{ h})(3,600 \text{ s/h}) = 203.655 \text{ m}^3$$

- The fifth column is the difference between the inflow volume and the outflow volume.

$$dS = V_{\text{in}} - V_{\text{out}} = 227.16 \text{ m}^3 - 203.655 = 23.505 \text{ m}^3$$

TABLE 20-12
Spreadsheet Calculations for Example 20-6

Time	Flow, m ³ /s	Vol _{in} , m ³	Vol _{out} , m ³	dS, m ³	Σ dS, m ³	BOD ₅ , mg/L	M _{BOD-in} , kg	S, mg/L	M _{BOD-out} , kg
0900	0.0631	227.16	203.65	23.51	23.51	140	31.80	140.00	28.51
1000	0.067	241.2	203.65	37.55	61.06	150	36.18	149.11	30.37
1100	0.0682	245.52	203.65	41.87	102.93	155	38.06	153.83	31.33
1200	0.0718	258.48	203.65	54.83	157.76	160	41.36	158.24	32.23
1300	0.0744	267.84	203.65	64.19	221.95	150	40.18	153.06	31.17
1400	0.075	270	203.65	66.35	288.3	140	37.80	145.89	29.71
1500	0.0781	281.16	203.65	77.51	365.81	135	37.96	140.51	28.62
1600	0.0806	290.16	203.65	86.51	452.32	130	37.72	135.86	27.67
1700	0.0843	303.48	203.65	99.83	552.15	120	36.42	129.49	26.37
1800	0.0854	307.44	203.65	103.79	655.94	125	38.43	127.89	26.04
1900	0.0806	290.16	203.65	86.51	742.45	150	43.52	134.67	27.43
2000	0.0781	281.16	203.65	77.51	819.96	200	56.23	152.61	31.08
2100	0.067	241.2	203.65	37.55	857.51	215	51.86	166.79	33.97
2200	0.0583	209.88	203.65	6.23	863.74	170	35.68	167.42	34.10
2300	0.0526	189.36	203.65	-14.29	849.45	130	24.62	160.69	32.73
0000	0.0481	173.16	203.65	-30.49	818.96	110	19.05	152.11	30.98
0100	0.0359	129.24	203.65	-74.41	744.55	81	10.47	142.42	29.00
0200	0.0226	81.36	203.65	-122.29	622.26	53	4.31	133.61	27.21
0300	0.0187	67.32	203.65	-136.33	485.93	35	2.36	123.98	25.25
0400	0.0187	67.32	203.65	-136.33	349.6	32	2.15	112.79	22.97
0500	0.0198	71.28	203.65	-132.37	217.23	40	2.85	100.46	20.46
0600	0.0226	81.36	203.65	-122.29	94.94	66	5.37	91.07	18.55
0700	0.0359	129.24	203.65	-74.41	20.53	92	11.89	91.61	18.66
0800	0.0509	183.24	203.65	-20.41	0.12	125	22.91	121.64	24.77

- f. The required storage is computed in the sixth column. It is the cumulative sum of the difference between the inflow and outflow. For the second time interval, it is

$$\text{Storage} = \Sigma dS = 37.55 \text{ m}^3 + 23.51 \text{ m}^3 = 61.06 \text{ m}^3$$

Note that the last value for the cumulative storage is 0.12 m³. It is not zero because of round-off truncation in the computations. At this point the equalization basin is empty and ready to begin the next day's cycle.

- g. The required volume for the equalization basin is the maximum cumulative storage. It is the shaded value. With the requirement for 25% excess, the volume would then be

$$\text{Storage} = (863.74 \text{ m}^3)(1.25) = 1,079.68 \text{ or } 1,080 \text{ m}^3$$

Evaluation of the impact on BOD₅ loading.

- h. The mass of BOD₅ entering the equalization basin is the product of the inflow (Q), the concentration of BOD₅ (S_0), and the integration time (Δt):

$$M_{\text{BOD-in}} = (Q)(S_0)(\Delta t)$$

The mass of BOD₅ leaving the equalization basin is the product of the average outflow (Q_{avg}), the average concentration (S_{avg}) in the basin, and the integration time (Δt):

$$M_{\text{BOD-out}} = (Q_{\text{avg}})(S_{\text{avg}})(\Delta t)$$

The average concentration is determined as:

$$S_{\text{avg}} = \frac{(\Psi_i)(S_0) + (\Psi_s)(S_{\text{prev}})}{\Psi_i + \Psi_s}$$

- where Ψ_i = volume of inflow during time interval Δt , m³
 S_0 = average BOD₅ concentration during time interval Δt , g/m³
 Ψ_s = volume of wastewater in the basin at the end of the previous time interval Δt , m³
 S_{prev} = concentration of BOD₅ in the basin at the end of the previous time interval Δt , g/m³

- i. Noting that 1 mg/L = 1 g/m³, find that the first row (0900 h time) computations in columns 8, 9, and 10 are

$$M_{\text{BOD-in}} = (0.0631 \text{ m}^3/\text{s})(140 \text{ g/m}^3)(1 \text{ h})(3,600 \text{ s/h})(10^{-3} \text{ kg/g}) = 31.8 \text{ kg}$$

$$S_{\text{avg}} = \frac{(227.16 \text{ m}^3)(140 \text{ g/m}^3) + 0}{227.16 \text{ m}^3 + 0} = 140 \text{ g/m}^3$$

$$M_{\text{BOD-out}} = (0.05657 \text{ m}^3/\text{s})(140 \text{ g/m}^3)(1 \text{ h})(3,600 \text{ s/h})(10^{-3} \text{ kg/g}) = 28.5 \text{ kg}$$

Note that the zero values in the computation of S_{avg} are valid only at start-up of an empty basin. Also note that in this case MBOD-in and MBOD-out differ only because of the difference in flow rates.

- j. For the second row (1000 h), the computations are

$$M_{\text{BOD-in}} = (0.0670 \text{ m}^3/\text{s})(150 \text{ g/m}^3)(1 \text{ h})(3,600 \text{ s/h})(10^{-3} \text{ kg/g}) = 36.2 \text{ kg}$$

$$S_{\text{avg}} = \frac{(241.2 \text{ m}^3)(150 \text{ g/m}^3) + (23.51 \text{ m}^3)(140 \text{ g/m}^3)}{241.2 \text{ m}^3 + 23.51 \text{ m}^3} = 149.11 \text{ mg/L}$$

$$M_{\text{BOD-out}} = (0.05657 \text{ m}^3/\text{s})(149.11 \text{ g/m}^3)(1 \text{ h})(3,600 \text{ s/h})(10^{-3} \text{ kg/g}) = 30.37 \text{ kg}$$

Note that Ψ_s is the volume of wastewater in the basin at the end of the previous time interval. Therefore, it is equal to the accumulated dS . The concentration of BOD₅ (S_{prev}) is the average concentration at the end of previous interval (S_{avg}) and *not* the influent concentration for the previous interval (S_0).

k. For the third row (1100 h), the concentration of BOD₅ is

$$S_{\text{avg}} = \frac{(245.52 \text{ m}^3)(155 \text{ g/m}^3) + (61.06 \text{ m}^3)(149.11 \text{ g/m}^3)}{245.52 \text{ m}^3 + 61.06 \text{ m}^3} = 153.83 \text{ mg/L}$$

l. The ratio of the maximum BOD mass to the minimum BOD mass drops from

$$56.23 \text{ kg} : 2.15 \text{ kg} \text{ or } 26.15 : 1$$

to

$$33.97 \text{ kg} : 18.55 \text{ kg} \text{ or } 1.83 : 1$$

Comments:

1. The BOD calculations assume a completely mixed basin.
2. The volume accumulation at the end of the diurnal cycle is unlikely to be exactly zero because the diurnal flow pattern is not a perfectly symmetrical sinusoidal curve. Therefore, the pumping rate out of the equalization basin cannot be constant.

Basin Geometry. If the basin configuration is for in-line equalization, the geometry should allow the basin to function as a continuous flow stirred tank reactor. This implies that long rectangular basins should be avoided, and inlet and outlet locations should be chosen to minimize short circuiting. In particular, the inlet should discharge near the mixing equipment.

Earth basins with an impermeable liner are generally the least expensive (Figure 20-17). The slopes vary between 3:1 and 2:1. The minimum water depth is dependent on the type of aeration equipment, but typically is in the range of 1.5 to 2 m. The upper level of the embankment may need to be protected from wind-induced erosion. The top of the embankment should be wide enough to facilitate vehicle maneuvering. Fencing must be provided to prevent public access.

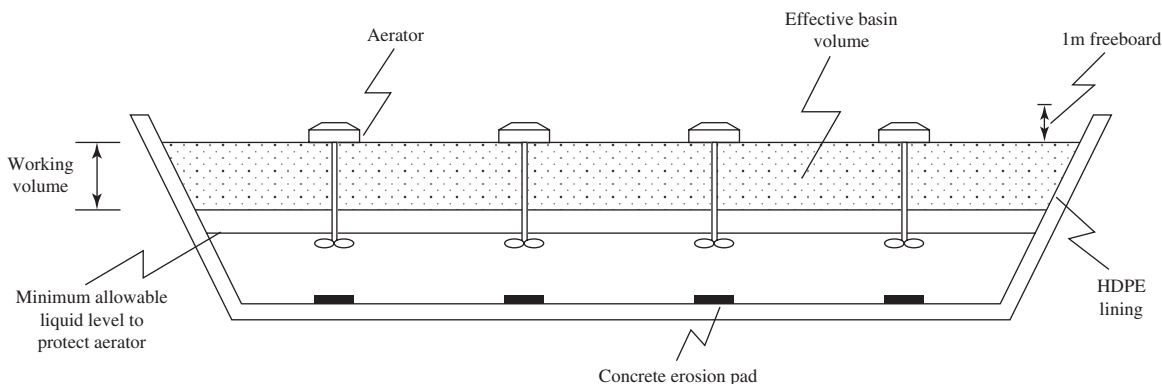

FIGURE 20-17
Equalization basin geometry for an earthen basin.

The basins may also be made out of concrete and in rare instances, out of steel. Concrete construction can minimize space requirements. If the plant is near neighborhoods, the basin can be covered to minimize odor complaints.

Mixing and Air Requirements. Both in-line and off-line equalization basins require mixing. Adequate aeration and mixing must be provided to prevent odors and solids deposition. Mechanical aerators and diffused aeration have been used to supply mixing and aeration.

The diffused aeration systems should provide 1.8 to 2.9 m³ of air/h · m³ of storage for mixing. They should use either coarse or intermediate bubble diffusers. The fine bubble diffusers tend to clog in this application. Because of the variation in depth over the operating cycle, pressure regulation should be considered in the design of the blower system. For example, positive displacement (PD) blowers are self-regulating. Others must have pressure regulator controls. The air supply should be isolated from other treatment plant aeration requirements to facilitate process aeration control (GLUMRB, 2004).

Mechanical mixing requirements for municipal wastewater with suspended solids concentrations on the order of 200 mg/L range from 0.004 to 0.008 kW/m³ of storage. To maintain aerobic conditions, air should be supplied at rate of 0.6 to 0.9 m³/h · m³ of storage (WEF, 1998).

The oxygen transfer efficiency of mechanical aerators is lower in wastewater than in tap water under standard conditions. A reasonable assumption for oxygen transfer efficiency for equalization basin design is 0.16 to 0.39 kg/MJ (WEF, 1998).

In earthen basins, a concrete pad is placed beneath mechanical aerators to prevent erosion of the bottom. The aerators may be either floating or pedestal mounted. The aerators must have a low-level shutoff in case the wastewater level is drawn below the minimum operating level.

Mechanical aerator selection is made from manufacturer's data similar to that provided in Table 20-13 and Figure 20-18. Example 20-7 illustrates the selection process.

TABLE 20-13
Selection table for floating mechanical aerators^a

Size, kW	OTR ^b , kg/MJ	Nominal operating, depth, m	Complete mix zone, m	Complete O ₂ dispersion zone, m
0.75	0.20	1.8	6	20
1.5	0.23	1.8	8	30
2.5	0.23	1.8	12	45
3.5	0.23	1.8	14	50
5.5	0.22	2.4	15	50
7.5	0.20	3.0	15	55
10	0.21	3.0	19	60
15	0.19	3.0	22	70
20	0.20	3.0	24	80
25	0.21	3.0	26	85

^aThese aerators are representative but do not represent actual choices. Actual manufacturers' data must be used for real world design.

^bOTR = oxygen transfer rate

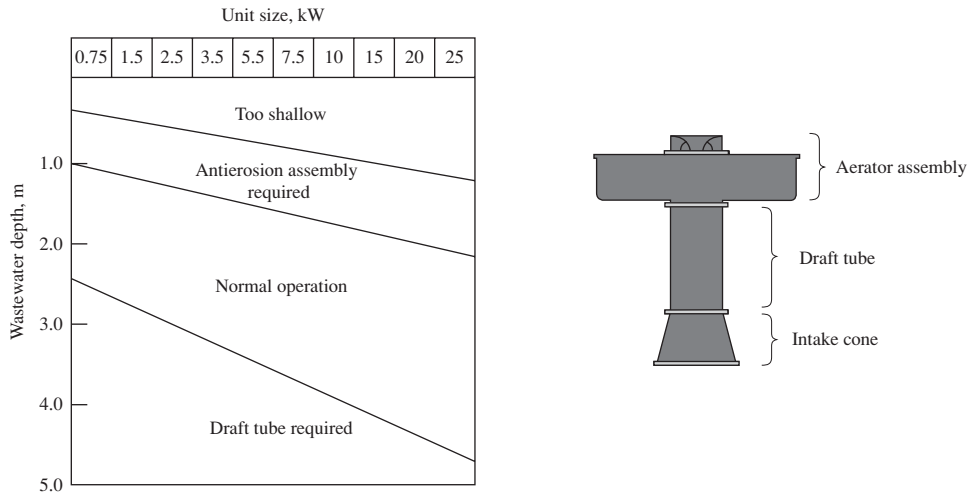

FIGURE 20-18 Floating aerator depth requirements and an illustration of a draft tub.

Example 20-7. Select an appropriate aerator and aerator configuration for the equalization basin volume calculated in Example 20-6. Assume that the aerators in Table 20-13 are available and that Figure 20-18 applies.

Solution:

- a. From Example 20-6, the required storage volume is 1,080 m³. Using the low end of the recommended range for mixing, estimate the total power required.

$$\text{Power} = (0.004 \text{ kW/m}^3)(1,080 \text{ m}^3) = 4.32 \text{ kW}$$

- b. Assume four aerators will be used. Each aerator must supply

$$\frac{4.32 \text{ kW}}{4} = 1.08 \text{ kW}$$

- c. From Table 20-13, the smallest size that will supply enough power is the 1.5 kW aerator. Use this aerator as a first trial.
- d. From Table 20-13, the nominal operating depth is 1.8 m. From Figure 20-18, the range of depths for normal operation is from 1.2 to 2.9 m. Use a depth of 2.9 m to estimate the surface area of the equalization basin.

$$A = \frac{V}{\text{depth}} = \frac{1,080 \text{ m}^3}{2.9 \text{ m}} = 372.41 \text{ m}^2$$

- e. Assume a square equalization basin and compute the dimensions.

$$\text{Length} = (372.41 \text{ m}^2)^{1/2} = 19.30 \text{ m}$$

- f. Assume each aerator is placed in one quadrant as shown in the sketch below.

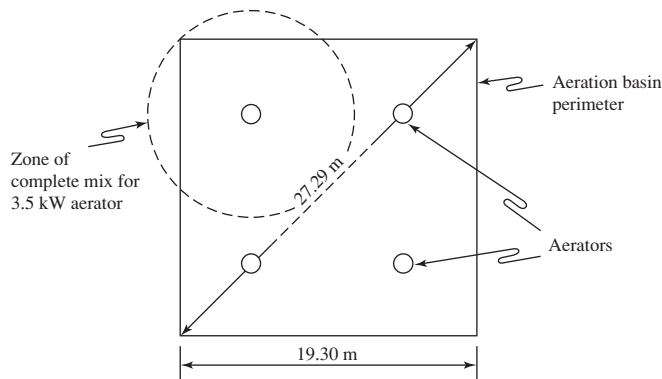

- g. The diagonal across the equalization basin is the hypotenuse of the triangle formed by the sides. The length of the hypotenuse is

$$L_{\text{hypotenuse}} = [(19.30)^2 + (19.30)^2]^{1/2} = 27.29 \text{ m}$$

- h. Check the zone of complete mixing. The specified complete mix zone is 8 m for the 1.5 kW aerator. With the aerator placed in the center of the quadrant as shown above, this aerator must completely mix a diameter of

$$\frac{27.29 \text{ m}}{2} = 13.64 \text{ m}$$

if there are to be no dead spots. Therefore, a larger aerator is required.

- i. For another trial, select a 3.5 kW aerator as it has a complete mix zone of 14 m.
j. Check the depth. From Figure 20-18, the depth is satisfactory for the 3.5 kW aerator.

Comments:

1. Multiple aerators are selected to provide redundancy.
2. Alternate solutions that require less power² are possible, but power requirements to prevent the deposition of solids may be greater than that required for blending. The actual power supplied from the four large aerators is 0.013 kW/m^3 .
3. Because the envelope for complete mixing is fixed by the diagonal, the zone of complete mixing of each aerator will overlap the edges of the basin. This may present erosion problems.

Appurtenances. The following appurtenances are provided to facilitate operation of the equalization basin: (1) hose facilities for flushing grease and solids from the basin walls, (2) a high-water takeoff to remove scum, (3) a spray system to reduce foam, (4) a bypass so that the basin may be dewatered for maintenance, and (5) a basin flushing system to remove sediment. If odors are of concern, then a covered basin with appropriate odor control should be provided.

Pumps. Low-head pumps may be required to carry the wastewater to downstream processes.

20-8 ALTERNATIVE PRELIMINARY PROCESS ARRANGEMENTS

There are a large number of arrangements for the preliminary treatment processes that will prove satisfactory. These are dependent on both the upstream and downstream processes that are employed. Combined sewage requires both a higher degree of processing and more rugged equipment than domestic sewage. The use of membrane treatment technology and/or fine bubble diffusers will require higher efficiency in removing inert solids.

Figure 20-19 illustrates a number of alternatives that have been employed. The list is not all-inclusive.

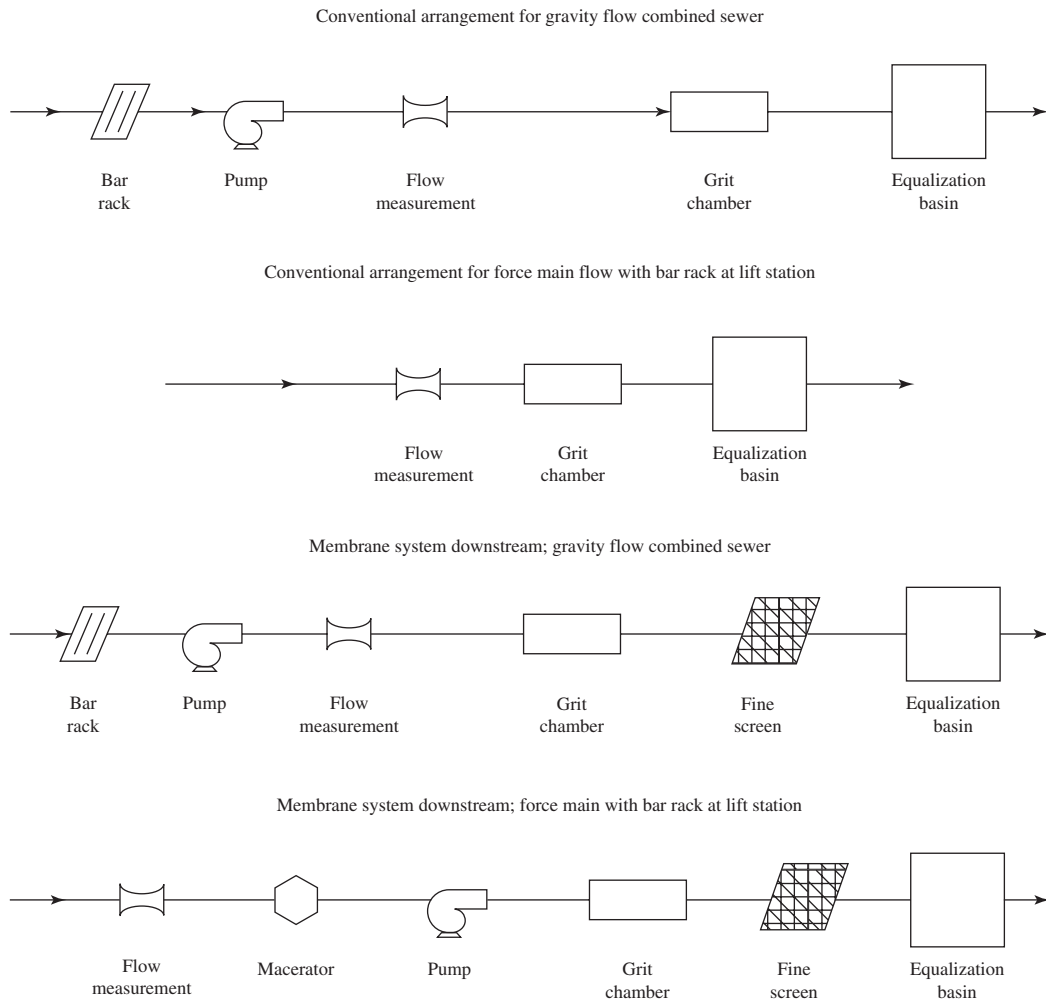

FIGURE 20-19 Examples of some alternative arrangements of preliminary treatment processes.

Visit the text website at www.mhprofessional.com/wwe for supplementary materials and a gallery of photos.

20-9 CHAPTER REVIEW

When you have completed studying this chapter, you should be able to do the following without the aid of your textbook or notes:

1. Explain the circumstances that favor the use of a screw pump or centrifugal pump in the headworks.
2. Explain the circumstances that favor the use of a Parshall flume or magnetic flow meter in the headworks.
3. Given a list of hydraulic capacities for a wastewater treatment plant, select the appropriate one for headworks processes.
4. Select an appropriate screen opening size given a description of the upstream and downstream processes and a list of available sizes.
5. Draw a sketch of the arrangement of channels for bar screens noting the method of isolation and approach distances as a function of depth of flow.
6. Discuss the philosophy of the use of coarse solids reduction versus the use of screens.
7. Sketch the cross section of an aerated grit chamber and label the longitudinal baffle, aeration header, and the critical dimension that controls the velocity across the bottom of the chamber.
8. Define SES and explain why it is a better criterion for grit removal than a sand particle.
9. Using a sketch you have drawn, show a class how an equalization basin dampens flow variations.

With the aid of this text, you should be able to do the following:

10. Design a screw pump system given the elevations and range of flow rates.
11. Select an appropriate Parshall flume given the range of flow rates and determine the depth of the flume.
12. Design the channel for a bar rack given the width to accommodate the screen.
13. Design a bar rack and estimate the headloss given an assumption about the allowable percent blockage before activation of the cleaning equipment.
14. Design an aerated grit chamber to remove a particle with a given SES.
15. Determine the volume of an equalization basin given the diurnal flow pattern.
16. Select an appropriate aeration system for a given volume of equalization basin.

20-10 PROBLEMS

- 20-1.** Using the pumps given in Table 20-1, design a screw pump system for the town of Pigeonroost using the following assumptions:

Interceptor sewer

Minimum sewage elevation = 41.91 m

Maximum sewage elevation = 42.21 m

Discharge elevation to stilling well = 46.11 m

Average flow at design life = 16,000 m³/d

Peaking factor for peak hour = 2.62

Ratio factor for minimum flow at beginning of design life = 0.49

Complete the design by providing the following: pump specifications (diameter, number of flights), number of pumps, and a sketch of the plan view with dimensions (assume the width of each pump equals the diameter of the screw plus 0.6 m).

- 20-2.** Using the pumps given in Table 20-1, design a screw pump system for the village of Fishkill using the following assumptions:

Interceptor sewer

Minimum sewage elevation = 112.60 m

Maximum sewage elevation = 112.80 m

Discharge elevation to stilling well = 116.40 m

Average flow at design life = 8,600 m³/d

Peaking factor for peak hour = 2.8

Ratio factor for minimum flow at beginning of design life = 0.49

Complete the design by providing the following: pump specifications (diameter, number of flights), number of pumps, and a sketch of the plan view with dimensions (assume the width of each pump equals the diameter of the screw plus 0.6 m).

- 20-3.** The manufacturer of the screw pumps listed in Table 20-1 has rated the pumps at an angle of 38° to shorten the footprint and increase the lift. The rating downsizes the flow rate by a factor of 0.71 and increases the head available by a factor of 1.4. Rework Problem 20-1 with the new ratings for the screw pumps.

Complete the design by providing the following: pump specifications (diameter, number of flights), number of pumps, sketch of the plan view with dimensions (assume the width of each pump equals the diameter of the screw plus 0.6 m).

- 20-4.** The manufacturer of the screw pumps listed in Table 20-1 has rated the pumps at an angle of 38° to shorten the footprint and increase the lift. The rating downsizes the flow rate by a factor of 0.71 and increases the head available by a factor of 1.4. Rework Problem 20-2 with the new ratings for the screw pumps.

Complete the design by providing the following: pump specifications (diameter, number of flights), number of pumps, sketch of the plan view with dimensions (assume the width of each pump equals the diameter of the screw plus 0.6 m).

- 20-5.** Using the data for the town of Pigeonroost (Problem 20-1), select a Parshall flume from the options available in Table 20-2. Identify the selection by the throat width. Determine the depth of the flume if 0.6 m of freeboard is to be provided.

- 20-6.** Using the data for the village of Fishkill (Problem 20-2), select a Parshall flume from the options available in Table 20-2. Identify the selection by the throat width. Determine the depth of the flume if 0.6 m of freeboard is to be provided.
- 20-7.** The preliminary design using a Parshall flume and screw pump for the town of Pigeonroost's WWTP (Problems 20-1 and 20-5) resulted in too much space. An alternative design calls for a pump to lift the sewage and a magnetic flow meter to measure the flow. Assuming that the velocity in the pipe is to be about 1 m/s, perform a web search to locate an appropriate magnetic flow meter. The flow meter must fit in one of the following standard pipe sizes (all in mm): 100, 125, 150, 200, 250, 300, 350, 375, 400.
- 20-8.** The Parshall flume and screw pump for the village of Fishkill's WWTP (Problems 20-2 and 20-6) resulted in too much space. An alternative design calls for a pump to lift the sewage and a magnetic flow meter. Assuming that the velocity in the pipe is to be about 1 m/s, perform a web search to locate an appropriate magnetic flow meter. The flow meter must fit in one of the following standard pipe sizes (all in mm): 100, 125, 150, 200, 250, 300, 350, 375, 400.
- 20-9.** Continuing the design of preliminary treatment facilities for the town of Pigeonroost WWTP (Problem 20-1), design a bar rack channel using an inlet channel width of 0.68 m, a slope of 0.00025, and the assumptions used in Example 20-3. Assume 0.6 m of freeboard is to be provided.
- 20-10.** Continuing the design of preliminary treatment facilities for the village of Fishkill WWTP (Problem 20-2), design a bar rack channel using an inlet channel width of 0.84 m, a slope of 0.00050 and the assumptions used in Example 20-3. Assume 0.6 m of freeboard is to be provided.
- 20-11.** Continuing the design of preliminary treatment facilities for the town of Pigeonroost's WWTP (Problem 20-1), estimate the headlosses for a bar rack using an inlet channel width of 0.68 m and the assumptions used in Example 20-4.
- 20-12.** Continuing the design of preliminary treatment facilities for the village of Fishkill WWTP (Problem 20-2), estimate the headlosses for a bar rack using using an inlet channel width of 0.84 m and the assumptions used in Example 20-4.
- 20-13.** Keller et al. (2006) reported that fine screens with 3 mm openings have approximately 35% effective open area. Estimate the headloss for a flow rate of 16,000 m³/d through a 3.2 m² clean fine screen with 3 mm openings.
- 20-14.** Keller et al. (2006) reported that fine screens with 1 mm openings have approximately 31% effective open area. Estimate the headloss for a flow rate of 8,600 m³/d through a 1.6 m² clean fine screen with 3 mm openings.
- 20-15.** Using Newton's equation (Equation 20-8) and Camp's scour equation (Equation 20-9), demonstrate that a grit particle with a diameter of 200 μ m and a specific gravity of 2.65 results in a design overflow rate of 0.021 m/s and a horizontal velocity greater than 0.056 m/s and less than 0.23 m/s for an horizontal flow grit chamber if the organic particles of the same size have a specific gravity of 1.10. Assume $\beta = 0.06$ and $f = 0.03$.

- 20-16.** Continuing the design of preliminary treatment facilities for the town of Pigeon-roost's WWTP (Problem 20-1), design an aerated grit chamber. Use Albrecht's equation and assume a slot velocity of ≤ 0.15 m/s is required to achieve removal of the design SES. Assume the sewers are separated and use a worst case situation for the design of the grit channel. To complete the design, specify the air supply rate and provide a sketch of the cross section with dimensions.
- 20-17.** Continuing the design of preliminary treatment facilities for the village of Fishkill WWTP (Problem 20-2), design an aerated grit chamber. Use Albrecht's equation and assume the required bottom velocity must achieve removal of a $60 \mu\text{m}$ SES particle. Assume the sewers are separated and use a worst case situation for the design of the grit channel. To complete the design, specify the air supply rate and provide a sketch of the cross section with dimensions.
- 20-18.** A treatment plant being designed for Cynusoidal City requires an equalization basin to even out flow and BOD variations. The average daily flow is $0.400 \text{ m}^3/\text{s}$. The following flows and BOD_5 have been found to be typical of the average variation over a day. What volume equalization basin is required to provide for a uniform outflow equal to the average daily flow? Assume the flows are hourly averages and that an addition of 25% to the estimated volume will be provided to account for contingencies.

Time	Flow, m^3/s	BOD_5 , mg/L	Time	Flow, m^3/s	BOD_5 , mg/L
0000	0.340	123	1200	0.508	268
0100	0.254	118	1300	0.526	282
0200	0.160	95	1400	0.530	280
0300	0.132	80	1500	0.552	268
0400	0.132	85	1600	0.570	250
0500	0.140	95	1700	0.596	205
0600	0.160	100	1800	0.604	168
0700	0.254	118	1900	0.570	140
0800	0.360	136	2000	0.552	130
0900	0.446	170	2100	0.474	146
1000	0.474	220	2200	0.412	158
1100	0.482	250	2300	0.372	154

- 20-19.** A treatment plant being designed for Metuchen requires an equalization basin to even out flow and BOD variations. The following flows and BOD_5 have been found to be typical of the average variation over a day. What volume of equalization basin is required to provide for a uniform outflow equal to the average daily flow? Assume the flows are hourly averages and that an addition of 25% to the estimated volume will be provided to account for contingencies.

Time	Flow, m ³ /s	BOD ₅ , mg/L	Time	Flow, m ³ /s	BOD ₅ , mg/L
0000	0.0875	110	1200	0.135	160
0100	0.0700	81	1300	0.129	150
0200	0.0525	53	1400	0.123	140
0300	0.0414	35	1500	0.111	135
0400	0.0334	32	1600	0.103	130
0500	0.0318	42	1700	0.104	120
0600	0.0382	66	1800	0.105	125
0700	0.0653	92	1900	0.116	150
0800	0.113	125	2000	0.127	200
0900	0.131	140	2100	0.128	215
1000	0.135	150	2200	0.121	170
1100	0.137	155	2300	0.110	130

- 20-20.** Using a spreadsheet program you have written, compute and plot the unequalized and the equalized hourly hydraulic loadings to the Cynusoidal City (Problem 20-18) for the maximum day. Assume that the ratio of the maximum day flow rate to the average day flow rate is 1.8. Determine the following ratios for hydraulic loading: peak to average, minimum to average, peak to minimum.
- 20-21.** Using a spreadsheet program you have written, compute and plot the unequalized and the equalized hourly hydraulic loadings to the Metuchen WWTP (Problem 20-19) for the maximum day. Assume that the ratio of the maximum day flow rate to the average day flow rate is 2.2. Determine the following ratios for hydraulic loading: peak to average, minimum to average, peak to minimum.
- 20-22.** Using a spreadsheet program you have written, compute and plot the unequalized and the equalized hourly BOD mass loadings to the Cynusoidal City WWTP (Problem 20-18). Determine the following ratios for BOD mass loading: peak to average, minimum to average, peak to minimum.
- 20-23.** Using a spreadsheet program you have written, compute and plot the unequalized and the equalized hourly BOD mass loadings to the Metuchen WWTP (Problem 20-19). Determine the following ratios for BOD mass loading: peak to average, minimum to average, peak to minimum.
- 20-24.** Design an aerator system for Cynusoidal City's equalization basin (Problem 20-18). Assume that the aerators in Table 20-13 are available and that Figure 20-18 applies. To complete the design, specify the aerator by the unit's power and provide a sketch of the plan view of the basin with the location of the aerators and the dimensions of the basin.
- 20-25.** Design an aerator system for Metuchen's equalization basin (Problem 20-19). Assume that the aerators in Table 20-13 are available and that Figure 20-18 applies. To complete the design, specify the aerator by the unit's power and provide a sketch of the plan view of the basin with the location of the aerators and the dimensions of the basin.

20-11 DISCUSSION QUESTIONS

- 20-1.** A Partial flume may be used to measure wastewater flow. True or false?
- 20-2.** Using a sketch, show how the 10D rule is to be implemented in designing a bar rack.
- 20-3.** A 100 mm diameter line has been installed to carry grit from an aerated grit chamber to the grit washer. It often plugs and must be dismantled for cleaning. Suggest a design that would minimize this difficulty.
- 20-4.** Mixing must be provided in equalization tanks to prevent solids from settling. True or false?

20-12 REFERENCES

- Albrecht, A. E. (1967) "Aerated Grit Operation, Design and Chamber," *Water and Sewage Works*, vol. 114, no. 9, pp. 331–335.
- ASTM (1991) *Standard Test Method for Open Channel Flow Measurement of Water with the Parshall Flume*, American Society for Testing and Materials, ASTM D1941-91.
- Burbano, M., W. McConnell, C. Knatz, D. Bisson, and B. Tarbuck (2009) "Affordable Modifications," *Water Environment & Technology*, vol. 21, no. 10, pp. 40–45.
- Camp, T. R. (1942) "Grit Chamber Design," *Sewage Works Journal*, vol. 14, pp. 368–381.
- Daukss, P. (2006) "Design Considerations for Screening," presented at Michigan Water Environment Association Process Seminar, Grand Rapids, Michigan, November, 2.
- Eutek (2008) Eutek Systems, Hillsboro, Oregon.
- Fair, G. M. and J. C. Geyer (1954) *Water Supply and Waste-Water Disposal*, John Wiley & Sons, New York, p. 611.
- Forstner, G. (2007) "Screen Selection Simplified," *Water Environment & Technology*, October, pp. 60–64.
- Garbus, R. O. (2006) "Types of Pumps," in G. M. Jones, (ed.), *Pump Station Design*, Elsevier, New York, pp. 11.37–11.39.
- GLUMRB (2004) *Recommended Standards for Wastewater Facilities*, Great Lakes–Upper Mississippi River Board of State and Provincial Public Health and Environmental Managers, Health Education Services, Albany, New York, pp. 60-1–60-9.
- Imhoff, K. and K. R. Imhoff (1979) *Taschbuch der stadtentwässerung*, R. Oldenbourg Verlag, Munich.
- ISO (1992) *Measurement of Liquid Flow in Open Channels—Parshall and Sanitary Flumes*, International Organization of Standards, ISO 9826:1992(E).
- Keller, J., C. Wallis-Lage, and I. Crabtree (2006) "The Fine Art of Screening," *Water Environment & Technology*, December, pp. 52–55.
- LMNO (2008) *Parshall Flume Calculations, Equations, Graphs Based on ISO 9826 Methodology*, at <http://www.lmnoeng.com/Flume/parshall.htm>.
- Makie, A. and K. Oyler (2007) "The Industry's Finest," *Water Environment & Technology*, July, pp. 69–74.
- Metcalf & Eddy (1930) *Sewerage and Sewage Disposal*, McGraw-Hill, New York, p. 507.
- Metcalf & Eddy (1972) *Wastewater Engineering: Collection, Treatment, Disposal*, McGraw-Hill, New York, pp. 97–98.
- Metcalf & Eddy (2003) *Wastewater Engineering: Collection, Treatment, Disposal*, 4th ed., McGraw-Hill, New York, pp. 315–344.
- Morales, L. and D. Reinhart (1984) "Full-Scale Evaluation of Aerated Grit Chambers," *Journal of Water Pollution Control Federation*, vol. 56, no. 4, pp. 337–343.

- Parshall, R. L. (1926a) *Bulletin 336*, Colorado Experiment Station, Bureau of Engineering, U.S. Department of Agriculture, Fort Collins, Colorado.
- Parshall, R. L. (1926b) "The Improved Venturi Flume," *Transactions of American Society of Civil Engineers*, vol. 89, p. 841.
- Parshall, R. L. (1941) *Farmer's Bulletin 1683*, U.S. Department of Agriculture, Washington, D.C.
- Pugh, L. (2008) Personal communication.
- Sawicki, J. M. (2004) "Aerated Grit Chambers Hydraulic Design Equation," *Journal of Environmental Engineering*, vol. 130, no. 9, pp. 1,050–1,058.
- Spangler, J. (2006) "The Grit of the Nitty Gritty," presented at Michigan Water Environment Association Process Seminar, Grand Rapids, Michigan, November, 2.
- Steel, E. W. and T. J. McGhee (1979) *Water Supply and Sewerage*, 5th ed., McGraw-Hill, New York, pp. 456–467.
- Stevens (1998) *Stevens Water Resources Data Book*, 6th ed., Stevens Water Monitoring Systems, Inc., Beaverton, Oregon.
- U.S. EPA (1979) *Process Design Manual for Sludge Treatment and Disposal*, U.S. Environmental Protection Agency Pub. No. 625/1-79-011, Washington, D.C.
- WEF (1998) *Design of Municipal Wastewater Treatment Plants*, 4th ed., Water Environment Federation Manual of Practice 8, Alexandria, Virginia, pp. 9-1–9-58, 10-1–10-70.
- Wilson, G., G. Tchobanoglous, and J. Griffiths (2007a) "The Nitty Gritty: Grit Sampling and Analysis," *Water Environment & Technology*, July, pp. 64–68.
- Wilson, G., G. Tchobanoglous, and J. Griffiths (2007b) "The Nitty Gritty: Designing a Grit Removal System," *Water Environment & Technology*, September, pp. 115–116.
- Wilson, G., G. Tchobanoglous, and J. Griffiths (2007c) "The Nitty Gritty: Grit Washing System Design," *Water Environment & Technology*, October, pp. 81–84.
- WPCF (1971) *Aeration in Wastewater Treatment*, Water Pollution Control Federation Manual of Practice No. 5, Washington, D.C., p. 3.

This page intentionally left blank

CHAPTER

21

PRIMARY TREATMENT

21-1 INTRODUCTION

21-2 SEDIMENTATION THEORY

21-3 SEDIMENTATION PRACTICE

21-4 SEDIMENTATION BASIN DESIGN

21-5 OTHER PRIMARY TREATMENT
ALTERNATIVES

21-6 CHAPTER REVIEW

21-7 PROBLEMS

21-8 REFERENCES

21-1 INTRODUCTION

Primary treatment is the first process in the wastewater treatment plant to remove a significant fraction of organic particulate matter (suspended solids). These suspended solids contribute to biochemical oxygen demand (BOD₅) of the wastewater. Thus, removing suspended solids also reduces BOD₅. The process is important because the reduction of suspended solids and BOD₅ lowers the oxygen demand, decreases the rate of energy consumption, and reduces operational problems with downstream biological treatment processes. Primary treatment also serves the important function of removing scum and inert particulate matter that was not removed in the grit chamber. The scum consists of grease, oil, plastic, leaves, rags, hair, and other floatable material.

The principal form of primary treatment is sedimentation. Consequently, this process is often referred to as *primary sedimentation*. It is the oldest and most widely used unit operation in wastewater treatment. Other modifications and alternatives that have seen increasing use are enhanced sedimentation, fine screens, and ballasted flocculation/sedimentation.

The major focus of this chapter is on the design of primary clarifiers. The use of plate and tube settlers, enhanced sedimentation, fine screens, and ballasted flocculation/sedimentation will also be discussed.

21-2 SEDIMENTATION THEORY

At its most fundamental level, the controlling parameter in primary sedimentation is the settling velocity of the particle. Although all “types” of settling probably occur in a primary clarifier, the behavior of settling particles is dominated by the phenomenon commonly described as Type II (flocculant) sedimentation. This phenomenon is described in Chapter 10.

Nonideal Behavior

As noted in Chapter 10, Camp (1936) demonstrated that the removal efficiency of discrete particles of uniform size, density, and shape may be established by design of the overflow rate. Wastewater solids seldom fit the description of discrete particles. Because they are flocculating, the detention time and depth of the tank become important variables both in theory and in practice.

Detention Time. As a general rule, the rate of flocculation of particles by fluid motion (*orthokinetic* flocculation) may be described as first order with respect to the concentration of particles, the velocity gradient of the fluid motion, and the floc volume fraction (O’Melia, 1972):

$$\frac{dN}{dt} = -4 \frac{\eta}{\pi} G \Omega N_0 \quad (21-1)$$

where dN/dt = change in the number of particles per unit volume with time

η = collision efficiency

G = velocity gradient, s^{-1}

Ω = volume of colloidal particles per unit volume, dimensionless

N_0 = initial number of particles per unit volume, m^{-3}

Thus, up to a point in time, a longer detention time will increase flocculation and improve the efficiency of the settling tank as the particles flocculate and settle more rapidly. Because the

number of particles decreases with time, and because the collisions break up some particles, there is a point in time where formation and breakup are about equal (Parker et al., 1972). Thus, there is a time beyond which further detention adds little to the efficiency of removal.

Because the settled material (commonly referred to as *sludge* or *raw sludge*) is biologically active, at some point it will become anaerobic after it settles. The gases released from the anaerobic decomposition will tend to lift the settled material back into the flow stream and, thus, lower the efficiency. There is an optimum detention time between the detention time required to achieve good flocculation removal and the excess detention time that causes gas production to lift the sludge. Of course, removal of the sludge in a timely manner increases the breadth of the optimum window of time.

Depth of Tank. With the recognition that the detention time is, in addition to overflow rate, theoretically (and practically) important in the design, then the depth of the tank also becomes of theoretical significance. To capture a settling particle, the particle must strike the sludge layer at the bottom of the tank. If the particle cannot settle through the depth of the wastewater to reach the bottom of the tank in the allotted detention time, it will not be captured. Thus, if the tank is too deep, the efficiency will be impaired. On the other hand, from a practical point of view, there must be some space provided to store the settled material and to accommodate the sludge removal equipment.

Velocity of Flow. Although there is an inherent assumption of quiescent conditions in the clarifier, there is a velocity of flow. This velocity must be low enough to avoid scouring of the settled material back into the flow stream. The scour velocity introduced in Chapter 20 (Equation 20-9) sets the upper bound for the velocity through the tank. The critical scour velocity may be estimated by Camp's (1942) equation, repeated here for convenience:

$$v_{\text{scour}} = \left[\frac{8\beta(\rho_s - \rho)(g)(d)}{1,000(f)} \right]^{1/2} \quad (21-2)$$

where β = dimensionless constant

ρ_s = density of particle, kg/m³

ρ = density of water, kg/m³

g = acceleration due to gravity = 9.81 m/s²

d = particle diameter, m

f = dimensionless Darcy-Weisbach friction factor

The dimensionless constant (β) ranges from 0.04 for unigranular material to 0.06 for sticky, interlocking material. The Darcy-Weisbach friction factor is taken to be in the range 0.02 to 0.03.

21-3 SEDIMENTATION PRACTICE

A Design Philosophy

Historically, the design goal of primary treatment has been framed in the context of an arbitrary percentage removal of total suspended particles without a justification for the selection of the percentage removal or a means of assessing whether or not the goal has been achieved. A currently evolving philosophy is that the primary clarifier should be designed on the basis of the oxidative capacity of the downstream biological processes. Primary clarifiers can remove more

BOD and solids for less operational cost than any other treatment process in use today (Wahlberg, 2006). Thus, it makes both economic sense and design sense to remove, to the maximum extent possible, the settleable solids and settleable BOD by primary settling.

From an operational perspective, under most situations the design should minimize the conditions that promote biological activity in the primary clarifier. An exception to this approach occurs when biological phosphorus removal is to occur downstream. In this case, the primary clarifier may be used to generate volatile fatty acids to promote biological phosphorus removal (Wahlberg, 2006). Biological phosphorus removal is discussed in Chapter 23.

Alternatives

Circular and rectangular tanks are the most common configurations. Square tanks with circular sludge collection mechanisms have been used. These have generally proven unsatisfactory because of sludge build up in the corners, and fouling of the more complex sludge collection mechanism. Stacked rectangular tanks have been used where space is highly restricted. They have a much higher construction cost and require more complex structural design. Plate settlers have become an important design alternative in primary sedimentation.

Of the alternatives, rectangular and circular tanks with and without plate settlers are favored for primary sedimentation. The following discussion will focus on these preferred alternatives.

Circular Tanks

In circular tanks the theoretical flow pattern is radial. The wastewater is introduced either in the center or around the periphery (Figure 21-1). The center-feed type is more commonly used for primary treatment. The wastewater is carried to the center of the tank by either a pipe suspended from a bridge or one that is encased in concrete below the tank floor. At the center of the tank, flow enters a circular feedwell that is designed to distribute the wastewater flow equally in all directions.

Small circular tanks (< 9 m diameter) have sludge removal equipment supported on beams spanning the tank. Larger tanks have a central pier that supports the equipment. Access for service is provided by a bridge-walkway. The bottom of the tank is sloped to form an inverted cone. The sludge is scraped to a hopper located near the center of the tank.

To provide redundancy, a minimum of two tanks is provided. Tanks are typically arranged in pairs with a flow-splitting box between them (Figure 21-2). Concrete is commonly used for construction of tanks for municipal systems.

Circular tanks are favored because they require less maintenance, the drive bearings are not under wastewater, and the construction cost is generally lower than that for rectangular tanks. The disadvantages of circular tanks are that they require a larger footprint because they cannot be built with a common wall, and that they require more yard piping and pumping facilities.

Rectangular Tanks

Although transverse and vertical flow tanks have been used, the typical primary settling tank is designed for longitudinal flow. The flow enters and exits through the narrow ends. Wastewater is carried to the tank in a covered channel. It enters the tank through one or more inlet ports. A baffle is provided immediately downstream of the inlet to dissipate the inlet port velocity and distribute the flow and solids equally across the cross-sectional area of the tank.

Typically chain-and-flight scrapers (Figure 21-3) are used to remove sludge. The chain-and-flight system differs from that used in water treatment plant settling tanks in that the “return” of the flights is placed at the top of the clarifier to remove scum.

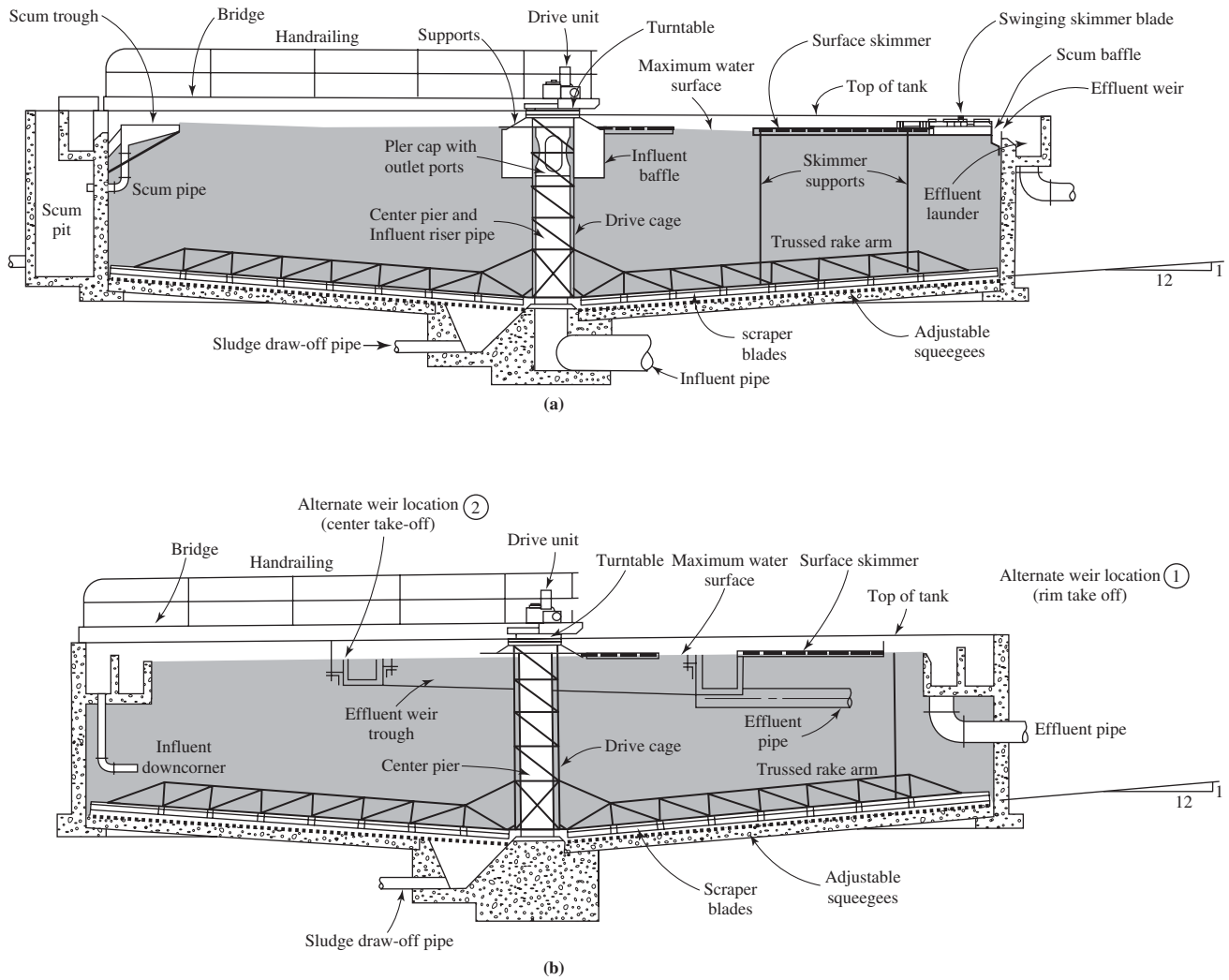

FIGURE 21-1
Circular primary setting tanks: (a) center-feed, (b) peripheral feed. (Source: Metcalf & Eddy, 1991.)

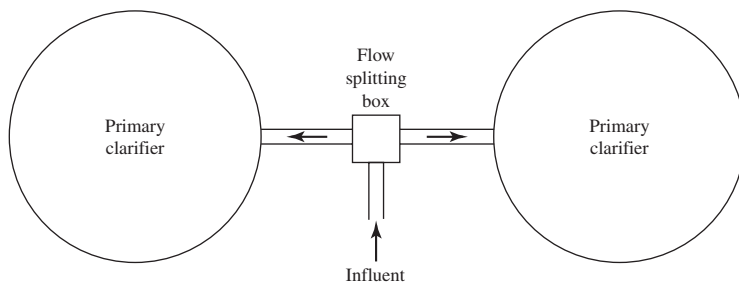

FIGURE 21-2
Flow splitting box for two circular primary clarifiers.

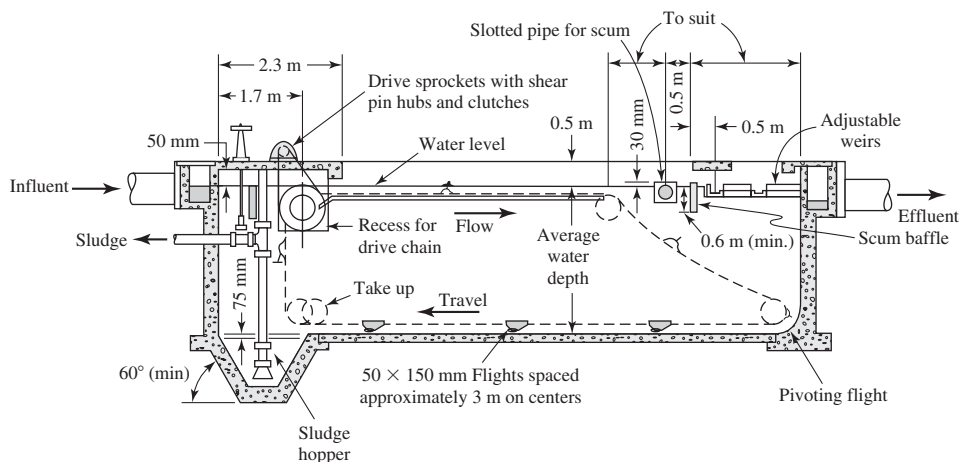

FIGURE 21-3
Rectangular primary settling tank. (Source: Davis and Cornwell, 2008.)

Sludge is carried to a hopper at one end of the tank. In larger tanks, this hopper will be a transverse trough with a cross collector that carries the sludge to one side of the tank where the sludge take-off pipe and pump are located. Because the tanks are typically built in multiple units for redundancy, a common sludge pump may serve several clarifiers.

Rectangular tanks are favored when space is a constraint because they may be constructed with a common wall and piping arrangements are more economical than for circular tanks. They have had the disadvantage that drive bearings are under water. The use of nonmetallic equipment in the tanks has significantly reduced the maintenance needs of rectangular tanks.

21-4 SEDIMENTATION BASIN DESIGN

General

The general design criteria for both circular and rectangular tanks are presented here. The special considerations that apply only to one or the other type are discussed separately in later sections that deal with these types specifically.

Redundancy. Multiple units capable of independent operation are required for all plants where design average flows exceed $380 \text{ m}^3/\text{d}$ (GLUMRB, 2004).

Hydraulic Load. The historic hydraulic design approach was to use the design average flow rate. As noted in Chapter 18, the peak flows may be a factor of 2 or 3 times the design average flow and in extreme cases, especially in very small communities or those with combined sewers, it may be as high as 10 to 15 times the design average. Young et al. (1978) suggest that the peak four-hour flow rate is an appropriate basis for design.

If the design philosophy is to maximize the efficiency of the primary clarifier in order to minimize the load on the downstream biological processes, then the hydraulic design should address the peak flow. This may be accomplished by equalization (discussed in Chapter 20),

or by sizing of the primary clarifier for the peak flow, or a combination of these techniques. An equalization basin provides a means of damping the peak flow, but it does not eliminate it.

An alternative approach is to design for less extreme peak-to-average flow rates in the primary clarifier and to design the biological treatment unit to handle the increased BOD load during peak flow events. This approach is advocated when low BOD loads predominate and a less efficient primary clarifier provides the organic matter required to support the microorganism mass. This condition frequently occurs in small plants at start-up.

Recycle streams from waste activated sludge, thickening supernatant, digester supernatant, dewatering operations, and backwashing must be considered in the hydraulic load. The potential for surges from these sources to disrupt the performance of the clarifier is high (WEF, 1998). The use of the primary clarifier as a thickener for waste activated sludge is particularly troublesome and should be avoided except in extenuating circumstances. However, it is recommended that the piping system be designed so that the primary tank can be used when the waste activated sludge thickener is out of service. Surges from other recycle streams should be minimized or returned during low-flow periods.

Overflow Rates. Recommended overflow rates range from 30 to 50 m/d ($\text{m}^3/\text{d} \cdot \text{m}^2$) at average design flow without waste activated sludge recycle (Metcalf & Eddy, 2003; U.S. EPA, 1975). Recommended peak hour overflow rates range from 60 to 120 m/d (Metcalf & Eddy, 2003; Reardon, 2006). GLUMRB (2004) recommends an overflow rate of 40 m/d at the average design flow and 60 to 80 m/d at the peak hourly flow.

Where waste activated sludge must be returned to the primary clarifier, the recommended overflow rates at average design flow range from 24 to 32 m/d. The peak hour overflow rates range from 40 to 70 m/d (Metcalf & Eddy, 2003). GLUMRB recommends a peak hour overflow rate less than 50 m/d when waste activated sludge is returned to the primary clarifier.

Hydraulic Detention Time. Typical theoretical hydraulic detention times range from 1.5 to 2.5 hours with a typical value of 2.0 hours. While not explicitly stated, it is assumed that these detention times are at the average design flow rate. Actual detention times may be considerably less than this. For example, reported dye tests on a tank with a theoretical detention time of 202 minutes had an actual detention time of 74 minutes (Daukss and Lunn, 2007).

From data presented by Wahlberg (2006), it appears that the fraction of solids removed by settling reaches a maximum in about 30 minutes at average design flow rates. This coincides with a 30 minute flocculation time to achieve the minimum supernatant concentration (Parker et al., 2000).

Low-flow periods at plant start up may result in substantially longer detention times with resultant septic conditions. Detention times of more than 1.5 hours without continuous sludge withdrawal may result in resolubilization of organic matter. This will reduce BOD removal efficiency and potentially result in odor problems (WEF, 1998). Multiple tanks allow more flexibility during the start up of a new plant.

Velocity. In practice, the linear flow-through velocity has been limited to 0.020 to 0.025 m/s to prevent scour and resuspension of settled solids (WEF, 1998).

Weirs and Weir Loading Rates. The most common type of weir plate is one made with 90-degree v-notches at 150 or 300 mm intervals. This design is selected in preference to a flat plate or a square notch weir that are subject to unbalanced flow if they are not perfectly level and/or they are subject to wind effects (Tekippe, 2006).

Weir loading rates have little effect on the performance of primary settling tanks with wall depths greater than 3.7 m (Metcalf & Eddy, 2003, WEF, 1998). In practice weir loading rates seldom exceed $120 \text{ m}^3/\text{d} \cdot \text{m}$ of weir length in plants with average design flow rates less than $3,800 \text{ m}^3/\text{d}$ or $190 \text{ m}^3/\text{d} \cdot \text{m}$ in plants treating more than $3,800 \text{ m}^3/\text{d}$ (WEF, 1998). However, Metcalf & Eddy (2003) reported loading rates ranging from 125 to $500 \text{ m}^3/\text{d} \cdot \text{m}$ with a typical value of $250 \text{ m}^3/\text{d} \cdot \text{m}$.

Sludge Hoppers. Because the raw sludge is very sticky, it tends to accumulate on the sludge hopper sides, in corners, and arch over the sludge draw-off piping. To minimize these effects, the sludge hopper side walls should have a minimum side wall slope of 1.7 vertical : 1 horizontal (60° from horizontal), and the bottom dimension should not exceed 0.6 m. Extra depth sludge hoppers for sludge thickening are not acceptable (GLUMRB, 2004).

Geotechnical Considerations. The foundation of all tanks in water and wastewater treatment must be addressed. The location of the wastewater treatment plant at a topographically low elevation next to a river to facilitate gravity collection and wastewater disposal increases the importance of geotechnical considerations. This is because the soils in these locations are often of poor stability, and are typically saturated.

Traditional geotechnical consideration of foundation settlement is addressed in depth in standard texts. It will not be discussed here. The other critical issue in the design of tanks is the potential for flotation.

The following definitions provide a basis for analysis of the problem:

- *Intergranular pressure* (p_{ig}): pressure that is transmitted from grain to grain of the solid constituents of the soil.
- *Porewater pressure* (p_w): pressure that is transmitted through the water that fills the voids of the soil.

Figure 21-4 shows a laboratory setup that illustrates the problem. It consists of a container on the right-hand side that is partly filled with granular material and completely filled with water. A flexible tube is connected to the bottom of the container, and a reservoir of water is on the left-hand side. In Figure 21-4a the water level in the reservoir is at the same elevation as the water level in the container so that no flow takes place. The soil is saturated. On a plane denoted by $a-b$ at a depth $H_L + z$ below the top of the container, the vertical pressure is

$$p = (H_L)(\gamma_w) + (z)(\gamma_{\text{sat}}) \quad (21-3)$$

where p = total pressure, kPa
 $= p_{ig} + p_w$
 γ_w = unit weight of water, kg/m^3
 γ_{sat} = unit weight of saturated soil, kg/m^3

and

$$p_w = (H_L + z)(\gamma_w) \quad (21-4)$$

$$p_{ig} = z(\gamma_{\text{sat}} - \gamma_w) = z\gamma' \quad (21-5)$$

where γ' = submerged unit weight, kg/m^3 .

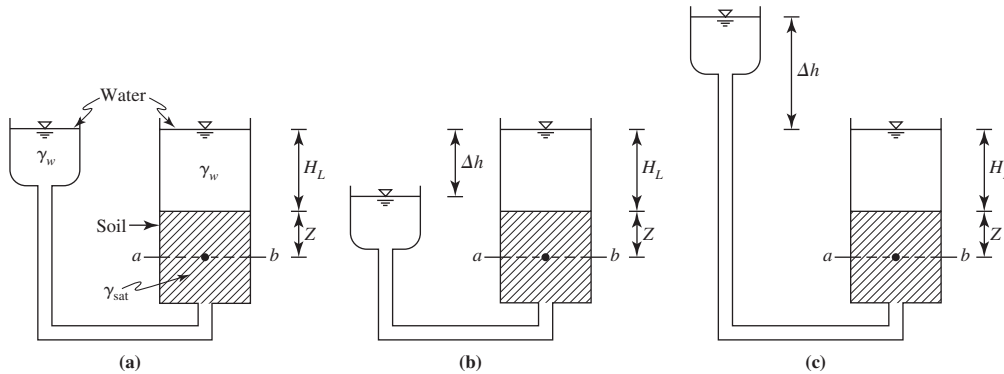

FIGURE 21-4

Experimental set up to demonstrate pressure relationships under different groundwater scenarios.

If the hydraulic gradient is such that downward flow exists, as shown in Figure 21-4b, then at $H_L + z$ the total pressure is

$$p = z\gamma' + \left(\frac{\Delta h}{H_s}\right)(z)(\gamma_w) \quad (21-6)$$

where Δh = difference in elevation between the top of the reservoir and the top of the water in the container, m

H_s = height of the soil layer in the container, m

$\Delta h/H_s$ = hydraulic gradient, dimensionless

At the bottom of the container, the pore water pressure is

$$p_w = (H_L + H_s - \Delta h)(\gamma_w) \quad (21-7)$$

If the hydraulic gradient is such that upward flow exists, as shown in Figure 21-4c, then at $H_L + z$ the total pressure is

$$p = z\gamma' - \left(\frac{\Delta h}{H_s}\right)(z)(\gamma_w) \quad (21-8)$$

When $(\Delta h/H_s)(z)(\gamma_w) = z\gamma'$, the soil cannot support any weight. This is commonly referred to as “quicksand.”

Now consider the case illustrated in Figure 21-5 where a tank has been dewatered for maintenance. At the bottom of the inside of the tank $z\gamma' = 0$ and $p_w = \Delta T \gamma_w$. If the product of the thickness of the tank and the unit weight of the tank material is less than the product of the depth of the groundwater and the unit weight of water, that is, $(a)(\gamma_{\text{tank}}) < (\Delta T)(\gamma_w)$, the tank will float! Conceptually, one may visualize this as buoyancy of the tank from the displaced mass of water. The friction on the walls of the tank and the mass of the walls are ignored in this simple analysis.

The design of tanks must then consider the very likely possibility that the tank will be emptied at a time when the groundwater table is high. Several alternatives are available. The

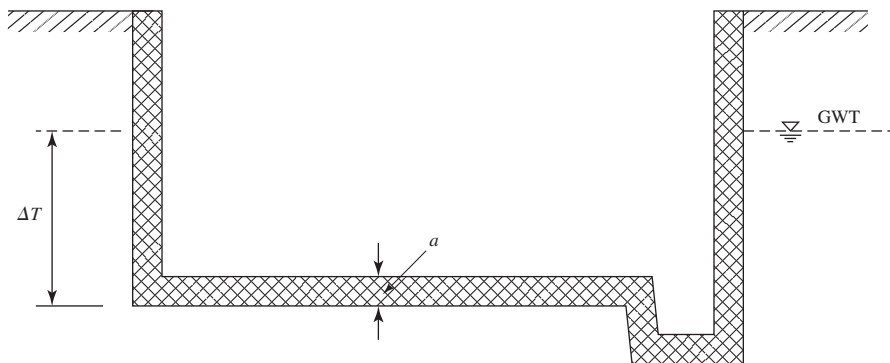
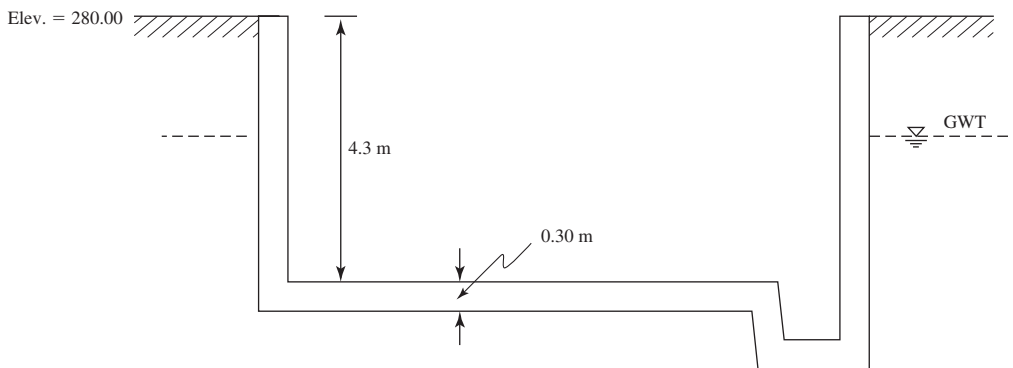

FIGURE 21-5
Empty tank with high ground water table (GWT). concrete thickness = a .

alternatives include anchors being driven into the soil below the tank, thickening the bottom of the tank (i.e., the dimension “ a ”) to increase the mass, providing *mud valves* in the bottom of the tank, or a combination of these measures.

Example 21-1 illustrates the geotechnical analysis of a settling tank.

Example 21-1. For the sketch shown below, determine the elevation of the groundwater table that will cause the tank to “float.” Assume that the density of the concrete is $2,400 \text{ kg/m}^3$.



Solution:

- a. The load of the tank on the soil is

$$(a)(\gamma_{\text{concrete}}) = (0.30 \text{ m})(2,400 \text{ kg/m}^3) = 720 \text{ kg/m}^2$$

- b. Set the pore water pressure equal to the load and solve for Δh assuming $\gamma_w = 1,000 \text{ kg/m}^3$.

$$\begin{aligned} (\Delta h)(\gamma_w) &= 720 \text{ kg/m}^2 \\ \Delta h &= \frac{720 \text{ kg/m}^2}{1,000 \text{ kg/m}^3} = 0.72 \text{ m} \end{aligned}$$

- c. The elevation of the bottom of the tank is

$$\text{Elevation of bottom} = 280.00 \text{ m} - 4.3 \text{ m} - 0.3 \text{ m} = 275.40 \text{ m}$$

- d. Elevation of groundwater table that is incipient to flotation:

$$\text{Elev.} = 275.40 \text{ m} + 0.72 \text{ m} = 276.12 \text{ m}$$

Comment. Because of soil friction and the mass of the tank walls, the groundwater table will have to be somewhat higher than shown by this calculation to cause flotation of the tank.

Circular Sedimentation Basin Design

Because center feed basins are the most commonly used systems, only they are discussed here. The specific elements to be considered are the diameter, depth, flow balancing, inlet configuration, sludge removal, and scum removal.

Diameter. Overflow rate is the controlling variable in determining both the area and the diameter of a circular clarifier. Although tanks up to 100 m in diameter have been built, generally they are limited to about 50 m because of the effects of wind (Tekippe, 2006). Metcalf & Eddy (2003) reported ranges from 3 to 60 m with typical values of 12 to 45 m.

Depth. Depths are measured as *side water depth*. With a sloped floor, the depth at the center of the tank will be deeper. Most floors have a constant floor slope of 1 on 12 (vertical:horizontal). The origin of this particular slope is uncertain, but it has received widespread use for decades (Tekippe, 2006).

The tanks must be deep enough to accommodate mechanical equipment for sludge removal, store settled solids, avoid scour, and avoid carryover of solids in the effluent. Excessive depth is to be avoided to prevent anaerobic conditions. Shallower tanks may be acceptable with continuous sludge removal.

Theoretically, removal efficiency should increase with depth because the opportunity for particle contact and flocculation increase with depth. In practice, it has been found that depth and overflow rate are intimately related. To achieve the highest efficiency, deeper tanks with lower overflow rates are required (Tekippe, 2006). Reported depths have ranged from 3 to 5 m with a typical value of 4.3 m (Metcalf & Eddy, 2003; WEF, 1998). Current trends favor the use of deeper tanks (Wahlberg, 2006).

Common practice is to provide a freeboard of 0.5 to 0.7 m.

Splitter Box. When multiple units are in service, the flow must be split so that both the hydraulic load and the solids load are in proportion to the design limits of the tank. Upflow distribution structures (*splitting boxes*) with fixed weirs can be used to provide identical flow to identical multiple units (Figure 21-6). Weir lengths are adjusted in proportion to the surface area if the units have different surface areas. When the settling tanks have different side water depths, the weir lengths are adjusted so that they are proportional to the volume of the tanks. When both the surface area and depth of the tanks differ, the weir length is adjusted in proportion to the volume of the tanks. To minimize turbulent conditions, the upflow velocity into the flow splitting box should be less than 0.3 m/s at peak flow. The top of the discharge should be sufficiently below

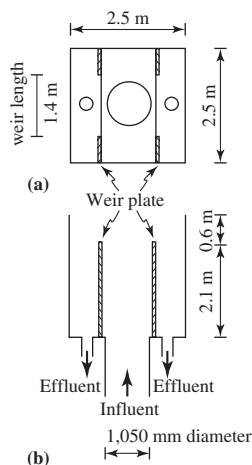

FIGURE 21-6
Splitter box. Dimensions are those found in Example 21-2. They are **not** standard.

the weir to dissipate turbulence at the weir. A depth of two to three times the diameter (or height) of the inlet pipe should be sufficient for velocities less than 1 m/s. Deeper boxes are required for higher velocities (Wahlberg, 2006). To isolate a tank for service, a sluice gate is placed on the outlet of the splitter box.

One type of weir that may be used is a sharp-crested rectangular weir. Under free flow conditions, the head over the weir may be calculated as

$$h_{sc} = \left[\frac{Q}{(C_w)(L)} \right]^{2/3} \quad (21-9)$$

where h_{sc} = head over the weir crest, m
 Q = flow rate, m^3/s
 C_w = discharge coefficient, dimensionless
 L = length of weir, m

The commonly used value for C_w is 1.82. Typically, end contractions (projections from sides of the channel) are present. To account for these, a modified form of Equation 21-9 is used:

$$h_{sc} = \left[\frac{Q}{(C_w)(L - 0.2 h_{sc})} \right]^{2/3} \quad (21-10)$$

Example 21-2 illustrates the design of a splitter box.

Example 21-2. The Camptown wastewater treatment plant is being designed to treat a flow rate of $56,800 \text{ m}^3/\text{d}$. Eight identical circular primary tanks will be used. Each pair will be served by one splitter box. Using a sharp-crested rectangular weir, design a splitter box for two identical circular clarifiers. Assume a peaking factor of 2.3 for the plant.

Solution:

- a. Note that the clarifiers are identical, so one-eighth of the flow must go to each. Convert the flow rate to appropriate units.

$$Q = \frac{56,800 \text{ m}^3/\text{d}}{8 \text{ tanks}} = 7,100 \text{ m}^3/\text{d} \cdot \text{tank}$$

$$Q = \frac{7,100 \text{ m}^3/\text{d} \cdot \text{tank}}{86,400 \text{ s/d}} = 0.082 \text{ m}^3/\text{s per tank}$$

- b. For a first trial, assume a head over the weir crest of 100 mm and use Equation 21-10 to determine the length of the weir.

$$\left[\frac{0.082 \text{ m}^3/\text{s}}{(1.82)[L - (0.2)(0.10 \text{ m})]} \right]^{2/3} = 0.10 \text{ m}$$

Solving for L ,

$$L = 1.425 + (0.2)(0.10) = 1.445 \text{ or } 1.4 \text{ m}$$

- c. Select an inlet pipe diameter to achieve a velocity of 0.3 m/s at peak flow. At peak flow with one tank out of service, the flow per tank for the remaining seven is estimated as

$$Q_{\text{peak}} = \frac{(2.3)(56,800 \text{ m}^3/\text{d})}{(86,400 \text{ s/d})(7 \text{ tanks})} = 0.216 \text{ m}^3/\text{s}$$

$$\text{Area of pipe} = \frac{0.216 \text{ m}^3/\text{s}}{0.3 \text{ m/s}} = 0.720 \text{ m}^2$$

The diameter of the pipe is found from the area:

$$\frac{\pi(D)^2}{4} = 0.720 \text{ m}^2$$

and $D = .957 \text{ m}$.

Select a standard pipe size = 1,050 mm.

- d. The depth of the box below the weir is two times the diameter of the pipe:

$$\text{Depth} = (2)(1.05 \text{ m}) = 2.1 \text{ m}$$

- e. Allowing for free discharge over the weir, select a plan area of 2.5 m × 2.5 m. The final splitter box with 0.6 m freeboard above the maximum head on the weir is sketched in Figure 21-6.

Comments:

1. Other weirs, such as a v-notch, may also be used.
2. If one tank is out of service when the peak flow occurs, the head over the weir will be higher.

Hints from the Field. Operators and experienced engineers have provided the following insights on the design of splitter boxes:

- The splitter box has the potential to be the crucial element in limiting the flexibility of operation of the plant. If the splitter box restricts the flow rate, the operator cannot adjust hydraulic loads during peak flows or when tanks are out of service.
- Isolation of a clarifier for service causes the outlet chamber to fill. Because it is stagnant, this may become a source of odors. For small installations, a simple cover may serve to mitigate the problem.

Inlet Configuration. The typical center feed tank has a vertical inlet pipe with ports that transmit the flow from the feed pipe to the feed well (Figure 21-7). The feedwell (also called a *flocculation center well*) should be equipped with an energy dissipating device to break up the jetting velocity into the inlet baffle area (Figure 21-8).

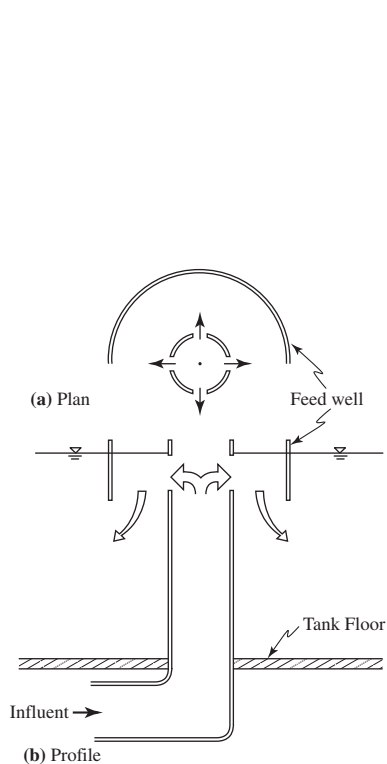

FIGURE 21-7
Standard center inlet.

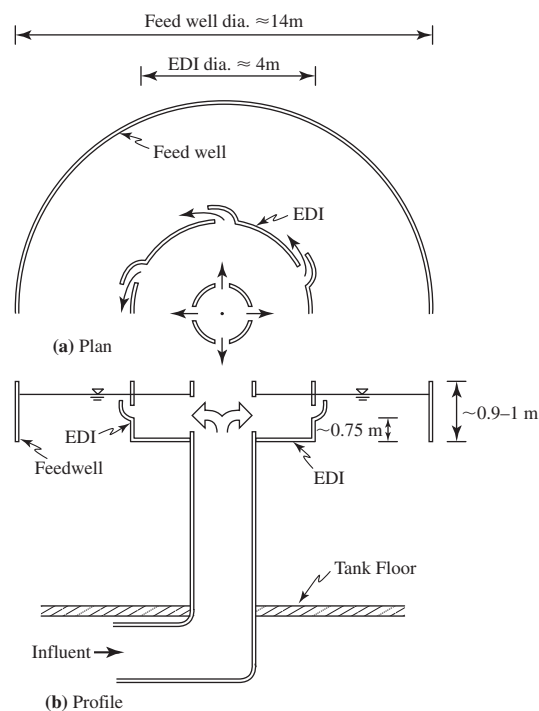

FIGURE 21-8
Center Feed with energy dissipating inlet (EDI). Approximate dimensions are for a 55 m diameter primary tank with a 4.6 m side water depth.

The feedwell can promote flocculation. Based on experimental observations, a detention time of about 20 minutes achieves over 90 percent of the obtainable flocculation. This has led to a rule of thumb that the flocculation center well should be sized to obtain 20 minutes of residence time at average dry weather flow. An additional 50 percent allowance is recommended when return activated sludge is added to the clarifier (Tekippe, 2006). It has been observed that, if the flocculation center well is too large, short circuiting may result.

The depth of the projection of the feedwell above the liquid level, and into the wastewater, are also important design criteria. The top elevation of the feedwell is generally designed to extend above the liquid level at peak hour flow with one unit out of service. Typically, four ports are cut in the top portion of the feedwell to allow scum to move out of the feedwell into the tank proper.

The projection of the feedwell downward into the tank may range from 30 to 75 percent of the tank depth. Some manufacturers recommend that submergence be 25 to 50 percent of the side water depth (Tekippe, 2006). The selection of the depth requires a balance of three components: (1) the need to prevent jetting from the inlet pipe ports, (2) the need to prevent energy dissipating device outflows from passing under the feedwell, and (3) the need to prevent a high horizontal discharge velocity that will scour settled sludge.

Energy dissipating inlets (EDIs) are used to distribute flow within the feedwell (Figure 21-8). These also mix the wastewater and provide a means of increasing flocculation. The diameter of the EDI assembly is often set at 10 to 13 percent of the tank diameter. Alternatively, it is designed to provide a detention time of 8 to 10 s. If the EDI assembly or ring is too large, it reduces the volume of the flocculation zone and increases downward velocities.

Unfortunately, the wide range of recommendations for feedwell and EDI dimensions allows almost any configuration without any assurance of a successful design. *Computational fluid dynamic* (CFD) modeling offers some possibility of optimizing the design. In the absence of CFD modeling, it appears that increasing the depth of the tank, using a low overflow rate and baffles (discussed later in this section) in conjunction with EDIs and a 20 s detention time in the feedwell provides the best opportunity for maximizing the primary clarifier efficiency.

Baffles. Currents in an ideal clarifier and in an unbaffled clarifier are shown schematically in Figure 21-9. Two important conclusions may be drawn from the model: (1) there is a circulation pattern rather than the idealized radial flow, and (2) there is a smaller vertical circulation pattern below the feedwell. The circulation pattern at the weir results in carryover of solids. This is especially evident with inboard weirs. The vertical circulation pattern tends to carry sludge that

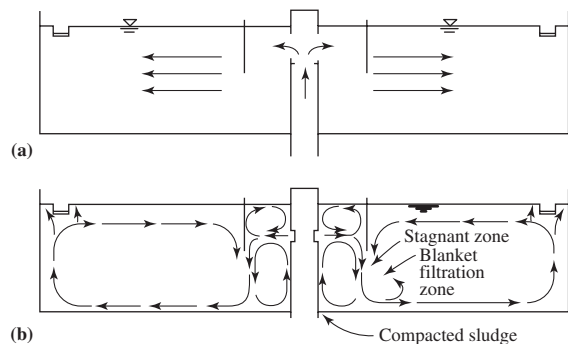

FIGURE 21-9

(a) Ideal and (b) typical velocity pattern in center feed circular clarifier.

has been scraped toward the hopper near the center of the tank back into wastewater. In addition to these effects, velocity measurements in full scale, shallow tanks with deep feedwells show high velocities across the sludge (Albertson and Alfonso, 1995).

To rectify these problems, three design adjustments are offered (Albertson and Alfonso, 1995; Stukenberg et al., 1983). The first is to use a wall-mounted effluent weir with a baffle as shown in Figure 21-10. The second is to provide a horizontal baffle beneath the feedwell as shown in Figure 21-11. The third is to reduce the depth of the feedwell.

Weir Configuration. Outlets for most circular center-feed clarifiers consist of a single perimeter v-notch weir that overflows into an effluent trough (Figures 21-1a and 21-10). Alternatives include cantilevered or suspended double weir troughs, and submerged-orifices. The preferred design is to mount the perimeter weir on a trough on the inside of the tank (Figures 21-1a and 21-10). This arrangement helps deflect some of the “wall effect” solids updraft inward near the surface and reduces the loss of suspended solids over the weir (Tekippe, 2006).

Algae growth is a problem with many clarifiers with open troughs. This is both a maintenance issue and a water quality issue as the algae break free and contribute to the effluent suspended solids load. Strategies that have been found to be effective in minimizing algae growth include installing trough covers, mounting algae brushes on the rotating mechanism, feeding chlorine solution, and hydraulic spray washing.

Sludge Scraper. The straight, multiblade scraper is the most widely used mechanism for primary tanks. Typically, they are manufactured with two arms in 1.5 m increments from 9 to 50 m. In the United States, the drive mechanism commonly provides torque applied at the center column. In Europe, it is common to have a drive located at the tank wall. The scraper plows furrows of sludge progressively toward a centrally located hopper. They are designed to rotate at a tip speed of approximately 3 m/min (Tekippe, 2006).

Sludge transport, treatment and disposal are discussed in Chapter 27.

Scum Removal. The most common system uses a rotating skimmer arm and wiper attached to the scraper mechanism. It travels around the outer edge of the tank next to the scum baffle

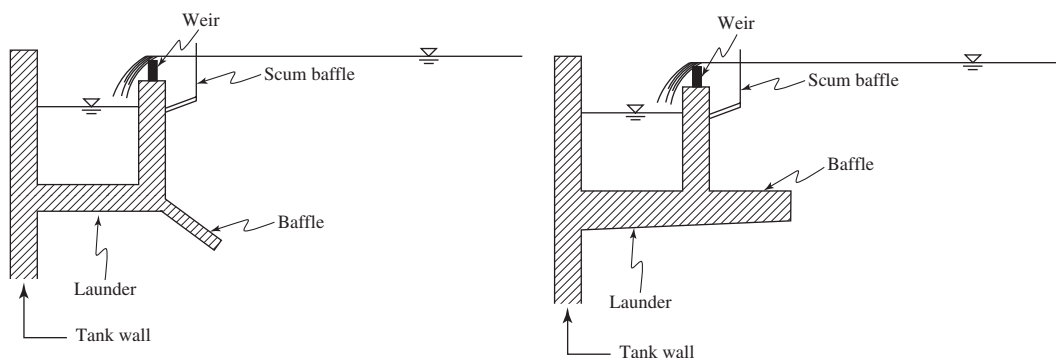

FIGURE 21-10
Examples of baffle arrangements at launder.

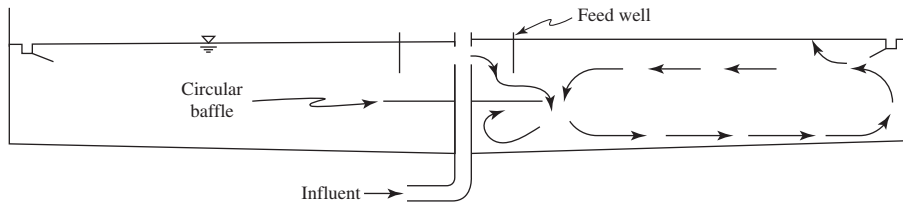

FIGURE 21-11
Circular baffle at inlet to reduce cascade effect.

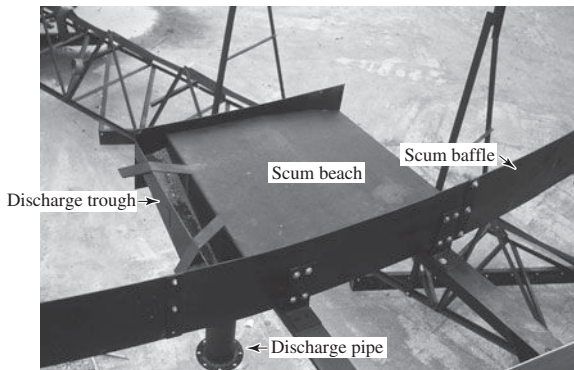

FIGURE 21-12
Scum “beach” for circular clarifier.

(Figure 21-10). The scum baffle should project 200 to 300 mm below the water surface (U.S. EPA, 1974). The skimmer arm moves the floatable material onto a *beach*, or egress ramp, connected to a scum removal box (Figure 21-12). The skimmer blade is most effective if it is attached tangentially to the feedwell baffle, rather than perpendicular to it. The pitch angle helps to move the floating material to the scum baffle. Once during each rotation, the scum is pushed up on the beach and into the discharge trough. The box is flushed to the scum piping system with wastewater from the tank.

Scum transport, treatment, and disposal are discussed in Chapter 27.

Example 21-3 illustrates the design of a circular sedimentation basin.

Example 21-3. Design a circular primary clarifier for the Camptown WWTP (Example 21-2). Assume an overflow rate of $40 \text{ m}^3/\text{d} \cdot \text{m}^2$, a side water depth of 4.3 m, and a sludge hopper volume of approximately 1 m^3 . To complete the design provide the following:

- Diameter of tank
- Diameter and depth of feedwell
- Diameter and depth of EDI
- Dimensions of sludge hopper
- Check of velocity across sludge zone
- Calculation of the weir loading rate

Solution:

- a. From Example 21-2, the flow rate for the clarifier is 7,100 m³/d. The diameter of the tank is calculated as follows:

$$\begin{aligned}\text{Surface area} &= \frac{Q}{v_0} = \frac{7,100 \text{ m}^3/\text{d}}{40 \text{ m}^3/\text{d} \cdot \text{m}^2} = 177.5 \text{ m}^2 \\ \frac{\pi(D_{\text{tank}})^2}{4} &= 177.5 \text{ m}^2 \\ D_{\text{tank}} &= \left(\frac{(177.5 \text{ m}^2)(4)}{\pi} \right) = 15.03 \text{ or } 15 \text{ m}\end{aligned}$$

This is a standard diameter for sludge removal equipment.

- b. Assuming a detention time of 20 min in the feedwell, and a depth equal to 50% of the tank depth, the feedwell dimensions are estimated as follows:

$$\begin{aligned}\Psi &= (7,100 \text{ m}^3/\text{d}) \left(\frac{20 \text{ min}}{1,440 \text{ min}/\text{d}} \right) = 98.6 \text{ m}^3 \\ \text{Depth of feedwell} &= (0.50)(4.3 \text{ m}) = 2.15 \text{ m} \\ \text{Surface area of feedwell} &= \frac{98.6 \text{ m}^3}{2.15 \text{ m}} = 45.86 \text{ m}^2 \\ \frac{\pi(D_{\text{feedwell}})^2}{4} &= 45.86 \text{ m}^2 \\ D_{\text{feedwell}} &= \left(\frac{(45.86 \text{ m}^2)(4)}{\pi} \right) = 7.64 \text{ m}\end{aligned}$$

This is slightly more than half the diameter of the tank and appears to be quite large.

- c. Check the flow velocity.

The area of the cylinder through which the wastewater must flow is

$$A_{\text{cylinder}} = \pi Dh = \pi(7.64 \text{ m})(4.3 \text{ m} - 2.15 \text{ m}) = 51.6 \text{ m}^2$$

Note that h = side water depth minus the depth of the feedwell.

The velocity through this area is

$$v = \frac{7,100 \text{ m}^3/\text{d}}{(51.6 \text{ m}^2)(86,400 \text{ s}/\text{d})} = 0.002 \text{ m/s}$$

This is substantially below the criteria of 0.020 m/s. Therefore, increase the depth of the feedwell to reduce the diameter.

- d. After another iteration, the feedwell dimensions selected are 6.2 m diameter and 3.2 m depth. The resulting velocity is estimated at 0.004 m/s.
- e. Using 10 s detention and a depth of one-half that of the feedwell (1.6 m), the EDI diameter is estimated as

$$V = (7,100 \text{ m}^3/\text{d}) \left(\frac{10 \text{ s}}{86,400 \text{ s/d}} \right) = 0.822 \text{ m}^3$$

$$\text{Surface area of EDI} = \frac{0.822 \text{ m}^3}{1.6 \text{ m}} = 0.51 \text{ m}^2$$

$$\frac{\pi(D_{\text{EDI}})^2}{4} = 0.51 \text{ m}^2$$

$$D_{\text{EDI}} = \left(\frac{(0.51 \text{ m}^2)(4)}{\pi} \right) = 0.809 \text{ or } 0.8 \text{ m}$$

- f. The bottom of the sludge hopper should not exceed 0.6 m in width, and the angle of the side wall must be greater than 60°. The shape of the hopper is the frustum of a right pyramid. The volume is given by:

$$V = \left(\frac{h}{3} \right) \{ W_{\text{top}} + W_{\text{bottom}} + [(W_{\text{top}})(W_{\text{bottom}})]^{1/2} \}$$

The volume required is 1 m³. Assume $W_{\text{bottom}} = 0.6 \text{ m}$. There are two unknowns: the height, h , and W_{top} . Using the Solver* tool in a spreadsheet with $W_{\text{bottom}} = 0.6 \text{ m}$, the dimensions were found to be:

Bottom = 0.6 m
 Top = 1.19 or 1.2 m
 Height = 1.139 m or 1.2 m
 Angle of side wall = 75°

- g. Place baffles as shown in Figure 21-11.
- h. The weir loading rate is the flow rate divided by the perimeter of the tank. At the design flow rate:

$$\text{Weir loading} = \frac{7,100 \text{ m}^3/\text{d}}{\pi(15 \text{ m})} = 150.66 \text{ or } 150 \text{ m}^3/\text{d} \cdot \text{m}$$

This is within the customary range of weir loading rates.

**Solver* is a "tool" in Excel®. Other spreadsheets may have a different name for this program.

Comments:

1. These dimensions are only preliminary estimates. The dimensions must conform to the manufacturer's standard dimensions to minimize special-order costs.
2. The placement of flocculator paddles in the feedwell may allow some reduction in volume. It will increase the efficiency of flocculation.

Rectangular Tanks

Dimensions. The length of the tank is seldom greater than 110 m and is typically in the range of 30 to 60 m. In very small tanks, a minimum flow length of 3 m is recommended. Because of wind currents, the difficulty in moving sludge to the hoppers, as well as the mechanical stress on the chain and flight system, long lengths are limited to very large plants.

Widths range from 3 to 24 m. The width increments are determined by the manufactured widths of the chain-in-flight sludge scrapers. If widths greater than 6 m are required, multiple bays in one tank may be used. This will permit widths up to 24 m (Metcalf & Eddy, 2003).

The floor slope is typically 1 percent toward the sludge hoppers. Side water depth is generally measured at the effluent end wall. The range of depths is from 2 to 5 m with a typical value of 4.3 m (Metcalf & Eddy, 2003). It is good practice to provide a depth of 4 m below the effluent weirs (Pettit, 2006). Common practice is to provide a freeboard of 0.5 to 0.7 m.

Flow Distribution. Because rectangular tanks are typically constructed side-by-side to take advantage of common walls, the distribution of wastewater is by a single channel that runs perpendicular to the flow through the tanks. The channel is covered with removable grates that allow access for cleaning. The design velocity of the channel should be a minimum of 0.3 m/s to prevent deposition of organic matter and a minimum of 0.75 m/s to prevent deposition of mineral matter at 50 percent of the design flow (Metcalf & Eddy, 1991; WEF, 1998). The channel design must provide an allowance for scum and a method for transferring scum to the primary tank. The scum from the primary tank and the channels is collected together for disposal.

One of three alternatives is generally used to provide equal flow distribution: inlet weirs, submerged orifices, or inlet gates. Weir inlets that discharge directly into the tank surface should be avoided to minimize odors and to prevent undue turbulence at the head end of the tank.

Submerged orifices (Figure 21-13) are acceptable. They may cause an undesirable backwater curve during peak flows. Storm inlet gates may have to be provided for this possibility. When flows

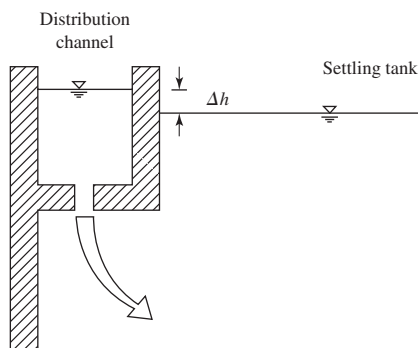
**FIGURE 21-13**

Distribution channel with submerged orifice.

are too low, the orifice may not be sufficiently restrictive to balance the flows. In this instance, the operator must recognize the need to take one or more units off-line. Orifices are plugged when a unit is taken out of service for maintenance. This will, of course, unbalance the flows.

Submerged gates seem to provide the most flexibility. The position of the gates can be adjusted for any extended flow condition. If gates are used, it is essential that automated actuators be provided. Each gate must have an associated accurate flow meter with a feedback signal to modulate the valve position (Tekippe, 2006; Wahlberg, 2006).

The design of the distribution channel is a complex open channel flow problem. Benefield et al. (1984) provide a detailed calculation procedure and a Fortran program for the design.

Inlet Configuration. There is no consensus on the design of the inlet. Recommendations include placing the inlet port lower in the tank, limiting inlet port velocities to a range of 0.075 to 0.150 m/s, using inlet diffusers, placing an inlet baffle (*target* or *finger* baffle) in the flow path (Figure 21-14), and placing slotted or perforated baffles across the full width of the settling tank (Figure 21-15). There is agreement on one point: in no case should the design permit a waterfall into the tank (Pettit, 2006).

The typical inlet configuration includes multiple ports placed and sized to uniformly distribute the flow over the width of the clarifier. For a 6 m wide tank, there are typically three or four inlet ports. Maximum horizontal spacing is less than 3 m and typically about 2 m.

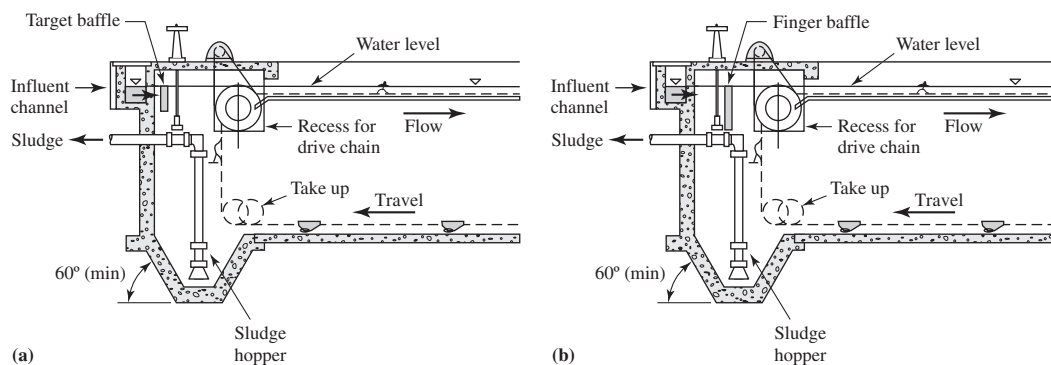

FIGURE 21-14
Examples of (a) target and (b) finger baffles.

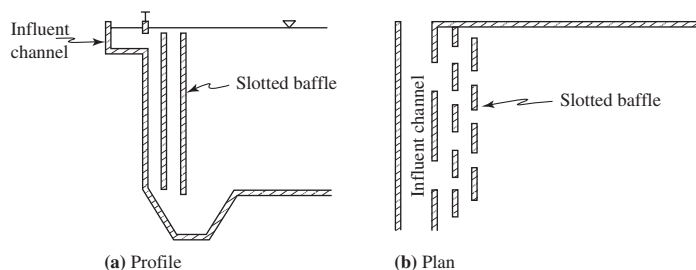

FIGURE 21-15
Slotted baffles in a rectangular primary tank.

An orifice inlet that exits the bottom of the inlet channel allows for a discharge pipe exit that is below the liquid surface. The range of location for the discharge is from a depth of approximately 2 m to midtank depth (Petit, 2006).

The function of target or finger baffles is to dissipate the jetting energy of the influent. The target baffle is solid. The finger baffle is perforated. Baffles are typically placed 0.6 to 0.9 m from the inlet and submerged 0.5 to 0.6 m, depending on the tank depth. The top of the baffle must be far enough below the wastewater surface to allow scum to pass over the top (WEF, 1998).

Two offset, slotted baffles with the slots offset have proven effective in distributing flow evenly across the tank. The baffles should extend to at least one-half the tank depth (U.S. EPA, 1974). Kawamura (1981) recommends the installation of three perforated baffles across the full width of the tank. Individual slots should be not less than 50 mm wide (or in diameter, if perforations are used) to minimize plugging with rags or plastic bags. The diameter of perforations should not be greater than 100 mm to avoid persistent jets. A porosity factor of 0.05 (5 percent open area) is typical (Krebs et al., 1992). This baffle system provides the additional advantage of providing some flocculation.

Weir Configuration. Unwanted hydraulic patterns that are produced by the bottom density current can be strong in the region next to the end of the tank. When the flow reaches the end wall, there is a strong upward current. This is particularly of concern if the sludge hoppers are placed at the end of the tank.

Although a number of alternative arrangements of the effluent launders have been used, the orientation does not appear to be critical (Kawamura and Lang, 1986; Pettit, 2006). What does appear to be important is that to avoid the strong upflow when the tank current reaches the end wall, the launder cannot be placed near the end wall. Comparable results can be obtained with either long parallel flow launders or short parallel flow launders if they are placed away from the end of the tank. From an economic point of view, short or transverse launders are less expensive to build. This appears to be the most typical arrangement (WEF, 1998).

To avoid loss of solids due to end wall upflow, placement of the launder at a distance from the outlet wall equal to the wastewater depth is recommended (ATV, 1988).

Sludge Removal. The two classes of sludge removal systems are the chain-and-flight and the traveling bridge. In the United States, the chain-and-flight systems are more common. Although the traveling bridge may be equipped with either a scraper or a suction system, the suction mechanism is not used in primary clarifiers. The traveling bridge is noted for its higher construction and maintenance costs (Pettit, 2006).

With the exception that the return flights move across the surface of the tank (Figure 21-3), chain-and-flight systems are very similar to those discussed in Chapter 10, and the reader is referred there for more details. The flight speed ranges from 0.3 to 1.2 m/min with a typical speed of 0.9 m/min. In general they are operated periodically rather than continuously.

Although the sludge hoppers may be placed at the influent end, effluent end, or in the middle of the tank, they are often placed at the influent end in primary settling tanks. This places the hoppers near where the bulk of the solids settle. It also alleviates the scour that lifts the solids up into the effluent weirs at the end wall. The disadvantage of locating the hopper at the head end of the tank is that the flight scraper induces a volumetric flow rate at the bottom of the tank that is countercurrent to the density flow current in the fluid above the sludge blanket. This may resuspend solids.

A single sludge hopper with a cross-collector is preferred over multiple hoppers (Metcalf & Eddy, 2003).

Sludge transport, treatment and disposal is discussed in Chapter 27.

Scum Removal. The typical scum removal system utilizes the return of the chain-and-flight scraper at the surface of the tank to move the scum toward the effluent (Figure 21-3). The scum is trapped by a scum baffle and/or, more commonly, a slotted pipe. The slotted pipe is periodically turned to allow the scum to be carried into the slot. The scum baffle should extend 0.3 to 0.6 m below the surface and 30 mm above the surface. It should be not less than 0.6 m upstream from the outlet weir (Pettit, 2006).

Scum transport, treatment, and disposal are discussed in Chapter 27.

Primary Sedimentation Tank Design Criteria

Typical design criteria are summarized in Table 21-1. Some design criteria are quite rigid, while others only provide guidance. For example, because of manufacturing constraints, the length of a chain-and-flight collection sets a firm maximum on the length of the settling basin. Although the maximum width is 6 m, multiple units may be mounted in parallel to achieve widths up to 24 m.

TABLE 21-1
Typical design criteria for primary sedimentation basins

Parameter	Range of values	Typical/comment
General		
Overflow rate (average flow)	30 to 50 m ³ /d · m ²	40 m ³ /d · m ²
Overflow rate (peak flow)	60 to 120 m ³ /d · m ²	100 m ³ /d · m ²
Detention time (average flow)	1.5 to 2.5 h	2.0 h
Flow velocity	0.020 to 0.025 m/s	
Weir loading rate	125 to 500 m ³ /d · m	250 m ³ /d · m
Sludge hoppers	1.7 vertical to 1 horizontal	Minimum; bottom width < 0.6 m
Geotechnical		Consider potential for flotation when tank is empty
Circular tanks		
<i>Dimensions</i>		
Diameter	3 to 100 m	12 to 45 m
Standard	9 to 45 m	In 1.5 m increments
Side water depth	3 to 5 m	4.3 m
Floor slope	1 vertical to 12 horizontal	
<i>Splitter box</i>		
Inlet velocity	< 0.3 m/s	At peak flow
<i>Inlet configuration</i>		
Detention time	20 minutes	Feedwell
Submergence	30 to 75% of depth	Size to prevent scour
EDI detention time	8 to 10 s	

(continued)

TABLE 21-1 (continued)
Typical design criteria for primary sedimentation basins

Parameter	Range of values	Typical/comment
<i>Baffles</i>		
Effluent		Below weir
Horizontal		Below feedwell
Rectangular tanks		
<i>Dimensions</i>		
Length	30 to 110 m	30 to 60 m
Width	3 to 24 m	6 m max per flight
Depth	2 to 5 m	4.3 m
Floor slope	1%	
<i>Distribution channel</i>		
Velocity	0.3 to 0.75 m/s	
Flow distribution		Prefer orifices or gates
<i>Inlet configuration</i>		
Ports	3 to 4 per tank at < 3 m	2 m
Energy dissipation		Target or finger baffle
<i>Baffles</i>		
Distance	0.6 to 0.9 m from inlet	
Submergence	0.5 to 0.6 m	
Porosity	Individual openings > 5 cm and < 10 cm	5% open area

Sources: GLUMRB, 2004; Krebs et al., 1992; Metcalf & Eddy, 2003; Pettit, 2006; Tekippe, 2006; Wahlberg et al., 1994; Wahlberg, 2006; WEF, 1998.

An example of the design of horizontal flow basin is presented in Chapter 10. Of course, the criteria for primary sedimentation basins are different and these must be accounted for in the design.

Operation and Maintenance

Provisions should be made for taking tanks out of service and dewatering. This includes recognition of the following:

- Dewatering a tank may result in untoward groundwater pressure that will have to be relieved.
- Taking one rectangular tank out of service that is paired with another tank requires provision for disengaging the drive and isolating the sludge pump so the remaining tank can remain in service.
- Interior walls must be designed for hydrostatic pressure on one side only.

Clean weir plates prevent unbalanced flows. Some designers provide covers to prevent algae growth. Alternatively, wiper blades are provided.

In circular tanks, the beach should be continuously flushed to prevent scum from clogging the lines.

Hose bibs should be provided at each tank, scum trough, sump, and pumping station for maintenance and clean up. Piping for treated wastewater may be used, provided it is separated from potable water and is clearly marked as nonpotable.

21-5 OTHER PRIMARY TREATMENT ALTERNATIVES

Three modifications/alternatives may be used in primary treatment. Enhanced sedimentation and plate settlers are modifications to standard sedimentation, and fine screens are used in lieu of sedimentation. Each of these will be discussed in the following sections.

Enhanced Sedimentation

The simple act of promoting increased contact between particles at the inlet of the sedimentation basin is a form of enhanced sedimentation. More commonly, enhanced sedimentation refers to the addition of chemicals. This practice is called *chemically enhanced primary treatment* (CEPT). As discussed in Chapter 6, the addition of chemicals, followed by gentle agitation results in coagulation of particles. The resulting increase in particle size enhances the efficiency of sedimentation. Increases of 40 to 80 percent in organic carbon removal and 60 to 90 percent in total suspended solids removal can be achieved in shorter settling times than conventional sedimentation.

CEPT is most effective if a complete treatment train, including rapid mix, coagulation, and sedimentation, are provided. However, substantial improvements can be achieved by adding the chemicals to aerated grit chambers or other upstream facilities for mixing, and using the inlet structures of a conventional primary settling tank to provide flocculation.

Alum ($\text{Al}_2(\text{SO})_4 \cdot 14\text{H}_2\text{O}$) or ferric chloride (FeCl_3) added in conjunction with anionic polymers are the chemicals most frequently used. Current practice is to use metal salt doses on the order of 20 to 40 mg/L in combination with polymer doses of less than 1 mg/L. Metcalf & Eddy (2003) recommends velocity gradients for flocculation in the range 200 to 400 s^{-1} .

The use of metal salts also results in precipitation of phosphorus. This may be a positive step in meeting discharge standards. It also may be detrimental to the downstream biological processes that require phosphorus. As an alternative, anionic polymers alone in high doses (~ 8 mg/L) are effective coagulants that do not remove phosphorus (Reardon, 2006).

CEPT may be used on an intermittent basis to achieve effective primary sedimentation during peak hydraulic events. This approach uses less chemicals and produces less sludge to handle.

Table 21-2 summarizes the advantages and disadvantages of CEPT.

Plate Settlers

Theoretical and design practices for inclined plate and tube settlers were discussed in Chapter 10. For more details the reader is referred there.

Although plate settlers have not been commonly used in municipal wastewater treatment plants in the United States, they have been used extensively in Europe. Metcalf & Eddy (2003) suggests an appropriate application is in conjunction with CEPT.

The common design is a countercurrent flow pattern. The influent is fed under the plates or tubes and flow is upwards. Solids settle to the plate and slide down the surface to the bottom of the tank.

For primary sedimentation applications, they increase the settling area by a factor of 8 to 10. This permits a smaller footprint or increases the capacity of existing overloaded tanks. They have been reported to produce a more dilute sludge. This may increase the cost of sludge handling.

TABLE 21-2
Advantages and disadvantages of CEPT

Advantages	Disadvantages
Increased removal of BOD, TSS, phosphorus, and metals	May remove too much phosphorus, thus making the primary effluent nutrient deficient
Increases primary tank capacity by allowing higher overflow rate	Chemical handling facilities required
Increases ability to absorb shock loads/wet weather flows	Chemical safety issues and regulatory requirements increase
Reduces size or increases capacity of biological process	Sludge quantities increase
Enhances biological treatment kinetics	May decrease biological sludge settleability
Decreases carbon to nitrogen ratio thus increasing the fraction of nitrifying microorganisms and enhancing ammonia removal	

Adapted from Reardon, 2006.

Potential problems that must be addressed are clogging from solids, algae, or grease. Fine screening, adequate grit removal, and enclosing the tank are some of the remedies offered for these problems. Maintenance requirements are expected to be higher than for standard settling tanks. Provision of independently supported units, easy access to the plates, and plates that can be independently removed are recommended (Reardon, 2006).

Fine Screens

Where high removal efficiencies are not required, for example, in biological phosphorus removal or membrane bioreactors, fine screens may be appropriate in place of sedimentation. Fine screens with openings from 0.25 to 1.5 mm typically only achieve removal efficiencies of 5 to 45 percent for suspended solids and 5 to 50 percent for BOD₅ (Metcalf & Eddy, 2003). The design practices for fine screens are discussed in Chapter 20.

Visit the text website at www.mhprofessional.com/wwe for supplementary materials and a gallery of additional photos.

21-6 CHAPTER REVIEW

When you have completed studying this chapter, you should be able to do the following without the aid of your textbook or notes:

1. Explain why there is an optimum hydraulic detention time for a primary settling tank.
2. Describe some of the practical aspects to be considered in setting the depth of a primary settling tank.
3. Describe the method for establishing the limiting upper bound of the velocity through a primary settling tank.

4. Discuss the proposed design philosophy for primary sedimentation practice explaining when it does and does not make sense.
5. Sketch a flow-splitting box and describe how flow is adjusted when the clarifiers are not identical.
6. Explain why hydraulic detention times greater than 1.5 hours are undesirable.
7. Draw a sketch to explain why an empty settling tank might “float.”
8. Sketch an EDI.
9. Sketch a baffle to be used at a perimeter weir on a circular settling tank.
10. Define CEPT and explain its role in improving settling tank efficiency.

With the aid of this text, you should be able to do the following:

11. Determine the half life of the number of particles per unit volume or the number remaining, given the collision efficiency, velocity gradient, and volume of particles per unit volume.
12. Estimate the scour velocity for sticky organic particles given their density.
13. Given diurnal flow pattern, estimate the ratio of the peak four-hour flow to the average flow.
14. Estimate the actual overflow rate and/or detention time for a given settling tank design and a diurnal flow pattern.
15. Determine whether or not a tank will “float” given the tank dimensions and the elevations of the tank bottom and the groundwater table.
16. Estimate the thickness of the bottom of an empty tank to prevent it from floating given the tank dimensions and the elevations of the tank bottom and the groundwater table.
17. Design a splitting box for two or three circular clarifiers given their dimensions.
18. Design a distribution channel for a set of rectangular settling tanks.
19. Design a circular sedimentation basin.
20. Design a rectangular sedimentation basin.

21-7 PROBLEMS

- 21-1. Estimate the half-life of particles in a flocculating solution based on the following assumptions:

Uniform particle diameter (d) = 5 μm

$\eta = 1.0$

Velocity gradient = 200 s^{-1}

$$\Omega = \frac{\pi(d)^3 N}{6}$$

where N = number of particles per unit volume = 10,000/mL.

- 21-2. Repeat Problem 21-1 with an assumption that a coagulant has been added and $\Omega = 2 \times 10^{-5} \text{ cm}^3/\text{cm}^3$.
- 21-3. WEF (1998) recommends that the clarifier linear flow-through velocity be limited to 0.020 m/s to prevent scour. Using a β for sticky particles and a Darcy-Weisback friction factor of 0.03, estimate the specific gravity of a 200 μm diameter particle that will be scoured at the recommended velocity.
- 21-4. If the flow-through velocity in Problem 21-3 is raised to 0.025 m/s, what size particle will be scoured?
- 21-5. Using the data for Cynusoidal City (Problem 20-18 in Chapter 20), estimate the peak four-hour flow rate and calculate the peak-to average ratio.
- 21-6. Using the data from Metuchen (Problem 20-19 in Chapter 20), estimate the peak four-hour flow rate and calculate the peak-to average ratio.
- 21-7. Assuming there is no equalization and that the primary tank for Cynusoidal City (Problem 20-18 in Chapter 20) has a design detention time at average flow of 2.0 hours, a volume of 2,880 m^3 , and a diameter of 29 m, determine the actual detention time and overflow rate for the peak four-hour flow rate.
- 21-8. Assuming there is no equalization and that the primary tank for Metuchen (Problem 20-19 in Chapter 20) has a design detention time at average flow of 2.0 hours, a volume of 704 m^3 , and a diameter of 15 m, determine the actual detention time and overflow rate for the peak four-hour flow rate.
- 21-9. A monitoring well has been placed near a primary settling tank. For the sketch shown in Figure P-21-9 determine the elevation of the water in the monitoring well that should not be exceeded if the tank is to be dewatered.
- 21-10. For the sketch shown in Figure P-21-10, estimate the thickness of the concrete that must be placed to prevent the tank from “floating” if the groundwater table rises to a depth 1.0 m below grade.
- 21-11. Design a splitting box for two identical circular clarifiers. The total flow rate is 8,450 m^3/d . To complete the design, provide the diameter of the inlet pipe, the dimensions of the splitting box, the weir length for each clarifier, and a sketch that shows the plan, profile, and cross section with dimensions. Assume a peaking factor of 3.0 and a head of 10 cm on a sharp-crested weir.

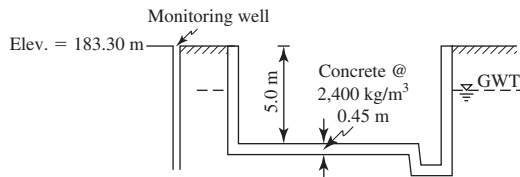

FIGURE P-21-9
Tank flotation elevation.

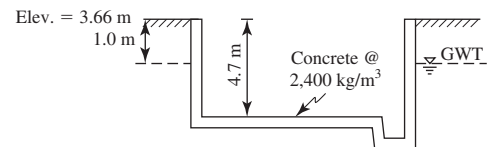

FIGURE P-21-10
Tank thickness to prevent flotation.

21-12. Design a splitting box for three circular clarifiers. The total design flow rate to the three clarifiers is $43,000 \text{ m}^3/\text{d}$. Two identical clarifiers have diameters of 30 m. The third clarifier has a diameter 15 m. The depth of each clarifier is 4.5 m. To complete the design provide the diameter of the inlet pipe, the dimensions of the splitting box, the weir length for each clarifier, and a sketch that shows the plan, profile, and cross section with dimensions. Assume a head of 20 cm on a sharp-crested weir. Use the design flow rate to size the inlet pipe.

21-13. Design a circular clarifier for a flow rate of $8,450 \text{ m}^3/\text{d}$. Assume the following:

Center feed

$$\text{Overflow rate} = 30 \text{ m}^3/\text{d} \cdot \text{m}^2$$

$$\text{Side water depth} = 4.3 \text{ m}$$

$$\text{Feedwell detention time} = 20 \text{ min}$$

$$\text{EDI detention time} = 10 \text{ s}$$

$$\text{Sludge hopper volume} \approx 0.5 \text{ m}^3$$

To complete the design provide the following:

Diameter of tank

Diameter and depth of feedwell

Diameter and depth of EDI

Dimensions of sludge hopper

Check of velocity across sludge zone

Calculation of the weir loading rate

A sketch of the plan and profile with dimensions and a detail of the weir cross-section configuration.

21-14. Design a circular clarifier for a flow rate of $34,560 \text{ m}^3/\text{d}$. Assume the following:

Center feed

$$\text{Overflow rate} = 30 \text{ m}^3/\text{d} \cdot \text{m}^2$$

$$\text{Side water depth} = 4.3 \text{ m}$$

$$\text{Feedwell detention time} = 20 \text{ min}$$

$$\text{EDI detention time} = 10 \text{ s}$$

$$\text{Sludge hopper volume} \approx 1.5 \text{ m}^3$$

To complete the design provide the following:

Diameter of tank

Diameter and depth of feedwell

Diameter and depth of EDI

Dimensions of sludge hopper

Check of velocity across sludge zone

Calculation of the weir loading rate

A sketch of the plan and profile with dimensions and a detail of the weir cross-section configuration.

21-8 REFERENCES

- Albertson, O. E. and P. Alfonso (1995) "Clarifier Performance Upgrade," *Water Environment and Technology*, March, pp. 56–59.
- ATV (1988) "Sludge Removal Systems for Secondary Sedimentation Tanks of Aeration Plants," *Abwassertechnische Vereinigung, Korrespondenz Abwasser*, vol. 35, no. 13, pp. 182–193.
- Benefield, L. D., J. F. Judkins, Jr., and A. David Parr (1984) *Treatment Plant Hydraulics for Environmental Engineers*, Prentice-Hall, Englewood Cliffs, New Jersey, pp. 108–118.
- Camp, T. R. (1936) "A Study of the Rational Design of Settling Tanks," *Sewage Works Journal*, vol. 8, no. 9, pp. 742–758.
- Camp, T. R. (1942) "Grit Chamber Design," *Sewage Works Journal*, vol. 14, pp 368–381.
- Daukss, P. and M. Lunn (2007) "Best Practices for Secondary Clarifier Performance," presented at Michigan Water Environment Association Annual Meeting, Boyne Highlands, Michigan.
- Davis, M. L. and D. A. Cornwell (2008) *Introduction to Environmental Engineering*, McGraw-Hill, New York, p. 447.
- GLUMRB (2004) *Recommended Standards for Wastewater Facilities*, Great Lakes–Upper Mississippi River Board of State and Provincial Public Health and Environmental Managers, Health Education Services, Albany, New York, pp. 70-1–70-7.
- Kawamura, S. (1981) "Hydraulic Scale Model Simulation of the Sedimentation Process," *Journal of American Water Works Association*, vol. 73, no. 7, pp. 372–379.
- Kawamura, S. and J. Lang (1986) "Re-evaluation of Launderers in Rectangular Sedimentation Basins," *Journal of Water Pollution Control Federation*, vol. 58, no. 12, pp. 1,124–1,128.
- Krebs, P., D. Vischer, and W. Gujer (1992) "Improvement of Secondary Clarifier Efficiency by by Porous Walls," *Water Science Technology*, vol. 26, nos. 5/6, pp. 1,147–1,156.
- Metcalf & Eddy (1991) *Wastewater Engineering: Collection and Pumping of Wastewater*, McGraw-Hill, New York, p. 109.
- Metcalf & Eddy (2003) *Wastewater Engineering: Treatment and Reuse*, 4th ed., McGraw-Hill, Boston, Massachusetts, pp. 396–417.
- O'Melia, C. R. (1972) "Coagulation and Flocculation," in W. J. Weber, Jr. (ed.), *Physiochemical Processes for Water Quality Control*, Wiley-Interscience, New York, pp. 94–95.
- Parker, D. S., W. J. Kaufmann, and D. Jenkins (1972) "Floc Breakup in Turbulent Flocculation Processes," *Journal of Sanitary Engineering Division*, American Society of Civil Engineers, vol. 98, pp.79–99.
- Parker, D. S., M. Esquer, M. Hetherington et al. (2000) Assessment and Optimization of a Chemically Enhanced Primary Treatment System," *Proceedings of the 73rd Annual Water Environment Federation Technical Exposition and Conference*, Anaheim, California, October 14–18, Water Environment Federation, Alexandria, Virginia.
- Pettit, M. V. (2006) "Rectangular Clarifiers," in *Clarifier Design*, 2nd ed., Water Environment Federation Manual of Practice no. FD-8, pp. 499–581.
- Reardon, R. D. (2006) "High-Rate and Wet Weather Clarifier Design Concepts and Considerations," *Clarifier Design*, 2nd ed., Water Environment Federation Manual of Practice no. FD-8, p. 71–77.
- Stukenberg, J. R., L. C. Rodman, J. E. Touslee (1983) "Activated Sludge Clarifier Improvements," *Journal of Water Pollution Control Federation*, vol. 55, no. 4, pp. 341–348.
- Tekippe, R. J. (2006) "Circular Clarifiers," in *Clarifier Design*, 2nd ed., Water Environment Federation Manual of Practice no. FD-8, pp. 397–488.
- U.S. EPA (1974) *Process Design Manual for Upgrading Existing Wastewater Treatment Plants*, United State Environmental Protection Agency, Washington, D.C., pp. 6–7.

- U.S. EPA (1975) *Process Design Manual for Suspended Solids Removal*, U.S. Environmental Protection Agency Report No. EPA-625/1-75-003a, Washington, D.C.
- Wahlberg, E. J., T. M. Keinath, and D. S. Parker (1994) "Influence of Activated Sludge Flocculation Time on Secondary Clarification" *Water Environment Research*, vol. 66, no. 6, pp. 779–786.
- Wahlberg, E. J. (2006) "Primary Clarifier Design Concepts and Considerations," in *Clarifier Design*, 2nd ed., Water Environment Federation Manual of Practice no. FD-8, pp. 9–42.
- WEF (1998) *Design of Municipal Wastewater Treatment Plants*, 4th ed., Water Environment Federation Manual of Practice 8, Alexandria, Virginia, pp. 10-1–10-70.
- WEF (2006) in *Clarifier Design*, 2nd ed., Water Environment Federation Manual of Practice no. FD-8.
- Young, J. C., J. L. Cleasby, and E. R. Baumann (1978) "Flow and Load Variations in Treatment Plant Design," *Journal of the Environmental Engineering Division*, American Society of Civil Engineers, vol. 104, EE2, pp. 289–303.

This page intentionally left blank

WASTEWATER MICROBIOLOGY

- | | |
|--|---------------------------------------|
| 22-1 INTRODUCTION | 22-8 OPERATION AND MAINTENANCE |
| 22-2 ROLE OF MICROORGANISMS | 22-9 CHAPTER REVIEW |
| 22-3 CLASSIFICATION OF MICROORGANISMS | 22-10 PROBLEMS |
| 22-4 MICROBIAL BIOCHEMISTRY | 22-11 DISCUSSION QUESTIONS |
| 22-5 POPULATION DYNAMICS | 22-12 REFERENCES |
| 22-6 DECOMPOSITION OF WASTE | |
| 22-7 MICROBIOLOGY OF SECONDARY
TREATMENT UNIT PROCESSES | |

22-1 INTRODUCTION

This chapter provides an introduction to wastewater microbiology. Emphasis is placed on microbial biochemistry because it forms the basis for selecting the appropriate unit process for treating the wastewater as well as establishing the fundamental relationships for design calculations.

22-2 ROLE OF MICROORGANISMS

The stabilization of wastewater is accomplished biologically using a variety of microorganisms. The microorganisms convert colloidal and dissolved carbonaceous organic matter into various gases and into protoplasm.* Because protoplasm has a specific gravity slightly greater than that of water, it can be removed from the treated liquid by gravity settling.

It is important to note that unless the protoplasm produced from the organic matter is removed from the solution, complete treatment will not be accomplished because the protoplasm, which itself is organic, will be measured as BOD in the effluent. If the protoplasm is not removed, the only treatment that will be achieved is that associated with the bacterial conversion of a portion of the organic matter originally present to various gaseous end products.

In addition to stabilization of carbonaceous organic matter, some organisms can remove nutrients that are responsible for eutrophication. A focus of the following discussion is the explanation of the environmental factors that promote the growth and biochemistry of these organisms.

22-3 CLASSIFICATION OF MICROORGANISMS

Classification by Energy and Carbon Source

The relationship between the source of carbon and the source of energy for the microorganism is important. Carbon is the basic building block for cell synthesis. A source of energy must be obtained from outside the cell to enable synthesis to proceed. The goal in wastewater treatment is to convert both the carbon and the energy in the wastewater into the cells of microorganisms, which can be removed from the water by settling or filtration. Therefore, the processes are designed and operated to encourage the growth of organisms that use organic material for both their carbon and energy source.

If microorganisms use organic material as a supply of carbon, they are called *heterotrophic*. *Autotrophs* require only CO₂ to supply their carbon needs. Organisms that rely only on light for energy are called *phototrophs*. *Chemotrophs* extract energy from organic or inorganic oxidation/reduction reactions. *Organotrophs* use organic materials, while *lithotrophs* oxidize inorganic compounds (Rittmann and McCarty, 2001).

Classification by Oxygen Relationship

Bacteria also are classified by their ability or inability to utilize oxygen in oxidation-reduction reactions. *Obligate aerobes* are microorganisms that must have oxygen. When wastewater contains oxygen and can support obligate aerobes, it is called *aerobic*.

*In the lexicon of wastewater treatment, this is called *biosolids*, or, more colloquially, *sludge*.

Obligate anaerobes are microorganisms that cannot survive in the presence of oxygen. Wastewater that is devoid of oxygen is called *anaerobic*. *Facultative anaerobes* can use oxygen in oxidation/reduction reactions and, under certain conditions, they can also grow in the absence of oxygen.

Under *anoxic* conditions, a group of facultative anaerobes called *denitrifiers* utilize nitrites (NO_2^-) and nitrates (NO_3^-) instead of oxygen. Nitrate nitrogen is converted to nitrogen gas in the absence of oxygen. This process is called *anoxic denitrification*.

Classification by Temperature

Each species of bacteria reproduces best within a limited range of temperatures. Four temperature ranges are used to classify bacteria. Those that grow best at temperatures below 20°C are called *psychrophiles*. *Mesophiles* grow best at temperatures between 25°C and 40°C . Between 45°C and 60°C , the *thermophiles* grow best. From about 60°C to near boiling, *hyperthermophiles* grow best. The growth range of *facultative thermophiles* extends from the thermophilic range into the mesophilic range. Growth is not limited to these ranges. Bacteria will grow at slower rates over a larger range of temperatures and will survive at a very large range of temperatures. For example, *Escherichia coli*, classified as a mesophile, will grow at temperatures between 20°C and 50°C and will reproduce, albeit very slowly, at temperatures down to 0°C . If frozen rapidly, they and many other microorganisms can be stored for years with no significant death rate. Once the optimum temperature range is exceeded, growth rate drops off rapidly due to the denaturation of key proteins.

Some Microbes of Interest in Wastewater Treatment

Bacteria. The highest population of microorganisms in a wastewater treatment plant will belong to the bacteria. They are single celled organisms that use soluble food. Conditions in the treatment plant are adjusted so that chemoheterotrophs predominate. No particular species is selected as “the best.”

Fungi. Fungi are multicellular, nonphotosynthetic, heterotrophic organisms. Fungi are obligate aerobes that reproduce by a variety of methods including fission, budding, and spore formation. Their cells require only half as much nitrogen as bacteria so that in a nitrogen deficient wastewater, they predominate over the bacteria (McKinney, 1962).

Algae. This group of microorganisms are photoautotrophs and may be either unicellular or multicellular. Because of the chlorophyll contained in most species, they produce oxygen through photosynthesis. In the presence of sunlight, the photosynthetic production of oxygen is greater than the amount used in respiration. At night they use up oxygen in respiration. If the daylight hours exceed the night hours by a reasonable amount, there is a net production of oxygen. Algae are of benefit in stabilization lagoons for wastewater treatment when they supply oxygen in excess of respiration. Other than production of oxygen, they do not contribute to the stabilization of waste because they use carbon dioxide or bicarbonates as a source of carbon rather than organic carbon. They are a liability when they leave in the lagoon effluent because they contribute to the total suspended particulate concentration and may cause discharge limits to be exceeded.

Protozoa. Protozoa are single-celled organisms that can reproduce by *binary fission* (dividing in two). Most are aerobic chemoheterotrophs, and they often consume bacteria. They are desirable in wastewater effluent because they act as polishers in consuming the bacteria.

Rotifers and Crustaceans. Both rotifers and crustaceans are animals—aerobic, multicellular chemoheterotrophs. The rotifer derives its name from the apparent rotating motion of two sets of cilia on its head. The cilia provide mobility and a mechanism for catching food. Rotifers consume bacteria and small particles of organic matter.

Crustaceans, a group that includes shrimp, lobsters, and barnacles, are characterized by their shell structure. They are a source of food for fish and are not found in wastewater treatment systems to any extent except in under-loaded lagoons. Their presence is indicative of a high level of dissolved oxygen and a very low level of organic matter.

22-4 MICROBIAL BIOCHEMISTRY

Energy Capture

Living organisms capture energy released from oxidation-reduction reactions. *Enzymes* are the organic catalysts produced by microorganisms and used by them to speed the rate of energy-yielding and cell-building reactions. The major source of energy is oxidation-reduction reactions that involve transfer of electrons from one atom to another or from one molecule to another. *Electron carriers* move the electrons from one compound to another. The initial electron donor is called the *primary electron donor*. The final electron acceptor is called the *terminal electron acceptor*. In aerobic systems, the spent electron combines with molecular oxygen to form water.

The electron carriers may be divided into two classes: those that are diffusible throughout the cell's cytoplasm and those that are attached to enzymes in the cytoplasmic membrane. The diffusible carriers include the coenzymes *nicotinamide-adenine dinucleotide* (NAD^+) and *nicotinamide-adenine dinucleotide phosphate* (NADP^+). NAD^+ is involved in energy-generating (*catabolic*) reactions. NADP^+ is involved in biosynthetic (*anabolic*) reactions. Electron carriers attached to the cytoplasmic membrane include NADH dehydrogenases, flavoproteins, cytochromes, and quinones (Rittmann and McCarty, 2001).

The reactions of NAD^+ and NADP^+ are

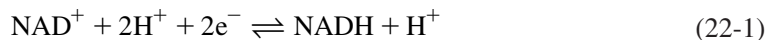

NAD^+ (or NADP^+) extracts two protons and two electrons from a molecule that is being oxidized. In turn they are converted to the reduced forms NADH and NADPH, respectively. The reaction free energy for each of these reactions is +62 kJ. This means that energy must be taken from the organic molecule in order for NADH (or NADPH) to be formed. When NADH (or NADPH) gives up the electrons to another carrier, it is reduced back to NAD^+ (or NADP^+). It also gives up the chemical energy.

If oxygen is the terminal electron acceptor, the energy that is released can be determined from the overall free energy of the NADH and O_2 half reactions (Rittmann and McCarty, 2001):

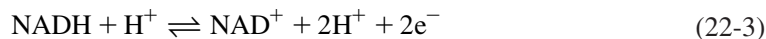



The reaction free energy for 22-3 and 22-4 is -62 kJ and -157 kJ, respectively. In an *aerobic system*, the energy that is transferred from the organic chemical to NADH is ultimately released to oxygen. The overall energy yield for use by the organism is -219 kJ/mole of NADH.

Nitrate, sulfate, and carbon dioxide are other important terminal electron acceptors in wastewater treatment. The overall oxidation-reduction reactions when these electron acceptors accept the electrons from NADH are (Rittmann and McCarty, 2001):

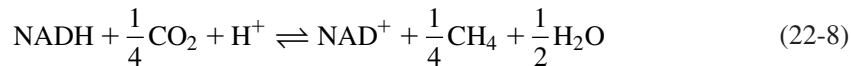
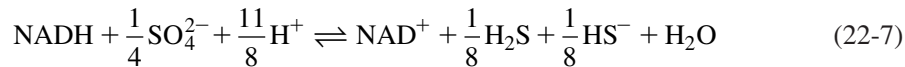
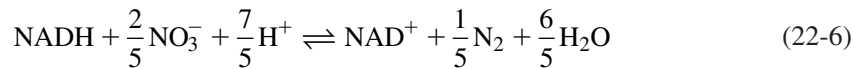

The reaction free energy for these reactions is -206 kJ, -20 kJ, and -15 kJ, respectively. When nitrate is the terminal electron acceptor, the system is called *anoxic*. When sulfate or carbon dioxide is the terminal electron acceptor, the system is called *anaerobic*. This energy analysis indicates that the energy available with nitrate as the electron acceptor is similar to that with oxygen, but sulfate and carbon dioxide yield much less energy per NADH.

The practical implication of these calculations of available energy is that there is a hierarchy of oxidation-reduction reactions. Because aerobic oxidation provides more energy for microorganism growth, it will proceed in preference to anoxic (nitrate) oxidation. Likewise, anoxic oxidation will proceed in preference to anaerobic (sulfate and carbon dioxide) oxidation.

The energy is captured by the organism by transferring the energy from intermediate electron carriers to *energy carriers*. The primary example of an energy carrier is *adenosine triphosphate* (ATP). When energy is released from an electron carrier, it is used to add a phosphate group to *adenosine diphosphate* (ADP):

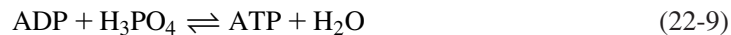

In this reaction ADP acquires 32 kJ while NADH has given up more than six times this amount of energy when oxygen is the terminal electron acceptor. Theoretically, under aerobic conditions, six moles of ATP could be formed from each mole of NADH. Because the actual reactions do not capture 100 percent of the standard free energy, only three moles of ATP are formed.

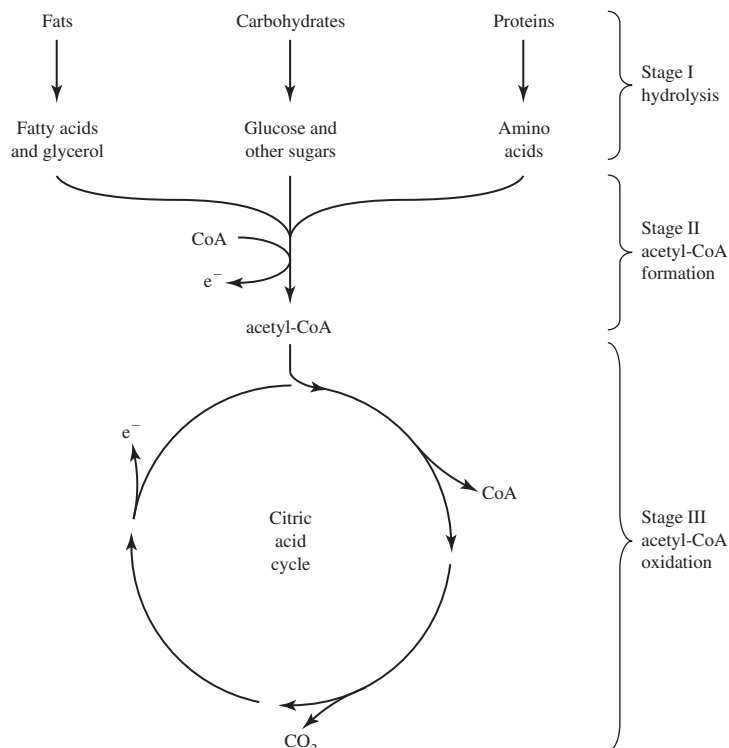
**FIGURE 22-1**

The three general stages of catabolism of fats, carbohydrates, and proteins under aerobic conditions. Reversing the processes gives anabolism. (Source: Rittmann and McCarty, 2001.)

Metabolism

The sum total of all the chemical processes of the cell is called *metabolism*. It may be separated into *catabolism*, which is the process of obtaining energy, and *anabolism*, which is the process of synthesis of cellular components. Both the catabolic processes and the anabolic processes are very complex. A simplified overview of the catabolic processes is presented in the following paragraphs.

The general stages of catabolism of fats, carbohydrates, and proteins is diagramed in Figure 22-1. *Hydrolysis* occurs in Stage I. It may be described as the splitting of a polymer by adding water to a covalent bond (Figure 22-2). The reaction is catalyzed by a hydrolyase enzyme.

The formation of acetyl-CoA* from fatty acids and glucose is illustrated in Figures 22-3 and 22-4.

An expanded view of the *citric acid cycle* (also known as the *Krebs cycle* after its author, or the *tricarboxylic acid cycle*) is shown in Figure 22-5. Two new compounds are introduced in the diagram: flavin adenine dinucleotide (FAD), a less energetic carrier than NAD^+ , and guanosine triphosphate (GTP), an analog of ATP.

*CoA is coenzyme A. An enzyme may be considered an organic catalytic agent. It consists of a protein portion (*apoenzyme*) and, in some cases, a prosthetic group (*coenzyme*) that is part of the enzyme as well.

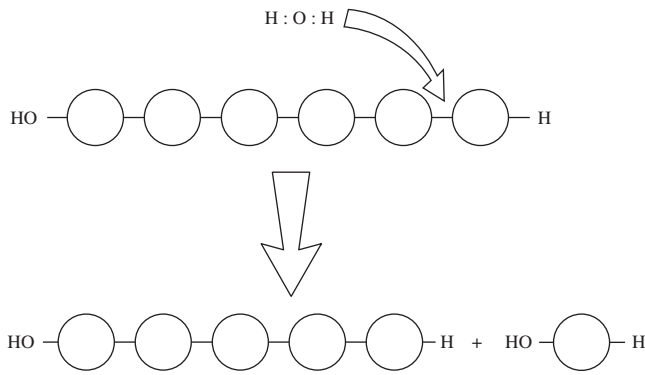

FIGURE 22-2
Hydrolysis of a polymer.

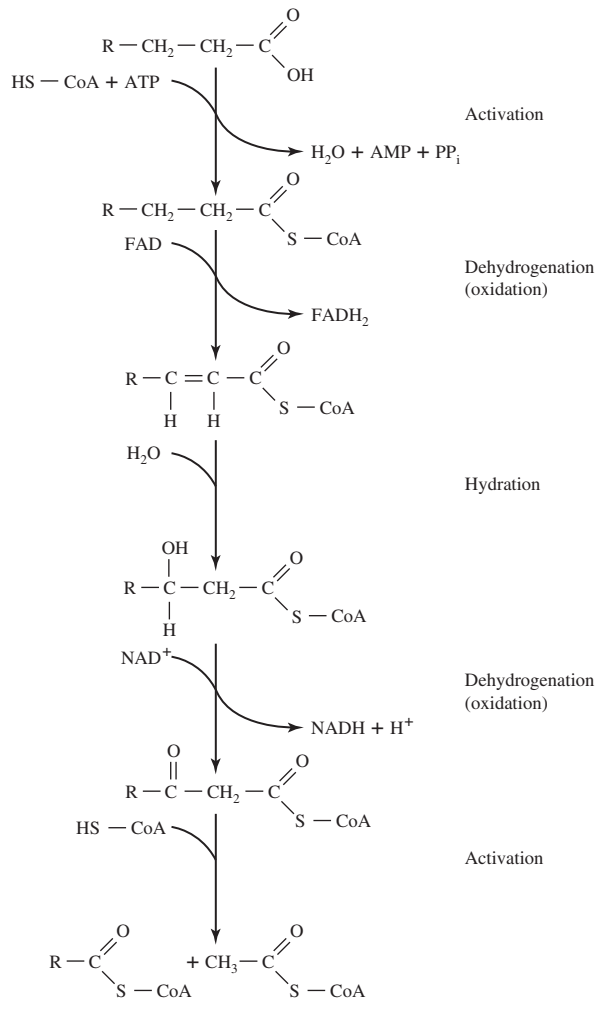

FIGURE 22-3
 β -oxidation of fatty acids to acetyl-CoA.
(Source: Rittmann and McCarty, 2001.)

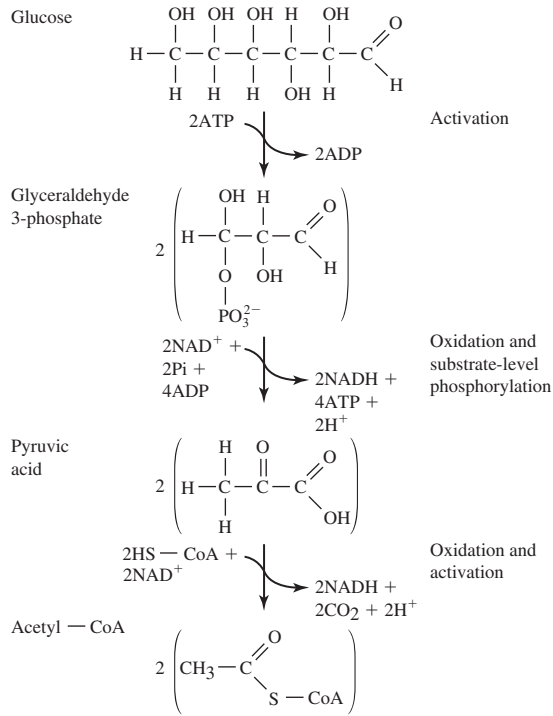

FIGURE 22-4 Conversion of carbohydrates, represented here by glucose, to acetyl CoA. (Source: Rittmann and McCarty, 2001.)

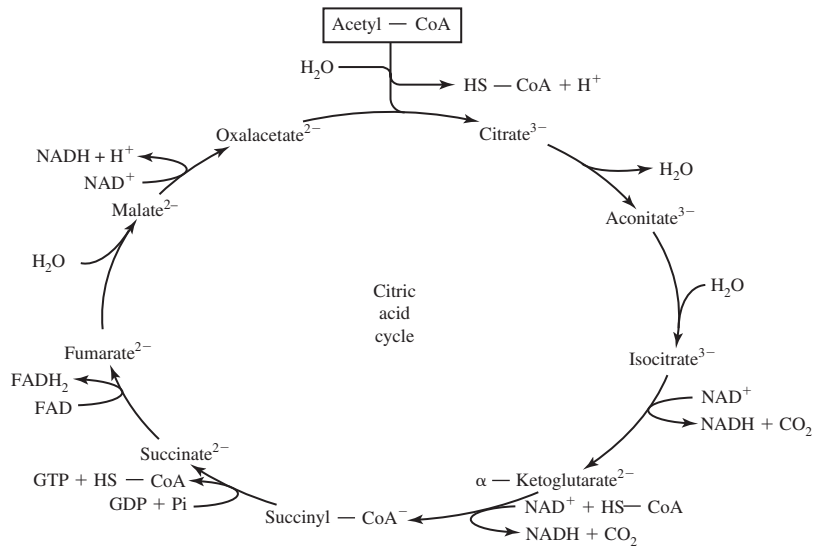
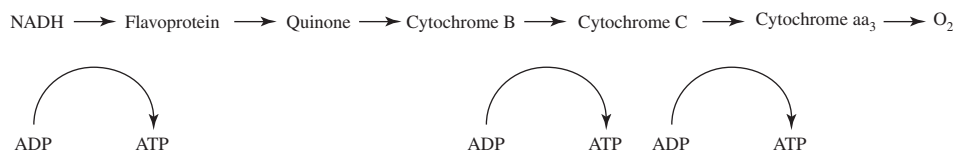

FIGURE 22-5 The citric acid cycle. (Source: Rittmann and McCarty, 2001.)

**FIGURE 22-6**

The mitochondrial electron transport chain for transfer of electrons from NADH to O₂. NADH comes from the citric acid cycle. From flavoprotein to quinone, four protons are translocated across an inner mitochondrial membrane. This creates a proton gradient that is later used to generate ATP. From quinone to cytochrome B, two electrons are removed.

The transport process proceeds through *oxidative phosphorylation* to convert the energy stored in NADH and FADH₂ to ATP. The major pathway for mitochondrial electron transport is shown schematically in Figure 22-6. Glucose, for example, is degraded completely to CO₂ and the electrons that are removed in the oxidative reactions are used to reduce the terminal electron acceptor, oxygen, as shown in the following half-reaction:



End Products

A summary of substrate categories and representative end products is presented in Table 22-1.

TABLE 22-1
Substrates and representative end products

Substrates	Aerobic and anoxic decomposition	Anaerobic decomposition
Proteins and other nitrogen-containing compounds	Amino acids Ammonia → nitrites → nitrates ^a	Amino acids Ammonia Hydrogen sulfide Methane Carbon dioxide Alcohols Organic acids
Carbohydrates	Alcohols → CO ₂ + H ₂ O Fatty acids	Carbon dioxide Fatty acids Methane
Fats and related substances	Fatty acids + glycerol Alcohols → CO ₂ + H ₂ O Lower fatty acids	Fatty acids + glycerol Carbon dioxide Alcohols Lower fatty acids Methane

^aUnder anoxic conditions the nitrates are converted to nitrogen gas.
Adapted from Pelczar and Reid, 1958.

Requirements for Microbial Growth

In order for bacteria to grow and maintain themselves, they must have available essential nutrients such as carbon, nitrogen, phosphorus, sulfur, and the elements required for the synthesis of proteins, nucleic acids, and other structural parts of the cells. If these requirements are not present in available forms in the wastewater that is to be treated, they must be provided. This may be of particular importance if a large fraction of the wastewater flow is contributed by industry.

The following list summarizes the major requirements that must be satisfied:

1. A terminal electron acceptor
2. Macronutrients
 - a. Carbon to build cells
 - b. Nitrogen to build cells (N:BOD₅ ≈ 1:32)
 - c. Phosphorus for ATP (energy carrier) and DNA (P:BOD₅ ≈ 1:150)
3. Micronutrients
 - a. Trace metals such as Co, Cu, Fe, Mn
 - b. Vitamins are required by some bacteria
4. Appropriate environment
 - a. Moisture
 - b. Temperature
 - c. pH
 - d. Light

22-5 POPULATION DYNAMICS

In the discussion of the behavior of bacterial cultures which follows, there is the inherent assumption that all the requirements for growth are initially present.

Pure Culture Growth Characteristics

A hypothetical laboratory experiment in which 1,400 bacteria of a single species are introduced into a synthetic liquid medium provides an illustration of growth in pure cultures. Initially nothing appears to happen. The bacteria must adjust to their new environment and begin to synthesize new protoplasm. On a plot of bacterial growth versus time (Figure 22-7), this phase of growth is called the *lag phase*. In the start-up of new plants, the lag phase may show a decrease in population.

At the end of the lag phase the bacteria begin to divide. Because all of the organisms do not divide at the same time, there is a gradual increase in population. This phase is labeled *accelerated growth* on the growth plot.

At the end of the accelerated growth phase, the population of organisms is large enough and the differences in generation time are small enough that the cells appear to divide at a regular rate. Because reproduction is by binary fission (each cell divides producing two new cells), the increase in population follows in geometric progression: 1 → 2 → 4 → 8 → 16 → 32, and so forth. The population of bacteria (P) after the n^{th} generation is given by the following expression:

$$P = P_0(2)^n \quad (22-11)$$

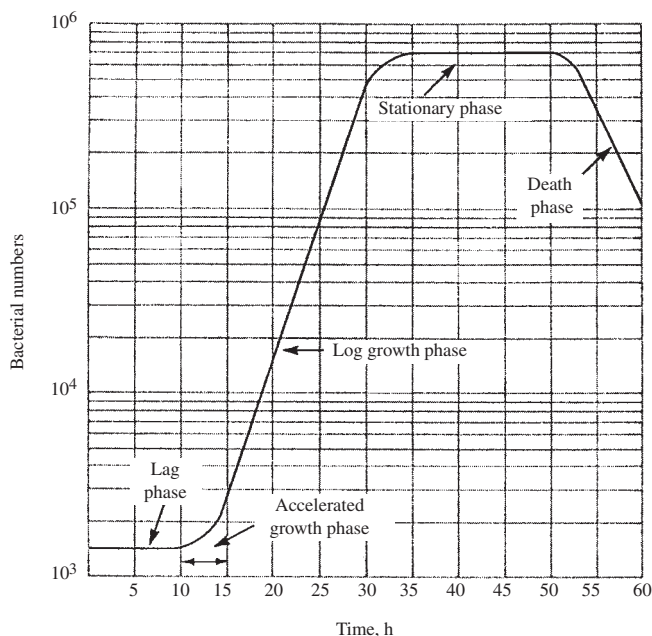

FIGURE 22-7
Pure culture bacterial growth curve.
(Source: Davis and Cornwell, 2008.)

where P_0 is the initial population at the end of the accelerated growth phase. Taking the log of both sides of Equation 22-11:

$$\text{Log } P = \log P_0 + n \log 2 \quad (22-12)$$

If the bacterial population is plotted on a logarithmic scale, this phase of growth plots as a straight line of slope n and intercept P_0 at t_0 . This phase of growth is called the *log growth* or *exponential growth phase*.

The log growth phase tapers off as the substrate becomes exhausted or as toxic byproducts build up. Thus, at some point the population becomes constant either as a result of cessation of fission or a balance in death and reproduction rates. This is depicted by the *stationary phase* on the growth curve.

Following the stationary phase, the bacteria begin to die faster than they reproduce. This death phase is due to a variety of causes that are basically an extension of those that lead to the stationary phase.

Mixed Culture Growth Characteristics

In wastewater treatment, as in nature, pure cultures of microorganisms do not exist. Rather, a mixture of species compete and survive within the limits set by the environment. *Population dynamics* is the term used to describe the time varying success of the various species in competition. It is expressed quantitatively in terms of relative mass of microorganisms.*

*If each individual organism of species A has, on the average, twice the mass at maturity as each individual organism of species B, and both compete equally, one would expect that both would have the same total biomass, but that there would be twice as many of species B as there would be of A.

The prime factor governing the dynamics of the various microbial populations in sewage is the competition for *substrate* (organic matter in the wastewater that is colloquially called *food*). The second most important factor is the predator-prey relationship.

The relative success of a pair of species competing for the same substrate is a function of the ability of the species to metabolize the substrate. The more successful species will be the one that metabolizes the substrate more completely. In so doing, it will obtain more energy for synthesis and consequently will achieve a greater mass.

Because of their relatively smaller size and, thus, larger surface area per unit mass, which allows a more rapid uptake of substrate, bacteria will predominate over fungi. For the same reason, the fungi predominate over the protozoa.

When the supply of soluble organic substrate becomes exhausted, the bacterial population is less successful in reproduction and the predator populations increase. In a closed system with an initial inoculum of mixed microorganisms and substrate, the populations will cycle as the bacteria give way to higher level organisms that in turn die for lack of substrate and are then decomposed by a different set of bacteria (Figure 22-8). In an open system, such as a wastewater treatment plant or a river, with a continuous inflow of new substrate, the predominant populations will change through the length of the plant (Figure 22-9). This condition is known as *dynamic equilibrium*. It is a highly sensitive state, and changes in influent characteristics must be regulated closely to maintain the proper balance of the various populations.

For the large numbers and mixed cultures of microorganisms found in waste treatment systems, it is convenient to measure biomass rather than numbers of organisms. Frequently, this is done by measuring the suspended solids or *volatile suspended solids* (VSS), that is, those that burn at $550^{\circ}\text{C} \pm 50^{\circ}\text{C}$. When the wastewater contains only soluble organic matter, the volatile suspended solids test is reasonably representative. The presence of organic particles (which is often the case in municipal wastewater) confuses the issue completely.

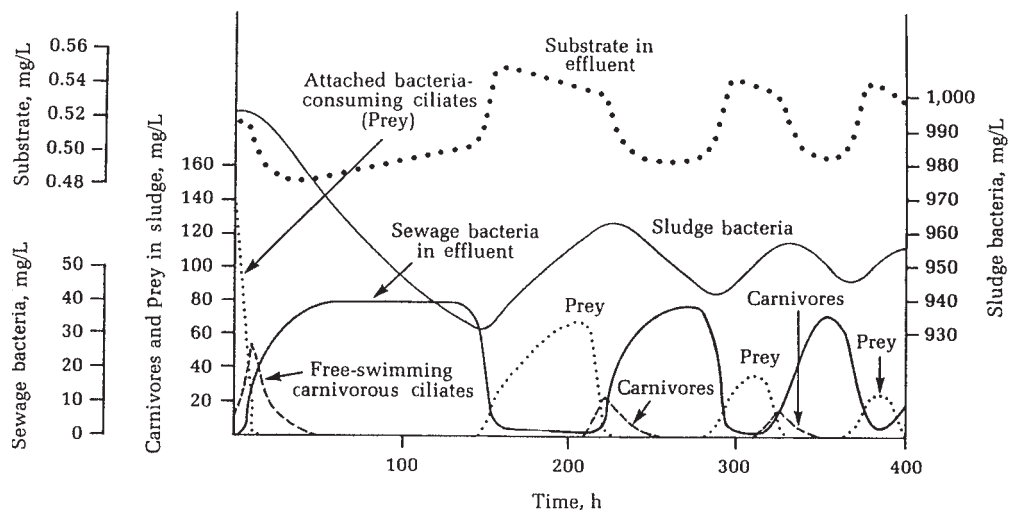

FIGURE 22-8

Population dynamics in a closed system. (Source: Curds, 1973.)

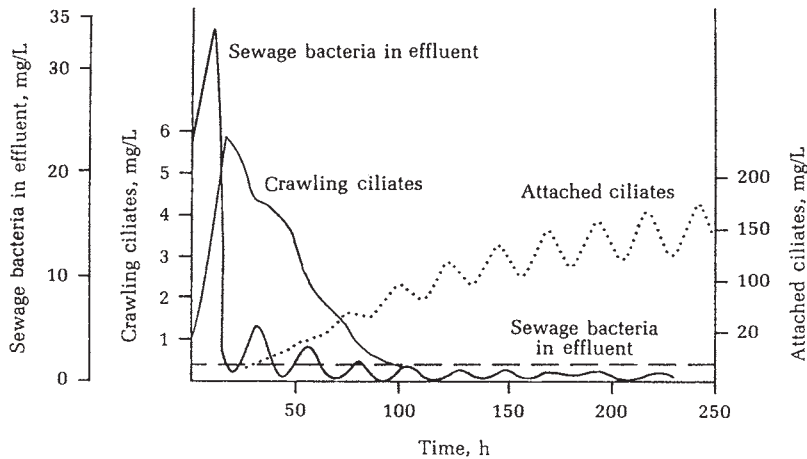

FIGURE 22-9
Population dynamics in an open system. (Source: Curds, 1973.)

The Monod Equation

In the log-growth phase, the rate expression for biomass increase is

$$\frac{dX}{dt} = \mu X \quad (22-13)$$

where dX/dt = growth rate of the biomass, mg/L · d
 μ = specific growth rate constant due to synthesis, d⁻¹
 X = concentration of biomass, mg/L

Because of the difficulty of direct measurement of μ in mixed cultures, Monod (1949) developed a model equation that assumes that the rate of substrate utilization, and therefore the rate of biomass production, is limited by the rate of enzyme reactions involving the substrate compound that is in shortest supply relative to its need. The Monod equation is

$$\mu = \frac{\mu_m S}{K_s + S} \quad (22-14)$$

where μ_m = maximum specific growth rate, d⁻¹
 S = concentration of rate limiting substrate, mg/L
 K_s = half saturation constant, mg/L
 = concentration of limiting substrate when $\mu = 0.5 \mu_m$

The growth rate of biomass follows a hyperbolic function as shown in Figure 22-10.

Two limiting cases are of interest in the application of Equation 22-14 to wastewater treatment systems. In those cases where there is an excess of the limiting substrate, then $S \gg K_s$ and the growth rate constant μ is approximately equal to μ_m . Equation 22-14 then becomes zero-order in substrate. At the other extreme, when $S \ll K_s$, the system is substrate-limited and the growth rate becomes first-order with respect to substrate.

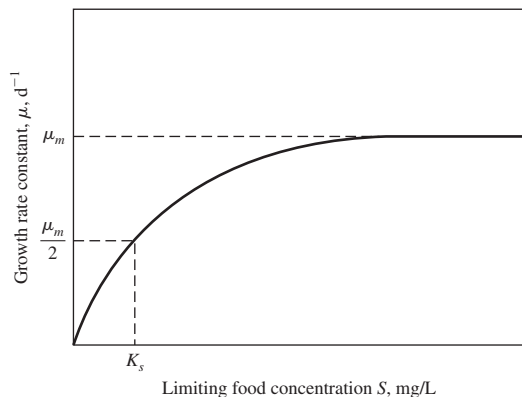
FIGURE 22-10

Monod growth rate constant as a function of limiting food concentration. (Source: Davis and Cornwell, 2001.)

Equation 22-14 assumes only growth of microorganisms and does not take into account natural die-off. It is generally assumed that the death or decay of the microbial mass is a first-order expression in biomass and hence Equations 22-13 and 22-14 are expanded to

$$\frac{dX}{dt} = \frac{\mu_m SX}{K_s + S} - k_d X \quad (22-15)$$

or

$$r_g = \frac{\mu_m SX}{K_s + S} - k_d X \quad (22-16)$$

where k_d = endogenous decay rate constant, d^{-1} .
 r_g = net biomass production rate, $g \text{ VSS}/m^3 \cdot d$

If all of the substrate in the system were converted to biomass, the rate of substrate utilization (dS/dt) would equal the rate of biomass production. Because of the inefficiency of the conversion process, the rate of substrate utilization will be greater than the rate of biomass utilization, so

$$-\frac{dS}{dt} = \frac{1}{Y} \frac{dX}{dt} \quad (22-17)$$

where Y = decimal fraction of substrate mass converted to biomass

$$= \text{yield coefficient, } \frac{\text{mg/L biomass}}{\text{mg/L substrate utilized}}$$

Combining Equations 22-13, 22-14, and 22-17:

$$-\frac{dS}{dt} = \frac{1}{Y} \frac{\mu_m SX}{K_s + S} \quad (22-18)$$

or

$$r_{su} = -\frac{1}{Y} \frac{\mu_m SX}{K_s + S} \quad (22-19)$$

where r_{su} = substrate utilization rate or rate of substrate concentration change due to utilization.

Equations 22-16 and 22-19 are a fundamental part of the development of the design equations for wastewater treatment processes.

22-6 DECOMPOSITION OF WASTE

The type of electron acceptor available for catabolism determines the type of decomposition (i.e., aerobic, anoxic, or anaerobic) used by a mixed culture of microorganisms. Each type of decomposition has particular characteristics that affect its use in wastewater treatment. In the following paragraphs a general discussion of the three types of decomposition is presented.

Aerobic Decomposition

Molecular oxygen (O_2) must be present as the terminal electron acceptor for decomposition to proceed by aerobic oxidation. The oxygen is measured as dissolved oxygen (DO). When oxygen is present, it is the only terminal electron acceptor used. The chemical end products of decomposition are primarily carbon dioxide, water, and new cell material. Odiferous gaseous end products are kept to a minimum. In healthy natural water systems, aerobic decomposition is the principal means of self purification.

A wider spectrum of organic material can be oxidized aerobically than by any other type of decomposition. This fact, coupled with the fact that the final end products are oxidized to a very low energy level, results in a more stable end product (i.e., one that can be disposed of without damage to the environment and without creating a nuisance condition) than can be achieved by the other oxidation systems.

Because of the large amount of energy released in aerobic oxidation, most aerobic organisms are capable of high growth rates. Consequently, there is a relatively large production of new cells in comparison with the other oxidation systems. This means that more biological sludge is generated in aerobic oxidation than in the other oxidation systems.

Aerobic decomposition is the method of choice for large quantities of dilute wastewater (BOD_5 less than 500 mg/L) because decomposition is rapid, efficient, and has a low odor potential. Typically, aerobic decomposition is not suitable for high strength wastewater (BOD_5 is greater than 1,000 mg/L) because of the difficulty in supplying enough oxygen and because of the large amount of biological sludge produced. However, in small communities and in special industrial applications where aerated lagoons are used, wastewater with BOD_5 up to 3,000 mg/L may be treated satisfactorily by aerobic decomposition. This is because the daily influent volume of wastewater is small, the detention time is long, and the lagoon acts as a complete mix reactor.

Anoxic Decomposition

Some microorganisms can use nitrate (NO_3^-) as the terminal electron acceptor in the absence of molecular oxygen. Oxidation by this route is called *denitrification*.

The end products from denitrification are nitrogen gas, carbon dioxide, water, and new cell material. The amount of energy made available to the cell during denitrification is about the same as that made available during aerobic decomposition. As a consequence, the rate of production of new cells, although not as high as in aerobic decomposition, is relatively high.

Denitrification is of importance in wastewater treatment where nitrogen must be removed to protect the receiving body. Another important aspect of denitrification is in relation to final

clarification of the treated wastewater. If the environment of the final clarifier becomes anoxic, the formation of nitrogen gas will cause large globs of sludge to float to the surface and escape from the treatment plant into the receiving water. Thus, it is necessary to ensure that anoxic conditions do not develop in the final clarifier.

Anaerobic Decomposition

In order to achieve anaerobic decomposition, molecular oxygen and nitrate must not be present as terminal electron acceptors. Sulfate (SO_4^{2-}), carbon dioxide, and organic compounds that can be reduced serve as terminal electron acceptors. The reduction of sulfate results in the production of hydrogen sulfide (H_2S) and a group of equally odoriferous organic sulfur compounds called *mercaptans*.

The anaerobic decomposition (*fermentation*) of organic matter generally is considered to be a three-step process. In the first step, waste components are hydrolysed. In the second step, complex organic compounds are fermented to low molecular weight fatty acids (*volatile acids*). In the third step, the organic acids are converted to methane. Carbon dioxide serves as the electron acceptor.

Anaerobic decomposition yields carbon dioxide, methane, and water as the major end products. Additional end products include ammonia, hydrogen sulfide, and mercaptans. As a consequence of these last three compounds, anaerobic decomposition is characterized by highly objectionable odors.

Because only small amounts of energy are released during anaerobic oxidation, the amount of cell production is low. Thus, sludge production is low. This fact is used in wastewater treatment to stabilize and reduce the volume of sludges produced during aerobic and anoxic decomposition.

Typically, direct anaerobic decomposition of wastewater is not used for dilute municipal wastewater. The optimum growth temperature for the anaerobic bacteria is at the upper end of the mesophilic range. Thus, to get reasonable biodegradation, the temperature of the culture must be elevated. For dilute wastewater, this is not practical. For concentrated wastes (BOD_5 greater than 1,000 mg/L) and sludge treatment, anaerobic digestion is quite appropriate.

22-7 MICROBIOLOGY OF SECONDARY TREATMENT UNIT PROCESSES

Four commonly used secondary treatment unit processes are aerobic oxidation, nitrification, denitrification, and phosphorous removal. An additional unit process that is becoming more common is the activated sludge selector. The objectives of these processes may be summarized as:

- Aerobic oxidation: removal of readily biodegradable COD (rbCOD) or BOD.
- Nitrification: oxidation of ammonia ($\text{NH}_4\text{-N}$) to nitrate.
- Denitrification: reduction of nitrate to nitric oxide, nitrous oxide, and nitrogen gas.
- Phosphorous removal: incorporation of phosphorus into cell biomass that is subsequently removed from the process.
- Selector: adjustment of the ecology of the activated sludge system to favor those organisms with good settling characteristics.

The microbiology, stoichiometry, growth kinetics, and environmental control factors of these unit processes are described in the following paragraphs. These are the fundamental basis for selection and design of secondary treatment alternatives.

Aerobic Oxidation

The unit processes used to remove BOD may be either *suspended growth* where microorganisms are suspended in the wastewater or *attached growth* where the microorganisms grow on a solid surface.

Microbiology. Aerobic heterotrophic bacteria predominate. Protozoa also play a role by consuming free bacteria and colloidal particles.

Stoichiometry. The stoichiometry of the oxidation may be described by the following generic equations:

Oxidation and synthesis

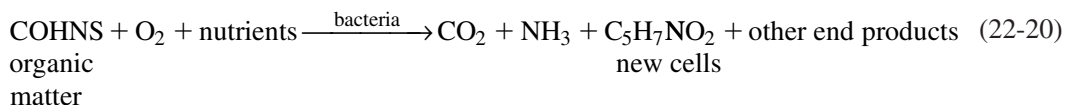

where COHNS is a generic representation of organic matter and C₅H₇NO₂ is a generic representation of new cells.

Endogenous respiration

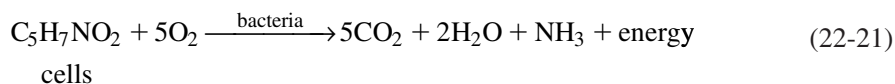

When the organic matter is used up, the cells begin to consume their own cell tissue to obtain energy for cell maintenance. This process is called *endogenous respiration*.

Growth Kinetics. The form of the rate expressions for net biomass growth and substrate utilization are given by Equations 22-15 and 22-18. These are used to develop design parameters in Chapter 23.

Environmental Factors. Although successful carbonaceous removal can be achieved over a range of 6.0 to 9.0, the optimum pH is near neutral. A common minimum limit for DO concentration is 2.0 mg/L (Metcalf & Eddy, 2003).

Nitrification

Nitrification is the term used to describe the two-step process in which ammonia (NH₄⁺) is oxidized to nitrite (NO₂⁻) that is, in turn, oxidized to nitrate (NO₃⁻) Nitrification may be accomplished by either suspended growth or attached growth unit processes.

Microbiology. Aerobic autotrophic bacteria must predominate to accomplish nitrification. Two genera are commonly recognized. Ammonia is oxidized to nitrite by *Nitrosomonas*. Nitrite is oxidized to nitrate by *Nitrobacter*. In the last two decades a number of other autotrophic genera have been identified that will also perform these functions (Metcalf & Eddy, 2003).

Stoichiometry. The oxidation steps that yield energy are:

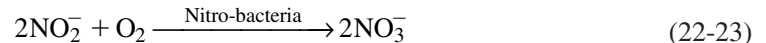
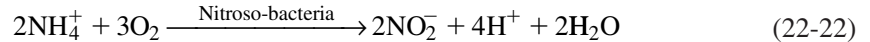

The total oxidation reaction may be written as

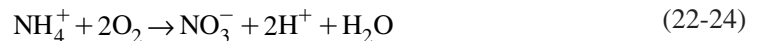

From the total oxidation reaction, the oxygen required for total oxidation of ammonia is 4.57 g of O_2/g of N. Of this amount, 3.43 g of O_2/g is used for nitrite production and 1.14 g of O_2 is used for oxidation of nitrite.

Neglecting cell tissue, the amount of alkalinity required to buffer the total oxidation reaction can be estimated from the following reaction:

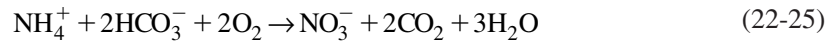

Thus, for each gram of ammonia nitrogen (as N) that is converted, 7.14 g of alkalinity as CaCO_3 is required.

The generic biomass synthesis reaction is

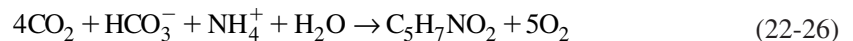

where $\text{C}_5\text{H}_7\text{NO}_2$ is the generic representation of bacterial cells.

Growth Kinetics. The growth rate of *Nitrosomonas* controls the overall conversion reaction. For nitrification systems operated at temperatures below 28°C , ammonia oxidation kinetics are rate limiting. Thus, designs are based on saturation kinetics for ammonia oxidation:

$$\mu_n = \left(\frac{\mu_{nm}N}{K_n + N} \right) - k_{dn} \quad (22-27)$$

where μ_n = specific growth rate for nitrifying bacteria, g new cells/g cells · d

μ_{nm} = maximum specific growth rate, g new cells/g cells · d

N = nitrogen concentration, g/m^3

K_n = half velocity constant, substrate concentration at one-half the maximum specific substrate utilization rate, g/m^3

k_{dn} = endogenous decay coefficient for nitrifying organisms, g VSS/g VSS · d

The μ_{nm} values for nitrifying organisms are much lower than μ_m for heterotrophic organisms. The values reported for μ_{nm} vary from 0.25 to 0.77 g VSS/g VSS · d (Randall et al., 1992). Because these values cover a wide range, whenever possible bench-scale or in-plant testing are highly recommended to evaluate site-specific nitrification values.

Nitrification rates are affected by the DO concentration in suspended growth processes. The rates increase up to DO concentrations of 3 to 4 mg/L. To account for the effects of DO, Equation 22-27 is modified as follows:

$$\mu_n = \left(\frac{\mu_{nm}N}{K_n + N} \right) \left(\frac{DO}{K_o + DO} \right) - k_{dn} \quad (22-28)$$

where K_o = half saturation constant for DO, g/m³
 DO = dissolved oxygen concentration, g/m³

At low to moderate organic loadings, the kinetic model coefficients are generally adequate. At high organic loadings, these models will over predict the nitrification rates (Metcalf & Eddy, 2003).

Because the growth rate for nitrifying organisms is less than that for heterotrophic organisms, the fraction of organisms in the reactor is considerably less than the fraction of heterotrophic organisms in a single stage carbon oxidation-nitrification process. The fraction of nitrifying organisms (f_N) can be estimated with the following equation (Crites and Tchobanoglous, 1998):

$$f_N = \frac{0.16(\text{NH}_3\text{removed})}{0.6(\text{BOD}_5\text{removed}) + 0.16(\text{NH}_3\text{removed})} \quad (22-29)$$

Environmental Factors. In addition to maintenance of sufficient DO as noted above, the pH must be controlled within a narrow range. Nitrification will occur at pH values in the range of 6.8 to 8.0. Typically the range of pH is held to 7.0 to 7.2 (Metcalf & Eddy, 2003). Where the alkalinity is low, it is added in the form of lime, soda ash, sodium bicarbonate, or magnesium hydroxide depending on cost.

Toxic effects from a wide variety of organic compounds, metals, and un-ionized ammonia have been observed.

Denitrification

To reduce the potential for eutrophication, nitrate may be reduced to nitric oxide, nitrous oxide, and nitrogen gas. Two modes of biological nitrate removal can occur: assimilating nitrate reduction and dissimilating nitrate reduction. Assimilating nitrate reduction involves the reduction of nitrate to ammonia for cell synthesis. It occurs when NH₄-N is not available. It is independent of DO concentration. Dissimilating nitrate reduction is coupled to the respiratory electron transport chain. Nitrate or nitrite is used as an electron acceptor for the oxidation of organic or inorganic electron donors.

The most common process used in municipal wastewater treatment plants is known as the *Modified Ludzak-Ettinger* (MLE) process. It consists of an anoxic tank followed by an aeration tank. Nitrification occurs in the aeration tank. Nitrate produced in the aeration tank is recycled back to the anoxic tank. Organic substrate in the influent wastewater provides the electron donor for oxidation-reduction reactions using nitrate. The process is also known as *preanoxic denitrification*.

An alternative process called *postanoxic denitrification* removes the BOD first in an aeration tank. Denitrification occurs in a second tank that is anoxic. The electron donor source is from endogenous decay. This process has a much slower rate of reaction than the MLE process. Often an *exogenous* carbon source such as methanol or acetate is added to provide sufficient rbCOD for nitrate reduction and to increase the rate of denitrification. Postanoxic processes may include both suspended growth and attached growth systems.

Microbiology. Both heterotrophic and autotrophic organisms are capable of denitrification. A large number of genera have been identified. Most of the bacteria are facultative anaerobes. *Pseudomonas* species are the most common.

Stoichiometry. The nitrate reduction reactions involve the following steps:



The reaction stoichiometry for the three common electron donors is as follows:

Influent wastewater

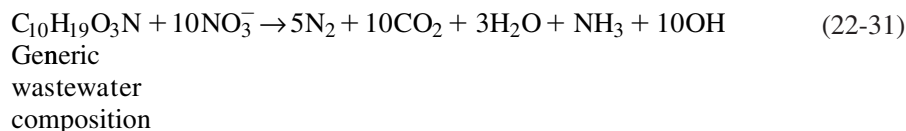

Methanol

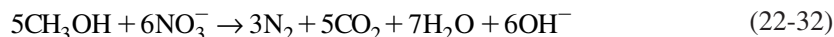

Acetate

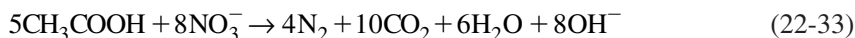

In each of these reactions one equivalent of alkalinity is produced for each equivalent of $\text{NO}_3\text{-N}$ reduced. This equates to 3.57 g of alkalinity as CaCO_3 per gram of nitrogen reduced. This means that about one-half of the alkalinity consumed in nitrification (7.14 g as CaCO_3) can be recovered in denitrification.

The oxygen equivalent of nitrate and nitrite is useful in design when the total oxygen required for nitrification-denitrification is to be calculated. For nitrate it is 2.86 g of O_2/g of $\text{NO}_3\text{-N}$. For nitrite it is 1.71 g of O_2/g of $\text{NO}_2\text{-N}$.

The amount of rbCOD required to provide a sufficient amount of electron donor for nitrate removal may be estimated as (Metcalf & Eddy, 2003):

$$\text{g of rbCOD/g NO}_3\text{-N} = \frac{2.86}{1 - 1.42 Y_n} \quad (22-34)$$

where Y_n = net biomass yield, g VSS/g rbCOD.

Growth Kinetics. The substrate utilization rate expression given by Equation 22-19 is modified by a term to show a lower utilization rate in the anoxic zone:

$$r_{su} = -\frac{\eta \mu_m SX}{Y K_s + S} \quad (22-35)$$

where η = fraction of denitrifying bacteria in the biomass, g VSS/ g VSS

The value of η has been found to vary from 0.20 to 0.80 for preanoxic denitrification reactions (Stensel and Horne, 2001). For postanoxic suspended growth and attached growth processes, the η term is not required because the biomass is predominately denitrifying bacteria.

DO can inhibit nitrate reduction by repressing the nitrate reduction enzyme. A DO concentration as low as 0.13 mg/L has been observed to cause denitrification to stop. The effect of nitrate and DO concentration is accounted for by two correction factors for Equation 22-35 (Barker and Dold, 1997):

$$r_{su} = -\left(\frac{1 \mu_m SX}{Y K_s + S}\right)\left(\frac{NO_3}{K_{s,NO_3} + NO_3}\right)\left(\frac{K'_O}{K'_O + DO}\right)\eta \quad (22-36)$$

where K'_O = DO inhibition coefficient for nitrate reduction, mg/L

K_{s,NO_3} = half velocity coefficient for nitrate limited reaction, mg/L

The value of K'_O is system specific. Values in the range of 0.1 to 0.2 mg/L have been proposed for K'_O and 0.1 mg/L for K_{s,NO_3} (Barker and Dold, 1997).

Environmental Factors. Alkalinity is produced in the denitrification process and the pH is generally elevated. No significant effect on the denitrification rate has been reported for pH values between 7.0 and 8.0.

Phosphorus Removal

In biological phosphorus removal (BPR or Bio-P) or enhanced biological phosphorus removal (EBPR) as it is sometimes called, the phosphorus in the wastewater is incorporated into cell mass in excess of levels needed for cell synthesis and maintenance. This is accomplished by moving the biomass from an anaerobic to an aerobic environment. The phosphorus contained in the biomass is removed from the process as sludge.

Microbiology. The original work on enhanced Bio-P identified *Acinetobacter* as the responsible genus. Subsequent work has identified Bio-P bacteria in other genera such as *Arthrobacter*, *Aeromonas*, *Nocardia*, and *Pseudomonas*. The Bio-P organisms in these genera are referred to as *phosphorus accumulating organisms* (PAOs).

Based on the work of Comeau et al. (1986), Wentzel et al. (1986) developed a mechanistic model used to explain BPR. This model proposes that (Stephens and Stensel, 1998):

Complex chemical oxygen demand (COD) is fermented to acetate by facultative bacteria under anaerobic conditions. The bacteria assimilate acetate in the anaerobic zone and convert it to polyhydroxybutyrate (PHB) using reducing equivalents provided from the tricarboxylic acid (TCA) cycle. Stored polyphosphate is degraded to provide adenosine triphosphate (ATP) necessary for PHB formation, and the polyphosphate degradation is accomplished by the release of orthophosphorus and magnesium, potassium, and

calcium. Under aerobic conditions, the PHB is oxidized to synthesize new cells and to produce reducing equivalents needed for ATP formation. Phosphate and inorganic cations are taken up, reforming polyphosphate granules. The amount of phosphate taken up under aerobic conditions exceeds the phosphorus released during anaerobic conditions, resulting in excess phosphorus removal.

Other proposed models incorporate glycogen into the phosphate removal mechanism. Based on laboratory measurements of cellular carbohydrates, Mino et al. (1987) speculated that under anaerobic conditions, glycogen serves as the electron donor for PHB formation. Then, under aerobic conditions, glycogen is synthesized from PHB oxidation to replenish the glycogen reserves needed under anaerobic conditions. In two papers, Smolders et al. (1994a and 1994b) presented a stoichiometric model that includes the role of glycogen for acetate uptake and PHB storage in the anaerobic phase and a stoichiometric model for PHB oxidation and glycogen and polyphosphate formation during the aerobic phase. . . . Both models produce PHB from acetyl-CoA formed from acetate, but the Wentzel model relies on the TCA cycle for NADH, whereas glycogen is produced under aerobic conditions in the Mino/Smolders model.

These models are illustrated in Figure 22-11.

Stoichiometry. Common heterotrophic bacteria in activated sludge have a phosphorus composition of 0.01 to 0.02 g P/g biomass. PAOs are capable of storing phosphorus in the form of phosphates. In the PAOs, the phosphorus content may be as high as 0.2 to 0.3 g P/g biomass.

Acetate uptake is critical in determining the amount of PAOs and, thus, the amount of phosphorus that can be removed by this pathway. If significant amounts of DO or nitrate enter the anaerobic zone, the acetate will be depleted before it is taken up by the PAOs. Bio-P removal is not used in systems that are designed for nitrification without providing a means of denitrification.

The amount of phosphorus removal can be estimated from the amount of rbCOD in the wastewater influent. The following assumptions are used to evaluate the stoichiometry of biological phosphorus removal: (1) 1.06 g of acetate/g of rbCOD will be produced as the COD is fermented

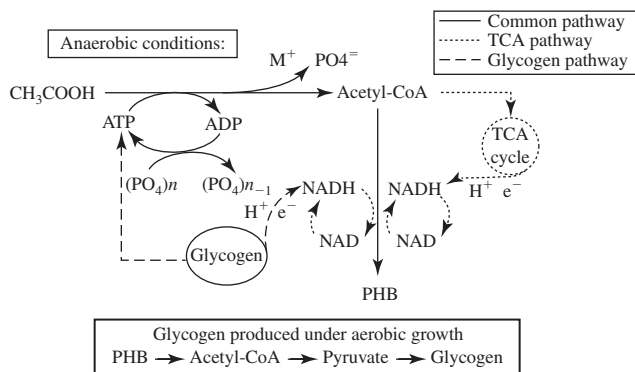

FIGURE 22-11

Comparison of mechanisms for anaerobic acetate uptake, phosphorus release, and PHB formation using either the TCA cycle in the Wentzel model or glycogen in the Mino/Smolders models for NADH. (Source: Stephens and Stensel, 1998.)

TABLE 22-2
Volatile fatty acids and phosphorus uptake

Volatile fatty acid	P uptake/VFA COD consumed
Acetic	0.37
Butyric	0.12
Isobutyric	0.14
Isovaleric	0.24
Propionic	0.10
Valeric	0.15

Adapted from WEF, 2006.

to volatile fatty acids (VFAs), (2) a cell yield of 0.3 g VSS/g of acetate, and (3) a cell phosphorus content of 0.3 g of P/ g VSS. With these assumptions, it is estimated that 10 g of rbCOD is required to remove 1 g of phosphorus (Metcalf & Eddy, 2003).

It should be noted that all VFAs are not equivalent in phosphorus uptake. Table 22-2 illustrates the importance of acetic acid. From an operational perspective a simple measurement of total VFAs may not be sufficient to identify performance deficiencies.

Growth Kinetics. Bio-P growth kinetics fall in the same order of magnitude as that of other heterotrophic bacteria. A maximum specific growth rate at 20°C is given as 0.95 g/g · d by Barker and Dold (1997).

Environmental Factors. Steady-state rbCOD or acetate availability is required for good phosphorus removal. Periods of starvation or low rbCOD concentrations result in lowering of intracellular storage reserves of glycogen, PHB, and polyphosphates. This leads to decreased phosphorus removal efficiency. This is a potential scenario at start-up of the plant when wastewater flow rates and loads are low. It is also a potential scenario during the diurnal cycle of BOD load because of nighttime decreases in anthropogenic activity.

Systems with excessive anaerobic contact times and without significant VFA production will experience phosphorus release with no uptake of acetate. Excessive anaerobic contact results in the release of orthophosphate without the addition of acetate as the bacteria use stored polyphosphate for an energy source. During subsequent aeration, the oxidation of PHB provides energy for bacteria to assimilate not only the released phosphorus but additional phosphorus from the influent wastewater to build polyphosphate reserves. Not all of the phosphorus that is released in the absence of acetate consumption can be taken up because there is not enough PHB storage to provide the energy for excess uptake during the aerobic period.

Likewise, excessive aeration time will result in less phosphorus uptake. This is the result of the competitive role of glycogen in the formation and utilization of PHB. From Figure 22-11 it may be noted that glycogen is degraded under anaerobic conditions to provide energy for PHB formation. Under aeration a portion of the PHB is converted to glycogen. If less glycogen is available during anaerobic contact, then less PHB formation is expected. Less PHB results in less phosphorus uptake during aeration. If glycogen reserves are depleted in the aerobic period because of excessive aeration, a greater portion of the PHB formed is used to replenish glycogen reserves. This results in less PHB available for phosphorus uptake under aerobic conditions.

System performance is not affected by DO as long as the aerobic zone DO is above 1.0 mg/L. The pH must be above 6.5 for appreciable phosphorus removal. The recommended molar ratios of Mg, K, and Ca to phosphorus are 0.71, 0.50, and 0.25, respectively (Wentzel et al., 1989).

Selector

A *selector* is a bioreactor design that favors the growth of floc-forming bacteria instead of filamentous bacteria so that the biomass has better settling and thickening properties. The selector designs are based on either kinetic or metabolic mechanisms.

Kinetic-Based Selector. While filamentous bacteria are more efficient for substrate utilization at low substrate concentrations, the floc-forming bacteria have a higher growth rate at high soluble substrate concentrations. One or more reactors with short detention times (minutes) is used for the kinetic selector. The ratio of the mass of COD or BOD to the mass of microorganisms is high. It is on the order of 3 to 5 g of BOD/g of suspended solids per day. To achieve the kinetic concept, the DO must be on the order of 6 to 8 mg/L. This allows the floc-forming bacteria to have a high growth rate.

Metabolic-Based Selector. The filamentous bacteria cannot use nitrate or nitrite for an electron acceptor. Because of this metabolic advantage, floc-forming bacteria that can use nitrate or nitrite, and can store polyphosphates, are favored over filamentous organisms that do not settle well. Thus, biological nutrient processes inherently have good sludge settling characteristics because the environmental conditions favor floc-forming bacteria over filamentous bacteria.

22-8 OPERATION AND MAINTENANCE

The most common operational problems encountered in the operation of activated sludge treatment systems are bulking sludge, rising sludge, and *Nocardia* foam. These problems result from changes in the microbial ecology of the reactor. They can be solved by maintaining an environment that inhibits unfavorable microbial populations.

Bulking Sludge

A *bulking sludge* is one that has poor settling characteristics and does not compact well. This frequently leads to discharge of floc particles and consequent permit violations for suspended solids. There are two principal types of sludge bulking. The first is caused by the growth of filamentous organisms, and the second is caused by water trapped in the bacterial floc, thus reducing the density of the agglomerate and resulting in poor settling.

Filamentous bacteria have been blamed for much of the bulking problem in activated sludge. Although filamentous organisms are effective in removing organic matter, they have poor floc-forming and-settling characteristics. Bulking may also be caused by a number of other factors, including long, slow-moving collection-system transport; low available ammonia nitrogen when the organic load is high; low pH, which could favor acid-favoring fungi; and the lack of macronutrients, which stimulates predomination of the filamentous actinomycetes over the normal floc-forming bacteria. The lack of nitrogen also favors slime-producing bacteria, which have a low specific gravity, even though they are not filamentous. The multicellular fungi cannot compete with the bacteria normally but can compete under specific environmental conditions, such as low

pH, low nitrogen, low oxygen, and high carbohydrates. As the pH decreases below 6.0, the fungi are less affected than the bacteria and tend to predominate. As the nitrogen concentrations drop below a BOD₅ : N ratio of 20:1, the fungi, which have a lower protein level than the bacteria, are able to produce normal protoplasm, while the bacteria produce nitrogen-deficient protoplasm. Limited DO concentration has been noted more frequently than any other cause. The DO must be at least 2 mg/L.

Control of bulking sludge by design includes providing adequate aeration capacity, a wide range of return and waste sludge pumping rates, and appropriate clarifier geometry. The use of an activated sludge selector upstream of the conventional process is a relatively new design alternative to provide an environment that favors floc-forming microorganisms over filamentous organisms.

Operational controls include adjustment of pH, BOD₅ to nitrogen ratio, and oxygen concentration.

Rising Sludge

A sludge that floats to the surface after apparently good settling is called a *rising sludge*. Rising sludge results from denitrification, that is, reduction of nitrates and nitrites to nitrogen gas in the sludge blanket (layer). Much of this gas remains trapped in the sludge blanket, causing globs of sludge to rise to the surface and float over the weirs into the receiving stream.

Rising-sludge problems can be overcome by increasing the rate of return sludge flow, by increasing the speed of the sludge-collecting mechanism, by decreasing the mean cell residence time, and, if possible, by decreasing the flow from the aeration tank to the offending tank.

Foaming

Excessive foam that floats on aeration tanks has been attributed to two bacteria genera: *Nocardia* and *Microthrix parvicella*. These are filamentous organisms. *Nocardia* growth is common where surface scum is trapped in either aeration basins or secondary clarifiers.

The use of a selector process reduces the ability of the *Nocardia* to compete for food, and, thus, reduces foaming. The foaming may also be minimized by avoiding trapping the foam, returning skimmings to the aeration basins, and by the use of surface sprays. The presence of *Nocardia* has also been associated with fats and edible oils in wastewater. The use of prevention programs that prohibit discharge of oil and grease from restaurants and meat packing facilities can help control potential *Nocardia* problems (Metcalf & Eddy, 2003).

Visit the text website at www.mhprofessional.com/wwe for supplementary materials and a gallery of photos.

22-9 CHAPTER REVIEW

When you have completed studying this chapter, you should be able to do the following without the aid of your textbook or notes:

1. Explain the difference between the following organism classifications:
 - a. Autotrophs and heterotrophs
 - b. Obligate aerobes, obligate anaerobes, and facultative anaerobes
 - c. Aerobes and denitrifiers

2. Explain the role of electron carriers, the primary electron donor, and the terminal electron acceptor.
3. For each type of decomposition (aerobic, anoxic, and anaerobic), list an electron acceptor, important end products, and relative advantages and disadvantages as a waste treatment process.
4. List the growth requirements of bacteria and explain why a bacterium needs them.
5. Sketch and label the bacterial growth curve for a pure culture. Define or explain each phase labeled on the curve.
6. Explain the difference between oxidation/synthesis and endogenous respiration.
7. Explain why alkalinity decreases in nitrification and increases in denitrification.
8. Describe the mechanistic model for BPR.
9. Describe the phenomenon known as *bulking sludge* and explain its primary cause.
10. Give two possible design remedies and two operational controls to minimize bulking sludge.
11. Describe the phenomenon known as *rising sludge* and explain its primary cause.
12. Give two operational controls to correct a rising sludge problem.

With the aid of this text, you should be able to do the following:

13. Determine energy yield for oxidation-reduction reactions given half reactions and ΔG_0 for the half reaction.
14. Estimate the oxygen demand of endogenous oxidation of cells (g of O_2 /g of cells) assuming cell oxidation can be described by Equation 22-21.
15. Show by calculation that the oxygen required for total oxidation of ammonia is 4.57 g of O_2 /g of N.
16. Show by calculation that 7.14 g of alkalinity as $CaCO_3$ is required for each gram of ammonia nitrogen (as N) that is oxidized.
17. Evaluate the effects of DO concentration on nitrification.
18. Show by calculation that 3.57 g of alkalinity as $CaCO_3$ is produced for each equivalent of NO_3-N that is reduced.
19. Evaluate the effects of DO concentration on denitrification.

22-10 PROBLEMS

Table 22-3 on page 22-27 provides half-reactions that are required to solve problems in this section.

- 22-1. Develop Equation 22-6 from the half-reactions and determine the energy yield.
- 22-2. Develop Equation 22-7 from the half-reactions and determine the energy yield.

TABLE 22-3
Half-reactions and their Gibb's standard free energy at pH=7.0

Half-reaction	ΔG_0 , kJ per electron equivalent
$\frac{1}{8} \text{CO}_2 + \text{H}^+ + \text{e}^- \rightleftharpoons \frac{1}{8} \text{CH}_4 + \frac{1}{4} \text{H}_2\text{O}$	25.53
$\text{NAD}^+ + 2\text{H}^+ + 2\text{e}^- \rightleftharpoons \text{NADH} + \text{H}^+$	62
$\text{NADP}^+ + 2\text{H}^+ + 2\text{e}^- \rightleftharpoons \text{NADPH} + \text{H}^+$	62
$\frac{1}{2} \text{NO}_3^- + \text{H}^+ + \text{e}^- \rightleftharpoons \frac{1}{2} \text{NO}_2^- + \frac{1}{2} \text{H}_2\text{O}$	- 41.65
$\frac{1}{5} \text{NO}_3^- + \frac{6}{5} \text{H}^+ + \text{e}^- \rightleftharpoons \frac{1}{10} \text{N}_2 + \frac{3}{5} \text{H}_2\text{O}$	- 72.20
$\frac{1}{8} \text{SO}_4^{2-} + \frac{19}{16} \text{H}^+ + \text{e}^- \rightleftharpoons \frac{1}{16} \text{H}_2\text{S} + \frac{1}{16} \text{HS}^- + \frac{1}{2} \text{H}_2\text{O}$	20.85
$\frac{1}{6} \text{SO}_3^{2-} + \frac{5}{4} \text{H}^+ + \text{e}^- \rightleftharpoons \frac{1}{12} \text{H}_2\text{S} + \frac{1}{12} \text{HS}^- + \frac{1}{2} \text{H}_2\text{O}$	011.03

Sources: Metcalf & Eddy, 2003; Rittmann and McCarty, 2001.

- 22-3.** Develop Equation 22-8 from the half-reactions and determine the energy yield.
- 22-4.** Determine by calculation the mass of oxygen required for total oxidation of ammonia in g of O_2/g of N.
- 22-5.** Determine by calculation the alkalinity in g as CaCO_3/g of ammonia nitrogen, as N, that is required to buffer the total oxidation reaction.
- 22-6.** If the influent ammonium concentration is 21.8 mg/L, estimate the amount of alkalinity (in mg/L) that must be added to buffer the oxidation reaction assuming that a residual alkalinity of 80 mg/L as CaCO_3 is required to keep the pH at approximately 7. Assume the influent alkalinity is 250 mg/L as CaCO_3 .
- 22-7.** If in Problem 22-6, the amount of alkalinity in the raw wastewater is 305 mg/L as CaCO_3 , what will the pH be after nitrification? Assume that the CO_2 concentration in the wastewater resulting from BOD oxidation and ammonia nitrification is 25 mg/L. Use the following equation for the estimate:

$$\text{pH} = pK_1 - \log \left\{ \frac{[\text{H}_2\text{CO}_3]}{[\text{HCO}_3^-]} \right\}$$

where $pK_1 = 6.38$.

- 22-8.** Using a value of $K_0 = 0.5$, plot a curve of μ_n versus DO using Equation 22-28. Metcalf & Eddy (2003) suggests that nitrification rates increase up to DO levels of 3 to 4 mg/L. Based on your plot, do you agree with this assessment?
- 22-9.** Determine by calculation the alkalinity in g as CaCO_3/g of nitrate nitrogen that may be recovered from the reduction reaction.

- 22-10.** Using a value of $K'_O = 0.10$ mg/L, estimate the reduction in substrate utilization (r_{su}) in nitrate reduction if the DO concentration is 0.10 mg/L.
- 22-11.** Using a value of $K'_O = 0.10$ mg/L, estimate the reduction in substrate utilization (r_{su}) in nitrate reduction if the DO concentration is 0.20 mg/L.

22-11 DISCUSSION QUESTIONS

- 22-1.** Consider the following experiment:

A glucose solution is placed in a series of BOD bottles with a seed of wastewater microorganisms. The solution contains nitrate ions, sulfate ions, and oxygen. The BOD bottles are sealed. Over several days to several weeks time, sequential bottles are opened. Each is analyzed for NO_3^- , O_2 , and SO_4^{2-} . List the order in which these compounds are expected to “disappear” and explain why.

- 22-2.** You are touring the research labs of the environmental engineers at your university. Two biological reactors are in a controlled temperature room that has a temperature of 35°C. Reactor A has a strong odor. Reactor B has virtually no odor. What electron acceptors are being used in each reactor?
- 22-3.** In its start-up phase a BPR process is not removing phosphorus as anticipated by design calculations. What laboratory analyses would you ask to be performed to help assess the problem? Why?
- 22-4.** Large globs of matlike sludge are observed in the supernatant of the secondary clarifier of an activated sludge plant.

This is a _____ sludge.

22-12 REFERENCES

- Barker, P. S. and P. L. Dold (1997) “General Model for Biological Nutrient Removal in Activated Sludge Systems: Model Presentation,” *Water Environment Research*, vol. 69, no. 5, pp. 969–984.
- Comeau, Y., K. J. Hall, R. E. W. Hancock, and W. K. Oldham (1986) “Biochemical Model for Enhanced Biological Phosphorus Removal,” *Water Research*, vol. 20, no. 12, pp. 1,511–1,522.
- Crites, R. and G. Tchobanoglous (1998) *Small Decentralized Wastewater Management Systems*, WCB McGraw-Hill, Boston, Massachusetts, pp. 438.
- Curds, C. R. (1973) “A Theoretical Study of Factors Influencing the Microbial Population Dynamics of the Activated Sludge Process,” *Water Research*, Vol. 7, pp. 1269–1284.
- Davis, M. L. and D. A. Cornwell (2008) *Introduction to Environmental Engineering*, McGraw-Hill, New York, p. 456.
- Lawrence, A. W. and P. L. McCarty (1970) “A Unified Basis for Biological Treatment Design and Operation,” *Journal of Sanitary Engineering Division*, American Society of Civil Engineers, vol. 96, no. SA3, pp. 757–778.
- McKinney, R. E. (1962) *Microbiology for Sanitary Engineers*, McGraw-Hill, New York, p. 40.
- Mino, T., A. Viswanath, T. Yoshiaki, and T. Matsuo (1987) “Effect of Phosphorus Accumulation on Acetate Metabolism in the Biological Phosphorus Removal Process,” *Proceedings of Biological Phosphorus Removal Wastewater International Association, Water Pollution Research Control Specialty Conference, Rome, Italy*.

- Monod, J. (1949) "The Growth of Bacterial Cultures," *Annual Review of Microbiology*, vol. 3, pp. 371–394.
- Metcalf & Eddy (2003) *Wastewater Engineering: Treatment and Reuse*, 4th ed., McGraw-Hill, Boston, Massachusetts, pp. 563–886.
- Pelczar, M. J. and R. D. Reid (1958) *Microbiology*, McGraw-Hill, New York, p. 424.
- Randall, C. W., J. L. Barnard, and H. D. Stensel (1992) "Design and Retrofit of Wastewater Treatment Plants for Biological Nutrient Removal," *Water Quality Management Library*, vol. 5, Technomic Publishing Co., Lancaster, PA.
- Rittmann, B. E. and P. L. McCarty (2001) *Environmental Biotechnology: Principles and Applications*, McGraw-Hill, Boston, Massachusetts, pp. 13–36, 293.
- Smolders, G. J. F., J. van derMeij, M. C. M. van Loosdrecht, and J. J. Heijnen (1994a) "Model of the Anaerobic Metabolism of the Biological Phosphorus Removal Process: Stoichiometry and pH Influences," *Biotechnology and Bioengineering*, vol. 43, p. 461.
- Smolders, G. J. F., J. van derMeij, M. C. M. van Loosdrecht, and J. J. Heijnen (1994b) "Stoichiometric Model of Aerobic Metabolism of the Biological Phosphorus Removal Process," *Biotechnology and Bioengineering*, vol. 44, p. 837.
- Stensel, H. D. and G. Horne (2001) "Evaluation of Denitrification Kinetics at Wastewater Treatment Facilities," *Research Symposium Proceedings, 73rd Annual Water Environment Federation Conference*, Anaheim, California, October 14–18.
- Stephens, H. L. and H. D. Stensel (1998) "Effect of Operating Conditions on Biological Phosphorus Removal," *Water Environment Research*, vol. 70, no. 3, pp. 362–369.
- WEF (2006) *Biological Nutrient Removal (BNR) Operation in Wastewater Treatment Plants*, Water Environment Federation, Water Environment Federation Manual of Practice 30, Alexandria, Virginia, p. 112.
- Wentzel, M. C., L. H. Lotter, R. E. Loewenthal, and G. v. R. Marais (1986) "Metabolic Behavior of *Acinetobacter* spp. in Enhanced Biological Phosphorous Removal—A Biochemical Model," *Water*, South Africa, vol. 12, p. 209.
- Wentzel, M. C., R. E. Loewenthal, G. A. Ekama, and G. v. R. Marais (1989) "Enhanced Polyphosphate Organism Cultures in Activated Sludge Systems—Part 1: Enhanced Culture Development," *Water*, South Africa, vol. 14, p. 81–92.

This page intentionally left blank

**SECONDARY TREATMENT BY SUSPENDED
GROWTH BIOLOGICAL PROCESSES**

- | | | | |
|-------------|--|--------------|--|
| 23-1 | INTRODUCTION | 23-7 | SUSPENDED GROWTH DESIGN PRACTICE |
| 23-2 | PROCESSES FOR BOD REMOVAL
AND NITRIFICATION | 23-8 | MEMBRANE BIOREACTOR DESIGN
PRACTICE |
| 23-3 | PROCESSES FOR DENITRIFICATION | 23-9 | CHAPTER REVIEW |
| 23-4 | PROCESSES FOR PHOSPHORUS REMOVAL | 23-10 | PROBLEMS |
| 23-5 | BIOLOGICAL TREATMENT WITH
MEMBRANE SEPARATION | 23-11 | DISCUSSION QUESTIONS |
| 23-6 | SUSPENDED GROWTH DESIGN
PRINCIPLES | 23-12 | REFERENCES |

23-1 INTRODUCTION

The major purpose of conventional secondary treatment is to oxidize the readily biodegradable BOD that escapes primary treatment and to provide further removal of suspended solids. Because of the increasing recognition of the deleterious effects of nutrients, secondary treatment often includes treatment of nitrogen and phosphorus. Processes for biological treatment of BOD and these nutrients are included in this chapter.

This chapter focuses on processes utilizing suspensions of microorganisms (*suspended growth*) to treat wastewater. Those processes that utilize films of microorganisms attached to inert media (*attached growth*) to treat wastewater are discussed in Chapter 24.

This chapter is organized into three parts: processes for treatment, design principles, and design practice.

23-2 PROCESSES FOR BOD REMOVAL AND NITRIFICATION

Oxidation Ponds

Treatment ponds have been used to treat wastewater for many years, particularly as wastewater treatment systems for small communities. Many terms have been used to describe the different types of systems employed in wastewater treatment. *Oxidation pond* has been widely used as a collective term for all types of ponds. Originally, an oxidation pond was a pond that received partially treated wastewater, whereas a pond that received raw wastewater was known as a *sewage lagoon*.

In this discussion, oxidation pond is used as an all-inclusive term that refers to a pond or lagoon used to treat organic waste by biological and physical processes. These processes would commonly be referred to as *self-purification* if they took place in a stream. *Waste stabilization pond* and *stabilization lagoon* are synonymous terms. Oxidation ponds are further classified as follows (Caldwell et al., 1973):

1. *Aerobic ponds*: Shallow ponds, less than 1 m in depth, where dissolved oxygen is maintained throughout the entire depth, mainly by the action of photosynthesis.
2. *Facultative ponds*: Ponds 1 to 2.5 m deep, which have an anaerobic lower zone, a facultative middle zone, and an aerobic upper zone maintained by photosynthesis and surface reaeration.
3. *Anaerobic ponds*: Deep ponds that receive high organic loadings such that anaerobic conditions prevail throughout the entire pond depth.
4. *Maturation or tertiary ponds*: Ponds used for polishing effluent from other biological processes. Dissolved oxygen is furnished through photosynthesis and surface reaeration. This type of pond is also known as a *polishing pond*.
5. *Aerated lagoons*: Ponds oxygenated through the action of surface or diffused air aeration.

Approximately 40 percent of the municipal wastewater treatment plants in the United States are oxidation ponds. Of the five types, facultative ponds and aerated lagoons predominate with facultative ponds outnumbering aerated lagoons by almost three to one (WEF, 1998). While the ponds are adequate for BOD oxidation, they do not provide biological nutrient removal.

Aerobic Ponds. The aerobic pond is a shallow pond in which light penetrates to the bottom, thereby maintaining active algal photosynthesis throughout the entire system. During the daylight hours, large amounts of oxygen are supplied by the photosynthesis process; during the hours of darkness, wind mixing of the shallow water mass generally provides a high degree of surface reaeration. Stabilization of the organic material entering an aerobic pond is accomplished mainly through the action of aerobic bacteria.

Facultative Ponds. These ponds are by far the most common type selected as wastewater treatment systems for small communities. About 90 percent of these ponds are located in communities of 5,000 people or fewer. Facultative ponds are popular because their long retention times facilitate the management of large fluctuations in wastewater flow and strength with no significant effect on effluent quality. The operating and maintenance costs are less than those of other biological systems that provide equivalent treatment. If land is not expensive, the capital cost is less.

The pond oxidation processes range from aerobic in the upper levels to anaerobic in the lower levels.

Anaerobic Ponds. The organic loading and the availability of dissolved oxygen determine whether the biological activity in a treatment pond will occur under aerobic or anaerobic conditions. A pond may be maintained in an anaerobic condition by applying a BOD₅ load that exceeds oxygen production from photosynthesis. Photosynthesis can be reduced by decreasing the surface area and increasing the depth. Anaerobic ponds become turbid from the presence of reduced metal sulfides. This restricts light penetration to the point that algal growth becomes negligible.

Anaerobic ponds are used primarily as a pretreatment process and are particularly suited for the treatment of high-temperature, high-strength wastewater. However, they have been used successfully to treat municipal wastewater as well.

Maturation or Tertiary Ponds. These ponds receive wastewater effluent from secondary treatment systems. They are not secondary treatment processes.

Aerated Lagoons. These ponds are oxygenated through the action of surface or diffused air aeration. They are a type of activated sludge process. They differ primarily in that earth structures are used and there is no recycling of biological solids.

Activated Sludge

The activated sludge process derives its name from the biological mass formed when air is continuously injected into the wastewater. In this process, microorganisms are mixed thoroughly with the organic compounds contained in wastewater under conditions that stimulate their growth through use of the organic compounds as substrate. As the microorganisms grow and are mixed by the agitation of the air, the individual organisms flocculate to form an active mass of microbes (biologic floc) called *activated sludge*.

In the conventional aerobic oxidation process, wastewater flows continuously into an aeration tank (Figure 23-1) where air is injected to mix the activated sludge with the wastewater and to supply the oxygen needed for the organisms to oxidize the organic compounds. The mixture of activated sludge and wastewater in the aeration tank is called *mixed liquor*. The concentration of active biomass is called *mixed liquor volatile suspended solids* (MLVSS). The concentration of active biomass plus inert solids is termed *mixed liquor*



FIGURE 23-1

Activated sludge aeration tank under air.

(Source: E. Lansing WWTP, photo courtesy of Harley Seeley of the Instructional Media Center, Michigan State University.)

suspended solids (MLSS). In a conventional aerobic oxidation process, the mixed liquor flows from the aeration tank to a secondary clarifier where the activated sludge is settled out. Most of the settled sludge is returned to the aeration tank (it is called *return sludge*) to maintain the high population of microbes that permits rapid breakdown of the organic compounds. Because more activated sludge is produced than is desirable in the process, some of the return sludge is diverted or wasted to the sludge handling system for treatment and disposal. The *mean cell residence time* (MCRT or θ_c), also called *solids retention time* (SRT) or *sludge age*, is defined as the average amount of time that microorganisms are kept in the system.

In conventional activated sludge systems, the wastewater is typically aerated for six to eight hours in long, rectangular aeration basins. Sufficient air is provided to keep the sludge in suspension. The air is injected near the bottom of the aeration tank through a system of diffusers. The volume of sludge returned to the aeration basin is typically 20 to 30 percent of the wastewater flow.

The activated sludge process is controlled by wasting a portion of the microorganisms each day in order to maintain the proper amount of microorganisms to efficiently oxidize the biodegradable COD (bCOD).* *Wasting* means that a portion of the microorganisms is discarded from the process. The discarded microorganisms are called *waste activated sludge* (WAS). A balance is then achieved between growth of new organisms and their removal by wasting. If too much

*See Table 18-4 in Chapter 18 for a complete list of abbreviations and their definitions.

TABLE 23-1
Selected activated sludge configurations
for oxidation of biodegradable COD and nitrification

Plug flow (conventional)
Step feed (step aeration)
Complete mix
Oxidation ditch
Sequencing batch reactor
Staged activated sludge
Contact stabilization
Conventional with selector
Tapered aeration
Extended aeration

sludge is wasted, the concentration of microorganisms in the mixed liquor will become too low for effective treatment. If too little sludge is wasted, a large concentration of microorganisms will accumulate and, ultimately, overflow the secondary tank and flow into the receiving stream.

There are many process arrangements of the basic activated sludge process. Table 23-1 lists some of the configurations used for oxidation of biodegradable COD and nitrification.

Because nitrifying bacteria grow much more slowly than heterotrophic bacteria, systems designed for nitrification generally have much longer hydraulic and solids retention times. These are discussed in the following paragraphs.

Plug Flow. This is the conventional arrangement where flow enters one end of a long narrow tank and exits at the other (Figure 23-2a). The solid line in Figure 23-3 illustrates how substrate and oxygen demand vary along the length of the tank. Oxygen demand is highest in the first 20 percent of the tank because of substrate oxidation. Oxygen demand along the remainder of the tank is due to endogenous respiration.

If the concentration of substrate is high, it may lead to complete depletion of dissolved oxygen. Oxygen depletion may be detrimental to some of the microbial population. It may also result in fermentation or partial oxidation that results in organic acid production and a drop in pH.

Step Feed. Although it is frequently called *step aeration*, step feeding is a more accurate descriptor (Figure 23-2b). In this modification of the plug flow configuration, the influent flows into the aeration tank at several locations along its length. The benefit of this arrangement is that it reduces oxygen demand at the head end of the tank. This is shown by the small-dashed line in Figure 23-3.

Complete Mix. This process is a completely mixed stirred tank reactor (CSTR). It is illustrated in Figure 23-2c. Because the influent is “immediately” diluted with the contents of the tank, the substrate concentration and dissolved oxygen (DO) are uniform over the reactor volume. This is illustrated by the large-dashed line in Figure 23-3. While this arrangement overcomes the high initial loading and DO problems in a plug flow system, its removal efficiency is not as high.

Oxidation Ditch. An oval or race-track channel equipped with mechanical aerators provides the benefits of plug flow and completely mixed reactor in one tank (Figure 23-2d). The energy used for aeration also provides mixing. The mixed liquor completes the circuit in 5 to 15 minutes. The flow in the channel dilutes the incoming wastewater by a factor of 20 to 30. As a result,

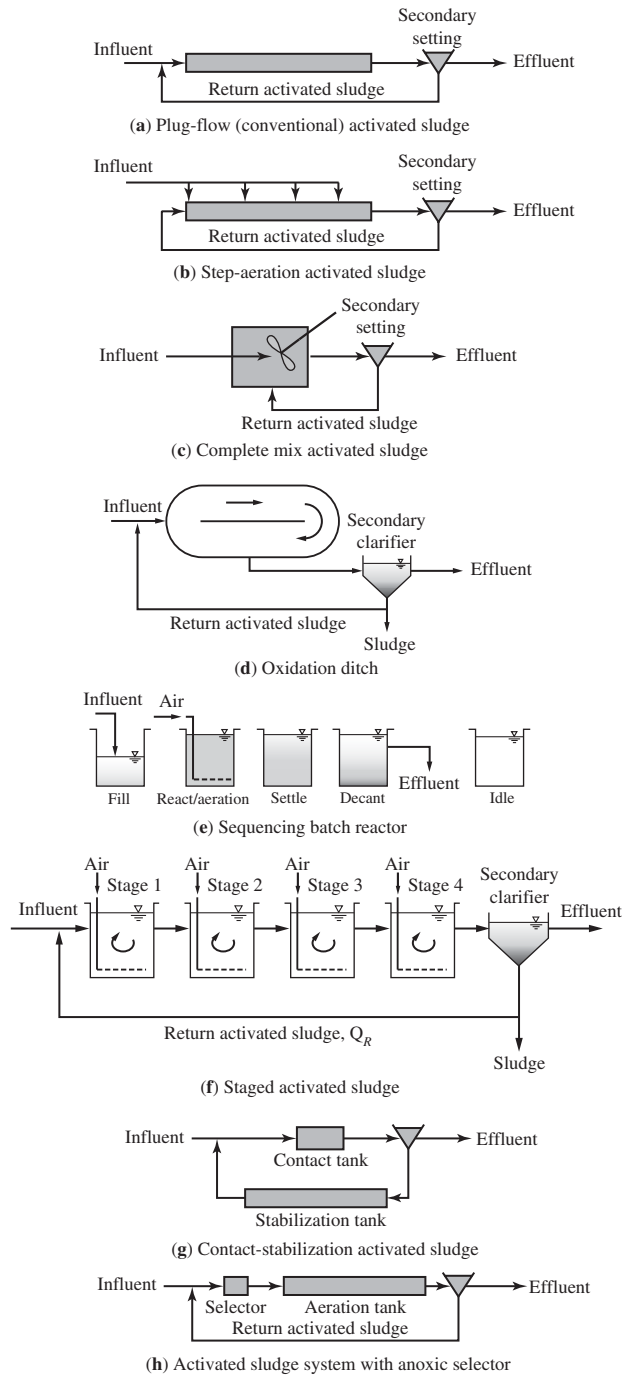

FIGURE 23-2

Selected activated sludge configurations for oxidation and nitrification. (Sources: Adapted from Rittmann and McCarty, 2001 and Metcalf & Eddy, 2003.)

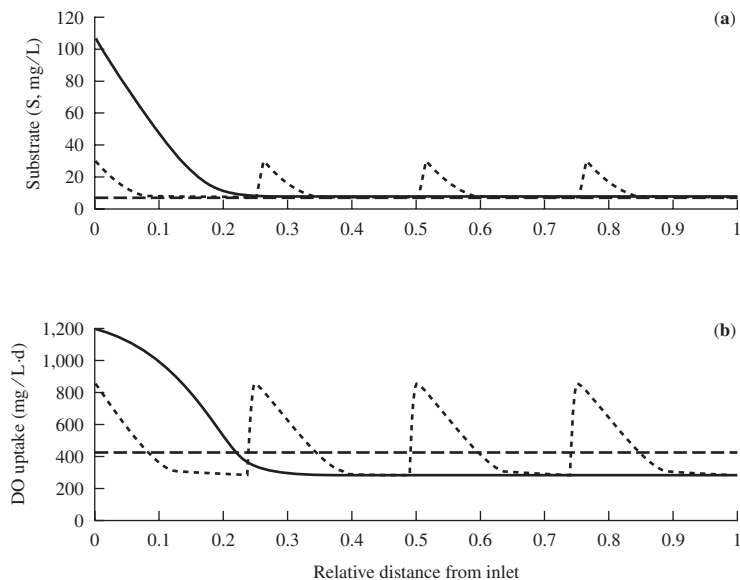

FIGURE 23-3

Changes in contaminant (substrate) concentration and oxygen (DO) uptake rate along the reactor length for plug flow (PF, solid lines), step aeration (SA, small-dash lines), and continuous-stirred tank (CSTR, large-dash lines) reactors for a typical loading with a dilute wastewater. (Source: Rittmann and McCarty, 2001.)

the process kinetics approach that of a completely mixed reactor but with plug flow along the channel. In typical designs, there is no primary treatment. Although the flow completes a circuit in a short time, the hydraulic detention time is relatively long.

This system may be operated to achieve denitrification as well as BOD reduction. It is relatively easy to operate and achieves better treatment than oxidation ponds. This process typically finds application in smaller, rural communities where space is not limited.

Sequencing Batch Reactor (SBR). The SBR is a completely mixed reactor that is operated on a batch basis. It has application in small communities where space is limited and/or treatment requirements do not permit the use of oxidation ponds. This system may be operated to achieve denitrification as well as BOD reduction.

These systems have five steps that are carried out in a timed sequence: (1) fill, (2) react (aeration), (3) sedimentation, (4) decant the supernatant, and (5) idle (Figure 23-2e).

Staged Activated Sludge. In this system several completely mixed tanks are placed in series (Figure 23-2f). Although each tank is mixed, the contents do not mix among them. Three or more tanks in series approximate a plug-flow system. This system provides the advantage of the plug flow system's efficiency as well as that of the complete mix system's capacity to deal with high organic load and ability to maintain acceptable DO levels.

Contact Stabilization. Wastewater is mixed with return activated sludge in a reactor that has a relatively short detention time. This contact reactor takes advantage of the fact that the most readily biodegradable COD is oxidized or stored in a relatively short time and the fact that particulate COD is adsorbed on activated sludge floc in the same time frame. The treated wastewater

is separated from the activated sludge in a settling tank. The wastewater is discharged and the settled activated sludge is sent to a second reactor (called a *stabilization tank*) where aeration is continued. Here the stored and adsorbed COD is oxidized (Figure 23-2g).

The advantage of this system is the reduction in overall tank volume. The disadvantage is that the system requires substantial operator skill and attention.

Conventional with Selector. Somewhat like the contact stabilization process, the detention time in the selector is too short for complete BOD oxidation. The detention time is shorter than that provided in the contact stabilization process. This system promotes the formation of floc that will settle. The selector is followed by an aeration tank of conventional design (Figure 23-2h).

Tapered Aeration. This is an alternative to step feeding. The air supply is increased at the head end of the conventional plug-flow tank. It is tapered to lower levels along the tank. Provided that the inlet organic load is not so high that oxygen cannot be supplied to meet the demand, this system reduces power costs and equipment sizes.

Extended Aeration. This process is used primarily to treat wastewater flows from small residential communities. Process aeration is extended to 24 hours or more. Under these conditions endogenous respiration (Chapter 22, Equation 22-21) governs the oxidation process. This minimizes the sludge mass.

While these systems can achieve good results, they have experienced problems with poor settling sludge, low pH due to nitrification, and high suspended solids in the effluent when operated in a conventional plug-flow reactor. With adequate operator supervision, these problems have been successfully overcome when extended aeration has been applied in an oxidation ditch.

23-3 PROCESSES FOR DENITRIFICATION

As discussed in Chapter 22, biological nitrogen removal requires both an aerobic and an anoxic zone. It is also referred to as *nitrification-denitrification* (NDN or BNDN). In addition, nitrate reduction requires an electron donor. This can be supplied by the influent wastewater, endogenous respiration, or an external (exogenous) carbon source. Table 23-2 lists some of the configurations used for biological denitrification. These are discussed in the following paragraphs.

Modified Ludzack-Ettinger (MLE). This preanoxic process is one of the most commonly used for denitrification. It relies on the return of nitrate formed in the aerobic zone to the anoxic zone (Figure 23-4a). The provision of an internal recycle is the “modification” to the original process. Both the denitrification rate and the overall nitrogen removal efficiency are increased by this modification.

TABLE 23-2
Selected biological denitrification configurations

Preanoxic	Postanoxic
Modified Ludzack-Ettinger (MLE)	Single sludge
Step feed	Bardenpho TM (4-stage)
Sequencing batch reactor (SBR)	Oxidation ditch

Preanoxic

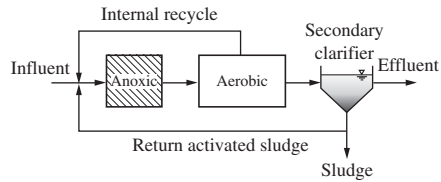

(a) Modified Ludzack-Ettinger (MLE)

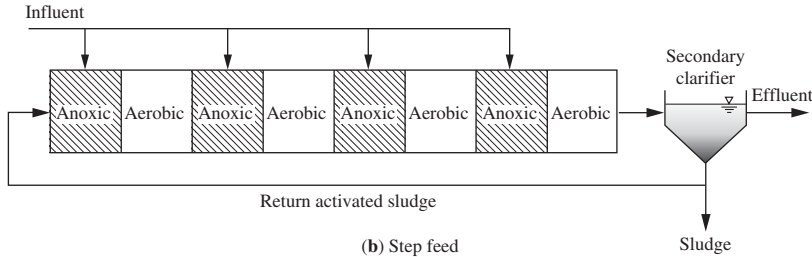

(b) Step feed

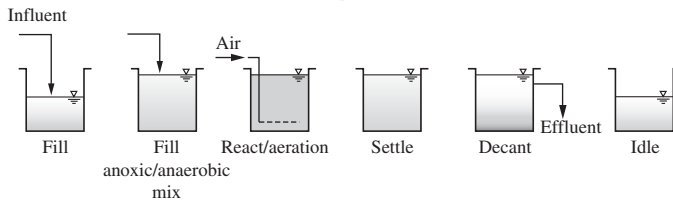

(c) Sequencing batch reactor (SBR)

Postanoxic

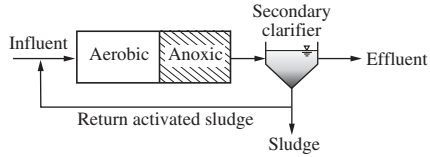

(d) Single-sludge

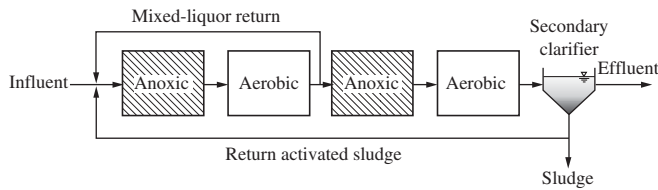

(e) Bardenpho™ (4-stage)

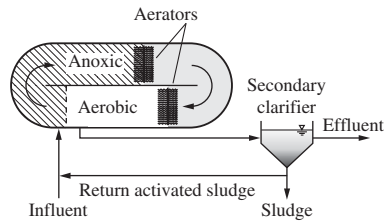

(f) Oxidation ditch

FIGURE 23-4
Processes for denitrification.
(Adapted from Metcalf & Eddy, 2003.)

Step Feed. The step feed process can be modified to perform biological nitrogen removal (BNR) as shown in Figure 23-4b. The final flow portion to the last anoxic/aerobic zone is critical in defining the final effluent concentration of $\text{NO}_3\text{-N}$ as the nitrate in that zone will not be reduced.

Sequencing Batch Reactor (SBR). The SBR system for BOD oxidation and nitrification is modified by an additional operational step (Figure 23-4c). Although sufficient BOD and fill time are available to remove almost all of the nitrate after the settle and decant steps, a separate mixing step without aeration provides more flexibility as well as improved nitrogen removal.

Single Sludge. In this process a mixed anoxic tank follows the aerobic tank (Figure 23-4d). To achieve a high nitrate removal efficiency, a long detention time in the anoxic tank is required because the denitrification rate is proportional to the endogenous respiration rate.

Bardenpho™ (4-Stage). Both preanoxic and postanoxic processes are incorporated in the Bardenpho four-stage process (Figure 23-4e). The hydraulic detention time of the postanoxic stage is about the same or longer than the preanoxic stage. In actual practice it was discovered that phosphorus removal also occurred. The process name is derived from the inventor's name (Barnard, 1974) and the truncation of "denitrification" and "phosphorus" removal.

Oxidation Ditch. By increasing the length of the oxidation ditch to provide an anoxic zone after the aerobic zone, BNR can be achieved in a single tank (Figure 23-4f). Most of the BOD is removed in the aerobic zone. Nitrate is used for endogenous respiration. A large tank volume and long sludge retention times are required for efficient BNR.

23-4 PROCESSES FOR PHOSPHORUS REMOVAL

As discussed in Chapter 22, biological phosphorus removal (BPR) requires an anaerobic zone followed by an aerobic zone. The alternating exposure to anaerobic and aerobic conditions can be accomplished in the main biological treatment process (called *mainstream*) or in the return sludge stream (called *side stream*). There are several modifications to the basic process. Among the most common are those that incorporate biological nitrogen removal. Table 23-3 lists some of the mainstream configurations used for BPR. These are discussed in the following paragraphs.

Phoredox. This is the name given by Barnard (1975) to represent any anaerobic/aerobic sequence to promote BPR. It is shown in Figure 23-5a. A version of this process with multiple stages is patented as A/O^{TM} (anaerobic/aerobic). These processes are not designed to promote nitrification/denitrification (Metcalf & Eddy, 2003). The anaerobic detention time is 30 min to 1 h. The SRT of the aerobic zone is 2 to 4 d.

TABLE 23-3
Selected mainstream biological
phosphorus removal configurations

Phoredox
Anaerobic/anoxic/aerobic ($\text{A}^2/\text{O}^{\text{TM}}$)
Bardenpho™ (5-stage)
University of Cape Town (UCT)
Sequencing batch reactor (SBR)

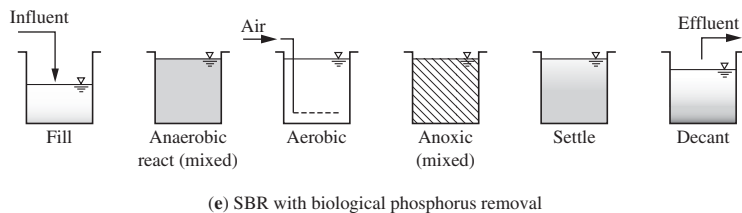
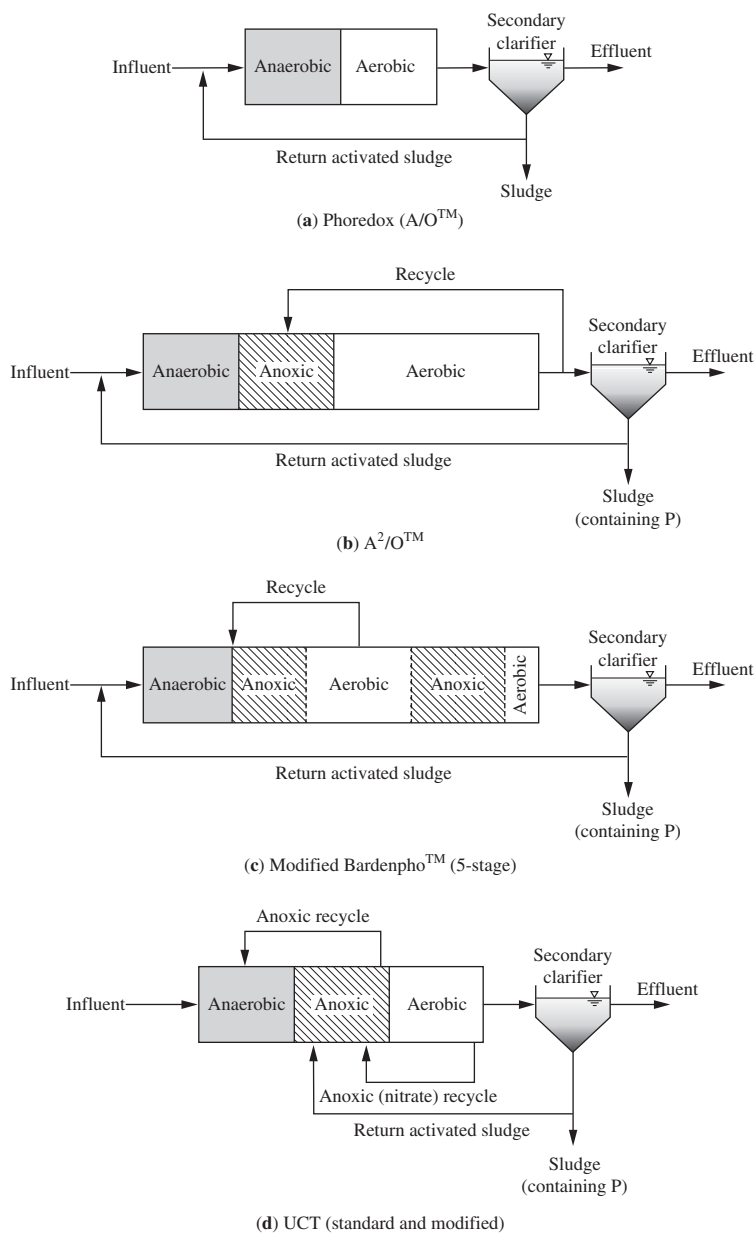

FIGURE 23-5
Processes for biological phosphorus removal.
(Adapted from Metcalf & Eddy, 2003.)

A²/OTM. This is a proprietary modification of the A/OTM process that provides internal recycle and an anoxic zone for denitrification (Figure 23-5b). The detention period in the anoxic zone is approximately 1 h.

BardenphoTM (5-Stage). This modification of the four-stage process provides for both denitrification and phosphorus removal (Figure 23-5c). The staging and recycle differ from the A²/OTM process. The five-stage process uses a longer SRT than the A²/OTM and thus increases the carbon oxidation capability.

University of Cape Town (UCT). The UCT process was developed at the University of Cape Town in South Africa. It is similar to the A²/OTM process with two exceptions. The return sludge is recycled to the anoxic stage instead of the aeration stage, and the internal recycle is from the anoxic stage to the anaerobic stage (Figure 23-5d). By returning the sludge to the anoxic stage, the introduction of nitrate to the anaerobic stage is avoided. This improves the phosphorus uptake. The internal recycle feed provides increased organic utilization in the anaerobic stage.

Sequencing Batch Reactor (SBR). The six operational steps of the SBR denitrification process are retained, but the conditions are modified (Figure 23-5e). One alternative is to provide an anoxic period after sufficient aerobic time has elapsed for nitrification to occur. Another alternative is to use cyclic aerobic and anoxic periods during the react period. This minimizes the nitrate concentration before settling. Little nitrate is available to compete for rbCOD during the fill period so that rbCOD uptake and storage by PAOs can occur instead of rbCOD consumption by nitrate reducing bacteria.

23-5 BIOLOGICAL TREATMENT WITH MEMBRANE SEPARATION

Membrane biological reactors (MBRs) consist of a biological reactor with suspended biomass and solids separation by microfiltration (MF) or ultrafiltration (UF) membranes. They may be used with any of the processes described in the previous sections of this chapter. Membranes are introduced in Chapter 9. MF filtration theory, practice, and design are discussed in Chapter 12. The following discussion focuses on the application to wastewater systems in contrast to the water treatment applications discussed in Chapter 12.

Process Description

MBRs have two fundamental process arrangements: (1) integrated systems that have membranes immersed in an activated sludge reactor and (2) separate systems that have a membrane module placed outside the reactor (Figure 23-6). Immersed membranes using hollow-fiber or flat sheet membranes are the most popular for several reasons. They operate at lower pressures, readily accommodate variations in the types of biosolids found in activated sludge bioreactors, concentrate biosolids without settling concerns, and, typically, have a lower life cycle cost for municipal systems. Separate systems use pressure-driven, in-pipe cartridge membranes. These are more prevalent in industrial settings (Metcalf & Eddy, 2003; WEF, 2006b).

Process arrangements for implementation of MBR for nitrification, nitrogen removal, and complete biological nutrient removal (BNR) are illustrated in Figure 23-7. In contrast to conventional activated sludge or typical BNR processes, the volume of sludge returned to the aeration basin is on the order of 400 percent of the wastewater flow.

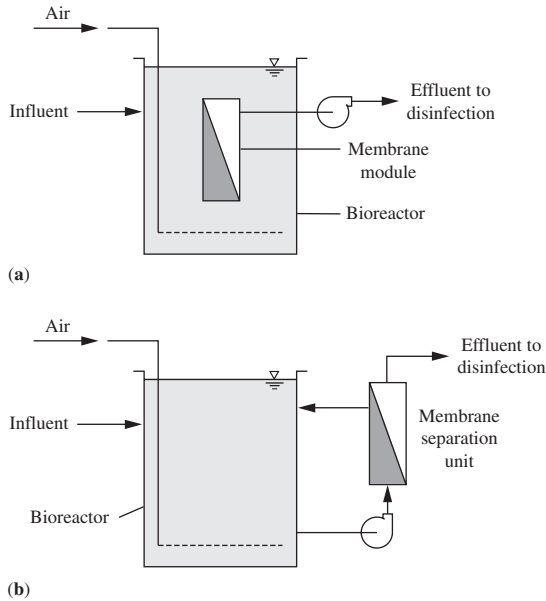

FIGURE 23-6 Schematic diagram of membrane bioreactors: (a) immersed membrane, (b) external membrane. (Source: Metcalf & Eddy, 2003.)

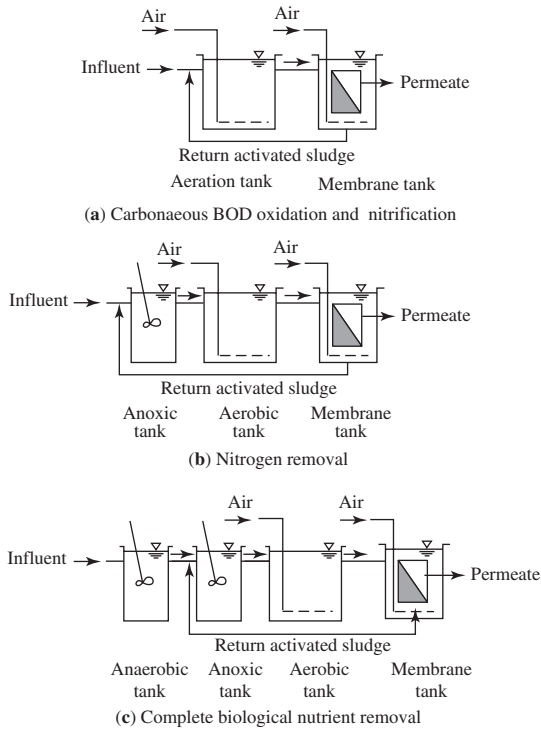

FIGURE 23-7 Process arrangements for membrane bioreactors (MBR).

23-6 SUSPENDED GROWTH DESIGN PRINCIPLES

Overview

The design principles of suspended growth processes may be broadly separated into two categories: those based on experience and those based on microbial biochemistry and microbial population dynamics. Facultative oxidation ponds fall into the first category. The remaining suspended growth treatment systems fall into the second category. In the following discussion the basic biological reactions of the facultative oxidation pond are discussed as well as the empirical basis for their design.

The completely mixed, conventional plug-flow, and batch reactor models that are presented in the next section serve as means of showing the relationship between several design variables for suspended growth processes. Mass balance relationships and applied microbial biochemistry relationships provide the basis for other process design relationships.

Oxidation Ponds

Although empirical expressions have been developed for the design of oxidation ponds, the design of facultative ponds is generally governed by prescriptive requirements of state regulatory agencies.

Facultative Ponds. A schematic representation of a facultative pond operation is given in Figure 23-8. Raw wastewater may enter at the center of the pond or at one end. Suspended solids contained in the wastewater settle to the pond bottom, where an anaerobic layer develops. Microorganisms occupying this region do not require molecular oxygen as an electron acceptor in energy metabolism, but rather use some other chemical species. Both acid fermentation and methane fermentation occur in the bottom sludge deposits.

The facultative zone exists just above the anaerobic zone. This means that molecular oxygen will not be available in the region at all times. Generally, the zone is aerobic during the daylight hours and anaerobic during the hours of darkness.

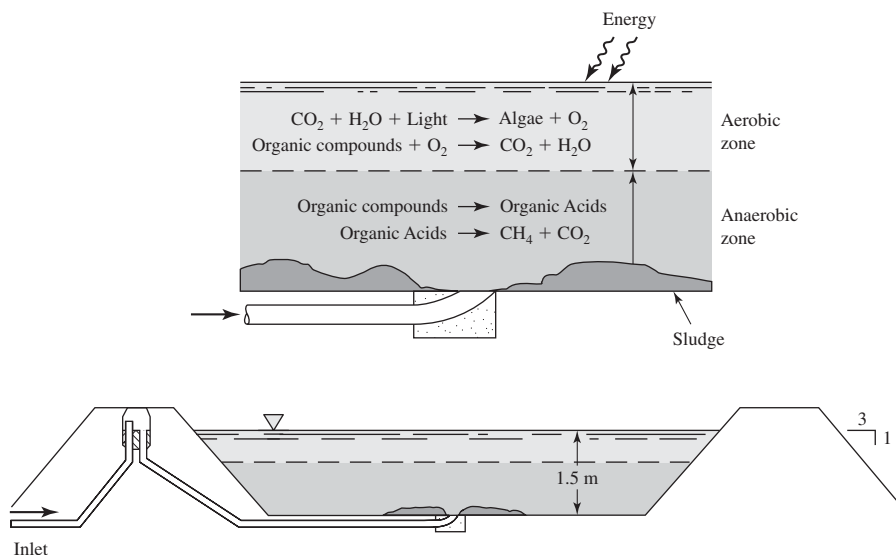

FIGURE 23-8

Schematic diagram of facultative pond relationships. (Source: Davis and Cornwell, 2008.)

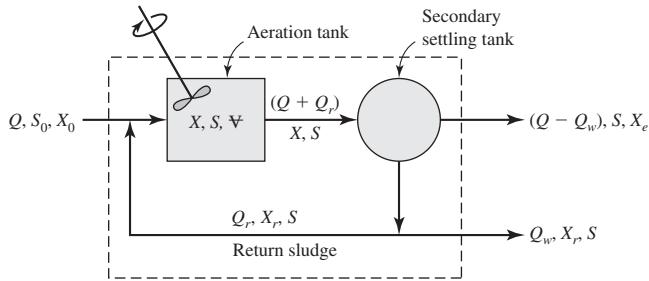

FIGURE 23-9
Completely mixed biological reactor with solids recycle. (Source: Davis and Cornwell, 2008.)

Above the facultative zone, there exists an aerobic zone that has molecular oxygen present at all times. The oxygen is supplied from two sources. A limited amount is supplied from air diffusion across the pond surface. However, the majority is supplied through algal photosynthesis.

Completely Mixed Reactor Model

In 1970, Lawrence and McCarty proposed a model of the activated sludge process based on microbial biochemistry and microbial population dynamics. It serves as starting point for understanding the design principles used in biological treatment reactor design. It is based on the Monod equation (Chapter 22, Equation 22-16) and mass balances across a defined volume for specific constituents of interest such as biomass and substrate.

Mass Balance for Biomass. A mass balance diagram for the completely mixed system (CSTR) is shown in Figure 23-9. The mass balance equations are written for the system boundary shown by the dashed line. Two mass balances are required to define the design of the reactor: one for biomass and one for substrate (*readily biodegradable soluble chemical oxygen demand, rbsCOD*).

Under steady-state conditions, the mass balance for biomass may be written as:

$$\begin{array}{l} \text{Biomass in} \\ \text{influent} \end{array} + \begin{array}{l} \text{Net biomass} \\ \text{growth} \end{array} = \begin{array}{l} \text{Biomass in} \\ \text{effluent} \end{array} + \begin{array}{l} \text{Biomass} \\ \text{wasted} \end{array} \quad (23-1)$$

The biomass in the influent is the product of the concentration of microorganisms in the influent (X_0) and the flow rate of wastewater (Q). The concentration of microorganisms in the influent (X_0) is measured as suspended solids* (mg/L). The biomass that grows in the aeration tank is the product of the volume of the tank (V) and the Monod expression for growth of microbial mass (Equation 22-16):

$$(V) \left(\frac{\mu_m S X}{K_s + S} - k_d X \right) \quad (23-2)$$

The biomass in the effluent is the product of flow rate of treated wastewater leaving the plant ($Q - Q_w$) and the concentration of microorganisms that does not settle in the secondary clarifier (X_e). The flow rate of wastewater leaving the plant does not equal the flow rate into the plant because some of the microorganisms must be wasted. The flow rate of wasting (Q_w) is deducted from the flow exiting the plant.

*Because the model is for soluble COD, the COD of the suspended solids in the influent is not considered. This problem is addressed in Example 23-1.

The biomass that is wasted is the product of the concentration of microorganisms in the WAS flow (X_r) and the WAS flow rate (Q_w). The narrative mass balance equation may be rewritten as

$$QX_0 + (V) \left(\frac{\mu_m SX}{K_s + S} - k_d X \right) = (Q - Q_w)X_e + Q_w X_r \quad (23-3)$$

The variables are summarized as follows:

- Q = wastewater flow rate into the aeration tank, m³/d
- X_o = microorganism concentration (volatile suspended solids or VSS)* entering aeration tank, mg/L
- V = volume of aeration tank, m³
- μ_m = maximum growth rate constant, d⁻¹
- S = readily biodegradable soluble COD (rbsCOD) in aeration tank and effluent, mg/L
- X = microorganism concentration (mixed-liquor volatile suspended solids or MLVSS)** in the aeration tank, mg/L
- K_s = half velocity constant
= soluble BOD₅ concentration at one-half the maximum growth rate, mg/L
- k_d = decay rate of microorganisms, d⁻¹
- Q_w = flow rate of liquid containing microorganisms to be wasted, m³/d
- X_e = microorganism concentration (VSS) in effluent from secondary settling tank, mg/L
- X_r = microorganism concentration (VSS) in sludge being wasted, mg/L

Mass Balance for Substrate. At steady-state, the mass balance equation for substrate (rbsCOD) may be written as

$$\begin{array}{ccccccc} \text{Substrate in} & & \text{Substrate} & & \text{Substrate in} & & \text{Substrate in} \\ \text{influent} & - & \text{consumed} & = & \text{effluent} & - & \text{WAS} \end{array} \quad (23-4)$$

The substrate in the influent is the product of the concentration of rbsCOD in the influent (S_0) and the flow rate of wastewater (Q). The substrate that is consumed in the aeration tank is the product of the volume of the wastewater in the tank (V) and the expression for the rate of substrate utilization

$$(V) \left(\frac{\mu_m SX}{Y(K_s + S)} \right) \quad (23-5)$$

The substrate in the effluent is the product of flow rate of treated wastewater leaving the plant ($Q - Q_w$) and the concentration of rbsCOD in the effluent (S). The concentration of rbsCOD in

*Suspended solids means that the material will be retained on a filter, unlike dissolved solids such as NaCl. The amount of suspended solids that volatilizes at 500°C ± 50°C is taken to be a measure of active biomass. The presence of nonliving organic particles in the influent wastewater will cause some error (usually small) in the use of VSS as a measure of biomass.

**Mixed-liquor volatile suspended solids is a measure of the active biomass in the aeration tank. The term "mixed liquor" implies a mixture of activated sludge and wastewater. The phrase "volatile suspended solids" has the same meaning as in the definition of X_o .

the effluent (S) is the same as that in the aeration tank because it is assumed that the aeration tank is completely mixed. Because the rbsCOD is soluble, the secondary settling tank will not change the concentration. Thus, the effluent concentration from the secondary settling tank is the same as the influent concentration.

The substrate in the waste activated sludge flow is the product of the concentration of rbsCOD in the effluent (S) and the WAS flow rate (Q_w). The narrative mass balance equation for steady-state conditions may be rewritten as

$$QS_o - (V) \left(\frac{\mu_m SX}{Y(K_s + S)} \right) = (Q - Q_w)S + Q_w S \quad (23-6)$$

where Y = yield coefficient (see Equation 22-17).

To develop working design equations the following assumptions are made:

1. The influent and effluent biomass concentrations are negligible compared to that in the reactor.
2. The influent substrate (S_0) is immediately diluted to the reactor concentration in accordance with the definition of a CSTR.
3. All reactions occur in the CSTR.

From the first assumption the following terms may be eliminated from Equation 23-3: QX_o and $(Q - Q_w)X_e$ because X_o and X_e are negligible compared to X . Equation 23-3 may be simplified to

$$(V) \left(\frac{\mu_m SX}{K_s + S} - k_d X \right) = Q_w X_r \quad (23-7)$$

For convenience, Equation 23-7 is rearranged in terms of the Monod equation:

$$\left(\frac{\mu_m S}{K_s + S} \right) = \frac{Q_w X_r}{(V)X} + k_d \quad (23-8)$$

Equation 23-6 may also be simplified and rearranged in terms of the Monod equation:

$$\left(\frac{\mu_m S}{K_s + S} \right) = \frac{Q}{V} \frac{Y}{X} (S_o - S) \quad (23-9)$$

Noting that the left side of Equations 23-8 and 23-9 are the same, set the right-hand side of these equations equal and rearrange to give:

$$\frac{Q_w X_r}{VX} = \frac{Q}{V} \frac{Y}{X} (S_o - S) - k_d \quad (23-10)$$

Two parts of this equation have physical significance in the design of a completely mixed activated sludge system. The inverse of Q/V is the *hydraulic detention time* (θ) of the reactor:

$$\frac{V}{Q} = \theta \quad (23-11)$$

The inverse of the left side of Equation 23-10 defines the mean cell residence time (θ_c):

$$\frac{VX}{Q_w X_r} = \theta_c \quad (23-12)$$

The mean cell residence time expressed in Equation 23-12 must be modified if the effluent biomass concentration is not negligible. Equation 23-13 accounts for effluent losses of biomass in calculating θ_c :

$$\theta_c = \frac{VX}{Q_w X_r + (Q - Q_w)(X_e)} \quad (23-13)$$

From Equations 23-8 and 23-12, it can be seen that once θ_c is selected, the concentration of rbsCOD in the effluent (S) is fixed:

$$S = \frac{K_s(1 + k_d\theta_c)}{\theta_c(\mu_m - k_d) - 1} \quad (23-14)$$

Typical values of the microbial growth constants are given in Table 23-4. Note that rbsCOD leaving the system (S) is affected only by the mean cell-residence time and not by the amount of BOD entering the aeration tank or by the hydraulic detention time.

The concentration of microorganisms in the aeration tank may be determined from Equation 23-15:

$$X = \frac{\theta_c(Y)(S_o - S)}{\theta(1 + k_d\theta_c)} \quad (23-15)$$

In its essence, θ_c is the master variable for the design and operation of suspended growth processes. It is the master variable because it is fundamentally related to the growth rate of the active microorganisms, which in turn controls the concentration of the growth-rate-limiting substance in the reactor. Furthermore, θ_c turns out to be an excellent choice as a master variable because all of the parameters that comprise it can be measured accurately and consistently (Rittmann and McCarty, 2001).

TABLE 23-4
Values of growth constants for domestic wastewater

Parameter	Basis	Value ^a	
		Range	Typical
K_s	mg/L BOD ₅	25–100	60
k_d	d ⁻¹	0–0.30	0.10
μ_m	d ⁻¹	1–8	3
Y	mg VSS/mg BOD ₅	0.4–0.8	0.6

^aValues are for 20°C

Sources: Metcalf & Eddy, 2003; and Shahriar et al., 2006.

Other useful relationships (Equations 23-16, 23-17, 23-18, 23-19) can be derived from this model (Metcalf & Eddy, 2003). For example:

$$\frac{1}{\theta_c} = -Y \frac{r_{su}}{X} - k_d \quad (23-16)$$

or

$$\frac{1}{\theta_c} = \mu \quad (23-17)$$

where r_{su} = substrate utilization rate
 μ = specific biomass growth rate

In Equation 23-16 the term $(-r_{su}/X)$ is known as the *specific substrate utilization rate*, U . It may be calculated as

$$U = -\frac{r_{su}}{X} = \frac{Q(S_o - S)}{VX} = \frac{S_o - S}{\theta X} \quad (23-18)$$

Substitution of U into Equation 23-16 yields:

$$\frac{1}{\theta_c} = YU - k_d \quad (23-19)$$

Batch Reactor

The principle batch reactor process is the sequencing batch reactor (SBR). The design principles for this reactor are keyed to the following treatment steps (NEIWPCC, 2005):

- *Fill*. During this phase the basin receives influent wastewater. Three scenarios may be selected:
 - *Static fill*. In this scenario there is no mixing and no aeration while the wastewater is entering the tank. This scenario is used during initial start-up of the facility. Static fill may be used in plants that do not need to nitrify or denitrify to save power during low flow periods.
 - *Mixed fill*. In this scenario aeration is minimized by the use of mechanical or jet mixers. Because there is no aeration, the wastewater/microorganism system becomes anoxic. This is used to promote denitrification. Anaerobic conditions can also be achieved to promote the release of phosphorus.
 - *Aerated fill*. In this scenario both aerators and mechanical mixing may be employed.

In batch processes the oxygen uptake rate is a factor of concern for two reasons. First, the cell concentration is very high at the beginning of fill, and, second, the maximum reactor BOD concentration also occurs at this time.

From a design perspective, this mode of filling requires a significantly higher air supply than is required in subsequent steps. Thus, the aeration system is overdesigned for the majority of the operating sequence. Two alternatives are available. One is to begin with a mixed fill (anoxic) and then switch to an aerated fill after some portion of the wastewater has been added. The other alternative is to provide a feedback control to decrease the air flow rate and energy consumption in subsequent steps (Schroeder, 1982).

- *React.* During this phase aeration and mixing units are on. No wastewater enters the basin. Most carbonaceous BOD removal occurs during this phase. With an appropriate aeration duration, nitrification will also occur in this phase. If anaerobic fill is employed, the phosphorus released during fill plus some additional phosphorus is taken up during this phase.
- *Settle.* Air and mixing are turned off. The activated sludge is allowed to settle. This is a critical step both for the recovery of biomass for the next cycle and the production of an effluent that is low in suspended solids.
- *Decant.* A decanter is used to remove the clear supernatant that is to be discharged. It needs to remove clear liquid without entrapping surface scum or entraining settled sludge.
- *Idle.* This step occurs between the decant and fill phases. Depending on the flow rate, this phase may be long or short. At high flow rates, this phase may be eliminated. At low flow rates, this phase may be very long. If this phase is too long, the sludge may become anaerobic.

Batch Reactor Model. The change in substrate concentration with time in a batch reactor can be determined by starting with the substrate mass balance for a CSTR (Metcalf & Eddy, 2003):

$$\frac{dS}{dt} V = QS_o - QS + r_{su} V \quad (23-20)$$

$$\text{where } r_{su} = -\frac{\mu_m SX}{Y(K_s + S)}$$

Other terms are the same as those defined previously.

Because $Q = 0$ for a batch reactor, Equation 23-20 can be simplified to

$$\frac{dS}{dt} = -\frac{\mu_m SX}{Y(K_s + S)} \quad (23-21)$$

Integration of Equation 23-21 with respect to time yields

$$K_s \ln\left(\frac{S_o}{S_t}\right) + (S_o - S_t) = X\left(\frac{\mu_m}{Y}\right)t \quad (23-22)$$

where S_o = initial substrate concentration at time $t = 0$, mg/L

t = time, d

S_t = substrate concentration at time t , mg/L

For nitrification, the Monod kinetic coefficients (Chapter 22, Equation 22-28) are substituted in Equation 23-22:

$$K_n \ln \left(\frac{N_o}{N_t} \right) + (N_o - N_t) = X_n \left(\frac{\mu_{mn}}{Y_n} \right) \left(\frac{DO}{K_0 + DO} \right) t \quad (23-23)$$

The terms in this equation are defined in Chapter 22.

The batch kinetic equations can be used to determine if the react period aeration time selected is sufficient to provide the desired amount of degradation. Because X and t are unknown, an iterative solution is required. Metcalf & Eddy (2003) suggests using an overall mass balance to estimate X or X_n based on an assumed substrate consumption.

It should be noted that sludge age does not appear in Equations 23-22 or 23-23. Nonetheless, the design is based on microbial biochemistry and microbial population dynamics. The SRT is used to develop the values for X or X_n in Equations 23-22 or 23-23.

Plug Flow with Recycle Model

Although it is difficult to achieve true plug flow, many long, narrow aeration tanks may be better approximated by plug flow than by completely mixed models. A kinetic model of a plug-flow system is difficult to develop from basic mass balance equations. With two simplifying assumptions, Lawrence and McCarty (1970) developed a useful equation. The assumptions are:

1. The concentration of microorganisms in the influent to the aeration tank is approximately the same as that in the effluent from the aeration tank. This assumption applies if θ_c/θ is greater than 5.
2. The rate of soluble BOD₅ utilization as the waste passes through the aeration tank is given by

$$r_u = \frac{\mu_m S X_{\text{avg}}}{K_s + S} \quad (23-24)$$

where X_{avg} is the average concentration of microorganisms in the tank.

The design equation is

$$\frac{1}{\theta_c} = \frac{Y \mu_m (S_o - S)}{(S_o - S) + (1 + RR) K_s \ln(S_i/S)} \quad (23-25)$$

where RR = recycle ratio, Q_r/Q

\ln = logarithm to base e

S_i = influent concentration to aeration tank after dilution with recycle flow, mg/L

$$= \frac{S_o + (RR)S}{1 + RR} \quad (23-26)$$

Other terms are the same as those defined previously.

Safety Factor

There is a value of θ_c below which waste will not be stabilized. This is called the *critical mean cell residence time* ($\theta_{c \text{ min}}$). Physically, $\theta_{c \text{ min}}$ is the residence time at which the cells are washed out or

wasted out of the system faster than they can reproduce. When washout occurs $S = S_o$. $\theta_{c \min}$ can be estimated by making this substitution in Equation 23-19:

$$\frac{1}{\theta_{c \min}} = \frac{\mu_m S_o}{(K_s + S_o)} - k_d \quad (23-27)$$

Because S_o is typically much greater than K_s , Equation 23-27 may be rewritten as

$$\frac{1}{\theta_{c \min}} \approx \mu_m - k_d \quad (23-28)$$

To minimize the potential for plant failure, plant design/operation must avoid $\theta_{c \min}$. The suggested approach is to select a design θ_c that is a multiple of $\theta_{c \min}$ (Christensen and McCarty, 1975). The safety factor is then defined as

$$SF = \frac{\theta_{c\text{-design}}}{\theta_{c\text{-min}}} \quad (23-29)$$

The implied safety factors are shown in Table 23-5. *High-rate* implies that the skill of the operator and system oversight is exceptional. *Low-rate* implies limited operator attention.

A key point is that the safety factors for the model are very high even with the best systems.

Evaluation of Assumptions

The assumptions of either CSTR or plug-flow reactors are seldom achieved in real systems. Thus, these models only serve as a starting point for evaluation and design. It is also important to reemphasize that S is rbsCOD, that is, the soluble COD that is readily biodegradable and not the total BOD. Some fraction of the suspended solids that do not settle in the secondary settling tank also contributes to the BOD load to the receiving body. To achieve a desired effluent quality, both the soluble and insoluble fractions of BOD must be considered. Thus, to use Equations 23-14, 23-15, 23-18, 23-19, 23-21, or 23-25 to achieve a desired effluent quality (S) by solving for θ_c or t , some estimate of the biodegradable COD (bCOD) or BOD of the suspended solids must be made first. The BOD of the suspended solids is subtracted from the total allowable BOD in the effluent to find the allowable S :

$$S = \text{Total BOD allowed} - \text{BOD in suspended solids} \quad (23-30)$$

TABLE 23-5
Implied safety factors for typical biological treatment design loadings

Loading	Implied SF
Conventional	10–80
High-rate	3–10
Low-rate	>80

Source: Rittmann and McCarty, 2001.

The development of these equations assumes that there are no reactions in the settling tank. Because the mass of microorganisms in the settling tank is quite large, this assumption may result in a significant error in estimating \bar{V} . If the settling tank has significant reactions, then \bar{V} in the model equations becomes the sum of the volume in the aeration tank and the settling tank. Assuming that the volumes may be added is a significant assumption. In general, prudent engineering practice requires a more conservative assumption.

Example 23-1 illustrates the estimation of the volume of a completely mixed activated tank for BOD₅ oxidation.

Example 23-1. The town of Lawrence has been directed to upgrade its primary WWTP to a secondary plant that can meet an effluent standard of 30.0 mg/L BOD₅ and 30.0 mg/L total suspended solids (TSS). They have selected a completely mixed activated sludge system. Assuming that the BOD₅ of the TSS may be estimated as equal to 63% of the TSS concentration, estimate the required volume of the aeration tank. The following data are available from the existing primary plant.

Existing primary plant effluent characteristics

$$\text{Flow} = 12,960 \text{ m}^3/\text{d}$$

$$\text{BOD}_5 = 84.0 \text{ mg/L}$$

Assume the following values for the growth constants: $K_s = 100 \text{ mg/L BOD}_5$; $\mu_m = 2.5 \text{ d}^{-1}$; $k_d = 0.050 \text{ d}^{-1}$; $Y = 0.50 \text{ mg VSS/mg BOD}_5 \text{ removed}$. Also assume that the secondary clarifier can produce an effluent with 30.0 mg/L TSS, and that MLVSS = 2,000 mg/L.

Solution:

- a. Estimate the allowable soluble BOD₅ in the effluent using the 63% assumption from above and Equation 23-30.

$$S = 30.0 \text{ mg/L} - (0.63)(30.0 \text{ mg/L}) = 11.1 \text{ mg/L}$$

- b. The mean cell-residence time can be estimated with Equation 23-14 and the assumed values for the growth constants.

$$11.1 = \frac{(100.0 \text{ mg/L BOD}_5)(1 + (0.050 \text{ d}^{-1})(\theta_c))}{\theta_c(2.5 \text{ d}^{-1} - 0.050 \text{ d}^{-1}) - 1}$$

Solving for θ_c

$$\begin{aligned} (11.1)(2.45 \theta_c - 1) &= 100.0 + 5.00 \theta_c \\ 27.20 \theta_c - 11.1 &= 100.0 + 5.00 \theta_c \\ \theta_c &= \frac{111.1}{22.2} = 5.00 \text{ or } 5.0 \text{ d} \end{aligned}$$

- c. Using the assumed value of 2,000 mg/L for the MLVSS, solve Equation 23-15 for the hydraulic detention time.

$$2,000 \text{ mg/L} = \frac{5.00 \text{ d}(0.50 \text{ mg VSS/mg BOD}_5)(84.0 \text{ mg/L} - 11.1 \text{ mg/L})}{\theta(1 + (0.050 \text{ d}^{-1})(5.00 \text{ d}))}$$

$$\theta = \frac{2.50(72.9)}{2,000(1.25)}$$

$$\theta = 0.0729 \text{ d or } 1.75 \text{ h}$$

The volume of the aeration tank is then estimated using Equation 23-11:

$$0.0729 \text{ d} = \frac{V}{12,960 \text{ m}^3/\text{d}}$$

$$V = 944.78 \text{ or } 945 \text{ m}^3$$

Comment. Two tanks of this size are required to meet redundancy requirements.

Sludge Return

Among the major decisions in developing a suspended growth reactor design is the selection of the mixed liquor volatile suspended solids (MLVSS) concentration and the corresponding mixed liquor suspended solids (MLSS) concentration. This selection is not simple. It depends on the objective of the reactor, settling characteristics of the sludge, and the rate of recycle of sludge (called the *sludge return rate* or *sludge return*, or *return activated sludge*—RAS).

A high MLVSS concentration is desirable because it leads to a smaller reactor and lower construction costs. But this may lead to a larger settling tank to handle the sludge load. In addition, a higher MLVSS also requires a higher aeration rate to meet the increase in oxygen demand. Increasing MLVSS also requires increasing the rate at which sludge is returned from the settling tank. Finally, a higher MLVSS may lead to a higher effluent suspended solids and BOD in the effluent.

A mass balance around the settling tank in Figure 23-9 is the basis for selecting a return sludge rate. Assuming that the amount of sludge in the secondary settling tank remains constant (steady-state conditions) and that the effluent suspended solids (X_e) are negligible, the mass balance is

$$\text{accumulation} = \text{inflow} - \text{outflow} \quad (23-31)$$

$$0 = (Q + Q_r)(X') - (Q_r X_r' + Q_w X_r') \quad (23-32)$$

where Q = wastewater flow rate, m^3/d
 Q_r = return sludge flow rate, m^3/d
 X' = mixed liquor suspended solids (MLSS), g/m^3
 X_r' = maximum return sludge concentration, g/m^3
 Q_w = sludge wasting flow rate, m^3/d

Solving for the return sludge flow rate:

$$Q_r = \frac{QX' - Q_w X_r'}{X_r' - X'} \quad (23-33)$$

Using Equation 23-12, this may be rewritten as

$$Q_r = \frac{QX' - \left(\frac{VX'}{\theta_c}\right)}{X_r' - X'} \quad (23-34)$$

Frequently, the assumption that the effluent suspended solids are negligible is not valid. If the effluent suspended solids are significant, the mass balance may then be expressed as

$$0 = (Q + Q_r)(X') - (Q_r X_r' + Q_w X_r') + (Q - Q_w)X_e \quad (23-35)$$

Solving for the return sludge flow rate gives

$$Q_r = \frac{QX' - Q_w X_r' - (Q - Q_w)X_e}{X_r' - X'} \quad (23-36)$$

Note that X_r' and X' include both the volatile and inert fractions. Thus, they differ from X_r and X by a constant factor. It is generally assumed that VSS is 60 to 80 percent of MLVSS. Thus, MLSS may be estimated by dividing MLVSS by a factor of 0.6 to 0.8 (or multiplying by 1.25 to 1.67).

With the volume of the tank and the mean cell-residence time, the sludge wasting flow rate can be determined with Equation 23-12 if the maximum return sludge concentration (X_r') can be determined. Operating experience has demonstrated a range of values for X_r' . For a typical good settling sludge the maximum X_r' is in the range of 10,000 to 14,000 mg/L. With poorly settling sludges the maximum X_r' may be as low as 3,000 to 6,000 mg/L.

For operational flexibility the return sludge pumping rate must be adjustable. Typically, the maximum sludge return rate is set equal to the design flow rate. Example 23-2 illustrates the estimation of a maximum RAS flowrate.

Example 23-2. Determine the return sludge concentration (X_r') that results in the maximum return sludge flow rate for the proposed activated sludge upgrade at Lawrence (Example 23-1). Also estimate the mass flow rate of sludge wasting. Use the following assumptions: MLVSS fraction of MLSS = 0.70 and volume of aeration tank = 950 m³.

Solution:

- a. The Solver* program in a spreadsheet was used to perform the iterations for solution of this problem. The spreadsheet cells are shown in Figure 23-10. The cell locations used in the figure are identified by brackets [] in the discussion below.
- b. Begin with the average design flow by setting the fixed parameters as follows:

[B5] $Q = 12,960 \text{ m}^3/\text{d}$

[B6] $\text{MLVSS} = 2.0 \text{ g/L}$

[B7] $\text{MLVSS fraction} = 0.70$

*Solver is a "tool" in Excel®. Other spreadsheets may have a different name for this program.

	A	B	C	D
3	Input Data			
4				
5	Q =	12960	m ³ /d	
6	MLVSS =	2	g/L	
7	MLVSS fraction =	0.7		
8	MLSS =	2.86	g/L	This is X'
9	Volume of AT =	950	m ³	
10	SRT =	5	d	
11	X' _e =	0.03	g/L	
12				
13	Calculation of Q_r and X_r'			
14				
15	X _r ' =	5.64	g/L	
16				
17	Q _w =	96.2	m ³ /d	
18				
19	Q _r =	12960.0	m ³ /d	
20				
21	Q _w X _r ' =	542.9	kg/d	

Solver parameters

Set target cell:

Equal to: Max. Min. Value of:

By changing cells:

Subject to the constraints:

<input type="text" value="\$B\$19 = \$B\$5"/>	<input type="button" value="Add"/>	<input type="button" value="Reset all"/>
	<input type="button" value="Change"/>	<input type="button" value="Help"/>
	<input type="button" value="Delete"/>	

FIGURE 23-10
Example 23-2 spreadsheet with solver dialog box.

c. In cell [B8] write an equation to convert MLVSS to MLSS.

$$= \frac{[B6]}{[B7]} = \frac{2.0 \text{ g/L}}{0.7} = 2.86 \text{ g/L}$$

d. Continue setting the fixed parameters from Example 23-1:

[B9] Volume of aeration tank = 950 m³

[B10] θ_c or SRT = 5.0 d

[B11] X'_e = 0.030 g/L

e. In cell [B15] insert a guess at X_r' between 3 and 20 g/L.

f. In cell [B17] calculate Q_w.

$$= \frac{([B9] * [B8])}{([B10] * [B15])}$$

g. Activate the dialog box for solver and designate the target cell as [B19], that is, the one for the return sludge flow rate.

h. Set *Equal to* to "Max."

i. Set *By changing* to the cell containing the return sludge MLSS (X_r'), that is, [B15].

- j. Add the following *constraint* in the dialog box: [B19] = [B5].
- k. Execute solve to find:

$$\begin{aligned} X_r' &= 5.64 \text{ g/L} \\ Q_w &= 96.2 \text{ m}^3/\text{d} \\ Q_r &= 12,960 \text{ m}^3/\text{d} \\ Q_w X_r' &= 542.9 \text{ kg/d} \end{aligned}$$

Comments:

1. Although an algebraic solution is possible, the spreadsheet solver function is a convenient tool for the solution.
 2. The spreadsheet can be used without the solver tool to explore the other relationships, that is, X_r' , Q_w , Q_r , and $Q_w X_r'$.
-

Sludge Production

An estimate of the sludge production is important for process design of the sludge handling facilities and the aeration system. As a suspended growth process removes substrate, the substrate is converted into new cell material. This cell material is activated sludge. The sludge will accumulate in the process if it cannot be processed by the sludge handling facility. Eventually, the sludge inventory will exceed the capacity of the system and will exit the secondary clarifier as suspended solids.

The estimate of the amount of oxygen required for biodegradation of carbonaceous BOD is determined from a mass balance of the bCOD concentration and the amount of biomass wasted from the system. The amount of biomass wasted is a function of the amount of sludge produced.

Two methods of estimating the sludge production are used. The first is satisfactory for preliminary design. It is based on rules-of-thumb and published data from existing facilities. In this method the net activated sludge produced each day is determined by:

$$Y_{\text{obs}} = \frac{Y}{1 + k_d \theta_c} \quad (23-37)$$

and

$$P_x = Y_{\text{obs}} Q(S_o - S)(10^{-3} \text{ kg/g}) \quad (23-38)$$

where P_x = net waste activated sludge produced each day in terms of VSS, kg/d

Y_{obs} = observed yield, kg MLVSS/kg BOD₅ removed

Other terms are as defined previously.

The amount of sludge that must be wasted each day is the difference between the amount of increase in sludge mass and the total suspended solids (TSS) lost in the effluent:

$$\text{Mass to be wasted} = \text{increase in MLSS} - \text{TSS lost in effluent} \quad (23-39)$$

The increase in MLSS may be estimated by assuming that VSS is some fraction of MLSS. It is generally assumed that VSS is 60 to 80 percent of MLVSS. Thus, the increase in MLSS may be estimated by dividing P_x by a factor of 0.6 to 0.8 (or multiplying by 1.25 to 1.67). The mass of

suspended solids lost in the effluent is the product of the flow rate ($Q - Q_w$) and the suspended solids concentration (X_e).

Example 23-3 illustrates the estimation of the mass of sludge to be wasted using Equation 23-38.

Example 23-3. Estimate the mass of sludge to be wasted each day from the new activated sludge plant at Lawrence (Examples 23-1 and 23-2).

Solution:

- a. Using the data from Example 23-1, calculate Y_{obs} :

$$Y_{\text{obs}} = \frac{0.50 \text{ kg VSS/kg BOD}_5 \text{ removed}}{1 + [(0.050 \text{ d}^{-1})(5 \text{ d})]} \\ = 0.40 \text{ kg/kg BOD}_5 \text{ removed}$$

- b. The net waste activated sludge produced each day is

$$P_x = (0.40)(12,960 \text{ m}^3/\text{d})(84.0 \text{ g/m}^3 - 11.1 \text{ g/m}^3) \\ = 377,914 \text{ g/d or } 377.9 \text{ kg/d of VSS}$$

- c. The total mass produced includes inert materials. Using the relationship between MLSS and MLVSS in Example 23-2,

$$\text{Increase in MLSS} = (1 / 0.70)(377.9 \text{ kg/d}) = 539.86 \text{ or } 540 \text{ kg/d}$$

- d. The mass of solids (both volatile and inert) lost in the effluent is

$$(Q - Q_w)(X_e) = (12,960 \text{ m}^3/\text{d} - 96.2 \text{ m}^3/\text{d})(30 \text{ g/m}^3) \\ = 385,914 \text{ g/d or } 385.9 \text{ kg/d}$$

- e. The mass to be wasted is then

$$\text{Mass to be wasted} = 539.86 - 385.9 = 153.96 \text{ or } 154 \text{ kg/d}$$

Comment. This mass is calculated as dry solids. Because the sludge is mostly water, the actual mass will be considerably larger. This is discussed Chapter 15.

A more accurate prediction of sludge production can be made with sufficient wastewater characterization. The following equation accounts for heterotrophic biomass growth (Part A), cell debris from endogenous decay (Part B), nitrifying biomass growth (Part C), and nonbiodegradable VSS in the influent (Part D) (Metcalf & Eddy, 2003):

$$P_{x,\text{vss}} = \frac{QY(S_o - S)(10^{-3} \text{ g/kg})}{1 + k_d \theta_c} \quad (\text{Part A}) \\ + \frac{(f_d)(k_d)QY(S_o - S)(\theta_c)(10^{-3} \text{ g/kg})}{1 + k_d \theta_c} \quad (\text{Part B}) \\ + \frac{QY_n(\text{NO}_x)(10^{-3} \text{ g/kg})}{1 + k_{dn} \theta_c} \quad (\text{Part C}) \\ + Q(\text{nbVSS})(10^{-3} \text{ g/kg}) \quad (\text{Part D}) \quad (23-40)$$

where NO_x = concentration of $\text{NH}_4\text{-N}$ in the influent that is to be nitrified, mg/L

f_d = fraction of cell mass that remains as cell debris, g VSS/g VSS

Other terms are as defined previously. In the absence of laboratory analysis, f_d may be assumed to be about 0.15.

To account for the total mass of solids, the total suspended solids (TSS) must be included. Assuming that the VSS fraction of the total biomass is about 0.85 based on cell composition, the production of TSS is estimated as (Metcalf & Eddy, 2003):

$$P_{x,\text{vss}} = \frac{\text{Part A}}{0.85} + \frac{\text{Part B}}{0.85} + \frac{\text{Part C}}{0.85} + \text{Part D} + Q(\text{TSS}_0 - \text{VSS}_0) \quad (23-41)$$

where TSS_0 = influent wastewater TSS, mg/L

VSS_0 = influent wastewater VSS, mg/L

The estimate of Part B becomes important if the concentration of bCOD is high. The estimate of Part C is particularly relevant in nitrification and denitrification processes because of the potential for washout of nitrifying bacteria. The estimate of Part D is important when nbVSS in the influent is high. This can happen when an industrial discharge contains a high concentration of nbVSS.

Oxygen Demand

Oxygen is used in reactions where substrate is degraded to produce the high-energy compounds required for cell synthesis and respiration. For long SRT systems, the oxygen needed for cell maintenance can be of the same order of magnitude as substrate metabolism. A minimum residual of 0.5 to 2 mg/L DO is usually maintained in the reactor basin to prevent oxygen deficiencies from limiting the rate of substrate removal.

An estimate of the oxygen requirements may be made from the bCOD of the waste and amount of biomass wasted each day. If it is assumed that all of the bCOD is converted to end products, the total oxygen demand would equal bCOD. Because a portion of waste is converted to new cells that are wasted, the bCOD of the wasted cells must be subtracted from the total oxygen demand. An approximation of the oxygen demand of the wasted cells may be made by assuming cell oxidation can be described by the following reaction:

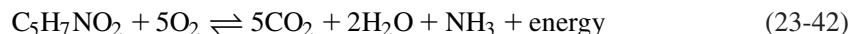

The ratio of gram molecular weights is

$$\frac{5(32)}{113} = 1.42$$

Thus the oxygen demand of the waste activated sludge may be estimated as 1.42 (P_x).

The mass of oxygen required may be estimated as:

$$M_{\text{O}_2} = Q(S_o - S)(10^{-3} \text{ kg/g}) - 1.42 (P_x) \quad (23-43)$$

where M_{O_2} = mass of oxygen, kg/d

Q = wastewater flow rate into the aeration tank, m^3/d

S_o = influent bCOD, g/m^3

S = effluent bCOD, g/m^3

P_x = waste activated sludge produced, kg/d (see Equation 23-38)

Note that the definition of S and S_o has been changed from readily biodegradable soluble COD (rbsCOD) to biodegradable COD (bCOD).

Where nitrification is included in the process, the oxygen requirement must include a term to account for ammonia and organic nitrogen oxidation:

$$M_{O_2} = Q(S_o - S)(10^{-3} \text{ kg/g}) - 1.42(P_x) + 4.33Q(\text{NO}_x) \quad (23-44)$$

where NO_x is the amount of TKN oxidized to nitrate.

A nitrogen balance that accounts for the influent TKN, nitrogen removed for biomass synthesis, and unoxidized effluent nitrogen is used to determine NO_x . Assuming the biomass composition may be described as $\text{C}_5\text{H}_7\text{NO}_2$, then synthesis nitrogen is estimated as 0.12 g N/g of biomass. The nitrogen mass balance is

$$\begin{aligned} \text{Nitrogen oxidized} &= \text{Nitrogen in influent} - \text{Nitrogen in effluent} - \text{Nitrogen in cell tissue} \\ Q(\text{NO}_x) &= Q(\text{TKN}_0) - QN_e - 0.12 P_x \end{aligned}$$

$$\text{NO}_x = \text{TKN}_0 - N_e - 0.12 \left(\frac{P_x}{Q} \right) \quad (23-45)$$

where NO_x = nitrogen oxidized, mg/L

TKN_0 = influent total Kjeldahl nitrogen, mg/L

N_e = effluent $\text{NH}_4\text{-N}$, mg/L

Other terms are as previously defined.

If the process includes denitrification, the amount of oxygen supplied by nitrate decreases the amount of oxygen that must be supplied by aeration. This "oxygen credit" amounts to 2.86 g O_2 /g $\text{NO}_3\text{-N}$.

The volume of air to be supplied must take into account the percent of air that is oxygen and the transfer efficiency of the dissolution of oxygen into the wastewater.

Example 23-4 illustrates the estimation of the mass of oxygen to be supplied.

Example 23-4. Estimate the mass of oxygen to be supplied (kg/d) for the new activated sludge plant at Lawrence (Examples 23-1 and 23-3). Assume that $\text{BOD}_5 = \text{rbsCOD}$ and that it is 68% of the bCOD.

Solution:

- a. Using the data from Examples 23-1 and 23-3, convert the rbsCOD to bCOD.

$$\text{bCOD} = \frac{\text{rbsCOD}}{0.68}$$

and

$$S_o = \frac{84.0 \text{ g/m}^3}{0.68} = 123.53 \text{ g/m}^3$$

$$S = \frac{11.1 \text{ g/m}^3}{0.68} = 16.32 \text{ g/m}^3$$

b. Estimate the mass of O₂ as

$$M_{O_2} = Q(S_o - S)(10^{-3} \text{ kg/g}) - 1.42(P_x)$$

$$M_{O_2} = (12,960 \text{ m}^3/\text{d})(123.53 \text{ g/m}^3 - 16.32 \text{ g/m}^3)(10^{-3} \text{ kg/g})$$

$$- 1.42(377.9 \text{ kg/d of VSS})$$

$$= 1,389.4 - 536.6 = 852.8 \text{ or } 850 \text{ kg/d of oxygen}$$

Comment. This is the theoretical amount of oxygen required. For aeration design, the fraction of air that is oxygen and the oxygen transfer efficiency must be taken into account.

Oxygen Transfer

In 1924, Lewis and Whitman postulated a two-film theory to describe the mass transfer of gases. According to their theory, the boundary between the gas phase and the liquid phase (also called the *interface*) is composed of two distinct films that serve as a barrier between the bulk phases (Figure 23-11). For a molecule of gas to go into solution, it must pass through the bulk of the gas, the gas film, the liquid film, and into the bulk of the liquid (Figure 23-11a). To leave the liquid, the gas molecule must follow the reverse course (Figure 23-11b). The driving force causing the gas to move, and hence the mass transfer, is the concentration gradient: $C_s - C$. C_s is the saturation concentration of the gas in the liquid, and C is the actual concentration. When C_s is greater than C , the gas will go into solution.

The rate of mass transfer is given by

$$\frac{dC}{dt} = K_L a (C_s - C_t) \quad (23-46)$$

where $K_L a$ is the volumetric mass transfer coefficient with units of s^{-1} and C_t is the concentration in the bulk liquid at time t . Integrating Equation 23-46 between the limits $C = C_0$ and

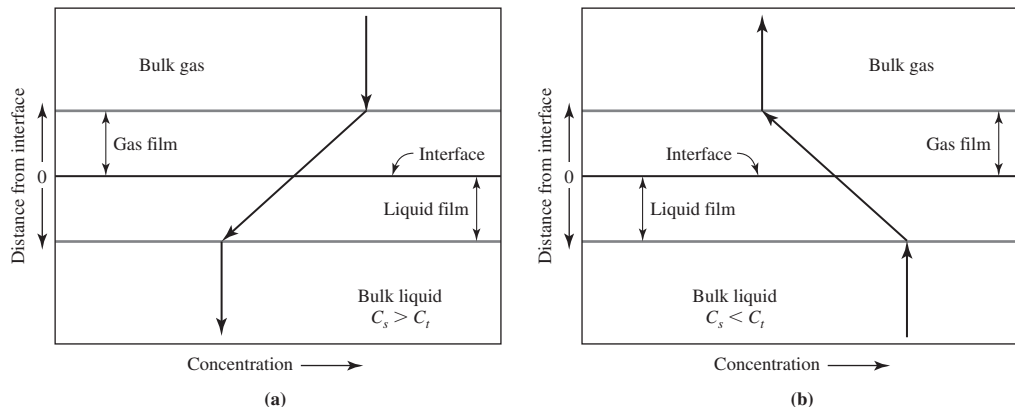

FIGURE 23-11

Two-film model of the interface between gas and liquid: (a) absorption mode and (b) desorption mode. (Source: Davis and Cornwell, 2008.)

$C = C_t$ and $t = 0$ and $t = t$, where C_0 is the initial concentration and C_t is the concentration at time t , yields

$$\frac{C_s - C_t}{C_s - C_0} = \exp[-(K_L a)(t)] \quad (23-47)$$

The effects of mixing intensity and tank geometry must be considered in the design process. In most cases aeration devices are rated by manufacturers based on clean water. A correction factor α is used to estimate $K_L a$ in the actual system:

$$\alpha = \frac{K_L a \text{ (wastewater)}}{K_L a \text{ (clean water)}} \quad (23-48)$$

Typical values of α are 0.2 to 0.5 for conventional BOD oxidation, 0.4 to 0.7 for nitrification only, and 0.5 to 0.75 for nitrification-denitrification (Rosso and Stenstrom, 2007).

A second correction factor β is used to correct the oxygen transfer rate for differences in oxygen solubility due to constituents in the water such as salts, particulate matter, and surface active substances:

$$\beta = \frac{C_s \text{ (wastewater)}}{C_s \text{ (clean water)}} \quad (23-49)$$

Values of β range from about 0.7 to 0.98. A typical value for wastewater is 0.95.

The interrelationship between these factors and temperature, elevation above sea level, and the depth of diffusers is expressed as follows (Metcalf & Eddy, 2003):

$$\text{AOTR} = \text{SOTR} \left(\frac{(\beta)(C_{\text{avg}} - C_L)}{C_{s20}} \right) (1.024^{T-20})(\alpha)(F) \quad (23-50)$$

where AOTR = actual oxygen transfer rate, kg O₂/h

SOTR = standard oxygen transfer rate in tap water at 20°C and zero DO, kg O₂/h

C_{avg} = average dissolved oxygen saturation concentration in clean water in aeration tank at temperature T and elevation H , mg/L

C_L = operating oxygen concentration, mg/L

$C_{s,20}$ = dissolved oxygen saturation in clean water at 20°C and 1 atm, mg/L

T = operating temperature, °C

F = fouling factor

The average dissolved oxygen saturation concentration in clean water (C_{avg}) in an aeration tank at temperature T and elevation H is defined as

$$C_{\text{avg}} = (C_{s,T,H})(0.5) \left(\frac{P_d}{P_{\text{atm},H}} + \frac{O_t}{21} \right)$$

where $C_{s,T,H}$ = oxygen saturation concentration in clean water at temperature T and elevation H , mg/L

P_d = pressure at depth of air release, kPa

$P_{\text{atm},H}$ = atmospheric pressure at elevation H , kPa

O_t = percent oxygen concentration leaving tank
= (21%)(1 - %O₂ absorbed)

TABLE 23-6
Typical clean water oxygen transfer efficiencies

Diffuser type and placement	Air flow rate/diffuser, m ³ /d	SOTE, % at 4.5 m submergence	SAE, kg O ₂ /kW · h
Diffused air			
Porous grid	100–160	13–45	1.9–6.6
Nonporous, single spiral roll	400–1,400	9–12	1.3–1.9
Jet, side header	2,000–12,000	15–24	2.2–3.5
Mechanical surface			
Radial flow, low speed	N/A ^a	N/A	1.5–2.1
Axial flow, high speed	N/A	N/A	1.1–1.4
Horizontal rotor	N/A	N/A	1.5–2.1

^aNot applicable.

Sources: Metcalf & Eddy, 2003; WEF, 1998.

The atmospheric pressure at elevation H is computed from the ratio of pressure at elevation H divided by the pressure at sea level:

$$P_H/P_{SL} = \exp\left[-\frac{g(M)(z_H - z_{SL})}{RT}\right]$$

where g = acceleration due to gravity, 9.81 m/s²

M = mole of air = 28.97 kg/kg-mole

z_H = elevation H , m

z_{SL} = elevation of sea level, m

R = universal gas constant, 8.314 N · m/kg · mole · K

T = temperature, K

The percent oxygen absorbed may range from 5 to 14 percent. Typically it is assumed to be 8 percent. This results in an O_t of about 19 percent. The fouling factor is typically 0.65 to 0.9. For mechanical aeration $C_{avg} = C_{s,T,H}$.

Other terms used to rate aeration systems are Standard Oxygen Transfer Efficiency (SOTE, %) and Standard Aeration Efficiency (SAE, kg O₂/kW-h). SAE is preferred in evaluating alternatives because it takes energy consumption into account.

Typical clean water transfer efficiencies are given in Table 23-6.

Example 23-5 illustrates the use of SOTR and AOTR in determining the number of aerators.

Example 23-5. Estimate the required air flow rate for the new activated sludge plant at Lawrence (Examples 23-1, 23-3, and 23-4). Use the following assumptions in preparing the estimate:

Clean water correction, $\alpha = 0.50$

Salinity correction, $\beta = 0.95$

Fouling factor = 0.9

Summer wastewater temperature = 22°C

Atmospheric pressure = 101.325 kPa
 Elevation = 100 m
 Depth of aerator = 5.6 m
 Operating DO = 2.0 mg/L
 % oxygen leaving aeration tank = 19%
 Manufacturer's SOTR = 650 kg/d
 Manufacturer's air flow rate at standard conditions = 50 m³/d · aerator

Solution:

- a. From Example 23-4, the required AOTR is 850 kg/d. This will be designated AOTR_{req} for this problem.
- b. Solve Equation 23-50 for SOTR. This is the required SOTR (SOTR_{req}).

$$\text{SOTR}_{\text{req}} = \frac{\text{AOTR}_{\text{req}}}{(1.024^{T-20})(\alpha)(F)} \left(\frac{C_{s,20}}{(\beta)(C_{\text{avg}} - C_L)} \right)$$

- c. From Appendix A, find $C_{s,T,H} = 9.17 \text{ mg/L}$ or 9.17 g/m^3 at 20°C.
- d. P_d is the pressure at the depth of air release. $P_d = P_{\text{atm}, H} + P_{\text{water}}$. Converting $P_{\text{atm}, H}$ to meters of water,

$$P_{\text{atm},H} = \frac{\text{Atmospheric pressure}}{\text{Specific weight of air}} = \frac{101.325 \text{ kN/m}^2}{9.8 \text{ kN/m}^3} = 10.34 \text{ m}$$

From the assumed depth of the aerator,

$$P_d = 10.34 \text{ m} + 5.6 \text{ m} = 15.9 \text{ m}$$

- e. Find $C_{s,T,H} = 8.83 \text{ mg/L}$ from Appendix A at 22°C and calculate C_{avg} .

$$\begin{aligned} C_{\text{avg}} &= (8.83 \text{ mg/L})(0.5) \left(\frac{15.9 \text{ m}}{10.34 \text{ m}} + \frac{19}{21} \right) \\ &= 10.8 \text{ mg/L} \end{aligned}$$

- f. Calculate SOTR_{req}.

$$\begin{aligned} \text{SOTR}_{\text{req}} &= \left(\frac{850 \text{ kg/d}}{(1.024^{22-20})(0.50)(0.9)} \right) \left(\frac{9.17 \text{ mg/L}}{(0.95)(10.8 \text{ mg/L} - 2.0 \text{ mg/L})} \right) \\ &= \left(\frac{850 \text{ kg/d}}{0.47} \right) \left(\frac{9.17 \text{ mg/L}}{8.36 \text{ mg/L}} \right) = 1,983.7 \text{ or } 1,980 \text{ kg/d} \end{aligned}$$

- g. Calculate the ratio of SOTR_{manuf}/SOTR_{req}.

$$\frac{\text{SOTR}_{\text{manuf}}}{\text{SOTR}_{\text{req}}} = \frac{650 \text{ kg/d}}{1,980 \text{ kg/d}} = 0.328$$

- h. The required air flow rate is found from the following relationship:

$$\left(\frac{\text{AOTR}_{\text{req}}}{(\text{Density of air})(\text{Mass \% O}_2 \text{ in air})} \right) \left(\frac{\text{SOTR}_{\text{req}}}{\text{SOTR}_{\text{manuf}}} \right)$$

The density of air at standard conditions is 1.185 kg/m^3 . Air contains about 23.2% oxygen on a mass basis. The required air flow rate is

$$\frac{850 \text{ kg/d}}{(1.185 \text{ kg/m}^3)(0.232)} \left(\frac{1}{0.328} \right) = 9,418 \text{ or } 9,400 \text{ m}^3/\text{d}$$

- i. The number of aerators required is

$$\frac{9,400 \text{ m}^3/\text{d}}{50 \text{ m}^3/\text{d} \cdot \text{aerator}} = 188 \text{ aerators}$$

Comments:

1. When elevation above mean sea level is important, for example in Denver, Colorado, then corrections for the standard atmospheric pressure may be in order.
2. If SOTE is provided by the manufacturer, the ratio $\text{SOTR}_{\text{manuf}}/\text{SOTR}_{\text{req}}$ can be replaced with SOTE provided that a correction is made for depth if it is not the same as that in the design.

Food-to-Microorganism Ratio (F/M)

The food-to-microorganism ratio was developed in the 1950s and 1960s. The “food” is substrate. It is still widely used. It is intuitive, conceptually easy to explain, and relies on measurements that are routinely taken.

In equation form, the food-to-microorganism ratio (F/M) is

$$F/M = \frac{QS_o}{VX} \quad (23-51)$$

where Q = wastewater flow rate into the aeration tank, m^3/d

S_o = influent readily biodegradable soluble COD (rbsCOD), mg/L

V = volume of aeration tank, m^3

X = microorganism concentration (mixed-liquor volatile suspended solids or MLVSS) in the aeration tank, mg/L

The units of F/M are

$$\frac{\text{mg BOD}_5/\text{d}}{\text{mg MLVSS}} = \frac{\text{mg}}{\text{mg} \cdot \text{d}}$$

The F/M ratio has some basis in theory, but the values used in practice are derived from empirical observations. They serve as a check on design calculations. Typical F/M ratios for various modifications of the activated sludge process range from 0.04 to $2.0 \text{ mg/mg} \cdot \text{d}$.

Example 23-6. Two “fill and draw,” batch-operated activated sludge tanks are operated as follows:

Tank A is settled once each day, and half the liquid is removed with care not to disturb the sludge that settles to the bottom. This liquid is replaced with fresh settled sewage. A plot of MLVSS concentration versus time takes the shape shown below.

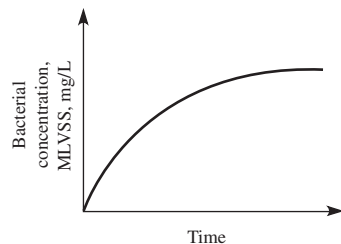

Tank B is not settled. Once each day half the mixed liquor is removed while the tank is being violently agitated. The liquid is replaced with fresh settled sewage. A plot of MLVSS concentration versus time is shown below.

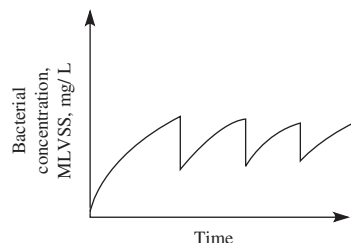

A comparison of the operating characteristics of the two systems is shown in the following table.

Parameter	Tank A	Tank B
F/M	Low	High
θ_c	Long	Short
Sludge volume	Small	Large
Oxygen required	High	Low
Power	High	Low

The optimum choice is somewhere between these extremes. A balance must be struck between the cost of sludge disposal and the cost of power to provide oxygen (air).

Specific Denitrification Rate

The specific denitrification rate (SDNR) must be determined for preanoxic nitrate removal processes. The best method for determining the SDNR is based on simulation modeling. Mass balances of biomass, $\text{NO}_3\text{-N}$, rbCOD, and bpCOD are coupled with internal recycle rates to determine SDNR. The following paragraphs describe a desktop design approach that makes use of plots generated from simulation modeling (Metcalf & Eddy, 2003).

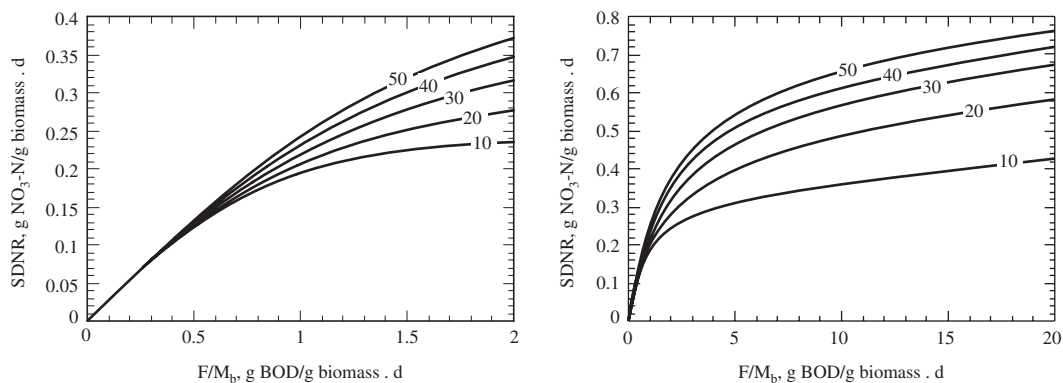

FIGURE 23-12

Plot of specific denitrification rates ($SDNR_b$) based on biomass concentration at 20°C versus food to biomass (F/M_b) ratio for various percentages of rbCOD relative to the biodegradable COD of the influent wastewater. (Source: Metcalf & Eddy, 2003.)

The amount of nitrate removed in the anoxic tank is described by the following equation:

$$NO_r = (V_{\text{anox}})(SDNR)(MLVSS) \quad (23-52)$$

where NO_r = nitrate removed, g/d
 V_{anox} = anoxic tank volume, m^3
 $SDNR$ = specific denitrification rate, g $NO_3\text{-N/g MLVSS} \cdot d$
 $MLVSS$ = mixed liquor volatile suspended solids, mg/L

An important design parameter is the amount of BOD needed to provide a sufficient amount of electron donor for nitrate removal. In the desktop technique, this is addressed by graphs relating $SDNR$ to the F/M ratio (Figure 23-12). Equation 23-51 is used to calculate the F/M ratio using $V_{\text{anox}} = V$.

To achieve typical effluent limits for nitrate, a portion of the aerobically treated wastewater must be recycled to the anoxic tank. This is called *internal recycle*. A mass balance accounts for the nitrate produced in the aerobic zone. As a conservative design approach, all of the influent TKN is assumed to be biodegradable and the effluent soluble organic nitrogen is ignored. The mass balance is expressed as

kg of nitrate produced in aerobic zone = nitrate in effluent + nitrate in internal recycle
 + nitrate in RAS

$$Q(NO_x) = N_e[Q + (IR)(Q) + (R)(Q)] \quad (23-53)$$

Solving for the internal recycle ratio:

$$IR = \frac{NO_x}{N_e} - 1.0 - R \quad (23-54)$$

where IR = internal recycle ratio
 = internal recycle/influent flow rate

NO_x = nitrate produced in aeration zone as a concentration relative to influent flow, mg
 $\text{NO}_3\text{-N/L}$

N_e = effluent $\text{NO}_3\text{-N}$ concentration, mg/L

R = RAS recycle ratio = RAS flow rate/influent flow rate

Temperature corrections and internal recycle ratios (IR) corrections greater than one are made using the following equations:

$$\text{SDNR}_T = \text{SDNR}_{20}(\phi)^{T-20} \quad (23-55)$$

where ϕ = temperature coefficient = 1.026

T = temperature, °C

$$\text{For IR} = 2 \quad \text{SDNR}_{\text{adj}} = \text{SDNR}_1 - 0.0166 \ln(F/M) - 0.0078 \quad (23-56)$$

$$\text{For IR} = 3-4 \quad \text{SDNR}_{\text{adj}} = \text{SDNR}_1 - 0.029 \ln(F/M) - 0.012 \quad (23-57)$$

where SDNR_1 = SDNR value at an internal recycle ratio = 1.

If the F/M is less than or equal to 1.0, no correction is required.

In contrast to the preanoxic processes, the process and organic substrate used are well defined in postanoxic processes. For these reasons, the SDNR design approach is not appropriate for postanoxic processes (Metcalf & Eddy, 2003).

Sludge Volume Index

The sludge volume index (SVI) is the volume of one gram of sludge after 30 minutes of settling. The SVI is determined by placing a mixed liquor sample in a one- to two-liter cylinder and measuring the volume of sludge after 30 minutes. A corresponding sample of the sludge is taken to measure the MLSS concentration. The SVI is calculated as:

$$\text{SVI} = \frac{(\text{settled volume of sludge, mL/L})(10^3 \text{ mg/g})}{\text{MLSS, mg/L}} = \frac{\text{mL}}{\text{g}} \quad (23-58)$$

An SVI of 100 mL/g or less is considered a good settling sludge. An SVI above 150 is typically associated with filamentous growth (Parker et al., 2001).

There are several alternative methods for conducting the test. The preferred technique is to use a vessel that is larger than a one- or two-liter cylinder. The vessel is equipped with a slow-speed stirring device.

The test is empirical. Because of this, the results may lead to significant errors in interpretation. For example, if a sludge with an MLSS of 10,000 mg/L did not settle at all after 30 minutes, the SVI would be 100!

A rearrangement of Equation 23-58 has been used as a design tool to predict the MLSS concentration in the return sludge. The MLSS is estimated by assuming the desired SVI:

$$X' = \frac{(1,000 \text{ mg/g})(1,000 \text{ mL/L})}{\text{SVI}} \quad (23-59)$$

where X' = MLSS, mg/L.

Because it is impossible to relate SVI to MLSS by any fundamental principles, its use as a basis of design is problematic at best and may, in the worst case, lead to significant design errors. It assumes that the underflow concentration from the secondary settling tank is fixed by the concentration of the sludge and is totally independent of the design of the final settling tank or the manner in which it is operated (Dick, 1976).

The use of an assumed SVI for design is **not** recommended. It rationalizes a bold assumption. It is more realistic to make an assumption about the MLSS concentration within typical design ranges, provide a rigorous secondary clarifier design, and provide sufficient flexibility in the operation of the system to achieve good settling.

Nonetheless, the SVI may be the best available method for operators to evaluate performance of their clarifiers because its conservative characteristics compensate for unknowns in the behavior of the sedimentation basin (Dick, 1976).

Volumetric Loading

The volumetric organic loading is defined as the amount of BOD applied to the aeration basin per day. Organic loadings are expressed as $\text{kg BOD}_5/\text{m}^3 \cdot \text{d}$. This parameter served as an early method to check for adequate treatment of domestic wastewater. It still appears in GLUMRB documents and serves as a very conservative check on aeration tank design for BOD oxidation. It is not useful in predicting effluent quality for biological nitrogen and phosphorus removal. It is not a design parameter; it is not an operating variable.

23-7 SUSPENDED GROWTH DESIGN PRACTICE

Typical design parameters for commonly used processes are summarized in Tables 23-7, 23-8, and 23-9.

TABLE 23-7
Typical design parameters for carbonaceous BOD oxidation and nitrification

Process	SRT, d	MLSS, mg/L	HRT, h	RAS, %
Complete mix	3–15	1,500–4,000	3–5	25–100 ^a
Contact stabilization	5–10	1,000–3,000 ^b 6,000–10,000 ^c	0.5–1 ^b 2–4 ^c	50–150
Conventional plug-flow	3–15	1,000–3,000	4–8	25–75 ^a
Extended aeration	20–40	2,000–5,000	20–30	50–150
Oxidation ditch	15–30	3,000–5,000	15–30	75–150
Sequencing batch reactor	10–30	2,000–5,000	15–40	N/A
Step feed	3–15	1,500–4,000	3–5	25–75

SRT = solids retention time; MLSS = mixed liquor suspended solids; HRT = hydraulic residence time; RAS = return activated sludge, % of average design flow rate.

^a For nitrification rates may be increased 25–50%.

^b MLSS and HRT in contact basin.

^c MLSS and HRT in stabilization basin.

N/A not applicable.

Adapted from Metcalf & Eddy, 2003.

TABLE 23-8
Typical design parameters for denitrification

Process	SRT, d	MLSS, mg/L	HRT, h			RAS, %	Internal recycle, %
			Total	Anoxic	Aerobic		
Bardenpho (4-stage)	10–20	3,000–4,000	8–20	1st stage 1–3 3rd stage 2–4	2nd stage 4–12 4th stage 0.5–1	50–100	200–400
MLE	7–20	3,000–4,000	5–15	1–3	4–12	50–100	100–200
Oxidation ditch	20–30	2,000–4,000	18–30	Variable	Variable	50–100	N/A
Sequencing batch reactor	10–30	3,000–5,000	20–30	Variable	Variable	N/A	N/A

SRT = solids retention time; MLSS = mixed liquor suspended solids; HRT = hydraulic residence time;
 RAS = return activated sludge, % of average design flow rate; internal recycle, % of average design flow rate.
 N/A = not applicable.
 Adapted from Metcalf & Eddy, 2003.

TABLE 23-9
Typical design parameters for phosphorus removal

Process	Aerobic zone SRT, d	MLSS, mg/L	HRT, h			RAS, %	Internal recycle, %
			Anaerobic	Anoxic	Aerobic		
A/O	2–5	3,000–4,000	0.5–1.5	N/A	1–3	25–100	N/A
A ² /O	5–25	3,000–4,000	0.5–1.5	0.5–1	4–8	25–100	100–400
Bardenpho (5-stage)	10–20	3,000–4,000	0.5–1.5	1st stage 1–3 2nd stage 2–4	1st stage 4–12 2nd stage 0.5–1	50–100	200–400
Sequencing batch reactor	20–40	3,000–4,000	1.5–3	1–3	2–4	N/A	N/A
UCT	10–25	3,000–4,000	1–2	2–4	4–12	80–100	200–400
Virginia Initiative Plant (VIP)	5–10	2,000–4,000	1–2	1–2	4–6	80–100	100–200

SRT = solids retention time; MLSS = mixed liquor suspended solids; HRT = hydraulic residence time;
 RAS = return activated sludge, % of average design flow rate.
 Notes: With the exception of A/O, these processes also remove nitrogen in the anoxic stage. A/OTM, A²/OTM, BardenphoTM, and VIPTM processes are patented.
 Adapted from Metcalf, & Eddy, 2003.

From the large number of alternative processes that are available, the following have been selected for more detailed discussion:

- As an example of prescriptive standard design for a small facility, a facultative oxidation pond;
- As an example of carbonaceous BOD oxidation and nitrification, an oxidation ditch;

- As an example of carbonaceous BOD oxidation, nitrification, and denitrification, a sequencing batch reactor;
- As an example of carbonaceous BOD oxidation, nitrification, denitrification, and biological phosphorus removal, the A²/OTM process.

With the exception of the oxidation pond, the design methodology used in the examples is based on using mean cell residence time (θ_c) or its equivalent, solids retention time (SRT), as the master variable for the designs.

Facultative Oxidation Ponds

Empirical methods have been developed for designing facultative ponds (see, for example, Gloyna, 1972, and Marais and Shaw, 1961). Unfortunately the predicted effluent quality often differs substantially from the actual effluent quality. As a consequence, in an effort to compensate for the many unknown design and operating variables that result in unsatisfactory operation, state standards are prescriptive and quite conservative. This philosophy is presented in the following discussion.

Redundancy. Unlike most other water and wastewater treatment systems, there is no general rule requiring redundant ponds. Typically there is a system of ponds. GLUMRB (2004) recommends that the system be designed with piping to permit isolation of a single pond without affecting the transfer and discharge capability of the total system.

Design Flow Rate. Because the retention time in the pond system is quite long, the average daily flow rate at the design life of the pond system is used as the design flow rate.

System Configuration. Typical practice is to operate three or more lagoons in series. Series operation improves removal efficiency and performance reliability (WEF, 1998). Influent screening is provided, but neither primary nor secondary settling are typical.

Although suspended solids settle in the lagoon, a common problem is a high concentration of suspended solids in the effluent. It is also possible for algal growth to result in a higher concentration of suspended solids in the effluent than in the influent. This typically happens with underloaded ponds. A series arrangement of ponds offers the opportunity to settle the algae in the last pond. Frequently, this implies more than three ponds in series. U.S. EPA (1977) recommends series configurations like those shown in Figure 23-13.

Loading. The use of *surface loading* (kilograms per hectare per day, kg/ha · d) as a design criterion is based on the concept that sufficient oxygen must be produced to offset the oxygen required for waste organic oxidation (Rittmann and McCarty, 2001). The oxygen is supplied from two sources: diffusion across the air/liquid interface and photosynthesis. The majority is supplied by photosynthesis. Because of the multiple metabolic regimes (aerobic, anoxic, and anaerobic) taking place in facultative lagoons, the design becomes dependent on other factors than solar radiation alone.

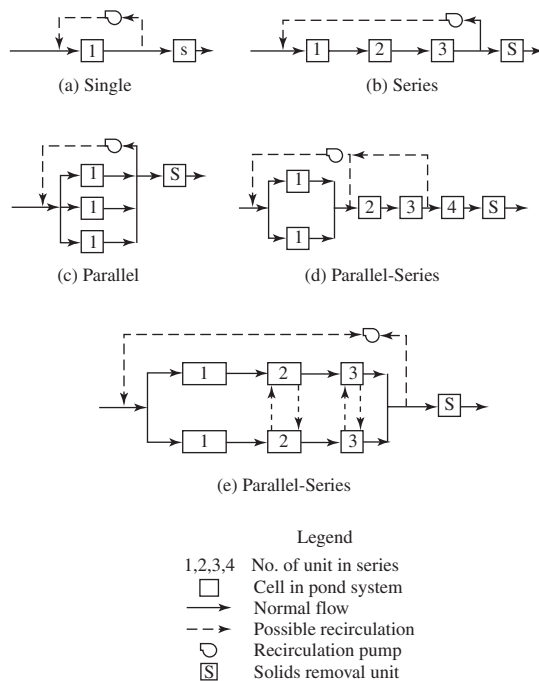
**FIGURE 23-13**

Facultative pond system configurations.

(Source: U.S. EPA, 1977.)

The GLUMRB (2004) loading recommendations are divided in two classes: controlled discharge or, as it is more commonly called, *seasonal discharge*, and flow-through discharge. The seasonal discharge ponds are those where the detention time and loading depend on climatic conditions and effluent discharge limits. The recommendations are:

- For controlled discharge: BOD_5 loading range is 17 to 40 kg/ha · d at the mean operating depth of the primary cell.
- For flow-through discharge: BOD_5 loading range is 17 to 40 kg/ha · d for the primary cell.

The *primary cell* is the first cell in a series arrangement of cells.

The U.S. EPA (1977) has proposed design criteria based on average winter air temperature (Table 23-10).

Note that the GLUMRB guidance is much more conservative than the EPA guidance. GLUMRB does not explain the rationale for the loading recommendations. EPA's recommendations are based on field surveys.

Area. GLUMRB (2004) recommends that the maximum area of a pond cell be 16 ha. For maximum flexibility the cells should be the same size.

Retention Time. The retention time is coupled with the surface loading rate as a controlling design variable. Enough time is required for the metabolic processes to proceed.

TABLE 23-10
U.S. EPA's recommended facultative pond loading rates

Average winter air temperature, °C	Primary cell BOD loading rate, kg/ha · d	Total system BOD loading rate, kg/ha · d
<0°C	34 to 67	11 to 22
0°C–15°C	67 to 135	22 to 45
>15°C	135 to 202	45 to 90

Source: U.S. EPA, 1977.

For the two classes, the GLUMRB (2004) recommendations are:

- For controlled discharge: at least 180 days detention time between the 0.6 m and maximum operating depth of the pond.
- For flow-through discharge: a detention time of 90 to 120 days depending on the duration of the cold period (temperature less than 5°C).

The U.S. EPA (1977) has proposed design criteria based on the average winter air temperature (Table 23-11).

In locations where ice forms, U.S. EPA (1977) recommends detention times of 150 to 240 days or sufficient for the period of ice cover plus 60 days be provided. This is to prevent odor and to polish the pond effluent.

As shown in Figure 23-14, ponds located in warmer climates are typically designed for higher surface loadings and shorter retention times.

Liquid Depth. U.S. EPA (1977) recommends the operating depths and extra depth for sludge storage shown in Table 23-12.

The minimum operating depth should not be less than 0.6 m to prevent growth of aquatic plants. The maximum water depth (not total depth) should be 1.8 m in primary cells (GLUMRB, 2004).

TABLE 23-11
U.S. EPA's recommended facultative pond retention time

Average winter air temperature, °C	Primary cell retention time, d	Total system retention time, d
<0°C	30 to 80	80 to 180
0–15°C	15 to 30	40 to 60
>15°C	5 to 15	25 to 40

Source: U.S. EPA, 1977.

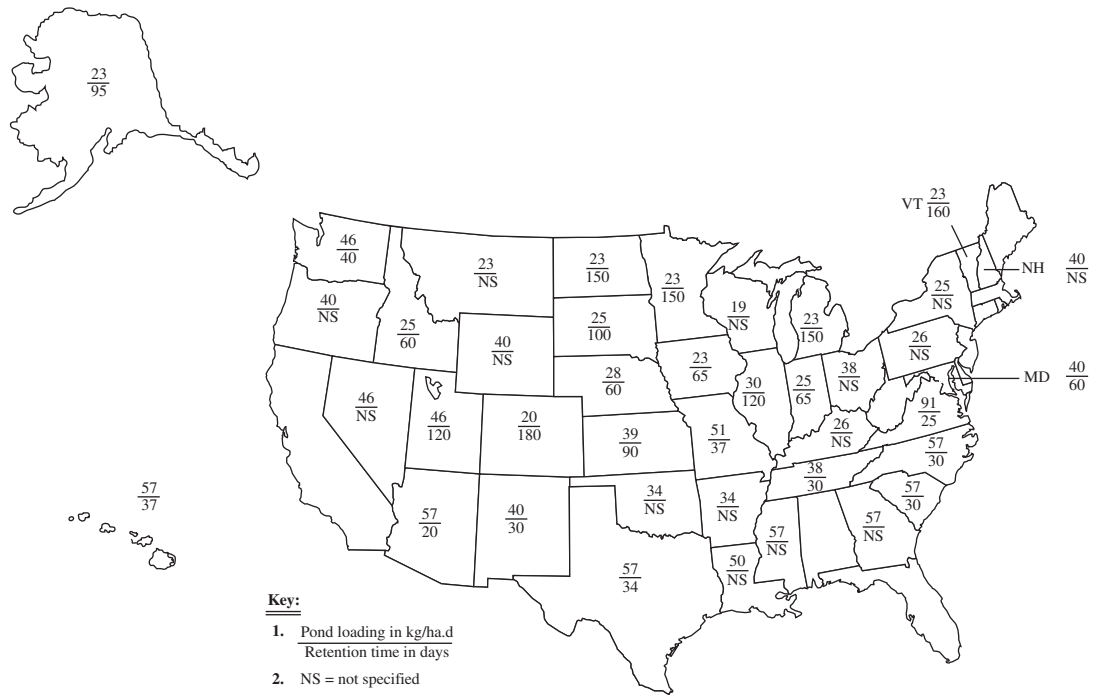

FIGURE 23-14
Sample of state regulations on oxidation pond loading and retention time.

TABLE 23-12
U.S. EPA’s recommended facultative pond depths

Average winter air temperature, °C	Primary cell extra depth for sludge storage, m	Total primary cell depth, m	Other cell depths, m
<0°C	1.2 to 1.8	2.7 to 3.9	1.5 to 2.1
0°C–15°C	0.9 to 1.5	2.1 to 3.3	1.2 to 1.8
>15°C	0.6 to 1.2	1.5 to 2.7	0.9 to 1.5

Source: U.S. EPA, 1977.

Inlet, Outlet, and Transfer Pipes. The inlet manhole should have an air break to prevent siphoning of the pond contents into the sewer line. The invert should be at least 150 mm above the maximum operating level of the pond (Figure 23-15).

The inlet pipe has traditionally been placed near the center of the primary pond. This has led to problems with short circuiting. The recommended arrangement is to place the discharge at the one-third point between the inlet and outlet, that is, two-thirds the length away from the outlet. The end of the discharge line should rest on a concrete apron large enough to prevent erosion. A minimum size apron approximately 0.6 m square is recommended (GLUMRB, 2004).

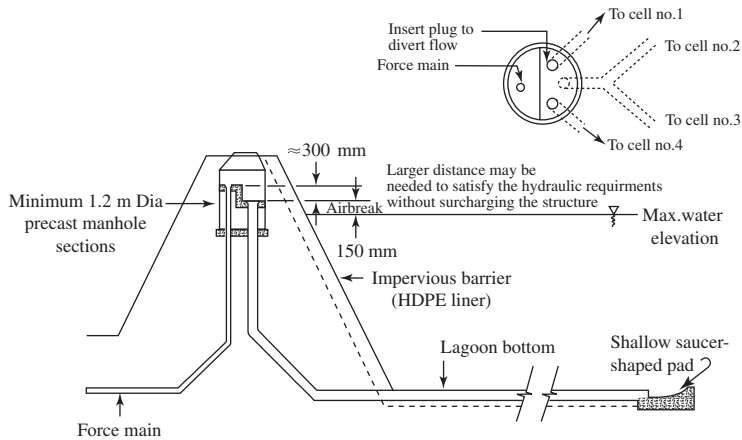

(a) Inlet structure for small lagoons (Not to Scale)

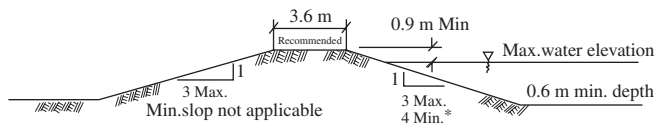

NTS

*Although 1:4 or flatter slopes, may be permitted for large installations to dampen wave action, they create more shallow water which will support emergent vegetation that must be controlled.

(b) Lagoon dike

FIGURE 23-15

Dimensions for lagoon structures.

Submerged takeoffs are used to transfer wastewater from one cell to another and to discharge the treated wastewater. A minimum of three pipes at different elevations is recommended. The intakes must be located a minimum of 3.0 m away from the toe of the embankment and 0.6 m from the top. A vertical withdrawal is used (Figure 23-16). An alternative is to provide a concrete structure with sluice gates. Because the sluice gates will be mounted on the outlet of the structure, they must be rated to hold the seal under the hydrostatic pressure from the lagoon.

To obtain maximum removal of microbial cells by settling, the area near the outlet must be designed to attain a surface overflow rate of less than about $32 \text{ m}^3/\text{m}^2 \cdot \text{d}$ and the velocities near the outlet should be less than 0.02 to 0.025 m/s. U.S. EPA (1977) recommends construction of baffles to obtain the desired quiescence. The presence of ice cover may preclude the use of this feature.

Hydraulic Capacity. For controlled discharge systems, the hydraulic capacity must permit transfer of water at a minimum rate of 150 mm of pond water depth per day at the available head. For flow-through systems, the piping is designed to handle 250 percent of design maximum day flow of the system.

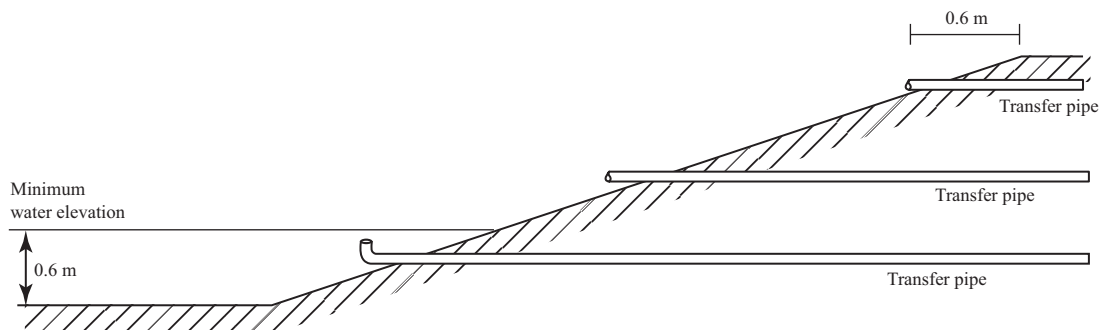

FIGURE 23-16
Dimensions for transfer pipes. Note lowest pipe has upturned intake.

Pond Bottom Seal. The pond bottom must be sealed to prevent seepage loss. Clay liners and/or impermeable material (for example, high density polyethylene, HDPE) have been used. A common standard for clay liners is a hydraulic conductivity of less than 1×10^{-7} cm/s. Michigan requires a double liner, that is, HDPE plus clay.

Embankment. The minimum dike width should be 2.4 m to permit access for maintenance vehicles. The recommended maximum inner and outer slope is 1:3 (vertical to horizontal) to permit mowing. Inner slopes should not be flatter than 1:4 to prevent emergent vegetation. The minimum freeboard should be 0.9 m. A typical profile is shown in Figure 23-15.

Fencing. Because the ponds are an attractive nuisance and a safety hazard, a 2 m high chain-link fence is typically placed at the outside toe of the embankment.

Example 23-7. Using the EPA criteria, design a controlled discharge oxidation pond for Waterloo. Waterloo is located in a state where the average winter temperature is 4°C . The design assumptions are as follows:

- Flow rate = $2,000 \text{ m}^3/\text{d}$
- $\text{BOD}_5 = 200 \text{ mg/L}$
- Three cells in series
- Minimum operating depth = 0.6 m

Solution:

- a. Calculate the surface area of the total pond system assuming a conservative loading rate of $22 \text{ kg/ha} \cdot \text{d}$ at 0°C to 15°C from Table 23-10. Note that $1.0 \text{ mg/L} = 1.0 \text{ g/m}^3$. The total lagoon surface area at the mean operating depth is

$$A = \frac{(200 \text{ g/m}^3)(2,000 \text{ m}^3/\text{d})}{(1,000 \text{ g/kg})(22 \text{ kg/ha} \cdot \text{d})} = 18.2 \text{ or } 18 \text{ ha}$$

- b. For three cells of equal size, the loading rate for the primary cell is

$$LR = \frac{(200 \text{ g/m}^3)(2,000 \text{ m}^3/\text{d})}{(1,000 \text{ g/kg})(6 \text{ ha})} = 66.67 \text{ or } 67 \text{ kg/ha} \cdot \text{d}$$

This is within the EPA recommended loading of 67 to 135 kg/ha · d for primary cells. However, the loading is larger than the more conservative GLUMRB recommendation of 17 to 40 kg/ha · d.

- c. Select a conservative total retention time of 60 d at 0°C to 15°C from Table 23-11. For three cells with the same volume, the retention time in the first cell is

$$\frac{60 \text{ d}}{3 \text{ cells}} = 20 \text{ d/cell}$$

This is within the acceptable range for the primary cell.

- d. The mean operating depth of the three-cell system is the average operating depth plus the minimum operating depth.

$$\text{Average depth} = \frac{(2,000 \text{ m}^3/\text{d})(60 \text{ d})}{(18 \text{ ha})(10,000 \text{ m}^2/\text{ha})} = 0.67 \text{ m}$$

With a minimum operating depth of 0.6 m, the mean operating depth from the bottom of the cell is

$$\text{Mean operating depth} = 0.67 \text{ m} + 0.6 \text{ m} = 1.27 \text{ m}$$

- e. The pond system will then operate between the minimum operating depth and twice the average depth. Thus, the maximum operating depth is

$$\text{Maximum operating depth} = 2(0.67 \text{ m}) + 0.6 \text{ m} = 1.94 \text{ or } 1.9 \text{ m}$$

This is slightly over the maximum recommended level of 1.8 m.

- f. The total depth of a cell is then

$$\text{Total depth} = 1.9 \text{ m} + 0.9 \text{ m freeboard} = 2.8 \text{ m}$$

- g. Assuming a square pond, the dimensions at the mean operating depth for each of the three ponds are

$$[(6 \text{ ha})(10,000 \text{ m}^2/\text{ha})]^{1/2} = 244.95 \text{ or } 245 \text{ m on each side}$$

Post-Pond Treatment. Three treatment processes may be required after stabilization in the oxidation pond. These are disinfection, removal of suspended solids, and/or post-aeration. Disinfection and post-aeration are discussed in Chapter 25. Suspended solids removal is discussed in the following paragraphs.

As noted previously, the suspended solids in the effluent may be excessive. This may result from turbulence in the final cell, a prolific growth of algae, or a combination of these factors. Oxidation ponds are usually selected for wastewater treatment because of their simplicity of operation. Thus, any additional treatment for removal of suspended solids should be simple to operate. Intermittent sand filters and land treatment have been the most successful.

The intermittent sand filters are about 0.9 m deep. The effective size of the sand should be 0.17 mm for best solids and BOD removal (Middlebrooks and Marshall, 1974). For proper operation, three filter beds are used. Flow is directed to one filter for 24 hours. This filter is allowed to drain and dry for two days while flow goes to an adjacent filter. A three-day cycle produces good operation and treatment. The design hydraulic loading rate for an individual filter is about $0.5 \text{ m}^3/\text{m}^2 \cdot \text{d}$.

Land treatment may take one of several approaches: spray irrigation, slow rate infiltration, overland flow, rapid infiltration, or discharge to wetlands. These are discussed in two U.S. EPA publications: *Environmental Control Alternatives for Municipal Wastewater* (U.S. EPA, 1979) and *Land Treatment of Municipal Wastewater Effluents, Design Factors I* (Pound et al., 1976). Crites and Tchobanoglous (1998) provide a detailed discussion with example problems in *Small and Decentralized Wastewater Management Systems*.

Oxidation Ditch

This is one example of processes used for carbonaceous BOD oxidation and nitrification. Other processes that perform these treatment functions are listed in Table 23-7.

Oxidation ditches, also known as *continuous loop reactors* (CLRs), are widely used in small to medium-sized communities where flow rates are in the range of 2,000 to 20,000 m^3/d . Performance data for 29 plants indicate that they are capable of meeting annual BOD_5 and total suspended solids discharge limits of 15 mg/L and 10 mg/L, respectively. In addition, they can achieve nitrification levels of 95 to 99 percent (U.S. EPA, 1978).

A typical oxidation ditch plant layout is illustrated in Figure 23-17. Note that while preliminary treatment is provided, primary treatment is not. This is typical.

Redundancy. Two units are provided for redundancy. They may be constructed with work space between them or with a common wall.

Preliminary Treatment. Bar screens or mechanical screens should be used instead of grinders or shredders. The shredded material has a tendency to mat and either float or collect on the aerator brushes.

Primary Treatment. Typically, primary treatment is not provided. This implies an additional solids load on the secondary clarifier beyond the production of biological solids.

Process Alternatives. Oxidation ditches have been operated in the following process configurations:

- Carbonaceous BOD removal,
- Carbonaceous BOD removal and nitrification,
- Carbonaceous BOD removal, nitrification, denitrification, and biological phosphorus removal.

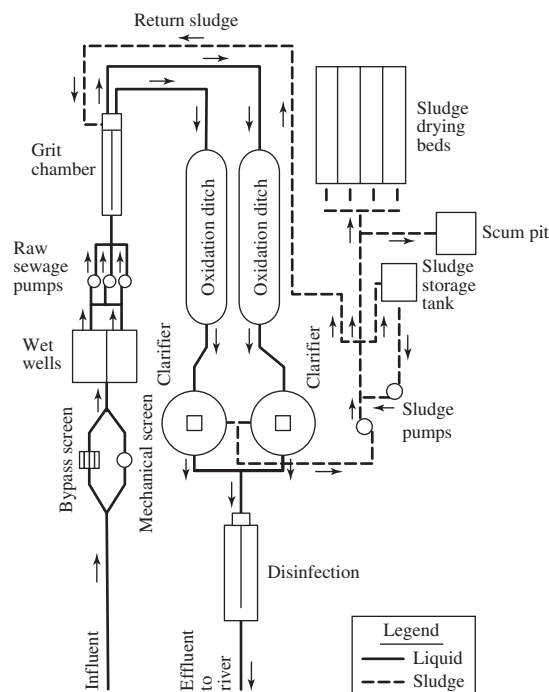
**FIGURE 23-17**

Typical oxidation ditch plant layout.

(Source: U.S. EPA, 1977.)

Typically, the process selected is extended aeration to nitrify and remove carbonaceous BOD. One of the primary reasons for selecting extended aeration is that it minimizes sludge production by providing a long period for endogenous decay of the sludge mass.

Design Loading. Unlike grit removal, primary settling, and secondary settling, suspended growth biological treatment systems are not hydraulically limited. They are process limited. Therefore, the *loading* (flow rate \times concentration) is an important design parameter.

Based on an extended aeration process alternative with equalization, the typical design flow rate is the annual average daily flow rate. Otherwise, the plant must hydraulically process daily peaks. It is recommended that the average BOD/NH₄-N loads (in kg/d) for the peak month be used as a basis for design (Young et al., 1978).

Type of Reactor. The flow regime of the oxidation ditch is classified as plug flow. However, the flow in the channel dilutes the incoming wastewater by a factor of 20 to 30. As a result, the process kinetics approach that of a completely mixed reactor.

Modeling Equations. Because the process kinetics approach that of a completely mixed reactor, Equations 23-11 through 23-19 are applicable. For municipal systems, WEF (1998) recommends that process design using the kinetic approach be based on an effluent soluble substrate concentration of zero, that is, $S = 0$. When both carbonaceous oxidation and nitrification are treatment objectives, nitrification growth kinetics (Equations 22-28 and 22-29) are assumed to govern (Mandt and Bell, 1982; U.S. EPA, 1975a).

Kinetic coefficients for removal of bCOD by heterotrophic bacteria are given in Table 23-13. The kinetic coefficients for design of nitrification with activated sludge are given in Table 23-14.

Safety Factor. Based on analysis of data at Chapel Hill, U.S. EPA (1975a) developed Figure 23-18. From this graph it appears that an SRT safety factor of 2.5 is reasonable. Unlike the Rittmann and McCarty (2001) safety factor in Table 23-5, this safety factor is to account for the ratio of peak to average ammonia concentrations.

Mixed Liquor Suspended Solids (MLSS). The MLSS is typically in the range of 3,000 to 5,000 mg/L (GLUMRB, 2004; Metcalf & Eddy, 2003). Mixed liquor volatile suspended solids (MLVSS) is often assumed to be 70 to 80 percent of MLSS for plants treating primarily domestic wastewater.

TABLE 23-13
Activated sludge kinetic coefficients for heterotrophic bacteria at 20°C

Coefficient	Range	Typical value
μ_m , g VSS/g VSS · d	3.0–13.2	6.0
K_s , g bCOD/m ³	5.0–40.0	20.0
Y , g VSS/g bCOD	0.30–0.50	0.40
k_d , g VSS/g VSS · d	0.06–0.20	0.12
f_d^a , g/g	0.08–0.2	0.15
Values for ϕ in the temperature correction equation: $C_t = C_{20}(\phi)^{T-20}$		
μ_m	1.03–1.08	1.07
K_s	1.00	1.00
k_d	1.03–1.08	1.04

^a f_d = fraction of cell mass remaining as cell debris.
Adapted from Metcalf & Eddy, 2003.

TABLE 23-14
Activated sludge nitrification kinetic coefficients at 20°C^a

Coefficient	Range	Typical value ^b
μ_{mn} , g VSS/g VSS · d	0.20–0.90	0.75
K_n , g NH ₄ -N/m ³	0.50–1.0	0.74
Y_n , g VSS/g NH ₄ -N	0.10–0.15	0.12
k_{dn} , g VSS/g VSS · d	0.05–0.15	0.08
K_0 , g/m ³	0.40–0.60	0.50
Values for ϕ in the temperature correction equation: $C_T = C_{20}(\phi)^{T-20}$		
μ_n	1.06–1.123	1.07
K_n	1.03–1.123	1.053
k_{dn}	1.03–1.08	1.04

^aBecause reported nitrification kinetics cover a wide range, bench-scale or in plant testing are recommended.

^bUpdated values may be found in Choybert, et al., 2009.
Adapted from Metcalf & Eddy, 2003.

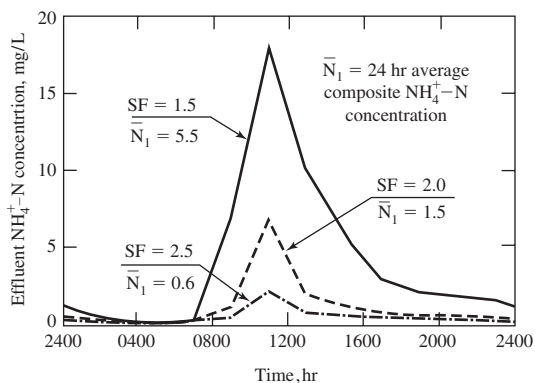
**FIGURE 23-18**

Effect of safety factor (SF) on diurnal variation in effluent ammonia.

(Source: U.S. EPA, 1975a.)

Solids Retention Time (SRT). To achieve endogenous decay, the solids retention time (mean cell residence time, θ_c) is typically on the order of 15 to 30 days (Metcalf & Eddy, 2003). Longer times (up to 40 days) may be used to reduce sludge wasting.

Dissolved Oxygen. For nitrification to proceed uninhibited, the DO must be above 2.0 mg/L. As noted in Chapter 22, nitrification rates increase with increasing DO up to about 3 or 4 mg/L.

Because surface aerators at fixed locations are typically used, the DO level drops with distance from the aerators. Thus, in addition to providing adequate oxygen, there must be enough aerators placed at reasonable distances between units. The provision of adequate velocity and aerator spacing is discussed later in this section.

Hydraulic Detention Time. The hydraulic detention time is **not** a basis for design. Although it appears in tables of design parameters, it is likewise **not** a design criterion. It does serve as a check on the results of model calculations and is essential in estimating the volume of the reactor. Typical hydraulic detention times for CLR are in the range 15 to 30 hours (Metcalf & Eddy, 2003).

Return Activated Sludge (RAS). Because of the need to retain nitrifying organisms in sufficient concentration, the upper bound for the range of RAS for CLR is higher than that for conventional or completely mixed activated sludge processes for carbonaceous BOD oxidation. The range is from 75 to 150 percent of the influent flowrate (Metcalf & Eddy, 2003).

Wasting. Although the design premise of the extended aeration process is “zero net cell production,” wasting of solids will be required to prevent an accumulation of solids in the oxidation ditch. Because there is no primary treatment, there will be inert material from the raw wastewater as well as cell debris that is not readily biodegradable that will accumulate.

Ditch Shape. The general shape of the CLR is typically an elongated oval. Other configurations include bent at one end, bent at both ends, folded in half, serpentine, and circular. The channels may be separated by a dividing wall or by a center island.

Shallow channels are typically 1.2 to 1.8 m deep with 45 degree sloping side walls. Deep channels have vertical side walls and are normally 3 to 4.2 m deep (U.S. EPA, 1978). The ditch is typically constructed of concrete, but lined earth structures have also been used.

TABLE 23-15
Typical manufacturer's brush surface aerator rotor data^a

Model	Diameter, mm	Length available, m	Speed range, rpm	Rotor capacity, m ³ /m	SOTR, kg/kWh	kg O ₂ per h per m
M	610	0.9–3.7	60–90	200	1.8	2.7
S	915	1.8–4.9	55–85	230	2.0	6.1
U	1,066	1.8–9.2	50–72	260	2.2	8.2

Dual rotors may be employed to double the available length.

^a For academic use. Use actual manufacturer's data for design.

Ditch Velocity. Typically, the design velocity in the channel is 0.3 m/s. The movement through the channel is provided by the surface aerators. Brush or disk aerators are commonly used. Manufacturers rate the aerators on a volume per meter of rotor length basis to maintain a velocity of approximately 0.3 m/s (Table 23-15). Rotor length, speed, immersion, ditch dimensions, and baffles all influence the velocity, so there is no exact design to achieve the desired velocity.

Dimensions. The volume is determined by the flow rate and hydraulic detention time (Equation 23-11). The hydraulic detention time is based on the kinetic equation (Equation 23-15).

Manufacturers provide rules-of-thumb for liquid depth and channel width relationships that are a function of the rotor length. An example of these rules-of-thumb is given in Table 23-16.

Baffles. To minimize solids deposition and maintain flow streamlines, return flow baffles are required in ditches with a center dividing wall (Figure 23-19). The following list provides an example of the rules for design of the baffles:

- Radius = channel width/2.
- Offset into incoming flow $\leq W/15$.

TABLE 23-16
Rules-of-thumb for liquid depth and channel width for oxidation ditch^a

Liquid depth (<i>D</i>)	Rotor length (<i>RL</i>)	Channel width (<i>W</i>)	Comment
≤ 2 m	1 to 5 m	$W/RL = 3.0$ to 1.8	Higher ratio with shorter rotor lengths
≤ 2 >2 m	>5 m	$W \leq RL + 3$ m $W = RL$	
Maximum depth for rotor models M & S = 2 m			See Table 23-15
Maximum depth for rotor model U = 5 m			See Table 23-15
With center island: $W \leq (1.5)$ (width of island)			
Freeboard ≥ 0.3 m for rotor models M & S			
Freeboard ≥ 0.5 m for rotor model U			

^a For academic use. Use actual manufacturer's data for design.

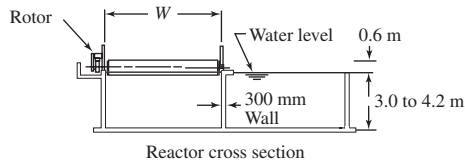
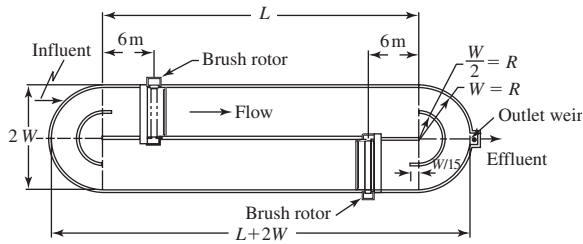

FIGURE 23-19
Baffle placement and dimensions.

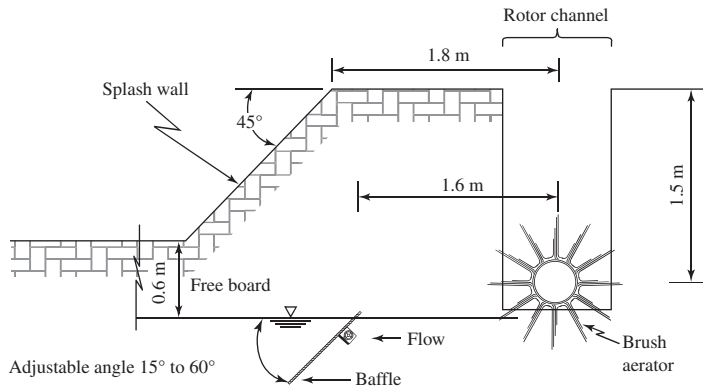

FIGURE 23-20
Downstream baffle for liquid depth greater than 2 m.

- Baffle extends 450 mm above liquid level.
- For channel width >14 m, two baffles are required.

In addition to baffles in the return flow, baffles are required downstream of the rotor if the liquid depth exceeds 2 m. An example of this baffle is shown in Figure 23-20.

Aerators. The suggested design condition for sizing the oxygen supply system is the peak BOD and ammonia load to be removed plus 50 percent of the peak four-hour load above the peak day rate (Young et al., 1978). This is very conservative. Current practice is to use the peak day.

Although vertically mounted aerators have been used, the horizontally mounted brush and disc aerators are more common. The oxygen transfer efficiency varies with the transfer rate. The factors that influence performance are the rotational speed and immersion. In the case of the disk aerators, the number of discs per meter of length also influences the performance.

In addition to the normal consideration of oxygen transfer rate and efficiency, the flexibility in operation should also be a factor in aerator selection. Some options to consider are variable speed and adjustable immersion depth.

Aerator Placement. Influent and return activated sludge (RAS) fed to the channel should be located just upstream of a rotor assembly to afford immediate mixing with the tank mixed liquor. Effluent from the channel should be far enough upstream of a rotor and far enough upstream of the raw wastewater influent and RAS to prevent short circuiting.

The velocity in the channel controls the location of the aerators. The U.S. EPA (1977) recommends that velocity be such that the travel time between aerators be no more than three to four minutes. Typically, rotors are placed in pairs. From the recommended velocity of 0.3 m/s and a maximum travel time of four minutes the maximum distance between rotors is

$$\text{Distance} = (0.3 \text{ m/s})(4 \text{ min})(60 \text{ s/min}) = 72 \text{ m}$$

For two rotors, this implies a maximum ditch length of $2 \times 72 \text{ m} = 144 \text{ m}$; for four rotors, the implied maximum ditch length is $4 \times 72 \text{ m} = 288 \text{ m}$.

Alkalinity. As noted in Chapter 22 (Equation 22-25) alkalinity is required to buffer the nitrification reaction. The required alkalinity may be estimated by the following equation (Metcalf & Eddy, 2003):

$$\text{Alkalinity to maintain pH} \sim 7 = \text{Influent Alk} - \text{Alk used} + \text{Alk to be added} \quad (23-60)$$

Typically the amount of residual alkalinity to maintain the pH near neutral is between 80 and 90 mg/L as CaCO_3 .

Options for adding alkalinity:

- Sodium bicarbonate (NaHCO_3) is most often recommended because it is easy to handle and it causes few scaling problems.
- Soda ash (sodium carbonate, Na_2CO_3) is also easy to handle and is generally less expensive than NaHCO_3 .
- Lime (CaO) is the least expensive but has several drawbacks. It has a propensity to form scale, it cakes and, thus, is more difficult to feed, and it produces more sludge.

Secondary Settling. The design of the secondary settling tank for this system is discussed in Chapter 25.

Appurtenances. Two important appurtenances are a weir to control the liquid level in the channel and rotor covers. The weir should be adjustable. Rotor covers may be required in cold climates to prevent icing.

Design Examples. The following five example problems illustrate the estimation of the volume of the oxidation ditch, required alkalinity addition, sludge production, number of brush aerators required, and the dimensions of the ditch and placement of the rotors.

Example 23-8. Estimate the volume of an extended-aeration oxidation ditch for carbonaceous BOD oxidation and nitrification for the city of Cartouche Lake using the following design data:

Influent data

Design flow rate = 14,200 m³/d
 bCOD = 205 mg/L
 NH₃-N = 16.8 mg/L
 Total suspended solids (TSS) = 160 mg/L
 Biodegradable volatile suspended solids = 95 mg/L
 Minimum sustained temperature = 12°C
 pH = 7.0
 Alkalinity = 90 mg/L as CaCO₃

Effluent discharge standards

bCOD ≤ 20 mg/L
 NH₃-N ≤ 1.0
 TSS ≤ 10 mg/L

Assume MLSS = 3,000 mg/L, MLVSS = (0.7) MLSS, and DO = 3.0 mg/L.

Solution:

- a. Assume nitrification governs, and select the following kinetic coefficients from Table 23-14:

Coefficient	ϕ for temperature correction	
μ_{mn} , g VSS/g VSS · d	0.75	1.07
K_n , g NH ₄ -N/m ³	0.74	1.053
Y_n , g VSS/g NH ₄ -N	0.12	
k_{dn} , g VSS/g VSS · d	0.08	1.04
K_0 , g/m ³	0.50	

- b. Correct kinetic coefficients to 12°C because this temperature limits the growth rate of nitrifying organisms. Use the correction equations in Table 23-14.

$$\begin{aligned}\mu_{n\max} &= (0.75 \text{ g VSS/g VSS} \cdot \text{d})(1.07)^{12-20} = 0.44 \text{ g VSS/g VSS} \cdot \text{d} \\ K_n &= (0.74 \text{ g NH}_4\text{-N/m}^3)(1.053)^{12-20} = 0.49 \text{ g NH}_4\text{-N/m}^3 \\ k_{dn} &= (0.08 \text{ g VSS/g VSS} \cdot \text{d})(1.04)^{12-20} = 0.06 \text{ g VSS/g VSS} \cdot \text{d}\end{aligned}$$

- c. Estimate μ_n using Equation 22-28. The value selected for N is the design effluent concentration because that is limiting. The DO is the design DO that must be achieved by the design of the aeration system.

$$\begin{aligned}\mu_n &= \left[(0.44 \text{ g VSS/g VSS}) \left(\frac{1.0 \text{ g/m}^3}{0.49 \text{ g NH}_4\text{-N/m}^3 + 1.0 \text{ g/m}^3} \right) \left(\frac{3.0 \text{ g/m}^3}{0.50 \text{ g/m}^3 + 3.0 \text{ g/m}^3} \right) \right] \\ &\quad - 0.06 \text{ g VSS/g VSS} \cdot \text{d} \\ \mu_n &= [(0.44)(0.67)(0.857)] - 0.06 = 0.19 \text{d}^{-1}\end{aligned}$$

- d. Using Equation 23-17 calculate $\theta_{c \min}$

$$\frac{1}{\theta_{c \min}} = \mu_n = 0.19 \text{ d}^{-1}$$

$$\theta_{c \min} = 5.26 \text{ d}$$

- e. Using a safety factor of 2.5 from Figure 23-18,

$$\theta_c = 2.5(5.26 \text{ d}) = 13.15 \text{ d}$$

- f. Estimate U for BOD oxidation using Equation 23-19 and the kinetic coefficients from Table 23-13 corrected for temperature. Solve Equation 23-19 for U .

$$U = \left(\frac{1}{\theta_c} + k_d \right) \left(\frac{1}{Y} \right)$$

$$U = \left(\frac{1}{13.15 \text{ d}} + 0.09 \text{ d}^{-1} \right) \left(\frac{1}{0.40} \right) = 0.415 \text{ d}^{-1}$$

- g. Solve Equation 23-18 for θ . Call this θ_{BOD} . Use this to estimate θ_{BOD} for the assumed MLSS = 3,000 mg/L and a conservative assumption of $S = 0$ as recommended by WEF (1998):

$$\theta_{\text{BOD}} = \frac{205 \text{ g/m}^3 - 0 \text{ g/m}^3}{(0.415 \text{ d}^{-1})(2,100 \text{ g/m}^3)}$$

$$= 0.235 \text{ d or } 5.64 \text{ h}$$

- h. As in step (f), estimate U for nitrification using Equation 23-19 and the kinetic coefficients from Table 23-14 corrected for temperature.

$$U = \left(\frac{1}{13.15} + 0.06 \right) \left(\frac{1}{0.12} \right) = (0.136)(8.33) = 1.13 \text{ d}^{-1}$$

- i. An estimate of the fraction of MLVSS that is nitrifying organisms is required to calculate θ for nitrification. Using Equation 22-29:

$$f_N = \frac{(0.16)(16.8 \text{ g/m}^3 - 1 \text{ g/m}^3)}{(0.6)(205 \text{ g/m}^3 - 0) + (0.16)(16.8 \text{ g/m}^3 - 1 \text{ g/m}^3)}$$

$$= \frac{2.53}{123 + 2.53} = 0.02$$

Note that the NH_3 concentrations were given in the problem statement. The MLVSS of nitrifying organisms is

$$\text{MLVSS} = (0.02)(2,100 \text{ mg/L}) = 42 \text{ mg/L}$$

- j. As in step (g), estimate $\theta_{\text{nitrification}}$.

$$\theta_{\text{nitrification}} = \frac{16.8 \text{ g/m}^3 - 1.0 \text{ g/m}^3}{(1.13 \text{ d}^{-1})(42 \text{ g/m}^3)} = 0.33 \text{ d or } 7.99 \text{ h}$$

The hydraulic detention time for nitrification governs.

- k. The volume of the oxidation ditch is estimated to be

$$V = (Q)(\theta) = (14,200 \text{ m}^3/\text{d})(0.33 \text{ d}) = 4,686 \text{ or } 4,700 \text{ m}^3$$

- l. To provide redundancy and flexibility of operation, two or three ditches should be provided. Assuming two ditches, the volume of each ditch is estimated to be $12,700 \text{ m}^3$.

Comment. Alkalinity is required to buffer the nitrification reaction. The estimation of the alkalinity required and the chemical dose to adjust it are explained in the next example.

Example 23-9. Determine whether or not there is sufficient alkalinity for nitrification of the extended aeration oxidation ditch at Cartouche Lake (Example 23-8). Compute the mass per day of sodium bicarbonate to add if alkalinity is required. Assume a residual of 80 mg/L as CaCO_3 is required to maintain the pH.

Solution:

- a. Compute the residual alkalinity using Equation 23-60.

Influent alkalinity from influent (Example 23-8) = 90 mg/L as CaCO_3 .

From Example 23-8 the amount of nitrogen converted to nitrate = $16.8 \text{ mg/L} - 1.0 \text{ mg/L} = 15.8 \text{ mg/L} = 15.8 \text{ g/m}^3$.

From Equation 22-25, the alkalinity used in nitrification = $(7.14 \text{ g CaCO}_3/\text{g NH}_4\text{-N})(15.8 \text{ g/m}^3) = 112.8 \text{ g/m}^3$.

Using the assumption that 80 mg/L as CaCO_3 is required to maintain the pH, the alkalinity balance is

$$80 \text{ g/m}^3 = 90 \text{ g/m}^3 - 112.8 \text{ g/m}^3 + \text{alkalinity to add}$$

Solving for alkalinity to add:

$$\text{alkalinity to add} = 80 \text{ g/m}^3 + 112.8 \text{ g/m}^3 - 90 \text{ g/m}^3 = 102.8 \text{ g/m}^3 \text{ as } \text{CaCO}_3$$

The mass per day is

$$(102.8 \text{ g/m}^3 \text{ as } \text{CaCO}_3)(14,200 \text{ m}^3/\text{d})(10^{-3} \text{ kg/g}) = 1,459.8 \text{ kg/d}$$

- b. Estimate the amount of sodium bicarbonate to add.

The equivalent weight of $\text{NaHCO}_3 = 84 \text{ g/equiv}$

The equivalent weight of $\text{CaCO}_3 = 50 \text{ g/equiv}$

$$\begin{aligned}\text{NaHCO}_3 \text{ required} &= \frac{(1,459.8 \text{ kg/d})(84 \text{ g/equiv})}{50 \text{ g/equiv}} \\ &= 2,452.4 \text{ or } 2,450 \text{ kg/d}\end{aligned}$$

Comment. This dose is an estimate. The chemical feed system should be flexible enough to allow the operator to adjust the dose.

Example 23-10. Estimate the mass of sludge to be wasted each day from the extended aeration oxidation ditch at Cartouche Lake (Example 23-8).

Solution:

- a. Assume that kinetic coefficients for heterotrophic bacteria govern because the fraction of heterotrophic bacteria is much greater than the fraction of nitrifying bacteria. From Table 23-13, $Y = 0.40 \text{ g VSS/g bCOD}$ and $k_d = 0.12 \text{ d}^{-1}$.
- b. Begin by calculating Y_{obs} using Equation 23-37. Use $\theta_c = 2.5(5.26 \text{ d}) = 13.15 \text{ d}$ and a corrected $k_d = 0.09 \text{ d}^{-1}$ from Example 23-8.

$$\begin{aligned}Y_{\text{obs}} &= \frac{0.40 \text{ g VSS/g bCOD removed}}{1 + [(0.09 \text{ d}^{-1})(13.15 \text{ d})]} \\ &= 0.183 \text{ g VSS/g bCOD removed}\end{aligned}$$

- c. Estimate the net waste activated sludge produced each day using Equation 23-38.

$$\begin{aligned}P_x &= (0.183)(14,200 \text{ m}^3/\text{d})(205 \text{ g/m}^3 - 0 \text{ g/m}^3)(10^{-3} \text{ kg/g}) \\ &= 532.7 \text{ or } 533 \text{ kg/d}\end{aligned}$$

- d. Because a primary settling tank is not included in the process flow scheme, the additional inert solids in the raw wastewater will pass through the oxidation ditch to the secondary clarifier. The concentration of inert solids is estimated as

$$\text{Inert SS} = \text{TSS} - \text{Biodegradable volatile suspended solids}$$

Using the data from Example 23-8:

$$\text{Inert SS} = 160 \text{ mg/L} - 95 \text{ mg/L} = 65 \text{ mg/L}$$

The mass of inert SS is estimated as

$$\begin{aligned}\text{Inert SS mass} &= (\text{Inert SS})(Q) \\ \text{Inert SS} &= (65 \text{ g/m}^3)(14,200 \text{ m}^3/\text{d})(10^{-3} \text{ kg/g}) \\ &= 923 \text{ or } 920 \text{ kg/d}\end{aligned}$$

- e. Assuming the secondary clarifier meets the design goal of 10 mg/L TSS in the effluent, the mass of solids (both volatile and inert) lost in the effluent is estimated as

$$\begin{aligned}(Q)(X_e) &= (14,200 \text{ m}^3/\text{d})(10 \text{ g/m}^3)(10^{-3} \text{ kg/g}) \\ &= 142 \text{ kg/d}\end{aligned}$$

The mass to be wasted is then

$$\text{Mass to be wasted} = 533 \text{ kg/d} + 920 \text{ kg/d} - 142 \text{ kg/d} = 1,311 \text{ or } 1,300 \text{ kg/d}$$

Comments:

1. The mass is for the total flow from the two oxidation ditches defined by Example 23-8.
2. Note that the biomass is substantially less than mass of inert materials.
3. The estimate of the mass of solids in the effluent is high because the flow rate for wasting is not included.
4. The mass to be wasted is calculated as dry solids. Because the sludge is mostly water, the actual mass will be considerably larger. This is discussed in Chapter 15.

Example 23-11. Determine the total length of brush aerators for the extended aeration oxidation ditch at Cartouche Lake (Example 23-8). Use the data in Table 23-15 for the length estimate. Use the following assumptions in the design:

Clean water correction, $\alpha = 0.60$ for nitrification

Salinity correction, $\beta = 0.95$

Summer wastewater temperature = 22°C

Operating DO = 3.0 mg/L

Solution:

- a. Using Equation 23-44 and the data from Examples 23-9 and 23-10 to estimate the mass of oxygen to be supplied (kg/d):

$$\begin{aligned}M_{O_2} &= (14,200 \text{ m}^3/\text{d})(205 \text{ g/m}^3 - 0)(10^{-3} \text{ kg/g}) - 1.42(533 \text{ kg/d}) \\ &\quad + 4.33(14,200 \text{ m}^3/\text{d})(16.8 \text{ g/m}^3 - 1 \text{ g/m}^3)(10^{-3} \text{ kg/g}) \\ &= 2,911 \text{ kg/d} - 756.9 \text{ kg/d} + 971.5 \text{ kg/d} \\ &= 3,125.6 \text{ or } 3,130 \text{ kg/d of oxygen}\end{aligned}$$

This is the required AOTR.

- b. Using the form of Equation 23-50 for mechanical aerators, that is, $C_{\text{avg}} = C_{s,T,H}$ and $F = 1.0$:

$$\text{AOTR} = \text{SOTR} \left(\frac{(\beta)(C_{s,T,H} - C_L)}{C_{s,20}} \right) (1.024^{T-20})(\alpha)$$

Solve for $SOTR_{req}$:

$$SOTR_{req} = \frac{AOTR_{req}}{(1.024^{T-20})(\alpha)} \left(\frac{C_{s20}}{(\beta)(C_{s,T,H} - C_L)} \right)$$

- c. From Appendix A, $C_{s,20} = 9.17 \text{ mg/L}$ or 9.17 g/m^3 at 20°C and $C_{s,T,H} = 8.83 \text{ mg/L}$ or 8.83 g/m^3 at 22°C .
- d. Calculate $SOTR_{req}$

$$\begin{aligned} SOTR_{req} &= \left(\frac{3,130 \text{ kg/d}}{(1.024^{22-20})(0.6)} \right) \left(\frac{9.17 \text{ mg/L}}{(0.95)(8.83 \text{ mg/L} - 3.0 \text{ mg/L})} \right) \\ &= \left(\frac{3,130 \text{ kg/d}}{0.63} \right) \left(\frac{9.17 \text{ mg/L}}{5.54 \text{ mg/L}} \right) = 8,223.6 \text{ or } 8,200 \text{ kg/d} \end{aligned}$$

- e. Using the highest transfer rate, calculate the total length of rotor from the manufacturer's data in Table 23-15. For Model U:

$$\frac{8,200 \text{ kg O}_2/\text{d}}{(8.2 \text{ kg O}_2/\text{h} \cdot \text{m})(24 \text{ h/d})} = 41.7 \text{ m or } 42 \text{ m of rotor U}$$

This estimate is the total length of rotor for the two oxidation ditches.

Comment. The selection of the appropriate rotor and the number of rotors is a function of the channel dimensions, velocity, and the manufacturer's constraints. The design process is explained in Example 23-12.

Example 23-12. Determine the oxidation ditch dimensions and select brush aerators for the extended aeration oxidation ditch at Cartouche Lake (Examples 23-8 and 23-9). Use the data in Tables 23-15 and 23-16.

Solution:

- a. Assume a four-rotor configuration and estimate the length of an individual rotor using the total rotor length calculated in Example 23-11:

$$\frac{41.7 \text{ m}}{(2 \text{ oxidation ditches})(4 \text{ rotors per ditch})} = 5.2 \text{ m/rotor}$$

From Table 23-15, the Model U rotor can be used.

- b. For four rotors the maximum length of the oxidation ditch should be $\leq 288 \text{ m}$ from the "aerator placement" discussion.

- c. The cross-sectional area of the ditch is then

$$\text{area} = \frac{\text{Volume of ditch}}{\text{Length of ditch}}$$

From Example 23-8, the volume of each ditch is $4,700 \text{ m}^3$.

$$\text{area} = \frac{4,700 \text{ m}^3}{288 \text{ m}} = 16.32 \text{ m}^2$$

As a first trial, assume a square cross section. The width and depth of the channel are estimated as

$$\text{width} = \text{depth} = (16.32 \text{ m}^2)^{1/2} = 4.04 \text{ or } 4.0 \text{ m}$$

The depth of the channel is 4.0 m plus 0.5 m freeboard.

- d. From Table 23-16, the maximum depth for rotor Model U is 5 m. Therefore, the trial dimensions are acceptable.
- e. The radius of the return channel is the width of the channel. The return flow baffle is placed at $4.0 \text{ m}/2 = 2.0 \text{ m}$ from the edge of the channel. It is offset into the downstream flow $W/15 = 4.0 \text{ m}/15 = 0.267 \text{ or } 0.3 \text{ m}$.
- f. Because the depth is greater than 2 m, a submerged baffle is required downstream of each rotor.
- g. A sketch of the oxidation ditch layout is shown below.

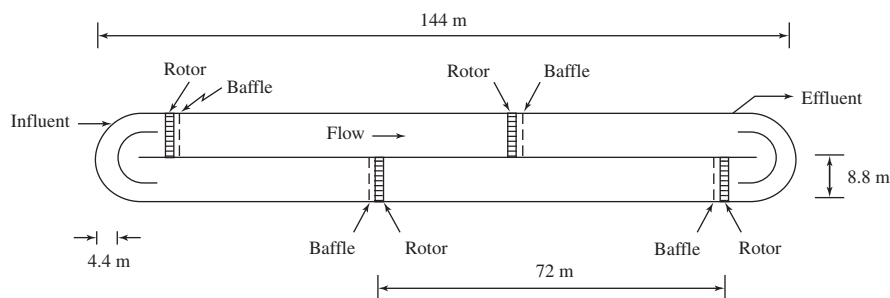

Comments:

1. Other combinations of these dimensions will also be acceptable.
2. Alternate rotors should be evaluated based on economic considerations. If other rotors are considered, then the calculations in Example 23-11 that were used as a starting point for calculation in this example would also have to be reworked.

Sequencing Batch Reactor

This is an example of processes used for carbonaceous BOD oxidation, nitrification, and denitrification. Other processes that perform these treatment functions are listed in Tables 23-2 and 23-3.

As of 1997, approximately 80 percent of the sequencing batch reactors (SBR) plants operating in the United States had flow rates less than 4,000 m³/d, and 70 percent had flows less than 2,000 m³/d. Although plants as large as 57,000 m³/d have been built internationally, the larger plants in the United States typically have not exceeded 20,000 m³/d (WEF, 1998). Performance data from 19 plants indicate that they are capable of meeting annual BOD₅ discharge limits of 15 mg/L, and total suspended solids (TSS) discharge limits of 15 mg/L. They can achieve nitrification levels of 90–96 percent (U.S. EPA, 1986).

Redundancy. A minimum of two units are provided for redundancy.

Preliminary Treatment. Bar screens or mechanical screens should be used instead of grinders or shredders. The shredded material has a tendency to mat and collect in the SBR. It interferes with settling and decanting.

Equalization is recommended. A plant with influent equalization will be able to operate as a true batch operation. It is particularly recommended when a plant needs to achieve nitrification and denitrification. It allows for flow-paced operation rather than time-based operation because it provides storage until the process cycle is complete. In addition, it allows for fewer tanks because one may be taken offline for maintenance (NEIWPCC, 2005).

Primary Treatment. Typically, primary treatment is not provided. This implies an additional solids load beyond the production of biological solids.

Process Alternatives. SBRs have been operated in the following process configurations:

- Carbonaceous BOD removal,
- Carbonaceous BOD removal and nitrification,
- Carbonaceous BOD removal and nitrification, denitrification, and biological phosphorus removal.

Design Flow Rate or Loading. Design flow rates range from 1.2 to 4.3 times the annual average daily flow rate. A typical value is 2.0 times the average daily flow rate.

Silverstein (1982) proposed that the ratio of specific organic input rate, L , to the maximum specific organic removal rate be used as an indicator of stability. L is defined as

$$L = \frac{QC_i}{\forall X} \quad (23-61)$$

where L = specific organic input rate, h⁻¹
 Q = volumetric flow rate, m³/h
 C_i = influent organic concentration, g/m³
 \forall = volume of reactor, m³
 X = MLSS concentration, g/m³

Values of L/μ_m greater than 0.3 result in stable nonfilamentous cultures while values of L/μ_m less than 0.15 are associated with bulking sludge.

GLUMRB (2004) specifies permissible aeration tank loading. When equalization is not provided, their recommendation for extended aeration tanks is $0.24 \text{ kg BOD}_5/\text{m}^3$ of tank volume \cdot d and an F/M between 0.05 and 0.1 $\text{kg BOD}_5/\text{kg MLVSS} \cdot \text{d}$. The reactor MLVSS and MLSS are to be calculated at low wastewater level.

Type of Reactor. The process kinetics are those of a completely mixed reactor.

Modeling Equations. Equations 23-22 and 23-23 are applicable. For municipal systems, WEF (1998) recommends that process design using the kinetic approach be based on an effluent soluble substrate concentration of zero, that is, $S_t = 0$. It is self-evident that this assumption is not valid for these equations. A small value, for example 0.5 mg/L, will meet the WEF recommendation. When both carbonaceous oxidation and nitrification are treatment objectives, nitrification growth kinetics are assumed to govern.

Kinetic coefficients for removal of bCOD by heterotrophic bacteria are given in Table 23-13. The kinetic coefficients for design of nitrification with activated sludge are given in Table 23-14.

Pacing. Flow-paced batch operation is generally preferable to time-based batch or continuous inflow systems. In a flow-paced batch system, the plant receives the same volumetric loading during every cycle. The time increment for each phase of the cycle remains constant. Once the tank is full, the cycle begins. Equalization prior to the SBR is essential for this system to perform satisfactorily.

In a time-paced batch operation, the basin may receive a different volumetric load every cycle. The start of the phases in the cycle is controlled by a clock. Under low flow conditions, the tank may not be full.

A time-paced operation that adjusts the cycle time and/or the time for each phase based on the flow rate can be achieved with a *programmable logic controller* (PLC). This system also allows for variable air flow rates so that aeration is reduced during low wastewater flows. This option provides both power savings and improved biokinetic conditions.

Cycle Time. Typical cycle times vary between four and eight hours. In practice six-hour cyclic operation has been found to be most suitable for the treatment of domestic wastewater from small communities (Goronszy, 1979).

Selection of an appropriate cycle time implicitly determines the number of tanks required to process a given flow rate to meet a given effluent standard. The worst case scenario is a sinusoidal variation in flow/concentration without equalization. This also happens to be typical of the diurnal flow pattern of small communities. For this case, Irvine and Richter (1978) found the minimum volume of tankage occurred with three tanks. A two-tank system with upstream equalization is a more economical way to achieve a given effluent standard.

Phases. The time allotted to each phase of the cycle is dependent on the objectives of the treatment. The following suggestions are typical:

Fill. A fill time between two and four hours is typical. In a two-tank system, the fill time is set equal to the sum of the react, settle, decant, and idle times so that when one tank is in the fill cycle the other tank can complete its cycle.

For good settling organisms, anoxic conditions during fill are recommended (Irvine and Busch, 1979). Mixing without aeration is provided to achieve an anoxic environment.

React. The react time is determined based on biokinetic requirements to achieve a given effluent concentration (Equation 23-22 or 23-23).

Fill:react ratio. In laboratory studies of carbonaceous BOD oxidation, Dennis and Irvine (1979) found that the ratio of fill time to react time plays an important role in the settleability of the sludge. The greatest settling velocity and most compact sludge was achieved by a 2:1 fill-to-react mode.

Settle. A minimum settling time is about 30 minutes (Schroeder, 1982). Typical settling times vary between 30 minutes and one hour.

Decant. A typical decant time interval is 30 minutes. Because the decant phase does not play a role in biokinetics or settling, it is the time that may be adjusted most easily.

Idle. The time for idle varies from zero to one hour or more. It is used to provide time for one reactor to complete its cycle before switching to another unit. Typically, the length of the idle time is determined by the flow rate into the plant.

Mixed Liquor Suspended Solids (MLSS). The range of MLSS concentrations is between 2,000 and 5,000 mg/L (Metcalf & Eddy, 2003). Schroeder (1982) suggests MLSS values between 1,700 and 3,000 mg/L result in reasonable reactor volumes for good to fair settling sludge.

Settled Volume. The estimation of the settled volume is both the most critical determination in the design of the SBR and the least predictable element in the design. It is critical because it is the basis for setting the volume of the tank. It is the least predictable because there is no rational means of forecasting the volume without a major assumption about the behavior of the settling characteristics of the sludge.

Based on very limited data, it appears that the concentration of the settled sludge that can be readily achieved is about 6,000 mg/L. Based on this value, the ratio of MLSS before settling to 6,000 mg/L can be used to estimate the volume of settled sludge:

$$\frac{\text{Volume of settled sludge}}{\text{Volume of tank}} = \frac{\text{MLSS concentration before settling}}{\text{MLSS concentration of settled sludge}} \quad (23-62)$$

Decant Volume. The decant volume must be equal to the fill volume. Under a flow-paced batch operation, no more than one-third of the volume in the basin should be decanted in a cycle. This prevents disturbance of the sludge blanket (NEIWPCC, 2005).

Schroeder (1982) suggests using an assumption of a settled sludge volume of 50 percent for a MLSS concentration of 3,000 mg/L and a settled sludge volume of 33 percent for a MLSS concentration of 2,000 mg/L as boundary conditions.

A suggested design approach is as follows:

- Estimate the volume of the tank occupied by the settled sludge using Equation 23-62 or Schroeder's assumptions.
- Provide a clear liquid depth above the depth of the settled sludge of 35 to 100 percent of the sludge depth for MLSS concentrations ranging from 3,000 to 2,000 mg/L, respectively.
- Estimate the volume of decant as a fraction of the total volume and check against the NEI-WPCC recommendation.

Volume of Tank. The volume of the tank is equal to the volume of the fill plus the volume of the settled sludge, plus a safety factor to preclude lowering the water level to the settled sludge.

Tank Dimensions. SBR tanks are typically built of concrete. Small systems may be built of steel. The shapes and dimensions have varied greatly. Initial full scale research in the United States was conducted in tanks that were originally designed for conventional plug-flow operation. Oxidation ditch shapes have also been used. The major requirements are that the layout must achieve complete mixing and good oxygen transfer (Schroeder, 1982).

Typically, the reactor plan is rectangular or square. Round tanks may be cheaper if space is available. For small systems ($< 20,000 \text{ m}^3/\text{d}$) sizes range from $7.5 \text{ m} \times 7.5 \text{ m}$ to $26 \text{ m} \times 26 \text{ m}$ for individual tanks. Tank volumes range in size from 80 to $1,500 \text{ m}^3$ (U.S. EPA, 1999b). Typical liquid depths are about 6 m. Freeboard of 0.6 m is provided.

Basins should have a slightly sloped bottom with a drain and sump for ease of cleaning. The slope should be minimized, so aeration equipment can be installed without significant depth below the equipment. Rectangular basins should be sloped to one corner. Circular basins should be sloped toward the center (NEIWPCC, 2005).

Solids Retention Time (SRT). The solids retention time (mean cell residence time, θ_c) is typically on the order of 10 to 30 days for carbonaceous BOD oxidation and nitrification, 20 to 30 days for denitrification, and 20 to 40 days for biological phosphorus removal (Metcalf & Eddy, 2003).

Anoxic Denitrification. Two design approaches are used to check the anoxic fill time. The method used here is a desktop approach that uses mass balances for nitrogen and the specific denitrification rate (Equation 23-52). Simulation modeling is the alternative approach.

The desktop method is iterative. The NO_x formed in nitrification is estimated. The assumed anoxic fill time and SDNR are used to estimate the amount of NO_x that can be denitrified in the fill time. If it is greater than the NO_x formed, the fill time is acceptable. If it is not, another iteration with a new anoxic fill time is performed.

For anoxic denitrification to be effective, the DO must be near zero. This means that mixing without aeration is required. Jet aerators that can operate without entraining air or submersible mechanical mixers rated at 8 to $13 \text{ W}/\text{m}^3$ are typically used (Metcalf & Eddy, 2003).

Hydraulic Detention Time. The hydraulic detention time is **not** a basis for design. Although it appears in tables of design parameters, it is likewise **not** a design criterion. Because the SBR

is a batch operation, the hydraulic detention time has little meaning in comparison to continuous flow reactors.

Dissolved Oxygen. For nitrification to proceed uninhibited, the DO must be above 2.0 mg/L. As noted in Chapter 22, nitrification rates increase with increasing DO up to about 3 or 4 mg/L.

Alkalinity. As noted in Chapter 22 (Equations 22-31, 22-32, and 22-33) about one-half of the alkalinity consumed in nitrification (7.14 g as CaCO_3) can be recovered in denitrification. Equation 23-60 is used to determine whether or not alkalinity addition is needed.

Wasting. Wasting is not included in the SBR cycle. Although it may occur during the react phase (Metcalf & Eddy, 2003), most authors suggest that it occur during the idle phase to maximize the sludge concentration (NEIWPC, 2005; Schroeder, 1982; U.S. EPA, 1986).

Because there is no primary treatment, there will be inert material from the raw wastewater and cell debris that is not readily biodegradable. This must be accounted for in the estimate of mass to be wasted.

Secondary Settling. There is no secondary settling tank because settling takes place in the SBR.

Return Activated Sludge (RAS). There is no RAS because there is no secondary settling tank.

Decanters. Decanters may be either floating or fixed. The design constraints include the following (Schroeder, 1982):

- Effluent should be withdrawn a few centimeters below the surface to minimize the discharge of scum.
- A scum baffle should be placed around the effluent point.
- The decanter inlet must be designed to move with the water surface.
- The minimum depth of the decanter inlet is selected during the design of the tank low-and high-water levels. It is set to minimize disturbance of the settled biomass.
- The decanter design must incorporate some mechanism to prevent MLSS from entering the decanter during the react phase.

The decanter flow rate must be high enough to decant the volume of the decant in the minimum cycle time allotted. In a time-paced operation, this will occur during peak flow events. This may be an appropriate application of a variable frequency drive pump to cover the range of flow rates.

Aerators. When aeration is initiated after anoxic fill, the oxygen uptake rate can be very high. It may exceed 125 mg/L · h. At the end of the react period, the uptake rate may fall as low as 15 mg/L · h. Thus, it is desirable that the aeration system be capable of providing a wide range of air flow rates.

Although diffused aeration with mixing and multiple blowers or variable frequency drive blowers can be used, jet aerators appear to have the advantage of providing mixing with or without aeration through one system (Schroeder, 1982).

Typically, jet aerators provide air flow rates from 1.5 to 8.5 m³/min · jet with SOTEs between 15 and 25 percent at 4.5 m submergence (Metcalf & Eddy, 2003).

Process Control. Because of the complexity of the timing and pumping cycles involved in this process, programmable computer control systems are required for efficient operation.

Appurtenances. In cold climates, there is a potential for the tank contents to freeze if flow rates are low. This is particularly true in very small communities where nighttime flows are nearly nonexistent. In these cases, the tanks should be placed in an enclosure. In extreme cases, the enclosure may need to be heated. Covering basins is not recommended as the covers hamper maintenance.

Post-Basin Effluent Equalization. If filtration and disinfection are required to meet discharge limits, an equalization basin downstream of the SBR will reduce surges to these processes. Post-basin effluent equalization allows downstream processes to be sized smaller. It also improves their efficiency.

Design Examples. The following four example problems illustrate the estimation of the volume and dimensions of the SBR, reaction time required for nitrification, nitrate removal capacity, and the number of jet aerators required.

Example 23-13. Estimate the volume and dimensions of an SBR for the town of Quintuple using the following design data:

Influent data

Design flow rate = 22,700 m³/d
 bCOD = 220 mg/L
 rbCOD = 50 mg/L
 Total Kjeldahl nitrogen (TKN) = 24 mg/L
 NH₃-N = 19 mg/L
 Total suspended solids (TSS) = 200 mg/L
 Volatile suspended solids (VSS) = 170 mg/L
 Biodegradable volatile suspended solids = 80 mg/L
 Minimum sustained temperature = 20°C
 pH = 7.2
 Alkalinity = 200 mg/L as CaCO₃

Effluent discharge standards

bCOD ≤ 20 mg/L
 NH₃-N ≤ 1.0
 TSS ≤ 10 mg/L

Assume MLSS = 3,000 mg/L, MLVSS = (0.8) MLSS, NO_x = 80% of TKN, and $\theta_c = 20$ d.

Solution:

- a. The solution procedure is iterative. The following assumptions are made based on the discussion of design practice. These are checked in the following calculations and subsequent examples.

- (1) Assume two tanks preceded by an equalization basin
- (2) Assume a 6-hour cycle time
- (3) Select the following phase times to achieve a total of 6 hours:

Anoxic fill = 135 min
 Aerated fill = 45 min
 React = 90 min
 Settle = 45 min
 Decant = 30 min
 Idle = 15 min
 Total cycle time = 360 min or 6 h

- b. Estimate the fill volume (V_F) for one SBR.

$$\text{Cycles/d} = \frac{24 \text{ h/d}}{6 \text{ h/cycle}} = 4 \text{ cycles/d}$$

Divide the flow between two tanks.

$$\frac{22,700 \text{ m}^3/\text{d}}{2 \text{ tanks}} = 11,350 \text{ m}^3/\text{d per tank}$$

Divide the flow per tank by the number of cycles to find the fill volume.

$$V_F = \frac{11,350 \text{ m}^3/\text{d per tank}}{4 \text{ cycles per day}} = 2,837.5 \text{ m}^3/\text{fill}$$

- c. Estimate the fill fraction using Equation 23-62, the assumed MLSS of 3,000 mg/L, and an assumption that the settled sludge will achieve a concentration of 6,000 mg/L.

$$\frac{V_S}{V_T} = \frac{3,000 \text{ mg/L}}{6,000 \text{ mg/L}} = 0.5$$

To provide a zone for decanting without disturbing the sludge blanket, assume 35% clear liquid volume above the sludge blanket based on Schroeder (1982) assumptions.

$$\frac{V_S}{V_T} = 1.35(0.5) = 0.675$$

Recognizing that $V_F + V_S = V_T$, determine the fill fraction:

$$\frac{V_F}{V_T} + \frac{V_S}{V_T} = 1.0$$

and

$$\frac{V_F}{V_T} = 1.0 - \frac{V_S}{V_T} = 1.0 - 0.675 = 0.325 \text{ or } 0.33$$

- d. Determine the volume of the tank.

$$V_T = \frac{V_F/\text{tank}}{0.33} = \frac{2,837.5 \text{ m}^3}{0.33} = 8,598.5 \text{ or } 8,600 \text{ m}^3$$

- e. Assume a tank depth of 6 m, and estimate the dimensions the tank.

$$\frac{8,600 \text{ m}^3}{6 \text{ m}} = 1,433.33 \text{ m}^2$$

Assuming a square tank, the length and width are

$$L = W = (1,433.33 \text{ m}^2)^{1/2} = 37.86 \text{ or } 38 \text{ m}$$

- f. The overall dimensions of the tank are then 38 m \times 38 m \times 6 m plus 0.6 m of free-board.

Example 23-14. Check the assumed react plus aerated mix time used to design the SBR for the town of Quintuple using the data from Example 23-13.

Solution:

- a. The time required for nitrification must be less than the assumed react aeration plus fill aeration in Example 23-13:

$$\text{React time} + \text{Fill time} = 90 \text{ min} + 45 \text{ min} = 135 \text{ min or } 2.25 \text{ h}$$

- b. Estimate the biomass using parts A, B, and C of Equation 23-40. Use the WEF (1998) assumption that $S = 0$. From Example 23-13 assumptions: $\text{NO}_x = 0.8(24 \text{ g/m}^3) = 19.2 \text{ g/m}^3$. Assume that $f_d = 0.15$ and that Table 23-13 applies.

Part A

$$\begin{aligned} P_{x,\text{bio}} &= \frac{(11,350 \text{ m}^3/\text{d})(0.40 \text{ g VSS/g COD})(220 \text{ g/m}^3 - 0)(10^{-3} \text{ kg/g})}{1 + (0.12 \text{ d}^{-1})(20 \text{ d})} \\ &= \frac{998.8}{3.4} = 293.76 \text{ kg/d} \end{aligned}$$

Part B

$$\begin{aligned}
 &= \frac{(0.15)(0.12 \text{ d}^{-1})(11,350 \text{ m}^3/\text{d})(0.40 \text{ g VSS/g COD})(220 \text{ g/m}^3)(20 \text{ d})(10^{-3} \text{ kg/g})}{1 + (0.12 \text{ d}^{-1})(20 \text{ d})} \\
 &= \frac{359.57}{3.4} = 105.76 \text{ kg/d}
 \end{aligned}$$

Part C

$$\begin{aligned}
 &\frac{(11,350 \text{ m}^3/\text{d})(0.12 \text{ g VSS/g NO}_x)(19.2 \text{ g/m}^3)(10^{-3} \text{ kg/g})}{1 + (0.08 \text{ d}^{-1})(20 \text{ d})} = \frac{26.15}{2.6} = 10.06 \text{ kg/d} \\
 &= 293.76 \text{ kg/d} + 105.76 \text{ kg/d} + 10.06 \text{ kg/d} = 409.6 \text{ kg/d}
 \end{aligned}$$

- c. Determine the amount of NO_x to be oxidized using the nitrogen balance (Equation 23-45).

$$\begin{aligned}
 \text{NO}_x &= 24 \text{ g/m}^3 - 1.0 \text{ g/m}^3 - \frac{(0.12 \text{ g VSS/g NH}_4 - \text{N})(409.6 \text{ kg/d})(10^3 \text{ g/kg})}{11,350 \text{ m}^3/\text{d}} \\
 &= 24 - 1.0 - 4.33 = 18.67 \text{ g/m}^3
 \end{aligned}$$

This is close to the assumed value of 19.2 g/m^3 so another iteration is not required.

- d. Determine the amount of N to be oxidized at the beginning of the cycle. This is the amount added during fill plus the amount remaining in the tank before fill.

$$\text{Oxidizable } N \text{ added per cycle} = (18.67 \text{ g/m}^3)(2,837.5 \text{ m}^3/\text{cycle}) = 52,976.1 \text{ g/cycle}$$

The $\text{NH}_4\text{-N}$ remaining before fill = (volume settled)(nitrogen in effluent) = $(V_s)(N_e)$ where $V_s = (V_T - V_F)$. N_e is the design effluent standard from Example 23-13.

$$\begin{aligned}
 \text{NH}_4\text{-N remaining before fill} &= N_e(V_T - V_F) \\
 &= (1.0 \text{ g/m}^3)(8,600 \text{ m}^3 - 2,837.5 \text{ m}^3) \\
 &= 5,762.5 \text{ g}
 \end{aligned}$$

$$\text{Total oxidizable } N = 52,976.1 \text{ g} + 5,762.5 \text{ g} = 58,738.6 \text{ g}$$

- e. Determine the oxidizable $\text{NH}_4\text{-N}$ concentration, N_0 .

$$\begin{aligned}
 N_0 &= \frac{\text{Mass of oxidizable N}}{\text{Volume of tank}} = \frac{58,738.6 \text{ g}}{8,600 \text{ m}^3} \\
 &= 6.8 \text{ g/m}^3
 \end{aligned}$$

- f. Determine the nitrifying bacteria concentration with kinetic coefficients from Table 23-14. At the design temperature of 20°C , the kinetic coefficients are as follows: $Y_n = 0.12 \text{ g}$

VSS/g NH₄-N; $k_{dn} = 0.08 \text{ g/g} \cdot \text{d}$. Note that X_n can be estimated with Equation 23-15 rewritten as:

$$X_n = \frac{Q(Y_n)(\text{NO}_x)(\theta_c)}{[1 + (k_{dn})(\theta_c)]V_T}$$

$$X_n = \frac{(11,350 \text{ m}^3/\text{d})(0.12 \text{ g VSS/g NH}_4\text{-N})(18.67 \text{ g/m}^3)(20 \text{ d})}{[1 + (0.08 \text{ g/g} \cdot \text{d})(20 \text{ d})](8,600 \text{ m}^3)}$$

$$= \frac{508,570}{(2.6)(8,600)} = 22.75 \text{ g/m}^3$$

- g. Using the kinetic coefficients from Table 23-14 and an assumed DO concentration equal to the minimum recommendation of 2.0 mg/L, solve Equation 23-23 for t . At the design temperature of 20°C, the kinetic coefficients are as follows: $\mu_m = 0.75 \text{ g VSS/g VSS} \cdot \text{d}$; $K_n = 0.74 \text{ g NH}_4\text{-N/m}^3$; $Y_n = 0.12 \text{ g VSS/g NH}_4\text{-N}$; $K_0 = 0.50 \text{ g/m}^3$.

$$\text{LHS} = (0.74 \text{ g/m}^3) \ln \left[\frac{6.8 \text{ g/m}^3}{1.0 \text{ g/m}^3} \right] + (6.8 \text{ g/m}^3 - 1.0 \text{ g/m}^3) = 7.2$$

$$\text{RHS} = (22.75 \text{ g/m}^3) \left[\frac{0.75 \text{ g/g} \cdot \text{d}}{0.12 \text{ g/g}} \right] \left[\frac{2.0 \text{ g/m}^3}{0.50 + 2.0 \text{ g/m}^3} \right] t = 113.75 t$$

$$\text{LHS} = \text{RHS}$$

$$7.2 = 113.75 t$$

$$t = 0.633 \text{ d or } 1.52 \text{ h}$$

- h. The aeration period provided by React and Fill is 2.25 h. This is greater than the 1.52 h required, so the design assumptions for React and Fill time aeration do not need to be changed.

Comments:

1. If the React plus Fill aeration time is not sufficient, the times must be adjusted and the check must be repeated. If denitrification is to be performed, as in the following example, the adjustment should be made after the next step as excess time in the denitrification step may provide more flexibility in adjusting the react plus fill times.
2. Because the waste characteristics assumed for design are not constant, the operator should be provided with a computer system that allows reprogramming the timing of phases and, perhaps, the cycle to account for changes.
3. The iterative nature of the design suggests that a spreadsheet be used to facilitate recalculation.

Example 23-15. Check the assumed anoxic fill time used to design the SBR for the town of Quintuple using the data from Examples 23-13 and 23-14.

Solution:

- a. The anoxic fill time must be greater than the time required for denitrification.

- b. From Example 23-14, the $\text{NO}_3\text{-N}$ concentration at the end of aeration with the tank full is 6.8 g/m^3 .

- c. The volume remaining after decant is the settled volume:

$$V_s = (V_T - V_F) = 8,600 \text{ m}^3 - 2,837.5 \text{ m}^3 = 5,762.5 \text{ m}^3$$

- d. The mass of nitrate remaining in the tank after decant is

$$\text{Mass NO}_3\text{-N} = (6.8 \text{ g/m}^3)(5,762.5 \text{ m}^3) = 39,185 \text{ g}$$

- e. Determine the SDNR in the fill period by computing the F/M ratio and using the graphs in Figure 23-12. Because the SBR is a batch operation, the value of X must be computed from

$$X = \frac{(\text{Active biomass})(\theta_c)}{V_T}$$

The active biomass is Part A of Equation 23-40 computed in Example 23-14. Therefore, at full tank volume

$$X = \frac{(293.76 \text{ kg/d})(20 \text{ d})(10^3 \text{ g/kg})}{8,600 \text{ m}^3} = 683 \text{ g/m}^3$$

The biomass in the system = $(683 \text{ g/m}^3)(8,600 \text{ m}^3)(10^{-3} \text{ kg/g}) = 5,873.8 \text{ kg}$

The BOD feed rate = $(Q_{\text{fill}})(S_0)$

Converting the fill volume to a flow rate,

$$\begin{aligned} \frac{V_{\text{fill}}}{t_{\text{fill}}} &= \frac{2,837.5 \text{ m}^3}{2.25 \text{ h}} (24 \text{ h/d}) = 30,266.67 \text{ m}^3/\text{d} \\ (Q_{\text{fill}})(S_0) &= (30,266.67 \text{ m}^3/\text{d})(220 \text{ g/m}^3)(10^{-3}) \\ &= 6,658.7 \text{ kg/d} \\ \frac{F}{M} &= \frac{6,658.7 \text{ kg/d}}{5,873.8 \text{ kg}} = 1.13 \text{ g/g} \cdot \text{d} \end{aligned}$$

From the data in Example 23-13, calculate the fraction of rbCOD:

$$\text{Fraction of rbCOD} = \frac{50 \text{ g/m}^3}{220 \text{ g/m}^3} = 0.23$$

From Figure 23-12 at $F/M = 1.13$ in the range 20–30, find $\text{SDNR} = 0.21 \text{ g NO}_3/\text{g biomass} \cdot \text{d}$. Because the design temperature is 20°C , no temperature correction is required.

- f. Determine the removal capacity during the fill period. Note that the biomass in the tank = $(X)(V_T)$.

$$\begin{aligned} \text{NO}_x &= (\text{SDNR})(X)(V_T) \\ &= (0.21 \text{ g NO}_3/\text{g biomass} \cdot \text{d.})(683 \text{ g/m}^3)(8,600 \text{ m}^3) = 1,233,498 \text{ g/d} \end{aligned}$$

At a fill time of 2.25 h

$$\text{NO}_x \text{ at 2.25 h} = \frac{(1,233,498 \text{ g/d})(2.25 \text{ h})}{24 \text{ h/d}} = 115,640 \text{ g}$$

From step (d), the NO_x available for denitrification = 39,185 g. Therefore, all of the $\text{NO}_3\text{-N}$ can be removed during the fill period.

Comment. The extra removal capacity for denitrification may be useful in adjusting the phase timing and/or the cycle time.

Example 23-16. Estimate the number of jet aerators for the SBR being designed for the town of Quintuple using data from Examples 23-13, 23-14, and 23-15. Assume that 60% of the theoretical oxygen released in denitrification is available for oxidation. Assume the following data for the jet aerators:

SBR is at sea level

$$O_t = 19\%$$

$$\alpha = 0.50$$

$$\beta = 0.95$$

$F = 1.0$ because jets are not prone to fouling

Depth of aerator is at 5.6 m

Wastewater temperature = 20°C

Manufacturer's SOTR = 1,240 kg/d at 5.6 m depth

Manufacturer's air flow rate at standard conditions = 1,800 $\text{m}^3/\text{d} \cdot \text{jet}$

Solution:

- a. The required oxygen may be estimated by modifying Equation 23-44 to account for the oxygen credit of 2.86 g O_2/g $\text{NO}_3\text{-N}$ for denitrification and the assumption of 60% recovery:

$$M_{\text{O}_2} = Q(S_0 - S)(10^{-3} \text{ kg/g}) - 1.42(P_x) + 4.33Q(\text{NO}_x) - (0.60)(2.86)(\text{NO}_x)$$

- b. Using the data from Examples 23-13, 23-14, and 23-15, the estimated mass of oxygen for one tank is:

$$\begin{aligned} M_{\text{O}_2} &= (11,350 \text{ m}^3/\text{d})(220 \text{ g/m}^3 - 0)(10^{-3} \text{ kg/g}) - 1.42(409.5 \text{ kg/d}) \\ &\quad + 4.33(11,350 \text{ m}^3/\text{d})(18.67 \text{ g/m}^3)(10^{-3} \text{ kg/g}) \\ &\quad - (0.60)(2.86)(39,185 \text{ g/cycle})(4 \text{ cycles/d})(10^{-3} \text{ kg/g}) \\ &= 2,497 \text{ kg/d} - 581.5 \text{ kg/d} + 917.5 \text{ kg/d} - 268.96 \text{ kg/d} \\ &= 2,564 \text{ or } 2,600 \text{ kg/d} \end{aligned}$$

This is the required AOTR. This is designated AOTR_{req} for this problem.

- c. Solve Equation 23-50 for SOTR. This is the required SOTR ($SOTR_{req}$).

$$SOTR_{req} = \frac{AOTR_{req}}{(1.024^{T-20})(\alpha)(F)} \left(\frac{C_{s,20}}{(\beta)(C_{avg} - C_L)} \right)$$

- d. From Appendix A, find $C_{s,T,H} = 9.17 \text{ mg/L}$ or 9.17 g/m^3 at 20°C .
 e. As in Example 23-5, P_d is the pressure at the depth of air release. $P_d = P_{atm,H} + P_{water}$.
 Converting $P_{atm,H}$ to meters of water,

$$P_{atm,H} = \frac{\text{Atmospheric pressure}}{\text{Specific weight of air}} = \frac{101.325 \text{ kN/m}^2}{9.8 \text{ kN/m}^3} = 10.34 \text{ m}$$

From the assumed depth of the aerator,

$$P_d = 10.34 \text{ m} + 5.6 \text{ m} = 15.9 \text{ m}$$

- f. Calculate C_{avg} .

$$C_{avg} = (9.17 \text{ mg/L})(0.5) \left(\frac{15.9 \text{ m}}{10.34 \text{ m}} + \frac{19}{21} \right) = 11.2 \text{ mg/L}$$

- g. Calculate $SOTR_{req}$ using DO required = 2.0 mg/L as assumed in Example 23-14.

$$SOTR_{req} = \frac{2,600 \text{ kg/d}}{(1.024^{20-20})(0.50)(1.0)} \left(\frac{9.17 \text{ mg/L}}{(0.95)(11.2 \text{ mg/L} - 2.0 \text{ mg/L})} \right) = \left(\frac{2,600 \text{ kg/d}}{0.50} \right) \left(\frac{9.17 \text{ mg/L}}{8.74 \text{ mg/L}} \right) = 5,455.8 \text{ or } 5,500 \text{ kg/d}$$

- h. Calculate the ratio of $SOTR_{manuf}/SOTR_{req}$.

$$\frac{SOTR_{manuf}}{SOTR_{req}} = \frac{1,240 \text{ kg/d}}{5,500 \text{ kg/d}} = 0.225$$

- i. The required air flow rate is found from the following relationship:

$$\left(\frac{AOTR_{req}}{(\text{Density of air})(\text{Mass \% O}_2 \text{ in air})} \right) \left(\frac{SOTR_{req}}{SOTR_{manuf}} \right)$$

The density of air at standard conditions is 1.185 kg/m^3 . Air contains about 23.2% oxygen on a mass basis. The required air flow rate is

$$\frac{2,600 \text{ kg/d}}{(1.185 \text{ kg/m}^3)(0.232)} \left(\frac{1}{0.225} \right) = 42,032 \text{ or } 42,000 \text{ m}^3/\text{d}$$

j. The number of aerators required is

$$\frac{42,000 \text{ m}^3/\text{d}}{1,800 \text{ m}^3/\text{d} \cdot \text{jet}} = 23.33 \text{ or } 24 \text{ jets}$$

Comment. Note that the assumed value for α is based on the Rosso and Stenstrom (2007) values presented after Equation 23-48.

A^2/O^{TM}

The A^2/O^{TM} process is shown schematically in Figure 23-5b. This is an example of processes used for carbonaceous BOD oxidation, nitrification, denitrification, and phosphorus removal. Other processes that perform these treatment functions are listed in Table 23-3. Although it is not listed in the table, the oxidation ditch process can be modified with a “front-end” anoxic/anaerobic stage to provide biological phosphorus removal (Yonker et al., 1998; Curley, 2007).

Operation of biological nutrient removal (BNR) systems requires substantial operator knowledge, skill, and oversight. To optimize the process, a sophisticated analytical laboratory capability is required. As of 1997, very few BNR plants had design flow rates less than $20,000 \text{ m}^3/\text{d}$ (WEF, 1998).

With the exception of the A/O process that was not designed to remove nitrogen, the BPR removal plants can achieve total nitrogen limits of 10 mg/L and total phosphorus limits less than 2 mg/L . Some plants can achieve nitrogen concentrations as low as 8 mg/L and phosphorus concentrations on the order of 1 to 2 mg/L . With chemical addition, these plants can achieve phosphorus concentrations less than 1 mg/L .

The A^2/O^{TM} discussion is organized as follows: upstream processes, general considerations, design practice for each stage in the A^2/O^{TM} process flow, appurtenances, and downstream process considerations.

Preliminary Treatment. Bar screens, mechanical screens, grinders or shredders, and grit chambers may be used. Equalization is highly recommended. Typically municipal wastewater flow rates and rbCOD concentrations follow a diurnal pattern that results in large changes in the mass flow rate of rbCOD to the wastewater treatment plant. This, in turn, results in large changes in the production of volatile fatty acids (VFA) and polyhydroxybutyrate (PHB). The number of phosphate accumulating organisms (PAOs) in the system will be representative of the average VFA load. The rate of phosphate release and uptake are more rapid than the growth of the PAOs. The result is that the PHB content of the PAOs becomes saturated and the effluent concentration of phosphorus increases. Equalization dampens this effect and decreases the amount of phosphorus discharged by a factor of 4 to 8 depending on the VFA concentration produced by degradation of rbCOD (Filipe et al., 2001).

It is recommended that the equalization volume be greater than or equal to 20 percent of the volume of the average daily flow. Equalization volumes up to 40 percent do not appreciably improve the results, but they do not adversely affect the results either (Filipe et al., 2001).

Primary Treatment. Clarifiers or screens may be used for primary treatment. While introduction of return activated sludge to the primary clarifier is generally discouraged, this practice may be selected to increase the production of VFAs for phosphorus removal. Likewise, screens may be selected in place of settling to allow more COD to pass to the BPR process.

Redundancy. A minimum of two units are provided for redundancy. For plants having design flow rates in the range of 19,000 to 38,000 m³/d, three units are preferred to allow for one unit to be out of service at the maximum flow rate. In the range of 38,000 to 190,000 m³/d, four or more tanks are often provided to allow operational flexibility and ease of maintenance.

Design Flow Rate and Loading. Unlike grit removal, primary settling, and secondary settling, suspended growth biological treatment systems are not hydraulically limited. They are process limited. The total tank capacity must be determined from the biological process design. Therefore, the *loading* (flow rate \times concentration) is an important design parameter.

It is recommended that the maximum month and peak daily loadings based on daily flow and concentration data be used for design (WEF, 2006a).

Type of Reactor. Both plug-flow and complete-mix reactors have been used. The anaerobic, anoxic, and aerobic regimes must be physically separated to be effective. This may be accomplished by dividing a tank into compartments. Although a theoretical plug-flow reactor will require less tank volume than a complete-mix reactor to achieve the same efficiency, actual plug-flow reactors seldom achieve ideal plug-flow. As a result it has been found that *staging* of complete-mix reactors is the best method of approximating plug-flow efficiency. As a practical matter, three or four reactors or stages in series will adequately approximate plug flow (WEF, 1998).

Modeling Equations. If completely mixed reactors are used, then Equations 23-14 and 23-15 are applicable for heterotrophic and nitrification biokinetics. BPR microorganism growth kinetics fall in the same order of magnitude as that of other heterotrophic bacteria. A maximum specific growth rate at 20°C is given as 0.95 g/g \cdot d by Barker and Dold (1997). Kinetic coefficients for removal of bCOD by heterotrophic bacteria are given in Table 23-13. The kinetic coefficients for design of nitrification are given in Table 23-14.

Design Practice for Phosphorus Removal. The following paragraphs outline the design practice for those portions of the BPR process that affect phosphorus removal.

rbCOD. The available rbCOD determines the amount of phosphorus that can be removed by the BPR mechanism. Metcalf & Eddy (2003) estimates that 10 g of rbCOD is required to remove 1 g of phosphorus.

Observations of the influent BOD to phosphorus ratio at operating plants as a function of their design SRT are shown in Table 23-17. Although these data do not include rbCOD, they give an indication of the trend with respect to SRT and their relationship to the types of BRP processes.

TABLE 23-17
BOD/P and COD/P ratios for phosphorus removal

Type of BPR process	g BOD/g P	g COD/g P	SRT, d
Phoredox (A/O TM), VIP	15–20	26–34	< 8
A ² O TM , UCT	20–25	34–43	7–15
Modified Bardenpho TM	> 25	> 43	15–25

Sources: Grady et al. (1999); Metcalf & Eddy, 2003.

Nitrate reduction in the anaerobic tank will proceed before the BPR mechanisms. This will reduce rbCOD that is available for BPR. In processes like A²OTM where RAS is returned to the anaerobic tank, the plant effluent nitrate concentration (which also appears in the RAS) must be minimized to maximize the amount of phosphorus that can be removed by the BPR mechanism. Likewise, the nitrate in the return flow from the anoxic tank will limit phosphorus removal for the same reason.

Hydraulic residence time (HRT). Despite advances in understanding the biochemistry of BPR, current practice for sizing the anaerobic tanks is based on empirical observations. The required HRT is dependent on the MLSS, which is dependent on the SRT of the system. This will be different for different BPR systems. While VFA uptake is relatively rapid, corresponding to an HRT of 0.75 hours or less, fermentation of rbCOD is slower. It typically requires an HRT of one to two hours or more. However, in some systems, such as the UCTTM process, two hours or more may be required (WEF, 2006a). Typical HRTs are in the range one-half to two hours (Metcalf & Eddy, 2003).

Longer detention times improve phosphorus removal. However, systems with excessive anaerobic contact times and without significant VFA production will experience phosphorus release with no uptake in acetate. This is called “secondary release.” Because this phosphorus release is not associated with PHB storage, no energy is available in the aerobic zone for subsequent uptake of the released phosphorus, and the full potential for phosphorus removal will not be achieved (Barnard, 1984; Stephens and Stensel, 1998).

Tankage. All the tanks in the BPR processes are typically built of concrete. For the anaerobic stage, a complete mix system with three tanks provides the most efficient tank arrangement. The design HRT is divided into thirds for the volume estimate. The tanks may stand alone or share a common wall. When a common wall is used, a broad-crested weir allows flow to move to successive tanks. The tanks typically will have the same depth as the anoxic and aerobic tanks. This is on the order of 4.5 to 7.5 m with a freeboard of 0.3 to 0.6 m. The plan of the tanks is square.

Mixing. Submersible mechanical mixers keep the biomass in suspension. The mixing should be just sufficient to keep the biomass suspended without entraining air. Typical power requirements are in the range of 3 to 13 W/m³.

Solids retention time (SRT). BPR systems with longer SRTs are less efficient than those with shorter SRT designs. Two adverse effects on phosphorus removal efficiency are associated with lightly loaded, long SRT processes. First, because the final amount of phosphorus removed is

proportional to the mass of biological phosphorus storing bacteria wasted, the phosphorus biomass production is lower so that less phosphorus is removed during wasting. Second, long SRTs mean that the PAOs are in an extended endogenous phase. This depletes glycogen, which results in less efficient acetate uptake, and PHB storage will occur in the anaerobic zone. This will make the overall BPR process less efficient (Stephens and Stensel, 1998).

The relationship between SRT, temperature, and performance is described later in this section. Typical SRTs for the A^2/O^{TM} process are 5 to 25 days. As shown in Table 23-9, the BPR process selected will strongly affect the choice of SRT. When nitrogen removal is part of the process as it is with the A^2/O^{TM} process, the aerobic SRT for nitrification governs.

Safety factor. Figure 23-21 shows the washout SRT values as a function of temperature and limiting conditions of COD or phosphorus. SRTs greater than 2.5 days are recommended when the temperature is 20°C (Mamais and Jenkins, 1992). This implies a minimum safety factor of 1.6 under COD limiting conditions and a safety factor of about 2.5 under phosphorus limiting conditions. When the aerobic nitrification SRT governs, the safety factor will fall in the range of 2 to 10.

Return activated sludge (RAS). In the A^2/O^{TM} process the RAS is returned to the head end of the anaerobic tank. This is of concern because excessive amounts of nitrate may enter the anaerobic tank. Heterotrophic bacteria will use nitrate to consume rbCOD. This will reduce the rbCOD available for PAOs, which, in turn, will reduce the phosphorus removal efficiency. Thus, the BPR is dependent on the efficiency of the biological denitrification step. Other BPR processes avoid this problem by routing the RAS to the anoxic tank.

The RAS pumping system must be flexible enough to allow RAS flow rates that vary from 25 to 100 percent of the influent flow rate.

Mixed liquor suspended solids (MLSS). Typical MLSS concentrations are given in Table 23-9. Some plants using the A^2/O^{TM} process have operated with MLSS concentrations in the range 800 to 2,000 mg/L, but the typical range is 3,000 to 4,000 mg/L.

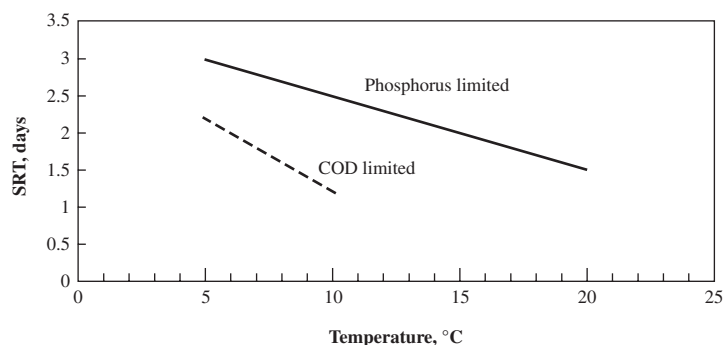

FIGURE 23-21

Effect of temperature and limiting nutrient on aerobic washout SRT for BPR.

(Data from Erdal, 2002; Erdal et al., 2003; Mamais and Jenkins, 1992; McClintock et al., 1991.)

Temperature. Very good BPR performance can be achieved as long as SRT values of 16 and 12 days are provided for temperatures of 5°C and 10°C, respectively. SRTs between 16 and 24 days did not affect system performance at 5°C. At 10°C, SRTs between 12 and 17 days did not affect system performance (WEF, 2006a).

Recycle streams. Solids processing return flows from sludge thickening, anaerobic digestion, and sludge dewatering typically contain high ammonia and phosphorus concentrations. The high concentrations and variable rates of generation will degrade the performance of BPR process if they are added on an ad hoc basis. At a minimum, the rate of flow should be equalized. Adding these streams when the strength of the influent wastewater is stronger (typically, during day-time) will help to increase the removal of recycled phosphorus. Separate treatment with chemical addition is the preferred alternative (Metcalf & Eddy, 2003; WEF, 2006a).

Chemical addition. To achieve phosphorus concentrations below 1.0 mg/L as well as to provide backup for the BPR process, chemical addition facilities should be provided.

Design Practice for Denitrification. The following paragraphs outline the design practice for those portions of the BPR process that affect denitrification and its relationship to phosphorus removal. The discussion is focused on the A²/OTM process. Alternative processes will require modifications of the design practices noted here. These are discussed in Metcalf & Eddy (2003), WEF (1998), and WEF (2006a).

Hydraulic residence time (HRT). The anoxic tank is typically sized based on the amount of nitrate to be denitrified. As discussed in the previous paragraphs on SBR design practice, two design approaches are used to check the anoxic HRT. The method used here is a desktop approach that uses mass balances for nitrogen and the specific denitrification rate (Equation 23-52). Simulation modeling is the alternative approach.

The desk top method is iterative. The NO_x formed in nitrification is estimated. The assumed anoxic HRT and SDNR are used to estimate the amount of NO_x that can be denitrified in the fill time. If it is greater than the NO_x formed, the fill time is acceptable. If it is not, another iteration with a new anoxic fill time is performed.

The major difference between the computational procedure here and that used for the SBR is that internal recycle (Equations 23-54 through 23-57) must be considered.

Typical HRTs for the A²/OTM process vary between 0.5 and 1.5 hours. Typical HRTs for other processes are given in Table 23-9.

Internal recycle. Equation 23-54 is used to estimate the internal recycle ratio (IR). To meet a standard of 10 mg/L total nitrogen or less, the design effluent NO₃-N concentration should be in the range of 5 to 7 mg/L.

The nitrate concentration in the RAS flow can have a significant adverse effect on the amount of rbCOD that is available for BPR. The nitrate consumption of rbCOD can be estimated from the ratio of rbCOD/NO₃-N used. It is 6.6 g rbCOD/g NO₃-N (Metcalf & Eddy, 2003).

An internal recycle ratio in the range of 3 to 4 is typical, but ratios in the range of 2 to 3 are also used with lower influent wastewater TKN concentrations. Recycle ratios above 4 are generally not warranted because the incremental NO₃-N removal is low and more DO is recycled to the anoxic tank (Metcalf & Eddy, 2003).

Tankage. A complete mix system with three tanks provides the most efficient tank arrangement. The design HRT is divided into thirds for the volume estimate. The tanks may stand alone or share a common wall. When a common wall is used, a broad-crested weir allows flow to move to successive tanks. The tanks typically will have the same depth as the anaerobic and aerobic tanks. This is on the order of 4.5 to 7.5 m with a freeboard of 0.3 to 0.6 m. The plan of the tanks is square.

Mixing. Submersible mechanical mixers keep the biomass in suspension. The mixing should be just sufficient to keep the biomass suspended without entraining air. Typical power requirements are in the range 3 to 13 W/m³.

Solids retention time (SRT). When nitrogen removal is part of the process as it is with the A²/OTM process, the aerobic SRT for nitrification governs.

Return activated sludge (RAS). In the A²/OTM process, RAS is returned to the anaerobic zone rather than the anoxic zone. Other BPR processes route the RAS to the anoxic tank to avoid adding nitrate to the anaerobic zone.

Mixed liquor suspended solids (MLSS). The MLSS concentration is in the range of 3,000 to 4,000 mg/L. This is the same range as that specified for BPR removal processes.

Temperature. Lower temperatures will lower the specific denitrification rate (SDNR). Equation 23-55 is used to correct for temperatures other than 20°C.

Alkalinity. About one-half of the alkalinity consumed in nitrification (7.14 g as CaCO₃) can be recovered in denitrification. Equation 23-60 is used to determine whether or not alkalinity addition is needed.

Design Practice for Nitrification. The following paragraphs outline the design practice for those portions of the BPR process that affect nitrification and its relationship to denitrification and phosphorus removal. The discussion is focused on the A²/OTM process. Alternative processes will require modifications of the design practices noted here. These are discussed in Metcalf & Eddy (2003), WEF (1998), and WEF (2006b).

Modeling equations. Assuming the process kinetics approach that of a completely mixed reactor, Equations 23-11 through 23-19 are applicable. For municipal systems, WEF (1998) recommends that process design using the kinetic approach be based on an effluent soluble substrate concentration of zero, that is, $S = 0$. Both carbonaceous oxidation and nitrification are treatment objectives. Nitrification growth kinetics (Equation 22-28) are assumed to govern (Mandt and Bell, 1982, U.S. EPA, 1975a). The kinetic coefficients for design of nitrification are given in Table 23-14.

Solids retention time (SRT). To achieve nitrification, the SRT is typically on the order of 3 to 15 days (Metcalf & Eddy, 2003). Because of its impact on phosphorus removal, shorter SRTs are preferred.

Safety factor. Based on analysis of NH₄-N data at Chapel Hill, U.S. EPA (1975a) developed Figure 23-18. From this graph it appears that an SRT safety factor of 2.5 is reasonable to achieve

an average effluent concentration of less than 1 mg/L NH₄-N. WEF (1998) uses a safety factor of 2.5 in process design examples.

Hydraulic residence time (HRT). The aerobic tank is sized based on the amount of TKN to be nitrified. The hydraulic detention time is **not** a basis for design. Although it appears in tables of design parameters, it is likewise **not** a design criterion. As shown in Table 23-9, the range of HRTs for the aerobic tank is quite large: 1 to 12 hours. For the A²/OTM process the typical HRT is 4 to 8 hours.

Tankage. Completely mixed basins are typically square, but they have been built in round and rectangular configurations. For rectangular tanks, the length-to-width ratio should be less than 3:1 if mechanical aerators are used. Multiple mechanical aeration units in long, narrow tanks (for example, with L:W of 5:1) create a mixing pattern that approaches mixed tanks in series. Multiple feed points also enhance complete mixing (WEF, 1998).

For mechanical aerators, widths range from 9 to 27 m depending on the aerator size. Depths range from 3 to 6 m. Freeboard is on the order of 1 to 1.5 m. The width and depth of the tank should be sized based on the power rating of the aerator. Typical aeration tank dimensions are given in Table 23-18.

For diffused air systems, the depth of wastewater should be between 4.5 and 7.5 m with a freeboard in the range of 0.3 to 0.6 m. If the tank geometry is a plug-flow configuration with spiral-flow mixing, the width-to-depth ratio should be in the range of 1:1 to 2.2:1, with 1.5:1 being the most common. The length-to-width ratio should be at least 5:1. For tanks with diffusers in a grid or panel pattern, greater widths are permissible (Metcalf & Eddy, 2003).

Mixed liquor suspended solids (MLSS). The MLSS is in the range 2,000 to 4,000 mg/L.

Dissolved oxygen. For nitrification to proceed uninhibited, the DO must be above 2.0 mg/L. As noted in Chapter 22, nitrification rates increase with increasing DO up to about 3 or 4 mg/L.

To minimize the DO that is recycled to the anoxic tank, the aerobic tank DO may be tapered with a lower DO at the downstream end. In a complete mix tank design, either multiple tanks or a single baffled tank may be used to reduce mixing of the higher DO wastewater with the effluent from the aeration tank. In plug-flow tanks, tapering is accomplished by regulating the air flow along the tank.

Return activated sludge (RAS). The RAS is returned to the anaerobic tank. It is not considered in the design of the aerobic tank.

TABLE 23-18
Typical aeration tank dimensions for mechanical aerators

Aerator size, kW	Tank depth, m	Tank width, m
7.5	3–3.6	9–12
15	3.6–4.2	10.5–15
30	3.6–5.1	13.5–20
75	4.5–6	18–27

Adapted from Metcalf & Eddy, 2003.

Alkalinity. A portion of the alkalinity consumed in nitrification is recovered in the denitrification process. The estimate of the required alkalinity addition that is made in the design of the anoxic stage is based on an estimate of alkalinity remaining after the nitrification stage and the internal recycle ratio.

Aerators. Surface aerators have typically been used in complete-mix systems. The design process follows the one discussed in Chapter 20 for equalization basin aerator selection.

In new construction, fine bubble diffusers have become common. These may be either ceramic domed or fine pore membrane diffusers. Full floor coverage is required to achieve maximum standard oxygen transfer efficiency (SOTE) and complete mixing (Stenstrom and Redmon, 1996). Figure 23-22 illustrates the very high SOTE for full floor coverage. The SOTE per meter of submergence varies with the air flow rate as shown in Figure 23-23.

Fine pore diffusers are susceptible to chemical and biological fouling. Fouling is generally classified as one of two types (U.S. EPA, 1999a):

- Type I: clogging by airborne particulate matter on the air-side or metal hydroxide precipitation on the liquid side.
- Type II: biofilm formation on the diffuser surface.

Preventive maintenance can virtually eliminate air side fouling by cleaning and changing the air filters. Corrective maintenance includes one or more of the following: removal and acid/alkali wash, high-pressure water jetting, and air bumping.

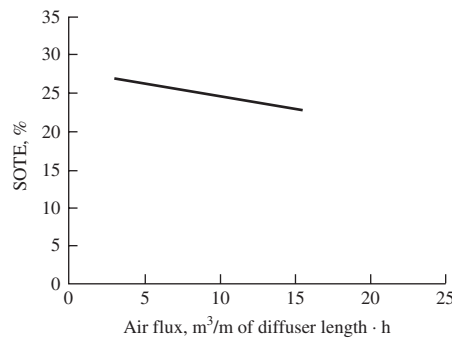

FIGURE 23-22
Clean water efficiency for full floor coverage with membrane diffuser.

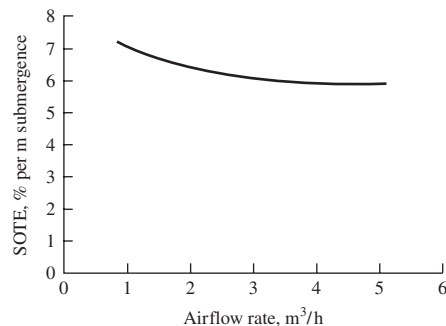

FIGURE 23-23
Clean water oxygen transfer efficiency for a membrane disc as a function of flow rate and submergence.

Approximately 50 to 65 percent of the net power demand for an activated sludge wastewater treatment plant is for aeration. The higher SOTE of fine pore diffusers may make them well worth their extra cost and maintenance.

Mixing. In diffused-air systems, the air flow rate required to ensure good mixing varies from 30 to 40 m³/d · m³ of tank volume (or 400 to 950 m³/d · m of header) for spiral roll aeration. For full grid systems of fine bubble diffusers, air flow rates of 15 to 20 m³/d · m³ of tank volume (or 20 to 55 m³/d · m² of floor) are suggested (Metcalf & Eddy, 2003; WEF, 1998).

Blowers. There are three types of blowers used for aeration: centrifugal, rotary lobe positive displacement, and inlet guide vane-variable diffuser. Centrifugal blowers are almost universally used where free air flow rates are greater than 425 m³/min. The rated discharge pressures range from 50 to 60 kPa. Rotary lobe positive displacement blowers are used for discharge pressures greater than 55 kPa, and free air flow rates less than 425 m³/min. The inlet guide vane-variable blowers have free air capacities ranging from 85 to 1,700 m³/min at pressures up to 170 kPa (Metcalf & Eddy, 2003).

To meet the wide range of airflows required, one or more of the following methods may be employed: (1) flow blowoff or bypassing, (2) inlet throttling, (3) adjustable discharge diffuser, (4) variable frequency drive (VFD), (5) parallel operation of multiple units. Of these methods, the VFD has found great acceptance because of its flexibility and the resultant savings in energy costs.

The performance curve for a centrifugal blower resembles the head-discharge curve for a pump. The pressure decreases as the inlet air flow rate increases. Blowers are rated at standard conditions that are defined as 20°C, 101.325 kPa, and 36 percent relative humidity.

Although there are a large number of factors in selecting a blower/VFD combination, two are significant in making a process selection. First, is that a multistage blower with a flat performance curve can be sensitive to changes in ambient air conditions, speed, or discharge pressure. This can be mitigated by selection of a blower with a performance curve that rises steadily from the design point to the surge point with little or no leveling off. Second, good design practice requires a separate VFD for each blower. Although new VFD designs are not subject to frequent failures, with a one to one match of VFD and blower, catastrophic aeration failure will be minimized (Jenkins, 2005).

Blowers must be sized to have capacity for a hot summer day with adequate driver power for cold winter months. The power requirement for adiabatic compression of air is estimated with the following equation:

$$P_w = \frac{wRT}{29.7(0.283)(e)} \left[\left(\frac{p_2}{p_1} \right)^{0.283} - 1 \right] \quad (23-63)$$

- where P_w = power requirement for each blower, kW
 w = mass flow of air, kg/s
 R = gas constant for air, 8.314 kJ/k mol K
 T = absolute temperature, K
 p_1 = absolute inlet pressure, atm
 p_2 = absolute outlet pressure, atm
29.7 = constant for SI units conversion
0.283 = constant for air
 e = efficiency (usual range is 0.70 to 0.90)

The required supply pressure at the blower (p_2) is the sum of all the headlosses in the air piping that gives the maximum headloss plus the submergence of the diffusers. Because the headlosses in the piping and diffusers depends on the supply pressure and temperature of the air, an iterative procedure is required for the solution.

Blowers are a major source of noise and heat. Noise suppression techniques should be employed in designing the building that houses the blowers. Occupational Safety and Health and Administration (OSHA) guidelines must be enforced for employees. Typical criteria are given in *Design of Municipal Wastewater Treatment Plants* (WEF, 1998). *Introduction to Environmental Engineering* (Davis and Cornwell, 2008) provides an introduction to basic principles of noise impact and control.

Adequate ventilation must be provided to reduce the heat load on personnel working in the blower room. OSHA guidelines and the American Society for Heating, Refrigeration, and Air Conditioning handbooks should be consulted for appropriate design values. As an energy conservation measure, the heat may be used beneficially in heating other buildings in the plant.

Air Piping. Primary considerations in piping material selection are strength and potential for corrosion. Typical materials include carbon and stainless steel, ductile iron, fiber glass reinforced plastic (FRP), high density polyethylene (HDPE), and polyvinyl chloride (PVC). Steel is typically used at the blower discharge because of the high temperatures. PVC piping must **not** be used above the liquid level in the tank. Thermal and pressure stresses may cause it to explode! Because thermal stresses can be significant, provisions for pipe expansion and contraction are required.

Stainless steel is typically used for drop legs and headers for coarse bubble diffuser systems because of corrosion potential and the load applied by the headers. PVC, placed within the tank, is more common with fine bubble dome and membrane diffusers.

The headloss in straight pipes carrying air may be estimated with the following equation (Steel and McGhee, 1979):

$$h_L = 9.82 \times 10^{-8} \left(\frac{fLQ^2}{PD^5} \right) \quad (23-64)$$

where h_L = headloss, mm of water
 f = dimensionless friction factor
 L = equivalent length of pipe, m
 T = absolute temperature, K
 Q = air flow, m³/min
 P = air supply pressure, atm
 D = pipe diameter, m

The absolute temperature is defined as

$$T = T_0 \left(\frac{P}{P_0} \right)^{0.283} \quad (23-65)$$

where T_0 = ambient temperature, K
 P = air supply pressure, atm
 P_0 = ambient atmospheric pressure, atm

It is recommended that the maximum summer air temperature be used for T_0 .

The dimensionless friction factor (f) may be obtained from a Moody diagram or, for steel pipe, it may be approximated by (Steel and McGhee, 1979):

$$f \approx 0.029 \left(\frac{D^{0.027}}{Q^{0.148}} \right) \quad (23-66)$$

Minor losses can be estimated as equivalent length of pipe using the following equation:

$$L = 55.4 CD^{1.2} \quad (23-67)$$

where L = equivalent length of pipe, m

C = resistance factor, dimensionless

D = pipe diameter, m

Resistance factors are given in Table 23-19. Other loss estimates are given in Table 23-20.

TABLE 23-19
Resistance factors for aeration piping fittings

Fitting	C
Angle valve	0.90
Gate valve	0.25
Globe valve	2.00
Long radius ell or run of tee	0.33
Medium radius ell or run of tee reduced 25%	0.42
Standard ell or run of tee reduced 50%	0.67

Adapted from Steel and McGhee, 1979.

TABLE 23-20
Other losses for aeration system

Appurtenance or source	Headloss, mm of water ^a
Air filter	50 to 380
Blower silencers	
Centrifugal	50 to 400
Rotary	100 to 800
Check valves	50 to 380
Diffusers	75 to 650
Diffuser clogging	150 to 250
Submergence	Water depth above diffuse

^aEquipment manufacturers should be consulted for actual design data.

Secondary Settling. The design of the secondary settling tank for this system is discussed in Chapter 25.

Sludge Processing. Anaerobic conditions in thickening and/or digestion of sludge can result in release of significant amounts of phosphorus. Thus, the recycle streams from these processes increase the influent phosphorus concentration to the anaerobic stage. This implies the need for a higher influent rbCOD to produce a low effluent phosphorus concentration.

Thickening of waste sludge by dissolved air flotation, gravity belt thickeners, or rotary drum thickeners is preferred over gravity thickening to minimize phosphorus release. Direct land application of liquid, digested sludge, or dewatered sludge minimizes recycled phosphorus loads.

Design Examples. The following six example problems illustrate the design of a BPR process. The design begins at the back end of the process with the aerobic stage to determine the amount of nitrate formed. This estimate is used to size the anoxic stage. The anaerobic stage is then designed. The examples focus on estimation of the SRT and volume of tank required for nitrification, nitrate removal capacity, alkalinity requirements, estimation of effluent soluble phosphorus concentration, volume and dimensions of the reactors, and the aeration system compressor design.

Example 23-17. Begin the design of a complete-mix BOD removal and nitrification stage for Tempe's new BPR wastewater treatment plant. As a first step determine the SRT and volume of tank required for nitrification using the following design data:

Influent data after primary settling

Design flow rate = 90,000 m³/d
 BOD₅ = 138 mg/L
 bCOD = 220 mg/L
 rbCOD = 80 mg/L
 Total Kjeldahl nitrogen (TKN) = 35 mg/L
 NH₃-N = 25 mg/L
 Soluble phosphorus = 8 g/m³
 Total suspended solids (TSS) = 70 mg/L
 Volatile suspended solids (VSS) = 60 mg/L
 Biodegradable volatile suspended solids = 40 mg/L
 Minimum sustained temperature = 20°C
 pH = 7.0
 Alkalinity = 220 mg/L as CaCO₃

Effluent discharge standards

bCOD ≤ 20 mg/L
 NH₃-N ≤ 1.0 mg/L
 NO₃-N ≤ 10 mg/L
 TSS ≤ 10 mg/L
 Total phosphorus ≤ 2.0 mg/L

Assume DO for aeration tank nitrification = 2.0 mg/L; MLSS = 3,000 mg/L, MLVSS = (0.8) MLSS, $\text{NO}_x = 80\%$ of TKN, and $\text{RAS} = 0.60(Q)$.

Solution:

- a. Assume that four identical process lines will be built for redundancy and flexibility. Each line will have a design flow rate of

$$\frac{90,000 \text{ m}^3/\text{d}}{4} = 22,500 \text{ m}^3/\text{d}$$

- b. Use Table 23-14 for the biokinetic constants because nitrification kinetics govern. The minimum sustained temperature is 20°C so no temperature corrections are required.

$$\begin{aligned}\mu_n \text{ max} &= 0.75 \text{ g VSS/g VSS} \cdot \text{d} \\ K_n &= 0.74 \text{ g NH}_4\text{-N/m}^3 \\ k_{dn} &= 0.08 \text{ g VSS/g VSS} \cdot \text{d} \\ K_0 &= 0.50 \text{ g/m}^3\end{aligned}$$

- c. Estimate μ_n using Equation 23-28. The value selected for N is the design effluent concentration because that is limiting. The DO is the design DO that must be achieved by the design of the aeration system. The assumed value is 2.0 mg/L.

$$\mu_n = \left[\frac{(0.75 \text{ g VSS/g VSS}) \left(\frac{1.0 \text{ g/m}^3}{0.74 \text{ g NH}_4\text{-N/m}^3 + 1.0 \text{ g/m}^3} \right) \left(\frac{2.0 \text{ g/m}^3}{0.50 \text{ g/m}^3 + 2.0 \text{ g/m}^3} \right)}{-0.08 \text{ g VSS/g VSS} \cdot \text{d}} \right]$$

$$\mu_n = [(0.75)(0.57)(0.80)] - 0.08 = 0.262 \text{ d}^{-1}$$

- d. Calculate $\theta_c \text{ min}$.

$$\frac{1}{\theta_c \text{ min}} = \mu_n = 0.262 \text{ d}^{-1}$$

$$\theta_c \text{ min} = 3.817 \text{ d}$$

- e. Using a safety factor of 2.5 from Figure 23-18,

$$\theta_c = 2.5(3.817 \text{ d}) = 9.54 \text{ d}$$

This is within the SRT guidelines for BPR and is at the desirable shorter end of the range.

- f. Using Parts A, B, and C of Equation 23-40, determine biomass production. Use the biokinetic constants for heterotrophic bacteria (Table 23-13) for Parts A and B. Use the biokinetic constants for nitrification for Part C. The minimum sustained temperature is 20°C, so no temperature corrections are required. Use a conservative assumption of

$S = 0$ as recommended by WEF (1998). Because a nitrogen balance cannot be computed without P_x , use the assumed NO_x fraction, $\text{NO}_x = 0.80(\text{TKN}) = 0.80(35) = 28 \text{ mg/L}$ as a first approximation. Use the kinetic coefficients from Tables 23-13 and 23-14:

$$\begin{aligned}\mu_m &= 6.0 \text{ g VSS/g VSS} \cdot \text{d} & f_d &= 0.15 \text{ g/g} \\ Y &= 0.40 \text{ g VSS/g bCOD} & Y_n &= 0.12 \text{ g VSS/g NH}_4\text{-N} \\ k_d &= 0.12 \text{ g VSS/g VSS} \cdot \text{d}\end{aligned}$$

$$\begin{aligned}P_x &= \frac{(22,500 \text{ m}^3/\text{d})(0.40 \text{ g VSS/g bCOD})(220 \text{ g/m}^3 - 0)(10^{-3} \text{ kg/g})}{[1 + (0.12 \text{ g VSS/g VSS} \cdot \text{d})(9.54 \text{ d})]} \\ &+ \frac{(0.15 \text{ g/g})(0.12 \text{ g VSS/g VSS} \cdot \text{d})(22,500 \text{ m}^3/\text{d})(0.40 \text{ g VSS/g bCOD})(220 \text{ g/m}^3 - 0)(9.54 \text{ d})(10^{-3} \text{ kg/g})}{[1 + (0.12 \text{ g VSS/g VSS} \cdot \text{d})(9.54 \text{ d})]} \\ &+ \frac{(22,500 \text{ m}^3/\text{d})(0.12 \text{ g VSS/g NH}_4\text{-N})(28 \text{ g/m}^3)(10^{-3} \text{ kg/g})}{[1 + (0.08 \text{ g VSS/g VSS} \cdot \text{d})(9.54 \text{ d})]} \\ P_x &= 923.16 + 158.53 + 42.87 = 1,124.56 \text{ kg VSS/d}\end{aligned}$$

g. Determine the amount of NO_x oxidized to nitrate using Equation 23-45.

$$\begin{aligned}\text{NO}_x &= 35 \text{ g/m}^3 - 1.0 \text{ g/m}^3 - 0.12 \left(\frac{1,124.56 \text{ kg VSS/d}}{22,500 \text{ m}^3/\text{d}} \right) (10^3 \text{ g/kg}) \\ &= 35.0 - 1.0 - 6.0 = 28.0 \text{ g/m}^3\end{aligned}$$

h. Determine the mass of VSS and TSS in the aeration basin. With the exception of the nbVSS, the mass has already been calculated in step (f). From the influent data, the mass of nbVSS is $60 \text{ g/m}^3 - 40 \text{ g/m}^3 = 20 \text{ g/m}^3$ and the

$$\begin{aligned}\text{Mass} &= (\text{nbVSS})(Q) \\ &= (20 \text{ g/m}^3)(22,500 \text{ m}^3/\text{d})(10^{-3} \text{ kg/g}) = 450 \text{ kg/d}\end{aligned}$$

The total mass of VSS is then

$$P_{x,\text{VSS}} = 1,124.56 \text{ kg/d} + 450 \text{ kg/d} = 1,574.56 \text{ or } 1,600 \text{ kg/d}$$

The mass of MLVSS is equal to the MLVSS concentration times the volume of the aeration tank, that is, $(X_{\text{VSS}})(V)$. This is equal to mass generated each day times the SRT, that is, $(P_{x,\text{VSS}})(\theta_c)$.

$$\text{Mass of MLVSS} = (1,124.56 \text{ kg/d})(9.54 \text{ d}) = 10,728.3 \text{ kg}$$

Using the assumed ratio of MLVSS to MLSS, the mass of MLSS may be estimated as

$$\text{Mass of MLSS} = \frac{10,728.3 \text{ kg}}{0.8} = 13,410 \text{ kg}$$

- i. The concentration of MLSS times the volume of the aeration tank is equal to the mass of MLSS, that is, $(X_{MLSS})(V)$. At the assumed MLSS of $3,000 \text{ g/m}^3$, the volume of the aeration tank may be estimated as follows:

$$\begin{aligned}(X_{MLSS})(V) &= 13,410 \text{ kg} \\ (V) &= \frac{13,410 \text{ kg}}{(X_{MLSS})} \\ &= \frac{13,410 \text{ kg}}{(3,000 \text{ g/m}^3)(10^{-3} \text{ kg/g})} = 4,470 \text{ or } 4,500 \text{ m}^3\end{aligned}$$

- j. Estimate the hydraulic detention time.

$$\theta = \frac{4,500 \text{ m}^3}{22,500 \text{ m}^3/\text{d}} = 0.199 \text{ d or } 4.78 \text{ h}$$

This is in the range of typical HRTs for the aerobic stage of BPR processes.

Comments:

1. A volume of $4,500 \text{ m}^3$ is too big to achieve complete mixing. A volume of about $3,000 \text{ m}^3$ is about the maximum that should be used. For this example the flow should be divided into eight parallel process lines.
2. Because a portion of the effluent from the aeration basin is recycled to the anoxic stage, the basin may be segregated into two or more chambers with a reduced DO concentration in the downstream chamber. This reduces the DO entering the anoxic tank.

Example 23-18. In continuing the design of the BPR process for Tempe's new wastewater treatment plant, determine the volume of the anoxic tank. Use the data provided in Example 23-17.

Solution:

- a. This design is iterative. The effluent nitrate concentration is used to estimate the phosphorus uptake in the anaerobic stage. If, in the next step of the design, the phosphorus uptake is not adequate, the anoxic tank may have to be enlarged or chemical treatment may be required.
- b. Assume an effluent $\text{NO}_3\text{-N}$ concentration of 6.0 g/m^3 and determine the IR ratio using Equation 23-54. From step (g) in Example 23-17, $\text{NO}_x = 28.0 \text{ g/m}^3$. From the assumptions in Example 23-17, $R = 0.60$.

$$IR = \frac{28.0 \text{ g/m}^3}{6.0 \text{ g/m}^3} - 1.0 - 0.6 = 3.07$$

- c. Determine the mass of $\text{NO}_3\text{-N}$ fed to the anoxic tank.

$$\begin{aligned}\text{Flow rate to anoxic tank} &= (IR)(Q) + (R)(Q) \\ &= 3.07(22,500 \text{ m}^3/\text{d}) + (0.60)(22,500 \text{ m}^3/\text{d}) \\ &= 82,575 \text{ m}^3/\text{d} \\ \text{NO}_x \text{ feed} &= (82,575 \text{ m}^3/\text{d})(6.0 \text{ g/m}^3) = 495,450 \text{ g/d}\end{aligned}$$

- d. Assume a detention time and estimate the volume of the anoxic tank. From Table 23-9 select an HRT of 1.0 h.

$$V = \left(\frac{1.0 \text{ h}}{24 \text{ h/d}} \right) (22,500 \text{ m}^3/\text{d}) = 937.5 \text{ or } 940 \text{ m}^3$$

- e. Calculate the F/M using Equation 23-51. Note from Example 23-17 that $\text{MLVSS} = 0.80(\text{MLSS})$ and therefore $\text{MLVSS} = (0.80)(3,000 \text{ g/m}^3) = 2,400 \text{ g/m}^3$.

$$\frac{F}{M} = \frac{(22,500 \text{ m}^3/\text{d})(138 \text{ g/m}^3)}{(940 \text{ m}^3)(2,400 \text{ g/m}^3)} = 1.38 \text{ g/g} \cdot \text{d}$$

- f. Determine the SDNR.

$$\text{The fraction of rbCOD/bCOD} = \frac{80 \text{ mg/L}}{220 \text{ mg/L}} = 0.36$$

From Figure 23-12, $\text{SDNR} = 0.28 \text{ g/g} \cdot \text{d}$

- g. Determine the amount of $\text{NO}_3\text{-N}$ that can be reduced using Equation 23-52:

$$\begin{aligned}\text{NO}_r &= (940 \text{ m}^3)(0.28 \text{ g/g} \cdot \text{d})(2,400 \text{ g/m}^3) \\ &= 631,680 \text{ g/d}\end{aligned}$$

From step (c), the NO_x in the feed is 490,050 g/d. Therefore, there is about 30% excess capacity.

Comments:

1. The excess capacity for nitrate removal provides several options for the designer: one is to consider it as a safety factor; another is to use a lower effluent concentration than the assumed value of 6.0 g/m^3 ; another is to rework the problem with an assumed HRT less than 1.0 h.
 2. There is an oxygen credit for the amount supplied by nitrate reduction that is not accounted for in this example. See Equation 23-44 and the oxygen credit calculation in Example 23-16.
 3. The alkalinity check includes a credit for the alkalinity produced in nitrate reduction. This check is demonstrated in Example 23-19.
-

Example 23-19. Check the alkalinity for the BPR wastewater plant being designed for Tempe. Use the data from Examples 23-17 and 23-18. Assume an alkalinity of 80 g/m^3 is needed to maintain a pH of about 7. The amount of nitrogen oxidized is $\text{NO}_x = 28.0 \text{ g/m}^3$ from step (g) in Example 23-17.

Solution:

- a. Prepare an alkalinity mass balance using the following equation:

$$\text{Alkalinity to be added} = 80 \text{ g/m}^3 - \text{influent alkalinity} + \text{alkalinity used} - \text{alkalinity produced}$$

(1) From Example 23-17, the influent alkalinity = 220 mg/L as CaCO_3 .

(2) Alkalinity used = $(7.14 \text{ g CaCO}_3/\text{g NH}_4\text{-N})(\text{NO}_x)$
 $= (7.14 \text{ g CaCO}_3/\text{g NH}_4\text{-N})(28.0 \text{ g/m}^3) = 199.92 \text{ g/m}^3$

(3) Alkalinity produced = $(3.57 \text{ g CaCO}_3/\text{g NO}_3\text{-N})(28.0 \text{ g/m}^3 - 6 \text{ g/m}^3) = 78.54 \text{ g/m}^3$

- b. Solving for “Alkalinity to be added”:

$$\text{Alkalinity to be added} = 80 \text{ g/m}^3 - 220 + 199.92 - 78.54 = -18.62 \text{ g/m}^3 \text{ as CaCO}_3$$

The negative number implies that there is sufficient alkalinity in the influent wastewater.

Example 23-20. Estimate the effluent phosphorus concentration for Tempe’s new BPR wastewater treatment plant. Use the data and assumptions from Examples 23-17 through 23-19. In addition, assume the following:

- 10 g rbCOD/g P is removed by BPR
- $\text{rbCOD/nitrate ratio}$ is $6.6 \text{ g rbCOD/g NO}_3\text{-N}$
- Phosphorus content of heterotrophic bacteria is $0.015 \text{ g P/g biomass}$
- No $\text{NO}_3\text{-N}$ in influent

Solution:

- a. Determine the rbCOD available for BPR using a mass balance at the influent to the reactor.

$$(Q_{\text{RAS}})(\text{NO}_3\text{-N})_{\text{inf}} + (Q_{\text{RAS}})(\text{NO}_3\text{-N})_{\text{RAS}} = (Q + Q_{\text{RAS}})(\text{NO}_3\text{-N})_{\text{React}}$$

where $Q_{\text{RAS}} = 0.60(Q)$ from Example 23-17

$(\text{NO}_3\text{-N})_{\text{RAS}} = 6.0 \text{ g/m}^3$ from Example 23-18 at step (b)

$(\text{NO}_3\text{-N})_{\text{React}} = \text{nitrate feed to reactor}$

Substituting from assumptions:

$$0.6Q + 0.6Q(6.0 \text{ g/m}^3) = 1.6Q((\text{NO}_3\text{-N})_{\text{React}})$$

$$(\text{NO}_3\text{-N})_{\text{React}} = \frac{0.6Q}{1.6Q}(6.0 \text{ g/m}^3) = 2.25 \text{ g NO}_3\text{-N/m}^3$$

Using the assumption of 6.6 g rbCOD/g NO₃-N:

$$\text{rbCOD equivalent} = (2.25 \text{ g NO}_3\text{-N/m}^3)(6.6 \text{ g rbCOD/g NO}_3\text{-N}) = 14.85 \text{ g/m}^3$$

From the influent data given in Example 23-17, the influent rbCOD is 80 g/m³. The rbCOD available for BPR is

$$80 \text{ g/m}^3 - 14.85 \text{ g/m}^3 = 65.15 \text{ g/m}^3$$

- b. Using the assumption that 10 g rbCOD/g P is removed by BPR, the estimated phosphorus removed by BPR mechanisms is

$$\text{BPR removal} = \frac{65.15 \text{ g rbCOD/m}^3}{10 \text{ g rbCOD/g P}} = 6.52 \text{ or } 6.5 \text{ g/m}^3$$

- c. Estimate the phosphorus used for heterotrophic biomass synthesis. Use Part A and Part C from step (f) in Example 23-17.

$$P_x = 923.16 \text{ kg} + 42.87 \text{ kg} = 966.0 \text{ kg}$$

Using the assumption that the phosphorus content of heterotrophic bacteria is 0.015 g P/g biomass:

$$P \text{ used} = (0.015 \text{ g P/g biomass})(966.0 \text{ kg})(10^3 \text{ g/kg}) = 14,490 \text{ g/d}$$

As a concentration, this is

$$\frac{14,490 \text{ g/d}}{22,500 \text{ m}^3/\text{d}} = 0.64 \text{ g/m}^3$$

- d. Estimate the effluent soluble P:

$$P \text{ removed} = 6.52 \text{ g/m}^3 + 0.64 \text{ g/m}^3 = 7.16 \text{ g/m}^3$$

$$\text{Effluent soluble P} = 8 \text{ g/m}^3 - 7.16 \text{ g/m}^3 = 0.84 \text{ or } 0.8 \text{ g/m}^3$$

This meets the effluent standard of $\leq 2 \text{ mg/L}$.

Comments:

1. A large number of assumptions were used in estimating the performance of the BPR process. Prudent designers will evaluate the advisability of chemical addition to augment the BPR.

2. The steps in this problem (Examples 23-17 through 23-20) were provided as an illustration of the computations that can be performed without simulation modeling. Prudent design of this complex system requires the use of a simulation model to explore alternate scenarios of flow, organic composition, and loading.

Example 23-21. As part of a preliminary design, estimate the required blower power for the complete-mix BOD removal and nitrification stage for Tempe's new BPR wastewater treatment plant (Example 23-17). The following estimates have been provided for the design of one of eight basins:

Wastewater depth = 4.5 m
 Equivalent length of pipe = 105 m
 Air flow rate = 90 m³/min
 Ambient air pressure = 101.325 kPa = 10.333 m of H₂O = 1 atmosphere
 Ambient air temperature = 47°C
 Steel pipe diameter = 350 mm
 Diffuser losses = 300 mm
 Allowance for clogging = 250 mm
 Silencer = 60 mm
 Air filter = 150 mm
 Silencer = 60 mm
 Submergence = 4,500 mm
 Headloss in pipe (h_L) = 55 mm

Assume a blower efficiency of 70%.

Solution:

- a. To size the blower, an estimate of the headloss for the steel delivery piping must be made. This is an iterative solution because the headloss is a function of pressure, and the headloss is used to determine the outlet pressure of the blower.
- b. Use Equation 23-66 to estimate the friction factor.

$$f \approx 0.029 \left(\frac{(0.350 \text{ m})^{0.027}}{(90 \text{ m}^3/\text{min})^{0.148}} \right) = 0.029 \left(\frac{0.97}{1.95} \right) = 0.0145$$

- c. From the range of rated discharge pressures, assume a trial pressure of 50 kPa. Convert to "atmospheres" using the standard atmospheric pressure of 101.325 kPa.

$$\frac{50 \text{ kPa}}{101.325 \text{ kPa/atm}} = 0.49 \text{ atm}$$

This is gage pressure. Absolute pressure is 1 atm + 0.49 atm = 1.49 atm.

- d. The temperature correction is estimated using Equation 23-65. The ambient temperature of 47°C must be converted to kelvins:

$$T = (47 + 273) \left(\frac{1.49 \text{ atm}}{1.0 \text{ atm}} \right)^{0.283} = 358.23 \text{ K}$$

- e. Calculate the headloss using Equation 23-64.

$$\begin{aligned} h_L &= 9.82 \times 10^{-8} \left(\frac{(0.0145)(105 \text{ m})(358.23)(90 \text{ m}^3/\text{min})^2}{(1.49)(0.350 \text{ m})^5} \right) \\ &= (9.82 \times 10^{-8}) \left(\frac{4.42 \times 10^6}{7.83 \times 10^{-3}} \right) \\ &= 55.44 \text{ or } 55 \text{ mm of water} \end{aligned}$$

- f. The total losses are estimated as follows:

Submergence = 4,500 mm
 Diffuser losses = 300 mm
 Allowance for clogging = 250 mm
 Silencer = 60 mm
 Air filter = 150 mm
 Headloss in pipe (h_L) = 55 mm
 Total headloss = 5,315 mm of water

Converting to absolute pressure in atmospheres:

$$\frac{(5,315 \text{ mm of water})(10^{-3} \text{ m/mm})}{10.34 \text{ m of water/atm}} = 0.514 \text{ atm}$$

The absolute pressure is 1 atm + 0.514 atm = 1.514 atm. Note that this differs from the assumed pressure of 1.49 atm used to compute the headloss. For a more refined analysis, a second iteration using 1.514 atm would be used to calculate the headloss.

- g. Size the blower based on an assumption that one blower serves two basins ($2 \times 90 \text{ m}^3/\text{min} = 180 \text{ m}^3/\text{min}$ at standard temperature and pressure). At 1 atm pressure and 298 K the density of air is 1.185 kg/m^3 . At the ambient temperature of 47°C , the density is estimated to be

$$(1.185 \text{ kg/m}^3) \frac{298 \text{ K}}{320 \text{ K}} = 1.1035 \text{ kg/m}^3$$

The mass flow rate of air is then

$$(180 \text{ m}^3/\text{min})(1.1035 \text{ kg/m}^3) = 198.65 \text{ kg/min or } 3.31 \text{ kg/s}$$

Using Equation 23-63, the blower power is estimated to be:

$$\begin{aligned} P_w &= \frac{(3.31 \text{ kg/s})8.314 \text{ kJ/k mol K}(320 \text{ K})}{29.7(0.283)(0.70)} \left[\left(\frac{1.514 \text{ atm}}{1.0 \text{ atm}} \right)^{0.283} - 1 \right] \\ &= \frac{8,806.2}{5.88} [1.125 - 1] = 187.20 \text{ or } 190 \text{ kW} \end{aligned}$$

Comments:

1. A standard blower rated at or above 190 kW would be selected.

2. For the eight basins, four blowers plus a spare would be specified to meet redundancy requirements.
 3. This is a preliminary design. Given the number of assumptions made to arrive at losses, iteration of the pressure assumption is not warranted.
 4. The air piping network problem is similar to a water distribution network problem. Typically, the solution will be obtained using a computer program.
-

23-8 MEMBRANE BIOREACTOR DESIGN PRACTICE

Because the membrane bioreactor (MBR) system can operate at a very high mixed liquor suspended solids concentration, it has the following advantages over a conventional activated sludge system: (1) higher volumetric loading rates and shorter hydraulic detention times, (2) longer sludge retention times that result in less sludge production, (3) operation at low DO concentrations, (4) very high quality effluent in terms of suspended solids and BOD, (5) smaller footprint, and (6) primary and secondary clarifiers are not required.

The disadvantages of the system are high capital costs, high replacement cost for membranes, higher energy costs, and maintenance issues with respect to membrane fouling. Fine screens are required.

Performance data indicate that MBR processes can achieve effluent BOD and COD concentrations much less than 5 mg/L and 30 mg/L, respectively. Ammonia nitrogen levels less than 1 mg/L and total nitrogen concentrations less than 10 mg/L have been achieved. Turbidity values less than 1 NTU can be achieved by the membrane.

Although the situation is rapidly changing, the number of membrane installations is relatively small and the length of experience with any given configuration is short. So far the experience has been excellent, but prudent engineering practice suggests that a thorough evaluation of the state-of-the-art be conducted before commitment to a MBR technology is made.

The following discussion of design practice is drawn primarily from Metcalf & Eddy (2003) and WEF (2006b).

Design Flow Rate

Unlike suspended growth processes that are process limited, MBRs have substantial hydraulic limitations. Typically, MBRs are designed with a peaking factor of 2.0 to 2.5 (WEF, 2006b).

Redundancy

Membranes are mounted in subunits. They may be called *arrays*, *racks*, or *cassettes*. The subunits can be taken out of service individually without interrupting the process flow of the entire line. A sufficient number of subunits should be provided so that the membrane system can handle the peak flow with one cassette out of service.

Hint from the Field. Because of the high cost of membranes and their limited life as well as their continued technological improvement and reduction in cost, the initial installation should be provided with the number of subunits required to meet the initial flow rather than the final design flow. However, facilities (building space, tanks, and piping) to hold the subunits for the design flow should be provided at the start of the design life.

Equalization

Sufficient tankage should be provided to equalize flows in excess of the design peaking factor. This may be either in-line or off-line storage.

Preliminary Treatment

Removal of grit and materials that can be screened is critical for the operation and maintenance of the membrane. Each membrane manufacturer has specific screening requirements. In practice, most new facilities are being designed with screens with openings smaller than 2 mm, and a trend toward 1 mm screens has been observed (WEF, 2006b). The best protection for membranes is to use the finest screen possible while minimizing the potential for bypass around the screen. The screen should be at the head end of the plant.

Primary Treatment

Primary clarifiers are not specifically required for a MBR. Fine screens will remove 15 to 25 percent of the BOD (WEF, 1998). If further reduction is required to improve the efficiency of the activated sludge system or to reduce the total energy required for aeration, a primary settling tank may be employed.

Solids Retention Time (SRT)

Most of the initial MBR systems were designed with SRTs on the order of 30 to 70 days. Recent experience with immersed membranes indicates that biopolymer fouling is not strongly related to SRT provided that the SRT is at least long enough to perform nitrification. It is anticipated that the selection of an SRT will now be governed by the objective of the process and, in the case of nitrification, the temperature of the wastewater.

Mixed Liquor Suspended Solids (MLSS)

Immersed MBR systems have been operated with MLSS concentrations ranging from 8,000 to 18,000 mg/L. However, the very high MLSS concentrations reduce membrane flux and the aeration alpha factor. This leads to higher energy requirements. Current design practice is to use MLSS concentrations in the range of 8,000 to 10,000 mg/L.

Dissolved Oxygen

Typical DO concentrations in various zones of an MBR are (WEF, 2006b):

- Anoxic: 0.0 to 0.5 mg/L
- Aerobic: 1.5 to 3.0 mg/L
- Membrane: 2.0 to 6.0 mg/L

Oxygen transfer efficiency may be adversely affected by the high MLSS concentration in the reactor because of the reduced alpha factor.

Return Activated Sludge (RAS)

RAS rates of 400 percent of the influent flow rate are not uncommon.

Hint from the Field. A mixed flow return sludge pump with a large turn down ratio is recommended.

Sludge Wasting

As in the suspended growth processes, the SRT requirements of the biological process determine the amount of sludge that must be wasted. Typical wasting points are from the return sludge line, the drain line from the membrane tanks, and the surface of the bioreactor. Wasting from the return sludge line provides the highest MLSS concentration.

Pumps

There are a number of special pumps associated with the membrane system that are not common to typical suspended growth processes. In particular, there are pumps for permeate and back-pulse. Typically the permeate pump is a rotary-lobe pump because it can handle a large percent of entrained air. The back-pulse pump is only used in MBR systems that use hollow-fiber membranes. Typically these pumps are centrifugal pumps.

Design Criteria

Table 23-21 provides a summary of the range of MBR design values.

Fouling

Theoretical concepts of membrane fouling are presented in Chapter 12. The fouling of membranes in MBR reactors results in similar pressure cycles as those shown in Figure 12-4. This results from biomass coating of the outer layers of the membrane and penetration of finer particles to the inner pores of the membrane. Additionally, some chemical precipitation on the surfaces may occur. To maintain the performance of the membrane, two types of cleaning are performed: maintenance cleaning and recovery cleaning.

TABLE 23-21
Range of MBR design values

Parameter	Range of values
Flux	25–46 L/m ² · h
Transmembrane pressure (TMP)	7 to 65 kPa
SRT	5–20 d
MLSS	8,000–10,000 mg/L
MLVSS	6,000–8,000 mg/L
HRT	4–6 h

Sources: Metcalf & Eddy, 2003; WEF, 2006b.

TABLE 23-22
Recovery cleaning chemical selection chart

Suspected fouling material	Recommended cleaning chemical	Alternate cleaning chemical	Cleaning solution concentration, mg/L
Aluminum oxide	Oxalic acid ^a	Citric acid	1,000–10,000
Calcium carbonate	HCl	Citric acid	1,000–10,000
Ferric oxide	Oxalic acid ^a	Citric acid	1,000–10,000
Organic material	NaOCl	H ₂ O ₂	500–5,000

^aDo not use oxalic acid in hard water. It will form calcium oxalate precipitate.
 Adapted from WEF, 2006b.

Maintenance Cleaning. Each manufacturer has a prescribed cleaning regime and frequency. The following scenario is representative but is not to be construed as having precedence over the manufacturer's recommendation:

- Coarse bubble aeration to provide mechanical scouring.
- Interruption of the filtration process every 12 to 15 minutes for backwashing with permeate for 30 to 60 s.
- Backwashing permeate may contain a low concentration of chlorine (< 5 mg/L).
- Approximately every two days, a strong sodium hypochlorite solution (~ 100–500 mg/L) or citric acid (~ 1,000–5,000 mg/L) is used to backwash for 45 minutes.

Recovery Cleaning. Maintenance cleaning is not completely effective, and the pressure drop across the membrane will increase with time. The intention of recovery cleaning is to improve membrane permeability to 80 percent or more of a new membranes permeability. As with maintenance cleaning, the manufacturer's recommendations are to be followed. The recovery chemicals and the concentration and cleaning duration are dependent on the fouling material. Table 23-22 shows a typical selection of alternatives. The cleaning duration may range from 6 to 24 hours. With proper isolation of each membrane tank, cleaning may take place in the tank (called *clean in place* or CIP). In small plants the cassette is removed and placed in a staging tank.

Visit the text website at www.mhprofessional.com/wwe for supplementary materials and a gallery of additional photos.

23-9 CHAPTER REVIEW

When you have completed studying this chapter, you should be able to do the following without the aid of your textbook or notes:

1. Define the following terms and abbreviations: activated sludge, mixed liquor, mixed liquor volatile suspended solids (MLVSS), mixed liquor suspended solids (MLSS), return sludge, RAS, wasting, waste activated sludge (WAS), mean cell residence time

(MCRT or θ_c), solids retention time (SRT) or sludge age, CSTR, SBR, BNR, MF, AOTR, SOTR, SOTE, SAE, F/M, SDNR, SVI, BPR.

2. Describe the following processes and give examples of their use: oxidation ditch, SBR, selector, Modified Ludzack-Ettinger (MLE), Bardenpho (4-stage), A^2/O^{TM} , MBR.
3. Explain why oxidation pond design criteria are often prescriptive.
4. Explain why solids retention time is referred to as the “master variable” in the design of activated sludge systems.
5. Explain the sequence of steps in the operation of a batch reactor for carbonaceous BOD oxidation and for denitrification.
6. List two of the major assumptions of reactor models that are rarely met in practice and explain some methods for correcting for the faults of these assumptions.
7. Explain when it becomes important to consider using the more accurate method of predicting sludge production.
8. Compare two systems operating at two different F/M ratios.
9. Define SVI, explain its use in the design of an activated sludge plant, and why that use is not recommended.

With the aid of this text, you should be able to do the following:

10. Design a facultative oxidation pond by determining the dimensions and specifying the piping and construction features.
11. Design an oxidation ditch by determining the dimensions, required alkalinity for nitrification, sludge production, and aeration equipment selection and placement.
12. Design a SBR by determining the dimensions, reaction time for nitrification, nitrate removal capacity, and aeration equipment selection.
13. Design an A^2/O^{TM} treatment system by determining the SRT, volume of the nitrification tank, nitrate removal capacity, alkalinity requirements, effluent soluble phosphorus concentration, volume and dimensions of anoxic and anaerobic reactors, and the aeration system design including compressor sizing.

23-10 PROBLEMS

- 23-1. Using the assumptions given in Example 23-1, the rule-of-thumb values for growth constants in the example, and the further assumption that the influent BOD_5 was reduced by 32% in the primary tank, estimate the liquid volume of a completely mixed activated sludge aeration tank for Perryville. The design flow rate is $34,560 \text{ m}^3/\text{d}$ and the design influent BOD_5 is 188 mg/L . Assume an MLVSS of $2,000 \text{ mg/L}$.
- 23-2. Repeat Problem 23-1 for the town of Pea Ridge using a design flow rate of $8,450 \text{ m}^3/\text{d}$ and an influent BOD_5 of 137 mg/L .

- 23-3.** The town of Camp Verde has been directed to upgrade its primary WWTP to a secondary plant that can meet an effluent standard of 25.0 mg/L BOD₅ and 30 mg/L suspended solids. They have selected a completely mixed activated sludge system for the upgrade. The existing primary treatment plant has a flow rate of 2,506 m³/d. The effluent from the primary tank has a BOD₅ of 240 mg/L. Using the following assumptions, estimate the required volume of the aeration tank:
1. BOD₅ of the effluent suspended solids is 70% of the allowable suspended solids concentration.
 2. Growth constant values are estimated to be: $K_s = 100$ mg/L BOD₅; $k_d = 0.025$ d⁻¹; $\mu_m = 10$ d⁻¹; $Y = 0.8$ mg VSS/mg BOD₅ removed.
 3. The design MLVSS is 3,000 mg/L.
- 23-4.** Using a spreadsheet program you have written, rework Example 23-1 using the following MLVSS concentrations instead of the 2,000 mg/L used in the example: 1,000 mg/L; 1,500 mg/L; 2,500 mg/L; and 3,000 mg/L.
- 23-5.** Using a spreadsheet program you have written, determine the effect of MLVSS concentration on the effluent soluble BOD₅ (S) using the data in Example 23-1. Assume the volume of the aeration tank remains constant at 945 m³. Use the same MLVSS values used in Problem 23-4.
- 23-6.** Determine the return sludge concentration (X_r') that results in the maximum return sludge flow rate for Perryville's proposed activated sludge plant described in Problem 23-1. Also estimate the mass flow rate of sludge wasting. Use the following assumption:
- MLVSS fraction of MLSS = 0.70
- 23-7.** Determine the return sludge concentration (X_r') that results in the maximum return sludge flow rate for Pea Ridge's proposed activated sludge plant described in Problem 23-2. Also estimate the mass flow rate of sludge wasting. Use the following assumption:
- MLVSS fraction of MLSS = 0.80
- 23-8.** Determine the return sludge concentration (X_r') that results in the maximum return sludge flow rate for Camp Verde's proposed activated sludge plant described in Problem 23-3. Also estimate the mass flow rate of sludge wasting. Use the following assumption:
- MLVSS fraction of MLSS = 0.70
- 23-9.** Estimate the mass of sludge to be wasted each day from the new activated sludge plant at Perryville (Problems 23-1 and 23-6).
- 23-10.** Estimate the mass of sludge to be wasted each day from the new activated sludge plant at Pea Ridge (Problems 23-2 and 23-7).
- 23-11.** Estimate the mass of sludge to be wasted each day from the new activated sludge plant at Camp Verde (Problems 23-3 and 23-8).

- 23-12.** Estimate the mass of oxygen to be supplied (kg/d) for the new activated sludge plant at Perryville (Problems 23-1, 23-6, and 23-9). Assume that $BOD_5 = \text{rbsCOD}$ and that it is 68% of the bCOD.
- 23-13.** Estimate the mass of oxygen to be supplied (kg/d) for the new activated sludge plant at Pea Ridge (Problems 23-2, 23-7, and 23-10). Assume that $BOD_5 = \text{rbsCOD}$ and that it is 68% of the bCOD.
- 23-14.** Estimate the mass of oxygen to be supplied (kg/d) for the new activated sludge plant at Camp Verde (Problems 23-3, 23-8, and 23-11). Assume that $BOD_5 = \text{rbsCOD}$ and that it is 68% of the bCOD.
- 23-15.** Estimate the required air flow rate for the new activated sludge plant at Perryville (Problems 23-1, 23-6, 23-9, and 23-12). Use the following assumptions in preparing the estimate:

Clean water correction, $\alpha = 0.45$
Salinity correction, $\beta = 0.95$
Fouling factor = 0.8
Summer wastewater temperature = 20°C
Atmospheric pressure = 101.325 kPa
Elevation = 100 m
Depth of aerator = 4.5 m
Operating DO = 2.0 mg/L
Percent oxygen leaving aeration tank = 19%
Manufacturer's SOTR = 525 kg/d
Manufacturer's air flow rate at standard conditions = 122 m³/d · aerator

- 23-16.** Estimate the required air flow rate for the new activated sludge plant at Pea Ridge (Problems 23-2, 23-7, 23-10, and 23-13). Use the following assumptions in preparing the estimate:

Clean water correction, $\alpha = 0.50$
Salinity correction, $\beta = 0.95$
Fouling factor = 0.9
Summer wastewater temperature = 12°C
Atmospheric pressure = 101.325 kPa
Elevation = 500 m
Depth of aerator = 5.6 m
Operating DO = 2.0 mg/L
Percent oxygen leaving aeration tank = 19%
Manufacturer's SOTR = 535 kg/d
Manufacturer's air flow rate at standard conditions = 50 m³/d · aerator

- 23-17.** Estimate the required air flow rate for the new activated sludge plant at Camp Verde (Problems 23-3, 23-8, 23-11, and 23-14). Use the following assumptions in preparing the estimate:

Clean water correction, $\alpha = 0.70$
Salinity correction, $\beta = 0.95$

Fouling factor = 0.8
 Summer wastewater temperature = 22°C
 Atmospheric pressure = 101.325 kPa
 Elevation = 2,135 m
 Depth of aerator = 4.5 m
 Operating DO = 2.0 mg/L
 Percent oxygen leaving aeration tank = 19%
 Manufacturer's SOTR = 650 kg/d
 Manufacturer's air flow rate at standard conditions = 20 m³/d · aerator

- 23-18.** If the F/M of a 0.4380 m³/s activated sludge plant is 0.200 mg/mg · d, the influent BOD₅ after primary settling is 150 mg/L, and the MLVSS is 2,200 mg/L, what is the volume of the aeration tank?
- 23-19.** If the operator of the plant described in Problem 23-18 reduces wasting and allows the MLVSS to rise to 3,000 mg/L, what is the new F/M ratio?
- 23-20.** If a new industry increases the influent BOD₅ after settling to 180 mg/L to the plant described in Problem 23-18, what is the new F/M ratio? Assume that the MLVSS remains constant at 2,200 mg/L.
- 23-21.** Two activated sludge aeration tanks at Turkey Run are operated in series. Each tank has the following dimensions: 7.0 m wide by 30.0 m long by 4.3 m effective liquid depth. The plant operating parameters are as follows:

Flow = 0.0796 m³/s
 Soluble BOD₅ after primary settling = 130 mg/L
 MLVSS = 1,500 mg/L
 MLSS = 1.40 (MLVSS)
 Settled sludge volume after 30 min = 230.0 mL/L

Determine the following: aeration period, F/M ratio, SVI.

- 23-22.** Using the following assumptions, determine the solids retention time, cell wastage flow rate, and the return sludge flow rate for the Turkey Run WWTP (Problem 23-21). Assume:

Suspended solids in the effluent are negligible
 Wastage is from the aeration tank
 Yield coefficient = 0.40 mg VSS/mg BOD₅ removed
 Decay rate of microorganisms = 0.040 d⁻¹
 Effluent BOD₅ = 5.0 mg/L (soluble)

- 23-23.** The 500-bed Lotta Hart Hospital has a small activated sludge plant to treat its wastewater. The average daily hospital discharge is 1,500 L per day per bed, and the average soluble BOD₅ after primary settling is 500 mg/L. The aeration tank has effective liquid dimensions of 10.0 m wide by 10.0 m long by 4.5 m deep. The plant operating parameters are as follows:

MLVSS = 2,500 mg/L
 MLSS = 1.20 (MLVSS)
 Settled sludge volume after 30 min = 200 mL/L

Determine the following: aeration period, F/M ratio, SVI.

- 23-24.** Using the following assumptions, determine the solids retention time, the cell wastage flow rate, and the return sludge flow rate for the Lotta Hart Hospital WWTP (Problem 23-23). Assume:

Allowable BOD₅ in effluent = 25.0 mg/L
 Suspended solids in effluent = 25.0 mg/L
 Wastage is from the return sludge line
 Yield coefficient = 0.60 mg VSS/mg BOD₅ removed
 Decay rate of microorganisms = 0.060 d⁻¹
 Inert fraction of suspended solids = 66.67%

- 23-25.** Rework Example 23-7 assuming that the State of Iowa rules for loading and detention time apply.
- 23-26.** An oxidation pond having a surface area of 90,000 m² is loaded with a waste flow of 500 m³/d containing 180 kg of BOD₅. The operating depth is from 0.6 to 1.6 m. Using the Michigan rules, determine whether this design is acceptable.
- 23-27.** Using the EPA criteria, design a controlled discharge oxidation pond for Coprolite. Coprolite is located in a state where the average winter temperature is 16°C. The design assumptions are as follows:

Flow rate = 3,800 m³/d
 BOD₅ = 100.0 mg/L
 Three cells in series
 Minimum operating depth = 0.6 m

- 23-28.** Estimate the volume of an extended-aeration oxidation ditch for carbonaceous BOD oxidation and nitrification for the city of Pasveer using the following design data:

Influent data

Design flow rate = 8,000 m³/d
 bCOD = 430 mg/L
 NH₃-N = 25 mg/L
 Total suspended solids (TSS) = 250 mg/L
 Biodegradable volatile suspended solids = 120 mg/L
 Minimum sustained temperature = 10°C
 pH = 7.2
 Alkalinity = 200 mg/L as CaCO₃

Effluent discharge standards

bCOD ≤ 20 mg/L
 NH₃-N ≤ 1.0
 TSS ≤ 10 mg/L

Assume the MLSS = 3,000 mg/L, MLVSS = (0.9) MLSS, and typical kinetic coefficients in Tables 23-13 and 23-14 apply.

- 23-29.** Determine whether or not there is sufficient alkalinity for nitrification of the extended aeration oxidation ditch at Pasveer (Problem 23-27). Compute the mass per day of sodium bicarbonate to add if alkalinity is required. Assume a residual of 80 mg/L as CaCO_3 is required to maintain the pH.
- 23-30.** Estimate the mass of sludge to be wasted each day from the extended aeration oxidation ditch at Pasveer (Problem 23-28).
- 23-31.** Determine the total length of brush aerators for the extended aeration oxidation ditch at Pasveer (Problem 23-28). Use the data in Table 23-15 for the length estimate. Use the following assumptions in the design:

Clean water correction, $\alpha = 0.50$ for nitrification
 Salinity correction, $\beta = 0.95$
 Summer wastewater temperature = 20°C
 Operating DO = 3.0 mg/L

- 23-32.** Determine the oxidation ditch dimensions and select brush aerators for the extended aeration oxidation ditch at Pasveer (Problems 23-28, 23-29, and 23-30). Use the data in Tables 23-15 and 23-16 to select the aerators.
- 23-33.** Estimate the volume of an extended-aeration oxidation ditch for carbonaceous BOD oxidation and nitrification for the city of Brooklyn using the following design data:

Influent data

Design flow rate = $26,500 \text{ m}^3/\text{d}$
 bCOD = 440 mg/L
 $\text{NH}_3\text{-N}$ = 18 mg/L
 Total suspended solids (TSS) = 240 mg/L
 Biodegradable volatile suspended solids = 190 mg/L
 Minimum sustained temperature = 13°C
 pH = 7.0
 Alkalinity = 120 mg/L as CaCO_3

Effluent discharge standards

bCOD \leq 20 mg/L
 $\text{NH}_3\text{-N}$ \leq 1.0
 TSS \leq 10 mg/L

Assume the MLSS = 3,000 mg/L, MLVSS = (0.75) MLSS, and typical kinetic coefficients in Tables 23-14 and 23-5 apply.

- 23-34.** Determine whether or not there is sufficient alkalinity for nitrification of the extended aeration oxidation ditch at Brooklyn (Problem 23-33). Compute the mass per day of sodium bicarbonate to add if alkalinity is required. Assume a residual of 80 mg/L as CaCO_3 is required to maintain the pH.
- 23-35.** Estimate the mass of sludge to be wasted each day from the extended aeration oxidation ditch at Brooklyn (Problem 23-33).

23-36. Determine the total length of brush aerators for the extended aeration oxidation ditch at Brooklyn (Problems 23-33, 23-34, 23-35). Use the data in Table 23-15 for the length estimate. Use the following assumptions in the design:

Clean water correction, $\alpha = 0.70$ for nitrification
 Salinity correction, $\beta = 0.95$
 Summer wastewater temperature = 24°C
 Operating DO = 3.0 mg/L

23-37. Determine the oxidation ditch dimensions and select brush aerators for the extended aeration oxidation ditch at Brooklyn (Problems 23-33, 23-34, 23-35, 23-36). Use the data in Tables 23-15 and 23-16 to select the aerators.

23-38. Estimate the volume and dimensions of an SBR for the town of Bath using the following design data:

Influent data

Design flow rate = $4,900\text{ m}^3/\text{d}$
 bCOD = 200 mg/L
 rbCOD = 45 mg/L
 Total Kjeldahl nitrogen (TKN) = 26 mg/L
 $\text{NH}_3\text{-N} = 23\text{ mg/L}$
 Total suspended solids (TSS) = 170 mg/L
 Volatile suspended solids (VSS) = 140 mg/L
 Biodegradable volatile suspended solids = 65 mg/L
 Minimum sustained temperature = 9°C
 pH = 7.4
 Alkalinity = 300 mg/L as CaCO_3

Effluent discharge standards

bCOD $\leq 20\text{ mg/L}$
 $\text{NH}_3\text{-N} \leq 1.0$
 TSS $\leq 10\text{ mg/L}$

Assume MLSS = $2,800\text{ mg/L}$, MLVSS = $(0.8)\text{ MLSS}$, $\text{NO}_x = 80\%$ of TKN, $\theta_c = 25\text{ d}$. Also assume the cycle time and phase times used in Example 23-13.

23-39. Check the assumed react plus aerated mix time used to design the SBR for the town of Bath using the data from Problem 23-38.

23-40. Check the assumed anoxic fill time used to design the SBR for the town of Bath using the data from Problems 23-38 and 23-39.

23-41. Estimate the number of jet aerators for the SBR being designed for the town of Bath using data from Problems 23-38, 23-39, and 23-40. Assume that 60% of the theoretical oxygen released in denitrification is available for oxidation and that the oxygen concentration leaving the tank is 19%. Assume the following data for the jet aerators:

SBR is at sea level
 $\alpha = 0.75$
 $\beta = 0.95$

$F = 1.0$
 Depth of aerator = 5.0 m
 Temperature = 9°C
 Manufacturer's SOTR = 1,570 kg/d at 6.0 m depth
 Manufacturer's air flow rate at standard conditions = 3,000 m³/d · jet

- 23-42.** Estimate the volume and dimensions of an SBR for the city of New Ark using the following design data:

Influent data

Design flow rate = 22,700 m³/d
 bCOD = 180 mg/L
 rbCOD = 40 mg/L
 Total Kjeldahl nitrogen (TKN) = 17 mg/L
 NH₃-N = 13 mg/L
 Total suspended solids (TSS) = 180 mg/L
 Volatile suspended solids (VSS) = 150 mg/L
 Biodegradable volatile suspended solids = 70 mg/L
 Minimum sustained temperature = 12°C
 pH = 7.1
 Alkalinity = 150 mg/L as CaCO₃

Effluent discharge standards

bCOD ≤ 20 mg/L
 NH₃-N ≤ 1.0
 TSS ≤ 10 mg/L

Assume MLSS = 2,800 mg/L, MLVSS = (0.8) MLSS, NO_x = 80% of TKN, $\theta_c = 25$ d. Also assume the cycle time and phase times used in Example 23-13.

- 23-43.** Check the assumed react plus aerated mix time used to design the SBR for the city of New Ark using the data from Problem 23-42.
- 23-44.** Check the assumed anoxic fill time used to design the SBR for the city of New Ark using the data from Problems 23-42 and 23-43.
- 23-45.** Estimate the number of jet aerators for the SBR being designed for the city of New Ark using data from Problems 23-42, 23-43, and 23-44. Assume that 60% of the theoretical oxygen released in denitrification is available for oxidation and that the oxygen concentration leaving the tank is 19%. Assume the following data for the jet aerators:

SBR elevation = 500 m
 $\alpha = 0.65$
 $\beta = 0.95$
 $F = 1.0$
 Depth of aerator = 5.0 m
 Temperature = 12°C
 Manufacturer's SOTR = 1,370 kg/d at 5.0 m depth
 Manufacturer's air flow rate at standard conditions = 2,200 m³/d · jet

- 23-46.** Your firm has been asked to do a preliminary study of the feasibility of a new A²/OTM BPR wastewater treatment plant for Pittsburgh. Begin the design of the complete-mix BOD removal and nitrification stage. As a first step determine the SRT and volume of tank required for nitrification using the following design data:

Influent data after primary settling

Design flow rate = 35,500 m³/d
 BOD₅ = 200 mg/L
 bCOD = 320 mg/L
 rbCOD = 60 mg/L
 Total Kjeldahl nitrogen (TKN) = 45 mg/L
 NH₃-N = 35 mg/L
 Soluble phosphorus = 7 g/m³
 Total suspended solids (TSS) = 75 mg/L
 Volatile suspended solids (VSS) = 65 mg/L
 Biodegradable volatile suspended solids = 40 mg/L
 Minimum sustained temperature = 15°C
 pH = 7.0
 Alkalinity = 220 mg/L as CaCO₃

Effluent discharge standards

bCOD ≤ 20 mg/L
 NH₃-N ≤ 1.0 mg/L
 NO₃-N ≤ 10 mg/L
 TSS ≤ 10 mg/L
 Total phosphorus ≤ 2.0 mg/L

Assume DO for aeration tank nitrification = 2.0 mg/L; MLSS = 3,500 mg/L, MLVSS = (0.8) MLSS, NO_x = 80% of TKN, and RAS = 0.54(Q).

- 23-47.** In continuing the design of the BPR process for Pittsburgh's new wastewater treatment plant, determine the volume of the anoxic tank. Use the data provided in Problem 23-46.
- 23-48.** Check the alkalinity for the BPR wastewater plant being designed for Pittsburgh. Use the data from Problems 23-46 and 23-47. Assume an alkalinity of 100 g/m³ is needed to maintain a pH of about 7.
- 23-49.** Estimate the effluent phosphorus concentration for Pittsburgh's new BPR wastewater treatment plant. Use the data and assumptions from Problems 23-46 through 23-48. In addition, assume the following:
- 9.5 g rbCOD/g P is removed by BPR
 - rbCOD/nitrate ratio is 6.6 g rbCOD/g NO₃-N
 - Phosphorus content of heterotrophic bacteria is 0.02 g P/g biomass
 - No NO₃-N in influent
- 23-50.** As part of a preliminary design, estimate the required blower power for the complete-mix BOD removal and nitrification stage for Pittsburgh's new BPR wastewater

treatment plant (Problem 23-46). The following estimates have been provided for the design of one of eight basins:

Wastewater depth = 4.5 m
 Equivalent length of pipe = 160 m
 Air flow rate = 140 m³/min
 Ambient air pressure = 101.325 kPa = 10.333 m of H₂O = 1 atmosphere
 Ambient air temperature = 27°C
 Steel pipe diameter = 350 mm
 Diffuser losses = 300 mm
 Allowance for clogging = 250 mm
 Silencer = 60 mm
 Air filter = 150 mm

Assume a blower efficiency of 70%.

- 23-51.** Your firm has been asked do a preliminary study of the feasibility of a new A²/O™ BPR wastewater treatment plant for Pekin. Begin the design of the complete-mix BOD removal and nitrification stage for the plant. As a first step determine the SRT and volume of tank required for nitrification using the following design data:

Influent data after primary settling

Design flow rate = 64,500 m³/d
 BOD₅ = 250 mg/L
 bCOD = 400 mg/L
 rbCOD = 50 mg/L
 Total Kjeldahl nitrogen (TKN) = 50 mg/L
 NH₃-N = 40 mg/L
 Soluble phosphorus = 9 g/m³
 Total suspended solids (TSS) = 80 mg/L
 Volatile suspended solids (VSS) = 70 mg/L
 Biodegradable volatile suspended solids = 50 mg/L
 Minimum sustained temperature = 9°C
 pH = 6.9
 Alkalinity = 100 mg/L as CaCO₃

Effluent discharge standards

bCOD ≤ 20 mg/L
 NH₃-N ≤ 1.0 mg/L
 NO₃-N ≤ 10 mg/L
 TSS ≤ 10 mg/L
 Total phosphorus ≤ 2.0 mg/L

Assume DO for aeration tank nitrification = 2.0 mg/L; MLSS = 4,000 mg/L, MLVSS = (0.8) MLSS, NO_x = 80% of TKN, and RAS = 0.50(Q).

- 23-52.** In continuing the design of the BPR process for Pekin's new wastewater treatment plant, determine the volume of the anoxic tank. Use the data provided in Problem 23-51.

- 23-53.** Check the alkalinity for the BPR wastewater plant being designed for Pekin. Use the data from Problems 23-51 and 23-52. Assume an alkalinity of 150 g/m^3 is needed to maintain a pH of about 7.
- 23-54.** Estimate the effluent phosphorus concentration for Pekin's new BPR wastewater treatment plant. Use the data and assumptions from Problems 23-51 through 23-53. In addition, assume the following:
- 10.5 g rbCOD/g P is removed by BPR
 - $\text{rbCOD/nitrate ratio is } 6.6 \text{ g rbCOD/g NO}_3\text{-N}$
 - Phosphorus content of heterotrophic bacteria is $0.015 \text{ g P/g biomass}$
 - No $\text{NO}_3\text{-N}$ in influent
- 23-55.** As part of a preliminary design, estimate the required blower power for the complete-mix BOD removal and nitrification stage for Pekin's new BPR wastewater treatment plant (Problem 23-51). The following estimates have been provided for the design of one of eight basins:

Wastewater depth = 4.5 m
Equivalent length of pipe = 150 m
Air flow rate = $130 \text{ m}^3/\text{min}$
Ambient air pressure = $101.325 \text{ kPa} = 10.333 \text{ m of H}_2\text{O} = 1 \text{ atmosphere}$
Ambient air temperature = 24°C
Steel pipe diameter = 350 mm
Diffuser losses = 300 mm
Allowance for clogging = 250 mm
Silencer = 60 mm
Air filter = 150 mm

Assume a blower efficiency of 75%.

23-11 DISCUSSION QUESTIONS

- 23-1.** Step aeration activated sludge provides more oxygen to the microorganisms by "stepping up" the air supplied as the waste moves through the aeration tank. True or false?
- 23-2.** An extended aeration activated sludge plant will be operated at an F/M ratio that is higher than a conventional activated sludge plant. True or false?
- 23-3.** A wastewater treatment plant operating at an F/M ratio of 0.32 d^{-1} is having trouble disposing of its sludge. The treatment plant operator knows that he must alter the F/M ratio to reduce the amount of sludge but cannot remember in which direction. Help the operator out by telling him which direction he should change the F/M ratio (higher or lower) and explain what effect this will have on the power requirements.
- 23-4.** Explain the difference between internal recycle and return activated sludge.
- 23-5.** Identify the common aerator for each of the following processes and explain why it is appropriate:
- Oxidation ditch
 - SBR
 - Completely mixed activated sludge

23-6. Using the influent wastewater characteristics and the effluent limits for the plant shown schematically below, mark how each treatment step affects the concentration of carbonaceous BOD on the graph (Muirhead, 2005a).

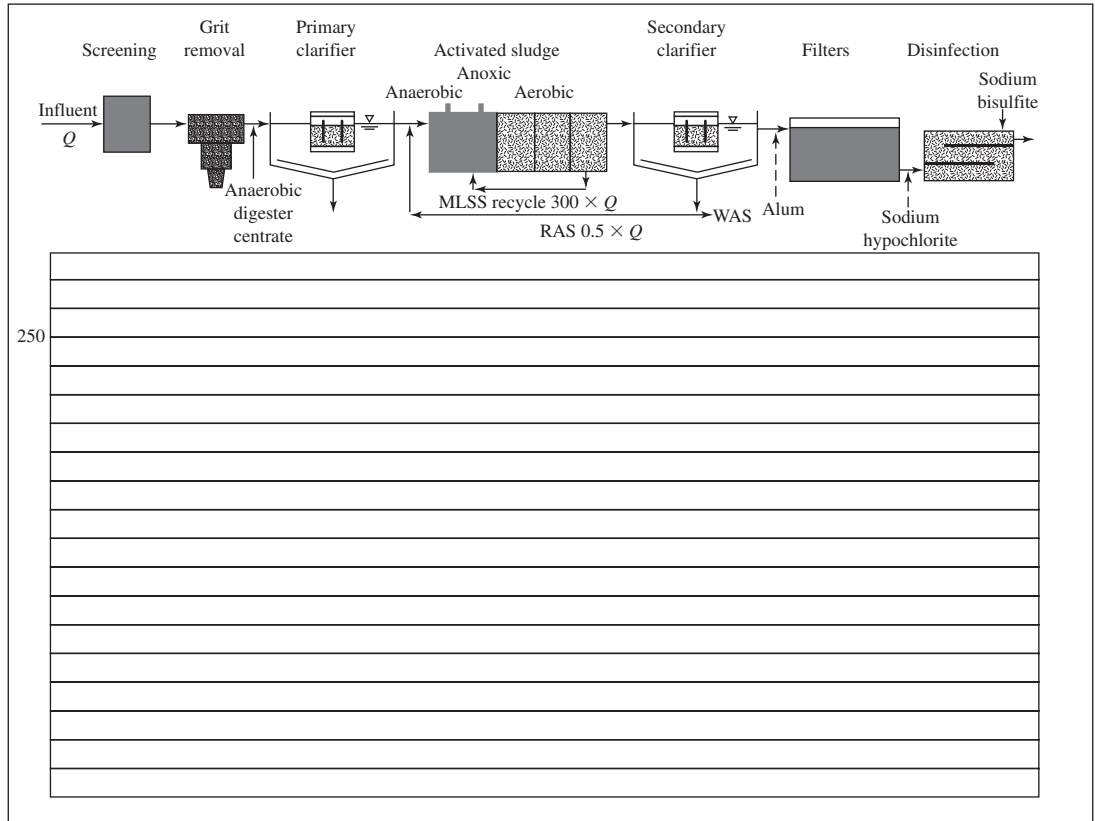

Wastewater characteristics and effluent limits			
Influent characteristics		Effluent limits	
Constituent	Concentration, mg/L	Constituent	Limit, mg/L
CBOD	250	CBOD	30
TSS	225	TSS	30
TKN	35	NH ₄ -N	1.0
Alkalinity	250	NO ₃ -N	10
P	6	P	1.0
Cl ⁻	30		
SO ₄ ⁻²	50		

FIGURE D-23-6 Carbonaceous BOD.

23-7. Using the influent wastewater characteristics and the effluent limits for the plant shown schematically below, mark how each treatment step affects the concentration of ammonia nitrogen on the graph (Muirhead, 2005b).

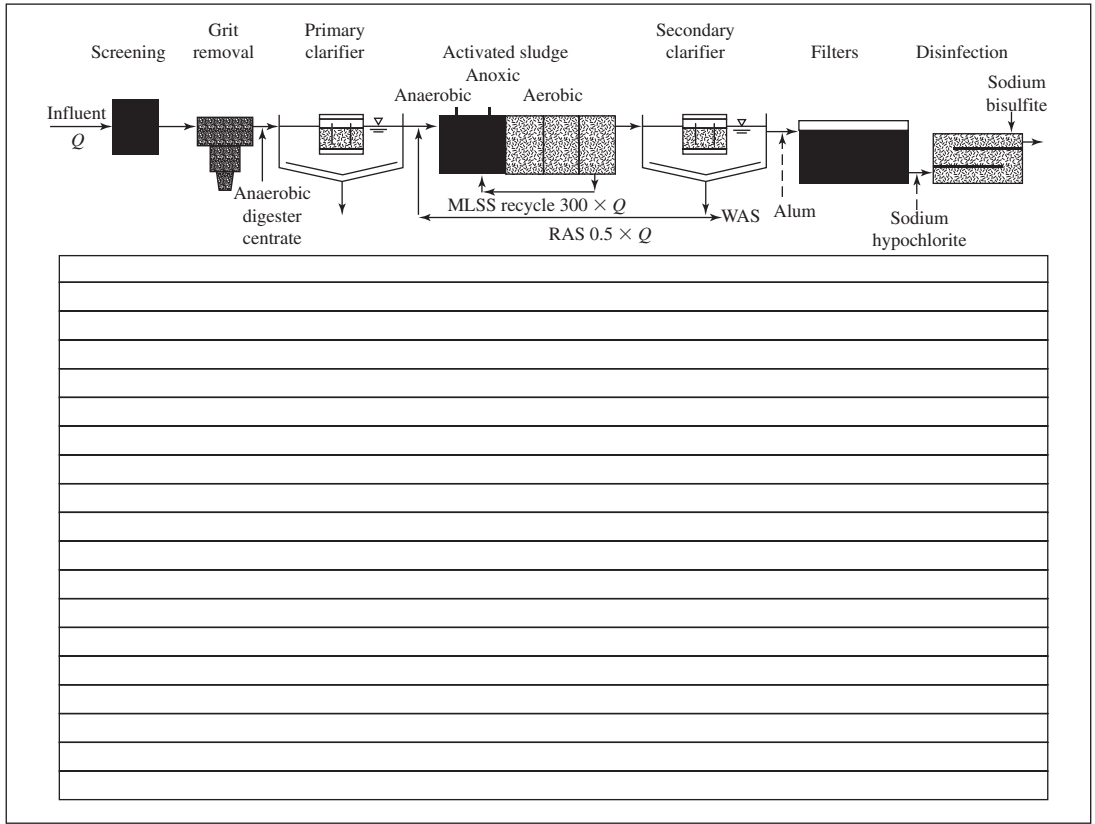

Wastewater characteristics and effluent limits			
Influent characteristics		Effluent limits	
Constituent	Concentration, mg/L	Constituent	Limit, mg/L
BOD/CBOD	250	CBOD	30
TSS	225	TSS	30
TKN	35	NH ₄ -N	1.0
Alkalinity	250	NO ₃ -N	10
P	6	P	1.0
Cl ⁻	50		
SO ₄ ⁻²	30		

FIGURE D-23-7 Ammonia nitrogen.

23-8. Using the influent wastewater characteristics and the effluent limits for the plant shown schematically below, mark how each treatment step affects the concentration of alkalinity on the graph (Muirhead, 2006).

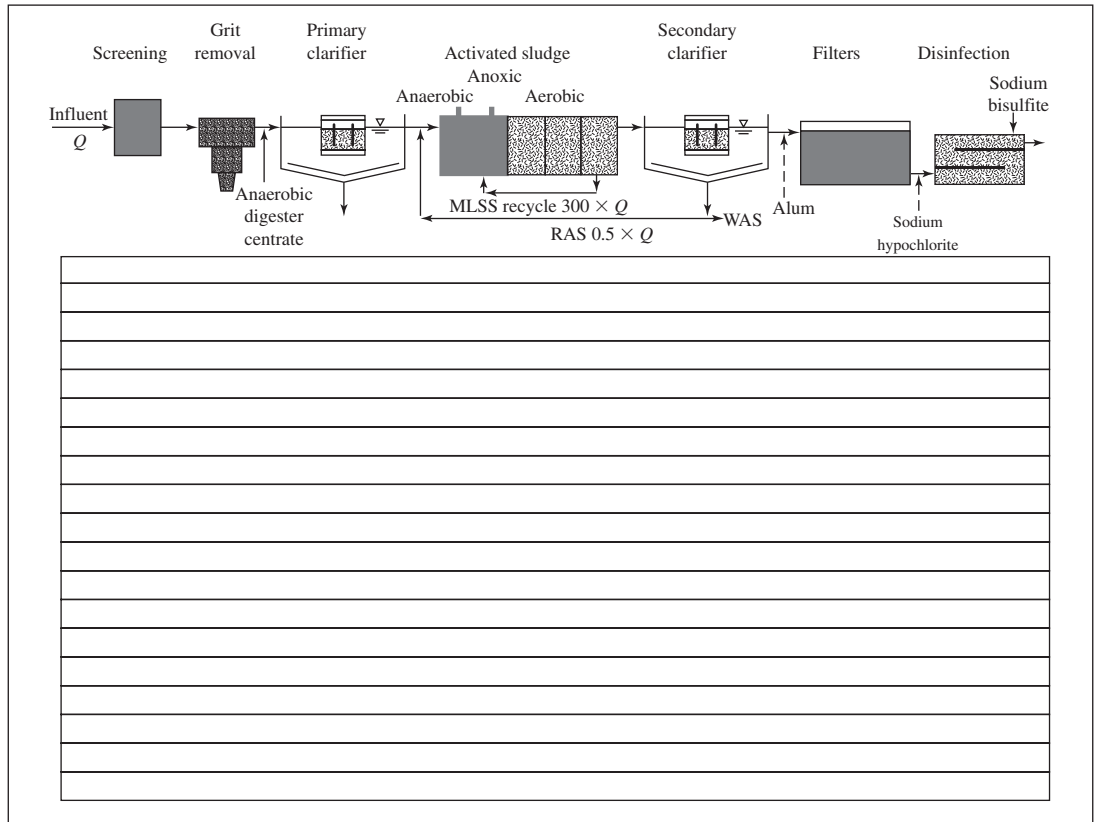

Wastewater characteristics and effluent limits			
Influent characteristics		Effluent limits	
Constituent	Concentration, mg/L	Constituent	Limit, mg/L
BOD/CBOD	250	CBOD	30
TSS	225	TSS	30
TKN	35	NH ₄ -N	1.0
Alkalinity	250	NO ₃ -N	10
P	6	P	1.0
Cl ⁻	50		
SO ₄ ²⁻	30		

FIGURE D-23-8 Alkalinity.

23-12 REFERENCES

- Barker, P. S. and P. L. Dold (1997) "General Model for Biological Nutrient Removal in Activated Sludge Systems: Model Presentation," *Water Environment Research*, vol. 69, no. 5, pp. 969–984.
- Barnard, J. L. (1974) "Cut P and N without Chemicals," *Water and Wastes Engineering*, vol. 11, pp. 41–44.
- Barnard, J. L. (1975) "Biological Nutrient Removal without the Addition of Chemicals," *Water Research*, vol. 9, pp. 485–490.
- Barnard, J. L. (1984) "Activated Primary Tanks for Phosphorus Removal," *Water (South Africa)*, vol. 10, p. 121.
- Caldwell, D. H., D. S. Parker, and W. R. Ute (1973) *Upgrading Lagoons*, U.S. Environmental Protection Agency Technology Transfer Publication, Washington, D.C.
- Choubert, J., A. Strickler, A. Marquot, Y. Racault, S. Gillot, and A. Heduit (2009) "Updated Activated Sludge Model No.1 Parameter Values for Improved Prediction of Nitrogen Removal in Activated Sludge Processes: Validation at 13 Full-Scale Plants," *Water Environment Research*, vol. 81, no. 9, pp. 858–865.
- Christensen, D. R. and P. L. McCarty (1975) "Multi-process Biological Treatment Model," *Journal Water Pollution Control Federation*, vol. 47, pp. 2,652–2,664.
- Crites, R. and G. Tchobanoglous (1998) *Small and Decentralized Wastewater Management Systems*, WCB McGraw-Hill, Boston, Massachusetts, pp. 397–521, 563–699.
- Curley, M. B. (2007) "Ditch the Phosphorus," *Water Environment & Technology*, vol. 19 February, pp. 40–45.
- Davis, M. L. and D. A. Cornwell (2008) *Introduction to Environmental Engineering*, McGraw-Hill, Boston, Massachusetts.
- Dennis, R. W. and R. L. Irvine (1979) "Effect of Fill: React Ratio on Sequencing Batch Biological Reactors," *Journal of Water Pollution Control Federation*, vol. 51, no. 2, pp. 255–263.
- Dick, R. I. (1976) "Folklore in the Design of Final Settling Tanks," *Journal of Water Pollution Control Federation*, vol. 48, no. 4, pp. 633–644.
- Filipe, C. D. M., J. Meinhold, S. Jorgensen, G. T. Daigger, and C. P. L. Grady, Jr. (2001) "Evaluation of the Potential Effects of Equalization on the Performance of Biological Phosphorus Removal Systems," *Water Environment Research*, vol. 73, no. 3, pp. 276–285.
- Erdal, U. G., Erdal, Z. K., C. W. Randall (2003) "The Mechanisms of EBPR Washout and Temperature Relationships," *Proceedings of the 76th Annual Water Environment Federation Technical Exhibition and Conference*, October 11–15, Los Angeles, California, Water Environment Federation, Alexandria, Virginia.
- Erdal, Z. K. (2002) *An Investigation of Biochemistry of Biological Phosphorus Removal Systems*, Ph.D. Dissertation, Virginia Polytechnic Institute and State University, Blacksburg, Virginia.
- Gloyna, E. F. (1972) "Waste Stabilization Pond Design," in E. L. Thackston and W. W. Eckenfelder (eds.), *Process Design in Water Quality Engineering*, Jenkins Publishing Co., New York.
- GLUMRB (2004) *Recommended Standards for Wastewater Facilities*, Great Lakes–Upper Mississippi River Board of State and Provincial Public Health and Environmental Managers, Health Education Services, Albany, New York, pp. 90-1–90-26.
- Goronszy, M. C. (1979) "Intermittent Operation of the Extended Aeration Process for Small Systems," *Journal of Water Pollution Control Federation*, vol. 51, no. 2, pp. 274–287.
- Grady, C. P. L. Jr., G. T. Daigger, and H. C. Lim (1999) *Biological Wastewater Treatment*, 2nd ed., Marcel Dekker, New York.
- Irvine, R. L. and A. W. Busch (1979) "Sequencing Batch Biological Reactors—An Overview," *Journal of Water Pollution Control Federation*, vol. 51, no. 2, pp. 235–243.
- Irvine, R. L. and R. O. Richter (1978) "Comparative Evaluation of Sequencing Batch Reactors," *Journal of the Environmental Engineering Division*, American Society of Civil Engineers, vol. 104, no. EE3, pp. 503–514.
- Jenkins, T. E. (2005) "Rethinking Conventional Wisdom," *Water Environment & Technology*, vol. 17 November, pp. 42–48.

- Lawrence, A. W. and P. L. McCarty (1970) "A Unified Basis for Biological Treatment Design and Operation," *Journal of Sanitary Engineering Division*, American Society of Civil Engineers, vol. 96, no. SA3, p. 757.
- Lewis, W. K., and W. G. Whitman (1924) "Principles of Gas Absorption," *Industrial Engineering Chemistry*, vol. 16, p. 1,215.
- Mamais, D. and D. Jenkins (1992) "The Effects of MCRT and Temperature on Enhanced Biological Phosphorus Removal," *Water Science and Technology*, vol. 26, pp. 955–965.
- Mandt, M. G. and B. A. Bell (1982) *Oxidation Ditches in Wastewater Treatment*, Ann Arbor Science, Ann Arbor, Michigan.
- Marais, G. V. R. and V. A. Shaw (1961) "A Rational Theory for the Design of Sewage Stabilization Ponds in Central and South Africa," *Transactions, South Africa Institute of Civil Engineers*, vol. 3, p. 205.
- McClintock, S. A., C. W. Randall, and V. M. Pattarkine (1991) "Effects of Temperature and Mean Cell Residence Time on Enhanced Biological Phosphorus Removal, *Proceedings of the 1991 Specialty Conference on Environmental Engineering*, Reno, Nevada, July 10–12, P. A. Krenkel (ed.), American Society of Civil Engineers, Reston, Virginia, pp. 319–324.
- Metcalf & Eddy (2003) *Wastewater Engineering: Treatment and Reuse*, 4th ed., McGraw-Hill, Boston, Massachusetts, pp. 429–430, 452–453, 563–886.
- Middlebrooks, E. J. and G. R. Marshall (1974) "Stabilization Pond Upgrading with Intermittent Sand Filters," *Symposium on Upgrading Stabilization Ponds*, Utah State University, November.
- Muirhead, W. M. (2005a) "Track the Path of Carbonaceous Biochemical Oxygen Demand," *Water Environment & Technology*, vol. 17, October, p. 101.
- Muirhead, W. M. (2005b) "Track the Path of Ammonia Nitrogen," *Water Environment & Technology*, vol. 17, December, p. 91.
- Muirhead, W. M. (2006) "Track the Path of Alkalinity," *Water Environment & Technology*, vol. 18, February, p. 63.
- NEIWPCC (2005) *Sequencing Batch Reactor Design and Operational Considerations*, New England Interstate Water Pollution Control Commission, www.neiwpcc.org.
- Parker D. S., D. J. Kinnea, and E. J. Wahlberg (2001) "Review of Folklore in Design and Operation of Secondary Clarifiers," *Journal of Environmental Engineering*, American Society of Civil Engineers vol. 127, pp. 476–484.
- Pound, C. E., R. W. Crites, and D. A. Griffes (1976) *Land Treatment of Municipal Wastewater Effluents, Design Factors I*, U.S. Environmental Protection Agency Technology Transfer Seminar Publication, Washington, D.C.
- Reynolds, T. D. and P. A. Richards (1996) *Unit Operations and Processes in Environmental Engineering*, PWS Publishing, Boston, Massachusetts, p. 444.
- Rittmann, B. E. and P. L. McCarty (2001) *Environmental Biotechnology: Principles and Applications*, McGraw-Hill, Boston, Massachusetts, pp. 313–346.
- Rosso, D. and M. K. Stenstrom (2007) "Energy-Saving Benefits of Denitrification," *Environmental Engineer*, Summer, pp. 29–38.
- Schroeder, E. D. (1982) *Design of Sequencing Batch Reactor Activated Sludge Processes*, presented at a seminar: Civil Engineering for Practicing and Design Engineers, December.
- Shahriar, H., C. Eskicioglu, and R. L. Droste (2006) "Simulating Activated System by Simple-to-Advanced Models," *Journal of Environmental Engineering*, American Society of Civil Engineers, vol. 132, pp. 42–50.
- Silverstein, J. A. (1982) *Operational Control of Bioflocculation and Solids Removal in a Batch Treatment System*, Ph.D. Dissertation, Department of Civil Engineering, University of California, Davis.
- Steel, E. W. and T. J. McGhee (1979) *Water Supply and Sewerage*, 5th ed., McGraw-Hill, New York, pp. 509–510.

- Stenstrom, M. K. and D. T. Redmon (1996) "Oxygen Transfer Performance of Fine Pore Aeration in ASBs—A Full Scale Review," *1996 International Environmental Conference & Exhibits*, pp. 121–131.
- Stephens, H. L. and H. D. Stensel (1998) "Effect of Operating Conditions on Biological Phosphorus Removal," *Water Environment Research*, vol. 70, no. 3, pp. 362–369.
- U.S. EPA (1975a) *Process Design Manual for Nitrogen Control*, U.S. Environmental Protection Agency, Washington, D.C.
- U.S. EPA (1975b) *Wastewater Treatment Lagoons*, U.S. Environmental Protection Agency publication no. EPA-430/9-74-001, MCD-14, Washington, D.C.
- U.S. EPA (1977) *Process Design Manual: Wastewater Treatment Facilities for Sewered Small Communities*, U.S. Environmental Protection Agency publication no. EPA-625/1-77-009, Washington, D.C., pp. 10-1–10-62.
- U.S. EPA (1978) *A Comparison of Oxidation Ditch Plants to Competing Processes for Secondary and Advanced Treatment of Municipal Wastes*, U.S. Environmental Protection Agency, Municipal Environmental Research Laboratory, Cincinnati, Ohio.
- U.S. EPA (1979) *Environmental Control Alternatives for Municipal Wastewater*, U.S. Environmental Protection Agency publication no. EPA-625/5-79-012, Washington, D.C.
- U.S. EPA (1986) *Summary Report: Sequencing Batch Reactors*, U.S. Environmental Protection Agency publication no. EPA-625/8-86/011, Washington, D.C.
- U.S. EPA (1992) *Sequencing Batch Reactor for Nitrogen and Nutrient Removal*, U.S. Environmental Protection Agency, Washington, D.C.
- U.S. EPA (1999a) *Wastewater Technology Fact Sheet: Fine Bubble Aeration*, U.S. Environmental Protection Agency publication no. EPA-832-F-99-065, Washington, D.C.
- U.S. EPA (1999b) *Wastewater Technology Fact Sheet: Sequencing Batch Reactors*, U.S. Environmental Protection Agency publication no. EPA-832-F-99-073, Washington, D.C.
- WEF (1998) *Design of Municipal Wastewater Treatment Plants*, 4th ed., Water Environment Federation Manual of Practice 8, Alexandria, Virginia, pp. 4–20, 11-1–11-241, 13-4–13-8, 15–83.
- WEF (2006a) *Biological Nutrient Removal (BNR) Operation in Wastewater Treatment Plants*, Water Environment Federation, Water Environment Federation Manual of Practice 30, Alexandria, Virginia, pp. 25, 105–226.
- WEF (2006b) *Membrane Systems for Wastewater Treatment*, Water Environment Federation, Water Environment Federation Manual of Practice 30, Alexandria, Virginia, pp. 37–40, 58–109.
- Yonker, S., D. Miller, and L. VanGilder (1998) "Another Class Act for Branson, Missouri," *Water Environment and Technology*, September, pp. 97–101.
- Young, J. C., J. L. Cleasby, and E. R. Baumann (1978) "Flow and Load Variation in Treatment Plant Design," *Journal of the Environmental Engineering Division*, American Society of Civil Engineers, vol. 104, EE2, pp. 289–303.

This page intentionally left blank

**SECONDARY TREATMENT BY ATTACHED
GROWTH AND HYBRID BIOLOGICAL PROCESSES**

- | | |
|---|------------------------------|
| 24-1 INTRODUCTION | 24-5 HYBRID PROCESSES |
| 24-2 ATTACHED GROWTH PROCESSES | 24-6 CHAPTER REVIEW |
| 24-3 ATTACHED GROWTH DESIGN
PRINCIPLES | 24-7 PROBLEMS |
| 24-4 ATTACHED GROWTH DESIGN PRACTICE | 24-8 REFERENCES |

24-1 INTRODUCTION

This chapter focuses on processes that utilize films of microorganisms attached to inert media (*attached growth*) to treat wastewater. In addition, *hybrid processes* that use a combination of suspended growth and attached growth microorganisms are discussed. Those processes utilizing only suspensions of microorganisms (*suspended growth*) to treat wastewater are discussed in Chapter 23.

The portion of this chapter that addresses attached growth is organized into three parts: processes for treatment, design principles, and design practice.

24-2 ATTACHED GROWTH PROCESSES

In attached growth processes, the microorganisms form a film on a bed, disk, or other support material, such as stones, slats, or plastic materials (*media*), over which wastewater is applied. Because the microorganisms that biodegrade the waste form a film on the media, this process is known as an *attached growth* process.

Air, provided by either natural draft or blowers, circulates in the void space between the media elements. Excess growths of microorganisms slough from the media. This would cause high levels of BOD and suspended solids in the plant effluent if not removed. Thus, the flow from the attached growth process is passed through a sedimentation basin to allow these solids to settle out. As in the case of the activated sludge process, this sedimentation basin is referred to as a *secondary clarifier*. Unlike the activated sludge process, the solids are not returned to the attached growth process. They are collected and removed for processing and disposal.

The attached growth process to be considered in this discussion is the *trickling filter*. In addition, the application of attached growth for odor control in the form of a *biofilter* will also be described.

Trickling Filters

Historically, trickling filters have been a popular biologic treatment process. The most widely used design for many years was simply a bed of stones from 1 to 3 m deep through which the wastewater passed. The wastewater is typically distributed over the surface of the rocks by a rotating arm (Figure 24-1a). Rock filter diameters may range up to 60 m.

Trickling filters are not primarily a filtering or straining process as the name implies. The rocks in a rock filter are 25 to 100 mm in diameter, and hence have openings too large to strain out solids. The rocks are a means of providing large amounts of surface area where the microorganisms can cling and grow in a slime on the rocks as they feed on the organic matter.

Although rock trickling filters have performed well for years, they have certain limitations. Under high organic loadings, the slime growths can be so prolific that they plug the void spaces between the rocks, causing flooding and failure of the system. Also, the volume of void spaces is limited in a rock filter. This restricts the circulation of air and the amount of oxygen available for the microbes. This limitation, in turn, restricts the amount of wastewater that can be processed.

To overcome these limitations, other materials have become popular for filling the trickling filter. These materials include modules of corrugated plastic sheets and plastic rings (Figure 24-1b).



(a)

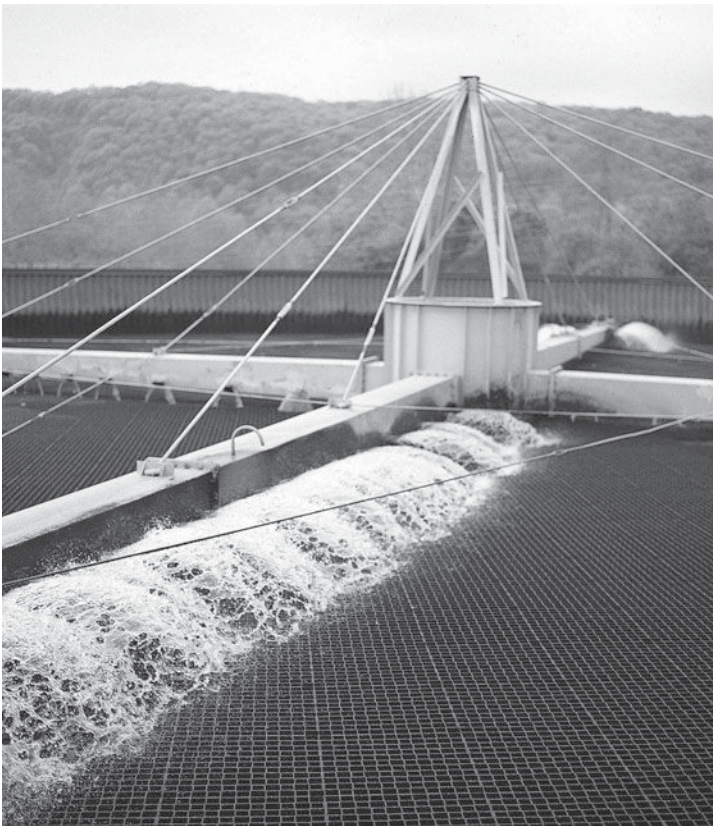

(b)

FIGURE 24-1

Trickling filters, rock media (a) and synthetic media (b). Sources: M. L. Davis and Brentwood Industries.

These media offer larger surface areas for slime growths (typically 90 square meters of surface area per cubic meter of bulk volume, as compared to 40 to 60 square meters per cubic meter for 75 mm rocks) and greatly increase void ratios for increased air flow. The materials are also much lighter than rock (by a factor of about 30), so the trickling filters can be much taller without facing structural problems. While the rock in filters is usually not more than 3 m deep, synthetic media depths may reach 12 m. This reduces the overall space requirements for the trickling filter portion of the treatment plant.

Oxygen is typically supplied to the rock filters by natural draft ventilation of air. Deeper synthetic media filters may be provided with forced draft ventilation (called a *biological aerated filter* or BAF). They may be designed with an aerobic zone at the top and an anoxic zone at the bottom to promote denitrification.

A 10-year side-by-side study of the performance of full scale conventional activated sludge and a biological aerated filter found the following (Hansen et al., 2007):

- Both systems are operationally reliable and easy to handle and maintain.
- The BAF is less sensitive to both hydraulic and BOD load fluctuations.
- The BAF maintains better and more stable nitrification at both normal and low temperatures.
- Activated sludge unit operating costs are less than BAFs.

Biofilters

This process is **not** used to treat wastewater. It is used to treat odors from wastewater treatment processes. Biofilters are packed bed filters. The packing material is often one of the following materials: peat, compost, or a mixture of compost and other materials such as perlite, oyster shells, and limestone. As the odorous gas passes through the biofilter, two processes occur simultaneously: absorption/adsorption and bioconversion. The gases are absorbed into the moist surface biofilm layer. Microorganisms, principally bacteria, actinomycetes, and fungi that are attached to the media, oxidize the absorbed/adsorbed gases. Moisture content and temperature are important environmental conditions that must be maintained.

Over 50 papers on the performance of biofilters have been written in the last two decades. Iranpour et al. (2005) presents a literature review of the effectiveness of these units for air pollution control. Many articles on modeling and design appear in the *Journal of the Air & Waste Management Association*.

24-3 ATTACHED GROWTH DESIGN PRINCIPLES

The growth conditions and the hydrodynamics of the trickling filter control the thickness of the biofilm. The thickness may range from 100 μm to 10 mm. A stagnant liquid layer called the *diffusion layer* separates the biofilm from the bulk liquid wastewater (Figure 24-2a). Substrate, oxygen, and nutrients diffuse across the stagnant liquid layer to the biofilm, and products of biodegradation diffuse from the biofilm to the bulk liquid layer.

As shown in Figure 24-2a, the substrate concentration, S_s , decreases with biofilm depth as it is consumed and diffuses into the film. As a result, the process is said to be *diffusion limited*. The rate of mass transfer is termed the *substrate surface flux*. It is expressed as mass per unit area

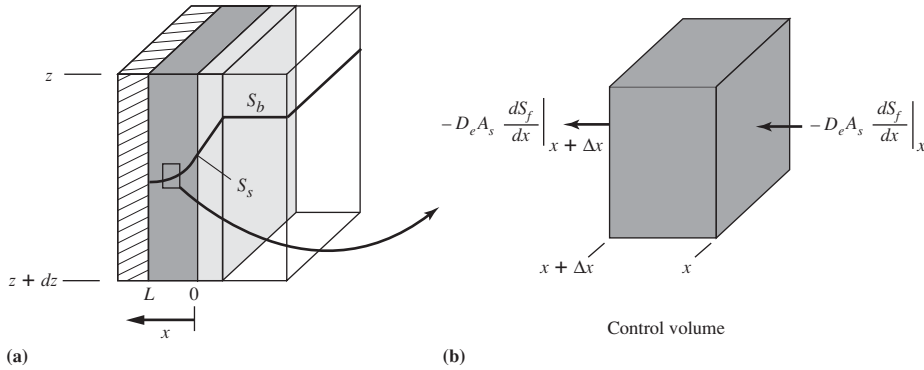
**FIGURE 24-2**

Definition sketch for the analysis of substrate concentration in the biofilm.

per unit time ($\text{g}/\text{m}^2 \cdot \text{d}$). The substrate flux is a function of the substrate diffusion coefficient and concentration (Metcalf & Eddy, 2003):

$$r_{sf} = -D_w \frac{dS}{dx} = -D_w \frac{(S_b - S_s)}{L} \quad (24-1)$$

where r_{sf} = rate of substrate surface flux, $\text{g}/\text{m}^2 \cdot \text{d}$
 D_w = diffusion coefficient of substrate in water, m^2/d
 dS/dx = substrate concentration gradient, $\text{g}/\text{m}^3 \cdot \text{m}$
 S_b = bulk liquid substrate concentration, g/m^3
 S_s = substrate concentration in outer layer of biofilm, g/m^3
 L = effective thickness of the stagnant film, m

The thickness of the stagnant layer will vary with the fluid velocity. Higher velocities will result in thinner films and greater substrate flux rates (Grady et al., 1999).

A mass balance around the differential element (dx) shown in Figure 24-2b yields the following general equation for the change in substrate concentration within the biofilm:

$$D_e \frac{d^2 S_f}{dx^2} - \left(\frac{\mu_m S_f X}{Y(K_s + S_f)} \right) = 0 \quad (24-2)$$

where D_e = effective diffusivity coefficient in biofilm, m^2/d
 μ_m = maximum specific bacterial growth rate, g new cells/g cells \cdot d
 S_f = substrate concentration at a point in the biofilm, g/m^3
 X = biomass concentration, g/m^3
 Y = yield coefficient, g/g
 K_s = half-velocity constant, g/m^3

Solutions to Equation 24-2 require two boundary conditions. The first boundary condition is that the substrate flux at the biofilm surface equals the substrate flux through the stagnant

film as given by Equation 24-1. The secondary boundary condition is that there is no flux at the media surface:

$$\frac{dS}{dx} \Big|_{x=L} = 0 \quad (24-3)$$

Solution approaches are provided in a number of references including the following: Grady et al. (1999), Rittmann and McCarty (2001), and Williamson and McCarty (1976).

There is an assumption in the diffusion-limited processes that either the electron donor or electron acceptor (i.e., oxygen or nitrate) is limiting. For example, nitrification rates in attached growth reactors are often limited by the bulk wastewater DO (Metcalf & Eddy, 2003).

The value of the mechanistic models is in providing an understanding of the relationship of the microbial stoichiometry to the behavior of the attached growth reactor. The complexity of attached growth reactors and the inability to define physical parameters and establish coefficients makes them impractical for design. Empirical relationships, based on experience, are used for design.

24-4 ATTACHED GROWTH DESIGN PRACTICE

Because of their stable operation and relative ease of operation, trickling filters were the method of choice for secondary treatment of municipal wastewater early in the 20th century. In 1984, 25 percent of municipal secondary treatment facilities in the United States used trickling filters (U.S. EPA, 1984). However, many of these have been phased out and few new ones have been built. The reasons for this are many, but primarily there are four:

- Activated sludge processes are more economical.
- Activated sludge processes are more flexible.
- Activated sludge processes can meet more stringent effluent standards.
- Odor complaints are more frequent when rock filters are used.

Nonetheless, modern technologic improvements in media and forced air aeration have made attached growth processes more attractive in recent years. This is especially so where an existing facility may be incorporated into a plant upgrade. The requirement for less skilled personnel for operation and the advantage of using less energy than activated sludge processes are often serious considerations favoring attached growth process selection.

Redundancy. A minimum of two parallel systems are provided for redundancy.

Preliminary Treatment. Grit removal and screening are typically provided. For municipal wastewater, operation has been more than adequate without equalization (WEF, 1998).

Primary Treatment. Primary clarification is typically provided. Instead of primary clarifiers, fine screens have been used successfully with plastic media, but the filter must be enlarged to handle the additional organic load. The filter may have to be flushed periodically to prevent solids accumulation (WEF, 1998).

Process Alternatives. Trickling filters have been operated to achieve the following:

- Carbonaceous BOD removal.
- Carbonaceous BOD removal, nitrification, and denitrification.

Design Loading. Trickling filters are classified according to the applied hydraulic and organic load. The hydraulic load may be expressed as cubic meters of wastewater applied per day per square meter of bulk filter surface area ($\text{m}^3/\text{d} \cdot \text{m}^2$) or, preferably, as the depth of water applied per unit of time (mm/s or m/d). Organic loading is expressed as kilograms of BOD₅ per day per cubic meter of bulk filter volume ($\text{kg}/\text{d} \cdot \text{m}^3$). Common hydraulic and organic loadings for the various filter classifications are summarized in Table 24-1.

Typical applications are summarized in Table 24-2.

Recirculation. An important element in trickling filter design is the provision for the return of a portion of the effluent to flow through the filter. This practice is called *recirculation*. The ratio

TABLE 24-1
Comparison of different types of trickling filters

Design characteristics	Trickling filter classification				
	Low or standard rate	Intermediate rate	High rate (stone media)	Super rate (plastic media)	Roughing
Hydraulic loading, m/d	1 to 4	4 to 10	10 to 40	15 to 90 ^a	60 to 180 ^a
Organic loading, kg BOD ₅ /d · m ³	0.08 to 0.22	0.26 to 0.51	0.36 to 1.8	0.32 to 1.0	Above 1.0
Recirculation ratio	0	0 to 1	1 to 3	1 to 2	0 to 2
Filter flies	Many	Varies	Few	Few	Few
Sloughing	Intermittent	Varies	Continuous	Continuous	Continuous
Depth, m	1.5 to 3	1.5 to 2.5	1 to 2	Up to 12	1 to 6
BOD ₅ removal, %	80 to 85	50 to 70	40 to 80	65 to 85	40 to 85
Effluent quality	Well nitrified	Some nitrification	No nitrification	No nitrification	No nitrification

^aNot including recirculation.

Adapted from WEF, 1998; Metcalf & Eddy, 2003.

TABLE 24-2
Typical trickling filter applications

Application	Loading	Effluent quality
Secondary treatment	0.3 to 1.0 kg BOD/m ³ · d	15–30 mg/L BOD 15–30 mg/L TSS
BOD removal and nitrification	0.1 to 0.3 kg BOD/m ³ · d 0.2 to 1.0 g TKN/m ² · d ^a	< 10 mg/L BOD < 3 mg/L NH ₄ -N
Tertiary nitrification	0.5 to 2.5 g NH ₄ -N/m ² · d*	0.5–3 mg/L NH ₄ -N

^aLoading based on packing surface area.

Source: Metcalf & Eddy, 2003.

of the returned flow to the incoming flow is called the *recirculation ratio* (R). Recirculation is practiced in rock filters for the following reasons:

1. To increase contact efficiency by bringing the waste into contact more than once with active biological material.
2. To dampen variations in loadings over a 24-hour period. The strength of the recirculated flow lags behind that of the incoming wastewater. Thus, recirculation dilutes strong influent and supplements weak influent.
3. To raise the DO of the influent.
4. To improve distribution over the surface, thus reducing the tendency to clog and also to reduce filter flies.
5. To prevent the biological slime from drying out and dying during nighttime periods when flows may be too low to keep the filter wet continuously.

Recirculation may or may not improve treatment efficiency. The more dilute the incoming wastewater, the less likely it is that recirculation will improve efficiency.

Recirculation is practiced for plastic media to provide the desired wetting rate to keep the microorganisms alive. Generally, increasing the hydraulic loading above the minimum wetting rate does not increase BOD_5 removal. The minimum wetting rate normally falls in the range of 25 to 60 m/d.

Stages. Two-stage trickling filters (Figure 24-3) provide a means of improving the performance of filters. The second stage acts as a polishing step for the effluent from the primary stage by providing additional contact time between the waste and the microorganisms. Both stages may use the same media or each stage may have different media as shown in Figure 24-3.

Design Formulas. Numerous investigators have attempted to correlate operating data with the bulk design parameters of trickling filters. Rather than attempt a comprehensive review of these formulations, the National Research Council (NRC, 1946) equations and Schulze's equation (Schulze, 1960) have been selected as illustrations. A thorough review of several of the more

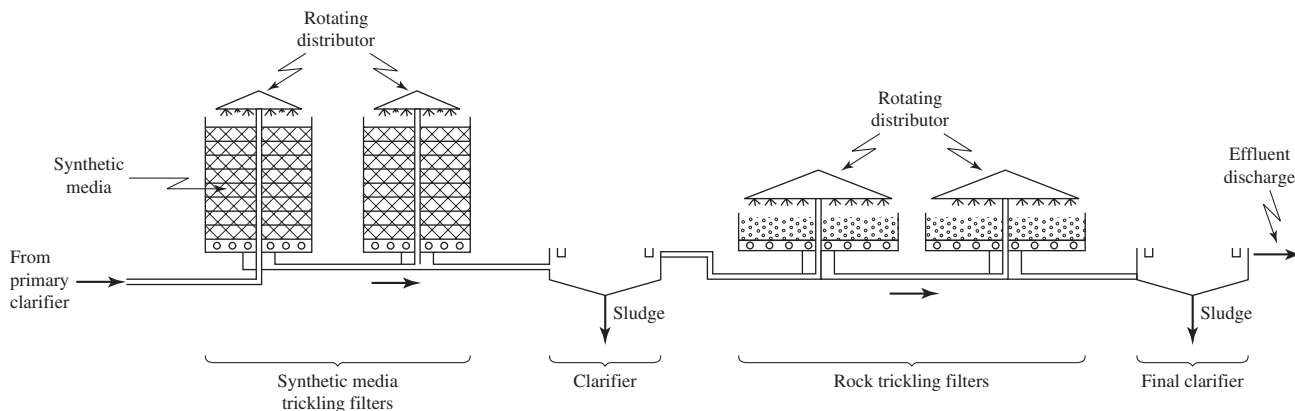

FIGURE 24-3
Two-stage trickling filter plant.

important equations is given in the Water Environment Federation's publication on wastewater treatment plant design (WEF, 1998).

During World War II, the NRC made an extensive study of the operation of trickling filters serving military installations. From this study, empirical equations were developed to predict the efficiency of the filters based on the BOD load, the volume of the filter media, and the recirculation. For a single-stage filter or the first stage of a two-stage, rock filter, the efficiency is

$$E_1 = \frac{1}{1 + 4.12 \left(\frac{QC_{in}}{VF} \right)^{0.5}} \quad (24-4)$$

where E_1 = fraction of BOD₅ removal for first stage at 20°C, including recirculation and sedimentation

Q = wastewater flow rate, m³/s

C_{in} = influent BOD₅, mg/L

V = volume of filter media, m³

F = recirculation factor

The recirculation factor is defined as

$$F = \frac{1 + R}{(1 + 0.1R)^2} \quad (24-5)$$

where R = recirculation ratio = Q_r/Q

Q_r = recirculation flow rate, m³/s

Q = wastewater flow rate, m³/s

The recirculation factor represents the average number of passes of the raw wastewater BOD through the filter. The 0.1 R factor is to account for the empirical observation that the biodegradability of the organic matter decreases as the number of passes increases. For the second-stage filter, the efficiency is

$$E_2 = \frac{1}{1 + \frac{4.12}{1 - E_1} \left(\frac{QC_e}{VF} \right)^{0.5}} \quad (24-6)$$

where E_2 = fraction of BOD₅ removal for second-stage filter at 20°C, including recirculation and sedimentation

E_1 = fraction of BOD₅ removed in first stage

C_e = effluent BOD₅ from first stage, mg/L

The effect of temperature on the efficiency may be estimated from the following equation:

$$E_T = E_{20} \varphi^{(T-20)} \quad (24-7)$$

where a value of 1.035 is used for φ .

Some care should be used in applying the NRC equations. Military wastewater during this period (World War II) had a higher strength than domestic wastewater today. The filter media was rock. Clarifiers associated with the trickling filters were shallower and carried higher hydraulic loads than current practice would permit. The second-stage filter is assumed to be preceded by an intermediate settling tank (see Figure 24-3).

Example 24-1. Using the NRC equations, determine the BOD₅ of the effluent from a single-stage, low-rate trickling filter that has a filter volume of 1,443 m³, a hydraulic flow rate of 1,900 m³/d, and a recirculation factor of 2.78. The influent BOD₅ is 150 mg/L.

Solution:

- a. To use the NRC equation, the flow rate must first be converted to the correct units.

$$Q = \frac{1,900 \text{ m}^3/\text{d}}{86,400 \text{ s/d}} = 0.022 \text{ m}^3/\text{s}$$

- b. The efficiency of a single-stage filter is

$$E_1 = \frac{1}{1 + 4.12 \left(\frac{(0.022 \text{ m}^3/\text{s})(150 \text{ mg/L})}{(1,443 \text{ m}^3)(2.78)} \right)^{0.5}}$$

$$= 0.8943$$

- c. The concentration of BOD₅ in the effluent is then

$$C_e = (1 - 0.8943)(150 \text{ mg/L}) = 15.9 \text{ mg/L}$$

Schulze (1960) proposed that the time of wastewater contact with the biological mass in the filter is directly proportional to the depth of the filter and inversely proportional to the hydraulic loading rate:

$$t = \frac{CD}{\left(\frac{Q}{A}\right)^n} \quad (24-8)$$

where C = mean active film per unit volume

D = filter depth, m

Q = hydraulic loading, m³/d

A = filter area over which wastewater is applied, m²

n = empirical constant based on filter media

The mean active film per unit volume may be approximated by

$$C \approx \frac{1}{D^m} \quad (24-9)$$

where m is an empirical constant that is an indicator of biological slime distribution. It is normally assumed that the distribution is uniform and that $m = 0$. Thus, C is 1.0.

Schulze combined his relationship with Velz's (1948) first-order equation for BOD removal:

$$\frac{S_t}{S_o} = \exp \left[\frac{KD}{\left(\frac{Q}{A}\right)^n} \right] \quad (24-10)$$

where S_t/S_o is the ratio of substrate concentration at a contact time t to the applied substrate concentration and K is an empirical rate constant with the units of

$$\frac{(\text{m/d})^n}{\text{m}}$$

The values of K and n determined by Schulze were $0.69 (\text{m/d})^n/\text{m}$ and 0.67 , respectively, at 20°C . The temperature correction for K may be computed with Equation 24-7 if K_T is substituted for E_T and K_{20} is substituted for E_{20} .

Example 24-2. Determine the BOD₅ of the effluent from a low-rate trickling filter that has a diameter of 35.0 m and a depth of 1.5 m if the flow rate is 1,900 m³/d and the influent BOD₅ is 150.0 mg/L. Assume the rate constant is $2.3 (\text{m/d})^n/\text{m}$ and $n = 0.67$.

Solution:

- a. Begin by computing the area of the filter.

$$A = \frac{\pi(35.0 \text{ m})^2}{4} = 962.11 \text{ m}^2$$

- b. This area is then used to compute the loading rate.

$$\frac{Q}{A} = \frac{1,900 \text{ m}^3/\text{d}}{962.11 \text{ m}^2} = 1.97 \text{ m}^3/\text{d} \cdot \text{m}^2 \text{ or } 1.97 \text{ m/d}$$

- c. Compute the effluent BOD using Equation 24-10

$$S_t = (150 \text{ mg/L}) \exp \left[\frac{-2.3(1.5)}{(1.97)^{0.67}} \right] = 16.8 \text{ mg/L}$$

Germain (1966) applied the Schulze equation to trickling filters with plastic media. In this application, the value for n is assumed to be 0.5 and pilot plant data is used to solve for K .

Dosing Systems. The wastewater is distributed over the filter by two or four horizontally mounted arms. The arms are typically driven by the dynamic reaction of the wastewater discharging from the nozzles. A clearance of 200 to 250 mm above the top of the filter is provided. Headloss through the distributor ranges from 0.6 to 1.5 m.

Underdrains. For rock filters, the underdrain system consists of precast blocks of vitrified clay placed on a concrete floor. For plastic media, the underdrain is typically either a beam and column or grating. The floor is sloped at 1 to 5 percent. The effluent channels are sized to produce a velocity of 0.6 m/s.

The underdrains should be designed so that forced-air ventilation may be added.

Fans. Forced draft or induced draft fans are recommended. An approximate air flow of $0.3 \text{ m}^3/\text{m}^2$ of filter area $\cdot \text{min}$ may be used for preliminary estimates. The design should provide multiple air distribution points.

24-5 HYBRID PROCESSES

Hybrid processes refer to activated sludge systems that incorporate some form of media in the suspended growth reactor. Three systems have been selected as examples: *rotating biological contactors* (RBCs), *integrated fixed-film activated sludge* (IFAS), and *moving bed biofilm reactors* (MBBR).

Rotating Biological Contactors (RBCs)

The RBC process consists of a series of closely spaced discs (3 to 3.5 m in diameter) mounted on a horizontal shaft. The discs are rotated while about one-half of their surface area is immersed in wastewater (Figure 24-4). The discs are typically constructed of lightweight plastic. The speed of rotation of the discs is adjustable.

When the process is placed in operation, the microbes in the wastewater begin to adhere to the rotating surfaces and grow there until the entire surface area of the discs is covered with a 1- to 3-mm layer of biological slime. As the discs rotate, they carry a film of wastewater into the air; this wastewater trickles down the surface of the discs, absorbing oxygen. As the discs complete their rotation, the film of water mixes with the reservoir of wastewater, adding to the oxygen in the reservoir and mixing the treated and partially treated wastewater. As the attached microbes pass through the reservoir, they absorb other organic compounds for oxidation. The excess growth of microbes is sheared from the discs as they move through the reservoir. These dislodged organisms are kept in suspension by the moving discs. Thus, the discs serve several purposes:

1. They provide media for the buildup of attached microbial growth.
2. They bring the growth into contact with the wastewater.
3. They aerate the wastewater and the suspended microbial growth in the reservoir.

The attached growths are similar in concept to a trickling filter, except the microbes are passed through the wastewater rather than the wastewater passing over the microbes. Some of the advantages of both the trickling filter and activated sludge processes are realized.

As the treated wastewater flows from the reservoir below the discs, it carries the suspended growths out to a downstream settling basin for removal. The process can achieve secondary effluent quality or better. By placing several sets of discs in series, it is possible to achieve even higher degrees of treatment, including biological conversion of ammonia to nitrates.

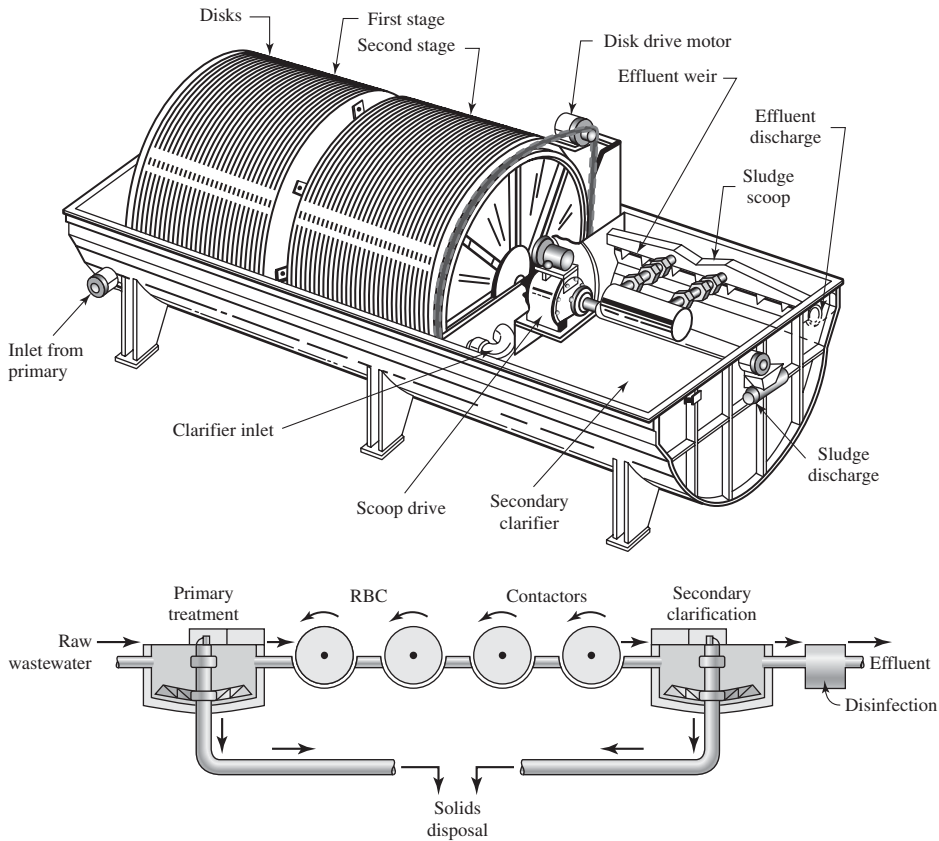

FIGURE 24-4
Rotating biological contactor (RBC) and process arrangement. (Source: U.S. EPA, 1977.)

The history of RBC installations has not been exemplary. Poor mechanical design and lack of understanding of the biological process has resulted in structural failure of shafts, disks, and so on. Many of the problems with early installations have been resolved and numerous installations are performing satisfactorily.

The principal advantages of the RBC process are simplicity of operation and relatively low energy costs. They have found application in small communities.

Integrated Fixed-Film Activated Sludge (IFAS)

This category includes any activated sludge system that incorporates a fixed-film media in a suspended growth reactor. The purpose of fixed-film media is to increase the biomass in the reactor. This offers the potential to reduce the basin size or to increase the capacity of an existing basin in a retrofit application. Various types of suspended growth systems have been used. Examples include conventional, modified Ludzack-Ettinger (MLE), and step denitrification. These processes differ from the MBBR described below in that they use a return sludge flow.

A number of proprietary media types have been used including rope (no longer in use), sponge, plastic carriers, and a honeycomb polyester fabric called BioWeb™. The media that are

fixed in a frame are preferred because they require fewer appurtenances and are less susceptible to hydraulic problems that result from free-floating media.

The media frames are placed in conventional aeration tanks above a grid of fine bubble diffusers. The frames vary in size to fit the aeration tank dimensions. For example, an arrangement of two units with dimensions of $3.8\text{ m} \times 3.8\text{ m} \times 4\text{ m}$ high is set side by side across the flow path of the reactor. One reported arrangement used 24 units spaced evenly along a plug flow reactor for a $17,000\text{ m}^3/\text{d}$ plant (Jackson et al., 2007).

Typical design criteria are as follows:

- MLSS: 1,000 to 3,000 mg/L
- MCRT: 3 to 10 days
- HRT: 3.5 to 4 hours

Moving Bed Biofilm Reactor (MBBR)

This process uses small, plastic elements (on the order of 7 to 22 mm effective diameter) to support the growth of biofilm in the reactor. The suspended growth portion of the hybrid is designed as a complete mix reactor. It is commonly mixed with aeration but may also be mixed with a mechanical mixer. The process does not use a return sludge flow.

The media (typically polyethylene) is formed in a geometry to provide a high surface area ($250\text{--}515\text{ m}^2/\text{m}^3$). It has a density near that of water ($\approx 0.96\text{ g}/\text{cm}^3$). The reactors are normally filled from one-third to two-thirds of their empty volume with media. Because of their shape, less than 15 percent of the water is displaced. A screen across the outlet is used to prevent the media from leaving the aeration tank. Aeration is typically by coarse bubble diffusers.

Typical design criteria are as follows:

- MLSS: 100 to 250 mg/L
- MCRT: 0.15 days
- HRT: 3 hours

Visit the text website at www.mhprofessional.com/wwe for supplementary materials and a gallery of additional photos.

24-6 CHAPTER REVIEW

When you have completed studying this chapter, you should be able to do the following without the aid of your text or notes:

1. Describe the difference between attached growth processes and suspended growth processes.
2. Explain why a trickling filter does not really “filter” the wastewater.
3. Describe the two methods used to provide oxygen to a trickling filter.
4. Explain how the function of a biofilter differs from that of a trickling filter.

5. Explain why an attached growth biological process is diffusion limited.
6. Explain the function of recirculation in a rock filter and in a synthetic media filter.
7. Describe under what circumstances recirculation may be beneficial and when it may not.
8. Describe three types of hybrid processes.
9. Define the following terms: media, biofilter, BAF, RBC, IFAS, MBBR.

With the aid of this text, you should be able to do the following:

10. Select an appropriate type of trickling filter for a specified application. For example: super rate for a BOD₅ loading of 0.5 kg BOD/m³ · d.
11. Use the appropriate trickling filter equation to determine one or more of the following, given the appropriate data: treatment efficiency, filter volume, filter depth, hydraulic loading rate.
12. Calculate empirical coefficients for use with proprietary media.

24-7 PROBLEMS

- 24-1. Envirotech Systems markets synthetic media for use in the construction of trickling filters. Envirotech uses the following formula to determine BOD removal efficiency:

$$\frac{L_e}{L_i} = \exp\left[-\frac{K\psi D}{Q^n}\right]$$

where L_e = BOD₅ of effluent, mg/L
 L_i = BOD₅ of influent, mg/L
 K = treatability factor, (m/d)^{0.5}/m
 ψ = temperature correction factor
 $= (1.035)^{T-20}$
 T = wastewater temperature, °C
 D = media depth, m
 Q = hydraulic loading rate, m/d
 $n = 0.5$

Using the following data for domestic wastewater, determine the treatability factor K .

Wastewater temperature = 13°C

Hydraulic loading rate = 41.1 m/d

% BOD remaining	Media depth, m
100.0	0.00
80.3	1.00
64.5	2.00
41.6	4.00
17.3	8.00

- 24-2.** Using the Envirotech Systems equation and the treatability factor from Problem 24-1, estimate the depth of filter required to achieve 82.7% BOD₅ removal if the wastewater temperature is 20°C and the hydraulic loading rate is 41.1 m/d.
- 24-3.** Koon et al. (1976) suggest that recirculation for a synthetic media filter may be considered by the following formula:

$$\frac{L_e}{L_i} = \frac{\exp\left[-\frac{K\psi D}{Q^n}\right]}{(1+R) - R \exp\left[-\frac{K\psi D}{Q^n}\right]}$$

where R = recirculation ratio and all other terms are as described in Problem 24-1.

Use this equation to determine the efficiency of a 1.8-m-deep synthetic media filter loaded at a hydraulic loading rate of 5.00 m/d with a recirculation ratio of 2.00. The wastewater temperature is 16°C and the treatability factor is 1.79 (m/d)^{0.5}/m at 20°C.

- 24-4.** Determine the concentration of the effluent BOD₅ for the two-stage trickling filter described below. The wastewater temperature is 17°C. Assume the NRC equations apply.

Design flow = 0.0509 m³/s
 Influent BOD₅ (after primary treatment) = 260 mg/L
 Diameter of each filter = 24.0 m
 Depth of each filter = 1.83 m
 Recirculation flow rate for each filter = 0.0594 m³/s

- 24-5.** Using a spreadsheet program you have written, plot a graph of the final effluent BOD₅ of the two-stage filter described in Problem 24-4 as a function of the influent flow rate. Assume that the ratio of recirculation flow to influent flow remains constant. Use flow rates of 0.02, 0.03, 0.04, 0.05, 0.06, 0.07, 0.08, 0.09, and 0.10 m³/s for the influent.
- 24-6.** Determine the diameter of a single-stage rock media filter to reduce an applied BOD₅ of 125 mg/L to 25 mg/L. Use a flow rate of 0.14 m³/s, a recirculation ratio of 12.0, and a filter depth of 1.83 m. Assume the NRC equations apply and that the wastewater temperature is 20°C.
- 24-7.** Using a spreadsheet program you have written, plot a graph of the final effluent BOD₅ of the single-stage filter described in Problem 24-6 as a function of the influent flow rate. Assume that the ratio of recirculation flow to influent flow remains constant and that the filter diameter is 35.0 m. Use hydraulic loading rates of 10, 12, 14, 16, 18, and 20 m³/m².

24-8 REFERENCES

- Germain, J. E. (1966) "Economical Treatment of Domestic Waste by Plastic Media Trickling Filters," *Journal Water Pollution Control Federation*, vol. 38, p. 192.
- Grady, C. P. L., Jr., G. T. Daigger, and H. C. Lin (1999) *Biological Wastewater Treatment*, 2nd ed., Marcel Dekker, New York.

- Hansen, R., T. Thogersen, and F. Rogalla (2007) "Comparing Cost and Process Performance of Activated Sludge (AS) and Biological Aerated Filters (BAF) Over Ten Years of Full Scale Operation," *Water Science & Technology*, vol. 55, nos. 8–9, pp. 99–106.
- Iranpour, R., H. H. J. Cox, M. A. Deshusses, and E. D. Schroeder (2005) "Literature Review of Air Pollution Control Biofilters and Biotrickling Filters for Odor and Volatile Organic Compound Removal" *Environmental Progress*, vol. 24, no. 3, pp. 254–267.
- Jackson, D. R., L. E. Ripley, T. Maurina, and S. Hubbell (2007) "Up to the Challenge," *Water Environment and Technology*, November, pp. 51–55.
- Koon, J. H., R. F. Curran, C. E. Adams, and W. W. Eckenfelder (1976) *Evaluation and Upgrading of a Multistage Trickling Filter Facility*, U.S. Environmental Protection Agency, Publication No. EPA 600/2-76-193, Washington, DC.
- Metcalf & Eddy (2003) *Wastewater Engineering: Treatment and Reuse*, 4th ed., McGraw-Hill, Boston, Massachusetts, pp. 602-607.
- NRC (1946) "Sewage Treatment at Military Installations," *Sewage Works Journal*, vol. 18, p. 787.
- Rittmann, B. E. and P. L. McCarty (2001) *Environmental Biotechnology: Principles and Applications*, McGraw-Hill, Boston, Massachusetts.
- Schulze, K. L. (1960) "Load and Efficiency of Trickling Filters," *Journal of Water Pollution Control Federation*, vol. 32, p. 245.
- U. S. EPA (1977) *Process Design Manual: Wastewater Treatment Facilities for Sewered Small Communities*, U. S. Environmental Protection Agency, EPA Pub. No. 625/1-77-09, Washington, D. C. p. 8–12.
- U.S. EPA (1984) *Needs Survey*, U.S. Environmental Protection Agency, Washington, D.C.
- Velz, C. J. (1948) "A Basic Law for the Performance of Biological Filters," *Sewage Works*, vol. 20, p. 607.
- WEF (1998) *Design of Municipal Wastewater Treatment Plants*, 4th ed., Water Environment Federation Manual of Practice 8, Alexandria, Virginia, pp. 12-1–12-187.
- Williamson, K. and P. L. McCarty (1976) "A Model of Substrate Utilization by Bacterial Films," *Journal Water Pollution Control Federation*, vol. 48, pp. 9–24.

This page intentionally left blank

**SECONDARY SETTLING, DISINFECTION,
AND POSTAERATION**

25-1 INTRODUCTION

25-2 SECONDARY SETTLING

25-3 DISINFECTION

25-4 POSTAERATION

25-5 CHAPTER REVIEW

25-6 PROBLEMS

25-7 DISCUSSION QUESTIONS

25-8 REFERENCES

25-1 INTRODUCTION

The EPA's requirements for secondary treatment include an effluent BOD₅ less than or equal to 30 mg/L and an effluent suspended solids less than or equal to 30 mg/L. Most National Pollution Discharge Elimination System (NPDES) permits also specify a fecal coliform concentration. Dissolved oxygen modeling may also reveal the need for postaeration to maintain the receiving body water quality. The secondary treatment processes to meet these requirements are the subject of this chapter.

As noted in the chapters devoted to biological treatment processes, the conversion of BOD to microbial cells does little to reduce the BOD in the effluent if the cells are discharged. Likewise, suspended solids limits cannot be met if the microbial mass grown in the biological processes is discharged. The conventional secondary treatment technology to remove the biomass is settling.

Disinfection may be carried out by a variety of means. The discussion in this chapter is limited to chlorine and ultraviolet disinfection.

Postaeration to improve the DO of the discharged wastewater completes the discussion of secondary treatment.

25-2 SECONDARY SETTLING

The function of secondary settling tanks that follow trickling filters is to produce a clarified effluent. Secondary settling tanks that follow activated sludge processes also serve the function of thickening to provide a higher solids concentration for either return activated sludge or wasting and subsequent treatment.

The following discussion is divided into two parts: design principles and design practice.

Design Principles

Trickling Filter. Sedimentation theory is discussed in Chapter 10. Trickling filter solids settling may be classified as Type II flocculant settling. Because the suspended solids loading is low, the overflow rate governs design.

Activated Sludge. Activated sludge solids settling classification falls into each of the four types depending on the depth in the clarifier. In the upper, clear water level, discrete floc particles settle (Type I settling). As the particles sink, they begin to flocculate (Type II settling). In the lower zones, hindered settling (Type III) and compression settling (Type IV) take place.

Both clarification and thickening are considered in the design of the secondary settling tank for activated sludge systems. Clarification is governed by the settling velocity of the light fluffy particles. Thickening is governed by the mass flux of solids in the zone where hindered settling takes place.

It is not possible to make estimates of overflow rates for clarification based on first principles. The irregular nature of activated sludge floc precludes any rational estimate of settling velocity that could be used to select an overflow rate.

The surface area required for thickening may be determined by one of two methods: *solids flux analysis* or *state point analysis*. Solids flux analysis is discussed in Chapter 15. State point

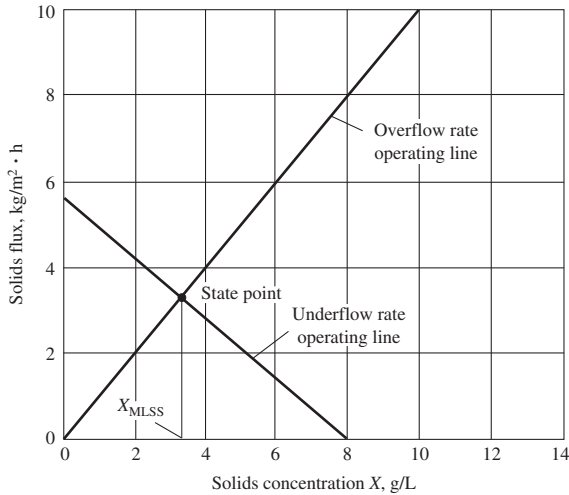
**FIGURE 25-1**

State point analysis for assessing clarifier operating conditions. The state point is at the intersection of the overflow rate and underflow rate operating lines.

(Source: Metcalf & Eddy, 2003.)

analysis is an extension of solids flux analysis to provide a means to assess different MLSS concentrations and operating conditions relative to the limiting solids concentration.

The *state point* (shown in Figure 25-1) is the intersection of the clarifier overflow solids-flux rate and the underflow solids-flux rate. This analysis accounts for the MLSS concentration, clarifier hydraulic loading, and RAS. It enables an assessment of these operating parameters to determine whether or not the conditions are within the clarifier solids-flux limitations.

The clarifier overflow solids flux is

$$SF = \frac{(Q)(X)}{A} \quad (25-1)$$

where SF = overflow solids flux rate, $\text{kg}/\text{m}^2 \cdot \text{d}$

Q = clarifier effluent flow rate, m^3/d

X = aeration tank MLSS, kg/m^3

A = clarifier surface area, m^2

The aeration tank MLSS at any point along the overflow solids-flux line is found by constructing a vertical line to the x -axis. In Figure 25-1, the MLSS is shown as about 3.8 g/L.

Because the underflow velocity (U_b) can be controlled by controlling the flow rate of return activated sludge, the underflow operating line is used for process control. U_b is defined as

$$U_b = \frac{Q_u}{A} \quad (25-2)$$

where U_b = underflow velocity, m/d

Q_u = underflow flow rate, $\text{m}^3/\text{d} = Q_R$, the return sludge rate or RAS

A = surface area, m^2

Other relationships for U_b can be used to evaluate the clarifier operation:

$$U_b = \frac{SF_t - SF}{0 - X_{MLSS}} \quad (25-3)$$

or

$$U_b = \frac{(Q + Q_R)(X_{MLSS}/A)}{-X_{MLSS}} \quad (25-4)$$

Where SF_t is the total solids flux.

The underflow operating line is represented as the negative slope of underflow velocity. The underflow solids flux is

$$SF_u = U_b X_i \quad (25-5)$$

where SF_u = solids flux resulting from underflow, $\text{kg/m}^2 \cdot \text{d}$

X_i = solids concentration at a given point, kg/m^3

To determine if the operation of the clarifier is within its solid flux limitation, a *gravity flux curve* is plotted on the state point graph. The gravity solids flux is calculated using Equation 25-6:

$$SF_g = C_i v_i \quad (25-6)$$

where SF_g = gravity flux, $\text{kg/m}^2 \cdot \text{d}$

C_i = initial MLSS concentration, kg/m^3

v_i = initial settling velocity, m/d

Batch settling curve data similar to that in Figure 25-2 are used in the computation.

Using Figure 25-3, the plots may be interpreted as follows:

- The underflow line at state point A is tangent to the gravity flux curve. This is the *limiting solids flux condition*.

If the operation is changed to obtain a higher MLSS concentration and the underflow line crosses the lower limb of the gravity flux curve, the limiting solids flux will be exceeded and the clarifier sludge blanket will rise to the effluent weir.

- The underflow line at state point B represents a lower MLSS concentration. This represents an underloaded operation relative to the solids loading.

From the state point analysis, it is self evident that the design and behavior of the secondary clarifier is intimately linked to the activated sludge process. The linkage is through control of the MLSS concentration by wasting and the return activated sludge flow rate. Table 25-1 and Figure 25-4 illustrate the use of state point analysis in design and operation of the secondary clarifier.

Mathematical models are available to facilitate design iterations using set point analysis (McCorquodale et al., 2004; McCorquodale et al., 2006).

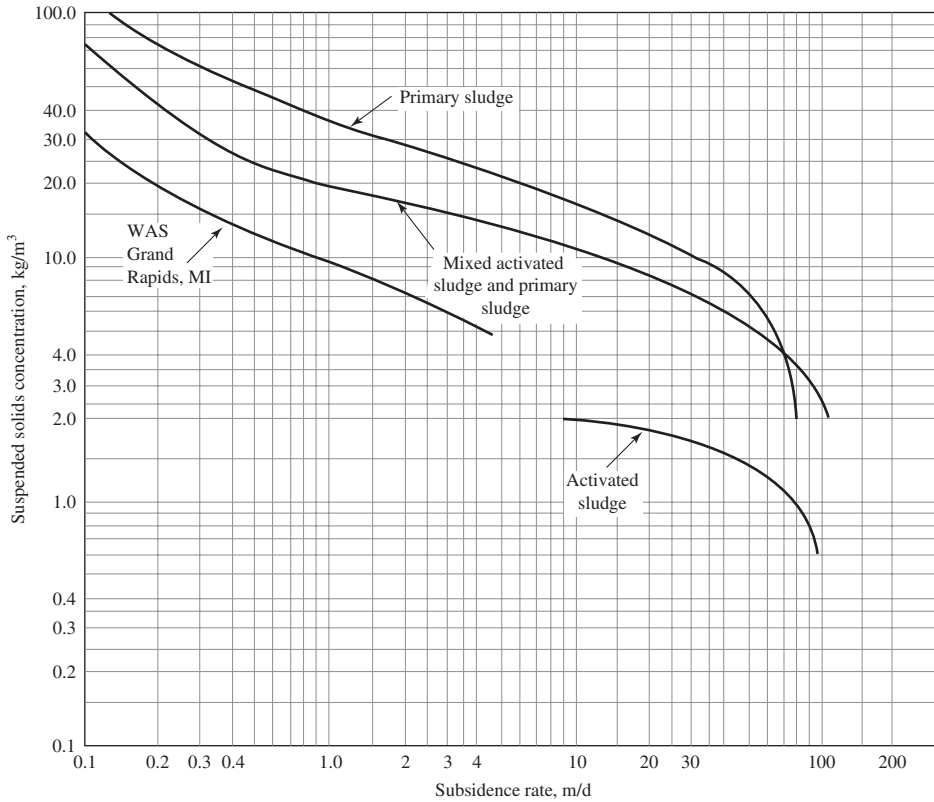

FIGURE 25-2
Batch settling curves. (Source: Davis and Cornwell, 2008.)

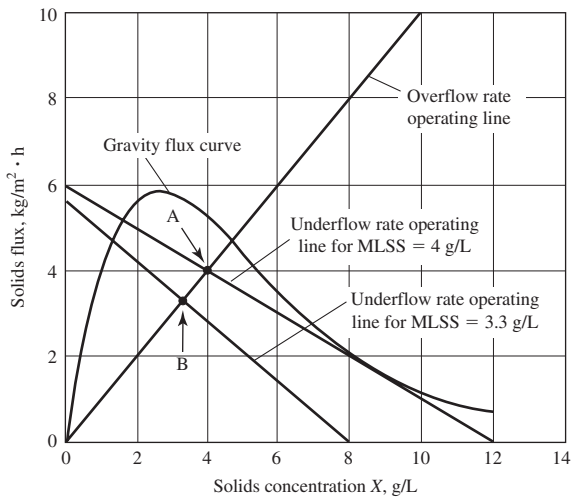

FIGURE 25-3
State point analysis illustrating critically loaded (A) and underloaded (B) state points relative to the gravity flux curve. (Source: Metcalf & Eddy, 2003.)

TABLE 25-1
Interpretation of the state point analysis

Location of state point	Location of underflow line relative to flux curve	Condition of clarifier	Suggested change
Within the flux curve (Figure 25-4a)	Below the descending limb	Underloaded	None
Within the flux curve (Figure 25-4b)	Tangential to descending limb line	Critically loaded	Increase RAS flow rate to become underloaded
Within the flux curve (Figure 25-4c)	Above the descending limb line	Overloaded	Increase RAS flow rate to become underloaded
On the flux curve (Figure 25-4d)	Below the descending limb line	Critically loaded	Reduce clarifier feed solids to become underloaded by converting to step feed or lower MLSS
On the flux curve (Figure 25-4e)	Above the descending limb line	Overloaded	Increase RAS flow rate to become critically loaded
Outside the flux curve (Figure 25-4f)	Above the descending limb line	Overloaded	Reduce clarifier feed solids to become underloaded by converting to step feed or lower MLSS by lowering SRT

Adapted from Jayanayagam, 2006.

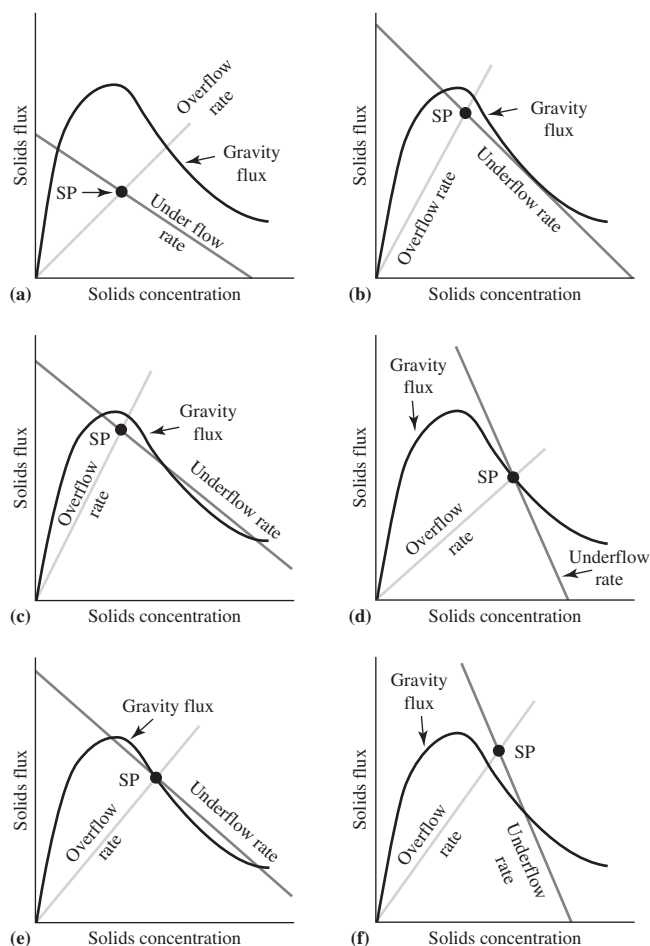

FIGURE 25-4
 State point (SP) analysis for varying conditions to be interpreted with Table 25-1. SP = State Point.

Example 25-1. Determine the limiting solids flux for a 35 m diameter secondary settling tank that is being used to thicken activated sludge. Also, determine whether or not the clarifier is overloaded, critically loaded, or underloaded. The average plant flow rate to the clarifier is 9,200 m³/d, the activated sludge MLSS is 3,125 mg/L, and the RAS concentration is 10,000 mg/L. Data from a batch settling analysis is shown below.

MLSS, g/m ³	v_i , m/h	MLSS, g/m ³	v_i , m/h
1,000	4.0	5,000	0.31
1,500	3.5	6,000	0.20
2,000	2.8	7,000	0.13
2,500	1.8	8,000	0.094
3,000	1.14	9,000	0.07
4,000	0.55		

Solution:

- a. Begin by computing the gravity solids flux.

C_i , g/m ³	v_i , m/h	SF_u , kg/m ² · h	C_i , g/m ³	v_i , m/h	SF_u , kg/m ² · h
1,000	4.0	4.00	5,000	0.31	1.55
1,500	3.5	5.25	6,000	0.20	1.20
2,000	2.8	5.60	7,000	0.13	0.91
2,500	1.8	4.50	8,000	0.094	0.75
3,000	1.14	3.42	9,000	0.07	0.63
4,000	0.55	2.20			

The data in the third and sixth column are the product $C_i v_i$, that is, for example, 1,000 g/m³ × 4.0 m/h × 10⁻³ kg/g = 4.00 kg/m² · h.

- b. Plot the gravity solids flux curve as shown in Figure 25-5.
c. Add an overflow operating line and MLSS concentration state point at 3,125 mg/L.

- (1) Determine the clarifier surface area:

$$A = \frac{\pi(35 \text{ m})^2}{4} = 962.11 \text{ m}^2$$

- (2) Determine the overflow solids flux rate using Equation 25-1:

$$SF = \frac{(9,200 \text{ m}^3/\text{d})(X)}{962.11 \text{ m}^2} = (9.56 \text{ m/d})(X)$$

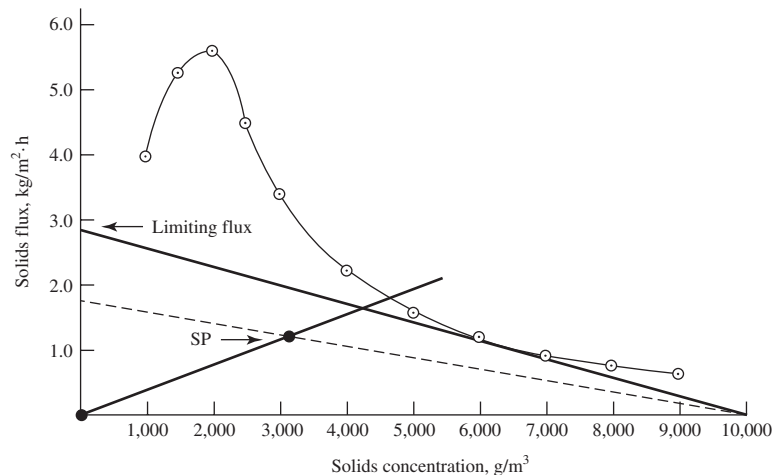

FIGURE 25-5
Gravity flux curve for Example 25-1.

- (3) Determine the plotting point for 3,125 mg/L or 3.125 kg/m³ MLSS:

$$SF = (9.56 \text{ m/d})(3.125 \text{ kg/m}^3) \left(\frac{1 \text{ d}}{24 \text{ h}} \right) = 1.24 \text{ kg/m}^3 \cdot \text{h}$$

- (4) Plot the overflow rate operating line through the points (0,0) and (3,125 g/m³, 1.24 kg/m³ · h)
- d. Determine the limiting solids flux by drawing a line from 10,000 g/m³ tangent to the gravity flux curve as shown in Figure 25-5. The limiting flux is 2.85 kg/m³ · h.
- e. A plot from 10,000 g/m³ through the state point indicates a solids flux rate of 1.75 kg/m³ · h. The underflow line is below the descending limb of the gravity flux curve. This implies that the clarifier is underloaded.

Example 25-2. Using the data in Example 25-1, determine the recycle ratio for the underflow concentration of 10,000 mg/L.

Solution:

- a. From Figure 25-5, the solids flux is 1.75 kg/m³ · h for the line drawn through the state point.
- b. Using Equation 25-3, the operating curve slope is

$$\text{Slope} = \frac{(1.75 \text{ kg/m}^2 \cdot \text{h} - 0 \text{ kg/m}^2 \cdot \text{h})}{(0 \text{ g/m}^3 - 10 \text{ kg/m}^3)} = -0.175 \text{ m/h}$$

- c. The underflow velocity is then

$$\text{Underflow velocity} = -(-0.175 \text{ m/h}) = 0.175 \text{ m/h}$$

d. The clarifier overflow rate (*OFR*) is

$$OFR = \frac{9,200 \text{ m}^3/\text{d}}{(962.11 \text{ m}^2)(24 \text{ h/d})} = 0.398 \text{ m/h}$$

e. The recycle ratio (*R*) is then

$$R = \frac{0.175 \text{ m/h}}{0.398 \text{ m/h}} = 0.4397 \text{ or } 0.44$$

f. As a check, calculate the recycle ratio based on a solids mass balance.

$$X_R Q_R = (Q_R + Q)X$$

with

$$R = \frac{Q_R}{Q}$$

then

$$X_R = (1 + R)X$$

and

$$R = \left(\frac{X_R}{X} - 1 \right)^{-1} = \left(\frac{10,000 \text{ mg/L}}{3,125 \text{ mg/L}} - 1 \right)^{-1} = 0.4545 \text{ or } 0.45$$

Comment. These estimates of the recycle ratio are, in essence, the same.

Secondary Settling Design Practice

Much of the discussion about primary settling tank design in Chapter 21 is also applicable to secondary settling tanks. This discussion focuses on the factors that must be considered because of the large volume of flocculent solids from the secondary biological processes.

The most popular configurations for secondary settling tanks are rectangular and circular. A well-designed rectangular tank can be expected to perform similarly as a well-designed circular tank. No observable differences in clarification performance at average or peak hydraulic loading rates have been attributed to shape alone (WEF, 1998).

Redundancy. Multiple units capable of independent operation are required for all plants where design average flows exceed 380 m³/d (GLUMRB, 2004). It has been argued that with current advances in materials and technology, downtime is minimal and a smaller number of larger clarifiers has both economic advantages and more reserve peak flow capacity. For example, for larger plants six larger clarifiers may be a better option than twelve smaller ones (Albertson and Wilson, 1997).

Hydraulic Load. The recommended hydraulic load should be either the peak four-hour flow of the peak day of the year, or some more extreme peak flow in systems where wet weather flow greatly exceeds normal weather flow (Young et al., 1978).

Flow Control. When multiple units are in service, the flow must be split so that both the hydraulic load and the solids load are in proportion to the design limits of the tank. Methods of balancing the flow include splitter boxes, flow control valves, hydraulic symmetry, and feed gate or inlet port control. Some of these are discussed in Chapter 21 under the headings “splitter box” and “inlet configuration.”

Of particular concern in designing the splitter box is the potential for hydraulic restriction and the limitations this places on operation during peak flow rates or when a tank is out of service. The splitter box must be able to pass the peak hydraulic load plus the maximum return sludge flow rate.

Inlet Design. Inlet configurations for circular and rectangular tanks are discussed in Chapter 21.

Overflow Rate. The calculation of overflow rate is based on wastewater flow rate (Q_{in}) instead of the mixed-liquor flow rate, that is, Q_{in} alone and not $Q_{in} + Q_R$. The overflow rate is equivalent to the upflow velocity. The return sludge portion of the flow (Q_R) is drawn off the bottom of the tank and does not contribute to the upflow velocity.

The overflow rate design criteria differ for trickling filter, activated sludge, integrated fixed-film activated sludge (IFAS), and moving bed biofilm reactors (MBBR) secondary settling tanks. The recommendations for each are discussed in the following paragraphs.

- *Trickling filter:* The historic use of high overflow rates and shallow secondary clarifiers resulted in poor performance. For shallow tanks, a conservative average overflow rate of 0.09 m/h with a maximum overflow rate of 0.28 m/h is suggested (Vesilind, 2003). GLUMRB (2004) specifies a peak hourly overflow rate of 2.0 m/h. Clarifier designs for trickling filters should be similar to designs used for activated sludge process clarifiers with appropriate feedwell size and depth, increased sidewater depth, and similar hydraulic overflow rates (Metcalf & Eddy, 2003). Recommended overflow rates as a function of sidewater depth are summarized in Table 25-2.
- *Activated sludge:* The previous two editions of the WEF design manual (WEF, 1998) suggested the following maximum allowable overflow rates at the minimum recommended

TABLE 25-2
Recommended trickling filter secondary clarifier overflow rates

Sidewater depth, m	Average overflow rate, m/h	Maximum overflow rate, m/h
2	0.4	0.75
3	0.8	1.6
4	1.2	2.2
5	1.4	2.8

Data compiled from Jayanayagam, 2006, and Metcalf & Eddy, 2003.

sidewater depths: 1.4 m/h at average flow, 2.4 m/h for the three-hour sustained peak flow rate, 2.7 m/h for the two-hour sustained peak flow rate.

A survey of design firms revealed that they prefer to select conservative overflow rates. A compilation of preferred overflow rates is shown in Table 25-3.

- *Integrated fixed-film activated sludge (IFAS)*: The overflow rates for IFAS processes as a function of sidewater depth are shown in Table 25-4.
- *Moving bed biofilm reactors (MBBR)*: The recommended range of overflow rates for MBBRs is 0.5 to 0.8 m/h (Metcalf & Eddy, 2003).

Example 25-3 illustrates the check on overflow rate for a design based on solids loading.

TABLE 25-3
Preferred secondary clarifier overflow rates for activated sludge processes

Flow rate	Average flow overflow rates, m/h	Peak flow overflow rate, m/h	Comments
Conventional activated sludge	0.68–1.2	1.7–2.7	
Extended aeration	0.33–0.68	1.0–1.3	
Oxidation ditch	0.51–0.68	< 1.7	
Biological nutrient removal (BNR)	0.68–1.2	1.7–2.7	
Biological phosphorus removal			
Total P = 2 mg/L	1.0–1.3		
Total P = 1 mg/L	0.67–1.0		Occasional chemical addition
Total P = 0.2 to 0.5 mg/L	0.50–0.83		Continuous chemical addition

Adapted from Metcalf & Eddy, 2003, and Lakeside Equipment Corporation.

TABLE 25-4
Secondary clarifier overflow rates for IFAS processes

Sidewater depth, m	Average overflow rates, m/h	Peak overflow rate, m/h	Comment
< 4.3 m	0.7–1	1.7	
Deep	in excess of 1.7		With flocculator center well and baffles to prevent wall currents

Adapted from Jayanayagam (2006).

Example 25-3. Check the overflow rate for the secondary clarifier diameter selected in Example 25-1.

Solution:

- The average plant flow rate to the clarifier given in Example 25-1 is $9,200 \text{ m}^3/\text{d}$. The surface area was calculated as 962.11 m^2 .
- The overflow rate is

$$v_0 = \frac{Q}{A} = \frac{9,200 \text{ m}^3/\text{d}}{(962.11 \text{ m}^2)(24 \text{ h/d})} = 0.40 \text{ m/d or } 0.017 \text{ m/h}$$

- In comparison with Table 25-3, this is conservatively low for conventional and BNR processes.

Comment. In selecting the diameter of the secondary settling tank for activated sludge processes, the design diameter must be checked for both overflow rate and solids loading. The larger of the diameters that results from these calculations governs the design.

Solids Loading. When data are available to perform a solids flux or state point analysis, this is the preferred method for determining the solids loading rate. Previous editions of the WEF design manual (WEF, 1998) provided a graphical approach using Figure 25-6 to select an appropriate solids loading rate. In the absence of test data, most design engineers prefer to keep the maximum solids loading rate, including full RAS capacity, in the range of 100 to $150 \text{ kg/m}^2 \cdot \text{d}$ (Jayanayagam, 2006). Table 25-5 summarizes typical design ranges.

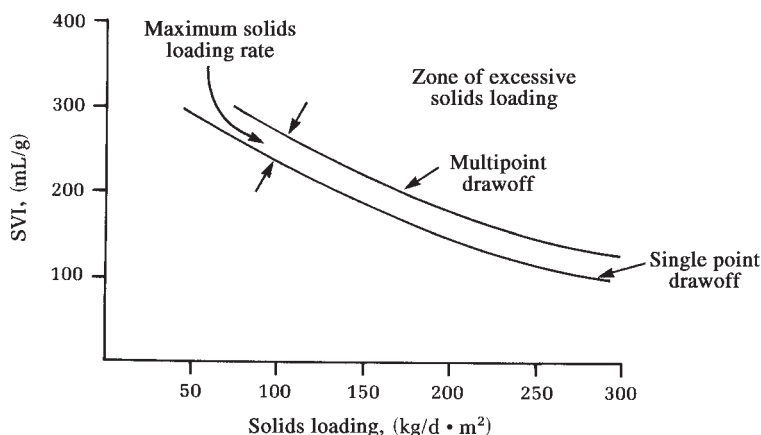

FIGURE 25-6

Design solids loading versus SVI. (Note: Rapid sludge removal design assumes that there will be no inventory in the settling tank. Source: WEF, 1998.)

TABLE 25-5
Ranges of loading rate for activated sludge process secondary clarifiers

Flow rate	Average solids loading rates, $\text{kg/m}^2 \cdot \text{h}$	Peak solids loading rates, $\text{kg/m}^2 \cdot \text{h}$
Conventional activated sludge	4–6	8
Extended aeration	1.0–5	7
Oxidation ditch		< 12
Biological nutrient removal	5–8	9

Adapted from Metcalf & Eddy, 2003, and Lakeside Equipment Corporation.

Sidewater Depth. Liquid depth in the secondary clarifier is measured at the sidewall in circular tanks and at the effluent end wall of rectangular clarifiers. Based on historical operating data, Parker (1983) demonstrated that at similar overflow rates, suspended solids in the effluent decreased with increasing depth. He also found that variability in effluent quality also decreased with increasing depth.

Most firms agree that larger tanks require greater depth. However, cost considerations generally restrict depths to less than 4.5 to 5 m. The suggested depths in Table 25-6 appear to be reasonable for circular tanks. Although it is suggested that they may also apply to rectangular tanks, the method of application is not stated. In addition, it suggested that rectangular tanks may not need to be as deep (WEF, 1998).

Weir Loading. GLUMRB (2004) specifies that plants with a capacity less than $3,800 \text{ m}^3/\text{d}$ should not have a hydraulic loading greater than $250 \text{ m}^3/\text{d} \cdot \text{m}$ of weir length at peak hourly flow. For plants larger than $3,800 \text{ m}^3/\text{d}$, the weir loading rate is specified as less than $350 \text{ m}^3/\text{d} \cdot \text{m}$.

Current design consensus is that weir placement and configuration have more effect on clarifier performance than the hydraulic loading.

Weir Configuration and Baffles. Suggestions for weir placement, configuration, and baffles are given in Chapter 21.

TABLE 25-6
Final settling basin side water depth

Tank diameter, m	Side water depth, m	
	Minimum	Recommended
<12	3.0	3.7
12 to 20	3.4	3.7
20 to 30	3.7	4.0
30 to 43	4.0	4.3
>43	4.3	4.6

Adapted from WEF, 1998.

Sludge Removal. The most common sludge collector for rectangular tanks in the United States is the chain-and-flight system. Although traveling bridge collectors have been used extensively in Europe, they have not become popular in the United States. The chain-and-flight system is described in Chapter 10.

At lower MLSS concentrations (1,000 to 2,000 mg/L) rectangular clarifiers have worked well. At the higher MLSS concentrations of biological nutrient removal processes, their capacity may be significantly reduced. Frequently, this reduction is due to the transport capacity of the scraper mechanism. Albertson (2008) presents the following recommendations to overcome this limitation:

1. Define the maximum transport requirements (RAS flow) based on the solids loading rate and the return sludge concentration. The lower return concentration consistent with the highest weekly sludge volume index (SVI) should be employed.
2. Establish the longitudinal scraper height and speed based on the theoretical transport capacity equal to 125 percent of the maximum RAS flow.
3. Provide variable speed drives for the longitudinal collectors. The speed range should be at least 0.61–2.44 m/min.
4. Replace cross-collectors with sludge collection headers.
5. Provide about 0.9 m additional depth (or 2.5 percent of basin length) at the inlet end in new basins to minimize peak flow sludge accumulation at the effluent end.
6. The maximum length of the longitudinal collector may be in the range of 45.7–48.8 m with peak solids loading rates of $5.1 \text{ kg/m}^2 \cdot \text{h}$. Longer basins will need two collection troughs or a trough near the center of the tank.

There is no general consensus as to which sludge mechanism is optimal for circular tanks. In the late 1980s, the majority of firms favored hydraulic suction when the plants were nitrifying, and the primary clarifiers were effective in removing debris that might clog the suction mechanism. Hydraulic suction mechanisms lift solids from across the entire tank radius. A hydraulic head differential is created by the use of pumps or adjustable valves. There are two types of hydraulic suction systems: the organ pipe, or riser pipe, and the manifold or header system. The riser pipe system has a separate collector pipe for each suction inlet orifice. A v-shaped plow directs the sludge to the pipe. The manifold system uses a horizontal pipe with orifices along its length.

Scraper mechanisms are favored because they presumably allow a thicker RAS and lower RAS flow rates, and create less turbulence in the tank. There are two types: those with straight scraper blades and those with spiral plows. The multiblade plow has been used most extensively in the United States. For lighter suspended growth sludges, the spiral plows are gaining favor (Tekippe, 2006).

Sludge transport, treatment, and disposal are discussed in Chapter 27.

Scum Removal. Suggestions for scum removal systems are given in Chapter 21.

Sludge Blanket Depth. The sludge blanket depth is not a design parameter. However, it has several operational impacts that demonstrate the need for adequate depth to store sludge, as well

as adequate sludge removal capacity, and the selection of the design overflow rate. Peng et al., (2007) found the following full scale tests:

- The sludge blanket level has a strong linear correlation with the surface overflow rate (SOR). Increasing SOR leads to an increase in the blanket level regardless of sludge blanket height.
- When a high SOR is applied to the clarifier, increasing the RAS may not reduce the blanket level.
- Low initial blanket levels do not help achieve a lower blanket level under high SOR.
- Critical blanket levels are determined by the sludge settleability. High blanket levels show a strong linear correlation with effluent total suspended solids.

Tank Dimensions. Rectangular tank lengths are seldom greater than 110 m and are typically 30 to 60 m. Historically, widths have been limited to 6 m by the sludge scraping mechanisms. Multiple parallel flights have expanded this width to 24 m. Recent advances in fiberglass composites have allowed single flight widths to be increased to 10 m. Current practice is to provide a depth of approximately 4 to 5 m. (Pettit, 2006).

Although circular tanks up to 100 m in diameter have been built, most engineers select diameters less than 50 m to avoid wind effects. In keeping with recommended sidewater depths, typical depths are in the range of 4 to 5 m.

25-3 DISINFECTION

Introduction

A goal of the Clean Water Act is, in essence, to make the nation's water "fishable and swimmable." Thus, unlike drinking water disinfection, the purpose of wastewater disinfection is to reduce pathogen concentrations to acceptable levels. Each state sets their standards based on water quality. This standard may be seasonal to take into account recreational activities. Seasonal disinfection has become less prevalent in recent years. Regulatory agencies are requiring year-round disinfection because the adverse effects of residual chlorine are eliminated by the use of UV disinfection or by chemical dechlorination.

Bacterial effluent limits may be included in the NPDES permit. For example, municipal wastewater treatment plants in Michigan must comply with limits of 200 fecal coliform bacteria (FC) per 100 mL of water as a monthly average, and 400 FC/100 mL as a seven-day average. More stringent requirements are imposed to protect waters that are used for recreation. Total-body-contact recreation waters must meet limits of 130 *Escherichia coli* per 100 mL of water as a 30-day average and 300 *E. coli* per 100 mL at any time. Partial-body-contact recreation is permitted for water with less than 1,000 *E. coli* per 100 mL of water.

Disinfection theory and disinfection chemistry are discussed in Chapter 13. The discussion in this section begins with a summary of dechlorination chemistry. The remainder of the discussion is on the use of chlorine (Cl_2 gas and NaOCl liquid) and ultraviolet light for wastewater disinfection.

Dechlorination

Methods for neutralizing the chlorine after disinfection are required to reduce toxic effects on natural biota and to reduce the production of disinfection byproducts. The common compounds

used in dechlorination are sulfur dioxide gas (SO₂) and sulfite compounds, such as sodium sulfite (Na₂SO₃), bisulfite (NaHSO₃), and metabisulfite (Na₂S₂O₃).

Reaction Chemistry. The redox reactions are summarized as follows:

For sulfur dioxide and chlorine

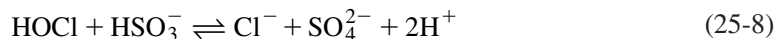

or

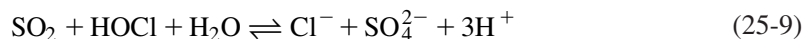

For sulfur dioxide and monochloramine

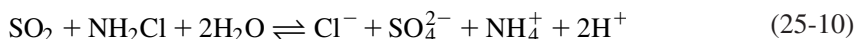

For sodium sulfite and chlorine

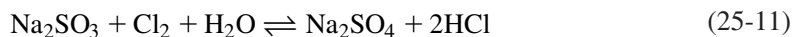

For sodium sulfite and monochloramine



For sodium bisulfite and chlorine

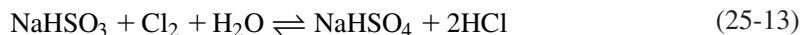

For sodium bisulfite and monochloramine



For sodium metabisulfite and chlorine



For sodium metabisulfite and monochloramine

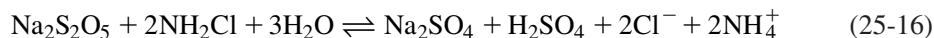

While sodium thiosulfate and activated carbon will also dechlorinate, their application is impractical because of the low pH required for thiosulfate and the cost for activated carbon.

Reaction Kinetics. Dechlorination reactions are nearly instantaneous.

Chlorination and Dechlorination Practice

Dosage. Typical chlorine dosages are given in Table 25-7.

Dechlorination dosages are based on the mg/L chlorine residual. Typical dechlorination dosages are given in Table 25-8.

TABLE 25-7
Typical chlorine dosages for wastewater

Type of wastewater	Initial coliform count, MPN/100 mL	Chlorine dose, mg/L	
		Effluent standard, MPN/100 mL	
		1,000	200
Trickling filter effluent	10^5 – 10^6	3–10	5–20
Activated sludge effluent	10^5 – 10^6	2–10	5–15
Filtered activated sludge effluent	10^4 – 10^6	4–8	5–15
Nitrified effluent	10^4 – 10^6	4–12	6–16
Microfiltration effluent	10^1 – 10^3	1–3	2–4

Note: based on combined chlorine and 30-minute contact time.

Source: Metcalf & Eddy, 2003.

TABLE 25-8
Typical wastewater dechlorination dosages

Compound	Range, mg per mg/L of chlorine residual
Sulfur dioxide	1.0–1.2
Sodium sulfite	1.8–2.0
Sodium bisulfite	1.5–1.7
Sodium metabisulfite	1.4–1.6

Source: Metcalf & Eddy, 2003.

Contact. Typical contact is in a baffled chamber or a pipe. Design of contact chambers is discussed in Chapter 13. The desired contact time is 30 minutes.

Chlorination and Dechlorination Design

Flow Diagrams. Typical chlorine/sulfur dioxide process flow diagrams are shown in Figure 25-7.

Design Criteria. Design criteria for handling Cl_2 , NaOCl , mixing systems, and contact basins are given in Chapter 13.

Ultraviolet Disinfection

UV disinfection is becoming increasingly popular as a means of disinfection. The elimination of chemical disinfection reduces the hazard potential of the plant, operation and maintenance effort, and the paperwork for numerous tracking requirements for the hazardous chemicals.

The principles of ultraviolet irradiation and sources of UV radiation for disinfection are discussed in Chapter 13. The following discussion highlights some of the issues in applying UV to wastewater disinfection.

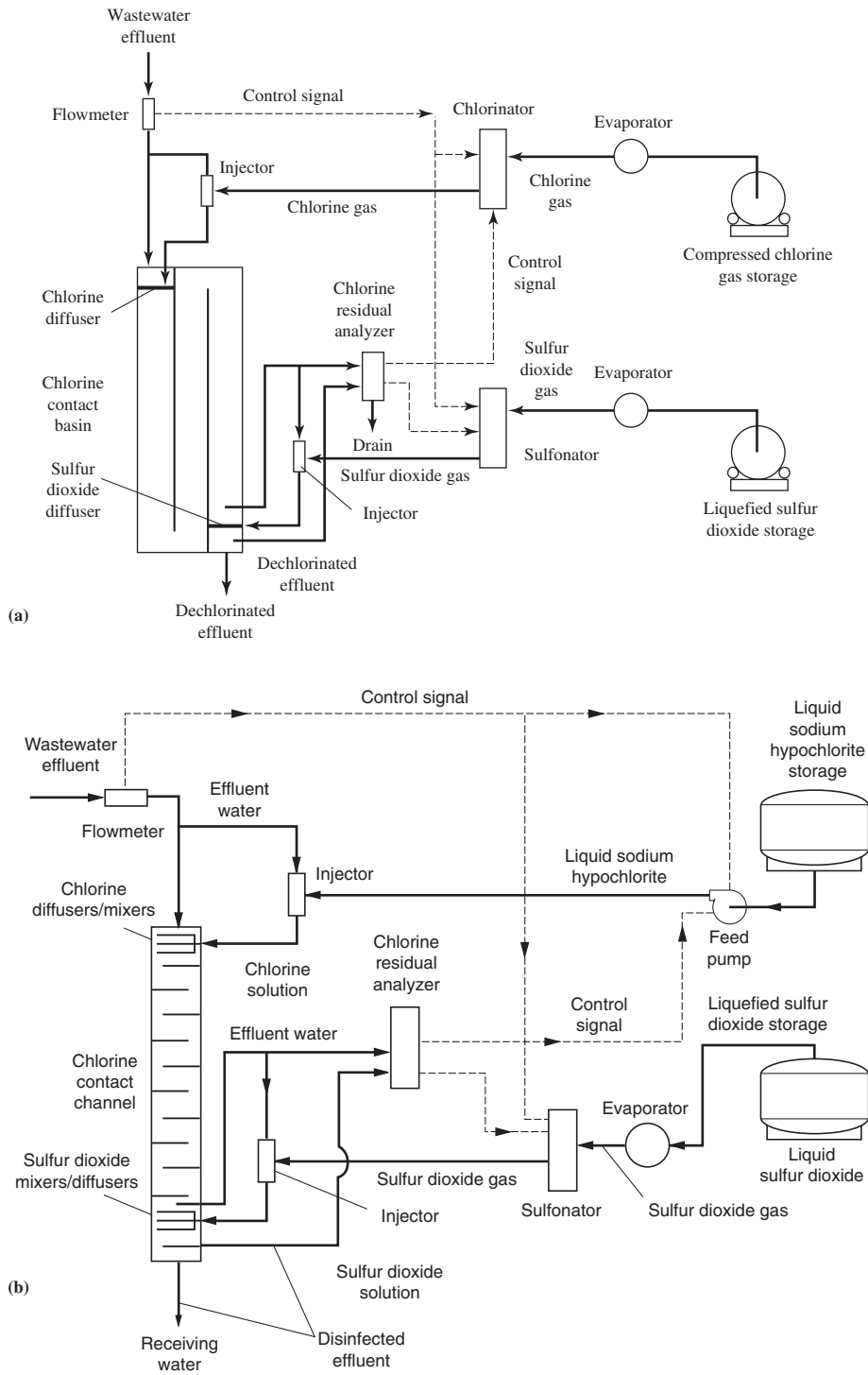

FIGURE 25-7 Schematic flow diagrams for chlorination/dechlorination. Schematic (a) uses a chlorine injector. Schematic (b) is for sodium hypochlorite injection. Both schematic use SO₂ for dechlorination. (Source: Metcalf & Eddy, 2003.)

Effect of Wastewater Constituents. A number of wastewater constituents adversely affect the efficiency of UV disinfection. A selected list is presented in Table 25-9. The raw water constituents, for example, hardness, iron, manganese, and TDS, may reduce the efficiency because they are either strongly adsorb UV, or they coat the lamps. In some case they do both.

Of the typical wastewater constituents, oil, grease, and total suspended solids are of obvious concern in the application of UV. Upstream processes that reduce the concentrations of these constituents are a normal part of secondary treatment. This, combined with special continuous cleaning of the lamps, improves the prospects for using UV. The use of ferric chloride to control phosphorus concentrations inhibits the implementation, but does not preclude the use of UV.

UV Design Practice. In small plants, the UV system is enclosed. In medium-to-large plants, UV systems are placed in an open channel. Typically, two parallel channels are provided. A water level controller is placed at the effluent end to keep the lamps submerged. In the majority

TABLE 25-9
Impact of wastewater constituents on the use of UV radiation for wastewater disinfection

Constituent ^a	Effect
BOD, COD, TOC, etc.	No or minor effect, unless humic materials comprise a large portion of the BOD
Humic materials	Strong adsorbers of UV radiation
Oil and grease	Can accumulate on quartz sleeves of UV lamps, can absorb UV radiation
TSS	Absorption of UV radiation, can shield embedded bacteria
Alkalinity	Can impact scaling potential. Also affects solubility of metals that may absorb UV light
Hardness	Calcium, magnesium, and other salts can form mineral deposits on quartz tubes, especially at elevated temperatures
Ammonia	No or minor effect
Nitrite	No or minor effect
Nitrate	No or minor effect
Iron	Strong adsorber of UV radiation, can precipitate on quartz tubes, can adsorb on suspended solids and shield bacteria by adsorption
Manganese	Strong adsorber of UV radiation
pH	Can affect solubility of metals and carbonates
TDS	Can impact scaling potential and the formation of mineral deposits
Industrial discharges	Depending on the constituents (e.g., dyes), may lead to diurnal and seasonal variations in the transmittance
Stormwater inflow	Depending on the constituents, may lead to short-term as well as seasonal variations in the transmittance

^aInorganic constituents including bicarbonate, chloride ion, and nitrate can affect the direct UV photolysis of constituents such as N-nitrosodimethylamine (NDMA).

(Source: Metcalf & Eddy, 2003.)

of UV disinfection applications, low-pressure mercury lamps have been used (WEF, 1998). Medium-pressure, high-intensity lamps have found application in larger plants where the flow rate exceeds 20,000 m³/d (Hanzon and Vigilia, 1999). The advantage of the medium-pressure, high-intensity lamp is that the UV output can be modulated over a range of 60 to 100 percent of full power. In addition, fewer lamps are required.

Quartz sleeves are used to isolate the lamps from direct water contact and to control the wall temperature. Mechanical wiping or a periodic acid dip of the sleeve is essential to avoid the formation of an opaque film. Mechanical wiping is preferred because of the lower labor requirement for maintenance.

The dose to achieve regulatory standards is typically in the range of 50 to 140 mJ/cm². Using higher doses to overcome elevated suspended particulate matter concentrations has proven ineffective (Metcalf & Eddy, 2003). Filtration prior to disinfection and conservative estimates of dose are recommended.

Factors that affect the number, type, and rating of lamps include (1) the hydraulic loading rate, (2) the aging and fouling characteristics of the lamps, (3) the wastewater quality, and (4) the discharge standards. Typical design parameters are summarized in Table 25-10. Because the UV system is preassembled, the design engineer's role is limited to assessment of existing configurations. For existing facilities, pilot testing is highly recommended.

Hints from the Field. Those with field experience have made the following suggestions:

- Step one for UV retrofit or upgrade is a long-term study (preferably one year) of UV transmittance at 254 nm wavelength. Transmittance values frequently may fall below the typical design value of 65 percent. Periodic excursions below 50 percent have been observed at some plants (Youngberg and Marko, 2008).
- Early sleeve wiping systems had maintenance issues. Careful evaluation should be made.

TABLE 25-10
Typical UV system design parameters

Design parameter	Range of values
Contact time	6–40 s
Lamp life	
Low pressure	8,000–12,000 h
Medium pressure	4,000–6,000 h
UV dosage	
Secondary treatment	50–140 mJ/cm ²
After granular filtration	100 mJ/cm ²
After membrane filtration	80 mJ/cm ²
After reverse osmosis	50 mJ/cm ²
Wastewater velocity	0.05–0.4 m/s

Sources: Hanzon and Vigilia, 1999; Metcalf & Eddy, 2003; WEF, 1998.

25-4 POSTAERATION

Requirements for increased dissolved oxygen (DO) levels have become standard for discharge to water-quality limited stream sections and to effluent dominated waters. If sufficient elevation head is not available, surface or diffuse aerators are employed. Cascade aeration is the simplest alternative available if sufficient elevation is available.

The most common method for determining the required cascade height for wastewater is that given by Barrett (1960):

$$H = \frac{R_{\text{deficit}} - 1}{0.289(b)(1 + 0.046T)} \quad (25-17)$$

where H = height through which wastewater must fall, m
 R_{deficit} = deficit ratio

$$= \frac{C_s - C_o}{C_s - C} \quad (25-18)$$

C_s = DO saturation concentration of the wastewater at temperature T , mg/L

C_o = DO concentration of the influent to the cascade, mg/L

C = DO required, mg/L

b = weir geometry parameter: for a broad-crested weir, $b = 1.0$; for steps, $b = 1.1$; for step weir, $b = 1.3$

T = wastewater temperature, °C

Typical design criteria are given in Table 25-11. Example 25-4 illustrates the calculation of the cascade height. An alternative to Barrett's approach is through the use of v-notch weirs or cascade structures in clarifiers (Bagatur, 2009). When there is insufficient elevation for a cascade to be employed, a conventional bubbler aeration system may be used.

TABLE 25-11
Typical cascade design ranges

Parameter	Range	Typical
Hydraulic loading rate at average design flow, m^3/m of width \cdot d	1,240–6,200	3,000
Step dimensions		
Height, mm	150–300	200
Length, mm	300–600	450
Cascade height, m	2–5	

Source: Metcalf & Eddy, 2003.

Example 25-4. The dissolved oxygen in the effluent from an oxidation pond must be increased from 1.0 mg/L to 4.0 mg/L before discharge. The average summer water temperature in the oxidation pond is 25°C. Estimate the height of a step cascade to achieve 4.0 mg/L DO.

Solution:

- a. From Appendix A, find the DO saturation concentration at 25°C is 8.38 mg/L.
- b. Calculate the deficit ratio.

$$R_{\text{deficit}} = \frac{8.38 \text{ mg/L} - 1.0 \text{ mg/L}}{8.38 \text{ mg/L} - 4.0 \text{ mg/L}} = 1.68$$

- c. Calculate the height of the cascade.

$$H = \frac{1.68 - 1}{(0.289)(1.1)[1 + 0.046(25)]} = \frac{0.68}{0.6835} = 1 \text{ m}$$

Comment. The summer water temperature is selected because this gives the critical R_{deficit} for design.

Visit the text website at www.mhprofessional.com/wwe for supplementary materials and a gallery of photos.

25-5 CHAPTER REVIEW

When you have completed studying this chapter, you should be able to do the following without the aid of your text or notes:

1. Describe the difference between the settling of trickling filter and activated sludge.
2. Sketch a solids flux curve you have drawn and identify the following: gravity flux curve, overflow rate operating line, underflow operating line, and the maximum solids flux rate.
3. Given a state point analysis, evaluate the performance of the secondary clarifier and make recommendations for possible operating changes.
4. Explain why the discharge limit for fecal coliform concentration may change with the seasons.
5. Explain why wastewater must be dechlorinated after disinfection with chlorine compounds.
6. Explain the advantages and disadvantages of UV disinfection.

With the aid of this text, you should be able to do the following:

7. Design a secondary settling tank for a trickling filter plant.
8. Design a secondary settling tank for an activated sludge plant.
9. Design a chlorine disinfection system for a wastewater plant.
10. Design a postaeration cascade.

25-6 PROBLEMS

- 25-1.** The two settling tanks at Turkey Run (Problem 23-21 in Chapter 23) are 16.0 m in diameter and 4.0 m deep. The effluent weir is a single launder set on the tank wall. Evaluate the overflow rate, depth, solids loading, and weir length for conformance to standard practice.
- 25-2.** The single secondary settling tank at Lotta Hart Hospital (Problem 23-23 in Chapter 23) is 10.0 m in diameter and 3.4 m deep at the side wall. The effluent weir is a single launder set on the tank wall. Evaluate the overflow rate, depth, solids loading, and weir length for conformance to standard practice.
- 25-3.** Your firm has been asked to design a new secondary clarifier for a conventional activated sludge plant. The MLSS concentration is 3,000 mg/L, the flow rate is 8,000 m³/d, and the recycle ratio is 0.46. The desired RAS concentration is 10,000 mg/L. Use the following column settling data (Peavy et al., 1985):

MLSS, mg/L	Settling velocity, m/h
1,400	3.0
2,200	1.85
3,000	1.21
3,700	0.76
4,500	0.45
5,200	0.28
6,500	0.13
8,200	0.089

To complete the design, provide the following:

- (1) limiting solids flux rate
- (2) solids loading rate
- (3) overflow rate
- (4) diameter
- (5) depth

- 25-4.** Your firm has been asked to design a new secondary clarifier for an extended aeration activated sludge plant. The MLSS concentration is 2,000 mg/L, the flow rate is 4,200 m³/d, and the recycle ratio is 0.46. The desired RAS concentration is 10,000 mg/L. Use the following column settling data (Peavy et al., 1985):

MLSS, mg/L	Settling velocity, m/h
1,000	2.8
2,000	1.4
3,000	0.4
4,000	0.2
5,000	0.1
6,000	0.06

To complete the design, provide the following:

- (1) limiting solids flux rate
 - (2) solids loading rate
 - (3) overflow rate
 - (4) diameter
 - (5) depth
- 25-5.** A wastewater is to be dechlorinated using sulfur dioxide. Estimate the stoichiometric dose to neutralize a chlorine residual of 6.5 mg/L.
- 25-6.** A wastewater is to be dechlorinated using sodium metabisulfite. Estimate the stoichiometric dose to neutralize a chlorine residual of 6.5 mg/L.
- 25-7.** Using typical design parameters, design a postaeration cascade for the town of Bath (Problem 23-38, Chapter 23). To meet regulatory requirements, the DO must be ≥ 5.0 mg/L. Assume that the SBR plant is using post-SBR equalization, that the effluent DO is 2.0 mg/L, and that the maximum sustained temperature is 21°C.
- 25-8.** Design a postaeration cascade for the city of Pittsburgh (Problem 23-46, Chapter 23). The maximum day flow rate is estimated to be 1.80 times the average design flow rate. To meet the regulatory requirements, the DO must be ≥ 4.0 mg/L. Assume that the plant effluent DO is 0.0 mg/L and that the maximum sustained temperature is 24°C. Although ample elevation is available for a cascade, the linear space along the river bank is limited.

25-7 DISCUSSION QUESTIONS

- 25-1.** Explain when a design engineer would select a rectangular rather than a circular secondary clarifier and what, if any, negative impacts this may have on performance.
- 25-2.** Sketch a curve of a solids flux analysis and draw a line that defines the limiting flux. Identify the limiting flux on the graph.
- 25-3.** Given that deeper secondary settling tanks perform better, what limits the depth?

- 25-4. Explain why UV disinfection has become a popular alternative to chlorine disinfection.
- 25-5. What is the major impediment to the use of a cascade for postaeration?

25-8 REFERENCES

- Albertson, O. E. (2008) "Solids Loading Limitations of Rectangular Secondary Clarifiers," *Journal of Environmental Engineering Division*, American Society of Civil Engineers, vol. 134, no. 1, pp. 14–21.
- Albertson, O. E. and J. P. Wilson (1997) "Clarifier Design Concept—Larger Is Better," *Journal of Environmental Engineering*, November, pp. 1,159–1,162.
- Bagatur, T. (2009) "Evaluation of Preaeration with V-notch and Cascade Structures in Clarifiers," *Journal of Environmental Engineering*, vol. 135, no. 3, pp. 176–184.
- Barrett, M. J. (1960) "Aeration Studies of Four Weir Systems," *Water and Wastes Engineering*, vol. 64, no. 9, pp. 407.
- Davis, M. L. and D. A. Cornwell (2008) *Introduction to Environmental Engineering*, McGraw-Hill, Boston, Massachusetts, pp. 510–513.
- GLUMRB (2004) *Recommended Standards for Wastewater Facilities*, Great Lakes–Upper Mississippi River Board of State and Provincial Public Health and Environmental Managers, Health Education Services, Albany, New York, pp. 70–3.
- Hanzon, B. D. and R. Vigilia (1999) "Just the Facts," *Water Environment & Technology*, vol. 11, November, pp. 35–42.
- Jayanayagam, S. S. (2006) "Secondary Clarifier Design Concepts and Considerations," in *Clarifier Design*, 2nd ed., Water Environment Federation Manual of Practice No. FD-8, pp. 143–209.
- McCorquodale, J. A., E. LaMotta, A. Griborio, J. D. Holmes, and I. Georgiou (2004) *Development of Software for Modeling Activated Sludge Clarifiers*, A Technology Transfer Report Submitted to U.S. Environmental Protection Agency, Washington, D.C.
- McCorquodale, J. A., J. E. Richardson and S. Zhou (2006) "Mathematical Modeling of Secondary Settling Tanks," *Clarifier Design*, 2nd ed., Water Environment Federation Manual of Practice No. FD-8, pp. 303–371.
- Metcalf & Eddy (2003) *Wastewater Engineering: Treatment and Reuse*, 4th ed., McGraw-Hill, Boston, pp. 452–453, 820–840, 1217–1343.
- Parker, D. S. (1983) "Assessment of Secondary Clarification Design Concepts," *Journal of Water Pollution Control Federation*, vol. 55, p. 349.
- Peavy, H. S., D. R. Rowe, and G. Tchobanoglous (1985) *Environmental Engineering*, McGraw-Hill, New York, pp. 275, 319.
- Peng, W, J. Rigdon, and G. Russell (2007) "Sludge Blanket Formation and Its Effects on Secondary Clarifier Performance," *Journal of Environmental Engineering*, vol. 133, no.7, pp. 758–764.
- Pettit, M. V. (2006) "Rectangular Clarifiers," in *Clarifier Design*, 2nd ed., Water Environment Federation Manual of Practice No. FD-8, pp. 489–581.
- Tekippe, R. J. (2006) "Circular Clarifiers," in *Clarifier Design*, 2nd ed., Water Environment Federation Manual of Practice No. FD-8, pp. 397–488.
- Vesilind, P. A. (2003) *Wastewater Treatment Plant Design*, Water Environment Federation, Alexandria, Virginia, p.7–20.
- WEF (1998) *Design of Municipal Wastewater Treatment Plants*, 4th ed., Water Environment Federation Manual of Practice 8, Alexandria, Virginia, pp. 11-95–11-137.
- Young, J. C., J. L. Cleasby, and E. R. Baumann (1978) "Flow and Load Variations in Treatment Plant Design," *Journal of the Environmental Engineering Division*, American Society of Civil Engineers, vol. 104, EE2, pp. 289–303.
- Youngberg, C. and K. Marko (2008) "UV Disinfection for a Real-World Effluent," *Water Environment & Technology*, vol. 20, March, pp. 76–81.

This page intentionally left blank

CHAPTER

26

TERTIARY TREATMENT

26-1 INTRODUCTION

**26-2 CHEMICAL PRECIPITATION
OF PHOSPHORUS**

26-3 GRANULAR FILTRATION

26-4 MEMBRANE FILTRATION

26-5 CARBON ADSORPTION

26-6 CHAPTER REVIEW

26-7 PROBLEMS

26-8 REFERENCES

26-1 INTRODUCTION

The need for treatment of wastewater beyond that which can normally be accomplished in secondary treatment is based on the recognition of one or more of the following:

1. Increasing population pressures result in increasing loads of organic matter and suspended solids to rivers, streams, and lakes.
2. The need to increase the removal of suspended solids to provide more efficient disinfection.
3. The need to remove nutrients to limit eutrophication of sensitive water bodies.
4. The need to remove constituents that preclude or inhibit water reclamation.

Initially, in the 1970s, these processes were called “advanced wastewater treatment” because they employed techniques that were more advanced than secondary treatment methods. In the last three decades many of these technologies have either been directly incorporated into the secondary processes, for example nutrient removal, or they are so inherent in meeting stringent discharge standards that they have become conventional. These processes include chemical precipitation, granular filtration, membrane filtration, and carbon adsorption. As conventional processes, they are better termed *tertiary treatment* processes rather than an advanced treatment process. In current practice, the employment of air stripping, ion exchange, NF or RO treatment, and other similar processes to meet water quality requirements is correctly termed *advanced wastewater treatment*. Advanced wastewater treatment technologies are, fundamentally, those employed to treat water for reuse.

The discussion in this chapter focuses on tertiary treatment processes: chemical precipitation, granular filtration, membrane filtration, and carbon adsorption. The emphasis in this chapter is on the application of these technologies in tertiary treatment of wastewater.

26-2 CHEMICAL PRECIPITATION OF PHOSPHORUS

Because phosphorus is a critical element in the promotion of eutrophication, restrictions on discharge concentrations are established for many NPDES permits. Before the development of biological phosphorus removal (BPR) technology, chemical precipitation was the primary means of removing phosphorus. In many cases, it is still the only practical method of achieving standards because of space or economic constraints. In addition, it is often provided in BPR plants as a prudent backup in case of process upset or because stringent standards cannot be met with BPR alone.

The theory of phosphorus precipitation and design strategies are discussed in this section. The design of mixing systems and settling tanks are discussed in Chapters 6 and 10.

Theory

All polyphosphates (molecularly dehydrated phosphates) gradually hydrolyze in aqueous solution, and revert to the ortho* form (PO_4^{3-}) from which they were derived. Phosphorus is typically found as monohydrogen phosphate (HPO_4^{2-}) in wastewater.

**Ortho* is the term used to designate the highest degree of hydration of the salt. For benzene rings, ortho refers to the number 2 and 6 positions.

The removal of phosphorus to prevent or reduce eutrophication is accomplished by chemical precipitation using one of three compounds. The precipitation reactions for each are shown below.

Using ferric chloride:

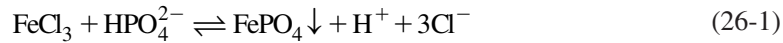

Using aluminum sulfate:

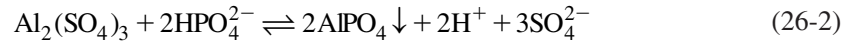

Using lime:

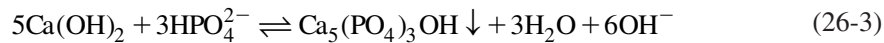

Ferric chloride and alum reduce the pH while lime increases it. The effective range of pH for alum and ferric chloride is between 5.5 and 7.0. If there is not enough naturally occurring alkalinity to buffer the system to this range, then lime must be added to counteract the formation of H^+ .

Example 26-1. If a wastewater has a soluble orthophosphate concentration of 4.00 mg/L as P, what *theoretical* amount of ferric chloride will be required to remove it completely?

Solution:

- a. From Equation 26-1, note that one mole of ferric chloride is required for each mole of phosphorus to be removed. The pertinent gram molecular weights are as follows:

$$\begin{aligned} \text{FeCl}_3 &= 162.2 \text{ g/mole} \\ \text{P} &= 30.97 \text{ g/mole} \end{aligned}$$

- b. With a $\text{PO}_4\text{-P}$ concentration of 4.00 mg/L, the theoretical amount of ferric chloride is

$$(4.00 \text{ mg/L}) \left(\frac{162.2 \text{ g/mole}}{30.97 \text{ g/mole}} \right) = 20.95 \text{ or } 21.0 \text{ mg/L}$$

Comment. Because of side reactions, solubility product limitations, and day-to-day variations, the actual amount of chemical to be added must be determined by jar tests on the wastewater.

Design Strategies

Selection of Chemicals. The principal chemicals used in precipitating phosphorus are alum ($\text{Al}_2(\text{SO}_4)_3 \cdot 14 \text{H}_2\text{O}$) and ferric chloride. Lime use has been sharply curtailed over the last few decades because of the substantial increase in sludge production, pH control requirements,

TABLE 26-1
Typical alum dosages to achieve various levels
of phosphorus reduction

Phosphorus reduction, %	Alum:P weight ratio	Al:P weight ratio
75%	13:1	1.2:1
85%	16:1	1.5:1
95%	22:1	2.0:1

Source: U.S. EPA, 1976.

and operation and maintenance problems with handling, storage and feeding. Alum and ferric chloride present storage and handling issues because they are corrosive. Because of numerous side reactions, the actual dose of alum or ferric chloride to achieve a high degree of removal is significantly larger than the stoichiometric dose. Table 26-1 summarizes some actual experience for alum. Actual dosages will be determined by the operator based on jar test results. From a design perspective, a conservative dose estimate and a large turndown ratio for the feed equipment is recommended.

The actual ferric chloride dose will be 1.5 to 3 times the theoretically calculated amount for 90 percent removal.

Polymers may be added to enhance settling of the precipitate.

Preprecipitation. The addition of a precipitating chemicals upstream of the primary settling tank is called *preprecipitation*. The influent structures of the primary tank mix the chemicals with the wastewater. The primary tank serves as both the reaction basin and the settling basin for the precipitant. The precipitated phosphate is removed with the primary sludge. This improves the efficiency of suspended solids removal in the primary tank but may deprive the biological processes of needed nutrients.

Coprecipitation. The addition of precipitating chemicals that are removed with the biological sludge in the secondary clarifier is called *coprecipitation*. They may be added in the effluent from the primary clarifier, the return mixed liquor, or the effluent from the biological treatment process before the secondary clarifier.

When ferric chloride and alum are used, the chemicals may be added directly to the aeration tank in the activated sludge system. Thus, the aeration tank serves as a reaction basin. The precipitate is then removed in the secondary clarifier. This is not possible with lime because the high pH required to form the precipitate is detrimental to the activated sludge organisms.

Postprecipitation. The addition of precipitating chemicals after secondary clarification is called *postprecipitation*. This arrangement requires separate mixing and settling facilities and/or filtration.

Sludge Production. The chemical precipitation of phosphorus will significantly increase the sludge production from the facility.

Hints from the Field. Experience from the field has revealed the following suggestions when chemical precipitation is to be employed:

- The quality of the metals salts is an important consideration in selecting a supplier. For example, FeCl_3 from waste pickling liquor may contain high concentrations of toxic chemicals such as chromium. Alum may contain mercury. These contaminants may cause an NPDES violation for the discharged wastewater or limit the ability to land apply the biosolids.
- Ferrous salts fed in the primary clarifier will be oxidized in the aeration tank. This may have adverse effects on fine bubble diffusers or membrane diffusers.

26-3 GRANULAR FILTRATION

Filtration Objectives and Performance

Filtration is used when the effluent limit for total suspended solids (TSS) is equal to or less than 10 mg/L. Average day effluent concentrations that filtration can achieve for secondary settled effluent are shown in Table 26-2.

Because a fraction of the TSS is biomass, and because a fraction of the biomass is biodegradable, removal of TSS will reduce the effluent BOD. BOD concentrations in the range of 4 to 10 mg/L may be achieved. In addition, the use of filtration in combination with chemical coagulation can reduce the effluent PO_4^{3-} concentration to 0.1 mg/L (WEF, 1998). It is also possible to combine nitrate removal with filtration. Up to 90 percent $\text{NO}_3\text{-N}$ can be removed (Savage, 1983).

Filtration Technologies

The five types of granular filters commonly used for wastewater filtration are (1) conventional downflow filters, (2) deep-bed downflow filters, (3) deep-bed upflow continuous-backwash filters, (4) pulsed-bed filters, and (5) traveling-bridge filters. The deep-bed upflow, pulsed-bed, and traveling-bridge filters are proprietary. Because the design details for the proprietary filters are supplied by the manufacturer, the following discussion is limited to conventional downflow and deep-bed downflow filters.

TABLE 26-2
Typical average day effluent concentrations from granular media filtration of secondary effluent

Filter influent	Without chemical coagulation	With tertiary chemical coagulation
	Effluent TSS, mg/L	Effluent TSS, mg/L
Conventional activated sludge	3–10	0–5
Extended aeration	1–5	0–5
High-rate trickling filter	10–20	0–3
Two-stage trickling filter	6–15	0–3

Adapted from WEF, 1998.

Although pressure filters are common for industrial applications, in practice their use for municipal application is not common. They are not included in this discussion.

Design Practice

Process Train. Typically, filtration is used to remove residual biological floc from a secondary settling tank effluent.

Pretreatment. Good design practice is to provide for the capability to add inorganic or organic coagulants both upstream of the sedimentation tank that precedes the filter and to the filter influent. Typical dosages of polyelectrolyte are 0.5 to 1.5 mg/L to the settling tank influent and/or 0.05 to 0.15 mg/L to the filter influent. Dosages are determined by the operator based on jar tests.

If the average influent TSS to the filter is anticipated to be greater than 20 mg/L, upstream pretreatment consisting of coagulation, flocculation, and sedimentation, or flotation, is required to achieve a TSS less than 3 mg/L (Metcalf & Eddy, 2003).

Filter Type. Most wastewater filters in the United States are downflow, dual-media or multi-media units (WEF, 1998). Single-medium stratified beds are no longer designed for municipal wastewater applications because of their unfavorable headloss buildup characteristics.

Number and Size. As in drinking water filters, multiple filter units are used to allow continuous operation during backwashing. The design guidance given in Chapter 11 is appropriate for selecting the number and size of units.

Filtration Rate and Terminal Headloss. Typical filtration rates range from 5 to 20 m/h with terminal headlosses of 2.4 to 3 m.

Underdrains, Backwashing, and Wash Troughs/Gullet. The design guidance given in Chapter 11 is appropriate for selecting the number and size of units.

Media. A summary of the guidance for the various media arrangements is given in the following tables.

TABLE 26-3
Design criteria for dual-media filters used in tertiary treatment of wastewater

Parameter	Reported range	Typical	GLUMRB recommendation
Anthracite coal on top			
Effective size	0.8–2.0 mm	1.3	
Uniformity coefficient	1.3–1.6	≤ 1.5	≤ 1.7
Shape factor (<i>f</i>)	0.40–0.60		
Porosity	0.56–0.60		
Specific gravity	1.4–1.75		
Depth of medium	360–900 mm	720 mm	

(continued)

Sand on bottom

Effective size	0.4–0.8 mm	0.65	
Uniformity coefficient	1.2–1.6	≤ 1.5	≤ 1.7
Shape factor (<i>f</i>)	0.7–0.8		
Porosity	0.40–0.47		
Specific gravity	2.55–2.65		
Depth of medium	180–360 mm	360 mm	
Filtration rate	5–24 m/h	12 m/h	
Backwash rate	48–72 m/h		
Backwash duration ^a	10–20 min		
Surface wash rate			
Revolving arms	1.2–2.4 m/h		

^aActual off-line time will be ≥ 30 min because of the time required to drain the filter and gradually increase to the full backwash rate. An additional 30–40 minutes off-line is required for “filter-to-waste” to clear the bed of wash water and dislodged turbidity. If air scour is provided, the time will be even longer because of the necessity of sequencing the air scour and wash water.

Sources: Cleasby and Logsdon, 1999; GLUMRB, 2004; Metcalf & Eddy, 2003; WEF, 1988.

TABLE 26-4
Design criteria for trimedia filters used in tertiary treatment of wastewater

Parameter	Reported range	Typical
Anthracite coal on top		
Effective size	1.0–2.0 mm	1.4 mm
Uniformity coefficient	1.4–1.8	≤1.5
Shape factor (<i>f</i>)	0.40–0.60	
Porosity	0.56–0.60	
Specific gravity	1.4–1.75	
Depth of medium	240–600 mm	480 mm
Sand in middle		
Effective size	0.4–0.8 mm	0.5 mm
Uniformity coefficient	1.3–1.8	≤1.5
Shape factor (<i>f</i>)	0.7–0.8	
Porosity	0.4–0.46	
Specific gravity	2.55–2.65	
Depth of medium	240–480 mm	300 mm

(continued)

TABLE 26-4 (continued)
Design criteria for tri-media filters used in tertiary treatment of wastewater

Parameter	Reported range	Typical
Garnet on bottom		
Effective size	0.20–0.6 mm	0.35 mm
Uniformity coefficient	1.5–1.8	≤1.5
Shape factor (<i>f</i>)	0.60–0.80	
Porosity	0.42–0.55	
Specific gravity	3.6–4.3	
Depth of medium	50–150 mm	100 mm
Filtration rate	5–24 m/h	12 m/h
Backwash rate	48–72 m/h	
Backwash duration ^a	10–20 min	≥15 min
Surface wash rate		
Revolving arms	1.2–2.4 m/h	

^aActual off-line time will be ≥ 30 min because of the time required to drain the filter and gradually increase to the full backwash rate. An additional 30–40 minutes off-line is required for “filter-to-waste” to clear the bed of wash water and dislodged turbidity. If air scour is provided, the time will be even longer because of the necessity of sequencing the air scour and wash water.

Sources: Cleasby and Logsdon, 1999; GLUMRB, 2004; Metcalf & Eddy, 2003; WEF, 1998.

TABLE 26-5
Design criteria for deep-bed monomedium filters used in tertiary treatment of wastewater

Parameter	Reported range of values	Typical
Anthracite coal		
Effective size	2–4 mm	
Uniformity coefficient	1.3–1.8	≤1.5
Shape factor (<i>f</i>)	0.40–0.60	
Specific gravity	1.4–1.75	
Porosity	0.56–0.60	
Depth of medium	900–2,100 mm	1,500 mm
Filtration rate	5–24 m/h	12 m/h
Backwash rate	37–45 m/h	
Backwash duration ^a	15 min	
Surface wash rate		
Revolving arms	1.2–2.4 m/h	

^aActual off-line time will be ≥ 30 min because of the time required to drain the filter and gradually increase to the full backwash rate. An additional 30–40 minutes off-line is required for “filter-to-waste” to clear the bed of wash water and dislodged turbidity. If air scour is provided, the time will be even longer because of the necessity of sequencing the air scour and wash water.

Sources: Cleasby and Logsdon, 1999; GLUMRB, 2004; Metcalf & Eddy, 2003; WEF, 1998.

Denitrification Filters. Coarse-media deep-bed denitrification has been in practice for over 30 years. Denitrification occurs when the filter grains serve as a medium for attached growth of denitrifying organisms. The filter operates anaerobically. A carbon source must be supplied. Typically, methanol, at a dosage of approximately 3 mg/L per mg/L of NO₃-N is used (Pickard et al., 1985).

Operation of denitrification filters is similar to that for typical granular filters except for the requirement to release nitrogen (called “bumps”). This is required because the nitrogen from denitrification accumulates in the filter. This causes an increase in headloss. This headloss is relieved by backwashing with water only for approximately 1 to 5 minutes. This backwash water is not captured, and the backwash is not intended to clean the filter. The number of denitrification bumps varies from 4 or 5 times per day, up to 14 to 16 times per day. It is a function of nitrate loading, media, and underdrain type.

The design of the filter is based on empty bed contact time (EBCT). Typically, this is about 20 minutes for warm water (20°C) to about 60 minutes for cold water (10°C). The beds are about 1.8 m deep and are loaded at an average of 1.7 to 5 m/h (WEF, 1998). Typical design parameters are shown in Table 26-6.

Hint from the Field. Experience has revealed that it is not necessary to fluidize a monomedium filter. However, the air scour must be fine tuned.

TABLE 26-6
Typical design parameters for denitrification filters

Parameter	Range	Typical	Comment
Sand monomedia			
Effective size (sand)	1.8–2.3 mm	2.3	2.3 mm is the largest commercially available, but larger media may be better
Uniformity coefficient		≤1.3	
Sphericity	0.8–0.9	0.82	≥0.9 is preferred; less spherical is effective but requires more frequent backwashing and bumps
Depth	1.2–2 m	1.6 m	
Dual media			
Effective size			
Coal	2.38–3.65 mm	3.65 mm	
Sand	1.8–2.3 mm	2.3 mm	
Depth			
Coal	0.3–0.9 m	0.6 m	
Sand	0.9–1.2 m	1.2 m	
General			
Empty bed contact time	20–60 min	20 min	Longer for cold water (10°C) than warm water (20°C)
Hydraulic loading			
20°C	60–120 m/d	100 m/d	m/d = m ³ /m ² · d
10°C	30–90 m/d	80 m/d	

(continued)

TABLE 26-6 (continued)
Typical design parameters for denitrification filters

Parameter	Range	Typical	Comment
NO ₃ -N loading			
20°C	1.4–1.8 kg/m ² · d	1.6 kg/m ² · d	
10°C	0.8–1.2 kg/m ² · d	1.0 kg/m ² · d	
Methanol to NO ₃ -N ratio	2.0–3.5	3.0	Units are mg/L methanol per mg/L NO ₃ -N
Backwash			
Water	15–25 m/h	20 m/h	m/h = m ³ /m ² · h. Duration is about 15 min
Air	19–120 m/h	100 m/h	Duration is about 20–40 s
Nitrogen release (bump)			
Water only	10–14 m/h	12 m/h	Introduction of air scour inhibits denitrification
Duration	2–15 min	5 min	
interval	1 to 6 h	2 h	

Sources: Metcalf & Eddy, 2003; U.S. EPA, 1975; WEF, 1998.

26-4 MEMBRANE FILTRATION

Low-pressure microfiltration (MF) and ultrafiltration (UF) membranes are used to provide tertiary treatment for effluent from municipal wastewater treatment plants. Although they may be used instead of granular filtration, currently the largest use is to pretreat secondary effluent to facilitate further treatment by reverse osmosis before aquifer recharge or indirect potable reuse.

Membrane filtration theory, properties of MF and UF membranes, and fundamental aspects of the design of membranes for filtration are discussed in Chapter 12. This discussion is focused on those design elements particular to wastewater practice.

Membrane Performance

As shown in Table 26-7, filtration with MF/UF membranes results in a high-quality effluent. Because MF and UF membranes act as physical barriers, their removal efficiency for conventional pollutants is dependent on the fraction of the pollutant that is associated with suspended matter. No removal can be expected in the absence of biological and/or chemical treatment that results in the formation of floc.

Feed Water Quality

To achieve the performance shown in Table 26-7, the influent to the MF/UF filter must, at a minimum, meet the standards for secondary effluent, that is, BOD₅ ≤ 30 mg/L, TSS ≤ 30 mg/L, and fecal coliforms (FC) ≤ 200/100 mL (WEF, 2006).

Pretreatment

Experience has shown that pretreatment of secondary effluent prior to tertiary MF/UF filtration is essential to optimize the membranes' performance. Pretreatment may include chemical coagulation, chlorination or chloramination, screening with strainers, and flow equalization.

TABLE 26-7
Typical filtrate water quality for MF/UF treatment of secondary effluent

Parameter	Range of values
Biochemical oxygen demand (BOD)	<2–5 mg/L
Total organic carbon (TOC)	5–25 mg/L as C
Total Kjeldahl nitrogen (TKN)	5–30 mg/L as N
Total phosphorus	0.1–8 mg/ as P
Total suspended solids (TSS)	ND ^a
Turbidity	<0.1 NTU
Fecal coliforms	<2–10 per 100 mL
Virus	<1–300 PFU per 100 mL

^aND = not detected.

Source: Extracted from WEF, 2006.

At low alum doses (< 12 mg/L), membrane fouling may be worse than filtration without coagulant. At high doses (> 25 mg/L) membrane performance may be improved significantly (Howe and Clark, 2006). Jar testing must be used as an operational control of chemical dose.

The feed water is chlorinated to prevent biofouling. A typical dose is 3 to 5 mg/L of NaOCl.

Strainers with a pore size $\leq 500 \mu\text{m}$ are used to prevent debris from mechanical abrasion of, or adhesion to, the membrane fibers.

The membrane systems are hydraulically limited to a peaking factor of about 2.0 to 2.5. If the upstream processes do not provide sufficient equalization, it may be required for the efficient operation of the membrane.

Design Criteria

Table 26-8 provides a summary of range of design values for MF and UF membranes used for filtration of secondary effluent.

TABLE 26-8
Range of design values for membrane filters

Parameter	Range of values	Comment
Flux		
MF	17–90 L/m ² · h	Prefiltering with cloth media may permit up to 127 L/m ² · h ^a
UF	17–34 L/m ² · h	
Transmembrane pressure (TMP)		
MF	70–170 kPa	
UF	100–700 kPa	

^aUpper limit of range achieved in pilot scale testing.

Sources: Gnirss and Dittrich, 2000; Metcalf & Eddy, 2003; Tooker and Darby, 2007; WEF, 2006.

Fouling and Cleaning

Biofouling is pervasive in tertiary treatment membranes. It may be described as a combination of the formation of biofilms and the accumulation of bioorganic material. The bioorganic material is composed of extracellular polymeric substances such as proteins, carbohydrates, polysaccharides, and lipids.

The addition of chlorine and/or chloramination of the feed water is a standard maintenance procedure. Thus, it is important to consider the effects of continuous addition of chlorine or chloramines in the selection of the membrane material for the filter. Detailed discussions of the contributions to membrane fouling, and fouling mechanisms, as well as maintenance and recovery cleaning procedures are discussed in Chapters 9, 12, and 23.

26-5 CARBON ADSORPTION

Even after secondary treatment, coagulation, sedimentation, and filtration, soluble organic materials that are resistant to biological breakdown will persist in the effluent. The persistent materials are often referred to as *refractory organics*. Refractory organic compounds can be detected in the effluent as soluble COD. Secondary effluent COD values are often 30 to 60 mg/L. The most practical available method for removing refractory organic compounds is by adsorbing them on activated carbon (U.S. EPA, 1979).

Process Alternatives

Both powdered activated carbon (PAC) and granular activated carbon (GAC) are used. PAC may be added to the effluent of a biological treatment process, or it may be applied directly to the aeration tank. GAC is used in a column. The columns may be fixed bed or moving bed.

GAC columns have been favored in tertiary treatment applications. Of the column types, the fixed-bed is most common (Metcalf & Eddy, 2003). Downflow columns are favored because of the advantage of achieving both adsorption and filtration in one step. Backwashing is provided to limit the headloss due to build up of particulate matter in the column.

Pretreatment

To make efficient use of the carbon and extend run times, typical flow charts show the carbon column preceded by granular media filtration and either chlorination or break point chlorination (U.S. EPA, 1973). Rules of thumb suggest that total suspended solids applied to the GAC column not exceed 5 mg/L, and fats, oil, and grease (FOG) be less than 10 mg/L. Chlorination is to inhibit microorganism growth on the carbon. Break point chlorination is to remove ammonia.

Reaction Vessels

The reaction vessel for the GAC column may be pressurized, or it may use a gravity flow system. Pressurized columns are fabricated with a flat, conical, or dish-shaped head. They have a carbon screen and support grid installed in the bottom.

Gravity reaction vessels are similar to rapid sand filters in configuration. They are designed using existing sand filter technology (U.S. EPA, 1973).

Carbon Selection

The critical element in the design of the carbon column is the selection of a manufacturer's activated carbon. The selection proceeds stepwise with the investigation of alternatives by simple laboratory tests to develop adsorption isotherms for the wastewater. From these data one or more carbon types are selected, and small scale column tests are used to develop kinetic data for design. The rapid small-scale column test (RSSCT) is recommended for this evaluation (Crittenden et al., 1991).

Other issues to be considered are resistance to abrasion, ash content, and particle size. Of these, the particle size is particularly relevant to the column design.

Carbon size is specified by "mesh" sizes. For example, an 8×30 mesh carbon is one that passes a U.S. Number 8 sieve (2.36 mm opening) and is retained on a Number 30 sieve (0.6 mm opening). Typically, an 8×30 mesh is used for downflow beds, and a 12×40 mesh is used for upflow beds.

Column Sizing

Empty Bed Contact Time (EBCT). Early reports of EBCT ranged from 10 to 50 minutes (U.S. EPA, 1973). More recently, EBCTs have been set based on desired effluent quality. For example, when effluent quality limits require a COD of 10 to 20 mg/L, the EBCT is typically in the range 15 to 20 minutes. For COD limits of 5 to 15 mg/L, EBCTs will range from 30 to 35 minutes (WEF, 1998).

Hydraulic Loading. The range of hydraulic loading is from 10 to $20 \text{ m}^3/\text{h} \cdot \text{m}^2$ (or 10 to 20 m/h) of cross section for upflow columns. Lower hydraulic loading rates between 5 to $12 \text{ m}^3/\text{h} \cdot \text{m}^2$ are used for downflow columns. Pressures seldom exceed 7 kPa (WEF, 1998).

Backwash. For typical mesh sizes, backwash rates vary from 20 to $50 \text{ m}^3/\text{h} \cdot \text{m}^2$. The backwash duration is 10 to 15 minutes.

Bed Depths. Depending on contact time, bed depths vary from 3 to 12 m. A minimum depth of 3 m is recommended.

Column Dimensions. Shop fabricated pressurized columns are restricted in size by transportation clearances. Prefabricated column diameters range from 0.75 to 3.6 m. Lengths do not exceed 18 m. Columns fabricated onsite may exceed these dimensions. Columns in series are used to obtain greater contact time and better use of carbon capacity. The ratio of column height to diameter is in the range 1.5:1 to 4:1. Tall, thin columns are preferred over short, fat ones.

While carbon bed depths are in the range 3 to 12 m, the column shell must be deep enough to allow bed expansion during backwash of 10 to 50 percent (U.S. EPA, 1973).

Carbon Regeneration

Although the actual mass of carbon must be determined from column tests, typical usage is summarized in Table 26-9.

After the adsorption capacity of the carbon has been exhausted, it can be restored by heating it in a furnace at a temperature sufficiently high to drive off the adsorbed organic matter. Keeping oxygen at very low levels in the furnace prevents carbon from burning. The organic matter is

TABLE 26-9
Typical carbon usage for wastewater

Prior treatment	Carbon use rate (CUR), g/m ³
Coagulated, settled, and filtered activated sludge effluent	24–48
Filtered secondary effluent	48–72

Source: WEF, 1998.

passed through an afterburner to prevent air pollution. In small plants where the cost of an onsite regeneration furnace cannot be justified, the spent carbon is shipped to a central regeneration facility for processing. There is a loss of about 5 to 10 percent during each regeneration cycle.

Carbon regeneration is a major consideration in the selection and design of GAC facilities. An extensive discussion of the options and operational considerations is given in Clark and Lykins (1989).

Design Criteria

Typical design criteria are listed in Table 26-10.

TABLE 26-10
Typical design ranges for GAC columns for wastewater treatment

Parameter	Value	Comment
Carbon mesh size	8 × 30	Downflow beds and upflow packed beds
	12 × 40	Upflow expanded beds
Hydraulic loading rate		
Upflow column	10–20 m ³ /h · m ²	
Downflow column	5–12 m ³ /h · m ²	
EBCT	10 to 50 min	Pilot tests are essential
Carbon use rate (CUR)	24 to 72 g/ m ³	Lower CURs are associated with longer EBCTs
Column height	≤ 18 m	Prefab will be sized to fit on flatbed trailer
Diameter	≤ 3.6 m	Restriction to 3.6 m for transport of prefab units
Height:Diameter	1.5:1 to 4:1	Without liquid redistribution use > 4:1 for proper liquid distribution
Backwash rate	20 to 50 m ³ /h · m ²	
Backwash expansion	10 to 50%	
Backwash duration	10–15 min	

Sources: Clark and Lykins, 1989; Culp et al., 1978; U.S EPA, 1973.

Visit the text website at www.mhprofessional.com/wwe for supplementary materials and a gallery of photos.

26-6 CHAPTER REVIEW

When you have completed studying this chapter, you should be able to do the following without the aid of your textbooks or notes:

1. Write theoretical precipitation reactions for removal of phosphorus with ferric chloride, alum, or lime.
2. Explain why the actual dose of chemicals to precipitate phosphorus is greater than the stoichiometric dose.
3. Sketch and label a granular filter identifying the following pertinent features: inlet main, outlet main, wash water outlet, gullet, support media (graded gravel), graded filter medium, and backwash troughs.
4. Define effective size and uniformity coefficient and explain their use in designing a granular filter.
5. From a design point of view, explain the role of filtration rate, grain size distribution, and porosity in controlling headloss through a granular filter.
6. Explain the role of estimating the depth of the expanded bed in designing a granular filter.
7. Compare the advantages and disadvantages in selecting the type of filter, that is, sand, dual media, or deep-bed monomedium anthracite.
8. Qualitatively compare the effectiveness of bed expansion and surface wash in back-washing a filter.
9. Explain to a client the circumstances that favor the use of MF/UF membranes.
10. Compare the mechanisms of filtration for granular filters and membranes.
11. Explain the role of the pore size and resistance coefficient in the design flux of a MF/UF membrane.
12. Draw a sketch of the flux or transmembrane pressure as a function of time that shows reversible and irreversible membrane fouling, and the effect of chemical cleaning.

With the use of this text, you should be able to do the following:

13. Perform a grain size analysis and determine the effective size and uniformity coefficient.
14. Calculate the headloss through a clean stratified filter bed and determine if it is excessive.
15. Calculate the depth of an expanded filter bed during back wash and locate the back wash trough elevation with respect to the top of the filter bed during filtration.

16. Calculate the number and size of filter beds given the maximum day flow rate and the filtration rate.
17. Calculate the equivalent diameter for a filter media having a specific gravity different from sand.
18. Design a backwash system including the layout for the placement of backwash troughs, size of the troughs, trough elevation, and the volume of backwash tank.
19. Determine gullet dimensions (depth and width) given the length, backwash flow rate, and wash water velocity in the effluent pipe.
20. Calculate the maximum headloss that can be achieved without creating a negative pressure in the filter media.
21. Calculate rejection, log removal, and percent removal of a constituent by a membrane filter.
22. Size a membrane system given the design flow rate and flux or determine the flux from the transmembrane pressure, water temperature, and membrane resistance coefficient.
23. Determine the number of MF/UF membrane modules and rack arrangement given the design flow rate, design flux, membrane area per module, and backwash cycle.

26-7 PROBLEMS

- 26-1. Rework Example 26-1 using alum ($\text{Al}_2(\text{SO}_4)_3 \cdot 14\text{H}_2\text{O}$) to remove the phosphorus.
- 26-2. Rework Example 26-1 using lime (CaO) to remove the phosphorus.
- 26-3. Given that the Al:P ratio is 1.2: in Table 26-1, show how the alum:P ratio in the table is calculated.
- 26-4. In Example 23-1 (Chapter 23), a correction was made for the allowable effluent BOD_5 to account for the BOD of the total suspended solids. Assume that tertiary filtration has been installed to reduce the TSS to 10 mg/L and recalculate the allowable effluent BOD_5 . Use this new estimate of S to determine the volume of the aeration tank.
- 26-5. A dual media denitrification filter is being considered for the effluent from the oxidation ditch being built for the city of Pasveer (Problem 23-28, Chapter 23). Using the data from Pasveer and a permit requirement that $\text{NO}_3\text{-N}$ not exceed 4.0 mg/L, determine the following:
 - a. Filter media volume
 - b. Filter hydraulic loading
 - c. Number of filters and their nominal dimensions
 - d. Methanol dose in mg/L and kg/d

Assume a typical $\text{NO}_3\text{-N}$ loading rate for the sustained minimum temperature and assume that the filters will be sized using the guidance in Chapter 11.

- 26-6.** A dual media denitrification filter is being considered for the effluent from the oxidation ditch being built for the city of Brooklyn (Problem 23-33, Chapter 23). Using the data from Brooklyn and a permit requirement that $\text{NO}_3\text{-N}$ not exceed 2.0 mg/L, determine the following:
- Filter media volume
 - Filter hydraulic loading
 - Number of filters and their nominal dimensions
 - Methanol dose in mg/L and kg/d

Assume a typical $\text{NO}_3\text{-N}$ loading rate for the sustained minimum temperature and assume that the filters will be sized using the guidance in Chapter 11.

- 26-7.** Estimate MF filter area required to treat effluent from the Pasveer tertiary filter (Problem 26-5). Assume a conservative hydraulic loading.
- 26-8.** Estimate MF filter area required to treat effluent from the Brooklyn tertiary filter (Problem 26-6). Assume a conservative hydraulic loading.
- 26-9.** To prepare the wastewater effluent from Pasveer's MF filters (Problem 26-7) for groundwater discharge, it will be passed through an activated carbon filter. Assuming a conservative EBCT, estimate the volume of activated carbon required for a column.
- 26-10.** To prepare the wastewater effluent from Brooklyn's MF filters (Problem 26-8) for groundwater discharge, it will be passed through an activated carbon filter. Assuming a conservative EBCT, estimate the volume of activated carbon required for a column.

26-8 REFERENCES

- Clark, R. M. and B. W. Lykins (1989) *Granular Activated Carbon: Design, Operation and Cost*, Lewis Publishers, Chelsea, Michigan.
- Cleasby, J. L. and G. S. Logsdon (1999) "Granular Bed and Precoat Filtration," in R. D. Letterman (ed.) *Water Quality and Treatment*, 5th ed., American Water Works Association, McGraw-Hill, New York, pp. 8.1–8.99.
- Crittenden, J. C., P. S. Reddy, H. Arora, J. Trynoski, D. W. Hand, D. L. Perrman, and R. S. Summers (1991) "Predicting GAC Performance with Rapid Small-Scale Column Tests," *Journal of American Water Works Association*, vol. 83, no. 1, pp. 77–87.
- Culp, R. L., G. M. Wesner, and G. L. Culp (1978) *Handbook of Advanced Wastewater Treatment*, 2nd ed., Van Nostrand Reinhold, New York, p. 95.
- GLUMRB (2004) *Recommended Standards for Wastewater Facilities*, Great Lakes–Upper Mississippi River Board of State and Provincial Public Health and Environmental Managers, Health Education Services, Albany, New York, pp. 110-5–110-8.
- Gnirss, R. and J. Dittrich (2000) "Microfiltration of Municipal Wastewater for Disinfection and Advanced Phosphorus Removal: Results from Trials with Different Small-Scale Pilot Plants," *Water Environment Research*, vol. 72, no. 5, pp. 602–609.
- Howe, K. J. and Mark M. Clark (2006) "Effect of Coagulation Pretreatment on Membrane Performance," *Journal of American Water Works Association*, vol. 98, no. 4, pp. 133–146.
- Metcalf & Eddy (2003) *Wastewater Engineering: Treatment and Reuse*, 4th ed., McGraw-Hill, Boston, Massachusetts, pp. 1,035–1,162.

- Pickard, D. W. et al. (1985) "Six Years of Successful Nitrogen Removal at Tampa, Florida," presented at the 58th Annual Conference of the Water Pollution Control Federation, Kansas City, Missouri.
- Savage, E. S. (1983) "Biological Denitrification Deep Bed Filters," presented at the Filtech Conference, Filtration Society, London.
- Tooker, N. B. and J. L. Darby (2007) "Cloth Media Filtration and Membrane Microfiltration: Serial Operation," *Water Environment Research*, vol. 79, no. 2, pp. 125–130.
- U.S. EPA (1973) *Process Design Manual for Carbon Adsorption*, U.S. Environmental Protection Agency, Technology Transfer, Washington, D.C.
- U.S. EPA (1975) *Process Design Manual for Nitrogen Control*, U.S. Environmental Protection Agency, Technology Transfer, Washington, D.C.
- U.S. EPA (1976) *Process Design Manual for Phosphorus Removal*, U.S. Environmental Protection Agency, Technology Transfer, Washington, D.C.
- U.S. EPA (1979) *Environmental Pollution Control Alternatives: Municipal Wastewater*, U.S. Environmental Protection Agency, EPA Pub. No. 625/5-79-012, Washington, DC, pp. 52–55.
- WEF (1998) *Design of Municipal Wastewater Treatment Plants*, 4th ed., Water Environment Federation Manual of Practice 8, Alexandria, VA, pp. 15-40–15-47, 16-4–16-18.
- WEF (2006) *Membrane Systems for Wastewater Treatment*, Water Environment Federation, Alexandria, Virginia, pp. 113–140.

WASTEWATER PLANT RESIDUALS MANAGEMENT

- 27-1 SLUDGE HANDLING ALTERNATIVES**
- 27-2 SOURCES AND CHARACTERISTICS OF SOLIDS AND BIOSOLIDS**
- 27-3 SOLIDS COMPUTATIONS**
- 27-4 GRIT HANDLING AND SLUDGE PUMPING**
- 27-5 MANAGEMENT OF SOLIDS**
- 27-6 STORAGE AND THICKENING OF SLUDGES**
- 27-7 ALKALINE STABILIZATION**
- 27-8 AEROBIC DIGESTION**
- 27-9 ANAEROBIC DIGESTION**
- 27-10 SLUDGE CONDITIONING**
- 27-11 DEWATERING**
- 27-12 ALTERNATIVE DISPOSAL TECHNIQUES**
- 27-13 LAND APPLICATION OF BIOSOLIDS**
- 27-14 CHAPTER REVIEW**
- 27-15 PROBLEMS**
- 27-16 REFERENCES**

27-1 SLUDGE HANDLING ALTERNATIVES

In the process of purifying wastewater, another problem is created: sludge. The higher the degree of wastewater treatment, the larger the residue of sludge that must be handled. Satisfactory treatment and disposal of the sludge can be the single most complex and costly operation in a municipal wastewater treatment system (U.S. EPA, 1979). The sludge consists of materials settled from the raw wastewater and of solids generated in the wastewater treatment processes.

The quantities of sludge involved are significant. For primary treatment, they may be 0.25 to 0.35 percent by volume of wastewater treated. Activated sludge processes increase the quantities to 1.5 to 2.0 percent of the volume of water treated. Use of chemicals for phosphorus removal can add another 1.0 percent. The sludges withdrawn from the treatment processes are still largely water. Sludge treatment processes, then, in large part are concerned with separating the large amounts of water from the solid residues. The separated water is returned to the wastewater plant for processing. In addition, the sludge is treated to reduce the pathogen density and to reduce its putrescence.

The basic processes for sludge treatment are:

1. *Preliminary operations*: Screening, grinding, degritting, blending, and storage may be part of the preliminary operations to protect downstream equipment and/or provide a homogeneous feed to subsequent process facilities.
2. *Thickening*: These processes are used to separate water from the solids to reduce the size of subsequent facilities and to improve their efficiency. The water is separated by gravity, flotation, gravity belt, rotary drum filtration, or centrifugation.
3. *Stabilization*: Sludge is stabilized to reduce pathogens, eliminate offensive odors, and inhibit putrefaction. *Biosolids* are the product that results from stabilization. The three stabilization processes discussed in this chapter are *alkaline stabilization*, *aerobic stabilization* (more commonly called *aerobic digestion*), and *anaerobic stabilization* (more commonly called *anaerobic digestion*). The latter two processes also provide additional benefits such as volume reduction and improved dewatering. In the case of anaerobic stabilization, methane is produced. The methane can be used as part of the energy source to run the wastewater treatment plant.
4. *Conditioning*: These processes treat the sludge with chemicals or heat so that more water can be readily separated.
5. *Dewatering*: These processes are used to further reduce the water to meet disposal regulations, improve handling, reduce transportation costs, prevent leachate from disposal sites and, in the case of follow-on reduction processes (i.e., incineration), reduce the energy requirements. The separation processes include centrifugation, filter presses, and drying beds.
6. *Reduction*: To achieve the most stable form of residue and to minimize the volume of residue, composting or thermal reduction processes such as drying or incineration are used.

Although energy and resource recovery have historically been considered an integral part of the residuals processing scheme, there will be increased emphasis on these aspects in the near future. Energy recovery from sludge/biosolids is a well-established technology that will find

renewed interest with the escalating cost of commercial energy. The nitrogen and phosphorus component of sludge is a valuable resource that can be recovered for beneficial use.

The large number of alternative combinations of equipment and processes used for treating sludges are limited by regulatory constraints. The ultimate depository of the materials contained in the sludge must either be land, air, or water. The “503” regulations, discussed in Chapter 18, control the disposition on land. Air pollution considerations necessitate air pollution control facilities as part of the sludge incineration process. Current regulations prohibit ocean dumping of sludge or discharge to waterways.

The basic alternative routes by which these processes may be employed are shown in Figure 27-1. With the exception of “Heat drying and other processing” and “Thermal reduction,” the following sections discuss the processes shown in Figure 27-1.

27-2 SOURCES AND CHARACTERISTICS OF SOLIDS AND BIOSOLIDS

In previous chapters, the disposition of the residuals has been deferred to this chapter. For convenience, these are summarized in this section.

Screenings

The material called *coarse screenings* consists of organic and inorganic materials large enough to be removed on bar racks. These include such items as rags, sticks, and plastic bags. In large systems objects as large as automobile tires, logs, and carpets may be captured by the bar racks. These items are often coated with fecal matter. As such they are putrescible and highly odoriferous.

Typical design properties for coarse screenings are summarized in Table 27-1 on page 27-5.

The general relationship between quantity of screenings and the size of the openings between bars is illustrated in Figure 27-2 on page 27-5.

Grit

True grit is inorganic material such as sand, broken glass, nuts, bolts, and metal fragments. In wastewater terminology, it also includes other material that is not biodegradable in secondary processes, for example, bubble gum, cigarette butts, egg shells, bone fragments, and seeds. It is frequently coated with grease and fecal material. It is putrescible and highly odoriferous.

The quantity of grit is highly variable. It depends on the type of sewer system (separate or combined), condition of the sewer system, industrial contributions, and capture efficiency of the grit collection system. Recorded quantities range from 2.5 to 180 m³/10⁶ m³ of wastewater with an average of about 28 m³/10⁶ m³ (WEF, 1998). The total grit storage volume is dependent on the frequency of removal from the plant. The following volumes are suggested for design (WPCF, 1977):

- Storage* of 74 to 220 m³/10⁶ m³ of wastewater for combined sewer systems.
- Storage* of 15 to 74 m³/10⁶ m³ of wastewater for separate sewer systems.

A suggested conservative design value is 60 m³/10⁶ m³ for separate sewers (Steel and McGhee, 1979).

*“Storage” is for the short time between removal from the wastewater and transport to a sanitary landfill.

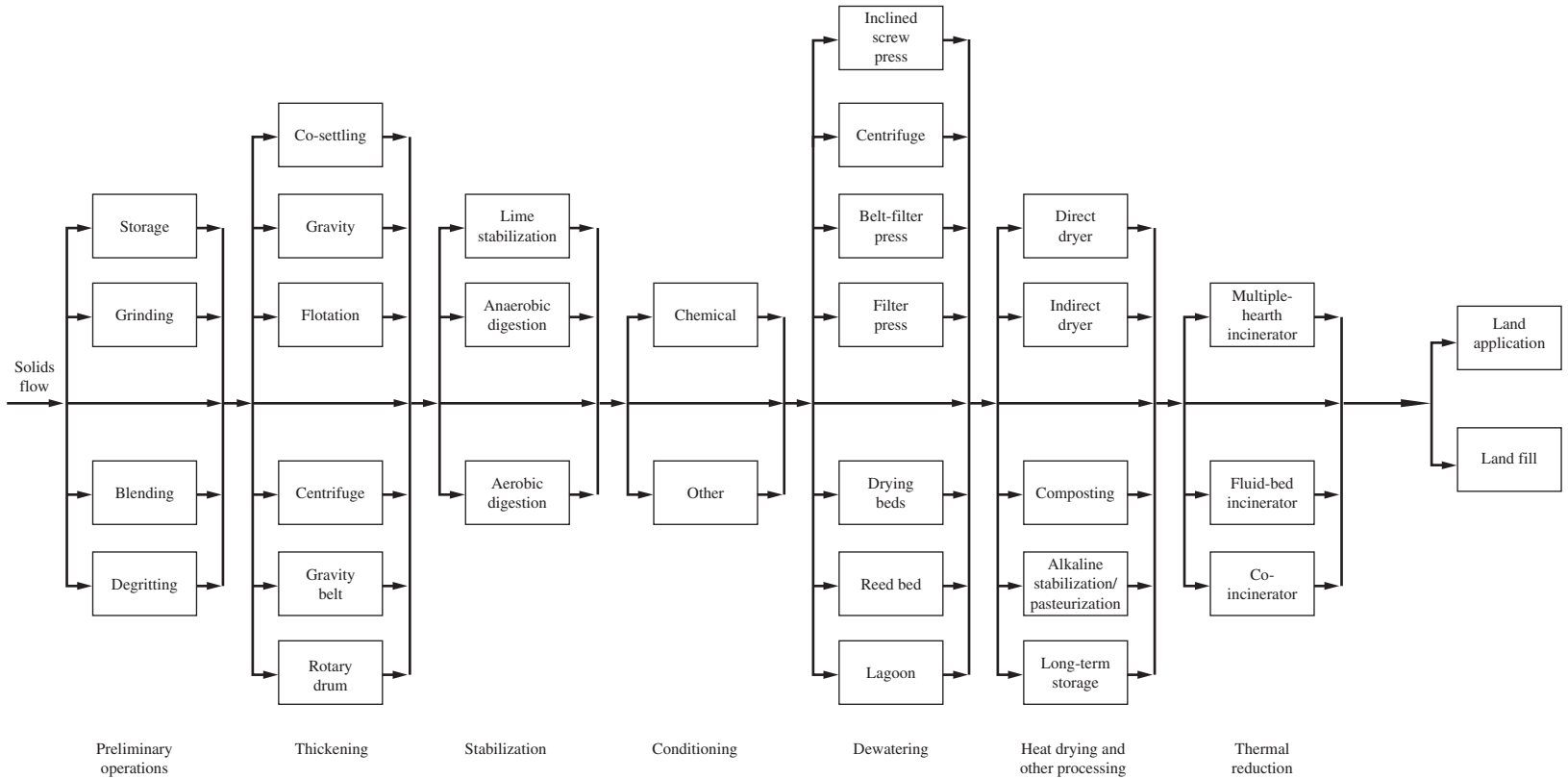

FIGURE 27-1

Generalized sludge-processing flow diagram.

(Source: Adapted from Metcalf & Eddy, 2003.)

TABLE 27-1
Typical design properties of coarse screenings

Item	Range	Comment
Quantities		
Separated sewer		
Average	3.5–35 m ³ /10 ⁶ m ³	Function of screen opening and system characteristics
Peaking factor	1:1–5:1	Hourly flows
Combined sewer		
Average	3.5–84 m ³ /10 ⁶ m ³	
Peaking factor	2:1– >20:1	
Solids content	10–20%	
Bulk density	640–1,100 kg/m ³	
Volatile content	70–95%	

Sources: U.S. EPA, 1987; WEF, 1998.

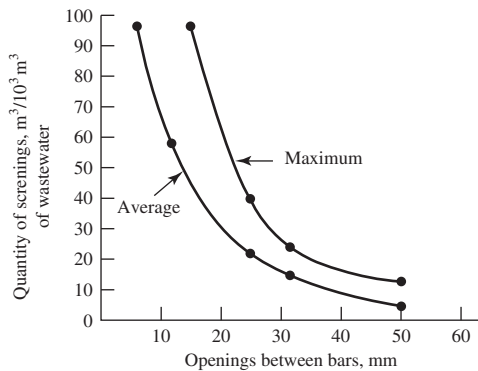

FIGURE 27-2

General relationship between volume of screenings and the size of openings between bars.

Cautious use of this information is recommended. There are extreme variations in both the quantity and character of the grit. A generous safety factor should be used in estimating the actual requirements for storage, handling, and disposal of grit.

Primary or Raw Sludge

Sludge from the bottom of the primary clarifiers contains from 2 to 8 percent solids, which is approximately 60 to 80 percent organic matter. It has a nitrogen content in the range of 1.5 to 4 percent with a typical value of 2.5 percent as N. The phosphorus content, as P₂O₅, ranges from 0.8 to 2.8 percent with a typical value of 1.6 percent (U.S. EPA, 1979; Metcalf & Eddy, 2003). This sludge rapidly becomes anaerobic and is highly odoriferous.

Secondary Sludge

This sludge consists of microorganisms and inert materials that have been wasted from the secondary treatment processes. Thus, the solids are about 60–85 percent organic matter. When the supply of air is removed, this sludge also becomes anaerobic, creating noxious conditions if

not treated before disposal. The solids content depends on the source. Wasted activated sludge is typically 0.5 to 2 percent solids, while trickling filter sludge contains 2 to 5 percent solids. The phosphorus content, as P_2O_5 , ranges from 1.5 to 3.0 percent (WEF, 1998). In some cases, secondary sludges contain large quantities of chemical precipitates because the aeration tank is used as the reaction basin for the addition of chemicals to remove phosphorus.

Tertiary Sludges

The characteristics of sludges from the tertiary treatment processes depend on the nature of the process. For example, phosphorus removal results in a chemical sludge that is difficult to handle and treat. When chemical phosphorus removal occurs in the activated sludge process, the chemical sludge is combined with the biological sludge, making the latter more difficult to treat. Nitrogen removal by denitrification results in a biological sludge with properties very similar to those of waste activated sludge.

Liquid Residuals

The major source of liquid residuals is from thickening and dewatering of biosolids. Other sources are from grit washing and from chemicals used to clean membranes. Clean-in-place (CIP) liquid residuals are characterized by very low pH and low volumes.

27-3 SOLIDS COMPUTATIONS

Volume–Mass Relationships

The relationships between volume and mass that were developed in Chapter 15 also apply to wastewater sludges.

Mass Balance

Quantitative estimates of sludge production may be made using mass balance techniques. The fundamental equation is

$$\frac{dS}{dt} = M_{in} - M_{out} \quad (27-1)$$

where M_{in} and M_{out} refer to the mass of dissolved chemicals, solids, or gas entering and leaving a process or group of processes. Assuming steady-state conditions, then $dS/dt = 0$ and Equation 27-1 reduces to the following:

$$M_{in} = M_{out} \quad (27-2)$$

Quantitative Flow Diagram (QFD). Several interrelated processes are examined together in the flowsheet shown in Figure 27-3. When labeled with mass flows, the flowsheet is called a *quantitative flow diagram* (QFD). The solids mass balance can be an important aid to a designer in predicting long-term average solids loadings on sludge treatment components. This allows the designer to establish such factors as operating costs and quantities of sludge for ultimate disposal. However, it does not establish the solids loading that each equipment item must be capable of processing. A particular component should be sized to handle the most rigorous

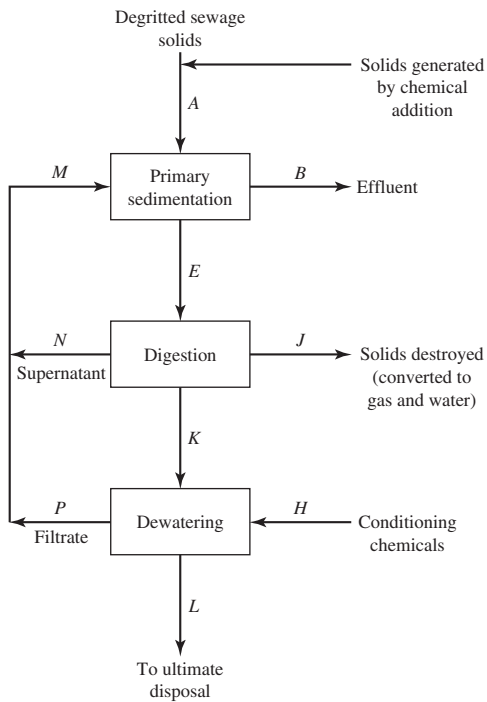

FIGURE 27-3
Primary WWTP flowsheet. (Source: U.S. EPA, 1979.)

loading conditions it is expected to encounter. This loading is usually not determined by applying steady-state models because of storage and plant scheduling considerations. Thus, the rate of solids reaching any particular piece of equipment does not usually rise and fall in direct proportion to the rate of solids arriving at the plant headworks.

The mass balance calculation is carried out in a step-by-step procedure:

1. Draw the flowsheet (as in Figure 27-3).
2. Identify all streams. For example, Stream A contains raw sewage solids plus chemical solids generated by dosing the sewage with chemicals. Let the *mass flow rate* of solids in Stream A be equal to A kg per day.
3. For each processing unit, identify the relationship of entering and leaving streams to one another in terms of mass. For example, for the primary sedimentation tank, let the ratio of solids in the tank underflow (E) to entering solids (A + M) be equal to ηE . ηE is actually an indicator of solids separation efficiency. The general form in which such relationships are expressed is:

$$\eta_i = \frac{\text{mass of solids in stream } i}{\text{mass of solids entering unit}} \quad (27-3)$$

For example,

$$\eta_P = \frac{P}{K + H}; \eta_J = \frac{J}{E}$$

The processing unit's performance is specified when a value is assigned to η_i .

4. Combine the mass balance relationships so as to reduce them to one equation describing a specific stream in terms of given or known quantities, or ones which can be calculated from a knowledge of the process behavior.

Example 27-1 illustrates the mass balance technique using the QFD.

Example 27-1. Using Figure 27-3 and assuming that A , η_E , η_j , η_N , η_P , and η_H are known or can be determined from a knowledge of water chemistry and an understanding of the general solids separation/destruction efficiencies of the processing involved, derive an expression for E , the mass flow out of the primary sedimentation tank.

Solution. The derivation is carried out as follows.

- a. Define M by solids balances on streams around the primary sedimentation tank:

$$\eta_E = \frac{E}{A + M} \quad (\text{i})$$

Therefore,

$$M = \frac{E}{\eta_E} - A \quad (\text{ii})$$

- b. Define M by balances on recycle streams:

$$M = N + P \quad (\text{iii})$$

$$N = \eta_N E \quad (\text{iv})$$

$$P = \eta_P (H + K) \quad (\text{v})$$

$$H = \eta_H K \quad (\text{vi})$$

Therefore,

$$P = \eta_P (1 + \eta_H) K \quad (\text{vii})$$

$$K + J + N = E \quad (\text{viii})$$

Therefore,

$$K = E - J - N = E - \eta_J E - \eta_N E = E(1 - \eta_J - \eta_N) \quad (\text{ix})$$

and

$$P = \eta_P E(1 - \eta_J - \eta_N)(1 + \eta_H) \quad (\text{x})$$

TABLE 27-2
Mass balance equations for Figure 27-3

$$E = \frac{A}{\frac{1}{\eta_E} - \eta_N - \eta_P(1 - \eta_J - \eta_N)(1 + \eta_H)}$$

$$M = \frac{E}{\eta_E} - A$$

$$B = (1 - \eta_E)(A + M)$$

$$J = \eta_J E$$

$$N = \eta_N E$$

$$K = E(1 - \eta_J - \eta_N)$$

$$H = \eta_H K$$

$$P = \eta_P(1 + \eta_H)K$$

$$L = K(1 + \eta_H)(1 - \eta_P)$$

Source: U.S. EPA, 1979.

Therefore,

$$M = E[\eta_N + \eta_P(1 - \eta_J - \eta_N)(1 + \eta_H)] \quad (\text{xi})$$

c. Equate equations (ii) and (xi) to eliminate M :

$$\frac{E}{\eta_E} - A = E[\eta_N + \eta_P(1 - \eta_J - \eta_N)(1 + \eta_H)]$$

$$E = \frac{A}{\frac{1}{\eta_E} - \eta_N - \eta_P(1 - \eta_J - \eta_N)(1 + \eta_H)}$$

E is expressed in terms of assumed or known influent solids loadings and solids separation/destruction efficiencies.

Once the equation for E is derived, equations for other streams follow rapidly; in fact, most have already been derived. These are summarized in Table 27-2.

Example 27-1 was relatively simple. A more complex system is illustrated in Figure 27-4. Mass balance equations for this system are summarized in Table 27-3 on page 27-11. For this flowsheet the following information must be specified:

A = Influent solids

X = Effluent solids, that is, overall suspended solids removal must be specified

η_E , η_G , η_J , η_N , η_R , and η_T = assumptions about the degree of solids removal, addition, or destruction

η_D = describes the net solids destruction/reduction or the net solids synthesis in the biological system, and must be estimated from yield data. A positive η_D signifies net solids destruction. A negative η_D signifies net solids growth. In this example, 8 percent of the solids entering the biological process are assumed destroyed, that is, converted to gas or liquified. Thus, $\eta_D = 0.08$.

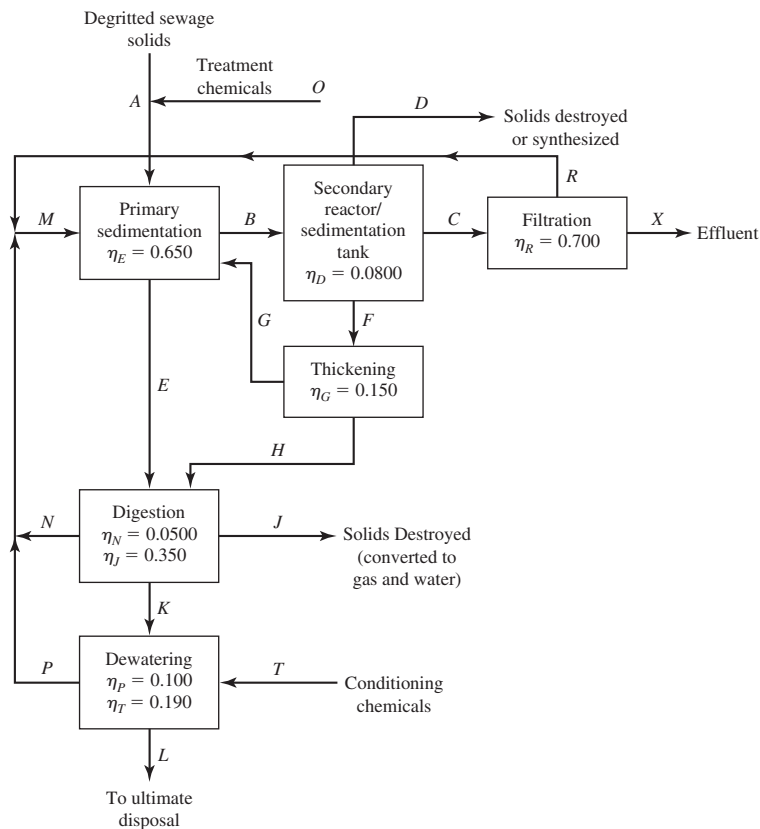

FIGURE 27-4
Flowsheet for a complex WWTP. (Source: U.S. EPA, 1979.)

Note that alternative processing schemes can be evaluated simply by manipulating appropriate variables. For example:

- Filtration can be eliminated by setting η_R to zero.
- Thickening can be eliminated by setting η_G to zero.
- Digestion can be eliminated by setting η_J to zero.
- Dewatering can be eliminated by setting η_P to zero.
- A system without primary sedimentation can be simulated by setting η_E equal to approximately zero, for example, 1×10^{-8} . η_E cannot be set equal to exactly zero, since division by η_E produces indeterminate solutions when computing.

A set of different mass balance equations must be derived if flow paths between processing units are altered. For example, the equations of Table 27-3 do not describe operations in which the dilute stream from the thickener (Stream G) is returned to the secondary reactor instead of the primary sedimentation tank.

TABLE 27-3
Mass balance equations for Figure 27-4

$$E = \frac{A - \left(\frac{X}{1 - \eta_R} \right) (\gamma - \eta_R)}{\frac{1}{\eta_E} - \alpha - \beta(\gamma)}$$

Where $\alpha = \eta_P(1 - \eta_J - \eta_N)(1 + \eta_T) + \eta_N$

$$\beta = \frac{(1 - \eta_E)(1 - \eta_D)}{\eta_E}$$

$$\gamma = \eta_G + \alpha(1 - \eta_G)$$

$$B = \frac{(1 - \eta_E)E}{\eta_E}$$

$$C = \frac{X}{1 - \eta_R}$$

$$D = \eta_D B$$

$$F = \beta E - \frac{X}{1 - \eta_R}$$

$$G = \eta_G F$$

$$H = (1 - \eta_G)F$$

$$J = \eta_J(E + H)$$

$$K = (1 - \eta_J - \eta_N)(E + H)$$

$$L = K(1 + \eta_T)(1 - \eta_P)$$

$$M = \frac{E}{\eta_E} - G - A$$

$$N = \eta_N(E + H)$$

$$P = \eta_P(1 + \eta_T)K$$

$$R = \frac{\eta_R}{1 - \eta_R} X$$

$$T = \eta_T K$$

Source: U.S. EPA, 1979.

27-4 GRIT HANDLING AND SLUDGE PUMPING

Pump Selection

Tables 27-4 and 27-5 provide guidance in selection of an appropriate pump for sludges and scum.

Headloss Determination

Grit. Slurries of grit are usually dilute. For dilute slurries, the equations that are used for estimating headloss in water pipes are adequate. A velocity of about 1.5 m/s is typically used. Low velocities may result in deposition of grit. High velocities may cause pipe erosion (U.S. EPA, 1979).

TABLE 27-4
Application of pumps to types of sludge and biosolids

Type of sludge or solids	Applicable pump	Comment
Ground screenings	Pumping screenings should be avoided	Pneumatic or screw conveyors ejectors may be used
Grit	Torque flow centrifugal	The abrasive character of grit and the presence of rags make grit difficult to handle. Hardened casings and impellers should be used for torque flow pumps. Pneumatic ejectors may also be used
Scum	Plunger; progressive cavity; diaphragm; centrifugal; chopper	Scum is often pumped by the sludge pumps; valves are manipulated in the scum and sludge lines to permit this. In larger plants separate scum pumps are used. Scum mixers are often used to ensure homogeneity prior to pumping. Pneumatic ejectors or air lift pumps may also be used
Primary sludge	Plunger; centrifugal torque flow; diaphragm progressive cavity; rotary lobe; chopper; hose	In most cases, it is desirable to obtain as concentrated a sludge as practicable from primary sedimentation tanks, usually by collecting the sludge in hoppers and pumping intermittently, allowing the solids to collect and consolidate between pumping periods. The character of untreated primary solids will vary considerably, depending on the characteristics of the solids in the wastewater and the types of treatment units and their efficiency. Where biological treatment follows, the quantity of solids from (1) waste-activated sludge, (2) humus sludge from settling tanks following trickling filters, (3) overflow liquors from digestion tanks, (4) and centrate or filtrate return from dewatering operations will also affect the sludge characteristics. In many cases, the character of the sludge is not suitable for the use of conventional nonclog centrifugal pumps. Where sludge contains rags, chopper pumps may be used
Sludge from chemical precipitation	Same as primary sludge	May contain large amounts of inorganic constituents depending on the type and amount of chemicals used
Trickling-filter humus	Nonclog and torque flow centrifugal; progressive cavity; plunger; diaphragm	Humus is usually of homogeneous character and can be easily pumped
Return or waste-activated sludge	Nonclog and torque flow centrifugal; progressive cavity; plunger; diaphragm	Sludge is dilute and contains only fine solids so that nonclog pumps may be used. For nonclog pumps, slow speeds are recommended to minimize the breakup of flocculent particles
Thickened or concentrated sludge	Plunger; progressive cavity; diaphragm; high-pressure piston; rotary lobe; hose	Positive-displacement pumps are most applicable for concentrated sludge because of their ability to generate movement of the sludge mass. Torque flow pumps may be used but may require the addition of flushing or dilution facilities
Digested biosolids	Plunger; torque flow centrifugal; progressive cavity; diaphragm; high-pressure piston; rotary lobe	Well-digested biosolids are homogeneous, containing 5 to 8% solids and a quantity of gas bubbles, but may contain up to 12% solids. Poorly digested biosolids may be difficult to handle. If good screening and grit removal are provided, nonclog centrifugal pumps may be considered

Adapted, in part, from U.S. EPA (1979).

TABLE 27-5
Advantages and disadvantages of selected types of sludge pumps

Type of pump	Advantages	Disadvantages
Plunger	<p>Can pump heavy solids concentrations (up to 15%)</p> <p>Self-priming and can handle suction lifts up to 3 m</p> <p>Constant but adjustable capacity regardless of variations in head</p> <p>Cost-effective choice for flow rates up to 100 m³/h and heads up to 60 m</p> <p>Pulsating action of simplex and duplex pumps sometimes helps to concentrate sludge in hoppers ahead of pumps and resuspend solids in pipelines when pumping at low velocities</p> <p>High-pressure capability</p>	<p>Low efficiency</p> <p>High maintenance if operated continuously</p> <p>Depending on downstream processes, pulsating flow may not be acceptable</p>
Progressing cavity	<p>Provides a relatively smooth flow</p> <p>Pumps greater than 10 m³/h capacity can pass solids of about 20 mm in size</p> <p>Easily controlled flow rates</p> <p>Minimal pulsation</p> <p>Relatively simple operation</p> <p>Stator/rotor tends to act as a check valve, thus preventing backflow through pump. An external check valve may not be required</p>	<p>Stator will burn out if pump is operated dry; needs a run dry protection system</p> <p>Smaller pumps usually require grinders to prevent clogging</p> <p>Power cost escalates when pumping heavy sludge</p> <p>Grit in sludge may cause excessive stator wear</p> <p>Seals and seal water required</p>
Diaphragm	<p>Pulsating action may help to concentrate sludge in hoppers ahead of pumps and resuspend solids in pipelines when pumping at low velocities</p> <p>Self-priming with suction lifts up to 3 m</p> <p>Can pump grit with relatively minimum wear</p> <p>Relatively simple operation</p>	<p>Depending on downstream processes, pulsating flow may not be acceptable</p> <p>Requires a source of compressed air</p> <p>Operation may be excessively noisy</p> <p>Low head and efficiency</p> <p>High maintenance if operated continuously</p>
Centrifugal nonclog (mixed flow)	<p>Has high volume and excellent efficiency for activated-sludge pumping applications</p> <p>Relatively low cost</p>	<p>Not recommended for other sludge pumping applications because of potential clogging due to rags and other debris</p>

Source: WEF, 1998.

Sludge. The headloss in pumping sludge depends on the flow properties (rheology) of the sludge, pipe diameter, and the velocity of the sludge. A plot of shear stress versus rate of shear at constant temperature and pressure illustrates examples of different rheological behavior (Figure 27-5). Fluids following simple linearity (curve C) are called *Newtonian fluids*. Water is a Newtonian fluid. Dilute sludges such as unconcentrated activated sludge and trickling-filter sludges behave similar to water. *Bingham plastics* (curve A) do not flow until a threshold shear stress greater than τ_o is achieved. At shear stresses above τ_o , the flow is nearly linear. Concentrated sludge has been found to behave much like a Bingham plastic.

With a 10 to 25 percent allowance for increased headloss, pumping calculations for unconcentrated activated sludge and trickling-filter sludge are similar to those for water. Primary, digested, and concentrated sludges exhibit Bingham plastic flow phenomenon. Once flow has started, resistance increases approximately with the first power of the velocity through the laminar range of flow to the lower critical velocity of about 1.1 m/s. Above the upper critical velocity of about 1.4 m/s, the flow may be considered turbulent.

Well-digested sludge flowing in the turbulent range may exhibit losses more than two to three times the losses for water. The losses for polymer treated primary and concentrated sludges may be considerably higher. Mixtures of scum and sludge exhibit losses similar to polymer treated concentrated sludges.

Simplified Headloss Calculation. For short pipelines, U.S. EPA (1979) outlined a simplified procedure for estimating headloss. The headloss is determined by multiplying the headloss determined for water by one of the standard techniques (Darcy-Weisbach, Hazen-Williams, or Manning equations) by the factor K determined from Figure 27-6.

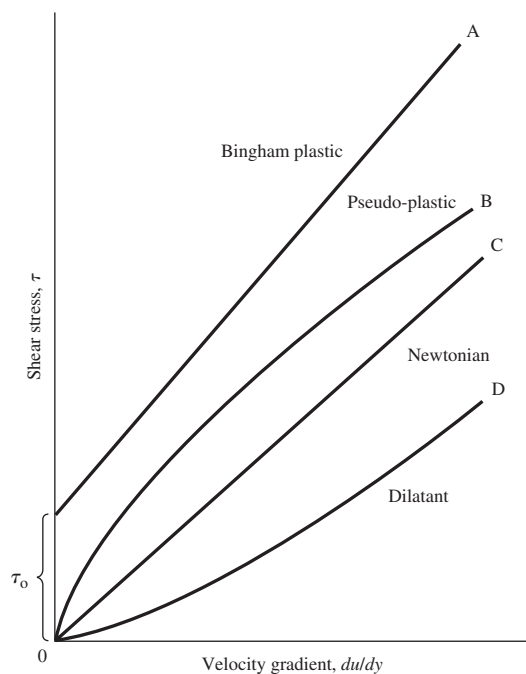

FIGURE 27-5

Shear stress versus velocity gradient for Newtonian and non-Newtonian fluids. Examples are as follows: A = sludge; B = rubber latex; C = water; D = quicksand

(Source: Adapted from McCabe et al., 2005.)

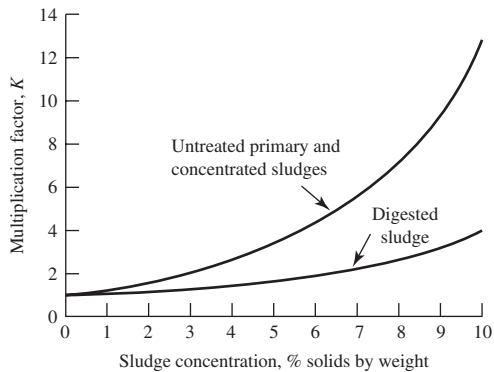

FIGURE 27-6

Approximate friction headloss for laminar flow of sludge.

NOTE: Multiply loss with clean water by K to estimate friction loss under laminar conditions.

(Source: U.S. EPA, 1979.)

This method should only be applied under the following conditions:

- Short sludge pipelines.
- Velocities ≥ 0.8 m/s but ≤ 2.4 m/s.
- Pipe is not obstructed with grease or other materials.

Thixotropic behavior (i.e., Bingham plastic) is not considered in this simplification. Because sludge lines within the treatment plant are usually short (usually < 200 m), this technique is a practical method for estimating headloss if conservative friction losses are used. A Hazen-Williams C of 100 has been used in EPA example calculations (U.S EPA, 1979).

Pumping Sludge over Long Distances. The Bingham plastic behavior of digested biosolids, thickened sludge, and concentrated activated sludge must be considered in the design of long pipelines (for example, > 1 km). Because of the specialized nature of these pipelines, their design is not considered in this discussion. The reader is referred to discussions in Metcalf & Eddy (2003), Bechtel (2005), and Murakami et al. (2001) that present rheological methods for estimating headloss.

The risk of underestimating the headloss increases as the piping distance and solids concentrations increase. Hydraulic studies to confirm the ranges of headloss characteristics are strongly recommended.

Sludge Piping

Sludge piping should not be less than 150 mm in diameter. Unless velocities exceed 1.5 to 1.8 m/s, sludge piping is generally less than 200 mm in diameter. Gravity sludge withdrawal lines should not be less than 200 mm diameter. Available head on gravity discharge pipe should be at least 1.2 m (GLUMRB, 2004; Metcalf & Eddy, 2003).

Typically lined ductile iron pipe (DIP) is used for sludge-pipe material. Appropriately pressure rated high density polyethylene (HDPE) pipe has also been used.

Stoppages in sludge pipelines are a major maintenance issue. Some suggested design features are (Metcalf & Eddy, 2003):

- Plugged tees or crosses instead of elbows to facilitate the use of a rod to remove stoppages.
- Pump connections not less than 100 mm diameter.
- Ample number of flushing connections in the piping.
- Flushing water (plant effluent) at a capacity of not less than 36 m³/h and 500 kPa.
- In large plants with larger piping, provide greater capacity and pressure of 700 kPa.

Hints from the Field

Plant operation and maintenance personnel have provided the following insights on the design of grit and sludge pipelines:

- Place grit pipes at locations that allow maintenance workers to stand at ground level.
- If overhead piping cannot be avoided, provide adequate floor space for maneuvering aerial work platforms (also known as *electric boom lifts* or *electric scissors*).
- Provide quick disconnects for grit pipes so they can be removed to clear stoppages.
- Make primary and concentrated sludge pipelines as short as possible. One hundred meters of pipeline seems like a hundred kilometers of pipeline when it becomes plugged.
- Assume that sludge pumping will be done over short time periods rather than over a 24-hour period or even an 8-hour shift.
- Provide for reverse flow through sludge pipes as a means of dislodging stoppages.

Example 27-2. The Omega Three activated sludge plant generates a peak sludge flow rate of 270 m³/d of a mixed primary and thickened waste activated sludge. The solids concentration is 3.8%. One-third of the sludge is to be pumped 200 m to a stabilization facility during each shift. Select a pipe diameter and estimate the friction headloss. Assume a Hazen-Williams $C = 100$ and a pumping time of one hour.

Solution:

- a. Convert the pumping rate to compatible units. Note that one-third of the sludge volume is 90 m³ for each pumping cycle. For a one-hour pumping time,

$$Q = \frac{90 \text{ m}^3}{(1 \text{ h})(3,600 \text{ s/h})} = 2.50 \times 10^{-2} \text{ m}^3/\text{s}$$

- b. Select the minimum pipe size of 150 mm or 0.15 m and check the velocity.

$$\begin{aligned} \text{Area of pipe} &= \frac{\pi(0.15 \text{ m})^2}{4} = 1.77 \times 10^{-2} \text{ m}^2 \\ v &= \frac{Q}{A} = \frac{2.50 \times 10^{-2} \text{ m}^3/\text{s}}{1.77 \times 10^{-2} \text{ m}^2} = 1.4 \text{ m/s} \end{aligned}$$

This is less than 1.5 m/s so the pipe size is reasonable.

- c. Compute the headloss with the Hazen-Williams headloss equation.

$$h_L = 10.7 \left(\frac{Q}{C} \right)^{1.85} \left(\frac{L}{D^{4.87}} \right)$$

$$h_L = 10.7 \left(\frac{2.50 \times 10^{-2} \text{ m}^3/\text{s}}{100} \right)^{1.85} \left(\frac{200 \text{ m}}{(0.15 \text{ m})^{4.87}} \right)$$

$$= 10.7(2.17 \times 10^{-7})(2.06 \times 10^6) = 4.78 \text{ m}$$

- d. From Figure 27-6, using the “untreated primary and concentrated sludges” curve, find $K = 2.4$.
- e. The estimated headloss is then

$$h_L = 2.4(4.78 \text{ m}) = 11.47 \text{ or about } 11 \text{ m}$$

Comments:

1. The value of C is conservative because the sludge will coat the pipe.
 2. The pumping time should be discussed with the plant personnel as it is an assumption that has a significant impact on the headloss and, thus, the design of the pumping system.
-

27-5 MANAGEMENT OF SOLIDS

Management of Screenings

Mechanical screens discharge the screenings to a compactor or removable containers. To control odors, both the screening equipment and the containers are placed in a building. For smaller facilities, there should be sufficient clearance (typically 1.3 to 1.5 m) under the discharge chute to facilitate placement and removal of the container. In larger facilities, the discharge is made on to a conveyor that carries the solids to a roll-off box that is located in the building. The conveyor system must provide for drainage from the screenings.

The screenings are typically transported to an approved disposal site. This is often a sanitary landfill. Another alternative is incineration with municipal solid waste.

Management of Grit

After removing grit from the grit chamber or vortex, it is typically washed to remove organic material. To control odors, the grit chamber, washing equipment, and storage hopper are placed in a building. The ventilation air from the building is scrubbed.

Two general types of grit washing equipment are employed: classifiers and hydrocyclones. The classifiers are either a reciprocating rake or a screw inclined at 15 to 30 degrees from horizontal. Flatter slopes will remove finer grit particles. Other design variables include flight tip speed and pitch. Water (plant effluent) is introduced at the solids exit end of the classifier. It flows down the incline to be discharged back into the flow at the head end of the plant. The grit is discharged at the upper end of the incline. In very small installations this may be into a wheelbarrow. Typically the grit is discharged into a small dumpster or roll-off box.

Hydrocyclones concentrate the grit by centrifugal force. A steady feed rate is required. The hydrocyclone influent is expected to be about 1 percent solids, and the effluent achieves between 5 and 15 percent solids.

The grit is typically transported to an approved disposal site. This is often a sanitary landfill. Although it rarely is, the grit should be sufficiently dry to prevent liquid leakage from the transporting truck. Plastic sheet liners in the truck bed minimize this problem.

27-6 STORAGE AND THICKENING OF SLUDGES

Storage

Storage should be provided to smooth out fluctuations in the rate of solids production that occur during night shifts, weekends, and off-line maintenance. Upstream storage is particularly important for the following processes: mechanical dewatering, alkaline stabilization, heat drying, and thermal reduction. Downstream storage is also important for dewatered sludges to allow for intermittent hauling to disposal sites. Typically, the downstream storage is in transport units. Otherwise, operation of the dewatering equipment is limited to periods when it can be hauled or used.

For biosolids that are to be land applied, sufficient storage must be provided to allow for intermittent application because of weather and crop constraints.

Thickening

The common methods of thickening include gravity thickening in the secondary clarifier or in a tank separate from the secondary clarifier, dissolved air flotation (DAF), solid-bowl centrifugation, rotary-drum thickening, and gravity belt thickening (GBT). Gravity thickening design principles are discussed in Chapter 15. The emphasis in this section is on application of gravity thickening, rotary-drum thickening, DAF, and GBT to wastewater sludges. Solid-bowl centrifugation is discussed under the heading of “Dewatering” later in this chapter.

The application of these thickeners to wastewater sludges as well as comments on their use are summarized in Table 27-6.

Gravity Thickening. The surface area required for thickening may be determined by one of two methods: *solids flux analysis* or *state point analysis*. Solids flux analysis is discussed in Chapter 15. State point analysis is discussed in Chapter 25.

The type of sludge being thickened has a major effect on performance. The best results are obtained with purely primary sludges. As the proportion of activated sludge increases, the thickness of settled sludge solids decreases. Purely primary sludges can be thickened from 1–3 percent to 10 percent solids. An alternative approach is to use gravity thickening for primary sludges and DAF thickening for activated sludges, and then blending the thickened sludges for further processing.

Typical gravity-thickener design criteria are summarized in Table 27-7. Wasting to the thickener may or may not be continuous, depending upon the size of the WWTP. Frequently, smaller plants will waste intermittently because of work schedules and lower volumes of sludge. Some examples of thickener performance are listed in Table 27-8 on page 27-20. The supernatant suspended solids levels are quite high. Thus, the supernatant must be returned to the head end of the WWTP.

TABLE 27-6
Occurrence of thickening methods in solids processing

Method	Type of solids	Frequency of use and relative success
Gravity, cosettling in clarifier	Primary and waste activated	Occasional use; may negatively impact the effectiveness of primary clarifier
Gravity, thickening in separate tank	Untreated primary sludge	Commonly used with excellent results; sometimes used with hydroclone degritting of sludge. Can be odorous
	Untreated primary and waste-activated sludge	Often used. For small plants, generally satisfactory results with solids concentrations in the range of 4 to 6 percent For large plants, results are marginal. Can be odorous in warm weather
Dissolved air flotation	Waste-activated sludge	Seldom used; poor solids concentration (2 to 3 percent)
	Untreated primary and waste-activated sludge	Limited use; results similar to gravity thickeners
	Waste-activated sludge	Commonly used, but use is decreasing because of high operating cost; good results (3.5 to 5 percent solids concentration)
Solid-bowl centrifuge	Waste-activated sludge	Often used in medium-to-large plants; good results (4 to 6 percent solids concentration)
Gravity-belt thickener	Waste-activated sludge	Often used; good results (3 to 6 percent solids concentration)
Rotary-drum thickener	Waste-activated sludge	Limited use; good results (3 to 6+ percent solids concentration)

Source: Metcalf & Eddy, 2003.

TABLE 27-7
Typical gravity-thickener design criteria

Sludge source	Influent suspended solids, %	Expected underflow concentration, %	Mass loading, kg/h · m ²
Individual sludges			
PS	2–7	5–10	4–6
TF	1–4	3–6	1.5–2.0
RBC	1–3.5	2–5	1.5–2.0
WAS	0.5–1.5	2–3	0.5–1.5
Tertiary sludges			
High CaO	3–4.5	12–15	5–12
Low CaO	3–4.5	10–12	2–6
Fe	0.5–1.5	3–4	0.5–2.0
Combined sludges			
PS + WAS	0.5–4	4–7	1–3.5
PS + TF	2–6	5–9	2–4

(continued)

TABLE 27-7 (continued)
Typical gravity-thickener design criteria

Sludge source	Influent suspended solids, %	Expected underflow concentration, %	Mass loading, kg/h · m ²
PS + RBC	2–6	5–8	2–3
PS + Fe	2	4	1
PS + Low CaO	5	7	4
PS + High CaO	7.5	12	5
PS + (WAS + Fe)	1.5	3	1
PS + (WAS + Al)	0.2–0.4	4.5–6.5	2–3.5
(PS + Fe) + TF	0.4–0.6	6.5–8.5	3–4
(PS + Fe) + WAS	1.8	3.6	1
WAS + TF	0.5–2.5	2–4	0.5–1.5

(Source: U.S. EPA, 1979.)

Legend: PS = primary sedimentation; TF = trickling filter; RBC = rotating biological contactor; WAS = waste activated sludge; High CaO = high lime; Low CaO = low lime; Fe = iron; Al = alum; + = mixture of sludges from processes indicated; () = chemical added to process is within parentheses.

TABLE 27-8
Reported operation results for gravity thickeners

Location	Sludge source	Influent TSS, %	Mass loading, kg/h · m ²	Underflow concentration, %	Overflow TSS, mg/L
Port Huron, MI	PS + WAS	0.6	1.7	4.7	2,500
Sheboygan, WI	PS + TF	0.3	2.2	8.6	400
	PS + (TF + Al)	0.5	3.6	7.8	2,400
Grand Rapids, MI	WAS	1.2	2.1	5.6	140
Lakewood, OH	PS + (WAS + Al)	0.3	2.9	5.6	1,400

(Source: U.S. EPA, 1979.)

(NOTE: Values shown are average values only.)

Rotary-Drum Thickening. The rotary-drum system consists of a polymer conditioning system, and a rotating cylindrical screen. Thickened sludge is discharged out the end of the screen, while separated water exits through the screen. Primary sludge fed at 3 to 6 percent solids may be thickened to 7–9 percent. Waste activated sludge (WAS) at 0.5 to 1.0 percent may be thickened to about 4 to 9 percent. Primary sludge plus WAS at 2 to 4 percent may be thickened to 5 to 9 percent. These units are typically used in small- to medium-sized plants. Capacities range up to 80 m³/h (Metcalf & Eddy, 2003).

Gravity Belt Thickener. The gravity belt thickener (GBT) is a modification of the upper drainage zone of the continuous belt thickener described in Chapter 15. A polymer is added to the solids to coagulate and flocculate the solids before they enter the GBT. Without proper coagulant addition, the process will fail. The solids flow down an inlet ramp that has guide vanes to uniformly disperse the sludge across the width of a continuously moving fabric belt. Free water is released from

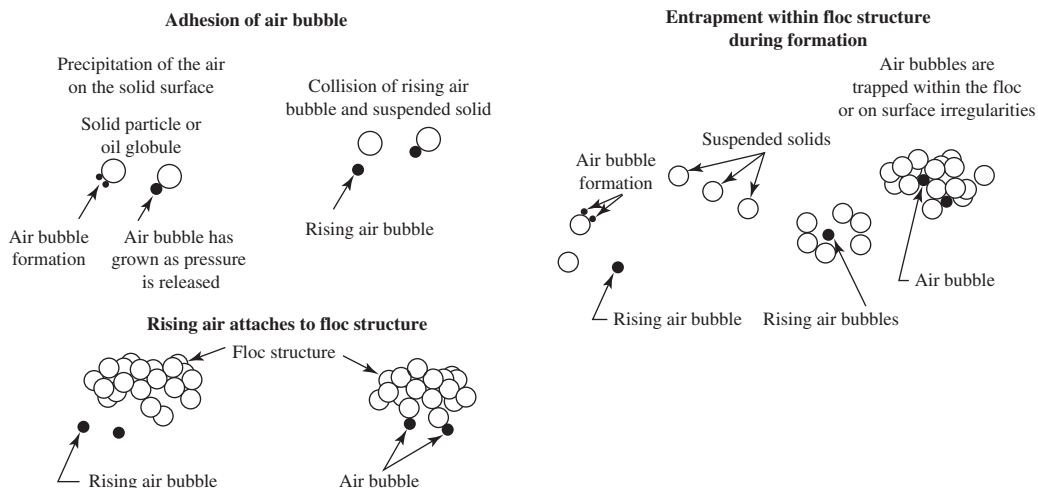

FIGURE 27-7
Solid-bubble contacting mechanisms.

(Source: WEF, 1998.)

the solids and drains through the fabric. Plows or vanes ride on the surface of the belt to fold and turn over the solids and expose clean areas of the fabric through which the water can drain.

Concentrations of biosolids in the range of 0.5 to 1 percent are thickened to 6 to 8 percent dry solids. The units have widths up to about 3 m.

Dissolved Air Flotation (DAF). A synopsis of the DAF process was presented in Chapter 15. The theoretical concept of air flotation is illustrated in Figure 27-7. Particles with specific gravity greater than 1 can be removed if the aggregate of the air bubbles and particle achieves a specific gravity less than 1.

Schematics of a typical DAF thickener and a DAF thickener system are illustrated in Figures 27-8 and 27-9. The DAF tank is baffled such that the clarified effluent passes under the baffle and over the outlet weir.

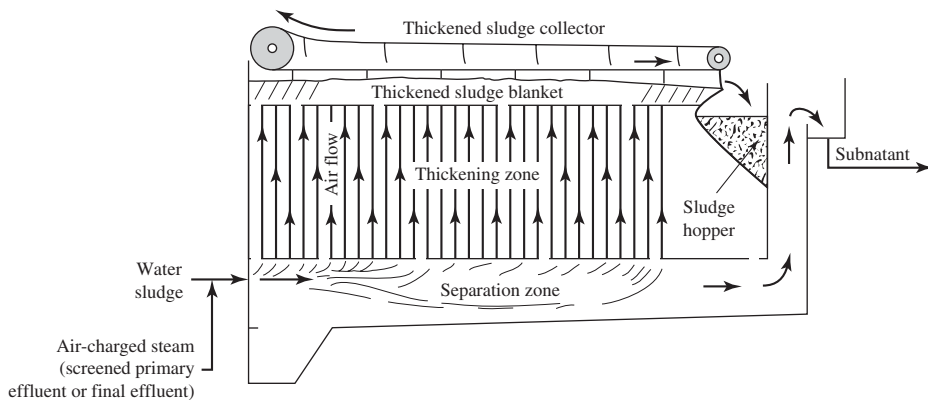

FIGURE 27-8
Air flotation thickener. (Source: Davis and Cornwell, 2008.)

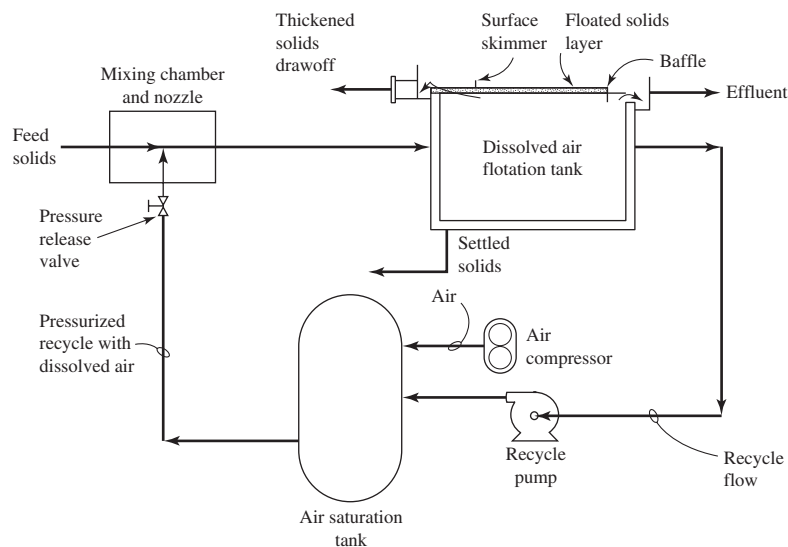

FIGURE 27-9
Schematic of dissolved air flotation thickener system.
(Source: WEF, 1998.)

Of the numerous factors that must be considered in the design of the DAF system, the following are highlighted (WEF, 1998):

- *Air-to-solids ratio:* The air-to-solids ratio is, perhaps, the single most important factor affecting DAF performance. The ratio is computed as the mass ratio of air available for flotation to the solids to be floated in the feed system. Adequate flotation is achieved in most municipal wastewater thickening applications at ratios of 0.02:1 to 0.06:1.
- *Hydraulic loading:* The rate of hydraulic loading is calculated as the sum of the feed and recycle flow rates divided by the net available flotation area. Typical designs are in the range of 30 to 120 $\text{m}^3/\text{d} \cdot \text{m}^2$ of surface area. Turbulence may result in hourly hydraulic loading rates in excess of $5 \text{ m}^3/\text{h} \cdot \text{m}^2$. This will hinder the formation of a stable float blanket. The addition of polymer markedly improves stability.
- *Polymer addition:* Typical polymer dosage is in the range of 2 to 5 g dry polymer/kg of dry feed solids. Bench scale testing is the best method to determine the optimum chemical conditioning polymer and dosage.
- *Solids-loading rate:* The solids-loading rate is calculated as the mass of solids per hour per effective flotation area. For thickening waste activated sludge without chemical addition, the range of loading rates is from 2 to 5 $\text{kg}/\text{h} \cdot \text{m}^2$ of surface area to produce a thickened float of 3 to 5 percent total solids. With the addition of polymer, the loading rate may be increased 50 to 100 percent with up to 0.5 to 1 percent increase in the solids float concentration. Operational difficulties arise if the loading rate exceeds $10 \text{ kg}/\text{h} \cdot \text{m}^2$.

Typical DAF performance in thickening of waste activated sludge is in the range of 3.5 to 4.0 percent total solids with a capture efficiency in the range of 98 to 99—plus percent. DAF is generally not used for primary or trickling filter sludges because gravity thickening is more economical (WEF, 1998).

27-7 ALKALINE STABILIZATION

The primary objectives of alkaline stabilization are to inhibit bacterial decomposition of the sludge and to inactivate pathogenic organisms. Quicklime and hydrated lime are the principle alkaline compounds used. Others are cement kiln dust, lime kiln dust, and fly ash. Because lime is the most widely used, it is the focus of this discussion. The application of other alkaline materials is discussed in Metcalf & Eddy (2003) and WEF (1998).

Theory

The addition of a sufficient quantity of lime to untreated sludge raises the pH to 12 or higher. The high pH substantially retards the microbial reactions that lead to odor production and vector attraction. If the pH is maintained at this level, the sludge will not putrefy, create odors, or pose a health hazard.

Chemical Reactions. Because of the heterogeneous nature of biological sludges, a large number of reactions can occur. Some examples of these are

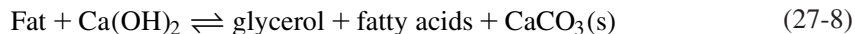
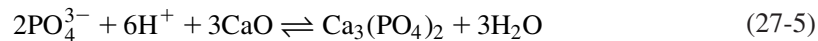
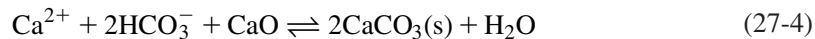

Other reactions include hydrolysis of polymers, proteins, and amino acids. Many of these reactions result in the production of off-gases, such as ammonia, that are odoriferous.

No direct reduction of organic matter occurs in lime treatment. If insufficient lime is added, the result of these reactions will be a reduction in pH. If the pH drops below 11.0, biological decomposition will resume and stabilization will then be inadequate.

Heat Generation. The addition of quicklime (CaO) to sludge results in a hydration reaction with water. This reaction is exothermic with a heat release of approximately 64 kJ/g · mole. The reaction with CO₂ is also exothermic with a heat release of approximately 180 kJ/g · mole.

Lime Pretreatment

The addition of lime to liquid sludge is called *pretreatment*. This method is used for direct land application of liquid sludge or as conditioning prior to dewatering. Lime pretreatment requires more lime per unit weight of sludge processed than is necessary for dewatering. This is because the chemical demand of the liquid requires a higher dose to achieve the required pH for disposition on land.

Lime Posttreatment

The addition of lime with dewatered sludge in a pug mill, paddle mixer, or screw conveyor is called *posttreatment*. Excellent mixing is required to ensure contact between particles of sludge and lime and to avoid pockets of putrescible material. When well mixed, the stabilized product is a crumbly mixture that can be stored for long periods.

Alkaline Stabilization Design Practice

The design objective is to meet the regulatory requirements specified in the Code of Federal Regulations (40 CFR Part 503). These are outlined in Chapter 18. To meet Class A criteria, sufficient alkali must be added to maintain the pH above 12 for more than 72 hours to ensure pathogen destruction. The temperature must be above 52°C for at least 12 hours during the period the pH is greater than 12. The solids must be air dried to over 50 percent after the 72-hour period at elevated temperature.

To meet Class B requirements and to reduce vector attraction, sufficient alkali must be added to raise the pH to at least 12 for two hours at 25°C and maintain a pH of 11.5 for 22 more hours (40 CFR 503.33(b)(6)). In theory, this should provide enough residual alkalinity so that the pH does not drop below 11 for several days. The recommended design criteria are (U.S. EPA, 1979):

- Treat the sludge in a liquid state.
- Bring the sludge to a pH of 12.5 by lime addition and maintain the pH above 12.5 for 30 minutes. This keeps the pH above 12 for two hours.

The amount of lime required is determined by the type of sludge, its chemical composition, and the solids concentration. Example lime dosages are given in Table 27-9. For specific applications testing must be performed to determine the actual dosage requirements.

A conceptual layout for a lime stabilization facility is shown in Figure 27-10. The mixing tank is typically designed to operate in a batch process mode. The volume of the tank must be large enough to hold the sludge for 30 minutes. The holding capacity may be considerably larger, depending on the plant operating mode and shift responsibilities for treating the sludge. For a Class A sludge, additional storage volume beyond the mixing tank must be provided to meet the temperature and time requirements (52°C for 12 hours).

Mixing may be either by air or by mechanical mixers. For air mixing, coarse bubble diffusers are mounted along one wall of the tank to create a spiral roll. The air supply should be

TABLE 27-9
Example lime dosages for pretreatment sludge stabilization at Lebanon, OH

Type of sludge	Solids concentration, %		Lime dosage, g Ca(OH) ₂ /kg dry solids	
	Range	Average	Range	Average
Primary	3–6	4.3	60–170	120
Waste activated	1–1.5	1.3	210–430	300
Anaerobically digested mixed	6–7	5.5	140–250	190

NOTE: lime requirement to keep pH at 12 for 30 minutes.
 Adapted from U.S. EPA, 1979.

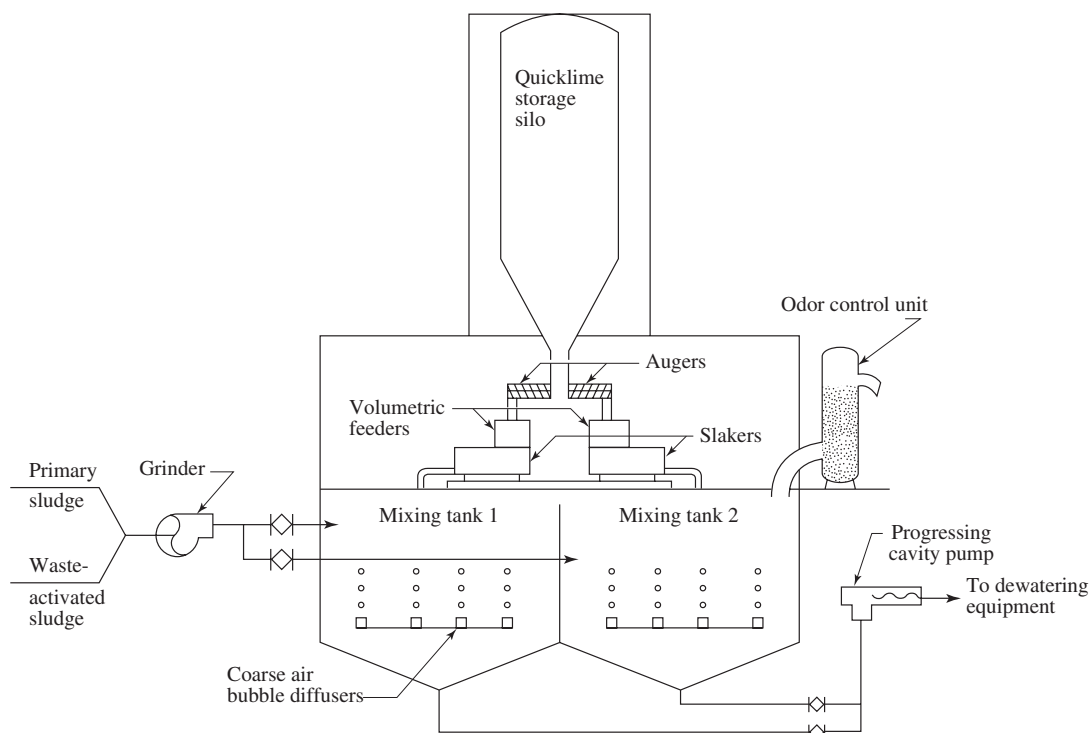

FIGURE 27-10
 Conceptual design for a lime stabilization facility.
 (Source: U.S. EPA, 1979.)

rated at $20 \text{ m}^3/\text{min} \cdot 1,000 \text{ m}^3$ of tank volume. For mechanical mixing, the bulk fluid velocity (turbine agitator pumping capacity divided by the cross-sectional area) should be greater than 8.5 m/min , and the impeller Reynolds number should be greater than 1,000 (U.S. EPA, 1975). Some examples are shown in Table 27-10.

TABLE 27-10
Mechanical mixer specifications for sludge slurries

Nominal tank size, m ³	Tank diameter, m	Turbine diameter, m	Motor size, kW	Shaft speed, rpm
20	2.9	0.82	5.6	125
		0.98	3.7	84
		1.1	2.2	56
60	4.2	1.1	14.9	100
		1.3	11.2	68
		1.6	7.5	45
		1.7	5.6	37
		1.5	30	84
115	5.2	1.6	22.4	68
		1.7	18.6	57
		2.1	14.5	37
		1.6	74.5	100
280	7.1	1.9	55.9	68
		2.0	44.7	56
		2.2	37.2	45
		1.8	93.2	84
380	7.8	2.0	74.5	68
		2.4	55.9	45

Assumptions:

Bulk fluid velocity > 8.5 m/min

Impeller Reynolds number > 1,000

Liquid depth equals tank diameter

Baffles with a width of 1/12 tank diameter placed at 90 degrees

Freeboard of 0.6 m added to liquid depth

Adapted from U.S. EPA (1975).

Example 27-3. Design a pretreatment lime stabilization system for Omega Three (Example 27-2). Determine the volume of the reactor tank, mixer size (kW, rpm, turbine diameter), lime feed rate, and lime storage volume for two-week delivery. Assume the specific gravity of the sludge is 1.012, that lime has a bulk density of 640 kg/m³, and that a 14-day supply will be stored.

Solution:

- From Example 27-2, the volume of sludge delivered per shift is 90 m³. From Table 27-10, a standard tank that will hold this volume is 115 m³.
- From Table 27-10, select a mixer with the following characteristics: 2.1 m turbine, 14.5 kW motor, and shaft speed of 37 rpm.
- The mass of dry solids is determined using Equation 15-9. From Example 27-2, the % solids is 3.8 and the volume of the sludge per pumping cycle is 90 m³.

$$V_{sl} = \frac{M_s}{(\rho)(S_{sl})(P_s)}$$

$$M_s = (90 \text{ m}^3)(1,000 \text{ kg/m}^3)(1.012)(0.038)$$

$$= 3,461 \text{ or } 3,500 \text{ kg per pumping cycle.}$$

- d. The mass of lime (CaO) for each batch is the ratio of the gram molecular weights for the slaking of lime. From the reaction shown below, one mole of CaO reacts with water to produce one mole of hydrated lime (Ca(OH)₂).

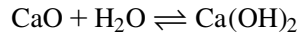

- e. From Table 27-9, assume a dose of 300 g Ca(OH)₂/kg dry solids for WAS. The mass of lime (CaO) for each batch is then

$$\frac{\text{GMW CaO}}{\text{GMW Ca(OH)}_2} (300 \text{ g/kg})(3,461 \text{ kg})(10^{-3} \text{ kg/g})$$

$$= \frac{56}{74} (300 \text{ g/kg})(3,461 \text{ kg})(10^{-3} \text{ kg/g})$$

$$= (0.76)(1,038.3) = 785.7 \text{ or } 790 \text{ kg per batch}$$

- f. The lime feed rate is set to match the flow rate of the sludge. The lime feed rate is then

$$\frac{785.7 \text{ kg per batch}}{60 \text{ min delivery per batch}} = 13.1 \text{ kg/min}$$

- g. The volume of the lime storage silo is

$$V = (3 \text{ batches per day})(785.7 \text{ kg per batch})(14 \text{ d supply})(1/640 \text{ kg/m}^3)$$

$$= 51.56 \text{ or } 52 \text{ m}^3$$

Comment. For practical, operational use, the specific gravity of sludge is often taken to be 1.0.

27-8 AEROBIC DIGESTION

Process Description

The aerobic digestion of biological sludges is a continuation of the activated sludge process. When a culture of aerobic heterotrophs is placed in an environment containing a source of organic material, the microorganisms remove and utilize most of this material. A fraction of the organic material removed will be used for the synthesis of new biomass. The remaining material will be channeled into energy metabolism and oxidized to carbon dioxide, water, and soluble inert material to provide energy for both synthesis and maintenance (life-support) functions. Once the external source of organic material is exhausted, however, the microorganisms enter into endogenous respiration, where cellular material is oxidized to satisfy the energy of maintenance (that is, energy for life-support requirements). If this condition is continued over an extended period of time, the total quantity of biomass will be considerably reduced. Furthermore, that

portion remaining will exist at such a low energy state that it can be considered biologically stable and suitable for disposal in the environment. This forms the basic principle of aerobic digestion.

Three aerobic stabilization processes are in common use: conventional aerobic digestion, high-purity oxygen aerobic digestion, and autothermal aerobic digestion (ATAD). Of these three, conventional aerobic digestion is the most common. This discussion is limited to conventional aerobic digestion.

Theory

Assuming the formula $C_5H_7NO_2$ is representative of cell mass, the biochemical changes in an aerobic digester may be described by the following equations (Metcalf & Eddy, 2003):

Biomass destruction:

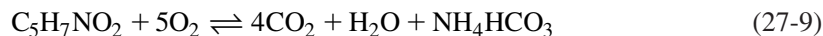

Nitrification of released ammonia:

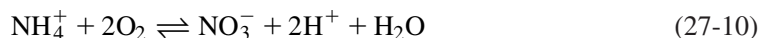

Overall equation with complete nitrification:

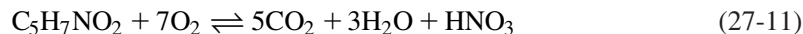

Using nitrate as an electron acceptor (denitrification):

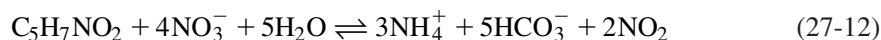

With complete nitrification/denitrification:

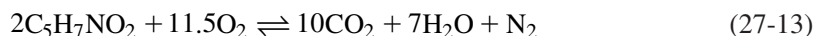

The conversion of organic nitrogen to nitrate results in a decrease in pH (Equations 27-9 through 27-11). Approximately 7 kg of $CaCO_3$ alkalinity are consumed for each kg of ammonia oxidized. If the dissolved oxygen concentration is kept below 1 mg/L, denitrification will occur. Theoretically, 50 percent of the alkalinity can be recovered. Cycling between aeration and mechanical mixing can be used to increase denitrification while maintaining pH control.

When there is insufficient buffering capacity to hold the pH above 5.5, lime, sodium bicarbonate, or sodium carbonate will have to be added.

Aerobic Digestion Design Practice

As with alkaline stabilization, the design objective is to meet the regulatory requirements specified in the Code of Federal Regulations (40 CFR Part 503). These are outlined in Chapter 18. The processes to meet the Class B criteria to significantly reduce pathogens (PSRP) and to reduce vector attraction serve as a basis for this discussion of design practice. These may be summarized as agitation of biosolids with air or oxygen to maintain aerobic conditions for a solids retention time (SRT) and temperature between 40 d at 20°C and 60 d at 15°C (40 CFR 503.33(b)). There are

several options given to verify that a significant reduction in pathogens and reduction of vector attraction have been achieved. Among the options to reduce vector attraction, the following are particularly applicable to the discussion of design practice. They require

- A 38 percent reduction in volatile solids by aerobic digestion, or
- Specific bench scale testing for volatile solids reduction, or
- A specific oxygen utilization rate (SOUR) at 20°C of ≤ 1.5 mg of oxygen/h · g total solids.

The influence of these requirements on the design of aerobic digesters is discussed in the following paragraphs under the headings of temperature, volatile solids reduction, tank volume, feed solids concentration, oxygen requirements, and energy requirements for mixing.

Temperature. As with all biological systems, lower temperatures will retard the biochemical processes. High temperatures lower the saturation value of dissolved oxygen in water and thus require an increase in the supply of air. Temperature boundary conditions for design require that the degree of sludge stabilization be determined at the lowest expected liquid operating temperature and that the maximum oxygen requirements be determined at the highest liquid operating temperature.

Volatile Solids Reduction. Approximately 20 to 35 percent of waste activated sludge from plants with primary treatment is not biodegradable. Thus, the goal of 38 percent reduction in volatile solids is a reasonable one. Both the liquid temperature and SRT control the degree of solids reduction. A plot of degree-days (temperature times SRT) versus volatile solids reduction (Figure 27-11) reveals that 38 percent reduction can be achieved above approximately 400 degree-days. To produce well-stabilized biosolids, at least 550 degree-days are recommended.

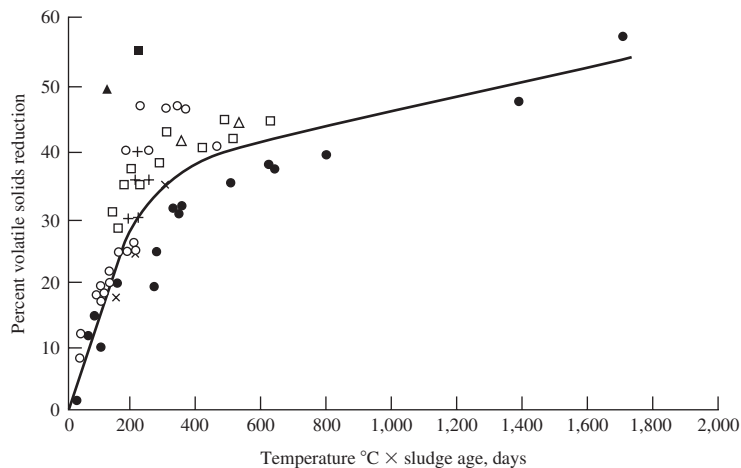

FIGURE 27-11

Volatile solids reduction as a function of digester liquid temperature and digester sludge age.

(Source: U.S. EPA, 1979.)

Tank Volume. The volume of the digester tank may be estimated with the following equation (WEF, 1998):

$$V = \frac{Q(X_i + F_{PS})}{X(k_d P_v + 1/SRT)} \quad (27-14)$$

where V = volume of aerobic digester, m^3
 Q = average flowrate to digester, m^3/d
 X_i = influent suspended solids, mg/L
 F_{PS} = fraction of influent BOD that is raw primary solids
 S = digester influent BOD, mg/L
 X = digester suspended solids, mg/L
 k_d = reaction rate constant, d^{-1}
 P_v = volatile fraction of digester suspended solids
 SRT = solids retention time, d

The term F_{PS} can be ignored if primary sludge is not included in the sludge load to the digester. Representative values for k_d range linearly from $0.02 d^{-1}$ at $10^\circ C$ to $0.14 d^{-1}$ at $25^\circ C$ for waste activated sludge (U.S. EPA, 1979). Bench-scale or pilot-scale studies are recommended to obtain site-specific decay coefficients.

Feed Solids Concentration. Thickening prior to aerobic digestion provides the following advantages: longer SRTs, smaller digester volume, easier process control, higher oxygen input per unit volume, and increased levels of volatile solids destruction. However, feed solids concentrations greater than 3.5 to 4 percent will impede mixing and adequate dissolved oxygen levels (Metcalf & Eddy, 2003). Solids concentrations greater than 4 percent are not recommended.

Oxygen Requirements. The oxygen concentration in the digester should be maintained at $\geq 1 mg/L$. The mass of oxygen required for complete oxidation of cell tissue and nitrification is about 2.3 kg/kg of cells. Oxidation of the BOD in primary sludge varies from 1.6 to 1.9 kg of oxygen/kg of BOD oxidized (Metcalf & Eddy, 2003).

Energy for Mixing. Coarse bubble diffusers are recommended. Plugging is a problem with either coarse or fine bubble diffusers. This is especially the case when periodic settling is used so supernatant can be removed. Air flow rates between 0.02 and $0.04 m^3$ of air/min $\cdot m^3$ of liquid volume ensure adequate mixing. The amount of air required to maintain the DO level usually exceeds this flow rate. Diffused aeration has advantages over mechanical mixing in cold climates because the compressed air adds heat to the system, and overall heat loss is less because of a smaller degree of surface disturbance.

Mechanical aerators are sized at 20 to $40 kW/10^3 m^3$ of liquid volume. Submerged turbines and jet aerators have also been used for mixing and aeration.

Mixing is difficult for concentrations greater than 3.5 percent. If polymers are used in the thickening process, a greater amount of unit energy may be required for mixing.

Supernatant. The supernatant is returned to the head end of the plant. The aerobic digestion process produces a low-strength supernatant (Table 27-11). The true loading from the supernatant is not the total BOD_5 but the filtered BOD_5 because the solids are in the endogenous stage of respiration. In addition, the flow rate is generally less than 1 percent of the influent plant flow.

TABLE 27-11
Characteristics of supernatant from aerobic digestion systems

Parameter	Range, mg/L	Typical, mg/L
BOD ₅	9–1,700	500
Filtered BOD ₅	4–183	50
COD	288–8,140	2,600
Kjeldahl nitrogen	10–400	170
Nitrate-N	N/A	30
Total P	19–241	100
Soluble P	2.5–64	25
Suspended solids	46–11,500	3,400

Adapted from WEF, 1998.

Dewatering. The literature addressing dewatering of aerobically digested sludge is contradictory. Good results can be obtained with sand drying beds. Mixed results with mechanical devices leads to the recommendation to conduct a thorough on-site investigation with pilot-scale devices. Interviews and site visits at other facilities employing these devices for aerobic sludge dewatering is also advisable.

Aerobic Digestion Design Criteria. Typical design criteria are summarized in Table 27-12. An example design follows the table.

TABLE 27-12
Typical design criteria for aerobic digesters

Parameter	Range of values
Feed concentration	1.5–3.5%
SRT to meet PSRP ^a	
At 15°C	60 d
At 20°C	40 d
k_d at 10°C	0.02 d ⁻¹
k_d at 15°C	0.06 d ⁻¹
k_d at 20°C	0.10 d ⁻¹
k_d at 25°C	0.14 d ⁻¹
Volatile solids loading	1.6–4.8 kg/m ³ · d
Oxygen requirements:	
Cell tissue	~2.3 kg O ₂ /kg VSS destroyed
BOD ₅ in primary sludge	1.6–1.9 kg O ₂ /kg VSS destroyed
Oxygen concentration	≥ 1 mg/L
Air flow rates for oxygen	
Waste activated sludge (WAS)	0.015–0.020 m ³ /min · m ³
Mixed primary and WAS	0.024–0.030 m ³ /min · m ³

(continued)

TABLE 27-12 (continued)
Typical design criteria for aerobic digesters

Parameter	Range of values
Mixing requirements	
Mechanical aerators/mixers	20–40 kW/10 ³ m ³
Diffused air mixing	0.02–0.040 m ³ /min · m ³
Reduction in VSS	38–50%
Tank dimensions	
Depth for diffused air	4.5–7.5 m
Depth for mechanical air	3–6 m
Circular diameter ^b	12–45 m
Rectangular	
W:D	1:1 to 2.2:1
L:W	≥ 5:1

^aPSRP = process to significantly reduce pathogens.

^bCircular is the typical configuration.

Sources: 40 CFR 503; Metcalf & Eddy, 2003; U.S. EPA, 1979; WEF, 1998.

Example 27-4. An aerobic digester for Omega Three (Examples 27-2 and 27-3) is being considered as an alternative to alkaline stabilization. Determine the volume of the digester and the required air flow rate to meet a Class B pathogen density (PSRP). The following data have been obtained for this analysis:

Winter conditions govern

Temperature of digester contents = 15°C

VSS = 0.8 TSS

VSS reduction goal = 40%

Influent BOD = 5,200 mg/L

Fraction of influent BOD consisting of primary solids = 0.35

Digester suspended solids concentration is 70% of the incoming thickened sludge concentration

Diffused air mixing is to be used

Solution:

- a. Check the requirements for volatile solids reduction and the SRT to meet PSRP (See Chapter 18). Find that the product of temperature and sludge age from Figure 27-11 at 40% VSS is 500°C · d. At a temperature of 15°C,

$$\text{SRT} = \frac{500^\circ\text{C} \cdot \text{d}}{15^\circ\text{C}} = 33.33 \text{ d}$$

This is less than the PSRP requirement for an SRT of 60 d at a temperature of 15°C, so the 60 d SRT governs (See Table 18-15).

- b. Using Equation 27-14, compute the volume of the digester. Note from Example 27-2 that the influent concentration is 3.8% or 38,000 g/m³ and that X = (38,000) (0.7).

$$\begin{aligned}
 V &= \frac{270 \text{ m}^3/\text{d}[38,000 \text{ g/m}^3 + (0.35)(5,200 \text{ g/m}^3)]}{(38,000 \text{ g/m}^3)(0.7)[(0.06 \text{ d}^{-1})(0.80) + 1/60 \text{ d}]} \\
 &= \frac{1.08 \times 10^7}{1.72 \times 10^3} = 6.25 \times 10^3 \text{ m}^3
 \end{aligned}$$

- c. From Examples 27-2 and 27-3, the mass of sludge is

$$M_{sl} = (3 \text{ cycles/d})(3,461 \text{ kg/cycle}) = 10,383 \text{ kg/d}$$

- d. The required oxygen is estimated using the design parameter of 2.3 kg O₂/kg VSS destroyed from Table 27-12.

$$\begin{aligned}
 \text{VSS} &= (0.80)(\text{TSS}) = (0.80)(10,383 \text{ kg/d}) = 8,306.4 \text{ kg/d} \\
 \text{VSS}_{\text{dest.}} &= (0.40)(8,306.4 \text{ kg/d}) = 3,322.56 \text{ kg/d} \\
 \text{O}_2 \text{ required} &= (3,322.56 \text{ kg/d})(2.3 \text{ kg O}_2/\text{kg VSS}) = 7,641.89 \text{ kg/d}
 \end{aligned}$$

- e. Assuming a 10% oxygen transfer efficiency, an air density of 1.204 kg/m³, and a mass fraction of oxygen in air of 0.232, the daily volume of air is estimated as

$$V_{\text{air}} = \frac{7,641.89 \text{ kg/d}}{(0.10)(1.204 \text{ kg/m}^3)(0.232)} = 273,581 \text{ or } 274,000 \text{ m}^3/\text{d} \text{ or } 190 \text{ m}^3/\text{min}$$

- f. Check the air required for oxygen and mixing.

$$Q_{\text{air}} = \frac{190 \text{ m}^3/\text{min}}{6.25 \times 10^3 \text{ m}^3} = 0.030 \text{ m}^3/\text{min} \cdot \text{m}^3$$

This is within the recommended aeration ranges of 0.024–0.030 m³/min · m³ for mixed primary and activated sludge and 0.02–0.040 m³/min · m³ for diffused air mixing.

Comments:

1. Two digesters are provided for redundancy.
 2. The aeration system is independent of that used for the activated sludge process.
-

27-9 ANAEROBIC DIGESTION

Process Description

The anaerobic treatment of biological sludges involves three distinct stages. In the first stage, complex waste components, including fats, proteins, and polysaccharides, are hydrolyzed to their component subunits. This is accomplished by a heterogeneous group of facultative and anaerobic bacteria. These bacteria then subject the products of hydrolysis (triglycerides, fatty acids, amino acids, and sugars) to fermentation and other metabolic processes leading to the formation of simple organic compounds and hydrogen in a process called *acidogenesis* or *acetogenesis*. The organic compounds are mainly short-chain (volatile) acids and alcohols. The second stage is

commonly referred to as *acid fermentation*. In this stage, organic material is simply converted to organic acids, alcohols, and new bacterial cells, so that little stabilization of BOD or COD is realized. In the third stage, the end products of the second stage are converted to gases (mainly methane, CH_4 , and carbon dioxide, CO_2) by several different species of strictly anaerobic bacteria. It is here that true stabilization of the organic material occurs. This stage is generally referred to as *methane fermentation*. The stages of anaerobic waste treatment are illustrated in Figures 27-12 and 27-13. Even though the anaerobic process is presented as being sequential in nature, all stages take place simultaneously and synergistically. The primary acid produced during acid fermentation is acetic acid (CH_3COOH). The significance of this acid as a precursor for methane formation is illustrated in Figure 27-13.

Microbiology

The microorganisms responsible for hydrolysis and acid fermentation include both facultative and obligate anaerobic bacteria. Examples of genera found in anaerobic digesters include *Clostridium*, *Corynebacterium*, *Actinomyces*, *Staphylococcus*, and *Escherichia*.

The microorganisms responsible for methane fermentation are strict obligate anaerobes. Examples of genera found in digesters include *Methanosarcina*, *Methanothrix*, *Methanococcus*, *Methanobacterium*, and *Methanobacillus*. Only the first two genera are able to use acetate to produce methane and carbon dioxide. The others oxidize hydrogen with carbon dioxide as the electron acceptor.

Syntrophic Relationships. The methanogens and acidogens form a mutually beneficial (*syntrophic*) relationship. The methanogens convert fermentation end products such as acetate (CH_3COO^-), formate (HCOO^-), and hydrogen to methane and carbon dioxide. Because the

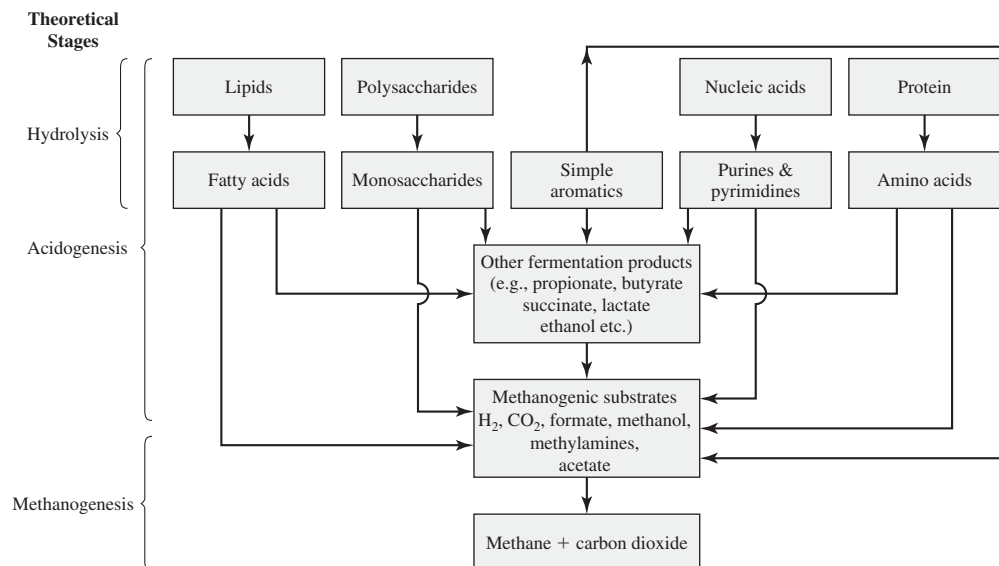
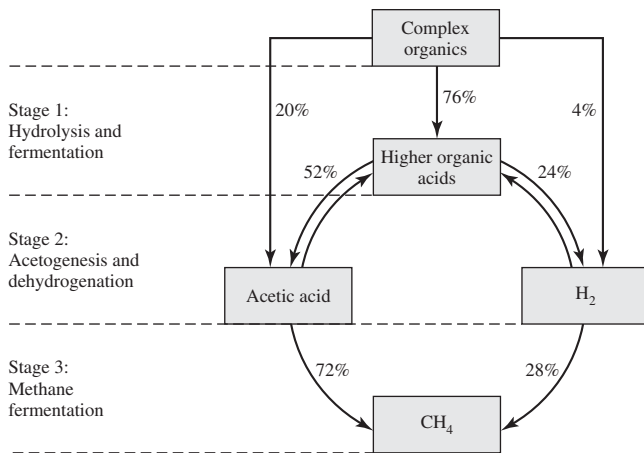

FIGURE 27-12

Schematic diagram of the patterns of carbon flow in anaerobic digestion. (Source: Davis and Cornwell, 2008.)

**FIGURE 27-13**

Steps in anaerobic digestion process with energy flow. (Source: Davis and Cornwell, 2008.)

methanogens are able to maintain a very low partial pressure of H₂, the equilibrium of the reactions is shifted toward more oxidized end products, that is, CH₃COO⁻ and HCOO⁻. In effect, the methanogenic organisms serve as a hydrogen sink that allows the fermentation reactions to proceed. If the methanogens do not utilize the hydrogen rapidly enough, propionate and butyrate fermentation (Figure 27-12) will be reduced and volatile fatty acids will accumulate. This will result in an adverse reduction in pH (Metcalf & Eddy, 2003).

Nuisance Organisms. Sulfate-reducing bacteria are nuisance organisms because they can reduce sulfate to sulfide. In high concentrations sulfide is toxic to methanogens.

Stoichiometry

A limited number of substrates are used by methanogens. Madigan et al. (1997) outlined the following reactions:

Oxidation of hydrogen



Oxidation of formic acid

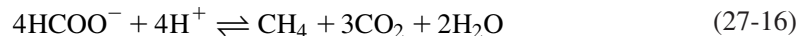

Oxidation of carbon monoxide

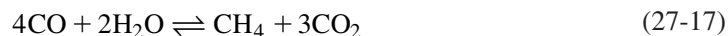

Oxidation of methanol

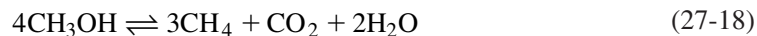

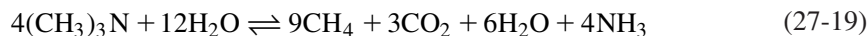
Oxidation of trimethylamine*Oxidation of acetic acid*

The COD loss in anaerobic digestion is accounted for by methane production. The COD equivalent of methane is the amount of oxygen needed to oxidize methane to carbon dioxide and water:



Thus, the COD per mole of methane is $2(32 \text{ g O}_2/\text{mole}) = 64 \text{ g O}_2/\text{mole CH}_4$.

The ideal gas law provides a method of estimating the volume of methane production for a given sludge bsCOD. At standard conditions (0°C and 1 atm) the volume of methane is 22.414 L/mole. The volume of CH_4 equivalent of COD converted under anaerobic conditions is

$$\frac{22.414 \text{ L/mole}}{64 \text{ g mole}} = 0.35 \text{ L/g COD} \quad (27-22)$$

CO_2 is also produced in substantial amounts in the anaerobic degradation process. Typically, this is estimated as 35 percent of the gas production.

Example 27-5 illustrates the method of estimating the gas production from the COD oxidized.

Example 27-5. Determine the daily volume of methane and total gas produced in an anaerobic digester that is operated at 35°C under the following conditions: biosolids flow = $300 \text{ m}^3/\text{d}$; bsCOD = $5,000 \text{ g/m}^3$. Assume $Y = 0.04 \text{ g VSS/g COD}$ and 95% bsCOD removal.

Solution:

- a. Use a steady-state mass balance to determine the amount of the influent COD converted to methane:

$$0 = \text{COD}_{\text{in}} - \text{COD}_{\text{eff}} - \text{COD}_{\text{vss}} - \text{COD}_{\text{CH}_4}$$

- b. Determine the individual COD values.

$$\text{COD}_{\text{in}} = (5,000 \text{ g/m}^3)(300 \text{ m}^3/\text{d}) = 1.5 \times 10^6 \text{ g/d}$$

$$\text{COD}_{\text{eff}} = (1 - 0.95)(1.5 \times 10^6 \text{ g/d}) = 7.50 \times 10^4 \text{ g/d}$$

Noting from Equation 23-42 in Chapter 23, that the COD of waste activated sludge is 1.42 (P_x),

$$\begin{aligned} \text{COD}_{\text{vss}} &= (1.42 \text{ g COD/g VSS})(0.04 \text{ g VSS/g COD})(0.95)(1.5 \times 10^6 \text{ g/d}) \\ &= 8.09 \times 10^4 \text{ g/d} \end{aligned}$$

- c. Solve the mass balance for COD_{CH_4} .

$$\begin{aligned}\text{COD}_{\text{CH}_4} &= \text{COD}_{\text{in}} - \text{COD}_{\text{eff}} - \text{COD}_{\text{vss}} \\ &= 1.5 \times 10^6 \text{ g/d} - 7.50 \times 10^4 \text{ g/d} - 8.09 \times 10^4 \text{ g/d} = 1.34 \times 10^6 \text{ g/d}\end{aligned}$$

- d. Correct the theoretical methane gas production for the actual anaerobic digester temperature. From Equation 27-22, the theoretical production is 0.35 L of $\text{CH}_4/\text{g COD}$.

$$\begin{aligned}\text{Actual gas production} &= (0.35 \text{ L of CH}_4/\text{g COD}) \frac{(273.15 \text{ K} + 35 \text{ K})}{273.15 \text{ K}} \\ &= 0.395 \text{ L of CH}_4/\text{g COD}\end{aligned}$$

- e. The methane production is then

$$\begin{aligned}\text{CH}_4 \text{ production} &= (1.34 \times 10^6 \text{ g COD/d})(0.395 \text{ L of CH}_4/\text{g COD})(10^{-3} \text{ m}^3/\text{L}) \\ &= 531 \text{ or } 530 \text{ m}^3/\text{d}\end{aligned}$$

- f. Assuming the methane is 65% of the gas volume, the total gas volume is

$$\text{Total } V_{\text{gas}} = \frac{531 \text{ m}^3/\text{d}}{0.65} = 817 \text{ or } 820 \text{ m}^3/\text{d}$$

Growth Kinetics

The bacteria responsible for acid fermentation are relatively tolerant to changes in pH and temperature and have a much higher rate of growth than the bacteria responsible for methane fermentation. As a result, methane fermentation is generally assumed to be the rate controlling step in anaerobic waste treatment processes.

Typical synthesis yield and endogenous decay coefficients for fermentation and methanogenic anaerobic reactions are given in Table 27-13. In the range of 20°C to 35°C, the kinetics of methane fermentation of long- and short-chain fatty acids will adequately describe the overall kinetics of anaerobic treatment (Lawrence and Milnes, 1971). Thus, the kinetic equations presented to describe the completely mixed activated sludge process are equally applicable to the anaerobic process.

Environmental Factors

Most anaerobic digestion systems are designed to operate in the mesophilic temperature range between 30°C and 38°C. Other systems are designed to operate in the thermophilic range of 50°C to 57°C. While the design operating temperature is important, maintaining a stable operating temperature is more important because the methane formers are sensitive to temperature changes. Changes greater than 1°C/d can result in process upset. A design that avoids a change greater than 0.5°C/d is recommended (WEF, 1998).

Methanogenic activity is inhibited at pH values less than 6.8. Because the CO_2 content of the gas produced is high, a high alkalinity is required to maintain the pH near neutral.

Inhibitory substances include ammonia, hydrogen sulfide, metals such as copper, chromium, and zinc, and a long list of organic compounds that includes aldehydes, benzene, and phenol (Metcalf & Eddy, 2003).

TABLE 27-13
Summary of design parameters for completely mixed suspended growth reactors treating soluble COD

Parameter	Unit	Value	
		Range	Typical
Solids yield, Y			
Fermentation	g VSS/g COD	0.06–0.12	0.10
Methanogenesis	g VSS/g COD	0.02–0.06	0.04
Overall combined	g VSS/g COD	0.05–0.10	0.08
Decay coefficient, k_d			
Fermentation	g/g · d	0.02–0.06	0.04
Methanogenesis	g/g · d	0.01–0.04	0.02
Overall combined	g/g · d	0.02–0.04	0.03
Maximum specific growth rate, μ_m			
35°C	g/g · d	0.30–0.38	0.35
30°C	g/g · d	0.22–0.28	0.25
25°C	g/g · d	0.18–0.24	0.20
Half-velocity constant, K_s			
35°C	mg/L	60–200	160
30°C	mg/L	300–500	360
25°C	mg/L	800–1100	900
Solids retention time (SRT)			
35°C	d	10–20 ^a	15
30°C	d	15–30 ^a	N/A
24°C	d	20–40 ^a	N/A
Methane			
Production at 35°C	m ³ /kg COD	0.4	0.4
Density at 35°C	kg/m ³	0.6346	0.6346
Content of gas	%	60–70	65
Energy content	kJ/g	50.1	50.1

^aSafety factors range from 2.5 to 5 times minimum SRT.

Adapted from Metcalf & Eddy, 2003.

Anaerobic Digester Design Principles

As with alkaline stabilization and aerobic digestion, the design objective is to meet the regulatory requirements specified in the Code of Federal Regulations (40 CFR Part 503). These are outlined in Chapter 18. The processes to meet the Class B criteria for a process to significantly reduce pathogens (PSRP) and to reduce vector attraction serve as a basis for this discussion of design principles. These may be summarized as treatment of biosolids in the absence of air or oxygen to maintain anaerobic conditions for a solids retention time (SRT) and temperature between 15 d at 35°C to 55°C and 60 d at 20°C (40 CFR 503.33(b)). There are several options given to verify that a significant reduction in pathogens and vector attraction reduction have been achieved. Among

the options to reduce vector attraction, the one requiring a 38 percent reduction in volatile solids by anaerobic digestion is particularly applicable to the discussion of design principles.

The alternative process arrangements for anaerobic digestion include (1) suspended growth, (2) sludge blanket, and (3) attached growth. Of these, the suspended growth processes predominate. The suspended growth processes are classified as complete-mix, contact, or sequencing batch reactor. The complete-mix process is found in most applications for municipal sludge treatment in the United States. It is the focus of this discussion.

Two temperature regimes are used in anaerobic digestion: mesophilic (30°C and 38°C) and thermophilic (50°C to 57°C). Although the thermophilic range has the advantages of increased reaction rates that result in smaller digesters, increased solids destruction, and increased destruction of pathogens and better dewatering, they have not found wide application for municipal sludges. The reasons for lack of use include higher energy requirements, poorer quality supernatant, and less process stability. Perhaps one of the overriding reasons is that both mesophilic and thermophilic digestion are classified as a *process to significantly reduce pathogens* (PSRP). Therefore, until recently, there has been little regulatory incentive to use thermophilic processes. In 2002 the U.S. EPA granted *conditional* national PFRP equivalency (i.e., a process to further reduce pathogens) to a two-step process that consists of thermophilic anaerobic digestion followed by mesophilic anaerobic digestion (Leffler and Bizier, 2009). This process will then be approved as one that can generate a Class A sludge. If the anticipated change to *full* national PFRP equivalency occurs, the thermophilic option will become much more attractive. This is especially true for existing two-stage digestion systems that can be renovated. In the interim the mesophilic process is considered more typical. For this reason, this discussion is limited to the mesophilic process.

The preferred design principle is one based on the solids retention time (SRT) as the controlling variable. Other bases for design that have been used include volumetric loading, volatile solids destruction, observed volume reduction, and population (Metcalf & Eddy, 2003). Only the SRT, volumetric loading, and volatile solids reduction methods are discussed in the following paragraphs.

Solids Retention Time (SRT). Substitution of Equation 22-19 into Equation 23-16 yields a working equation for estimating the SRT or mean cell residence time (θ_c):

$$\frac{1}{\theta_c} = \frac{\mu_m S_e}{K_s + S_e} - k_d \quad (27-23)$$

where μ_m = maximum specific growth rate, g/g · d

S_e = effluent soluble COD, g/m³

k_d = decay coefficient, g/g · d

K_s = half-velocity constant, mg/L

When recycle is not practiced, the solids retention time equals the hydraulic residence time, that is, SRT = HRT. This is typical of municipal anaerobic digestion systems.

At 35°C, the washout or SRT_{min} for methanogenesis is 3.2 d (Lawrence and McCarty, 1970). A safety factor of 5 or greater is recommended. Safety factors greater than 5 provide a more stable process (Parker and Owen, 1986).

The kinetic equations may be used to estimate the methane gas production by utilizing the stoichiometric relationship between COD and CH₄ production shown in Equation 27-22:

$$Q_{\text{CH}_4} = (0.35)[(S_o - S)(Q)(10^{-3} \text{ g/kg}) - 1.42 P_x] \quad (27-24)$$

where Q_{CH_4} = flow rate of methane produced at standard conditions, m³/d
 0.35 = theoretical conversion factor from Equation 27-22
 S_o = influent bCOD, mg/L
 S = effluent bCOD
 Q = flow rate, m³/d
 P_x = net mass of cell tissue produced per day, kg/d

Note that this flow rate is at standard conditions. It must be corrected to the digester temperature and pressure using the ideal gas law.

The mass of biological solids synthesized (P_x) may be estimated as

$$P_x = \frac{YQ(S_o - S)(10^{-3} \text{ g/kg})}{1 + k_d(\theta_c)} \quad (27-25)$$

where the terms are the same as those in the preceding two equations.

The determination of the volume of a complete-mix digester and the volume of gas production is illustrated in Example 27-6.

Example 27-6. An anaerobic digester for Omega Three (Examples 27-2, 27-3, and 27-4) is being considered as an alternative to alkaline stabilization or aerobic digestion. Determine the volume of the digester and the flow rate of methane. The following data have been obtained for this analysis:

Temperature of digester contents = 35°C
 Influent bCOD = 5,000 g/m³
 Design effluent bCOD = 500 g/m³
 Design safety factor = 5
 There will be no recycle

Solution:

- a. Using Equation 27-23, with the kinetic parameters for 35°C from Table 27-13, calculate the SRT and check with requirements of PSRP.

$$\begin{aligned} \frac{1}{\theta_c} &= \frac{(0.35 \text{ g/g} \cdot \text{d})(500 \text{ g/m}^3)}{160 \text{ g/m}^3 + 500 \text{ g/m}^3} - 0.03 \text{ g/g} \cdot \text{d} \\ &= 0.265 - 0.03 = 0.235 \text{ d}^{-1} \end{aligned}$$

and

$$\theta_c = \frac{1}{0.235} = 4.25 \text{ d}$$

With a safety factor of 5, the estimate is

$$\theta_c = (5)(4.25) = 21.2 \text{ or } 21 \text{ d}$$

This exceeds the PSRP requirement of 15 d at 35°C (Table 18-15). The SRT of 21 d governs.

- b. Without recycle, the HRT = SRT and the volume of the digester is

$$V = Qt = (270 \text{ m}^3/\text{d})(21 \text{ d}) = 5,670 \text{ m}^3$$

- c. The mass of biological solids synthesized is estimated with Equations 23-37, 23-38 and the kinetic parameters from Table 27-13.

$$\begin{aligned} P_x &= \frac{(0.08 \text{ g VSS/g COD})(270 \text{ m}^3/\text{d})(5,000 \text{ g/m}^3 - 500 \text{ g/m}^3)(10^{-3} \text{ kg/g})}{1 + (0.03)(21 \text{ d})} \\ &= 59.6 \text{ kg/d} \end{aligned}$$

- d. The methane production is estimated using Equation 23-38 and the corrected theoretical production of 0.395 L of CH₄/g COD from Example 27-5.

$$\begin{aligned} Q_{\text{CH}_4} &= (0.395)[(5,000 \text{ g/m}^3 - 500 \text{ g/m}^3)(270 \text{ m}^3/\text{d})(10^{-3} \text{ kg/g}) - 1.42(59.6 \text{ kg/d})] \\ &= 395.3 \text{ or about } 400 \text{ m}^3/\text{d} \end{aligned}$$

Comments:

1. Two digesters are provided for redundancy.
2. Gas storage volume was not considered in the digester volume calculation.

Volumetric Loading. This is an historic method of sizing the digester volume. Based on empirical observations, the mass of volatile solids added to the digester per day per unit volume of digester was selected in the range 1.6 to 4.8 kg/m³ · d. The loading criterion was based on a sustained loading condition. Typically, this was the peak two-week or peak month solids production. Excessively low volatile solids loading rates can result in expensive designs and operating problems. Dilute sludge results in reduced HRT, reduced volatile solids destruction, reduced methane production, reduced alkalinity, increased volume of solids and supernatant, and increased heating requirements.

Volatile Solids Reduction. Although the reduction in volatile solids is more commonly used as a monitoring parameter in the operation of a digester, it can be used for design. An estimate of the volatile solids destroyed in a high-rate, complete-mix digester can be made with the following empirical equation (Liptak, 1974):

$$VS_d = 13.7 \ln(\theta_c) + 18.9 \quad (27-26)$$

where VS_d = volatile solids destruction,%. The suggested value of θ_c is 15 to 20 d.

Anaerobic Digester Design Practice

Pretreatment. Because the preliminary treatment systems do not remove 100 percent of the rags, grit, and other objects, the uncaptured material ends up in the primary and secondary clarifier sludge. Maceration and grit-grinding are typically used to minimize accumulation of these materials in the digester.

Process Configurations. The mesophilic anaerobic digesters are described as standard-rate, two-stage, separate digesters, and high-rate digesters.

The standard-rate process does not employ sludge mixing, but rather the digester contents are allowed to stratify into zones. The major disadvantage of the standard-rate process is the large tank volume required because of long retention times, low loading rates, and thick scum-layer formation. Only about one-third of the tank volume is utilized in the digestion process. The remaining two-thirds of the tank volume contains the scum layer, stabilized solids, and the supernatant. It is seldom used for digester design today.

The two-stage system evolved as a result of efforts to improve the standard-rate unit. Although many units are now in operation, it is seldom used in modern digester design. In this process, two digesters operating in series separate the functions of fermentation and solids/liquid separation. The contents of the first-stage, high-rate unit are thoroughly mixed, and the sludge is heated to increase the rate of fermentation. Because the contents are thoroughly mixed, temperature distribution is more uniform throughout the tank volume. Sludge feeding and withdrawal are continuous or nearly so.

The primary functions of the second-stage digester are solids/liquid separation and residual gas extraction. First-stage digesters may be equipped with fixed or floating covers. Second-stage digester covers are often of the floating type. Second-stage units are generally not heated.

Separate sludge digestion employs a separate digester for primary sludge and for activated sludge. The goal of this arrangement is to improve the separation of the sludge solids from the liquid after digestion. Design criteria for this process are very limited.

The most common design today is a single-stage, high-rate digester (Figure 27-14). It is characterized by heating, auxiliary mixing, uniform feeding, and thickening of the feed stream. Uniform feeding of the sludge is very important to the operation of the digester. For economical anaerobic digestion, a feed concentration of at least 4 percent total solids is desirable (Shimp et al., 1995). The digestion tanks may have fixed or floating covers. Gas may be stored under the floating cover or in a separate structure. There is no supernatant separation.

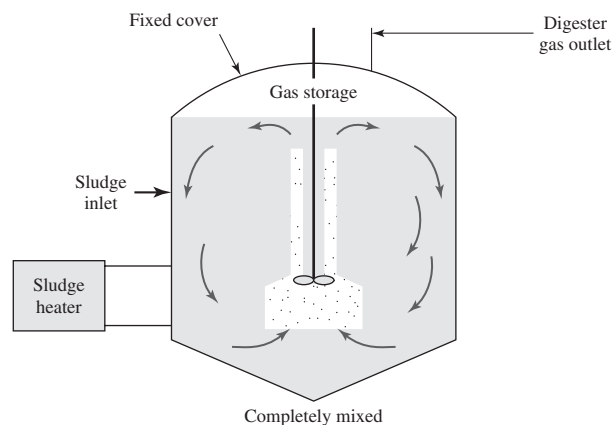

FIGURE 27-14

Schematic of a high-rate anaerobic digester.
(Source: Davis and Cornwell, 2008.)

The remainder of the discussion on anaerobic digestion focuses on high-rate digestion.

Tank Design. Essentially all of the modern digester designs in the United States are either cylindrical or egg-shaped (Figure 27-15). The advantages and disadvantages of the two types are summarized in Table 27-14. Site constraints are a major consideration in selecting the digester shape.

The cylindrical shapes are the most common in the United States, but the egg shapes are growing in popularity. This is especially true for plant expansion when space is limited.

Cylindrical tanks are seldom less than 6 m or more than 40 m in diameter. The water depth should not be less than 7.5 m at the sidewall because of the difficulty of mixing shallow tanks. They may be up to 14 m deep. For tanks provided with a suction mechanism for sludge withdrawal, a bottom slope not less than 1:12 (vertical to horizontal) is recommended. For gravity withdrawal, a minimum bottom slope of 1:6 is suggested. Slopes greater than 1:3, although desirable for grit removal, are difficult to construct and hard to work on during cleaning (GLUMRB, 2004; Metcalf & Eddy, 2003; WEF, 1998). These tanks are commonly constructed of concrete.

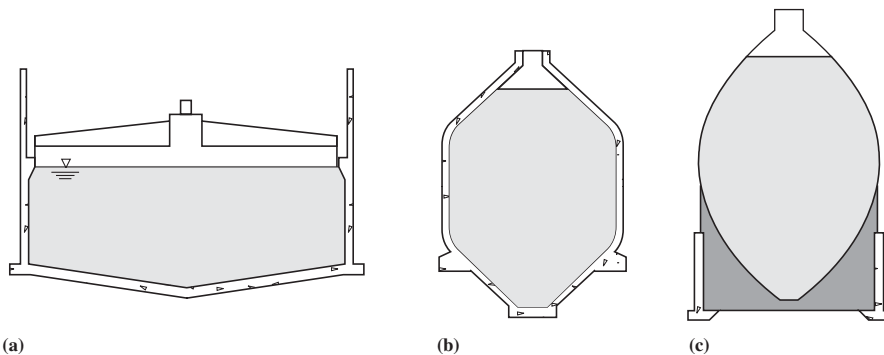

FIGURE 27-15

Typical shapes of anaerobic digesters: (a) cylindrical with reinforced concrete construction, (b) conventional German design with reinforced concrete construction, and (c) egg-shaped with steel shell.

(Source: Metcalf & Eddy, 2003.)

TABLE 27-14

Comparison of cylindrical and egg-shaped anaerobic digesters

Type of digester	
Cylindrical	Egg-shaped
Large volume for gas storage	Virtually no gas storage volume
Poor mixing efficiency	High mixing efficiency
High grit and silt accumulation ^a	Minimum grit accumulation
Large surface area for scum accumulation ^a	Reduced scum formation
Conventional construction	Specialized construction
Larger footprint (lower volume/unit area)	Smaller footprint (larger volume per unit area)
Lower unit cost (\$/m ³ of volume)	Higher unit cost (\$/m ³ of volume)

^aSubmerged, fixed cover design introduced in early 1990s limits scum build-up, and continuous removal of sludge from the bottom of the digester reduces grit accumulation.

Sources: Metcalf & Eddy, 2003; Witzgall et al., 1998.

Fewer data are available on the dimensions of egg-shaped digesters, but diameters of up to 25 m and heights in excess of 40 m have been reported. The bottom slope is on the order of 45 degrees from the horizontal. Although they can be built of concrete, typically they are constructed of steel.

Mixing Systems. Mixing of the digester contents is essential for high-rate digestion. If feed solids concentrations exceed 6 to 6.5 percent, good mixing may be difficult to achieve (Shimp et al., 1995). The three alternative mixing systems are gas injection, mechanical stirring, and mechanical pumping.

The gas produced as a result of the anaerobic digestion processes is used for mixing. In *unconfined systems* the compressed gas is released through bottom diffusers or lances (Figure 27-16a). As the bubbles rise to the surface they carry sludge upwards and stir the tank contents. The *confined systems* employ an eductor or draft tube that carries the gas from the bottom of the tank to the surface (Figure 27-16b). The diffuser systems are difficult to maintain.

Mechanical mixers may be low-speed turbines or low-speed mixers. Mechanical mixing systems are limited because of the wear of impellers, bearing failures, and gas leaks at the seals.

Pumping systems withdraw a portion of the biomass and reinject it tangentially through nozzles at the bottom of the tank. A high-flow, low-head solids handling pump is used.

Gas Safety. Digester gas and air **must not** be allowed to mix because of the potential for fire and explosions. The explosive range is defined by the *Lower Explosive Limit* (LEL) and the *Higher Explosive Limit* (HEL) or *Upper Explosive Limit* (UEL). Mixtures of hydrocarbons, such as methane, and air that have such low concentrations that they cannot be ignited are below the LEL. Mixtures that have such high concentrations in air that ignition is not possible until more air

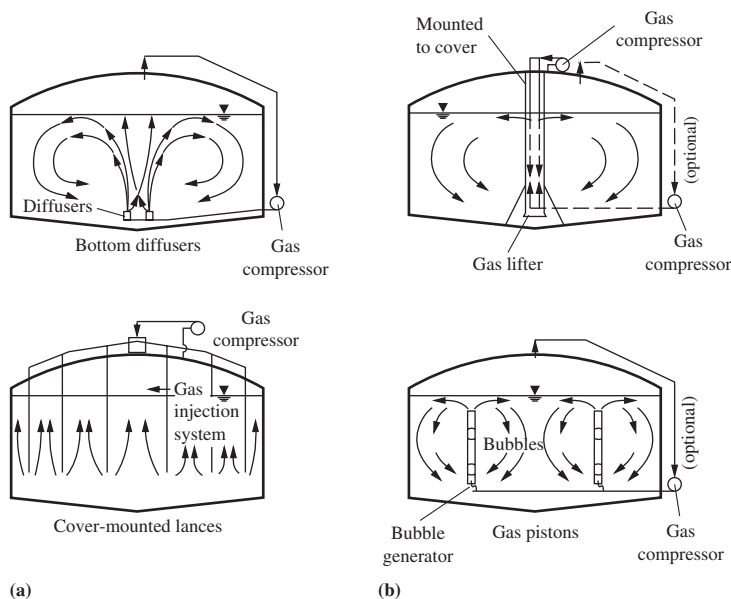

FIGURE 27-16

Devices used for mixing contents of anaerobic high-rate digesters: (a) unconfined gas-injection systems, (b) confined gas-injection systems.

(Source: Metcalf & Eddy, 2003.)

is added are said to be above the HEL. The LEL for methane is 5.0 percent by volume. The HEL is 15.0 percent by volume (LaGrega et al., 2001).

Some of the design features that are provided to minimize the potential for explosions are vacuum and pressure relief valves, drip traps, flame traps, and automatic thermal shutoff valves in the gas collection/piping system. Explosion proof switches and light fixtures as well as explosion-proof vent fans for positive ventilation are provided in work areas. Gas detectors for methane, oxygen, and hydrogen sulfide, with alarm systems are recommended. Self-contained breathing units and appropriate personal protective equipment (PPE) must be provided for work inside the tanks (GLUMRB, 2004; WEF, 1998).

A waste-gas burner is provided to safely flare excess gas to the atmosphere. It should have an all-weather pilot with an ignition system. Natural gas or propane should be used to fuel the pilot to provide a steady reliable flame. The waste-gas burner should be at least 15 m from the digesters or gas-holder tanks (WEF, 1998).

The following resources provide additional guidance on safety features: *National Electric Code* (NFPA, 1993), *Standards for Fire Protection in Wastewater Treatment and Collection Facilities* (NFPA, 1995), *Safety and Health in Wastewater Systems* (WEF, 1994), and GLUMRB, 2004.

Gas Collection. The gas is collected under the cover in cylindrical digesters. The covers may be floating, fixed, or membrane. Floating covers (Figure 27-17) allow the volume of the digester to change without allowing air to enter. When fixed covers are used, provisions must be made so that when the liquid volume changes, gas, and not air, will be drawn into the digester. One alternative is to provide external gas storage. Membrane covers (Figure 27-18) consist of a support structure and flexible membranes for air and gas. A blower is provided to pressurize the air space.

External storage is provided for egg-shaped digesters. Pressure-type tanks usually are spheres that hold the gas at pressures from 140 to 700 kPa. Typical values are on the order of 140 to 350 kPa.

Gas storage capacity of at least 25 to 33 percent of the daily gas production should be provided.

Gas Piping. The main gas collector line from the digester should be greater than 65 mm in diameter. Large systems may require lines 200 mm or more in diameter. The intake should be at least 1.4 m above the liquid level. The pipe slope should not be less than 10 mm/m. A pipe slope of 20 mm/m is recommended to provide for drainage of condensate. The gas velocity should be limited to 3.4 to 3.5 m/s to maintain acceptable line pressure losses and prevent carryover of moisture from condensate traps.

Most systems operate at pressures less than 3.5 kPa.

Gas Use. Methane from anaerobic digesters is a valuable energy source. In many plants, it is used as a fuel for boiler and internal-combustion engines that provide electricity or motive power for pumps, blowers, and other plant energy needs. A primary use is in heating sludge to maintain the mesophilic temperature in the range between 30°C and 38°C. In very large plants, excess methane may be sold to local utilities.

Because digester gas is only 65 percent methane, its lower heating value is less than that of natural gas. The lower heating value ranges from 20 to 25 MJ/m³. Typically, a lower heating value of approximately 22.40 MJ/m³ is used in design calculations. For comparison, the lower heating value of natural gas is about 37.3 MJ/m³ (Metcalf & Eddy, 2003; WEF, 1998).

Digester gas contains hydrogen sulfide, particulate matter, and water vapor. These must be removed by gas scrubbing equipment before it can be used in internal-combustion engines that

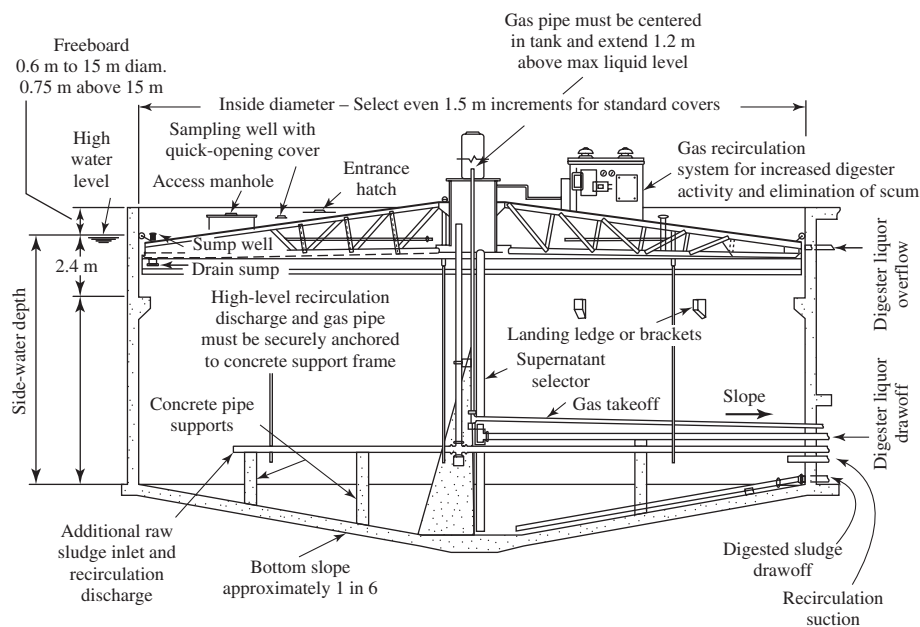

FIGURE 27-17
Cross section detail of an anaerobic digester with a floating cover. (Courtesy of Envirex.)

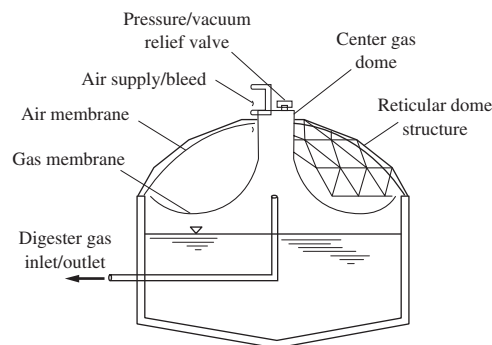

FIGURE 27-18
Anaerobic digester with membrane gas cover. (Source: Metcalf & Eddy, 2003.)

are used to drive generators. Hydrogen sulfide is particularly corrosive as well as extremely toxic at low concentrations. Special attention must be given to its removal for successful use of the digester gas.

Digester Heating. The sludge in anaerobic digestion tanks is heated by pumping the sludge through an external heat exchanger and returning it to the tank. An energy balance is used to determine the feasibility of using digester gas to maintain the temperature of the digester in the mesophilic range. The energy balance includes the energy to raise the temperature of the incoming sludge to the digestion tank, the energy to compensate for heat losses, and losses in transport from the tank and the heat exchanger.

A basic assumption in computing the energy balance is that the specific heat of sludge and that of water are essentially the same, that is, 4.186 kJ/kg · K. The heat addition required to raise the temperature of the incoming sludge is estimated by the following equation:

$$q_r = (M_{sl})(C_p)(T_2 - T_1) \quad (27-27)$$

where q_r = heat required, kJ/d

M_{sl} = mass of sludge, kg/d

C_p = specific heat of water = 4.186 kJ/kg · K

T_1 = temperature of sludge entering digester, K

T_2 = temperature of sludge in digester, K

Heat losses from the digester are computed using the following expression:

$$q_L = (U)(A)(\Delta T) \quad (27-28)$$

where q_L = heat loss, J/s

U = overall coefficient of heat transfer, J/m² · s · K or W/m² · K

A = cross-sectional area through which the heat is lost, m²

ΔT = temperature change across the surface, K

Typical values of heat transfer coefficients are shown in Table 27-15.

TABLE 27-15
Typical values of heat transfer coefficients for anaerobic digesters

Structural composition	U , W/m ² · K
Concrete walls above ground	
300 mm thick, not insulated	4.7–5.1
300 mm thick with air space and brick facing	1.8–2.4
300 mm thick with insulation	0.6–0.8
Concrete walls below ground	
Surrounded by dry soil	0.57–0.68
Surrounded by moist soil	1.1–1.4
Concrete floor	
300 mm thick in contact with dry soil	1.7
300 mm thick in contact with moist soil	2.85
Floating cover	
35 mm wood deck, built-up roofing, no insulation	1.8–2.0
25 mm insulating board installed under roofing	0.9–1.0
Fixed concrete cover	
100 mm thick, built-up roofing, not insulated	4.0–5.0
100 mm thick, built-up roofing, 25 mm of insulation	1.2–1.6
225 mm thick, not insulated	3.0–3.6
Steel cover	
6 mm thick	4.0–5.4

Source: Metcalf & Eddy, 2003.

Because the heat losses from the tank warm the soil, it is assumed that approximately 1.5 to 3 m of the soil from the digester is warmed before ambient ground temperatures are achieved. In cold climates, frost may penetrate to a depth of 1.2 m or more. Thus, the ground temperature may be assumed to be 0°C at this depth. Below 1.2 m, normal winter ground temperatures can be assumed. In the absence of actual data, a cold climate winter ground temperature of 5°C at a depth of 2 m may be assumed. The ground temperatures are 5°C to 10°C higher at the base of the wall.

Heat transfer requirements must also include the efficiency of the heat exchanger.

Example 27-7 illustrates the estimation of the heating requirements for an anaerobic digester in a cold climate.

Example 27-7. Evaluate the feasibility of heating the digester designed for Omega Three (Example 27-6) with the methane produced in the digester. The proposed digester design and temperatures are given in the sketch below. Ignore the slope of the bottom of the digester in calculating the area of the bottom. The mean temperature in January is -8°C . The incoming sludge temperature is 10°C . Assume conservative values for U , a heat exchange efficiency of 80%, and a lower heating value for methane of 22.40 MJ/m^3 .

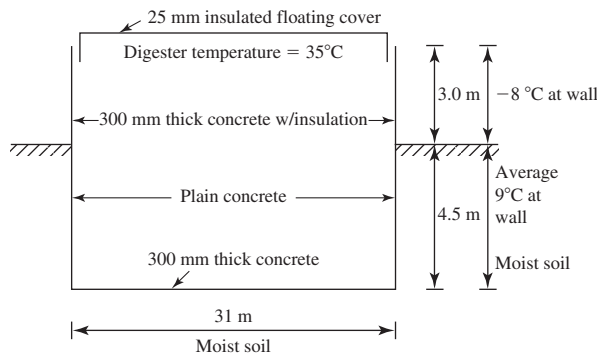

Solution:

- a. Compute the heat requirement to raise the sludge temperature to the digester temperature. From Example 27-3, the mass of sludge is 3,461 kg per pumping cycle and there are three pumping cycles per day.

$$\begin{aligned} q_r &= (3,461 \text{ kg/cycle})(3 \text{ cycles/d})(4.186 \text{ kJ/kg} \cdot \text{K})[(273.15 \text{ K} + 35 \text{ K}) \\ &\quad - (273.15 \text{ K} + 10 \text{ K})] \\ &= 1.09 \times 10^6 \text{ kJ/d} = 1.09 \times 10^9 \text{ J/d} \end{aligned}$$

- b. Compute the areas for the walls, roof, and floor.

$$\text{Wall area above ground} = (\pi)(31 \text{ m})(3 \text{ m}) = 292.2 \text{ m}^2$$

$$\text{Wall area below ground} = (\pi)(31 \text{ m})(4.5 \text{ m}) = 438.3 \text{ m}^2$$

$$\text{Roof area} = \frac{(\pi)(31 \text{ m})^2}{4} = 754.8 \text{ m}^2$$

$$\text{Floor area} = \text{Roof area}$$

- c. Compute the heat loss by conduction using Equation 27-28.

Wall above ground:

$$q_L = (0.8 \text{ W/m}^2 \cdot \text{K})(292.2 \text{ m}^2)(35^\circ\text{C} + 8^\circ\text{C})(86,400 \text{ s/d}) = 8.68 \times 10^8 \text{ J/d}$$

Wall below ground:

$$q_L = (1.4 \text{ W/m}^2 \cdot \text{K})(438.3 \text{ m}^2)(35^\circ\text{C} - 9^\circ\text{C})(86,400 \text{ s/d}) = 1.38 \times 10^9 \text{ J/d}$$

Roof:

$$q_L = (1.0 \text{ W/m}^2 \cdot \text{K})(754.8 \text{ m}^2)(35^\circ\text{C} + 8^\circ\text{C})(86,400 \text{ s/d}) = 2.8 \times 10^9 \text{ J/d}$$

Floor:

$$q_L = (2.85 \text{ W/m}^2 \cdot \text{K})(754.8 \text{ m}^2)(35^\circ\text{C} - 9^\circ\text{C})(86,400 \text{ s/d}) = 4.83 \times 10^9 \text{ J/d}$$

- d. The total capacity of the heat exchanger required is

$$\begin{aligned} \text{Capacity} &= 1.09 \times 10^9 \text{ J/d} + 8.68 \times 10^8 \text{ J/d} + 1.38 \times 10^9 \text{ J/d} + 2.8 \times 10^9 \text{ J/d} + 4.83 \times 10^9 \text{ J/d} \\ &= 1.10 \times 10^{10} \text{ J/d} \end{aligned}$$

- e. With a heat exchanger efficiency of 80%, the lower heating value of the fuel must be

$$\frac{1.10 \times 10^{10} \text{ J/d}}{0.8} = 1.37 \times 10^{10} \text{ J/d} = 1.4 \times 10^4 \text{ MJ/d}$$

- f. The methane produced by the digester has a lower heating value of

$$(395.3 \text{ m}^3/\text{d})(22.40 \text{ MJ/m}^3) = 8.9 \times 10^3 \text{ MJ/d}$$

The methane production will not be enough to maintain the digester temperature during January.

Comments:

1. Note that this assessment is the worst case scenario, that is, January. For months with more moderate temperatures, the digester should be self-sustaining.
2. The options for design to overcome the the need for more energy to maintain the temperature include auxiliary fuel, storing methane during the warmer months, and increasing the insulation to reduce the heat loss.

Heat Exchangers. Although internal heating systems have been used, they have inherent operating and maintenance problems. Their use is not recommended. External heat exchangers may be of the tube-in-tube, spiral-plate, or water-bath type. Flow of the heating fluid (typically water) is countercurrent to the flow of sludge. Water temperatures are typically held below 68°C to keep sludge

from caking on the exchanger. Heat transfer coefficients are on the order of 0.9 to 1.6 kJ/m² · K. The efficiency of the heat exchanger may range from 60 to 90 percent.

Anaerobic Digestion Design Criteria. Typical anaerobic digester kinetic design parameters are summarized in Table 27-13. Typical physical design parameters for anaerobic digesters are summarized in Table 27-16.

Operational Considerations

The anaerobic digestion process is sensitive to changes in operating conditions. Of the numerous parameters that can affect operation, four are particularly noteworthy: temperature, uniform feeding, pH, and ammonia. These are important in ensuring effective gas production and avoiding digester upsets. The need for temperature stability was discussed earlier in this section. Uniform feeding, pH, and ammonia are discussed in the following paragraphs.

Uniform Feeding. For single-stage high-rate digesters, sludge should be pumped to the digester continuously or on a 30-min to 2-h cycle to help maintain constant conditions in the digester. Where cycles of 8 or 24 h are the only ones practical, it is important to withdraw digested sludge from the digester **before** adding the feed sludge because the pathogen kill is significantly greater.

pH Control. The effective range for methanogens is a pH from 6.5 to 7.5, with an optimum range of 6.8 to 7.2. The stability of the digestion process depends on the buffering capacity of the digester contents and the production of carbon dioxide. The normal operating range is dependent on the relationship between bicarbonate alkalinity, pH, and carbon dioxide as shown in Figure 27-19.

TABLE 27-16
Range of physical design criteria for high-rate anaerobic digester facilities

Parameter	Range of values	Comment
Feed concentrations	2–6%	≥ 4% preferred > 6% will have mixing problems
Tank (cylindrical)		
Diameter	6–40 m	
Depth	6–15 m	≥ 7.5 m preferred
Bottom slope	1:3 to 1:6	1:6 preferred for gravity withdrawal
Mixing		
Mechanical	5–8 W/m ³	
Gas (unconfined)	0.27–0.30 m ³ /m ³ · h	m ³ of gas/m ³ of digester volume
Gas (confined)	0.30–0.42 m ³ /m ³ · h	
Gas production	0.75–1.12 m ³ /kg VSS destroyed	
Lower heating value	20–25 MJ/m ³	22.4 MJ/m ³ typical
Heat exchanger transfer coefficient	0.9–1.6 kJ/m ² · K	External heat exchanger

Sources: Metcalf & Eddy, 2003; Shimp et al. 1995; WEF, 1998.

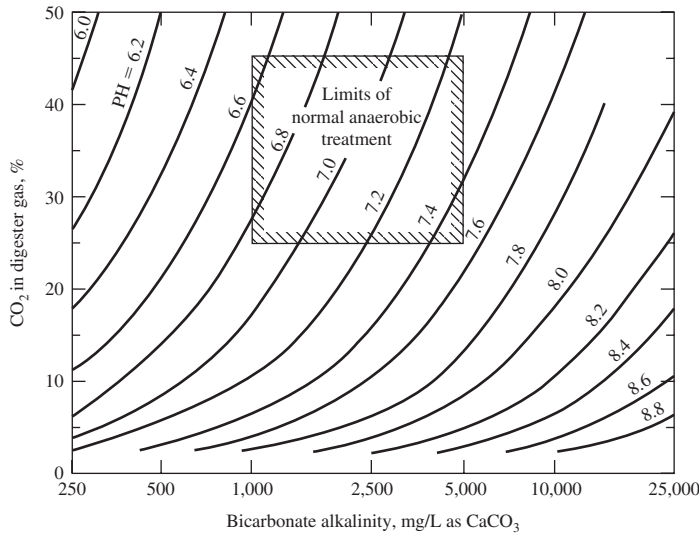
**FIGURE 27-19**

Relationship between pH and bicarbonate concentration (35°C).

(Source: McCarty, 1964.)

Upset of a digester operation known as a *stuck digester* or a *sour digester* results from the following sequence of events: (1) increasing volatile acids and low alkalinity that results in a decreasing pH, and (2) inhibition of the methanogens that results in a drop in methane production and foaming. As an operational tool, pH measurements have limited value. By the time the alkalinity has been destroyed and the volatile acid concentration has risen enough to depress the pH, the digester is already “stuck.”

Alkalinity, volatile acids, and gas analysis are of much more value in assessing the operation of the digester. Falling alkalinity and increasing volatile acid concentrations are warning signals of impending trouble. Some rules-of-thumb are:

- If the volatile acid concentration is within 1,000 mg/L of the alkalinity concentration, there is a danger of a pH drop;
- An alkalinity of 500 to 1,000 mg/L as CaCO₃ provides a very small margin of safety;
- An alkalinity of 2,500 to 5,000 mg/L as CaCO₃ provides a large margin of safety;
- Volatile acid concentrations should be in the range of 50 to 300 mg/L.

If the percentage of CO₂ in the digester gas rises from 30–40 percent and the CH₄ percentage falls from 60–70 percent, this is also an indicator of impending trouble.

The suggested remedies are: stop feeding, increase the alkalinity by concentrating the sludge, and carefully add of NaHCO₃. Other pH control methods include reseedling the digester with actively digesting microorganisms and by scrubbing the CO₂ from the digester gas before it is recirculated back to the digester for mixing (Andrews, 1969). The addition of lime is not recommended as the strong base may result in the formation of precipitates and, potentially, an overdose that results in too high of a pH.

Ammonia Control. Ammonia formation results from the breakdown of protein. The ammonia normally combines with carbon dioxide to form NH₄(HCO₃). With excess free ammonia in

solution, the pH is high and the volatile acid concentration is high, but there is no gas production. This situation is termed *ammonia toxicity*. Inhibitory concentrations of total ammonia-nitrogen have been reported in the range of 1,500 to 3,000 mg/L at a pH above 7.4. At concentrations above 3,000 mg/L, ammonia-nitrogen may be toxic at any pH (McCarty, 1964; WEF, 1998).

Acclimation to high total ammonia-nitrogen concentration can be achieved over long periods of time (Parkin and Miller, 1982). The suggested remedy in the short-term is to carefully add small amounts of HCl to lower the pH. H₂SO₄ is to be avoided as it may result in sulfide toxicity.

27-10 SLUDGE CONDITIONING

Sludge is conditioned to improve dewatering characteristics. Conditioning by the addition of chemicals is the predominant method used in the United States. It is the focus of this discussion. Heat treatment is used to a limited extent. It will be discussed more briefly.

Chemical Conditioning

Chemical conditioning results in coagulation of the solids and release of the absorbed water. The most common coagulants are ferric chloride, lime, or organic polymers. Ash from incinerated sludge has also found use as a conditioning agent. Ash, ferric chloride, and lime in combination are effective but result in an increase of 20 to 30 percent in the dry solids that must be disposed.

Application of organic polymers has become typical for sludge conditioning because they do not increase the dry solids. They are easy to handle, require little storage space, and are very effective. They also are very expensive.

Chemical Selection and Dosage. Polymers are frequently used when dewatering is to take place with centrifuges or belt filter presses. Lime and ferric chloride are often used when pressure filtration is the method selected for dewatering.

The dosage is determined by routine laboratory testing. The commonly used tests include the Buchner funnel test for determination of specific resistance, capillary suction test time, and standard jar tests. For belt-filter presses, typical polymer dosages range from 1 to 8.5 kg/Mg of dry solids.

Chemical Application. Chemicals are most easily applied and metered in liquid form. Dry chemicals are dissolved in day tanks. Polyvinyl chloride, polyethylene, and rubber lined tanks are suitable. Corrosion resistant metering pumps are used. Typically, these are positive displacement, variable speed pumps (Metcalf & Eddy, 2003).

The chemical dosing point may be an important factor in determining the size of the dose. The polymer does not mix and react with the biosolids instantaneously. The provision of polymer addition points 9 to 12 m and 18 to 24 m ahead of the dewatering device provides the operator flexibility in selecting the best option. For centrifuges, internal addition is often the best (LaMontagne and Yevilevich, 2006).

Mixing. The selection of the mixing system is dependent on the dewatering method. Separate mixing and flocculation tanks are typically provided ahead of pressure filters. If a belt-filter press is to be used, either an upstream flocculation tank or direct addition to the feed line may be employed. In-line mixers are typically used with centrifuges.

Heat Treatment

Another conditioning approach is to heat the sludge at high temperatures (175°C to 230°C) and pressures (1,000 to 2,000 kPa). Under these conditions, much like those of a pressure cooker, water that is bound up in the solids is released, improving the dewatering characteristics of the sludge. Heat treatment has the advantage of producing a sludge that dewateres better than chemically conditioned sludge. The process has the disadvantages of relatively complex operation, high maintenance requirements, and the creation of highly polluted cooking liquors (soluble BOD may exceed 5,000 mg/L) that when recycled to the treatment plant impose a significant added treatment burden. In addition, the process has high capital and operating costs. For these reasons, very few new facilities have been built in recent years (Metcalf & Eddy, 2003).

27-11 DEWATERING

Many of the methods for dewatering biomass sludges are the same as those used to dewater water treatment plant residuals. Their basic mechanism of operation is discussed and illustrated in Chapter 15. The following discussion focuses on the particular considerations in application to dewatering biomass sludge. In the past, vacuum filtration was the predominant dewatering device for municipal sludge. It has been replaced by alternative mechanical dewatering equipment (Metcalf & Eddy, 2003). Vacuum filters, reed beds, and lagoons are not considered in this discussion.

Sludge Drying Beds

The most popular method of sludge dewatering in the past has been the use of sludge drying beds. These beds are especially popular in small plants because of their simplicity of operation and maintenance. In 1979, 77 percent of all United States wastewater treatment plants utilized drying beds; one-half of all the municipal sludge produced in the United States was dewatered by this method (U.S. EPA, 1979). Most of these plants are located in small- and medium-sized communities, with an average flow rate of less than 8,000 m³/d. Some larger cities, such as Albuquerque, Fort Worth, Texas, Phoenix, and Salt Lake City, use sand drying beds. Although the use of drying beds might be expected in the warmer, sunny regions, they are also used in several large facilities in northern climates.

Operational procedures common to all types of drying beds involve the following steps:

1. Pump 0.20 to 0.30 m of stabilized liquid sludge onto the drying bed surface.
2. Add chemical conditioners continuously, if conditioners are used, by injection into the sludge as it is pumped onto the bed.
3. When the bed is filled to the desired level, allow the sludge to dry to the desired final solids concentration. This concentration can vary from 18 to 60 percent, depending on several factors, including type of sludge, processing rate needed, and degree of dryness required for lifting. Nominal drying times vary from 10 to 15 d under favorable conditions, to 30 to 60 d under barely acceptable conditions.
4. Remove the dewatered sludge either mechanically or manually.
5. Repeat the cycle.

Sand drying beds for wastewater sludge are constructed in the same manner as water treatment plant sludge-drying beds as discussed and illustrated in Chapter 15. Typical loading rates are given in Table 27-17.

Sand drying beds can be built with or without a roof. Newly constructed beds are designed for mechanical sludge removal.

Centrifugation

In addition to the solid-bowl centrifuge discussed in Chapter 15, a “high-solids” centrifuge is used to dewater biosolids. The high-solids centrifuge is a modification of the solid-bowl configuration. The modification primarily consists of a slightly longer bowl length, a lower differential bowl speed to increase residence time, and a modified scroll.

Dosage rates for polymers range from 0.1 to 7.5 g/kg of sludge measured on a dry solids basis. Higher polymer doses may be required for the high-solids centrifuge. Typical performance data are given in Table 27-18.

TABLE 27-17
Typical loading rates for open sludge drying beds

Type of biosolids	Sludge loading rate, kg dry solids/m ² · y
Primary, digested	120–150
Primary and waste activated, digested	60–100

Source: Metcalf & Eddy, 2003.

TABLE 27-18
Typical dewatering performance for solid-bowl centrifuges

Type of sludge	Cake solids, %	Solids capture, %	
		Without chemicals	With chemicals
Untreated primary			
Alone	25–35	75–90	95+
With air activated sludge	12–20	55–65	92+
Waste activated sludge	5–15	60–80	92+
Anaerobically digested			
Primary	25–35	65–80	92+
Primary and activated sludge	15–20	50–65	90+
Aerobically digested			
Waste activated sludge	8–10	60–75	90+

Source: Metcalf & Eddy, 2003; U.S. EPA, 1979.

Continuous Belt-Filter Presses

The continuous belt-filter presses (CBFP) used in treating wastewater sludges is the same as that used for water treatment plant sludges (Chapter 15). It is one of the predominant dewatering devices used in the United States today.

The CBFP is successful with many normal mixed sludges. Typical dewatering results for various types of sludges are given in Table 27-19.

CBFPs are available in belt widths from 0.5 to 3.5 m. The most common size used for municipal applications is 2.0 m. Belt speeds vary from 1.0 to 2.5 m/min. At low feed-solids concentrations, the capacity of the gravity drainage zone usually is limiting and belt speed must be reduced to maximize gravity drainage. As the feed solids concentration increases, a point is reached where the solids loading and thickness of the cake becomes controlling. At this point, the

TABLE 27-19
Typical performance data for a belt filter press

Type of sludge	Dry feed solids, %	Loading per metre belt width		Dry polymer ^a , g/kg dry solids	Cake solids, %	
		L/min	kg/h		Typical	Range
Raw primary (P)	3–7	110–190	360–550	1–4	28	26–32
Waste activated sludge (WAS)	1–4	40–150	45–180	3–10	15	12–20
P + WAS (50:50) ^b	3–6	80–190	180–320	2–8	23	20–28
P + WAS (40:60) ^b	3–6	80–190	180–320	2–10	20	18–25
P + trickling filter (TF)	3–6	80–190	180–320	2–8	25	23–30
Anaerobically digested:						
P	3–7	80–190	360–550	2–5	28	24–30
WAS	3–4	40–150	45–135	4–10	15	12–20
P + WAS	3–6	80–190	180–320	3–8	22	20–25
Aerobically digested:						
P + WAS, unthickened	1–3	40–190	135–225	2–8	16	12–20
P + WAS (50:50), thickened	4–8	40–190	135–225	2–8	18	12–25
Oxygen activated WAS	1–3	40–150	90–180	4–10	18	15–23

^aPolymer needs based on high molecular weight polymer (100% strength, dry basis).

^bRatio is based on dry solids for the primary and WAS.

Source: WEF, 1998.

TABLE 27-20
Typical continuous filter press manufacturer's data

Hydraulic loading, m ³ /h	Solids loading, kg/h	Belt width, m
1–3	25–120	0.5
3–5	120–200	0.75
5–20	125–510	1.0
20–30	510–815	1.5
30–40	765–1,070	2.0
40–50	1,020–1,275	2.5
50–60	1,275–1,530	3.0

Note: These presses are representative but do not represent actual choices. Actual manufacturers' data must be used for real world design.

loading rate must be reduced to prevent sludge from being forced out of the edges of the CBFP (Task Committee, 1988).

Example 27-8 illustrates the method for selecting an appropriate size CBFP from manufacturer's data like that shown in Table 27-20.

Example 27-8. Select a CBFP to dewater an anaerobic digester sludge. The sludge is primary plus waste activated sludge that has a solids concentration of 2.5% and a specific gravity of 1.02. The design sludge flow rate is 171.2 m³/d. The plant managers wish to operate on a two-shift basis, that is, 16 h/d to minimize labor costs. Using Table 27-20, select an appropriate CBFP belt width.

Solution:

- a. Convert the sludge flow rate to units compatible with Table 27-20 taking into account that dewatering will take place over the 16 h workday.

$$\frac{171.2 \text{ m}^3/\text{d}}{16 \text{ h/d}} = 10.7 \text{ m}^3/\text{h}$$

- b. From Table 27-20, select a 1.0 m width belt as a first trial.
 c. Compute the solids loading rate using Equation 15-9 from Chapter 15.

$$\begin{aligned} M_{sl} &= (Q_{sl})(\rho)(S_{sl})(P_s) \\ &= (10.7 \text{ m}^3/\text{h})(1,000 \text{ kg/m}^3)(1.02)(0.025) = 272.85 \text{ or } 273 \text{ kg/h} \end{aligned}$$

This is within the range of 125–510 kg/h specified by the manufacturer.

- d. Check the hydraulic and solids loading.

Hydraulic:

$$\frac{10.7 \text{ m}^3/\text{h}}{1.0 \text{ m belt width}} = 10.7 \text{ m}^3/\text{h} \cdot \text{m} \text{ or } 178.3 \text{ L}/\text{min} \cdot \text{m}$$

Solids loading:

$$\frac{273 \text{ kg}/\text{h}}{1.0 \text{ m belt width}} = 273 \text{ kg}/\text{h} \cdot \text{m}$$

The hydraulic loading is within the typical ranges of 80–190 L/min · m, and the solids loading is within the typical range of 180–320 kg/h · m given in Table 27-19.

Comments:

1. This is a trial selection. Other factors to be considered are polymer addition and the low % solids of the feed.
 2. For existing facilities, the use of pilot units is highly recommended.
-

Filter Press

Both the recessed plate and diaphragm filter presses described in Chapter 15 are used to dewater biosolids sludges. Advantages cited for filter presses include high concentrations of cake solids, good filtrate clarity, and high solids capture. Disadvantages include batch operation, mechanical complexity, high chemical costs, high labor costs, and limited filter cloth life.

Features that should be considered in the design of filter press installations include a sludge grinder ahead of the press, high pressure washing systems, an acid wash to remove calcium scale when lime is used as a conditioner, cake breakers following the press, and equipment such as an overhead crane to facilitate removal and maintenance of the plates.

Inclined Screw Press

The screw conveyor is located inside a stainless steel, wedge-shaped wire screen basket. It is inclined about 20° from horizontal. The lower, wider section of the basket serves as a gravity dewatering stage where free water drains by gravity. The screen openings are about 0.25 mm. The screw rotates at 1 to 4 rpm. As the sludge moves up the rotating screw, the screen narrows. This creates pressure that forces the water to flow out through the screen. The pressure in the pressure zone is controlled by the position of a cone at the discharge end of the basket. The dewatered sludge is driven through the gap between the cone and the basket and drops into a conveyor or dumpster.

A polymer-fed reactor is an essential part of the process. Hydraulic loading rates range from 10 to 20 m³/h. Solids loading rates range from 275 to 500 kg/h. Polymer consumption ranges from 1 to 6g/kg of dry solids. Wash water to clear the screen is on the order of 400 L/h. Reported performance data indicates that a solids feed of 2 to 3 percent may be dewatered to 20 to 25 percent cake solids, while a feed of 1 percent may be dewatered to 12 to 15 percent cake solids (Atherton et al., 2006; Newhof, 2009).

TABLE 27-21
Comparison of mechanical dewatering performance

Dewatering unit	Cake solids, % TSS ^a	Recovery cost, % TSS	Polymer cost, % Mg dry solids ^b
Belt press	X	90–95 ^c	Y
Centrifuge	$X \pm 2$	90–95 ^c	0.8 Y
Filter press—low pressure	$X + 8$	98+	1.1 Y
Filter press—high pressure	$X + 10$	98+	1.1 Y
Filter press—diaphragm	$X + 12$	98+	1.1 Y
Screw press	$X - 2$	90+	1.2 Y

^aRelative to belt press, X denotes base level; TSS = total suspended solids.

^bRelative to belt press, Y denotes base level; %/Mg = percent per megagram.

^cControlled by polymer, dosage.

Source: U.S. EPA, 1979.

Comparison of Mechanical Dewatering

A brief summary of comparative performance of mechanical dewatering processes is given in Table 27-21.

Safety

The mechanical dewatering devices operate under conditions of high pressure and parts that move at substantial speed. Adequate safety precautions should be taken in the design of the facility housing the devices to protect workers from ruptured hoses, to prevent loose clothing being caught between rollers (equipment guards), and to prevent inadvertent start-up during maintenance (lockout systems).

Adequate ventilation consisting of 6 to 12 air changes per hour is recommended. This air may be hazardous (H₂S) and certainly will be odorous, so some form of treatment should be considered.

Liquid Streams

The theoretical oxygen demand (ThOD) of the liquid stream from a dewatering process may be as high as 12,000 mg/L. Likewise, the suspended solids may be as high as 12,000 mg/L, while the TKN may be on the order of 1,000 mg/L (WEF, 1998). Because of the high concentrations of ThOD, TSS, and TKN, the liquid stream is returned to the head end of the plant for treatment. It must **not** be discharged to the head end of the plant as a pulse. It should be metered in at a flow rate that is compatible with the capacity of the head of the plant systems, that is, hydraulic loading and aeration capacity. Preferably, this flow should be added during periods of diurnal high flow rather than at nighttime low flows.

27-12 ALTERNATIVE DISPOSAL TECHNIQUES

“Ultimate disposition” of biosolids or residue (i.e., ash from incineration) falls into four general categories: land application, landfilling, dedicated land disposal, and utilization. Land application is discussed in the next section of this chapter.

Landfilling

When there is an acceptable, convenient site, the landfill is typically selected for ultimate disposal of biosolids, grit, screenings and other solids. Landfilling of biosolids and/or ash in a sanitary landfill with municipal solid waste is regulated by the U.S. EPA under 40 CFR 258.

Dewatering is typically required and stabilization may be required before the landfill can be used. If methane recovery is practiced at the landfill site, the addition of biosolids may be welcome as it will increase gas production.

Dedicated Land Disposal

Dedicated land disposal means the application of heavy sludge loadings to some finite land area that has limited public access and has been set aside or dedicated “for all time” to the disposal of wastewater sludge. Dedicated land disposal does not mean in-place utilization. No crops may be grown. Dedicated sites typically receive liquid sludges. While application of dewatered sludges is possible, it is not common. In addition, disposal of dewatered sludge in landfills is generally more cost-effective.

One of the common sites for dedicated land disposal is a location where surface mining has taken place. The biosolids improve the recovery of the land by providing organic matter and nutrients for plant growth.

Utilization

Wastewater solids may sometimes be used beneficially in ways other than as a soil nutrient. Of the several methods worthy of note, composting and co-firing with municipal solid waste are two that have received increasing amounts of interest in the last few years. The recovery of lime and the use of the sludge to form activated carbon have also been in practice to a lesser extent.

27-13 LAND APPLICATION OF BIOSOLIDS

One of the methods for disposition of biosolids/wastewater sludge is by land application. Land application is defined as the spreading of biosolids on or just below the soil surface. The application to land for agricultural purposes is beneficial because the organic matter improves soil structure, soil aggregation, water holding capacity, water infiltration, and soil aeration. In addition, macronutrients (such as nitrogen, phosphorus, and potassium) and micronutrients (such as iron, manganese, copper, and zinc) aid plant growth. These contributions also serve as a partial replacement for chemical fertilizers.

To qualify for application to agricultural and nonagricultural land, the biosolids must, at a minimum, meet the pollutant ceiling concentrations, Class B requirements for pathogens, and vector attraction requirements. For biosolids processed for application to lawns and gardens, Class A criteria and one of the vector-attraction reduction requirements must be met. These are discussed in Chapter 18.

Site Selection

A critical step in land application of biosolids is the identification of a suitable site. Among the factors that must be considered are topography (for erosion potential), soil characteristics, depth to the groundwater, accessibility, proximity to critical areas (such as domestic water supply, property boundaries, public access), and haul distance. The employment of a soil scientist to assist in the assessment is critical. The plan that determines the selection process should involve all the stake holders.

Design Loading Rates

Nitrogen and heavy metals concentrations in the sludge are two of the major concerns in determining the sludge loading rate. The nitrogen limit is typically determined on an annual basis. Heavy-metal loadings are based on long-term averages.

The nitrogen loading rate is typically set to match the available nitrogen provided by commercial fertilizers. It is dependent on the crop and can vary from 120 to 245 kg/ha · y for field crops (corn, wheat, and soybeans) and from 175 to 670 kg/ha · y for forage crops (alfalfa, and grasses).

Extensive soil testing and analysis by a soil scientist is essential in determining an appropriate loading rate.

Application Methods

The application methods are broadly classified as liquid application and dewatered biosolids application.

Liquid Biosolids Application. This method is attractive because of its simplicity. Dewatering processes are not required. The solids concentrations range from 1 to 10 percent. The application method may be by vehicular application or by irrigation.

Vehicular application may be either surface distribution or subsurface distribution. Special vehicles are used. They have wheels designed to minimize compaction and to improve mobility. For surface distribution, rear-mounted spray manifolds, nozzles, or guns are used. For subsurface injection, two alternatives are commonly used. Injection shanks force the liquid into the ground directly. Alternatively, plows or discs with manifolds apply the biosolids that are then incorporated immediately after injection by covering spoons.

Injection below the soil surface is preferred as it minimizes odors, reduces vector attraction, minimizes ammonia loss, eliminates surface runoff, and minimizes visibility, which leads to better public acceptance. However, this method is not suitable for all crops.

Irrigation may be by sprinkling or furrow irrigation. These methods find application in locations isolated from public view and access. They have the following disadvantages: high power costs for the pumps, contact of all parts of the crop with the biosolids, potential odors, vector attraction, and high visibility to the public.

Dewatered Biosolids Application. Application of dewatered solids is similar to the application of semisolid animal manure. Typical solids concentrations are in the range of 15 to 20 percent. It must be followed by incorporation.

This method has the potential to generate dust and odors as well as being an attraction to vectors. Public acceptance of this application method may be difficult to achieve.

Visit the text website at www.mhprofessional.com/wwe for supplementary materials and a gallery of photos.

27-14 CHAPTER REVIEW

When you have completed studying this chapter, you should be able to do the following without the aid of your textbooks or notes:

1. Outline the basic processes for sludge treatment and explain their purpose.

2. Describe the difference between screenings, grit, and sludge.
3. Describe the difference between primary, secondary, and tertiary sludges.
4. Explain the difference between a Newtonian fluid and a Bingham plastic.
5. Explain why the headloss in pumping sludge is larger than the headloss in pumping water.
6. Describe the basic management of screenings and grit.
7. Explain why stabilization occurs in each of the following processes: alkaline stabilization, aerobic digestion, and anaerobic digestion.
8. Explain the advantages of using a higher feed concentration in aerobic and anaerobic digestion and what limits the upper bound of solids concentration.
9. Identify the primary controlling factors in selecting detention time and operating temperature relationships in sludge stabilization.
10. Explain why there is a LEL and a HEL for methane concentrations in air.
11. Compare the general methods for land application of biosolids.

With the use of this text, you should be able to do the following:

12. Estimate the volumes of screenings and grit to be disposed in a given time period.
13. Perform a quantitative mass balance given appropriate removal efficiencies.
14. Calculate the headloss for short distance pumping of sludge.
15. Design a gravity thickener for biosolids/sludge.
16. Evaluate manufacturers' DAF data for selection of equipment for thickening.
17. Determine the volume of tank, mixer size, lime feed rate, and lime storage volume for an alkaline stabilization facility.
18. Determine the volume of the digester and the required air flow rate for an aerobic digester.
19. Determine the volume of an anaerobic digester, daily volume of methane, and total gas produced.
20. Perform an energy balance on an anaerobic digester.
21. Select an appropriate size continuous belt filter press for a specified sludge.

27-15 PROBLEMS

- 27-1. Determine the daily and annual primary sludge production for a WWTP having the following operating characteristics:

$$\text{Flow} = 0.0500 \text{ m}^3/\text{s}$$

$$\text{Influent suspended solids} = 155.0 \text{ mg/L}$$

Removal efficiency = 53.0%
 Volatile solids = 70.0%
 Specific gravity of volatile solids = 0.970
 Fixed solids = 30.0%
 Specific gravity of fixed solids = 2.50
 Sludge concentration = 4.50%

27-2. Repeat Problem 27-1 using the following operating data:

Flow = $2.00 \text{ m}^3/\text{s}$
 Influent suspended solids = 179.0 mg/L
 Removal efficiency = 47.0%
 Specific gravity of fixed solids = 2.50
 Specific gravity of volatile solids = 0.999
 Fixed solids = 32.0%
 Volatile solids = 68.0%
 Sludge concentration = 5.20%

- 27-3. Using a computer spreadsheet you have written, and the data in Problem 27-2, determine the daily and annual sludge production at the following removal efficiencies: 40, 45, 50, 55, 60, and 65%. Plot annual sludge production as a function of efficiency.
- 27-4. Using Figure 27-3, Table 27-2, and the following data, determine B , E , J , K , and L in megagrams per day (Mg/d). Assume $A = 185.686 \text{ Mg/d}$ and $\eta_E = 0.900$; $\eta_J = 0.250$; $\eta_N = 0.00$; $\eta_P = 0.150$; $\eta_H = 0.190$.
- 27-5. Rework Problem 27-4 assuming that the digestion solids are not dewatered prior to ultimate disposal, that is $K = L$.
- 27-6. The value for η_E in Problem 27-4 is quite high. Rework the problem with a more realistic value of $\eta_E = 0.50$.
- 27-7. The flowsheet for the Doubtful WWTP is shown in Figure P-27-7. Assuming that the appropriate values of η given in Figure 27-4 may be used when needed and that $A = 7.250 \text{ Mg/d}$, $X = 1.288 \text{ Mg/d}$, and $N = 0.000 \text{ Mg/d}$, what is the mass flow (in kg/d) of sludge to be sent to ultimate disposal?

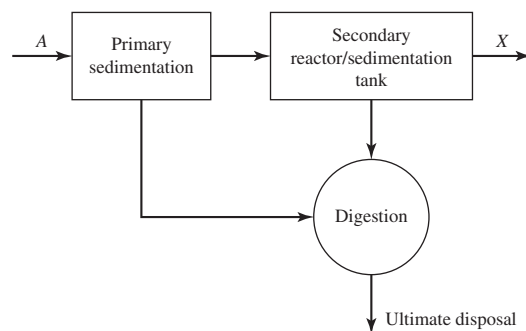

FIGURE P-27-7
 Flowsheet for Doubtful WWTP.

- 27-8.** Using the following mass flow data from the Doubtful WWTP (Problem 27-7) determine η_E , η_D , η_N , η_J , η_X . Mass flows for Doubtful WWTP in Mg/d: $A = 7.280$, $B = 7.798$, $D = 0.390$, $E = 8.910$, $F = 6.940$, $J = 4.755$, $K = 6.422$, $N = 9.428$, $X = 0.468$.
- 27-9.** The city of Doubtful (Problem 27-7) is considering the installation of thickening and dewatering facilities. The revised flow diagram for Doubtful to include thickening and dewatering with appropriate return lines is shown in Figure P-27-9. Calculate a value for L in Mg/d. Assume that the appropriate values of η given in Figure 27-4 may be used when needed and that $A = 7.250$ Mg/d, $X = 1.288$ Mg/d.
- 27-10.** Determine the surface area required for the gravity thickeners (assume that no thickener is greater than 30.0 m in diameter) to thicken the waste activated sludge (WAS) at Grand Rapids, Michigan, from 10,600 mg/L to 2.50% solids. The waste activated sludge flow is 3,255 m³/d. Assume that the batch settling curves of Figure P-27-10 apply. Use a spreadsheet program you have written to plot the data and fit the tangent line.
- 27-11.** Determine the surface area required for the gravity thickeners of Problem 27-10 if 710 m³/d of primary sludge is mixed with the WAS to form a sludge having 2% solids. The final sludge is to have a solids concentration of 5%. The batch settling curve for mixed WAS and PS in Figure P-27-10 is assumed to apply. Because of the additional sludge, assume five thickeners will be used. Use a spreadsheet program you have written to plot the data and fit the tangent line.

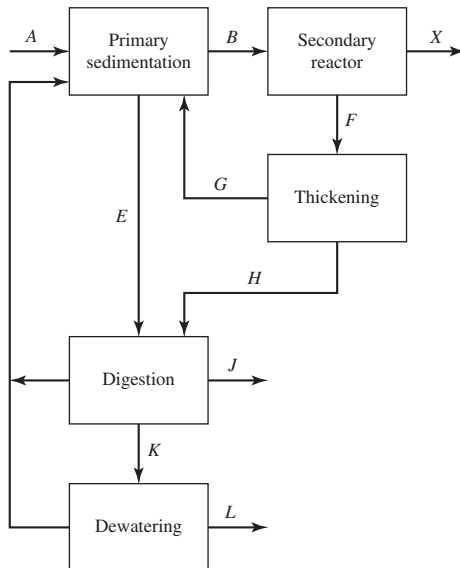

FIGURE P-27-9
Revised flowsheet for Doubtful WWTP.

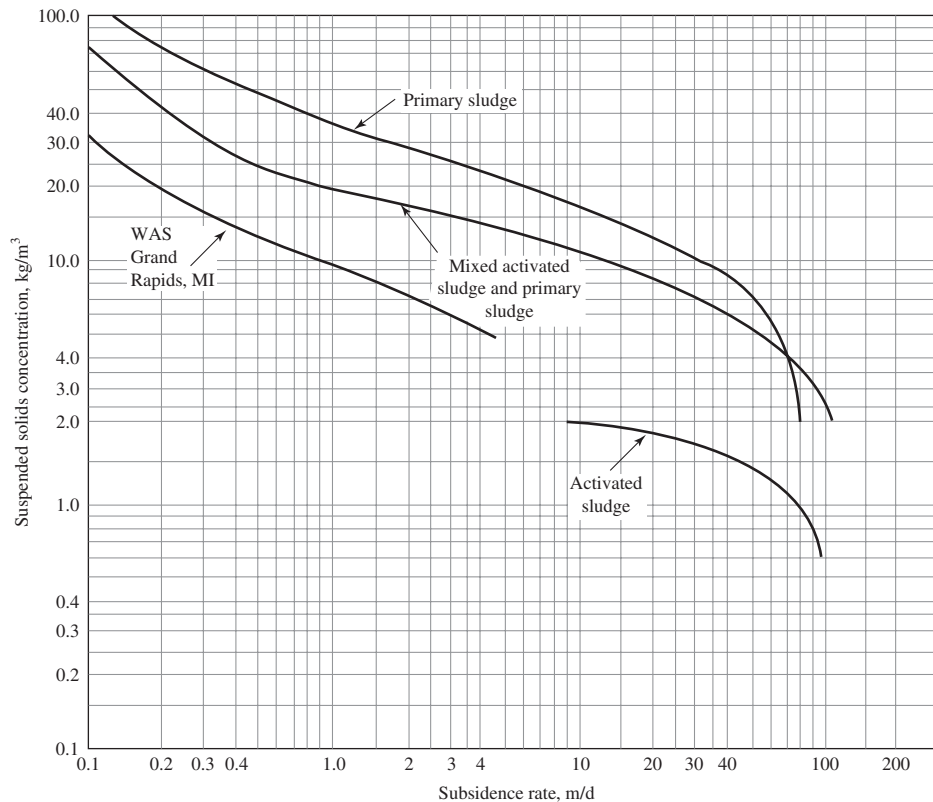

FIGURE P-27-10
Batch settling curves.

27-12. Settling test data from the Little Falls WWTP are shown below. Determine the surface area for a gravity thickener for 733 m³/d of waste activated sludge. The final sludge concentration is to be 3.6%. Use a spreadsheet program you have written to plot the data and fit the tangent line.

Suspended solids concentration, g/L	Initial settling velocity, m/d
4.0	58.5
6.0	36.6
8.0	24.1
14.0	8.1
29.0	2.2
41.0	0.73

27-13. Select a pipe diameter and estimate the friction headloss for pumping 38,500 kg/d of a thickened mixture of primary and activated sludge that has a solids concentration of

6% and a specific gravity of 1.03. The sludge is to be pumped 112 m to an anaerobic digester. Assume a Hazen-Williams $C = 100$ and a pumping time of 1/2 hour once per day.

- 27-14.** To improve the performance of the digester in Problem 27-13, it has been proposed that a more uniform feed be employed by using a clock control to operate a pump for 5 minutes at an interval of 96 minutes. Determine the pumping flow rate and the approximate number of cycles per day. (The spreadsheet solver tool may be useful for this solution.) Use this flow rate to select a pipe diameter and estimate the friction headloss.
- 27-15.** Design a pretreatment lime stabilization system for Quirm. The daily sludge flow rate of 112 m^3 is to be treated in one batch. The primary sludge has a solids concentration of 6% and a specific gravity of 1.02. Determine the volume of tank, mixer size (kW, rpm, turbine dia.), lime feed rate, and lime storage volume for two-week delivery.
- 27-16.** Design a pretreatment lime stabilization system for Pseudopolis. The daily sludge flow rate of 216 m^3 is to be treated in one batch. Half of the sludge volume is primary sludge with a solids concentration of 4.3% and a specific gravity of 1.02. The other half of the volume is WAS with a solids concentration of 1.3% and a specific gravity of 1.005. Determine the volume of tank, mixer size (kW, rpm, turbine dia.), lime feed rate, and lime storage volume for two-week delivery.
- 27-17.** In the preliminary analysis of alternatives for stabilizing the WAS sludge from Sunset's activated sludge plant, your boss has asked you to design an aerobic digester. The sludge flow rate is $62.3 \text{ m}^3/\text{d}$. The solids concentration is 2.8%, and the specific gravity of the sludge is 1.01. Use the following data for the design:

Winter conditions govern
Temperature of digester contents = 20°C
VSS = 0.8 TSS
VSS reduction goal = 40%
Influent BOD = 2,600 mg/L
Fraction of influent BOD consisting of primary solids = 0.35
Sludge concentration is 70% of the incoming thickened sludge concentration
Diffused air mixing is to be used

- 27-18.** In the preliminary analysis of alternatives for stabilizing a mixture of primary and WAS sludge from Knight Falls' activated sludge plant, your boss has asked you to design an aerobic digester. The sludge flow rate is $404 \text{ m}^3/\text{d}$. The solids concentration 2.8% and the specific gravity of the sludge is 1.01. Use the following data for the design:

Winter conditions govern
Temperature of digester contents = 15°C
VSS = 0.7 TSS
VSS reduction goal = 40%
Influent BOD = 1,700 mg/L
Fraction of influent BOD consisting of primary solids = 0.28
Sludge concentration is 70% of the incoming thickened sludge concentration
Diffused air mixing is to be used

- 27-19.** In the preliminary analysis of alternatives for stabilizing the WAS sludge from Sunset's activated sludge plant your boss has asked you to design an anaerobic digester. Determine the volume of the digester, the flow rate of methane, and the volume of an external tank pressurized to 350 kPa. Use the data from Problem 27-17 and the following data for this design:

Sludge thickened to 4.0%

Temperature of digester contents = 35°C

Influent bCOD = 2,600 g/m³

Design effluent bCOD = 500 g/m³

Design safety factor = 5

There will be no recycle

Gas evolves from the digester at atmospheric pressure (101.3 kPa)

- 27-20.** In the preliminary analysis of alternatives for stabilizing the mixture of primary and WAS sludge from Knight Falls' activated sludge plant, your boss has asked you to design an anaerobic digester. Determine the volume of the digester, the flow rate of methane, and the volume of an external tank pressurized to 350 kPa. Use the data from Problem 27-18 and the following data for this design:

Sludge thickened to 4.0%

Temperature of digester contents = 35°C

Influent bCOD = 1,700 g/m³

Design effluent bCOD = 118 g/m³

Design safety factor = 5

There will be no recycle

Gas evolves from the digester at atmospheric pressure (101.3 kPa)

- 27-21.** Determine the dimensions of Sunset's anaerobic digester designed in Problem 27-19. Assume a depth of 7.5 m and a bottom slope of 1:6. Provide a floating cover. The floating cover diameters are sold in 1.5 m increments.
- 27-22.** Determine the dimensions of Knight Falls' anaerobic digester designed in Problem 27-20. Assume a depth of 10.0 m and a bottom slope of 1:3. Provide a floating cover. The floating cover diameters are sold in 1.5 m increments.
- 27-23.** For the sketch shown on page 27-67 in Figure P-27-23, perform a heat balance on the digester designed in Problem 27-21. Is enough methane produced to heat the digester in January if the mean ambient temperature is 15°C? Assume optimistic heat transfer coefficients for the building materials and a heat exchanger efficiency of 90%. The temperature of the sludge is 12°C.
- 27-24.** For the sketch shown on page 27-67 in Figure P-27-24, perform a heat balance on the digester designed in Problem 27-22. Is enough methane produced to heat the digester in January if the mean ambient temperature is -12°C? Assume conservative heat transfer coefficients for the building materials and a heat exchanger efficiency of 60%. The temperature of the sludge is 10°C.
- 27-25.** Using Table 27-20, select a CBFP to dewater an anaerobic digester sludge. The primary sludge has a solids concentration of 4.0% and a specific gravity of 1.04. The

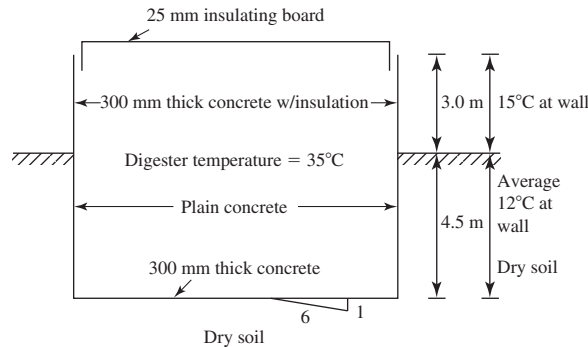

FIGURE P-27-23
Anaerobic digester.

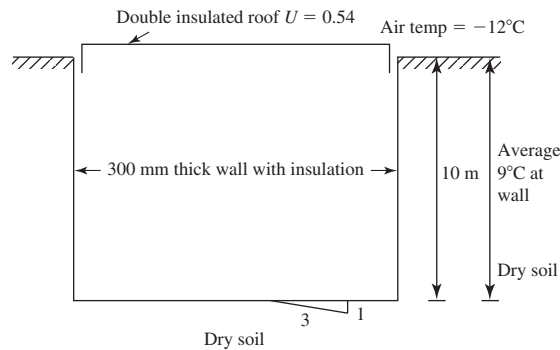

FIGURE P-27-24
Anaerobic digester.

design sludge flow rate is $62.3 \text{ m}^3/\text{d}$. The plant managers wish to operate on a two-shift basis, that is, 16 h/d to minimize labor costs.

- 27-26.** Using Table 27-20, select a CBFP to dewater an anaerobic digester sludge. The sludge is primary plus WAS that has a solids concentration of 2.5% and a specific gravity of 1.03. The design sludge flow rate is $404 \text{ m}^3/\text{d}$. The plant will operate on a three-shift basis.
- 27-27.** The Pomdeterra anaerobic digester produces a sludge that has a total solids concentration of 3.8%. They are investigating a filter press that will yield a solids concentration of 24%. If they now produce $33 \text{ m}^3/\text{d}$ of sludge, what annual volume savings will they achieve if they install the press? (*Hint*: use the approximate method from Chapter 15.)
- 27-28.** Ottawa's anaerobic digester produces $13 \text{ m}^3/\text{d}$ of sludge with a total solids concentration of 2.8%. What volume of sludge must they dispose of each year if their sand drying beds yield a solids concentration of 35%? (*Hint*: use the approximate method from Chapter 15.)
- 27-29.** Weed Patch's digester produces $30 \text{ m}^3/\text{mo}$ of sludge with a total solids concentration of 2.5%. What solids concentration must their drying facility achieve to reduce the volume to $3 \text{ m}^3/\text{mo}$? (*Hint*: use the approximate method from Chapter 15.)

27-16 REFERENCES

- Andrews, J. F. (1969) "Dynamic Model of the Anaerobic Digestion Process," *Journal of the Sanitary Engineering Division*, American Society of Civil Engineers, vol. 95, p. 95.
- Atherton, P. C., R. Steen, G. Stenson, T. McGovern, and D. Smith (2006) "Old Town Learns New Trick," *Water Environment & Technology*, vol. 18, January, pp. 47–51.
- Bechtel, T. B. (2005) "A Computational Technique for Turbulent Flow of Wastewater Sludge," *Water Environment Research*, vol. 77, no. 4, pp. 417–422.
- Davis, M. L. and D. A. Cornwell (2008) *Introduction to Environmental Engineering*, McGraw-Hill, Boston, Massachusetts, p. 510.
- GLUMRB (2004) *Recommended Standards for Wastewater Facilities*, Great Lakes–Upper Mississippi River Board of State and Provincial Public Health and Environmental Managers, Health Education Services, Albany, New York, pp. 80-1–80-23.
- Lawrence, A. W. and P. L. McCarty (1970) "A Unified Basis for Biological Treatment Design and Operation," *Journal of Sanitary Engineering Division*, American Society of Civil Engineers, vol. 96, no. SA3, pp. 757–778.
- Lawrence, A. W. and T. R. Milnes (1971) "Discussion Paper," *Journal of the Sanitary Engineering Division*, American Society of Civil Engineers, vol. 97, p.121.
- Leffler, M. R. and P. Bizier (2009) "Refining Residuals," *Civil Engineering*, American Society of Civil Engineers, vol. 79, January, pp. 56–63.
- LaGrega, M. D., P. L. Buckingham, and J. C. Evans (2001) *Hazardous Waste Management*, 2nd ed., McGraw-Hill, Boston, Massachusetts, pp. 759–761.
- LaMontagne, P. L. and I. Yeveilevich (2006) "Polymer Power," *Water Environment & Technology*, vol. 18, May, pp. 61–64.
- Liptak, B. G. (1974) *Environmental Engineers Handbook*, Chilton Book Company, Radnor, Pennsylvania.
- Madigan, M. T., J. M. Martinko, and J. Parker (1997) *Brock Biology of Microorganisms* 8th ed., Prentice-Hall, Upper Saddle River, New Jersey.
- McCabe, W. L., J. C. Smith, and P. Harriot (2005) *Unit Operations of Chemical Engineering*, McGraw-Hill, Boston, Massachusetts, p.48.
- McCarty, P. L. (1964) "Anaerobic Waste Treatment Fundamentals, Part 2-Environmental Requirements and Control," *Public Works*, October, p. 123.
- Metcalf & Eddy (2003) *Wastewater Engineering: Treatment and Reuse*, 4th ed., McGraw-Hill, Boston, Massachusetts, pp. 983–1034, 1447–1632.
- Murakami, H., H. Katayama, and H. Matsuura (2001) "Pipe Friction Headloss in Transportation of High-Concentration Sludge for Centralized Solids Treatment," *Water Environment Research*, vol. 73, no. 5, pp. 558–566.
- Newhof, T. (2009) personal communication.
- NFPA (1993) *National Electric Code*, Quincy, Massachusetts.
- NFPA (1995) *Standards for Fire Protection in Wastewater Treatment and Collection Facilities*, Document No. 820, Quincy, Massachusetts.
- Parker, G. F. and S. W. Miller (1982) "Response of Methane Fermentation to Continuous Addition of Selected Industrial Toxicants," *Proceedings of the 37th Purdue Industrial Waste Conference*, Lafayette, Indiana.
- Parker, G. F. and W. F. Owen (1986) "Fundamentals of Anaerobic Digestion of Wastewater Sludges," *Journal of Environmental Engineering*, American Society of Civil Engineers, vol. 112, no. 5, pp. 867–920.
- Shimp, G. F., D. M. Bond, J. Sandino, and D. W. Oerke (1995) "Biosolids Budgets," *Water Environment & Technology*, vol. 7, November, pp. 44–49.
- Steel, E. W. and T. J. McGhee (1979) *Water Supply and Sewerage*, 5th ed., McGraw-Hill, New York, p. 466.

- Task Committee (1988) "Belt Filter Press Dewatering of Wastewater Sludge," *Journal of Environmental Engineering*, American Society of Civil Engineers, Task Committee on Belt Filter Presses, vol. 114, pp. 991–1,006.
- U.S. EPA (1975) *Lime Stabilized Sludge: Its Stability and Effect on Agricultural Land*, U.S. Environmental Protection Agency, EPA Pub. No. 670/2-75-012, Washington, D.C.
- U.S. EPA (1979) *Process Design Manual—Sludge Treatment and Disposal*, U.S. Environmental Protection Agency, EPA Pub. No. 625/1-79-011, Washington, D.C., pp. 4-1-4-74, 6-2-6-127, 14-1-14-3, 9-1-9-70.
- U.S. EPA (1987) *Preliminary Treatment Facilities—Design and Operational Considerations*, U.S. Environmental Protection Agency, EPA Pub. No. 430/09-87-007, Washington, D.C.
- WEF (1994) *Safety and Health in Wastewater Systems*, Manual of Practice No. FD-9, Alexandria, Virginia.
- WEF (1998) *Design of Municipal Wastewater Treatment Plants*, 4th ed., Water Environment Federation Manual of Practice 8, Alexandria, Virginia, pp. 9-12-9-16, 19-1-19-61, 20-1-20-118, 21-1-21-126, 22-1-22-226.
- Witzgall, R. A., G. J. Volpe, R. T. Haug, W. A. Lawson, and W. H. Kido (1998) "Digester Evaluation," *Water Environment & Technology*, vol. 10, May, pp. 59–65.
- WPCF (1977) *Wastewater Treatment Plant Design*, Water Pollution Control Federation Manual of Practice No. 8, pp.145–150.

This page intentionally left blank

CLEAN WATER PLANT PROCESS SELECTION AND INTEGRATION

*If the objective of the plant is to produce clean water,
we should call it a Clean Water Plant!*

*Dan Wolz
Superintendent
Clean Water Plant
Wyoming, MI*

*It's good to be on the cutting edge. It's not
good to be on the bleeding edge.*

*Jimmy Spangler
Former Superintendent
Wastewater Division
Lansing, MI*

28-1 INTRODUCTION

28-2 PROCESS SELECTION

28-3 SIMULATION MODELING

28-4 PROCESS INTEGRATION

28-5 CHAPTER REVIEW

28-6 PROBLEMS

28-7 REFERENCES

28-1 INTRODUCTION

The primary goal of municipal wastewater treatment is to protect the health, safety, and welfare of the public. A secondary but essential goal is to protect and provide for the propagation of fish, shellfish, and wildlife. A concomitant goal is to provide for recreation in and on the receiving water. To achieve sustainable development, maximum beneficial reuse of the wastewater and recovery of minerals and energy in the biosolids must be considered.

Based on the results of a 1,000 plant survey, the Water Pollution Control Federation (now the Water Environment Federation) identified four major issues that future designs must focus on (WPCF, 1989):

- Infiltration and inflow
- Equipment breakdown
- Climatic conditions
- Odor

The survey revealed that even though a majority of the plants were operating below their rated average daily flow capacity, hydraulic overload problems were significant because of infiltration and inflow. Equipment problems were attributed to a wide variety of issues including: inappropriate application, inadequate design, poor manufacture, and inadequate maintenance funding. Climatic issues included precipitation induced flow, restricted availability of disposal sites for biosolids due to wet or frozen ground, and lack of equipment and plant appurtenances necessary to deal with local weather conditions. Odor complaints were listed as one of the most frequent management issues encountered. The odor issues were one of the most difficult to deal with because of their plant-wide pervasiveness and the sensitivity of people to the nature of the odor.

28-2 PROCESS SELECTION

Experience has taught us the following fundamental precepts in process selection:

1. The raw wastewater quality of every community is different.
2. Raw wastewater quality is variable.
3. There is no standard treatment plant design that is applicable to all sources.
4. For every source, a number of treatment process alternatives are available.
5. Site conditions often limit the types of treatment process that can be used.
6. Retrofitting and upgrading of existing plants requires creative solutions that are not presented in standard textbooks such as this one.
7. Pilot plant testing is highly recommended in the selection of new technologies or proven technologies for new applications.
8. Pilot plant testing requires careful planning and execution to obtain useful design and operating criteria.

9. It is essential that residuals management be a feature of all designs.
10. Operator experience is invaluable in developing a design.

Evaluation of Process Options

While experts with a large body of knowledge gained from experience will often be able to screen the universe of available processes to select a set of options for study and evaluation, the sorting process they use is not intuitively obvious. In simplified form, the sorting process may be represented as a matrix table in which all the relevant treatment processes are listed on one axis and the factors related to process selection are listed on another axis. Each process is given a rating or ranking for each of the factors. In addition, a weighting system may be employed to account for greater influence of more important aspects of some of the factors than others. Some of the important factors that must be considered are listed in Tables 28-1 and 28-2 (Metcalf & Eddy, 1991).

Focus Issues. The following issues have been selected as focus issues because of their importance in process selection and the major findings of the WPCF survey:

- Contaminant removal.
- Reliability.
- Process flexibility.
- Utility capability.
- Cost.
- Odor control.
- Nutrient and residuals management.
- Energy management.

These factors are discussed in the following paragraphs.

Contaminant Removal. Removal of contaminants is the primary purpose of wastewater treatment processes. In the United States, the regulations promulgated by the U.S. Environmental Protection Agency set the maximum allowable contaminant levels in discharged water. Obviously, processes that cannot meet National Pollution Discharge Elimination System (NPDES) requirements can be quickly eliminated. The NPDES is complex. The following quotation illustrates the complexity (WEF, 1998):

Effluent compliance standards, with pollutant limits for the maximum monthly and weekly period each year, statistically dictate a design process reliability up to the maximum monthly effluent restriction 92 percent of the time, and processing reliability up to the maximum allowable weekly effluent limitation approximately 98 percent of the time. Some regulatory agencies impose more stringent standards, defining effluent standards in terms of the maximum daily event per year (a design reliability of approximately 99.7 percent) or in terms of not exceeding or falling below certain criteria at any time (one hour per year has a design or performance reliability of approximately 99.99 percent).

TABLE 28-1
Important factors to consider in evaluation of process alternatives

Factor	Comments
Design flow	The process must be able to handle the design flow rate. For example, oxidation ponds are rarely selected for populations over 5,000.
Flow variation	The process must be able to handle the expected range of flows. This includes the long-term change in flow from the minimum at start-up to the maximum at the design life as well as diurnal, seasonal, and emergency variations.
Performance	Does the process typically meet or exceed effluent discharge requirements?
Reliability	Experience at similar facilities operating under similar conditions should be considered in determining the answers to the following questions. Is the process easily upset? Can it meet performance requirements under periodic shock loads? On a more fundamental level, what is the maintenance history of the hardware?
Flexibility	This factor has three components. Is the process scheme such that it can be operated at the low flow conditions at start-up as well as the design flows? Does the operator have the capability to meet performance criteria when extreme changes in flows and/or loads occur? Does the operator have the ability to “work around” process components during scheduled out-of-service maintenance requirements as well as unscheduled maintenance for repair of failures?
Area required	The process must fit on the available land with space for future capacity or process upgrades.
Complexity	What is the degree of difficulty in operating the plant under routine or emergency conditions? Does the plant require a high level of attention, extraordinary staff training, and outsourced maintenance?
Staffing requirements	How many people and what level of skills are required to operate the process? Are these skills readily available? How much training is required?
Safety	Safety concerns include the potential for falls, confined space entry for routine maintenance, exposed equipment or moving parts, chemical transport, storage, and application.
Noise	Noise impacts on operating personnel are a safety issue. They must be addressed in equipment selection and housing. Environmental impacts of noise on the neighboring community must be addressed in plant location and maintenance activities.
Climatic constraints	Climatic issues include precipitation induced flow, restricted availability of disposal sites for biosolids due to wet or frozen ground, and lack of plant appurtenances necessary to deal with local weather conditions. Warm temperatures will result in higher odor complaints. Cold temperatures, ice, and snow will impede maintenance and increase safety issues. Cold temperatures also adversely affect biological treatment. The frequency of storm events and their impact on the power supply, flooding, and physical damage should be considered.
Odors	What is the potential for odorous emissions? Are they difficult to control?
Wastewater characteristics	What constituents of the wastewater may inhibit the process?
Chemicals	The chemicals to be employed, the quantities required, their safe handling and storage, and impact on the downstream process and treatment residuals must be addressed.
Treatment residuals	The quantity and characteristics of the treatment residuals affects the treatment technologies and disposition of the treated residual. Are there any constraints that influence the processing scheme? An example would be the need or desire to produce Class A biosolids. What are the impacts of recycle streams on the process?

(continued)

TABLE 28-1 (continued)

Important factors to consider in evaluation of process alternatives

Factor	Comments
Energy	With the current trends in energy costs, the energy requirements of the process are a major consideration in the selection process. Likewise, opportunities to recover and/or conserve energy are critical to process selection.
Operating and maintenance requirements	What special operating and maintenance requirements must be provided? Some examples are access ports, elevators, and overhead cranes.
Construction issues	Special construction issues such as foundations, slope, and site access may be a major consideration in the process selection.
Cost	Both capital and operating costs must be considered in the selection process.

Adapted from Metcalf & Eddy, 1991.

TABLE 28-2

Factors affecting performance of activated sludge processes

Aeration capacity
Ammonia loading
bCOD loading
Environmental factors such as pH and temperature
Food-to-microorganism ratio
Hydraulic loading
Hydraulic detention time
Nutrients
Reactor type
Return activated sludge rate
Solids retention time (SRT)

Adapted from Metcalf & Eddy, 1991.

While these requirements are demanding, many utilities choose to produce water that is much better in quality than that required to comply with the regulations. This includes improving the aesthetic characteristics of the water. Many of the processes that are needed to meet the regulations may be operated in a manner that yields a higher quality than is required by the regulations. One way to get higher quality is to operate at lower loading rates than the customary norms. Another way is to provide additional treatment processes. Because these design considerations are also cost issues, they must be addressed with the client.

Reliability. As used here, the term *reliability* includes robustness as well as mean time between failures. Robustness includes the ability to handle changes in wastewater quality, on-off cyclic operations, normal climatic changes, adverse weather events, and the degree of maintenance required to maintain efficient operation. Although minimum redundancy requirements (see, for example, Table 1-4) help to ensure reliability, they do not take into account failures because

equipment is operated outside of its normal operating range or failure to meet discharge goals because of frequent or very long downtime for repairs.

Process Flexibility. The ability of the operator to mix and match various processes to adapt to variations in flow rates ranging from minimum flows at initial start-up of the plant to maximum flows at the design life is essential to providing consistently good quality effluent. In addition, the ability to “work around” scheduled out-of-service maintenance requirements as well as unscheduled maintenance for repair of failures should be planned in the selection of process options. Both the plant layout and the hydraulics of the plant play a role in providing this flexibility. These are discussed later in this chapter.

A more difficult requirement is the flexibility to meet changing regulatory requirements (which, generally, will become more stringent rather than less stringent) or changes in the wastewater characteristics. For a given set of site characteristics, planning for future expansion is one logical way to provide flexibility. In some cases, it may be possible to provide extra space in the hardened facilities (i.e., concrete structures) to allow for addition of equipment when the need arises. Providing access doors or roof structures to the space is also a good idea. There is, of course, the risk that the space will never be needed.

Utility Capabilities. The clean water utility must be able to operate the plant once it is built. This includes repairs as well as day-to-day adjustments, ordering supplies, taking samples, and so on. Processes should be selected that can be operated and maintained by the available personnel or personnel that can be trained. The plant management must be informed of the complexities and requirements of the treatment process before plans are adopted. Staff training as well as availability and access to service are important considerations in selecting a process.

For many small (501 to 3,300 people) and very small communities (25 to 500 people) and even some medium (3,301 to 10,000) to very large communities (> 100,000 people), there are economies of scale in joining with others to provide treatment. The economies of scale are found primarily in capital cost, outside services, and materials. Energy and, to a lesser extent, labor costs do not exhibit as significant an economy of scale. However, larger size does not guarantee lower costs. In addition to the political issues of local control, a careful economic evaluation of the alternative of joining with another community is warranted.

Costs. The capital cost may be the key factor in selection of a process. As noted in Chapter 1, the operating cost is, in all likelihood, equally relevant. It may be even more important than capital cost in the decision process because of the rising cost of energy and labor.

Odor Control. The stench of waste and decay has been associated with disease for centuries. Long after the scientific recognition of the germ theory of disease, people attribute disease to miasmas. Malodors still send a psychological warning signal that distresses the recipient.

As the United States has become urbanized and less agricultural, urban, suburban, and even rural communities lack tolerance for even ephemeral exposure to extremely low odor concentrations. In addition to psychological stress, they cause a measurable decline in property values. Because the public rates odors as a primary concern in the implementation of clean water facilities, odor control must rank as a major consideration in process selection and implementation.

Nutrient and Residuals Management. The regulatory trends in control of nutrients suggest that planning for new facilities or renovation of old ones must provide for implementation of more technologically advanced systems than permit requirements impose. Examples include provision of space for expansion to implement biological nutrient removal and/or tertiary treatment, and provision of “front-end” systems such as fine screening for membrane bioreactors.

Because it provides greater flexibility in disposition of biosolids, there is a trend toward selection of processes that can produce Class A biosolids. Current designs that can be modified or expanded to meet processes to further reduce pathogens (PFRP) requirements to produce Class A biosolids should be among the alternatives considered.

Energy Management. The surging demand for energy and its escalating cost require rigorous investigation of energy management in the selection and design of processes. Energy conservation in facilities construction, the use of wind and solar power, and recovery of energy from biosolids should be considered.

Initial Screening

Aids for initial screening that may be found in previous chapters are summarized in Table 28-3. Additional aids in screening that were not included in previous chapters are provided in the following tables. These are organized under the following topics:

- Clarifiers (Table 28-4).
- Secondary treatment with a focus on nutrient removal (Figure 28-1 and Tables 28-5 through 28-10).
- Tertiary treatment (Tables 28-11 and 28-12).
- Thickening (Table 28-13).
- Stabilization (Table 28-14).

TABLE 28-3
Summary of tables to aid in screening alternatives

Process	Table	Remarks
Bar racks and screens	20-3	Typical use
Bar racks	20-4	
Fine screens	20-6, 20-7	
Grit removal	20-9, 20-10	
Primary treatment	21-2	Chemically enhanced primary treatment
Secondary treatment	24-1	Attached growth
Sludge pumps	27-4, 27-5	
Thickening	27-6	
Anaerobic digestion	27-14	Cylindrical versus egg-shaped
Dewatering	27-21	

TABLE 28-4
Comparison of rectangular and circular clarifiers

	Rectangular clarifiers	Circular clarifiers
Advantages	Less land and construction cost in a multiple unit design Longer flow path and less chance for short-circuiting than center-feed/peripheral overflow circular clarifiers More even distribution of sludge loads on collectors Can be shallower Low headloss for flow distribution Can be easily covered for odor control More effective foam/scum trapping and positive removal Not proprietary	Short detention time for settled sludge Better effect of dynamic filtration Simple and more reliable sludge-collecting system Low maintenance requirements
Disadvantages	Longer detention time for settled sludge (except for Gould-type designs ^a which have very short detention times) Possibly less effective for high solids loading ^b Increased maintenance of collectors	Center feed/peripheral units have higher potential for short-circuiting Lower limits for effluent weir loading Generally proprietary More susceptible to wind effects High headloss for flow distribution

^aGould-type tanks have sludge hopper in middle of tank.

^bLack of data at high loadings; most rectangular clarifiers are operated at lower solids loadings.

Source: WEF, 2006a.

TABLE 28-5
Nitrogen and phosphorus removal process selection

Process	Nitrification	Nitrogen removal	Sensitivity to TBOD ₅ /TP ratio ^a
A/O	No	No ^b	Moderate
Phostrip	No	No ^c	Low
A2/O TM	Yes	6 to 8 mg/L ^d	High
UCT/VIP	Yes	6 to 12 mg/L ^d	Moderate
Modified UCT	Yes	6 to 12 mg/L ^d	Moderate
Bardenpho	Yes	3 mg/L ^d	High

^aAll processes except Phostrip can benefit from using fermenters. TBOD₅ = total biochemical oxygen demand at 5 days; TP = total phosphorus.

^bSame degree as achieved in conventional activated sludge.

^cUsed in particular if wastewater is fresh and low in readily biodegradable organic matter; can be used with any of the other processes.

^dApproximate effluent concentration.

Source: WEF, 2006b.

TABLE 28-6
Conceptual process selection for nutrient removal

Process	Effluent quality ^a							
	Secondary ^b	5 mg/L BOD	5 mg/L TSS ^c	Nitrification	10 mg/L nitrate nitrogen	3 mg/L total nitrogen ^c	1.0 mg/L total phosphorus ^c	0.5 mg/L total phosphorus ^c
Activated sludge	X	M	X	M				
Extended aeration (oxidation ditch)	X	M	X	X	M			
A/O TM	X	M	X	M			M	
Modified Ludzack-Ettinger	X	M	X	X	X			
Operationally modified activated sludge	X	M	X	M	M		M	
PhoStrip TM	X	M	X	M	M		X	X
University of Cape Town and VIP	X	M	X	X	X		M	
A ² /O TM	X	M	X	X	X		M	
Trickling filters	X			M				
Fluidized bed ^d	M			M	X	X		
Postaeration anoxic rank ^d					X	X		
Two-sludge process ^d	X	M	X	X	X	X		
Three-sludge process with chemical addition ^d	X	M	X	X	X	X	X	X
Denitrification filters ^d			X		X	X		
Bardenpho TM	X	M	X	X		M		
Modified Bardenpho TM	X	M	X	X		M	M	
Simpre TM	X	M	X	X	X	M		
Bionutre TM	X	M	X	X	X	M	M	
OWASA nitrification	X	M	X	X	M		M	
Sequencing batch reactors	X	M	X	M	X	M	M	
Phase isolation ditches	X	M	X	M	M	M	M	
Chemical addition (alum, lime, or iron salts)							X	X

^aX—process capable of producing effluent meeting indicated standard: M—process should be capable of meeting indicated standard with proper design, acceptable influent characteristics, and/or tertiary filtration.

^b20–30 mg/L effluent biochemical oxygen demand (BOD₅) and total suspended solids (TSS).

^cFiltration recommended to meet indicated standard.

^dRequires methanol addition for denitrification.

Source: WEF, 1998.

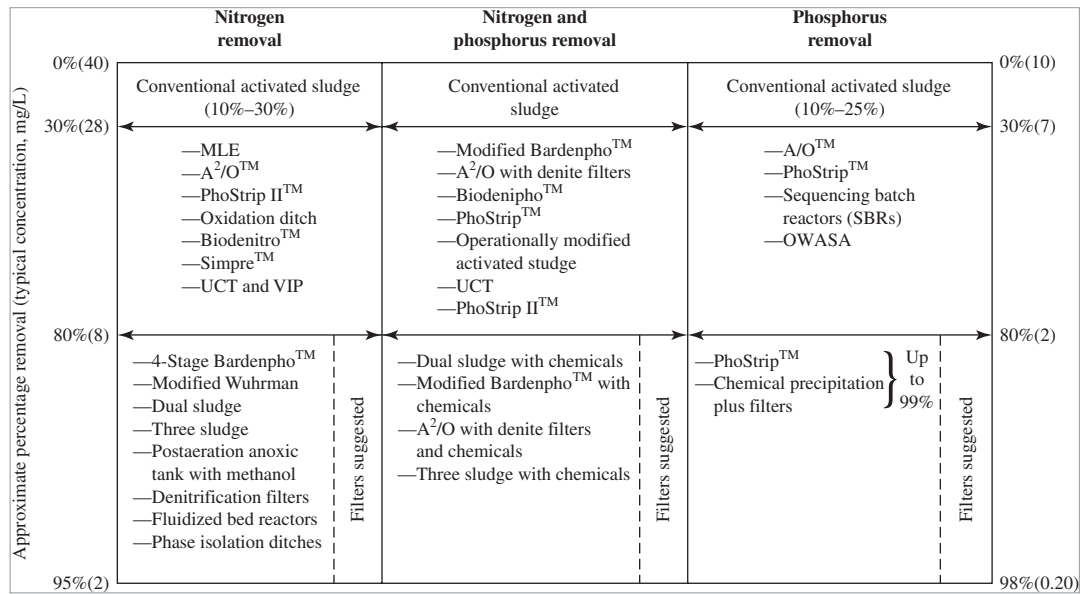

FIGURE 28-1 Process selection matrix for nutrient removal (MLE = modified Ludzack-Ettinger and UTC = University of Cape Town). (Source: WEF, 1998.)

TABLE 28-7 Advantages and limitations of activated sludge processes for BOD removal and nitrification

Process	Advantages	Limitations
Complete mix (CMAS)	<ul style="list-style-type: none"> Common, proven process Adaptable to many types of wastewater Large dilution capacity for shock and toxic loads Uniform oxygen demand Design is relatively uncomplicated Suitable for all types of aeration equipment 	Susceptible to filamentous sludge bulking
Conventional plug flow	<ul style="list-style-type: none"> Proven process May achieve a somewhat higher level of ammonia removal than the complete-mix process Adaptable to many operating schemes including step-feed, selector design, and anoxic/aerobic processes 	<ul style="list-style-type: none"> Design and operation for tapered aeration is more complex May be difficult to match oxygen supply to oxygen demand in first pass
High rate	<ul style="list-style-type: none"> Requires less aeration tank volume than conventional plug flow Uses less aeration energy 	<ul style="list-style-type: none"> Less stable operation; produces lower-quality effluent Not suitable for nitrification Sludge production is higher High peak flows can disrupt operation by washing out MLSS
Contact stabilization	<ul style="list-style-type: none"> Requires smaller aeration volume Handles wet-weather flows without loss of MLSS 	<ul style="list-style-type: none"> Has little or no nitrification capability Operation somewhat more complex

TABLE 28-7 (continued)

Process	Advantages	Limitations
Step feed	<p>Distributes load to provide more uniform oxygen demand</p> <p>Peak wet-weather flows can be bypassed to the last pass to minimize high clarifier solids loading</p> <p>Flexible operation</p> <p>Adaptable to many operating schemes including anoxic/aerobic processes</p>	<p>More complex operation</p> <p>Flow split is not usually measured or known accurately</p> <p>More complicated design for process and aeration system</p>
Extended aeration	<p>High-quality effluent possible</p> <p>Relatively uncomplicated design and operation</p> <p>Capable of treating shock/toxic loads</p> <p>Well-stabilized sludge; low biosolids production</p>	<p>Aeration energy use is high</p> <p>Relatively large aeration tanks</p> <p>Adaptable mostly to small plants</p>
High-purity oxygen	<p>Requires relatively small aeration tank volume</p> <p>Emits less VOC and off-gas volume</p> <p>Generally produces good settling sludge</p> <p>Operation and DO control are relatively uncomplicated</p> <p>Adaptable to many types of wastewater</p>	<p>Limited capability for nitrification</p> <p>More complex equipment to install, operate, and maintain</p> <p><i>Nocardia</i> foaming</p> <p>High peak flows can disrupt operation by washing out MLSS</p>
Oxidation ditch	<p>Highly reliable process; simple operation</p> <p>Capable of treating shock/toxic loads without affecting effluent quality</p> <p>Economical process for small plants</p> <p>Uses less energy than extended aeration</p> <p>Adaptable to nutrient removal</p> <p>High-quality effluent possible</p> <p>Well-stabilized sludge; low biosolids production</p>	<p>Large structure, greater space requirement</p> <p>Low F/M bulking is possible</p> <p>Some oxidation ditch process modifications are proprietary and license fees may be required</p> <p>Requires more aeration energy than conventional CMAS and plug-flow treatment</p> <p>Plant capacity expansion is more difficult</p>
Sequencing batch reactor	<p>Process is simplified; final clarifiers and RAS pumping are not required</p> <p>Compact facility</p> <p>Operation is flexible; nutrient removal can be accomplished by operational changes</p> <p>Can be operated as a selector process to minimize sludge bulking potential</p> <p>Quiescent settling enhances solids separation (low effluent suspended solids)</p> <p>Applicable for a variety of plant sizes</p>	<p>Process control more complicated</p> <p>High peak flows can disrupt operation unless accounted for in design</p> <p>Batch discharge may require equalization prior to filtration and disinfection</p> <p>Higher maintenance skills required for instruments, monitoring devices, and automatic valves</p> <p>Some designs use less efficient aeration devices</p>
Countercurrent aeration	<p>High-quality effluent possible</p> <p>Oxygen transfer efficiencies are higher than conventional aeration systems</p> <p>Well-stabilized sludge; low biosolids production</p> <p>Process design can be modified to accommodate nutrient removal</p>	<p>Fine screening is required to prevent diffuser fouling</p> <p>Process is proprietary</p> <p>Significant downtime of aeration unit for maintenance will affect plant performance</p> <p>Good operator skills required</p>

Source: Metcalf & Eddy, 2003.

TABLE 28-8
Advantages and limitations of nitrogen-removal processes

Process	Advantages	Limitations
Preanoxic—general	Saves energy; BOD is removed before aerobic zone Alkalinity is produced before nitrification Design includes an SVI ^a selector	
MLE	Very adaptable to existing activated sludge processes 5 to 8 mg/L TN ^b is achievable	Nitrogen-removal capability is a function of internal recycle Potential <i>Nocardia</i> growth problem DO control is required before recycle
Step feed	Adaptable to existing step-feed activated-sludge processes With internal recycle in last pass, nitrogen concentrations less than 5 mg/L are possible 5 to 8 mg/L TN is achievable	Nitrogen-removal capability is a function of flow distribution More complex operation than MLE; requires flow split control to optimize operation Potential <i>Nocardia</i> growth problem Requires DO control in each aeration zone
Sequencing batch reactor	Process is flexible and easy to operate Mixed-liquor solids cannot be washed out by hydraulic surges because flow equalization is provided Quiescent settling provides low effluent TSS ^c concentration 5 to 8 mg/L TN is achievable	Redundant units are required for operational reliability unless aeration system can be maintained without draining the aeration tank More complex process design Effluent quality depends upon reliable decanting facility May need effluent equalization of batch discharge before filtration and disinfection
Batch decant	5 to 8 mg/L TN is achievable Mixed-liquor solids cannot be washed out by hydraulic surges	Less flexible to operate than SBR Effluent quality depends upon reliable decanting facility
Bio-denitro TM	5 to 8 mg/L TN is achievable Large reactor volume is resistant to shock loads	Complex system to operate Two oxidation ditch reactors are required; increases construction cost
Nitrox TM	Large reactor volume is resistant to shock loads Easy and economical to upgrade existing oxidation ditch processes Provides SVI control	Nitrogen-removal capability is limited by higher influent TKN concentrations Process is susceptible to ammonia bleed-through Performance is affected by influent variations
Bardenpho TM (4-stage)	Capable of achieving effluent nitrogen levels less than 3 mg/L	Large reactor volumes required Second anoxic tank has low efficiency
Oxidation ditch	Large reactor volume is resistant to load variations without affecting effluent quality significantly Has good capacity for nitrogen removal; less than 10 mg/L effluent TN is possible	Nitrogen-removal capability is related to skills of operating staff and control methods
Postanoxic with carbon addition	Capable of achieving effluent nitrogen levels less than 3 mg/L May be combined with effluent filtration	Higher operating cost due to purchase of methanol Methanol feed control required

(continued)

TABLE 28-8 (continued)

Process	Advantages	Limitations
Simultaneous nitrification/denitrification	<p>Low effluent nitrogen level possible (3 mg/L lower limit)</p> <p>Significant energy savings possible</p> <p>Process may be incorporated into existing facilities without new construction</p> <p>SVI control enhanced</p> <p>Produces alkalinity</p>	<p>Large reactor volume; skilled operation also required</p> <p>Process control system required</p>

^aSVI = sludge volume index^bTN = total nitrogen^cTSS = total suspended solids

Source: Metcalf & Eddy, 2003.

TABLE 28-9
Advantages and limitations of phosphorus-removal processes

Process	Advantages	Limitations
Phoredox (A/O TM)	<p>Operation is relatively simple when compared to other processes</p> <p>Low BOD/P ratio possible</p> <p>Relatively short hydraulic retention time</p> <p>Produces good settling sludge</p> <p>Good phosphorus removal</p>	<p>Phosphorus removal declines if nitrification occurs</p> <p>Limited process control flexibility is available</p>
A ² O TM	<p>Removes both nitrogen and phosphorus</p> <p>Provides alkalinity for nitrification</p> <p>Produces good settling sludge</p> <p>Operation is relatively simple</p> <p>Saves energy</p>	<p>RAS containing nitrate is recycled to anaerobic zone, thus affecting phosphorus-removal capability</p> <p>Nitrogen removal is limited by internal recycle ratio</p> <p>Needs higher BOD/P ratio than the A/O process</p>
UCT	<p>Nitrate loading on anaerobic zone is reduced, thus increasing phosphorus-removal capability</p> <p>For weaker wastewater, process can achieve improved phosphorus removal</p> <p>Produces good settling sludge</p> <p>Good nitrogen removal</p>	<p>More complex operation</p> <p>Requires additional recycle system</p>
VIP	<p>Nitrate loading on anaerobic zone is reduced, thus increasing phosphorus-removal capability</p> <p>Produces good settling sludge</p> <p>Requires lower BOD/P ratio than UCT</p>	<p>More complex operation</p> <p>Requires additional recycle system</p> <p>More equipment required for staged operation</p>
[Bardenpho TM (5-stage)	<p>Can achieve 3 to 5 mg/L TN in unfiltered effluent</p> <p>Produces good settling sludge</p>	<p>Less efficient phosphorus removal</p> <p>Requires larger tank volumes</p>

(continued)

TABLE 28-9 (continued)

Process	Advantages	Limitations
SBR	Both nitrogen and phosphorus removal are possible Process is easy to operate Mixed-liquor solids cannot be washed out by hydraulic surges Quiescent settling may produce lower effluent TSS concentration Flexible operation	More complex operation for N and P removal Needs larger volume than SBR for N removal only Effluent quality depends upon reliable decanting facility Design is more complex Skilled maintenance is required More suitable for smaller flow rates
PhoStrip™	Can be incorporated easily into existing activated sludge plants Process is flexible; phosphorus-removal performance is not controlled by BOD/phosphorus ratio Significantly less chemical usage than mainstream chemical precipitation process Can achieve reliable effluent orthophosphate concentrations less than 1 mg/L	Requires lime addition for phosphorus precipitation Requires higher mixed-liquor dissolved oxygen to prevent phosphorus release in final clarifier Additional tank capacity required for stripping Lime scaling may be a maintenance problem

Source: Metcalf & Eddy, 2003.

TABLE 28-10
Advantages and disadvantages of MBR reactors

Parameter	Comment
Advantages	
Effluent quality	Consistently high-quality with effluent solids concentrations less than 1 mg/L
Footprint	Footprint is smaller because primary and secondary clarifiers can be eliminated. Aeration basin can be smaller because MLSS concentration is higher.
Sludge production	Long SRTs result in lower sludge production compared to conventional activated sludge
Ease of expansion	Because the membrane systems are modular, they can easily be expanded
Robust operation	System can operate within a wide range of SRTs
Reduced disinfection requirements	Because the membrane serves as a physical mechanism to remove microorganisms and turbidity, the chlorine demand is less and the higher transmissivity means less energy is needed for UV disinfection
Disadvantages	
Limited flow capacity	Because of the hydraulic limits of the membrane, the range of flows that can be treated is less than conventional activated sludge. The peaking factor is 2.0 to 2.5.
Increased potential for foam	Operating conditions in a MBR system often favor foaming
System monitoring and maintenance	MBRs must be closely monitored to detect changes in flux rate and permeability.
Cost	Although the capital cost of membranes is falling rapidly, the capital cost is still significantly higher than that of conventional activated sludge
Limited availability of long-term data	Because of the limited availability of long-term data, it is difficult to verify manufacturer's claims

Adapted from WEF, 2006c.

TABLE 28-11
Typical average day effluent concentrations from granular media filtration of secondary effluent

Filter influent type	Without chemical coagulation— single or multimedia filter, effluent SS, mg/L	With tertiary chemical coagulation—dual or multimedia filter		
		Effluent SS, mg/L	Total P, mg/L	Turbidity, NTU
High-rate trickling filter effluent	10–20	0–3	0.1	0.1–0.4
Two-stage trickling filter effluent	6–15	0–3	0.1	0.1–0.4
Contact stabilization effluent	6–15	0–3	0.1	0.1–0.4
Conventional activated sludge effluent	3–10	0–5	0.1	0.1–0.4
Extended aeration effluent	1–5	0–5	0.1	0.1–0.4
Aerated/facultative lagoon effluent	10–50	0–30 ^a	0.1	N/A ^a

^aPoor removal efficiency can result from filtering lagoon effluent because of the presence of algae.

Source: WEF, 1998.

Other Considerations

Infiltration and Inflow Reduction. The implementation of comprehensive programs to reduce infiltration and inflow have a direct impact on process performance and an indirect impact on process selection. Plant influent flow rates may be reduced between 5 and 25 percent. In general, this would be expected to have a positive effect on clarifier performance. However, the wastewater strength is also likely to increase significantly.

Water Conservation. The increasing cost of water and wastewater has resulted in reductions in industrial water use. These activities coupled with implementation of water conservation devices and new “tight” sewer systems may result in significant increases in both the BOD and solids concentration entering the plant. The lower flow rates and higher strength waste will have a major impact on process selection and residuals management.

Special Considerations for MBRs. In the application of MBRs, the traditional procurement and delivery methods for equipment are evolving. Because of the manufacturer-specific membrane design, which prevents the competitive procurement of replacement membranes, and the very high cost of membranes, owners are requiring performance guarantees. The resulting liability issues have resulted in MBR supplier requirements for involvement in the design of the overall process scheme. In the most controlled scenario, the MBR is selected before the upstream and downstream processes are designed. These processes are then designed “around” the MBR. There are many variations of this approach including specifying the treatment requirements and open bidding the membrane supplier with life cycle cost being the deciding factor.

Process Selection Examples

The following three case studies were selected to demonstrate the wide range of choices in selecting a process and to illustrate some of the logic that was used in making the choices. A literature review of the many other examples that are reported in the Water Environment Federation journals (*Water Environment Research* and *Water Environment and Technology*) should be part of any study to evaluate process alternatives.

TABLE 28-12

Add-on processes—general considerations

	Process capability	Process control	Operational factors	Sidestreams and recycle	Solids	Air emissions	Energy requirement	Space requirement
Filtration	Suspended solids removal to < 10 mg/L	Headloss and flow rate control typically automated	Three basic modes: constant pressure, constant rate; variable declining rate; backwash	Backwash water	Sludge from solids contained in backwash	None	Low to moderate	Low
Adsorption	Dissolved organics removal to > 99%; some toxic metal removal	Headloss, flow rate, and pollutant breakthrough control	Backwash, column downtime for carbon replacement	Backwash water	None ^a	None	Low to moderate	Low
Chemical treatment	Phosphate removal to <1 mg/L; metals removal to <1 mg/L, acid–base neutralization	pH, ORP, ^b chemical dosage	Chemical storage, chemical feed, mixing	Drainage from chemical sludge dewatering	Hydroxide, carbonate, and phosphate precipitates; other chemical sludges	Dust from chemical handling and storage	Moderate to high	Moderate to high
Membrane processes	Removal of TSS, TDS, ^c microorganisms, viruses, and some organic compounds	Pretreatment, transmembrane pressure, concentrate flow, membrane flux	Pretreatment requirements, concentrate disposal	Concentrate, cleaning solutions	Solids from backwash on MF/UF ^d processes	Fugitive emissions from chemical storage and use	Low to high	Low to moderate
Air stripping	Volatile organic carbon removal to > 99% Ammonia removal to > 99%	Minimal air-to-water ratio Minimal pH and air-to-water ratio		Possible column wash liquid	Possible carbonate precipitates	Volatile organics, ammonia, or both	Low to moderate	Low
Reoxygenation (post-aeration)	Effluent dissolved oxygen increased to nearly saturation concentration	Dissolved oxygen level	Aeration rate	None	None	Minimal, volatile chemicals	Moderate to high	Moderate

^aRegeneration of spent carbon can produce air emissions.

^bORP = oxidation–reduction potential.

^cTDS = total dissolved solids.

^dMF/UF = microfiltration/ultrafiltration.

Source: WEF, 1998.

TABLE 28-13
Advantages and disadvantages of thickening methods

Method	Advantages	Disadvantages
Gravity	<ul style="list-style-type: none"> Simple Low operating cost Low operator attention required Ideal for dense rapidly settling sludges such as primary and lime Provides a degree of storage as well as thickening Conditioning chemicals not typically required Minimal power consumption 	<ul style="list-style-type: none"> Odor potential Erratic for WAS^a Thickened solids concentration limited for WAS High space requirements for WAS Floating solids
Dissolved air flotation	<ul style="list-style-type: none"> Effective for WAS Will work without conditioning chemicals at reduced loadings Relatively simple equipment components 	<ul style="list-style-type: none"> Relatively high power consumption Thickening solids concentration limited Odor potential Space requirements compared to other mechanical methods Moderate operator attention requirements Building corrosion potential, if enclosed Requires polymer for high solids capture or increased loading
Centrifuge	<ul style="list-style-type: none"> Space requirements Control capability for process performance Effective for WAS Contained process minimizes housekeeping and odor considerations Will work without conditioning chemicals High thickened concentrations available 	<ul style="list-style-type: none"> Relatively high capital cost and power consumption Sophisticated maintenance requirements Best suited for continuous operation Moderate operator attention requirements
Gravity belt thickener	<ul style="list-style-type: none"> Space requirements Control capability for process performance Relatively low capital cost Relatively lower power consumption High solids capture with minimum polymer High thickened concentrations available 	<ul style="list-style-type: none"> Housekeeping Polymer dependent Moderate operator attention requirements Odor potential Building corrosion potential, if enclosed
Rotary drum thickener	<ul style="list-style-type: none"> Space requirements Low capital cost Relatively low power consumption High solids capture Can be easily enclosed 	<ul style="list-style-type: none"> Polymer dependent Sensitivity to polymer type Housekeeping Moderate operator attention requirements Odor potential if not enclosed

Source: WEF, 1998.

^aWAS = waste activated sludge

TABLE 28-14
Comparison of stabilization processes

Process	Advantages	Disadvantages
Anaerobic digestion	<ul style="list-style-type: none"> Good volatile suspended solids destruction (40 to 60%) Net operational costs can be low if gas (methane) is used Broad applicability Biosolids suitable for agricultural use Good pathogen inactivation Reduces total sludge mass Low net energy requirements 	<ul style="list-style-type: none"> Requires skilled operators May experience foaming Methane formers are slow growing; hence, “acid digester” sometimes occurs Recovers slowly from upset Supernatant strong in carbonaceous oxygen demand, biochemical oxygen demand, suspended solids, and ammonia Cleaning is difficult (scum and grit) Can generate nuisance odors resulting from anaerobic nature of process High initial cost Potential for struvite (mineral deposit) Safety issues concerned with flammable gas
Aerobic digestion	<ul style="list-style-type: none"> Low initial cost, particularly for small plants Supernatant less objectionable than anaerobic Simple operational control Broad applicability If properly designed, does not generate nuisance odors Reduces total sludge mass 	<ul style="list-style-type: none"> High energy costs Generally lower volatile suspended solids destruction than anaerobic digestion Reduced pH and alkalinity Potential for pathogen spread through aerosol drift Biosolids typically are difficult to dewater by mechanical means Cold temperatures adversely affect performance May experience foaming
Autothermal thermophilic aerobic digestion	<ul style="list-style-type: none"> Reduced hydraulic retention compared with conventional aerobic digestion Volume reduction Excess heat can be used for building heat Pasteurization of the sludge, pathogen reduction 	<ul style="list-style-type: none"> High energy costs Potential of foaming Requires skilled operators Potential for odors
Composting	<ul style="list-style-type: none"> High-quality, potentially saleable product suitable for agricultural use Can be combined with other processes Low initial cost (static pile and windrow) 	<ul style="list-style-type: none"> Requires 18 to 30% dewatered solids Requires bulking agent Requires either forced air (power) or turning (labor) Potential for pathogen spread through dust High operational cost: can be power, labor, or chemical intensive, or all three May require significant land area Requires carbon source Potential for odors
Lime stabilization	<ul style="list-style-type: none"> Low capital cost Easy operation Good as interim or emergency stabilization method 	<ul style="list-style-type: none"> Biosolids not always appropriate for land application Chemical intensive Overall cost very site specific Volume of biosolids to be disposed of is increased pH drop after treatment can lead to odors and biological growth

(continued)

TABLE 28-14 (continued)

Process	Advantages	Disadvantages
Advanced alkaline stabilization	<ul style="list-style-type: none"> Produces a high-quality Class A product Can be started quickly Excellent pathogen reduction 	<ul style="list-style-type: none"> Operator intensive Chemical intensive Potential for odors Volume of biosolids to be disposed of is increased May require significant land area
Sludge dryers	<ul style="list-style-type: none"> Substantially reduces volume Can be combined with other processes Produces a Class A product Not a biological process so it can be started quickly Retains nutrients 	<ul style="list-style-type: none"> Some dryers could be labor intensive Produces an off-gas that must be treated

Source: WEF, 1998.

Case Study 28-1

Some design constraints force the design engineer to think “inside the box,” or in this case inside the tank. This is especially true when the existing process cannot achieve new permit requirements for constituents that were not previously regulated, or because of population growth, or a combination of these events. The lack of land for plant expansion is often a driving force to think inside the box.

Discussion. The paper by Jackson et al. (2007) was selected to illustrate the use of integrated fixed-film activated sludge (IFAS) and partitioning of the tank to bring a 30-year-old plant up to a new set of standards.

The City of The Colony, Texas, clean water plant was designed as a contact stabilization process to remove biochemical oxygen demand (BOD) and total suspended solids (TSS). The historic influent and effluent concentrations are shown in the table below. The plant was routinely capable of meeting the discharge limits of 10 mg/L BOD and 15 mg/L TSS. However, the growth in population increased the mass loading on the stream. To protect the receiving stream, the State of Texas imposed additional discharge limits of 3 mg/L ammonia nitrogen ($\text{NH}_4^+\text{-N}$) and 1 mg/L phosphorus. The contact stabilization process was not designed to provide nitrification or phosphorus removal.

The Colony influent and effluent characteristics prior to renovation

Parameter	Influent	Effluent
Average annual flow	8,400 m ³ /d	8,400 m ³ /d
BOD ₅	236 mg/L	6.5 mg/L
TSS	324 mg/L	4.2 mg/L
$\text{NH}_4^+\text{-N}$	30 mg/L	9.4 mg/L

The existing configuration was a “bull’s-eye” tank with the aeration basin in an exterior annulus and the final clarifier in the center (Figure 28-2a). To accomplish nitrification, the solids retention time (SRT) was increased by removing the old divider walls and adding fixed media to form an integrated fixed-film activated sludge (IFAS) unit (Figure 28-2b). The existing fine-bubble diffuser system was left in place. To accomplish biological phosphorus removal, new divider walls were installed to form anaerobic zones. To handle the additional biomass loading on the clarifier, a splitter box was installed to route some of the flow to an external secondary clarifier. An external addition included an anoxic tank for denitrification of the return sludge (Figure 28-3).

After these modifications the plant was able to consistently meet effluent discharge requirements of 10, 15, and 3 mg/L of BOD₅, TSS, and NH₄⁺-N, respectively.

Comment. The start-up of this plant was plagued by a number of mechanical malfunctions. The existing fine bubble diffuser broke at one of the diffuser joints after start-up. This resulted in a dramatic increase in air buoyancy under one IFAS unit. This caused the unit to work loose from its anchor bolts. Other failures in the air fine-bubble diffuser grid and in the automatic wasting system also occurred.

The lesson learned is that existing piping and mechanical systems need to be inspected, tested, and repaired as part of any renovation. This is particularly true for IFAS systems as they stand above the diffusers after installation.

Case Study 28-2

The age of an old plant combined with population growth and the increasing likelihood more stringent standards often brings the reality of the need for renovation. The City of Wyoming, Michigan, began to address these issues in the early 1990s. The information for this discussion was provided by Dave Koch, P.E., Project Manager, Black and Veatch.

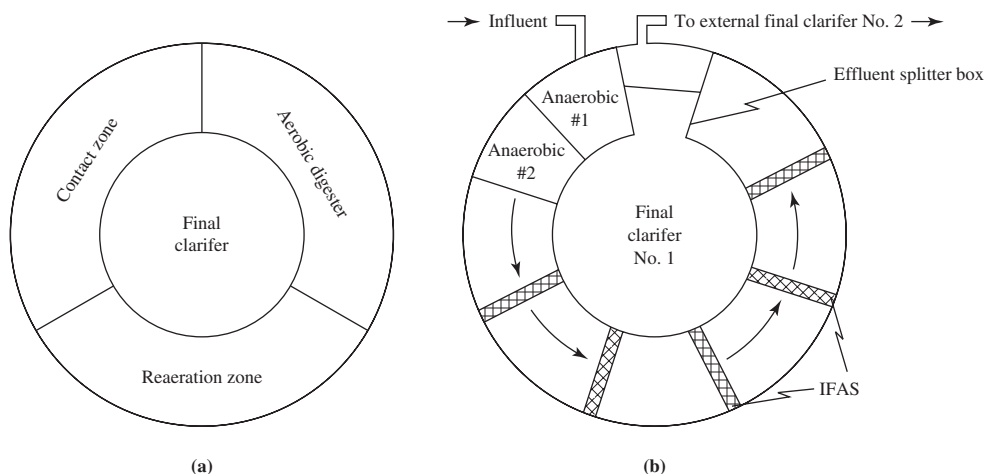

FIGURE 28-2
Existing (a) and proposed (b) aeration basin configurations.

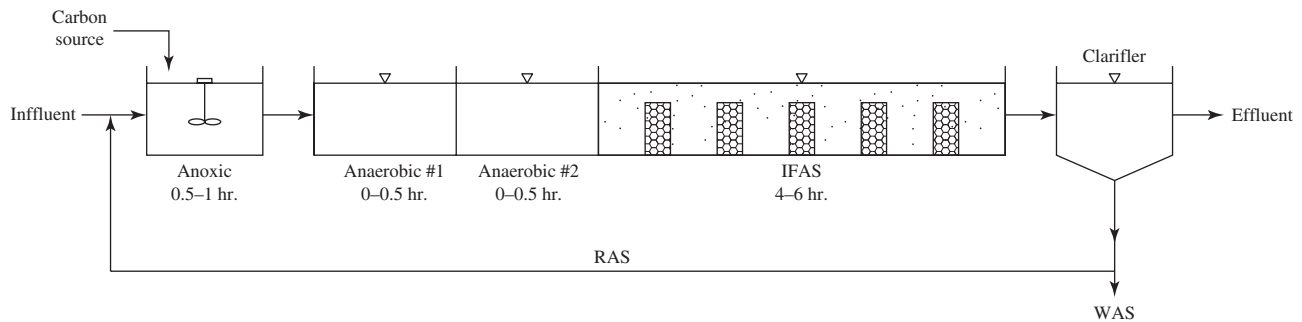

FIGURE 28-3
IFAS process flow diagram.

Discussion. The Wastewater Treatment Plant Facilities Plan for the City of Wyoming was completed in 1995. In scope, it identified four phases of construction that were to begin in 1998: (1) new preliminary treatment and biosolids facilities, (2) addition of new process facilities to meet anticipated regulatory and flow projection requirements through 2015, (3) addition of new biosolids processing and disinfection facilities, and (4) preparation for further expansion beyond 2015.

The 1998 influent conditions and basis for design are shown in the table below. It may be noted that the projections for 2015 were limited to wastewater flow. This is because of the long record of data for wastewater characteristics and the likelihood that, because of the size of the community, population growth would not change the characteristics of the wastewater.

City of Wyoming influent wastewater characteristics^a

Parameter	1998	2015
Population equivalent	183,886	249,869
Flow	60,560 m ³ /d	83,270 m ³ /d
BOD ₅	312 mg/L	312 mg/L
TSS	237 mg/L	237 mg/L
NH ₄ ⁺ -N	17 mg/L	17 mg/L
Organic nitrogen	11 mg/L	11 mg/L
Phosphorus (PO ₄ -P)	8 mg/L	8 mg/L
VSS/TSS	0.8	0.8

^aAll are annual averages.

The new preliminary treatment facilities were used to try out a designer–client relationship that had not previously been used at the facility. Significant input from the users was obtained in the design. Operators and maintenance personnel as well as management personnel were consulted. Teams of experienced personnel met the the design team before and during the design process. Operators and maintenance personnel were given the opportunity to review and comment on plans. Of particular note was the completion of preliminary works that avoided confined space and used stainless steel for critical parts. The new facility reduced the odor impact of the preliminary treatment facility.

The placement of the biological treatment processes required an analysis of four alternatives. A rating scheme was used that considered the following criteria:

- Ease of implementation
- Construction cost
- O&M cost
- Wetlands impact
- Engineering feasibility
- Operational flexibility

Of the process options considered, a biological phosphorus removal plant was selected as the best alternative to meet future regulatory requirements. This alternative required the construction of three new aeration basins, four new clarifiers, and a new RAS/WAS pumping station. The same designer-client relationship that was developed in the preliminary treatment design was used in laying out the biological treatment process. The plant went on line in 2008.

The existing complete mix activated sludge system remains in place as backup. The existing trickling filters were demolished.

Comments.

1. As with all biological processes, the bio-p plant had start-up problems. Among the most difficult to resolve was the removal of phosphorus. The proportions of raw sewage and return-activated sludge must be adjusted to achieve the appropriate volatile acid fractions. Although the plant had tried to operate only two of the three aeration basins because it was the beginning of its design life, ultimately all three aeration basins had to be put into service to achieve good phosphorus removal.
2. The trickling filters were a major source of odor complaints, and the facility was glad to see them removed.

Case Study 28-3

In rare instances, the design engineer has the opportunity to design a new plant with a client that has both the long-range view of the trends in regulatory requirements and the resources to allow the engineer to design for the future. This case study illustrates both common difficulties with the site and state-of-the-art design for the future.

The owner and operator of this facility is the North Kent Sewer Authority in Kent County, Michigan. The plant is called the PARCC Side Clean Water Plant. The design firm was Prein&Newhof. The information for this discussion was provided by Tom Newhof of Prein&Newhof.

Discussion. After considering five locations, vacant land that had been used for farming was purchased. One-third of the 15.4 ha site is wetland. Most of the site was below the 100-year flood elevation. A flood plain and flood way permit was obtained and a compensating cut was made in the flood plain and flood way.

A grading contract was let one year before construction began. Fill was moved to the site to raise it above the 100-flood elevation. The sand fill was surcharged in the areas where the reactor

tanks were to be placed. The design assumption was that the reactor tanks would be filled in the event of a 100-year flood to compensate for the buoyancy effect. Earth anchors were provided for the sludge storage tanks.

The NPDES permit requirements are summarized in the table below.

PARCC Side Clean Water Plant NPDES requirements

Parameter	Summer	Winter	Comment
BOD ₅	10		Daily maximum
		40	7 day maximum
	4	25	Monthly maximum
TSS	30	45	7 day maximum
	20	30	Monthly maximum
NH ₄ ⁺ -N	2.0	N/A	Daily maximum
	0.5	N/A	Monthly maximum
P	1.0		Monthly average

Units are all mg/L.

N/A = There are no winter limits.

The design flow rates are 30,000 m³/d for the average day, 45,000 m³/d for the maximum day, and 60,000 m³/d for the peak hour. The design average influent constituent concentrations were: BOD₅ of 330 mg/L, TSS of 300 mg/L, NH₄⁺-N of 60 mg/L.

Early in the design process several alternatives were considered. The choices were narrowed to extended aeration and MBR. The final process arrangement selected is a form of the Modified Ludzack-Ettinger process (Figure 23-7) with an anoxic tank and a “swing” tank upstream of the aeration tank. Although the current permit only requires nitrification, this arrangement provides the plant with the capability to meet potential future requirements for denitrification. To protect the membranes, fine screens (1 mm) were selected in lieu of primary sedimentation tanks. The use of the membranes eliminated the need for secondary tanks. Biosolids are stored in an open aerated tank before final disposition. Inclined screw presses were selected to dewater the biosolids before disposal to a sanitary landfill.

The plant layout includes ample room for expansion. This includes space to double the aeration tank capacity and the membrane chambers. Space is available to build an equalization basin. The excess aeration tank capacity at start-up currently provides for equalization if needed. Because the membrane life is less than the time to reach the expected design capacity of the plant, the initially purchased membranes occupy only two-thirds of the chambers that were built.

As part of the project management process, proposals for the membranes were received about two years before construction started. Bids were evaluated on a life cycle cost basis.

A comprehensive odor control system was integrated into the design. An air handling system collects off-gases from the major odor producing processes. The air is scrubbed in a biofilter.

To enhance the visual appearance of the plant, the architecture of the major structures gives the appearance of a farm house with barn and outbuildings.

As shown in the table below, in its early stages of operation (about two months after acclimation), the effluent is generally meeting design expectations. The average daily flow rate was about 15,000 m³/d when the data in the table were gathered.

PARCC Side Clean Water Plant performance

Parameter	Average daily effluent concentration ^a	NPDES winter limits	Comment
BOD ₅	< 2	40	7 day maximum
		25	Monthly maximum
TSS	< 2	45	7 day maximum
		30	Monthly maximum
NH ₄ ⁺ -N	0.1 to 3	N/A	
		N/A	
P	< 0.5		

^aJanuary and February.

Units are all mg/L, N/A = there are no winter limits.

The state-of-the-art features of the plant include:

- MBR process.
- Fine screens (1 mm) without a coarse prescreen.
- Elimination of primary and secondary settling tanks.
- Inclined screw press.
- Integrated odor control.
- Environmentally compatible architecture.

Comments:

1. As with all plant start-ups, it took about two months for the biological process to acclimate and begin functioning as planned. In this instance, this period was at the start of winter conditions in Michigan (November–December). This proved to be an extremely challenging period of time for the newly formed operating staff. The membranes were very beneficial in this period as the effluent permit requirements were consistently met.
2. There were operational problems with the fine screens. The 1.0 mm fine screens were replaced with 1.5 mm screens. This, coupled with modification of the influent distribution systems, appears to have resolved the problems.
3. The capital cost of the plant is about 10 percent higher than it would have been for a conventional plant.
4. The Authority is composed of four townships and one city. The plant was named using the initials from each of the five Authority members (Plainfield, Alpine, Rockford, Cannon, and Courtland). There is a county park between the plant and the Grand River. In this context, the name PARCC Side Clean Water Plant appealed to the Authority members.

28-3 SIMULATION MODELING

Simulation software that was developed originally and used predominantly by researchers on mainframe computers has now become routinely available for consultants and operators to run on their own personal computers. Although it is relatively simple to construct and run a model with

current software, learning which parameters to adjust and how the results should be interpreted or applied requires a substantial time investment. Nonetheless, the simulator packages are powerful tools both for process selection and process integration.

The simulators have a library of process scenarios with adjustable default values for model parameters. Current simulators use “Activated Sludge Model No. 3” also known as ASM3 (Gujer et al., 1999). Some typical model scenarios include carbonaceous BOD removal and nitrification, nitrification/denitrification, and carbon-nitrogen-phosphorus removal. Preconfigured layouts are provided. Some examples include conventional activated sludge, oxidation ditch, SBR, IFAS, and MBR. Alternatively, users can assemble their own plant.

Because the simulators allow the user to change almost all parameters used in the models, they can be used to test a wide range of process configurations and situations. The common use of a model is to make one or more “virtual” designs. Different scenarios can then be run virtually side by side to determine which approach works best.

The models can also be used as design tools. They can help to answer such questions as “How many aeration basins are required?” They can be used to perform sensitivity analysis to optimize the design of parameters such as recycle flow rates.

The models are not foolproof. They do not include any of the safety factors commonly used in the design and operation of facilities. The accuracy of a model is highly dependent on the data used to develop it. “Garbage in = garbage out” still applies regardless of the sophistication of the model. Adjustment of several parameters simultaneously may yield impressive results that cannot be achieved in a real plant. Realistic application of the simulations requires calibration of the model. While this may be possible for an upgrade or retrofit, for a new plant in a new situation, this is impractical.

The general outline for good modeling practice is (Shaw et al., 2007):

- Define what is to be done with the model.
- Collect data regarding tank sizes and configuration, flows, waste characteristics, and solids quantities.
- Set up the model.
- Calibrate the model by matching outputs to measured data, and validate the model by checking how it behaves under different conditions with a different set of data.
- Use the model.

The North American market for wastewater process simulators is dominated by Biowin[®], which is made by EnviroSim Associates LTD (Flamborough, Ontario), and GPS-X[®], a product of Hydromantis, Inc. (Hamilton, Ontario).

28-4 PROCESS INTEGRATION

Plant Layout

The discussion on plant layout for drinking water plants in Chapter 16 applies equally well for clean water plants. It will not be repeated here. The PARCC Side Clean Water Plant (Figure 28-4) is an example of the plant layout of a state-of-the-art membrane bioreactor. The schematic of the plant shows the relationship of the process components and their interconnections. The highlights of this plan are the absence of primary and secondary clarifiers, the use of fine screens, the designation of space for future expansion, and the prominence of the odor collection system and biofilter.

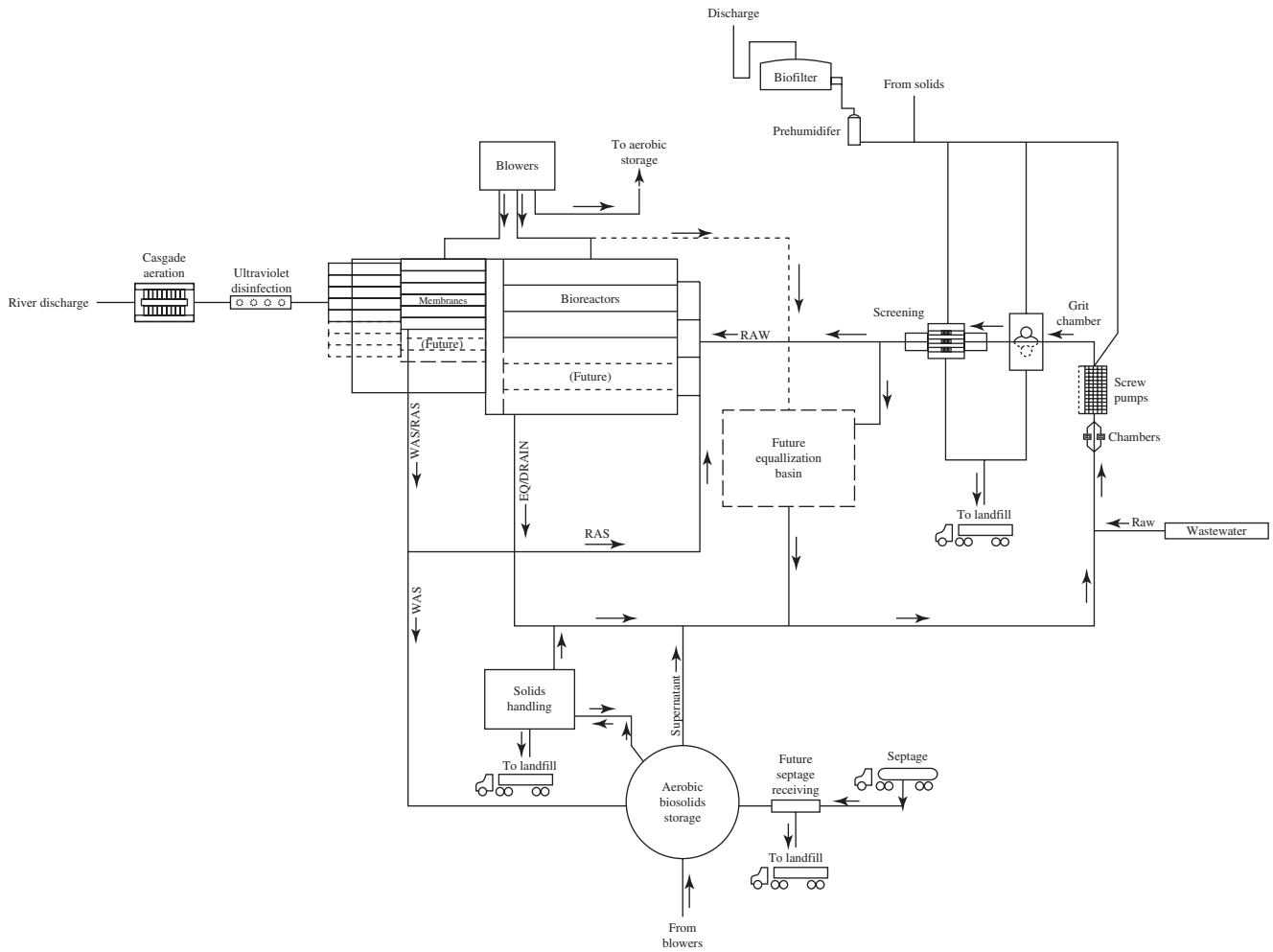

FIGURE 28-4
Process schematic of PARCC Side Clean Water Plant.

Plant Hydraulics

Plant hydraulics are represented by a drawing that shows the hydraulic grade line across the treatment plant. The drawing should show the elevations of the walkway (top of the structure), the water levels, the bottom elevation of each unit process as well as the invert and crown of all connecting pipes and the invert of all channels. An example hydraulic profile is shown in Figure 28-5.

Ideally, the water flows through the plant by gravity after it is pumped to the head end of the plant. This minimizes the number of pumps to move the water through the plant. The elevation of the surface of the water as it flows through the plant follows the hydraulic grade line. These elevations are set by the design based on calculations of headloss through the various structures of the plant. Once the headlosses are known, the elevations of the surface water are set

by working upstream from a selected elevation for the effluent discharge to the influent to the plant. The elevation of the water surface in each process upstream is set to overcome the headloss in moving the water to the next downstream process.

Some of the headloss calculations have already been demonstrated. These are listed in Table 28-15.

Typical headlosses in clean water plants are given in Table 28-16.

Clean water plant headloss calculations must include return flows from the biological processes. While return activated sludge (RAS) flows may equal 100 to 150 percent of the influent flow in conventional activated sludge plant, the RAS in a membrane bioreactor (MBR) plant will be on the order of 400 percent of the influent flow. In extremely high flow conditions, the MBR system may need to recycle a much greater percentage of the influent flow.

Hydraulic Loading Variability. Almost all the kinetic and empirical factors used in design are based on constant wastewater flow rate and loading conditions. In practice, the flow rates and loadings vary. Table 28-17 identifies some of the hydraulic design and sizing criteria for suspended growth secondary treatment facilities. Other loading factors are discussed in the next section of this chapter.

TABLE 28-15
Summary of locations of headloss estimation calculations

Source of headloss	Chapter reference
Baffles	6
Bar racks and screens	20
Channels	16
Grit chambers	20
Granular filtration	11
Pipe, sludge	20
Pipe, water	3

TABLE 28-16
Typical clean water plant headlosses

Treatment unit	Range of headloss, m
Bar screen	0.15–0.30
Grit chambers	
Aerated	0.4–1.2
Vortex	~ 0.15
Primary sedimentation	0.4–1
Aeration tank	0.2–0.6
Secondary sedimentation	0.4–1.2
Granular filtration	3–5
Carbon adsorption	3–6
Chlorine contact tank	0.2–1.88
UV contact tank	~ 0.6

Adapted from Metcalf & Eddy, 1991.

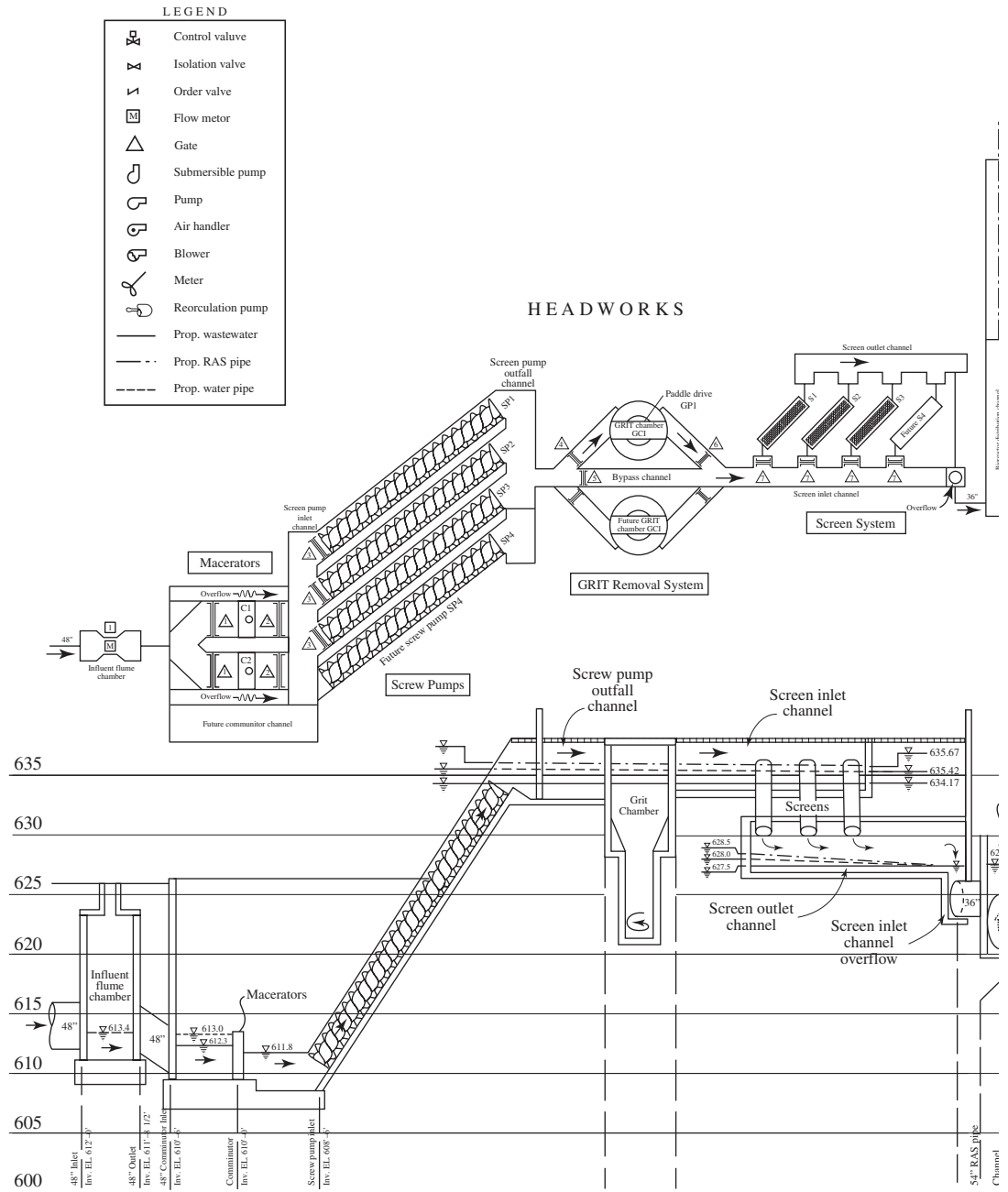
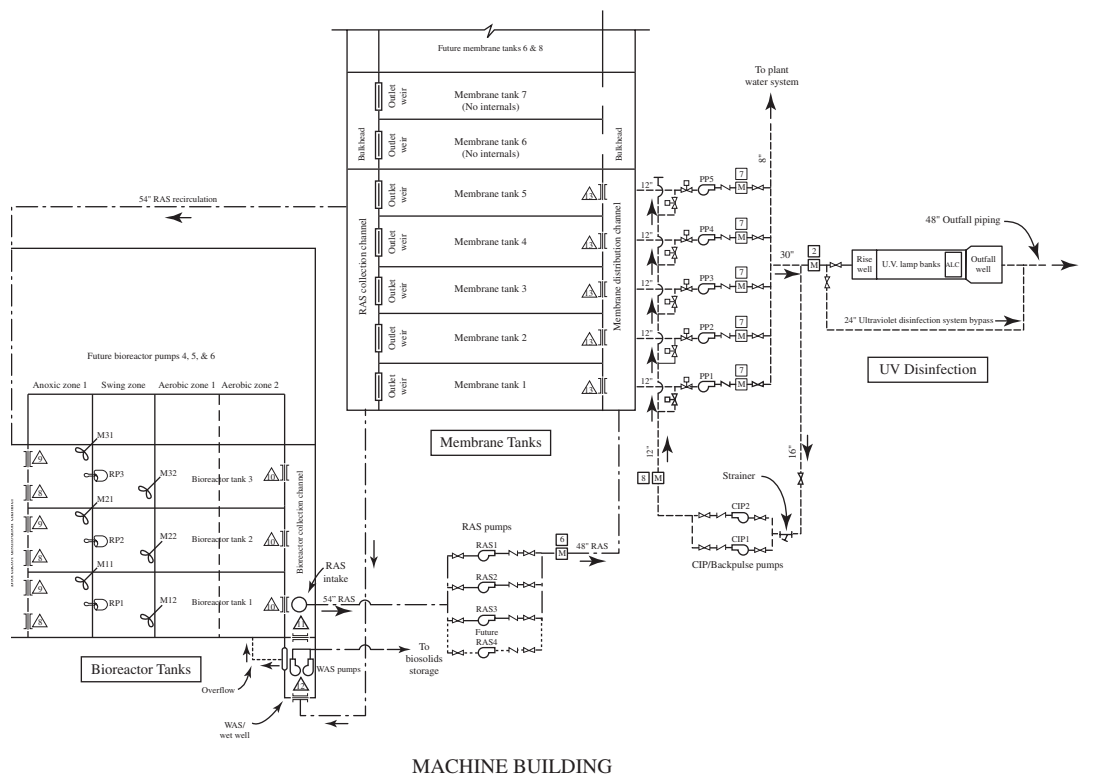

FIGURE 28-5
Hydraulic profile of PARCC Side Clean Water Plant.



MACHINE BUILDING

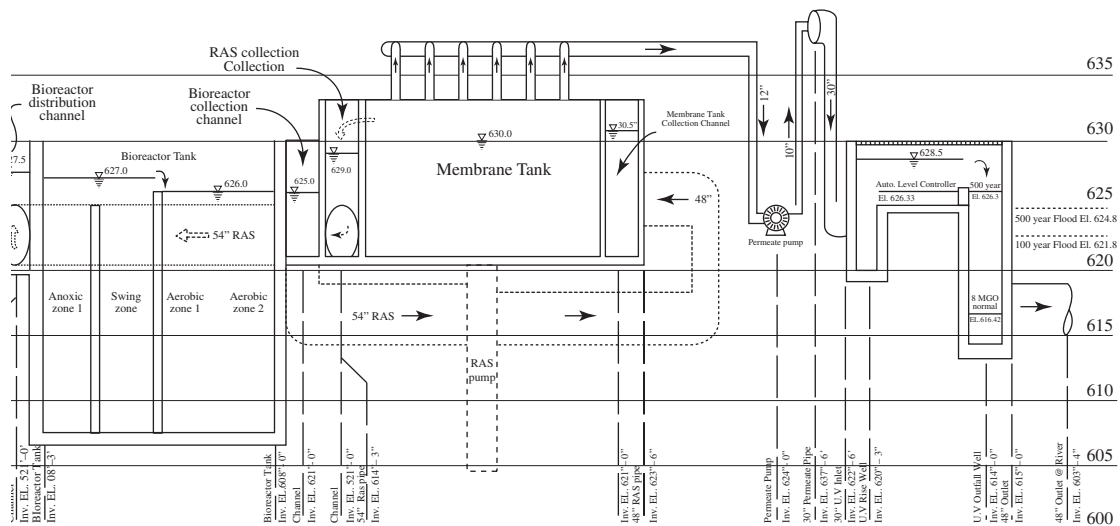

FIGURE 28-5 (continued)

TABLE 28-17
Effect of flow rates and constituent mass loadings on the selection and sizing of secondary treatment plant facilities

Unit operation or process	Critical design factor(s)	Sizing criteria	Effects of design criteria on plant performance
Wastewater pumping and piping	Maximum hour flow rate	Flow rate	Wetwell may flood, collection system may surcharge, or treatment units may overflow if peak rate is exceeded
Screening	Maximum hour flow rate	Flow rate	Headlosses through bar rack and screens increase at high flow rates
	Minimum flow rate	Channel approach velocity	Solids may deposit in approach channel at low flow rates
Grit removal	Maximum hour flow rate ^a	Overflow rate	At high flow rates, grit removal efficiency decreases in flow-through type grit chambers causing grit problems in other processes
Primary sedimentation	Maximum hour flow rate ^a	Overflow rate	Solids removal efficiency decreases at high overflow rates; increases loading on secondary treatment system
	Minimum hour flow rate	Detention time	At low flow rates, long detention times may cause the wastewater to be septic
Activated sludge	Maximum hour flow rate ^a	Hydraulic residence time	Solids washout at high flow rates; may need effluent recycle at low flow rates
	Maximum daily organic load	Food/microorganism ratio	High oxygen demand may exceed aeration capacity and cause poor treatment performance
	Nitrification requirement	SRT	Long SRT required—to maintain slow growing nitrifying organism population to grow
Secondary sedimentation	Maximum hour flow rate ^a	Overflow rate or detention time	Reduced solids removal efficiency at high overflow rates or short detention times
	Minimum hour flow rate	Detention time	Possible rising sludge at long detention time
	Maximum daily organic load	Solids loading rate	Solids loading to sedimentation tanks may be limiting
Chlorine-contact tank	Maximum hour flow rate	Detention time	Reduced bacteria kill at reduced detention time

^aTypically, the 99 percentile value is used.

Adapted from Metcalf & Eddy, 1991.

Mass Balances

In conceptual design, mass balances provide an analytical tool for comparing alternatives. In detailed design, mass balances provide a standard frame of reference for consistent use of design criteria and quantity estimates. The mass balances also provide a basis for the control logic of the process and instrumentation diagrams. Typically, mass balances are calculated for the following constituents: suspended solids, BOD, COD, nitrogen (as N), alkalinity, and phosphorus (as P).

The reader is referred to *Introduction to Environmental Engineering* (Davis and Cornwell, 2008) for a general introduction to the mass balance technique. An introduction to solids mass balance is given in Chapter 27 of this text.

Process Loading Variability. One aspect of a mass balance analysis is the investigation of the impact of changes in process loading. In the absence of on-site field data, the peaking factors and time intervals suggested in Table 28-18 provide a starting point. These data were extracted from a large (190,000 m³/d) northeast sewer service area with a mix of combined and separated sewers.

Somewhat higher values for primary sludge and effluent organic mass may be encountered at smaller plants with flows less than 4,000 m³/d (WEF, 1998).

Special Considerations for MBR Plants

Stable, long-term operation of membrane bioreactors demands adequate pretreatment. Without adequate pretreatment, membranes may be expected to accumulate trash, hair, lint and other fibrous material. Ultimately, this will result in reduction in hydraulic capacity and effluent quality. Membrane suppliers will not guarantee performance without adequate pretreatment. In short, this means fine screening.

The recommended treatment processes include one of two approaches. The first approach uses two screens in series: a 5 mm screen followed by a 2 mm screen. This approach minimizes overloading of the finer screen while generating a very clean process stream. The second approach uses three treatment processes: a 25 mm bar rack followed by a primary clarifier and a 2 mm screen. Finer screens with 1 mm openings have also been used. Finer mesh screens will generate more solids and more entrapped wastewater. In any case, drainage and dewatering of the screenings must be considered in the design of conveying systems.

Both wire mesh and punched-hole screens have been used successfully. The amount of screenings is typically in the range of 10 to 25 mg of dry solids/L of wastewater (Coté et al., 2007). For MBR plants, the fine screens make dewatering of the biosolids more difficult than for conventional plants. This is because the fibrous material which otherwise would give “structure” to the biosolids is removed by the fine screens.

Supervisory Control and Data Acquisition (SCADA)

The SCADA discussion in Chapter 16 also applies to clean water plants. Some of the data that is required to operate a clean water plant must be sampled by hand (e.g., sludge settling). The reliability of oxygen probes and suspended solids monitors for remote data acquisition must be evaluated carefully. For many operational decisions, it is best for the operator to walk out in the plant and observe the behavior of the process rather than sit in a chair and watch a monitor.

Security

The security issues for a clean water plant are similar with respect to protecting supplies of chemicals and preventing intrusion at a drinking water plant. The reader is referred to Chapter 16 for a detailed discussion.

Visit the text website at www.mhprofessional.com/ww for supplementary materials and a gallery of photos.

28-5 CHAPTER REVIEW

When you have completed studying this chapter, you should be able to do the following without the aid of your textbook or notes:

1. Explain the concept of a treatment train in designing a clean water treatment plant.
2. Given a precept of process selection, provide an example to explain it to a client.

TABLE 28-18
Unit process peaking factors

Substance	Comment	Peaking factors for consecutive days ^a			
		1	3	5	7
Screenings	Average day value will vary as function of screen size. Size container for maximum 3 consecutive days of screenings	8	Yearly maximum 4	2.5	2
Grit	Average day value will vary as function of design mesh capture, service area, sewer age, locality, and snow removal practices Size container for maximum 3 consecutive days of grit	8	Yearly maximum 4	3	2
Raw wastewater scum	Convey in dilute slurry until ready for final disposal if at all possible; average day value may vary with industrial base; size for maximum week to maximum month at concentration or destruction step with excess return and easy ability to operate at significantly lower values	8	Yearly maximum 4	3 Maximum month 1.5–2.0	2
Primary sludge	Average month peaking factors are usually adequate because of primary sedimentation tank solids-storage capacity; this should be checked	2–3	Yearly maximum 1.6–2.1	1.5–1.6	1.3–1.4
Primary effluent organic mass (excluding recycles)	Hourly interval values can be estimated from frequency distribution graphs. Values highly sensitive to soluble industrial releases.	1.6–1.7	Average month 1.3–1.4	1.2–1.3	1.1–1.2
		1.8–2.2	Yearly maximum 1.3–1.6	1.3–1.4	1.2–1.3
Nitrogen and phosphorus		1.3–1.5	Average month 1.2–1.3	1.1–1.2	1.1–1.2
		1.8–2.2	Yearly maximum 1.3–1.6	1.3–1.4	1.2–1.3
		1.3–1.5	Average month 1.2–1.3	1.1–1.2	1.1–1.2

(continued)

TABLE 28-18 (continued)
Unit process peaking factors

Substance	Comment	Peaking factors for consecutive days ^a			
		1	3	5	7
Oxygen demand and waste secondary sludge	Will vary as function of reactor configuration, cell residence time, operating solids concentration, secondary system hydraulic detention time and recycle rate, and the applied mass and form of oxygen-demanding materials. Actual waste secondary sludge mass will reflect solids storage reserve capacity (ability to operate at higher solids concentration) maintained in the reactor. Attached-growth systems have no reserve.				
Recycles	Will vary as function of unit process and unit process operating strategy and, for solids processing, the operating strategies and processes for the upsystem reactors and separators and the mainstream biological treatment system. Typically, granular media filters exert the greatest hydraulic stress (especially if backwash is discontinuous); the greatest biodegradable carbon recycle is associated with thermal conditioning of high-rate biological sludge; the greatest nitrogen recycle is associated with anaerobic and composting digestion of high-rate secondary solids, with discontinuous supernating and dewatering more troublesome than digestion and dewatering and composting of raw solids; the greatest recycle of phosphorus occurs with anaerobic digestion of biologically enhanced phosphorus-laden secondary solids.				

^aThe peaking factor represents the result of dividing the average of maximum-consecutive day loadings within the tabulated time interval by the average daily loadings for the year.

Source: WEF, 1998.

- Given a process flow sheet and raw wastewater characteristics, identify the characteristics or upstream processes that point to the selection of each of the processes.

With the aid of this text, you should be able to do the following:

- Given a process flow sheet and raw wastewater characteristics, identify alternative processes that may have or should have been considered.
- Given raw wastewater characteristics and design criteria, perform a screening analysis to select an initial set of processes for further evaluation.
- Given a selected list of processes, organize them into a treatment train and draw and label a process flow diagram.

28-6 PROBLEMS

- Assume that The Colony (Case Study 28-1) decided to build a new clean water plant at a new location where space is not limited but that effluent standards are more stringent. The standards for CBOD, TSS, and $\text{NH}_4^+\text{-N}$ remained the same, but a total phosphorus limit of 1.0 mg/L is added to the permit requirements. Select a treatment train that can meet the new discharge standards. Class A biosolids are to be produced.
- Assume that the PARCC Side Clean Water Plant shown in Figure 28-5 is concerned with overloading the proposed 1 mm fine screens. What alternative(s) in the process flowsheet would you propose?
- A proposed upscale residential development, Sunrise Estates, has been proposed. The location is in a year-round warm weather climate. A new, on-site, clean water plant must be built for the development. The assumed influent parameters and state standard for groundwater discharge are shown below. Select a treatment process train that can meet the discharge standards. Class B biosolids are to be produced, and 45 days of storage are to be provided before agricultural disposition.

Sunrise Estates Clean Water Plant data

Parameter	Influent flow or concentration	Effluent standard
Average day influent	2,000 m ³ /d	
Peak day peaking factor	2.0	
Peak hour peaking factor	2.5	
CBOD	225 mg/L	< 5 mg/L
TSS	240 mg/L	< 5 mg/L
Total N	40 mg/L	< 4 mg/L
Total P	7 mg/L	< 2 mg/L
Fecal coliforms	N/A	nondetect

- Recalculate the elevation top of the top of the chlorine contact wall in Figure P-28-4 if a vortex grit chamber is used in place of the aerated grit chamber.

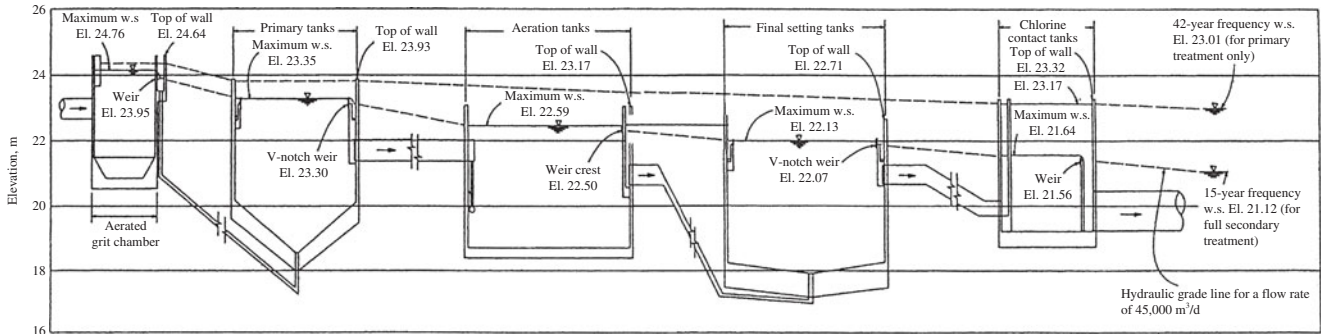

FIGURE P-28-4
Hydraulic profiles for clean water plant. (Note: WS = water surface.)

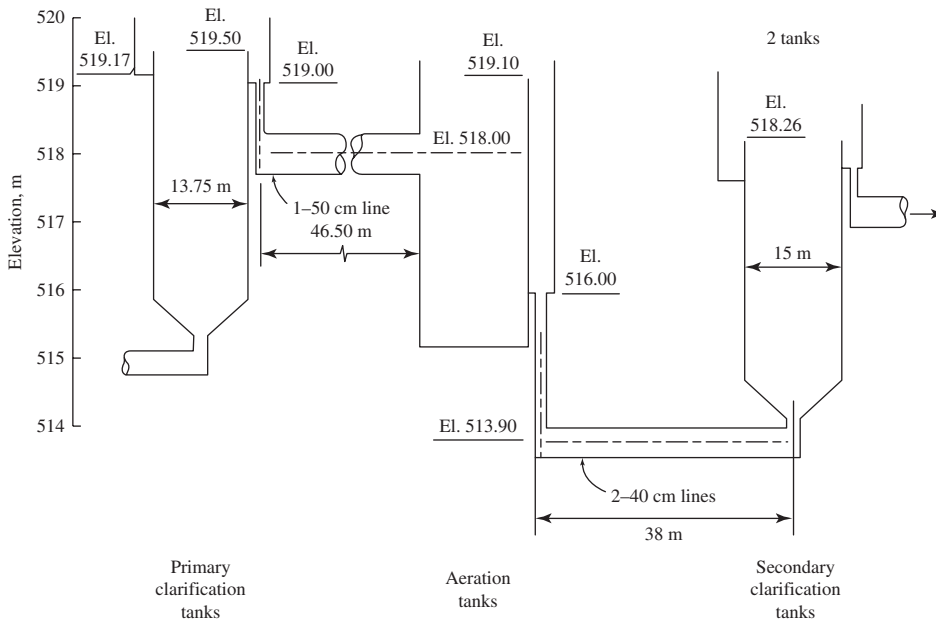

FIGURE P-28-5
Hydraulic profile for clean water plant.

28-5. Develop the hydraulic profile for the average flow for the portion of the clean water plant shown in Figure P-28-5. Use the following assumptions (Metcalf & Eddy, 1991):

- Average flow rate = 7,500 m³/d plus 100% recycle
- Two primary clarifiers each with a diameter of 13.75 m
- Two secondary clarifiers each with a diameter of 15 m
- 90° v-notch weirs with notches at 0.3 m intervals are used around the periphery of the clarifiers

RAS is returned directly to the aeration tank

A Francis-type weir with two end contractions is used for the aeration tank overflow weir

Ignore channel and pipe losses

- 28-6.** Develop the hydraulic profile for the peak flow for the portion of the clean water plant shown in Figure P-28-5. Use a peak flow rate of 15,000 m³/d and, with the exception of the flow rate, the same assumptions as those in Problem 28-5.

28-7 REFERENCES

- Coté, P., D. Brink, and A. Adnan (2007) "Prerequisite Pretreatment," *Water Environment and Technology*, vol. 19, no. 3, March, pp. 40–45.
- Davis, M. L. and D. A. Cornwell (2008) *Introduction to Environmental Engineering*, 4th ed., McGraw-Hill, New York.
- Gujer, W., M. Henze, T. Mino, and M. Loosdrecht (1999) "Activated Sludge Model No. 3," *Water Science and Technology*, vol. 39, no. 1, pp. 183–193.
- Jackson, D. R., L. E. Ripley, T. Maurina, and S. Hubbell (2007) "Up to the Challenge," *Water Environment and Technology*, vol. 19, November, pp. 51–55.
- Metcalf & Eddy (1991) *Wastewater Engineering: Treatment, Disposal and Reuse*, 3rd ed., McGraw-Hill, New York, pp. 166–191.
- Metcalf & Eddy (2003) *Wastewater Engineering: Treatment and Reuse*, 4th ed., McGraw-Hill, Boston, Massachusetts, pp. 429–430, 452–453, 563–886.
- Shaw, A., H. M. Phillips, B. Sabherwal, and C. DeBarbadillo (2007) "Succeeding at Simulation," *Water Environment and Technology*, vol. 19 April, pp. 54–58.
- WEF (1998) *Design of Municipal Wastewater Treatment Plants*, 4th ed., Water Environment Federation Manual of Practice 8, Alexandria, Virginia, pp. 3-1–3-52, 15-7–15-8, 16-5–16-7, 20-113, 22-8–22-9.
- WEF (2006a) *Clarifier Design*, 2nd ed., Water Environment Federation Manual of Practice No. FD-8, Alexandria, Virginia.
- WEF (2006b) *Biological Nutrient Removal (BNR) Operation in Wastewater Treatment Plants*, Water Environment Federation, Water Environment Federation Manual of Practice 30, Alexandria, Virginia, pp. 25, 105–226.
- WEF (2006c) *Membrane Systems for Wastewater Treatment*, Water Environment Federation, Alexandria, Virginia, pp. 61–62.
- WPCF (1989) "Technology and Design Deficiencies at Publicly Owned Treatment Works," *Water Environment and Technology*, vol. 1, p. 515.

APPENDIX

A

PROPERTIES OF AIR, WATER, AND SELECTED CHEMICALS

TABLE A-1
Physical properties of water at 1 atm

Temperature (°C)	Density, ρ (kg/m ³)	Specific weight, γ (kN/m ³)	Dynamic viscosity, μ (mPa · s)*	Kinematic viscosity, ν ($\mu\text{m}^2/\text{s}$)*
0	999.842	9.805	1.787	1.787
3.98	1,000.000	9.807	1.567	1.567
5	999.967	9.807	1.519	1.519
10	999.703	9.804	1.307	1.307
12	999.500	9.802	1.235	1.236
15	999.103	9.798	1.139	1.140
17	998.778	9.795	1.081	1.082
18	998.599	9.793	1.053	1.054
19	998.408	9.791	1.027	1.029
20	998.207	9.789	1.002	1.004
21	997.996	9.787	0.998	1.000
22	997.774	9.785	0.955	0.957
23	997.542	9.783	0.932	0.934
24	997.300	9.781	0.911	0.913
25	997.048	9.778	0.890	0.893
26	996.787	9.775	0.870	0.873
27	996.516	9.773	0.851	0.854
28	996.236	9.770	0.833	0.836
29	995.948	9.767	0.815	0.818
30	995.650	9.764	0.798	0.801
35	994.035	9.749	0.719	0.723
40	992.219	9.731	0.653	0.658
45	990.216	9.711	0.596	0.602
50	988.039	9.690	0.547	0.554
60	983.202	9.642	0.466	0.474
70	977.773	9.589	0.404	0.413
80	971.801	9.530	0.355	0.365
90	965.323	9.467	0.315	0.326
100	958.366	9.399	0.282	0.294

*Pa · s = (mPa · s) $\times 10^{-3}$

*m²/s = ($\mu\text{m}^2/\text{s}$) $\times 10^{-6}$

TABLE A-2
Saturation values of dissolved oxygen in freshwater exposed to a saturated atmosphere containing 20.9% oxygen under a pressure of 101.325 kPa^a

Temperature (°C)	Dissolved oxygen (mg/L)	Saturated vapor pressure (kPa)
0	14.62	0.6108
1	14.23	0.6566
2	13.84	0.7055
3	13.48	0.7575
4	13.13	0.8129
5	12.80	0.8719
6	12.48	0.9347
7	12.17	1.0013
8	11.87	1.0722
9	11.59	1.1474
10	11.33	1.2272
11	11.08	1.3119
12	10.83	1.4017
13	10.60	1.4969
14	10.37	1.5977
15	10.15	1.7044
16	9.95	1.8173
17	9.74	1.9367
18	9.54	2.0630
19	9.35	2.1964
20	9.17	2.3373
21	8.99	2.4861
22	8.83	2.6430
23	8.68	2.8086
24	8.53	2.9831
25	8.38	3.1671
26	8.22	3.3608
27	8.07	3.5649
28	7.92	3.7796
29	7.77	4.0055
30	7.63	4.2430
31	7.51	4.4927
32	7.42	4.7551
33	7.28	5.0307
34	7.17	5.3200
35	7.07	5.6236
36	6.96	5.9422
37	6.86	6.2762
38	6.75	6.6264

^aFor other barometric pressures, the solubilities vary approximately in proportion to the ratios of these pressures to the standard pressures.

(Source: Calculated by G. C. Whipple and M. C. Whipple from measurements of C. J. J. Fox, *Journal of the American Chemical Society*, vol. 33, p. 362, 1911.)

TABLE A-3
Properties of saturated water at 298 K

Molecular weight	M	18.02
Gas constant	R	461.4 J/kg · K
Specific heat	c	4,181 J/kg · K
Prandtl number	Pr	6.395
Thermal conductivity	k	0.604 W/m · K

TABLE A-4
Frequently used constants

Standard atmospheric pressure	P_{atm}	101.325 kPa
Standard gravitational acceleration	g	9.8067 m/s ²
Universal gas constant	R_u	8,314.3 J/kg · mol · K
Electrical permittivity constant	ϵ_0	8.85×10^{-12} C/V · m
Electron charge	q_e	1.60×10^{-19} C
Boltzmann's constant	k	1.38×10^{-23} J/K

TABLE A-5
Selected weak acid dissociation constants at 25°C

Substance	Equilibrium equation	pK_a	Significance
Acetic acid	$\text{CH}_3\text{COOH} \rightleftharpoons \text{H}^+ + \text{CH}_3\text{COO}^-$	4.75	Anaerobic digestion
Carbonic acid	$\text{H}_2\text{CO}_3 (\text{CO}_2 + \text{H}_2\text{O}) \rightleftharpoons \text{H}^+ + \text{HCO}_3^-$	6.35	Corrosion, coagulation softening, pH control
	$\text{HCO}_3^- \rightleftharpoons \text{H}^+ + \text{CO}_3^{2-}$	10.33	
Hydrogen sulfide	$\text{H}_2\text{S} \rightleftharpoons \text{H}^+ + \text{HS}^-$	7.2	Aeration, odor control corrosion
	$\text{HS}^- \rightleftharpoons \text{H}^+ + \text{S}^{2-}$	11.89	
Hypochlorous acid	$\text{HOCl} \rightleftharpoons \text{H}^+ + \text{OCl}^-$	7.54	Disinfection
Phosphoric acid	$\text{H}_3\text{PO}_4 \rightleftharpoons \text{H}^+ + \text{H}_2\text{PO}_4^-$	2.12	Phosphate removal, plant nutrient, analytical
	$\text{H}_2\text{PO}_4^- \rightleftharpoons \text{H}^+ + \text{HPO}_4^{2-}$	7.20	
	$\text{HPO}_4^{2-} \rightleftharpoons \text{H}^+ + \text{PO}_4^{3-}$	12.32	

Davis and Cornwell, 2008

TABLE A-6
Typical solubility product constants

Equilibrium equation	K_{sp} at 25°C
$\text{AgCl} \rightleftharpoons \text{Ag}^+ + \text{Cl}^-$	1.76×10^{-10}
$\text{Al(OH)}_3 \rightleftharpoons \text{Al}^{3+} + 3\text{OH}^-$	1.26×10^{-33}
$\text{AlPO}_4 \rightleftharpoons \text{Al}^{3+} + \text{PO}_4^{3-}$	9.84×10^{-21}
$\text{BaSO}_4 \rightleftharpoons \text{Ba}^{2+} + \text{SO}_4^{2-}$	1.05×10^{-10}
$\text{Cd(OH)}_2 \rightleftharpoons \text{Cd}^{2+} + 2\text{OH}^-$	5.33×10^{-15}
$\text{CdS} \rightleftharpoons \text{Cd}^{2+} + \text{S}^{2-}$	1.40×10^{-29}
$\text{CdCO}_3 \rightleftharpoons \text{Ca}^{2+} + \text{CO}_3^{2-}$	6.20×10^{-12}
$\text{CaCO}_3 \rightleftharpoons \text{Ca}^{2+} + \text{CO}_3^{2-}$	4.95×10^{-9}
$\text{CaF}_2 \rightleftharpoons \text{Ca}^{2+} + 2\text{F}^-$	3.45×10^{-11}
$\text{Ca(OH)}_2 \rightleftharpoons \text{Ca}^{2+} + 2\text{OH}^-$	7.88×10^{-6}
$\text{Ca}_3(\text{PO}_4)_2 \rightleftharpoons 3\text{Ca}^{2+} + 2\text{PO}_4^{3-}$	2.02×10^{-33}
$\text{CaSO}_4 \rightleftharpoons \text{Ca}^{2+} + \text{SO}_4^{2-}$	4.93×10^{-5}
$\text{Cr(OH)}_3 \rightleftharpoons \text{Cr}^{3+} + 3\text{OH}^-$	6.0×10^{-31}
$\text{Cu(OH)}_2 \rightleftharpoons \text{Cu}^{2+} + 2\text{OH}^-$	2.0×10^{-19}
$\text{CuS} \rightleftharpoons \text{Cu}^{2+} + \text{S}^{2-}$	1.0×10^{-36}
$\text{Fe(OH)}_3 \rightleftharpoons \text{Fe}^{3+} + 3\text{OH}^-$	2.67×10^{-39}
$\text{FePO}_4 \rightleftharpoons \text{Fe}^{3+} + \text{PO}_4^{3-}$	1.3×10^{-22}
$\text{FeCO}_3 \rightleftharpoons \text{Fe}^{2+} + \text{CO}_3^{2-}$	3.13×10^{-11}
$\text{Fe(OH)} \rightleftharpoons \text{Fe}^{2+} + 2\text{OH}^-$	4.79×10^{-17}
$\text{FeS} \rightleftharpoons \text{Fe}^{2+} + \text{S}^{2-}$	1.57×10^{-19}
$\text{PbCO}_3 \rightleftharpoons \text{Pb}^{2+} + \text{CO}_3^{2-}$	1.48×10^{-13}
$\text{Pb(OH)}_2 \rightleftharpoons \text{Pb}^{2+} + 2\text{OH}^-$	1.40×10^{-20}
$\text{PbS} \rightleftharpoons \text{Pb}^{2+} + \text{S}^{2-}$	8.81×10^{-29}
$\text{Mg(OH)}_2 \rightleftharpoons \text{Mg}^{2+} + 2\text{OH}^-$	5.66×10^{-12}
$\text{MgCO}_3 \rightleftharpoons \text{Mg}^{2+} + \text{CO}_3^{2-}$	1.15×10^{-5}
$\text{MnCO}_3 \rightleftharpoons \text{Mn}^{2+} + \text{CO}_3^{2-}$	2.23×10^{-11}
$\text{Mn(OH)}_2 \rightleftharpoons \text{Mn}^{2+} + 2\text{OH}^-$	2.04×10^{-13}
$\text{NiCO}_3 \rightleftharpoons \text{Ni}^{2+} + \text{CO}_3^{2-}$	1.45×10^{-7}
$\text{Ni(OH)}_2 \rightleftharpoons \text{Ni}^{2+} + 2\text{OH}^-$	5.54×10^{-16}
$\text{NiS} \rightleftharpoons \text{Ni}^{2+} + \text{S}^{2-}$	1.08×10^{-21}
$\text{SrCO}_3 \rightleftharpoons \text{Sr}^{2+} + \text{CO}_3^{2-}$	5.60×10^{-10}
$\text{Zn(OH)}_2 \rightleftharpoons \text{Zn}^{2+} + 2\text{OH}^-$	7.68×10^{-17}
$\text{ZnS} \rightleftharpoons \text{Zn}^{2+} + \text{S}^{2-}$	2.91×10^{-25}

(Sources: Linde, 2000; Sawyer, McCarty, and Parkin, 2003; Weast, 1983.)

TABLE A-7
Properties of air at standard conditions^a

Molecular weight	M	28.97
Gas constant	R	287 J/kg · K
Specific heat at constant pressure	c_p	1,005 J/kg · K
Specific heat at constant volume	c_v	718 J/kg · K
Density	ρ	1.185 kg/m ³
Dynamic viscosity	μ	1.8515 × 10 ⁻⁵ Pa · s
Kinematic viscosity	ν	1.5624 × 10 ⁻⁵ m ² /s
Thermal conductivity	k	0.0257 W/m · K
Ratio of specific heats, c_p/c_v	k	1.3997
Prandtl number	Pr	0.720

^aMeasured at 101.325 kPa pressure and 298 K temperature.

TABLE A-8
Henry's law constants at 20°C

	H^* (atm)	H_u^\dagger (dimensionless)	H_D^\dagger (atm · L/mg)	H_m^\dagger (atm · m ³ /mol)
Oxygen	4.3 × 10 ⁴	3.21 × 10	2.42 × 10 ⁻²	7.73 × 10 ⁻¹
Methane	3.8 × 10 ⁴	2.84 × 10	9.71 × 10 ⁻²	6.38 × 10 ⁻¹
Carbon dioxide	1.51 × 10 ²	1.13 × 10 ⁻¹	6.17 × 10 ⁻⁵	2.72 × 10 ⁻³
Hydrogen sulfide	5.15 × 10 ²	3.84 × 10 ⁻¹	2.72 × 10 ⁻⁴	9.26 × 10 ⁻³
Vinyl chloride	3.55 × 10 ⁵	2.65 × 10 ²	1.02 × 10 ⁻¹	6.38
Carbon tetrachloride	1.29 × 10 ³	9.63 × 10 ⁻¹	1.51 × 10 ⁻⁴	2.32 × 10 ⁻²
Trichloroethylene	5.5 × 10 ²	4.1 × 10 ⁻¹	7.46 × 10 ⁻⁵	9.89 × 10 ⁻³
Benzene	2.4 × 10 ²	1.8 × 10 ⁻¹	5.52 × 10 ⁻⁵	4.31 × 10 ⁻³
Chloroform	1.7 × 10 ²	1.27 × 10 ⁻¹	2.55 × 10 ⁻⁵	3.06 × 10 ⁻³
Bromoform	3.5 × 10	2.61 × 10 ⁻²	2.40 × 10 ⁻⁶	6.29 × 10 ⁻⁴
Ozone	5.0 × 10 ³	3.71	1.87 × 10 ⁻³	8.99 × 10 ⁻²

* H values from Montgomery, 1985.

† H_u , H_D , and H_m calculated via Eqs. A-1 to A-4

The dimensionless or unitless Henry's law constant is:

$$p = H_u c \quad (\text{A-1})$$

Where p = concentration units, e.g., kg/m³, mol/L, mg/L

H_u = unitless

c = same concentration units used for p

At 1 atm pressure and 0°C, 22.412 L of air is 1 mol of air. At other temperatures, 1 mol of air is $0.082T$ L [where T = temperature in kelvin (K)] of air. The following conversion between H and H_u can be made:

$$\begin{aligned}
 H_u &= \left[H \frac{\text{atm (mol gas/mol air)}}{\text{mol gas/mol water}} \right] \left(\frac{\text{mol air}}{0.082T \text{ L air}} \right) \left(\frac{\text{L water}}{55.6 \text{ mol}} \right) \\
 &= \frac{H}{4.56T} \text{ or } H_u = H \times 7.49 \times 10^{-4} \text{ at } 20^\circ\text{C}
 \end{aligned}
 \tag{A-2}$$

Another method for reporting Henry's constant is to use mixed units for p and c .

$$p = \frac{H_m c}{P_T}
 \tag{A-3}$$

Where p = mol gas/mol air (partial pressure)

c = mol gas/m³ water

H_m = atm × m³ water/mol gas

$$\begin{aligned}
 &= \left[H \frac{\text{atm (mol gas/mol air)}}{\text{mol gas/mol water}} \right] \left(\frac{\text{m}^3 \text{ water}}{55,600 \text{ mol}} \right) \\
 &= \frac{H}{55,600}
 \end{aligned}$$

Alternatively, milligram per liter units for c may be used:

$$p = \frac{H_D c}{P_T}
 \tag{A-4}$$

Where p = mol gas/mol air (partial pressure)

c = mg/L

H_D = (atm)(L)/mg

$$H_D = \frac{H_m}{\text{MW}} = \frac{H}{55,600 \text{ MW}}$$

MW = molecular weight of gas of interest

The Henry's law coefficient varies both with the temperature and the concentration of other dissolved substances.

TABLE A-9
Properties of selected organic compounds

Name	Formula	M.W.	Density, g/mL	Vapor pressure, mm Hg	Henry's law constant kPa · m ³ /mol
Acetone	CH ₃ COCH ₃	58.08	0.79	184	0.01
Benzene	C ₆ H ₆	78.11	0.879	95	0.6
Bromodichloromethane	CHBrCl ₂	163.8	1.971		0.2
Bromoform	CHBr ₃	252.75	2.8899	5	0.06
Bromomethane	CH ₃ Br	94.94	1.6755	1,300	0.5
Carbon tetrachloride	CCl ₄	153.82	1.594	90	3
Chlorobenzene	C ₆ H ₅ Cl	112.56	1.107	12	0.4
Chlorodibromomethane	CHBr ₂ Cl	208.29	2.451	50	0.09
Chloroethane	C ₂ H ₅ Cl	64.52	0.8978	700	0.2
Chloroethylene	C ₂ H ₃ Cl	62.5	0.912	2,550	4
Chloroform	CHCl ₃	119.39	1.4892	190	0.4
Chloromethane	CH ₃ Cl	50.49	0.9159	3,750	1.0
1,2-Dibromoethane	C ₂ H ₂ Br ₂	187.87	2.18	10	0.06
1,2-Dichlorobenzene	1,2-Cl ₂ -C ₆ H ₄	147.01	1.3048	1.5	0.2
1,3-Dichlorobenzene	1,3-Cl ₂ -C ₆ H ₄	147.01	1.2884	2	0.4
1,4-Dichlorobenzene	1,4-Cl ₂ -C ₆ H ₄	147.01	1.2475	0.7	0.2
1,1-Dichloroethylene	CH ₂ =CCl ₂	96.94	1.218	500	15
1,2-Dichloroethane	ClCH ₂ CH ₂ Cl	98.96	1.2351	60	0.1
1,1-Dichloroethane	CH ₃ CHCl ₂	98.96	1.1757	180	0.6
Trans-1,2-Dichloroethylene	CHCl=CHCl	96.94	1.2565	300	0.6
Dichloromethane	CH ₂ Cl ₂	84.93	1.327	350	0.3
1,2-Dichloropropane	CH ₃ CHClCH ₂ Cl	112.99	1.1560	50	0.4
Cis-1,3-Dichloropropylene	ClCH ₂ CH=CHCl	110.97	1.217	40	0.2
Ethyl benzene	C ₆ H ₅ CH ₂ CH ₃	106.17	0.8670	9	0.8
Formaldehyde	HCHO	30.05	0.815		
Hexachlorobenzene	C ₆ Cl ₆	284.79	1.5691		
Pentachlorophenol	Cl ₅ C ₆ OH	266.34	1.978		
Phenol	C ₆ H ₅ OH	94.11	1.0576		
1,1,2,2-Tetrachloroethane	CHCl ₂ CHCl ₂	167.85	1.5953	5	0.05
Tetrachloroethylene	Cl ₂ C=CCl ₂	165.83	1.6227	15	3
Toluene	C ₆ H ₅ CH ₃	92.14	0.8669	28	0.7
1,1,1-Trichloroethane	CH ₃ CCl ₃	133.41	1.3390	100	3.0
1,1,2-Trichloroethane	CH ₂ ClCHCl ₂	133.41	1.4397	25	0.1
Trichloroethylene	ClHC=CCl ₂	131.29	1.476	50	0.9
Vinyl chloride	H ₂ C=CHCl	62.50	0.9106	2,200	50
<i>o</i> -Xylene	1,2-(CH ₃) ₂ C ₆ H ₄	106.17	0.8802	6	0.5
<i>m</i> -Xylene	1,3-(CH ₃) ₂ C ₆ H ₄	106.17	0.8642	8	0.7
<i>p</i> -Xylene	1,4-(CH ₃) ₂ C ₆ H ₄	106.17	0.8611	8	0.7

Note: Ethene = ethylene; ethyl chloride = chloroethane; ethylene chloride = 1,2-dichloroethane; ethylidene chloride = 1,1-dichloroethane; methyl benzene = toluene; methyl chloride = chloromethane; methyl chloroform = 1,1,1-trichloroethane; methylene chloride = dichloromethane; tetrachloromethane = carbon tetrachloride; tribromomethane = bromoform.

TABLE A-10
Typical valences of elements and compounds in water

Element or compound	Valence
Aluminum	3 ⁺
Ammonium (NH ₄ ⁺)	1 ⁺
Barium	2 ⁺
Boron	3 ⁺
Cadmium	2 ⁺
Calcium	2 ⁺
Carbonate (CO ₃ ²⁻)	2 ⁻
Carbon dioxide (CO ₂)	^a
Chloride (<i>not</i> chlorine)	1 ⁻
Chromium	3 ⁺ , 6 ⁺
Copper	2 ⁺
Fluoride (<i>not</i> fluorine)	1 ⁻
Hydrogen	1 ⁺
Hydroxide (OH ⁻)	1 ⁻
Iron	2 ⁺ , 3 ⁺
Lead	2 ⁺
Magnesium	2 ⁺
Manganese	2 ⁺
Nickel	2 ⁺
Oxygen	2 ⁻
Nitrogen	3 ⁺ , 5 ⁺ , 3 ⁻
Nitrate (NO ₃ ⁻)	1 ⁻
Nitrite (NO ₂ ⁻)	1 ⁻
Phosphorus	5 ⁺ , 3 ⁻
Phosphate (PO ₄ ³⁻)	3 ⁻
Potassium	1 ⁺
Silver	1 ⁺
Silica	^b
Silicate (SiO ₄ ⁴⁻)	4 ⁻
Sodium	1 ⁺
Sulfate (SO ₄ ²⁻)	2 ⁻
Sulfide (S ²⁻)	2 ⁻
Zinc	2 ⁺

^aCarbon dioxide in water is essentially carbonic acid:

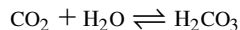

As such, the equivalent weight = GMW/2.

^bSilica in water is reported as SiO₂. The equivalent weight is equal to the gram molecular weight.

SOURCES

- Linde, D. R. (2000) *CRC Handbook of Chemistry and Physics*, 81st ed., CRC Press, Boca Raton, Florida, pp. 8-111–8-112.
- Montgomery, J. M. (1985) *Water Treatment Principles and Design*, John Wiley & Sons, New York, p. 236.
- Sawyer, C. N., P. L. McCarty, and G. F. Parkin (2003) *Chemistry for Environmental Engineering and Science*, 5th ed., McGraw-Hill, Boston, pp. 39–40.
- Weast, R. C. (1983) *CRC Handbook of Chemistry and Physics*, 64th ed., CRC Press, Boca Raton, FL, pp. B-219–B-220.

TABLE A-11
Characteristics of common water and wastewater treatment chemicals and materials

Chemical or trade name	Formula	Specific gravity	Bulk density, kg/m ³	Total molecular weight	Active molecular weight	Active (%)	Commercial strength (%)	Freezing point, °C	Suitable storage material
Activated carbon		1.3 to 1.7	240 to 480						Dry: iron, steel; wet: rubber and silicon linings, type 316 stainless steel
Alum	Al ₂ (SO ₄) ₃	1.32	1,340	342	342.0	100	50.0	-13	FRP, ^b PE, ^c type 316 stainless steel, rubber linings
Ammonium hydroxide	NH ₄ OH	0.9	900	35	35.0	100	29		Glass lining, steel, iron, FRP, PE
Anhydrous ammonia	NH ₃		620	17			99.9 +		
Calcium oxide	CaO		560 to 1,140	56			75 to 99 Typical ~ 90		FRP, PE, iron, steel, rubber
Caustic soda	NaOH	1.54	1,530	40	40.0	100	50.0	10	Carbon steel, polypropylene, FRP, rubber lining
Chlorine	Cl ₂		1,470	70.9			99.8		Shipping containers
Ferric chloride	FeCl ₃	1.42	1,430	162.5	162.5	100	37 to 47 Typical ~ 40.0		Glass, PVC, and rubber linings; FRP, PE
Ferric sulfate	Fe ₂ (SO ₄) ₃ · 9H ₂ O		1,100	561.7	399.7	71	90-94		Glass, plastic, and rubber linings; FRP, PE, type 316 stainless steel
Fluorosilicic acid	H ₂ SiF ₆	1.21	1,210	144.1	144.1	79.2	~ 40		Rubber-lined steel, PE
Phosphoric acid	H ₃ PO ₄	1.57	1,570	98	95.0	96.9	75.0 to 85	-17.5	FRP, epoxy, rubber lining, polypropylene, type 316 stainless steel
Sodium bisulfite	NaHSO ₃	1.2 to 1.4	1,200 to 1,400	104.06			28 to 43		Plastic, FRP, stainless steel
Sodium carbonate	Na ₂ CO ₃		500 to 1,100	106			97 to 99.4		Iron, rubber lining, steel, FRP, PE
Sodium fluoride	NaF		800 to 1,200	42			90 to 95		Iron, steel, FRP, PE
Sodium hypochlorite	NaOCl	1.21	1,210	74.5	51.5	69.1	12 to 15 (available Cl ₂)	-17.8	Ceramic, glass, plastic, and rubber linings, FRP, PE

(continued)

TABLE A-11 (continued)
 Characteristics of common water and wastewater treatment chemicals and materials

Chemical name	Formula	Specific gravity	Bulk density, kg/m ³	Total molecular weight	Active molecular weight	Active (%)	Commercial strength (%)	Freezing point, ^a °C	Suitable storage material
Sodium metabisulfite	Na ₂ S ₂ O ₅	1.48	1,480	190.10			98		Plastic, FRP, stainless steel
Sodium sulfite	Na ₂ SO ₃		1,280 to 1,440	126.04			23 (available SO ₂)		Cast iron, rubber lining, steel, FRP, PE
Sulfuric acid	H ₂ SO ₄		1,300	98	98	100	77		FRP, PE, porcelain, glass, and rubber linings
Sulfur dioxide	SO ₂			64.09			99		Shipping container

^aAt typical solution strength.

^bFRP = Fiber-reinforced plastic.

^cPE = polyethylene.

APPENDIX

B

U.S. STANDARD SIEVE SIZES

U.S. sieve designation	Size of opening (mm)	U.S. sieve designation	Size of opening (mm)
3	6.35	35	0.500
4	4.76	40	0.420
5	4	45	0.350
6	3.36	50	0.297
7	2.8	60	0.250
8	2.38	70	0.210
10	2.00	80	0.177
12	1.68	100	0.149
14	1.41	120	0.125
16	1.19	140	0.105
18	1.00	170	0.09
20	0.841	200	0.074
25	0.710	230	0.063
30	0.590	270	0.053

This page intentionally left blank

APPENDIX

C

PIPE, FITTING, AND VALVE DATA

TABLE C-1
Hazen-Williams friction coefficients (*C*) for
nonaggressive water^a

Concrete pipe, centrifugally spun	
New	140
5 y old	130
10 y old	100
20 y old	80
Ductile iron pipe (DIP)	
Lined	
10–40 y old	125–140
Unlined	
5 y old, > 600 mm	130
5 y old, 75 to 600 mm	120
20 y old	100
30 y old	80
Severely tuberculated	40
FRP (higher <i>C</i> for larger diameter)	120–150
Plastic (PVC) (higher <i>C</i> for larger diameter)	120–150
Steel, new, unlined	140
Steel, 10 y old, lined	100

^aPrecipitates from softened water can lower *C* from 140 to 120 in as short a period as six months. Slime buildup over a 5 y period can lower *C* from 140 to 100.

TABLE C-2
Pipe diameters for mortar-lined ductile iron pipe sizes in SI
and U.S. customary units

SI, nominal mm	SI, ID mm	U.S. nominal inches	U.S. ID inches
75	82	3	3.22
100	102	4	4.04
150	155	6	6.10
200	208	8	8.21
250	259	10	10.2
300	312	12	12.3
350	363	14	14.3
400	415	16	16.3
450	468	18	18.4
500	521	20	20.5
600	627	24	24.7
750	781	30	30.7
900	937	36	36.9

TABLE C-3
Sewer pipe sizes in SI and U.S. customary units

SI, nominal mm	SI, ID mm	U.S. nominal inches
100	101.6	4
150	152.4	6
200	203.2	8
250	254.0	10
300	304.8	12
350	355.6	14
400	406.4	16
450	457.2	18
500	508.0	20
600	609.6	24
750	762.0	30
900	914.4	36

TABLE C-4
SI-based velocity and friction headloss

Capacity		Pipe diameters in mm											
		50		75		100		125		150		200	
m ³ /h	m ³ /s	v ² /2g	h _f	v ² /2g	h _f	v ² /2g	h _f	v ² /2g	h _f	v ² /2g	h _f	v ² /2g	h _f
1	0.0003	0.001	0.12										
2	0.0006	0.004	0.44	0.001	0.06								
3	0.0008	0.009	0.93	0.002	0.13								
4	0.0011	0.016	1.6	0.003	0.22	0.001	0.05						
5	0.0014	0.026	2.4	0.005	0.33	0.002	0.08						
6	0.0017	0.037	3.4	0.007	0.47	0.002	0.11						
7	0.0019	0.050	4.5	0.010	0.62	0.003	0.15						
8	0.0022	0.065	5.7	0.013	0.79	0.004	0.20	0.002	0.07				
9	0.0025	0.083	7.1	0.016	1.0	0.005	0.24	0.002	0.08				
10	0.0028	0.102	8.6	0.020	1.2	0.006	0.30	0.003	0.10	0.001	0.04		
15	0.0042			0.045	2.5	0.014	0.63	0.006	0.21	0.003	0.09		
20	0.0056			0.081	4.3	0.026	1.1	0.010	0.36	0.005	0.15		
25	0.0069			0.126	6.5	0.040	1.6	0.016	0.54	0.008	0.22	0.002	0.06
30	0.0083			0.181	9.1	0.057	2.3	0.024	0.76	0.011	0.31	0.004	0.08
40	0.0111					0.102	3.8	0.042	1.3	0.020	0.53	0.006	0.13
50	0.0139					0.159	5.8	0.065	2.0	0.031	0.80	0.010	0.20
60	0.0167					0.230	8.1	0.094	2.7	0.045	1.1	0.014	0.28
70	0.0194					0.313	10.8	0.128	3.6	0.062	1.5	0.020	0.37
80	0.0222							0.167	4.7	0.081	1.9	0.026	0.47
90	0.0250							0.212	5.8	0.102	2.4	0.032	0.59
100	0.0278							0.261	7.1	0.126	2.9	0.040	0.71
125	0.0347							0.408	10.7	0.197	4.4	0.062	1.1
150	0.0417									0.283	6.1	0.090	1.5
175	0.0486									0.386	8.2	0.122	2.0

Headloss (h_f) in m/100 m.
 $C = 100$
Velocity headloss ($v^2/2g$) in m.

(continued)

TABLE C-4 (continued)
SI-based velocity and friction headloss

Capacity		Pipe diameters in mm											
		200		250		300		350		375		400	
m ³ /h	m ³ /s	v ² /2g	h _f	v ² /2g	h _f	v ² /2g	h _f	v ² /2g	h _f	v ² /2g	h _f	v ² /2g	h _f
30	0.008	0.004	0.08										
40	0.011	0.006	0.13										
50	0.014	0.010	0.20	0.004	0.07								
60	0.017	0.014	0.28	0.006	0.09								
70	0.019	0.020	0.37	0.008	0.12								
80	0.022	0.026	0.47	0.010	0.16	0.005	0.07						
90	0.025	0.032	0.59	0.013	0.20	0.006	0.08						
100	0.028	0.040	0.71	0.016	0.24	0.008	0.10						
125	0.035	0.062	1.1	0.026	0.36	0.012	0.15	0.007	0.07	0.005	0.05		
150	0.042	0.090	1.5	0.037	0.51	0.018	0.21	0.010	0.10	0.007	0.07		
175	0.049	0.122	2.0	0.050	0.68	0.024	0.28	0.013	0.13	0.010	0.09	0.008	0.07
200	0.056	0.159	2.6	0.065	0.87	0.031	0.36	0.017	0.17	0.013	0.12	0.010	0.09
250	0.069	0.249	3.9	0.102	1.3	0.049	0.54	0.027	0.26	0.020	0.18	0.016	0.13
300	0.083	0.359	5.5	0.147	1.8	0.071	0.76	0.038	0.36	0.029	0.26	0.022	0.19
350	0.097	0.488	7.3	0.200	2.4	0.096	1.0	0.052	0.48	0.040	0.34	0.031	0.25
400	0.111	0.638	9.3	0.261	3.1	0.126	1.3	0.068	0.61	0.052	0.44	0.040	0.32
500	0.139			0.408	4.7	0.197	1.9	0.106	0.92	0.081	0.66	0.062	0.48
600	0.167			0.588	6.6	0.283	2.7	0.153	1.3	0.116	0.92	0.090	0.67
700	0.194			0.800	8.8	0.386	3.6	0.208	1.7	0.158	1.2	0.122	0.89
800	0.222			1.045	11.3	0.504	4.6	0.272	2.2	0.206	1.6	0.159	1.1
900	0.250					0.638	5.8	0.344	2.7	0.261	2.0	0.202	1.4
1000	0.278					0.787	7.0	0.425	3.3	0.323	2.4	0.249	1.7
1500	0.417							0.956	7.0	0.726	5.0	0.561	3.7
2000	0.556									1.290	8.5	0.997	6.2

Headloss (h_f) in m/100 m.

$C = 100$

Velocity headloss ($v^2/2g$) in m.

TABLE C-4 (continued)
SI-based velocity and friction headloss

Capacity		Pipe diameters in mm											
		450		500		525		600		675		750	
m ³ /h	m ³ /s	v ² /2g	h _f	v ² /2g	h _f	v ² /2g	h _f	v ² /2g	h _f	v ² /2g	h _f	v ² /2g	h _f
350	0.097	0.019	0.14	0.013	0.08	0.010	0.07						
400	0.111	0.025	0.18	0.016	0.11	0.013	0.08						
500	0.139	0.039	0.27	0.026	0.16	0.021	0.13	0.012	0.07				
600	0.167	0.056	0.38	0.037	0.23	0.030	0.18	0.018	0.09				
500	0.139	0.039	0.27	0.026	0.16	0.021	0.13	0.012	0.07				
700	0.194	0.076	0.50	0.050	0.30	0.041	0.24	0.024	0.12	0.015	0.07		
800	0.222	0.10	0.65	0.065	0.39	0.054	0.30	0.031	0.16	0.020	0.09		
900	0.250	0.13	0.80	0.083	0.48	0.068	0.38	0.040	0.20	0.025	0.11	0.016	0.07
1000	0.278	0.16	0.98	0.10	0.58	0.084	0.46	0.049	0.24	0.031	0.14	0.020	0.08
1500	0.417	0.35	2.1	0.23	1.2	0.19	0.97	0.11	0.51	0.069	0.29	0.045	0.17
2000	0.556	0.62	3.5	0.41	2.1	0.34	1.7	0.20	0.87	0.12	0.49	0.081	0.29
2500	0.694	0.97	5.3	0.64	3.2	0.52	2.5	0.31	1.3	0.19	0.74	0.13	0.44
3000	0.833	1.40	7.4	0.92	4.5	0.76	3.5	0.44	1.8	0.28	1.0	0.18	0.62
3500	0.972	1.91	9.9	1.25	5.9	1.03	4.7	0.60	2.4	0.38	1.4	0.25	0.82
4000	1.111			1.63	7.6	1.34	6.0	0.79	3.1	0.49	1.8	0.32	1.1
4500	1.250			2.07	9.4	1.70	7.4	1.00	3.9	0.62	2.2	0.41	1.3
5000	1.389					2.10	9.0	1.23	4.7	0.77	2.7	0.50	1.6
5500	1.528							1.49	5.6	0.93	3.2	0.61	1.9
6000	1.667							1.77	6.6	1.11	3.7	0.73	2.2
6500	1.806							2.08	7.7	1.30	4.3	0.85	2.6
7000	1.944							2.41	8.8	1.51	5.0	0.99	3.0
7500	2.083							2.77	10.0	1.73	5.6	1.13	3.4
8000	2.222									1.97	6.3	1.29	3.8
8500	2.361									2.22	7.1	1.46	4.2

Headloss (h_f) in m/100 m.
 $C = 100$
 Velocity headloss ($v^2/2g$) in m.

TABLE C-5
Hydraulic headlosses for appurtenances

Appurtenance— alphabetically	Headloss as multiple of ($v^2/2g$)	Appurtenance— alphabetically	Headloss as multiple of ($v^2/2g$)
1. <i>Butterfly valves</i>		8. <i>Entrance losses</i>	
Fully open	0.3	Bell mouthed	0.04
Angle closed, $\theta = 10^\circ$	0.46	Pipe flush with tank	0.5
$\theta = 20^\circ$	1.38	Pipe projecting into tank (Borda entrance)	0.83–1.0
$\theta = 30^\circ$	3.6	Slightly rounded	0.23
$\theta = 40^\circ$	10	Strainer and foot valve	2.50
$\theta = 50^\circ$	31	9. <i>Gate valves</i>	
$\theta = 60^\circ$	94	Open	0.19
2. <i>Check (reflux) valves</i>		¼ closed	1.15
Ball type (fully open)	2.5–3.5	½ closed	5.6
Horizontal lift type	8–12	¾ closed	24.0
Swing check	0.6–2.3	also see Sluice gates	
Swing check (fully open)	2.5	10. <i>Increasers</i>	
3. <i>Contraction—sudden</i>		$0.25 (v_1^2/2g - v_2^2/2g)$	
4:1 (in terms of velocities of small end)	0.42	where v_1 = velocity at small end	
2:1	0.33	11. <i>Miter bends</i> Deflection angle, θ	
4:3	0.19	5°	0.016–0.024
also see Reducers		10°	0.034–0.044
4. <i>Diaphragm valve</i>		15°	0.042–0.062
Fully open	2.3	22.5°	0.066–0.154
¾ open	2.6	30°	0.130–0.165
½ open	4.3	45°	0.236–0.320
¼ open	21.0	60°	0.471–0.684
5. <i>Elbow—90°</i>		90	1.129–1.265
Flanged—regular	0.21–0.30	12. <i>Obstructions in pipes</i> (in terms of pipe velocities)	
Flanged—long radius	0.18–0.20	Pipe to obstruction area ratio	
Intersection of two cylinders (welded pipe—not rounded)	1.25–1.8	1.1	0.21
Screwed—short radius	0.9	1.4	1.15
Screwed—medium radius	0.75	1.6	2.40
Screwed—long radius	0.60	2.0	5.55
6. <i>Elbow—45°</i>		3.0	15.0
Flanged—regular	0.20–0.30	4.0	27.3
Flanged—long radius	0.18–0.20	5.0	42.0
Screwed—regular	0.30–0.42	6.0	57.0
7. <i>Enlargement—sudden</i>		7.0	72.5
1:4 (in terms of velocities of small end)	0.92	10.0	121.0
1:2	0.56		
3:4	0.19		
also see Increasers			

(continued)

TABLE C-5 (continued)
Hydraulic headlosses for appurtenances

Appurtenance— alphabetically	Headloss as multiple of ($v^2/2g$)	Appurtenance— alphabetically	Headloss as multiple of ($v^2/2g$)
13. <i>Orifice meters</i> (in terms of velocities of pipe) Orifice to pipe diameter ratio		18. <i>Sluice gates</i>	
0.25 (1:4)	4.8	Contraction in conduit	0.5
0.33 (1:3)	2.5	Same as conduit width without top submergence	0.2
0.50 (1:2)	1.0	Submerged port in 12 inch wall	0.8
0.67 (2:3)	0.4	19. <i>Tees</i>	
0.75 (3:4)	0.24	Standard—bifurcating	1.5–1.8
14. <i>Outlet losses</i>		Standard—90° turn	1.80
Bell mouthed outlet	$0.1 \left(\frac{v_1^2}{2g} - \frac{v_2^2}{2g} \right)$	Standard—run of tee	0.60
Sharp cornered outlet	$\left(\frac{v_1^2}{2g} - \frac{v_2^2}{2g} \right)$	Reducing—run of tee	
Pipe into still water or air (free discharge)	1.0	2:1 (based on velocities)	0.90
15. <i>Plug globe or stop valve</i>		4:1 of smaller end)	0.75
Fully open	4.0	20. <i>Venturi meters</i>	
¾ open	4.6	The headloss occurs mostly in and downstream of throat, but losses shown are given <i>in terms of velocities at inlet ends to assist in design.</i>	
½ open	6.4	Long tube type—throat-to-inlet diameter ratio	
¼ open	780.0	0.33 (1:3)	1.0–1.2
16. <i>Reducers</i>		0.50 (1:2)	0.44–0.52
Ordinary (in terms of velocities of small end)	0.25	0.67 (2:3)	0.25–0.30
Bell mouthed	0.10	0.75 (3:4)	0.20–0.23
Standard	0.04	Short tube type—throat-to-inlet diameter ratio	
Bushing or coupling	0.05–2.0	0.33 (1:3)	2.43
17. <i>Return bend (2 nos. 90°)</i>		0.50 (1:2)	0.72
Flanged—regular	0.38	0.67 (2:3)	0.32
Flanged—long radius	0.25	0.75 (3:4)	0.24
Screwed	2.2		

Source: A. Amirtharajah (1978) "Design of Granular Media Filter Units," in R. L. Sanks (Ed.), *Water Treatment Plant Design*, Ann Arbor Science, Ann Arbor, Michigan, PP. 702–704.

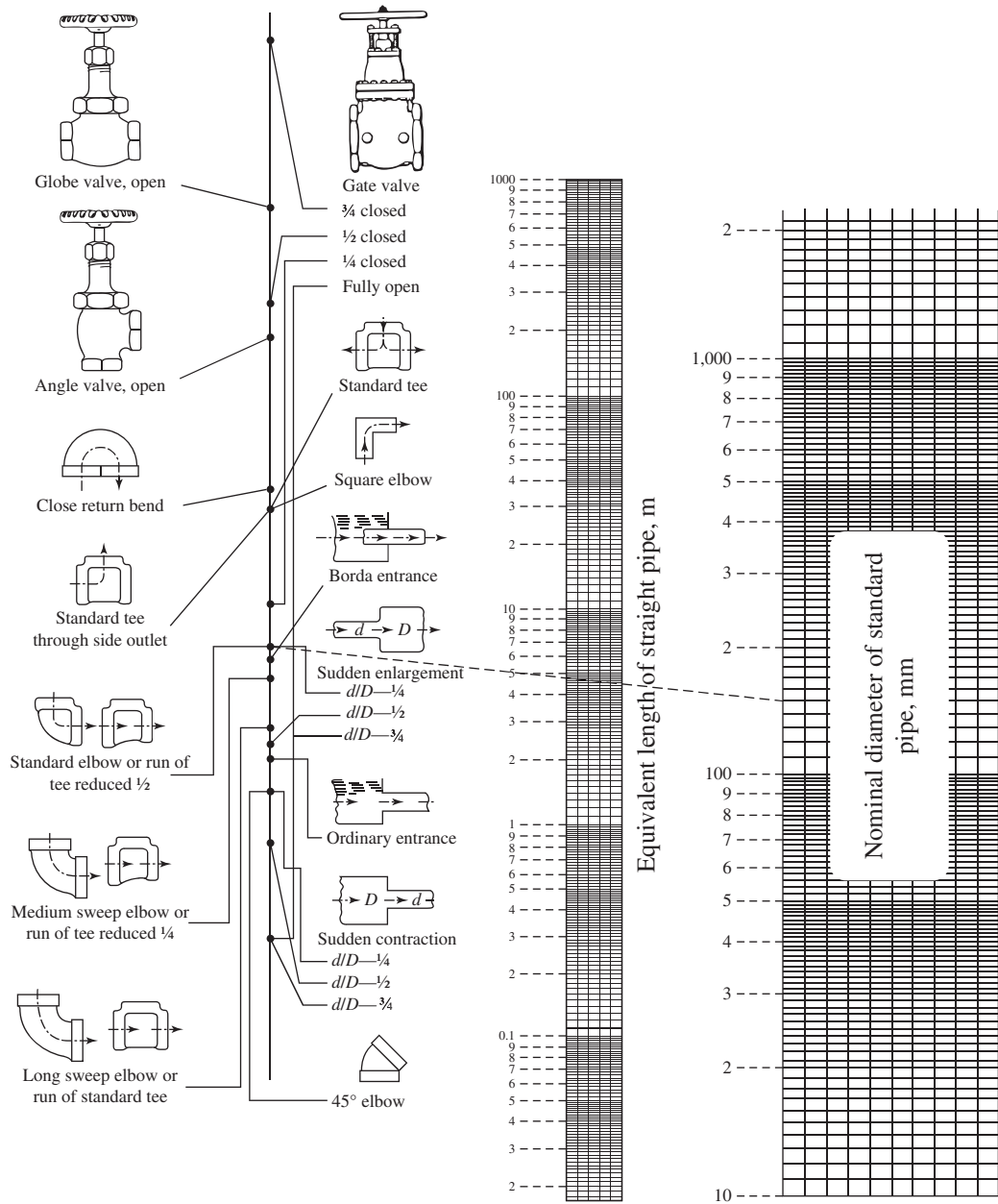

Example: The dashed line shows the headloss for a nominal 150 mm diameter elbow is approximately equivalent to 5 m of 150 mm diameter standard pipe.

Note: For sudden enlargements or sudden contractions, use the smaller diameter on the pipe scale.

FIGURE C-1
Nomograph for headloss for valves and fittings.

APPENDIX

D

**U.S. ENVIRONMENTAL PROTECTION AGENCY Ct
VALUES FOR DISINFECTANTS**

TABLE D-1
Ct values (mg · min/L) for inactivation of *Giardia* cysts by free chlorine at 0.5°C or lower

Chlorine concentration (mg/L)	pH ≤ 6 Log inactivation						pH = 6.5 Log inactivation						pH = 7.0 Log inactivation					
	0.5	1.0	1.5	2.0	2.5	3.0	0.5	1.0	1.5	2.0	2.5	3.0	0.5	1.0	1.5	2.0	2.5	3.0
< = 0.4	23	46	69	91	114	137	27	54	82	109	136	163	33	65	98	130	163	195
0.6	24	47	71	94	118	141	28	56	84	112	140	168	33	67	100	133	167	200
0.8	24	48	73	97	121	145	29	57	86	115	143	172	34	68	103	137	171	205
1	25	49	74	99	123	148	29	59	88	117	147	176	35	70	105	140	175	210
1.2	25	51	76	101	127	152	30	60	90	120	150	180	36	72	108	143	179	215
1.4	26	52	78	103	129	155	31	61	92	123	153	184	37	74	111	147	184	221
1.6	26	52	79	105	131	157	32	63	95	126	158	189	38	75	113	151	188	226
1.8	27	54	81	108	135	162	32	64	97	129	161	193	39	77	116	154	193	231
2	28	55	83	110	138	165	33	66	99	131	164	197	39	79	118	157	197	236
2.2	28	56	85	113	141	169	34	67	101	134	168	201	40	81	121	161	202	242
2.4	29	57	86	115	143	172	34	68	103	137	171	205	41	82	124	165	206	247
2.6	29	58	88	117	146	175	35	70	105	139	174	209	42	84	126	168	210	252
2.8	30	59	89	119	148	178	36	71	107	142	178	213	43	86	129	171	214	257
3	30	60	91	121	151	181	36	72	109	145	181	217	44	87	131	174	218	261

Source: U.S. EPA (1991) Guidance Manual for Compliance with the Filtration and Disinfection Required for Public Water Systems Using Surface Water Sources, U.S. Environmental Protection Agency, Washington, D.C.

TABLE D-2
Ct values (mg · min/L) for inactivation of *Giardia* cysts by free chlorine at 5°C

Chlorine concentration (mg/L)	pH ≤ 6 Log inactivation						pH = 6.5 Log inactivation						pH = 7.0 Log inactivation					
	0.5	1.0	1.5	2.0	2.5	3.0	0.5	1.0	1.5	2.0	2.5	3.0	0.5	1.0	1.5	2.0	2.5	3.0
< = 0.4	16	32	49	65	81	97	20	39	59	78	98	117	23	46	70	93	116	139
0.6	17	33	50	67	83	100	20	40	60	80	100	120	24	48	72	95	119	143
0.8	17	34	52	69	86	103	20	41	61	81	102	122	24	49	73	97	122	146
1	18	35	53	70	88	105	21	42	63	83	104	125	25	50	75	99	124	149
1.2	18	36	54	71	89	107	21	42	64	85	106	127	25	51	76	101	127	152
1.4	18	36	55	73	91	109	22	43	65	87	108	130	26	52	78	103	129	155
1.6	19	37	56	74	93	111	22	44	66	88	110	132	26	53	79	105	132	158
1.8	19	38	57	76	95	114	23	45	68	90	113	135	27	54	81	108	135	162
2	19	39	58	77	97	116	23	46	69	92	115	138	28	55	83	110	138	165
2.2	20	39	59	79	98	118	23	47	70	93	117	140	28	56	85	113	141	169
2.4	20	40	60	80	100	120	24	48	72	95	119	143	29	57	86	115	143	172
2.6	20	41	61	81	102	122	24	49	73	97	122	146	29	58	88	117	146	175
2.8	21	41	62	83	103	124	25	49	74	99	123	148	30	59	89	119	148	178
3	21	42	63	84	105	126	25	50	76	101	126	151	30	61	91	121	152	182

Source: U.S. EPA (1991) Guidance Manual for Compliance with the Filtration and Disinfection Required for Public Water Systems Using Surface Water Sources, U.S. Environmental Protection Agency, Washington, D.C.

TABLE D-1 (continued)

Ct values (mg · min/L) for inactivation of *Giardia* cysts by free chlorine at 0.5°C or lower

pH = 7.5 Log inactivation						pH = 8.0 Log inactivation						pH = 8.5 Log inactivation						pH = 9.0 Log inactivation					
0.5	1.0	1.5	2.0	2.5	3.0	0.5	1.0	1.5	2.0	2.5	3.0	0.5	1.0	1.5	2.0	2.5	3.0	0.5	1.0	1.5	2.0	2.5	3.0
40	79	119	158	198	237	46	92	139	185	231	277	55	110	165	219	274	329	65	130	195	260	325	390
40	80	120	159	199	239	48	95	143	191	238	286	57	114	171	228	285	342	68	136	204	271	339	407
41	82	123	164	205	246	49	98	148	197	246	295	59	118	177	236	295	354	70	141	211	281	352	422
42	84	127	169	211	253	51	101	152	203	253	304	61	122	183	243	304	365	73	146	219	291	364	437
43	86	130	173	216	259	52	104	157	209	261	313	63	125	188	251	313	376	75	150	226	301	376	451
44	89	133	177	222	266	54	107	161	214	268	321	65	129	194	258	323	387	77	155	232	309	387	464
46	91	137	182	228	273	55	110	165	219	274	329	66	132	199	265	331	397	80	159	239	318	398	477
47	93	140	186	233	279	56	113	169	225	282	338	68	136	204	271	339	407	82	163	245	326	408	489
48	95	143	191	238	286	58	115	173	231	288	346	70	139	209	278	348	417	83	167	250	333	417	500
50	99	149	198	248	297	59	118	177	235	294	353	71	142	213	284	355	426	85	170	256	341	426	511
50	99	149	199	248	298	60	120	181	241	301	361	73	145	218	290	363	435	87	174	261	348	435	522
51	101	152	203	253	304	61	123	184	245	307	368	74	148	222	296	370	444	89	178	267	355	444	533
52	103	155	207	258	310	63	125	188	250	313	375	75	151	226	301	377	452	91	181	272	362	453	543
53	105	158	211	263	316	64	127	191	255	318	382	77	153	230	307	383	460	92	184	276	368	460	552

TABLE D-2 (continued)

Ct values (mg · min/L) for inactivation of *Giardia* cysts by free chlorine at 5°C

pH = 7.5 Log inactivation						pH = 8.0 Log inactivation						pH = 8.5 Log inactivation						pH = 9.0 Log inactivation					
0.5	1.0	1.5	2.0	2.5	3.0	0.5	1.0	1.5	2.0	2.5	3.0	0.5	1.0	1.5	2.0	2.5	3.0	0.5	1.0	1.5	2.0	2.5	3.0
28	55	83	111	138	166	33	66	99	132	165	198	39	79	118	157	197	236	47	93	140	186	233	279
29	57	86	114	143	171	34	68	102	136	170	204	41	81	122	163	203	244	49	97	146	194	243	291
29	58	88	117	146	175	35	70	105	140	175	210	42	84	126	168	210	252	50	100	151	201	251	301
30	60	90	119	149	179	36	72	108	144	180	216	43	87	130	173	217	260	52	104	156	208	260	312
31	61	92	122	153	183	37	74	111	147	184	221	45	89	134	178	223	267	53	107	160	213	267	320
31	62	94	125	156	187	38	76	114	151	189	227	46	91	137	183	228	274	55	110	165	219	274	329
32	64	96	128	160	192	39	77	116	155	193	232	47	94	141	187	234	281	56	112	169	225	281	337
33	65	98	131	163	196	40	79	119	159	198	238	48	96	144	191	239	287	58	115	173	230	288	345
33	67	100	133	167	200	41	81	122	162	203	243	49	98	147	196	245	294	59	118	177	235	294	353
34	68	102	136	170	204	41	83	124	165	207	248	50	100	150	200	250	300	60	120	181	241	301	361
35	70	105	139	174	209	42	84	127	169	211	253	51	102	153	204	255	306	61	123	184	245	307	368
36	71	107	142	178	213	43	86	129	172	215	258	52	104	156	208	260	312	63	125	188	250	313	375
36	72	109	145	181	217	44	88	132	175	219	263	53	106	159	212	265	318	64	127	191	255	318	382
37	74	111	147	184	221	45	89	134	179	223	268	54	108	162	216	270	324	65	130	195	259	324	389

TABLE D-3
Ct values (mg · min/L) for inactivation of *Giardia* cysts by free chlorine at 10°C

Chlorine concentration (mg/L)	pH ≤ 6 Log inactivation						pH = 6.5 Log inactivation						pH = 7.0 Log inactivation					
	0.5	1.0	1.5	2.0	2.5	3.0	0.5	1.0	1.5	2.0	2.5	3.0	0.5	1.0	1.5	2.0	2.5	3.0
< = 0.4	12	24	37	49	61	73	15	29	44	59	73	88	17	35	52	69	87	104
0.6	13	25	38	50	63	75	15	30	45	60	75	90	18	36	54	71	89	107
0.8	13	26	39	52	65	78	15	31	46	61	77	92	18	37	55	73	92	110
1	13	26	40	53	66	79	16	31	47	63	78	94	19	37	56	75	93	112
1.2	13	27	40	53	67	80	16	32	48	63	79	95	19	38	57	76	95	114
1.4	14	27	41	55	68	82	16	33	49	65	82	98	19	39	58	77	97	116
1.6	14	28	42	55	69	83	17	33	50	66	83	99	20	40	60	79	99	119
1.8	14	29	43	57	72	86	17	34	51	67	84	101	20	41	61	81	102	122
2	15	29	44	58	73	87	17	35	52	69	87	104	21	41	62	83	103	124
2.2	15	30	45	59	74	89	18	35	53	70	88	105	21	42	64	85	106	127
2.4	15	30	45	60	75	90	18	36	54	71	89	107	22	43	65	86	108	129
2.6	15	31	46	61	77	92	18	37	55	73	92	110	22	44	66	87	109	131
2.8	16	31	47	62	78	93	19	37	56	74	93	111	22	45	67	89	112	134
3	16	32	48	63	79	95	19	38	57	75	94	113	23	46	69	91	114	137

Source: U.S. EPA (1991) Guidance Manual for Compliance with the Filtration and Disinfection Required for Public Water Systems Using Surface Water Sources, U.S. Environmental Protection Agency, Washington, D.C.

TABLE D-4
Ct values (mg · min/L) for inactivation of *Giardia* cysts by free chlorine at 15°C

Chlorine concentration (mg/L)	pH ≤ 6 Log inactivation						pH = 6.5 Log inactivation						pH = 7.0 Log inactivation					
	0.5	1.0	1.5	2.0	2.5	3.0	0.5	1.0	1.5	2.0	2.5	3.0	0.5	1.0	1.5	2.0	2.5	3.0
< = 0.4	8	16	25	33	41	49	10	20	30	39	49	59	12	23	35	47	58	70
0.6	8	17	25	33	42	50	10	20	30	40	50	60	12	24	36	48	60	72
0.8	9	17	26	35	43	52	10	20	31	41	51	61	12	24	37	49	61	73
1	9	18	27	35	44	53	11	21	32	42	53	63	13	25	38	50	63	75
1.2	9	18	27	36	45	54	11	21	32	43	53	64	13	25	38	51	63	76
1.4	9	18	28	37	46	55	11	22	33	43	54	65	13	26	39	52	65	78
1.6	9	19	28	37	47	56	11	22	33	44	55	66	13	26	40	53	66	79
1.8	10	19	29	38	48	57	11	23	34	45	57	68	14	27	41	54	68	81
2	10	19	29	39	48	58	12	23	35	46	58	69	14	28	42	55	69	83
2.2	10	20	30	39	49	59	12	23	35	47	58	70	14	28	43	57	71	85
2.4	10	20	30	40	50	60	12	24	36	48	60	72	14	29	43	57	72	86
2.6	10	20	31	41	51	61	12	24	37	49	61	73	15	29	44	58	73	88
2.8	10	21	31	41	52	62	12	25	37	49	62	74	15	30	45	59	74	89
3	11	21	32	42	53	63	13	25	38	51	63	76	15	30	46	61	76	91

Source: U.S. EPA (1991) Guidance Manual for Compliance with the Filtration and Disinfection Required for Public Water Systems Using Surface Water Sources, U.S. Environmental Protection Agency, Washington, D.C.

TABLE D-3 (continued)

Ct values (mg · min/L) for inactivation of *Giardia* cysts by free chlorine at 10°C

pH = 7.5 Log inactivation						pH = 8.0 Log inactivation						pH = 8.5 Log inactivation						pH = 9.0 Log inactivation					
0.5	1.0	1.5	2.0	2.5	3.0	0.5	1.0	1.5	2.0	2.5	3.0	0.5	1.0	1.5	2.0	2.5	3.0	0.5	1.0	1.5	2.0	2.5	3.0
21	42	63	83	104	125	25	50	75	99	124	149	30	59	89	118	148	177	35	70	105	139	174	209
21	43	64	85	107	128	26	51	77	102	128	153	31	61	92	122	153	183	36	73	109	145	182	218
22	44	66	87	109	131	26	53	79	105	132	158	32	63	95	126	158	189	38	75	113	151	188	226
22	45	67	89	112	134	27	54	81	108	135	162	33	65	98	130	163	195	39	78	117	156	195	234
23	46	69	91	114	137	28	55	83	111	138	166	33	67	100	133	167	200	40	80	120	160	200	240
23	47	70	93	117	140	28	57	85	113	142	170	34	69	103	137	172	206	41	82	124	165	206	247
24	48	72	96	120	144	29	58	87	116	145	174	35	70	106	141	176	211	42	84	127	169	211	253
25	49	74	98	123	147	30	60	90	119	149	179	36	72	108	143	179	215	43	86	130	173	216	259
25	50	75	100	125	150	30	61	91	121	152	182	37	74	111	147	184	221	44	88	133	177	221	265
26	51	77	102	128	153	31	62	93	124	155	186	38	75	113	150	188	225	45	90	136	181	226	271
26	52	79	105	131	157	32	63	95	127	158	190	38	77	115	153	192	230	46	92	138	184	230	276
27	53	80	107	133	160	32	65	97	129	162	194	39	78	117	156	195	234	47	94	141	187	234	281
27	54	82	109	136	163	33	66	99	131	164	197	40	80	120	159	199	239	48	96	144	191	239	287
28	55	83	111	138	166	34	67	101	134	168	201	41	81	122	162	203	243	49	97	146	195	243	292

TABLE D-4 (continued)

Ct values (mg · min/L) for inactivation of *Giardia* cysts by free chlorine at 15°C

pH = 7.5 Log inactivation						pH = 8.0 Log inactivation						pH = 8.5 Log inactivation						pH = 9.0 Log inactivation					
0.5	1.0	1.5	2.0	2.5	3.0	0.5	1.0	1.5	2.0	2.5	3.0	0.5	1.0	1.5	2.0	2.5	3.0	0.5	1.0	1.5	2.0	2.5	3.0
14	28	42	55	68	83	17	33	50	66	83	99	20	39	59	79	98	118	23	47	70	93	117	140
14	29	43	57	72	86	17	34	51	68	85	102	20	41	61	81	102	122	24	49	73	97	122	146
15	29	44	59	73	88	18	35	53	70	88	105	21	42	63	84	105	126	25	50	76	101	126	151
15	30	45	60	75	90	18	36	54	72	90	108	22	43	65	87	108	130	26	52	78	104	130	156
15	31	46	61	77	92	19	37	56	74	93	111	22	45	67	89	112	134	27	53	80	107	133	160
16	31	47	63	78	94	19	38	57	76	95	114	23	46	69	91	114	137	28	55	83	110	138	165
16	32	48	64	80	96	19	39	58	77	97	116	24	47	71	94	118	141	28	56	85	113	141	169
16	33	49	65	82	98	20	40	60	79	99	119	24	48	72	96	120	144	29	58	87	115	144	173
17	33	50	67	83	100	20	41	61	81	102	122	25	49	74	98	123	147	30	59	89	118	148	177
17	34	51	68	85	102	21	41	62	83	103	124	25	50	75	100	125	150	30	60	91	121	151	181
18	35	53	70	88	105	21	42	64	85	106	127	26	51	77	102	128	153	31	61	92	123	153	184
18	36	54	71	89	107	22	43	65	86	108	129	26	52	78	104	130	156	31	63	94	125	157	188
18	36	55	73	91	109	22	44	66	88	110	132	27	53	80	106	133	159	32	64	96	127	159	191
19	37	56	74	93	111	22	45	67	89	112	134	27	54	81	108	135	162	33	65	98	130	163	195

TABLE D-5
Ct values (mg · min/L) for inactivation of *Giardia* cysts by free chlorine at 20°C

Chlorine concentration (mg/L)	pH < = 6 Log inactivation						pH = 6.5 Log inactivation						pH = 7.0 Log inactivation					
	0.5	1.0	1.5	2.0	2.5	3.0	0.5	1.0	1.5	2.0	2.5	3.0	0.5	1.0	1.5	2.0	2.5	3.0
< = 0.4	6	12	18	24	30	36	7	15	22	29	37	44	9	17	26	35	43	52
0.6	6	13	19	25	32	38	8	15	23	30	38	45	9	18	27	36	45	54
0.8	7	13	20	26	33	39	8	15	23	31	38	46	9	18	28	37	46	55
1	7	13	20	26	33	39	8	16	24	31	39	47	9	19	28	37	47	56
1.2	7	13	20	27	33	40	8	16	24	32	40	48	10	19	29	38	48	57
1.4	7	14	21	27	34	41	8	16	25	33	41	49	10	19	29	39	48	58
1.6	7	14	21	28	35	42	8	17	25	33	42	50	10	20	30	39	49	59
1.8	7	14	22	29	36	43	9	17	26	34	43	51	10	20	31	41	51	61
2	7	15	22	29	37	44	9	17	26	35	43	52	10	21	31	41	52	62
2.2	7	15	22	29	37	44	9	18	27	35	44	53	11	21	32	42	53	63
2.4	8	15	23	30	38	45	9	18	27	36	45	54	11	22	33	43	54	65
2.6	8	15	23	31	38	46	9	18	28	37	46	55	11	22	33	44	55	66
2.8	8	16	24	31	39	47	9	19	28	37	47	56	11	22	34	45	56	67
3	8	16	24	31	39	47	10	19	29	38	48	57	11	23	34	45	57	68

Source: U.S. EPA (1991) Guidance Manual for Compliance with the Filtration and Disinfection Required for Public Water Systems Using Surface Water Sources, U.S. Environmental Protection Agency, Washington, D.C.

TABLE D-6
Ct values (mg · min/L) for inactivation of *Giardia* cysts by free chlorine at 25°C

Chlorine concentration (mg/L)	pH < = 6 Log inactivation						pH = 6.5 Log inactivation						pH = 7.0 Log inactivation					
	0.5	1.0	1.5	2.0	2.5	3.0	0.5	1.0	1.5	2.0	2.5	3.0	0.5	1.0	1.5	2.0	2.5	3.0
< = 0.4	4	8	12	16	20	24	5	10	15	19	24	29	6	12	18	23	29	35
0.6	4	8	13	17	21	25	5	10	15	20	25	30	6	12	18	24	30	36
0.8	4	9	13	17	22	26	5	10	16	21	26	31	6	12	19	25	31	37
1	4	9	13	17	22	26	5	10	16	21	26	31	6	12	19	25	31	37
1.2	5	9	14	18	23	27	5	11	16	21	27	32	6	13	19	25	32	38
1.4	5	9	14	18	23	27	6	11	17	22	28	33	7	13	20	26	33	39
1.6	5	9	14	19	23	28	6	11	17	22	28	33	7	13	20	27	33	40
1.8	5	10	15	19	24	29	6	11	17	23	28	34	7	14	21	27	34	41
2	5	10	15	19	24	29	6	12	18	23	29	35	7	14	21	27	34	41
2.2	5	10	15	20	25	30	6	12	18	23	29	35	7	14	21	28	35	42
2.4	5	10	15	20	25	30	6	12	18	24	30	36	7	14	22	29	36	43
2.6	5	10	16	21	26	31	6	12	19	25	31	37	7	15	22	29	37	44
2.8	5	10	16	21	26	31	6	12	19	25	31	37	8	15	23	30	38	45
3	5	11	16	21	27	32	6	13	19	25	32	38	8	15	23	31	38	46

Source: U.S. EPA (1991) Guidance Manual for Compliance with the Filtration and Disinfection Required for Public Water Systems Using Surface Water Sources, U.S. Environmental Protection Agency, Washington, D.C.

TABLE D-5 (continued)

Ct values (mg · min/L) for inactivation of *Giardia* cysts by free chlorine at 20°C

pH = 7.5						pH = 8.0						pH = 8.5						pH = 9.0					
Log inactivation						Log inactivation						Log inactivation						Log inactivation					
0.5	1.0	1.5	2.0	2.5	3.0	0.5	1.0	1.5	2.0	2.5	3.0	0.5	1.0	1.5	2.0	2.5	3.0	0.5	1.0	1.5	2.0	2.5	3.0
10	21	31	41	52	62	12	25	37	49	62	74	15	30	45	59	74	89	18	35	53	70	88	105
11	21	32	43	53	64	13	26	39	51	64	77	15	31	46	61	77	92	18	36	55	73	91	109
11	22	33	44	55	66	13	26	40	53	66	79	16	32	48	63	79	95	19	38	57	75	94	113
11	22	34	45	56	67	14	27	41	54	68	81	16	33	49	65	82	98	20	39	59	78	98	117
12	23	35	46	58	69	14	28	42	55	69	83	17	33	50	67	83	100	20	40	60	80	100	120
12	23	35	47	58	70	14	28	43	57	71	85	17	34	52	69	86	103	21	41	62	82	103	123
12	24	36	48	60	72	15	29	44	58	73	87	18	35	53	70	88	105	21	42	63	84	105	126
12	25	37	49	62	74	15	30	45	59	74	89	18	36	54	72	90	108	22	43	65	86	108	129
13	25	38	50	63	75	15	30	46	61	76	91	18	37	55	73	92	110	22	44	66	88	110	132
13	26	39	51	64	77	16	31	47	62	78	93	19	38	57	75	94	113	23	45	68	90	113	135
13	26	39	52	65	78	16	32	48	63	79	95	19	38	58	77	96	115	23	46	69	92	115	138
13	27	40	53	67	80	16	32	49	65	81	97	20	39	59	78	98	117	24	47	71	94	118	141
14	27	41	54	68	81	17	33	50	66	83	99	20	40	60	79	99	119	24	48	72	95	119	143
14	28	42	55	69	83	17	34	51	67	84	101	20	41	61	81	102	122	24	49	73	97	122	146

TABLE D-6 (continued)

Ct values (mg · min/L) for inactivation of *Giardia* cysts by free chlorine at 25°C

pH = 7.5						pH = 8.0						pH = 8.5						pH = 9.0					
Log inactivation						Log inactivation						Log inactivation						Log inactivation					
0.5	1.0	1.5	2.0	2.5	3.0	0.5	1.0	1.5	2.0	2.5	3.0	0.5	1.0	1.5	2.0	2.5	3.0	0.5	1.0	1.5	2.0	2.5	3.0
7	14	21	28	35	42	8	17	25	33	42	50	10	20	30	39	49	59	12	23	35	47	58	70
7	14	22	29	36	43	9	17	26	34	43	51	10	20	31	41	51	61	12	24	37	49	61	73
7	15	22	29	37	44	9	18	27	35	44	53	11	21	32	42	53	63	13	25	38	50	63	75
8	15	23	30	38	45	9	18	27	36	45	54	11	22	33	43	54	65	13	26	39	52	65	78
8	15	23	31	38	46	9	18	28	37	46	55	11	22	34	45	56	67	13	27	40	53	67	80
8	16	24	31	39	47	10	19	29	38	48	57	12	23	35	46	58	69	14	27	41	55	68	82
8	16	24	32	40	48	10	19	29	39	48	58	12	23	35	47	58	70	14	28	42	56	70	84
8	16	25	33	41	49	10	20	30	40	50	60	12	24	36	48	60	72	14	29	43	57	72	86
8	17	25	33	42	50	10	20	31	41	51	61	12	25	37	49	62	74	15	29	44	59	73	88
9	17	26	34	43	51	10	21	31	41	52	62	13	25	38	50	63	75	15	30	45	60	75	90
9	17	26	35	43	52	11	21	32	42	53	63	13	26	39	51	64	77	15	31	46	61	77	92
9	18	27	35	44	53	11	22	33	43	54	65	13	26	39	52	65	78	16	31	47	63	78	94
9	18	27	36	45	54	11	22	33	44	55	66	13	27	40	53	67	80	16	32	48	64	80	96
9	18	28	37	46	54	11	22	34	45	56	67	14	27	41	54	68	81	16	32	49	65	81	97

TABLE D-7
Ct values (mg · min/L) for inactivation of viruses by free chlorine

pH 6 to 9 Log inactivation	Temperature, °C					
	0.5	5	10	15	20	25
2.0	6	4	3	2	1	1
3.0	9	6	4	3	2	1
4.0	12	8	6	4	3	2

pH 10 Log inactivation	Temperature, °C					
	0.5	5	10	15	20	25
2.0	45	30	22	15	11	7
3.0	66	44	33	22	16	11
4.0	90	60	45	30	22	15

Source: U.S. EPA (1991) Guidance Manual for Compliance with the Filtration and Disinfection Required for Public Water Systems Using Surface Water Sources, U.S. Environmental Protection Agency, Washington, D.C.

TABLE D-8
Ct values (mg · min/L) for inactivation of *Giardia* cysts by chloramine, pH 6–9

Log inactivation	Temperature, °C					
	≤ 1	5	10	15	20	25
0.5	635	365	310	250	185	125
1	1,270	735	615	500	370	250
1.5	1,900	1,100	930	750	550	375
2	2,535	1,470	1,230	1,000	735	500
2.5	3,170	1,830	1,540	1,250	915	625
3	3,800	2,200	1,850	1,500	1,100	750

Source: U.S. EPA (1991) Guidance Manual for Compliance with the Filtration and Disinfection Required for Public Water Systems Using Surface Water Sources, U.S. Environmental Protection Agency, Washington, D.C.

TABLE D-9
Ct values (mg · min/L) for inactivation of viruses by chloramine

Log inactivation	Temperature (°C)					
	≤ 1	5	10	15	20	25
2	1,243	857	643	428	321	214
3	2,063	1,423	1,067	712	534	356
4	2,883	1,988	1,491	994	746	497

Source: U.S. EPA (1991) Guidance Manual for Compliance with the Filtration and Disinfection Required for Public Water Systems Using Surface Water Sources, U.S. Environmental Protection Agency, Washington, D.C.

TABLE D-10
Ct values (mg · min/L) for *Cryptosporidium* inactivation by chlorine dioxide

Log credit	Water temperature, °C										
	< = 0.5	1	2	3	5	7	10	15	20	25	30
0.25	159	153	140	128	107	90	69	45	29	19	12
0.5	319	305	279	256	214	180	138	89	58	38	24
1	637	610	558	511	429	360	277	179	116	75	49
1.5	956	915	838	767	643	539	415	268	174	113	73
2	1,275	1,220	1,117	1,023	858	719	553	357	232	150	98
2.5	1,594	1,525	1,396	1,278	1,072	899	691	447	289	188	122
3	1,912	1,830	1,675	1,534	1,266	1,079	830	536	347	226	147

Source: (2006) Code of Federal Regulations, 40 CFR 141.720.

TABLE D-11
Ct values (mg · min/L) for *Cryptosporidium* inactivation by ozone

Log inactivation	Water temperature, °C											
	< = 0.5	1	2	3	5	7	10	15	20	25	30	
0.25	6.0	5.8	5.2	4.8	4.0	3.3	2.5	1.6	1.0	0.6	0.39	
0.5	12	12	10	9.5	7.9	6.5	4.9	3.1	2.0	1.2	0.78	
1	24	23	21	19	16	13	9.9	6.2	3.9	2.5	1.6	
1.5	36	35	31	29	24	20	15	9.3	5.9	3.7	2.4	
2	48	46	42	38	32	26	20	12	7.8	4.9	3.1	
2.5	60	58	52	48	40	33	25	16	9.8	6.2	3.9	
3	72	69	63	57	47	39	30	19	12	7.4	4.7	

Source: (2006) Code of Federal Regulations, 40 CFR 141.720.

TABLE D-12
UV dose table for *Cryptosporidium*, *Giardia lamblia*, and virus inactivation credit

Log credit	<i>Cryptosporidium</i> UV dose (mJ/cm ²)	<i>Giardia lamblia</i> UV dose (mJ/cm ²)	Virus UV dose (mJ/cm ²)
0.5	1.6	1.5	39
1.0	2.5	2.1	58
1.5	3.9	3.0	79
2.0	5.8	5.2	100
2.5	8.5	7.7	121
3.0	12	11	143
3.5	15	15	163
4.0	22	22	186

Source: (2006) Code of Federal Regulations, 40 CFR 141.720.

TABLE D-13
Ct values (min · mg/L) for 3-log inactivation of *Giardia* cysts

Inactivation by	Temperature, °C					
	≤ 1	5	10	15	20	25
Chlorine dioxide	63	26	23	19	15	11
Ozone	2.9	1.9	1.43	0.95	0.72	0.48

Source: U.S. EPA (2003) EPA Guidance Manual, Appendix B, Ct Tables, LT1ESWTR Disinfection Profiling and Benchmarking, U.S. Environmental Protection Agency, Washington, D.C.

TABLE D-14
Ct values (min · mg/L) for 4-log inactivation of viruses

Inactivation by	Temperature, °C					
	≤ 1	5	10	15	20	25
Chlorine dioxide	50.1	33.4	25.1	16.7	12.5	8.4
Ozone	1.8	1.2	1	0.6	0.5	0.3

Source: U.S. EPA (2003) EPA Guidance Manual, Appendix B, Ct Tables, LT1ESWTR Disinfection Profiling and Benchmarking, U.S. Environmental Protection Agency, Washington, D.C.

- A/O, 23-10, 23-11
A²/OTM, 23-11, 23-12, 23-75–23-95
Accelerated growth, log-growth curve, 22-10
Acceptable (or allowable) operating region (AOR), 3-28
Acetogenesis, 27-33–27-35
Acid fermentation, 27-34
Acidogenesis, 27-33–27-35
Action implementation (for security), 16-34
Activated alumina, 14-5, 14-8, 14-21, 15-47, 15-48
Activated carbon (charcoal):
 and NOM removal, 14-17
 in wastewater treatment, 26-12–26-14
 in water treatment, 13-22, 14-18, 14-19, 14-20, 14-21, 14-29–14-31, 14-33, 26-12
Activated sludge:
 ASM 3, 28-25
 completely mixed process, 23-5–23-7, 23-15
 defined, 23-3
 design parameters, 23-39–23-40
 F/M ratio, 23-35–23-36
 growth constants, tables of, 23-18, 23-50
 IFAS, 24-13–24-14, 25-11
 kinetic coefficients, 23-50
 models, 23-15–23-23
 and nitrogen:BOD ratio, 22-10
 oxygen demand, 23-29–23-35
 and phosphorus:BOD ratio, 22-10
 process alternatives, 23-5–23-13
 return activated sludge (RAS), 23-24
 secondary clarifier, 25-2–25-15
 and selectors, 22-16, 22-24
 sludge problems, 22-18–22-19
 sludge production, 23-27–23-29
 sludge return, 23-24–23-26
 sludge volume index (SVI), 23-38–23-39
 specific denitrification rate (SDNR), 23-36–23-38
 suspended growth, 23-2
 volumetric loading, 23-39
 waste activated sludge (WAS), 23-4
 wasting, 23-4
Actual oxygen transfer rate (AOTR), 23-32
Adenosine diphosphate (ADP), 22-5
Adenosine triphosphate (ATP), 22-5, 22-10
Adjustable frequency drive (afd), 3-18
Adsorbate, 14-29
Adsorbent, 14-29
Adsorption:
 and charge neutralization, 6-9
 and interparticle bridging, 6-9
 isotherm, 14-29
 and membranes, 12-3
Adsorption-destabilization, 6-9, 6-36, 6-17, 6-25, 6-26
Advanced oxidation processes (AOPs), 13-9
Advanced wastewater treatment (AWT), 26-2
Aerated grit chamber:
 air supply, 20-31
 baffles, 20-31
 capacity, 20-30
 design criteria, 20-33
 design tools, 20-32–20-34
 detention time, 20-30
 geometry, 20-30–20-31
 location 20-30,
 removal equipment, 20-32
 velocities, 20-31
Aerated lagoon, 23-2, 23-3
Aeration and carbon dioxide, 7-12
Aeration, post-, 25-21
Aeration systems:
 blowers, 23-67, 23-83
 brush, 23-53
 cascade, 25-21
 coarse bubble, 20-43
 design, 23-53–23-54, 23-66–23-67, 23-82–23-83
 diffused air, 20-43, 23-33, 23-67
 fine bubble, 20-43, 23-82
 headlosses, 23-84–23-85
 jet, 23-67
 mechanical, 20-43, 23-82
 membrane diffusers, 23-82
 multiple tray, 14-6
 and noise, 23-84
 piping, 23-84–23-85
 and variable frequency drives, 23-83
Aeration tank, activated sludge, 23-4, 23-81, 23-83, 23-89
Aerobacter aerogenes, 2-25
Aerobes, obligate, 22-2
Aerobic:
 decomposition, 22-9, 22-15
 defined, 22-2
 digestion, 27-27–27-32
 lagoons, 23-2, 23-3
 oxidation, 22-16, 22-17
 ponds, 23-2, 23-3
 system energy, 22-5
Air binding in filters, 11-36
Air flotation, 6-2, 15-17–15-23, 27-18, 27-21–27-23
Air mixing, 20-43
Air pollution control, 24-4
Air scour and backwashing, 11-29
Air stripping, 7-12, 14-6, 14-21, 14-22–14-29
Algae:
 growth requirements, 22-3
 and oxidation ponds, 22-3, 23-48
 and taste and odor, 2-23
Alkaline stabilization:
 chemical reactions, 27-23
 design practice, 27-24–27-26
Alkalinity:
 bicarbonate, 6-12
 carbonate, 6-12
 and coagulation, 6-14–6-16, 6-20
 defined, 6-11
 and denitrification, 22-20, 23-66, 23-80
 and hardness, 7-3–7-5
 and nitrification, 22-18, 23-54, 23-82
 and softening, 7-3
 units, 6-12
 wastewater, 18-9
Alpha factor (α) in aeration, 23-32

- Alum:
 and coagulation, 6-14–6-22
 and control of phosphorus
 in wastewater, 26-3–26-4
 sludge concentration, 15-7, 15-21
 specific gravity,
 sludge, 15-21
 solids, 15-7, 15-21
- Ammonia:
 and anaerobic decomposition,
 27-51–27-52
 discharge limits, 18-12
 feed for chloramines, 13-28, 13-29
 oxidation, 22-17–22-18, 23-50–23-51
 reaction with chlorine, 13-4, 13-11–13-12
 safety, 13-28
 in sewers, 19-40
- Anabolic, 22-4
- Anabolism, 22-6
- Anaerobes:
 facultative, 22-3
 obligate, 22-3
- Anaerobic:
 decomposition, 22-9, 22-16
 defined, 22-3
 digestion, 27-33–27-52
 digestion biochemistry, 27-34–27-35
 digestion microbiology, 27-34
 lagoons, 23-2, 23-3
 ponds, 23-2, 23-3
 process description, 27-33–27-38
 system energy, 22-5
- Anchor ice, 3-33
- Anionic polymer, 6-23, 15-28
- Anoxic:
 decomposition, 22-9, 22-15
 denitrification, 22-3, 23-65
 and secondary settling tank, 22-25
 system energy, 22-5
- Annual maxima, 2-12
- Annual minima, 2-12
- Annual series, 2-12
- Antennas on water towers, 17-31–17-32
- Anthracite filter medium, 11-4, 11-7
- AOC, 13-20, 13-23
- AOP, 13-9
- AOTR, 23-32
- Appurtenances:
 equalization basin, 20-45
 rapid filters, 11-39–11-40
- Aquiclude, 2-19
- Aquifer:
 confined, 2-18–2-20
 hydraulic properties, 2-20
 porosity, 2-20
 recharge, 2-21
 unconfined, 2-21
- Archimedes screw, 20-2
- Array, RO/NF, 9-8, 9-10, 9-15
- Arsenic in drinking water, 2-23
- Arsenic removal:
 comparison of technologies, 14-9,
 14-10, 14-11
 decision tree, 14-7
 oxidation states, 14-2
 oxidation-reduction reactions,
 14-2–14-3
 preoxidation processes, 14-2
 process selection guide, 14-8
 residuals, 15-45
 and softening, 7-26
 treatment strategies, 14-2–14-6
- ASM 3, 28-25
- Asset management system, 1-22
- Assimilable organic carbon (AOC),
 13-20, 13-23
- Atmospheric pressure and altitude,
 table of, 3-23
- Atomic weight,
 table of, inside front cover
- ATP and bacterial growth, 22-5
- Attached growth process, 23-2, 24-2
- Authorization estimate, 1-15
- Automatic fire sprinkler systems,
 17-3–17-7
- Autotroph, 22-2
- Average daily flow rate, wastewater,
 18-3, 18-5
- Average daily water consumption, 2-6
- Average day demand, 17-2
- Average dry weather flow, 18-6
- AWWA goals, 2-37
- Axial-flow impeller, 6-33, 6-34, 6-41
- Bacillus anthracis*, 13-13
- Backwashing:
 granular filters, 11-4, 11-16–11-19,
 11-28–11-35
 ion exchange columns, 8-11, 8-16
 MF and UF filters, 12-7, 12-16, 15-9
- Bacteria:
 biochemistry of, 22-4–22-10
 discharge limits, 18-12
 growth, 22-10–22-15
 growth requirements, 22-10
 in wastewater, 18-12, 22-3
 in water, 2-25, 2-35–2-36
- Baffle:
 aerated grit chamber, 20-31
 chamber for mixing, 6-41, 6-42
 and disinfection, 13-30–13-34
 and flocculators, 6-37–6-41
 and rapid mixing, 6-33
 and settling tanks, 10-25, 21-15–21-16
 and Solver program, 6-38–6-41
- Baffled channel, 6-41, 6-42
- Ballasted flocculation, 6-23
- Ballasted settling, 10-16, 10-23–10-25,
 10-38
- Band screens, 20-21
- Bank filtration, 16-10
- Bar racks (screens):
 bar design, 20-13, 20-17–20-20
 capacity, 20-11
 channel, 20-13
 cleaning mechanism, 20-10
 comparison, table, 20-12
 intake, lake and river, 3-10
 location, 20-13
 screenings, 20-20
 stop logs, 20-13
 stop plates, 20-13
 velocities, 20-13
 water intake, 3-10
- Bardenpho™ :
 (4 stage), 23-10
 (5 stage), 23-12
- Bar screens, 20-21
- Basket bowl centrifuge, 15-36
- Batch flux curve, 15-18, 15-19
- Batch reactor, 23-19–23-21
See also Sequencing Batch Reactor
 (SBR)
- Becquerel (Bq), 15-49, 15-50
- Bed volumes per hour (BV/h), 8-16
- Bernoulli's equation, 11-36, 17-12,
 20-17
- Best available technology (BAT), 2-30
 for SOCs and VOCs substances, 14-22
- Best efficiency point (BEP), 3-27

- Beta (β) factor in aeration, 23-32
- Bicarbonate:
 alkalinity, 6-10-6-14
 buffer system, 6-10
See also Carbonate, buffer system
 defined, 6-10
- Bid estimates, 1-15
- Bid letting, 1-20
- Binary fission of bacteria, 22-10
- Biochemical oxygen demand (BOD),
 18-7-18-9
 and carbonaceous (CBOD), 18-11
 and COD, 18-7
 digester supernatant, 27-58
 discharge limits, 18-11
 and nitrogen ratio, 22-10, 22-25
 oxidation, 23-2
 and phosphorus ratio, 22-10
 and settling tank, 21-4, 21-7
 and suspended solids, 22-2, 23-22
 and waste strength, 18-9
- Biodegradable organic matter (BOM),
 13-19
- Biofilter, 24-4
- Biological nutrient removal (BNR),
 22-9-22-21, 23-2, 23-8-23-9,
 23-40, 23-62-23-75
- Biological phosphorus removal (BPR),
 22-16, 22-21-22-24, 23-10-23-12,
 23-40, 23-75-23-86, 26-2
- Biological threats, 16-31
- Biologically active filter (BAF), 13-23
- Biomass, 22-13-22-14
- Bio-P, 22-21
- Biosolids:
 defined, 27-2
 dewatered, 27-60
 land disposition, 27-59-27-60
 liquid, 27-60
- Bleach as a disinfectant, 4-13, 13-42
- Blocking laws, 12-7, 12-8
- Blowdown, 7-34
- Blower power, 23-83
- Blower room:
 noise abatement, 23-84
 ventilation, 23-84
- Blowers, 23-67, 23-83
- Blue baby syndrome, 2-24
- BNR, 23-2
- BOD, *see* Biochemical oxygen demand
- Boil water advisory, 13-42
- Booster station, 17-34
- Bowl, pump, 3-17, 3-18
- BPR, 22-16, 22-21-22-24, 23-10-23-12,
 23-40, 23-75-23-86, 26-2
- Break power, pump, 3-19
- Breakpoint chlorination, 13-11-13-12
- Breakthrough:
 granular filters, 11-3, 11-4
 ion exchange, 8-4
- Brine, 9-11, 15-9
- Bromide, 13-9, 13-19, 13-22
- Buffer:
 capacity, 6-12
 carbonate, 6-10
 defined, 6-10
- Build-out, 2-3
- Bulking sludge, 22-24-22-25
- Bump, denitrification filter, 26-9
- Bypass, split treatment, 7-14, 7-22-7-25
- Byproducts, disinfection, 2-34-2-35
- CA membrane, 9-6, 12-9
- Cake formation, membrane, 12-3
- Cake, sludge, 15-5, 15-16, 15-39, 15-40
- Calcium:
 hardness, 7-2
 scale, 7-2
- Calcium carbonate,
 alkalinity, expressed in mg/L as, 6-12
- Calcium hydroxide:
 and coagulation, 6-20
 and softening, 7-7-7-9
- Calcium hypochlorite, 4-13, 13-2, 13-6,
 13-25
- Calcium oxide:
 and alkaline stabilization,
 27-23-27-25
 and coagulation, 6-20
 and phosphorus removal, 26-3
 and softening, 7-7
- Caldwell-Lowrence diagrams, 7-25
- CALWET, 15-47
- Capacity, design, 2-2
- Capacity, pump, 3-19
- Capital cost, 1-15-1-16
- Carbon:
 adsorption, 26-12-26-14
 and algal growth, 22-3
 and bacterial growth, 22-2
- Carbon dioxide:
 as carbon source, 22-2, 22-3
 and carbonate buffer system, 6-10-6-11
 and coagulation, 6-10-6-11
 as electron acceptor, 22-5
 estimating concentration in water,
 7-15-7-17
 and recarbonation, 7-14-7-15, 7-38
 and safety, 7-38
 in sewers, 19-40
 and softening, 7-8, 7-12
 and stabilization, 7-36-7-38
 stripping, 6-10, 7-12, 14-6
- Carbon monoxide, 19-40
- Carbon source for microorganism, 22-2
- Carbonaceous BOD (CBOD):
 design SRT, 18-11
- Carbonate:
 alkalinity, 6-11-6-14
 buffer system, 6-10-6-14
 defined, 6-10
- Carbonate hardness (CH):
 bar chart of, 7-4
 defined, 7-2, 7-3
 formation of, 7-3
 precipitation of, 7-8
- Carbonic acid, 6-10
- Carmen-Kozeny equation, 11-13
- Carousel system, ion exchange, 8-13
- Cascade aerator, 25-21
- Casing, well, 4-4, 4-6-4-9, 4-34
- Casing materials, 4-6-4-7
- Catabolic, 22-4
- Catabolism, 22-6
- Cationic polymer, 6-23, 15-28
- Cavitation, pump, 3-21
- C_D:
 paddle flocculator, 6-44, 6-45
 particle, 10-3, 10-4, 11-17
See also Drag coefficient
- Cell debris, fraction, 23-29
- Cellular antennas, 17-31-17-32
- Cellulose acetate (CA) membrane, 9-6
- Cement grout, 4-8
- Cementing shoe, 4-8, 4-9
- Centrate, 15-36
- Centrifugal pump, nonclog, 20-2
- Centrifuging sludge, 15-16, 15-36-15-38,
 27-54
- CFD, 13-34, 20-33, 21-15

- CFR, *see* Code of Federal Regulations
 CH, 7-2, 7-3
 Chain-and-flight sludge collector, 10-21, 10-28, 21-4
 Characteristics of particles, 6-3–6-5
 Chemical compatibility, 5-14–5-15
 Chemical delivery and handling:
 dry, 5-2
 liquid, 5-3
 gas, 5-3
 Chemical feeding systems:
 dry, 5-3–5-10
 gas, 5-12–5-13
 liquid, 5-10–5-12
 Chemical oxidant demand, disinfection, 13-11
 Chemical oxygen demand (COD),
 defined, 18-7
 Chemical storage:
 dry, 5-3–5-5
 gas, 5-7
 liquid, 5-5–5-6
 Chemical threats, 16-31
 Chemically enhanced backwashing
 (CEB), 11-30
 Chemically enhanced primary treatment
 (CEPT), 21-25
 Chemotrophs, 22-2
 Chick's law, 13-13
 Chick-Watson model, 13-14
 Chloramines, 13-4–13-5, 13-8, 13-21
 Chloride:
 in drinking water, 2-24
 in wastewater, 18-9
 Chlorination and chlorine, 13-2–13-4
 Chlorinator, 5-12
 Chlorine:
 and ammonia reactions, 13-4–13-5, 13-11–13-12
 and arsenic reactions, 14-2
 demand, 13-11–13-12
 disinfectant properties, 13-21
 disinfection, 13-13
 dose, 13-36
 feed, 13-25, 13-29
 weight percent, 13-25
 and zebra mussels, 3-33
 Chlorine dioxide, 13-2, 13-5, 13-9, 13-13, 13-21, 13-29
 lower explosive limit, 13-5
 Citric acid cycle, 22-6, 22-8
 Clarifier:
 circular, 21-4
 defined, 10-2
 horizontal flow, 10-10
 reactor, 10-20
 sludge blanket, 10-20
 upflow, 10-9
 See also Secondary settling tank;
 Sedimentation basin; Settling tank
 Class A pathogen requirements, 18-17, 27-24, 27-39
 and fine screens, 20-23
 Class B pathogen requirements, 18-17, 18-18, 27-24, 27-28, 27-38
 Clean Water Act (CWA), 18-12
 Cleaning, membrane files, 23-98
 Clean-in-place (CIP), 12-16, 15-9, 23-98
 Clear well, 16-17, 16-18, 16-19, 16-25
 Clorite, 13-9
 Closed circuit television (CCTV), 16-34
 Coagulants:
 alum, 6-6, 6-14
 recovery, 15-13–15-14
 aluminum sulfate, 6-6, 6-14
 characteristics, 6-5–6-6
 ferric chloride, 6-15
 ferric sulfate, 6-15
 inorganic, table of, 6-7
 iron, 6-15
 organic, table of, 6-7
 polymers, 6-22, 6-23
 selection of, 6-22
 Coagulation:
 aids, 6-23
 and alkalinity, 6-11–6-16
 chemistry, 6-10–6-22
 of color, 6-22
 and compression of double layer, 6-8–6-9
 defined, 6-2
 DLVO model, 6-5, 6-8, 6-9
 and dose, 6-16–6-22
 enhanced, 6-22
 floc, 6-2
 G and Gt values, 6-26
 mixing time, 6-26
 and NOM, 6-2, 6-3, 6-22
 and pH, 6-16–6-22
 physics, 6-6–6-10
 and polymer, 6-22, 6-23
 and radionuclide removal, 14-21
 sludge, 15-6–15-7, 15-11, 15-13–15-14
 of softening precipitate, 7-27
 sweep, 6-9, 6-16, 6-17, 6-26, 6-33
 and turbidity, 6-22
 Coarse screens,
 intake structures, 3-10
 wastewater treatment, 20-10–20-12, 20-17–20-20
 Cocurrent flow, 8-10
 Code of Ethics, 1-2–1-9
 Code of Federal Regulations (CFR), 2-26, 18-13, 18-14–18-20
 Codisposal of sludge, 15-51
 Coefficient of variation (COV), 6-30
 Cofiring of sludge, 27-59
 Coliform:
 group, 2-25
 limits, 2-36
 rule (CR), 2-36, 16-6
 test, 2-25, 2-36
 Colisure technique, 2-36
 Color:
 apparent, 2-23
 coagulation of, 6-22
 secondary MCL, 2-37
 and softening, 7-26
 sources of, 2-23
 Column pipe, pump, 3-17, 3-18, 4-4, 4-6
 Combined available chlorine, 13-5
 Combined sewer overflow (CSO), 18-4
 Combined sewers, 18-4, 21-6
 Comminutors, 20-24
 Community sewer system, 18-7
 Community water system (CWS), 2-29
 Complete series analysis, 2-9–2-12
 Completely mixed activated sludge, 23-5, 23-15–23-20
 Completely mixed flow reactor (CMF), 23-5, 23-15–23-20
 Completely stirred tank reactor (CSTR), 23-5, 23-15–23-20
 Composting of sludge, 27-59
 Compression settling, 10-2, 10-15–10-16, 15-7
 Computational fluid dynamics (CFD), 13-34, 20-33, 21-15
 Concentrate, membrane, 9-2, 12-2, 15-2, 15-3, 15-9

- Concentrate, RO/NF, 9-9
- Conceptual design, 1-10–1-16
- Conditioning, sludge, 15-16, 27-2, 27-4, 27-52–27-53
- Conduit, intake:
 - defined, 3-8
 - protection, 3-14
 - size, 3-11–3-12
 - slope, 3-15
- Cone of depression, well, 4-16
- Confined aquifer, 2-18–2-21
- Confined space, 19-40
- Confining layer (aquiclude), 2-19
- Constant speed pump drive, 3-18
- Construction management:
 - agent, 1-10
 - at risk, 1-10
- Construction process, 1-19–1-23
- Contact chamber, disinfection, 13-29–13-36
- Contact stabilization, 23-7
- Continuity equation, 17-13
- Continuous belt filter press (CBFP), 15-39–15-40, 27-55–27-56
- Conventional filters, 11-3, 11-5, 26-5–26-8
- Conventional pollutants, 18-9
- Conventional treatment, 11-3, 11-5, 13-20, 23-2, 23-8
- Copper in drinking water, 2-29
- Corrosion, 7-34–7-38, 9-16–9-17
- Cost estimates, 1-15
- Countercurrent flow, 8-12
- CR, 2-36, 16-6
- Crane:
 - bridge, 19-34
 - circular bridge, 3-3
 - traveling, 3-4
- Crib, intake 3-11
- Cross-baffled contact chamber, 13-33–13-34
- Cross collector, sludge, 10-21
- Crown corrosion, 19-11
- Crustaceans, 22-4
- Cryptosporidium, 2-35, 13-19–13-21, 13-33, 15-8
 - Ct tables, Appendix D
- CSO, 18-4
- Ct:
 - concept, 13-14, 13-16
 - and pH, 13-16
- and temperature, 13-16
 - values, tables of, Appendix D
- Cumulative frequency distribution:
 - of sand, 11-5
- Cyber threats, 16-31
- Cycle time:
 - ion exchange, 8-19
 - membrane filtration, 12-16
- DAF, 6-2, 15-17, 15-23, 27-18, 27-21–27-23
- Day tank, 5-6
- DBP, 2-34–2-35
- DBP formation potential (DBPFP), 13-20, 13-23
- DBPR, 2-34, 16-6
- Death phase, log-growth curve, 22-11
- Decanting, sludge, 15-28
- Decay rate coefficients, disinfection, 13-9
- Dechlorination, 25-15–25-20
- Decomposition of waste, 22-15–22-16
- Deep bed filter, 11-5, 11-20, 11-44, 26-5, 26-8
- Deep well injection, 15-44
- Demand, water:
 - average, 2-6–2-8
 - defined, 2-2
 - maximum day, 2-7
 - peak hour, 2-7, 2-8
 - variation, 2-6–2-8
- Denitrification:
 - anoxic, 22-3
 - anoxic decomposition, 22-16
 - growth kinetics, 22-21
 - microbiology, 22-19–22-21
 - and oxygen concentration, 22-21
 - processes, 23-40, 23-48–23-93, 26-9
 - and secondary settling, 22-25
- Density:
 - organic compounds, table of, Appendix A
 - water, table of, Appendix A
- Density currents, 10-20
- Dental caries and fluoride, 2-24
- Depressed sewer, 19-7
- Design, final, 1-17–1-18
- Design, preliminary, 1-16–1-17
- Design-build, 1-10
- Design capacity, 2-2
- Design criteria:
 - A²/OTM, 23-40, 23-75–23-86
 - aerated grit chamber, 20-33
 - aeration basins, 23-77, 23-80, 23-81
 - aerators, 23-53–23-54, 23-66–23-67, 23-82–23-83
 - aerobic digestion, 27-29–27-32
 - alkaline stabilization, 27-24–27-26
 - anaerobic digestion, 27-42–27-52
 - table of, 27-50
 - baffle wall, 6-37, 10-25
 - bar rack, 20-13, 20-17–20-18
 - biological phosphorus removal, 23-40
 - BOD oxidation and nitrification, 23-39
 - carbon adsorption, 26-13–26-14
 - carbonaceous BOD oxidation and nitrification, 23-39
 - cascade aeration, 25-21
 - chain-and-flight sludge collectors, 10-21, 10-28
 - CO₂ and softening, 7-12, 14-6
 - contact chambers,
 - chlorine, 13-29–13-32
 - ozone, 13-33–13-35
 - denitrification, 23-40
 - denitrification filters, 26-9–26-10
 - diffuser wall, 10-25, 10-29, 10-33
 - disinfection, 13-36–13-42
 - tables, 13-20, 13-37
 - dissolved air flotation (DAF), 27-22–27-23
 - facultative oxidation ponds, 23-41–23-48
 - filters, granular, 11-40–11-45, 26-6–26-10
 - tables, 11-40–11-45, 26-6–26-9
 - fine screens, 20-22–20-23
 - flash mixing for coagulation, 6-25, 6-26–6-36
 - flash mixing for softening, 7-28
 - flocculation basin, 6-37
 - flocculation for coagulation, 6-25, 6-36–6-48
 - Gt table, 6-37
 - flocculation for softening, 7-30
 - fluoridation, 13-44
 - grit chamber for wastewater, 20-33, 20-36
 - grit chamber for water intake, 3-32

Design criteria:—(Cont.)

- high-rater settlers, 10-33–10-35
- impellers, 6-34
- in-line blending, 6-27
- in-line mechanical mixer, 6-27
- in-line static mixer, 6-30
- intake structures, 3-8–3-16
- integrated fixed-film activated sludge (IFAS), 24-14
- ion exchange backwash, 8-16
- ion exchange pressure drop, 8-16, 8-21
- ion exchange regeneration, 8-19
- ion exchange resin, 8-10, 8-11
 - life, 8-24
- ion exchange vessel, 8-15, 8-20–8-21
- lime stabilization, 27-24–27-26
- magnesium hardness, 7-2, 7-3, 7-8–7-9
- membrane array, 9-8, 9-10, 9-15
- membrane bioreactors (MBR), 23-95–23-98
- membrane element, 9-8, 9-15
- membrane filters for wastewater, 26-10–26-12
- membrane filters for water, 12-9, 12-18
- moving bed biofilm reactors (MBBR), 24-14
- nitrification, 23-39
- oxidation ditch, 23-48–23-54
- oxidation pond, 23-41–23-48
- packed tower, 14-26
- paddle flocculator, 6-44–6-49
 - table, 6-45
- performance, 1-11, 1-12
- phosphorus removal, 23-40, 26-3–26-5
- prescriptive, 1-11
- pressure, water distribution system, 17-9–17-10
- rapid mixing for coagulation, 6-25, 6-26–6-36
- rapid mixing for softening, 7-28
- recarbonation basin, 7-38
- reverse osmosis/nanofiltration, 9-6, 9-9, 9-11–9-17
- screw pumps, 20-3
- sequencing batch reactor, 23-62–23-67
- settling tanks, primary, 21-6–21-8, 21-11, 21-15–21-17, 21-20–21-24
- settling tanks, secondary, 25-9–25-14
- settling tanks, water, 10-25–10-38
 - tables, 10-26, 10-29, 10-33, 10-35
 - sludge lagoon, 15-25–15-27
 - static mixer, 6-30
 - stripping tower, 14-26
 - surface wash, 11-29
 - sewer, 19-12–19-20
 - thickener, 15-16, 15-21
 - traveling bridge sludge collector, 10-28, 10-29
 - trickling filter, 24-7
 - turbidity, 2-35–2-36, 11-2, 13-20
 - upflow solids contact basin, 7-30–7-32
 - well,
 - casing, 4-29
 - drawdown, 4-17
 - pump, 4-27
 - screen, 4-30–4-33
 - wet well, 3-16
- Design-engineer/construction manager, 1-10
- Design flow rates for:
 - commercial districts, 18-3, 18-4
 - domestic sources, 17-9, 18-3, 18-4
 - fire protection, 17-3–17-8
 - industrial sources, 18-2, 18-4
 - infiltration, 18-5–18-7
 - intake structures, 3-8
 - maximum day, 2-7, 18-5
 - minimum day, 18-5
 - peak hour, 2-7, 2-8, 18-5
 - primary treatment, 21-6
 - secondary settling, 25-9
 - secondary treatment, 23-49, 23-62, 23-76, 23-95
 - variation, 2-6–2-8
- Design life, 2-2–2-3, 18-2
- Design period, 2-2, 2-3, 18-2
- Detention time (t_0):
 - activated sludge aeration tank, 23-17, 23-39
 - aerobic digester, 27-29
 - anaerobic digester, 27-38
 - biological nitrogen removal, 23-40
 - biological phosphorus removal, 23-40
 - coagulation, 6-25
 - defined, 6-25, 10-10
 - disinfection of water, 13-36
 - disinfection of wastewater, 25-17
 - feedwell, 21-15
 - flash mixing, 6-25
 - flocculation, 6-25
 - grit chambers, 20-30
 - lime stabilization, 27-24
 - and mixing, 6-25
 - oxidation ponds, 23-43–23-44
 - primary settling tank, 21-2, 21-7
 - rapid mixing, 6-25
 - settling tank, water, 10-10, 10-13
 - high-rate, 10-34
 - and scale-up, 10-13
 - softening, 7-28–7-29
- Dewatering sludge,
 - mechanical, 15-36–15-44
 - nonmechanical, 15-24–15-35
- Dichloramine, 13-4, 13-11
- Diffuse layer, particle, 6-3
- Diffuser, coarse bubble. 27-30
- Digester, heating, 27-46–27-50
- Digester gas, 27-36, 27-40, 27-45
- Digestion, stabilization of sludge, 27-4, 27-27–27-28, 27-33–27-34
- Direct filtration, 11-5
- Discharge, pump, 3-18
 - head, 3-18
 - pressure, 3-18
- Disinfectant;
 - chemistry, 13-2–13-12
 - kinetics, 13-9–13-11
 - primary, 13-22, 13-23
 - properties, 13-21
 - secondary, 13-22, 13-23
 - selection, 13-21–13-23
- Disinfection:
 - and bromide, 13-9, 13-22
 - byproducts (DBPs), 2-34–2-35, 13-8–13-9, 13-22
 - and Chick–Watson model, 13-14
 - and Chick’s law, 13-13
 - contact facilities, 13-29–13-36, 13-41
 - emergency, 13-42
 - Hom-Haas model, 13-17
 - kinetics, 13-13–13-18
 - mechanisms, 13-12–13-13
 - practice, 13-18–13-36
 - reactors, 13-29–13-36, 13-41
 - regulatory context, 13-19–13-21
 - requirements, 2-36, 13-20
 - storage tanks, 17-38
 - wastewater, 25-15–25-20
 - water mains, 17-39
 - well, 4-13

- Dissociation:
 table of constants, Appendix A
 of weak acids, Appendix A
- Dissolved air flotation (DAF), 6-2,
 15-17, 15-23, 27-18,
 27-21–27-23
- Dissolved organic carbon (DOC), 13-9
- Dissolved oxygen (DO):
 and denitrification, 22-21
 and nitrification, 22-19
 and oxidation, 22-17
 and oxygen demand, 23-29
 saturation, table of, Appendix A
- Distribution main, 17-2
- Distribution system, 17-2, 17-10, 17-16,
 17-20, 17-36
- District, in distribution system, 17-2
- DLVO model, 6-5, 6-8, 6-9
- DNA and bacterial growth, 22-10
- DOC, 13-9
- Domestic:
 sewage, 18-2
 wastewater, 18-2, 18-3
 wastewater characteristics, 18-7–18-10
- Donnandialysis, 15-14
- Drag coefficient (C_D):
 filter backwash, 11-17, 11-18
 filter headloss, 11-13
 paddle, 6-44, 6-45
 settling, 10-3, 10-4
- Drawdown:
 confined aquifer, 2-19–2-20
 estimation, 2-19–2-20, 4-17–4-26
 unconfined aquifer, 2-21
- Drilling methods, well, 4-5, 4-7, 4-8
- Drive, pump:
 adjustable frequency (afd), 3-18
 constant speed, 3-18
 variable frequency (vfd), 3-18
 variable speed (vsd), 3-18
- Drop manhole, 19-6
- Drum screens, 20-21
- Dry weather flow, 2-14, 18-6
- Dry well, 19-7, 19-37
- Drying bed, sludge, 15-28–15-35,
 27-53–27-54
- Dual media filter, 11-4, 11-7, 11-20–11-24,
 11-42
- Duration curve, 2-9–2-12
- Dynamic equilibrium of microorganisms,
 22-12
- Dynamic viscosity:
 water, table of, Appendix A
- E, 8-10, 11-5, 11-7
- EBCT, 8-14, 8-15, 26-3
- Economic analysis, 1-15–1-16
- Economic analysis primer, *see* Chapter 1
 at text Web site
- EDCs, 14-20
- Effective size (E):
 defined, 8-10, 11-5
 of filter media, 11-7
 of ion exchange resin, 8-10
 of sand, 11-5
- Efficiency, disinfection, 13-19–13-20
- Effluent:
 BOD, 18-3
 limitations, 18-3
 suspended solids, 18-3
E. histolytica, 13-16–13-17
- Electrodialysis, 9-10
- Electron acceptor and decomposition,
 22-15–22-16
- Electron carrier, 22-4
- Electrophoresis, 6-3
- Element, membrane, 9-8, 9-15
- Emergency disinfection, 13-42
- Empty bed contact time (EBCT):
 carbon adsorption, 26-13
 denitrification filter, 26-9
 ion exchange, 8-14, 8-15
- End products of waste decomposition,
 22-9
- Endocrine disrupting chemicals (EDCs),
 14-20
- Endogeneous decay, 22-7, 22-14
- Energy capture, microbial, 22-4
- Energy carrier, bacterial metabolism,
 22-5
- Energy dissipating inlet (EDI), 21-15
- Energy loss coefficient (K):
 defined, 3-20
 table of, Appendix C
- Energy source, microorganism, 22-2
- Enhanced coagulation, 6-22, 12-14,
 14-17
- Enhanced lime softening, 14-5
- Enmeshment of particles, 6-9
- Environmental ethics, 1-7
- Enzymes, 22-4
- EPANET2, 17-37
- Epi-DMA, 6-7, 6-23
- Equalization basin:
 air requirements, 20-43–20-44
 appurtenances, 20-45
 geometry, 20-42
 location and configuration, 20-37
 mixing, 20-43–20-44
 and primary sedimentation, 21-6
 volume, 20-38
- Equivalent length of pipe, 17-21–17-22,
 Appendix C
- Escherichia coli*, 2-25, 13-13, 18-12,
 22-3, 25-15
- Estimating methods for softening, 7-25
- Ethics:
 environmental, 1-7
 professional, 1-3–1-10
- Exchange capacity, 8-5
- Exogenous carbon, 22-20
- Expanded porosity, 11-16–11-17
- Explosion hazard, 13-5, 13-27,
 27-44–27-45
- Explosive limits for vapors, 13-5,
 27-44–27-45
- Exponential growth, log-growth curve,
 22-11
- Exposed intake, 3-5, 3-6, 3-18
- Extended aeration, 23-8
- Extreme-value analysis, 2-12
- 503 regulations, 18-14–18-21
- Facultative:
 anaerobes, 22-3
 ponds, 23-2, 23-3, 23-14,
 23-41–23-46
 thermophiles, 22-3
- FAD, 22-6, 22-7
- FADH, 22-7, 22-9
- Fats, oils, and grease (FOG), 20-22
- Fecal coliform group (FC):
 in drinking water, 2-36
 in wastewater, 18-12, 25-15
- Fee structures, 1-6
- Feedback control, 16-27
- Feedforward control, 16-27
- Feeding systems, chemical, 5-3–5-13
- Feedwell, settling tanks:
 detention time, 21-15
 energy dissipating inlet (EDI), 21-15
- Fermentation and anaerobic
 decomposition, 22-16, 27-34

- Fermentation tube method, 2-36
- Ferric chloride:
 - as coagulant, 6-15, 6-22, 7-27
 - sludge, 15-7, 15-11, 15-14
 - and phosphorus removal, 6-22, 26-3
 - and softening, 7-27
- Ferrous sulfate as coagulant, 6-7
- Field bus, 16-30
- Filamentous organisms, 22-24
- Filter:
 - backwash sludge, 15-8, 15-35
 - blocks, 11-26–11-27
 - box, 11-22
 - cake, 15-5, 15-16, 15-38, 15-40
 - cells, 11-22
 - continuous belt press, 15-16, 15-39–15-40, 27-55–27-56
 - deep-bed, 11-5, 11-44, 26-8
 - denitrification, 26-9
 - dimensions, 11-22–11-24
 - dual media, 11-4, 11-7, 11-20–11-24, 11-42, 26-6
 - grain size, 11-5–11-6
 - gullet, 11-33–11-34
 - headloss, 11-3, 11-36–11-37
 - hydraulics, 11-12–11-20
 - loading rate, 11-4, 11-41–11-44
 - maturation, 11-3
 - media properties, 11-7, 11-24
 - See also Membrane: Microfiltration and Ultrafiltration*
 - number of, 11-21
 - press, 15-6, 15-40–15-42, 27-4, 27-57
 - rapid sand, 11-4, 11-13–11-20
 - ripening, 11-3
 - run, 11-3
 - slow sand, 11-4
 - support, 11-26–11-28
 - trimedia, 26-7
 - and turbidity, 11-2, 11-3
 - type, selection of, 11-20
 - underdrains, 11-26–11-28
 - vacuum, 15-16, 15-38
 - washwater,
 - pressure, 11-29
 - rate, 11-29
 - recycle, 11-46
 - troughs, 11-22, 11-30–11-31
 - to waste, 11-39
 - wastewater, 11-39
- Filtration:
 - contact, 11-5
 - conventional, 11-5
 - direct, 11-5
 - in-line, 11-5
 - and iron removal, 14-13
 - and manganese removal, 14-13
 - mechanisms, 11-9–11-12
 - rate, 11-4, 11-41–11-44
 - roughing, 11-5
- Final clarifier,
 - see* Secondary settling tank
- Final design, 1-10, 1-17–1-19
- Financing projects, 1-19
- Fine screens, 20-21–20-23, 21-26
- Finger baffle, 21-21
- Fire protection: and anaerobic digesters, 27-44–27-45
 - flow rates, 17-3–17-8
 - needed fire flow (NFF), 17-6
 - sprinkler systems, 17-3–17-6
- First-order reaction, disinfection, 13-9
- Fish protection, 3-33–3-34
- Fitting headlosses, 3-20
 - table of, Appendix C
- Flash mixer, 6-26–6-36
- Float shoe, 4-8, 4-9
- Floc:
 - activated sludge, 23-3
 - coagulation, 6-2, 6-22, 6-23
 - defined, 6-2
 - settling, 6-24, 10-12–10-15
- Flocculation:
 - absorption and destabilization, 6-9, 6-16, 6-17, 6-25, 6-26
 - aids, 6-23
 - ballasted, 6-23, 10-16, 10-23–10-25
 - basin, 6-37–6-41
 - centerwell, 21-14
 - chemical sequence, 6-24
 - defined, 6-3
 - DLVO model, 6-5
 - double layer compression, 6-8–6-9
 - Gt values, 6-26, 7-30
 - orthokinetic, 6-23
 - perikinetic, 6-23
 - and softening, 7-28–7-30
 - sweep, 6-9, 6-16, 6-17
 - velocity gradient (G), 6-24–6-25
 - and water temperature, 6-37
- Flocculator design, 6-41–6-49
- Flotation of tanks, 21-8–21-11
- Flotation thickening of sludge, 6-2, 15-17, 15-23, 27-18, 27-21–27-23
- Flow apportionment, filters, 11-35
- Flow balance, 8-12
- Flow distribution, 21-20–21-21
- Flow equalization, 20-2, 20-36–20-45
- Flow measurement,
 - location, 20-8–20-9
 - magmeter, 20-8
 - Parshall flume, 20-8
- Flow rate, *see* Design flow rate
- Flow splitting box, 21-4, 21-11–21-12
- Fluidized bed reactor (FBR), 14-19
- Fluoridation,
 - chemistry, 13-42–13-43
 - dose, 13-44
 - feed systems, 13-44
 - safety, 13-45
 - and softening, 13-45
 - and TOC removal, 13-45
- Fluoride in drinking water, 2-24, 13-44
- Fluorosilicic acid, 13-42–13-44
- Fluorosis, 2-24
- Flux:
 - batch, 15-18, 15-19
 - granular filter, *see* Filtration rate
 - limiting, 25-4
 - MF/UF, 12-5
 - NF/RO, 9-5–9-6
 - solids, 15-18, 15-19
- Foaming on aeration tank, 22-25
- Food to microorganism ratio (F/M), 23-35–23-36
- Footprint, equipment, 20-3
- Force main, 19-2, 19-6
 - design, 19-31
- Fouling, membrane, 9-8, 9-9, 12-6–12-8
 - irreversible, 12-6
 - reversible, 12-6
- Fraction of nitrifying organisms (f_N), 23-19
- Frazil ice, 3-31–3-33
- Free available chlorine, 13-2, 13-3
- Freeboard, 6-36, 6-44, 10-26, 11-31, 21-11, 21-20
- Freeze treatment of sludge, 15-35
- Frequency of occurrence, hydrologic, 2-8, 2-12–2-15

- Freundlich equation, 14-29
- Froude number, 10-19, 10-26–10-27, 10-34
- Fungi, 22-3
- G (velocity gradient):
 defined, 6-24–6-25
 typical values, 6-26, 6-37, 6-45, 7-28, 7-30
- GAC, 13-22, 14-18, 14-19, 14-20, 14-21, 14-22, 14-29–14-31, 26-12
- Gang stirrer, 6-17
- Gas transfer, 23-31
- Gates:
 slide, 20-13
 sluice, 3-10
- Geosmin, 14-33, 14-35
- Geotechnical considerations for tanks, 21-8–21-11
- Giardia*, 2-35, 13-16–13-17, 13-19–13-20, 15-8
 Ct tables, Appendix D
- GLUMRB, 2-7
- Grain size analysis of sand, 11-5–11-6, 11-7–11-8
- Granular activated carbon (GAC), 13-22, 14-18, 14-19, 14-20, 14-21, 14-22, 14-29–14-31, 26-12
- Gravel packed well, 4-4, 4-10–4-11
- Gravity belt thickener, 27-20–27-21
- Gravity force main, 19-15
- Gravity thickening, 15-20–15-23, 27-18–27-20
- Great Lakes Upper Mississippi River Board (GLUMRB), 1-12, 2-7
- Greensand, 4-13, 14-21
- Grinders, 20-2, 20-25
- Grit,
 characteristics of, 3-31, 10-2
 management, 27-18
 pumping, 27-11, 27-12
 quantity, 20-32
 and scour velocity, 20-26
 and settling velocity, 20-25–20-27
 storage, 27-3
- Grit chamber:
 aerated, 20-27–20-36
 and preliminary treatment, 20-2
 sludge, 27-3, 27-11, 27-17–27-18
 vortex, 20-27, 20-36
 water intake, 3-32
- Groundwater:
 characteristics, 2-8
 Rule (GWR), *see* Chapter 2 at text
 Web site
 supply, 2-18, 2-22
 table (GWT), 2-21, 4-16
 under the influence, 16-10
 and wastewater treatment, 18-3–18-7
- Grout, around well casing, 4-8
- Growth, kinetic coefficients,
 tables of, 23-18, 23-50
- Growth requirements:
 algal, 22-3
 bacterial, 22-10
- Gt values, 6-26, 6-37, 7-28–7-30
- Gullet, 11-33–11-34
- Gumbel paper, 2-12
- GWDR, 16-6
- HAA5, 2-31, 2-34, 13-8
- Half-reactions:
 oxidation-reduction, 13-6
 microbial, 22-4–22-5
 table of, 13-6
- Half saturation constant, 22-13
- Haloacetic acids (HAA5), 2-34, 7-26
- Hardness:
 bar chart of, 7-4
 carbonate (CH), 7-2, 7-3
 classification, 7-1
 defined, 7-2, 7-3
 of filter media, 11-6, 11-7
 formation of, 7-3
 noncarbonate (NCH), 7-2, 7-3
 polyvalent cations, 7-2
 total (TH), 7-2
- Hazen-Williams coefficient of roughness (C):
 for force mains, 19-31, 19-32
 for sludge, 27-15
 table of, Appendix C
- Hazen-Williams equation, 3-12, 17-13, 19-15, 19-31, 27-17
- Head, terminology, 3-19–3-23
- Head-discharge curve, 3-27, 4-40
- Headloss:
 accommodation in filters, 11-37–11-38
 in aeration systems, table of, 23-85
 in air piping, 23-84–23-85
 in granular filter, 11-12–11-16, 11-19–11-20, 11-28
 in packed tower, 14-24
 in sewers, 19-15, 19-17
 in sludge pumping, 27-11, 27-14–27-15
 through baffles, 6-38, 10-25
 through bar racks, 20-17
 through fine screens, 20-22
 through manholes, 19-14
 through membranes, 9-11, 12-15, 26-11
 through static mixers, 6-31
 terminology, 3-19–3-23
 in underdrains, 11-28
 wastewater treatment plant, 28-27
 in water piping, 3-19, 3-20, 17-13, 17-20–17-21
- Headloss coefficient:
 Hazen-Williams (C), 3-12, 15-15, Appendix C
 Manning (n), 20-14
- Headworks, defined, 20-2
- Hearing protection, 23-84
- Heat exchangers, 27-49
- Heat transfer coefficients, 27-47
- Heat treatment of sludge, 27-53
- Heavy metals in drinking water, 2-23–2-24, 2-29, 2-32
- Height of mass transfer unit (HTU), 14-22
- Henry's law, Appendix A
- Henry's law constant, 14-23
 table of, Appendix A
- Heterotrophic bacteria, 2-35, 22-2
- High test hypochlorite (HTH™), 4-13, 13-2, 13-6, 13-25
- Higher explosive limit (HEL), 27-44–27-45
- High-lift, 3-2
- High-rate filters, 11-4
- High-rate settling, 10-16–10-19, 10-22–10-23, 10-33–10-35
- High-service, 3-2
- Hindered settling, 10-15, 15-17
- Hints from the field:
 cellular antennas on water towers, 17-31–17-32
 chemical handling and storage, 5-20
 coagulation and flocculation, 6-49
 granular filtration, 11-46
 headworks and preliminary treatment, 20-25

- Hints from the field:—(*Cont.*)
- intake structures, 3-35
 - lime-soda softening, 7-34
 - membranes, 12-18
 - phosphorus precipitation, 26-5
 - pipelines for grit and sludge, 27-16
 - primary treatment, 21-14
 - pump operation, 19-39
 - pump stations, 19-39
 - secondary treatment by suspended growth, 23-95, 23-97
 - sedimentation, 10-38
 - sewer design, 19-14
 - supervisory control and data acquisition (SCADA), 16-30
 - UV disinfection of wastewater, 25-20
 - water pressure, 17-10
- Hollow fiber membrane, 9-6, 9-8, 12-9, 12-10
- Hopper, sludge, 10-21, 10-22, 21-19, 21-22
- Household bleach as disinfectant, 13-42
- HTH™, 4-13, 13-2, 13-6, 13-25
- HTU, 14-22
- Hybrid processes, 24-2, 24-12–24-14
- Hydrant spacing, 17-20
- Hydrated lime, 7-7
- Hydraulic conductivity:
 - of aquifers, 2-20
 - of pond liners, 23-46
- Hydraulic detention time, *see* Detention time
- Hydraulic grade line, 16-19–16-25, 28-26–28-29
- Hydraulic loading:
 - GAC columns, 26-13
 - granular filters, 11-4, 11-41–11-44
 - ion exchange columns, 8-14, 8-16
 - primary settling tanks, 21-6–21-7
 - secondary settling tanks, 25-9, 25-10–25-11
- Hydraulic properties of aquifer, 2-20
- Hydraulic retention time, *see* Detention time
- Hydraulic radius, 19-15, 19-16
- Hydrogen sulfide (H₂S):
 - and anaerobic decomposition, 27-37, 27-45
 - and confined spaces, 19-40
 - in sewers, 19-40
- Hydrologic year, 2-12
- Hydrolysis, 22-6, 22-7, 27-34, 27-35
- Hydropneumatic tank, 17-22, 17-23
- Hyperthermophiles, 22-3
- Hypobromite, 13-9
- Hypochlorite, 13-4
- Hypochlorous acid, 13-2–13-3
- I/I or I&I, 18-2–18-4
- Ice and intake structures, 3-31–3-33
- IFAS, 24-13–24-14, 25-11
- Impaired water, 18-12
- Impeller:
 - axial-flow, 6-34
 - power for mixing, 6-34
 - pump, 3-17, 3-18
 - radial-flow, 6-34
 - types for mixing, 6-33
- Inclined plate settlers, 10-16–10-19, 10-22–10-23, 10-33–10-35
- Indexing grid sludge collector, 10-22, 10-24
- Industrial wastewater:
 - characteristics, 18-9–18-10
 - pretreatment, 18-13–18-14
- Infiltration, groundwater, 18-3
- Infiltration allowances, 18-6
- Infiltration and inflow (I & I), 18-2–18-4
- Infiltration gallery, 3-5, 3-7, 3-30–3-31
- Inlet configuration, 21-14–21-15, 21-21–21-22
- In-line blender, 6-27–6-29
- In-line mechanical mixer, 6-27–6-29
- In-line static mixer, 6-29–6-33
- Inside-out (cross-flow) membrane, 12-10, 12-11
- Inside-out (dead end) membrane, 12-10, 12-11
- Intake:
 - bar rack, 3-10
 - conduit, 3-11
 - conduit size, 3-11–3-12
 - conduit slope, 3-15
 - crib, 3-11
 - design criteria, 3-8–3-16
 - design flow rate, 3-8
 - exposed, 3-5, 3-6, 3-18
 - infiltration gallery, 3-5, 3-7
 - lake, 3-4–3-6
 - operation and maintenance, 3-5
 - ports, 3-9, 3-11
 - Ranney well, 3-5, 3-7
 - reservoir, 3-4–3-6
 - river, 3-4–3-8
 - screens, 3-10, 3-11, 3-15
 - submerged, 3-5, 3-6
 - tower, 3-3, 3-6, 3-9
 - T-screens, 3-13
- Integrated fixed-film activated-sludge (IFAS), 24-13–24-14, 25-11
- Interface, gas-liquid, 23-31
- Interference, well, 4-16, 4-22–4-26
- Interim enhanced surface water treatment rule (IESWTR), 2-35
- Interim primary drinking water regulations (IPDWRs), 2-29
- Intermittent sand filter (ISF), 23-48
- Internal recycle (IR), 23-37
- International System of Units (SI), table of, inside back cover
- Interparticle bridging, 6-6, 6-9
- Interruptible chemical, 5-2, 5-4
- Inverted siphon, 19-7–19-9
- IOC, 16-6
- Ion exchange:
 - and arsenic removal, 14-5
 - backwash, 8-11
 - breakthrough curve, 8-4
 - bypass, 8-12
 - capacity, 8-5
 - defined, 8-2
 - empty bed contact time (EBCT), 8-14, 8-15
 - and iron removal, 14-14
 - kinetics, 8-3–8-4
 - and manganese removal, 14-14
 - and nitrate removal, 14-14
 - and NOM removal, 14-17
 - operating capacity, 8-13
 - process operation,
 - bypass, 8-12
 - cocurrent, 8-10–8-12
 - countercurrent, 8-12
 - multiple columns, 8-13
 - and radionuclide removal, 14-21
 - reactions, 8-2–8-3
 - regeneration, 8-11, 8-19
 - residuals, 15-10
 - resin selection, 8-13–8-15

- resins, 8-2
 - backbone, 8-2, 8-3
 - matrix, 8-2, 8-3
 - particle size, 8-9–8-10
 - properties of, 8-5–8-10
- selectivity, 8-5–8-9
- service flow rate (SFR), 8-14, 8-15
- service life, 8-10
- slow rinse, 8-11, 8-19
- surface loading rate (SLR), 8-16
- and turbidity, 8-10
- vessel design, 8-20–8-24
- Ionic strength:
 - and coagulation, 6-8
 - defined, 6-8
 - and stabilization, 7-35
- Iron:
 - as coagulant, 6-15, 6-22
 - sludge, 15-7, 15-11, 15-14, 15-21
 - in drinking water, 2-24
 - and ion exchange, 8-10
 - and MF/UF filtration, 12-14
 - and oxidant demand, 13-23
 - and softening, 7-26
 - specific gravity,
 - sludge, 15-21
 - solids, 15-7, 15-21
- Iron and manganese removal:
 - decision trees, 14-15, 14-16
 - oxidation-reduction reactions,
 - 14-12–14-13
 - preoxidation, 14-12–14-13
 - treatment strategies, 14-12–14-14
- Iron-based sorbents (IBS), 14-5
- Isolation, well, 4-3, 4-5
- Isolation distances, 4-5
- Isotherm, adsorption, 14-29
- IX, *see* ion exchange

- Jar tests, 6-17–6-20
- Jet aerator, 23-33, 23-67
- Jet mixing, 23-67

- K_a , 6-12, 7-15
 - table of, Appendix A
- K_j^i , 8-5
- K_{La} , 14-23, 23-31–23-32
- K_{sp} , 7-7
 - table of, Appendix A
- K_w , defined, 6-13

- Kinematic viscosity,
 - water, table of, Appendix A
- Kinetic coefficients:
 - activated sludge, 23-50
 - anaerobic digestion, 27-38
- Kjeldahl nitrogen, 18-7
- Krebs cycle, 22-6, 22-8

- Lag phase, log growth curve, 22-10
- Lag time, log-growth curve, 22-10
- Lagoons:
 - aerated, 23-2, 23-3
 - sewage, 23-2
 - sludge, 15-24–15-27
 - wastewater treatment, 23-2–23-3,
 - 23-41–23-48
- Lake intake, 3-4–3-6
- Lamella plate settlers, 10-16–10-19,
 - 10-22–10-23, 10-33–10-35, 21-25
- Land disposition of sludge, 15-49,
 - 27-59–27-60
- Landfilling of sludge, 15-51, 27-59
- Langlier saturation index (LSI), 7-34–7-36
- Lateral sewer, 19-2
- Launders, settling tank:
 - wastewater, 21-16
 - water, 10-27
- Layered security, 16-32–16-34
- LCR, 2-29, 2-34, 16-6
- Lead:
 - and copper rule, 2-29, 2-34, 16-6
 - in drinking water, 2-24
- LeChatelier's principle, 7-7
- Legionella*, 2-35
- Life expectancy:
 - equipment, 2-3, 18-2
 - facilities, 2-3, 18-2
- Lift station, 19-6, 19-7, 19-31–19-39
 - prefabricated, 19-7, 19-38
- Light, UV wavelength, 13-8
- Lime:
 - and alkaline stabilization, 27-23–27-25
 - and calcium hydroxide, 7-7
 - and coagulation, 6-20
 - and phosphorus removal, 26-3
 - purity, 7-17
 - slaking, 7-7
 - sludge,
 - concentration, 15-8
 - specific gravity, 15-8, 15-21
- Lime-soda softening:
 - chemistry, 7-6–7-11
 - and iron removal, 14-14
 - and manganese removal, 14-14
 - pH, 7-9–7-10
 - and radionuclide removal, 14-21
 - reactions, 7-8–7-9
 - sludge, concentration, 7-34, 15-8
 - See also* Softening
- Lime stabilization, 27-23–27-26
- Limiting flux, 25-4
- Limiting salt, 9-8, 9-11–9-15
- Liner:
 - equalization basin, 20-42
 - oxidation pond, 23-46
 - sludge lagoon, 15-26
- Liquid biosolids application, 27-60
- Liquid oxygen (LOX), 13-5, 13-27
- Liters per capita per day (Lpcd), 2-3
- Lithotrophs, 22-2
- Load allocation (LA), 18-13
- Loading rate:
 - anaerobic digester, 27-41
 - defined,
 - filters, 11-4
 - settling tanks, 10-9
 - weirs, 10-28
 - dual media filters, 11-4, 11-42
 - ion exchange column, 8-16
 - multimedia filters, 11-4, 11-43
 - oxidation ponds, 23-41–23-43
 - primary settling, 21-7
 - rapid sand filter, 11-4, 11-41
 - secondary settling, 25-10, 25-12
 - settling tank, surface, 10-9, 25-11, 25-15
 - slow sand filter, 11-4
 - solids, 25-12
 - trickling filter, 24-7
 - weir, 7-31, 10-28, 21-7–21-8, 25-3
- Locational running annual average (LRAA), 2-35
- Log growth curve, bacterial, 22-11
- Log inactivation (LI), 13-19
- Log removal (LR), 12-4
- Long Term 1 Enhanced Surface Water Treatment Rule (LT1ESWTR), 2-35, 13-20
- Long Term 2 Enhanced Surface Water Treatment Rule (LT2ESWTR), 2-35, 13-20

- Loose RO, 9-2
- Low pressure RO, 9-2
- Lower explosive limit (LEL):
 - chlorine dioxide, 13-5
 - methane, 27-44–27-45
- Lower heating value, digester gas, 27-45
- Low-flow duration, 2-14
- Low-lift, 3-2
- Low-lift pumping station, 3-2
- Low-service, 3-2
- LOX, 13-5, 13-27
- LSI, 7-34–7-36

- Macerator, 20-24
- Macronutrients, 22-10
- Manganese in drinking water, 2-24
 - and ion exchange, 8-10
 - and MF/UF filtration, 12-14
 - and oxidant demand, 13-23
- Magnesium:
 - hardness, 7-2, 7-3, 7-8–7-9
 - scale, 7-11
 - softening, 7-7, 7-8–7-9
 - and split treatment, 7-22–7-25
- Magnetic flow meters, 20-8
- Magnetic ion exchange (MIEX[®]), 14-17, 14-18
- Main, sewer, 19-2
- Maintenance cleaning, membrane filter, 23-98
- Manhole, 19-2, 19-5, 19-6
 - covers, 19-40
 - safety, 19-40
- Manning equation, 16-22, 19-15, 20-14
- Manning's *n*, 19-17, 19-18
- Manufacturer's standard conditions, 9-16
- Margin of safety (MOS), 18-13
- Mass balance:
 - activated sludge process, 23-15–23-16
 - equalization basin, 2-15
 - ion exchange, 8-12
 - nitrogen, 23-30
 - reservoir design, 2-15–2-18
 - retention basin, 2-15
 - return sludge, 23-24–23-25
 - sludge, 15-10, 27-6
 - wastewater treatment, 28-30–28-31
- Mass transfer, oxygen, 23-31
- Materials recovery, sludge, 15-13–15-15
- Maturation ponds, 23-2, 23-3

- Maximum contaminant level (MCL), 2-28
 - tables of, 2-30–2-37
- Maximum contaminant level goal (MCLG), 2-29, 2-30–2-33
- Maximum day, 17-9, 18-5
- Maximum day demand, 2-27, 17-2, 17-9
- Maximum month, 18-5
- Maximum residual disinfectant level (MRDL), 2-34
- Maximum residual disinfectant level goal (MRDLG), 2-34
- Maximum specific growth rate, 22-3
- MBBR, 24-14
- MBR, 23-12–23-13, 23-95–23-98, 28-15, 28-31
- Mean cell residence time (θ_c), 23-4
 - See also* Solids retention time (SRT)
- Mechanical sludge collectors, 10-21, 10-22, 10-24
- Media:
 - dual, 11-20, 11-21, 11-42, 26-6–26-7, 26-9
 - mono-, 11-20, 11-21, 11-44, 26-8
 - multi-, 11-21, 11-43, 26-7–26-8
 - properties, 11-7
 - single, 11-41
 - tri-, 11-43, 26-7–26-8
 - trickling filter, 24-2
- Membrane:
 - array, 9-8, 9-10, 9-15
 - backwash, 15-9
 - bioreactor (MBR), 23-12–23-13, 23-95–23-98
 - and fine screens, 20-23
 - brine, 9-11, 15-9
 - chemical cleaning, 12-16, 23-98
 - comparison of, 9-2, 9-3
 - concentrate, 9-11, 12-14, 15-9
 - configuration, 9-6–9-7, 12-9–12-10
 - design, 9-11–9-16, 12-15–12-18
 - diffusers, 20-43, 23-82
 - electrodialysis, 9-18
 - element, 9-8, 9-15, 12-16
 - filter technique, 2-36
 - filtration of wastewater, 26-10–26-12
 - flux, MF/UF, 12-5, 26-11
 - flux, NF/RO, 9-5
 - fouling, 9-8, 9-9, 12-6–12-7, 23-97
 - hollow fiber, 9-6, 9-8, 12-9, 12-10
 - inside-out (cross-flow), 12-10, 12-11
 - inside-out (dead end), 12-10, 12-11
 - and limiting salt, 9-8, 9-11–9-15
 - materials, 9-8, 12-7, 12-9
 - mechanics of filtration, 12-3–12-4
 - microfiltration (MF), 9-2, 9-3, 12-2, 12-3, 23-12, 26-10
 - models of filtration, 12-4–12-5
 - models of fouling, 12-6–12-8
 - nanofiltration (NF), 9-2, 9-3, 12-2, 12-3
 - outside-in, 12-10, 12-11
 - outside-in (cross-flow), 12-10, 12-11
 - permeability, 12-12
 - posttreatment, 9-9
 - pressure, effects, 12-12
 - pretreatment, 9-9, 12-13–12-14
 - recovery (*r*), 9-5, 9-6, 15-9
 - rejection, 9-6, 12-4, 15-9
 - residuals, 15-9
 - resistance coefficient, 12-5
 - reverse osmosis (RO), 9-2, 9-3, 12-2
 - scaling, 9-9
 - service life, 9-7, 12-12
 - specific flux, 12-12
 - spiral-wound, 9-6, 9-7
 - stage, 9-8
 - temperature effects, 9-7, 9-16, 12-10
 - transmembrane pressure (TMP), 9-5, 12-5, 12-15, 26-11
 - ultrafiltration (UF), 9-2, 9-3, 26-10
- Mercaptans, 22-16
- Merry-go-round, ion exchange, 8-13
- Mesh size, 8-10, 14-8
- Mesophiles, 22-3
- Metabolism, 22-6
- Methane:
 - and anaerobic digestion, 27-34–27-36
 - as an end product, 27-34–27-36
 - explosive limits, 27-44–27-45
 - fermentation, 27-34
 - gas production, 27-36, 27-40
 - heating value, 27-45
 - in sewers, 19-40
- Methemoglobinemia, 2-24
- mg/L as CaCO₃, 6-12, 7-2
- MIB, 14-33, 14-35
- Microbial growth characteristics, 22-10–22-15
- Microbial growth requirements, 22-10
- Microbiological characteristics of drinking water, 2-25

- Microfiltration (MF) and ultrafiltration (UF):
- backwashing, 12-7, 12-1
 - chemical cleaning, 12-16
 - clean-in-place (CIP), 12-16
 - concentrate, 12-14
 - configuration, 12-9–12-10
 - defined, 12-2, 12-3
 - design, 12-15–12-18
 - flux, 12-5
 - fouling, 12-6–12-7
 - hollow fiber, 12-9, 12-10
 - inside-out (cross-flow), 12-10, 12-11
 - inside-out (dead end), 12-10, 12-11
 - and iron, 12-14
 - and manganese, 12-14
 - materials, 12-7, 12-10
 - mechanisms, 12-3–12-4
 - models of filtration, 12-4–12-5
 - models of fouling, 12-6–12-8
 - and NOM, 12-13
 - operating pressure, 12-15
 - outside-in, 12-10, 12-11
 - outside-in (cross-flow), 12-10, 12-11
 - permeability, 12-12
 - pressure, effects, 12-12
 - pretreatment, 9-9, 12-13–12-14
 - recovery (r), 9-5, 9-6
 - rejection, 12-4
 - resistance coefficient, 12-5
 - service life, 12-12
 - temperature effects, 12-10
 - transmembrane pressure (TMP), 12-5, 12-15
 - and turbidity, 12-13
- Micronutrients, 22-10
- Milliequivalents (meq), 7-2
- Minimal media test, 2-36
- Minimum day, 18-5
- Minimum day demand, 17-2
- Minimum hour, 18-5
- Minimum month, 18-5
- Minor losses, 3-20, 17-20–17-21
- table of, Appendix C
- Mitochondrial electron transport, 22-9
- Mixed liquor:
- activated sludge, 23-3
 - suspended solids (MLSS), 23-3
 - volatile suspended solids (MLVSS), 23-3
- Mixers, 6-26, 6-33, 6-41
- Mixing:
- and aerobic digestion, 27-30
 - and anaerobic digestion, 27-44
 - detention time,
 - for flash mixing, 6-25
 - for flocculation, 6-25
 - for softening, 7-30
 - flash, 6-26–6-37
 - flocculation, 6-37, 6-41–6-48
 - flow equalization, 20-43
 - lime stabilization, 27-24–27-26
 - power for, 6-31, 6-34
 - rapid, 6-33–6-37
 - for softening, 7-28, 7-31
 - velocity gradients for, 6-26, 6-33, 6-37
- MLE, 22-19, 23-8
- MLSS, 23-4
- MLVSS, 23-3
- Models, activated sludge, 23-5–23-23
- Modified iron removal (MIR), 14-6
- Modified Ludzack-Ettinger (MLE), 22-19, 23-8
- Molecular weight cut-off (MWCO), 12-2, 12-3
- Monitoring wells, 15-44
- Monochloramine, 13-4, 13-11
- Monod equation, 22-4, 23-15
- Monomedia filters, 11-20, 11-21, 11-44, 26-8
- Mottling of teeth, fluoride, 2-24
- Moving bed biofilm reactor (MBBR), 24-14
- Multimedia filter, 11-21, 11-43, 26-7–26-8
- Multiple-tube fermentation technique (MTF), 2-36
- NAD, NADH, NADP, NADPH, 22-4
- Nanofiltration (NF):
- defined, 9-2, 9-3
 - and iron removal, 14-14
 - and manganese removal, 14-14
 - and NOM removal, 14-17
 - See also* Reverse Osmosis
- National Fire Protection Association (NFPA), 17-3
- National Pollution Discharge Elimination System (NPDES), 18-11, 25-2, 25-15, 26-2
- National Primary Drinking Water Regulations, 2-29
- National Research Council (NRC), 24-8, 24-9
- National Safe Drinking Water Act, 2-28
- Natural organic matter (NOM), 6-2
- and chlorine demand, 13-11
 - and disinfection byproducts, 13-8, 13-22
 - and MF/UF filtration, 12-13
 - removal of by adsorption, 14-17
 - removal of by enhanced coagulation, 6-22, 14-17
 - removal of by ion exchange, 14-17
 - removal of by lime-soda softening, 7-2, 7-6, 7-27
 - removal of by NF and RO, 14-16
 - and total organic carbon (TOC), 14-15, 14-17
- Neat cement grout, 4-8
- Needed fire flow (NFF), 17-6
- Nephelometric turbidity unit (NTU), 2-23
- Net positive suction head (NPSH_A, NPSH_R), 3-22–3-24, 3-27, 4-34, 4-40
- Neutralization reactions, table of, 6-20
- Newton's equation, 10-2–10-3, 20-25, 20-26
- Newtonian fluids, 27-14
- Nitrate:
- in drinking water, 2-24
 - as an electron acceptor, 22-5
 - removal, 14-14–14-15
- Nitrification:
- and alkalinity, 22-18–22-19
 - ammonia oxidation, 22-16, 22-17–22-19
 - and denitrification, 23-8
 - growth kinetics, 22-18
 - oxygen requirements, 22-18, 23-30
- Nitrifying organisms, 22-18
- Nitrogen:
- and bacterial growth, 22-10
 - mass balance, 23-30
 - oxidation, 22-18
 - treatment, 22-17–22-21, 23-40, 23-48–23-93, 26-9
- Noise, control, 23-84
- NOM, 6-2, 6-22, 6-23, 7-2, 7-6, 7-26, 12-13
- Nomograph:
- for minor loss estimates, Appendix C
 - nomenclature, 17-21

- Noncarbonate hardness (NCH), 7-2, 7-4
precipitation of, 7-9
- Noncommunity water system, 2-29
- Nonconventional pollutants, 18-9, 18-10
- Noninterruptible chemical, 5-2, 5-4
- Nonionic polymer, 6-23, 15-28
- Non-Transient, Non-community Water System (NTNCWS), 2-29
- NPDES, 18-11, 25-2, 25-15, 26-2
- NPSH_A, NPSH_R, 3-22–3-24, 3-27, 4-34, 4-40
- NRC equations, trickling filter, 24-9
- NTU, 2-23, 14-22, 14-23
- Null alternative, 1-10, 1-15, 1-18
- Obligate:
- aerobes, 22-2
 - anaerobes, 22-3
- Observed yield (Y_{obs}), 23-27
- Occupational Safety and Health Administration (OSHA), 13-28, 19-37, 19-40
- Odor control, 28-6
- Oil and grease, 20-22
- ONPG-MUG test, 2-36
- Oocysts, *Cryptosporidium*, 2-35, 13-19–13-21, 13-33
- Operating capacity, ion exchange, 8-13–8-14
- Operating cost, 1-15
- Operating deck, 3-8
- Operating floor, 3-8
- Operation and maintenance (O&M):
- activated sludge process, 22-25
 - anaerobic digestion process, 27-50–27-52
 - coagulation/flocculation, 6-49
 - cost, 1-15–1-16
 - fluoridation, 13-46
 - granular filters, 11-45
 - ion exchange, 8-24
 - intake structures, 3-5, 3-34
 - lime-soda softening, 7-34
 - manual, 1-22, 1-23
 - MF/UF filters, 12-18
 - NF/RO softening, 9-17
 - settling tanks, 10-38, 21-24, 22-24–22-25
 - sewers and lift stations, 19-39
- Organic compounds as electron acceptors, 22-5
- Organic loading of trickling filter, 24-7
- Organotrophs, 22-2
- Orifice equation, 6-38, 16-21
- Ortho-, 26-2
- Orthokinetic flocculation, 6-23, 21-2
- OSHA, 13-28
- Osmosis, 9-3, 9-4
- Osmotic pressure, 9-3–9-4
- Outside-in, membrane, 12-10, 12-11
- Outside-in (cross-flow), membrane, 12-10, 12-11
- Overflow rate (v_o):
- defined, 10-9
 - determination of, 10-12–10-15
 - primary settling, 21-7
 - and return sludge, 21-7
 - secondary settling, 25-10–25-11
 - upflow solids contact basin, 7-31
 - water treatment,
 - and scale-up, 10-13
 - table of, 10-26
 - weir, 7-31, 10-27–10-28, 25-13
- Owner procured equipment, 1-18
- Oxidation ditch, 23-5, 23-10, 23-39, 23-40, 23-48–23-61
- Oxidation growth kinetics, 22-13–22-14, 22-17
- Oxidation ponds, 23-2–23-3, 23-4
- Oxidation/filtration iron removal, 14-5
- Oxidation-reduction reactions:
- arsenic, 14-2–14-3
 - chloramines, 13-6
 - chlorine, 13-2
 - dechlorination, 25-16
 - disinfection, 13-6
 - iron, 14-12–14-13
 - manganese, 14-13
 - microbial, 22-4–22-5
 - NAD, 22-4
 - NADP, 22-4
 - nitrate, 22-5
 - ozone, 13-6
 - sodium bisulfite, 25-16
 - sodium hypochlorite, 13-6
 - sodium metabisulfite, 25-16
 - sodium sulfite, 25-16
 - sulfate, 13-6, 22-5
 - sulfur dioxide, 25-16
 - table of half-reactions, 13-6
- Oxidative phosphorylation, 22-9
- Oxygen:
- for aerobic digestion, 27-30
 - demand, activated sludge, 23-29–23-35
 - and denitrification, 22-21
 - and DO, 23-29
 - as an electron acceptor, 22-4–22-5, 22-9, 22-15
 - for nitrification, 22-18
 - for ozone generation, 13-5
 - from photosynthesis, 22-3
 - solubility, table of, Appendix A
 - transfer, 23-31–23-35
- Ozone:
- and arsenic reactions, 14-3
 - contact chamber, 13-33
 - decay rate constant, 13-10
 - destruction, 13-27
 - disinfectant properties, 13-21
 - disinfection, 13-5–13-6, 13-9, 13-13
 - gas transfer rates, 13-35
 - and zebra mussels, 3-33
- PA membrane, 9-6
- PAC, 14-33, 26-12
- Packed tower, 14-22, 14-23
- Paddle flocculator, design, 6-44–6-49
- G values, 6-45
 - power for, 6-44
- PAO, 22-21
- Parshall flume, 20-5–20-8
- Partial-duration series, 2-13
- Partial lime softening, 7-13
- Particle:
- counting, 11-40
 - diffuse layer, electrical, 6-3
 - double layer, electrical, 6-3
 - electrical properties, 6-3
 - settling velocity, 10-3–10-5
 - sizes, 6-2
 - stability, 6-4–6-5
 - and van der Waals forces, 6-4
 - zeta potential, 6-3
- Pathogen and vector attraction reduction, 18-20–18-21

- Pathogens, in drinking water, 2-25, 13-13, 13-14, 13-16, 13-19
- Peak flow, 2-7, 2-8
- Peak hour, 18-5
- Peak hour demand, 17-2, 17-8
- Peak rate of demand, 2-7, 2-8
- Peaking factor, 17-2, 17-8
- Percent available chlorine, 13-6
- Percent removal,
 - disinfection, 13-19
 - membrane, 12-4
- Perchlorate removal, 14-18–14-19
- Performance design criteria, 1-11, 1-12
- Perikentic flocculation, 6-23
- Periodic table, inside front cover
- Permanent hardness, 7-4
- Permanganate, 3-33, 13-21
 - and arsenic reactions, 14-2
- Permeability, 12-12
- Permeate:
 - defined, 9-2
 - flux, 9-5–9-6, 12-5
 - recovery, 9-5
 - stability, 9-16–9-17
- Permit, NPDES, 18-11
- Personal protective equipment (PPE), 5-17–5-19, 13-28, 19-41
- PFRP, 18-18, 27-28, 27-39
- pH:
 - and bacterial growth, 22-7, 22-19, 22-24
 - and bulking sludge, 22-24
 - and chloramine formation, 13-27
 - and coagulation, 6-16–6-22
 - defined, 6-21
 - and disinfection, 13-2, 13-16, 13-21, 13-26
 - and NaOCl storage, 13-26
 - and phosphorus removal, 22-24, 26-3
 - and softening, 7-8, 7-10–7-13, 7-15, 7-26
 - of wastewater, 18-9
- Pharmaceuticals, 14-20
- Phoredox, 23-10
- Phosphorus:
 - accumulating organisms (PAOs), 22-21–22-22, 23-78
 - biological removal of, 22-16, 22-21–22-24, 23-10–23-12, 23-40, 23-75–23-95
 - and biological treatment, 22-10
 - chemical precipitation of, 26-2–26-5
 - in wastewater, 18-7, 18-9
- Phosphorylation, 22-9
- Photosynthesis, 22-3
- Phototrophs, 22-2
- Physical threats, 16-31
- PID, 16-26, 16-27
- Piezometric surface, 2-18, 2-19
- Pipe materials:
 - asbestos-cement pipe (ACP), 17-11
 - chlorinated polyvinyl chloride, 5-14
 - copper, 5-15
 - ductile iron pipe (DIP), 17-11, 19-6, 19-10, 19-34
 - fiberglass-reinforced polyester, 5-15
 - high-density, cross-linked, polyethylene (HDXLPE), 5-14
 - high-density polyethylene (HDPE), 17-11, 19-10
 - polypropylene, 5-15
 - polyvinyl chloride (PVC), 3-30, 5-14, 5-15, 17-11, 19-10, 19-31
 - reinforced concrete pressure pipe (RCCP), 17-11, 19-10
 - selection, 5-15, 17-11, 19-10
 - steel for casing, 4-6–4-7
 - truss pipe, 19-11
 - type 304 stainless steel, 5-15
 - type 316 stainless steel, 5-14, 5-15
 - vitriified clay pipe (VCP), 19-10
- Pipe network analysis, 17-13–17-16, 17-36–17-38
- Pipe network design equations, 17-12–17-13
- Piping:
 - air, 23-84–23-85
 - chemical compatibility, 5-14, 5-15
 - design criteria, 17-12
 - digester gas, 27-45
 - sewer, 19-10, 19-31
 - sludge, 27-15
 - water, 17-12
- pK_a , 6-12, 7-15
 - table of, Appendix A
- pK_{sp} , 7-7
 - table of, Appendix A
- pK_w , 6-13
- Plant hydraulics, 16-19–16-25
- Plant layout, 16-16–16-19
- Plate, pressure filter for sludge, 15-16, 15-40–15-42, 27-4, 27-57
- Plate settlers, 10-16–10-19, 10-22–10-23, 10-33–10-35, 21-25
- PLC, 23-63
- Plug flow:
 - activated sludge, 23-5
 - with reaction, 23-21
 - reactor, 23-5
- Point of entry, (POE), 8-2
- Point of use, 8-2
- Polio virus, 13-16–13-17
- Polishing ponds, 23-2
- Polyamide (PA) membrane, 9-6
- Polychlorinated biphenyl (PCB), 18-14
- Poly-DMA, 6-7, 6-23
- Polyelectrolytes, 6-6
- Polyethersulfone, (PES), 12-9
- Polyhydroxybutyrate (PHB), 22-21–22-23
- Polymers, 6-23, 15-28
- Polyphosphate, 26-2
- Polypropylene, (PP), 12-9
- Poly sulfone (PS), 12-9
- Polyvalent cations, 7-2
- Polyvinylidene difluoride (PVDF), 12-9
- Population dynamics, microorganism, 22-11–22-13
- Porosity, of rapid filter, 11-6, 11-7, 11-13, 11-14
- Porosity of aquifers, 2-20
- Ports, intake, 3-9, 3-11
- Postaeration, 25-21
- Posttreatment, RO/NF, 9-9
- POTW, 18-14
- Powdered activated carbon (PAC), 14-33, 26-12
- Power:
 - blower, 23-83
 - and head, 6-31
 - number, 6-34
 - pump motor, 3-19, 4-33
 - requirements for mixing, 6-25
 - and static mixer, 6-31
- Precipitation:
 - chemical, 7-6–7-9
 - of phosphorus, 26-2–26-5

- Precursor:
 - defined, 2-34
 - trihalomethanes, 2-34
- Preferred operating range (POR), 3-28
- Preliminary design, 1-10, 1-16
- Preliminary treatment, defined, 20-2
- Preliminary treatment process
 - arrangements, 20-46
- Prescriptive design criteria, 1-11
- Presence-absence coliform test, 2-36
- Press, filter, 15-16, 15-40–15-42, 27-4, 27-57
- Pressure:
 - drop, ion exchange, 8-16
 - drop, packed tower, 14-24
 - drop, static mixer, 6-31
 - head, 3-18
 - membrane, 12-12
 - operating, MF/UF, 12-15
 - operating, RO/NF, 9-11
 - osmotic, 9-3
 - water, 17-9–17-10
- Pretreatment for RO/NF, 9-9
- Pretreatment of industrial waste, 18-13–18-14
- Primary disinfectant, 13-19, 13-22
- Primary Drinking Water Regulations (IPDWRs), 2-29
 - maximum contaminant levels (MCLs), 2-28
- Primary electron donor, 22-4
- Primary sedimentation:
 - baffles, 21-15–21-16, 21-21
 - and BOD, 21-4, 21-7
 - chain-and-flight scraper, 21-4
 - circular tanks, 21-4
 - depth of tank, 21-3, 21-11
 - detention time, 21-2, 21-7
 - dimesions, 21-11, 21-20
 - feedwell, 21-15
 - flocculation center well, 21-14
 - flow distribution, 21-20–21-21
 - flow-splitting box, 21-4, 21-11–21-12
 - freeboard, 21-11, 21-20
 - geotechnical considerations, 21-8–21-11
 - hydraulic detention time, 21-2, 21-7
 - hydraulic load, 21-6–21-7
 - inlet configuration, 21-14–21-15, 21-24–21-22
 - launder, 21-16
 - overflow rate, 21-7
 - overflow rate and return sludge, 21-7
 - rectangular tanks, 21-4
 - scour velocity, 21-3
 - scum beach, 21-17
 - scum removal, 21-16, 21-23
 - side water depth (SWD), 21-3, 21-11
 - sludge hopper, 21-6, 21-8, 21-19, 21-22
 - sludge scraper, 21-16, 21-22
 - splitter box, 21-4, 21-11
 - velocity of flow, 21-3, 21-7
 - weir configuration, 21-16, 21-22
 - weir loading, 21-7
- Priority pollutants, table of, 2-26
- Process alternatives, activated sludge, 23-5–23-13
- Process redundancy, 1-12–1-14
- Process to further reduce pathogens (PFRP), 18-18, 27-28, 27-39
- Process to significantly reduce pathogens (PSRP), 18-19, 27-38, 27-39
- Professional ethics, 1-3–1-9
- Programmable logic controller (PLC), 16-26, 16-29, 23-63
- Prohibited discharge standards, 18-13
- Proportional, plus integral, plus derivative control system (PID), 16-27
- Proportional control, 16-27
- Protoplasm, 22-2
- Protozoa, 22-4
- PSRP, 18-9, 27-38, 27-39
- Psychrophiles, 22-3
- Public water supply systems, defined, 2-28–2-29
- Publicly owned treatment works (POTW), 18-14
- Pump:
 - acceptable (or allowable) operating region (AOR), 3-28
 - axial flow, 19-32
 - best efficiency point (BEP), 3-27
 - bowl, 3-17, 3-18
 - break power, 3-19
 - capacity, 3-19
 - cavitation, 3-21
 - column pipe, 3-17, 3-18, 4-4, 4-6
 - discharge, 3-18
 - discharge head, 3-18
 - discharge pressure, 3-18
 - drive,
 - adjustable frequency (afd), 3-18
 - constant speed, 3-18
 - variable frequency (vfd), 3-18, 17-32
 - variable speed (vsd), 3-18
 - head-discharge curve, 3-27, 4-40
 - high-lift, 3-2
 - high-service, 3-2, 17-32
 - horizontal centrifugal, 17-32
 - impeller, 3-17, 3-18
 - low-lift, 3-2
 - low-service, 3-2
 - mixed-flow volute, 19-32
 - nonclog, radial-flow, 19-32, 19-33
 - parallel and series operation, 17-33–17-36
 - power, 3-19, 4-33
 - preferred operating range (POR), 3-28
 - selection, 3-26–3-28, 17-32–17-36, 19-32–19-33, 27-11–27-13
 - sludge, 27-11–27-13
 - split case, 17-32, 17-33
 - stage, 3-18, 3-27
 - station, 3-2, 17-32
 - submersible, 4-26–4-27
 - terminology, 3-17–3-18
 - vertical turbine, 3-17–3-18, 4-4, 4-6, 17-32
 - well, 4-26, 4-27
- Pump house, 4-14
- Pump station:
 - floor, 3-8
 - high-service, 3-2
 - low-lift, 3-2
 - low service, 3-2
 - operating deck, 3-8
 - operating floor, 3-8
 - wastewater, 19-31–19-39
- Pumping, sludge, 15-15, 27-11–27-15
- Pumping test curve, 4-20–4-21
- Punch list, 1-22

- QBS, 1-2
- Qualified bidder selection (QBS), 1-2
- Quantitative flow diagram, 27-6–27-10
- Quicklime, 5-9, 7-7, 27-23

- Radial-flow impeller, 6-33, 6-34
- Radiological characteristics of drinking water, 2-27

- Radium-226, removal of, 14-21
- Radon-222, removal of, 14-21
- Ranney well, 3-5, 3-7
- Rapid mix:
 - detention times, 6-25, 6-26, 6-27, 6-30, 6-33
 - G values, 6-25, 6-26, 6-27, 6-30, 6-33
 - geometries, table of, 6-34
 - power, 6-34
 - tanks, 6-33
- Rapid sand filter, 11-4, 11-13–11-20
- RAS, 23-24
- Rate, *see* Loading rate
- Rate control, filter, 11-35–11-36
- Ratio of extreme flows, 2-8
- Raw:
 - sewage, 18-7–18-9
 - sludge, 21-3
 - water, 1-11, 2-27–2-28
- Reactors:
 - completely mixed flow reactor (CMFR), 6-33
 - completely stirred tank (CSTR), 6-33
 - disinfection, 13-29–13-35
 - plug flow, 13-29, 23-5
- Recarbonation, 7-11, 7-14–7-15
 - basin design, 7-38
- Recirculation ratio, 24-9
- Recommended Standards for Water Works, 2-7
- Recovery ratio (r), NF/RO, 9-5–9-6
- Recurrence interval, 2-8
- Redundancy:
 - process, 1-12–1-14
 - well, 4-16
- Redox reactions:
 - biochemical, 22-4–22-5
 - chlorination, 13-6
 - dechlorination, 25-6
 - half reactions, table of, 13-6
 - See also* Oxidation-reduction reactions
- Refractory organics, 26-12
- Regeneration of ion exchange, 8-11, 8-19
- Reject, defined, 9-2, 9-6
- Rejection:
 - MF/UF, 12-4
 - NF/RO, 9-6
- Reliability, 1-12–1-14
- Remote terminal units (RTU), 16-26, 16-29
- Request for proposals (RFP), 1-2
- Request for qualifications (RFQ), 1-2
- Reservoir intake structures, 3-4–3-6
- Reservoirs, 2-15
- Resident project representative (RPR), 1-20–1-21
- Residuals, water treatment:
 - arsenic, 15-45–15-47
 - beneficial use, 15-50
 - defined, 7-10, 15-2
 - fluoride, 15-48
 - ion exchange, 15-10
 - iron and manganese, 15-48
 - liquid, 15-44–15-45
 - management, 15-2
 - membrane, 15-9
 - MF/UF, 15-45
 - NF/RO, 15-46
 - nitrate, 15-48
 - perchlorate, 15-48
 - radioactive, 15-48–15-50
 - sludge, 15-2
 - spent filter backwash water (SFBW), 15-2
 - synthetic organic chemicals (SOC), 15-48
- Resins, ion exchange:
 - effective size, 8-10
 - particle size, 8-9–8-10
 - properties of, 8-5–8-10
 - and turbidity, 8-10
 - types, 8-2
 - uniformity coefficient, 8-10
- Responsible care, 1-20–1-21
- Retention basin, 2-15
- Retention time (t_0 or θ), *see* Detention time
- Return activated sludge (RAS), 21-7, 23-4, 23-24
- Return period, 2-8
- Return rate, activated sludge, 23-24–23-29
- Return sludge, 23-15, 23-24
- Reverse osmosis/nanofiltration:
 - array, 9-8, 9-10
 - array design, 9-15–9-16
 - and arsenic removal, 14-5
 - brine disposal, 9-11
 - concentrate, 9-9, 9-11
 - configuration, 9-6–9-7
 - defined, 9-2, 9-3
 - flux, 9-5–9-6
 - fouling, 9-8, 9-9
 - hollow-fiber, 9-6, 9-8
 - and limiting salt, 9-8, 9-11–9-15
 - membrane material, 9-6
 - operating pressure, 9-11
 - and osmosis, 9-3
 - and osmotic pressure, 9-3
 - permeate, 9-2
 - and posttreatment, 9-9
 - and pretreatment, 9-9
 - and radionuclide removal, 14-21
 - and recovery of feed water, 9-5–9-6
 - rejection, 9-6
 - scaling, 9-9
 - service life, 9-7
 - spiral-wound, 9-6–9-7
 - and stabilization, 9-16–9-17
 - stage, 9-8
 - and TDS, 9-11
 - and temperature effects, 9-7, 9-17
- Reynolds number (R):
 - defined, 10-4
 - and drag coefficient, 10-4
 - and filter headloss, 11-14–11-20
 - and gravity sedimentation, 10-4–10-5, 10-26, 10-29, 10-33
 - and high-rate settler, 10-34
 - and mixing, 27-26
 - and settling tank turbulence, 10-19, 10-26–10-27
- RFP, 1-2
- RFQ, 1-2
- Rippl method, 2-15–2-18
- Rising sludge, 22-25
- River bank filtration, 16-10
- Rose equation, 11-13
- Rotary-drum thickening, 27-20
- Rotating biological contactor (RBC), 24-12–24-13
- Rotifers, 22-4
- Running torque, 15-22
- Run-of-bank sand, 11-6
- SAC, 8-2, 8-8
- SAE, 23-33
- Safe Drinking Water Act (SDWA), 2-28

Safety:

ammonia, 13-27–13-28
 anaerobic digester gas, 27-44–27-45
 carbon dioxide, 7-38
 chemical handling, 13-25–13-29, 13-45
 chloramine, 13-27
 chlorine, 13-25–13-26
 chlorine dioxide, 13-27
 digester gas, 27-44–27-45
 and disinfection, 13-21
 and fluoridation, 13-45
 manhole, 19-40
 mechanical dewatering, 27-58
 ozone disinfection, 13-27
 personal protective equipment (PPE),
 13-28
 recarbonation, 7-38
 self-contained breathing apparatus
 (SCBA), 13-28

Safety factors:
 activated sludge, 23-21–23-22,
 23-50–23-51, 23-78
 anaerobic digestion, 27-39

Salmonella in sludge, 18-17
Salmonella typhi, 13-13

Sand drying beds for sludge,
 15-28–15-35

Sand filter, *see* Rapid filter

Sanitary:
 protection of storage tanks, 17-38
 protection of water mains, 17-39
 seal, well, 4-34
 sewage, 18-1
 sewer, 18-5, 18-7

Saturation concentration of
 oxygen in water, table of, Appendix A

Saturation index, Langelier, 7-34–7-36

SBA, 8-8

SBR, 23-7, 23-62–23-75

SCADA, 16-26–16-31

SCADA security, 16-34

Scaling, RO/NF, 9-9

Scale-up factors, settling column data,
 10-13

SCBA, 13-28, 17-38

Schultz-Hardy rule, 6-9

Schulze's equation, 24-10

Scour velocity, 20-26, 21-3

Scouring in sedimentation tank, 21-3

Screening, membrane, 12-3

Screenings, 20-20, 20-23

Screenings, management of, 27-17

Screens, 20-10

Screens:
 wastewater, 20-13–20-23
 water intake, 3-10, 3-11, 3-15
 well, 4-10, 4-30–4-33

Screw pump, 20-2–20-5

Scum beach, 21-7

Scum removal, 21-16, 21-23

SDNR, 23-36

Second-order decay, 13-10

Second stage digestion, 27-42

Secondary clarifier, *see* Secondary
 settling tank

Secondary containment, 5-5

Secondary disinfectant, 13-19, 13-23

Secondary maximum contaminant levels
 (SMCL), 2-37
 table of, 2-37

Secondary settling tank:
 denitrification in, 22-25
 design criteria, 25-9–25-15
 overflow rates, 25-10–25-11
 side water depth (SWD), table of, 25-13
 sludge removal, 25-14
 solids loading, 25-12–25-13
 state point analysis, 25-2–25-6
 trickling filter, 24-2, 25-2
 weir loading, 25-13

Secondary sludge, 25-14, 27-5–27-6

Secondary treatment, defined, 18-11

Security, 16-31–16-35

Sediment and reservoirs, 2-18

Sedimentation,
 activated sludge, *see* Secondary settling
 basin, 10-2
 grit, 10-2
 Type I, 10-2, 10-4, 25-2
 Type II, 10-2, 10-12, 25-2
 Type III, 10-2, 10-15–10-16, 15-17,
 25-2
 Type IV, 10-2, 10-15–10-16, 15-17,
 25-2
 zones, 10-8
See also Settling tank

Self-contained breathing apparatus
 (SCBA), 13-28, 17-38

Selective calcium removal, 7-13

Selectivity, ion exchange, 8-5, 8-9

Selector, 22-16, 22-24, 23-8

Semipermeable membrane, 9-2, 9-3

Separation factors, ion exchange, 8-8

Sequencing batch reactor (SBR), 23-7,
 23-10–23-12, 23-19–23-21,
 23-39, 23-40, 23-62–23-75

Serpentine contact chambers, 13-30,
 13-33–13-34

Service flow rate (SFR), 8-14, 8-15

Service life:
 design, 2-2, 2-3
 ion exchange resin, 8-10
 membrane, 9-7, 12-12

Settling column, 10-12, 10-16

Settling tank, water treatment:
 baffles, 10-25
 ballasted, 10-16, 10-53–10-25
 detention time, 10-10
 diffuser wall, 10-25
 freeboard, 10-26
 high-rate, 10-16–10-19, 10-22–10-25,
 10-33–10-35
 horizontal flow clarifier,
 particle trajectory, 10-15
 percentage removal, 10-11
 hydraulic surface loading, 10-9
 ideal, 10-8
 inclined plate, 10-16–10-19,
 10-22–10-23, 10-33–10-35
 inclined tubes, 10-16–10-19,
 10-22–10-23
 inlet zone, 10-8, 10-25, 10-33
 outlet zone, 10-8, 10-27, 10-34
 overflow rate, 10-9, 10-12
 overflow rates, table of, 10-26
 removal efficiency, 10-11
 scale-up factors, 10-13
 short-circuiting, 10-20
 side water depth, 10-25
 sludge,
 hopper, 10-28
 scraper, 10-21, 10-28
 storage, 10-8, 10-28
 volume, 15-3–15-5
 surface loading rate, 10-9
 turbulence, 10-19
 upflow clarifier, 10-9
 weir arrangement, 10-27
 weir overflow rates, 10-28
 zones, 10-8, 10-28

- Settling velocity, 10-3–10-7
and Solver program, 10-6
- Sewage:
domestic, 18-7–18-9
flow rates, 2-4–2-6, 18-3–18-7
industrial, 18-9–18-10
lagoon, 23-2
raw, 18-7–18-9
- Sewer design:
alignment, 19-13
changes in pipe size, 19-14
design equations, 19-15
flow rates, 19-10
layout, 19-20
manholes, 19-14
minimum slopes, 19-13
pipe material selection, 19-10
slope, 19-13
- Sewer gases, 19-40
- Sewer nomenclature, 19-2
- Sewer safety, 19-40–19-41
- Sewers:
combined, 18-4
grinder pump (GP), 19-29, 19-30
pressure pipe, 19-30–19-31
sanitary, 18-7
septic tank effluent pump (STEP),
19-29, 19-30
small-diameter gravity (SDG), 19-28,
19-30
storm, 18-4
vacuum, 19-29–19-30
- Side water depth (SWD):
primary settling tank, 21-3, 21-8, 21-11
rectangular basin, water, 10-25
secondary settling tank, 25-13
upflow solids contact basin, 7-31
- SI units, inside back cover
- Sieve:
analysis, 11-5–11-8
U.S. Standard, Appendix B
- Simulation modeling, 28-24–28-25
- Single sludge, 23-10
- Site restrictions, Class B biosolids, 18-19
- Slaking, 5-9, 7-7
- Slip stream, 13-29
- Slippage, screw pump, 20-3
- Slot size, well screen, 4-31–4-32
- Slotted baffle, 21-21
- Slow sand filter, 11-4
- Sludge:
503 regulations, 18-14–18-21
age, *see* Solids retention time (SRT)
alum, 15-6–15-7
blanket, 25-14–25-15
blanket clarifier, 10-20
bulking, 22-18
cake, 15-5, 15-16, 15-38–15-40
centrifuging, 15-36–15-38, 27-54
characteristics of,
alum, 15-7, 15-21
coagulation, 15-6–15-7, 15-21
grit, 27-3
iron, 15-7, 15-21
raw, wastewater, 27-5
screenings, 27-3
secondary, 27-5–27-6
spent filter backwash, 15-21
tertiary, 27-6
- Class A pathogen requirements, 18-17
and fine screens, 20-23
- Class B pathogen requirements, 18-17,
18-18
- collectors, 10-21, 10-22, 10-24
conditioning, 15-16, 27-2, 27-52–27-53
continuous belt filter press (CBFP),
15-39–15-40, 27-55–27-57
dewatering, 15-5, 15-23–15-44, 27-2,
27-53–27-58
disposal regulations, 18-14–18-21
drainage, 15-28
drying bed, 15-28–15-35, 27-53–27-54
ferric, 15-7
filter backwash, 15-2
filter press, 15-40–15-44, 27-57
freeze treatment, 15-35
handling options, 27-2–27-4
hopper, settling tank, 10-21, 10-24,
10-28, 21-19, 21-22
inclined screw press, 27-57
iron, 15-7, 15-9
lagoon, 15-24–15-27
management, 15-15–15-16
manganese, 15-8
mass balance, 15-10
mechanical collectors, 10-21, 10-22,
10-24
minimization, 15-11–15-13
nonmechanical dewatering,
15-24–15-35
- pipng, 27-15–27-16
plate and frame filters, 15-40–15-44
preliminary operations, 27-2
primary, 21-3, 27-5
production, 15-7–15-8, 23-27–23-29
pumping, 15-15, 27-11–27-15
headloss, 15-15, 27-14–27-15
raw, 21-3, 27-5
reduction, 15-11–15-15, 27-2
regulations, 18-14–18-21
retention time (SRT), 23-4,
23-39–23-40
return, 23-24–23-26
rising, 22-25
sand drying beds, 15-28–15-35
scrapers, 10-21, 10-22, 10-24, 21-16,
21-22
secondary, 27-5–27-6
softening, 15-8
solar drying, beds, 15-35
specific gravity, 15-3–15-5, 15-8,
15-21
stabilization, 22-2, 27-2
standards, 18-14–18-21
storage, settling tank, 10-8, 10-28,
25-14, 25-15
storage for equalization, 27-18
tertiary, 27-6
thickening, 15-16–15-23, 27-2,
27-18–27-23
ultimate disposition, 15-49–15-51,
27-59–27-60
utilization, 27-59
vacuum filtration, 15-38–15-39
vector attraction reduction, 18-20,
18-21, 27-24
volume,
coagulation, 15-7
and mass relationships, 15-3–15-5
reduction, 15-5
wasting, 23-4, 23-27
water treatment plant, 15-2
- Sludge volume index (SVI), 23-38–23-39
- SOC, 15-48, 16-6
- Soda ash (soda), 6-20, 7-8
- Sodium carbonate, 6-20, 7-8
- Sodium fluoride, 13-42–13-44
- Sodium fluorosilicate, 13-42–13-44
- Sodium hydroxide, 6-20
and softening, 7-25–7-26

- Sodium hypochlorite:
 and bleach, 13-42
 considerations for selecting, 13-21
 and pH, 13-26
 safety, 13-26
 storage, 13-26
 and well disinfection, 4-13
- Sodium in drinking water, 2-24
- Softening:
 and air stripping, 7-12
 and alkalinity, 7-3
 and bicarbonate, 7-7-7-9
 and carbon dioxide, 7-8
 and carbonate, 7-7-7-9
 and carbonate hardness (CH), 7-8
 cases, 7-12, 7-13
 and caustic soda (NaOH), 7-25-7-26
 chemistry, 7-6-7-11
 and concurrent removal of other constituents, 7-26-7-27
 defined, 7-5
 empirical considerations, 7-10
 excess lime, 7-13
 floc, 7-27
 and fluoridation, 13-45
 and magnesium concentration, 7-22
 mixing, 7-28, 7-30, 7-31
 and noncarbonate hardness (NCH), 7-9
 other estimating methods, 7-25
 and pH, 7-9-7-10
 to practical limits, 7-10, 7-13, 7-20-7-22
 process limitations, 7-10-7-11
 processes, 7-11-7-15, 7-29
 reactions, 7-6-7-11
 and recarbonation, 7-11, 7-14-7-15
 selective calcium removal, 7-13, 7-17-7-19
 sludge, 7-34, 15-8, 15-12, 15-14
 and sodium hydroxide, 7-25-7-26
 and split treatment, 7-14, 7-22-7-25
 and stabilization, 7-36-7-39
 and stripping, 7-12
 upflow solids contact basin, 7-30-7-34
- Solar drying bed, 15-35
- Solid bowl centrifuge, 15-16, 15-36-15-37, 27-54
- Solids:
 computations, 15-3-15-5, 27-6-27-11
 dissolved, 18-7
 flux, 15-8, 15-9, 25-2, 27-18
 loading rate, 25-12
 mass balance, 15-10
 settleable, 18-7
 suspended, 18-7
- Solids retention time (SRT):
 aerobic digestion, 27-28-27-29
 anaerobic digestion, 27-38, 27-39
 for biological nitrogen removal, 23-40
 for biological phosphorus removal, 23-40
 conventional activated sludge, 23-39
 definition, 23-4
 for MBR, 23-96
- Solubility:
 product constant, 7-6-7-9
 reactions for softening, 7-8-7-9
 table of, Appendix A
- Solute, RO/NF, 9-3
- Solvent, RO/NF, 9-3
- Solver program for:
 baffle wall, 6-38-6-41
 bar rack, channel, 20-14-20-17
 filter box, 11-24, 11-25
 ion exchange vessel, 8-21-8-24
 laundry, 16-23
 particle settling velocity, 10-6-10-7
 return activated sludge, 23-25-23-27
- SOR, 25-15
- SOTE, 23-33
- SOTR, 23-32
- SOUR, 27-29
- Specific denitrification rate (SDNR), 23-36-23-38
- Specific gravity of:
 alum floc, 10-16
 filter media, 11-6-11-7
 lime floc, 10-16
 microorganisms, 22-2
 sludge, 15-7, 15-8
- Specific growth rate, 22-13
- Specific heat, 27-47
- Specific oxygen utilization rate (SOUR), 27-29
- Specific substrate utilization rate (U), 23-19
- Specific weight of water, table of, Appendix A
- Specific yield of aquifer, 2-20
- Spent filter backwash water (SFBW):
 freeze treatment of, 15-35
 solids, 15-8, 15-21
- Sphericity of filter materials, 11-7, 11-14
- Spiral-wound membranes, 9-6-9-7
- Splitter box, 21-4, 21-11, 25-10
- Sprinkler systems, for fire protection, 17-3-17-6
- SRT, 23-4, 23-39-23-40, 27-28-27-29, 27-38, 27-39
- Stability of particles, 6-4
- Stabilization of:
 lime-soda softened water, 7-14, 7-36-7-39
 NF/RO softened water, 9-16-9-17
 wastewater sludge, 27-23, 27-27-27-28, 27-38
- Stabilization pond, 23-2
- Stage, RO/NF, 9-8
- Staged activated sludge, 23-7
- Standard aeration efficiency (SAE), 23-33
- Standard oxygen transfer efficiency (SOTE), 23-33
- Standard oxygen transfer rate (SOTR), 23-32
- Standards:
 503, 18-14-18-21
 biosolids, 18-14-18-21
 sludge, 18-14-18-21
 wastewater, 18-11-18-14
 water, 2-28-2-37
- Standpipe, 17-22
- State point analysis, 25-2-25-6, 27-18
- Static mixers, 6-29-6-33
 aspect ratio, 6-29
 elements, 6-29
 power, 6-31
 power and head, 6-31
 pressure drop, 6-31
- Static water table, 4-16
- Stationary phase, log growth curve, 22-11
- Step aeration, 23-5, 23-10
- Step feed, 23-5, 23-10
- Step screens, 20-21
- Sterilization, 13-2
- Stokes law, 10-2-10-4
- Storage coefficient, 4-17, 4-20
- Storage of chemicals, 5-3-5-7
- Storage reservoir, 2-15
- Storage tank:
 appurtenances, 17-28-17-30
 disinfection, 17-38

- levels, 17-26
- location, 17-23–17-25, 17-38
- sanitary protection, 17-38
- terminology, 17-22
- typical, 17-46
- volume, 17-26–17-28
 - for equalization storage, 17-26
 - for emergencies, 17-26, 17-27
 - examples, 17-46
 - for fire demand, 17-26, 17-27
 - and water quality, 17-30–17-31
- Stormwater, 18-2
- Streaming current detector, 6-49
- Stripping:
 - carbon dioxide, 7-12
 - tower, 14-22, 14-23
- Strong acid cation exchangers (SAC), 8-2, 8-8
- Strong base anion exchangers (SBA), 8-8, 14-14, 14-18
- Study and conceptual design, 1-10–1-16
- Submerged intake, 3-5, 3-6
- Submerged orifice, 21-20
- Substrate, waste as a, 22-9, 22-12
- Substrate utilization rate, 23-19
- Suction bell, wet well, 3-16, 19-36
- Sulfate:
 - in drinking water, 2-24
 - as an electron acceptor, 22-5
- Sulfide oxidant demand, 13-23
- Sulfur dioxide, 25-16, 25-17
- Sunk cost, 1-15
- Supervisory control and data acquisition (SCADA), 16-26–16-31
- Supervisory control and data acquisition (SCADA) security, 16-34
- Support media, filter, 11-26
- Surface loading rate (SLR), 8-16
 - granular filter, 11-4, 11-42, 11-43
 - ion exchange column, 8-16
 - settling tank, 10-9
- Surface overflow rate (SOR), 25-15
- Surface wash, filter, 11-29–11-30
- Surface water treatment rule (SWTR), 2-35
- Suspended growth process, 23-2
- Suspended solids (SS):
 - and biomass, 23-3
 - digester supernatant, 27-58
 - filtration, 26-5
 - residual, 27-58
- Sustainable development, 1-7
- Sweep coagulation, 6-9, 6-16, 6-17, 6-25, 6-26, 6-33
- SWTR/ESWTR, 2-35, 16-6
- Synthetic organic compounds, SOC, 15-48
 - removal of, 14-22
- System head curves, 3-24–3-25, 17-35–17-36
- System reliability, 1-12–1-14
- Tapered aeration, 23-8
- Target baffle, 10-20, 21-21
- Taste and odor, 2-23, 13-11, 14-31–14-36
- TCLP, 15-45
- TDH, 3-19
- TDS, 2-37, 7-35
- Temperature:
 - and aerobic digestion, 27-29
 - and anaerobic digestion, 27-37
 - and backwashing, 11-28
 - and bacterial growth, 22-3
 - and Ct tables, 13-36, Appendix D
 - and density currents, 10-20
 - of drinking water, 2-23
 - and flocculation, 6-37
 - and kinetic coefficients, 23-50, 27-38
 - and membrane performance, 9-7, 9-16, 12-10
 - and short circuiting, 10-20
 - and wastewater, 18-7
- Temperature correction:
 - for aeration, 23-32
 - for heterotrophic bacteria kinetic coefficients, 23-50
 - for NF/RO, 9-7, 9-16
 - for nitrification kinetic coefficients, 23-50
 - for oxygen transfer, 23-32
- Temporary hardness, 7-3
- Terminal electron acceptor, 22-4
- Terminal head loss, 11-3, 11-16
- Terminal settling velocity (v_s), 10-3
 - calculation of, 10-3, 10-4–10-7
- Tertiary:
 - ponds, 23-2–23-3
 - sludge, 27-6
 - treatment, defined, 26-2
- Text Web site: www.mhprofessional.com/wwe
- TH, 7-2
- Theis equation, 4-17
- Theoretical detention time (t_0 or θ), *see* Detention time; Retention time
- Thermophiles, 22-3
- Thickener design, 15-20–15-23
- Thickening, sludge, 15-16–15-23, 27-18–27-23
- Thiem equation, 2-20
- Throat, Parshall flume, 20-5, 20-6
- TMDL, 18-12–18-13
- TOC, 13-9, 13-19, 13-22, 13-45
- Torque, running, 15-22
- Total coliforms,
 - analytical methods, 2-36
- Total dissolved solids (TDS), 2-37, 7-35, 9-11
- Total dynamic head (TDH), 3-19
- Total haloacetic acids (HAA5), 2-34
- Total hardness (TH), 7-2
- Total Kjeldahl nitrogen (TKN):
 - in digester supernatant, 27-58
 - in wastewater, 18-7, 18-8
- Total maximum daily load (TMDL), 18-12–18-13
- Total organic carbon and NOM, 14-15, 14-17
- Total organic carbon (TOC), 13-9, 13-19, 13-22, 13-45
- Total suspended solids (TSS), 18-9, 18-11
- Total trihalomethanes (TTHM), 2-34
- Tower, absorption
- Tower, intake, 3-3, 3-6, 3-9
- Toxic inorganic substances,
 - in drinking water, 2-24–2-25
- Toxic organic substances in drinking water, 2-25
- Toxicity characteristic leaching procedure, (TCLP), 15-45
- Trade percent, 13-26
- Transient Non-Community Water System (TNCWS), 2-29
- Transmembrane pressure (TMP), 9-5, 12-5
- Transmission main, 17-2
- Transmissivity, 2-20, 4-17, 4-20–4-21
- Traveling bridge sludge collector, 10-21
- Treatment ponds for wastewater, 23-2–23-3, 23-14
- Treatment train, 16-2

- Tricarboxylic acid cycle, 22-6, 22-8
- Trichloramine, 13-4
- Trickling filter:
 - design criteria, 24-6–24-8, 24-11–24-12
 - design equations, 24-8–24-11
 - media, 24-2–24-4
 - settling tank, 25-2
 - two stage, 24-8
- Trihalomethanes (THMs):
 - defined, 2-34
 - precursors, 2-34, 13-8
 - and softening, 7-26
 - total (TTHMS), 2-34
- Trunk line, 17-2
- T-screens, 3-13
- TSS, 18-9, 18-11
- TT, 2-29
- Turbidity:
 - and coagulation, 6-22
 - defined, 2-23
 - and disinfection, 13-20, 13-36
 - and filtration, 11-2, 11-3
 - and ion exchange, 8-10
 - limits, 2-35–2-36, 11-2
 - and MF/UF, 12-13
 - and RO/NF membranes, 9-9
 - and softening, 7-27
- Turbidity unit (TU), 2-23
- Turn-down ratio, 5-2
- Type I, II, III and IV settling,
 - see* Sedimentation

- U, 8-10, 11-5, 23-19
- UCT, 23-11, 23-12
- Ultrafiltration (UF), 9-2, 9-3, 12-2, 12-3
 - See also* Microfiltration; Ultrafiltration
- Ultraviolet radiation:
 - and disinfection, 13-2, 13-7–13-8, 13-13, 13-17, 25-17–25-20
 - dose for disinfection, 25-20, Appendix D
- Unconfined aquifer, 2-21
- Underdrains, filter, 11-26–11-28
- Underground storage tanks (UST)
- Uniformity coefficient (U):
 - defined, 4-31, 8-10, 11-5
 - filter media, 11-7
 - ion exchange resin, 8-10
 - and well screens, 4-31
- Units of measure, SI, inside back cover

- Universal gas constant, Appendix A
- University of Cape Town (UCT), 23-11, 23-12
- Upflow clarifier, 10-20, 10-21
- Upflow solids-contact basin, 7-30–7-34
- Uranium-234, removal of, 14-21
- U.S. Standard Sieve Series, 11-5, Appendix B
- UV ballasts, 13-36
- UV disinfection, 13-2, 13-7–13-8, 13-13, 13-17
- UV dose, Appendix D
- UV radiation, 13-7–13-8, 13-29
- UV reactors, 13-35
- UVA, UVB, UVC, 13-8

- Vacuum filter for sludge, 15-38–15-39
- Valve headloss coefficients, 3-20,
 - table of, Appendix C
- Valve placement, 17-20
- Valve selection, 17-16–17-20
- van der Waals forces, 6-4
- Vapor pressure as a function of temperature,
 - table of, 3-24
- Variable frequency drive (vfd), 3-18, 17-32, 19-35, 23-83
- Variable speed drive (vsd), 3-18, 17-32
- Vector attraction reduction requirements, 18-20, 18-21, 27-24
- Velocity controlled grit chamber, 20-27
- Velocity gradient (G):
 - defined, 6-24–6-25
 - typical values,
 - flash mixing, 6-25, 6-26–6-36
 - flocculation, 6-26, 6-37, 6-45
 - rapid mix, 6-25, 6-26–6-36
 - softening, 7-28, 7-29
- Velz's equation, trickling filter, 24-11
- Vent, well, 4-12
- Ventilation:
 - blower room, 23-84
 - lift station, 19-37, 19-40
 - manhole, 19-40
 - ozonation, 13-27
 - recarbonation, 7-38
 - sludge dewatering, 27-58
- Vertical shaft mixer, 6-33, 6-41
- Vertical turbine pump, 3-17–3-18, 4-26, 17-32

- Vibration, centrifuge, 15-37
- Viruses, 2-35, 13-14, 13-19–13-21, 13-33
 - Ct tables, Appendix D
- Viscosity:
 - and mixing, 6-25
 - and rapid filtration, 11-14
 - and Reynolds number, 10-4
 - and water, table of, Appendix A
- Volatile acids, 27-33
- Volatile organic chemicals (VOCs), 14-22
- Volatile suspended solids (VSS), defined, 22-12
- Volume of:
 - after dewatering, 15-5
 - rapid mix, 6-33
 - resin, 8-17
 - reservoir, 2-15–2-18
 - sludge, 15-3–15-4
- Volumetric loading, 23-39, 27-41
- Vortex separator, 20-27, 20-28, 20-36
- Vulnerability assessment, 16-31–16-33

- Wash troughs, filter, 11-22, 11-30–11-31
- Waste activated sludge (WAS), 23-4
- Waste decomposition and products, table of, 22-9
- Waste load allocation (WLA), 18-13
- Waste stabilization pond, 23-2
- Wastewater:
 - characteristics,
 - domestic, 18-7–18-9
 - industrial, 18-9–18-10
 - disinfection, 25-15–25-20
 - domestic, 18-2
 - equalization basins, 2-15, 20-38–20-45, 21-6
 - flow rates, 18-4–18-7
 - industrial, 18-2
 - reclaimed, 2-21–2-22
 - sanitary, 18-2
 - temperature, 18-7
 - treatment standards, 18-11–18-14
- Wastewater treatment process
 - evaluations:
 - BOD and nitrification, 28-10
 - clarifiers, 28-8
 - MBR, 28-14
 - nitrogen and phosphorus removal, 28-8
 - nutrient removal, 28-9
 - phosphorus removal, 28-13

- stabilization, 28-18
- thickening, 28-17
- Wasting:
 - activated sludge, 23-4, 23-27
 - and food to microorganism ratio, 23-35–23-36
- Water, drinking:
 - chemical characteristics, 2-23–2-27
 - microbial characteristics, 2-25
 - physical characteristics, 2-23
 - physical properties of,
 - tables of, Appendix A
 - raw, 1-11, 2-27–2-28
- Water consumption, 2-6–2-8
- Water demand, 2-6–2-8, 17-2–17-9
- Water mains, 17-2, 17-9–17-10
 - disinfection, 17-39
 - location, 17-39
 - sanitary protection, 17-39
- Water pressure, 17-9–17-10
- Water quality, drinking, 2-22–2-37
- Water quality goals, 2-37
- Water quality standards:
 - contaminants, 2-23–2-27
 - maximum contaminant level, tables of, 2-30–2-37
 - standards, 2-28–2-37
- Water saving devices, 2-7
- Water systems, community, 2-29
- Water table:
 - defined, 2-21
 - and tank flotation, 21-8–21-11
- Water tower, 17-22, 17-46
- Water use, 2-3–2-7
- Water vapor pressure as a function of temperature,
 - table of, 3-24
- Wavelength,
 - UV radiation, 13-7–13-8, 13-29, 25-20
- Weak acid:
 - cation exchange resin, 8-3
 - dissociation constants, Appendix A
- Web site for this text:
 - www.mhprofessional.com/wwe**
- Weibull's formula, 2-12
- Weight percent, 13-25
- Weir:
 - arrangements, 10-27, 21-16, 21-22
 - broad crested, 25-21
 - grit chamber, 20-27, 20-28
 - loading rates (overflow rates), 7-31, 10-28, 21-7
 - orifice, 10-28, 21-20
 - plate, 21-7
 - settling tank, 10-27–10-28
 - sharp crested, 21-12
 - v-notch, 10-2, 21-7, 21-16
- Well:
 - capacity, 4-2
 - casing, 4-4, 4-6–4-7, 4-34
 - casing materials, 4-6–4-7
 - cement grout, 4-8
 - cone-of-depression, 4-16
 - construction, 4-3–4-11
 - depth, 4-29
 - design,
 - drawdown, 4-17
 - elements, 4-2–4-3, 4-15–4-41
 - development, 4-11–4-12
 - diameter, 4-29, 4-33
 - disinfection of, 4-13
 - drawdown, 2-19–2-21, 4-17–4-26
 - drilling methods, 4-5
 - gravel packed, 4-4, 4-10–4-11
 - grouting and sealing, 4-8
 - head, 4-4, 4-6
 - house, 4-14
 - hydraulics, 2-19–2-21, 4-17–4-26
 - injection of brine waste, 15-44
 - interference, 4-16, 4-22–4-26
 - location, 4-5, 4-16–4-26
 - piezometric surface, 2-19
 - protection from contamination, 4-2, 4-3–4-11
- pump,
 - house, 4-14
 - size, 4-27
 - type, 4-26
- redundancy, 4-16
- reliability, 4-2
- sanitary construction, 4-2, 4-3–4-12
- sanitary seal, 4-34
- screen,
 - entrance velocities, 4-30, 4-33
 - length, 4-30
 - purpose, 4-10
 - slot size, 4-31–4-32
- seal, 4-12, 4-15, 4-34
- static water table, 4-16
- vent, 4-12
- water table (GWT), 2-21
- Well function of u (W(u)), 4-17
 - table of, 4-18–4-19
- Wet air oxidation, 27-53
- Wet extraction test (WET), 15-45
- Wet well:
 - defined, 3-15
 - design, 3-16, 19-35–19-37
- Yield, safe, 2-8, 2-18
- Yield analysis, 2-9–2-12
- Yield coefficient, 22-4
 - observed (Y_{obs}), 23-27
- Yield curve, 2-9
- Zebra mussel, 3-33
- Zeta potential, 6-3–6-4
- Zinc in drinking water, 2-24
- Zone settling, 10-15, 15-17
- Zones in settling tank, 10-8
- 503 regulations, 18-14–18-21

McGraw-Hill's ACCESS Engineering

Authoritative content · Immediate solutions

AccessEngineering offers the complete contents of hundreds of outstanding McGraw-Hill books, including *Marks' Standard Handbook for Mechanical Engineers*, *Perry's Chemical Engineers' Handbook*, and *Roark's Formulas for Stress and Strain*, with new books added biweekly. This dynamic source of world-renowned engineering content supports all levels of scientific and technical research in the corporate, industrial, government, and academic sectors.

Focused around 14 major areas of engineering, **AccessEngineering** offers comprehensive coverage and fast title-by-title access to our engineering collection in the following subject areas:

- / Biomedical
- / Chemical
- / Civil
- / Communications
- / Construction
- / Electrical
- / Energy
- / Environmental
- / Green/Sustainable
- / Industrial
- / Material Science
- / Mechanical
- / Nanotechnology
- / Optical

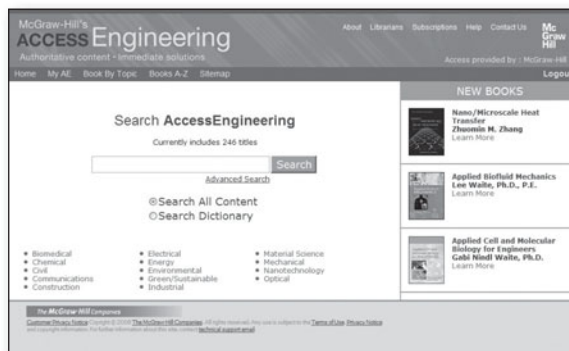

In addition, sophisticated personalization tools allow content to be easily integrated into user workflow. A science and engineering dictionary containing more than 18,000 terms is included in a fully searchable, taxonomically organized database.

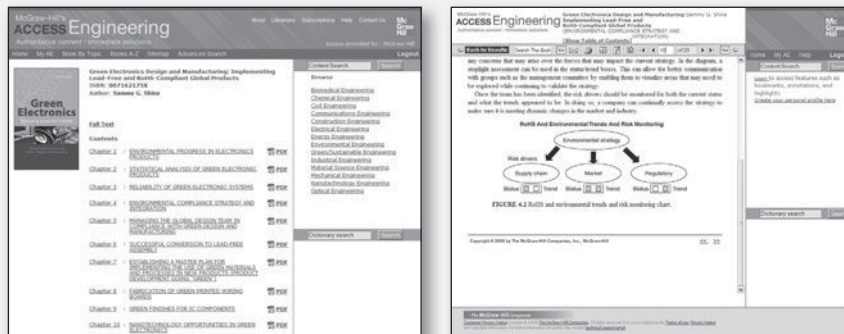

For more information on individual and institutional subscriptions,
please visit www.accessengineeringlibrary.com

Useful conversion factors

Multiply	By	To Obtain
atmosphere (atm)	101.325	kilopascal (kPa)
centipoise	10^{-3}	Pa · s
centistoke	10^{-6}	m ² /s
cubic meter (m ³)	35.31	cubic feet (ft ³)
cubic meter	1.308	cubic yard (yd ³)
cubic meter	1,000.00	liter (L)
cubic meter/d	2.642×10^{-4}	million gal/d (MGD)
cubic meter/d	0.1835	gallons/min (gpm)
cubic meter/h	4.405	gallons/min (gpm)
cubic meter/s	15,850.0	gallons/min (gpm)
cubic meter/s	22.8245	million gal/d (MGD)
cubic meter/m ²	24.545	gallons/sq ft (gal/ft ²)
cubic meter/d · m	80.52	gal/d · ft (gpd/ft)
cubic meter/d · m ²	24.545	gal/d · ft ² (gpd/ft ²)
days (d)	24.00	hours (h)
days (d)	1,440.00	minutes (min)
days (d)	86,400.00	seconds (s)
dyne	10^{-5}	Newtons (N)
erg	10^{-7}	Joules (J)
grains (gr)	6.480×10^{-2}	grams (g)
grains/U.S. gallon	17.118	mg/L
grams (g)	2.205×10^{-3}	pounds mass (lb _m)
hectare (ha)	10^4	m ²
Hertz (Hz)	1	cycle/s
Joule (J)	1	N · m
J/m ³	2.684×10^{-5}	Btu/ft ³
kilogram/m ³ (kg/m ³)	8.346×10^{-3}	lb _m /gal
kilogram/m ³	1.6855	lb _m /yd ³
kilogram/ha (kg/ha)	8.922×10^{-1}	lb _m /acre
kilogram/m ² (kg/m ²)	2.0482×10^{-1}	lb _m /ft ²
kilometers (km)	6.2150×10^{-1}	miles (mi)
kilopascal (kPa)	0.1450	psi
kilowatt (kW)	1.3410	horsepower (hp)
kilowatt-hour	3.600	megajoules (MJ)
liters (L)	10^{-3}	cubic meters (m ³)
liters	1,000.00	milliliters (mL)
liters	2.642×10^{-1}	U.S. gallons
megagrams (Mg)	1.1023	U.S. short tons
meters (m)	3.281	feet (ft)
meters of water	9.8067	kilopascal (kPa)
meters/d (m/d)	2.2785×10^{-3}	ft/min
meters/d	3.7975×10^{-5}	meters/s (m/s)
meters/s (m/s)	196.85	ft/min
meters/s	2.237	miles/h (mph)
micrometer (μ)	10^{-6}	meters
milligrams (mg)	10^{-3}	grams (g)
milligrams/L	1	g/m ³
milligrams/L	10^{-3}	kg/m ³
Newton (N)	1	kg · m/s ²
Pascal (Pa)	1	N/m ²
square meter (m ²)	2.471×10^{-4}	acres
square meter (m ²)	10.7639	sq ft (ft ²)
square meter/s	6.9589×10^6	gpd/ft
Watt (W)	1	J/s
Watt/cu meter (W/m ³)	3.7978×10^{-2}	hp/1,000 ft ³
Watt/sq meter · °C (W/m ² · °C)	1.761×10^{-1}	Btu/h · ft ² · °F

SI unit prefixes

Amount	Multiples and submultiples	Prefixes	Symbols
1,000,000,000,000,000,000	10^{18}	exa	E
1,000,000,000,000,000	10^{15}	peta	P
1,000,000,000,000	10^{12}	tera	T
1,000,000,000	10^9	giga	G
1,000,000	10^6	mega	M ^a
1,000	10^3	kilo	k ^a
100	10^2	hecto	h
10	10	deka	da
0.1	10^{-1}	deci	d
0.01	10^{-2}	centi	c ^a
0.001	10^{-3}	milli	m ^a
0.000,001	10^{-6}	micro	μ^a
0.000,000,001	10^{-9}	nano	n
0.000,000,000,001	10^{-12}	pico	p
0.000,000,000,000,001	10^{-15}	femto	f
0.000,000,000,000,000,001	10^{-18}	atto	a

^aMost commonly used.

Greek alphabet

A	α	Alpha	N	ν	Nu
B	β	Beta	Ξ	ξ	Xi
Γ	γ	Gamma	O	o	Omicron
Δ	δ	Delta	Π	π	Pi
E	ϵ	Epsilon	P	ρ	Rho
Z	ζ	Zeta	Σ	σ	Sigma
H	η	Eta	T	τ	Tau
Θ	θ	Theta	Y	υ	Upsilon
I	ι	Iota	Φ	ϕ	Phi
K	κ	Kappa	X	χ	Chi
Λ	λ	Lambda	Ψ	ψ	Psi
M	μ	Mu	Ω	ω	Omega