

Technology of Cheesemaking

Second Edition

Edited by

Barry A. Law

R&D Consultant to the Dairy Industry
Victoria, Australia

and

A.Y. Tamime

Consultant in Dairy Science and Technology
Ayr, UK

 **WILEY-BLACKWELL**

A John Wiley & Sons, Ltd., Publication



Technology of Cheesemaking

Second Edition

The Society of Dairy Technology (SDT) has joined with Wiley-Blackwell to produce a series of technical dairy-related handbooks providing an invaluable resource for all those involved in the dairy industry, from practitioners to technologists, working in both traditional and modern large-scale dairy operations. For information regarding the SDT, please contact Maurice Walton, Executive Director, Society of Dairy Technology, P. O. Box 12, Appleby in Westmorland, CA16 6YJ, UK. email: execdirector@sdt.org

Other volumes in the Society of Dairy Technology book series:

Probiotic Dairy Products (ISBN 978 1 4051 2124 8)

Fermented Milks (ISBN 978 0 6320 6458 8)

Brined Cheeses (ISBN 978 1 4051 2460 7)

Structure of Dairy Products (ISBN 978 1 4051 2975 6)

Cleaning-in-Place (ISBN 978 1 4051 5503 8)

Milk Processing and Quality Management (ISBN 978 1 4051 4530 5)

Dairy Fats (ISBN 978 1 4051 5090 3)

Dairy Powders and Concentrated Products (978 1 4051 5764 3)

Technology of Cheesemaking

Second Edition

Edited by

Barry A. Law

R&D Consultant to the Dairy Industry
Victoria, Australia

and

A.Y. Tamime

Consultant in Dairy Science and Technology
Ayr, UK

 **WILEY-BLACKWELL**

A John Wiley & Sons, Ltd., Publication



This edition second published 2010
First edition published 1999 Sheffield Academic Press
© 2010 Blackwell Publishing Ltd

Blackwell Publishing was acquired by John Wiley & Sons in February 2007. Blackwell's publishing programme has been merged with Wiley's global Scientific, Technical, and Medical business to form Wiley-Blackwell.

Registered office

John Wiley & Sons Ltd, The Atrium, Southern Gate, Chichester, West Sussex, PO19 8SQ, United Kingdom

Editorial offices

9600 Garsington Road, Oxford, OX4 2DQ, United Kingdom
2121 State Avenue, Ames, Iowa 50014-8300, USA

For details of our global editorial offices, for customer services and for information about how to apply for permission to reuse the copyright material in this book please see our website at www.wiley.com/wiley-blackwell.

The right of the author to be identified as the author of this work has been asserted in accordance with the UK Copyright, Designs and Patents Act 1988.

All rights reserved. No part of this publication may be reproduced, stored in a retrieval system, or transmitted, in any form or by any means, electronic, mechanical, photocopying, recording or otherwise, except as permitted by the UK Copyright, Designs and Patents Act 1988, without the prior permission of the publisher.

Wiley also publishes its books in a variety of electronic formats. Some content that appears in print may not be available in electronic books.

Designations used by companies to distinguish their products are often claimed as trademarks. All brand names and product names used in this book are trade names, service marks, trademarks or registered trademarks of their respective owners. The publisher is not associated with any product or vendor mentioned in this book. This publication is designed to provide accurate and authoritative information in regard to the subject matter covered. It is sold on the understanding that the publisher is not engaged in rendering professional services. If professional advice or other expert assistance is required, the services of a competent professional should be sought.

Library of Congress Cataloging-in-Publication Data

Technology of cheesemaking / edited by Barry A. Law, A.Y. Tamime. – 2nd ed.
p. cm.

Includes bibliographical references and index.

ISBN 978-1-4051-8298-0 (hardback : alk. paper)

I. Cheesemaking. I. Law, Barry A. II. Tamime, A. Y.

SF271.T36 2010

637'.3–dc22

2009048133

A catalogue record for this book is available from the British Library.

Set in 10/12.5pt Times by Aptara® Inc., New Delhi, India
Printed in Singapore

Contents

<i>Preface to the Technical Series</i>	xvi
<i>Preface to the Second Edition</i>	xvii
<i>Preface to the First Edition</i>	xix
<i>Contributors</i>	xxi
1 The Quality of Milk for Cheese Manufacture	1
T.P. Guinee and B. O'Brien	
1.1 Introduction	1
1.2 Overview of milk composition	2
1.2.1 Casein	3
1.2.2 Whey protein	6
1.2.3 Minerals	7
1.2.4 Milk lipids	8
1.3 Principles of cheese manufacture	9
1.3.1 Rennet-induced gelation	10
1.3.2 Acid-induced gelation	13
1.4 Quality definition of milk	15
1.4.1 Safety/public health (pathogens including <i>Mycobacterium tuberculosis</i> , <i>Brucella</i> spp., toxic residues, and contaminants)	16
1.4.2 Composition (protein, casein, fat, total solids, lactose, and mineral)	18
1.4.3 Microbiology (total bacterial count)	22
1.4.4 Sensory (appearance, colour, smell, and taste)	23
1.4.5 Authenticity (non-adulteration with residues or other milks/milk fractions)	23
1.5 Factors affecting the quality of milk for cheese manufacture	24
1.5.1 Milk composition	24
1.5.2 Microbial activity of milk	31
1.5.3 Somatic cell count	34
1.5.4 Enzymatic activity of milk	36
1.5.5 Chemical residues	43
1.6 Strategy for quality milk production	45
1.7 Conclusions	47
References	50

2	The Origins, Development and Basic Operations of Cheesemaking Technology	68
	M. Johnson and B.A. Law	
2.1	Introduction	68
2.2	The world market for cheese	68
2.3	The fundamentals of cheese technology	69
2.4	Basic cheese manufacture	70
2.5	The stages of cheesemaking	77
	2.5.1 Standardisation of milk	77
	2.5.2 Heat treatment of milk	78
	2.5.3 Addition of the starter culture	78
	2.5.4 Coagulation and cutting	80
	2.5.5 Stirring, heating and syneresis (moisture control)	81
	2.5.6 Whey removal, hooping and salting	83
	2.5.7 Brining and/or dry surface salting	85
	2.5.8 Pressing	86
2.6	Cheese ripening/maturation	87
	2.6.1 Diversity arising from composition	87
	2.6.2 Diversity arising from the starter cultures and the adventitious microflora in cheese	87
2.7	Reduced-fat versions of traditional cheeses	88
	2.7.1 Background	88
	2.7.2 Manufacture of reduced-fat cheese	89
2.8	Whey technology for cheesemakers	90
	2.8.1 The composition of cheese whey	91
	2.8.2 Membrane filtration technology	91
	2.8.3 Whey pre-treatment	93
	2.8.4 Production of WPC	94
	2.8.5 Lactose recovery	95
2.9	The role of research and development in the future of cheese technology	95
2.10	Acknowledgements	96
	References	96
3	The Production, Action and Application of Rennet and Coagulants	98
	M. Harboe, M.L. Broe and K.B. Qvist	
3.1	Historical background and nomenclature	98
3.2	Types of rennet and coagulants	99
	3.2.1 Animal rennet and coagulants	99
	3.2.2 Microbial coagulants	100
	3.2.3 Fermentation-produced chymosin	100
	3.2.4 Vegetable coagulants	101
3.3	Molecular aspects of the enzymes in rennet and coagulants	101
	3.3.1 Introduction	101
	3.3.2 Specific molecular aspects	102

3.4	Technology of enzymes production	103
3.4.1	General background	103
3.4.2	Production of enzymes	103
3.4.3	Formulation, standardisation and quality control	106
3.5	Analysis of coagulants	107
3.6	Legislation and approvals	110
3.7	Physical chemistry and kinetics of enzymatic coagulation of milk	111
3.7.1	Stability and destabilisation of the casein micelles	111
3.7.2	Kinetics of enzymatic coagulation of milk	112
3.8	Application of rennet and coagulants	115
3.8.1	Trends in use	115
3.8.2	Handling and use of rennet and coagulants	116
3.8.3	Milk quality, treatment and additives	116
3.8.4	Controlling the curd firmness at cutting	119
3.8.5	Performance of different rennet and coagulants available in the market	119
3.8.6	Coagulants and cheese ripening	123
3.8.7	Choice of coagulant	124
3.9	Conclusions	125
	References	125
4	The Formation of Cheese Curd	130
	T. Janhøj and K.B. Qvist	
4.1	Introduction	130
4.2	Chemistry and physics of curd formation	130
4.2.1	Some factors affecting aggregation	130
4.2.2	Formation of a gel	133
4.2.3	Rheological properties of rennet gels	135
4.2.4	Syneresis	138
4.3	Effect of milk composition on curd formation	140
4.3.1	Variations in main components	140
4.3.2	Casein micelle size	141
4.3.3	Genetic polymorphism of milk proteins	141
4.3.4	Lactational variation and somatic cell count	142
4.4	Effects of milk pre-treatment on curd formation	143
4.4.1	Cooling	143
4.4.2	High heat treatment	144
4.4.3	Restoring the rennetability of high heat treated milk	145
4.4.4	pH adjustment by carbon dioxide injection	146
4.4.5	Homogenisation	147
4.4.6	Phospholipase addition	147
4.4.7	Microfiltration and microfiltration combined with heat treatment	148

4.5	Factors controlling curd formation in the vat	148
4.5.1	Rennet concentration	149
4.5.2	pH	149
4.5.3	Temperature	150
4.5.4	Cutting time	151
4.5.5	Washing of the curd	151
4.6	On-line measurement of curd firmness and syneresis	152
4.6.1	On-line measurement of curd setting	152
4.6.2	Modelling and controlling gelation and cutting time	152
4.6.3	On-line measurement of syneresis	153
4.7	Cheese with reduced-fat content	154
	References	156
5	The Production, Application and Action of Lactic Cheese Starter Cultures	166
	E. Høier, T. Janzen, F. Rattray, K. Sørensen, M.W. Børsting, E. Brockmann and E. Johansen	
5.1	Introduction	166
5.2	Historical background	166
5.3	Production of starter cultures	167
5.4	Range of LAB used as starter cultures	169
5.4.1	Traditional starter cultures	169
5.4.2	Probiotic starter cultures	170
5.5	Taxonomy of LAB	172
5.5.1	Identification	172
5.5.2	Species important in cheese making	173
5.6	The types of lactic cultures	174
5.6.1	Development of mesophilic cultures	174
5.6.2	Use of DVS cultures	175
5.6.3	Selection of culture strains	177
5.7	Modern approaches to the development of new starter cultures	177
5.7.1	Genomics and traditional bacterial genetics	177
5.7.2	Food-grade GMOs for the dairy industry	178
5.7.3	Use of automated laboratory methods to develop new starter cultures	179
5.8	Biochemistry of acidification by LAB	180
5.8.1	Introduction	180
5.8.2	Sugar metabolism	180
5.9	Proteolysis by LAB	181
5.9.1	Proteases	181
5.9.2	Peptidases of LAB	182
5.9.3	Amino acid catabolism by LAB	183
5.10	Bacteriophage of LAB	183
5.10.1	Phage control during culture preparation	184

5.10.2	Phage control in the dairy	184
5.10.3	Phage monitoring	185
5.11	Development of phage-resistant starters	186
5.11.1	Isolation of spontaneous phage-resistant mutants	186
5.11.2	Conjugal transfer of phage resistance plasmids	186
5.11.3	Inhibition of phage adsorption	187
5.11.4	Prevention of phage DNA injection	187
5.11.5	Restriction and modification systems	187
5.11.6	Abortive infection	187
5.11.7	Additional routes to bacteriophage resistance	187
5.12	Future perspectives in starter culture development	188
	References	189
6	Secondary Cheese Starter Cultures	193
	W. Bockelmann	
6.1	Introduction	193
6.2	Surface-ripened cheeses	198
6.2.1	Examples of some popular varieties	198
6.2.2	Control of surface ripening	199
6.3	Classification of secondary starter cultures	200
6.3.1	Moulds and yeasts	200
6.3.2	Staphylococci	201
6.3.3	Coryneforms	202
6.4	Commercially available secondary cheese starter cultures	203
6.4.1	Moulds	203
6.4.2	Yeasts	204
6.4.3	Brevibacteria	205
6.4.4	Staphylococci	205
6.4.5	Coryneforms	205
6.4.6	Mixed starter cultures	206
6.5	Surface ripening	206
6.5.1	Ripening strategies	206
6.5.2	Yeasts and moulds	207
6.5.3	Staphylococci	209
6.5.4	Smear bacteria (coryneforms)	209
6.5.5	Food safety	211
6.5.6	Old–young smearing	211
6.5.7	<i>L. monocytogenes</i>	213
6.5.8	Mould spoilage	213
6.5.9	Anti-listeria starter cultures	214
6.6	Development of defined surface starter cultures	215
6.6.1	Surface starter cultures for semi-soft cheeses	216
6.6.2	Surface starter cultures for smeared soft cheeses	217
6.6.3	Starter cultures for acid curd cheeses (yellow type)	218

6.6.4	Colour development	220
6.6.5	Application of defined starter cultures	220
6.7	Proteolysis and lipolysis	221
6.8	Aroma	222
6.9	Conclusions	224
	References	224
7	Cheese-Ripening and Cheese Flavour Technology	231
	B.A. Law	
7.1	Introduction	231
7.2	The breakdown of milk proteins to flavour compounds in cheese	231
7.2.1	Proteinase and peptidase enzymes (proteolytic systems)	231
7.2.2	Amino acid catabolism	235
7.3	Breakdown of milk lipids in cheese	237
7.4	Lactose and citrate metabolism in cheese	238
7.5	The commercial drive for cheese-ripening and flavour technology	239
7.6	Commercial opportunities created by cheese-ripening and flavour technologies	240
7.7	Methods for the controlled and accelerated ripening of cheese	241
7.7.1	Elevated storage temperatures	241
7.7.2	Ultra-high-pressure technology	244
7.7.3	Enzyme additions	244
7.7.4	Attenuated starter cultures	246
7.7.5	Non-starter adjunct cultures	248
7.7.6	Genetically modified LAB	249
7.7.7	Rules and regulations for GMOs in foods	252
7.8	EMCs and cheese flavour products	253
7.9	Acknowledgements	255
	References	255
8	Control and Prediction of Quality Characteristics in the Manufacture and Ripening of Cheese	260
	T.P. Guinee and D.J. O'Callaghan	
8.1	Introduction	260
8.2	Principles of cheese manufacture	262
8.3	Cheese quality characteristics	264
8.3.1	Definition of cheese quality	264
8.3.2	Assessment of cheese quality	264
8.3.3	Sensory tests	266
8.3.4	Rheology and texture of cheese	267
8.3.5	Colorimetry	268
8.3.6	Image analysis	268
8.4	Cheese quality: influence of chemical composition of milk	269

8.5	Cheese quality: effect of milk pre-treatments and manufacturing operations	271
8.5.1	Cold storage of milk prior to pasteurisation at the cheese factory	271
8.5.2	Thermisation	273
8.5.3	Milk pasteurisation and incorporation of in situ denatured whey proteins	273
8.5.4	Bactofugation	279
8.5.5	Clarification	280
8.5.6	Standardisation of protein-to-fat ratio	280
8.5.7	Homogenisation	286
8.5.8	Addition of calcium chloride	289
8.5.9	Milk gelation	290
8.5.10	Curd-cutting programmes	291
8.5.11	Stirring and cooking	294
8.5.12	Curd washing: standardisation of lactose level in the moisture phase of the curd	295
8.5.13	Whey drainage and remaining operations	298
8.6	Cheese quality: effect of cheese composition	299
8.7	Cheese quality: effect of ripening	301
8.7.1	Overview of the ripening process	301
8.7.2	Factors affecting ripening	303
8.8	Quality assurance in cheese manufacture	304
8.8.1	Background	304
8.8.2	Key concepts in quality assurance	305
8.8.3	Control and prediction of quality characteristics of curd and cheese	310
8.8.4	Robots in cheese manufacturing	313
8.9	Conclusions	313
	References	314
9	Technology, Biochemistry and Functionality of Pasta Filata/Pizza Cheese	330
	P.S. Kindstedt, A.J. Hillier and J.J. Mayes	
9.1	Introduction	330
9.2	Measuring functional properties of pizza cheese	330
9.2.1	Background	330
9.2.2	Measurement of functionality	331
9.3	Manufacture of pizza cheese	332
9.3.1	Treatment of milk	332
9.3.2	Starter culture	334
9.3.3	Coagulant	337
9.3.4	Cooking and cheddaring	338
9.3.5	Stretching and moulding	339
9.3.6	Brining/salting	342

9.3.7	Process control in pizza cheese manufacture	344
9.3.8	Factors affecting cheese yield	345
9.4	Microbiological, proteolytic and physicochemical properties	345
9.4.1	Microbiological properties	345
9.4.2	Proteolytic properties	347
9.4.3	Physicochemical properties	347
9.4.4	Functionality changes during storage	349
9.5	Non-traditional methods of manufacture	349
9.5.1	Direct acidification	349
9.5.2	Cheese blends	350
9.5.3	Low-fat pizza cheese	350
9.5.4	Imitation (analogue) pizza cheese	351
9.5.5	Processed pizza cheese	352
	References	352
10	Eye Formation and Swiss-Type Cheeses	360
	A. Thierry, F. Berthier, V. Gagnaire, J.R. Kerjean, C. Lopez and Y. Noël	
10.1	Introduction	360
10.1.1	Which kinds of cheese?	360
10.1.2	Manufacture and chemical composition	361
10.1.3	Scope of the present chapter	361
10.2	Open texture and eye formation	363
10.2.1	Gas production – a sign of quality	363
10.2.2	Eye formation	365
10.2.3	Cheese cohesion	366
10.3	Gas formation through propionic fermentation	366
10.3.1	Main sources of gas in Swiss-type cheeses	366
10.3.2	Taxonomy, ecology and presence of PAB in cheese	367
10.3.3	Metabolism of PAB	368
10.3.4	Influence of LAB on propionibacteria	370
10.3.5	Relationship between eye formation and flavour development	371
10.4	Cheese structure and eye formation	372
10.4.1	Mechanical properties and eye formation of cheese	372
10.4.2	Changes during ripening and eye formation	374
10.4.3	Eye formation and slit development	376
10.5	Conclusions	377
	References	378
11	Microbiological Surveillance and Control in Cheese Manufacture	384
	P. Neves and A.P. Williams	
11.1	Introduction	384
11.2	Milk for cheese manufacture	386
11.3	Heat treatment	389

11.4	Cheesemaking	391
11.5	Maturation of the curd	393
11.6	Specialist cheeses and cheese products	394
11.6.1	Cheeses made from unpasteurised milk	395
11.6.2	Grated cheese for manufacture	395
11.6.3	Cheese with additives	396
11.6.4	Processed cheeses	396
11.7	Cheese defects	397
11.8	Prevention and control	399
11.9	End-product testing and environmental monitoring	401
11.9.1	End-product testing	401
11.9.2	Environmental monitoring	404
11.10	Microbiological techniques	406
11.11	Conclusions	408
	References	409
12	Packaging Materials and Equipment	413
	Y. Schneider, C. Kluge, U. Weiß and H. Rohm	
12.1	Introduction	413
12.2	Cutting of the cheese	415
12.2.1	Characteristics and features of food cutting	415
12.2.2	Parameters affecting cutting performance	416
12.2.3	Cutting velocity	417
12.3	Applications of cutting	419
12.3.1	Partitioning and segmentation	419
12.3.2	Slicing	420
12.3.3	Dicing	420
12.3.4	Shredding	421
12.4	Packaging of cheeses	421
12.4.1	Specific requirements	421
12.4.2	Packaging materials	422
12.4.3	Packaging of hard and semi-hard cheeses	425
12.4.4	Packaging of soft cheeses	428
12.5	Packaging machines	428
12.5.1	Control of the packaging process	428
12.5.2	Machinery for cheese packaging	430
12.5.3	Miscellaneous methods of cheese packaging	436
12.6	Conclusion	437
	References	438
13	The Grading and Sensory Profiling of Cheese	440
	D.D. Muir	
13.1	Introduction to cheese-grading systems	440
13.2	Fundamentals of sensory processing	440

13.2.1	The three dimensions of sensory experience	440
13.2.2	Integration versus selection of sensory information	441
13.3	Grading systems: defect versus attribute grading	442
13.3.1	The Australian grading system	442
13.3.2	The UK grading system	443
13.3.3	The US grading system	443
13.3.4	The Canadian grading system	443
13.3.5	The International Dairy Federation grading system	443
13.3.6	The New Zealand grading system	444
13.4	The direct link: cheesemaking to consumer	444
13.4.1	The link between cheesemaking, grading and the consumer	444
13.4.2	The link between grading and consumer	445
13.4.3	The cheesemaking – grading link	446
13.5	Introduction to sensory profiling of cheese	446
13.6	Sensory vocabulary	447
13.6.1	A working vocabulary for cheese	448
13.6.2	Evolution of the vocabulary	448
13.7	Sample preparation and presentation	448
13.7.1	Environment	448
13.7.2	Isolation	449
13.7.3	Rating of samples	449
13.7.4	Presentation order	449
13.8	Assessor selection	450
13.8.1	Internal versus external panels	450
13.8.2	Pre-selection procedure	450
13.8.3	Initial testing	451
13.8.4	Acclimatisation and confirmation	451
13.8.5	Monitoring assessors' performance	452
13.9	Integrated design and analysis of data	452
13.9.1	The design, data capture and analysis of the sensory-profiling protocol	452
13.9.2	Preliminary treatment	453
13.9.3	Sensory space maps	454
13.9.4	Principal Component Analysis	455
13.9.5	Interpretation of sensory dimensions	456
13.9.6	Generalised Procrustes Analysis (GPA)	458
13.9.7	Interpretation of sensory space maps	459
13.9.8	Multivariate prediction	459
13.9.9	Measurement of assessors' performance	461
13.10	Sensory character of commercial cheese	467
13.10.1	Comparison of maturity declaration on cheese packaging with sensory panel ratings	467
13.10.2	Discrimination amongst cheese types	468
13.11	Development of flavour lexicons	469

13.12	Overview	471
13.13	Acknowledgements	472
	References	472
	<i>Index</i>	475

Preface to the Technical Series

For more than 60 years, the Society of Dairy Technology (SDT) has sought to provide education and training in the dairy field, disseminating knowledge and fostering personal development through symposia, conferences, residential courses, publications, and its journal, the *International Journal of Dairy Technology* (previously published as the *Journal of the Society of Dairy Technology*).

In recent years, there have been significant advances in our understanding of milk systems, probably the most complex natural food available to man. At the same time, improvements in process technology have been accompanied by massive changes in the scale of many milk processing operations, and the manufacture a wide range of dairy and other related products.

The Society has embarked on a project with Wiley-Blackwell to produce a technical series of dairy-related books to provide an invaluable source of information for practicing dairy scientists and technologists, covering the range from small enterprises to modern large-scale operation. This ninth volume in the series, the second edition of *Technology of Cheesemaking* under the joint editorship of Barry Law and Adnan Tamime, provides a timely and comprehensive update on the principles and practices involved in cheese production. This new edition also introduces chapters on milk for cheesemaking, packaging technology for cheese and the prediction and control of the overall manufacturing process for hard cheeses.

This book provides a timely and valuable review of the progress being made in the greater understanding of the factors contributing to cheesemaking and how this knowledge may be applied to producing better and more consistent products.

Andrew Wilbey
Chairman of the Publications Committee, SDT

Preface to the Second Edition

The first edition of *Technology of Cheesemaking* aimed to assess critically the pool of scientific knowledge, which was then available to the cheesemaking industry as a tool for process and product innovation, quality improvement and safety. I had also hoped to provide an advanced text that would help those in higher education to understand the way that knowledge from strategic and applied research can be fed into commercial innovation in cheese manufacture and distribution. To this end, the second edition is intended to update that knowledge pool in the light of further demands for new data and technologies from an already mature industry seeking to further refine and expand its products and its production technologies. We have covered advances in the fields of coagulants, starter cultures and the manufacturing/maturation of a range of generic cheese varieties in order to update the original chapters, and also introduced new chapters in fields that have advanced dramatically over the ten years that have elapsed since the first edition.

New areas include specific coverage of milk pre-treatment science and technologies, emphasising the special needs of cheesemakers for a consistent and safe raw material. Emerging technologies that were confined to experimental studies ten years ago are now applied to improve the manufacturing properties of milk for cheesemaking.

We have also introduced an appraisal of the key stages of cheese manufacture which can be manipulated to control and maintain the consistency quality of cheese. Although this has produced some overlap with our coverage of milk quality for cheesemaking, we have felt justified in allowing this overlap because it emphasises the prime importance of milk preparation practice for the quality and consistency of cheese for the end user. We also acknowledge that many of these control techniques have been known and used by cheesemakers for many years, but it is only more recently that the science base has delivered a level of basic understanding of their underlying workings. This has led to refinements and new opportunities in cheese production recipes and line technologies, which we have included in this volume.

The first edition did not include packaging as a separate field for scientific and technological input into cheese manufacture. In recognition of the vital role of this area within the industry, and the knowledge-based advances in packaging methods specifically applicable to such a 'live' and varied product as cheese, the second edition includes a chapter dedicated to the knowledge and application of packaging materials and equipment. This includes general principles, through to specific challenges from cheese technology.

We would like to acknowledge the time and effort that the expert contributors have given to make this second edition possible. Many are the original authors who helped create the first edition, and our thanks go to them for adding to their already excellent work. We were

also fortunate to have a number of new contributors, and we hope they will be as exciting by the results of their efforts as we are, in that this updated volume reflects another decade of progress in the industry and its base of science and technology.

Whilst reflecting on the satisfaction of delivering this volume, we must also pay special tribute to our colleague, Tony Williams, who passed away while the book was in final preparation. Tony, with his partner Paul Neaves, was an outstanding food microbiologist and a vital member of the team which delivered great practical benefits to food quality and safety through the astute gathering and application of basic knowledge to the sharp end of the food industry; the interface between the manufacturer and the retailer/consumer. Tony will be missed not only by those close to him, but also by professionals in food microbiology worldwide.

Barry Law and Adnan Tamime
October 2009

Preface to the First Edition

Cheesemaking remains an art even today, when many of the once-variable stages of the process have been smoothed out by technology. The purpose of this book was to present the state of the art, to show where and how technology enhances the art, and to point the way towards further improvements in cheesemaking technology, which are achievable through exploitation of the basic science and technology. The book is about cheesemaking technology, and I hope that the reader will be able to feel the excitement of uncertainty and the satisfaction of success-through-understanding that cheesemakers experience when the product of their combined know-how and machinery emerges just as they say, the sellers of the cheeses and consumer would have liked.

It is not my intention to develop a complacent view of cheesemaking – it is hard work, and it sometimes goes wrong. However, I firmly believe that cheese technology supports one of the most advanced food manufacturing industries in the world, having overcome most of the problems of milk variability, microbiological control and culture failure that used to cause so much wastage and potential hazard for consumers. In this volume, we firstly describe and discuss cheesemaking technology from the point of view of cheesemakers. Authors explain the process step by step, showing how the universal elements of milk-conversion technology can be varied by process design and culture technology to yield so many wonderful and individual varieties of cheeses. The book is unique in this respect, and it will add to existing range of books and review articles by viewing cheese technology as the product of tradition, pragmatic development and the application of front-line science.

Having established a detailed knowledge of cheesemaking per se, authors take the reader on to learn about rennets and coagulants – how they are made, standardised and used, and their concerted action (with lactic starter cultures) in forming the basis of all cheese, the curd. Following a logical progression, the book proceeds to consider how the lactic culture, the added moulds and non-lactics, and the eye-forming bacteria work in and on the ripening cheese in their different ways to convert the bland curd into the familiar cheddars, pizza cheeses, blue cheeses, camembert, Swiss-type cheeses and the aromatic smear-ripened varieties. Pressure on cheesemakers to produce both traditional and new varieties from increasingly uniform and controlled plant has pushed cheese technology to find new ways of accelerating and controlling the balance of cheese ripening – topics which this volume covers in depth.

Cheesemakers are ultimately answerable to, and dependent on, consumers for their livelihoods. This book includes chapters on food safety assurance as well on cheese grading and sensory assessment, showing how to ensure that the technology not only produces what the cheesemaker intends to do, but what the consumer expects and wants.

The book is for the enlightenment and support of a wide range of potential readers, ranging from the forever curious to cheesemakers who want to understand more clearly what they are making every day. It will be equally valuable to product development specialists seeking insights into the scope for innovation from the basic cheese technology, and to advanced students of food science and technology wishing to go beyond the standard cheese textbook. The experienced research scientist will find in these pages many examples of the working interface between research and applications, through which to establish communications with product development technologists. By including chapters by specialists in the technology of coagulants, cultures and ripening systems, we have widened the value of the book to include the interests of the dairy ingredients business.

I should like to acknowledge the contributors to this book. It is all very well to have an idea about a new approach to the integration of cheesemaking practice, technology and underlying science but, without the help of this group of expert and very busy people, the idea would be unattainable. Thank you all and please remember that any shortcomings in the quality of the book are the responsibility of me alone.

Barry A. Law

Contributors

Editor

Dr. A.Y. Tamime

24 Queens Terrace
Ayr KA7 1DX
UK
Tel. +44 (0)1292 265498
Fax +44 (0)1292 265498
Mobile +44 (0)7980 278950
E-mail: adnan@tamime.fsnet.co.uk

Contributors

Dr. F. Berthier

INRA
UR 342 UR TAL, Technologie et Analyses
Laitières
39801 Poligny
France
Tel. +33 (0)3 84 37 63 13
Fax: +33 (0)3 84 37 37 81
E-mail: francoise.berthier@poligny.inra.fr

Dr. W. Bockelmann

Federal Research Centre for Nutrition and
Food (BFEL)
Location Kiel
Hermann Weigmann Straße 1
P.O. Box 6069
24121 Kiel
Germany
Tel. +49 (0)431 609 2438
Fax +49 (0)431 609 2306
E-mail: wilhelm.bockelmann@bfel.de

Ms M.W. Børsting

Chr. Hansen A/S
10-12 Bøge Allé
DK-2970 Hørsholm
Denmark
Tel. +45 (0)45 74 85 38 (direct)
Fax +45 (0)45 74 88 16
E-mail: dkmew@chr-hansen.com

Dr. E. Brockmann

Chr. Hansen A/S
10-12 Bøge Allé
DK-2970 Hørsholm
Denmark
Tel. +45 (0)45 74 85 16 (direct)
Fax +45 (0)45 74 89 94
E-mail: dkebr@chr-hansen.com

Mr. M.L. Broe

Chr. Hansen A/S
10-12 Bøge Allé
DK-2970 Hørsholm
Denmark
Tel. +45 (0)45 74 85 04 (direct)
Fax +45 (0)45 74 88 16
E-mail: dkmbe@chr-hansen.com

Dr. V. Gagnaire

INRA
Agrocampus Rennes
UMR 1253 Science et Technologie du Lait
et de l'Oeuf
65 Rue de Saint Brieuc
35042 Rennes Cedex
France

Tel. +33 (0)2 23 48 53 46
Fax +33 (0)2 23 48 53 50
E-mail: valerie.gagnaire@rennes.inra.fr

Dr. T.P. Guinee

Moorepark Food Research Centre
Teagasc Moorepark
Fermoy
Co. Cork
Ireland
Tel. +353 (0)25 42204
Fax: +353 (0)25 42340
E-mail: Tim.Guinee@teagasc.ie

Dr. M. Harboe

Chr. Hansen A/S
10-12 Bøge Allé
DK-2970 Hørsholm
Denmark
Tel. +45 (0)45 74 85 25 (direct)
Fax +45 (0)45 74 88 16
E-mail: dkmh@chr-hansen.com

Dr. A.J. Hillier

CSIRO Food and Nutritional Sciences
Private Bag 16
Werribee
Victoria 3030
Australia
Tel. +61 (0)3 9731 3268
Fax +61 (0)3 9731 3322
E-mail: alan.hillier@csiro.au

Mr. E. Høier

Chr. Hansen A/S
10-12 Bøge Allé
DK-2970 Hørsholm,
Denmark
Tel. +45 (0)45 74 85 13 (direct)
Fax +45 (0)45 74 88 16
E-mail: dkeh@chr-hansen.com

Dr. T. Janhøj

Department of Food Science
Faculty of Life Sciences

Rolighedsvej 30
1958 Frederiksberg C
Denmark
Tel. +45 (0)3533 3192
Mobile +45 (0) 2089 3183
Fax +45 (0)3533 3190
E-mail: tj@life.ku.dk

Dr. T. Janzen

Chr. Hansen A/S
10-12 Bøge Allé
DK-2970 Hørsholm
Denmark
Tel. +45 (0)45 74 84 63 (direct)
Fax +45 (0)45 74 89 94
E-mail: dkthj@chr-hansen.com

Dr. E. Johansen

Chr. Hansen A/S
10-12 Bøge Allé
DK-2970 Hørsholm
Denmark
Tel. +45 (0)45 74 84 64 (direct)
Fax +45 (0)45 74 89 94
E-mail: dkejo@chr-hansen.com

Dr. M. Johnson

Wisconsin Centre for Dairy Research
Wisconsin University
1605 Linden Drive
Madison, WI 53562
USA
Tel. +1 (0)608 262 0275
Fax +1 (0)608 262 1578
E-mail: jumbo@cdr.wisc.edu

Dr. J.R. Kerjean

Actilait – Pôle Ouest
P.O. Box 50915
35009 Rennes Cedex
France
Tel. +33 (0)2 23 48 55 88
Fax +33 (0)2 23 48 55 89
E-mail: jr.kerjean@actilait.com

Dr. P.S. Kindstedt

Department of Nutrition and Food
Science
University of Vermont
253 Carrigan Wing
Burlington
Vermont 05405-0086
USA
Tel. +1 802 656 2935
E-mail: pkindste@uvm.edu

Dr. C. Kluge

Institute of Food Technology and
Bioprocess Engineering
Technische Universität Dresden
Bergstraße 120
D-01069 Dresden
Germany
Tel. +49 (0)351 32585
Fax +49 (0)351 37126
E-mail: christoph.kluge@tu-dresden.de

Professor B.A. Law

15 Dover Place
Parkdale
Victoria 3195
Australia
Tel. +61 (0)3 9587 4702
Fax +61 (0)3 9587 4695
Mobile +61 (0)405 791138
E-mail: bazlaw@ozemail.com.au

Dr. C. Lopez

INRA
Agrocampus Rennes
UMR 1253 Science et Technologie du Lait
et de l'Oeuf
65 Rue de Saint Briec
35042 Rennes Cedex
France
Tel. +33 (0)2 23 48 56 17
Fax +33 (0)2 23 48 53 50
E-mail: christelle.lopez@rennes.inra.fr

Dr. J.J. Mayes

CSIRO Food and Nutritional Science
Private Bag 16
Werribee
Victoria 3030
Australia
Tel. +61 (0)3 9731 3456
Fax +61 (0)3 9731 3322
E-mail: jeff.mayes@csiro.au

Professor D.D. Muir

DD Muir Consultants
26 Pennyvenie Way
Girdle Toll
Irvine KA11 1QQ
UK
Tel. +44 (0)1294 213137
Fax (not available)
E-mail: Donald@ddmuir.com

Dr. P. Neaves

Williams & Neaves
The Food Microbiologists
28 Randalls Road
Leatherhead
Surrey KT22 7TQ
United Kingdom
Tel. +44 (0)1372 375483
Fax +44 (0)1372 375483
E-mail: wilnea@globalnet.co.uk

Dr. Y. Noël

INRA
Délégation au Partenariat avec les
Entreprises
P.O. Box 35327
Domaine de la Motte
35653 Le Rheu
France
Tel. +33 (0)2 23 48 70 18
Fax +33 (0)2 23 48 52 50
E-mail: yolande.noel@rennes.inra.fr

Dr. B. O'Brien

Dairy Production Research Centre
Teagasc Moorepark
Fermoy
Co. Cork
Ireland
Tel. +353 (0)25 42274
Fax: +353 (0)25 42340
E-mail: Bernadette.O'Brien@teagasc.ie

Dr. D.J. O'Callaghan

Moorepark Food Research Centre
Teagasc Moorepark
Fermoy
Co. Cork
Ireland
Tel. +353 (0)25 42205
Fax: +353 (0)25 42340
E-mail: Donal.O'Callaghan@teagasc.ie

Dr. K.B. Qvist

Chr. Hansen A/S
10-12 Bøge Allé
DK-2970 Hørsholm
Denmark
Tel. +45 (0)45 74 8553
Fax +45 (0)45 74 8816
E-mail: dkkbq@chr-hansen.com

Dr. F. Rattray

Chr. Hansen A/S
10-12 Bøge Allé
DK-2970 Hørsholm
Denmark
Tel. +45 (0)45 74 85 45 (direct)
Fax +45 (0)45 74 89 94
E-mail: dkfpr@chr-hansen.com

Professor H. Rohm

Institute of Food Technology and
Bioprocess Engineering

Technische Universität Dresden
Bergstraße 120
D-01069 Dresden
Germany
Tel. +49 (0)351 463 34985
Fax +49 (0)351 463 37126
E-mail: harald.rohm@tu-dresden.de

Dr. Y. Schneider

Institute of Food Technology and
Bioprocess Engineering
Technische Universität Dresden
Bergstraße 120
D-01069 Dresden
Germany
Tel. +49 (0)351 32596
Fax +49 (0)351 37126
E-mail: yvonne.schneider@tu-dresden.de

Dr. K. Sørensen

Chr. Hansen A/S
10-12 Bøge Allé
DK-2970 Hørsholm
Denmark
Tel. +45 (0)45 74 83 54 (direct)
Fax +45 (0)45 74 89 94
E-mail: dkksr@chr-hansen.com

Dr. A. Thierry

INRA
Agrocampus Rennes
UMR 1253 Science et Technologie du Lait
et de l'Oeuf
65 Rue de Saint Briec
35042 Rennes Cedex
France
Tel. +33 (0)2 23 48 53 37
Fax +33 (0)2 23 48 53 50
E-mail: anne.thierry@rennes.inra.fr

Dr. U. Weiß

Institute of Processing Machines
Engineering and Agricultural
Technology
Technische Universität Dresden
Bergstraße 120
D-01069 Dresden
Germany
Tel. +49 (0)351 35101
Fax +49 (0)351 37142
E-mail: uta.weiss@tu-dresden.de

Mr. A.P. Williams

Williams & Neaves
The Food Microbiologists
28 Randalls Road
Leatherhead
Surrey KT22 7TQ
United Kingdom
Tel. +44 (0)1372 375483
Fax +44 (0)1372 375483
E-mail: wilnea@globalnet.co.uk

1 The Quality of Milk for Cheese Manufacture

T.P. Guinee and B. O'Brien

1.1 Introduction

World production of milk in 2008 is estimated at $\sim 576 \times 10^6$ tonnes (ZMP, 2008), with India/Pakistan, the Americas and Europe being the major producing regions. The proportions of total milk produced by cow, water buffalo, goat, ewe, camel and other are ~ 84.0 , 12.1, 2.0, 1.3, 0.2 and 0.2, respectively (International Dairy Federation – IDF, 2008). Cows' milk is the major milk used for cheese manufacture; however, significant quantities of cheese are also made from goat, sheep and water buffalo milks in some European Union (EU) countries, such as France, Italy and Spain.

Based on an estimated yield of 1 kg cheese 10 kg^{-1} milk, the percentage of total milk used for cheese is $\sim 25\%$, but varies widely from $\sim 70\text{--}90\%$ in some European countries (Italy, France, Denmark and Germany) to $\sim 0.5\%$ in China. While cheese-like products are produced in most parts of the world, the principal cheese-producing regions are Europe, North America and Oceania. Cheese production has increased consistently over the last two decades at an annual average rate of $\sim 1.5\%$. As discussed in Chapter 8, this may be attributed to a number of factors including increases in global population and per capita income, globalisation of eating trends/habits, changing lifestyles, growth in use of cheese as an ingredient in the food service (in pizza-type dishes, cheese burgers and salad dishes) and industrial sectors (cordon bleu entrees, co-extruded products with cheese and gratins).

The increase in consumption has been paralleled by a greater emphasis on improved quality and consistency with respect to the levels of particular nutrients (fat, protein, calcium -Ca^{2+} and sodium -Na^+), physical properties (texture and cooking attributes), sensory characteristics and processability (size reduction attributes, such as shredability; ability to yield processed cheeses or other cheese products when subjected to secondary processing). Consequently, this has necessitated an increase in the quality and consistency of all inputs (milk composition/quality, enzyme activity/purity, starter cultures characteristics, for example, acid productivity, phage resistance, autolytic properties and flavour-imparting characteristics) and standardisation of the manufacturing process (cf. Chapter 8). In an overall context, milk quality for cheese manufacture may be defined as its suitability for conversion into cheese and deliver cheese of the desired quality and yield. The current chapter examines milk quality for cheese manufacture and the factors affecting it, together with broad-based strategies for improving quality and consistency.

1.2 Overview of milk composition

Milk consists of protein (caseins and whey proteins), lipid, lactose, minerals (soluble and insoluble), minor components (enzymes, free amino acids, peptides) and water (Table 1.1).

The casein fraction coexists with the insoluble minerals as a calcium phosphate–casein complex. The water and its soluble constituents (lactose, native whey proteins, some minerals, citric acid and minor components) are referred to as serum. During cheese manufacture, the milk is subjected to a partial dehydration, involving controlled expulsion of serum and concentration of fat, caseins (and in some cases denatured, aggregated whey proteins) and some of the minerals. The methods engaged to affect the dehydration include limited destabilisation and aggregation of the calcium phosphate casein in the form of a gel network which

Table 1.1 Compositional and gelation characteristics of cows' milks.

Characteristic	Mean	Range
Gross composition		
Dry matter (g 100 g ⁻¹)	12.04	11.52–12.44
Fat (g 100 g ⁻¹)	3.55	3.24–3.90
Lactose (g 100 g ⁻¹)	4.42	4.21–4.56
Total protein (g 100 g ⁻¹)	3.25	2.99–3.71
True protein (g 100 g ⁻¹)	3.06	2.77–3.47
Casein (g 100 g ⁻¹)	2.51	2.29–2.93
Whey protein (g 100 g ⁻¹)	0.54	0.48–0.64
Non-protein nitrogen (N) (g 100 g ⁻¹ N)	5.33	4.79–6.16
Urea (mg 100 g ⁻¹)	27.60	22.00–37.50
Ash (g 100 g ⁻¹)	0.74	0.71–0.77
Calcium (mg 100 mL ⁻¹)	118	108–137
Iron (mg 100 mL ⁻¹)	976	460–1490
Magnesium (mg 100 mL ⁻¹)	107	96–117
Chloride (mg 100 mL ⁻¹)	100	95–116
Vitamins/vitamin components		
β-Carotene (μg g ⁻¹ fat)	3.18	0.48–8.37
Thiamine (μg mL ⁻¹)	0.18	0.09–0.35
Riboflavin (μg mL ⁻¹)	0.88	0.19–1.85
Vitamin A (μg g ⁻¹ fat)	9.41	2.18–27.85
Vitamin E (μg g ⁻¹ fat)	25.56	6.84–42.15
Iodine (I) (μg mL ⁻¹)	0.28	0.20–0.51
Cobalt (Co) (μg mL ⁻¹)	0.96	0.44–1.70
Gelation properties ^a		
RCT (min)	6.15	4.50–7.44
A ₃₀ (mm)	46.80	43.00–51.38
1/k ₂₀ (mm ⁻¹)	0.23	0.3–0.19
Other components		
Total free fatty acids (mg kg ⁻¹ fat)	3769	2629–5108

Source: Compiled from O'Brien *et al.* (1999b–d), Mehra *et al.* (1999) and Hickey *et al.* (2006b) for manufacturing milks.

^aBased on the analysis using the Formagraph (Type 1170, Foss Electric, Denmark) on milks at pH 6.55 and rennet-treated at a level corresponding to ~0.18 mL L⁻¹ (Chymax Plus, Pfizer Inc., Milwaukee, WI); RCT is an index of rennet coagulation (gelation) time, A₃₀ of the curd firmness after 30 min, and 1/k₂₀ of gel firming rate.

encloses the fat and serum via specific enzymatic hydrolysis of the casein, acidification (by fermentation of milk lactose to lactic acid by added bacterial cultures), elevated temperature and various mechanical operations as discussed in Chapter 8. Amongst others, the degrees of casein aggregation and dehydration are critical parameters controlling the properties and quality of the final cheese.

Although manufacturing procedures for most cheese types are very defined (at least in large modern cheesemaking facilities) in terms of technology applied and the type and levels of operations imposed on the milk (cf. Chapter 8), variations in cheese quality do occur. Seasonal variation in the composition and quality of milk are considered to be crucial factors contributing to the inconsistency in quality. Consequently, an overview of milk composition in terms of its relevance to cheese manufacture is presented below. The main focus of this chapter is on cows' milk, which accounts for an estimated 95% of total milk used in cheese manufacture; the characteristics of other milks are discussed elsewhere (Anifantakis, 1986; Juárez, 1986; Remeuf & Lenoir, 1986; Muir *et al.*, 1993a,b; Garcia-Ruiz *et al.*, 2000; Bramanti *et al.*, 2003; Huppertz *et al.*, 2006; Kuchtik *et al.*, 2008; Caravaca *et al.*, 2009).

1.2.1 Casein

The nitrogenous fraction of cows' milk typically consists of casein, whey protein and non-protein nitrogen (urea, proteose-peptones, peptides) at levels of ~ 78 , 18 and 4 g 100 g⁻¹, respectively, of total nitrogen (Table 1.1).

Casein, which is typically present at a level of 2.5 g 100 g⁻¹ in cows' milk, is the main structural protein of both rennet- and acid-induced milk gels (Table 1.1). The casein is heterogeneous, comprising four main types: α_{s1} , α_{s2} , β and κ , which represent ~ 38 , 10, 35 and 15 g 100 g⁻¹ of the total casein, respectively (Fox & McSweeney, 1998; Fox, 2003; Swaisgood, 2003). Model studies in dilute dispersions indicate that the individual caseins vary in the content and distribution of phosphate (Table 1.2); the respective number of (serine) phosphate residues *per* mole of casein are ~ 8 , 10–13, 5 and 1 for α_{s1} -, α_{s2} -, β - and κ -caseins, respectively. The serine phosphates bind calcium and calcium phosphate, and consequently, different caseins have different calcium-binding properties. Generally, α_{s1} -, α_{s2} - and β -caseins bind calcium strongly and precipitate at relatively low calcium concentrations (~ 0.005 – 0.1 M CaCl₂ solutions), inclusive of the calcium level in milk (30 mM); in contrast, κ -casein is not sensitive to these calcium concentrations and can, in fact, stabilise up to 10 times its mass of the calcium-sensitive caseins.

Casein in milk exists in the form of spherical-shaped colloid particles (~ 40 – 300 nm diameter), known as casein micelles (Fox & Brodkorb, 2008; McMahan & Oommen, 2008). Different models have been proposed for the structure of the casein micelle on the basis of the location of individual caseins (in response to their calcium sensitivity) and the calcium phosphate. These include:

- sub-micelle model (Schmidt, 1982), in which sub-micelles are 'cemented' together by colloidal calcium phosphate (CCP) and κ -casein-rich sub-micelles are mainly concentrated at the surface of the micelle; the hydrophilic C-terminal region of the κ -casein

Table 1.2 Characteristics of cows' milk proteins of relevance to cheese manufacture.

Protein	Level in skimmed milk (g 100 g ⁻¹ protein)	Amino acids	Glu residues	Asp residues	-SH groups	Disulphide (S-S) bonds	Phosphate residues	Glycosylated residues	Sensitivity to Ca ²⁺ at temperatures >18°C	Approximate isoionic pH	Approximate isoelectric pH in milk	Sensitivity to chymosin hydrolysis during milk gelation
Caseins												
α_{s1} -casein	38	199	24	7	0	0	9	No	High at >4 mM	—	4.96	Low
α_{s2} -casein	10	207	25	4	2	0	8	No	High at >4 mM	5.4	5.4	Low
β -casein	35	209	11	4	2	0	11	No	High	5.3	5.3	Low
κ -casein	15	169	12	4	2	0	12	Yes, with galactose, GalNAc, sialic acid	Very low	5.2	5.2	High
γ -casein	3	183	11	4	0	0	13	No	—	5.3	5.3	Low
		103	4	2	0	0	1	No	—	—	—	—
		1001	4	2	0	0	0	—	—	—	—	—
Whey proteins												
β -lactoglobulin (β -Lg)	55	162	—	—	1	2	0	No	—	5.4	5.13	Very low
α -lactalbumin (α -La)	21	123	—	—	0	4	0	No	—	—	4.4	Very low
Serum albumin	7	34	—	—	1	17	0	No	—	5.1	4.8	Very low
Others	16	—	—	—	—	—	—	—	—	—	—	—
Immunoglobulins												
Lactoferrin												

Source: Compiled from Mulvihill & Donovan (1987), Fox & McSweeney (1998), Fox (2003) and Swaigood (2003).

- orient into the serum as a highly hydrated ‘hairy layer’ that is in a state of constant flux and confers stability to the micelle by steric repulsion;
- dual bonding model (Horne, 1998), in which the interior of the micelle is composed of α_s - and β -caseins which form a lattice through interactions between hydrophobic regions (hydrophobic-induced) and between hydrophilic regions containing phosphoserine clusters (that attach to CCP clusters), while κ -casein molecules located at the surface interact hydrophobically with the other caseins (α_s - or β -) and orient their highly hydrophilic regions (hairs) into the serum;
 - tangled, cross-linked web model (Holt & Horne, 1996), comprising a ‘tangled’ mass of rheomorphic casein chains cross-linked by calcium phosphate nanoclusters, similar in casein composition throughout but with the chains becoming more diffuse at the micelle periphery (on moving outwards from the dense centre); and
 - interlocked lattice model (McMahon & Oomen, 2008), featuring a system of interlocking sites composed of anchoring calcium phosphate nanoclusters (several hundred per micelle), which bind the phosphoserine domains of α_s - and β -caseins; the hydrophobic ends of these caseins orientate away from the calcium phosphate nanocluster and interact hydrophobically with other α - and β -caseins, while κ -casein is predominantly surface located because of its lack of phosphoserine domains (to bind to the calcium phosphate nanoclusters) and its highly charged C-terminal regions (which prevents strong electrostatic interactions).

In all of the above models, the arrangement of casein within the micelle is such that the interior is mainly occupied by the calcium-sensitive caseins (α_s - and β -) and κ -casein is principally located at the surface, with its hydrophilic C-terminal region (caseinomacropptide) oriented outwards toward the serum phase in the form of protruding negatively charged hairs, which create an electrokinetic potential of ~ -20 mV and confer stability to the micelle by electrostatic repulsion, Brownian movement and a consequent steric repulsion (de Kruif & Holt, 2003; Horne & Banks, 2004). The κ -casein C-terminal projecting from the micelle surface has been considered as an extended polyelectrolyte brush (de Kruif, 1999), a region containing 14 carboxylic acid groups and immersed in a milk serum with a high ionic strength (~ 0.08 M) due to the presence of various ions (e.g. potassium, sodium, chloride, phosphate, citrate). Consequently, electrostatic interactions (between the C-terminal regions) at physiological conditions are very short and highly screened (by the high ionic strength). This is conducive to a high degree of ‘solventcy’ and extension of the κ -casein C-terminal hairs and to the stability of the micelle as a whole. Moreover, the C-terminal region of the κ -casein is glycosylated to varying degrees (Table 1.2; Saito & Itoh, 1992; Mollé & Leonil, 1995; Fox & McSweeney, 1998; Mollé *et al.*, 2006), containing galactose, *N*-acetylgalactosamine (GalNAc) and/or *N*-acetylneuraminic (sialic) acid (NANA) (Dziuba & Minkiewicz, 1996). These may further enhance the ability of κ -casein to increase micelle stability by steric impedance and electrostatic repulsion via their contribution to increase in water binding (to carbohydrate moieties) and to negatively charged carboxylic groups (on the NANA molecule). O’Connell & Fox (2000) found that the level of glycosylation of κ -casein and protein surface hydrophobicity increased as a function of micelle size.

While a predominant surface location of κ -casein confers stability to the casein micelle in native milk, it renders it susceptible to aggregation/flocculation by processes which reduce the solvency of (and collapse/flatten) the κ -casein hairs or remove them, and thereby enable contact between the more hydrophobic micelle cores, for example cleavage of the κ -casein by acid proteinases, reducing the negative charge by acidification, reducing ionic strength by microfiltration/diafiltration at native pH. However, the interactions between the micelle cores are modified by many factors, including pH, composition of the serum phase, ionic strength, protein concentration and conditions to which milk is subjected (heat, acidification, ultrafiltration/diafiltration homogenisation, shearing).

The casein micelles on a dry weight basis consist of ~ 7 g 100 g⁻¹ ash (mainly calcium and phosphorous), 92 g 100 g⁻¹ casein and 1 g 100 g⁻¹ minor compounds including magnesium and other salts. They are present in milk at 10¹⁴–10¹⁶ mL⁻¹, are highly hydrated (~ 3.7 g H₂O g⁻¹ protein), are spherical and have a diameter of ~ 80 nm (100–500 nm), a surface area of $\sim 8 \times 10^{-10}$ cm² and a density of ~ 1.063 g cm⁻³ (Fox & McSweeney, 1998).

1.2.2 Whey protein

Whey protein in cows' milk is typically ~ 0.6 – 0.7 g 100 g⁻¹ and consists of four main types – β -lactoglobulin (β -Lg), α -lactalbumin (α -La), immunoglobulin(s) (Ig) and bovine serum albumin (BSA) at levels of ~ 54 , 21, 14 and 6 g 100 g⁻¹ of total (Table 1.2). The properties of the individual whey proteins have been extensively reviewed (Table 1.2; Mulvihill & Donovan, 1987; Brew, 2003; Fox, 2003; Hurley, 2003; Sawyer, 2003). In milk, they exist as soluble globular proteins and are characterised by a relatively high level of intramolecular disulphide bonding, and β -Lg and BSA each contain one cysteine residue per mole. On heat-induced denaturation, the whey proteins can interact via thiol–disulphide bonds with other whey proteins and with κ -casein. The latter results in the formation of κ -casein/ β -Lg aggregates either at the surface of the casein micelle or in the serum phase or both (cf. Chapter 8). The size and location (serum/micelle surface) of these aggregates are affected by severity of heat treatment of milk, pH at heating, ionic strength, calcium level and casein-to-whey protein ratio. The degree of interaction and size/location of aggregates have a profound effect on the structure and physical properties of rennet- and acid-induced milk gels, and hence on cheeses (see Chapter 8). For example, a high level of casein–whey protein interaction, induced by high heat treatment of the milk (e.g. 95°C for ≥ 1 – 2 min, $\sim \geq 40\%$ denaturation of total whey protein; Guinee *et al.*, 1995), is highly favoured in the manufacture of yoghurt and smooth-textured cheeses with a high moisture-to-protein ratio, such as cream cheese and ultrafiltration-produced Quark. In these products it increases protein recovery and moisture binding (reduce syneresis), contributes smoothness and enhances yield (Guinee *et al.*, 1993). In contrast, high heat treatment of milk is unsuitable for acid-curd cheeses with a granular structure (Cottage cheese) or for Quark manufactured using a mechanical separator, as it impedes whey expulsion during separation and makes it difficult to achieve the desired dry matter and texture characteristics. High heat treatment of milk is generally undesirable for rennet-curd cheeses as denatured protein at levels of $\geq 25\%$ of total (at heat treatments of 82°C for 26 s, or greater) impedes the ability of the milk to gel on rennet addition, causes

marked deterioration in melt properties of the cheese (Rynne *et al.*, 2004) and reduces the recovery of fat from milk to cheese (see Chapter 8). However, a higher-than-normal heat treatment that gives a moderate degree of whey protein denaturation may be desirable as a means of modulating the texture of reduced fat cheese, e.g. reduce firmness (Guinee, 2003; Rynne *et al.*, 2004).

1.2.3 Minerals

Cows' milk contains ~ 0.75 g 100 g⁻¹ ash, which comprises K⁺, Ca²⁺, Cl⁻, P⁵⁺, Na⁺ and Mg²⁺ at concentrations (mg 100 g⁻¹) of ~ 140 , 120, 105, 95, 58 and 12, respectively (Table 1.2; White & Davies, 1958a; Chapman & Burnett, 1972; Keogh *et al.*, 1982; Grandison *et al.*, 1984; O'Brien *et al.*, 1999c). These minerals are partitioned to varying degrees between the serum (soluble) and the casein (colloidal or insoluble) in native milk (pH ~ 6.6 – 6.7) at room temperature. Serum concentrations as a percentage of the total concentration for each of the minerals are ~ 100 , 100, 100, 66, 43 and 34 for Na⁺, K⁺, Cl⁻, Mg²⁺, P²⁺ and Ca²⁺, respectively. The partition concentrations of Ca²⁺ and P²⁺ between the colloidal and soluble states in native milk is controlled mainly by the degree of ionisation of the casein (micelle), which in milk may be considered as a very large dominant anion that regulates the degree of binding of the counterion calcium, to an extent affected by the concentration of calcium *per se* and those of citric acid and phosphate. A major difference between the calcium salts of citrate (tricalcium citrate – Ca₃(C₆H₅O₇)₂) and phosphate (tricalcium phosphate – Ca₃(PO₄)₂) is their solubility, with the solubility product of the latter being very low (2.07×10^{-33} mol L⁻¹ at 25°C) compared to the former (3.23×10^{-3} mol L⁻¹ at 25°C).

Cows' milk typically contains ~ 120 mg 100 mL⁻¹ calcium (~ 30 mM), which exists as colloidal inorganic calcium (~ 12.5 mM), caseinate calcium (8.5 mM), soluble unionised calcium (6.5 mM) and serum ionic calcium (2.5 mM). Calcium attached to the casein micelle, referred to as micellar calcium phosphate, is composed of the colloidal inorganic Ca²⁺ (more frequently denoted CCP) and caseinate Ca²⁺. The former occurs as a calcium phosphate complex attached indirectly to the organic serine phosphate groups, while the latter is attached directly to casein via the dissociated ϵ -carboxyl groups of acidic amino acids including aspartic (pK_a ~ 3.9) and glutamic (pK_a ~ 4.1) acids. Owing to the high molarity of glutamic and aspartic acids (~ 25 and 7 mM) in milk (with a casein content of 2.5 g 100 g⁻¹), it can be inferred that only ~ 26 g 100 g⁻¹ of the available ϵ -carboxyl groups are titrated with calcium and that these groups could potentially bind with added calcium to increase the susceptibility of the casein to aggregation, especially on rennet treatment. The sensitivity of the individual caseins to calcium precipitation as found from model studies in dilute solutions varies and tends to increase with the number of moles of both phosphate and glutamic acid per mole of casein. Hence, the concentration of Ca²⁺ at which the individual caseins precipitate is lowest for α_{s1} -casein (< 2 mM), intermediate for α_{s2} -casein (3–8 mM) and β -casein (8–15 mM), and highest for κ -casein, which remains soluble at all of these concentrations and can prevent the precipitation of the other caseins (Aoki *et al.*, 1985).

In the context of the milk salt system, the milk may be viewed as a ‘soup’ consisting of a large colloidal anion (calcium phosphate casein) dispersed in a serum containing various soluble salt and ionic species (calcium citrate, sodium phosphate, potassium and ionic calcium). The insoluble (colloidal salts associated with the casein) and soluble (serum) salts exist in equilibrium. While the soluble citrate and phosphate compete with the casein for calcium ions (resulting in the formation of calcium citrate and insoluble calcium phosphate), the polyvalent casein is the main player controlling the equilibrium concentrations of salts. However, slight changes in pH and concentrations of serum salts (e.g. as a consequence of natural variation or fortification) can affect the equilibrium balance, and consequently the charge and reactivity of the casein.

1.2.4 Milk lipids

Cows’ milk typically contains ~ 3.7 g 100 g⁻¹ lipid, but the level varies significantly (from ~ 3.0 to 5.0 g 100 g⁻¹) with breed, diet, health, stage of lactation and animal husbandry. Triacylglycerols, denoted as milk fat, represent ~ 96 –99 g 100 g⁻¹ lipid. The remaining (1–2 g 100 g⁻¹) consists of phospholipids (0.8 g 100 g⁻¹), diacylglycerols, sterols (0.3 g 100 g⁻¹) and trace quantities of carotenoids, fat-soluble vitamins and traces of free fatty acids (FFA) (Jensen, 2002; Huppertz *et al.*, 2009). The fat in milk exists in the form of dispersed globules (~ 2 –6 μm average volume weighted diameter) (Wiking *et al.*, 2004), surrounded by a lipoprotein membrane (milk fat globule membrane, MFGM) (Keenan & Maher, 2006). The MFGM stabilises the enclosed fat against coalescence and fusion (and hence, phase separation) and access from lipases, such as the lipoprotein lipase (LPL) naturally present in native milk, or from lipases of contaminating microorganisms, such as *Pseudomonas* spp. (Ward *et al.*, 2006). Inadvertent damage of the membrane, as, for example, by manhandling of the milk (e.g. excessive shearing, turbulence, cavitation; see Section 1.5.4), is highly undesirable in cheese manufacture. It leads to free fat in the cheese milk, lower recovery of milk fat to cheese, lipolysis of the fat by lipases that survive pasteurisation treatment, high levels of FFA and undesirable flavours (e.g. bitter, soapiness, metallic), especially in some cheese types (e.g. Emmental, Gouda, Cheddar). In the latter cheeses, only low to moderate levels of FFA are required for satisfactory flavour (Cousin & Marth, 1977; Woo, 1983; Gripon, 1993; Brand *et al.*, 2000; Collins *et al.*, 2004; Ouattara *et al.*, 2004; Deeth & FitzGerald, 2006; see also Chapter 8). Nevertheless, there are a number of applications in cheese manufacture where the cheese milk is homogenised, resulting in physical breakage of the MFGM and its replacement by a newly formed membrane composed of casein and whey proteins, and smaller fat globules (Huppertz & Kelly, 2006). The reformed fat globule, owing to its smaller size (~ 1.0 μm), is stable to flocculation and creaming, but does not isolate the enclosed fat from lipolytic enzymes. These properties are exploited in the manufacture of cheeses (see Chapter 8):

- high-fat acid-curd cheeses, such as Cream cheese, where the smaller fat globules prevent flocculation and creaming during the relatively long incubation/gelation period and where the reformed fat globule membrane enables the fat globule to behave as a fat-filled protein

Table 1.3 Free fatty acid profile of milk fat triacylglycerols.

Fatty acid/ common name	Number of carbon atoms	Number of double bond	Typical level in milk fat	
			mol mol ⁻¹ fat	g 100 g ⁻¹ fat ^a
Saturated				
Butyric	4	0	10.1	3.9 (2–5)
Caproic	6	0	4.9	2.5 (1–5)
Caprylic	8	0	2.4	1.5 (1–3)
Capric	10	0	4.3	3.2 (2–4)
Lauric	12	0	4.1	3.6 (2–5)
Myristic	14	0	11.1	11.1 (8–14)
Palmitic	16	0	24.9	27.9 (22–35)
Stearic	18	0	9.8	12.2 (9–14)
Unsaturated				
Myristoleic	14	1	0.8	0.8 (0.5–1.1)
Palmitoleic	16	1	1.4	1.5 (1–3)
Oleic	18	2	17.1	21.1 (20–30)
Linoleic	18	2	2.0	2.5 (1–3)
Linolenic	18	3	0.8	1.0 (0.5–2)

Source: Compiled from Jensen (2002) and MacGibbon & Taylor (2006).

^aValues in parentheses indicate the range of values reported in the literature.

particle, become an integral part of the gel network during acid gelation and contribute to the desired texture characteristics (Guinee & Hickey, 2009; cf. Chapter 8); and

- rennet-curd cheeses where a high level of lipolysis is desirable (e.g. blue-type cheeses), where added lipases or lipases from secondary starter cultures can access the fat more easily, bring about selective hydrolysis of the triacylglycerols and release the FFA that lead to the desired flavour.

The principal fatty acids in milk fat on a total weight basis are C_{16:0} (palmitic), C_{18:1} (oleic) and C_{14:0} (myristic) in decreasing order (Table 1.3). While the shorter chain fatty acids (C_{4:0} to C_{12:0}) are present in lower quantities on a weight basis, they are primarily responsible for the piquant flavour of hard Italian cheeses, such as Parmesan and Romano, or the sharp goaty/sheep-like flavours of soft goat milk cheeses. These fatty acids are hydrolysed from the milk fat triacylglycerols by lipase enzymes, which gain access owing to damage of the MFGM during cheese manufacture and maturation. The principal sources of these lipases are added exogenous enzymes (added rennet paste, pregastric esterase), secondary flora (*Brevibacterium linens*, *Penicillium roqueforti*, *Geotrichium candidum*; see also Chapter 6), starter culture lactic acid bacteria and culture adjuncts (*Lactococcus* spp., *Lactobacillus helveticus*) (Collins *et al.*, 2004; Hickey *et al.*, 2006b; Santillo *et al.*, 2007; Hashemi *et al.*, 2009; Jooyandeh *et al.*, 2009).

1.3 Principles of cheese manufacture

Cheese is a concentrated protein gel, which occludes fat and moisture. Its manufacture essentially involves gelation of cheese milk, dehydration of the gel to form a curd and

treatment of the curd (e.g. dry stirring, cheddaring, texturisation, salting, moulding, pressing). The moulded curd may be consumed fresh (shortly after manufacture, for example within 1 week) or matured for periods of ~2 weeks to 2 years to form a ripened cheese. The gelation of milk may be induced by:

- selective hydrolysis of the κ -casein at the phenylalanine₁₀₅–methionine₁₀₆ peptide bond by the addition of acid proteinases, referred to generically as rennets (chymosin, pepsin);
- acidification (using starter cultures or food-grade acids and/or acidogens), at a temperature of 20–40°C, to a pH value close to the isoelectric pH of casein, i.e. ~4.6; and/or
- a combination of acid and heat, for example heating milk at pH ~5.6 to ~90°C.

1.3.1 Rennet-induced gelation

On treatment of milk with chymosin (rennet), the κ -casein is hydrolysed, with the primary cleavage point being the peptide bond phenylalanine₁₀₅–methionine₁₀₆, and the liberation of the highly charged, hydrophilic methionine₁₀₆–valine₁₆₉ caseinomacropeptide into the milk serum (whey). This results in an effective ‘shaving’ of the hairy layer from the micelle surface, a marked reduction in the negative surface charge to ~–10 mV, and an increase in the attractive forces between, or ‘stickiness’ of, the *para*-casein micelle surfaces. Consequently, the latter begin to aggregate when sufficient κ -casein is hydrolysed (~80–90 g 100 g⁻¹ of total; Green *et al.*, 1978; Dalglish, 1979), resulting in the formation of clusters/aggregates of *para*-casein micelles that fuse gradually and eventually ‘knit’ into a restricted, periodic repeating, solid-like viscoelastic gel network (Fig. 1.1). The enzymatic stage of rennet coagulation and the aggregation of enzymatically altered sensitised *para*-casein micelles overlap. While the exact contribution of calcium to rennet coagulation is unclear, it is likely that the casein calcium (which in effect may be considered as pre-bound ionic calcium) is the principal agent inducing cross-linking and aggregation of the *para*-casein micelles into a gel. The serum ionic calcium in milk is in equilibrium with the casein calcium. Hence, apart from reflecting the level of casein-bound calcium, serum ionic calcium probably plays little, or no, direct role in rennet-induced casein aggregation and gelation of milk. Similarly, the progressive increase in gel firmness of rennet-treated milks on the addition of calcium chloride (ionic calcium) while retaining a constant pH (Fig. 1.2) probably reflects the consequent increases in the levels of casein calcium and CCP rather than an increase in the serum ionic calcium *per se*. Hence, it is noteworthy that on concentration of milk by evaporation, the calcium ion activity slightly decreases from ~1.0 to 0.75 mM L⁻¹ while the levels of micellar calcium increase (Nieuwenhuijse *et al.*, 1988). Rennet-induced gelation of milk is hindered by a variety of factors, which either:

- restrict access of the rennet to its substrate (κ -casein), for example complexation of denatured whey protein with κ -casein at the micelle surface, as a result of high heat treatment of the cheese milk (Fig. 1.1; Guinee, 2003);
- act as obstacles to the aggregation and fusion of rennet-treated casein micelles, for example κ -casein/ β -Lg appendages at micelle surface, or serum κ -casein/ β -Lg particles (Guyomarc’h, 2006);

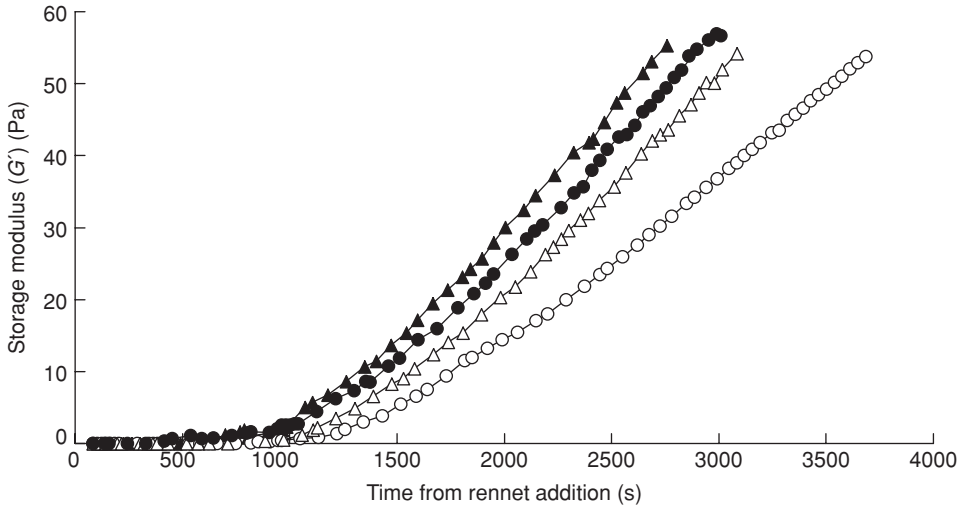

Fig. 1.1 Effect of pasteurisation temperature on changes in storage modulus G' during the rennet gelation of milk. Note: Milks were heated to various temperatures (in $^{\circ}\text{C}$) for 26 s prior to rennet addition: 72 (\bullet), 74.6 (\blacktriangle), 75.9 (\circ) or 78.5 (\triangle); the milks were cooled to 31°C , adjusted to pH 6.55 if necessary with lactic acid solution ($5\text{ g } 100\text{ g}^{-1}$), treated with chymosin (Chymax Plus, Pfizer Inc., Milwaukee, WI) at a rate of 0.18 mL of undiluted rennet per litre of milk; all milks had similar contents of protein ($3.3\text{ g } 100\text{ g}^{-1}$) and fat ($3.4\text{ g } 100\text{ g}^{-1}$); G' was measured dynamically using low-amplitude strain oscillation rheometry (controlled stress rheometer).

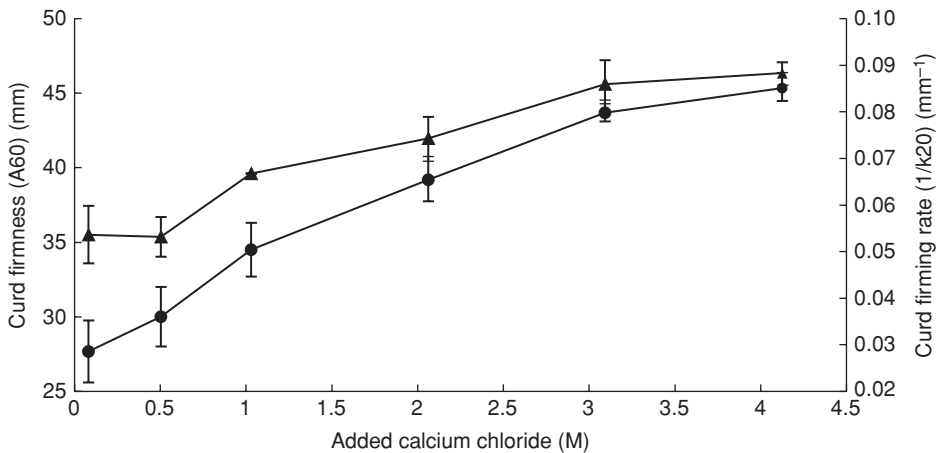

Fig. 1.2 Changes in curd firmness at 60 min (A_{60} ; \bullet) and curd firming rate ($1/k_{20}$; \blacktriangle) of skimmed milk as a function of the level of added calcium chloride. Note: All milk samples ($\sim 3.45\text{ g protein } 100\text{ g}^{-1}$ of milk) were adjusted to pH 6.55 prior to measuring the rennet gelation properties at 31°C on the Formagraph (Type 1170, Foss Electric, Denmark); the following parameters were measured k_{20} , a measure of time from the onset of gelation to a output signal width of 20 mm, and A_{60} , the width of the output signal at 60 after rennet addition.

- reduce the ‘stickiness’ of rennet-altered casein micelles, for example increased ionic strength (e.g. by the addition of NaCl to the cheese milk as in Domiati cheese) (Awad, 2007; Huppertz, 2007), negative charge (high pH); and/or
- reduce the degree of bonding between touching micelles, for example reducing the level of calcium by the addition of ethylenediaminetetraacetic acid (EDTA) or other chelants (Shalabi & Fox, 1982; Mohammad & Fox, 1983; Choi *et al.*, 2007), ion exchange (Mei-Jen-Lin *et al.*, 2006) and/or dialysis (Wahba *et al.*, 1975), or by a naturally low level of Ca^{2+} as in late lactation milks or milks from cows with subclinical mastitis (White & Davies, 1958a).

Following gel formation, the resultant milk gel is subjected to a number of operations that promote the release of whey, an approximate tenfold concentration of the casein, fat and micellar calcium phosphate components, and a transformation to a curd with much higher dry matter content than the original milk gel (45 g 100 g⁻¹ for Cheddar curd at whey drainage). These operations include cutting the gel into pieces (referred to as curd particles, ~0.5–1.5-cm cubes), stirring and heating the particles in expressed whey, reducing the pH of the aqueous phase inside the curd particle by fermentation of lactose to lactic acid (by the lactic bacteria in the starter culture added to the milk prior to rennet addition), and physical draining of the whey from the curd particles by pumping the curd particle–whey mixture onto perforated screens (cf. Chapter 8). Following whey drainage, the curd particles knit together into a cohesive mass of curd, which is treated to enhance further whey expulsion and concentration to the desired dry matter content of the cheese variety being manufactured; these treatments differ according to variety but typically include further lactose fermentation and pH reduction, cutting the curd mass into pieces (slabs), moulding the pieces to the desired shape and weight of finished cheese, salt addition and pressing. During the dehydration process of the gel, protein concentration and aggregation continues via various types of intra- and intermolecular interactions (Lucey *et al.*, 2003), including calcium bridging (between glutamate/aspartate residues, calcium–CCP bridges between phosphoserine residues), hydrophobic interactions between lipophilic domains and electrostatic interactions (other than calcium bridging). The strength of these interactions is modulated by ionic strength, pH, calcium and temperature, and hydrolysis of proteins to peptides, which alters the hydrophile/lipophile balance of the proteinaceous fraction.

Following manufacture, rennet-curd cheeses are usually matured or ripened by holding under specific conditions of temperature and humidity for periods which range from ~2 to 4 weeks for soft cheeses (for Camembert-type cheeses) to ~2 years for some hard cheeses (for Parmesan-style cheeses). During this period, a host of physico-chemical changes take place which transform the ‘rubbery/chewy’-textured fresh cheese curd to the finished cheese with the desired variety quality characteristics, for example a soft, smooth, short and adhesive texture with a mushroom-like flavour and creamy mouth-feel for Camembert, or a long, elastic sliceable texture and mild, sweet flavour for Leerdammer cheese. These physico-chemical changes include:

- glycolysis, conversion of residual lactose to lactic acid by the starter culture and of lactic acid to other compounds, such as acetic acid and propionic acid by secondary starter

cultures such as *Propionibacteria freudenreichii* subsp. *shermanii* in Emmental-style cheese;

- proteolysis, hydrolysis of caseins to peptides and free amino acids by proteinases and peptidases present in the cheese (residual rennet; plasmin, and proteinases and peptidases from the cells of starter culture and non-starter lactic acid bacteria); and
- lipolysis, involving the hydrolysis of triacylglycerols to FFA, di- and monoacylglycerols by lipases and esterases from various sources, including native milk LPL, added pregastric esterases and/or secondary cultures.

The physico-chemical and biochemical changes that occur during ripening are discussed in Chapter 8 and several comprehensive reviews are available (Collins *et al.*, 2004; McSweeney & Fox, 2004; Upadhyay *et al.*, 2004; Kilcawley, 2009).

Of particular interest in relation to milk composition and cheese quality is the impact of the proportion of intact α_{s1} -casein content in milk on casein aggregation, strength of the rennet-induced milk gel and texture of the final cheese. The sequence of residues 14–24 is a strongly hydrophobic domain and confers intact α_{s1} -casein with strong self-association and aggregation tendencies in the cheese environment (Creamer *et al.*, 1982); interestingly, this domain also has 3 mol of glutamate, which are expected to contribute to intra- and intermolecular calcium bridges. It has been suggested that self-association of α_{s1} -casein in cheese, via these hydrophobic ‘patches’, leads to extensive cross-linking of *para*-casein molecules and thus contributes to the overall continuity and integrity of the casein matrix in the cheese curd (de Jong, 1976, 1978; Creamer *et al.*, 1982; Lawrence *et al.*, 1987). The early hydrolysis of α_{s1} -casein at the phenylalanine₂₃–phenylalanine₂₄ peptide bond, by residual rennet retained in the cheese curd following manufacture (~10% of that added), results in a marked weakening of the *para*-casein matrix and reductions in fracture stress and firmness of the cheese during maturation (de Jong, 1976, 1977; Creamer & Olson, 1982; Malin *et al.*, 1993; Tunick *et al.*, 1996; Fenelon & Guinee, 2000). This hydrolysis is a key step in mediating the conversion from a fresh rubbery curd to a mature cheese with the desired textural and cooking properties (meltability) (cf. Chapters 7–10).

1.3.2 Acid-induced gelation

The caseins in milk are insoluble at their isoelectric points (pH ~4.6) at temperatures $> \sim 8^{\circ}\text{C}$ (Mulvihill, 1992). This property is exploited in the formation of acid-curd cheeses, such as Cottage cheese, Quark and Cream cheese, the manufacture of which involves slow quiescent acidification of the cheese milk to pH ~4.6–4.8 by starter culture, acidogens (e.g. glucono- δ -lactone) at temperatures of 20–30°C (Guinee *et al.*, 1993; Lucey & Singh, 1997; Fox *et al.*, 2000; Farkye, 2004; Lucey, 2004; Schulz-Collins & Zenge, 2004). Acidification results in a number of physico-chemical changes promoting hydration/dispersion or dehydration/aggregation effects on the casein micelle, with the ratio of these effects changing as the pH declines during the acidification (fermentation) process. Reducing the pH from 6.6 to ~5.2–5.4 results in a decrease in the negative charge of the micelles due to titration of negative charges with H⁺ ions. Nevertheless, this is generally not accompanied by the onset

of gelation because of:

- solubilisation of micelle ‘cementing’ agent CCP (fully soluble at pH ~ 5.2 at 20°C);
- diffusion of all caseins from the micelle to the serum (owing to a decrease in the degree of electrostatic interaction between phosphoserine residues of α_s - and β -caseins and the CCP nanoclusters);
- increases in ionic strength of the serum phase; and
- hydration of the casein micelles.

However, further reduction in pH in the range ~ 5.2 – 4.6 results in aggregation of casein and gel formation, as forces promoting dispersion of casein micelles are overtaken by the sharp reductions in the negative charge and hydration of the casein, the collapse in steric effect associated with the κ -casein C-terminal ‘hairs’ and the increase in hydrophobic interactions. The onset of gelation typically occurs at pH ~ 5.1 and further reduction in pH toward 4.6 coincides with the eventual formation of a continuous gel structure with sufficient rigidity to enable separation of whey from the curd by physical means (e.g. breakage, stirring, and whey drainage, or centrifugation). The increase in gel rigidity coincides with a sigmoidal increase in the elastic shear modulus of the gelling cheese milk, as the pH continues to decrease towards 4.6 during incubation and the fermentation of lactose to lactic acid (Fig. 1.3).

High heat treatment of the cheese milk (e.g. 95°C for ≥ 1 min) leads to an increase in the pH at the onset of gelation (from ~ 4.7 to 5.3) and the rigidity of the resultant gel (cf. Chapter 8; Vasbinder *et al.*, 2003; Anema *et al.*, 2004). These changes coincide with increases in the level of whey protein denaturation and its covalent interaction with κ -casein,

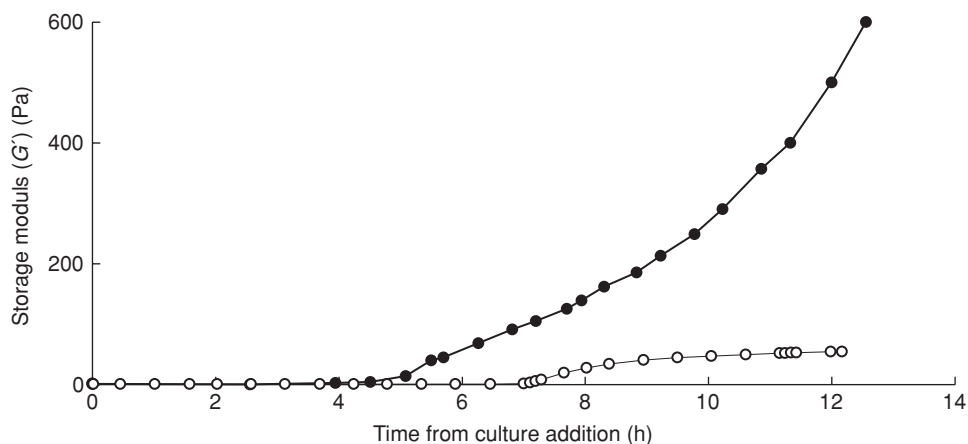

Fig. 1.3 Effect of milk treatment (heated to 90°C for 30 min – ●, or unheated – ○) on changes in modulus G' during acid gelation of milk. Note: The milks (1.5 g fat 100 g $^{-1}$, 3.2 g protein 100 g $^{-1}$) were cooled to 40°C and a thermophilic starter culture (*Streptococcus thermophilus*) was added at a rate of 2.5 g 100 g $^{-1}$; G' was measured dynamically using low-amplitude strain oscillation rheometry (controlled stress rheometer).

via thiol–disulphide interchange. This interaction occurs both at the surface of the micelle, resulting in the formation of filamentous appendages projecting from the micelle surface, as well as in the serum phase when κ -casein dissociates from the micelle into the serum and interacts with β -Lg to form soluble complexes that sediment as the pH is reduced during fermentation and/or rennet treatment. The different types of interactions are influenced by pH and the level of whey proteins (Donato & Guyomarc'h, 2009; cf. Chapter 8). *In situ* denatured whey protein increases the concentration of gel-forming protein, the spatial uniformity of the gel matrix and the number of stress-bearing strands in the matrix. Denatured whey proteins, whether in the form of filamentous appendages (κ -casein/ β -Lg) that occur at the surface of micelle and 'flatten' on pH reduction or that occur as serum-soluble κ -casein/ β -Lg particles that sediment on pH reduction (and/or rennet treatment), act as obstructions that physically obstruct/prevent a high level of interaction of the native casein micelles and, thereby, lead a more continuous gel structure with higher rigidity. The increase in micelle size resulting from complexation with denatured whey protein (Anema & Li, 2003) is conducive to an earlier touching of the casein micelles during the acidification/gelation process and the onset of gelation at a higher pH. The changes in gel structure associated with high heat treatment of milk lead to significant increases in the stiffness (G') and visual smoothness of the resultant acid gel (Fig. 1.3), a principle which has long been exploited in the manufacture of yoghurt.

In the manufacture of acid-curd cheeses, the milk gel is cut or broken, and whey removal is achieved by various means including centrifugation, ultrafiltration and/or straining the broken gel in muslin cheese bags. In some varieties (e.g. cream cheese), whey separation is further enhanced by heating the broken gel to temperatures of $\sim 80^\circ\text{C}$ prior to centrifugation or to $\sim 50^\circ\text{C}$ prior to ultrafiltration or straining. Treatments of the curd differ with cheese variety. In the manufacture of Quark, the temperature of the concentrated curd ($\sim 18\text{ g } 100\text{ g}^{-1}$ dry matter) is cooled rapidly to $< 8^\circ\text{C}$ by passing through suitable heat exchangers so as to limit hydrophobic interactions between the proteins and to, thereby, minimise the likelihood of defects associated with excessive protein interaction in the final cheese, for example sandy, chalky, or grainy mouth-feel, and/or wheying-off. In contrast, the manufacture of Cream cheese involves high heat treatment of the curd ($\sim 80^\circ\text{C}$), the addition of NaCl ($\sim 0.5\text{ g } 100\text{ g}^{-1}$) and hydrocolloids (blends of xanthan/guar gums: $\sim 0.3\text{ g } 100\text{ g}^{-1}$), mixing, homogenisation and cooling. The added hydrocolloids, hydrated and dispersed at high temperature, increase the viscosity of the hot molten cheese curd and reduce the growth of protein aggregates and the occurrence of chalky/grainy texture.

The degree to which the attributes (stiffness, structure) of the gel prior to whey separation and concentration influence the characteristics of the final acid-curd cheese is influenced by the type and extent of operations (whey separation method, heat treatment, type/level of hydrocolloid) following gel formation; this subject is beyond the scope of this chapter and the reader is referred to earlier reviews (Guinee *et al.*, 1993; Lucey *et al.*, 2003; Farkye, 2004; Schulz-Collins & Zenge, 2004; Guinee & Hickey, 2009).

1.4 Quality definition of milk

In an overall context, the quality of milk for cheese may be defined as its characteristics that fulfil the requirements of its users – direct (the cheese manufacturer) and indirect (the cheese

user, consumer) (Peri, 2006). The quality requirements may be defined as:

- safety, which denotes the absence of associated risk (e.g. pathogenic microorganisms, 'toxic' residues) in milk from consuming the cheese from which it is made;
- compositional/nutritional, which indicate the conformity to minimum levels of particular components (fat, protein, casein, calcium) that make it suitable for cheese manufacture, for example enable the milk to form a gel suitable for cutting within a certain time after addition of rennet; to give desired manufacturing efficiency (percentage recovery of fat and casein; product yield), composition (levels of protein, calcium, moisture) and sensory characteristics;
- microbiological, ensuring that total bacterial count does not exceed a maximum value so as to reduce the risk of the milk quality (level of intact casein, absence of rancidity associated with hydrolysis of milk fat) being compromised in terms of its cheesemaking capacity (rennet coagulability, altered levels of pH at different stages of manufacture), cheese yield efficiency (recoveries of fat and casein, cheese yield) and cheese quality (flavour and physical properties);
- sensory and functional, implying its possession of the desired hedonic (absence of taints) and physico-chemical characteristics (coagulability by rennet under defined conditions), enabling it to be satisfactorily made into cheese with the desired hedonic (taste, smell), usage (techno-functional) and nutritional characteristics; and
- ethical, in terms of its naturalness (non-adulterated) and its compliance to production standards including those pertaining to animal breeding, animal welfare and agricultural/husbandry systems.

Requirements of the first four aspects either can be quantified directly by tests (microbiological, chemical, physical) undertaken by the cheese manufacturer or regulatory agencies, or can generally be perceived by both the manufactures and users of the milk, as they may impact on cheesemaking capacity of the milk, yield efficiency or product quality. Generally, ethical requirements (apart from adulteration) cannot be tested and/or perceived directly by the users; for example, analysis of milk or consumption of the resultant cheese cannot verify that the milk was produced in compliance with organic farming methods. Compliance to ethical requirements is generally considered to be fulfilled by the milk producer and, moreover, is ensured by specifications set by government agencies (EU, 1992, 2004) and organisations such as dairy cooperatives and organic milk supplier organisations.

In the current chapter, milk quality for cheese manufacture will be discussed under the following criteria, each of which involves different types of sub-criteria or characteristics.

1.4.1 *Safety/public health (pathogens including Mycobacterium tuberculosis, Brucella spp., toxic residues, and contaminants)*

Directive 92/46 (EU, 1992) specifies that raw milk must come from healthy animals and should not endanger human health by way of infectious diseases or foreign substances that are communicable to human beings through the milk. A recent study has attributed 9% of foodborne disease cases to milk consumption (Adak *et al.*, 2005).

Pathogenic bacteria

The presence of potentially pathogenic bacteria in milk is well documented (Rea *et al.*, 1992; Jayarao & Henning, 2001). The pathogens reported as the most common agents implicated in milkborne disease include *Salmonella* spp., *Campylobacter* spp. and *Escherichia coli* (Gillespie *et al.*, 2003), but others found in milk could also have public health implications, such as *Mycobacterium tuberculosis* and *Listeria monocytogenes* (Jayarao & Henning, 2001). Reed and Grivetti (2000) reported that surveys on Californian dairies revealed the presence of a variety of bacteria that could make people ill, and raw milk consumption has often been associated with foodborne epidemics due to pathogens, such as *Campylobacter* spp., *Listeria* spp. and *Salmonella dublin*. These microorganisms may enter the mammary gland and thus the milk, from the external environment through the teat orifice during the milking process or during the interval between milkings. Contamination of the external surface of the teat with faecal and other environmental organisms is scarcely avoidable, but is minimised by compliance to the highest standards of hygiene at milking. However, if initial contamination levels are low and subsequent milk storage conditions (hygiene and temperature) are correct, then further bacterial growth will be minimised.

Mycobacterium bovis

This organism has a broad host range and is the principal agent of tuberculosis in wild and domestic animals. This organism can also infect humans causing zoonotic tuberculosis. The transmission of tuberculosis to humans in the United Kingdom following consumption of unpasteurised milk was reported by de la Rua-Domenech (2006). *Brucella* spp. are pathogens, which are highly infectious and capable of causing disease in both animals and humans. The pathogenic strain *Brucella abortus* is more associated with cows, whereas *Brucella melitensis* is more commonly found in sheep and goats. Transmission to humans can be (amongst other routes) via milk and milk products (Gupta *et al.*, 2006).

Regulation 853/2004 (EU, 2004) (Annex III, Section IX) states that raw milk must come from animals that do not show symptoms of infectious diseases communicable to humans through milk. In particular, as regards tuberculosis and brucellosis, this regulation states that raw milk must come from cows (or buffalos) belonging to a herd which, within the meaning of Directive 64/432 (EU, 1964), is free or officially free of tuberculosis and brucellosis, and if not, the milk may only be used with the authorisation of the competent authority. In addition to compliance with directivities on milk quality, perhaps the most effective means of ensuring the safety of milk from a public health perspective may be to implement ongoing training of dairy farmers and their employees in the areas of cow management, milk handling and storage procedures, fundamentals of toxin and disease transmission, and pathogen effects on human health. In addition, pasteurisation of milk represents possibly the most significant and successful contribution to milk safety (Holsinger *et al.*, 1997).

Toxic residues/contaminants

These compounds in the animal's body may be shed into milk and thus pose a threat to human health. Chemical residues are remnants of purposeful additions to the food chain (see Section 1.5.5), whereas contaminants represent any biological or chemical agent and

any other foreign substances (e.g. dioxins, pesticides) that could gain entry to the milk and, as a result, compromise food safety or suitability for use. The most common chemical residues found in milk are antibiotics, following administration to treat mastitis. Regulation 853/2004 (EU, 2004) (Annex III, Section IX) states that raw milk must come from animals to which no unauthorised substances have been administered and that where authorised products or substances have been administered, the withdrawal periods for those products have been observed. The most effective means of controlling toxic residues/contaminants is by legislation, voluntary codes of practice, monitoring and surveillance of animal feeds, and prudent use of all animal inputs (Buncic, 2006).

1.4.2 *Composition (protein, casein, fat, total solids, lactose, and mineral)*

Regulation 2597/97 (EU, 1997) outlines marketing standards to guarantee compositional quality of non-standardised whole milk, and include minimum fat and protein concentrations ($\text{g } 100 \text{ g}^{-1}$) of 3.5 and 2.9 (based on a fat content of $3.5 \text{ g } 100 \text{ g}^{-1}$), respectively. The specific combination of milk characteristics required for cheese depends on the type of cheese being manufactured. For example, sheep's milk is more suited than cows' milk for the production of piquant-flavoured cheeses, such as Pecorino Romano owing to the higher concentration of short-chain fatty acids ($\text{C}_{4:0}$, $\text{C}_{6:0}$, $\text{C}_{8:0}$, $\text{C}_{10:0}$ and $\text{C}_{12:0}$) in its milk fat, which contributes to this flavour profile (Nelson *et al.*, 1977; Lindsay, 1983; Woo & Lindsay, 1984; Medina & N  nez, 2004). The low carotenoid content of sheep's and goat's milk relative to cows' milk is also more suited to the manufacture of white-coloured cheese varieties, such as Manchego and Roquefort cheeses (Anifantakis, 1986; Fox *et al.*, 2000). However, cows' milk can vary dramatically in carotenoid content from ~ 4 to $13 \mu\text{g g}^{-1}$ fat, depending on breed, feed type and stage of lactation (Noziere *et al.*, 2006; Calderon *et al.*, 2007). In contrast, sheep's milk because of the above characteristics is unlikely to be suitable for the manufacture of Cheddar cheese, in which the rich straw-yellow colour, relatively low level of lipolysis (Hickey *et al.*, 2006a,b, 2007) and non-rancid flavour are key quality criteria. Owing to its low ratio of α_{s1} - to α_{s2} -casein, goat milk gels much more slowly than cow milk on rennet addition and forms markedly weaker gels and curds, and is consequently much more suited to the manufacture of soft cheese (Storry *et al.*, 1983; Ju  rez & Ramos, 1986; Medina & N  nez, 2004), but much less so to the large-scale manufacture of hard cheeses, such as Emmental, Gouda, Mozzarella and Cheddar. Apart from the altered proportions of individual caseins, other factors such as the (generally) lower contents of calcium and total casein may also contribute to the relatively poor rennet coagulation characteristics of goat milk.

Optimising manufacturing procedures for milks of varying compositions

Rennet-curd cheese is a product created through controlled enzymatic destabilisation and aggregation of colloidal calcium phosphate casein micelles in the form of a calcium phosphate *para*-casein gel, enclosing fat and moisture. The gel is subjected to various operations (e.g. breaking/cutting, pH reduction, temperature elevation) to induce expulsion of whey and transition from a low-solids gel to a high-solids cheese curd. During this dehydration, involving breakage and shrinking of the gel, the gel/matrix structure continually rearranges, resulting

in further aggregation and fusion of the *para*-casein. The compositional characteristics of good quality milk for the manufacture of all cheeses are those that enhance this controlled aggregation under optimised cheesemaking conditions to give an acceptable manufacturing time, cheese with the desired composition, high yield and excellent quality.

However, a given set of milk compositional characteristics may not fulfil all three requirements simultaneously unless the manufacturing procedure is optimised. For example, the potential of milk with a higher than normal intact casein content to deliver a high yield of cheese with the desired composition and quality may not be realised if the standard operating procedure (SOP) was developed using milks with lower casein content. A critical step in the SOP for any cheese recipe is the firmness of the gel at cut, which can affect the cheese moisture, pH, salt in moisture, yield and quality (cf. Chapter 8). Yet in most modern cheesemaking operations, rennet is added to the milk on a volume basis (rather than on basis of casein load: volume \times concentration) and the gel is cut at a fixed time after rennet addition (rather than on the basis of firmness). While such a process may appear to be standardised (fixed rennet dosage per volume of milk, fixed set-to-cut time), it automatically promotes variable curd firmness at cutting when the properties of the cheese milk (e.g. casein number, casein content, pH, calcium content) presented to the SOP change seasonally. Such SOPs are frequently established by the investigations of production support personnel, working over relatively short-time periods on milks with composition parameters falling within a narrow range. However, seasonal variations in milk composition can be relatively large; for example, in Ireland, protein can vary from ~ 3.1 to $3.8 \text{ g } 100 \text{ g}^{-1}$ in milk from pasture-fed, spring-calved herds (Mehra *et al.*, 1999; O'Brien *et al.*, 1999d; Guinee *et al.*, 2006). Significant seasonal changes in milk composition are also common elsewhere, including the United Kingdom (Grandison 1986; Banks & Tamime, 1987), France (Martin & Coulon, 1995), New Zealand (Auldism *et al.*, 1998; Nicholas *et al.*, 2002), Australia (Auldism *et al.*, 1996; Broome *et al.*, 1998a; Walker *et al.*, 2004) and Canada (Kroeker *et al.*, 1985). Hence, there is a need to standardise basic parameters, such as protein-to-fat ratio, casein content (ideally), ratios of starter culture and rennet to casein load, starter culture activity, firmness at cut and the pH at different stages of manufacture (e.g. at set) to achieve the optimum performance from good quality milk. Using such an approach to develop SOPs should minimise seasonal variations in cheese composition, manufacturing efficiency, biochemical changes during maturation and quality (cf. Chapter 8). The use of the most-up-to-date technology (including milk casein standardisation), process modelling, in combination with on-line monitoring (in-vat curd firmness sensors), is seen as an approach for further optimisation of process control and improvement in cheese quality.

Effects of variations in different compositional parameters

The effects of many compositional parameters of milk on cheese manufacture (rennet coagulation characteristics), cheese yield and/or cheese quality have been investigated (Okigbo *et al.*, 1985a–c; Guinee *et al.*, 1994, 1997, 2006; Broome *et al.*, 1998a,b; Auldism *et al.*, 2004; Mei-Jen-Lin *et al.*, 2006; Wedholm *et al.*, 2006; Jöudu *et al.*, 2008) and are summarised in Table 1.4. Generally, numerically higher values of the following variables are positively correlated with enhanced rennet coagulation properties (more rapid curd firming rate, higher curd firmness and shorter set-to-cut time in manufacture) and cheese yield: casein number; contents of total casein, individual (α_{s1} -, β - and κ -) caseins, β -Lg, calcium;

Table 1.4 Characteristics of milk ex-farm important for cheese manufacture.

Characteristic	Suggested values	Comment
Visual/sensory characteristics		
Appearance		Should be typical of milk (cream-white colour, homogeneous, no free fat or froth)
Smell		Free from atypical smells and taints
Biochemical/physical characteristics		
Colour (instrumental measurement)	ND ^a	Ideally should have instrumental measured (colour coordinates L^* , a^* , b^* values; for further detail, see Chapter 8)
pH	≤ 6.7 to ≥ 6.5	
Protein content (g 100 g ⁻¹)	3.3	
Casein (g 100 g ⁻¹)	≥ 2.55	
Casein number	≥ 77	
Non-protein nitrogen (N) (g 100 g ⁻¹ total N)	<6	
Serum casein (g 100 g ⁻¹ total casein)	<4	Serum casein as percentage of total casein should ideally be very low
κ -casein (g 100 g ⁻¹ total casein)	>15	
γ -casein (g 100 g ⁻¹ total casein)	<3	
Fat content (g 100 g ⁻¹)	>3.6	Should remain relatively consistent to avoid large changes in liquid-to-solid fat ratio and rheology of fat phase in cheese
Free fatty acid (mg kg ⁻¹)	<3500	Should be low to avoid rancid off-flavours
Lactose content (g 100 g ⁻¹)	>4.3	
Somatic cell count (cells mL ⁻¹)	$\leq 100 \times 10^3$	
Total bacterial count (colony forming units (cfu) mL ⁻¹)	$\leq 30 \times 10^3$	
Plasmin (AMC units mL ⁻¹) ^b	<0.18	
Plasminogen (AMC units mL ⁻¹) ^b	<0.18	
Residues		
Antibiotics	Not detectable	
Iodine ($\mu\text{g kg}^{-1}$)	<250	
Trichloromethane ($\mu\text{g kg}^{-1}$)	<2	
Processability characteristics		
Gel firmness		
Rheometer (G' , Pa)	50 Pa at 31°C in 60 min ^a	
Formagraph (A60, mm)	>45 mm	
Syneresis	ND	Gel should undergo syneresis readily on cutting (could be measured empirically, for example, by centrifugation under defined condition, or $\mu\text{g kg}^{-1}$)

^aND, not defined.^bAminomethyl coumarin.

and ratios of κ -casein to total casein and to individual (α_{s2} - and β -) caseins. For a given rennet-to-casein ratio, the positive effect of the increases in the above milk characteristics on rennet coagulation and/or cheese yield are consistent with a higher concentration of gel-forming casein and/or enhanced aggregation via calcium bridges, calcium phosphate bridges and hydrophobic interactions. The positive effect of a high κ -casein-to-total casein ratio is expected because of:

- the presence of three hydrophobic domains and a high level of aspartic acid (4 mol) on the N-terminal (AA₁₋₂₀) region of the *para*- κ -casein;
- the reduction in casein micelle size that generally accompanies an increase in the ratio of κ -casein to total casein (Dagleish *et al.*, 1989; Umeda & Aoki, 2002);
- the relatively high hydrophobicity of the *para*- κ -casein, which would enhance the aggregation of the rennet-altered micelles.

However, it is noteworthy that while an increase in the proportion of κ -casein to total casein has been found to enhance the rennet gelation characteristics of milk, it has been found to give a non-significant decrease in the yield of laboratory-scale cheeses (Wedholm *et al.*, 2006); this contrasts with the results of studies on the influence of genetic variants of κ -casein and β -Lg, which show that the B-alleles of these proteins have, in addition to other factors (casein micelle size), higher levels of κ -casein as a percentage of total casein. While a higher κ -casein, as a percentage of total casein, may coincide with a higher loss of caseinomacropeptide, care must be taken when interpreting results on cheese yield as affected by any parameter, owing to the confounding effects of indirect variables (e.g. variation in firmness of gel at cut, moisture content of curd).

The genetic variant of κ -casein has a major influence on cheesemaking properties of milk, with κ -casein BB variant giving superior rennet coagulation characteristics, fat recovery from milk to cheese and cheese yield capacity compared to milk having the κ -casein AB, which in turn is superior to milk with the corresponding AA or AE genotypes (van den Berg *et al.*, 1992; Walsh *et al.*, 1995, 1998a; Ng-Kwai-Hang & Grosclaude, 2003; Wedholm *et al.*, 2006). Reported increases in moisture-adjusted cheese yield with the κ -casein BB variant, compared to κ -casein AA variant range from ~3 to 8%, depending on milk composition and cheese type. Generally, the κ -casein AB variant has been found to exhibit rennet coagulation and cheese-yielding characteristics that are intermediate between those of κ -casein AA and BB. The superior rennet coagulation and cheese-yielding characteristics of the κ -casein BB variant compared to the AA variant appear to be related to its higher casein content, higher level of κ -casein as a percentage of total casein, smaller micelles and lower negative charge. These properties are conducive to a higher degree of casein aggregation and a more compact arrangement of the *para*-casein micelles, which in turn favours more numerous intermicellar bonds during gel formation. Indeed, it has been shown using model rennet coagulation studies that for a given casein concentration, the curd firming rate of rennet-treated micelle suspensions was inversely proportional to the cube of the micelle diameter (Horne *et al.*, 1996).

In milk there is an inverse relationship between the concentrations of lactose and chloride, which is the basis of the test for Koestler number, to distinguish between normal and

abnormal (e.g. mastitic) milks (Ferreiro *et al.*, 1980; Horvath *et al.*, 1980; Fox & McSweeney, 1998)

$$\text{Koestler number} = \frac{100 \times \text{Chloride (g 100 g}^{-1}\text{)}}{\text{Lactose (g 100 g}^{-1}\text{)}}$$

where a value of <2 is normal and $>2.8\text{--}3.0$ is abnormal. Mastitis increases the concentrations of Na^+ , K^+ , Cl^- ions but decreases the concentration of lactose in the milk, as a response to maintain osmotic pressure within the mammary gland system. While a high level of Cl^- (or Na^+ , K^+) *per se* probably has little direct negative impact on *para*-casein aggregation and curd formation, apart from giving a slight increase in ionic strength, its occurrence is indicative of high somatic cell count (SCC) (250 to $>400 \times 10^3$ and $>1000 \times 10^3$ cells mL^{-1} for subclinical and clinical mastitis, respectively). Elevated SCC results in a marked increase in γ -caseins, proteose-peptones and the ratio of soluble to micellar casein (Anderson & Andrews, 1977; Ali *et al.*, 1980a,b; Schaar 1985a; Saeman *et al.*, 1988). These changes ensue from hydrolysis of β - and α_{s2} -caseins by the elevated activity of plasmin (and probably other proteinases) in the milk; κ -casein is hydrolysed more slowly by plasmin than β - and α_{s2} -caseins. The ensuing decrease in the intact casein level reduces the degree of casein aggregation as reflected by a marked deterioration in rennet gelation properties, syneretic properties and cheese yield (Donnelly *et al.*, 1984; Okigbo, *et al.*, 1985a; Mitchell *et al.*, 1986; Politis & Ng-Kwai-Hang, 1988a-c; Barbano *et al.*, 1991; Barbano, 1994; Auldish *et al.*, 1996; Klei *et al.*, 1998). An increase in SCC from 1×10^5 to $>5 \times 10^5$ cells mL^{-1} typically results in a reduction of $\sim 3\text{--}7\%$ in the moisture-adjusted (to $37 \text{ g } 100 \text{ g}^{-1}$) yield of Cheddar cheese. However, it is noteworthy that the decrease is also relatively large ($\sim 0.4 \text{ kg Cheddar cheese } 100 \text{ kg}^{-1} \text{ milk}$) on increasing the SCC from 1×10^5 to 2×10^5 cell mL^{-1} , a range that would be considered relatively low for good quality bulk milk. Losses of fat and protein during Cheddar cheese manufacture increased, more or less linearly, by ~ 0.7 and $2.5 \text{ g } 100 \text{ g}^{-1}$, respectively, with SCC in the range 1×10^5 to 1×10^6 cells mL^{-1} (Politis & Ng-Kwai-Hang, 1988a,c).

1.4.3 Microbiology (total bacterial count)

Microbial contamination of milk can occur pre-milking as a consequence of animal infection or during, or post-milking as a consequence of direct contact with bacteria in the environment or milk handling equipment and/or, for example, milking machine, on-farm storage, transport. Directive 92/46 (EU, 1992), which became effective from 1 January 1994, contained animal health requirements for raw milk, hygiene requirements for registered holdings and hygiene requirements for milking, collection and transport of milk to collection centres. A package of new hygiene regulations was adopted in April 2004 by the European Parliament and the Council (Regulation 853/2004) (EU, 2004). These became applicable from January 2006, and in the case of milk and milk products, these replace Directive 92/46 (EU, 1992). The new regulations are binding in EU Member States without the necessity of national legislation to be enacted to implement their provisions. However, instead of all of the hygiene requirements being incorporated in a single piece of legislation, the requirements for the dairy sector are

contained in three main regulations. One specific Regulation 853/2004 (EU, 2004) lays down specific hygiene rules for food of animal origin, with Annex III (Section IX) containing specific requirements for raw milk and dairy products. Specifically, with regard to plate count standards, milk-processing operators must ensure that raw milk meets the following criteria:

- plate count at 30°C $\leq 100 \times 10^3$ colony forming units (cfu) mL⁻¹ for cows' milk, corresponding to the rolling geometric average over a 2-month period, with at least two samples per month;
- plate count at 30°C $\leq 150 \times 10^4$ cfu mL⁻¹ for milk from other species, corresponding to the rolling geometric average over a 2-month period, with at least two samples per month;
- plate count at 30°C $\leq 50 \times 10^4$ cfu mL⁻¹ for raw milk from species other than cows when to be used for manufacture of products using processes that do not involve pasteurisation, corresponding to the rolling geometric average over a 2-month period, with at least two samples per month.

1.4.4 Sensory (appearance, colour, smell, and taste)

Sensory analysis may be used to test the characteristics of milk and may be considered as part of the overall quality control of the product. The sensory attributes of appearance and aroma are important factors in determining the quality of milk. Factors that influence the sensory evaluation of cows' milk include cow health and feed and the absorption of foreign flavours after milking (Ishler & Roberts, 1991). Flavour defects that are chemically induced (rancidity – specific chemical flavour) cannot be removed or improved, and may become more pronounced on storage (Mouchili *et al.*, 2005). For example, off-flavours in milk may arise as a consequence of improper milking practices (inadequate removal of teat disinfectant prior to milking) and milk handling procedures (excessive agitation leading to free fat) and reduce consumer acceptability. Hence, milk with good sensory characteristics may be maintained by: (a) control of cow diet, (b) optimisation of milking practices, (c) milk handling/pumping procedures, (d) storage conditions and (e) minimisation of storage time prior to processing.

1.4.5 Authenticity (non-adulteration with residues or other milks/milk fractions)

Authenticity of milk may be detected by specific tests, often using advanced instrumentation and methods in specialised laboratories; for example, detection of cows' milk fat in ovine milk using differential scanning calorimetry or free fatty profile using gas chromatography. The current EU reference method for the detection of cows' milk in goat or sheep milks is based on the separation of the γ -casein peptides after digestion of the sample by plasmin (EU, 1996). Further examples of fraudulent addition of ingredients include water, whey proteins or non-dairy proteins (of plant or animal origin).

1.5 Factors affecting the quality of milk for cheese manufacture

The quality of milk for cheese manufacture is affected by five key parameters, namely composition, microbiology, SCC, enzymatic activity and levels of residues/contaminants.

1.5.1 Milk composition

Several studies have shown seasonal variations in composition of milk (Chapman & Burnett, 1972; Phelan *et al.*, 1982; Auldust *et al.*, 1998; O'Brien *et al.*, 1999c,d). The gross composition of cheese milk, especially the concentrations of protein, casein and fat, has a major influence on several aspects of cheese manufacture, including rennet coagulability, gel strength, curd syneresis, cheese composition, yield and quality (Chapman, 1974; Grandison *et al.*, 1984; Fox & Guinee, 2000; Guinee *et al.*, 2006b; cf. Chapter 8).

Ceteris paribus, Cheddar cheese yield increases by $\sim 0.25\text{--}0.30$ kg 100 kg⁻¹ milk for every 0.1 g 100 g⁻¹ increase in milk protein in the range 3.0–4.5 g 100 g⁻¹ while retaining the protein-to-fat ratio constant at 0.96 (Guinee *et al.*, 1994, 1996, 2006), and by ~ 0.11 kg 100 kg⁻¹ milk for every 0.1 g 100 g⁻¹ increase in milk fat in the range 3.4–4.7 g 100 g⁻¹ while retaining the protein level constant at 3.7 g 100 g⁻¹ (Guinee *et al.*, 2007a). The importance of casein and fat to yield is reflected by the following general equation for the prediction of cheese yield:

$$Y = aF + bC$$

where Y is the yield (kg cheese 100 kg⁻¹ milk), F and C are the concentrations (g 100 g⁻¹) of milk fat (F) and casein (C) in the milk, a and b are coefficients, the magnitude of which depend on the contributions of fat and casein to yield. The values of a and b have been found to range from ~ 1.47 to 1.6 and from 1.44 to 1.9, respectively, for Cheddar cheese (Emmons, 1991). The relatively high contribution of casein is expected as it forms the continuous *para*-casein matrix, which, acting like a sponge, occludes the fat and moisture (serum) phases. Occluded moisture contributes directly to cheese yield and indirectly due to the presence of dissolved solids such as lactate and soluble salts. While fat on its own has little water-holding capacity, its presence in the *para*-casein matrix affects the degree of matrix contraction and hence moisture content and cheese yield. The occluded fat globules physically limit contraction, and hence aggregation, of the surrounding *para*-casein network and, therefore, reduce the extent of syneresis. Hence, as the fat content of the curd is increased, it becomes more difficult to expel moisture; consequently, the moisture-to-casein ratio generally increases unless the cheesemaking process is modified to enhance casein aggregation, for example, by reducing the firmness of gel at cut, reducing curd particle size, cooking more slowly and/or increasing the scald temperature (Gilles & Lawrence, 1985; Fenelon & Guinee, 1999). However, if the content of moisture-in-non-fat substances is maintained constant (e.g. by process modifications), fat contributes less than its own weight to cheese yield (~ 0.9 kg kg⁻¹), because $\sim 8\text{--}10$ g 100 g⁻¹ of the milk fat is normally lost in the cheese whey.

The levels of fat, protein and moisture in cheese are interdependent, with the levels of protein and fat decreasing pro rata as the moisture content increases (Fenelon & Guinee,

1999; Guinee *et al.*, 2006b). Reducing the protein-to-fat ratio of the cheese milk (by increasing fat content while retaining the protein level constant) leads to lower moisture and protein and higher levels of fat and fat-in-dry matter. The effects of increasing the protein content, for a given protein-to-fat ratio, on cheese composition can vary with the SOP applied during manufacture. In the absence of process intervention, it increases the moisture content of the cheese, where rennet is added to the milk on a casein load basis (kilogrammes of casein *per* unit volume) and cutting of the rennet-induced milk gel is performed on the basis of time (cf. Chapter 8), as is typical in large modern cheese factories with production capacities of 10–15 tonnes h⁻¹. The higher moisture coincides with an attenuated ability of the calcium phosphate *para*-casein curd matrix to rearrange and contract during cutting and the early stages of stirring/cooking of the curd particles in the whey, as a consequence of the higher gel firmness/stiffness at cutting. Conversely, when the gel is cut at a defined firmness, increasing the protein content of the cheese milk leads to a reduction in moisture content (Bush *et al.*, 1983; Guinee *et al.*, 1994, 1996; Broome, 1998a) of ~0.29 g 100 g⁻¹ *per* 0.1 g 100 g⁻¹ increase in milk protein (Guinee *et al.*, 2006). The latter effect probably resides in the concomitant increases in the ratio of protein to serum calcium and the collision frequency of curd particles in the cheese vat during stirring, because of a concomitant increase in the volume fraction of the curd in the cheese vat (cf. Chapter 8).

Variation in fat content of the raw milk is generally of little practical significance, as milk for cheese manufacture is easily standardised to a protein-to-fat ratio within a defined range (~0.85–0.90 for Cheddar cheese) as part of a SOP (cf. Chapter 8) by the appropriate removal of fat *via* mechanical separation (skimming) (for low-moisture, partly skimmed Mozzarella) or the addition of cream (for cream cheese). Similarly, the protein content, or more specifically the casein content, of raw milk has little effect when the protein content of the cheese milk is standardised to a defined level, e.g., by the low concentration factor (1–1.5×) ultrafiltration of the raw milk or by the addition of milk protein supplements. However, protein standardisation is not a universal practice, and consequently variation in milk protein levels can have significant effects on cheese composition, yield and quality (Banks & Tamime, 1987; Kefford *et al.*, 1995; Auldism *et al.*, 1996; Guinee *et al.*, 2007a). In such a situation, the following should assist in minimising variation in moisture content, and hence other compositional parameters:

- optimising firmness of gel at cutting, by using *ex-post* information on the relationship between gel firmness at cutting and moisture content for the particular cheese recipe; and
- standardising the levels of starter culture and rennet per unit weight of casein, and pH at different stages of manufacture (set, whey drainage, salting).

The calcium content of milk changes with stage of lactation and season. The mean concentration in milk from individual cows showed a marked decrease (from 150 to 155 mg 100 g⁻¹) during the first 16 days of lactation and an increase (from 115 to 170 mg 100 g⁻¹) after 300 days in lactation (DIL) (White & Davies 1958a); however, between the extremes of the lactation period, the calcium concentration typically fluctuates between 105 and 130 mg 100 g⁻¹ and shows little or no trend with stage of lactation. A similar trend for seasonal changes in total calcium occurs in manufacturing milks and milks from spring- and autumn-calved herds (White & Davies, 1958a; O'Brien *et al.*, 1999a). Likewise, the concentrations

of ionic and soluble unionised calcium vary between ~ 10 and $14 \text{ mg } 100 \text{ g}^{-1}$ (2.5 – 3.5 mM) and between ~ 20 and $34 \text{ mg } 100 \text{ g}^{-1}$ (4 – 8 mM), respectively, with stage of lactation and season (White & Davies, 1958b). Other factors have also been found to affect the concentrations of different forms of calcium, with the transition from stall to pasture grazing during Spring resulting in decreases in the concentrations of both total and ionic calcium, citrate and Mg^{2+} (Grimley *et al.*, 2008) and increases in Na^+ and casein. While little information is available on the direct effects of natural (seasonal) variation in calcium content of milk on its cheesemaking properties, available results suggest that calcium concentration is a factor in the pool of compositional-related parameters (e.g. level of intact casein, citrate, pH, casein micelle size, ionic strength) that interactively affect rennet gelation of milk and cheesemaking efficiency yield (Chapman & Burnett, 1972; Grandison *et al.*, 1984). Keogh *et al.* (1982) found that the content of colloidal calcium in spring-calved herd milks and bulked-herd manufacturing milks remained relatively constant between March and September and increased slightly (65 – $70 \text{ mg } 100 \text{ g}^{-1}$) in October/November before returning to baseline values of $\sim 65 \text{ mg } 100 \text{ g}^{-1}$ (Keogh *et al.*, 1982).

The casein content of the same milks increased progressively from July ($\sim 2.4 \text{ g } 100 \text{ g}^{-1}$) to October/November ($3 \text{ g } 100 \text{ g}^{-1}$), and thereafter decreased (Phelan *et al.*, 1982). Further analyses of these data (Keogh *et al.*, 1982; Phelan *et al.*, 1982) indicate that as the proportional increase in casein from mid to late lactation is higher than that of calcium, the ratios of colloidal calcium and ionic calcium decrease from ~ 26 and $4.8 \text{ mg } \text{g}^{-1}$ casein in mid lactation (July) to ~ 23 and $3.9 \text{ mg } \text{g}^{-1}$ casein in late lactation (November). Similarly, the data of White and Davies (1958a) indicated a reduction in the ratios of ionic calcium and soluble unionised calcium to casein between mid and late lactation, but an increase in the ratio of colloidal calcium to casein. The reductions in the former ratios, amongst other factors (such as increase in milk pH and casein hydrolysis by plasmin and/or SCC proteinases), are likely to contribute to the deterioration in rennet coagulability and impaired curd syneretic properties frequently observed in manufacturing milks (cf. Sections 1.2 and 1.3), especially those from spring-calved herds, in late lactation (O’Keeffe 1984; O’Keeffe *et al.*, 1982). Increases in the levels of ionic (10 – $14 \text{ mg } 100 \text{ g}^{-1}$) and soluble unionised (19 – $28 \text{ mg } 100 \text{ g}^{-1}$) calcium in seasonal milk have coincided with reductions in rennet gelation time (White & Davies, 1958b). This trend is consistent with the results of experimental studies reporting an improvement in rennet gelation properties on the addition of CaCl_2 at the levels of 0 – 2 mM to mid-lactation (Fig. 1.2) and late-lactation milks (Lucey & Fox, 1992). An investigation on the commercial manufacture of Swiss-type cheese showed that the addition of CaCl_2 ($0.1 \text{ g } \text{L}^{-1}$) gave insignificant increases in the mean recoveries of milk fat (85.3 vs 84.7%) and non-fat milk solids (33.85 vs 33.75) and a significant increase in the mean cheese yield ($0.038 \text{ kg } 100 \text{ kg}^{-1}$) (Wolfschoon-Pombo, 1997). The proportion of large curd particles (i.e. 5.5 – 7.5 mm) increased while the proportion of small particles ($<3.5 \text{ mm}$) decreased on the addition of CaCl_2 . These trends suggest that the positive effects of CaCl_2 on recoveries and cheese yield probably ensue from the enhanced degree of casein aggregation, which reduces the susceptibility of the curd to fracturing during cutting and the initial phase of stirring (cf. Chapter 8).

Apart from variations in the levels of gross constituents, seasonal variation can also occur in the ‘quality’ of the protein in terms of its ability to form a gel with satisfactory curd firming and syneretic (wheying off) properties and to produce cheese curd of satisfactory

moisture content. Late-lactation milk generally gives poor rennet coagulability (low curd firmness), impaired curd syneresis, high moisture Cheddar cheese and lower recovery of milk fat to cheese (O’Keeffe, 1984; Banks & Tamime, 1987; Auldism *et al.*, 1996). These defects coincide with low levels ($<4.3 \text{ g } 100 \text{ g}^{-1}$) of milk lactose, low casein number (<72 , casein as a percentage of true protein) and increased levels of serum casein ($>40 \text{ g } 100 \text{ g}^{-1}$ total protein), which was non-sedimentable at $30\,000 \times g$ (O’Keeffe, 1984). In this context it is noteworthy that low lactose levels in milk generally coincide with high SCC and levels of plasmin activity (Somers *et al.*, 2003), and may be indicative of udder infection and increased excretion of blood constituents into the milk. Similarly, Lucey *et al.* (1992) found that late-lactation milk from spring-calved herds (258–280 DIL in October) had impaired rennet coagulability, and resulted in Mozzarella cheeses, which had a higher moisture level, were softer and had a lower apparent viscosity when melted compared to the corresponding cheeses from mid-lactation milk from an autumn-calved herd. In contrast, Kefford *et al.* (1995) reported no differences between the compositions of Cheddar cheeses made from early- or late-lactation milk; they also observed a higher recovery of milk fat to cheese with late-lactation milk compared to mid-lactation milk. Discrepancies between the above studies may be due to differences in diet, SCC and the definition of late-lactation milk, which for Irish studies (O’Keeffe, 1984; Lucey *et al.*, 1992) typically refer to milk from cows $>\sim 250$ DIL compared to ~ 200 – 220 DIL in Australia (Kefford *et al.*, 1995; Auldism *et al.*, 1996) and New Zealand (Auldism *et al.*, 1998; Nicholas *et al.*, 2002). O’Keeffe (1984) found that the extent of these cheesemaking defects in late-lactation spring-calved herds in Ireland was accentuated when both the plane of nutrition of the cow and the milk yield at drying off were low (e.g. high stocking density on pasture in October and November without dietary supplementation, and $<6 \text{ L of milk cow}^{-1} \text{ day}^{-1}$). Hence, Guinee *et al.* (2007a) reported satisfactory composition and functionality of low moisture Mozzarella cheese made from late-lactation milk (266–284 DIL) from spring-calved cows maintained on a high plane of nutrition and with a high milk yield ($>6 \text{ L of milk cow}^{-1} \text{ day}^{-1}$).

Effect of cow nutrition on milk composition

One alternative to influence the manufacturing potential of milk is through the nutrition of the cow, but the response may vary depending on the stage of lactation.

- *Early lactation:* In pasture-fed systems, calving date is targeted to commence with the start of the grass herbage-growing season. The objective of the system is to allow grazed grass herbage to make up as large a contribution as possible to the total diet of the cow. Recommendations over a number of years have been to allow cows out to pasture from mid to late February when the soil conditions allow (firm under foot) and herbage mass is sufficient, i.e. from a milk production viewpoint (Dillon *et al.*, 1995). However, supplementing spring-calved cows on grass silage and concentrates with grazed grass in late February to late April (by allowing cows on pasture for 2–4 hours day^{-1}) was also found to significantly improve the gelation properties of milk (Dillon *et al.*, 2002), an effect concomitant with numerical increases in protein concentration (3.06–3.17 g 100 g^{-1}).

- *Mid lactation:* Increasing herbage allowance from 16 to 24 kg grass dry matter in mid lactation resulted in significant increases in both the yields and concentrations of total protein (3.2–3.4 g 100 g⁻¹), casein (2.43–2.61 g 100 g⁻¹) and lactose (4.60–4.65 g 100 g⁻¹). However, the concentrations of calcium and phosphorous, the rennet gelation properties or the alcohol stability of the milk was not affected (O'Brien *et al.*, 1997). In a complimentary study, Guinee *et al.* (1998) showed that increasing herbage allowance increased the moisture-adjusted yield of low-moisture Mozzarella cheese, but did not significantly affect the gross composition, rheological characteristics or cooking properties. An increase in milk casein of 0.1 g 100 g⁻¹ raised the yield of moisture-adjusted cheese by more than 0.5 kg 100 kg⁻¹ of milk. A similar trend was observed by Kefford *et al.* (1995) for Cheddar cheese. A further study (O'Brien *et al.*, 1999a) found that increasing stocking density above a standard limit (defined as post-grazing grass height of 60 mm) resulted in significant reductions in milk fat and protein yields, the concentrations of total protein (3.22 vs 3.40 g 100 g⁻¹), casein (2.48 vs 2.58 g 100 g⁻¹) and whey proteins and a deterioration in rennet coagulability. Imposing concentrate supplementation on the standard system increased the levels of total protein (3.40 vs 3.49 g 100 g⁻¹), casein (2.58 vs 2.65 g 100 g⁻¹) and whey protein but generally did not affect processing characteristics; alcohol stability was measured at alcohol levels of 76–79 g 100 mL⁻¹. It can be inferred from the Irish studies (O'Brien *et al.*, 1997a; Dillon *et al.*, 2002) that adequate herbage is a necessary requirement for quality milk and, if not available, concentrate supplementation of the grass diet is recommended in order to increase the energy supply to cows. However, in the presence of adequate grass, concentrate supplementation increases the concentrations of milk constituents but has little effect on milk processability characteristics (rennet coagulation, alcohol stability).
- *Late lactation:* O'Brien *et al.* (2006) and Guinee *et al.* (2007a) found that good management of spring-calved cows close to the end of lactation (261–307 DIL) gave good milk composition (lactose \geq 4.3 g 100 g⁻¹, protein 3.6 g 100 g⁻¹, casein 2.8 g 100 g⁻¹), rennet gelation (Formagraph Type 1170, Foss Electric, Denmark; curd firmness, A60 = 42.1 mm at 60 min) (Auldust *et al.*, 2001) and Mozzarella cheesemaking properties. These practices included maintenance of milk yield at >6 kg cow day⁻¹ and supplementation of pasture and/or silage with concentrates.

Effect of stage of lactation on milk composition

Milk from cows in late lactation has been found to have lower casein as a percentage of true protein and a higher level of FFA than milk from cows in early lactation (Sapru *et al.*, 1997). In the same study, cheese manufactured from late-lactation milk had higher moisture content, a trend also reported by Broome *et al.* (1998a). Stage of lactation also affected cheese pH and degradation of α_{s1} -casein in cheese during ageing. Late-lactation milk has also been found to give lower recoveries of fat and protein from milk to cheese (Auldust *et al.*, 1996; Sapru *et al.*, 1997). Furthermore, Auldust *et al.* (1996) found adverse effects of a high SCC milk on the yield and quality of Cheddar cheese in late lactation, and concluded that the effect of stage of lactation was magnified by an elevated bulk milk SCC and that many of the problems encountered when processing late season milk could be overcome by controlling mastitis at this time.

The generally detrimental impact of late lactation on cheesemaking quality of milk may be reduced by maintaining a high plane of nutrition in combination with application of a strict cow drying-off policy, i.e. ceasing to milk individual cows when milk yields decrease below 8–9 kg day⁻¹ or drying-off herds at average yields of 10–11 kg day⁻¹ (Guinee *et al.*, 2007a; O'Brien, 2008). This practice would eliminate extremely late-lactation milk from the product manufacturing process, and assist in retaining the characteristics (gel formation and gel syneresis) required for satisfactory manufacture of Mozzarella cheese into late lactation (276 DIL).

Effect of genetic variants of milk proteins on composition

All the major proteins in milk (α_s -, β -, κ -caseins, β -Lg, α -La) exhibit genetic polymorphism (Ng-Kwai-Hang & Grosclaude, 2003). The genetic variants, which have been investigated most thoroughly for their effects on the rennet coagulation and cheesemaking characteristics of milk, are those of κ -casein and β -Lg. Compared to the AA variants, the BB genotypes of both κ -casein and β -Lg are generally associated with a higher concentration of casein and superior rennet coagulation properties, as reflected by higher curd firming rates and gel firmness after a given renneting time (Schaar, 1985b; Green & Grandison, 1993; Walsh *et al.*, 1998a,b). The BB variants of κ -casein and β -Lg have also been associated with superior cheesemaking properties, as reflected by the higher recovery of fat, a lower level of curd fines in cheese whey, and higher actual and moisture-adjusted cheese yields for a range of varieties, including Cheddar, Svecia, Parmigiano-Reggiano, Edam and Gouda, low-moisture Mozzarella and Camembert (Aleandri *et al.*, 1990; van den Berg *et al.*, 1992; Walsh *et al.*, 1998a,b; Ng-Kwai-Hang & Grosclaude, 2003). Reported increases in moisture-adjusted cheese yield with the κ -casein BB range from ~3 to 8%, depending on milk composition and cheese type. The superior milk gelation and cheese-yielding capacity of κ -casein BB milks compared to AA milks are probably associated with the higher levels of casein, ratio of κ -casein to other casein and of casein to whey protein, smaller casein micelle size, lower negative charge, and possible alteration in the interactivity of the caseins (due to the amino acid substitutions). It is also noteworthy that the κ -casein B allele induced higher levels of non-glycosylated κ -casein than the corresponding A, C or E alleles (Lodes *et al.*, 1996) and that a lower level of glycosylation of κ -casein is associated with smaller, more hydrophobic micelles (O'Connell & Fox, 2000). The latter factors are expected to favour firmer rennet gels because of a more rapid hydrolysis of κ -casein by chymosin (Dziuba & Minkiewicz, 1996) and a more close pack arrangement (and aggregation between) of *para*-casein micelles forming the basic building blocks (*para*-casein aggregates) of the gel matrix. The generally higher casein content of milk containing the κ -casein BB compared to the AA variant also contributes to superior rennet coagulation and cheese-yielding properties. Generally, the κ -casein AB variant has been found to exhibit rennet coagulation and cheese-yielding characteristics which are intermediate between those of κ -casein AA and BB.

The different genotypes of β -Lg have also been found to be important in cheese manufacture, even though it does not have a direct role *per se* in the formation of rennet-curd cheeses. Milk containing the β -Lg BB produced firmer curds than that containing the AA or AB variants (Marziali & Ng-Kwai-Hang, 1986). Similarly, Schaar *et al.* (1985) reported a higher cheese yield (9.25 vs 8.94 kg 100 kg⁻¹) and dry matter content (53.1 vs 50.8 g

100 g⁻¹) from milk with β -Lg BB than from milk with β -Lg AA. Thus, there appears to be potential for the cheese industry to include selection of milk protein genotypes in breeding programmes. Auldrist *et al.* (2002) examined composition and rennet gelation characteristics of milk from conventional dairy breeds (Holstein-Friesian) and dual-purpose breeds (Montbelliard and Normandy) under Irish pasture grazing conditions. Higher frequency of the κ -casein B variant for both the latter breeds was associated with higher concentrations of protein and casein (3.49 vs 3.20 g 100 g⁻¹ and 2.77 vs 2.50 g 100 g⁻¹, respectively), smaller casein micelle size (151 vs 158 nm diameter) and improved rennet gelation characteristics (48.0 vs 35.0 mm curd firmness, A30).

Effect of season on milk composition

The influence of season on milk quality normally relates to changes in climate, lactation and natural feed. In general, environmental factors affect the protein content of milk in the same way as fat content, but less markedly. Protein content of bovine milk tends to be higher in winter than in summer.

Effect of parity (lactation number) on composition

It is unlikely that age of the cow is an important factor influencing cheese-yielding capacity of bulk milk since herds usually include cows of varying ages. A Canadian study (Ng-Kwai-Hang *et al.*, 1987) showed that the concentrations of total protein and serum protein increased slightly from 2 to 3 years of age, whereas casein content remained unchanged. After 3 years, the casein level decreased and serum protein remained the same. Maintaining a young herd is generally considered important in optimising milk composition. Sheldrake *et al.* (1983) reported that there was little change in SCC with parity if the cow remained free of infection between lactations. However, Schutz *et al.* (1990) reported that SCC increased as parity increased. Fuerst-Waltl *et al.* (2004) found that the relationship between cow age and SCC was inconsistent, while Valde *et al.* (2004), Carlén *et al.* (2004) and Walsh *et al.* (2007) all observed an increase in SCC with parity. While parity may affect milk quality directly from milk component concentration or indirectly through milk SCC, it is likely that parity has a relatively minor influence compared to cow nutrition or the presence of contagious/environment mastitis pathogens.

Effect of milking frequency on milk composition

Once-a-day (OAD) milking may be used as a labour-saving technique on farms. Stelwagen and Lacy-Hulbert (1996) suggested that OAD milking may initiate changes in the permeability of the mammary gland through impairment of tight junctions between the alveolar cells, leading to changes in milk composition through increased influx of serum proteins and ions and increased efflux of lactose and potassium. A study by Kelly *et al.* (1998) reported reduced lactose, elevated plasmin concentrations and increased SCC levels with OAD milking. O'Brien *et al.* (2005) reported that the fat and protein contents of OAD milk (4.41 and 3.65 g 100 g⁻¹) were significantly higher than those of twice-a-day (TAD) milk (4.09 and 3.38 g 100 g⁻¹). However, the total yield of milk solids (fat + protein yield) was reduced

due to the significant decrease in milk volume associated with OAD milking. Milk SCC was not significantly affected by milking frequency; only cows with SCC $<250 \times 10^3$ cells mL^{-1} had been selected for trial. Gel strength for the OAD milk was significantly higher than that of the TAD milk (105 vs 85 Pa), an effect attributed to the higher casein content of the OAD milk. Overall, OAD milking increased concentrations of protein, casein and fat, improved the gelation properties of milk and did not affect the SCC or level of plasmin activity in milk, provided that cows had a good nutritional status and an acceptable udder health history.

1.5.2 *Microbial activity of milk*

Microbial contamination of milk is important from two perspectives: (a) public health, as discussed above (see Section 1.4), and (b) dairy product manufacture.

Hygienic milk production on-farm

The hygienic production of milk is critically important to dairy product manufacture from two perspectives: efficiency of manufacture and quality of product; for example, poor hygiene leads to high counts of somatic cells and bacteria, which enhance undesirable protein hydrolysis and loss of yield (see Sections 1.4.2, 1.5.1 and 1.5.3). In accordance with legislation and driven by demands for efficient production of high-quality products, processors are now increasing their demands on the quality of raw milk produced on-farm (Vissers, 2007; Vissers & Driehuis, 2009). Consequently, they are increasingly developing and implementing schemes to accommodate differential payment for milk according to its quality. Legal requirements for safety, quality and hygienic production conditions are currently enforced under European Directive 92/46 (EU, 1992) and Regulation 853/2004 (EU, 2004) (Annex III, Section IX). This legislation specifies that raw milk must come from healthy animals and that equipment and conditions under which it is produced must fulfil certain minimum requirements. The milk itself must also satisfy specified hygienic standards in terms of bacterial numbers present, for example the plate count at 30°C for raw cows' milk is $\leq 100 \times 10^3$ cells mL^{-1} , corresponding to the rolling geometric average over a 2-month period, with at least two samples per month.

Milk is virtually sterile when secreted into the alveoli of the udder. Beyond this stage of milk production, microbial contamination can generally occur from three main sources: from within the udder, the exterior of the udder (cow environment) and the surface of milk handling and storage equipment. The health and hygiene of the cow, the environment in which the cow is housed and milked, the procedures used in cleaning and sanitising the milking and storage equipment, and the temperature and length of time of storage are all key factors in influencing the level of microbial contamination of raw milk.

Microbial contamination from within the mammary gland

Microbial contamination from within the udder of healthy animals is not considered to contribute significantly to the total numbers of bacteria in milk. However, a cow with mastitis has

the potential to shed large numbers of bacteria into the milk supply, for example *Staphylococcus aureus*, which is commonly responsible for mastitis in cows. If bacteria penetrate the teat canal and proliferate and induce an inflammation process in the mammary gland, mastitis develops. A number of factors predisposing the cow to mastitis include an impaired teat canal defence mechanism, an unhygienic cow environment, poorly maintained or malfunctioning milking machine facility and transfer of bacteria from affected cows to unaffected cows. The influence of mastitis on the total bacterial count of bulk milk depends on the strain of the infecting bacteria, the stage of infection and the percentage of the herd infected. Infected cows have the potential to shed in excess of 1×10^7 cfu mL⁻¹.

Microbial contamination from outside of the mammary gland

Contamination outside the udder can originate from two main sources, namely the environment of the cow and milk contact surfaces. Potential for microbial contamination of milk during the on-farm production process is present in the general environment. Microbes may be transferred to milk through the medium of feed, faeces, bedding material and soil, and, if not removed prior to milking, are washed into the milk during milking. The influence of dirty cows on total bacterial count in milk depends on the extent of soiling of the teat surface and the teat cleaning procedures used immediately before milking. Milking heavily soiled cows could potentially result in bulk milk counts exceeding 1×10^4 cfu mL⁻¹. For example, contamination of milk by unclean teats can potentially contaminate the milk with heat-resistant bacterial spores, which are problematic for the dairy industry, especially in the manufacture of milk powders where these organisms survive pasteurisation and grow during evaporation. The presence of *Bacillus cereus* is a limiting factor for the potential shelf life of pasteurised dairy products (te Giffel *et al.*, 1997), and may be a potential food poisoning agent. *B. cereus* is commonly found in soil and may be frequently found in milk during the grazing season when the risk of teat contamination with soil is greatest (Slaghuis *et al.*, 1997; Christiansson *et al.*, 1999). Also, spore-forming bacteria of the clostridium species (*Clostridium tyrobutyricum*) can cause problems with late gas-blowing development in some types of cheese (cf. Chapter 8). The main source of clostridia in milk is feeding of poor-quality silage (Stadhouders & Spoelstra, 1990). Spores can then be found in faeces of the animals consuming the silage and are transferred to the milk via the teat (Stadhouders & Jorgensen, 1990; Herlin & Christiansson, 1993).

A further source of microorganisms in milk and frequently the principal cause of consistently high bacterial counts is the build-up of contaminated deposits within the milking machine. Milk residue left on equipment contact surfaces supports the growth of a variety of bacteria (*Micrococcus*, *Streptococcus* and *Bacillus* spp.) (Bramley & McKinnon, 1990). Except in very cold and dry weather, bacteria can multiply on these surfaces during the interval between milkings. This risk can only be corrected by an appropriate machine washing routine. This is particularly relevant for thermophilic bacteria, which may be removed with hot water. Insufficient cleaning may result in persistent growth of thermophilic bacteria on surfaces (Vissers, 2007; Vissers & Driehuis, 2009). During the next milking, adhered microorganisms may be released into the milk. Hence, thorough cleaning of all surfaces

in contact with milk, including the bulk tank, is essential in order to minimise bacterial contamination and growth.

Milk storage conditions

Refrigerated storage of milk is conducive to the growth of psychrotrophic bacteria. These bacteria typically come from the cows' environment, such as dirt and manure. The extent to which the bacterial count increases in milk during storage depends on both the temperature and duration of storage as well as the numbers and types of bacteria present in the milk. The total bacterial count of milk at the end of a refrigerated storage period on-farm is also influenced by the initial count of that milk. When milk is stored at 4°C, one and two doublings of bacterial growth occur after 2 and 3 days of storage, respectively (O'Brien, 2008). For example, in situations of non-hygienic milk production, the initial bacterial count when milk enters the bulk tank may be high (20×10^3 cfu mL⁻¹) and lead to a very large bacterial count (40×10^3 – 120×10^3 cfu mL⁻¹) after 2–3 days at refrigerated temperature (O'Brien, 2008). Hence, refrigerated cooling is not a substitute for unhygienic milk practices. Efficient cooling of milk to 4°C immediately after production in conjunction with good milking hygiene makes it possible to maintain good quality milk for up to 2–3 days on the farm, provided that the milk container/tank is well insulated.

Psychrotrophic bacteria are often associated with poorly cleaned refrigerated farm bulk tanks (Thomas *et al.*, 1966; MacKenzie, 1973; Murphy & Boor, 2000). The longer the period of refrigerated storage of raw milk prior to processing, the greater is the chance that psychrotrophic bacteria increase in number. While milk produced under ideal conditions may have an initial psychrotrophic bacterial population of <10% of the total bacteria, psychrotrophic bacteria become the dominant microflora after 2–3 days at ~4°C (Gehring, 1980).

The temperature of the large volumes of milk in road tankers (used to transfer the milk from the farm to factory) is unlikely to rise significantly during transport. Milk collected daily from the farm and having a mean initial psychrotrophic bacteria count of 1×10^4 cfu mL⁻¹ (on arrival at the factory) showed an increase to over 1×10^6 cfu mL⁻¹ on storage for 3 days at 5°C at the factory (Cousins & Bramley, 1984). Bacterial contamination of milk is likely to occur during collection and transport as a result of contact with transport tankers, hoses, pumps, metres and automatic samplers. Although the extent of contamination is difficult to assess, milk collection/transport is likely to augment the bacterial content of milk being transferred to bulk storage at processing plants. Heat treatment of milk (thermisation, pasteurisation) at the dairy may destroy the psychrotrophic bacteria (cf. Chapter 8), but not necessarily the products of their metabolism (FFA) or their enzymes that can adversely affect rennet coagulation properties of the milk, cheese yield and quality (cf. Chapter 8). Psychrotrophic bacteria commonly produce extracellular enzymes capable of hydrolysing proteins and fats of milk and milk products. Thus, they can increase the likelihood of off-flavours and odours and cause changes in body, texture and colour. Weatherup and Mullen (1993) indicated that storage of milk at 3°C for periods of 3 or more days resulted in a significant reduction in cheese yield, with a considerable loss in revenue to the cheesemaker. The latter also found that cheese manufactured from stored milk gave a significant reduction in quality, with the results being more pronounced after 5 days of storage.

1.5.3 Somatic cell count

The influence of somatic cells and mastitis on the composition of milk and its suitability for cheese manufacture has been studied extensively. Somatic cells are of three main types, namely lymphocytes (L), phagocytes and mammary gland epithelial cells (E) (Burvenich *et al.*, 1995). Lymphocytes function in humoral and cell-mediated immunity, while phagocytes, of which there are two types – polymorphonuclear leucocytes (PMN) and macrophages (M ϕ), ingest and kill pathogenic microorganisms, which invade the mammary gland. Somatic cells are present at low levels ($<100 \times 10^3$ cells mL $^{-1}$) in normal milk from healthy animals during mid lactation, with M ϕ , L, PMN and E cells typically at a ratio of $\sim 2.1:1.0:0.4:0.2$, respectively. It is generally agreed that somatic cells are released from the blood to combat udder infection, and thereby prevent or reduce inflammation (mastitis). Factors that contribute to increases in SCC of bulk manufacturing milk include subclinical mastitis, advance in stage of lactation, lactation number, stress and poor nutrition. During clinical mastitis, there is a rapid increase in SCC primarily due to PMN. Depending on the type and extent of bacterial infection, milk from infected quarters of the udder may have an SCC of 200×10^3 to 5000×10^3 cells mL $^{-1}$. However, the milk from animals suffering from clinical mastitis is excluded from the commercial milk supply. Such milk frequently forms clots within the udder, formed from a mixture of somatic cells and precipitated milk proteins; in severe mastitis, these clots block the drainage ductules and ducts in the mammary gland, thereby preventing milk drainage. The initial stage of mastitic infection is subclinical, with inflammation so slight that it is not detectable by visual examination. Hence, the milk from cows suffering from subclinical mastitis becomes part of bulk herd milk and bulk manufacturing milk, unless individual cows are tested routinely at farm level for subclinical mastitis (by monitoring SCC), which is not routinely conducted. While bulking dilutes such as milk, subclinical mastitis may contribute to an increased SCC of manufacturing milk, and thereby impact negatively on the suitability of milk for cheese manufacture.

Increasing SCC in milk is associated with marked changes in both the concentrations of milk constituents, the state (degree of hydrolysis) of the milk components and the cheese-making properties (Kosikowski & Mistry, 1988; Klei *et al.*, 1998; Cooney *et al.*, 2000; Kalit *et al.*, 2002; Franceschi *et al.*, 2003; Jaeggi *et al.*, 2003; Albenzio *et al.*, 2004; Mazal *et al.*, 2007). An increase in SCC in the range 100×10^3 to 1000×10^3 cells mL $^{-1}$ has generally been found to:

- reduce lactose, fat and casein contents in milk, casein as a percentage of true protein, gel firmness, recoveries of protein from milk to cheese, and cheese yield; and
- increase milk pH, levels of chloride, whey protein, and non-protein nitrogen in milk, curd fines in cheese whey, cheese moisture, rates of primary and secondary proteolysis during maturation (as monitored by urea polyacrylamide gel electrophoresis, levels of water-soluble and trichloroacetic acid-soluble nitrogen).

Increasing SCC in the range 1×10^5 to 6×10^5 cells mL $^{-1}$ resulted in an increase in rennet coagulation time and reductions in curd-firming rate (reciprocal of k_{20} , as measured using Formagraph Type 1170) and curd firmness (Politis & Ng-Kwai-Hang, 1988b). Fat and protein losses during Cheddar cheese manufacture increased, more or less linearly, by ~ 0.7

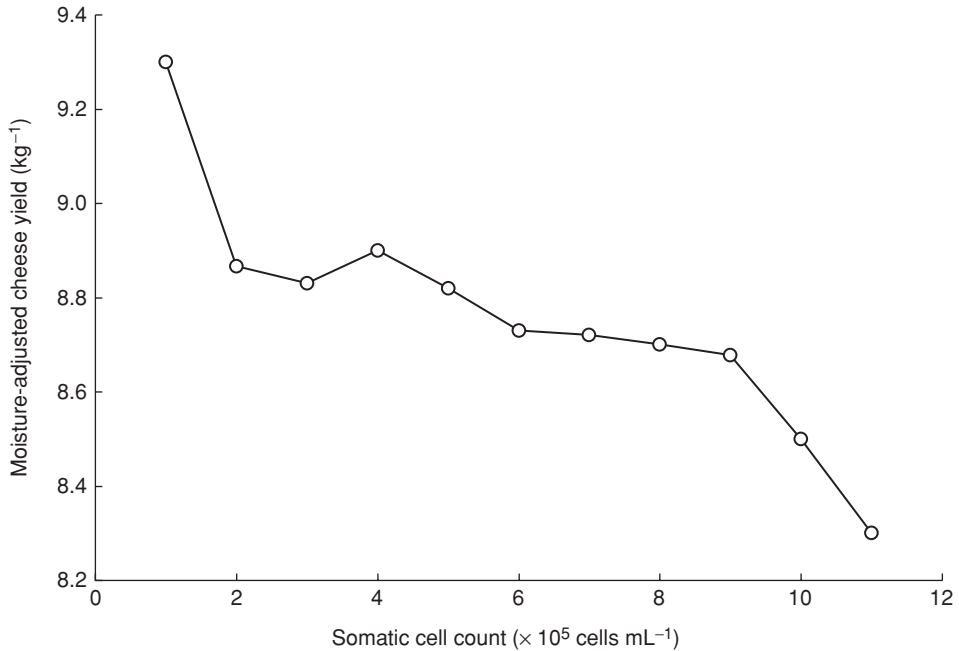

Fig. 1.4 Influence of somatic cell count on the moisture-adjusted (to 37 g kg^{-1}) Cheddar cheese yield from milks from individual cows. (Redrawn from Politis & Ng-Kwai-Hang, 1988a.)

and 2.5%, respectively, with SCC in the range 10^5 – 10^6 cells mL^{-1} (Politis & Ng-Kwai-Hang, 1988a,c). The increase in SCC from 1×10^5 to 6×10^5 cells mL^{-1} resulted in an approximate 6% reduction in moisture-adjusted (to $37.0 \text{ g } 100 \text{ g}^{-1}$) Cheddar cheese yield (Fig. 1.4). It is noteworthy that there was also a relatively large decrease in yield (i.e. $\sim 0.4 \text{ kg } 100 \text{ kg}^{-1}$ milk) on increasing the SCC from 1×10^5 to 2×10^5 cells mL^{-1} , a range which would be considered relatively low for bulk milk of good quality. Hence, Barbano *et al.* (1991) concluded that any increase in SCC to values greater than 100×10^3 cells mL^{-1} for bulk milk herd will have a negative impact on cheese yield efficiency when milk from all the contributing herds had similar SCC. Auldust *et al.* (1998) found that an increase in SCC from $>3 \times 10^5$ to $>5 \times 10^5$ cells mL^{-1} in late lactation (220 DIL) resulted in a 9.3% decrease in moisture-adjusted (to $35.5 \text{ g } 100 \text{ g}^{-1}$) yield of Cheddar cheese and decreases in the recovery of fat (from 90.1 to $86.6 \text{ g } 100 \text{ g}^{-1}$ fat) and protein (from 78.3 to $74.4 \text{ g } 100 \text{ g}^{-1}$ protein). Significant decreases have also been reported in the yield of uncreamed Cottage cheese, with a 4.3% reduction in the percentage yield efficiency on increasing the mean SCC from 83×10^3 to 872×10^3 cells mL^{-1} (Klei *et al.*, 1998).

The negative impact of SCC on yield and recoveries are due in large part to the increase in proteolysis of α_s - and β -caseins to products (γ -caseins, proteose-peptones and other peptides) that are soluble in the serum and are not recovered in the cheese. Such proteolysis ensues from the elevated proteolytic activity of plasmin (and probably other proteinases), plasminogen, plasminogen activator in the milk that parallels increasing SCC (Mijacevic *et al.*, 1993; Rogers & Mitchell, 1994; Gilmore *et al.*, 1995; Kennedy & Kelly, 1997). Moreover, the lower effective concentration of gel-forming protein results in a slower curd-firming

rate, and hence a lower degree of casein–casein interaction in the gel following cutting (at a given firmness) and during the early stage of stirring. A gel with the latter characteristics exhibits:

- a greater susceptibility to shattering during cutting and the early stages of stirring, resulting in higher losses of curd fines and milk fat; and
- an impaired syneretic capacity, with a consequent increase in moisture level.

A high SCC may also inhibit the activity of some strains of lactococci during cheese manufacture, an effect expected to further impair curd firming rate and reduce firmness at cutting. In commercial practice, the gel is generally not cut on the basis of firmness, but rather on the basis of a preset renneting time, which gives curd firmness within the acceptable range for normal milk. In large modern factories, the conditions are not conducive to testing curd firmness of cheese vats from separate milk silos because of the large scale of operation (frequently $>1 \times 10^6$ L day⁻¹) and the use of pre-programmed vats with limited operator access. In such operations, the effects of increases in SCC may be accentuated, as the slower-than-normal curd firming rate is conducive to lower-than-optimum firmness at cutting.

In conclusion, high SCC is detrimental to cheese yield and cheesemaking profitability. It is estimated that the monetary loss resulting from a 2% reduction in cheese yield on increasing the SCC from 1×10^5 to 5×10^5 cells mL⁻¹ would be ~€4000 day⁻¹ for a Cheddar cheese plant processing 1×10^6 L of milk day⁻¹ (at a fresh curd value of ~€2.0 kg⁻¹). Consequently, a concerted effort is being undertaken to reduce SCC through the use of good on-farm practices, for example reducing the percentage of animals in herds with subclinical mastitis, meeting regulations and the introduction of payment incentives for lower SCC. The EU has set the legislative limit of $\leq 400 \times 10^3$ SCC mL⁻¹ as the value above which milk cannot be sold by producers or used for further processing (EU, 2004). The permitted limit count varies internationally, for example $\leq 400 \times 10^3$ cells mL⁻¹ in New Zealand and $\leq 750 \times 10^3$ cells mL⁻¹ in the United States. However, it is noteworthy that Hamann (2003) suggests that milk constituents ‘abandon their physiological ranges’ at SCC $>100 \times 10^3$ cells mL⁻¹.

1.5.4 Enzymatic activity of milk

Milk enzymes are proteins that have biological functions and originate from a number of sources, for example milk itself, bacterial contamination and somatic cells present in milk. In the context of cheese manufacture, proteinase and lipase enzymes can have significant effects on cheesemaking properties, yield and quality.

Proteolytic activity

Native milk contains proteinases from a number of sources, the indigenous milk trypsin-like proteinase, plasmin proteinase (EC 3.4.21.7), lysosomal proteinases of somatic cells and bacterial proteinases of bacteria (especially psychrotrophic bacteria, such as *Pseudomonas*

spp. or *Bacillus* spp.). These proteinase systems hydrolyse caseins, are complex in their regulation and vary in activity according to factors such as stage of lactation and mastitis status (Kelly *et al.*, 2006). Excessive proteolytic activity is undesirable as it hydrolyses caseins to water-soluble peptides that are lost in whey and not recovered during the manufacture of products such as casein or cheese. Moreover, hydrolysis alters the chemistry and interactivity of the remaining (recovered) protein and thus the techno-functionality of the resultant products, such as the ability of the resultant cheese to shred or grate, or the ability of casein to hydrate, form gels or impart structure/texture to products in which it is used as an ingredient (e.g. gluten substitute in bakery products, imitation cheese and processed cheese products).

Plasmin proteinase

The native proteinase system of milk comprises plasmin as the active enzyme, its zymogen (plasminogen) and enzyme activators/inhibitors (Verdi & Barbano, 1991; Bastian & Brown, 1996; Nielsen, 2002). While plasminogen, plasminogen activator and plasmin are all very heat stable (Lu & Nielsen, 1993; Bastian & Brown, 1996), the plasmin inhibitor is heat labile (Richardson, 1983). Plasmin and plasminogen in milk fully survive pasteurisation temperature at pH 6.8 (Dulley, 1972; Driessen and van der Waals, 1978; Richardson, 1983; Metwalli *et al.*, 1998). Plasmin is associated with the casein micelles and readily hydrolyses α_{s1} -, α_{s2} - and β -caseins, resulting in an increase in γ -caseins (Ali *et al.* 1980a,b; Le-Bars & Gripon, 1989; McSweeney *et al.*, 1993). κ -Casein can also undergo some degree of hydrolysis by plasmin but reports differ on the extent of hydrolysis, which may be due to environmental conditions or the concentrations of enzymes and substrates used (Grufferty & Fox, 1988).

Discrepancies exist between various studies in relation to the effects of plasmin on the cheesemaking properties of milk (Pearse *et al.*, 1986; Bastian *et al.*, 1991; Farkye and Fox, 1992; Mara *et al.*, 1998), which may be related to many factors such as method of assessment (based on indigenous plasmin or added plasmin), plasmin activity, variation in the storage of milk with added plasmin, degree of casein hydrolysis at rennet addition, the presence of varying degrees of bacterial proteinases, assay pH and manufacturing process (pH of curd at whey drainage). However, high levels of plasmin activity and corresponding proteolysis (>40–50% of total α_{s1} - and β -caseins), as affected by the addition of plasmin to milk, have generally been found to give longer rennet gelation times and markedly lower gel firmness (Grufferty & Fox, 1988; Mara *et al.*, 1998; Srinivasan & Lucey, 2002). The impaired rennet gelation characteristics coincide with a more porous open structured gel and less connectivity between the particles and clusters making up the gel matrix (Srinivasan & Lucey, 2002). Despite its adverse effects on rennet gelation, addition of plasmin to milk (1.2 Sigma units L⁻¹ milk) and incubating for up to 48 h at 4°C prior to rennet addition had little effect on the composition, rheological or cooking properties of low-moisture, partly skimmed Mozzarella cheese (Somers *et al.*, 2002). This suggests that the adverse effects of high plasmin activity on gel structure, which may be considered as equivalent to a reduction in gel-forming protein, are by and large overcome by ongoing contraction and shrinkage of the gel matrix during the dehydration stages (cutting, stirring, whey removal) of manufacture. Farkye & Fox (1992) and Farkye & Landkammer (1992) added plasmin to milk for Cheddar cheese manufacture, resulting in levels in the experimental Cheddar that were 1.5–6

times that in the control cheese. Plasmin addition resulted in greater hydrolysis of β -casein and higher levels of γ -caseins and water-soluble N, but did not effect cheese composition. The organoleptic quality of the plasmin-enriched cheeses was judged superior to that of the controls and ripening was considerably accelerated; a plasmin level 3–4 times the indigenous value appeared to be optimal. O'Farrell *et al.* (2002) reported that the addition of plasmin (0.125 or 0.25 mg L⁻¹) to milk increased the rates of primary proteolysis, as measured by levels of pH 4.6-soluble N and urea-polyacrylamide gel electrophoresis, in the cheese. A similar effect was obtained on addition of 10–20% mastitic milk (with an SCC of $>1 \times 10^6$ cells mL⁻¹) to control milk, reflecting a high content of plasmin or plasminogen activators in mastitic milk. However, Kelly & O'Donnell (1998) reported that plasmin addition (6 mg L⁻¹) to milk (and incubation at 37°C for 6 h) for Quark manufacture resulted in higher moisture content, a lower level of protein and a reduced moisture-adjusted cheese yield.

The plasmin activity of milk is markedly affected by stage of lactation. Nicholas *et al.* (2002) found increases in plasminogen activity associated with advancing lactation. This was in agreement with the studies of Politis *et al.* (1989) and Bastian *et al.* (1991). Plasmin activity has also been shown to increase with advancing lactation (Donnelly & Barry, 1983; Gilmore *et al.*, 1995), but this is not consistent in all studies (Richardson, 1983), which may be due to variation in cows. Management practices such as nutritional status and milking frequency (Lacy-Hulbert *et al.*, 1999), udder health (Auldust & Hubble, 1998) and onset of involution (Politis *et al.*, 1989) may also contribute to inter-study discrepancy. Stelwagen *et al.* (1994) suggested that a likely mechanism for the increase in plasmin activity in late-lactation milk was by *para*-cellular leakage from the blood system, assisted by disruption of tight junctions between mammary epithelial cells. Those authors suggested a positive correlation between loosening of the mammary tight junctions and plasmin and plasminogen-derived activity in milk. This phenomenon is normally associated with reductions in milk yield and lactose level (Kelly *et al.* 1998). Nicholas *et al.* (2002) concluded that increased proteinase activity occurs in milk with advanced lactation because more of both plasmin and plasminogen enter milk rather than solely because of increased plasminogen activation. However, maintenance of cow nutritional level together with milk yield at the approach of lactation end can assist in significantly restricting proteolytic activity due to plasmin (O'Brien *et al.*, 2006).

Lysosomal proteinases of somatic cells

The lysosomes of somatic cells in milk are a significant source of proteinases, for example cathepsin D (Larsen *et al.*, 1996). Lysosomes of somatic cells also contain a number of serine proteinases (cathepsin B), which are also involved in the hydrolysis of proteins. The level of cathepsin D in milk is correlated significantly with SCC (O'Driscoll *et al.*, 1999), and the elevated activity derived from cathepsin D is due to an increased level of procathepsin D rather than mature cathepsin D (Larsen *et al.*, 2006). SCC of milk is an indicator of the intensity of the cellular immune defence in cows. When mastitis infection occurs, cellular damage at the site of this infection initiates chemical signals that attract white blood cells to the area of infection. Some of the white blood cells are transferred to milk and therefore the SCC of milk increases during mastitis. Many studies have shown different patterns of proteolytic activity between milk samples of low and high SCC (Le Roux *et al.*, 1995;

Larsen *et al.*, 2004). In consideration of a number of studies, Kelly *et al.* (2006) indicated that there is a consensus that proteolysis in low SCC milk is dominated by plasmin with a minor contribution by cathepsin D, while in milk of increasing SCC the relative significance of plasmin decreases and the activity of other enzymes (e.g. cathepsin D, procathepsin D) increases.

Leitner *et al.* (2006) examined the effects of four different pathogens frequently associated with the occurrence of subclinical mastitis (*S. aureus*, *Staphylococcus chromogenes*, *Escherichia coli* and *Staphylococcus dysgalactiae*) on quality of cheese milk. Infection with these pathogens increased SCC and increased proteolysis of casein. Regardless of pathogen type, the plasmin activity in milk from the infected glands increased twofold compared with that in milk from uninfected quarters. These changes coincided with increased rennet clotting time and lower curd firmness for the milk from infected glands, indicating that cheese milk quality was negatively affected by infection. These authors concluded that indices of casein proteolysis proved to be a much better prediction of cheese milk quality than SCC alone.

Milk produced from cows with mastitis or high SCC has different cheesemaking properties to that produced by cows free of mastitis (Barbano, 1994). An SCC standard of 400×10^3 cells mL⁻¹ for bulk milk is adopted in European milk quality schemes, with many milk purchasers now applying bonus payments for milk with $\leq 200 \times 10^3$ cells mL⁻¹, and this has reduced the effects of mastitis and high SCC on product quality. However, Barbano *et al.* (1991) reported that milk SCC begins to affect product quality as the SCC increases above 100×10^3 cells mL⁻¹.

Increased SCC in milk coincides with an increase in the proteolytic activity (Politis & Ng-Kwai-Hang, 1988c; Mijacevic *et al.*, 1993; Rogers & Mitchell, 1994), which, as discussed earlier (see Sections 1.4.2 and 1.5.3), impacts negatively on cheese manufacture, including giving higher moisture cheese, and lower component recoveries and cheese yield. The increase in moisture content is undesirable as it can easily place the product outside of specification. Moreover, elevated cheese moisture often causes a reduction in curd firmness and fracture stress, an increase in stickiness, a deterioration in shredability and an alteration of cooking properties (a melted cheese with a liquid, 'soupy' consistency, a loss of stretchability) (Guinee, 2003; Guinee & Kilcawley, 2004). The defects associated with high SCC has thus forced processors to target low SCC milk supplies – hence the current trend in penalty or bonus payments for low SCC milk.

Proteinases from psychrotrophic bacteria

Although the refrigerated storage of raw milk is used to prolong shelf life and reduce spoilage by mesophilic bacteria, it favours the growth of psychrotrophic microorganisms, which produce heat-resistant extracellular enzymes such as proteinases and lipases (Ali *et al.*, 1980a–c; Cromie, 1992; Shah, 1994; Guinot-Thomas *et al.*, 1995; van den Berg *et al.*, 1996; Haryani *et al.*, 2003). These proteinases hydrolyse the caseins in milk, to a degree dependent on temperature (2–7°C) and duration of cold storage (Celestino *et al.*, 1996; Haryani *et al.*, 2003). The caseins are particularly susceptible to hydrolysis at low temperatures because of the solubilisation of CCP, lower degree of hydrophobic-induced casein interactions, loosening of the micelle structure and the solubilisation and dissociation

of all caseins, especially β -casein, into the serum phase (cf. Chapter 8, Fox, 1970; Dalgleish & Law, 1988, 1989; Roupas, 2001).

Hydrolysis of casein by psychrotrophic proteinases is undesirable because of the associated defects in milk quality (e.g. off flavours) and processability (lower protein recoveries), especially at high total counts of psychrotrophic bacteria (Shah, 1994). Hydrolysis of caseins in cold-stored milk has been found to result in increased rennet coagulation, reduced curd firmness, higher losses of protein in cheese whey, lower cheese yield and/or higher cheese moisture (McCaskey & Babel, 1966; Ali *et al.*, 1980c; Hicks *et al.*, 1982). The extent of these effects generally increased with storage temperature in the range 1–10°C and time, though the rate of change appeared highest in the first 24–48 h. Kumaresan *et al.* (2007) found that storage of raw milk at 2°C supported significantly lower growth, proteolytic and lipolytic activities of psychrotrophic bacteria and had better sensory qualities when compared to milk stored at 4 and 7°C for a period of up to 14 days. They concluded that raw milk should be stored at 2°C before processing to protect the nutritional and sensory qualities of raw milk. Conversely, very extensive hydrolysis as affected by prolonged storage at 20°C led to very high bacterial counts ($>10^7$ cfu mL⁻¹), extensive casein hydrolysis, very short gelation times, spontaneous gelation and marked losses in cheese yield (Ali *et al.*, 1980c); it is probable that a concomitant reduction in pH and proteolytic-induced release of sialic acid from the casein macropeptide region of the κ -casein (Zalazar *et al.*, 1993) accelerated such defects.

Lipolytic activity

The hydrolysis of triacylglycerols by lipases into mono- and diacylglycerols and FFA is commonly referred to as lipolysis. Inadvertent lipolysis in milk and cheeses can give off-flavours (rancid, soapy, bitter) and flavour inconsistency. Hence, it is undesirable in all cheeses, even in those where the make procedure is designed to promote hydrolysis by the addition of exogenous lipases/esterases and/or lipolytic cultures (Blue cheese) (see Section 1.2.4).

Most lipolysis in milk is caused by the native LPL enzyme (EC 3.1.1.3.4), which is normally present in milk (Olivecrona *et al.*, 2003). LPL is essentially completely inactivated by conventional pasteurisation treatment (72°C for 15 s) (Martin *et al.*, 2005), and it therefore makes little contribution to lipolysis in milk or cheese, unless the milk fat globule in the raw milk is physically damaged, allowing access of the LPL to the milk fat triacylglycerols (Deeth & Fitz-Gerald, 1976). In addition to the indigenous lipolytic activity, milk may contain lipase/esterase activities from contaminating bacteria (Shah, 1994; Celestino *et al.*, 1996; Ouattara *et al.*, 2004).

Lipolysis in milk can be broadly classified into two types, depending on the causative/activating factor, namely induced lipolysis and spontaneous lipolysis.

Induced lipolysis

This is defined as lipolysis promoted by both mechanical damage and temperature alterations of the milk (Deeth, 2006). The degree to which lipolysis occurs depends generally on the extent of contact or association between the enzyme and the fat. Thus, little or no lipolysis

occurs normally in fresh milk, because the access of the enzyme to the milk fat is denied by the presence of the intact native MFGM (see Section 1.2.4). However, damage to the MFGM or its replacement by a reformed membrane of caseins and whey proteins (during homogenisation) increases the susceptibility of the milk fat triacylglycerols to the lipolytic and esterolytic activities present in the milk. Such damage may be accelerated by subjecting the milk to mechanical processes and/or temperature cycling (cooling/reheating). Physical actions that promote mechanically induced lipolysis include agitation and pumping (especially with air incorporation), homogenisation, and freezing and thawing of milk (Deeth, 2006).

The method of milk agitation can influence the degree of lipolysis. With low-speed agitation, the fat globules coalesce, while under high-speed agitation the fat globules are dispersed and form much smaller globules similar to the effect of homogenisation (Deeth & Fitz-Gerald, 1977). While the extent of the globule membrane damage may be similar in both cases, the extent of the lipolysis resulting from the high-speed agitation is much greater because the surface area of the lipase accessible fat is greater (Deeth, 2006). Once induced by agitation, lipolysis proceeds rapidly for a short time, followed by no further accumulation of FFA. Downey (1980a) attributed this to the accumulation of FFA at the fat globule interface, and failure of the enzyme to desorb from the interface. However, if vigorous agitation is repeated, accumulated FFA are swept from the interface and formation of a new enzyme substrate complex leads to resumption of lipolysis until the interface again becomes blocked. The incorporation of air during agitation/pumping of milk results in significantly more lipolysis than agitation/pumping of milk without air inclusion.

Homogenisation of milk breaks down the fat globules into a smaller, uniform size and can result in very strong activation of lipolysis. The newly reformed membrane of caseins and whey proteins (see Section 1.2.4) is more permeable to lipase, and consequently, the fat is more vulnerable (Deeth & Fitz-Gerald, 1976). Lipolysis proceeds very quickly after homogenisation, and rancidity may be evident within 5–10 min. Ideally, milk should be pasteurised prior to, or immediately after, homogenisation to minimise the lipolysis as a result of LPL or other lipases/esterases.

Freezing and thawing disrupt the native MFGM and allow access to the fat by the lipase (Willart & Sjostrom, 1966). The amount of disruption is increased by repeated freezing and thawing. Freezing by slow cooling causes more damage to the globules than fast cooling.

Temperature-activated lipolysis is induced by temperature cycling, which can occur at several stages on the farm and during milk collection and assembly at the factory. Milk as it leaves the cow is at $\sim 37^{\circ}\text{C}$. Kitchen and Aston (1970) suggested that maximum activation of LPL occurred at 30°C and marked decreases were observed at temperatures $>37^{\circ}\text{C}$ and $<12^{\circ}\text{C}$. However, change in temperature can also promote the development of lipolysis, for example cooling to 5°C followed by re-warming to $25\text{--}37^{\circ}\text{C}$ and re-cooling (Kon & Saito, 1997). A maximum degree of lipolysis occurs when milk is warmed to $\sim 30^{\circ}\text{C}$, followed by cooling to $<10^{\circ}\text{C}$ (Deeth & Fitz-Gerald, 1976; Kon & Saito, 1997). Temperature activation appears to be related to the release of an LPL-inhibitory component from the MFGM and an increase in the association between lipase(s) present in the milk with fat globules on heating to 30°C ; the decrease in lipolysis on heating cooled milk to temperatures $>37^{\circ}\text{C}$ may be associated with an inhibitory effect of skimmed milk components associated with the fat globule.

Spontaneous lipolysis

This is defined as lipolysis that develops in the milk of some cows during cold storage without being subjected to any physical or mechanical treatment. Lipolysis in these milks is initiated just by prompt cooling of the milk after removal from the cow. Milks from individual cows differ in their tendency to develop rancidity (Frankel & Tarassuk, 1955; Sundheim & Bengtsson-Olivecrona, 1987). This phenomenon is the least understood aspect of lipolysis. Susceptibility of this milk to produce elevated levels of FFA is highly variable and depends on biochemical changes in milk and several predisposing factors in the animal (Jellema, 1975). The main biochemical factors include the amount of lipase activity, the integrity of the MFGM and the balance of lipolysis activating and inhibiting factors (Deeth & Fitz-Gerald, 1975; Sundheim, 1988; Cartier & Chilliard, 1990). The major predisposing factors associated with spontaneous lipolysis in the cow are late stage of lactation (Chazal & Chilliard, 1986), poor quality feed (Jellema, 1980) and mastitis (Downey, 1980b).

Contribution of bacterial lipases to lipolysis

Modern farm and milk collection practices have resulted in milk being cooled rapidly to $<8^{\circ}\text{C}$ following milking and a relatively low frequency of milk collection from the farm, for example every 2 or 3 days. Moreover, cold milk is hauled over long distances and is often cold stored at the cheese plant for 1–3 days, depending on time of year and the manufacturing schedules; hence, milk can be cold stored for up 2–5 days prior to processing. Psychrotrophic bacteria grow during refrigerated storage of milk and produce lipase enzyme, which can have a major effect on the quality of products (Shah, 1994; Sorhaug & Stepaniak, 1997). These lipases are heat-stable enzymes and generally survive pasteurisation and ultra-high temperature treatments (Cogan, 1977; Shipe and Senyk, 1981). Even though the bacterial lipase is not inactivated by pasteurisation (unlike indigenous LPL), the psychrotrophic bacteria that produced them are destroyed. This has implications in that the bacterial lipase may be carried through to the manufactured cheese where they contribute to off-flavours (rancidity, soapiness, bitterness) during advanced maturation, especially when large populations ($>1 \times 10^6 - 1 \times 10^7$ cfu mL^{-1}) are present in the milk (Chapman *et al.*, 1976; Cousin & Marth, 1977; Law *et al.*, 1979).

Occurrence of lipolysis in the dairy industry and minimisation of the problem

Lipolysis in milk and milk products is a persistent concern in the dairy industry. The effect of agitation/pumping on the rate of lipolysis depends on the nature and severity of the mechanical treatment, temperature during activation and characteristics of the milk. The design, installation and operating characteristics of the milking machine can strongly influence mechanically induced lipolysis. The agitation or pumping of milk, particularly when incorporating air entrainment and when milk temperature is relatively high at $>30^{\circ}\text{C}$, are major predisposing factors to lipolysis. Milking equipment on the farm should be designed and maintained to minimise frothing, foaming or agitation, thereby reducing physical damage to the milk fat and the development of FFA. It is important that laminar flow conditions prevail in the milk line and that pumps do not run in a 'starved' condition so as to minimise the increase in FFA. The height of the milk line can be a significant factor, particularly in the presence of air leaks (O'Brien *et al.* 1998). In addition, the bulk tank design should promote

gentle movement and handling, thus minimising FFA development. Although rapid cooling of milk is important to inhibit lipolysis, re-warming and re-cooling are very conducive to lipolysis and this can occur normally twice *per* day as fresh milks at $\sim 35^{\circ}\text{C}$ are added to the bulk tank containing milk at 4°C , bringing the blend temperature to $\sim 15^{\circ}\text{C}$. This effect may be minimised if the bulk tank is capable of rapid cooling to 4°C . However, care must be taken to avoid freezing of the milk onto the tank surface when small volumes of milk are being cooled rapidly (e.g. in direct expansion tanks). The most effective means of reducing lipolysis due to psychrotrophic bacteria is firstly by hygienic milk production to reduce bacterial numbers and secondly by minimising milk storage time between milking and processing. The processing plant also has a responsibility in ensuring minimal agitation, cavitation effects and temperature changes in milk during collection/transport and distribution to storage silos and cheese vats, and in avoiding contact between homogenised and raw milks (Reuter, 1978).

A number of studies (Deeth & Fitz-Gerald, 1976; Sapru *et al.*, 1997; O'Brien *et al.*, 2006) have reported that milk from cows in late lactation has a higher FFA level than that from cows in early lactation. This may be due to changes in milk and MFGM integrity at that time or mechanical damage of the MFGM due to excessive mixing of air into relatively small volumes of milk, particularly at evening milkings, within a seasonal milk production system. Cow diet also impacts on lipolysis, with cows under nutritional stress producing milk with relatively high FFA levels (Jellema, 1980).

1.5.5 Chemical residues

The presence of chemical residues and contaminants in milk is of public health concern and a cause of economic loss in the dairy industry. Milk is quite susceptible to contamination for many reasons. A range of veterinary drugs including antibiotics are commonly administered to animals to combat various diseases, the most prevalent being mastitis. Furthermore, other sources of contaminants to milk include cleaning and disinfecting agents (trichloromethane (TCM), iodine) and compounded animal feeds (mycotoxins).

Antibiotics

Antimicrobial drugs are administered to treat bacterial infections or employed prophylactically to prevent spread of disease. All antimicrobial drugs administered to dairy cows enter the milk to a certain degree, and each drug is given a certain withdrawal period, during which time the concentration in the tissues declines and the drug is excreted by the animal. The most frequently and commonly used antimicrobials are antibiotics, employed to combat mastitis-causing pathogens. Other infectious diseases such as laminitis and respiratory diseases are also treated with antimicrobial agents, but are of relatively minor importance (Fisher *et al.*, 2003).

The occurrence of residues of antimicrobials in milk has both economical and technological impact on the dairy industry. Antimicrobial residues can lead to partial or complete inhibition of acid production by starter cultures, inadequate ripening and ageing of cheese and cause defects of flavour and texture of these products (Honkanen-Buzalski & Reybroeck, 1997). A general concern linked to the widespread usage of antimicrobials at farm level is the potential development of antibiotic-resistant pathogens. This may complicate human

treatment and possibly cause selection of antibiotic-resistant strains of bacteria in the gut. Further concern exists that sensitive individuals may exhibit allergic reactions to antibiotic residues (Lee *et al.*, 2001). A survey in the United States of America (USA) between 1993 and 1994 reported that ~6% of milk samples (~2495) tested positive for antibiotics (Anonymous, 2005). Since mastitis is quite a common disease within dairy herds, it is likely that a high incidence of antibiotic residues arises from the use of lactating and dry cow intramammary formulations. In addition, failure to discard the milk from such treated cows for the recommended period is the principal cause of antibiotic residues in milk. Contamination of milking equipment after milking a treated cow also causes antibiotic residues in milk. Antibiotic residues on the milking equipment can be avoided by milking treated cows last or by flushing contaminated parts of the equipment before it is used on subsequent cows. Thus, both the withdrawal period of milk (from sale) and the separation of equipment (surfaces) with residues of antibiotic-contaminated milk from those that do not are critical in eliminating antibiotic residues in milk.

Milk indicated as positive for antibiotic residues on receipt at dairy companies is discarded, the incident is investigated and the implicated producer may be fined and not allowed to sell milk for a period of time. Thus, the challenge to the dairy industry has been to develop an approach that eliminates the incidence of antibiotic-contaminated milk. This approach may differ in the detail of application in different countries, but the international principles are similar. The control strategy for antibiotics in milk normally includes monitoring of milk supplies on a routine basis, imposition of penalties for the delivery of contaminated milk and veterinary supervision of antibiotic treatment of cows.

Mycotoxins

Mycotoxins are metabolites of moulds, which can result in pathological changes in humans or animals. Their presence in food products can induce a toxic response (deterioration in kidney or liver function) in humans and other animals (O'Brien *et al.*, 2004), and for this reason is undesirable. The EU maximum level of aflatoxin M1 in milk is 0.5 $\mu\text{g kg}^{-1}$ (van Egmond & Dekker, 1995). Mycotoxins occur in cheese (Sengun *et al.*, 2008; Rahimi *et al.*, 2009) as a result of transfer from the milk or due to production by moulds (*Penicillium* spp. and *Aspergillus* spp.) (Erdogan & Sert, 2004; O'Brien *et al.*, 2004; Sengun *et al.*, 2008).

The presence of mycotoxins in milk normally occurs by indirect contamination through the feedstuffs consumed by dairy cattle. Of major importance in this respect is aflatoxin M1, the milk metabolite of aflatoxin B1. Aflatoxin M1 appears in milk and milk products as the direct result of the intake of aflatoxin B1-contaminated feed by dairy cows. Aflatoxin B1 can be present in feeds due to poor storage and favourable climatic conditions suitable for fungal growth. Aflatoxin B1 can be produced by the fungi *Aspergillus flavus* and *Aspergillus parasiticus* under certain conditions of temperature, water activity and availability of nutrients. Mycotoxins produced by fungal species other than *Aspergillus* and *Penicillium* are of minor concern for dairy products. While there has been concern in recent years over the presence of aflatoxin M1 in milk, bovine milk normally contains extremely low levels of aflatoxin M1 (Blanco *et al.*, 1988). The efficiency of aflatoxin conversion in cows is poor; Frobish *et al.* (1986) reported that <2% of aflatoxin B1 deliberately added to feed offered to lactating animals was converted to the hydroxylated form (M1).

Other residues

Targeted or desired limits for other milk residues are becoming evident in specifications by retailers in some countries for some dairy products, for example 0.03 mg kg⁻¹ of TCM in lactic butter and 250 µg kg⁻¹ iodine in milk for infant feed formulation. TCM, otherwise known as chloroform, is classed as a Group 2B carcinogen, and has been shown to cause cancer in laboratory animals (International Agency for Research in Cancer, 1999), while excess iodine in the human diet causes alterations in thyroid activity (Castillo *et al.*, 2003). The formation of TCM in milk is a consequence of the reaction between the organic matter in milk and active chlorine in the detergent solvent used to clean the milk contact surfaces (Resch & Guthy, 2000). The TCM is formed in the detergent solvent and is then transferred to milk as a consequence of solvent residues on surfaces that come in contact with the milk, for example milk pipelines. TCM development is minimised by sufficient rinsing of milking equipment both before and after detergent washing and correct use of cleaning products having the appropriate chlorine content.

Excess iodine in milk results from either transfer from animal feeds containing high iodine levels or teat disinfection of cows pre- or post-milking. Thus, monitoring of iodine content in animal feed and reducing the carry-over of teat disinfectants (containing iodine) from the teat to the milk would minimise the level of iodine in milk.

1.6 Strategy for quality milk production

Cheese is a concentrated gelled product that structurally consists of a casein/*para*-casein matrix, enclosing fat and moisture. It is essentially formed by controlled gelation (aggregation) of the milk protein (in particular casein) and dehydration of the gel to the desired degree by subjecting it to various operations (such as gel cutting, stirring, heating) and drainage of the expressed whey. Gelation is induced by enzymatic treatment of the milk with rennet (e.g. chymosin) in rennet-curd cheeses and by acidification (to pH 4.8–4.6) in acid-curd cheeses. In both cases, the basic building blocks of the gel are aggregates (of *para*-casein in rennet-curd cheese and of casein in acid-curd cheese), comprising interacted casein micelles. The aggregates subsequently fuse together to form a constrained, periodic-repeating structural continuum of protein throughout the milk. On defining the formation of cheese using this approach, the most important milk quality characteristics for cheese manufacture are those that enhance:

- aggregation of the casein to form a gel that is sufficiently firm to cut within an acceptable time frame (typically 30–50 min for rennet-curd cheeses and 4–14 h for acid-curd cheeses);
- continued aggregation together with whey expulsion during the remaining cheesemaking operations post-gelation; and
- development of a gel structure and curd rheology, which at all stages of manufacture provides a robustness that maximises the retention of fat and casein in the curd and curd yield.

These attributes are a prerequisite to the formation of a fresh curd with desired composition, structure, texture and yield. Characteristics of the milk that are generally positively correlated with enhanced rennet coagulation include:

- high values for casein number, intact casein content, contents of total casein, individual (α_{s1} -, β - and κ -) caseins, calcium-to-casein ratio, and ratios of κ -casein to total casein and to individual caseins (α_{s2} - and β -caseins); and
- low values for serum casein, micelle size and degree of κ -casein glycosylation.

These characteristics are conditional on a number of factors including the breed, health status, age, plane of nutrition and stage of lactation of the cow, the SCC and bacterial count of the milk, associated enzymatic activities, season and milk production practices. Apart from these characteristics, it is also important that the milk characteristics are conducive to the development of a finished cheese that has satisfactory sensory properties, such as desired flavour by having a clean bland taste free from off-flavours, such as rancidity, taints and chemical tastes of residues, and complies with the safety and wholesomeness expected by the consumer/user. Some recommended attributes of good quality milk for cheese manufacture are listed in Table 1.4.

The factors affecting the overall quality of milk produced on the farm are summarised in Fig. 1.5. Some of these can be controlled short term (implementing proper cleaning protocols prior to milking) or longer term (implementing selection/breeding programmes for desired composition characteristics – protein content, frequency of genetic variants); others cannot (weather, environment). The optimum ‘designer’ milk for cheesemaking is more naturally and cheaply arrived at through ‘best farm and cow management practices’. Some technological interventions within the milk-processing factory just before the cheesemaking process can modify some milk characteristics to make it more suitable for cheesemaking (e.g. casein content by ultrafiltration of milk; cf. Chapter 8). However, some other milk characteristics, such as effects of SCC, microbial and enzymatic activity, cannot be modified at this point. The quality of the raw material leaving the farm (and being purchased by the dairy processor) is of ultimate importance and is most difficult to control. Thus, it is critical that optimum production methods for ‘designer’ milk for cheesemaking be employed. The key elements of good milk production management are outlined as follows:

- breeding/selecting for target cheesemaking properties;
- maintaining a high plane of animal nutrition;
- minimising bacterial count of milk;
- maintaining a low SCC in milk;
- minimising enzymatic activity associated with somatic cells and contaminating bacteria;
- minimising chemical residues and contaminants; and
- minimising fat damage and levels of FFA.

The details of implementation of each of these steps are outlined in Appendix 1.1.

In summary, milk for cheesemaking should be of optimum quality, produced on-farm following guiding principles of optimum animal health, milking hygiene, animal feeding, animal welfare and environment. This approach should also incorporate record keeping for various

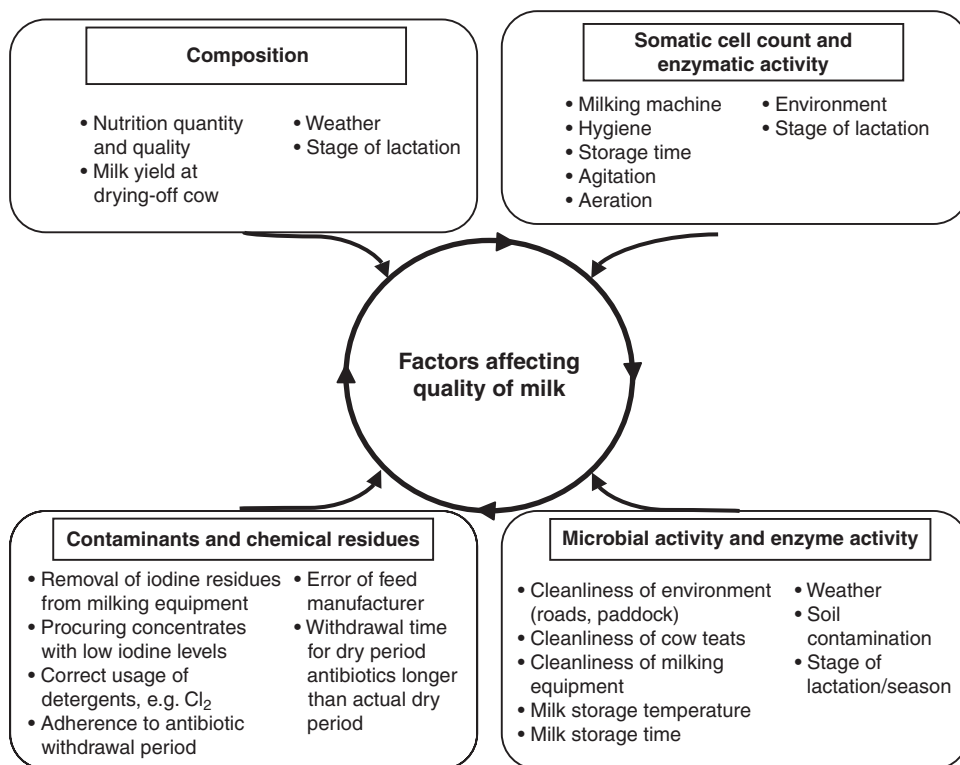

Fig. 1.5 Factors affecting the quality of milk produced on the farm. Note: There are four key quality parameters that influence quality of milk for cheese manufacture directly or indirectly: (a) composition, (b) somatic cell count and enzymatic activity, (c) microbial activity and (d) residues/contaminants. For each parameter, there are factors which can or cannot be controlled by the farmer, and these are represented by the bullet points on the left- and right-hand sides of the parameter boxes, respectively.

procedures (milk storage temperatures and veterinary or medication treatments of individual animals). Additional everyday guidelines to achieve milking excellence on-farm include setting performance goals, rapidly identifying mastitis problems, standardising the milking routine, training of staff (having standard operating protocols for each of these) and allotting adequate time to manage milk quality issues.

1.7 Conclusions

The efficient manufacture of high-quality cheese consistently is a highly complex biotechnological process involving controlled destabilisation and gelation of the milk protein, fermentation of the milk sugar lactose to lactic acid, dehydration of the gel to obtain cheese curd and maturation of the curd to a ripened cheese with the desired quality attributes (sensory, aesthetic, usage, safety, convenience, wholesomeness, value for money) required by the consumer (cf. Chapter 8). A critical prerequisite for the manufacture of quality cheese is to start with milk of the highest quality. This chapter has examined the factors affecting the

quality of milk for generic manufacture of cheese. These include the composition, state of the components (ratio of globular to free fat; degree of hydrolysis of casein or fat), the levels of indigenous and contaminating enzyme activity (from bacteria, somatic cells) and levels of contaminants and chemical residues. The quality of milk for cheese manufacture has greatly improved in recent years as a direct consequence of: (a) greater scientific knowledge of the factors affecting milk composition and how these are affected by animal breeding, husbandry and milk handling, and (b) the quality control measures that have been implemented at farm level, for example training and education of farmers, improved hygiene, measurement systems, documentation and traceability. However, the milk quality concept is a dynamic entity, and a continuous quality improvement approach is required to meet the requirements of different stakeholders including the cheese manufacturer and the consumer. Currently, the demands of the consumer appear to be increasing in importance and it is likely that this will continue as a consequence of the increasing awareness of food, health and security concerns on the part of the consumer, who consequently requires more assurance about food quality. Further improvement in the quality of milk for cheese manufacture will be assisted by:

- developing a better understanding of the relationships between milk composition and chemistry and various aspects of cheese quality and manufacturing efficiency, from manufacture through to the final characteristics of the finished cheese (for example effects of lipolysis and FFA in milk on the levels of FFA and sensory aspects of cheese; effects of degree of glycosylation of κ -casein on the rate of hydrolysis by rennets and on the flocculation/gelation of *para*- κ -casein, for example by comparison of the behaviour of native casein micelles with casein micelles treated *in situ* with glycosidases to remove sialic acid and other glycans from the κ -casein; effects of various factors such as pH, ionic strength, whey protein type and concentration on the interaction of κ -casein with denatured whey protein in high-temperature-treated milks and the assimilation of the resultant aggregates into the rennet-induced milk gel, and their impact on the physical properties of the final cheese; effects of feed on flavour and physical properties of milk fat and the properties of the resultant cheese);
- breeding and selection of cows for the most desired quality attributes in milk (protein level and protein genetic variants);
- ongoing developments in proteomics, i.e. as a means of elucidating the molecular basis for inter-cow variations in milk gelation properties (Tyriseva *et al.*, 2008);
- improvements in analytical capability, such as high-pressure liquid chromatography has contributed to quantifying individual proteins and assisting our understanding of protein interactions of importance to cheese (Donato & Guyomarc'h, 2009), or the aggregation of micelles varying in sialic acid content; and
- progressing quality milk production on farms via an integrated education programme covering all rudimentary aspects (breeding, husbandry, hygiene, milk handling/storage, relationship between milk and product, consumer requirements, traceability/documentation) of quality milk production for products such as cheese (see Appendix 1.1).

In addition, the application of a quality management programme on-farm where risk identification and prevention would play a role is important. This programme should be similar to a hazard analysis critical control points programme as operated in the cheese

manufacturing industry. This structure would allow measurement of critical points throughout the milk production chain (feed, cow, milk, milk tank, with regard to pathogens, indicator organisms of contamination, antibiotics, toxins, chemical contaminants).

Appendix 1.1 strategy for quality milk production

- Breeding/selecting for target cheesemaking properties
 - select cow breeds for high casein and/or fat contents, or for BB genetic variants of κ -casein and β -lactoglobulin
- Maintaining a high plane of animal nutrition
 - offering a high pasture diet can support efficient production of quality milk when adequate grass is available
 - supplementing a pasture-based system with concentrates to increase the energy supply to cows in periods of inadequate grass availability
 - implementing a good cow management system during the late stage of lactation, such as maintenance of milk yield (through supplementation of pasture and subsequently silage, with concentrates and drying off cows at milk yields of 8–9 kg day⁻¹)
- Minimising bacterial count of milk
 - maintaining good hygiene standards at all stages of milk production
 - providing an environment in which cows are maintained in a clean condition and one in which bacterial challenge to the udder is minimised (good grazing conditions or bedding material)
 - carrying out a complete pre-milking routine that ensures minimal bacteria on the udder and teat skin is necessary
 - practicing an effective cleaning routine for the milking plant after each milking
 - rapidly cooling milk to below 4°C
- Maintaining a low SCC in milk
 - reducing the risk of bacterial contamination of the cows' teats and udder through the maintenance of clean cows and post-milking teat disinfection
 - providing winter accommodation that is clean, dry and comfortable for the cow
 - preventing the transfer of mastitis-causing organisms from cow to cow or from one quarter to other quarters of the same animal during the milking process
 - ensuring proper sizing of the milking equipment for individual herds, thus allowing sufficient time for cow preparation prior to milking and avoidance of overmilking
 - ensuring that the milking machine is properly installed, regularly maintained, tested and serviced routinely, and generally functioning properly
 - setting time aside to manage milk SCC and mastitis incidence in terms of the collection, recording, checking and interpretation of herd and individual cow SCC data as well as clinical mastitis incidences
 - buying cows of known SCC from a healthy herd, e.g. a milk recording herd with a normal SCC of $<150 \times 10^3$ cells mL⁻¹
 - application of dry cow therapy
 - culling of cows with persistent high SCC and/or clinical mastitis incidence

- Minimising enzymatic activity associated with somatic cells and contaminating bacteria
 - maintaining cow milk yields towards the end of lactation through maintaining a good cow diet
 - minimising the occurrence of mastitis and high SCC levels in milk
 - reducing the effect of proteolytic activities contributed by psychrotrophic bacteria by reducing the bacterial level in the milk, degree of microbial growth and the duration of storage time
 - maintaining excellent hygiene (low bacterial levels) together with fast milk cooling (to minimise microbial growth) and minimum storage time
- Minimising fat damage and levels of FFA
 - ensuring that milk transfer equipment is designed and maintained to minimise cavitation, frothing, foaming or agitation and to promote laminar milk flow conditions
 - ensuring bulk tank design that allows gentle movement and handling of milk
 - avoidance of freezing of the initial milk in the tank onto the surface in very fast cooling tanks
 - ensuring minimal agitation and temperature changes as milk is transferred into storage silos and vats together with avoiding contact between homogenised and raw milks within the processing plant
 - maintaining a good nutritional cow diet to prevent nutritional stress particularly in late lactation
- Minimising chemical residues and contaminants
 - discarding milk from antibiotic-treated cows for the recommended withdrawal period
 - flushing milking equipment after milking an antibiotic-treated cow to prevent contamination of the main milk pool
 - ensuring the quality, traceability and storage conditions of feed

References

- Adak, G.K., Meakins, S.M., Yip, H., Loopman, B.J. & O'Brien, S.J. (2005) Disease risks from foods, England and Wales, 1996–2000. *Emerging Infectious Disease*, **11**, 365–372.
- Albenzio, M., Caroprese, M., Santillo, A., Marino, R., Taibi, L. & Sevi, A. (2004) Effects of somatic cell count and stage of lactation on the plasmin activity and cheese-making properties of ewe milk. *Journal of Dairy Science*, **87**, 533–542.
- Aleandri, R., Buttazzoni, L.G., Schneider, J.C., Caroli, A. & Davoli, R. (1990) The effects of milk protein polymorphisms on milk components and cheese-producing ability. *Journal of Dairy Science*, **73**, 241–255.
- Ali, A.E., Andrews, A.T. & Cheeseman, G.C. (1980a) Influence of elevated somatic cell count on casein distribution and cheese-making. *Journal of Dairy Research*, **47**, 393–400.
- Ali, A.E., Andrews, A.T. & Cheeseman, G.C. (1980b) Influence of storage of milk on casein distribution between the micellar and soluble phases and its relationship to cheese-making parameters. *Journal of Dairy Research*, **47**, 371–382.
- Ali, A.E., Andrews, A.T., Gordon, C. & Cheeseman, C. (1980c) Factors influencing casein distribution in cold-stored milk and their effects on cheese-making parameters. *Journal of Dairy Research*, **47**, 383–391.

- Anderson, M. & Andrews, A.T. (1977) Progressive changes in individual milk protein concentrations associated with high somatic cell counts. *Journal of Dairy Research*, **44**, 223–230.
- Anema, S.G. & Li, Y. (2003) Association of denatured whey proteins with casein micelles in heated reconstituted skim milk and its effect on casein micelle size. *Journal of Dairy Research*, **70**, 73–83.
- Anema, S.G., Lee, S.K., Lowe, E.K. & Klostermeyer, H. (2004) Rheological properties of acid gels prepared from heated pH-adjusted skim milk. *Journal of Agricultural and Food Chemistry*, **52**, 337–343.
- Anifantakis, E.M. (1986) Comparison of the physico-chemical properties of ewes' and cows' milk. *Production and Utilisation of Ewes' and Goats' Milk*, Document No. 202, pp. 42–53, International Dairy Federation, Brussels.
- Anonymous (2005) *National Milk Drug Residue Database*, Fiscal Year 2004 Annual Report, October 1, 2003 – September 30, 2004, GLH, Incorporated, Florida.
- Aoki, T., Toyooka, K. & Kako, Y. (1985) Role of phosphate groups in the calcium sensitivity of α_{s2} -casein. *Journal of Dairy Science*, **68**, 1624–1629.
- Auldish, M.J., Coats, S., Sutherland, B.J. Mayes, J.J.M., McDowell, G. & Rogers, G.L. (1996) Effects of somatic cell count and stage of lactation on raw milk composition and the yield and quality of Cheddar cheese. *Journal of Dairy Research*, **63**, 269–280.
- Auldish, M.J. & Hubble, I.B. (1998) Effects of mastitis on raw milk and dairy products. *Australian Journal of Dairy Technology*, **53**, 28–36.
- Auldish, M.J., Johnston, K.A., White, N.J., Fitzsimons, W.P. & Boland, M.J. (2004) A comparison of the composition, coagulation characteristics and cheesemaking capacity of milk from Friesian and Jersey dairy cows. *Journal of Dairy Research*, **71**, 51–57.
- Auldish, M., Mullins, C., O'Brien, B. & Guinee, T. (2001) A comparison of the Formagraph and low amplitude strain oscillation rheometry as methods for assessing the rennet coagulation properties of bovine milk. *Milchwissenschaft*, **56**, 89–92.
- Auldish, M., Mullins, C., O'Brien, B., O'Kennedy, B.T. & Guinee, T. (2002) Effect of cow breed on milk coagulation properties. *Milchwissenschaft*, **57**, 140–143.
- Auldish, M.J., Walsh, B.J. & Thomson, N.A. (1998) Seasonal and lactational influences on bovine milk composition in New Zealand. *Journal of Dairy Research*, **65**, 401–411.
- Awad, S. (2007) Effect of sodium chloride and pH on the rennet coagulation and gel firmness. *Lebensmittel Wissenschaft und Technologie*, **40**, 220–224.
- Banks, J.M. & Tamime, A.Y. (1987) Seasonal trends in the efficiency of recovery of milk fat and casein in cheese manufacture. *Journal of the Society of Dairy Technology*, **40**, 64–66.
- Barbano, D.M. (1994) Overview – influence of mastitis on cheese yield and factors affecting its control. *Cheese Yield and Factors Affecting Its Control*, Special Issue No. 9402, pp. 48–54, International Dairy Federation, Brussels.
- Barbano, D.M., Rasmussen, R.R. & Lynch, J.M. (1991) Influence of somatic cell count and milk age on cheese yield. *Journal of Dairy Science*, **74**, 369–388.
- Bastian, E.D. & Brown, R.J. (1996) Plasmin in milk and dairy products: an update. *International Dairy Journal*, **6**, 435–457.
- Bastian, E.D., Hansen, K.G. & Brown, R.J. (1991) Activation of plasmin with urokinase in ultrafiltered milk for cheese manufacture. *Journal of Dairy Science*, **74**, 3669–3679.
- Blanco, J.L., Dominguez, L., Gomez-Lucia, E., Garayzabal, J.F.F., Garcia, J.A. & Suarez, G. (1988) Presence of aflatoxin M₁ in commercial ultra-high-temperature-treated milk. *Applied and Environmental Microbiology*, **54**, 1622–1623.
- Bramanti, E., Sortino, C., Onor, M., Beni, F. & Raspi, G. (2003) Separation and determination of denatured α_{s1} -, α_{s2} -, β - and κ -caseins by hydrophobic interaction chromatography in cows', ewes' and goats' milk, milk mixtures and cheeses. *Journal of Chromatography A*, **994** (1–2), 59–74.

- Bramley, A.J. & McKinnon, C.H. (1990) The microbiology of raw milk. *Dairy Microbiology* (ed. R.K. Robinson), vol. 1, pp. 163–208, Elsevier Science Publishers, London.
- Brand, E., Liaudat, M., Olt, R. & Linxweiler, W. (2000) Rapid determination of lipase in raw, pasteurised and UHT-milk. *Milchwissenschaft*, **55**, 573–576.
- Brew, K. (2003) α -Lactalbumin. *Advanced Dairy Chemistry, Volume 1: Proteins* (eds P.F. Fox and P.L.H. McSweeney), 3rd edn, Part A, pp. 387–421, Kluwer Academic/Plenum Publishers, New York.
- Broome, M.C., Tan, S.E., Alexander, M.A. & Manser, B. (1998a) Low-concentration-ratio ultrafiltration for Cheddar cheese manufacture. I: Effect on seasonal cheese composition. *Australian Journal of Dairy Technology*, **53**, 5–10.
- Broome, M.C., Tan, S.E., Alexander, M.A. & Manser, B. (1998b) Low-concentration-ratio ultrafiltration for Cheddar cheese manufacture. II: Effect on maturation. *Australian Journal of Dairy Technology*, **53**, 11–16.
- Buncic, S. (2006) On-farm phase in the context of the food chain. *Integrated Food Safety and Veterinary Public Health* (ed. S. Buncic), pp. 26–31, CABI, Oxford.
- Burvenich, C., Guidry, A.J. & Paape, M.J. (1995) Natural defence mechanisms of the lactating and dry mammary gland. *Proceedings of the Third IDF International Mastitis Seminar* (eds A. Saran and S. Soback), pp. 3–13, Beit-Dagan, The National Mastitis Reference Centre, Kimron Veterinary Institute, Tel Aviv.
- Bush, C.S., Caroutte, C.A., Amundson, C.H. & Olson, N.F. (1983) Manufacture of Colby and brick cheeses from ultrafiltered milk. *Journal of Dairy Science*, **66**, 415–421.
- Calderon, F., Chauveau-Duriot, B., Martin, B., Graulet, B., Doreau, M. & Noziere, P. (2007) Variations in carotenoids, vitamins A and E, and color in cow's plasma and milk during late pregnancy and the first three months of lactation. *Journal of Dairy Science*, **90**, 2335–2346.
- Caravaca, F., Carrizosa, J., Urrutia, B., Baena, F., Jordana, J., Amills, M., Badaoui, B., Sanchez, A., Angiolillo, A. & Serradilla, J.M. (2009) Effect of α_{s1} -casein (CSN1S1) and κ -casein (CSN3) genotypes on milk composition in Murciano-Granadina goats. *Journal of Dairy Science*, **92**, 2960–2964.
- Carlén, E., Strandberg, E. & Roth, A. (2004) Genetic parameters for clinical mastitis, somatic cell score, and production in the first three lactations of Swedish holstein cows. *Journal of Dairy Science*, **87**, 3062–3070.
- Cartier, P. & Chilliard, Y. (1990) Spontaneous lipolysis in bovine milk: combined effects of nine characteristics in native milk. *Journal of Dairy Science*, **73**, 1178–1186.
- Castillo, V.A., Rodriguez, M.S., Lalia, J.C. & Pisarev, M.A. (2003). Morphologic changes in the thyroid glands of puppies fed a high-iodine commercial diet. *International Journal of Applied Research in Veterinary Medicine*, **1**, 45–50.
- Celestino, E.L., Iyer, M. & Roginski, H. (1996) The effects of storage on the quality of raw milk. *Australian Journal of Dairy Technology*, **51**, 59–63.
- Chapman, H.R. (1974) The effect the chemical quality of milk has on cheese quality. *Dairy Industries International*, **39**, 329–334.
- Chapman, H.R. & Burnett, J. (1972) Seasonal changes in the physical properties of milk for cheesemaking. *Dairy Industries International*, **37**, 207–211.
- Chapman, H.R., Sharpe, M.E. & Law, B.A. (1976) Some effects of low-temperature storage of milk on cheese production and Cheddar cheese flavour. *Dairy Industries International*, **41**, 42–45.
- Chazal, M.P. & Chilliard, Y. (1986) Effect of stage of lactation, stage of pregnancy, milk yield and herd management on seasonal variation in spontaneous lipolysis in bovine milk. *Journal of Dairy Research*, **53**, 529–538.
- Choi, J., Horne, D.S. & Lucey, J.A. (2007) Effect of insoluble calcium concentration on rennet coagulation properties of milk. *Journal of Dairy Science*, **90**, 2612–2623.

- Christiansson, A., Bertilsson, J. & Svensson, B. (1999) *Bacillus cereus* spores in raw milk: factors affecting the contamination of milk during the grazing period. *Journal of Dairy Science*, **82**, 305–314.
- Cogan, R.M. (1977) A review of heat resistant lipase and proteinases and the quality of dairy products. *Irish Journal of Food Science and Technology*, **4**, 95–105.
- Collins, Y.F., McSweeney, P.L.H. & Wilkinson, M.G. (2004) Lipolysis and catabolism of fatty acids in cheese. *Cheese: Chemistry, Physics and Microbiology, Volume 1: General Aspects* (eds P.F. Fox, P.L.H. McSweeney, T.M. Cogan and T.P. Guinee), 3rd edn, pp. 373–389, Elsevier Academic Press, Amsterdam.
- Cooney, S., Tiernan, D., Joyce, P. & Kelly, A.L. (2000) Effect of somatic cell count and polymorphonuclear leucocyte content of milk on composition and proteolysis during ripening of Swiss-type cheese. *Journal of Dairy Research*, **67**, 301–307.
- Cousin, M.A. & Marth, E.H. (1977) Cheddar cheese made from milk that was precultured with psychrotrophic bacteria. *Journal of Dairy Science*, **60**, 1048–1056.
- Cousins, C.M. & Bramley, A.J. (1984) The microbiology of raw milk. *Dairy Microbiology* (ed. R.K. Robinson), vol. 1, pp. 119–163, Elsevier Science Publishers, London.
- Creamer, L.K. & Olson, N.F. (1982) Rheological evaluation of maturing Cheddar cheese. *Journal of Food Science*, **47**, 631–636, 646.
- Creamer, L.K., Zoerb, H.F., Olson, N.F. & Richardson, T. (1982) Surface hydrophobicity of α_{s1} -I, α_{s1} -casein A and B and its implications in cheese structure. *Journal of Dairy Science*, **65**, 902–906.
- Cromie, S. (1992) Psychrotrophs and their enzyme residues in cheese milk. *Australian Journal of Dairy Technology*, **47**, 96–100.
- Dalgleish, D.G. (1979) Proteolysis and aggregation of casein micelles treated with immobilized or soluble chymosin. *Journal of Dairy Research*, **46**, 653–661.
- Dalgleish, D.G., Horne, D.S. & Law, A.J.R. (1989) Size-related differences in bovine casein micelles. *Biochimica et Biophysica Acta*, **991**, 383–387.
- Dalgleish, D.G. & Law, A.J.R. (1988) pH-induced dissociation of bovine casein micelles.– I: Analysis of liberated caseins. *Journal of Dairy Research*, **55**, 529–538.
- Dalgleish, D.G. & Law, A.J.R. (1989) pH-induced dissociation of bovine casein micelles.– II: Mineral solubilization and its relation to casein release. *Journal of Dairy Research*, **56**, 727–735.
- Deeth, H.C. (2006) Lipoprotein lipase and lipolysis in milk. *International Dairy Journal*, **16**, 555–562.
- Deeth, H.C. & Fitz-Gerald, C.H. (1975) Factors governing the susceptibility of milk to spontaneous lipolysis. *Proceedings of the Lipolysis Symposium*, Document No. 86, pp. 24–34, International Dairy Federation, Brussels.
- Deeth, H.C. & Fitz-Gerald, C.H. (1976) Lipolysis in dairy products: a review. *Australian Journal of Dairy Technology*, **31**, 53–64.
- Deeth, H.C. & Fitz-Gerald, C.H. (1977) Some factors involved in milk lipase activation by agitation. *Journal of Dairy Research*, **44**, 569–583.
- Deeth, H.C. & Fitz-Gerald, C.H. (2006) Lipolytic enzymes and hydrolytic rancidity. *Advanced Dairy Chemistry, Volume 2: Lipids* (eds P.F. Fox and P.L.H. McSweeney), 3rd edn, pp. 481–556, Springer Science + Business Media, Inc, New York.
- Dillon, P.G., Crosse, S., O'Brien, B. & Mayes, R.W. (2002) The effect of forage type and concentrate supplementation on the performance of spring-calving dairy cows in early lactation. *Grass and Forage Science*, **57**, 1–12.
- Dillon, P., Crosse, S., Stakelum, G. & Flynn, F. (1995) The effect of calving date and stocking rate on the performance of spring-calving dairy cows. *Grass and Forage Science*, **50**, 26–29.

- Donato, L. & Guyomarc'h, F. (2009) Formation and properties of the whey protein/ κ -casein complexes in heated skim milk – a review. *Lait – Dairy Science and Technology*, **89**, 3–29.
- Donnelly, W.J. & Barry, J.G. (1983) Casein compositional studies. III: Changes in Irish milk for manufacturing and role of milk proteinase. *Journal of Dairy Research*, **50**, 433–441.
- Donnelly, W.J., Barry, J.G. & Buchheim, W. (1984) Casein micelle composition and synergetic properties of late lactation milk. *Irish Journal of Food Science and Technology*, **8**, 121–130.
- Downey, W.K. (1980a) Flavour impairment from pre- and post-manufacture lipolysis in milk and dairy products. *Journal of Dairy Research*, **47**, 237–252.
- Downey, W.K. (1980b) Risks from pre- and post-manufacture lipolysis. *Flavour Impairment of Milk and Milk Products due to Lipolysis*, Document No. 118, pp. 4–18, International Dairy Federation, Brussels.
- Driessen, F.M. & Van Der Waals, C.B. (1978) Inactivation of native milk proteinase by heat treatment. *Netherlands Milk and Dairy Journal*, **32**, 245–254.
- Dulley, J.R. (1972) Bovine milk protease. *Journal of Dairy Research*, **39**, 1–9.
- Dziuba, J. & Minkiewicz, P. (1996). Influence of glycosylation on micelle-stabilizing ability and biological properties of C-terminal fragments of cow's κ -casein. *International Dairy Journal*, **6**, 1017–1044.
- van Egmond, H.P. & Dekker, W.H. (1995) Worldwide regulations for mycotoxins in 1994. *Natural Toxins*, **3**, 332–336.
- Emmons, D.B. (1991). Yield formulae. *Factors Affecting the Yield of Cheese*, Special Issue No. 9301, pp. 21–47. International Dairy Federation, Brussels.
- Erdogan, A. & Sert, S. (2004) Mycotoxin-forming ability of two *Penicillium roqueforti* strains in blue moldy Tulum cheese ripened at various temperatures. *Journal of Food Protection*, **67**, 533–535.
- EU (1964) Council Directive 64/432/EEC of 26 June 1964 on animal health problems affecting intra community trade in bovine animals and swine. *Official Journal of the European Commission*, **121**, 1977–2012.
- EU (1992) Council Directive 92/46/EEC of 16 June 1992 laying down health rules for the production and placing on the market for raw milk, heat-treated milk and milk-based products. *Official Journal of European Commission*, **L1268**, 1–32.
- EU (1996) Commission Regulation (EC) No. 1081/96 of 14 June 1996 establishing a reference method for the detection of cows milk and caseinate in cheeses made from ewes milk, goats milk or buffalos milk or mixtures of ewes, goats, and buffalos milk and repealing Regulation (EEC) No. 690/92. *Official Journal of European Communities*, **L142**, 15–25.
- EU (1997) Council Regulation (EC) No 2597/97 of 18 December 1997 laying down additional rules on the common organization of the market in milk and milk products for drinking milk. *Official Journal of European Communities*, **L351**, 13–15.
- EU (2004) Regulation (EC) No. 853/2004 of 29 April 2004 laying down specific rules for food of animal origin. *Official Journal of the European Commission*, **L226**, 22–82.
- Farkye, N.Y. (2004) Acid- and acid/rennet-curd cheeses. Part C: Acid-heat coagulated cheeses. *Cheese: Chemistry, Physics and Microbiology, Volume 2: Major Cheese Groups* (eds P.F. Fox, P.L.H. McSweeney, T.M. Cogan and T.P. Guinee), 3rd edn, pp. 343–348, Elsevier Academic Press, Amsterdam.
- Farkye, N. & Fox, P.F. (1992) Contribution of plasmin to Cheddar cheese ripening: effect of added plasmin. *Journal of Dairy Research*, **59**, 209–216.
- Farkye, N.Y. & Landkammer, C.F. (1992) Milk plasmin activity influence on Cheddar cheese quality during ripening. *Journal of Food Science*, **57**, 622–624, 639.
- Fenelon, M.A. & Guinee, T.P. (1999) The effect of milk fat on Cheddar cheese yield and its prediction, using modifications of the Van Slyke cheese yield formula. *Journal of Dairy Science*, **82**, 2287–2299.

- Fenelon, M.A. & Guinee, T.P. (2000) Primary proteolysis and textural changes during ripening in Cheddar cheeses manufactured to different fat contents. *International Dairy Journal*, **10**, 151–158.
- Ferreiro, L., de Souza, H.M. & Heineck, L.A. (1980) Effect of subclinical bovine mastitis on composition of milk from crossbred cattle. *Revista do Instituto de Laticínios Cândido Tostes*, **35**, 19–24.
- Fisher, W.J., Trischer, A.M., Schiter, B. & Standler, R.J. (2003) Contaminants of milk and dairy products (A) Contaminants resulting from agricultural and dairy practices. *Encyclopaedia of Dairy Sciences* (eds H. Roginski, J.W. Fuquay & P.F. Fox), pp. 516–525, Academic Press, Oxford.
- Fox, P.F. (1970) Influence of aggregation on the susceptibility of casein to proteolysis. *Journal of Dairy Research*, **37**, 173–180.
- Fox, P.F. (2003) Milk proteins: General and historical aspects. *Advanced Dairy Chemistry, Volume 1: Proteins* (eds P.F. Fox & P.L.H. McSweeney), 3rd edn Part A, pp. 1–48, Kluwer Academic/Plenum Publishers, New York.
- Fox, P.F. & Brodtkorb, A. (2008) The casein micelle: historical aspects, current concepts and significance. *International Dairy Journal*, **18**, 677–684.
- Fox, P.F. & Guinee, T.P. (2000) Processing Characteristics of Milk Constituents, *Occasional Publication No. 25* (eds R.E. Agnew and A.M. Fearon), pp. 29–68, British Society of Animal Science, Edinburgh.
- Fox, P.F., Guinee, T.P., Cogan, T.M. & McSweeney, P.L.H. (2000) *Fundamentals of Cheese Science*, Aspen Publishers, Gaithersburg.
- Fox, P.F. & McSweeney, P.L.H. (1998) *Dairy Chemistry and Biochemistry*, Blackie Academic & Professional, London.
- Franceschi, P., Formaggioni, P., Malacarne, M., Summer, A., Fieni, S. & Mariani, P. (2003) Variations of nitrogen fractions, proteolysis and rennet-coagulation properties of milks with different somatic cell values. *Scienza e Tecnica Lattiero-Casearia*, **54**, 301–310.
- Frankel, E.N. & Tarassuk, N.P. (1955) Technical notes on the mechanism of activation of lipolysis and the stability of lipase systems in normal milk. *Journal of Dairy Science*, **38**, 438.
- Frobish, R.A., Bradley, D.D., Wagner, D.D., Long-Bradley, P.E. & Hairston, H. (1986) Aflatoxin residues in milk of dairy cows after ingestion of naturally contaminated grain. *Journal of Food Protection*, **49**, 781–785.
- Fuerst-Waltl, B., Reichl, A., Fuerst, C., Baumung, R. & Sölkner, J. (2004) Effect of maternal age on milk production traits, fertility and longevity in cattle. *Journal of Dairy Science*, **87**, 2293–2298.
- García-Ruiz, A., López-Fandino, R., Lozada, L., Fontecha, J., Fraga, M.J. & Juárez, M. (2000). Distribution of nitrogen in goats' milk and use of capillary electrophoresis to determine casein fractions. *Journal of Dairy Research*, **67**, 113–117.
- Gehring, G. (1980) Multiplication of bacteria during farm storage. *Factors Influencing the Bacteriological Quality of Raw Milk*, Document No. 120, pp. 24–31, International Dairy Federation, Brussels.
- te Giffel, M.C., Beumer, R.R., Granum, P.E. & Rombouts, F.M. (1997) Isolation and characterization of *Bacillus cereus* from pasteurized milk in household refrigerators in the Netherlands. *International Journal of Food Microbiology*, **34**, 207–318.
- Gilles, J. & Lawrence, R.C. (1985) The yield of cheese. *New Zealand Journal of Dairy Science and Technology*, **20**, 205–214.
- Gillespie, I.A., Adak, G.K., O'Nrien, S.J. & Bolton, F.J. (2003) Milkborne general outbreaks of infectious intestinal disease in England and Wales, 1992–2000. *Epidemiology and Infection*, **130**, 461–468.
- Gilmore, J.A., White, J.H., Zavizion, B. & Politis, I. (1995) Effects of stage of lactation and somatic cell count on plasminogen activator activity in bovine milk. *Journal of Dairy Research*, **62**, 141–145.
- Grandison, A. (1986) Causes of variation in milk composition and their effects on coagulation and cheesemaking. *Dairy Industries International*, **51** (3), **21**, 23–24.

- Grandison, A.S., Ford, G.D., Owen, A.J. & Millard, D. (1984) Chemical composition and coagulating properties of renneted Friesian milk during the transition from winter rations to spring grazing. *Journal of Dairy Research*, **51**, 69–78.
- Green, M.L. & Grandison, A.S. (1993) Secondary (non-enzymatic) phase of rennet coagulation and post-coagulation phenomena. *Cheese: Chemistry, Physics and Microbiology, Volume 1: General Aspects* (ed. P.F. Fox), pp. 101–140, Elsevier Applied Science, London.
- Green, M.L., Hobbs, D.G., Morant, S.V. & Hill, V.A. (1978) Inter-micellar relationships in rennet-treated separated milk. II: Process of gel assembly. *Journal of Dairy Research*, **45**, 413–422.
- Grimley, H., Grandison, A. & Lewis, M. (2008) Changes in milk composition and processing properties during the spring flush period. *Proceedings of the IDF/INRA 1st International Symposium on Minerals and Dairy products*, Saint-Malo France, 1–2 October 2008, p. 1.
- Gripon, J.C. (1993) Mould-ripened cheeses. *Cheese Chemistry, Physics and Microbiology, Volume 2: Major Cheese Groups* (ed. P.F. Fox), 2nd edn, pp. 207–259, Chapman & Hall, London.
- Grufferty, M.B. & Fox, P.F. (1988) Milk alkaline proteinase. *Journal of Dairy Research*, **55**, 609.
- Guinee, T.P. (2003) Role of protein in cheese and cheese products. *Advanced Dairy Chemistry, Volume 1: Proteins* (eds Fox P.F. & McSweeney, P.L.H.), pp. 1083–1174, Kluwer Academic Publishers/Plenum, New York.
- Guinee, T., Connolly, J.F., Beresford, T., Mulholland, E., Mullins, C., Corcoran, M., Mehra, R., O'Brien, B., Murphy, J., Stakelum, G. & Harrington, D. (1998) The influence of altering the daily herbage allowance in mid-lactation on the composition, ripening and functionality of low-moisture, part-skim Mozzarella cheese. *Journal of Dairy Research*, **65**, 23–30.
- Guinee, T.P., Gorry, C.B., O'Callaghan, D.J., O'Kennedy, B.T., O'Brien, N. & Fenelon, M.A. (1997) The effects of composition and some processing treatments on the rennet coagulation properties of milk. *International Journal of Dairy Technology*, **50**, 99–106.
- Guinee, T.P. & Hickey, M. (2009) Cream cheese and related products. *Dairy Fats and Related Products* (ed. A.Y. Tamime), pp. 195–256, Wiley-Blackwell, Oxford.
- Guinee, T.P. & Kilcawley, K.N. (2004) Cheese as an ingredient. *Cheese: Chemistry, Physics and Microbiology, Volume 2: Major Cheese Groups* (eds P.F. Fox, P.L.H. McSweeney, T.M. Cogan and T.P. Guinee), 3rd edn, pp. 395–428, Elsevier Academic Press, Amsterdam.
- Guinee, T.P., Mulholland, E.O., Kelly, J. & O'Callaghan, D.J. (2007b) Effect of protein-to-fat ratio of milk on the composition, manufacturing efficiency, and yield of Cheddar cheese. *Journal of Dairy Science*, **90**, 110–123.
- Guinee, T.P., O'Brien, B. & Mulholland, E. (2007a) The suitability of milk from a spring calved dairy herd during the transition from normal to very late lactation for the manufacture of low-moisture Mozzarella cheese. *International Dairy Journal*, **17**, 133–142.
- Guinee, T.P., O'Callaghan, D.J., Mulholland, E.O. & Harrington, D. (1996) Milk protein standardization by ultrafiltration for Cheddar cheese manufacture. *Journal of Dairy Research*, **63**, 281–293.
- Guinee, T.P., O'Kennedy, B.T. & Kelly, P.M. (2006) Effect of milk protein standardization using different methods on the composition and yields of Cheddar cheese. *Journal of Dairy Science*, **89**, 468–482.
- Guinee, T.P., Pudja, P.D. & Farkye, N.Y. (1993) Fresh acid-curd cheese varieties. *Cheese: Chemistry, Physics and Microbiology, Volume 2: Major Cheese Groups* (ed. P.F. Fox), 3rd edn, pp. 363–419, Elsevier Academic Press, Amsterdam.
- Guinee, T.P., Pudja, P.D. & Mulholland, E.O. (1994) Effect of milk protein standardization, by ultrafiltration, on the manufacture, composition and maturation of Cheddar cheese. *Journal of Dairy Research*, **61**, 117–131.
- Guinee, T.P., Pudja, P.D., Reville, W.J., Harrington, D., Mulholland, E.O., Cotter, M. & Cogan, T.M. (1995) Composition, microstructure and maturation of semi-hard cheeses from high protein ultrafiltered milk retentates with different levels of denatured whey protein. *International Dairy Journal*, **5**, 543–568.

- Guinot-Thomas, P., Al Ammoury, M., Le Roux, Y. & Laurent, F. (1995) A study of proteolysis during storage of raw milk at 4°C: effect of plasmin and microbial proteinases. *International Dairy Journal*, **5**, 685–697.
- Gupta, V.K., Verma, D.K., Rout, P.K., Singh, S.V. & Vihan, V.S. (2006) Polymerase chain reaction (PCR) for detection of *Brucella melitensis* in goats milk. *Small Ruminant Research*, **65**, 79–84.
- Guyomarc'h, F. (2006) Formation of heat-induced protein aggregates in milk as a means to recover the whey protein fraction in cheese manufacture, and potential of heat-treating milk at alkaline pH values in order to keep its rennet coagulation properties – a review. *Lait*, **86**, 1–20.
- Hamann, J. (2003) Definition of the physiological cell count threshold based on changes in milk composition. *Mastitis Newsletter* 25, Document No. 381, pp. 9–12, International Dairy Federation, Brussels.
- Haryani, S., Datta, N., Elliott, A.J. & Deeth, H.C. (2003) Production of proteinases by psychrotrophic bacteria in raw milk stored at low temperature. *Australian Journal of Dairy Technology*, **58**, 15–20.
- Hashemi, M., Azar, M. & Mazlumi, M.T. (2009) Effect of commercial adjunct lactobacilli on biochemical and sensory characteristics of Iranian white-brined cheese. *International Journal of Dairy Technology*, **62**, 48–55.
- Herlin, A.H. & Christiansson, A. (1993) Cheese-blowing anaerobic spores in bulk milk from loose-housed and tied dairy cows. *Milchwissenschaft*, **48**, 686–690.
- Hickey, D.K., Kilcawley, K.N., Beresford, T.P., Sheehan, E.M. & Wilkinson, M.G. (2006a) The influence of a seasonal milk supply on the biochemical and sensory properties of Cheddar cheese. *International Dairy Journal*, **16**, 679–690.
- Hickey, D.K., Kilcawley, K.N., Beresford, T.P. & Wilkinson, M.G. (2006b) Starter bacteria are the prime agents of lipolysis in Cheddar cheese. *Journal of Agricultural and Food Chemistry*, **54**, 8229–8235.
- Hickey, D.K., Kilcawley, K.N., Beresford, T.P. & Wilkinson, M.G. (2007) Lipolysis in Cheddar cheese made from raw, thermized and pasteurized milks. *Journal of Dairy Science*, **90**, 47–56.
- Hicks, C.L., Allauddin, M., Langlois, B.E. & O'Leary, J. (1982) Psychrotrophic bacteria reduce cheese yield. *Journal of Food Protection*, **45**, 331–334.
- Holsinger, V.H., Rajkowski, K.T. & Stabel, J.R. (1997) Milk pasteurisation: brief history and update. *Specific and Technical Review of the OIE*, **16**, 441–451.
- Holt, C. & Horne, D.S. (1996) The hairy casein micelle: evolution of the concept and its implication for dairy technology. *Netherlands Milk and Dairy Journal*, **50**, 85–111.
- Honkanen-Buzalski, T. & Reybroeck, W. (1997) Antimicrobials. *Monograph on Residues and Contaminants in Milk and Milk Products*, Special Issue No. 9701, pp. 26–34, International Dairy Federation, Brussels.
- Horne, D.S. (1998) Casein interactions: casting light on the black boxes, the structure in dairy products. *International Dairy Journal*, **8**, 171–177.
- Horne, D.S. & Banks, J.M. (2004) Rennet-induced coagulation of milk. *Chemistry, Physics and Microbiology, Volume 1: General Aspects* (eds P.F. Fox, P.L.H. McSweeney, T.M. Cogan and T.P. Guinee), 3rd edn, pp. 47–70, Elsevier Academic Press, Amsterdam.
- Horne, D.S., Banks, J.M. & Muir, D.D. (1996) Genetic polymorphism of milk proteins: understanding the technological effects. *Hannah Research Institute Yearbook*, pp. 70–78, Hannah Research Institute, Ayr.
- Horvath, G., Mohamed, A.I.H., Varga, J., Szemerédi, G. & Quarini, L. (1980) Effect of subclinical mastitis on milk composition. *Magyar Allatorvosok Lapja*, **35**, 615–619.
- Huppertz, T. (2007) Reversibility of NaCl-induced changes in physicochemical properties of bovine milk. *Milchwissenschaft*, **62**, 135–139.
- Huppertz, T. & Kelly, A.L. (2006) Physical chemistry of milk fat globules. *Advanced Dairy Chemistry, Volume 2: Lipids* (eds P.F. Fox & P.L.H. McSweeney), 3rd edn, pp. 173–212, Springer Science + Business Media, New York.

- Huppertz, T., Kelly, A.L. & Fox, P.F. (2006) High pressure-induced changes in ovine milk. 2: Effects on casein micelles and whey proteins. *Milchwissenschaft*, **61**, 394–397.
- Huppertz, T., Kelly, A.L. & Fox, P.F. (2009) Milk lipids—composition, origin and properties. *Dairy Fats and Related Products* (ed. A.Y. Tamime), pp. 1–27, Wiley-Blackwell, Oxford.
- Hurley, W.L. (2003) Immunoglobulins in mammary secretions. *Advanced Dairy Chemistry, Volume 1: Proteins* (eds P.F. Fox and P.L.H. McSweeney), 3rd edn, Part A, pp. 422–448, Kluwer Academic/Plenum Publishers, New York.
- International Agency for Research in Cancer (1999) Chloroform. *Monographs on the Evaluation of Carcinogenic Risks to Humans*, **73**, 131–182.
- International Dairy Federation (2008) *The World Dairy Situation 2008*, Document No. 432, International Dairy Federation, Brussels.
- Ishler, V. & Roberts, B. (1991) *Guidelines for Preventing Off-Flavours in Milk*, Guideline No. 38, The Dairy Practices Council, Pennsylvania.
- Jaeggi, J.J., Govindasamy-Lucey, S., Berger, Y.M., Johnson, M.E., McKusick, B.C., Thomas, D.L. & Wendorff, W.L. (2003) Hard ewe's milk cheese manufactured from milk of three different groups of somatic cell counts. *Journal of Dairy Science*, **86**, 3082–3089.
- Jayarao, B.M. & Henning, B.R. (2001) Prevalence of foodborne pathogens in bulk tank milk. *Journal of Dairy Science*, **84**, 2157–2162.
- Jellema, A. (1975) Note on the susceptibility of bovine milk to lipolysis. *Netherlands Milk and Dairy Journal*, **29**, 145–152.
- Jellema, A. (1980) Physiological factors associated with lipolytic activity in cows milk. *Flavour Impairment of Milk and Milk Products due to Lipolysis*, Document No. 118, pp. 33–40, International Dairy Federation, Brussels.
- Jensen, R.G. (2002) The composition of bovine milk lipids: January 1995 to December 2000. *Journal of Dairy Science*, **85**, 295–350.
- de Jong, L. (1976) Protein breakdown in soft cheese and its relationship to consistency. 1: Proteolysis and consistency of 'Noordhollandase Meshanger' cheese. *Netherlands Milk and Dairy Journal*, **30**, 242–253.
- de Jong, L. (1977) Protein breakdown in soft cheese and its relation to consistency. 2: The influence of rennet concentration. *Netherlands Milk and Dairy Journal*, **31**, 314–327.
- de Jong, L. (1978) Protein breakdown in soft cheese and its relation to consistency. 3: The micellar structure of Meshanger cheese. *Netherlands Milk and Dairy Journal*, **32**, 15–25.
- Jooyandeh, H., Amarjeet-Kaur & Minhas, K.S. (2009) Lipases in dairy industry: a review. *Journal of Food Science and Technology*, **46**, 181–189.
- Jõudu, I., Henno, M., Kaart, T., Pussa, T. & Kart, O. (2008) The effect of milk protein contents on the rennet coagulation properties of milk from individual dairy cows. *International Dairy Journal*, **18**, 964–967.
- Juárez, M. (1986) Physico-chemical properties of goat's milk as distinct from those of cow's milk. *Production and Utilization of Ewe's and Goat's Milk*, Document No. 202, pp. 54–67, International Federation, Brussels.
- Juárez, M. & Ramos, M. (1986) Physico-chemical characteristics of goats' milk as distinct from those of cows' milk. *Productions and Utilisation of Ewes' and Goats' Milk*, Document No. 202, pp. 42–53, International Dairy Federation, Brussels.
- Kalit, S., Lukac-Havranek, J. & Kaps, M. (2002) Plasminogen activation and somatic cell count (SCC) in cheese milk: influence on Podravec cheese ripening. *Milchwissenschaft*, **57**, 380–382.
- Keenan, T.W. & Maher, I.H. (2006) Intracellular origin of milk fat globules and the nature of the milk fat globule membrane. *Advanced Dairy Chemistry, Volume 2: Lipids* (eds P.F. Fox and McSweeney, P.L.H.), 3rd edn, pp. 137–171, Springer Science & Business Media, New York.
- Kefford, B., Christian, M.P., Sutherland, J., Mayes, J.J. & Grainger, C. (1995) Seasonal influences on Cheddar cheese manufacture: influence of diet quality and stage of lactation. *Journal of Dairy Research*, **62**, 529–537.

- Kelly, A.L. & O'Donnell, H.J. (1998) Composition, gel properties and microstructure of quarg as affected by processing parameters and milk quality. *International Dairy Journal*, **8**, 295–301.
- Kelly, A.L., O'Flaherty, F. & Fox, P.F. (2006) Indigenous proteolytic enzymes in milk: a brief overview of the present state of knowledge. *International Dairy Journal*, **16**, 563–572.
- Kelly, A.L., Reid, S., Joyce, P., Meaney, W.J. & Foley, J. (1998) Effect of decreased milking frequency of cows in late lactation on milk somatic cell count, polymorphonuclear leucocyte numbers, composition and proteolytic activity. *Journal of Dairy Research*, **65**, 365–373.
- Kennedy, A. & Kelly, A.L. (1997) The influence of somatic cell count on the heat stability of bovine milk plasmin activity. *International Dairy Journal*, **7**, 717–721.
- Keogh, M.K., Kelly, P.M., O'Keeffe, A.M. & Phelan, J.A. (1982) Studies of milk composition and its relationship to some processing criteria. 2: Seasonal variation in the mineral levels of milk. *Irish Journal of Food Science and Technology*, **6**, 13–27.
- Kilcawley, K.N. (2009). Determination of lipolysis. *Handbook of Dairy Foods and Lipolysis* (eds F. Toldrá and Nollet, L.), Book 4, pp. 431–452, CRC Press, Boca Raton.
- Kitchen, B.J. & Aston, J.W. (1970) Milk lipase activation. *Australian Journal of Dairy Technology*, **25**, 10–13.
- Klei, L., Yun, J., Sapru, A., Lynch, J., Barbano, D., Sears, P. & Galton, D. (1998) Effects of milk somatic cell count on Cottage cheese yield and quality. *Journal of Dairy Science*, **81**, 1205–1213.
- Kon, H. & Saito, Z. (1997) Factors causing temperature activation of lipolysis in cow milk. *Milchwissenschaft*, **52**, 435–440.
- Kosikowski, F.V. & Mistry, V.V. (1988) Yield and quality of cheese made from high somatic cell milks supplemented with retentates of ultrafiltration. *Milchwissenschaft*, **43**, 27–30.
- Kroeker, E. M., Ng-Kwai-Hang, K.F., Hayes, J.F. & Moxley, J.E. (1985) Effect of β -lactoglobulin variant and environmental factors on variation in the detailed composition of bovine milk serum proteins. *Journal of Dairy Science*, **68**, 1637–1641.
- de Kruif, C.G. (1999) Casein micelle interactions. *International Dairy Journal*, **9**, 183–188.
- de Kruif, C.G. & Holt, C. (2003) Casein micelle structure, functions, and interactions. *Advanced Dairy Chemistry, Volume 1: Proteins* (eds P.F. Fox and P.L.H. McSweeney), 3rd edn, Part A, pp. 233–276, Kluwer Academic/Plenum Publishers, New York.
- Kuchtik, J., Sustova, K., Urban, T. & Zapletal, D. (2008) Effect of the stage of lactation on milk composition, its properties and the quality of rennet curdling in East Friesian ewes. *Czech Journal of Animal Science*, **53** (2), 55–63.
- Kumaresan, G., Annalvilli, R. & Sivakumar, K. (2007) Psychrotrophic spoilage of raw milk at different temperatures of storage. *Journal of Applied Sciences Research*, **3**, 1383–1387.
- Lacy-Hulbert, S.J., Woolford, M.W., Nicholas, G.D., Prosser, C.G. & Stelwagen, K. (1999) Effect of milking frequency and pasture intake on milk yield and composition of late lactation cows. *Journal of Dairy Science*, **82**, 1232–1239.
- Larsen, L.B., Benfeldt, C., Rasmussen, L.K. & Petersen, T.E. (1996) Bovine milk procathepsin D and cathepsin D: coagulation and milk protein degradation. *Journal of Dairy Research*, **63**, 119–130.
- Larsen, L.B., McSweeney, P.L.H., Hayes, M.G., Andersen, J.B., Ingvarsten, K.L. & Kelly, A.L. (2006) Variation in activity and heterogeneity of bovine milk proteases with stage of lactation and somatic cell count. *International Dairy Journal*, **16**, 1–8.
- Larsen, L.B., Rasmussen, M.D., Bjerring, M. & Nielsen, J.H. (2004) Proteases and protein degradation in milk from cows infected with *Streptococcus uberis*. *International Dairy Journal*, **14**, 899–907.
- Law, B.A., Andrews, A.T., Cliffe, A.J., Sharpe, M.E. & Chapman, H.R. (1979) Effect of proteolytic raw milk psychrotrophs on Cheddar cheese-making with stored milk. *Journal of Dairy Research*, **46**, 497–509.
- Lawrence, R.C., Creamer, L.K. & Gilles, J. (1987) Texture development during cheese ripening. *Journal Dairy Science*, **70**, 1748–1760.
- Le-Bars, D. & Gripon, J.C. (1989) Specificity of plasmin towards α_{s2} -casein. *Journal of Dairy Research*, **56**, 817–821.

- Lee, M.H., Lee, H.J. & Ryu, P.D. (2001) Public health risks: chemical and antibiotic residues. Review. *Asian-Australasian Journal of Animal Sciences*, **14**, 402–413.
- Leitner, G., Krifucks, O., Merin, U., Lavi, Y. & Silanikove, N. (2006) Interactions between bacteria type, proteolysis of casein and physico-chemical properties of bovine milk. *International Dairy Journal*, **16**, 648–654.
- Le Roux, Y., Colin, D. & Laurent, F. (1995) Proteolysis in samples of quarter milk with varying somatic cell counts. I: Comparison of some indicators of indigenous proteolysis in milk. *Journal of Dairy Science*, **78**, 1289–1297.
- Lindsay, R.C. (1983) Analysis of free fatty acids in Italian cheese. *Dairy Field*, **166** (5), 20–21.
- Lodes, A., Krause, I., Buchberger, J., Aumann, J. & Klostermeyer, H. (1996) The influence of genetic variants of milk protein on the compositional and technological properties of milk. I: Casein micelle size and the content of non-glycosylated κ -casein. *Milchwissenschaft*, **51**, 368–373.
- Lu, D.D. & Nielsen S.S. (1993) Heat inactivation of native plasminogen activators in bovine milk. *Journal of Food Science*, **58**, 1010–1016.
- Lucey, J.A. (2004) Formation, structural properties and rheology of acid-coagulated milk gels. *Cheese: Chemistry, Physics and Microbiology, Volume 1: General Aspects* (eds P.F. Fox, P.L.H. McSweeney, T.M. Cogan and T.P. Guinee), 3rd edn, pp. 105–122, Elsevier Academic Press, Amsterdam.
- Lucey, J.A. & Fox, P.F. (1992) Rennet coagulation properties of late-lactation milk: effect of pH adjustment, addition of CaCl₂, variation in rennet level and blending with mid lactation milk. *Irish Journal of Agricultural and Food Research*, **31**, 173–184.
- Lucey, J.A., Johnson, M.E. & Horne, D.S. (2003) Invited review: perspectives on the basis of the rheology and texture properties of cheese. *Journal of Dairy Science*, **86**, 2725–2743.
- Lucey, J.A., Kindstedt, P.S. & Fox, P.F. (1992) Seasonality: its impact on the production of good quality Mozzarella cheese. *Third Cheese Symposium* (ed. T.M. Cogan), pp. 41–47, National Dairy Products Research Centre, Teagasc Moorepark, Fermoy, Co. Cork, Ireland.
- Lucey, J.A. & Singh, H. (1997) Formation and physical properties of acid milk gels. *Food Research International*, **30**, 529–542.
- MacGibbon, A.K.H. & Taylor, M.W. (2006) Composition and structure of bovine milk lipids. *Advanced Dairy Chemistry, Volume 2: Lipids* (eds P.F. Fox and P.L.H. McSweeney), 3rd edn, pp. 1–42, Springer Science & Business Media, New York.
- MacKenzie, E. (1973) Thermotrophic and psychrotrophic organisms on poorly cleaned milking plants and farm bulk tanks. *Journal of Applied Bacteriology*, **36**, 457–463.
- Malin, E.L., Banks, J.M., Tunick, M.H., Law, A.J.R., Leaver, J. & Holsinger, V.H. (1993) Texture enhancement of low-fat Mozzarella cheese by refrigerated storage. *International Dairy Journal*, **3**, 548.
- Mara, O., Roupie, C., Duffy, A. & Kelly, A.L. (1998) The curd-forming properties of milk as affected by the action of plasmin. *International Dairy Journal*, **8**, 807–812.
- Martin, B. & Coulon, J.B. (1995). Facteurs de production du lait et caractéristiques des fromages. I: Influence des facteurs de production sur l'aptitude à la coagulation des laits de troupeaux. *Lait*, **75**, 61–80.
- Martin, D., Linxweiler, W., Tanzer, D., Vormbrock, R., Olt, R., Kiesner, C. & Meisel, H. (2005) Use of the Reflectoquant rapid tests for determination of thermal inactivation of the indigenous milk enzymes lipase, alkaline phosphatase and lactoperoxidase. *Deutsche Lebensmittel-Rundschau*, **101**, 281–286.
- Marziali, A.S. & Ng-Kwai-Hang, K.F. (1986) Effects of milk-composition and genetic-polymorphism on coagulation properties of milk. *Journal of Dairy Science*, **69**, 1793–1798.
- Mazal, G., Vianna, P.C.B., Santos, M.V. & Gigante, M.L. (2007) Effect of somatic cell count on Prato cheese composition. *Journal of Dairy Science*, **90**, 630–636.

- McCaskey, T.A. & Babel, F.J. (1966) Protein losses in whey as related to bacterial growth and age of milk. *Journal of Dairy Science*, **49**, 697.
- McMahon, D.J. & Oommen, B.S. (2008) Supramolecular structure of the casein micelle. *Journal of Dairy Science*, **91**, 1709–1721.
- McSweeney, P.L.H. & Fox, P.F. (2004) Metabolism of residual lactose and of lactate and citrate. *Cheese: Chemistry, Physics and Microbiology, Volume 1: General Aspects* (eds P.F. Fox, P.L.H. McSweeney, T.M. Cogan and T.P. Guinee), 3rd edn, pp. 361–371, Elsevier Academic Press, Amsterdam.
- McSweeney, P.L.H., Oslon, N.F., Fox, P.F., Healy, A. & Højrup, P. (1993) Proteolytic specificity of plasmin on bovine α_{s1} -casein. *Food Biotechnology*, **7**, 143–158.
- Medina, M. & Nñez, M. (2004) Cheeses made from ewes' and goats' milk. *Chemistry, Physics and Microbiology, Volume 2: Major Cheese Groups* (eds P.F. Fox, P.L.H. McSweeney, T.M. Cogan and T.P. Guinee), 3rd edn, pp. 279–299, Elsevier Academic Press, Amsterdam.
- Mehra, R., O'Brien, B., Connolly, J.F. & Harrington, D. (1999) Seasonal variation in the composition of Irish manufacturing and retail milks. 2: Nitrogen fractions. *Irish Journal of Agriculture and Food Research*, **38**, 65–74.
- Lin, M.-J., Grandison, A., Chryssanthou, X., Goodwin, C., Tsioulpas, A., Koliandris, A. & Lewis, M. (2006) Calcium removal from milk by ion exchange. *Milchwissenschaft*, **61**, 370–374.
- Metwalli, A.A.M., de Hongh, H.H.J. & van Boekel, M.A.J.S. (1998) Heat inactivation of bovine plasmin. *International Dairy Journal*, **8**, 47–56.
- Mijacevic, Z., Ivanovic, D. & Stojanovic, L. (1993) Changes of quality of semihard cheese depending on the somatic-cell count (SCC). *Acta Veterinaria – Beograd*, **43**, 323–328.
- Mitchell, G.E., Fedrick, I.A. & Rogers, S.A. (1986) The relationship between somatic cell count, composition and manufacturing properties of bulk milk. 2: Cheddar cheese from farm bulk milk. *Australian Journal of Dairy Technology*, **41**, 12–14.
- Mohammad, K.S. & Fox, P.F. (1983) Influence of some polyvalent organic acids and salts on the colloidal stability of milk. *Journal of the Society of Dairy Technology*, **36**, 112–117.
- Mollé, D., Jean, K. & Guyomarch, F. (2006) Chymosin sensitivity of the heat-induced serum protein aggregates isolated from skim milk. *International Dairy Journal*, **16**, 1435–1441.
- Mollé, D. & Leonil, J. (1995) Heterogeneity of the bovine κ -casein caseinomacropeptide, resolved by liquid chromatography on-line with electrospray ionization mass spectrometry. *Journal of Chromatography A*, **708**, 223–230.
- Mouchili, A., Wichtel, J.J., Bosset, J.O., Dohoo, I.R., Imhof, M., Altien, D., Mallia, S. & Stryhn, H. (2005) HS-SPME gas chromatographic characterization of volatile compounds in milk tainted with off-flavour. *International Dairy Journal*, **15**, 1203–1215.
- Muir, D.D., Horne, D.S., Law, A.J.R. & Steele, W. (1993a) Ovine milk. I: Seasonal changes in composition of milk from a commercial Scottish flock. *Milchwissenschaft*, **48**, 363–366.
- Muir, D.D., Horne, D.S., Law, A.J.R. & Sweetsur, A.W.M. (1993b) Ovine milk. II: Seasonal changes in indices of stability. *Milchwissenschaft*, **48**, 442–445.
- Mulvihill, D.M. (1992) Production, functional properties and utilization of milk protein products. *Advanced Dairy Chemistry, Volume 1: Proteins* (ed. P.F. Fox), pp. 369–404, Elsevier Science Publishers, Barking.
- Mulvihill, D.M. & Donovan, M. (1987) Whey proteins and their thermal denaturation – a review. *Irish Journal of Food Science and Technology*, **11**, 43–75.
- Murphy, S.C. & Boor, K.J. (2000) Trouble-shooting sources and causes of high bacteria counts in raw milk. *Dairy Food Environmental Sanitation*, **20**, 606–611.
- Nelson, J.H., Jensen, R.G. & Pitas, R.E. (1977) Pregastric esterase and other oral lipases – a review. *Journal of Dairy Science*, **60**, 327–362.
- Ng-Kwai-Hang, K.F. & Grosclaude, F. (2003) Genetic polymorphism of milk proteins. *Advanced Dairy Chemistry, Volume 1: Proteins* (eds P.F. Fox and P.L.H. McSweeney), 3rd edn, pp. 739–816, Kluwer Academic/Plenum Publishers, New York.

- Ng-Kwai-Hang, K.F., Hayes, J.F., Moxley, J.E. & Monardes, H.G. (1987) Variation in milk protein concentrations associated with genetic polymorphism and environmental factors. *Journal of Dairy Science*, **70**, 563–570.
- Nicholas, G.D., Auld, M.J., Molan, P.C., Stelwagen, K. & Prosser, G. (2002) Effects of stage of lactation and time of year on plasmin-derived proteolytic activity in bovine milk in New Zealand. *Journal of Dairy Research*, **69**, 533–540.
- Nielsen, S.S. (2002) Plasmin system and microbial proteases in milk: characteristics, roles and relationship. *Journal of Agricultural and Food Chemistry*, **50**, 6628–6634.
- Nieuwenhuijse, J.A., Timmermans, W. & Walstra, P. (1988) Calcium and phosphate partitions during the manufacture of sterilized concentrated milk and their relations to the heat stability. *Netherlands Milk and Dairy Journal*, **42**, 387–421.
- Noziere, P., Graulet, B., Lucas, A., Martin, B., Grolier, P. & Doreau, M. (2006) Carotenoids for ruminants: from forages to dairy products. *Animal Feed Science and Technology*, **131**, 418–450.
- O'Brien, B. (2008) *Milk Quality Handbook – Practical Steps to Improve Milk Quality*, Teagasc, Moorepark Dairy Production Research Centre, Fermoy, Co., Cork, Ireland.
- O'Brien, B., Dillon, P., Murphy, J., Mehra, R., Guinee, T., Connolly, J.F., Kelly, A. & Joyce, P. (1999a) Effect of stocking density and concentrate supplementation of grazing dairy cows on milk production, composition and processing characteristics. *Journal of Dairy Research*, **66**, 165–176.
- O'Brien, B., Gleeson, D. & Mee, J.F. (2005) Effect of milking frequency and nutritional level on milk production characteristics and reproductive performance of dairy cows. *Proceedings of the 56th Annual Meeting of the European Association for Animal Production*, EAAP, Uppsala, Sweden, 5–8 June 2005, p. 348, Wageningen Academic Publishers, Wageningen, The Netherlands.
- O'Brien, B., Guinee, T.P., Kelly, A. & Joyce, P. (2006) Processability of late lactation milk from a spring-calved herd. *Australian Journal of Dairy Technology*, **61**, 3–7.
- O'Brien, B., Lennartsson, T., Mehra, R., Cogan, T.M., Connolly, J.F., Morrissey, P.A. & Harrington, D. (1999b). Seasonal variation in the composition of Irish manufacturing and retail milks. 3: Vitamins. *Irish Journal of Agricultural and Food Research*, **38**, 75–85.
- O'Brien, B., Mehra, R., Connolly, J.F. & Harrington, D. (1999c) Seasonal variation in the composition of Irish manufacturing and retail milks. 4: Minerals and trace elements. *Irish Journal of Agriculture and Food Research*, **38**, 87–99.
- O'Brien, B., Mehra, R., Connolly, J.F. & Harrington, D. (1999d) Seasonal variation in the composition of Irish manufacturing and retail milks. 1: Chemical composition and renneting properties. *Irish Journal of Agricultural Food Research*, **38**, 53–64.
- O'Brien, B., Murphy, J., Connolly, J.F., Mehra, R., Guinee, T. and Stakelum, G. (1997) Effect of altering daily herbage allowance in mid-lactation on the composition and processing characteristics of bovine milk. *Journal of Dairy Research*, **64**, 621–626.
- O'Brien, B., O'Callaghan, E. & Dillon, P. (1998) Effect of various milking systems and components on free fatty acid levels in milk. *Journal of Dairy Research*, **65**, 335–339.
- O'Brien, N.M., O'Connor, T.P., O'Callaghan, J. & Dobson, A.D.W. (2004) Toxins in cheese. *Cheese: Chemistry, Physics and Microbiology, Volume 1: General Aspects* (eds P.F. Fox, P.L.H. McSweeney, T.M. Cogan and T.P. Guinee), 3rd edn, pp. 562–571, Elsevier Academic Press, Amsterdam.
- O'Connell, J.E. & Fox, P.F. (2000) The two-stage coagulation of milk proteins in the minimum of the heat coagulation time–pH profile of milk: effect of casein micelle size. *Journal of Dairy Science*, **83**, 378–386.
- O'Driscoll, B.M., Rattray, F.P., McSweeney, P.L.H. & Kelly, A.L. (1999) Protease activities in raw milk determined using synthetic heptapeptide substrate. *Journal of Food Science*, **64**, 606–611.
- O'Farrell, I.P., Sheehan, J.J., Wilkinson, M.G., Harrington, D. & Kelly, A.L. (2002) Influence of addition of plasmin or mastitic milk to cheesemilk on quality of smear-ripened cheese. *Lait*, **82**, 305–316.
- O'Keefe, A.M. (1984) Seasonal and lactational influences on moisture content of Cheddar cheese. *Irish Journal of Food Science and Technology*, **8**, 27–37.

- O’Keeffe, A.M., Phelan, J.A., Keogh, K. and Kelley, P. (1982) Studies of milk composition and its relationship to some processing criteria. 4: Factors influencing the properties of a seasonal milk supply. *Irish Journal of Food Science and Technology*, **6**, 39–48.
- Okigbo, L.M., Richardson, G.H., Brown, R.J. & Ernstrom, C.A. (1985a) Casein composition of cow’s milk of different chymosin coagulation properties. *Journal of Dairy Science*, **68**, 1887–1892.
- Okigbo, L.M., Richardson, G.H., Brown, R.J. & Ernstrom, C.A. (1985b) Coagulation properties of abnormal and normal milk from individual cow quarters. *Journal of Dairy Science*, **68**, 1893–1896.
- Okigbo, L.M., Richardson, G.H., Brown, R.J. & Ernstrom, C.A. (1985c) Effects of pH, calcium chloride and chymosin concentration on coagulation properties of abnormal and normal milk. *Journal of Dairy Science*, **68**, 2527–2533.
- Olivecrona, T., Vilaro, S. & Olivecrona, G. (2003) Lipases in milk. *Advanced Dairy Chemistry, Volume 1: Proteins* (eds F. Fox and P.L.H. McSweeney), 3rd edn, pp. 473–494, Kluwer Academic Publishers/Plenum Press, New York.
- Ouattara, G.C., Jeon, I.J., Hart-Thakur, R.A. & Schmidt, K.A. (2004) Fatty acids released from milk fat by lipoprotein lipase and lipolytic psychrotrophs. *Journal of Food Science*, **69**, C659–C664.
- Pearse, M.J., Linklater, P.M., Hall, R.J., Phelan, J.A. & McKinlay, A.G. (1986) Extensive degradation of casein by plasmin does not impede subsequent curd formation and syneresis. *Journal of Dairy Research*, **53**, 477–480.
- Peri, C. (2006) The universe of food quality. *Food Quality and Preference*, **17**, 3–8.
- Phelan, J.A., O’Keeffe, A.M., Keogh, M.K. & Kelly, P.M. (1982) Studies of milk composition and its relationship to some processing criteria. I: Seasonal changes in the composition of Irish milk. *Irish Journal of Food Science and Technology*, **6**, 1–11.
- Politis, I., Lachance, E., Block, E. & Turner, J.D. (1989) Plasmin and plasminogen in bovine milk: a relationship with involution? *Journal of Dairy Science*, **72**, 900–906.
- Politis, I. & Ng-Kwai-Hang, K.F. (1988a) Effects of somatic cell count and milk composition on cheese composition and cheese making efficiency. *Journal of Dairy Science*, **71**, 1711–1719.
- Politis, I. & NgKwai-Hang, K.F. (1988b) Effects of somatic cell counts and milk composition on the coagulating properties of milk. *Journal of Dairy Science*, **71**, 1740–1746.
- Politis, I. & Ng-Kwai-Hang, K.F. (1988c) Association between somatic cell count of milk and cheese-yielding capacity. *Journal of Dairy Science*, **71**, 1720–1727.
- Rahimi, E., Karim, G. & Shakerian, A. (2009) Occurrence of aflatoxin M₁ in traditional cheese consumed in Esfahan, Iran. *World Mycotoxin Journal*, **2**, 91–94.
- Rea, M.C., Cogan, T.M. & Tobin, S. (1992) Prevalence of pathogenic bacteria in raw milk in Ireland. *Journal of Applied Bacteriology*, **73**, 331–336.
- Reed, B.A. & Grivetti, L.E. (2000) Controlling on-farm inventories of bulk tank raw milk – an opportunity to protect human health. *Journal of Dairy Science*, **83**, 2988–2991.
- Remeuf, F. & Lenoir, J. (1986) Relationship between the physico-chemical characteristics of goat’s milk and its rennetability. *Production and Utilization of Ewes’ and Goats’ Milk*, Document No. 202, pp. 68–72, International Dairy Federation, Brussels.
- Resch, P. & Guthy, K. (2000) Chloroform in milk and dairy products. Part B: Transfer of chloroform from cleaning and disinfection agents to dairy products via CIP. *Deutsche Lebensmittel-Rundschau*, **96**, 9–16.
- Reuter, H. (1978) The effect of flow processes on raw milk. *XX International Dairy Congress – Proceedings*, Vol. **E**, p. 329.
- Richardson, B.C. (1983) Variation of concentration of plasmin and plasminogen in bovine milk with lactation. *New Zealand Journal of Dairy Science and Technology*, **18**, 247–252.
- Rogers, S.A. & Mitchell, G.E. (1994) The relationship between somatic-cell count, composition and manufacturing properties of bulk milk on cheddar cheese and skim-milk yoghurt. *Australian Journal of Dairy Technology*, **49**, 70–74.
- Roupas, P. (2001) On-farm practices and post farmgate processing parameters affecting composition of milk for cheesemaking. *Australian Journal of Dairy Technology*, **56**, 219–232.

- de la Rúa-Domenech, R. (2006) Human *Mycobacterium bovis* infection in the United Kingdom: incidence, risks, control measures and review of the zoonotic aspects of bovine tuberculosis. *Tuberculosis (Edinburgh)*, **86**, 77–109.
- Rynne, N.M., Beresford, T.P., Kelly, A.L. & Guinee, T.P. (2004) Effect of milk pasteurization temperature and *in situ* whey protein denaturation on the composition, texture and heat-induced functionality of half-fat Cheddar cheese. *International Dairy Journal*, **14**, 989–1001.
- Saeman, A.I., Verdi, R.J., Galton, D.M. & Barbano, D.M. (1988) Effect of mastitis on proteolytic activity in bovine milk. *Journal of Dairy Science*, **71**, 505–512.
- Saito, T. & Ito, T. (1992) Variations and distributions of o-glycosidically linked sugar chains in bovine κ -casein. *Journal of Dairy Science*, **75**, 1768–1774.
- Santillo, A., Quinto, M., Dentico, M., Muscio, A., Sevi, A. & Albenzio, M. (2007) Rennet paste from lambs fed a milk substitute supplemented with *Lactobacillus acidophilus*: effects on lipolysis in ovine cheese. *Journal of Dairy Science*, **90**, 3134–3142.
- Sapru, A., Barbano, D.M., Yun, J.J., Klei, L.R., Oltenacu, P.A. & Bandler, D.K. (1997) Influence of milking frequency and stage of lactation on composition and yield. *Journal of Dairy Science*, **80**, 437–446.
- Sawyer, L. (2003) β -Lactoglobulin. *Advanced Dairy Chemistry, Volume 1: Proteins* (eds P.F. Fox and P.L.H. McSweeney), 3rd edn, Part A, pp. 319–386, Kluwer Academic/Plenum Publishers, New York.
- Schaar, J. (1985) Plasmin activity and proteose-peptone content of individual milks. *Journal of Dairy Research*, **52**, 369–378.
- Schaar, J., Hansson, B. & Pettersson, H.E. (1985) Effects of genetic variants of κ -casein and β -lactoglobulin on cheesemaking. *Journal of Dairy Research*, **52**, 429–437.
- Schmidt, D.G. (1982) Association of caseins and casein micelle structure. *Developments in Dairy Chemistry – 1* (ed. P.F. Fox), pp. 61–80, Applied Science Publishers, London.
- Schulz-Collins, D. & Zenge, B. (2004) Acid- and acid/rennet-curd cheeses. Part A.: Quark, cream cheese and related varieties. *Cheese Chemistry, Physics and Microbiology, Volume 2: Major Cheese Groups* (eds P.F. Fox, P.L.H. McSweeney, T.M. Cogan and T.P. Guinee), 3rd edn, pp. 301–328, Elsevier Academic Press, Amsterdam.
- Schutz, M.M., Hansen, L.B., Steuernagel, G.R. & Kuck, A.L. (1990) Variation of milk, fat, protein and somatic cells for dairy cattle. *Journal of Dairy Science*, **73**, 484–493.
- Sengun, I.Y., Yaman, D.B. & Gonul, S.A. (2008) Mycotoxins and mould contamination in cheese: a review. *World Mycotoxin Journal*, **1**, 291–298.
- Shah, N.P. (1994) Psychrotrophs in milk: a review. *Milchwissenschaft*, **49**, 432–437.
- Shalabi, S.I. & Fox, P.F. (1982) Influence of pH on the rennet coagulation of milk. *Journal of Dairy Research*, **49**, 153–157.
- Sheldrake, R.F., Hoare, R.J.T. & McGregor, G.D. (1983) Lactation stage, parity, and infection affecting somatic cells, electrical conductivity and serum albumin in milk. *Journal of Dairy Science*, **66**, 542–547.
- Shipe, W.F. & Senyk. (1981) Effects of processing conditions on lipolysis in milk. *Journal of Dairy Science*, **64**, 2146–2149.
- Slaghuis, B.A., te Giffel, M.C., Beumer, R.R. & Andre, G. (1997) Effect of pasturing on the incidence of *Bacillus cereus* spores in raw milk. *International Dairy Journal*, **7**, 201–205.
- Somers, J.M., Guinee, T.P. & Kelly, A.L. (2002) The effect of plasmin activity and cold storage of cheese milk on the composition, ripening and functionality of mozzarella-type cheese. *International Journal of Dairy Technology*, **55**, 5–11.
- Somers, J.M., O'Brien, B., Meaney, W.J. & Kelly, A.L. (2003) Heterogeneity of proteolytic enzyme activities in milk samples of different somatic cell count. *Journal of Dairy Research*, **70**, 45–50.
- Sorhaug, T. & Stepaniak, L. (1997) Psychrotrophs and their enzymes in milk and dairy products: quality aspects. *Trends in Food Science Technology*, **8**, 35–41.

- Srinivasan, M. & Lucey, J.A. (2002) Effects of added plasmin on the formation and rheological properties of rennet-induced skim milk gels. *Journal of Dairy Science*, **85**, 1070–1078.
- Stadhouders, J. & Jørgensen, K. (1990) Prevention of contamination of raw milk by a hygienic milk production. *Production of Chymosin by Microorganisms and its use for Cheesemaking, Detection and Prevention of Spore Formers and Cheese Quality*, Document No. 251, pp. 32–36, International Dairy Federation, Brussels.
- Stadhouders, J. & Spoelstra, S.F. (1990) Prevention of the contamination of raw milk by a making a good silage. *Production of Chymosin by Microorganisms and its use for Cheesemaking, Detection and Prevention of Spore Formers and Cheese Quality*, Document No. 251, pp. 24–31, International Dairy Federation, Brussels.
- Stelwagen, K. & Lacy-Hulbert, S.J. (1996) Effect of milking frequency on somatic cell count characteristics and mammary secretory cell damage in cows. *American Journal of Veterinary Research*, **57**, 902–905.
- Stelwagen, K., Politis, I., White, J.H., Zavizion, B., Prosser, C.G., Davis, S.R. & Farr, V.C. (1994) Effect of milking frequency and somatotropin on the activity of plasminogen activator, plasminogen and plasmin in bovine milk. *Journal of Dairy Science*, **77**, 3577–3583.
- Storry, J.E., Grandison, A.S., Millard, D., Owen, A.J. & Ford, G.D. (1983) Chemical composition and coagulating properties of renneted milks from different breeds and species of ruminant. *Journal of Dairy Research*, **50**, 215–229.
- Sundheim, G. (1988). Spontaneous lipolysis in bovine milk: combined effects of cream, skim milk, and lipoprotein lipase activity. *Journal of Dairy Science*, **71**, 620–626.
- Sundheim, G. & Bengtsson-Olivecrona, G. (1987) Isolated milk fat globules as substrate for lipoprotein lipase: study of factors relevant to spontaneous lipolysis in milk. *Journal of Dairy Science*, **70**, 499–505.
- Swaigood, H.E. (2003) Chemistry of caseins. *Advanced Dairy Chemistry, Volume 1: Proteins* (eds P.F. Fox and P.L.H. McSweeney), 3rd edn, Part A, pp. 139–201, Kluwer Academic/Plenum Publishers, New York.
- Thomas, S.B., Druce, R.G. & King, K.P. (1966) The microflora of poorly cleansed farm dairy equipment. *Journal of Applied Bacteriology*, **29**, 409.
- Tunick, M.H., Malin, E.L., Smith, P.W., Cooke, P.H. & Holsinger, V.H. (1996) Influence of rennet source on proteolysis, rheology, and microstructure of low-fat Mozzarella cheese. *Journal of Dairy Science*, **78** (Suppl. 1), 101.
- Tyriseva, A.M., Elo, K., Kuusipuro, A., Vilva, V., Janonen, I., Karjalainen, H., Ikonen, T. & Ojala, M. (2008) Chromosomal regions underlying noncoagulation of milk in Finnish Ayrshire cows. *Genetics*, **180**, 1211–1220.
- Umeda, T. & Aoki, T. (2002). Relation between micelle size and micellar calcium phosphate. *Milch-wissenschaft*, **57**, 131–133.
- Upadhyay, V.K., McSweeney, P.L.H., Magboul, A.A.A. & Fox, P.F. (2004) Proteolysis in cheese during ripening. *Cheese: Chemistry, Physics and Microbiology, Volume 1: General Aspects* (eds P.F. Fox, P.L.H. McSweeney, T.M. Cogan & T.P. Guinee), 3rd edn, pp. 391–433, Elsevier Academic Press, Amsterdam.
- Valde, J.P., Lawson, L.G., Lindberg, A., Agger, J.F., Saloniemi, H. & Østerås, O. (2004) Cumulative risk of bovine mastitis treatments in Denmark, Finland, Norway and Sweden. *Acta Veterinaria Scandinavica*, **45**, 201–210.
- Van Den Berg, G., Escher, J.T.M., de Koning, P.J. & Bovenhuis, H. (1992) Genetic polymorphism of κ -casein and β -lactoglobulin in relation to milk composition and processing properties. *Netherlands Milk and Dairy Journal*, **46**, 145–163.
- Van Den Berg, M.G., van den Berg, G. & van Boekel, M.A.J.S. (1996) Mass transfer processes involved in Gouda cheese manufacture, in relation to casein and yield. *Netherlands Milk and Dairy Journal*, **50**, 501–540.

- Vasbinder, A.J., Alting, A.C., Visschers, R.W. & de Kruif, C.G. (2003) Texture of acid milk gels: formation of disulfide cross-links during acidification. *International Dairy Journal*, **13**, 29–38.
- Verdi, R.J. & Barbano, D.M. (1991) Effect of coagulants, somatic cell enzymes, and extracellular bacterial enzymes on plasminogen activation. *Journal of Dairy Science*, **74**, 772–782.
- Vissers, M.M.M. (2007) *Modeling to Control Spores in Raw Milk*, Ph.D. Thesis, Wageningen University, Wageningen, The Netherlands.
- Vissers, M.M.M. & Driehuis, F. (2009) On-farm hygienic milk production. *Milk Processing and Quality Management* (ed. A.Y. Tamime), pp. 1–22, Wiley-Blackwell, Oxford.
- Wahba, A., El-Hagarawy, I.S., El-Hawary, M.Y. & Sirry, I. (1975). Role of calcium in the coagulation of dialyzed and heated skim-milk. *Egyptian Journal of Dairy Science*, **3**, 176–178.
- Walker, G.P., Dunschea, F.R. & Doyle, P.T. (2004) Effects of nutrition and management on the production and composition of milk fat and protein: a review. *Australian Journal of Agricultural Research*, **55**, 1009–1028.
- Walsh, C.D., Guinee, T., Harrington, D., Mehra, R., Murphy, J., Connolly, J.F. & FitzGerald, R.J. (1995) Cheddar cheesemaking and rennet coagulation characteristics of bovine milks containing κ -casein AA or BB genetic variants. *Milchwissenschaft*, **50**, 492–495.
- Walsh, C.D., Guinee, T.P., Harrington, D., Mehra, R., Murphy, J., Connolly, J.F. & FitzGerald, R.J. (1998b) Cheesemaking, compositional and functional characteristics of low-moisture part-skim mozzarella cheese from bovine milks containing κ -casein AA, AB or BB genetic variants. *Journal of Dairy Research*, **65**, 307–315.
- Walsh, C.D., Guinee, T.P., Reville, W.D., Harrington, D., Murphy, J.J., O’Kennedy, B.T. & FitzGerald, R.J. (1998a) Influence of κ -casein genetic variant on rennet gel microstructure, Cheddar cheese-making properties and casein micelle size. *International Dairy Journal*, **8**, 707–714.
- Walsh, S., Buckley, F., Berry, D.P., Rath, M., Pierce, K., Byrne, N. & Dillon, P. (2007) Effects of breed, feeding system and parity on udder health and milking characteristics. *Journal of Dairy Science*, **90**, 5767–5779.
- Ward, R.E., German, J.B. & Corredig, M. (2006) Composition, applications, fractionation, technological and nutritional significance of milk fat globule membrane material. *Advanced Dairy Chemistry, Volume 2: Lipids* (eds P.F. Fox & McSweeney, P.L.H.), 3rd edn, pp. 213–244, Springer Science & Business Media, New York.
- Weatherup, W. & Mullan, W.M.A. (1993) Effects of low temperature storage of milk on the quality and yield of cheese. *Proceedings of IDF Seminar on Cheese Yield and Factors Affecting Its Control*, Cork, Ireland, pp. 85–94.
- Wedholm, A., Larsen, L.B., Lindmark-Mansson, H., Karlsson, A.H. & Andren, A. (2006) Effect of protein composition on the cheese-making properties of milk from individual dairy cows. *Journal of Dairy Science*, **89**, 3296–3305.
- White, J.C.D. & Davies, D.T. (1958a) The relation between the chemical composition of milk and the stability of the caseinate complex. I: General introduction, description of samples, methods and chemical composition of samples. *Journal of Dairy Research*, **25**, 263–255.
- White, J.C.D. & Davies, D.T. (1958b) The relation between the chemical composition of milk and the stability of the caseinate complex. III: Coagulation by rennet. *Journal of Dairy Research*, **25**, 267–280.
- Wiking, L., Stagsted, J., Björck, L. & Nielsen, H. (2004) Milk fat globule size is affected by fat production in dairy cows. *International Dairy Journal*, **14**, 909–913.
- Willart, S. & Sjoström, G. (1966) The effects of cooling and the lipolysis in raw milk. *Proceedings of the 17th International Dairy Congress*, Munich, Vol. A, pp. 287–295.
- Wolfschoon-Pombo, A.F. (1997) Influence of calcium chloride addition to milk on the cheese yield. *International Dairy Journal*, **7**, 249–254.
- Woo, A.H.Y. (1983) Characterization of the relationships between free fatty acids and dairy flavors. *Dissertation Abstracts International B*, **44**, 742.

- Woo, A.H. & Lindsay, R.C. (1984). Concentrations of major free fatty acids and flavour development in Italian cheese varieties. *Journal of Dairy Science*, **67**, 960–968.
- Zalazar, C.A., Meinardi, C.A., Palma, S., Suarez, V.B. & Reinheimer, J.A. (1993) Increase in soluble sialic acid during bacterial growth in milk. *Australian Journal of Dairy Technology*, **48**, 1–4.
- ZMP (2008) *ZMP Martbilanz Milch: Deutschland, EU, Welt*, ZMP Zentrale Markt- und Preisberichtsstelle HmbH, Bonn.

2 The Origins, Development and Basic Operations of Cheesemaking Technology

M. Johnson and B.A. Law

2.1 Introduction

The modern cheese industry owes its existence to the progression of cheesemaking from a cottage industry, based on the subsistence economics of preserving surplus for times of shortage, to a high-technology fermentation industry, which is now an integral part of a national and multinational food business, supplying gourmet and commodity markets alike. This phenomenon alone demonstrates the central importance of cheese as a stable and versatile food, which can take on very many forms but which in all of them is capable of generating profitable business, employment, challenges to science and technology, staple nutrition and pleasant sensory experiences. Little wonder then that so much commercial and intellectual energy goes into the making of cheeses.

The following chapters will explain and critically discuss the chain of interdependent processes, which convert milk into cheese: coagulation by rennet; acidification and syneresis of the coagulum by the lactic starter culture; culture technology *per se*; curd formation and texturisation; cheese maturation and flavour development; product safety assurance and, finally, options for assessing and grading cheese, both as a check on the manufacturing process and as a means of meeting customer requirements. In addition, this chapter examines the evolution of cheese manufacture and describes the universal characteristics of the process, explaining how the scientific understanding of cheesemaking and its technological practice can go hand in hand to yield technological improvement and commercial innovation.

2.2 The world market for cheese

Although much is written in market reports and official government surveys about the developing markets for cheese and other dairy products in South America (especially Brazil and Argentina) and South East Asia, the major cheese-consuming regions remain the European Union (EU – 27 countries) and the United States of America (USA). Excluding fresh cheeses, the EU (6.4 million tonnes) and the USA (4.5 million tonnes) account for over 10.9 million tonnes of cheese consumption in 2008 (International Dairy Federation, 2008; USDA, 2008). This is about 80% of world consumption, and even the growing Japanese and Brazilian market, significant though it is, still only accounted for about 0.3 and 0.6 million tonnes, respectively, in 2008. Russia and the Ukraine account for almost 0.9 million tonnes of cheese consumed in 2008. This is not to say that these countries are not important within the overall picture. Lessons learnt by home producers and exporters alike, in attempting to meet

specific national taste preferences and to adjust to local conditions, have had universal impact on cheese technology; not least in the delivery of cheeses to consistently high-sensory and -microbiological quality through science-based processes and surveillance procedures, and through the enforced increase in the understanding of the origins of key flavour defects, such as bitterness, and their elimination.

Although there has been a steady (9%) rise in worldwide cheese consumption between 2004 and 2008, the trend is levelling-off in the USA and the EU countries with a tradition of large-scale consumption, but increasing dramatically in Brazil (38%) and Argentina (32%). The rapid growth in low-consuming countries is not expected to grow to anywhere near the size of the USA and EU markets in the foreseeable future. The total increase in consumption of the USA and EU countries in the last 4 years was 0.65 million tonnes whilst the increase in Brazil and Argentina was 0.52 million tonnes. However, there are major opportunities to add value, if not volume, to the market. This is being achieved through the increased use of cheese as a food ingredient, the development of cheese usage in convenience foods, development of healthier cheese through calcium fortification, reduced fat content, increased (natural) vitamin content from new cultures and the use of probiotic cultures. Also, the alliance of cheese companies with packaging companies to develop novel methods of presenting cheese (granular, shape-formed, sticks) has already emerged and offers new technologically based cheese-marketing opportunities. Finally, new flavour/texture combinations can stimulate new interest in cheese, and the science and technology base can deliver the tools to achieve this, if properly managed.

2.3 The fundamentals of cheese technology

The technology of cheesemaking has two overriding goals: firstly, to establish the parameters that make a given cheese desirable (flavour, body, texture, melt and stretch properties); and, second, to develop a manufacturing and ripening protocol that will routinely reproduce these parameters every time this cheese is made.

Cheesemaking is a rather simple process in itself, but it involves complex chemical and physical phenomena. It is essentially a concentration process, beginning with the coagulation of the major milk protein, casein and then proceeding with manufacturing steps designed to control the chemistry of the casein molecules. The physical or rheological characteristics of cheese are governed by interactions between casein molecules (Johnson & Lucey, 2006). Factors that influence these interactions are the following:

- pH;
- Dissolution of colloidal calcium phosphate;
- Proteolysis;
- Temperature;
- Cheese composition (in particular, casein content and distribution of moisture and fat).

Whilst each factor can be considered independently, it must also be considered in context with all the other factors.

Cheesemakers find it useful to have cheese described in a way that defines how it will be used, in addition to the desired flavour and physical properties. All of these demands dictate

cheese composition (fat, casein and moisture) and cheese pH (and demineralisation). In turn, these physical and chemical parameters dictate the manufacturing process. The key elements in producing the desired cheese are: (a) milk composition (because this, in part, determines cheese composition) and (b) the rate and extent of acid development during manufacture (because this influences the loss of moisture, the extent of dissolution of colloidal calcium phosphate and the lowest pH obtainable in the cheese, all key factors in deciding the texture of the finished cheese).

2.4 Basic cheese manufacture

The following is a summary of cheese manufacturing practices and the influence that they may have on cheese, beginning with the milk-clotting stage. Fig. 2.1, which presents the steps in cheesemaking that are common to the manufacture of most varieties, can be used as an illustrative reference throughout Section 2.5. Fig. 2.2 summarises the process flow from milk to cheese, showing the main variations used to make different varieties of cheese.

In order for milk to clot, the casein must be coagulated; in Chapters 3 and 4 this aspect of the technology is described and discussed in detail, at the molecular and practical level. In cheese technology, there are three ways in which the casein can be coagulated, and the type of cheese dictates the method employed.

The first method, which is used for most varieties of cheese, is to add a coagulating enzyme, which destabilises the casein colloidal suspension of micelles and makes them aggregate to form a gel network, seen as a clot in the cheese vat. This process is described in detail in Chapters 3 and 4. The first coagulants were derived from calf stomachs and were called rennets; though today there are many sources from which coagulants are derived, including plants and fungi (see Chapter 3).

The second method, which is used for cottage and cream cheese, uses low pH to cause the casein micelles to form a clot. In this technology, the destabilisation process is purely physical, not enzymatic; the low pH (4.6) reduces the repulsive charge differences between the casein micelles to a point at which they aggregate and form a gel or clot.

The third method, which is used for Ricotta and Queso Blanco cheeses, uses acid and high heat to precipitate both casein and serum/whey proteins (WPs) to form a clot.

Regardless of the method of coagulation (or precipitation) of the casein, milk fat is surrounded by the casein as the coagulum forms and is trapped together with serum. The serum (which will now be referred to as whey) contains water-soluble components, i.e. lactose, WPs and minerals. Further processing steps are used to remove the whey from the coagulum and these will differ, based on how the casein was coagulated.

After the milk is clotted and to facilitate the removal of whey from the coagulated casein, the coagulum is cut into small pieces, called 'grains' or 'curd' (Fig. 2.1a); acid- and heat-precipitated curd is handled differently (as explained later in this section). The curd immediately begins to shrink and expel whey. Internally, the casein molecules are rearranging and 'tightening'. This process is called 'syneresis' and results in the squeezing out of the whey from the casein gel network. From now on, the way the curd and whey mixture is handled differs, depending upon the cheese type. The curd and whey mixture is stirred, heated

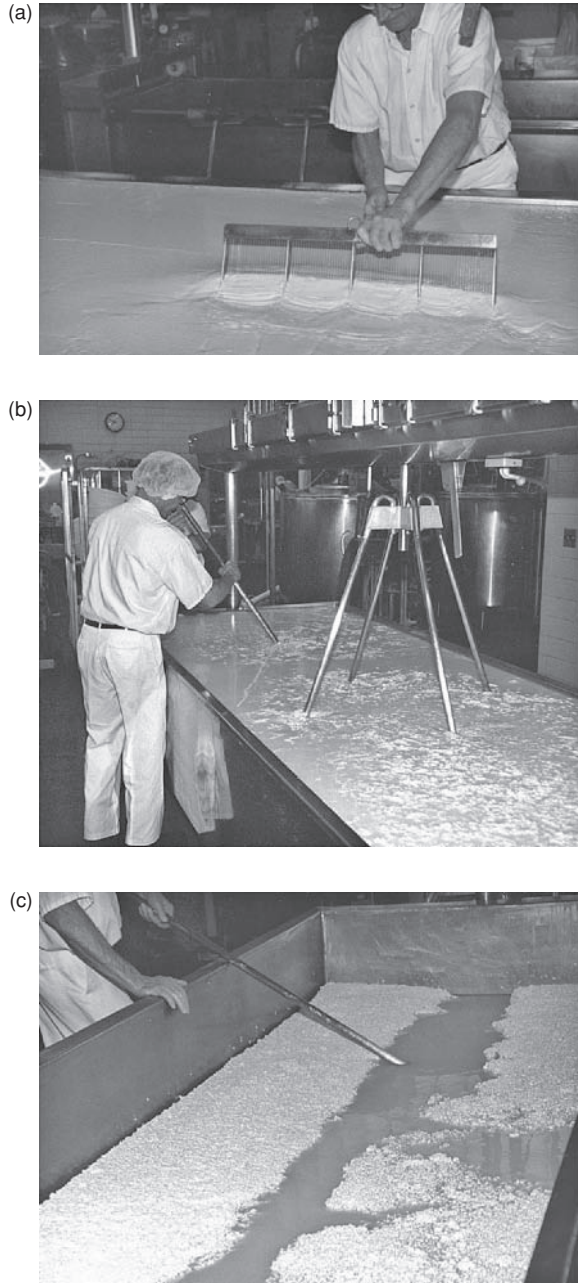

Fig. 2.1 Traditional manufacture of cheddar cheese. (a) Milk is first inoculated with a culture of LAB; the 'starter' and rennet is added shortly afterwards. The coagulum, formed by action of rennet on the milk, is cut with sets of horizontal and vertical wires in a metal frame to form cubes of curd, which contract naturally (aided by heat and acid from the starter bacteria) to expel moisture as whey. (b) The curd and whey is stirred and heated (cooking or scalding). The time and maximum temperature of heating governs the moisture content and consistency of the curd before it is made into cheese. (c) At the proper time, the curd is separated from the whey. In Cheddar cheesemaking, the curd cubes are allowed to mat together as the whey is drained. Other cheese types are formed by putting the curds into moulds immediately after draining (most soft cheeses).

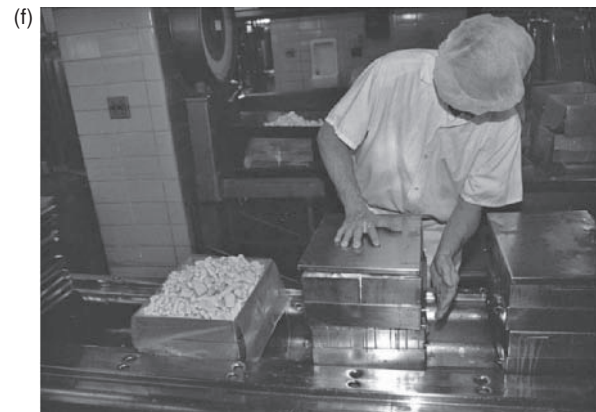

Fig. 2.1 (Continued) (d, e) In traditional Cheddar cheesemaking, the matted curd is cut into large slabs which are turned and piled on top of one another to induce 'flow' and to texturise it to the consistency of cooked chicken breast. This process is called 'cheddaring'. Mozzarella-like cheese for pizza toppings can be made from this curd by stretching it at 50–60°C. (f) Cheddar curd is milled to reduce it to small strips and salted to enhance flavour and stop further fermentation by the starter bacteria. The milled, salted curd is packed into 'hoops' (metal moulds or boxes) and pressed overnight before waxing or bagging under vacuum, and transferred to the cheese store to mature at 6–10°C.

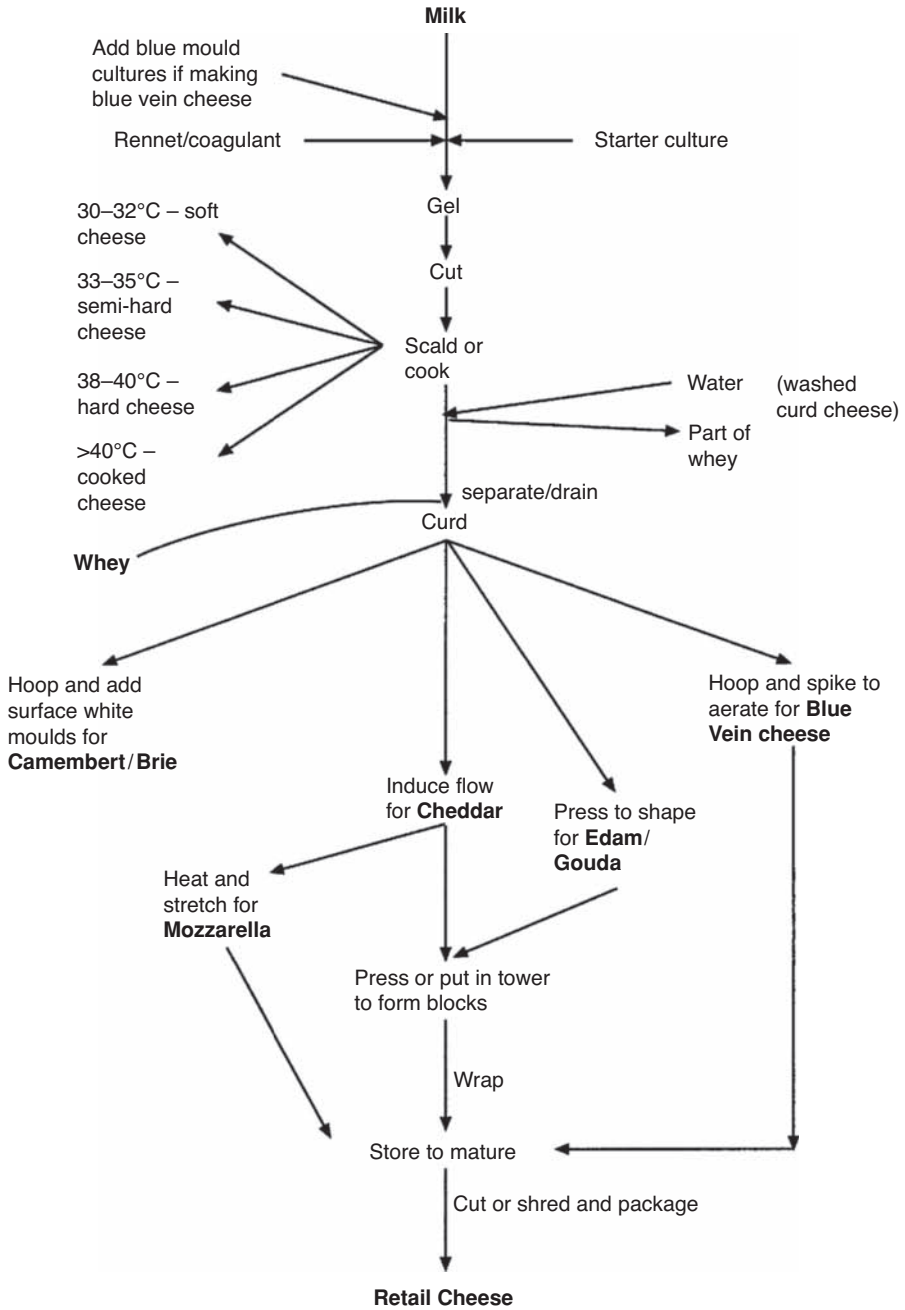

Fig. 2.2 Flow diagram of the main steps in cheesemaking, showing some of the variations which are used to make different varieties of cheese.

(Fig. 2.1b) and, at some point, separated (whey is drained; Fig. 2.1c). The curd may be textured, milled and salted (Figs. 2.1d–2.1f), and then put into a container or mould (colloquially called a ‘hoop’ or ‘form’). Soft cheeses are generally hooped directly after draining or whilst they drain. Pressure may be applied to the container but the amount of pressure and time applied varies with the type of cheese. The size and shape of the container is dependent on the type of cheese and on the whims of the manufacturer. Salt is added to the whey-free curd either prior to putting the curd into the container (direct salting) or after the pressed block of cheese has been removed from the ‘hoop’. Salt may be applied to the cheese surface (dry salting) or by immersing the block of cheese in brine. When the cheese has been pressed and salted, it is ripened.

The ripening process varies depending upon the type of cheese. During ripening, chemical and enzymatic reactions occur that result in the development of flavour and changes to the body, texture and physical properties (melt, stretch) of the cheese. Temperature during ripening, pH of the cheese, manufacturing protocol and the addition of specific enzymes and microorganisms affect these changes (see also Chapter 7). Indeed, the distinguishing flavour characteristics of many cheeses can only be developed by the metabolism of fat, casein, residual lactose and citric and lactic acids by the starter culture and other added microorganisms (Table 2.1). This is discussed further in Chapter 7, as a basis for understanding cheese-ripening technology. Enzymes, such as lipases (which hydrolyse milk fat to fatty acids), are necessary for the piquant (rancid) flavour of Romano, Feta and Provolone cheeses, and these enzymes are added to the milk prior to cheesemaking.

Undesirable rancidity in cheese is the result of contaminating bacteria (in milk or cheese) or native milk lipases. Cheeses made from milk of animals with mastitis are often prone to develop rancidity even if the milk is pasteurised (72°C for 15 s) prior to cheese making. Improper handling of raw milk including excessive pumping, agitation or freezing will disrupt the milk fat globular membrane making the milk fat easily assessable to the native milk lipase. Whilst the activities of native milk lipases are greatly decreased by pasteurisation, those of certain psychrotrophic bacteria may not be. This source of undesirable lipase activity in milk is usually due to the psychrotrophic Gram-negative rods (typically *Pseudomonas* spp.), which enter the milk supply from the milking environment, and which can grow significantly in raw milk at temperatures above 4°C. However, they have to multiply to $> 1 \times 10^6$ colony-forming units (cfu) mL⁻¹ of milk to produce enough residual lipase to spoil cheese, and good hygiene on the farm and during milk-handling, and storage at <5°C will ensure that such populations are never reached in milk used for cheesemaking. Acid- and heat-coagulated curd (Ricotta and Queso Blanco) is not cut. Ricotta curd floats, and is scooped from the surface of the whey or filtered through screens. The curd is usually placed in a container, where the remaining whey is allowed to drain from the curd. Queso Blanco curd sinks, the whey is drained, the curd salted (or brined) and then put into a container. With cream cheese, once the milk is clotted, it is stirred (not cut), and the mixture is centrifuged to remove the whey. The curd is then packaged (cold-packed cream cheese) or used as the major ingredient in a mixture of cream, non-fat dry milk or condensed milk, stabilisers and salt to make hot-packed cream cheese. In this process, the mixture is homogenised, heated and then packaged. This cream cheese has a longer shelf life than the cold-packed cream cheese.

Table 2.1 Major cheese categories, their starter compositions and secondary microflora.

Cheese category/variety	Moisture content (g 100 g ⁻¹)	Starter composition	Starter function	Secondary flora	Major flavour compounds
Unripened (soft) Cottage	Not >80	<i>Lactococcus lactis</i> subsp. <i>lactis</i> ^a and <i>Leuconostoc</i> spp.	Acid production	None	Lactic acid, diacetyl and acetaldehyde
Mozzarella	50	<i>Streptococcus thermophilus</i> and <i>Lactobacillus delbrueckii</i> subsp. <i>bulgaricus</i>	Acid production	None	Lactic acid
Ripened (soft) Camembert	48	<i>Lc. lactis</i> subsp. <i>lactis</i> and <i>Lactococcus lactis</i> subsp. <i>cremoris</i>	Acid production	<i>Penicillium caseicolaum</i> yeasts	Fatty acids, ammonia, aromatic hydrocarbons, oct-1-en-3-ol, bis-(methyl thiomethane), phenylethanol and thioesters
Brie	55	As above	As above	As above	As above
Semi-soft Carephilly	45	<i>Lc. lactis</i> subsp. <i>cremoris</i> , <i>Lc. lactis</i> subsp. <i>lactis</i> , and <i>Lactococcus lactis</i> subsp. <i>lactis</i> biovar. <i>Diacetylactis</i>	Acid and diacetyl production	Lactobacilli	Lactic acid and diacetyl
Limburger	45	<i>Lc. lactis</i> subsp. <i>cremoris</i> and <i>Lc. lactis</i> subsp. <i>lactis</i>	Acid production	Yeasts, Arthrobacter <i>Brevibacterium linens</i> and <i>Staphylococcus</i> spp.	Amino acids, fatty acids, ammonia, methanethiol, thioesters and methyl disulphide
Semi-hard Gouda	40	<i>Lc. lactis</i> subsp. <i>lactis</i> , <i>Lc. lactis</i> subsp. <i>lactis</i> biovar. <i>diacetylactis</i> and <i>Leuconostoc</i> spp.	Acid and CO ₂ production		Amino acids and fatty acids

(continued)

Table 2.1 (Continued)

Cheese category/variety	Moisture content (g 100 g ⁻¹)	Starter composition	Starter function	Secondary flora	Major flavour compounds
Blue vein Roquefort, Gorgonzola, Stilton and Danish blue	40–45	<i>Lc. lactis</i> subsp. <i>lactis</i> , <i>Lc. lactis</i> subsp. <i>lactis</i> biovar. <i>diacetylactis</i> , <i>Lc. lactis</i> subsp. <i>cremoris</i> and <i>Leuconostoc</i> spp.	Acid and CO ₂ production	<i>Penicillium roqueforti</i> , <i>Geotrichum candidum</i> , yeasts and micrococci.	Fatty acids, ketones, esters, lactones, aromatic hydrocarbons, terpenes and pyrazines
Hard Cheddar	35 to >40	<i>Lc. lactis</i> subsp. <i>cremoris</i> , <i>Lc. lactis</i> subsp. <i>lactis</i> , <i>Lc. lactis</i> subsp. <i>lactis</i> biovar. <i>diacetylactis</i> ^b , <i>Leuconostoc</i> spp. ^b and <i>S. thermophilus</i>	Acid production	Lactobacilli and pediococci	Amino acids, fatty acids, alcohols, pentanone, hydrogen sulphide, methanethiol and many unidentified compounds
Emmental	38	<i>S. thermophilus</i> , <i>Lactobacillus helveticus</i> , <i>Lactobacillus delbrueckii</i> subsp. <i>lactis</i> , <i>Lb. delbrueckii</i> subsp. <i>bulgaricus</i> and <i>Propionibacterium shermanii</i> ^c	Acid, CO ₂ and propionic acid production	<i>Propionibacterium shermanii</i> and group D streptococci	Amino acids (especially proline), peptides, butyric acid, acetic acid, methanethiol, thioesters, dimethyl sulphide and alkyl pyrazines
Gruyère	38–40	As above	Acid, CO ₂ and propionic acid production	<i>Propionibacterium shermanii</i> , group D streptococci plus yeasts and coryneforms, including <i>B. linens</i>	As above

^aMost manufacturers use *Lc. lactis* subsp. *lactis* for acidification and *Lc. lactis* subsp. *lactis* biovar. *diacetylactis* for dressing.

^bNot always included but can be used to obtain open texture variants.

^cIntroduced with the starter but have no lactic-acid-forming function (they grow as a secondary flora and produce 'eyes'.)

2.5 The stages of cheesemaking

2.5.1 *Standardisation of milk*

The first condition necessary to produce a cheese of consistent composition is to start with milk of consistent composition (refer to Chapters 3 and 4 for in-depth coverage of raw milk handling). If the milk composition is not consistent, the subsequent standardised manufacturing and ripening processes will not produce the same cheese. Milk composition can vary in all aspects, and these are related to factors over which the cheesemaker has no control (weather, animal-feeding practices, breed of animal, etc.). The cheesemaker can alter (standardise) milk composition by adding milk solids (condensed or milk powder) or by removing cream. The ratio of casein to fat (C/F) determines cheese composition in terms of the amount of fat in the total solids (TS) portion of cheese, i.e. fat-in-dry matter (FDM). The total amount of casein and fat, in part, determines the yield potential of milk. The latter is important in the manufacturing protocol, to ensure that the equipment can handle the amount of curd in a vat (cutting, stirring, etc.) and for moisture control.

Most countries have laws governing two aspects of the composition of cheese: minimum FDM and maximum moisture (and in some cases, minimum moisture as well). However, not all cheeses have standards. Standards are set to ensure a certain degree of continuity in composition for a given variety of cheese, even though produced by different manufactures, to protect both the consumer and manufacturing process. Approaches to setting standards vary from country to country: for example, recently proposed standards for some cheeses suggest maximum moisture relative to a particular fat content. Thus, Cheddar cheeses with more than 55 g 100 g⁻¹ FDM would not be permitted to have more than 36 g 100 g⁻¹ moisture. A Cheddar cheese with less than 55 g 100 g⁻¹ FDM would be permitted to have 39 g 100 g⁻¹ moisture. Approximately 90 g 100 g⁻¹ of the dry matter of cheese is casein and fat; the remaining solids are primarily lactic acid, minerals, salt and a very small amount of WP, unless this is deliberately added. Whilst not all cheeses (especially those which have a minimum 50 g 100 g⁻¹ FDM, e.g. Cheddar, Colby, Muenster) are made from standardised milk, the trend in large operations is in that direction.

Standardisation of milk is generally necessary for cheeses with FDM (g 100 g⁻¹) <50 or >57, because milk composition is normally sufficient to produce a cheese within this range. If a higher FDM (lower C/F) is required, cream is added. If a lower FDM (higher C/F) is desired (low-fat cheeses) cream is removed or non-fat dry milk, ultrafiltered (UF) skimmed milk, condensed or evaporated skimmed milk are added. Many factories use UF whole milk to remove water prior to cheese making to improve efficiency. Removal of cream results in decreased cheese yield, but some manufacturers will not accept the potential for decreased cheese quality sometimes observed when milk solids are added. The increase in solids (fat and casein) increases cheese yield and is very attractive as a result of this positive economic potential. When cream is removed, not only fat but casein is also removed. Cream is generally 30–45 g fat 100 g⁻¹, i.e. it is 55–70 g 100 g⁻¹ skimmed milk. The major problem with the addition of solids is the carry-over to the cheese of any off-flavour from these solids. Of particular note are stale or oxidised flavours. Moreover, it is sometimes difficult to get the non-fat dry milk to fully dissolve in the milk. This is due, in part, to the physical nature of the powder and, in part, to the improper procedure for addition of the powder.

Excessive heating of milk during the drying process will create a powder that is less soluble. Some cheesemakers add the powder directly to the bulk tank (or silo) and hold the blended milk overnight to ensure adequate hydration of the powder. However, even with agitation, the powder may sink and be slowly hydrated. This may result in sludge on the bottom of the tank, which will not be incorporated into the milk, so that the milk will not be standardized as expected. The trend (and most manufacturers follow this technique) is to first make condensed milk from the powder and then add it to the silo or blend it with the milk in the cheese vat. A special mixing device is used to sift the powder into warm (30°C) water. The water (plus powder) is recycled through the system until all the powder has been added. Typical solids of this blend are between 20 and 30 g 100 g⁻¹.

To blend the milk and the standardising agents that will yield the desired C/F, the cheesemaker needs both milk and the standardising agents to be of accurate composition. Newer technologies have proved useful in simultaneously measuring the composition of each and also metering the correct ratio of milk and standardising agents in a continuous flow (in-line standardisation) to the cheese vat.

2.5.2 Heat treatment of milk

After receipt and standardisation, the milk is usually given a heat treatment although in many smaller cheese plants the milk is never heated above the temperature of the animal. However, there is considerable controversy as to whether or not to require a mandatory minimum heat treatment of milk that is to be processed into cheese. For example, although this procedure is not compulsory in EU countries, it is mandatory to label raw milk cheese clearly. Pasteurisation proponents base their argument on public health issues. No pathogen has been shown to survive in pasteurised milk (treated at 72°C for 15 s), although most pathogens do not survive slightly lower heat treatments either (Johnson *et al.*, 1990). Antagonists argue that cheese made from pasteurised milk does not taste the same as cheese made from raw or minimally heated milk, and that during ageing any pathogen initially present will die (a claim not borne out by objective cheese microbiological investigations) (Donnelly, 2001). In addition, there is opportunity for post-pasteurisation contamination of cheese with pathogens. Proponents argue that, by starting with pathogen-free milk, if the cheese is produced in a pathogen-free environment and handled properly, it will be free and remain free of pathogens. They further argue that the flavour difference is not necessarily real or detrimental. Pasteurisation at 72–76°C for 15–18 s is not a severe enough heat treatment to cause problems in cheesemaking, and adjustments are not usually necessary in the manufacturing protocol, other than the addition of a small amount of calcium chloride.

The resolution of this apparent conflict between ‘safe-but-boring’ and ‘dangerous-but-exciting’ cheese was discussed by Law (1998) in terms of emerging cold sterilisation technologies for milk, on the one hand, and the isolation of non-pathogenic raw milk/factory microflora from the natural microflora to provide the excitement without the danger, on the other.

2.5.3 Addition of the starter culture

The starter is the acid-producing bacterial culture used in cheesemaking, although the term is sometimes used to include any bacteria deliberately added to the milk to influence the

taste, aroma and texture of the cheese. The latter are specific bacteria not used for acid development but whose primary purpose is for production of specific flavour compounds or gas (see Chapters 6 and 7). The differences in starter and non-starter microbiology and their effects on the diversity of cheese varieties is summarized in Table 2.1.

The reduction in pH brought about by the metabolism of the starter increases the rate of enzyme activity of the coagulant, increases the rate of syneresis, slows the growth of some bacteria (including some pathogens) and causes the dissolution of colloidal calcium phosphate from the casein. In addition to the loss of calcium phosphate, the net charge repulsion between casein molecules increases initially but then decreases as the pH nears the isoelectric point of casein (4.6). Both of these events have profound influence on the chemistry of the casein network, especially the mobility of casein molecules and the ultimate configuration of the aggregating micelles. These in turn affect the physical properties of cheese such as firmness, smoothness of mouth-feel and even the colour of the cheese (discussed in-depth in Chapter 4).

The choice of starter bacteria to use for cheesemaking is based on tradition, flavour desired in the cheese and rate and extent of acid development desired during manufacture and in the finished cheese (this is discussed in detail in Chapter 5). Starter strains differ in their sensitivity to salt, temperature and pH, and these characteristics are exploited in cheesemaking. The starter will continue to ferment lactose (or galactose if it has the metabolic capability to do so) until conditions within the cheese prevent it (high salt, low pH, low temperature and additive effects of all three). Sometimes, high cooking temperatures are used to slow acid production; the starters are not killed and resume activity as soon as the temperature is lowered. This technique is often used in the manufacture of Swiss-type cheese, where high cooking temperatures are used to remove water from the curd and where a fast rate of acid development is undesirable. It is desirable to have most of the acid develop in the curd during pressing, to aid in better curd fusion, better eye development and retention of colloidal calcium phosphate to buffer against low pH (see Chapter 10).

Mesophilic starter cultures (mainly lactococci) are generally more salt-tolerant than thermophilic strains (e.g. *Streptococcus thermophilus*). Mesophiles are also more likely to ferment residual sugar (lactose and galactose) at cheese storage temperatures (8–12°C). For example, in Muenster cheese, the rate of acid development by certain strains of *S. thermophilus* slows to the point of almost stopping at a pH of 5.1–5.3. Cooling the cheese quickly to <20°C almost totally halts further metabolism, even though there is plenty of lactose remaining in the cheese. If, on the other hand, mesophiles were used, the pH would drop below 4.9 even if the cheese was cooled to 8°C. The manufacture of Brick cheese is very similar to that of Muenster cheese with one major exception, i.e. a whey dilution step. Brick cheese is manufactured with a mesophilic starter, it is high in moisture (44 g 100 g⁻¹) and brine-salted. Without removing some of the sugar, the final pH of the cheese would be around 4.6–4.8, far too acid for Brick cheese. Therefore, in Brick and other brine-salted cheeses in which mesophiles are used (Gouda and Havarti), some of the whey (25–50 g 100 g⁻¹ of the milk weight) is removed and replaced by warm water. Sugar leaches from the curd. The mesophiles eventually ferment all the remaining sugar during the forming and pressing of the cheese. The final pH will be 5.1–5.3. This technique is used in the manufacture of non-traditional Mozzarella cheese to reduce the darkness of the colour if it should burn on a pizza. Manufacturers of Swiss-type cheese will add a small amount (5–7 g 100 g⁻¹ of the

milk weight) of water directly to the milk (without first removing whey) to avoid producing a cheese with a low pH.

The amount of starter added to milk for cheesemaking depends on the rate and extent of acid development and conditions of culture propagation (media, pH control and age). Large-scale cheese manufacturers require that the rate of acid development be predictable every time cheese is made (see Chapter 5). This enables the manufacturer to standardise the entire cheesemaking protocol. However, acid-damaged or phage-sensitive cultures have the potential to slow and even stop the rate of acid development. It is for these reasons that manufacturers use pH-controlled conditions for bulk starter growth and phage-insensitive starters in the cheesemaking process. However, the latter precaution is not vital if a series of phage-unrelated, defined, mixed-strain cultures are used in rotation, so that bacteriophages that attack one or more strains in one culture cannot build up from day to day in the cheese plant (refer to Chapter 5 for details of the alternatives used in phage control).

2.5.4 *Coagulation and cutting*

During slow coagulation, casein micelles initially form a network of thin strands and small aggregates (for in-depth coverage see Chapters 3 and 4). The spaces between the strands are filled with whey. Because initially the spaces or pores between the strands and aggregates are small; this is often referred to as a 'fine coagulum'. The network develops around the fat globules, which are huge compared to the micelles and aggregates of micelles. As coagulation continues, the strands begin to form into larger, interconnecting aggregates, and the pores between the aggregates become larger. This is now called a 'coarse coagulum'.

A fine coagulum is softer than a coarse coagulum because there is less interaction between and amongst the casein micelles. There is considerable potential for new interactions to occur, as evidenced by the formation of larger aggregates later. When a soft coagulum is cut (Fig. 2.1a), this potential is realised and casein micelles continue to aggregate or interact. The net result is that the curd particle begins to shrink rapidly, especially at the surface, swiftly expelling large amounts of whey. Whey is trapped in the interior of the curd particle but can be squeezed out. The curd develops a 'skin', or more dense layers of casein micelles due to the loss of fat and whey. At the cut surface, fat is too large to be trapped or surrounded by the casein network and is lost to the whey. The skin prevents further fat loss but contains small pores, through which whey from the interior of the curd particle can be squeezed out. The skin also makes the curd more resilient to stress and less likely to break or tear. The development of the skin is often referred to as allowing the curd to 'heal'. However, if the curd is subjected to enough stress (stirring or agitation) it can break, especially if it has not healed (curd is too weak). In essence, it is like cutting the curd into smaller curd particles. Very small curd particles are called 'fines'. Because of their small size, they may not be incorporated into the curd mass when whey and curd are later separated, and thus represent a loss in cheese yield. Fat globules are also lost at the newly exposed surface, but a new skin develops, albeit more slowly. The same process of curd shrinkage and skin formation occurs in the firm or coarse coagulum, but again more slowly. Consequently, the curd does not heal as rapidly and is more prone to breakage (more fat loss, more fines) when agitated. Thus, stirring soon after the coagulum is cut is more detrimental to a coagulum that is cut firm than

to one that is cut soft (Johnston *et al.*, 1991). Similarly, if the coagulum is cut and agitated too soon, the curd will also be prone to tearing and fracturing. Therefore cutting too soon or too late can result in an increase in fines and fat loss, especially if the subsequent rate of stirring is too fast for the resiliency of the curd.

Coagulum firmness is traditionally a subjective measurement by the cheesemaker. There may be considerable (a few minutes) variation between cheesemakers within a single cheese plant in determining the 'proper' time to cut the coagulum. For this reason, cheesemakers have started using instrumental methods to determine coagulum firmness. The cheesemaker carries out a series of tests to identify the optimum firmness for cutting. This is done by determining the firmness which, at cutting, results in the least amount of fines and fat in the whey. Once the optimum value for coagulum firmness is determined, the instrument is 'set' to 'inform' the cheesemaker when to cut the coagulum (this is discussed more fully in Chapter 4).

For this system to work most efficiently, the composition of the milk must be similar from vat to vat. The optimum firmness will change for different cheeses. In the manufacture of reduced-fat cheeses, it may be more economical to cut the coagulum firmer and suffer fines and fat loss. Cutting a firmer coagulum is one means of obtaining a higher level of moisture in the cheese. The increase in moisture and yield will off-set the loss in yield due to fines and fat lost to the whey (Johnson *et al.*, 2001). A firm coagulum can be obtained by adding the coagulant at a lower milk pH (pre-acidification, increased ripening time and faster acid development by the starter), increasing the casein content of the milk, increasing the temperature of the milk at the time that the coagulant is added and simply allowing more time from coagulant addition to cutting.

What about curd size? The smaller the coagulum is cut, the greater the surface area exposed and the more fat lost. There is also less volume within the curd (the surface area ratio is increased). The rapid shrinking of the surface leads to a larger amount of whey lost (per unit volume of curd) in comparison to a larger piece of curd. Large curd is also more likely to be torn apart during agitation. Low-moisture cheeses are made from a coagulum in which the curd is cut small and soft. Conversely, high-moisture cheeses are made from a coagulum in which the curd is cut large and firm.

A lower C/F in the milk (e.g. 0.5 for creamy Havarti), or milks of low casein content, will result in casein aggregates that are further apart. A softer or weaker coagulum is formed. The curd may require a slightly longer healing time before agitation and gentler stirring. At the other extreme, e.g. at a C/F of 2.0, or in milk with high casein content (UF or condensed milks), the clot firms more rapidly (more casein per unit volume of milk). However, in condensed milks, whilst the clot firms more rapidly, the actual degree of interaction between caseins may be less than in a firm coagulum formed from milk with less casein. For this reason, UF milks are generally allowed to sit longer before cutting, even though they physically appear to be firm enough to be cut.

2.5.5 *Stirring, heating and syneresis (moisture control)*

After the curd is cut, it is stirred and heated (Fig. 2.1b). The starter continues to produce acid, and the combination of stirring, heating and acid development has a profound effect

on moisture (syneresis) and dissolution of calcium phosphate. These, in turn, have major implications for the characteristics of the cheese. Colloidal calcium phosphate is the main buffer in milk and cheese and removing it during cheesemaking (too low pH, i.e. <6.2, at rennet addition and drain) will increase the potential for development of an excessively low pH (<5.0) in the cheese (Lucey & Fox, 1993; Johnson & Lucey, 2006). This principle has been put into practice in the manufacture of reduced-fat cheeses that are typically made with a curd wash or whey dilution step. Johnson and Chen (1995) manufactured a reduced-fat Cheddar cheese without a rinse step yet the pH was maintained above 5.0, and all residual lactose was fermented. Lawrence *et al.* (1984) indicated that the sensitivity of the starter culture also plays a key role in fermentation of residual lactose after salting and consequently lowering the cheese pH.

Syneresis is the rearrangement of casein molecules, which results in a tightening of the casein network. The end result is that moisture is squeezed out of the casein network. The most important factors influencing syneresis are: (a) temperature, (b) the drop in pH after the curd is cut (rate of acid development) and (c) pressure. The greater the drop in pH after cutting the coagulum, the more moisture will be squeezed out of the curd. The higher the temperature used to heat the curd after the coagulum is cut, the lower the moisture in the curd. Other factors that increase the rate of syneresis and the rate at which the 'free serum' is squeezed out of the curd as whey are related to pressure exerted on the curd; these include the following:

- Stirring (rate and duration);
- Increasing the ratio of curd to whey during stirring;
- Stirring the curd after whey separation ('stirred curd' procedure);
- Keeping the curd warm during dry stir out;
- Direct addition of salt during dry stir out.

In addition, slow rate, high intensity of pressure applied and long duration of pressure, increase the amount of whey that is removed from the curd. However, as the curd cools, syneresis also slows; indeed, one processing step used to increase moisture in reduced-fat cheeses is to add cold water to the curd. This is more effective if the pH of the curd is <5.4; when cooled, low pH curd (5.0–5.3) reabsorbs entrapped moisture more readily than warm curd or curd at higher pH (>5.4). Moisture retention and absorption in cheese will be discussed in more detail later in this chapter (cheese at pressing and during ripening).

Most water in cheese is mobile; i.e. it is not bound to the casein or other ingredients. It is mechanically entrapped within the casein network (Van Vliet & Walstra, 1994). It will freely move out of the cheese if sufficient 'force' compels it to do so. Forces sufficient to move water out of the casein network include: (a) low pH (<4.95), (b) low humidity or drying, (c) dry salting of the pressed block of cheese (moisture moves to where the salt is) and (d) proteolysis or the breakdown of the casein network, especially if the cheese is warmed (it sweats).

Moisture clings to the curd even after salt is added, but after the cheese is put into a container/mould and pressure is applied, some of the water is rapidly pressed out of the cheese. The pressure on the curd fuses the outer layer of curd and some of the moisture is caught inside the block. The curd eventually absorbs the entrapped water.

Residual lactose from the curd leaches into the water pockets and, when fermented, will cause localised areas of low pH as compared to the rest of the block of cheese. The result will be bleached or lighter-coloured areas. This is very apparent in cheeses in which annatto has been added to the milk (to produce an orange cheese). A similar result can occur in any cheese, although it may not be as apparent.

2.5.6 *Whey removal, hooping and salting*

The manner in which the whey and curd are separated can play a role in the texture of the cheese, as well as influencing colour and flavour. There are basically three ways in which whey is removed. In the manufacture of soft cheese, whey is drained from the perforations in the cheese moulds. In the manufacture of most hard and semi-hard cheese, whey is drained from the vat, the curds being held back behind a screen, and a channel being made in the curd mat to allow the whey to flow (Fig. 2.1c). In large-scale practice, the whey and curd slurry is pumped to a vat with a perforated screen at the bottom; the whey flows through and the curd is held back. The curd is allowed to mat together as the whey is drained, and the mat is then cut into slabs. The slabs are turned and eventually piled on top of each other (Figs. 2.1d and 2.1e). This process is called ‘cheddaring’. The faster the slabs are stacked, the more moisture will be trapped within the curd. Once the desired pH is obtained, the slabs are shredded (milled) into thumb-sized or smaller pieces, called ‘curd chips’. Whey and fat are released from the newly exposed surfaces. The curd may be misted with a fine warm water spray and stirred to facilitate drainage of the whey. Salt is sprinkled onto the curd (Fig. 2.1f) and this pulls more moisture from it. With or without continued stirring, the salty whey is allowed to drain. The curds are then put into containers/moulds and pressed.

Automatic systems for Cheddar and Mozzarella cheeses use a perforated belt that holds back the curd, allowing it to form a mat. The belt (and curd mass) continues moving, but eventually turns over once (Mozzarella) or twice (Cheddar). The curds knit together into a solid mass of cheese. The speed of the belt is timed, so that by the time the curd mass reaches the chipping mill (located at the end of the belt), the curd is at the desired pH. With Cheddar, after the curd is milled it may be lightly misted with warm water and then salted. The misting removes whey that collects around the newly cut surfaces. If left, it may result in a defect called seaminess. In this case, the individual milled pieces are outlined by a white border of cheese with a slightly lower pH. It is more common in acid or low-pH cheese but it usually disappears. Salting is performed by automatically metering the salt from a hopper onto a moving belt holding the milled curd. Metering is usually based on a mechanical sensor, which measures fluctuations in the depth of curd on the belt. The salted curd is then tumbled for salt distribution and whey drainage. After mixing, the curd is placed in a container for pressing. Alternatively, the curd may be vacuumed into towers, which create pressure by the weight of a vertical column of curd. In the towers, whey continues to be expelled as the cheese is stacked vertically. Whey continues to be siphoned-off as it collects in the tower, at the base of which is a special guillotine system called a ‘block former’. A block is cut from the stack at regular intervals and pushed away to be packaged.

No further direct pressing is needed in this system, but the packages are vacuumed, which exerts some pressure on the curd. If the free whey is not drained completely from the curd,

some may collect in the bag; it is then eventually absorbed into the cheese. The whey contains lactose and, if fermented, will produce localised areas of high acid. The cheese colour is lighter in these areas.

The mass of Mozzarella curd is treated just like Cheddar and may also be salted, but rather than being packaged it is mixed in hot water (or brine). The molten mass of cheese is pulled out of the hot water and salt (or flavours) may be added. The mass of curd is then put into containers and cooled. If the curd was not salted, the cooled cheeses are then brine-salted. The manufacture of Mozzarella is described in detail in Chapter 9.

Most Cheddar or Mozzarella, which is to be used in the manufacture of processed cheeses, may be made by the 'stirred curd' process. To facilitate whey drainage, the curds are not allowed to mat but are continuously stirred. When the desired pH has been reached, the curds are salted (Cheddar) or, in the case of Mozzarella, added to the hot water as before. A variation to the stirred curd process is to cool the curd with cold water. This technique is used in the manufacture of Colby cheese and reduced-fat cheeses. This slows syneresis and incorporates water into the curd. The water will be trapped within the curd mass during pressing and will eventually be absorbed within the cheese, resulting in a higher moisture content. The wash step also removes some of the lactose, lactic acid (resulting in a curd with a slightly higher pH) and solubilised calcium phosphate. Because the curd is cooled and salted, it may only slowly deform during pressing. This will result in small mechanical openings in the cheese.

With Swiss and Gouda cheeses (cheeses with eyes), the whey and curds are pumped into a special vat, which contains a slightly smaller perforated form, or the curd and whey may be pumped to a tower; in both cases, the whey is not immediately separated from the curd. The curd is allowed to settle beneath the whey. The curd mass is pressed and the whey is then drained. In the tower system, a block of curd is guillotined from the stack and placed into a container for pressing. In traditional Swiss-type cheese manufacture, the entire curd mass is enveloped in a cloth bag, which is then placed into the cheese hoop (form in which the curds are pressed). In either case, air is prevented from being incorporated into the curd. If the perforated form is used, a large single block of cheese is formed and pressed in the vat. The block is cut into smaller pieces and, as with the other systems, the blocks are then brined. The manufacture of cheeses with eyes is described in detail in Chapter 10.

With Muenster, Brick and similar cheese types, curds are separated from the whey simply by pumping the curd and whey mixture directly into a perforated container or form (Fig. 2.1). The curd may or may not be pressed. This technique usually results in a cheese with small openings (called mechanical openings). The forms are turned periodically to allow even drainage of the whey and a smooth cheese surface. The curd must be warm when put into the form or it will not knit properly on the surface. A hot water rinse is sometimes used to ensure a smooth surface. If the curd is put into the form at a high pH and the pH continues to drop, the mechanical openings may be very tiny or the curd may fuse completely. Without a drop in pH, the curds do not knit or fuse and the mechanical openings remain. If large and plentiful openings are desired (Havarti and blue cheeses), the curd has to be first completely separated from the whey, and then placed into the mould. Salt may also be added. The cheeses are held in the forms until the proper pH has been reached, and are then brined.

2.5.7 *Brining and/or dry surface salting*

If salt is not added to the curd before pressing, it is added to the cheese by soaking it in brine or by rubbing salt onto its surface during ripening. The brine is usually a saturated salt solution (approximately 23 g salt 100 g⁻¹; but some are only 15 g 100 g⁻¹), at or near the pH of the cheese and at 40–50°C. Calcium chloride (0.2–0.3 g 100 g⁻¹) is also added to the brine. If the calcium content of the brine is low, calcium will leach from the casein and the caseins become more hydrated and solubilised. The cheese surface may become too soft or slimey, which may lead to ‘rind rot’ in packaged cheese if bacterial growth occurs. This process also occurs inside the block of a direct-salted cheese, and it is responsible for the absorption of entrapped whey during the first few days of ripening. Moisture absorption by the casein network occurs as long as the calcium is no longer bound to the casein and the charge repulsion between casein molecules is high. As casein molecules repel each other due to negative charges it opens up the casein network forming tiny channels where serum is absorbed causing the network to swell. The casein also becomes hydrated as water is attracted to the charged sites. However at very-low-pH cheeses such as cottage cheese curd (pH 4.6–4.7) or high-pH and high-salt cheeses (Queso Fresco, pH 6.3–6.5), the casein network contracts forming large aggregates as the charge repulsion between casein molecules becomes neutralised. Consequently, the physical structure of the casein network is more open with large pools of serum forming between aggregates. The casein network cannot absorb or hold the moisture very readily and will rapidly lose serum especially if the cheese is warmed.

When dry salt is rubbed onto the cheese, a rind is formed. The rind is low in moisture, high in salt and the caseins form a very dense network. Fat may be squeezed out and the surface becomes greasy. The situation is exacerbated by evaporation, if dry-salted cheeses are ripened in low humidity. However, the rind actually slows moisture loss from the rest of the cheese and the interior of the cheese does not become too dry. The moisture cannot move readily through the dense casein network but neither can the salt. Thus, cheeses which are dry-salted may also be initially brined or salted before pressing. Rubbing salt onto the cheese is a traditional means of ripening cheese and is practised by farmstead cheesemakers. These cheesemakers may allow microorganisms (usually yeasts and moulds because of their ability to survive in high-salt and dry conditions) to grow on the cheese (see Chapter 5 for details). The rind protects the interior of the cheese; however, metabolites of the yeasts and moulds may move through the rind and results in either desirable or undesirable cheese flavour depending upon the tasters point of reference. The cheese looks ‘traditional’ and has a certain natural, earthy appeal.

Brining results in a salt gradient in the cheese. Moisture is also pulled to the surface that is high in salt. If the cheese is ripened in open air a rind forms as the moisture is readily lost. If the cheese is high in moisture and vacuum-packaged the outer layer of cheese often becomes excessively soft as the moisture is not lost. Thus, the composition within a block of cheese can vary considerably in brined cheeses. This may have a positive or negative effect on the ripening process as moisture and salt (salt in moisture phase) and A_w play major roles in enzymatic and microbiological activities. Equilibrium (but not homology) in composition occurs within the cheese but this may take months. The trend is towards direct addition of salt to the cheese and away from brining. This is mainly

the result of stricter regulations concerning the disposal of brines and the cost of maintaining them both chemically and microbiologically. It does have consequences for high salt cheese that are direct-salted such as 'barrel parmesan'. In this direct-salted cheese the high salt inhibits the starter culture metabolism resulting in residual lactose and galactose. During ageing non-enzymatic browning may occur but also flavour development is retarded.

2.5.8 Pressing

This accomplishes three objectives: *firstly*, the curd is formed into the desired shape, *secondly*, whey is forced out and, *thirdly*, under pressure, the curds knit together more quickly. The time, pressure and efficiency of pressing are related to the condition of the curd at the time of pressing and the decrease in pH (loss of colloidal calcium) during pressing.

Curd fusion involves two steps: (a) the curd particles have to flow, resulting in an increase in contact area between adjacent curd particles and (b) new bonds have to be formed between adjacent particles (Luyten *et al.*, 1991). When loose curd is put into a container, the contact area between individual curd particles is small. Pressure distorts the curd and increases the contact area between curd particles. The curd distorts better the warmer it is, the more colloidal calcium phosphate that is dissolved from the casein micelles, the lower the pH and the higher the moisture and fat content held within the casein network.

If too much of the contact area between curd particles is covered with free fat, the curds will not knit. There must be casein/casein interaction. Free fat appears on the surface of curd when warm curd is stirred too long, especially salted, milled curd. The curd may be rinsed with very warm water to remove the fat. The outer layer of individual curd particles is covered by casein and not fat because, when the coagulum was originally cut, fat at the surface was not enclosed within the casein network and was lost to the whey. Similarly, if the curd is broken open (or milled), a new surface is exposed and fat is released. In addition, when salt is added to milled or freshly broken curd, moisture is pulled from the curd, the casein network shrinks and fat near the surface is pushed out, especially when the curd is pressed. The casein molecules at the surface of each particle actually associate with casein molecules of adjacent curd particles. The more flexible (bonds are more easily broken and reformed) the casein molecules, the better the knitting of the curds. Casein molecules are more flexible at lower pH (5.0–5.3). If the pH of the curd drops during pressing, the increase in flexibility of the casein molecules increases the rate of knitting of the curd. The larger the drop, the better the knitting of the curd.

Whey separation and salting techniques have an important influence on the texture of the cheese. In stirred, dry-salted cheese, the curd is firmer. Even with a large pH drop and pressure, the curds knit slowly and may not knit sufficiently. Lack of curd fusion leads to curdiness, a condition in which the cheese, when chewed, breaks into the original curd particles. Curdiness is more prone to occur in cheeses salted at a higher pH (5.5–5.8) and in which the pH does not drop, curd that is cooled and curd that is low in fat and moisture. During ripening, proteolysis of casein allows for rearrangement of the casein molecules and results in better curd fusion or, at least, a softer cheese with the sensation of a smoother body.

2.6 Cheese ripening/maturation

Cheeses ripen into distinct varieties, partly because they are made physically different by the technology in the cheese plant (as described above) and partly because they are made with different microbial cultures.

2.6.1 *Diversity arising from composition*

Demineralisation and pH play important roles in proteolysis and casein interaction and these, in turn, influence the physical properties of cheese. As a consequence of primary proteolysis (the initial hydrolysis of intact protein molecules), peptides are released and solubilised, and the protein network rearranges. The residual coagulant in cheese is the key proteolytic enzyme in initial proteolysis. The effect of proteolysis is different in individual cheeses and is based on cheese composition or, more accurately, the ratio of casein to the combination of water and fat; the lower the ratio, the greater the effect of proteolysis on the cheese towards becoming very soft, creamy or smooth, pasty or sticky (more so as fat decreases), or weak and tacky (high-fat cheeses).

If the ratio is high, the cheese tends to be crumbly or short (less cohesive) and breaks or fractures when pressure is applied. The latter is an attribute in English Territorial cheeses, but a defect when it occurs in Swiss-type cheeses, and is responsible for splits or cracks if gas is formed after extensive proteolysis. Sliceability is reduced (the slices fracture) and although the cheeses are shreddable, the shreds tend to be very short; this is observed in Parmesan and Romano cheeses. In general, the changes that occur in cheeses with high casein/water and fat ratio are much more acceptable to consumers than the changes that occur to cheeses lower in casein/water and fat ratio. There are exceptions of course, as a creamy or almost runny body is sometimes demanded of mould-ripened (Camembert) and some surface-ripened cheeses (Limberger). However, a mushy Havarti, Muenster or Mozzarella is undesirable.

2.6.2 *Diversity arising from the starter cultures and the adventitious microflora in cheese*

After the cheese curd has been formed, salted, pressed and placed in the maturation area, its microflora go to work transforming the bland product of the fermentation stage into a cheese whose flavour, texture and appearance are largely dependent on the microorganisms present within the curd mass and/or on its surface. Some of these microorganisms will have been added deliberately as the starter culture, as a ripening blue or white mould culture, or as a surface smear of bacteria and yeasts. Others, mainly non-starter lactic acid bacteria (NSLAB) (lactobacilli and pediococci) gain access to the cheese from the milk or from the factory environment or added as adjunct culture and contribute to ripening from within the cheese through their biomass (enzymes and substrates) and their metabolism.

Thus, the diversity amongst cheeses produced by the primary manufacturing process is added to by their microflora, to create categories, including mould-ripened (internal blue

and white surface; *Penicillium roqueforti* and *Penicillium caseicolum*, respectively); surface smear-ripened (orange to red smears containing coryneforms, non-pathogenic staphylococci and yeasts; see Chapter 6); those ripened by internal lactic acid bacteria (LAB) flora (starter enzymes and growing adventitious NSLAB) and cheeses with eyes (formed by CO₂-producing propionibacteria added with the starter) (see Chapter 10). Of course, some cheeses are not ripened at all and are sold within days as very moist, acid-flavoured cheese, such as cottage cheese.

These cheese categories and their characteristics are summarised in Table 2.1. The selection, use and influence of most of these microorganisms are subjects of Chapters 5, 6, 9 and 10, to which the reader is referred. Those interested in the use of cultures and enzymes in controlled and accelerated cheese-ripening technology should consult Chapter 7, which also reviews the biochemical basis of flavour in maturing cheese as part of the explanation and review of flavour control technology.

2.7 Reduced-fat versions of traditional cheeses

2.7.1 Background

Since the early 1980s, there has been considerable interest in the manufacture of reduced-fat versions of traditional full-fat cheeses, due to consumer concern about the contribution of fat to the diet. However, with the exception of Mozzarella, reduced-fat or low-fat cheese probably accounts for less than 10 g 100 g⁻¹ of total cheese sold. The major reasons for the lower than expected consumption of reduced-fat cheese has been lack of quality and high price; current research on reduced-fat cheeses, therefore, is addressing these issues. To achieve the quality objective, the trend in the industry is to use adjunct bacterial cultures or added enzyme systems (see Chapter 7). To accomplish the second objective, the amount of cheese obtained from a given quantity of milk must be increased.

Industrial yield is improved by increasing the protein concentration of the milk and incorporating inexpensive fillers, such as particulate or denatured WPs. Milk solids are increased either by concentration of the milk through evaporation or ultrafiltration or by the addition of non-fat dry milk, condensed or UF milk. Another means of increasing the yield of cheese is to increase the moisture content, though this puts limitations on shelf life.

There are differing ways to produce a reduced-fat version of cheese that mimics the physical attributes of the higher-fat version, but degrees of difficulty in doing this are variety-dependent. For instance, 25–50% fat reduction in Cheddar cheese can be accomplished, which will satisfy all but the most discriminating consumer. However, there does not yet exist a low-fat or zero-fat Cheddar about which that statement can be made; but zero-fat Mozzarella mimics the higher-fat versions in terms of colour, melt, stretch and chewiness, when used as an ingredient in other foods. Zero-fat Mozzarella dries too much when baked in specialised hot air blast pizza ovens, leading to a skin or burnt specks on the cheese. To overcome this problem, vegetable oil can be sprayed onto the surface of the pizza or incorporated into the cheese during shredding (Rudan & Barbano, 1998).

2.7.2 Manufacture of reduced-fat cheese

A delicious low-fat cheese, in the form of cottage cheese (4 g fat 100 g⁻¹) already exists. Consumers, however, want more variety, so the industry has taken two different approaches to accommodate consumer demands. One is to produce a cheese that mimics, as closely as possible, the equivalent full-fat variety, and the other is to produce a cheese with the desired reduction in fat that lacks objectionable flavour and body characteristics but does not necessarily mimic the full-fat counterpart. They stand alone as a good cheese, without the expectations of being a traditional Cheddar, Swiss, Gouda, etc.

A major complaint about some reduced-fat cheeses is that they can be too firm. The reason for this is twofold: *firstly*, the casein network is too concentrated or compact; and, *secondly*, the interaction between casein molecules is too strong; i.e. there are too few 'breaks' in the association of the casein micelles (or molecules) with each other. The critical parameters governing the body (firmness and chewiness) of any cheese are casein density, as determined by the association with moisture, and degree of disruption by fat, pH, charge repulsion and level of intact casein (proteolysis). One way to decrease the casein density is to increase the moisture content; another is to add filler, such as denatured WP, starch, gums or a reduced-calorie fat. Fillers also often result in a cheese with higher moisture content (McMahon *et al.*, 1996; Lobato-Calleros *et al.*, 2008). Other materials, such as mono- and di-glycerides (Lucey *et al.*, 2007), lecithin, (Drake *et al.*, 1996) and sucrose polyesters (Crites *et al.*, 1997) may also interact with casein molecules and disrupt the associations between casein molecules. A third method is to break up the existing fat into smaller globules (homogenisation); the cream rather than the milk is homogenised and then the cream and skimmed milk portion are combined to give the desired fat content of the milk for cheesemaking (Metzger & Mistry, 1994). Homogenisation can also result in a higher moisture cheese but decreased melt or flow when heated. Regardless of the method to break up the casein network, the interactions between casein molecules must also be reduced. This is accomplished through proteolysis and by dissolving colloidal calcium phosphate (usually through lowering the pH of the milk at rennet addition) and decreasing the pH of the cheese. The net result is an increase in the charge repulsion between casein molecules (Johnson & Lucey, 2006) and a softer, less chewy cheese.

The addition of heated milk (condensed or non-fat dry milk) or the use of higher-than-normal pasteurisation of the milk results in the denaturation of serum/WPs, especially β -lactoglobulin. Cheeses made from milk containing denatured WPs exhibit decreased syneresis and therefore, higher moisture. Other means much more commonly used to increase the moisture of cheese, include decreasing the pH at renneting, slowing the rate of acid development during cooking; reducing the amount of time the curd is stirred (especially after the whey is drained from the curd); increasing curd size and firmness at cutting and by using a cold-water rinse prior to salting. In the case of Cheddar or Mozzarella cheese made with the milled curd process, the sooner the curd is piled or stacked, the higher the moisture content will be. Although not as apparent in the manufacture of full-fat cheeses as in the manufacture of reduced-fat cheeses, a firmer coagulum at cutting, or a faster rate of coagulation, results in a cheese with a slightly higher moisture content.

A different approach to increasing the moisture content of cheese is the use of starter bacteria with the ability to produce an exopolysaccharide capsule (Low *et al.*, 1998; Awad *et al.*, 2005; Dabour *et al.*, 2006). The exopolysaccharide appears to hold or absorb water.

With an increase in the moisture content of low-fat cheese, there is a corresponding increase in lactose, especially if the milk is standardised by the addition of non-fat dry milk or condensed milk. Whey-protein-based fillers may also contain lactose. If the lactose is fermented, an overacid (low pH) cheese may result. To compensate, manufacturers will often wash or rinse the curd, or partially drain the whey and add water back to dilute the remaining whey and pull sugar from the curd. Another means of preventing an overacid or low-pH cheese is to increase the buffer capacity of the cheese but this has limitations. Higher moisture cheese ($>48 \text{ g } 100 \text{ g}^{-1}$) may contain too much lactose and if fermented may overwhelm the buffer capacity. Colloidal calcium phosphate is a good buffer. As the starter bacteria develop acid, some of the colloidal calcium phosphate begins to slowly dissolve from the casein. If this happens before the whey is drained, the calcium phosphate will be lost in the whey. However, if the whey is separated from the curd before a lot of acid has developed, then the colloidal calcium phosphate will remain in the curd and will act as a buffer later as the cheese is being pressed. Therefore, to prevent an excessively low pH in the finished cheese, a high pH is used at curd and whey separation and salting. In very low-fat cheese a low pH at rennet addition may be necessary to remove colloidal calcium phosphate to attain a better texture. Consequently, the removal of lactose is necessary. When a lower pH at rennet addition is used a lot of buffering capacity is also lost and a low pH cheese could result. Consequently, a cold-water rinse or soaking of the curd is done. Cooling the curd also results in a higher moisture content. Reduction in the curd temperature not only slows expulsion of free whey from the curd, but any trapped whey will later become more rapidly absorbed and integrated within the casein network, softening the cheese.

The rinsing, or whey removal and whey dilution, also alters the chemistry of the cheese. The effect is most noticeable if the pH of the curd at rinse is lower or when salt is also added to the whey. When water is added, not only is the lactose diluted but also are the solubilised minerals. In addition, minerals, such as calcium, leach from the casein to equilibrate with the low mineral content of the whey. By removing calcium bound to casein, the curd has a tendency to absorb whey (especially if a small amount of sodium chloride is present and/or the pH is between 5.4 and 5.0). With ripening, the cheese becomes softer, develops a smoother body and appears to be more prone to proteolysis than non-rinsed cheese. Lower fat cheeses often do not develop desired strong flavours of their full-fat counterparts or the flavour that does develop is undesirable. The environment of lower fat cheeses is usually marked by a high water activity, low-salt and acid in the moisture phase of cheese and thus microbial and enzymatic reactions are impacted. Many full-fat, low-salt, low-acid cheeses with high A_w are similar to lower fat cheeses in that they often do not develop characteristic or desired flavour. Some of the undesirable flavours are similar to the flavour notes seen in low-fat cheeses that develop after ripening several months (meaty-brothy and unclean).

2.8 Whey technology for cheesemakers

Cheese whey is no longer regarded as a waste product of cheesemaking to be spread on fields, dumped down drains or used as a no/low-value animal feed. Indeed, the drains option was abandoned long ago for all but the small amount of splash whey and/or salt whey

Table 2.2 Composition (g 100 g⁻¹) of sweet whey from cheesemaking.

Component	Percentage/amount
Water	93.2
Total solids	6.8
Protein	0.8
Fat	0.5
Lactose	4.6
Minerals (ash)	0.5
Lactic acid	<0.1
Cheese fines	0.1–0.3

from Cheddar cheese plants, due to the high biological oxygen demand of the whey solids, coming mainly from lactose. Also, the field spreading disposal method causes severe odour problems. Modern whey technology is a vast subject in its own right; in the present volume, no attempt is made to cover the whole field but a working description of whey processing is given, which can be incorporated into cheesemaking businesses.

2.8.1 *The composition of cheese whey*

The solids composition of ‘sweet’ (pH 5.9–6.3) cheese whey is presented in Table 2.2, and it will be clear from this that the bulk of whey is water. Thus, although whey contains some potentially valuable and useful components in the form of functional food proteins, lactose, vitamins and minerals, their state of dilution and lack of purity limits their value in whole whey. If the potentially valuable solids could be concentrated and isolated, they would have real value as by-products. The development of industrial membrane technology over the last two to three decades has provided the cheese industry with the tools to do this, and whey recovery is now a profitable part of cheese technology.

2.8.2 *Membrane filtration technology*

The following should only be taken as a general guide to the generic principles, and detailed information can be found in manufacturers’ technical literature as well as International Dairy Federation (IDF)/Federation Internationale de Laiterie (FIL) Bulletins; all of these organisations have websites on the internet and access is now very easy (Anonymous, 2000, 2003). The most recent, detailed, state-of-the-art reviews of WP membrane technology are by Maubois and Ollivier (1997) and Smith (2008). An excellent overview, still worth reading, is that of Maubois *et al.* (1987).

Membrane configurations vary from manufacturer to manufacturer and according to the material from which the membranes are made – ceramics or polymers. Polymer membranes made up as spiral-wound modular elements are very efficient and typical. Obviously, the detailed performance of membrane plant depends on feed rates, pressures, temperatures, solids concentrations and frequency of cleaning; all issues that can be worked out with the equipment manufacturer during commissioning. The following, therefore, is a

summary of the broad definitions and main usage areas of the different membrane technologies, as a guide to understanding the subsequent discussion of applications to whey technology.

UF allows the free passage into the permeate of dissolved salts, vitamins and lactose, but retains (in the retentate) macromolecules (WPs in this case) and fat globules. Its main use is in preparing a basic whey protein concentrate (WPC) from defatted whey.

Reverse osmosis (RO) is used for dewatering whey or, looked at from the other perspective, recovering reusable water from whey. It retains even the smallest dissolved molecules and ions, but requires relatively high-energy input in the form of high pressure to overcome the natural force of normal ('forward') osmotic pressure between retentate and permeate. The main advantage is that this process concentrates whey or whey fractions without changing the chemical or phase composition of the whey components.

Nanofiltration (NF) is intermediate between UF and RO; 'loose' RO, as it were, with thin film composite membranes, which let salts through but retain all of the protein in the whey and most of the lactose. NF can be operated at higher flux rates than RO and is an excellent option for demineralising UF permeate before lactose recovery by crystallisation. However, it can also partially demineralise whey itself at the same time as pre-concentrating it for WP fractionation by ion exchange or electrodialysis, where separated WPs are part of the upgrading/added value strategy. Demineralisation at the expense of high concentration ratios can be achieved by adding water during the filtration process ('diafiltration'). NF will remove salt from Cheddar salt whey, as an alternative to sending it to the effluent plant. The desalted whey retentate can rejoin the main whey stream, and the permeate can be evaporated to recover the solid salt.

Microfiltration (MF) is more commonly used in dairies as an alternative to the heat treatment of milk to reduce bacterial loads, especially for cheeses susceptible to spoilage by spore-formers. Cheese brine can also be kept bacteria-free using this technology. In whey technology, it can be used to pre-treat whey to remove fat, since the fat globules are retained by the membrane, whilst the proteins are (mostly) passed through to the permeate. Whey defatted by MF is superior to centrifugally defatted whey because its almost zero fat content reduces clogging of UF membranes and gives 'cleaner' WPCs, with better protein functionality. The higher value WPC, therefore, compensates for some loss of WP yield in the MF stage.

Thus, the advent of membrane filtration options opens up many routes to high-value by-products from cheese whey (Fig. 2.3). However, for the majority of cheese producers, the bottom left corner of Fig. 2.3 will hold most interest. Indeed, the 'fine tuning' of WPCs is now a commercial enterprise in itself, because the feedstock pre-treatment, UF time/temperature conditions and, to a lesser extent, drying conditions, can be adjusted to optimise a range of value- and use-determining functional properties, such as water-binding, emulsification, foam stabilisation, gelling and mouth-feel control in the final products. The know-how in this area is proprietary knowledge, and held by research and development (R&D) suppliers, who use a combination of advanced colloid science, protein chemistry and mathematical modelling expertise, together with hands-on process technology, to develop directly-applicable strategies for cheesemaking companies.

The following is a generic guide to the state of the art in cheese whey-processing and upgrading, with the emphasis on protein recovery and refinement for food applications.

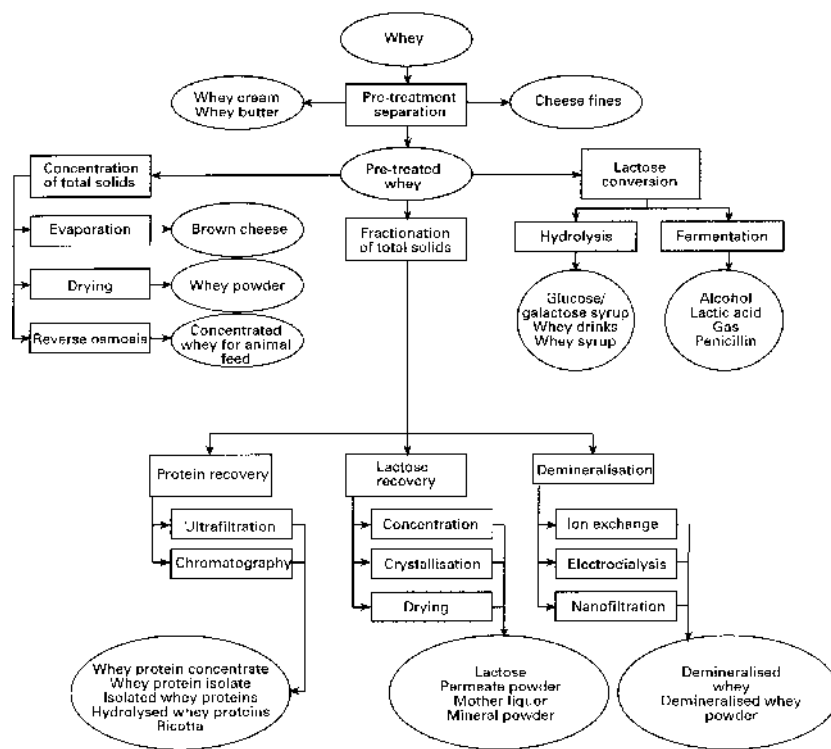

Fig. 2.3 Technology options for adding value to cheese whey through concentration, membrane processing and fractionation.

2.8.3 *Whey pre-treatment*

After leaving the cheese vat at the drawing stage, whey is passed through a wire mesh to remove curd fines. The fines are added back to the curd mat and the whey goes to a holding tank, on its way to either a centrifugal clarifier or a very fine mesh screen, to remove the very small fines that escaped the first screen. If this whey is to be held before further processing, it is cooled to below 10°C; the most energy-efficient plants use the recovered heat to warm incoming refrigerated milk prior to pasteurisation. The whey is now free from particulate matter but still contains significant amounts of fat in globular form, which would be concentrated by subsequent UF and would interfere with protein recovery. To remove it, the whey is heated to about 50–55°C to liquify all of the fat. The fat can then be centrifugally separated, such that only about 0.05 g 100 g⁻¹ remains in the whey. At this stage, the whey is ready for concentration by evaporation and/or membrane filtration, but first it is stabilised microbiologically by plate heat exchange (PHE) pasteurisation, usually high temperature–short time (72–74°C for 17–20 s). The cooling regime for the pasteurised, clarified whey depends on its next processing stage. If it is to be held for more than a few hours, it should be cooled to <10°C, but it can be sent directly for concentration and protein recovery by UF, in which case the cooling process depends on the operation temperature of the UF membrane unit (anything from 10–55°C). Note that some plants pre-concentrate

Table 2.3 The designations and compositions (g 100 g⁻¹) of the most common WPCs compared with whole whey powder.

Component	WPC-35	WPC-60	WPC-80	WP
True protein	29.9	54.0	71.2	9.7
NPN	3.4	3.0	4.8	3.3
Total protein	33.3	57.0	76.0	13.0
Fat	3.1	5.5	7.6	1.0
Lactose	51.0	25.8	5.3	72.9
Ash	6.3	4.4	3.1	8.1
Total solids	95.0	95.0	95.0	95.0
Protein in solids	35.0	60.0	80.0	13.7

WPC, whey protein concentrate; WP, whey protein; NPN, non-protein nitrogen.

clarified whey by evaporation or RO to save transport costs if the UF plant is not on site. Also, an MF unit can be used to remove practically all traces of fat if the WPC from the UF plant is to have the very best foaming properties (fat limits the foaming action of α -lactalbumin and β -lactoglobulin). However, although MF removes up to 80 g 100 g⁻¹ of the remaining fat there is a loss of WP at this stage, the amount depending on the operation temperature of the MF plant.

Salt whey from Cheddar plants can be separated to recover fat once a day after the bulk whey has been processed, or can be sent to the effluent plant. In countries which have tight consent regulations on the disposal of highly saline effluents, the salt whey can be desalinated by NF.

2.8.4 Production of WPC

WPC products are made in many varieties, from the basic 'WPC-35' specification to specially low-fat products, those enriched in specific functional WPs and low-ash products. Table 2.3 lists the designations and compositions of the most common WPCs compared with whole whey powder.

To make WPCs, the pre-treated whey is passed through a commercial UF plant module, so that the lactose, minerals and water pass through to the permeate and the proteins (and any remaining fat) are concentrated on the retentate side of the membrane plant. The factors which govern the TS of the WPC retentate and the overall performance of the plant are feed capacity (kg h⁻¹); operating temperature (10–55°C) and operating time per day between cleaning by 'cleaning-in-place'. The WP retentate from the UF plant would usually be heat-treated before further processing to kill any microorganisms, which, if present in the feedstock, will have been concentrated by a factor of 50–130 times. The options for heat treatment are too numerous to describe here but generally, a PHE system would be used, operating at around 70°C; however, this can be varied to selectively enhance the different WP functionalities to match different end uses, by partial denaturation. After heat treatment, the liquid WPC can be dried by conventional spray-drying, with or without an evaporation step. Tall form driers are the preferred type for WPCs.

WPs can be fractionated further for special applications. This whole area has been well reviewed from the technologists' point of view by Pearce (1992), Maubois and Ollivier (1997), Zydney (1998), Smith (2008) and Vivekanand *et al.* (2004).

2.8.5 Lactose recovery

The permeate from UF-concentrated whey is a suitable feedstock for lactose production, especially if it is first passed through an NF plant to remove salts and minerals. The NF process will also concentrate the lactose in the retentate, which needs further concentration to 60–70 g TS 100 g⁻¹ if crystalline lactose is to be the end product. Lactose crystallisation plants are available commercially; details of the optimisation of the process are beyond the scope of the present chapter, and best left as an issue between the cheese plant/whey plant operator and the equipment supplier. Further generic information is available in trade publications and bulletins, a good example being the APV system (Anonymous, 2000).

2.9 The role of research and development in the future of cheese technology

With the increasing use of Technology Foresight exercises by governments to map the future needs of industry to the science and technology base, there appears to be universal agreement that the main challenges in the cheese-manufacturing sector for R&D are to:

- increase the yield efficiency of cheesemaking in order to increase margins (particularly important in economic regions with politically-governed milk-pricing);
- improve the cheesemakers' control over the process, through the development of sensors, automation and expert systems;
- reduce spoilage and infection incidents through the development of knowledge-based hazard analysis critical control points (HACCP) system;
- develop scientific knowledge of maturation biochemistry/microbiology into diversification technology to maintain a steady flow of product improvements and innovations into the marketplace.

Although many large dairy companies have powerful R&D capability, they often choose to work in partnership with academic institutions to add value to their stock of useable knowledge. Much productive R&D, in terms of commercial innovation and advances in public health and safety, is carried out in projects and programmes involving various forms of partnership or consortium between the public and private sectors. They can be one-to-one arrangements, highly structured industry levy-funded R&D Centres and Corporations, or Government-subsidised, industry-led pre-competitive research programmes, typified by the LINK scheme in the United Kingdom.

The types of R&D goals achieved within these industry-led research initiatives involve all of the existing science disciplines but especially data-handling, chemometrics,

computer-modelling and flavour chemistry. For a recent review of this aspect of science support in cheese technology (see Law, 1998).

The following chapters of this volume reveal many other examples of the value of R&D to cheesemaking technology in all of its stages, from milk conversion to maturation and grading.

2.10 Acknowledgements

Tables 2.2, 2.3 and Fig. 2.3 were reproduced by kind permission of APV Limited, United Kingdom.

References

- Anonymous (2000) *Membrane Filtration – A Related Molecular Separation Technologies*, APV System, Silkeborg.
- Anonymous (2003) *Dairy Processing Handbook*, 2nd and revised edition of G. Bylund (1995), Tetra Pak Processing Systems AB, Lund, Sweden.
- Awad, S., Hassan, A.N. & Muthukumarappan, K. (2005) Application of exopolysaccharide producing cultures in reduced-fat Cheddar cheese: texture and melting properties. *Journal of Dairy Science*, **88**, 4204–4213.
- Crites, S.G., Drake, M.A. & Swanson, B.G. (1997) Microstructure of low-fat Cheddar cheese containing varying concentrations of sucrose polyesters. *Lebensmittel- Wissenschaft und Technologie*, **30**, 762–766.
- Dabour, N., Kheadr, E., Benhamou, N., Fliss, I. & Lapoint, G. (2006) Improvement of texture and structure of reduced-fat Cheddar cheese by exopolysaccharide-producing lactococci. *Journal of Dairy Science*, **89**, 95–110.
- Donnelly, C.W. (2001) Factors associated with hygienic control and quality of cheeses prepared from raw milk: a review. *Cheeses in all their Aspect – Detection of Antibiotic Residues in Liquid Whey and Demineralized Whey Powders – Safety Performance Criteria for Microbiocidal Step (Treatment)*, Document No. 369, pp. 16–27, International Dairy Federation, Brussels.
- Drake, M.A., Boylston, T. D. & Swanson, B. G. (1996) Fat mimetics in low fat Cheddar cheese. *Journal of Food Science*, **61**, 1267–1271.
- International Dairy Federation (2008) *The World Dairy Situation – 2008*, Document No. 432, pp. 90, International Dairy Federation, Brussels.
- Johnson, E.A., Nelson, J.H. & Johnson, M.E. (1990) Microbiological safety of cheese made from heat-treated milk – Part II: Microbiology. *Journal of Food Protection*, **53**, 519–251.
- Johnson, M.E. & Chen, C.M. (1995) Technology of manufacture of reduced fat cheddar cheese. *Chemistry of Structure –Function Relationships in Cheese* (eds E.L. Malin and M.H. Tunick), pp. 331–339, Plenum Press, New York.
- Johnson, M.E. & Lucey, J.L. (2006) Calcium: a key factor in controlling cheese functionality. *Australian Journal of Dairy Technology*, **61**, 147–153.
- Johnson, M.E., Chen, C.M. & Jaeggi, J.J. (2001) Effect of rennet coagulation time on composition, yield and quality of reduced-fat Cheddar cheese. *Journal of Dairy Science*, **84**, 1027–1033.
- Johnston, K.A., Dunlop, F.P. & Lawson, M.F. (1991) Effects of speed and duration of cutting in mechanised Cheddar cheesemaking on curd particle size and yield. *Journal of Dairy Research*, **58**, 345–354.

- Law, B.A. (1998) Research aimed at improving cheese quality. *Australian Journal of Dairy Technology*, **53**, 48–52.
- Lawrence, R.C., Heap, H.A. & Gilles, J. (1984) A controlled approach to cheese technology. *Journal of Dairy Science*, **67**, 1632–1645.
- Lobato-Calleros, C., Sosa-Pérez, A., Rodríguez-Tafoya, J., Sandoval-Castilla, O., Pérez-Alonso, C. and Vernoncarter, E.J. (2008) Structural and textural characteristics of reduced-fat cheese-like products made from W1/O/W2 emulsions and skim milk. *Lebensmittel-Wissenschaft und Technologie*, **41**, 1847–1856.
- Low, D., Ahlgren, J.A., Horne, D., McMahon, D.J., Oberg, C.J. & Broadbent, J.F. (1998) Influence of *Streptococcus thermophilus* MR-1C capsular exopolysaccharide on cheese moisture levels. *Applied and Environmental Microbiology*, **64**, 2147–2151.
- Lucey, J.A., Brickley, C.A., Govindasamy-Lucey, S., Johnson, M.E. & Jaeggi, J.J. (2007) Low-fat and fat-free cheese with improved texture and baking properties. United States Patent Application, P07144US.
- Lucey, J.L. & Fox, P.F. (1993) Importance of calcium and phosphate in cheese manufacture: a review. *Journal of Dairy Science*, **76**, 1714–1724.
- Luyten, H., van Vliet, T. & Walstra, P. (1991) Characterization of the consistency of Gouda cheese: rheological properties. *Netherlands Milk and Dairy Journal*, **45**, 33–53.
- Maubois, J.-L. & Ollivier, G. (1997) Extraction of milk proteins. *Food Proteins and Their Applications* (eds S. Damodaran & A. Paraf), pp. 575–595, Marcel Dekker, New York.
- Maubois, J.-L., Pierre, A., Fauquant, J. & Piot, M. (1987) Industrial fractionation of main whey proteins. *Trends in Whey Utilization*, Document No. 212, pp. 154–159, International Dairy Federation, Brussels.
- McMahon, D.J., Alleyne, M.C., Fife, R.L. & Oberg, C.J. (1996) Use of fat replacers in low fat Mozzarella cheese. *Journal of Dairy Science*, **79**, 1911–1921.
- Metzger, L.E. & Mistry, V.V. (1994) A new approach using homogenization of cream in the manufacture of reduced-fat Cheddar cheese – 1: Manufacture, composition and yield. *Journal of Dairy Science*, **77**, 3506–3515.
- Pearce, R.J. (1992) Whey protein recovery and whey protein fractionation. *Whey and Lactose Processing* (ed. G. Zadow), pp. 271–316, Elsevier Applied Science Publishers, New York.
- Rudan, M.A. & Barbano, D.M. (1998) A model of Mozzarella cheese melting and browning during pizza baking. *Journal of Dairy Science*, **81**, 2312–2319.
- Smith, K.E. (2008) *Dried Dairy Ingredients Handbook*, pp. 25–55, Wisconsin Center for Dairy Research, Madison.
- USDA (2008) *Dairy: World Markets and Trade*, p. 13, Foreign Agriculture Services, Office of Global Analysis, Washington, DC. Available at http://ffas.usda.gov/dairy_arc.asp.
- Van Vliet, T. & Walstra, P. (1994) Water in casein gels; how to keep it out or keep it in. *Journal of Food Engineering*, **22**, 75–88.
- Vivekanand, V., Kentish, S.E., O’Conner, A.J., Barber, A.R. & Stevens, G.W. (2004) Microfiltration offers environmentally friendly fractionation of milk proteins. *Australian Journal of Dairy Technology*, **59**, 186–188.
- Zydney, A.L. (1998) Protein separations using membrane filtration: new opportunities for whey fractionation. *International Dairy Journal*, **8**, 243–250.

3 The Production, Action and Application of Rennet and Coagulants

M. Harboe, M.L. Broe and K.B. Qvist

3.1 Historical background and nomenclature

Rennet and coagulants are preparations of proteolytic enzymes, some of which have been used in cheesemaking for thousands of years, and they seem to be the oldest known application of enzymes. The earliest indication of cheesemaking descends from cave paintings around 5000 BC. Historically, most enzyme preparations used for cheese have been extracts from the stomachs of ruminants, but coagulants from microbes and plants were also used at very early dates. It is likely that cheesemaking was invented by accident, when nomads travelled on hot days with milk kept in bags made from the stomachs of ruminants, *Camelus dromedarius* most likely. If the milk was left undisturbed, clotting of the milk occurred due to the developed acidity as a result of bacterial activity and possibly due to the presence of clotting enzymes originated from the stomachs used as bags. As a consequence, a soft coagulum was formed, and some of the liquid phase (whey) was absorbed into the skin or seeped through the bag and was lost by evaporation (Tamime, 1993). Hence, partial concentration of the coagulum took place and further concentration by hand squeezing and sun drying. However, by introducing standardised rennet in 1874, Chr. Hansen in Denmark was the first to sell a commercial enzyme product.

The nomenclature of enzymes is marked by the long history, during which the nature of enzymes was realised, and knowledge about their identity and diversity gradually increased. Originally, enzymes extracted from the stomachs of young ruminants were used and characterised. The first name for the milk-clotting enzyme was chymosin, derived from the Greek word for gastric liquid 'chyme', given by Deschamps (1840) to the main enzyme from the fourth stomach of the calf. In 1890, the name rennin, derived from the word rennet, was suggested for the same enzyme, and for many years it was adopted in English-speaking countries (Foltmann, 1966), as well as in international enzyme nomenclature. Due to confusion with the related proteolytic enzyme renin, the main milk-clotting enzyme was again named chymosin (International Union of Biochemistry and Molecular Biology – IUBMB, 1992).

Cheese is produced by milk-clotting enzymes of different origin. The active milk-clotting enzymes in all rennet and coagulants, which have been found successful for cheesemaking, are aspartic proteinases having the IUBMB number EC 3.4.23.

The original rennet preparation is, by definition, an extract of ruminant abomasums (Andrén, 1998); it is commonly called animal rennet. This definition is now generally accepted, and it is agreed that the name 'rennet' should be reserved for enzyme preparations from ruminant stomachs, whereas other milk-clotting enzymes should be named 'coagulants', The common group names are microbial and vegetal coagulants, respectively. It is also

generally accepted that chymosin produced by a genetically modified organism (GMO) is called ‘fermentation-produced chymosin’ (FPC).

3.2 Types of rennet and coagulants

Many different types of rennet and coagulants are, or have been, used for manufacturing of cheese. The types of rennet and coagulants as well as their characteristics have been reviewed by several authors (Harboe, 1985, 1992b; Guinee & Wilkinson, 1992; Garg & Johri, 1994; Wigley, 1996). Rennet and coagulants are most efficiently categorised according to their source. Table 3.1 shows the predominant types of coagulant used for cheesemaking today, as well as their active enzyme components.

3.2.1 Animal rennet and coagulants

Within the group of products of animal origin, calf rennet is regarded as the ideal enzyme product for cheesemaking due to its high content of chymosin, nature’s own enzyme for coagulating bovine milk. In the abomasum and extracts from its tissues, the proportion varies between the two enzymes, chymosin and pepsin, depending on the age of the animal and the type of feed (Andrén, 1982). Extracts from young calves have high proportion of chymosin content, typically 80–95 IMCU (international milk clotting units) 100 IMCU⁻¹ chymosin and 5–20 IMCU 100 IMCU⁻¹ pepsin. Adult bovine rennet is an extract from older animals and has a much higher content of pepsin, typically 80–90 IMCU 100 IMCU⁻¹, but a content as high as ~97 IMCU 100 IMCU⁻¹ is evident for Brazilian ox rennet. Throughout the world, animals are slaughtered at different ages and all kinds of mixtures of the extracts exist, resulting in a broad range of composition for commercial rennet.

Table 3.1 The most commonly used rennet and coagulants and their enzymes.

Group	Source	Examples of rennet and coagulants	Active enzyme components
Animal	Bovine stomachs	Calf rennet, adult bovine rennet	Bovine chymosin A, B and C, pepsin A and gastriscin
		Rennet paste	The same as above, plus lipase
	Ovine stomachs Caprine stomachs	Lamb rennet, ovine rennet Kid-caprine rennet, caprine rennet	Ovine chymosin and pepsin Caprine chymosin and pepsin
Microbial	<i>Rhizomucor miehei</i>	Miehei coagulant type L, TL, XL	<i>Rhizomucor miehei</i> aspartic proteinase
	<i>Cryphonectria parasitica</i>	and XLG/XP Parasitica coagulant	<i>Cryphonectria parasitica</i> aspartic proteinase
FPC ^a	<i>Aspergillus niger</i>	CHY-MAX TM CHY-MAX TM M	Bovine chymosin B Camelus chymosin
	<i>Kluyveromyces marxianus</i> var. <i>lactis</i>	Maxiren [®]	Bovine chymosin B
Vegetable	<i>Cynara cardunculus</i>	Cardoon	Cyprosin 1, 2 and 3 and/or cardosin A and B

^aFermentation-produced chymosin.

The traditional product, calf rennet, has until recently been the reference product against which alternative products are measured. Adult bovine rennet is the most widely used alternative to calf rennet, which is not surprising as it contains the same active enzymes. The high pepsin content in adult bovine rennet gives the product a high sensitivity to pH, and a higher general proteolytic activity.

Several niche products exist, of these lamb/ovine and kid-caprine/caprino rennet are very similar to calf/adult bovine rennet, but they are best suited for clotting milk of their own species (Foltmann, 1992). Animal rennet is sometimes used in mixtures with lipases, especially during the manufacture of South Italian cheeses, in which they produce a characteristic flavour. Such products are called rennet paste, and they are made by maceration and drying of stomachs from calves, lambs or kid-caprine, which have recently been suckling, to have the stomachs filled with milk. Therefore, rennet paste contains a mixture of rennet and lipase (pregastric and possibly gastric) enzymes in an un-standardised ratio. Porcine and chicken pepsin is hardly used anymore.

3.2.2 *Microbial coagulants*

All the well-known microbial coagulants used for cheesemaking are of fungal origin. Most of the bacterial proteases described as milk-clotting enzymes have been found to be unsuitable, mainly because they have too high a proteolytic activity. Of the two microbial coagulants used for cheesemaking (Table 3.1), *Rhizomucor miehei* is predominant. It exists in four types, all significantly more proteolytic than chymosin.

Firstly, the native type, often designated 'type L' is characterised by being very heat stable; *Secondly*, the destabilised product, often designated 'type TL', is made by oxidation of the native enzyme, and it is characterised by being heat labile, more pH-dependent and slightly less proteolytic than type L;

Thirdly, the extra heat-labile form, designated 'type XL', is made by a stronger oxidation than type TL, and it is characterised by being extra heat labile, more pH-dependent and slightly less proteolytic than the type TL;

Fourthly, the chromatographically purified form of type XL, designated 'type XLG or XP', has functional properties like type XL, but contains less non-enzymatic impurities.

The *Cryphonectria parasitica* coagulant is characterised by having a very high general proteolytic activity, by giving good curd formation, by having a low pH dependency and by being very heat labile. Because of its properties, the product is only used for cheeses cooked at high temperatures, such as Emmental;

Rhizomucor pusillus coagulant is similar to the *R. miehei* product; it was used in the past, but has no advantages over *R. miehei* coagulant, and is no longer produced commercially.

3.2.3 *Fermentation-produced chymosin*

FPC is chymosin produced by fermentation of a GMO (see Table 3.1). The products contain chymosin identical to the animal source, meaning that they have the same amino acid sequence as chymosin from the corresponding animal stomach, but it is just produced by

more efficient means. FPC products have been on the market since 1990. The main FPC, which contains bovine chymosin B, is today considered to be the ideal milk-clotting enzyme against which all other milk-clotting enzymes are measured. The production and application of bovine-type FPC has been reviewed by several authors (Harboe, 1992a, 1993; Repelius, 1993).

Recently, a new generation of FPC, identical to camel chymosin, has been developed. FPC (camelus) has been found to be an even more efficient coagulant for bovine milk than FPC (bovine), and is among others characterised by its very high specificity against caseins, which leads to high cheese yields without creating any bitterness.

3.2.4 Vegetable coagulants

The last group of enzymes shown in Table 3.1 is from plants. Many enzymes from plants have been found to coagulate milk (Garg & Johri, 1994), but one extracted from *Cynara cardunculus* (L.) cardoon (Heimgartner *et al.*, 1990), seems especially suitable. Since ancient times, the flowers of *C. cardunculus* have been used in artisan cheesemaking, especially in Portugal, where it is considered a superior for cheeses like Serra and Serpa. Cardoon coagulants are not widely used, but they are produced and used locally in some Mediterranean countries.

3.3 Molecular aspects of the enzymes in rennet and coagulants

3.3.1 Introduction

The molecular aspects of the milk-clotting enzymes present in rennet and coagulants are important for the understanding of the similarities and differences between the products. All enzymes primarily used for making cheese belong to the family of aspartic proteases, which is characterised by having the same catalytic mechanism, with two aspartic acid residues in the catalytic site (Szecsi, 1992; Foltmann, 1993; Chitpinityol & Crabbe, 1998). The molecular aspects of the aspartic proteinases have been comprehensively reviewed in many papers and books (Kostka, 1985; Dunn, 1991; James, 1998); therefore, only a short summary is given here.

The aspartic proteinases, at least the well-characterised ones used in cheesemaking, are produced as inactive precursors (zymogens), which are converted to the active enzymes by autocatalytic cleavage of the N-terminal pro-part. The activation process, which takes place by a mono- or bi-molecular reaction depending on the enzyme and the condition, has been better understood during recent years (Dunn, 1997). The molecular weight of most of the milk-clotting enzymes is around 35 000–40 000 Da, and their isoelectric points as well as their pH optima are acidic. Basic characteristics, such as stability and solubility, which are still very useful, are described mainly in the older literature (Foltmann, 1966). Many of the enzymes have been characterised by amino acid sequence and three-dimensional (3-D) structure. The structural homology, especially the 3-D structure, is high. Immunologically, some of the enzymes cross-react, like porcine pepsin with cow pepsin and *R. miehei* proteinase with *R. pusillus* proteinase; indicating that, in most cases, an amino acid identity of at least 85 amino

acids $100 \text{ amino acids}^{-1}$ is present when such cross-reaction occurs. The enzymes have, in the main, endopeptidase activity and very low exopeptidase activity, because of the extended binding cleft, which is able to accommodate at least seven amino acids. This fact makes the specificity complex and the enzymes seem unspecified. Some of the aspartic proteinases exist in different molecular variants; some products contain minor enzyme components and micro-heterogeneity is more or less pronounced for all the enzymes. The micro-heterogeneity is caused by *N*-glycosylation, phosphorylation, deaminations or partial proteolysis.

3.3.2 Specific molecular aspects

The milk-clotting enzymes are further divided into the following groups according to their specificity against substrates (Foltmann, 1985; IUBMB, 1992):

- EC 3.4.23.1 – Pepsin A (or just pepsin) is the predominant gastric proteinase in adult mammals, and it is characterised by having a lower specificity and a higher pH-dependency than chymosin.
- EC 3.4.23.2 – Pepsin B is a minor proteinase found in porcine stomachs, characterised by low milk-clotting and general proteolytic activity.
- EC 3.4.23.3 – Gastricsin is a distinctive type of aspartic protease, which has had many different names, such as pepsin B, C, I, II, III, 6 or 7. It is found in small amounts in bovine abomasum.
- EC 3.4.23.4 – Chymosin is a neonatal proteinase found in mammals which have a postnatal uptake of immunoglobulins. Chymosin is characterised by its very high and specific milk-clotting activity and its low general proteolytic activity. The milk-clotting activity have to some extent been optimised towards milk from the same natural species; chymosin has been found to have high activity against milk of own species. The zymogen is called prochymosin and, by acid treatment (activation), it is converted to the active enzyme, i.e. chymosin. At pH 2, when the activation rate is fast, this happens via the intermediate form, pseudochymosin, which is converted to chymosin at high pH. Calf chymosin is found in three allelic forms, A, B and C, and the main differences of these forms are shown in Table 3.2. A single difference in one amino acid gives chymosin A approximately $25 \text{ IMCU } 100 \text{ IMCU}^{-1}$ higher milk-clotting activity than the B-form has, and makes it able to degrade itself by excision of a tripeptide to chymosin A₂, which has only $25 \text{ IMCU } 100 \text{ IMCU}^{-1}$ activity remaining. Chymosin C seems to represent a third allelic variant (Rampilli *et al.*, 2005), but the sequence is not known. Chymosin C has in the literature often been mixed up with the degradation product A₂, primarily because the two variants by chromatography are eluted very close to each other. Chymosin B is the most abundant in rennet. Chymosin A and B have been found to respond identically to all cheesemaking parameters, and the C variant seems to have similar properties.
- EC 3.4.23.22 – *C. parasitica* proteinase is the native acid protease from the fungus, previously called *Endothia parasitica*.
- EC 3.4.23.23 *R. miehei* and *R. pusillus* proteinases are native acid proteases from the filamentous fungi. The enzymes are homologous, but they have different specificity. They are characterised by having rather high proteolytic activity and by being heat stable.

Table 3.2 Chymosin A, B and C, main differences and identities.

Chymosin A	Chymosin B	Chymosin C
Aspartic acid as amino acid no. 244	Glycine as amino acid no. 244	Several amino acid differences to chymosins A and B
Less abundant in animal rennet	Dominant in animal rennet	Minor component in animal rennet
Less stable, easily degraded, autocatalytic to chymosin A ₂ at lower pH values	More stable, is not as easily degraded at pH as chymosin A is	More stable, is not as easily degraded at low pH as chymosin A is
About 30% higher specific activity than for B; ~290 IMCU ^a mg ⁻¹	Lowest specific activity; ~223 IMCU mg ⁻¹	About 65% higher specific activity than for B; ~368 IMCU mg ⁻¹
All known cheesemaking properties are the same as for chymosins B and C	All known cheesemaking properties are the same as for chymosins A and C	All known cheesemaking properties are the same as for chymosins A and B

^aInternational milk clotting units.

3.4 Technology of enzymes production

3.4.1 General background

Production procedures vary with the type of product, but generally involve all or most of the following steps: (a) production, (b) recovery, (c) purification, (d) formulation, (e) standardisation and (f) quality control. During the last decades, the tendency has been to rationalise the production and to merge small production units into a few large and more efficient factories. This trend does, of course, have an influence on the production processes, as large facilities can afford to use more sophisticated procedures.

3.4.2 Production of enzymes

Animal rennet was produced in the past from dried stomachs or sometimes fresh stomachs, but today most rennet is produced from frozen stomachs. The process varies from producer to producer, but the most commonly used steps are as follows (see Fig. 3.1). The enzymes are produced in the mucosa of the abomasum (the fourth stomach) as inactive proenzymes, where the pre-part has the function of secreting the proenzyme into channels which have direct connection to the lumen of the stomach. The production and cellular location are known in detail (Andrén, 1982, 1992). The stomachs are cut to obtain mainly the mucosa, which is minced and extracted with water, often with salt, buffer and/or preservatives added, and the tissue residues are then separated from the extract by centrifugation or filtration. The crude extract contains a mixture of the proenzymes and active enzymes, and the extract has to be 'activated' by acid to convert all proenzyme to active enzyme. This process occurs fastest at pH 2, but a higher pH is sometimes used for activation. The subsequent clarification, by filtration or centrifugation, is normally the only purification step for animal rennet. However,

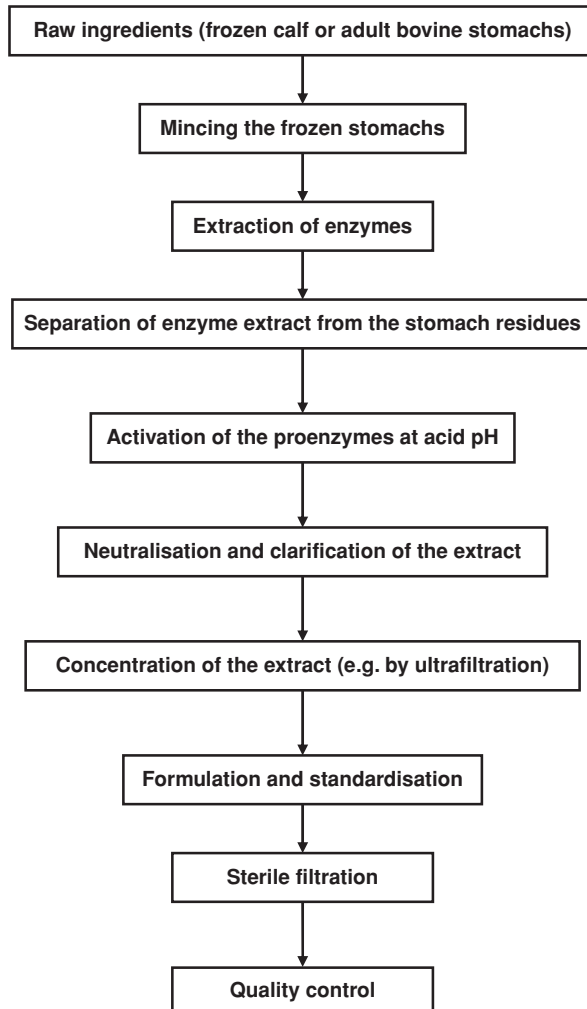

Fig. 3.1 Generalised outline of the production stages of animal rennet.

some products are purified further by ion exchange chromatography, mainly to obtain a product with a higher percentage of chymosin than that naturally present in the stomach.

Microbial coagulants are all produced commercially by fermentation of fungi. The milk-clotting enzymes are produced as inactive precursors, but only the mature enzymes are found at the end of a fermentation. This shows that the proenzyme is activated automatically, probably due to the slightly acid pH during the fermentation. The fermentations are most often submerged fed batch mode. The fermentation is initiated by inoculation of seed material of the optimised production host into a sterile medium, the latter typically being responsible for the major part of the fermentation costs. The fermentations often take days and are controlled by physical factors, such as temperature, airflow, pressure and agitation, and chemical variables, such as pH, oxygen tension, concentration of important ingredients in the medium, and the level of enzymes and by-products. The enzyme is recovered by removal of the fungus

(by filtration or centrifugation), concentrated (e.g. by ultrafiltration) and filtered. Typically, microbial coagulants are crude fermentates, which are not subjected to any purification. The strains used for the production have been selected and improved in such a way that they produce a minimum of unwanted secondary enzymes, such as lipase; but, for example, the *Rhizomucor* spp. coagulants contain secondary enzymes, such as starch-degrading enzymes, which for some products (type XL) need to be eliminated by a separate process step.

FPC is mainly produced commercially by two host organisms: (a) the filamentous fungus, *Aspergillus niger* and (b) the yeast, *Kluyveromyces marxianus* var. *lactis*. All products are made by submerged fermentation under contained conditions, but the details of how the enzymes are produced and how much purification is carried out varies with the host organism. The production process for FPC produced in *Aspergillus* spp. is outlined in Fig. 3.2. *Aspergillus* spp. has a long history of safe use for production of food enzymes, and it is

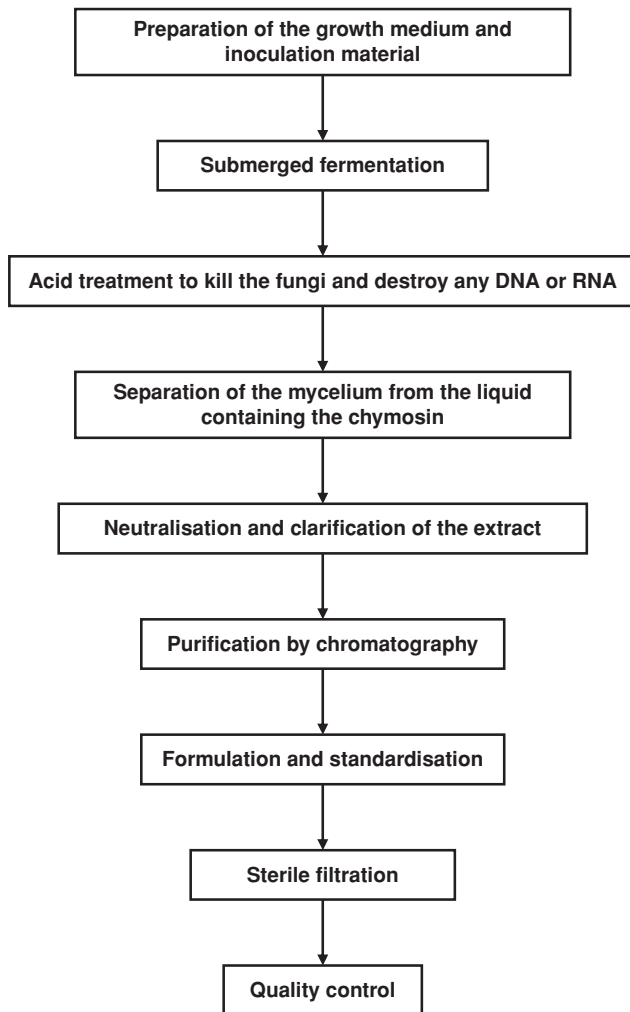

Fig. 3.2 An outline of the production process of the fermentation-produced chymosin by *Aspergillus* spp.

characterised by being able to produce and secrete very large amounts of proteins. This means that, in addition to the chymosin, *Aspergillus* spp. produces other secondary enzymes, and consequently the fermentate has to be purified if a pure product, free of side activity, is desired. The prochymosin is produced as a fusion protein together with glucoamylase (Harboe, 1992a), and it is converted into active chymosin automatically, which means that no activation step is necessary. However, acid treatment occurs directly in the fermenter, with the purpose of killing the *Aspergillus*, and as a side effect this also hydrolyses the deoxyribonucleic acid (DNA) and ribonucleic acid (RNA) present in the extract. The dead *Aspergillus* spp. is removed by centrifugation or filtration, and the liquid containing the mature chymosin is further purified by chromatography.

The yeast (*K. marxianus* var. *lactis*) has the potential to produce some secondary enzymes, but the level is lower than for *Aspergillus* spp. The main enzyme is produced as prochymosin, which needs to be acid-activated, and the fermentate is subjected to a recovery process but no real purification.

However, a bacterium, such as *Escherichia coli*, was previously used for the manufacture of FPC, and produces hardly any side activities. *E. coli* does not secrete proteins, but stores most proteins which are overproduced, e.g. prochymosin, as intracellular inclusion bodies. These can easily be isolated from the ruptured bacteria by centrifugation. The inclusion body, which almost only contains prochymosin, is washed to remove the medium and acid-treated to inactivate any residual bacteria and to hydrolyse any DNA and RNA present. At this stage, the enzyme is present as misfolded, inactive prochymosin, which needs to be dissolved, refolded, activated and purified by ion exchange chromatography.

3.4.3 Formulation, standardisation and quality control

The formulation of rennet and coagulants has the purpose of stabilising the products, making them suitable for transport, storage and application. There is no essential difference in the formulation of the different types of products. The formulations are made by adding stabilisers, such as sodium chloride, a buffering substance and often a preservative, and by adjusting the pH within the narrow range at which the enzymes are stable. Sometimes, other stabilisers, such as propylene glycol, glycerol and sorbitol, are used depending on the producer and the country in which the product is to be used, and sometimes colour is added to standardise the appearance or to avoid mistakes between water and coagulant in the dairy. The preservative, which serves the purpose of preventing microbiological growth in the product, has to be selected from those approved and those which are active at the pH value of the product. Sodium benzoate is by far the most commonly used preservative. However, a recent trend is customers increasing demand for benzoate-free products supposedly to minimise the risk for infants' reaction to benzoate. However, the preservative from rennet and coagulants ends up in the cheese is extremely at low concentrations compared with benzoate present in other foods, and the risk of having preservative-free ingredients, which could be easier contaminated, may be of a greater risk to health.

Commercial rennet and coagulants are formulated as liquid, powder or as tablets. The liquid form is the most inexpensive to produce, the easiest to use, and is especially well-suited for transport over shorter distances. Powdered products are well-suited for shipment

over long distances and at warmer temperatures, as the products are more stable than those in liquid form. Tablets have the same advantages as the powder form, and are also easily divided into the correct dosages.

Rennet and coagulants are standardised with respect to strength and sometimes enzyme composition and additives. Liquid products are filtered; even sterile filtered by some producers. All rennet and coagulants are subjected to quality control according to specifications.

3.5 Analysis of coagulants

The need to be able to analyse rennet and coagulants has increased since the 1970s, due to the wide range of products and mixtures of products on the market. Although all enzymes used for cheesemaking have similar milk-clotting properties and belong to the same group of aspartic proteinases, they exhibit many small but important differences for the application. In fact, the great similarity causes most of the difficulties when analysing milk-clotting enzymes. The different rennets/coagulants have different values for cheesemaking, and it is important to analyse the products for financial and quality reasons. The analytical methods make it easier for the producer and user to compare different products across the field, and for the dairy to choose the desired product for a specific cheese.

The most important parameters of rennet and coagulants to be analysed are strength (enzyme activity), enzyme composition, identity and purity. Many methods have been used to measure the strength, and most have been influenced by Soxhlet or Berridge (Andr n, 1998). Soxhlet units are defined as the volume of milk, which one volume of enzyme preparation is able to clot in 40 min at 35°C. The strength is expressed as ratios, e.g. 1:15 000 (which means that 1 mL of rennet is able to clot 15 000 mL of milk). This unit is easy for the cheesemaker to understand, but it depends very much on the pH and the quality of the milk, and it will also vary a lot because no reference standards are used. The strength in Soxhlet units, which is occasionally still used, exist in many different variants and should, therefore, only be used as a guideline for the approximate strength.

Subsequently, the Berridge units or rennin units (RU) have been used to a great extent. One RU is defined as the activity which is able to clot 10 mL of standardised milk in 100 s at 30°C. The main drawback of this method is that the pH 6.3 of Berridge substrate is much below the level of most cheesemaking, pH 6.4–6.6, and the calcium content of the Berridge milk is abnormally high, which gives a misleading strength compared to how the products behave during most cheesemaking. Each milk-clotting enzyme has a different pH-dependency, and this characteristic has most influence on the analysis.

Today, the strength is mainly analysed by the international standard methods, which are developed and published jointly by the International Organisation for Standardisation (ISO) and the International Dairy Federation (IDF). The IDF method (IDF, 2007) is developed for analysis of total milk-clotting activity of animal rennet, but can also be applied for FPC, whereas the IDF (2002) is the method used for the analyses of microbial coagulants. The principle is that the clotting time is measured in milk at pH 6.5, for a sample relative to the international reference standards with the same enzyme composition as the sample. This method is very robust because the standards would react in the same way to any variations in the test conditions. The strength measured by the IDF methods is expressed in IMCU.

Table 3.3 Approximate conversion between different units of activity and milligrams for the main enzymes in calf bovine rennet and adult bovine rennet.

	IMCU ^a	Soxhlet units	RU ^b
1 mg chymosin A	291	1:24 400	168
1 mg chymosin B	223	1:18 750	130
1 mg pepsin	81	1:5 500	59
1 IMCU chymosin A		1:85	0.58
1 IMCU chymosin B		1:85	0.58
1 IMCU pepsin		1:70	0.73

^aInternational milk clotting units.^bRennin units.

The large number of methods used has made it difficult to compare the units for strength, and the situation is further complicated because each enzyme has its own conversion factor. Moreover, the quality, and thus the properties, of the enzymes may vary, the composition of commercial products varies, and each enzyme responds differently to the milk pH. In France, the strength has traditionally been expressed in milligrams of active enzyme, measured by converting the measured RU. Table 3.3 provides a guide to conversion factors between the units for chymosin and pepsin.

Over the years, many methods have been developed for measuring enzyme composition, for example, selective inactivation (Mulvihill & Fox, 1977), activity ratio based on the different pH dependencies of the enzymes (Rothe *et al.*, 1977), and rocket immunoelectrophoresis (RIE; Rothe *et al.*, 1977). These methods can still be used, although they have some drawbacks. Today, the preferred method developed for bovine rennet is the IDF Standard 110B (IDF, 1997a), which is a chromatographic method. Firstly, the product is checked to ensure that the sample contains the enzymes bovine chymosin and pepsin only (immunomethod), then the total strength is measured by the IDF Standard 157 A method (IDF, 1997b), and finally the composition is measured by chromatographic separation of a desalted sample into two fractions, chymosin and pepsin. The milk-clotting activity of each fraction is measured and the composition calculated in percentages. In France, it is by law still demanded to express the enzyme content of rennet as milligrams chymosin as well as the ratio between the milligrams of the two enzymes.

No perfect method exists for measuring the composition of active milk-clotting enzymes if they are mixtures and not solely of bovine origin. Various methods can be used, if applied in a critical way, but immunological methods are reliable for identification of the enzymes (of the molecule – not the activity). Of these, the diffusion method is the simplest to use (IDF, 1997b), but RIE gives both identification and a quantification in one test, and the ability to ‘see’ whether the enzymes are partially identical. Recent methods for identifying the enzyme by mass spectrometry, directly or after digestion, are even more accurate, but require better equipment and more labour.

Besides the identification of enzyme components in the products, there is an interest in identifying and quantifying the enzymes in cheese and whey (Baer & Collin, 1993). These methods are expected to be developed further in the years to come. There has also been an interest in differentiation of the animal chymosin and FPC, as well as identification of the origin of the FPC. Simple methods can be used for the pure FPC products (non-mixtures),

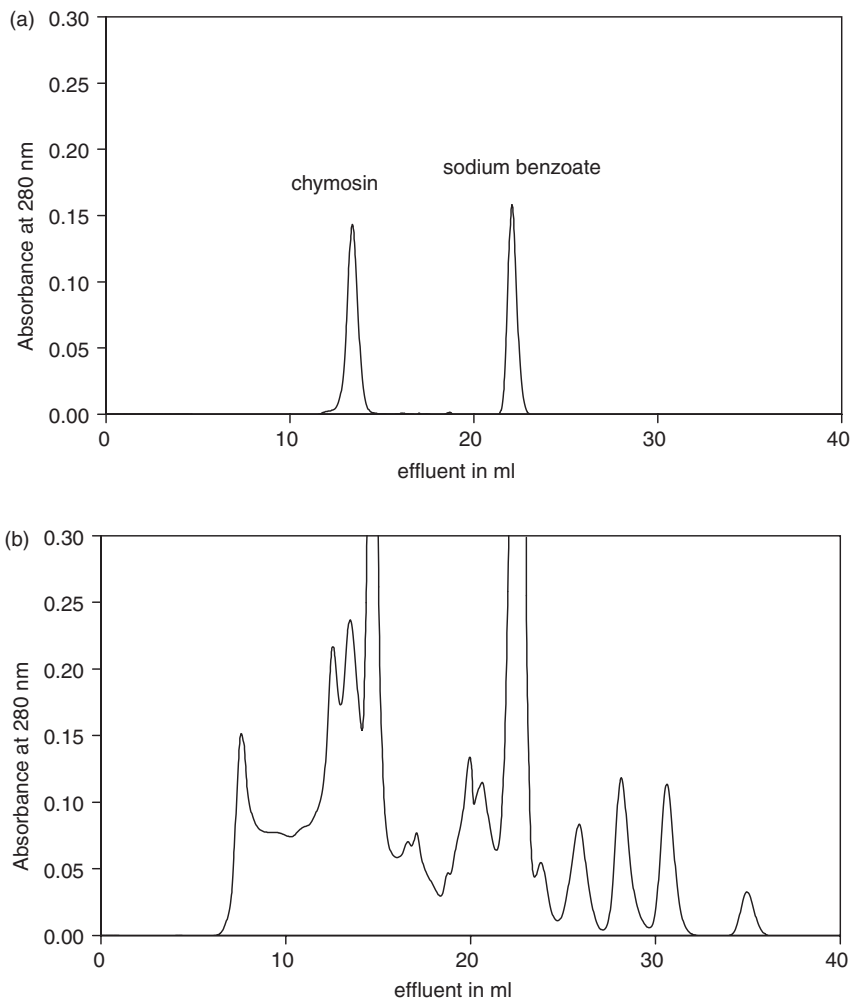

Fig. 3.3 Finger print/purity profile for *Aspergillus niger* fermentation-produced chymosin (FPC) (bovine) (a) and calf rennet (86/14) (b). Note: The analysis has been made by molecular size chromatography (gel filtration) on Superose 12 HR10/30 (FPLC). The buffer is 0.05 M phosphate buffer pH 6.0, containing 0.15 M NaCl; 100 μL sample of 200 IMCU mL^{-1} has been applied and the flow rate is 0.5 mL min^{-1} . The largest molecules are eluted first (left) and the smallest to the right. The FPC profile (a) shows only two peaks chymosin (MW 35 000 Da) and the preservative, sodium benzoate (MW 144 Da). On the calf rennet profile (b), these two substances are eluted at the same position as on the FPC profile. It is seen that the *Aspergillus* spp. produced chymosin is very pure whereas calf rennet contains large amounts of inactive substances. IMCU, international milk clotting units

such as the fingerprint (purity profile) as shown in Fig. 3.3, but the most reliable method both for pure FPC products and mixtures is probably the one developed by Collin *et al.* (1997). The principle is based on immunochemical identification of impurities in the products, which originate from the production organism.

Purity is an important aspect for rennet and coagulants, but the terms 'chemical purity' and 'enzyme purity' should be distinguished. It is most important that the products contain

no side activities (i.e. 'enzyme purity'), which can cause unpredictable reactions during cheesemaking or the later use of the whey. Highly purified products, containing only identified substances (i.e. 'chemical purity'), are not technologically important in themselves, but they do ensure that the products do not contain significant amounts of side activities, and it reduces the risk of allergic reactions. Rennet and coagulants can be more or less pure and with impurities originating from the production source or the production process. Among the side activities, only proteolytic activity has been found to have a significant influence on cheesemaking, by affecting bitter flavour, off-flavour or by influencing the texture. However, indirect effects during later use of the whey protein are becoming increasingly important, as whey powder is today used for an ever greater number of food applications (see Section 3.8.5). Many methods have been used to measure the purity of rennet and coagulants and only a few will be mentioned here.

The main method for expressing chemical purity is the one required by many authorities, such as the Food and Agriculture Organisation (FAO, 2006) and the Commission of the European Union (ECC, 1991); i.e. that the composition and purity are characterised by:

$$\text{TOS} = 100 - (A + W + D)$$

where TOS is the % of total organic solid ($\text{g } 100 \text{ g}^{-1}$), A is % ash, W is % water and D is % of other known non-organic ingredients. The TOS can be further divided into: (a) protein, consisting of the enzyme and other proteins and (b) non-protein organic material, comprising the known organic ingredients and other (unknown) organic material. Another method, which shows the chemical purity, is the fingerprint type profile as, for example, shown for *A. niger* FPC and calf rennet in Fig. 3.3. It is evident that the *Aspergillus* spp. FPC is extremely pure and that it does not contain any significant amounts of side activities, whereas calf rennet contains many (inactive) unidentified components.

In addition to the chemical purity, it is interesting to measure the side activities enzymatically. The general proteolytic activity can be measured by any of the well-known methods. These methods are, however, not specific and the activities of the milk-clotting enzymes are included in the final result. The starch-degrading enzymes can be measured by enzymatic assays for amylase and glucoamylase or by a diffusion test using starch agar. Microbial coagulants type L and TL contain high levels of starch-degrading enzymes, whereas this side activity has been removed from most other types of microbial coagulants and from FPC to allow the broad use of the whey.

3.6 Legislation and approvals

Commercial rennet and coagulants should fulfil the recommendations of international organisations, and they must conform to the regulatory authorities and be approved by the customer. It is not possible to give a full review of regulatory and approval matters, and this section is meant only as an introduction to the subject.

Several organisations exist, which have a special interest in improving the quality of products used in food. The Joint Expert Committee on Food Additives, under FAO/World Health Organisation (2006) and Food Chemicals Codex (2003) make specifications and

recommendations for enzymes and certain food additives. Besides the general requirements related to parameters such as purity, identity and safety, it contains specific limits for heavy metals and microbial contaminants. There is no harmonised European Union (EU) legislation, but there are guidelines for safety assessment of food enzymes (ECC, 1991), which are used for safety evaluations in countries like Denmark and France. A proposal for a harmonised EU regulation on food enzymes has been presented to the Council, and the Parliament adopted the proposal (EU, 2008). In the United States, the Food and Drug Administration (FDA) has affirmed the main rennet and coagulants as 'generally recognised as safe' including but not limited to the FPC products (Flamm, 1991). At present, the FDA uses a so-called notification process for approvals. The producers of rennet and coagulants have formed associations to secure and improve the product quality, e.g. the Association of Manufacturers of Natural Animal-derived Food Enzymes (AMAFE) and the Association of Manufacturers and Formulators of Enzyme Products (AMFEP).

According to the latest EU regulation (EU, 2003), enzymes produced by fermentation by using a genetically modified microorganism, which is kept under contained conditions, need no GM labelling; this includes FPC.

The producers use several tools to make uniform and safe products. Nowadays, besides using specifications and quality control, most producers use the ISO system to ensure that every activity that may affect the quality of the product is well documented, and the hazard analysis of critical control points system is used as a preventive approach to control food safety.

3.7 Physical chemistry and kinetics of enzymatic coagulation of milk

In this section, the aim is to present an understanding of the kinetics of enzymatic coagulation of milk, or renneting as it is often called. To achieve this, a description of the stability of casein micelles follows.

3.7.1 *Stability and destabilisation of the casein micelles*

The casein component constitutes around $80 \text{ g } 100 \text{ g}^{-1}$ of milk protein. It is present as roughly spherical aggregates called casein micelles, consisting of several thousand casein molecules, and ranging in diameter from around twenty to several hundred nanometres, with an average diameter around 150 nm. Casein micelles are thus in the size range of colloidal particles, and their stability is usually explained using principles from colloidal chemistry. It should be borne in mind, however, that casein micelles are association colloids with an equilibrium structure that is not unaffected by changes in the overall conditions, as is normally assumed in colloidal theories. Changes in solvent composition, temperature, pH and/or ionic strength will lead to changes in micelle composition that can affect its stability.

It is generally agreed that κ -casein is predominantly located at the micelle surface with the hydrophobic *para*- κ -casein part (residues 1–105) linked to the micelle, and the hydrophilic and negatively charged caseinomacropptide (CMP) part (residues 106–169), rich in carbohydrates, protruding into the solution. Like all other particles in solution, casein micelles are

in constant Brownian motion and frequently collide. Collision can lead to either aggregation caused by overall attractive forces, or separation caused by overall repulsive forces. The stability of intact micelles against aggregation shows that repulsive forces are dominating and this is caused by two mechanisms: (a) electrostatic repulsion and (b) steric repulsion. The caseins generally have negative overall charge at pH values relevant to cheesemaking, and especially the CMP part of κ -casein carries high-negative charge. However, electrostatic repulsion cannot alone account for the stability of casein micelles. Calculations based on the Derjaguin, Landau, Verwey and Overbeek theory which considers the effects of electrostatic repulsion and van der Waals attraction show that casein micelles would not be stable towards aggregation if electrostatic repulsion were the only repulsive effect (Payens, 1979). Additional stabilisation comes from the fact that the CMP part of κ -casein protrudes from the micelle surface, thus physically hindering contact between micelles through steric stabilisation (Holt, 1975; Walstra, 1979). The protruding CMP is often referred to as 'the hairy layer' and the micelle as 'the hairy micelle' (Holt & Horne, 1996).

Upon hydrolysis of κ -casein by the coagulant, CMP is released, leaving *para*- κ -casein attached to the micelle. The removal of CMP from the micelle surface leads to a decrease in electrostatic repulsion between micelles as indicated by the drop in ζ -potential from -19 mV of intact micelles to -12 mV for fully hydrolysed micelles at 30°C (Dalglish, 1984), and the steric stabilisation is also decreased. The loss of electrostatic repulsion and steric stabilisation allows attractive forces to come into play, and the micelles start to aggregate. Van der Waals forces act between all molecules and particles, and they are always attractive between like particles. Hydrophobic interactions are probably also important since all the caseins have hydrophobic regions and hydrophobic interactions are thought to be important for bonding between casein molecules inside the micelles. The temperature dependence of aggregation could also indicate the importance of hydrophobic interactions. Aggregation is reduced by decrease in temperature, and below $\sim 15^\circ\text{C}$ aggregation does not normally take place (Dalglish, 1983). Since aggregation is also very dependent on the concentration of calcium, it has been speculated that calcium is involved in specific binding between micelles, but calcium might also simply reduce electrostatic repulsion by neutralisation of negative charges on the caseins.

3.7.2 Kinetics of enzymatic coagulation of milk

Fig. 3.4 shows an overview of the time course of the different reactions happening during enzymatic coagulation of milk. The first reaction, often called the primary enzymatic reaction, is the hydrolysis of κ -casein, which leads to release of the CMP-part of κ -casein, thus gradually destabilising the micelles. When the hydrolysis has reached a certain level, the so-called secondary aggregation process starts, the *clotting time* (CT) being defined as the time taken from the addition of the coagulant until the first visible flocks are formed in a milk film. In an undisturbed milk sample, flocks will continue to grow, and eventually one flock will span the entire volume of milk; this marks the *gelation time* (GT). The firmness of the gel will continue to grow, and the *time to cutting* (TC) is then defined as the time from coagulant addition until the gel has the firmness needed to start cutting. It is worthwhile to note that while the strength of coagulants is defined by methods based on clotting time

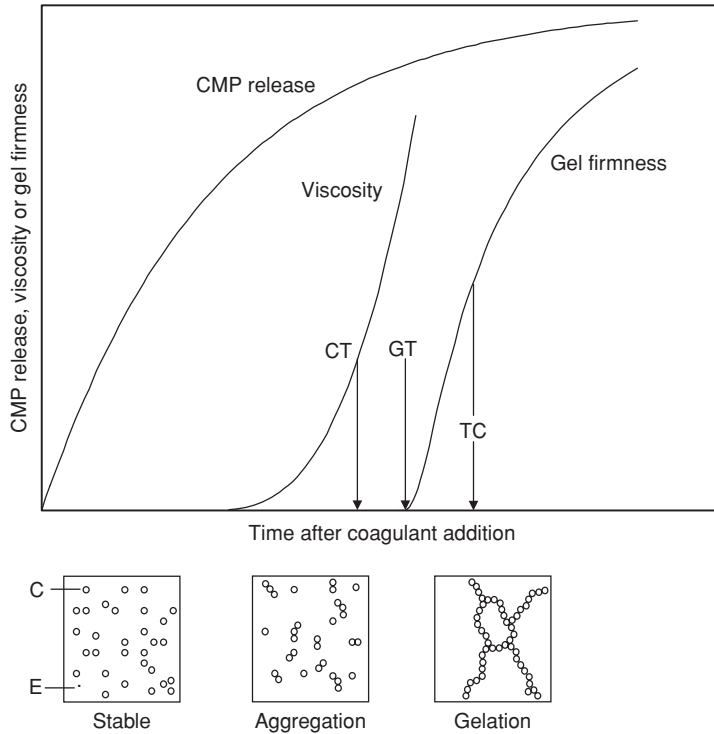

Fig. 3.4 Schematic representation of the time course of the events during enzymatic milk coagulation (release of CMP, development of viscosity and gel firmness) and their relation to the stages of stability, aggregation and gelation. CMP, caseinomacropeptide; C, casein micelles; E, enzyme molecule. Characteristic times: CT, clotting time, GT, gelation time, TC, time to cutting, i.e. to obtain the desired firmness. (Data modified after van Hooydonk and van den Berg, 1988.)

(e.g. IMCU), the time to cutting is of much more practical importance, since it marks the appropriate time for initiation of the next step in the cheesemaking process.

The relation between enzyme concentration and clotting time is often described by the Holter–Foltmann equation (Foltmann, 1959):

$$CT([E]) = \left(\frac{k}{[E]} \right) + A$$

where CT is the clotting time, [E] the enzyme concentration, and *k* and *A* are constants. When plotting the clotting time versus the reciprocal of the coagulant concentration, the so-called Holter–Foltmann plot, a straight line with a positive intercept (*A*) at the ordinate axis is obtained (Fig. 3.5). This highlights that, while the clotting time is highly dependent on the enzyme concentration, there is no simple inverse proportionality between the two. The reason is that clotting is a result of two reactions: firstly, the enzymatic hydrolysis of κ-casein and secondly, the subsequent aggregation of the (partly) renneted micelles. If the rate of the overall process were determined by the rate of the enzymatic hydrolysis of κ-casein alone, an inverse proportionality would be expected, since it is known that the rate of κ-casein

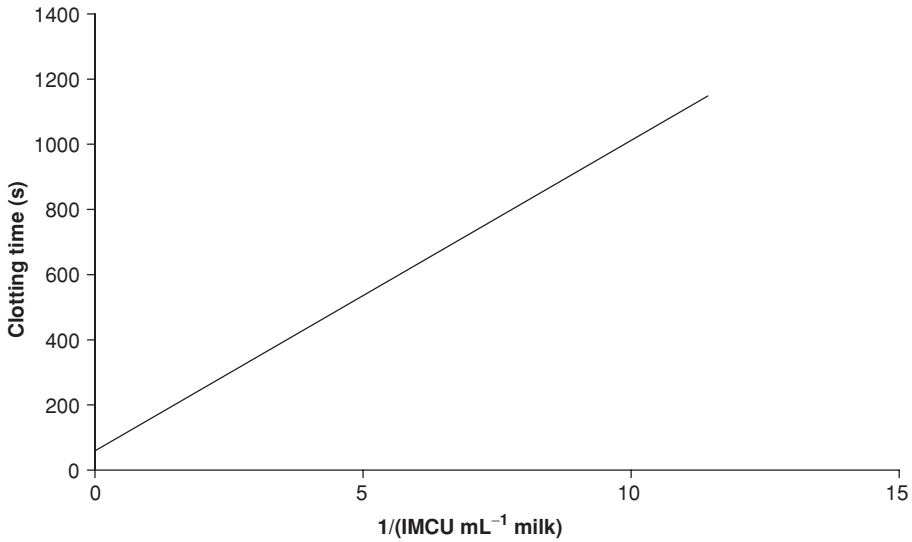

Fig. 3.5 A schematic illustration of the Hoelter–Foltmann plot, depicting the clotting time as a function of the reciprocal of the amount of coagulant used.

hydrolysis by coagulant in milk under normal cheesemaking conditions is proportional to the coagulant concentration (van Hooydonk *et al.*, 1984; Lomholt & Qvist, 1997). According to the equation, CT is equal to A at infinite $[E]$; i.e. under conditions where the enzymatic reaction would proceed infinitely fast. The parameter A has thus been interpreted as the amount of time needed by the aggregation process to reach the level of aggregation where clotting can be observed. And:

$$CT([E]) - A = \frac{k}{[E]}$$

must, consequently, be the time needed for the enzymatic process to reach the critical degree of κ -casein hydrolysis necessary for aggregation to begin. Calling this time t_c , and noting that first-order kinetics applies for the enzymatic reaction under usual conditions, we can write:

$$t_c = -\frac{\ln(1 - \alpha_c)}{k_1}$$

where k_1 is the first-order reaction rate constant. By equating the two expressions for the critical time and making use of $k_1 = k_1' \times [E]$ (k_1' being the turnover rate of the enzyme), the slope in the Holter–Foltmann plot turns out to be:

$$k = -\frac{\ln(1 - \alpha_c)}{k_1'}$$

Thus, the slope k is increased when the critical degree of hydrolysis goes up, or when the turnover rate goes down, i.e. under conditions where the enzymatic reaction takes more time, and it is possible to get some indications about the enzymatic and aggregation reactions from Holter–Foltmann plots. They should be interpreted with care, however, since it is a simplified

and empirical description of the reaction. It also turns out, that the Holter–Foltmann equation is only valid over restricted ranges of enzyme concentrations.

The Holter–Foltmann equation illustrates that a kinetic description of clotting must take both the enzymatic and aggregation reactions into account. A more realistic description must further take into account that the two processes are overlapping in time. The conversion from a stable system to an aggregating one is not instantaneous, but the result of a gradual increase in the rate of aggregation as a function of the hydrolysis of κ -casein. Viscosity measurements indicate that measurable aggregation starts when around 60 g 100 g⁻¹ of κ -casein has been hydrolysed around 30°C in undiluted milk at its natural pH (Lomholt & Qvist, 1997).

An overall kinetic description of the process as a whole must describe how aggregation depends on the degree of hydrolysis. While hydrolysis of κ -casein in milk can be described as a first-order reaction, aggregation reactions in dilute systems have been described using von Smoluchowski's equation that gives the rate of change in the number of particles, and allows the calculation of the average degree of aggregation as a function of time. The basic equation describes so-called rapid aggregation where all collisions lead to aggregation, but a stability factor can be introduced to account for so-called slow aggregation where only a fraction of collisions lead to aggregation. von Smoluchowski's equation has been used as a basis for describing the aggregation part of the reaction in a number of models for the overall kinetics of the reaction (Payens, 1976; Hyslop *et al.*, 1979; Dalgleish, 1980, 1988; Darling & van Hooydonk, 1981; Hyslop, 1989; Bauer *et al.*, 1995). The difference between models is largely based on how the aggregation rate constant is modelled and how it depends on the enzymatic hydrolysis of κ -casein.

A number of these models have been reviewed and tested by Hyslop & Qvist (1996) and Lomholt *et al.* (1998). The model shown to be best in accordance with experimental data is based on an idea of an energy barrier against aggregation, which was introduced by Darling and van Hooydonk (1981), and later used by several authors. Before coagulant addition, the barrier is so high that only a negligible fraction of all collisions have the energy to overcome the barrier and thus aggregation is negligible. As the CMP part of κ -casein is removed, the energy barrier is gradually decreased so that the number of collisions having the energy to overcome the barrier gradually increases leading to a gradually decreased stability factor in the terms of von Smoluchowski's equation, and thus an increasing aggregation rate. The energy barrier model describes the initial stages of enzymatic coagulation, up to aggregates of ~5–10 micelles have been formed quite well, and adequately accounts for the effect of enzyme concentration and to some extent casein concentration (Lomholt *et al.*, 1998). When aggregates become larger, ultimately a gel is formed; von Smoluchowski's equation is no longer valid.

3.8 Application of rennet and coagulants

This section gives an overview on the most important aspects relating to the use of rennet and coagulants in cheesemaking.

3.8.1 Trends in use

The use of FPC has grown steadily since it was introduced in 1990 and, today, the FPC is applied in more than half of the world's enzyme-coagulated cheese production. The main

reasons for its success are high specificity, purity, good and robust curd formation properties as well as a number of certifications necessary to fulfil the requirements from various consumer groups/segments, e.g. religious or vegetarian. The price of traditional rennet extracted from animal stomachs has fluctuated considerably over the years due to varying availability of stomachs, or due to veterinarian crises, such as mad cow disease. The use of animal rennet has gradually decreased, and it is now primarily applied for traditional cheese types with protected designation of origin, such as *Appellation d'Origine Contrôlée* and *Denominazione di Origine Protetta* cheeses for which only animal rennet is allowed, and in markets where GM issues are of concern. Microbial coagulants, especially *R. miehei* aspartic protease, constitute a considerable part of the total market and today they are used to a larger extent than animal rennet, primarily due to a relatively low price. The majority of all rennet and coagulant products are traded in IMCU, which makes it easy for the cheesemaker to compare activity and prices of similar type coagulants. Different types of coagulants cannot be compared by IMCU only, as differences in dosage, yield and flavour development may occur depending on the cheesemaking conditions.

3.8.2 Handling and use of rennet and coagulants

While the formulation of commercial rennet and coagulants helps protect the enzyme activity during transportation, storage and handling, the enzyme is still susceptible to self-digestion and to contamination by microorganisms. Cold storage (0–8°C) improves the stability of the products significantly. The coagulant is normally added to the cheese milk after the starter culture has been added and slightly lowered the pH of the cheese milk (the 'pre-ripening step'). Dilution of the coagulant in good quality tap water is generally recommended prior to addition to facilitate an even distribution in the milk. Normally, it should take less than 5 min of agitation to accomplish this, after which stirring is stopped. The water should be cold, free of chlorine and have a neutral to slightly acidic pH. If chlorine is present in the water or the pH is too high, dilution should be done immediately before addition or, alternatively, a small amount of milk can be added to the dilution water to scavenge the chlorine and high pH. A too long holding time of the diluted coagulant at ambient temperatures may lead to activity loss, in particular if the water of poor quality is used. Various automatic or semi-automatic dosage systems, typically involving some holding of the diluted coagulant, are used to facilitate coagulant addition into the cheese vat. Excessive stirring, mixing or pumping may cause some inactivation and should be avoided. The dosage of coagulants varies considerably with cheese type, coagulant type and the technology applied. The typical dosage range is 3000–6000 IMCU 100 kg⁻¹ of cheese milk to obtain a curd ready for cutting within 20–40 min after addition.

3.8.3 Milk quality, treatment and additives

Some parts of the world face the phenomenon of poorly coagulating milk, which makes cheesemaking difficult. The clotting and curd formation properties vary considerably between individual cows, and are related to protein composition and genetic polymorphism (Wedholm *et al.*, 2006) as well as the calcium content and pH. Poor microbial quality and high

somatic cell count can negatively affect the coagulation properties (Cassandro *et al.*, 2008). Interestingly, un-pasteurised milk may be difficult to coagulate using *R. miehei* coagulants due to presence of active antibodies inhibiting these enzymes.

Cold storage of milk at low temperatures increases coagulation time and may cause weaker curd and a higher fat, protein and fines losses in the whey. This is mainly due to solubilisation of calcium phosphate and casein (especially β -casein) from the micelles and to progressive degradation of casein by plasmin and proteolytic enzymes from psychotropic microorganisms. Casein micelle structure, and coagulation and curd-forming properties can be partially re-established by a normal pasteurisation, e.g. 72°C for 15 s (Qvist, 1979), or by holding the milk after cold storage for 30–60 min at 60–65°C (Reimerdes *et al.*, 1977).

Standardisation of milk composition – Often the fat and sometimes the protein contents of milk are adjusted prior to cheesemaking. The purpose of fat standardisation is to maintain the composition of the cheese within legal limits, and to achieve the desired cheese characteristics. Standardisation of protein content to a higher level, in combination with fat standardisation, can be used to increase cheese output per vat, and as a means to even out annual and lactational differences in milk composition, thus obtaining better process control throughout the year. Finally, various concentrated or dried milk or milk protein products are sometimes added to the cheese milk, when it is economically advantageous to do so. Most of these modifications of milk composition affect curd formation. High fat levels tend to weaken the curd, and may lead to higher fat loss in the whey. Increasing the casein content will usually not affect the clotting time greatly, but result in faster development of gel firmness (Thomann *et al.*, 2008). Generally, the protein content of milk should not be increased more than about 1.5-fold when normal cheesemaking equipment is used; otherwise it will be difficult to control the firmness at cutting, which may lead to excessive loss of fat and fines due to tearing of the curd. Supplementing milk with milk-protein products containing considerable amounts of denatured whey proteins will generally impair coagulation. If vegetable oil is used as a fat substitute, the associated homogenisation step will cause some impairment of the coagulation properties.

Excessive heating at temperatures above 70°C leads to denaturation of whey proteins, prolongs the coagulation time and reduces the rates of curd formation (Lucey *et al.*, 1994; Steffl *et al.*, 1996), due to complex formation of κ -casein with denatured β -lactoglobulin, which impedes the aggregation of micelles.

Homogenisation results in slower curd formation and syneresis, leading to higher moisture content in the final cheese. After homogenisation, the fat globules are covered mainly by casein, and they become an integral part of the casein network during coagulation (Green *et al.*, 1983). Consequently, curd formation of reduced-fat cheese may be less affected by homogenisation than of full-fat cheese.

Addition of calcium and sodium

Addition of calcium chloride (CaCl_2) to cheese milk decreases the pH, reduces clotting time and speeds up the curd formation. In a typical cheese production site, 0–20 g CaCl_2 100 kg⁻¹ milk is added before the addition of the coagulant, without affecting final cheese quality. Addition of calcium chloride to the cheese milk can alleviate cold-storage and heat-induced impairments of clotting and curd firmness, and improve poor coagulating milk if the cause is

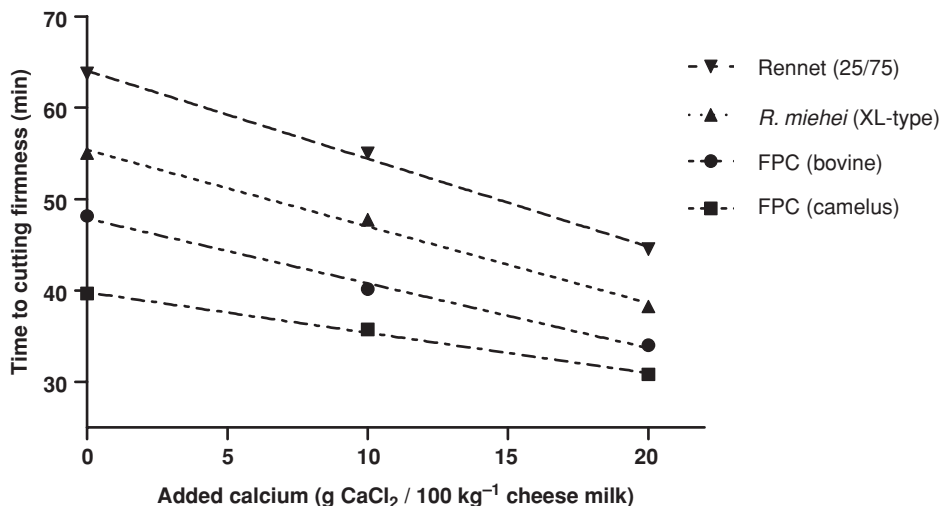

Fig. 3.6 The effect of calcium addition on curd formation (time to cutting firmness) using four types of commercial coagulants. Note: Animal rennet (25% chymosin, 75% pepsin), *Rhizomucor miehei* XL-type, fermentation-produced chymosin (FPC) (bovine) and FPC (camelus) dosed at 3500 IMCU 100 kg⁻¹ cheese milk containing 2.5 g fat 100 g⁻¹ and 3.3 g protein 100 g⁻¹ at 32°C and pH 6.55 before calcium chloride addition.

low calcium content (Fig. 3.6). The effect is probably due to a combination of: (a) calcium-binding to the casein micelles in such a way that it reduces the repulsive forces between them, thus enhancing hydrophobic interactions and (b) a slight drop in pH promotes the action of the coagulant and increases the rate of aggregation.

The addition of NaCl is limited to <0.5 g 100 g⁻¹ as it increases the speed of curd formation, while higher dosage has the opposite effect.

Coagulation temperature and pH

The rates of hydrolysis, aggregation and syneresis increases with increasing temperature, until the enzyme starts to be heat inactivated. The optimum temperature for curd formation at pH 6.5 is in the range of 34–38°C for most commercial coagulants. In practice, coagulation is usually done at temperatures from 30 to 35°C to have adequate control over curd firmness at cutting, and to give the starter culture suitable conditions to start fermenting the milk. The pH has a large effect on coagulation and the properties of the curd, as a reduction in pH will speed up the rate of κ -casein hydrolysis and the subsequent aggregation of casein micelles. Lowering the pH and increasing the temperature of the milk from normal values (~pH 6.6 and 31°C) allow the coagulation to occur at a lower degree of κ -casein hydrolysis (Guinee & Wilkinson, 1992). A moderate decrease in milk pH (e.g. to pH 6.4) results in modest solubilisation of the calcium from the casein micelles, which leads to a faster formation and a firmer curd. However, a higher degree of calcium solubilisation leads to extensive demineralisation of casein micelles, which results in weaker and more flexible curd gels (Choi *et al.*, 2007). For some soft cheeses, a step of extensive demineralisation is

required before coagulant addition to obtain the desired structure and body of the mature cheese.

3.8.4 Controlling the curd firmness at cutting

Controlling the curd firmness at cutting is a key parameter to control loss of dry matter into the whey and thereby maximise the cheese yield. Beyond a certain level, a higher firmness at cutting tends to result in the retention of more moisture in the final cheese, decreased recovery of fat (Johnson *et al.*, 2001) and possibly more fines in the whey leading to reduced protein recovery. It is important to note that no universal optimal firmness at cutting exists; the best firmness depends both on the equipment used, cheese type and on operating conditions. After cutting, a healing time of 5–10 min is often used to allow the newly formed cheese grains to form a surface skin, and thereby greater mechanical stability, before stirring and the mechanical stress associated with it is initiated.

Traditionally, a manual curd cut test has been used to assess firmness, but this has become more difficult with closed cheese vats. Large cheese plants, therefore, often initiate cutting simply based on a predefined time protocol. Some producers find it useful to determine the CT and then, based on experience, fix the TC to 1.2–2.0 times the value of CT. Options available for securing a consistent firmness at cutting through online monitoring of coagulation in the cheese vat have been reviewed by O’Callaghan *et al.*, (2002), and include several types of optical probes, vibration probes and so-called hot-wire probes. Recent work has suggested that an online optical sensor detecting light backscatter can be applied to monitor both coagulation and syneresis during cheesemaking (Fagan, 2008), which could potentially allow improved cheese moisture control.

Over the years, a number of laboratory instruments have been developed with the aim of providing an objective measure of curd firmness. An example recently applied is the ‘ReoRox’, based on free oscillation, which can be used in the laboratory or beside the cheese vat to monitor and predict influence on curd formation of different factors and conditions of interest.

3.8.5 Performance of different rennet and coagulants available in the market

The ratio between milk-clotting activity and general proteolytic activity, the so-called C/P ratio where C represents the clotting activity measured in IMCU, and P the general proteolytic activity towards a casein substrate is a useful measure of the specificity of the enzymes. The C/P ratio is, therefore, an intrinsic factor linking directly to the performance in cheese making such as dosage, curd formation properties, cheese yield and/or flavour. It is generally agreed that a ranking of the commercially available rennet and coagulants by decreasing specificity (C/P ratio) is as follows: FPC (camelus) > FPC (bovine), calf chymosin > bovine pepsin > *R. miehei* (XL type) > *R. miehei* (L type) > *C. parasitica*.

The influence of pH is one of the main process factors affecting the curd formation, and the pH-dependency differs between the types of rennet and coagulants. Curd forming properties of destabilised *R. miehei* (XL type) is more influenced by changes in pH than FPC (camelus)

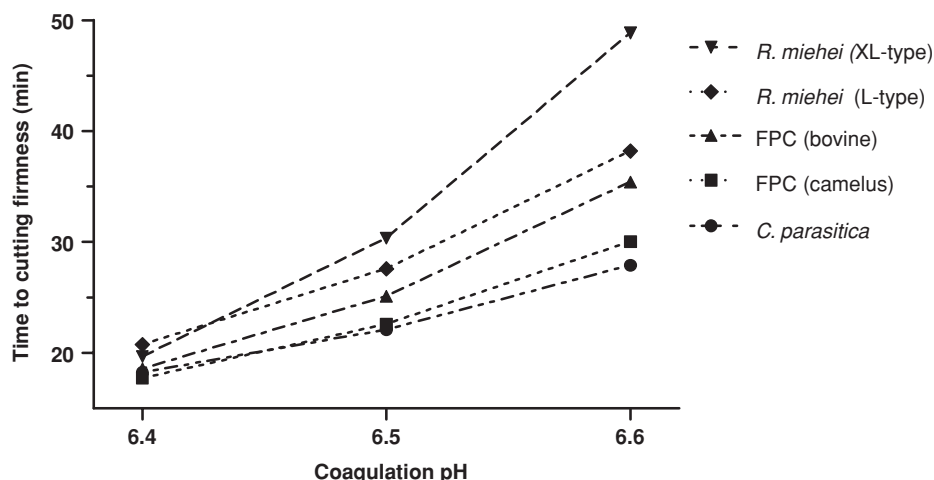

Fig. 3.7 pH influence on curd formation using five types of commercial coagulants dosed at 3700 IMCU 100 kg⁻¹ milk containing 3.1 g fat 100 g⁻¹ and 3.5 g protein 100 g⁻¹ at temperature 32°C. FPC, fermentation-produced chymosin; IMCU, international milk clotting units.

or *C. parasitica* as illustrated in Fig. 3.7. In a typical range of pH 6.4–6.6 a listing of pH influence on curd-firming properties in decreasing order is bovine pepsin > *R. miehei* (XL type) > *R. miehei* (L type), FPC (bovine), calf chymosin > FPC (camelus) > *C. parasitica*.

Calcium addition to the milk increases the speed of curd formation with a linear effect. However, the curd formation of FPC (camelus) seems to be least influenced by calcium addition followed by FPC (bovine), *R. miehei* (XL) and rennet with high pepsin level (25/75), which may be linked strongly to the effect on pH.

The temperature influences the speed of curd formation as all enzymes tend to give faster curd formation at increasing temperature until they approach their optimal temperature. The dependency on temperature is also influenced by pH, the lower the pH (6.3–6.7), the better they tolerate higher temperature because the enzymes are more stable at lower pH. Among the coagulants, the heat-labile type XL version of *R. miehei* and *C. parasitica* coagulants are most affected (inactivated) at high temperatures whereas the L type is least affected.

Dosage differences among rennet and coagulants – Dosage of coagulants is mostly calculated in IMCU 100 L⁻¹ milk. In general, the coagulant dosage is related to the proteolytic specificity with the relation that higher specificity leads to lower IMCU needed to coagulate within a specific set time. Table 3.4 shows the relative dosages when using different types of milk-clotting enzymes and pH, which gives the same cured firmness within the same given time. *C. parasitica*, for example, deviates from the general rule mentioned above by giving a very efficient curd formation, but at the same time having a low C/P ratio. Pepsin is a less efficient curd former (per IMCU) compared to chymosin, and it is much more influenced by pH changes. In practice, this means that applying high-chymosin compared to high-pepsin rennet a much lower dosage of high-chymosin coagulant is needed to form the same curd firmness within the same time.

Cheese yield is often defined simply as the amount of cheese obtained from a given amount of cheese milk, e.g. kg 100 kg⁻¹ milk, and is influenced by the loss of fat, solids non-fat, curd fines in the whey; in addition, by the moisture and salt content of the cheese. Usually,

Table 3.4 Typical relative dosage differences in IMCU^a among rennet and coagulants at typical coagulation pH.

Coagulant type	pH			
	6.6	6.5	6.4	6.3
FPC ^b (bovine)	100	100	100	100
Calf rennet (75/25) ^c	110–120	105–115	100–110	100
Adult bovine rennet (25/75) ^c	140–165	125–150	110–120	100–110
FPC (camelus)	65–80	70–85	75–90	90–100
<i>Rhizomucor miehei</i> (L type)	110–120	105–115	100–110	100
<i>Rhizomucor miehei</i> (TL-type)	115–130	110–120	105–115	95–105
<i>Rhizomucor miehei</i> (XL-type)	125–150	115–140	110–130	100–115
<i>Cryphonectria parasitica</i>	60–75	65–80	70–90	80–100

Note: FPC (100% chymosin) is set to an index value of 100 as a reference.

^aInternational milk clotting units.

^bFermentation-produced chymosin.

^cRatio of chymosin/pepsin.

it is preferable to report cheese yield in a manner that is independent of the actual moisture content, e.g. as moisture adjusted yield, or as dry matter yield. Cheese yield trials at industrial scale are often a big challenge; while yield differences between vats are often comparable to normal process variation, they may, nevertheless, be of considerable economic consequence. Although a complete mass balance for transfer of fat and protein from milk to cheese and whey undoubtedly is the most satisfactory way to conduct cheese yield investigations, it is often difficult or impossible to quantify the product streams sufficiently accurate and/or to secure adequate sampling. Fortunately, when identical milk can be used, the much simpler approach of analysing the whey will give a good indication of the yield differences that one can expect.

In the cheese vat, the casein micelles and later the casein matrix undergo proteolytic attack by the coagulant added, and depending of its general proteolytic activity more or less casein-derived peptides will be released, and end up in the whey, thus detracting from the cheese yield. Fig. 3.8 clearly demonstrates that the concentration of small peptides in the whey made with three coagulants decrease in the order *R. miehei* > FPC (bovine) > FPC (camelus).

Differences in the cheese yield among different types of coagulants are linked to their proteolytic specificity (see the C/P ratio explained above), as highly specific coagulants provides higher cheese yield. This has been substantiated in numerous cheese yield trials and quality studies comparing various commercial rennet and coagulant types (Broome & Hickey, 1990; Emmons *et al.*, 1990; Ustunol & Hicks, 1990; Emmons & Binns, 1991; Banks, 1992; Barbano & Rasmussen, 1992; Guinee & Wilkinson, 1992; Quade & Rüdiger, 1998) and reviewed by Emmons & Binns (1990) and Garg & Johri (1995). To obtain good data on cheese yield studies with different coagulants, it is important to secure that the different milk supplies used are distributed over the coagulants to be compared in a balanced way, and that they are all dosed as such that cutting happens at similar curd firmness. In other words, sound experimental design is essential.

Table 3.5 is based on a number of cheese yield studies and contains a comparison of the differences in cheese yield that can be expected when using different coagulants, compared

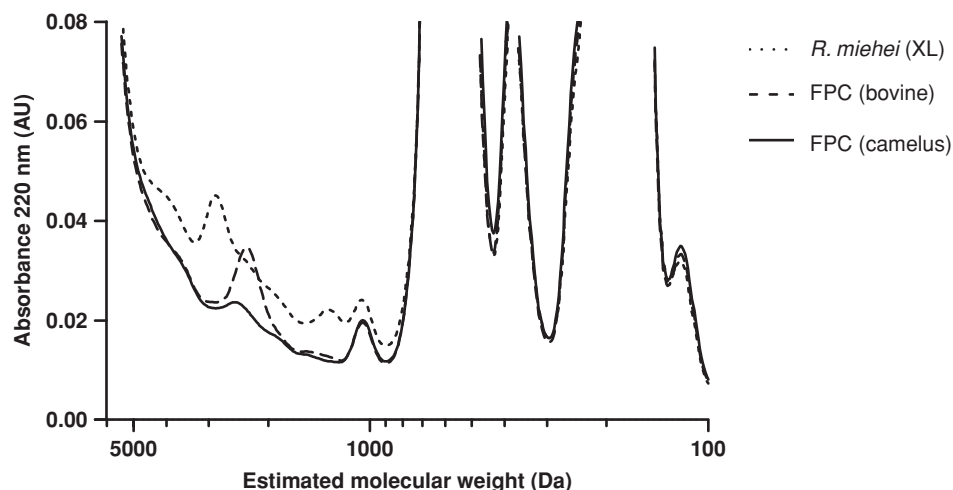

Fig. 3.8 Size exclusion chromatogram (Superdex10/300 GL; Eluent: 150 mM NaCl, 50 mM NaH₂PO₄, pH 5.8) showing peptide profiles of Cheddar whey produced with *Rhizomucor miehei*, FPC (bovine) and FPC (camelus), dosed to obtain similar firmness at cutting. FPC, fermentation-produced chymosin.

with the use of FPC (bovine). A careful calculation based on coagulant prices and dosage, cheese yield and price, and whey composition and value will often find the differences to be economically significant for the cheese producer.

Coagulants and whey processing – Over the past 30 years, whey has become increasingly valuable due to development of a market for a large number of whey-derived products, such as whey protein concentrates, whey protein isolates, fractions enriched in, for example, β -lactoglobulin or α -lactalbumin, high-value proteins, such as lactoferrin, lactoperoxidase, immunoglobulins and CMP, as well as phospholipids and lactose. Also, there is a growing requirement for pharmaceutical grade products and for products certified as Halal and Kosher. The value of whey has thus increased to an extent where cheese production in many cases would not be profitable if the economical potential of whey were not harvested. Consequently,

Table 3.5 Cheese yield difference compared to FPC^a (bovine) using different coagulants.

Coagulant	Yield ^b difference compared to FPC (bovine) (kg cheese 100 kg ⁻¹ cheese)
FPC (camelus)	+0.2
FPC (bovine)	0.0
Calf rennet (95/5) ^c	-0.0
Adult bovine rennet (25/75) ^c	-0.3
<i>Rhizomucor miehei</i> (L/XL-type)	-0.7/-0.5
<i>Cryphonectria parasitica</i>	-1.2

^aFermentation-produced chymosin.

^bData based on studies by Emmons *et al.* (1990), Emmons and Binns (1990, 1991), Banks (1992), Barbano and Rasmussen (1992) and M.L. Broe (unpublished results, 2007).

^cRatio of chymosin:pepsin in IMCU.

Table 3.6 Heat liability of coagulants in whey.

Type of coagulant	Loss of activity (%) after pasteurisation at 72°C for 15 s		
	pH		
	5.0	5.5	6.0
Animal rennet (calf, adult bovine) and FPC ^a	6	40	>98
Microbial coagulant type L	1	2	3
Microbial coagulant type TL	14	41	82
Microbial coagulant type XL, XLG/XP	17	68	>98

^aFermentation-produced chymosin.

it has become very important to consider the effect of all elements of the cheesemaking technology on the properties of whey as a raw material for processing. The choice of coagulant is no exception to this.

Residual-clotting activity in whey protein products is highly unwanted, and it is therefore important that the coagulant can be inactivated by a heat treatment that does not damage whey protein functionality significantly, e.g. 72°C for 15 s. Table 3.6 shows that in the case of FPC (bovine) more than 98% of the clotting activity is destroyed after pasteurisation at pH 6.0 or higher, which is sufficient. The original versions of *Rhizomucor* spp. coagulants were much more heat stable, but variants destabilised through oxidation are available.

Enzymatic side activities can also cause problems in whey products. Both *R. miehei* coagulants and FPC may contain starch-degrading enzymes that partly survive pasteurisation and cause problems in food products containing starch. Lipase is another example of unwanted side activity in coagulants. Therefore, today steps are taken to remove these activities in most fermentation-produced coagulants. Chromatographic purification is an efficient method for removing not only starch-degrading enzymes, but also all side activities, which is convenient, given that whey proteins are used in an ever expanding range of food compositions. Further, chromatographic purification, by reducing complexity, helps to reduce the likelihood of allergic response to the coagulant.

Even the unspecific cleavage of casein by a coagulant may be considered as side activity, causing the whey to contain casein-derived peptides to a larger extent (Fig. 3.8). Due to their small molecular size, it is questionable to what extent these peptides will end up in whey protein products and, if they do, they may contribute little to the functional properties. In line with this, it makes sense to strive towards production systems with 'pure' product streams, e.g. whey with as little casein-derived material, or other reaction products from enzymatic side activities, as possible. Coagulants with high purity and specificity are of course helpful in that respect.

3.8.6 Coagulants and cheese ripening

The general role of coagulants during cheese ripening is to cleave casein into fairly large peptides that are subsequently degraded by proteases and peptidases from microorganisms

(starter, adjunct or non-starter lactic acid bacteria), and are finally turned into amino acids and flavour compounds. The degradation of casein by coagulants and plasmin has often been linked to early texture changes in cheese (Guinee & Wilkinson, 1992), but recent studies have suggested that solubilisation of calcium plays also an important role (O'Mahony *et al.*, 2005; Choi *et al.*, 2007). Chapter 7, Fox & McSweeney (1997) and Upadhyay *et al.*, (2004) review cheese ripening.

The proportion of coagulant retained in the curd after whey separation is greater than would be expected by simple water partition, suggesting binding of coagulant to the curd. Casein and coagulant interaction is complex, but electrostatic forces seem to play an important role for the retention (Bansal *et al.*, 2007). For chymosin, it has been shown that the retention increases with decreasing pH, whereas it is more pH-independent for the *R. miehei* derived coagulants (Guinee & Wilkinson, 1992). For chymosin (i.e. calf rennet) up to 15–30% retention has been found, but the amount which remains in the final cheese varies with factors such as enzyme type, cooking temperature and pH at whey drainage (Guinee & Wilkinson, 1992; Upadhyay *et al.*, 2004). Cooking or scalding of the curd will inactivate part of the retained enzyme; in a highly cooked cheese, such as Emmental, only little amount of the enzyme is left in the product. Once transferred to the cheese in active form, coagulants retain their activity throughout ripening.

Most cheese types can be made with satisfactory results using most coagulants, but differences in their proteolytic properties cause differences in texture development and cheese flavour (Bansal *et al.*, 2009). The use of high chymosin (bovine rennet) compared to FPC (bovine) caused, as expected, no major sensory differences in Gouda cheese (van den Berg & de Koning, 1990) or in Cheddar cheese (Broome & Hickey, 1990). In Cheddar cheese, Broome *et al.*, (2006) found that *C. parasitica* and FPC (bovine) were more active on α_{s1} -casein compared to *R. miehei* (XL type), whereas β -casein was more excessively degraded by *C. parasitica* followed by *R. miehei* and FPC (bovine). The coagulants with highest general proteolytic activity (lowest C/P ratio) tend to give faster but less balanced proteolysis, and some have been reported to give transient bitterness, which caused by temporary accumulation of bitter peptides, short texture or texture softening (Guinee & Wilkinson, 1992; Garg & Johri, 1994; Bansal *et al.*, 2009).

FPC (camelus), with the highest known specificity to bovine milk, has recently been shown to be suitable for Cheddar cheese production and, compared to FPC (bovine), it efficiently reduces the development of bitterness during ripening. Bitterness scores of Cheddar cheese made with FPC (camelus) were lower than those of FPC (bovine) cheeses, apparently due to absence of the bitter peptides β -Cn ($f_{193-209}$) and β -Cn ($f_{190-209}$) in FPC (camelus) cheeses (Bansal *et al.*, 2009).

3.8.7 Choice of coagulant

Below is a list of considerations that it is useful to take into account when choosing coagulants:

- Fulfilment of legal requirements, e.g. relating to purity, safety and absence of unwanted components. If applicable, fulfilment of further requirement such as Kosher, Halal or organic certification.

- The overall economical consequences, taking into account the cheese yield, quality and price of the product, as well as coagulant cost and value of the whey.
- Ratio between clotting and general proteolytic activity (C/P ratio), a high ratio being desirable, since it promotes high cheese yield and protects against flavour and texture defects.
- Ability to develop high curd firmness at a given dosage in IMCU, meaning that the smallest possible dosage in IMCU can be used; generally related to a high C/P ratio.
- Stability of the coagulant at the pH and temperature of cheesemaking; in addition, stability supports good process control, and helps minimise losses of fat and curd fines in the whey due to variation in curd firmness at cutting.
- Robustness to pH and temperature. Since the pH and temperature of cheese milk is not always constant, the performance should influence as little as possible on variations. Again, this supports good process control.
- Development of normal cheese flavour and texture.
- Inactivation during whey pasteurisation; the coagulant should be essentially inactivated at 72°C for 15 s.
- Storage stability and ease of use of the coagulant.

3.9 Conclusions

Rennet has been used for clotting of milk and cheesemaking for thousands of years and became a commercial product in 1874. Lack of stomachs for rennet production led to the development of microbial milk-clotting enzymes in the 1960s and, the next generation of coagulants, FPC was introduced in 1990, with a newer generation of FPC based on camelus chymosin recently developed.

This chapter summarises for each type of milk-clotting enzyme the production, analysis, their characteristics and use in cheesemaking. Furthermore, the principle behind the complex reactions of curd formation and syneresis is described, when milk is enzymatically coagulated during cheesemaking.

In spite of the long history of rennet and coagulants many aspects concerning the milk-clotting enzymes and in particular their function is still not fully understood.

In future, the detailed understanding of the cheesemaking process will gradually increase and it is expected that the development of improved and new milk-clotting enzymes will continue.

References

- Andrén, A. (1982) *Chymosin and Pepsin in Bovine Abomasal Mucosa Studied by Use of Immunological Methods*, PhD Thesis, Department of Animal Husbandry, Swedish University of Agricultural Sciences, Uppsala, Sweden.
- Andrén, A. (1992) Production of prochymosin, pepsinogen and progastricsin, and their cellular and intracellular localisation in bovine abomasal mucosa. *Scandinavian Journal of Clinical and Laboratory Investigation*, **52** (Suppl 210), 59–64.
- Andrén, A. (1998) Milk-clotting activity of various rennets and coagulants: background and information regarding IDF standards. *The Use of Enzymes in Dairying*, Document No. 332, pp. 9–14, International Dairy Federation, Brussels.

- Baer, A. & Collin, J.C. (1993) Determination of residual activity of milk-clotting enzymes in cheese: specific identification of chymosin and its substitutes in cheese. Document No. 284, pp. 18–23, International Dairy Federation, Brussels.
- Banks, J.M. (1992) Yield and quality of Cheddar cheese produced using a fermentation-derived calf chymosin. *Milchwissenschaft*, **3**, 153–156.
- Bansal, N., Drake, M.A., Pirainoc, P., Broe, M.L., Harboe, M., Fox, P.F. & McSweeney, P.L.H. (2009) Suitability of recombinant camel (*Camelus dromedarius*) chymosin as a coagulant for Cheddar cheese. *International Dairy Journal*, **19**, 510–517.
- Bansal, N., Fox, P.F. & McSweeney, P.L.H. (2007) Factors affecting the retention of rennet in cheese curd. *Journal of Agricultural and Food Chemistry*, **55**, 9219–9225.
- Barbano, D.M. & Rasmussen, R.R. (1992) Cheese yield performance of fermentation-produced chymosin and other milk coagulants. *Journal of Dairy Science*, **75**, 1–12.
- Bauer, R., Hansen, M.B., Hansen, S., Øgendal, L., Lomholt, S.B., Qvist, K.B. & Horne, D.S. (1995) The structure of casein aggregates during renneting studied by indirect Fourier transformation and inverse Laplace transformation of static and dynamic light scattering data, respectively. *Journal of Chemical Physics*, **103**, 2725–2737.
- Broome, M.C. & Hickey, M.W. (1990) Comparison of fermentation produced chymosin and calf rennet in Cheddar cheese. *Australian Journal of Dairy Technology*, **45**, 53–59.
- Broome, M.C., Xu, X. & Mayes, J.J. (2006). Proteolysis in cheddar cheese made with alternative coagulants. *Australia Journal of Dairy Technology*, **60**, 85–87.
- Cassandro, M., Comin, A., Ojala, M., Zotto, R.D., Marchi, M. de Gallo, L., Carnier, P. & Bittante, G. (2008). Genetic parameters of milk coagulation properties and their relationships with milk yield and quality traits in Italian Holstein cows. *Journal of Dairy Science*, **91**, 371–376.
- Chitpinyol, S. & Crabbe, M.J.C. (1998) Chymosin and aspartic proteinases. *Food Chemistry*, **61**, 395–418.
- Choi, J., Horne, D.S. & Lucey, J.A. (2007). Effect of insoluble calcium concentration on rennet coagulation properties of milk. *Journal of Dairy Science*, **90**, 2612–2623.
- Collin, J.C., Moulins, I., Rolet-Répécaud, O., Bailly, C. & Lagarde, G. (1997) Detection of recombinant chymosins in calf rennet by enzyme-linked immunosorbent assay. *Lait*, **77**, 425–431.
- Dalgleish, D.G. (1980) A mechanism for the chymosin-induced flocculation of casein micelles. *Biophysical Chemistry*, **11**, 147–155.
- Dalgleish, D.G. (1983) Coagulation of renneted bovine casein micelles: dependence on temperature, calcium ion concentration and ionic strength. *Journal of Dairy Research*, **50**, 331–340.
- Dalgleish, D.G. (1984) Measurement of electrophoretic mobilities and zeta-potentials of particles from milk using laser doppler electrophoresis. *Journal of Dairy Research*, **51**, 425–438.
- Dalgleish, D.G. (1988) A new calculation of the kinetics of the renneting reaction. *Journal of Dairy Research*, **55**, 521–528.
- Darling, D.F. & van Hooydonk, A.C.M. (1981) Derivation of a mathematical model for the mechanism of casein micelle coagulation by rennet. *Journal of Dairy Research*, **48**, 189–200.
- Deschamps, J.P. (1840) De la pression. *Journal of Pharmacology*, **26**, 412–420.
- Dunn, B.M. (1997) Splitting image. *Nature Structure Biology*, **4**, 969–972.
- Dunn, B.M. (ed.) (1991) *Structure and Function of the Aspartic Proteinases*, Plenum Press, New York.
- ECC (1991) *Guidelines for the Presentation of Data on Food Enzymes*, Report of the Scientific Committee for Food, 27th series, pp. 13–21, Commission of the European Communities, Brussels.
- Emmons, D.B. & Binns, M. (1990) Cheese yield experiments and proteolysis by milk-clotting enzymes. *Journal of Dairy Science*, **73**, 2028–2043.
- Emmons, D.B. & Binns, M.R. (1991) Milk clotting enzymes. 4. Proteolysis during cheddar cheese making in relation to estimated losses of basic yield using chymosin derived by fermentation (*A. niger*) and modified enzymes from *M. Miehei*. *Milchwissenschaft*, **6**, 343–346.
- Emmons, D.B., Beckett, D.C. & Binns, M. (1990) Milk-Clotting Enzymes. 1. Proteolysis during cheese making in relation to estimated losses of yield. *Journal of Dairy Science*, **73**, 2007–2015.

- EU (2003) Regulation No 1829/2003 of the European Parliament and of the Council of 22 September 2003 on genetically modified food and feed and implementation report on regulation No 1829/2003 dated October 25, 2006. Available at http://eur-lex.europa.eu/pri/en/oj/dat/2003/L_268/L_26820031018en00010023.pdf.
- EU (2008) Regulation No 1332/2008 of the European Parliament and of the Council of 16 December 2008 on food enzymes and amending Council Directive 83/417/EEC, Council Regulation (EC) No 1493/1999, Directive 2000/13/EC, Council Directive 2001/112/EC and Regulation (EC) No 258/97. Available at <http://eur-lex.europa.eu/LexUriServ/LexUriServ.do?uri=OJ:L:2008:354:0007:0015:EN:PDF>.
- Fagan, C.C. (2008) On-line prediction of cheese making indices using backscatter of near infrared light. *International Dairy Journal*, **18**, 120–128.
- FAO (2006) Evaluation of certain food additives and contaminants. *Annex 5 General Specifications and Considerations for Enzyme Preparations Used in Food Processing*, WHO Technical Report series 940, Food and Agricultural Organization of the United Nations, Rome.
- Food Chemicals Codex (2003) *Food Chemicals Codex*, 5th edn, National Academy Press, Washington, DC.
- Flamm, E.L. (1991) How FDA approved chymosin: a case history. *Biotechnology*, **9**, 349–351.
- Foltmann, B. (1959) On the enzymatic and coagulation stages of the renneting process. *Proceedings 15th International Dairy Congress*, **2**, 655–661.
- Foltmann, B.F. (1966) A review on prorennin and rennin. *Comptes Rendus des Travaux des Laboratoire Carlsberg*, **35** (8), 143–231.
- Foltmann, B.F. (1985) Comments on the nomenclature of aspartic proteinases. *Aspartic Proteinases and their Inhibitors* (ed. V. Kostka), pp. 19–26, Walter de Gruyter & Co., Berlin.
- Foltmann, B.F. (1992) Chymosin: a short review on foetal and neonatal gastric proteases. *Scandinavian Journal of Clinical and Laboratory Investigations*, **52** (Suppl 210), 65–79.
- Foltmann, B.F. (1993) General and molecular aspects of rennets. *Cheese: Chemistry, Physics and Microbiology, Volume 1: General Aspects* (ed. P.F. Fox), pp. 37–68, Chapman & Hall, London.
- Fox, P.F. & McSweeney, P.L.H. (1997) Rennets: their role in milk coagulation and cheese ripening. *Microbiology and Biochemistry of Cheese and Fermented Milk* (ed. B.A. Law), 2nd edn, pp. 1–49, Blackie Academic & Professional, London.
- Garg, S.K. & Johri, B.N. (1994) Current trends and future research. *Food Reviews International*, **10**, 313–355.
- Garg, S.K. & Johri, B.N. (1995) Application of recombinant calf chymosin in cheesemaking – Review. *Journal of Applied Animal Research*, **7**, 105–147.
- Green, M.L., Marshall, R.J. & Glover, F.A. (1983) Influence of homogenization of concentrated milks on structure and properties of rennet curds. *Journal of Dairy Research*, **50**, 341–348.
- Guinee, T.P. & Wilkinson, M.G. (1992) Rennet coagulation and coagulants in cheese manufacture. *Journal of the Society of Dairy Technology*, **45**, 94–104.
- Harboe, M.K. (1985) Commercial aspects of aspartic proteases. *Aspartic Proteinases and their Inhibitors* (ed. V. Kostka), pp. 637–550, Walter de Gruyter & Co., Berlin.
- Harboe, M.K. (1992a) Chymogen, a chymosin rennet manufactured by fermentation of *Aspergillus niger*. *Fermentation-Produced Enzymes and Accelerated Ripening in Cheesemaking*, Document No. 269, pp. 3–7, International Dairy Federation, Brussels.
- Harboe, M.K. (1992b) Coagulants of different origin. *European Dairy Magazine*, **2**, 6–15.
- Harboe, M.K. (1993) Chymogen, Chr. Hansen's fermentation produced rennet. *Milk Proteins '93* (ed. J. Mathieu), pp. 122–131, ENILV, La Roche-sur Foron, France.
- Heimgartner, U., Pietrzak, M., Geertsen, R., Brodelius, P., Figueiredo, A.C. & Pais, M.S.S. (1990) Purification and partial characterisation of milk-clotting proteases from flowers of *Cynara Cardunculus*. *Phytochemistry*, **29**, 1405–1410.
- van Hooydonk, A.C.M., Olieman, C. & Hagedoorn, H.G. (1984) Kinetics of the chymosin-catalysed proteolysis of -casein. *Netherlands Milk and Dairy Journal*, **38**, 207–222.

- van Hooydonk, A.C.M. and van den Berg, G. (1988) Control and determination of the curd-setting during cheesemaking. *IDF Bulletin*, **225**, 2–10.
- Holt, C. & Horne, D.S. (1996) The hairy casein micelle: evolution of the concept and its implications for dairy technology. *Netherlands Milk and Dairy Journal*, **50**, 85–111.
- Holt, C. (1975) The stability of bovine casein micelles. *Proceedings International Conference on Colloid and Interface Science* (ed. E. Wolfram), pp. 641–644. Akademia Kiado, Budapest.
- Hyslop, D.B. & Qvist, K.B. (1996) Application of numerical analysis to a number of models for chymosin-induced coagulation of casein micelles. *Journal of Dairy Research*, **63**, 223–232.
- Hyslop, D.B. (1989) Enzymatically initiated coagulation of casein micelles: a kinetic model. *Netherlands Milk and Dairy Journal*, **43**, 163–170.
- Hyslop, D.B., Richardson, T., & Ryan, D.S. (1979) Kinetics of pepsin-initiated coagulation of kappa-casein. *Biochimica et Biophysica Acta*, **566**, 390–396.
- IDF (1997a) *Standard 110B – Calf Rennet and Adult Bovine Rennet – Determination of Chymosin and Bovine Pepsin Contents (Chromatographic Method)*, International Dairy Federation, Brussels.
- IDF (1997b) *Standard 157 A – Bovine Rennets – Determination of Total Milk-Clotting Activity*, International Dairy Federation, Brussels.
- IDF (2002) *Standard 176 – Milk and milk products – Microbial coagulants (Determination of Total Milk-Clotting Activity)*, International Dairy Federation, Brussels.
- IDF (2007) *Standard 157 – Determination of Total Milk-Clotting Activity of Bovine Rennets*, International Dairy Federation, Brussels.
- IUBMB (1992) Recommendations of the nomenclature committee of the International Union of Biochemistry and Molecular Biology on the nomenclature and classification of enzymes. *Enzyme Nomenclature*, pp. 403–408, Academic Press Inc., New York.
- James, M.N.G. (ed.) (1998) *Aspartic Proteinases*, Plenum Press, New York.
- Johnson, M.E., Chen, C.M., & Jaeggi, J.J. (2001) Effect of rennet coagulation time on composition, yield, and quality of reduced-fat Cheddar cheese. *Journal of Dairy Science*, **84**, 1027–1033.
- Kostka, V. (ed.) (1985) *Aspartic Proteinases and their Inhibitors*, Walter de Gruyter, Berlin and New York.
- Lomholt, S.B. & Qvist, K.B. (1997) Relationship between rheological properties and degree of kappa-casein proteolysis during renneting of milk. *Journal of Dairy Research*, **64**, 541–549.
- Lomholt, S.B., Worning, P., Øgendal, L., Qvist, K.B., Hyslop, D.B., & Bauer, R. (1998) Kinetics of the renneting reaction followed by measurement of turbidity as a function of wavelength. *Journal of Dairy Research*, **65**, 545–554.
- Lucey, J.A., Gorry, C. & Fox, P.F. (1994) Methods for improving the rennet coagulation properties of heated milk. *Cheese Yield and Factors Affecting its Control*, Special Issue 9402, pp. 448–456, International Dairy Federation, Brussels.
- Mulvihill, D.M. & Fox, O.F. (1977) Selective denaturation of milk coagulants in 5 M urea. *Journal of Dairy Research*, **44**, 319–324.
- O’Callaghan, D.J., O’Donnell, C.P. & Payne, F.A. (2002) Review of systems for monitoring curd setting during cheesemaking. *International Journal of Dairy Technology*, **55**, 55–64.
- O’Mahony, J.A., Lucey, J.A. & McSweeney, P.L.F. (2005). Chymosin-mediated proteolysis, calcium solubilisation and texture development during ripening of Cheddar cheese. *Journal of Dairy Science*, **88**, 3101–3114.
- Payens, T.A.J. (1976) On the enzyme-triggered clotting of casein; a preliminary account. *Netherlands Milk and Dairy Journal*, **30**, 55–59.
- Payens, T.A.J. (1979) Casein micelles: the colloid-chemical approach. *Journal of Dairy Research*, **46**, 291–306.
- Quade, H.D & Rüdiger, H. (1998). Ausbeutestudie zur Käseherstellung. *Deutsche Milchwirtschaft*, **12**, 484–487.

- Qvist, K.B. (1979) Reestablishment of the original rennetability of milk after cooling. I. The effect of cooling and LTST pasteurization of milk on renneting. *Milchwissenschaft*, **34**, 467–470.
- Rampilli, M., Larsen, R. & Harboe, M. (2005) Natural heterogeneity of chymosin and pepsin in extracts of bovine stomachs. *International Dairy Journal*, **15**, 1130–1137.
- Reimerdes, E.H., Pérez, S.J. & Ringqvist, B.M. (1977). Temperaturabhängige Veränderungen in Milch und Milchproducten. II. Der einfluss der Tiefkühlung auf käseerechnologische Eigenschaften der Milch. *Milchwissenschaft*, **32**, 154–158.
- Repelius, C. (1993) Application of Maxiren in cheesemaking. *Milk Proteins '93* (ed. J. Mathieu), pp. 114–121, ENILV, La Roche-sur-Foron, France.
- Rothe, G.A.L., Harboe, M.K. and Martiny, S.C. (1977). Quantification of milk-clotting enzymes in 40 commercial bovine rennets, comparing rocket immunoelectrophoresis with an activity ratio assay. *Journal of Dairy Research*, **44**, 73–77.
- Steffl, A., Ghosh, B.C. & Kessler, H.-G. (1996) Rennetability of milk containing different heat-denaturated whey protein. *Milchwissenschaft*, **51**, 28–31.
- Szecs, P.B. (1992) The aspartic proteases. *Scandinavian Journal of Clinical Laboratory Investigations*, **52** (Suppl 210), 5–22.
- Tamime, A.Y. (1993) Modern cheesemaking: hard cheeses. *Modern Dairy Technology – Advances in Milk Processing* (ed. R.K. Robinson), 2nd edn, pp. 49–220, Elsevier Applied Science, London.
- Thomann, S., Schenkel, P., & Hinrichs, J. (2008). Effect of homogenisation, microfiltration and pH on curd formation and syneresis of curd grains. *LWT – Food Science and Technology*, **41**, 826–835.
- Upadhyay, V.K., McSweeney, P.L.F., Magboul, A.A.A. & Fox, P.F. (2004). Proteolysis in cheese during ripening. *Cheese: Chemistry, Physics and Microbiology, Volume 1: General Aspects* (eds P.F. Fox, P.L.H. McSweeney, T.M. Cogan & T.P. Guinee) 3rd edn, pp. 391–434, Elsevier, London.
- Ustunol, Z., & Hicks, C.L. (1990) Effect of milk clotting enzymes on cheese yield. *Journal of Dairy Science*, **73**, 8–16.
- Van Den Berg, G. & de Koning, P.J. (1990) Gouda cheesemaking with purified calf chymosin and microbially produced chymosin. *Netherlands Milk and Dairy Journal*, **44**, 189–206.
- Walstra, P. (1979) The voluminosity of bovine casein micelles and some of its implications. *Journal of Dairy Research*, **46**, 317–323.
- Wedholm, A., Larsen, L.B. Lindmark-Mansson, H. Karlsson, A.H. & Andren, A. (2006). Effect of protein composition on the cheese-making properties of milk from individual cows. *Journal of Dairy Science*, **89**, 3296–3305.
- World Health Organisation (2006) Evaluation of certain food additives and contaminants. *Annex 5 General Specifications and Considerations for Enzyme Preparations Used in Food Processing*, Technical Report series 940, Geneva, Switzerland.
- Wigley, R.C. (1996) Cheese and whey. *Industrial Enzymology* (eds T. Godfrey & S. West), 2nd edn, pp. 133–154, Macmillan Press, London.

4 The Formation of Cheese Curd

T. Janhøj and K.B. Qvist

4.1 Introduction

An essential part of the cheesemaking process is the conversion of a milk (liquid) into a solid material (the curd), which contains the casein and fat of the milk, but has expelled the main part of the water and, usually, the whey proteins and part of the lactose content. This is achieved by the coagulation of the casein in the milk by addition of rennet and the subsequent expulsion of whey by syneresis of the casein gel. The cheese curd thus forms the basis of the cheese that is later modified by processes like pressing, salting and ripening. In most cheeses the structure of the curd is largely unaltered through the rest of the cheesemaking process, though proteolysis and calcium solubilisation during ripening can change the casein matrix significantly. The curd formation in the cheese vat is thus important for controlling the structure, moisture content and rheological properties of the cheese. This chapter describes the basic chemistry and physics behind aggregation, gel formation and syneresis, and the effects of milk composition and technological variables on these processes.

4.2 Chemistry and physics of curd formation

The hydrolysis in cow's milk of the Phe₁₀₅–Met₁₀₆ bond of κ -casein by rennet transforms the caseins from a stable colloidal system to an unstable aggregating one forming a gel that eventually can expel liquid by syneresis. Since general information about the physical chemistry and kinetics of rennet coagulation is given in Chapter 3, this chapter will proceed directly to describing the effects of various factors on aggregation.

4.2.1 *Some factors affecting aggregation*

Rennet concentration

The rate of the enzymatic hydrolysis of κ -casein in milk is proportional to the amount of rennet added. The rennet concentration does not in itself affect the rate of aggregation, since this is determined by the frequency of collisions and the fraction of collisions leading to bonding and aggregate formation, called the efficiency of collisions. According to the so-called energy barrier model (Lomholt *et al.*, 1998), the efficiency depends on the amount of κ -casein that has been hydrolysed. Thus, the aggregation is overlapping with and depending on the enzymatic reaction, and in this way the rennet concentration indirectly affects aggregation. Measurements of viscosity and gel firmness show that when the rennet concentration is

changed, the amount of κ -casein that has been hydrolysed at a given viscosity or gel firmness is affected (Lomholt & Qvist, 1997). This is because changing the rennet concentration changes the balance between the rates of the enzymatic and aggregation reactions. Higher rennet concentration results in the enzymatic reaction being faster and running to a higher degree of κ -casein hydrolysis before aggregation can reach the same degree as at a lower rennet concentration. With the higher rennet concentration the casein micelles will thus have less caseinomacropetide (CMP) on the surface at a given degree of aggregation or gel formation. One might expect this to affect the structure of the aggregates and the resulting gel and the results of Bauer *et al.* (1995) actually suggest that the rennet concentration affects the structure of aggregates formed during the initial aggregation in highly diluted milk.

Casein concentration

From von Smoluchowski's equation it follows that the collision frequency is highly dependent on the concentration of particles and the aggregation rate is proportional to the square of the concentration. Thus, changing the casein concentration will have large effects on the aggregation rate. As changing the rate of the enzymatic reaction by changing the rennet concentration, also changing the rate of the aggregation reaction by changing the casein concentration affects the balance between the rates of the two reactions. With a higher casein concentration the aggregation runs to a higher degree before hydrolysis of κ -casein can reach the same degree as at a lower casein concentration (Dalglish, 1980; Hyldig, 1993; Lomholt & Qvist, 1997). Casein micelles thus have more CMP on the surface at the same degree of aggregation and gel formation, when casein concentration is increased.

pH

Changing the pH of the milk strongly affects the renneting reaction. First of all the rate of enzymatic breakdown of κ -casein is very dependent on pH (van Hooydonk *et al.*, 1984; Hyldig, 1993). For chymosin in milk the optimum activity is around pH 6.0, and decreasing pH from the natural pH thus increases the rate of proteolysis considerably (van Hooydonk *et al.*, 1986a). The pH also affects the structure of the micelles. When lowering the pH, calcium phosphate is dissociated from the micelles, and at pH \sim 5.7 half of the calcium present in the micelles at pH 6.7 has been lost (van Hooydonk *et al.*, 1986b). However, in the pH 'window' used for milk coagulation with most cheese varieties much less calcium is solubilised. Choi *et al.* (2007) found that colloidal calcium phosphate only decreased slightly by lowering pH from 6.7 to 6.4, while the maximal elastic modulus increased appreciably. Further lowering of pH down to 5.4 led to a decrease in curd firmness due to excessive loss of colloidal calcium phosphate; similar results were obtained by addition of increasing amount of calcium-binding ethylenediamine tetra acetic acid. Salt equilibria between serum and the micellar phase can be computed using a programme developed recently at Institute National de la Recherche Agronomique (INRA) in France (Mekmene *et al.*, 2009). Depending on the temperature, casein molecules dissociate from the micelles upon lowering pH. At 30°C only little casein dissociate, at 20°C casein starts to dissociate appreciably when pH is lowered under pH 6.0, and at 4°C casein dissociation is significant even at small pH reductions (Dalglish & Law, 1988). The charge of casein micelles is decreased when pH is lowered,

and Wade *et al.* (1996) found a ζ -potential of -18 mV at pH 6.7 increasing gradually to ~ -11 mV at pH 5.5.

Lowering the pH of the milk leads to a decrease in coagulation time the main effect probably being the increase in enzyme activity, but also aggregation is affected. van Hooydonk *et al.* (1986a) found that viscosity started to increase when $70 \text{ g } 100 \text{ g}^{-1}$ of κ -casein had been hydrolysed at pH 6.7 whereas at pH 6.2 only $64 \text{ g } 100 \text{ g}^{-1}$ and at pH 5.6 only $30 \text{ g } 100 \text{ g}^{-1}$ of κ -casein needed to be hydrolysed before viscosity started to increase. They also observed that gelation occurred at a lower degree of κ -casein hydrolysis at the lower pH. It is not clear from these experiments whether the rate of aggregation is actually increased at low pH. In terms of the energy barrier model mentioned above, it seems probable that the energy barrier is generally lowered as a result of the decrease in charge, which would lead to an increase in the aggregation rate at a given degree of κ -casein hydrolysis. In practice, however, this will lead to flocculation and coagulation at a lower degree of κ -casein hydrolysis and the actual rate of aggregation during the initial stages of aggregate and gel formation may thus be affected only little.

Temperature

It is a common experience that milk will not clot when the temperature is below 15°C . This is an effect of the inefficiency of the aggregation reaction since the enzymatic hydrolysis of κ -casein still proceeds at low temperature; heating will then lead to almost immediate coagulation, a phenomenon termed cold renneting. At 15°C , the aggregation rate can be increased by addition of calcium chloride (CaCl_2) and by lowering pH (Bansal *et al.*, 2008). The aggregation rate of fully renneted micelles increases with increasing temperature in the range 20 – 60°C (Dalglish, 1983; Brinkhuis & Payens, 1984). Assuming von Smoluchowski kinetics this result is expected since an increase in temperature leads to an increased collision frequency. Dalglish (1983) found that the aggregation rate increases more than can be explained by the increase in collision frequency meaning that the efficiency of collisions is also increased with temperature up to $\sim 45^\circ\text{C}$ where the maximum efficiency is reached and all collisions lead to bonding. This probably reflects the temperature dependence of hydrophobic bonds that are stronger at higher temperatures. At low temperatures, β -casein is less tightly bound in the micelle and may start to protrude from the micelle surface contributing to the steric stabilisation of the micelles and hindering aggregation (Walstra & van Vliet, 1986).

Ions

Calcium and other ions are often added to the milk during cheesemaking in the form of CaCl_2 , leading to increased rates of both the enzymatic and aggregation reactions. This is partly caused by the decrease in pH resulting from CaCl_2 addition that will affect the rates of both the enzymatic reaction and the aggregation reaction. If the decrease in pH is compensated for, the rate of the enzymatic process is not affected by calcium addition (van Hooydonk, 1987). The rate of aggregation increases with the concentration of calcium ions, the effect being highest at low temperatures and smaller at high temperatures when collision efficiency approaches maximum (Dalglish, 1983). The main effect of calcium ions is probably reduction of charge by binding to the casein, though it has been speculated that calcium ions may play a more specific role. Addition of sodium chloride (NaCl) will

also decrease the pH of the milk. van Hooydonk (1987) measured the rate of the enzymatic reaction as a function of NaCl addition without correcting pH. They found a rate constant linearly decreasing with NaCl concentration giving a $\sim 10\%$ decrease with addition of 50 mM NaCl. The decrease would probably be more pronounced if the pH was corrected, considering the effect of pH on the rate constant. Dalgleish (1983) found that increasing ionic strength by the addition of NaCl decreased aggregation rate. An increased ionic strength will decrease electrostatic forces by increased charge shielding but, upon addition of NaCl to milk, colloidal calcium phosphate will also dissociate from the casein micelles (Gouda *et al.*, 1985), which could expose negatively charged phosphoserine residues and thereby increase electrostatic repulsion. However, addition of small amounts of NaCl, less than around 120 mM, decreases the coagulation time (Qvist, 1979b). Larger amounts increases coagulation time if both pH is corrected (Gouda *et al.*, 1985) and without pH correction (van Hooydonk, 1987), as could be expected from the effects on both the enzymatic and aggregation reactions.

4.2.2 Formation of a gel

Light-scattering investigations have shown that during initial aggregation of casein micelles linear aggregates are formed until an aggregation number of ~ 10 (aggregation number is the average number of casein micelles in an aggregate); hereafter aggregates grow more compact (Bauer *et al.*, 1995; Worning, 1998). Similar results have been observed by electron microscopy (Green *et al.*, 1978). The time when aggregates are big enough to be seen by the naked eye is called the flocculation time or rennet coagulation time (RCT). Shortly hereafter a three-dimensional network of casein, a gel, is formed. The firmness of the gel increases for several hours after gel formation, depending on the conditions (Zoon *et al.*, 1988a), and also changes in gel microstructure can be observed microscopically as illustrated in Fig. 4.1. The network becomes coarser with larger pores and thicker strands (Bremer, 1992), and

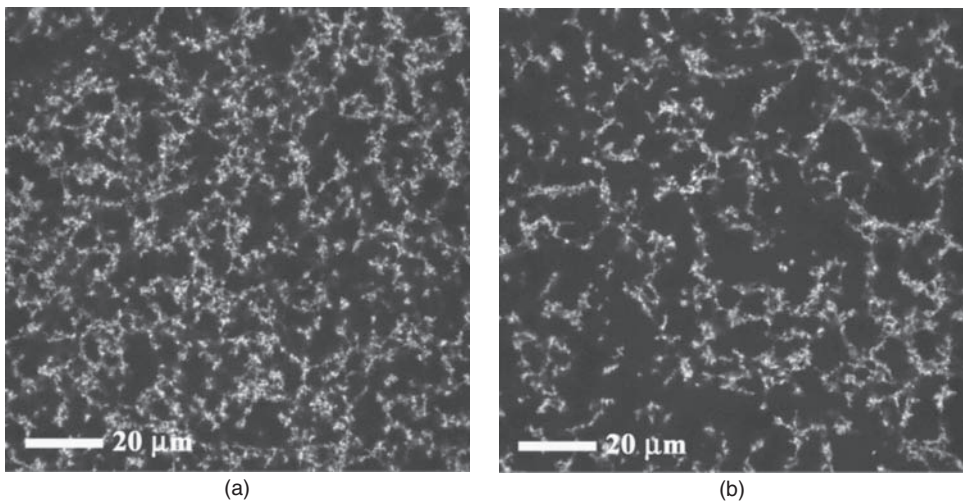

Fig. 4.1 Confocal scanning laser microscopy (CSLM) images of a rennet gel of reconstituted skimmed milk (pH 6.0 at 30°C) after 2.5 h (a) and 6 h (b) after rennet addition. Note: The figure illustrates the restructuring of the gel with time leading to a coarser network with larger pores.

accordingly the permeability of the gel also increases with time after gelation (van Dijk, 1982; van den Bijgaart, 1988).

The phase angle of the gel is virtually constant after gel formation (Dejmek, 1987; López *et al.*, 1998) indicating that the nature of the bonds does not change, at least with respect to relaxation behaviour, and it is therefore likely that the increase in gel firmness is caused by an increase in the number of bonds with time. More and more casein micelles are probably incorporated in the network increasing the number of bonds and loose strands that are only connected to the network at one end may come in contact with other strands and be bonded closer to the network, thus increasing the number of stress-bearing bonds. It also seems that micelles gradually fuse together, which will also strengthen bonds. These mechanisms can be seen as a continuation of the aggregation process after a gel has formed and are thought to be the reason for the change in gel structure and the increase in gel firmness (Walstra & van Vliet, 1986).

Light scattering and computer simulations of aggregating colloidal particles, as well as image analysis of gels have lead to the use of fractal geometry for the description of the structure of rennet gels (Horne, 1987; Bremer *et al.*, 1989; Bremer, 1992). Aggregates of casein micelles and the resulting gels have a number of properties in common with fractal structures. Fractal structures are characterised by scale invariance, meaning that essential geometric features are invariant to the scale of observation, and that they can be characterised by their fractal dimensionality. A power law relationship exists between the size and the number of particles in a fractal aggregate:

$$N = \left(\frac{R}{a}\right)^D$$

where N is the number of particles in an aggregate, R is the radius of the aggregate, a is the radius of the monomer and D is the fractal dimensionality. The aggregate can thus be described as scale invariant in the range between the monomer radius (a) and the aggregate radius (R). Likewise fractal aggregates show scaling behaviour of other properties, and especially light scattering and turbidity measurement has been used to determine fractal dimensionalities using the scaling behaviour between the scattered intensity (I) and the wavevector (q):

$$I \propto q^{-D}$$

valid for $R^{-1} \ll q \ll a^{-1}$. The fractal dimensionality of aggregating casein micelles and rennet gels determined by turbidity is around 2.3 (Horne, 1987; Bremer *et al.*, 1989; Bremer, 1992). This is in good accordance with results from permeability measurement and microscopy of rennet gels (Bremer, 1992). The validity of the turbidimetric approach as applied to aggregating casein micelles has, however, been questioned by Worning *et al.* (1998), and who determined a fractal dimensionality between 1.9 and 2.0 by using light scattered at low angles during aggregation. These values lie between the values of 1.8 expected for diffusion limited and 2.1 expected for reaction limited aggregation, in line with the von Smoluchowski type models where the rate of both the enzymatic reaction and the aggregation, depending on diffusion coefficient, affects the overall rate. As mentioned above, the structure of the gel changes with time because of rearrangements, leading to increasing fractal dimensionality

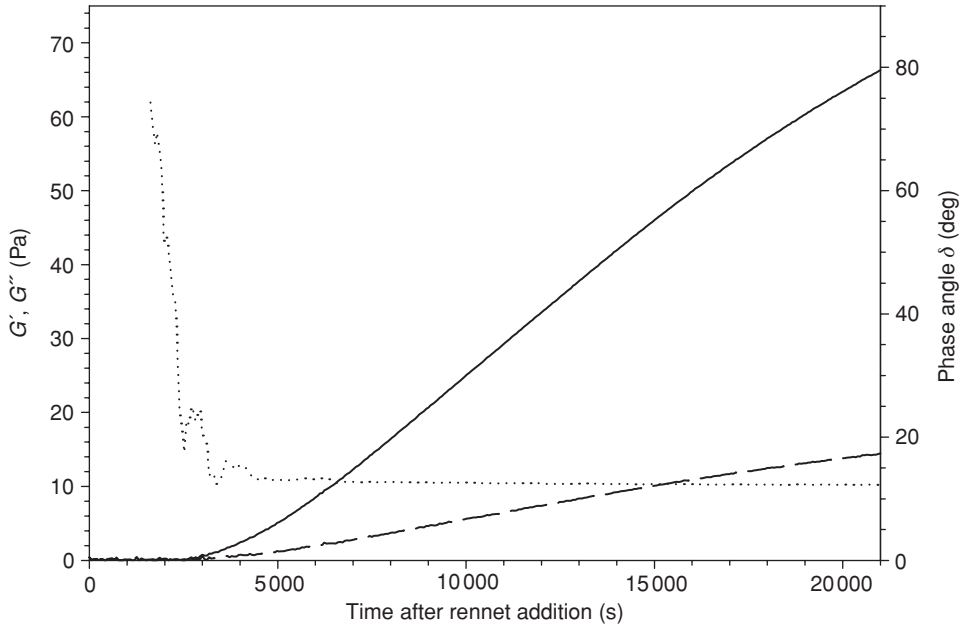

Fig. 4.2 Oscillation measurements at 1 Hz of rheological moduli during coagulation of reconstituted skimmed milk at 30°C with 9.80×10^{-9} M chymosin added. Storage modulus, G' (—), loss modulus G'' (---) and phase angle δ (.....).

that perhaps could justify the higher values found for the fully formed gels by permeability measurement and microscopy.

4.2.3 Rheological properties of rennet gels

Rennet gels show linear viscoelastic behaviour, i.e. deformation is proportional to applied stress, for relative deformations up to 0.026–0.05 (van Dijk, 1982; Dejmek, 1987; Hyldig, 1993). At larger deformations the gel structure will be damaged. Fig. 4.2 shows an example of a dynamic oscillatory measurement on renneting skimmed milk within the linear viscoelastic region. Shortly after visible flocculation a sharp decrease of the phase angle from close to 90° to 15–20° at a frequency of 1 Hz is generally observed, indicating the transition from a viscous material to a viscoelastic one. At this time gel firmness measured as rheological moduli starts to increase. The moduli versus time show sigmoidal-shaped curves that tend to approach a constant value at long time. At very long times the moduli may decrease again (Bohlin *et al.*, 1984; Dejmek, 1987; Zoon *et al.*, 1988a; Hyldig, 1993 – for examples of dynamic oscillatory measurements on renneting milk). Most detailed rheological investigations of renneting has been carried out on skimmed milk, but Storry *et al.* (1983) and Grandison *et al.* (1984) did not find any effect of fat content on the coagulation time or gel strength of unhomogenised milks.

Rennet concentration

The amount of rennet added to the milk has a large effect on the rate of the overall process. An increased rennet concentration leads to a shorter flocculation time, gel firmness starts to increase earlier and the rate of increase is higher (Zoon *et al.*, 1988a; Hyldig, 1993; Lomholt & Qvist, 1997). When compared at the same value of gel firmness the rate of increase of gel firmness is still higher even after more than $99 \text{ g } 100 \text{ g}^{-1}$ of κ -casein has been hydrolysed (Lomholt & Qvist, 1997). Since the gels are at the same stage in gel formation with respect to gel firmness, and the enzymatic reaction is completed, other differences between the gels must be responsible for the difference in gel firming rate. In addition, since rennet concentration seems to affect the structure of initial aggregates, it seems reasonable to expect that structural differences between gels made with different rennet concentrations can explain this effect. In the case of milk concentrated by ultrafiltration (UF) it has even been shown that rennet concentration has as huge impact on both microstructure and large-scale deformation properties of model Feta cheese (Wium *et al.*, 2003).

Temperature

Changing the temperature of gel formation affects the rate of both the enzymatic and aggregation reactions, as previously mentioned, and it also increases the initial rate of gel firming (Tokita *et al.*, 1982; Zoon *et al.*, 1988b) though at temperatures above $\sim 40^\circ\text{C}$ the rate may decrease again because of inactivation of chymosin. Zoon *et al.* (1988b) investigated the effect of temperature thoroughly, and found that the gel becomes more viscous-like and less firm with increasing temperature of formation, seen by an increasing phase angle and decreasing maximum firmness with increasing temperature in the range $20\text{--}40^\circ\text{C}$. When the temperature of the gel is changed from the formation temperature the firmness of the gel will change to reach a new equilibrium. A decrease in temperature leads to an increase in firmness and vice versa. The change is fastest at higher temperatures and is reversible for gels that have reached the maximum firmness. When the temperature of gels formed at different temperatures (i.e. between 25 and 35°C) were changed to 30°C , the firmness of the gel reached the same equilibrium value and showed the same frequency dependence of the phase angle. It was also shown that when the temperature of gels formed at 30°C was changed to different temperatures in the range $25\text{--}35^\circ\text{C}$ the firmness of the gels approached the values of gels formed at the respective temperature. These results suggest that the formation temperature did not affect the structure of the gels at the maximum gel firmness very much.

Increasing the temperature also increases the rate of change of the permeability of the gel, indicating an increased rate of rearrangements (van den Bijgaart, 1988; Green 1987) found that the structure of rennet gels determined 45 min after coagulation was coarser when the temperature was higher. This could either be an effect of the increased aggregation rate giving rise to a coarser structure, or it could simply be caused by the higher rate of rearrangements giving a coarser structure when compared at the same time after coagulation. When making model Feta cheese from milk concentrated by UF it was shown that higher coagulation temperatures lead to coarser protein networks and higher stress at fracture (Wium *et al.*, 2003).

pH

Lowering the pH of milk while keeping the rennet concentration constant leads to a shorter coagulation time and a faster initial increase of gel firmness in the pH range 6.65–5.72 (Zoon *et al.*, 1988a). This is to some extent a result of the increase in rennet activity as the optimum pH of chymosin in milk is reached around pH 6. If the rennet concentration is varied to keep the coagulation time constant, the rate of gel firming still increases with decreasing pH at least down to pH 6.3 (Kowalchuk & Olson, 1977). A higher plateau or maximum value of gel firmness is reached at lower pH down to pH 6.3, or at even lower pH values it decreases again. The phase angle was unaffected by pH in the range 6.65–6.0, but increased slightly at pH values under 6.0 (Zoon *et al.*, 1988a) decreasing again when pH is lowered below 5.2 (Roefs *et al.*, 1990). A decreasing pH leads to a decrease in the negative charge of the caseins that may favour aggregation and bond formation. On the other hand, it also leads to dissolution of calcium phosphate from the casein micelles working in the opposite direction to increase the negative charge. The balance between these effects can probably explain the effect of pH on gel firming. Decreasing the pH leads to a large increase in the rate of increase of permeability, at least down to pH 5.3 (van den Bijgaart, 1988) indicating that also the rate of rearrangements is increased.

Calcium chloride and sodium chloride

When calcium chloride is added to the milk while keeping pH constant, the gelation time is shortened and the degree of κ -casein proteolysis at the gelation time is decreased (McMahon *et al.*, 1984; van Hooydonk, 1987; Zoon *et al.*, 1988c). When more than ~50 mM CaCl₂ was added, the gelation time increased again (McMahon *et al.*, 1984). Also firming of the gel is faster, the rate of increase of gel firmness increases and stays higher for several hours with addition of <50 mM CaCl₂ when pH is kept constant (McMahon *et al.*, 1984; Zoon *et al.*, 1988c). With constant pH, no effect of CaCl₂ addition on the phase angle (Zoon *et al.*, 1988c), or the permeability (van den Bijgaart, 1988) was observed.

Keeping the enzyme concentration constant and correcting the pH level, Zoon *et al.* (1989) found that the initial rate of gel firming decreased with increasing addition of NaCl, but the gel strength at long times (8–10 h) increased with concentration up to ~100 mM NaCl, and then decreased again at higher concentrations. The higher initial rate was also observed by Gouda *et al.* (1985). Without pH correction, van Hooydonk (1987) found no apparent effect on the rate of gel firming from adding up to 200 mM NaCl to the milk, keeping rennet concentration constant. Sodium chloride addition with pH correction did not affect the phase angle (Zoon *et al.*, 1989) or the permeability (van den Bijgaart, 1988) significantly.

Interactions between technological parameters

Nájera *et al.* (2003) studied the effect of temperature, pH and CaCl₂ addition on rennet coagulation time, curd firmness, gel firming rate. Temperature was found to be the only significant variable for curd firmness, while all the factors as well as their two-way and three-way interactions were significant for rennet coagulation time. Both temperature and pH and all their interactions were significant for gel firming rate. Notably, the correlation

between rennet coagulation time and curd firmness was poor ($r = 0.365$). Similarly, Mishra *et al.* (2005) modelled the effect of gelation temperature, pH and non-fat milk solids on fundamental rheological parameters (i.e. dynamic moduli and gelation time) using second-order polynomial models. All the studied variables were found to have significant effects on the rheological parameters, and high explained variances were found ($R^2 = 0.96$ – 0.98).

4.2.4 Syneresis

A rennet gel will be stable for several hours, depending on the conditions, if it is left undisturbed. At some time, however, the gel will start to expel whey and contract. This process is very greatly enhanced by cutting, stirring, pressing or other external mechanical handling. During cheesemaking, the concentration of casein and fat by the expulsion of the main part of the water as whey is an essential step for the creation of the cheese curd. In traditional cheesemaking, this is accomplished by syneresis of the rennet gel, which is cut, stirred and sometimes pressed to promote this process. But even if the gel is left undisturbed it is not static as mentioned previously; the pores become larger and the strands thicker (see Fig. 4.1). This process has been called microsineresis since it can be seen as syneresis on a microscopic scale, and because rearrangement of the gel is also thought to be the mechanism behind macroscopic syneresis. Wetting of the gel surface is sufficient to induce syneresis, presumably because the surface tension is overcome, allowing whey to be expelled (van Dijk, 1982). The gel thus has an inherent tendency to shrink and will do so as soon as it is allowed to expel whey. This form of syneresis without external pressure has been called endogenous syneresis (van Dijk, 1982; Walstra *et al.*, 1985). The process of endogenous syneresis implies that the gel exerts a pressure on the whey phase, called the syneresis pressure. This pressure, or stress, is built up in the gel as a result of rearrangement. The syneresis pressure increases just after gel formation to reach maximum shortly after and then decreases slowly for hours, depending on the conditions (van Dijk, 1982; van Dijk & Walstra, 1986; van den Bijgaart, 1988). Since a rennet gel is a viscoelastic material, a stress in the gel will relax over time. The average relaxation time for a rennet gel is in the order of minutes (Zoon *et al.*, 1989) and, since the syneresis pressure decreases much slower, there must be a continuous process building the syneresis pressure until long after gel formation. This is in good agreement with the fact that rearrangements continue for many hours.

Modelling of syneresis

The one-dimensional flow of whey through a curd slab resulting from endogenous syneresis has been modelled using Darcy's equation for flow through a porous medium (van Dijk, 1982; van Dijk & Walstra, 1986; van den Bijgaart, 1988). In this model, two factors mainly determine the flow rate and thus the rate of shrinkage of the gel – the syneresis pressure and the permeability. While syneresis pressure is the driving force for syneresis, the permeability expresses how easily whey can flow through the gel. The value of the syneresis pressure is up to a few pascals, a very small pressure compared to the pressure exerted by stirring, pressing, etc. When external pressure is applied this can in principle be added to the endogenous syneresis pressure to give the resulting shrinkage rate. However, the higher the pressure and the more whey has already been expelled, the more the resistance of the casein matrix to deformation will be an important factor (van den Bijgaart, 1988; Akkerman *et al.*, 1994),

as will be the case during drainage and pressing of curd grains. Nevertheless, the effects of most technological variables on endogenous syneresis are qualitatively similar to the effects observed during actual cheesemaking experiments. If the rearrangement of the gel network is seen as a continuation of the aggregation and gel-firming process, it is not surprising that factors that increase the rate of aggregation and gel firming in general also increase the rate of syneresis. Tijssens and De Baerdemaker (2004) used the theory of mechanics of porous media to model the syneresis process in one dimension. Following this, the curd grain is considered as consisting of two overlapping continua, the *skeleton* (i.e. the *para*-casein network) and the *fluid* (i.e. the whey). A reasonably good prediction of experimental results could be achieved, and it was found that the model could be extended to the three-dimensional case as it accurately identified the relevant physical properties.

Rennet concentration

In general, the rennet concentration has been found to have no or at least very little influence on the rate and extent of syneresis (see the review by Walstra *et al.*, 1985). This may be related to the state of the gel at the time of cutting or start of syneresis. In most experiments, syneresis has been started at a fixed time after rennet addition. In this case, it is clear that gels made with different concentrations of rennet will have different firmness at cutting. Lelievre (1977) found that syneresis decreased with increasing rennet concentration when gels were cut at the same time, but that there was no significant difference when cutting was done at a specified firmness.

Dimensions of the gel or curd grains

These aspects are very important for the rate of syneresis. It follows from the modelling of endogenous syneresis by Darcy's equation that the flow rate will be higher when the distance whey has to flow is reduced, and this is also found during actual cheesemaking. However, in experiments in a lab scale cheese vat, Everard *et al.* (2008) did not find an effect of cutting intensity, and hence dimensions of curd grains, on the final extent of syneresis.

Stirring

Stirring of the curd grains in the whey promotes the expulsion of whey, probably for two reasons: firstly, it keeps them from sedimenting and thus keeps the surface free, and second, it gives rise to pressure on the grains as they collide with each other, the stirrer and the walls of the vat (van den Bijgaart, 1988). The latter is probably also the explanation behind the observation that syneresis is increased when part of the whey is drained off since the smaller volume of whey will increase the rate and energy of collisions. The effect of stirring has been the subject of a series of recent studies involving on-line measurements in laboratory-scale cheese vats. Everard *et al.* (2007) used computer vision setup to predict the extent of syneresis, and found that stirring speed could be discerned as a statistically significant factor, while its interaction with pH was not.

pH

Lowering the pH in the range 6.7–5.0 greatly enhances syneresis (Marshall, 1982; van Dijk, 1982; Pearse *et al.*, 1984; van den Bijgaart, 1988; Daviau *et al.*, 2000; Lodaite *et al.*, 2000).

This can, to a large extent, be explained by the increased rate of rearrangements, which leads to increased permeability and increased syneresis pressure, both facilitating the flow of whey out of the grains.

Temperature

Increasing the temperature up to around 60°C increases syneresis rate (van Dijk, 1982; Marshall, 1982; van den Bijgaart, 1988; Walstra, 1993). This can be explained by both a higher rate of increase of the permeability and an increased syneresis pressure.

Calcium chloride

Addition of CaCl₂ has generally not been found to have any great effect on syneresis when the drop in milk pH upon CaCl₂ addition is compensated for (van den Bijgaart, 1988; Walstra, 1993).

4.3 Effect of milk composition on curd formation

In recent studies of the rennetability of individual cow's milk up to 30% of the samples were poor or non-coagulating (Tyrisevä *et al.*, 2004; Wedholm *et al.*, 2006). Although the variation in renneting properties of bulk cheese milk is much less than that of individual cow's milk, it is no doubt an important problem, and it seems natural to seek to explain it in terms of chemical composition. The natural variation in milk composition is characterised by large covariations in the levels of the various components. Thus, although it tends to be neglected, it may not often be possible to make clear-cut deductions about the effects of single components on rennet coagulation on the basis of natural variation of milk composition, as the net effect in many cases arises from the pattern of covariation.

4.3.1 Variations in main components

Many researchers have found a relationship between RCT, natural milk pH and calcium concentration, such that a low pH and high calcium concentration is associated with a short RCT (White and Davies, 1958; Flüeler, 1978; Qvist, 1981). McGann and Pyne (1960) demonstrated that removal of the colloidal phosphate from the casein micelles does not affect the rate of the enzymatic reaction with rennet, but prevents aggregation. Further, an inverse relationship between the naturally occurring level of colloidal phosphate and the duration of the aggregation stage was demonstrated (Pyne & McGann, 1962). Similarly, it has been found that the ratio of calcium to casein is lower in slow-renneting milk than in normal milk (Mocquot *et al.*, 1954; Flüeler, 1978), and that differences in RCT between normal and slow-renneting milk can be eliminated by extensive diafiltration with a CaCl₂ solution (Flüeler & Puhán, 1979).

High levels of protein, casein and calcium increased curd firmness and decreased curd-firming time, while only high calcium gave a short RCT (Tervalá *et al.*, 1985), and time

from rennet addition until a defined firmness suitable for cutting was reached was negatively correlated with total calcium (Qvist, 1981).

Citrate participates in the formation of casein micelles. A recent study by Alvarez *et al.* (2006) has shown that increasing citrate concentrations in colloidal casein aggregates (i.e. reformed casein micelles) decreases the calcium activity due to binding as well as the rate of aggregation. Citrate concentration is positively correlated with rennet coagulation time ($r = 0.34$; Tsioulpas *et al.*, 2007), and addition of a mere 5 mM of citrate to milk has been reported to prevent coagulation entirely (Udabage *et al.*, 2001). Citrate concentration in milk has been found to be related to de novo synthesis of fatty acids (Garnsworthy *et al.*, 2006), which is lower when cows are pasture-fed, and citrate concentrations are generally higher during the grazing season. This relationship could possibly account for some of the seasonal variability in milk rennetability (Lucey & Horne, 2009).

Okigbo *et al.* (1985b) found increased levels of γ -casein (β -casein fragments) and some unidentified proteins, suggesting increased plasmin activity, and lower levels of β - and κ -casein in individual cow's milk samples exhibiting a long RCT and/or poor gel firmness. Grandison *et al.* (1985) found significant positive correlations between coagulum strength after 60 min and total casein, α_s -casein, inorganic phosphate, and whey protein. However, none of these correlations explained more than about half the variation in coagulum strength, meaning that they were not very useful as a basis for prediction of renneting properties.

4.3.2 Casein micelle size

Ekstrand *et al.* (1980) found a longer coagulation time for larger micelles than for medium-sized micelles, and Dalglish *et al.* (1981) found indications that small micelles start to aggregate at a lower degree of conversion of κ -casein than larger micelles. Niki *et al.* (1994) found shorter gelation time and larger ultimate modulus for smaller micelles. Also, Horne *et al.* (1995b) suggested that small micelles lead to firmer gels.

4.3.3 Genetic polymorphism of milk proteins

All of the major milk proteins exist in more than one genetic variant and this affects renneting properties. The genetic variation between the different caseins is strongly linked, which complicates disentanglement of the effects of individual protein variants. A review of the effects of genetic polymorphism of milk proteins on technological properties has been given by Jakob and Puhan (1992) and Jakob (1994). Generally, the most consistent relations between genetic variants and renneting properties have been found for κ -casein and β -lactoglobulin (β -Lg).

κ -Casein variants A and B are linked to major differences in renneting behaviour of milk. Milk with the κ -casein B variant has a higher casein content, a higher casein number, (i.e. a higher relative content of κ -casein of total casein) (Jakob & Puhan, 1986; Law *et al.*, 1994), smaller micelles (Devold *et al.*, 1995), a shorter RCT and gives a firmer gel than milk with the A variant (Schaar, 1984; Jakob & Puhan, 1986; Hallén *et al.* 2007). A tendency for milk with the B variant to have a lower pH, a higher calcium activity, and a higher total calcium content and total calcium to protein ratio, and for the A variant to have a high incidence in milk with abnormal (slow) renneting behaviour has been reported by van Hooydonk (1987)

and Jakob and Puhan (1986). Although the difference in RCT can be minimised by lowering the pH or adding CaCl_2 the difference in curd firmness still exists (Schaar, 1984).

Based on the above, milk with the κ -casein B variant (or AB) is considered superior to milk with the A variant only, which has been deemed unsuitable for cheese production when the protein concentration is less than $3.15 \text{ g } 100 \text{ g}^{-1}$ (Jakob, 1994). However, some evidence suggests that the reasons for the superiority of milk with κ -casein B may be complex. The enzymatic rate constant for cleavage of κ -casein is on average the same in milk with κ -casein AA and BB, but the critical extent of proteolysis (percent of total) is significantly less with the κ -casein BB milk (Horne *et al.*, 1995a). Horne *et al.* (1995b) suggested that the higher firmness of gels made from milk with the B-variant is rooted in a higher proportion of κ -casein (of total casein) in this milk. Since κ -casein is preferentially located on the micelle surface, this is associated with smaller micelles and a larger number of micelles with the B variant, which in turn leads to a stronger gel, because more inter-particle bonds can be formed. The difference in gel firmness between the two variants may thus have little to do with any specific properties of the two molecules, but may come about through correlation with compositional parameters that affect micelle size.

The influence of the C and E variants of κ -casein on renneting has been studied much less than that of the A and B variants. The C variant is hydrolysed much slower than the A and B variants by chymosin, and has been associated with much longer renneting times, although the curd may eventually become quite strong. The E variant has been associated with a short RCT, but a very weak curd (Jakob, 1994; Lodes *et al.*, 1996), or inferior renneting properties in general (Hallén *et al.*, 2007).

Glycosylation

Genetic differences in post-translational modifications of κ -casein might account for some of the individual differences in milk coagulation ability (Tyrisevä, 2008). Differences in glycosylation, which determines, to a large degree, the calcium-binding ability of κ -casein (Farrell *et al.*, 2006), could therefore be of importance.

β -Lactoglobulin

The B variant of β -lactoglobulin (β -Lg) is associated with higher levels of casein and lower levels of β -Lg than the A variant, meaning that the casein number is higher. Because of this milk with the B variant of β -Lg gives higher protein recovery in cheesemaking and higher curd firmness (Hill *et al.*, 1995; Wedholm *et al.*, 2006; Heck *et al.*, 2009).

Generally, the above suggests that κ -casein BB and β -Lg BB is a desirable combination for cheesemaking. Extending on this, a recent study concluded that selection for both the β -Lg genotype B and the β - κ -casein haplotype A²B should result in cows that produce milk that is more suitable for cheese production (Heck *et al.*, 2009).

4.3.4 *Lactational variation and somatic cell count*

Although there may very well be different covariation patterns associated with seasonal and lactational stage it is often difficult to disentangle these effects in published reports. Late lactation milk is usually found to have longer RCT and increased proteose peptone content,

the latter suggesting increased plasmin activity (White & Davies, 1958; O’Keeffe *et al.*, 1981). While extensive plasmin activity impairs all aspects of rennet coagulation, a limited activity has been found to decrease RCT and increased gelation rate in model experiments (Srinivasan & Lucey, 2002). Okigbo *et al.* (1985a) found the frequency of non-coagulating samples, and an increased coagulation time of individual cow’s milk during lactation, to be positively correlated with pH. Curd firming rate was largest in mid-lactation. It has been suggested that the late lactation effect is smaller for cows calving in the autumn, than for spring-calving cows (O’Keeffe *et al.*, 1982).

Increased levels of somatic cells have been associated with increased pH, RCT, gel-firming time and decreased gel firmness (Mariani *et al.*, 1981; Okigbo *et al.*, 1985b; Politis & Ng Kwai Hang, 1988), and selecting for low somatic cell count (SCC) has been suggested as a means of genetically improving rennetability (Ikonen *et al.*, 2004). In milks with a SCC $>500 \times 10^3 \text{ mL}^{-1}$ rennetability was reduced by up to 43%, casein and calcium content significantly reduced (Todorova, 1996), and Cheddar cheese yield was lower (Mitchell *et al.*, 1986). In experiments mixing milk with fairly low number of SCC with up to 10–30% of milk with high cell counts, coagulum firmness decreased while Cheddar cheese moisture and protein content in the whey increased (Grandison & Ford, 1986). Non-protein nitrogen and pH in the milk showed positive correlations with cell count, while casein and lactose content showed negative correlations.

4.4 Effects of milk pre-treatment on curd formation

A recent detailed review of the pre-treatment of cheese milk has been given by Kelly *et al.* (2008).

4.4.1 Cooling

Although an excellent strategy for producing cheese it is usually not possible to make cheese immediately after milking. To control development of microorganisms it has become common practice to cool milk to 4°C at the farm and keep it at that temperature during collection and transport to the cheese factory, where further storage at low temperature until needed for processing is common. While this treatment is effective in keeping the number of microorganisms at a low level for several days it does have a number of side effects.

Over a period of about 24 h, the pH of milk will increase about 0.2–0.3 units when cooled to 4°C (Qvist, 1979a; Schmutz & Puhan, 1980). Part of this effect is reversible, being linked to decreased ionisation of water and of calcium phosphate at low temperature, but some of the effect is irreversible, being linked to loss of carbon dioxide from the milk. A number of investigations have shown that caseins, calcium, magnesium, phosphate and citrate is released from the casein micelles during cooling, equilibrium being attained in 24 h or less (Reimerdes & Klostermeyer, 1976; Reimerdes *et al.*, 1977a; Qvist, 1979a; Schmutz & Puhan, 1980). Among the caseins especially the dissociation of β -casein is pronounced ($>40 \text{ g } 100 \text{ g}^{-1}$ of total β -casein; Schmutz & Puhan, 1980). The dissociation of micelle components is linked to a significant increase in rennet coagulation time upon cooling (Peltola & Vogt, 1959; Reimerdes *et al.*, 1977a; Qvist, 1979a; Schmutz & Puhan, 1980). Application of plots

based on the Hoelter–Foltmann equation suggest that the aggregation phase is markedly prolonged by cooling, although the enzymatic phase is also slowed down (Qvist 1979a; Schmutz & Puhán, 1980; van Hooydonk *et al.*, 1984).

By thermising the milk before cold storage it is possible to obtain even better control over development of microorganisms than by cooling alone (Forsingdal & Thomsen, 1985). However, if this procedure is used, the rennet coagulation time will be extended much more than it is by cooling alone (Qvist, 1979a).

Also syneresis seems to be slowed down in cooled milk compared to un-cooled control (Schmutz & Puhán, 1980; Nielsen, 1982), although the opposite effect has also been reported (Peters & Knoop, 1978). In experimental production of Cheddar cheese, larger losses of fat and curd fines were observed in cold stored milks and the curd was weaker with higher moisture content (Ali *et al.*, 1980).

Fortunately, the increased level of caseins in milk serum caused by cooling does not cause an increased level of (intact) casein in whey (Reimerdes *et al.*, 1977a; Schmutz & Puhán, 1980), meaning that cheese yield is not directly affected, provided proteolysis has not taken place. If, however, growth of psychrotrophic bacteria has been significant, proteolytic degradation of casein can be a source of decreasing cheese yield. Recently, Leitner *et al.* (2008) found 4–7% decrease in curd yield in laboratory experiments, as a result of cold storage for 48 h, but only modest correlations to plate count ($r = -0.475$) and SCC ($r = -0.420$), suggesting enzymatic activity to be the cause.

When milk is pasteurised, or given a heat treatment between cooling and production of cheese, this reverses some of the effects of cooling. For instance, when milk was heated at 60°C for 30 min after cooling at 4°C for 24 h then both the original rennet coagulation time and gel firmness was restored (Reimerdes *et al.*, 1977b; Ali *et al.*, 1980). Pasteurisation at 72°C for 15 s only results in a partial restoration of the original rennetability although both caseins and minerals are transferred back to the micelles. The aggregation step seems to be restored (Qvist, 1979a), but the rate of the enzymatic reaction is not (Qvist, 1979a; Schmutz & Puhán, 1980; van Hooydonk *et al.*, 1984). However, when CaCl_2 (0.1 g L⁻¹) or NaCl (2 g L⁻¹) was added to cold stored and pasteurised milk, the rennetability of the original un-cooled milk was re-established (Qvist, 1979b).

4.4.2 High heat treatment

Heat treatment of cheese milk at high temperatures can be attractive for two reasons: (a) control of the microflora by increased reduction of microorganisms in the raw milk and (b) increased cheese yield. The latter effect is attained by denaturation of whey proteins and formation of complexes with the casein leading to a larger part of whey protein being retained in the cheese. High heat treatment has large effects on curd formation and cheesemaking technology must be adjusted accordingly.

When milk is heated to an extent that will induce substantial denaturation of whey proteins, the total amount of CMP released during renneting is reduced. Several researchers found up to 25% reduction of CMP when heating at 90°C for 60 min, which gave 100% denaturation of whey protein (Hindle & Wheelock, 1970; Wilson & Wheelock, 1972; Wheelock & Kirk, 1974; Shalabi & Wheelock, 1976). When heating at 120°C for 5 min, completely denaturing the whey protein, van Hooydonk *et al.* (1987) found a reduction of 10%, around half of which

could be attributed to thermal breakdown of κ -casein since CMP was found in the heated milk already before rennet addition. From the results of Marshall (1986) a reduction of 5–10% can be calculated when heating for 75–85°C for 30 min with 59–100% denaturation of the whey protein. The reduction is assumed to be a consequence of complex formation between κ -casein and β -lactoglobulin especially, though Shalabi and Wheelock (1976) also detected complex formation between κ -casein and α -lactalbumin (α -La). The rate of proteolysis of κ -casein decreases with increasing heat treatment, when heating for 5 min. van Hooydonk *et al.* (1987) found that the rate decreased with increasing temperature up to ~95°C where the rate was reduced by 18%. They also found a linear relationship between the degree of denaturation of β -Lg and the rate of proteolysis.

Heat treatment at temperatures above 70°C, which leads to denaturation of the whey protein, prolongs coagulation time and reduces the rate of gel firming (Marshall, 1986; van Hooydonk *et al.*, 1987; Singh *et al.*, 1988; Lucey *et al.*, 1994; Ghosh *et al.*, 1996). Ghosh *et al.* (1996) found that up to ~20% of the whey proteins could be denatured before significant changes in gel firmness was detected. When more than ~75% of whey protein is denatured no gel is formed though some aggregation of protein particles can be observed (van Hooydonk *et al.*, 1987).

Syneresis is also inhibited by high heat treatment, and the rate decreased with increasing heating temperature above 65°C when milk was heated for 10 min. At 85°C, syneresis rate was reduced by 57%. Only a minor decrease was found when artificial micelle milk not containing whey proteins was used indicating that complex formation between κ -casein and β -Lg was responsible (Pearse *et al.*, 1985). Ghosh *et al.* (1996) found that the syneresis rate decreased linearly with the degree of denaturation of whey protein, giving a reduction of syneresis rate of around two-thirds at 100% denaturation.

The main effect behind the reduced rennetability of heated milk is probably complexation between κ -casein and β -Lg hindering aggregation and bond formation because of increased steric and electrostatic repulsion. Heat treatment at temperatures above ~90°C does also lead to changes in the state of calcium phosphate in the milk. There are indications that part of the micellar calcium phosphate is transformed into another structure probably resembling hydroxyapatite (Aoki *et al.*, 1990; van Dijk & Hersevoort, 1992). Some calcium and phosphate is precipitated during heating and consequently the concentration in serum is reduced. Upon cooling it is slowly dissolved again (Pouliot *et al.*, 1989), and Law (1996) found the equilibrium to be completely restored after 22 h storage. van Hooydonk *et al.* (1987) argued that after heat treatment the intact colloidal calcium phosphate is dissolved faster than the hydroxyapatite-type calcium phosphate formed during heating. This could lead to a decreased neutralisation of the negative charges of casein phosphoserine groups, thus increasing electrostatic repulsion and inhibiting aggregation and syneresis.

4.4.3 Restoring the rennetability of high heat treated milk

Addition of CaCl₂ to the milk and/or acidifying it can to some extent reverse the effect of heat treatment on coagulation time and gel firmness (Marshall, 1986; van Hooydonk *et al.*, 1987; Singh *et al.*, 1988; Lucey *et al.*, 1994; Zoon, 1994) though the coagulation does not proceed in the exact same manner. Marshall (1986) adjusted pH to 6.3–6.4 with lactic acid before renneting, and Banks *et al.* (1994b) reduced it to 6.2 during production of Cheddar cheese. They

found higher moisture content of cheeses from highly heated milk than cheeses made from pasteurised milk indicating that syneresis was reduced; in addition, they also found comparable texture, but less Cheddar flavour and more bitterness in cheeses from high heated milk. Cheese yield was increased with up to 9% compared to cheese from pasteurised milk. A reduced pH of cheese milk also leads to a lower pH at whey separation giving a higher retention of rennet in the curd and for this reason the rennet concentration was reduced compared to normal Cheddar manufacturing. A lower pH at whey separation also leads to reduced calcium content, and this can lead to a more crumbly cheese (Creamer *et al.*, 1985; Marshall, 1986).

To overcome the problems related to reduced pH of the cheese milk, several researchers have investigated the effect of acidification and subsequent neutralisation to normal pH, and found that this treatment can, at least partly, restore the renneting properties of heated milk. Singh *et al.* (1988) heated milk to 90°C for 10 min and subsequently acidified the milk to pH 5.5 and neutralised it, and found that this restored both the coagulation time and the gel firmness. This process has been named pH cycling (Singh & Waungana, 2001). Likewise, Lucey *et al.* (1994) found that the rennetability of milk heated to 100°C for 10 min could be repaired by acidification to pH <5.5 and subsequent neutralisation; however, the gel firmness was not completely restored. The effect was improved if the milk was kept at the low pH for 24 h before neutralisation. Generally speaking, the extent to which rennetability is restored by pH cycling depends on the severity of the heat treatment (Singh & Waungana, 2001). The effect of acidification and neutralisation is probably to dissolve the hydroxyapatite-type calcium phosphate that upon neutralisation is reformed in the same form as the original micellar calcium phosphate (van Hooydonk *et al.*, 1987). This cannot be the whole explanation; however, since acidification and neutralisation also reduces the coagulation time and increases the gel strength of unheated milk (Lucey *et al.*, 1994). Addition of >2.5 mM CaCl₂ also restored the coagulation time of milk heated at 100°C for 10 min, and improved the gel firmness although the gel firmness was still 20–30% lower than obtained with non-heated milk (Lucey *et al.*, 1994).

A further recovery approach of the rennet coagulation properties, so far scarcely used, is heat treatment at an elevated pH (Guyomarc'h, 2006). At pH >6.9, κ -casein dissociates, and heating leads to the formation of κ -casein/whey protein complexes in the serum phase rather than on the κ -casein-depleted casein micelles. Therefore there is a strong inverse relationship between pH of heating and degree of binding of β -Lg to the casein micelles. Combined with pH cycling, this process results in a shorter rennet coagulation time, while the increase in yield is conserved. One definite advantage of this process is reduced formation of cooked flavours in the high heat treated milk.

Finally, a protein hydrolysate product that ameliorates the curd firmness when using high heat treated milk has recently been introduced commercially under the trade name of Maxicurd[®]. It appears that certain negatively charged peptides have a positive effect (van Rooijen, 2008; van Dijk *et al.*, 2009).

4.4.4 pH adjustment by carbon dioxide injection

Milk can be acidified reversibly by injection of carbon dioxide (CO₂). After depressurising the pH reverts to its initial value, and restores the salt equilibrium between the micellar and

serum phases (Guillaume *et al.*, 2004a, 2004b). Renneting of CO₂-treated milk resulted in a reduction in rennet coagulation time of 50% while the gel firming rate doubled. In particular, the rate of the enzymatic reaction was increased, presumably due to an increased accessibility of κ -casein to chymosin.

4.4.5 Homogenisation

Storry *et al.* (1983) found that the gel firmness was increased after homogenisation of milk. Emmons *et al.* (1980) and Green *et al.* (1983), on the other hand, found that curd formed from homogenised milk was weaker than curd from un-homogenised milk. Reduced-fat Cheddar cheese produced from homogenised milk was found to be less hard, and had a smoother texture than control cheeses from un-homogenised milk (Metzger and Mistry, 1994). For Mozzarella cheese, however, Tunick *et al.* (1993b) found the opposite effect that cheeses from homogenised milk were harder, but springiness could be reduced. Green *et al.* (1983) found that the structure of the protein network was less coarse in gels made from homogenised concentrated milks compared to un-homogenised controls. Ordinary homogenisation of skimmed milk does not lead to changes of renneting properties (Walstra, 1980) so the effects are not caused by changes of the casein micelles themselves. An important consequence of homogenisation is that casein micelles are incorporated into the surface membrane of the fat globules meaning that contrary to intact fat globules homogenised globules are aggregating with the casein and bound in the casein network during renneting. The adsorption of casein micelles on the fat globule surface also leads to a lower concentration of 'free' casein micelles in the serum phase.

The rennet coagulation time is generally reduced by the use of homogenisation. Although homogenisation has been found to strongly decrease the rate of syneresis, Emmons *et al.* (1980), Storry *et al.* (1983) and Drake *et al.* (1995) suggested that moisture content of reduced-fat Cheddar cheese made from homogenised milk was not significantly affected. The actual effects of homogenisation may depend on specific conditions, e.g. fat content of the milk.

Thomann *et al.* (2007) studied the effect of homogenisation pressure as well as pH and concentration by microfiltration on curd firmness and syneresis. The idea was to use microfiltration to compensate for the loss in curd firmness caused by homogenisation, which proved to be possible. All three design variables were found to be significant, and syneresis could be predicted with $R^2 = 0.847$.

Homogenisation at very high pressures (ultra high pressure homogenisation – UHPP), up to more than 300 MPa, is an emerging technology that has mostly found use in the pharmaceutical and biotechnology industries. Using this technology, Zamora *et al.* (2007) found a reduction in rennet coagulation time, as with conventional homogenisation. UHPP produced fat-protein particles one-third the size of those produced by conventional homogenisation. A potential problem of this technology is the extensive generation of heat, which can lead to uncontrollable whey protein denaturation.

4.4.6 Phospholipase addition

A phospholipase, to boost fat retention in cheese, especially pasta filata types, has recently been introduced commercially under the trade name YieldMax[®]. It is believed

that the hydrolysis of phospholipids in milk results in the formation of more amphiphilic lysophospholipids which emulsify and retain water and fat in the cheese matrix, leading to higher yields (Lilbaek *et al.*, 2006).

4.4.7 Microfiltration and microfiltration combined with heat treatment

As a method for ‘cold sterilisation’ and alternative to heat treatment, microfiltration (MF) has interesting potential. The implications are that it is possible to make raw milk cheeses from milk of a defined and very high bacteriological quality, and that late blowing caused by *Clostridium tyrobutyricum* can be prevented without adding nitrate or lysozyme.

The so-called Bactocatch process (Meersohn, 1989) consists of a combination of cross-flow MF of skimmed milk with constant trans-membrane pressure, and a high heat treatment (120–130°C for 4 s) of the MF concentrate (often 5–10% of the product stream) and cream, normally followed by pasteurisation of the remixed MF filtrate, heat-treated MF concentrate and cream. The high heat treatment of the MF concentrate gives sufficient reduction in the number of bacteria and spores that it can be used in cheese production, but also results in a slightly increased level of denatured whey protein, which leads to a slightly longer rennet coagulation time, a softer, or more fragile curd, and a higher moisture content in the cheese if other measures are not taken to correct for this (Lidberg & Bredahl, 1990; Solberg, 1991). Corrections are, however, possible by using standard procedures for increasing curd strength and decreasing moisture content. By cascading two MF units it is possible to decrease the amount of MF concentrate to less than 1% of the product stream. The consequences with respect to rennet coagulation and cheese moisture of giving such a small proportion of the milk a high heat treatment are of course very limited.

4.5 Factors controlling curd formation in the vat

In this section, a number of factors that can be varied during cheesemaking and their effect on curd formation and properties are examined. Our knowledge about the effect of these factors on structure and fundamental properties of the cheese curd is, however, limited. Only few studies carried out under actual cheesemaking conditions have investigated such properties, and often factors have not been varied greatly. It is important to realise that a number of the factors will also affect later stages in the cheesemaking process, ripening and flavour formation, which lies outside the scope of this chapter, but must be taken into account when designing an actual manufacturing process. Especially factors like acidity, water content and salt in moisture affects the flavour development of the cheese. This of course limits how much the manufacturing process can be varied in practice.

The structural changes over time observed in rennet gels are also found during curd formation in the cheese vat (Green *et al.*, 1981). The casein network gradually becomes coarser with larger pores though this to some extent is counteracted by the shrinkage of the curd as whey is being expelled. Fusion of casein micelles can also be observed. The structure of the casein network created during curd formation in the cheese vat is largely unaltered during the subsequent stages of cheesemaking, at least for Cheddar cheese.

4.5.1 Rennet concentration

Rennet concentration has generally not been found to have any great influence on the properties of the fresh curd or the extent of syneresis in the vat (Lelievre, 1977; Luyten, 1988; Spangler *et al.*, 1991; Kindstedt *et al.*, 1995), though systematic investigations are lacking. During cheesemaking, the consideration of an optimal proteolysis during ripening restricts the range of rennet concentrations that can be used. Laboratory results on rennet gels (see Section 4.2) indicate that the rennet concentration does have an effect on the structure of the gel, but in the range of rennet concentrations generally used this effect might be small compared to the effects of other variables.

4.5.2 pH

The pH has a large effect on the renneting reaction and the properties of the rennet gel (see Section 4.2). Since calcium and phosphate are dissolved from the casein micelles when pH is decreased, the pH also largely determines the content of calcium and phosphate in the whey, and thus how much calcium and phosphate is removed during whey drainage. The pH will also influence the state of calcium phosphate and other minerals in the curd. This makes it difficult to separate the effects of pH in itself and of pH-induced changes. Emmental cheese with a pH around 5.6 contains almost 50% more calcium than Cheddar cheese with a pH of around 5.1 but, because of the lower pH of Cheddar cheese, around 28% of calcium is dissolved as opposed to only 9% in Emmental (Lucey & Fox, 1993). This is reflected in the more elastic texture of Emmental compared to Cheddar.

In the cheesemaking process, acidification and solubilisation of calcium phosphate happens concurrently with whey expulsion and the rates of the two processes needs to be balanced correctly for the type of cheese in question. As an example, Qvist *et al.* (1986) determined the ideal relation between pH reduction and whey expulsion during the first 24 h when making rindless semi-hard cheese with round holes. This relation was found by extracting only those experiments that lead to very good cheeses from a large number of cheesemaking trials with large variation. Since the data material contained information on pH value and water content at whey drainage, end of stirring, and after 4.5, 6 and 24 h it was possible to construct the ideal curve shown in Fig. 4.3. This graph represents the curve one should aim to follow from right to left, when making this particular type of cheese. For instance, if a trace located lower in the graph is followed, the curd will be too demineralised.

Even when the content of calcium is kept constant, the rheological properties of the gel will depend on pH. Lawrence and Gilles (1982) found that Cheddar cheeses made with the same content of calcium but, with varying pH, had different textures from 'curdy' at pH >5.3, over 'waxy' at pH between 5.1 and 5.3 to 'mealy' at pH <5.1. Generally, cheeses with high pH behave more viscous-like, whereas cheeses with low pH are more brittle (Marshall, 1986; Luyten *et al.*, 1991) in accordance with the behaviour of rennet and acid casein gels respectively (Roefs *et al.*, 1990).

As mentioned earlier, pH also has strong influence on the rate of syneresis, and it is important in controlling the amount of whey expelled. Decreasing pH normally increases the syneresis rate of curd but, for milks concentrated by UF after acidification to pH 6.0–6.4,

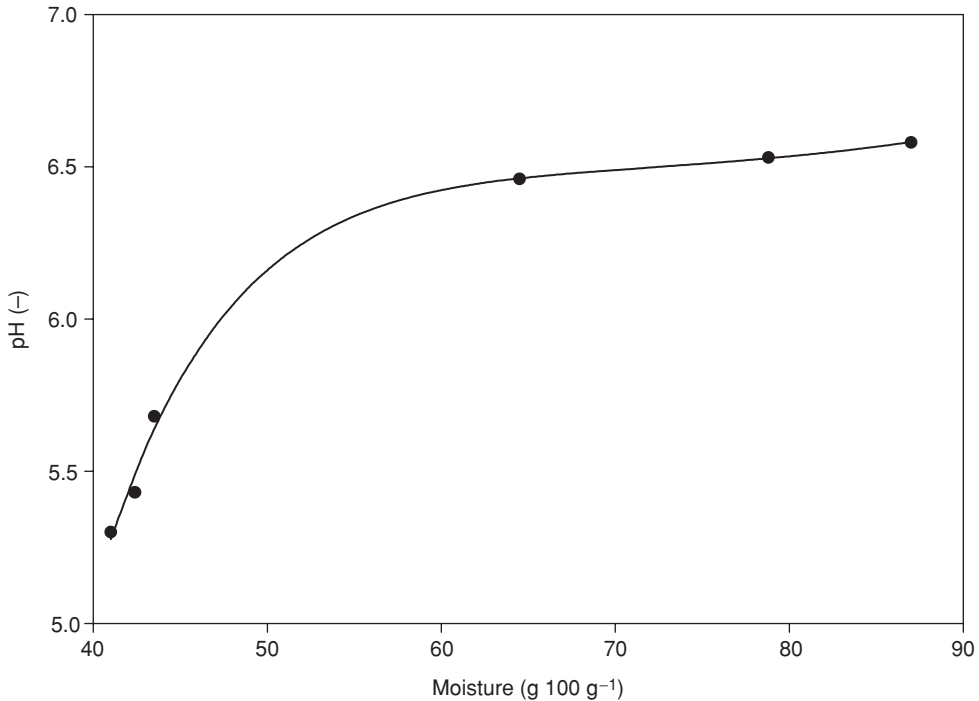

Fig. 4.3 Ideal curve for a rindless, semi-hard cheese with round holes, depicting the typical development of moisture and pH during the first 24 h. Note: Points represent, from right to left, renneting, whey drainage, end of stirring and 4.5-, 6- and 24-h-old cheese. (After Qvist *et al.*, 1986.)

Green (1987) found that the rate of syneresis was decreased compared to concentrated milk at normal pH. The effect was ascribed to the reduction in calcium and phosphate content caused by UF at low pH and possibly differences in structure of the resulting gels.

4.5.3 Temperature

Increasing the temperature of the cheese milk will increase the rate of coagulation, gel firming and syneresis. While the temperature is seldom varied very much during coagulation and gel firming, increasing the temperature during syneresis (cooking) is an important parameter to control the moisture content of cheese.

Mateo *et al.* (2009) found that \log_{10} (temperature) and milk fat level could predict the extent of syneresis ($R^2 = 0.76$). Drake *et al.* (1995) found that decreasing the cooking temperature from 36.5 to 35°C increased the moisture content of low-fat Cheddar cheese from 47.5 to 49.3%. Increasing the overall temperature of the complete process thus increases syneresis rate, but Green (1987) found that when varying the temperature of coagulation and curd formation between 22 and 38°C and, then letting the gel expel whey at 30°C, the syneresis rate actually decreased with increasing temperature of gel formation. This might be related to the increased coarseness of gels formed at high temperatures. The effect

of temperature on growth of starter culture and acid production must of course also be considered when changing temperature.

4.5.4 Cutting time

The cutting of the curd is normally done either at a predefined time after rennet addition or when the cheesemaker empirically determines that the curd has the right properties for cutting; often by cutting the curd with a knife and visually evaluating the surfaces and the splitting of the milk gel. López *et al.* (1998) measured the gel firmness of the curd at the cutting time, as empirically determined by a cheesemaker, in an experiment where rennet concentration and milk pH was varied. The firmness of the gel at the cutting time varied with conditions. At pH 6.74, the elastic modulus (G') was 7.4–9.8 Pa, at pH 6.5 it was 1.0–3.3 Pa and at pH 6.25 it was 4.3–6.3 Pa. Generally, the firmness decreased with decreasing rennet concentration. The evaluation done by the cheesemaker thus appears to be not solely based on the firmness of the gel. The authors found a correlation between the time of the maximum of dG'/dt (where t is time), and the cutting time, indicating some relation between the empirically evaluated properties and fundamental rheological properties.

Qvist (1981) found that when cutting was done at the same predefined time, slow-ripening milk, which consequently had lower firmness at cutting, gave higher moisture content in cheese 24-h old and throughout ripening. There were indications that, in the range studied, an increase of 1 Formagraph unit in firmness at cutting was associated with a decrease in moisture content of the 24-h-old cheese by about $0.1 \text{ g } 100 \text{ g}^{-1}$. Lelievre (1977) observed increasing syneresis with gel modulus at cutting when modulus was $<15 \text{ Pa}$, whereas syneresis decreased with increasing modulus when the modulus was $>25 \text{ Pa}$. Qvist (1981) and Bynum and Olson (1982) found that a higher curd firmness at cutting increased yield and retention of fat and casein. The same effect was observed by Riddel-Lawrence and Hicks (1989) in pilot-scale experiments when the healing time of the curd after cutting and before cooking was increased for the curd cut at lowest firmness. If healing time was kept constant they found the opposite effect. It thus seems that controlling firmness at cutting time can be important for controlling cheese yield and moisture content. According to van Hooydonk and van den Berg (1988), the construction of the cheese vat, including its cutting equipment has an important impact on the optimum gel firmness at cutting.

4.5.5 Washing of the curd

Washing of the curd, i.e. removing some of the whey and adding water during stirring, is commonly used with some cheese varieties to control acidification and the amount of lactose and minerals transferred to the curd. Walstra (1993) reported that addition of equal amounts of whey or water, respectively, at the same temperature gave up to $2 \text{ g } 100 \text{ g}^{-1}$ higher moisture content in the curd where water was added as compared to addition of whey. The difference could be fully explained by the reduction of dry matter content of the liquid in the cheese resulting from dilution with water. During cheesemaking washing of the curd will often be accompanied by changes in temperature, changes in the effectiveness of stirring, etc., that can affect syneresis.

4.6 On-line measurement of curd firmness and syneresis

Development and implementation of on-line methods for monitoring industrial processes has been a general trend in the process industries in the past decade, an area often termed process analytical technologies. The field has developed with the data analytical field of chemometrics, which delivers the tools to predict product properties from analytical data (e.g. near-infrared spectra).

4.6.1 *On-line measurement of curd setting*

Techniques for monitoring curd setting have actually been under development since the 1970s, and have been reviewed by Fox *et al.* (2000) and O'Callaghan *et al.* (2002). To be of any use in an industrial setting such a method should operate on-line within the vat, be non-destructive and comply with sanitary design standards. The objective is normally to establish the optimal cutting time objectively. Hence, the method needs to be able to discern curd firmness rather than merely sensing the RCT. Two methods will be mentioned here, both of which have found some use, especially outside Europe.

The hot-wire method essentially measures viscosity. A constant current is passed through a wire immersed in the milk, generating heat which is dissipated as long as the milk is liquid. Upon gelation, when the viscosity increases abruptly, heat dissipation becomes much less efficient, causing a temperature increase in the wire, which in turn translates into an increase in resistance. The method can measure the gelation point with high sensitivity, but is insensitive to the curd firming process; the cutting time is thus estimated by multiplying the gelation time with a constant that depends on, for example, the pH. Diffuse reflectance measurements can also be used to estimate cutting time. The amount of light reflected increases with aggregation. Usually the time of the point of inflection of the reflectance curve, t_{\max} , is used to estimate the cutting time, by multiplying t_{\max} by a factor which has to be established empirically for each case.

The reason that these techniques are little used in industry is probably related to the time constraints in high-volume cheese production, where there is little or no time available to vary the cutting time by even a few minutes. Another important aspect is precision, which is not very well documented for industrial trials except perhaps for methods based on near-infrared reflectance.

4.6.2 *Modelling and controlling gelation and cutting time*

Although it is desirable to always perform cutting at the optimum curd firmness for the type of cheese and equipment in question, it is undesirable in modern cheesemaking to allow the cutting time to vary. What is needed is, therefore, methods to control renneting of the cheese milk, so that the optimum curd firmness is always obtained in the same, desired number of minutes. Such methods should use control variables that are convenient to use, and allow for both speeding up and slowing down of the renneting process. Amount of rennet used, and addition of either water or CaCl_2 to the milk is an example of a small, but useful set of control variables. A statistical approach to control of rennetability was proposed by Qvist

(1981). Using the Formagraph (McMahon & Brown, 1982) to measure coagulation and gel formation a complete $3 \times 3 \times 3$ factorial design [amount of standard rennet (20–50 mL 100 L^{-1}), addition of water (0–8 mL 100 mL^{-1}) or CaCl_2 (0–0.02 g 100 mL^{-1})] was applied to a set of milk samples with varying rennetability. The predicted value of the time needed to obtain a firmness of 30 Formagraph units (or any other desired firmness), \hat{T}_{30} , was described with a quadratic response surface model with terms for the amount of rennet, R , water, W and CaCl_2 , C , used, in addition to a measure of the rennetability, T_{30s} , of the milk sample in question:

$$\hat{T}_{30} = f(T_{30s}, R, W, C)$$

For each milk sample, T_{30s} was obtained as the time needed to reach a firmness of 30 Formagraph units, when using 30 mL standard rennet 100 L^{-1} with no added water or CaCl_2 .

With the above model one can find suitable values of R , W or C if T_{30} of a given milk supply deviates from the desired value of T_{30} . The model was found to work well, describing 99% of the variation in T_{30} in the data set (Qvist, 1981), and was incorporated in the Danish Cheese Simulator (Nielsen, 1996), a software package to simulate cheesemaking.

Another approach to predicting renneting properties is based on using spectroscopic data, which can be obtained quickly and easily prior to cheesemaking, and contain a wealth of information. De Marchi *et al.* (2009) used data from the Milko-Scan FT120, a widely used FT-IR-based instrument, to predict rennet coagulation time and gel firmness (as determined using a computerised instrument similar to the Formagraph), of more than 1000 samples from individual cows. Using partial least square regression, rennet coagulation time could be predicted with modest precision ($R^2 = 0.62$), while gel firmness, which is far more important for the cheesemaker, could not be predicted satisfactorily ($R^2 = 0.37$). The authors concluded that the approach showed potential, but needs further development.

4.6.3 On-line measurement of syneresis

There is currently no commercially available on-line method for measuring the extent of syneresis as it happens. Such a method could possibly bring about substantial improvements in the process capability of cheese production, and in particular enable improved control of moisture content in cheese, the variability of which is much higher than for other dairy products. Maynes (1992) attempted a fundamental approach to the problem, using diffraction theory to predict particle size of cheese grains. However, the developed method required the particles to be in suspension, which happens only after a certain time after cutting. More importantly, the sampling volume had to be so small that stacking of particles was precluded. Other authors have taken a rather different approach using optical sensors originally developed for monitoring of curd formation, and relating the results to syneresis data acquired by different means. Guillemin *et al.* (2006) used a near-infrared sensor modified to allow online determination of not only the volume fraction of whey but also the particle size distribution of the cheese grains. The acquired data were related to the known volume fractions by the use of neural networks. A relative error of 23% for the determination of volume fraction was

obtained (an improvement of more than an order of magnitude will be needed to make this method worthwhile for the cheese industry). Along the same lines, Fagan *et al.* (2007, 2008a) used a backscatter sensor, similar to one used to measure curd formation, but with a larger field of view. The backscatter, measured at 980 nm, decreased asymptotically upon cutting. Using the time from renneting to the inflection point of the backscatter ratio, final curd yield was estimated ($R^2 = 0.75$). Fagan *et al.* (2009) improved the method by using wavelengths between 300 and 1100 nm, and selected the most useful wavelengths by jackknifing. Computer vision techniques are an obvious choice for quantitating the fraction of whey at any given time. Everard *et al.* (2007) captured images (100 mm²) at the surface of the curd/whey mixture, and related the ratios of white/yellow as well as red, green and blue values averaged across the images to predict the whey volume, measured by sieving; similar measurements were performed with a tristimulus colorimeter. The highest absolute correlation coefficient between the computer vision metrics and whey volume fraction was 0.716. Fagan *et al.* (2008b) used the same setup to predict curd moisture and whey solids from a series of image texture features. Fractal dimension turned out to be the best predictor of whey solids ($R^2 = 0.80$). A fundamental problem with these endeavours is that the particulate phase, where most of the change takes place during syneresis (apart from the fat level, the composition of the whey hardly changes), is difficult to access for an on-line method. In particular, the location of the camera above the surface is problematic, as the cheese grains tend to sediment as they become heavier.

4.7 Cheese with reduced-fat content

Production of cheese with reduced-fat content presents significant challenges concerning texture, flavour and functionality (Mistry, 2001; Banks, 2004; Johnson *et al.*, 2009). Here we will concentrate on the consequences of fat reduction for curd formation and on the adjustments in manufacturing that can be used to obtain the desired properties of the curd. Many of the possible adjustments involve changes in chemical composition and other properties that can greatly affect cheese ripening and flavour formation. It is therefore essential to keep these effects in mind when designing manufacturing processes, but that lies outside the scope of this chapter.

Milk fat plays an important role in formation of cheese curd and studies on reduced fat cheeses show several possible textural defects. Storry *et al.* (1983) investigated the renneting and syneresis of milk with varying fat content from 0.24 to 7.24 g 100 g⁻¹. They found that fat content had no significant influence on clotting time or gel firmness, but that the syneresis rate at 7.24 g fat 100 g⁻¹ was only 60% of what it was at 0.24 g fat 100 g⁻¹. If no means are used to adjust the manufacturing procedure when making low-fat cheese, the curd contains more moisture and protein, less moisture in non-fat substance (MNFS), and the cheese tends to be harder, and have increased springiness and reduced adhesiveness. Electron and confocal laser scanning microscopy reveals a much more compact protein structure with fewer openings for fat globules, and less fusion of fat droplets (Tunick *et al.*, 1993a; Bryant *et al.*, 1995; Drake *et al.*, 1995; Ustunol *et al.*, 1995; Guinee *et al.*, 2000). For 1-week-old Mozzarella cheese with different levels of fat and moisture content, Tunick *et al.* (1993a)

showed that hardness, springiness and adhesiveness were closely related to the amount of MNFS, and that low-fat cheeses generally had lower MNFS. Fife *et al.* (1996) further found reduced-fat Mozzarella to have impaired melting properties, which did not substantially improve during storage. Anderson *et al.* (1993) found that low-fat Cheddar cheeses with lower MNFS than full-fat cheese were too firm and crumbly. Increasing the moisture content through decreasing syneresis; thus is a key factor in assuring acceptable texture of the low fat cheese curd.

Methods suggested to decrease syneresis during cheese manufacture include decreasing cooking temperature, shorter stirring time, washing of curd with cold water, cutting the curd into larger size pieces, increasing pH at milling, allowing the curd to become firmer before cutting, homogenisation of cheese milk, high heat treatment of milk, decreasing level of starter addition, or using a slower acid-producing culture, and adding non-fat milk solids (Ardö, 1993; Katsiari & Voutsinas, 1994; Banks *et al.*, 1994a; Drake *et al.*, 1995), and reviews by Drake & Swanson (1995), Rodriguez (1998), Banks (2004) and Johnston *et al.* (2009).

By decreasing cooking temperature from 45.9 to 32.4°C Tunick *et al.* (1993a) obtained low-fat Mozzarella cheese with MNFS comparable to full-fat cheese. As a lower cooking temperature is generally used with lower fat cheese, measures may need to be taken to prevent overacidification, e.g. higher draining pH, washing the curd, or use of a slower acid producing culture. It is, however, also important that the calcium content does not become too high, as this leads to hard cheeses with low meltability. A very effective way to moderate the calcium content of the cheese is by reducing the pH at renneting, especially if done with a chelating acid, such as citric acid (Keceli *et al.*, 2006; Zisu & Shah, 2007). Obtaining the optimum balance of moisture, acidity and calcium in low-fat cheese is a considerable challenge.

Homogenisation of cream has been used for production of reduced-fat Cheddar cheeses, and gave an improved texture. Cheeses from homogenised milk were less hard and had a smoother texture than the control samples from un-homogenised milk as judged by sensory assessment, though differences were small (Metzger & Mistry, 1994). For the production of reduced-fat Mozzarella cheese, Tunick *et al.* (1993b) found that homogenisation increased hardness, but that springiness could be reduced with homogenisation at 17 MPa.

A number of different fat replacers have been used in attempt to improve the texture of cheeses with low-fat content. The exact mechanisms of modification of curd structure and rheological properties by fat replacers are, in general, poorly understood. Drake *et al.* (1996a) compared two protein-based fat replacer and one carbohydrate-based fat replacer for the production of low-fat Cheddar cheese. The fat replacers resulted in an increased moisture content compared to a low-fat control cheese, but the cheeses with fat replacers obtained lower scores than the control low-fat cheese in sensory analysis by both trained judges and a consumer panel. McMahon *et al.* (1996) used two protein-based fat replacers and two carbohydrate-based fat replacers for production of Mozzarella cheese. All fat replacers increased the moisture content, two of the fat replacers (i.e. one protein and one carbohydrate based) increased melting whereas the other two decreased melting. While obtaining substantial improvement in several instrumental texture parameters from the texture profile analysis test, using either a protein or a polysaccharide fat replacer, Romeih *et al.* (2002) in the production of a white-brined cheese, improvements were not clearly evident by sensory testing. Everett and Auty (2008) demonstrated the novel concept of using water globules as a fat

mimetic by introducing an additional polysaccharide containing water phase, incompatible with the normal cheese moisture and, therefore, segregated in globules.

Lecithin has been used to improve the texture of low-fat Cheddar cheese to the same level as full-fat control cheese, but did also result in unpleasant off-flavours. Addition of 0.2 g lecithin 100 g⁻¹ to the cheese milk for production of reduced-fat Cheddar cheese considerably increased moisture content and reduced firmness and crumbliness, and cheeses obtained texture scores by trained panellists that did not differ from full-fat control cheese. Flavour scores were very low, however, due to undesirable and unusual aromas and flavours. Addition of 0.5 g lecithin 100 g⁻¹ resulted in a too soft and undesirable texture (Drake *et al.*, 1996b). Contrary to this, Dabour *et al.* (2006) found little effect of lecithin on texture and microstructure when making reduced-fat Cheddar cheese. Poduval & Mistry (1999) obtained improved body and texture, but decreased meltability when adding ultrafiltered buttermilk, containing significant amounts of phospholipids in the manufacture of Mozzarella.

Fenelon *et al.* (1999) showed that blending of full-fat and non-fat Cheddar cheese curd particles at whey drainage led to a lower yield stress compared to a control reduced-fat cheese, and also a reduced firmness when a shredding step was included. Recently, Bansal *et al.* (2009) found that addition of 10% shredded (of the expected yield) mature full-fat Cheddar to the curd/whey mixture when making low-fat Cheddar led to substantial improvements in both instrumental and sensory texture attributes, compared to control low-fat cheese.

It should be evident from the results mentioned above that there is a multitude of different recommendations for adjustment of cheesemaking technology for production of cheeses with lower fat content, and determination of the optimal procedure is not an easy task. Furthermore, it should be stressed again that due consideration must be taken to the flavour development during ripening of the cheese, as moisture in non-fat substance, salt in moisture, and pH are some of the important variables that will influence proteolysis and flavour development.

References

- Akkerman, J.C., Fox, F.H.J. & Walstra, P. (1994) Drainage of curd; expressions of single curd grains. *Netherlands Milk and Dairy Journal*, **48**, 1–17.
- Ali, A.E., Andrews, A.T. & Cheeseman, G.C. (1980) Influence of storage of milk on casein distribution between the micellar and soluble phases and its relationship to cheese-making parameters. *Journal of Dairy Research*, **47**, 371–382.
- Alvarez, E.M., Risso, P.H., Gatti, C.A., Armesto, M.S., Burgos, M. & Relling, V.M. (2006) Effects of citrate on the composition and enzymic coagulation of colloidal bovine casein aggregates. *Colloid and Polymer Science*, **284**, 1016–1023.
- Anderson, D.L., Mistry, V.V., Brandsma, R.L. & Baldwin, K.A. (1993) Reduced fat Cheddar cheese from condensed milk. 1. Manufacture, composition, and ripening. *Journal of Dairy Science*, **76**, 2832–2844.
- Aoki, T., Umeda, T. & Kako, Y. (1990) Cleavage of the linkage between colloidal calcium phosphate and casein on heating milk at high temperature. *Journal of Dairy Research*, **57**, 349–354.
- Ardó, Y. (1993) Characterizing ripening in low-fat, semi-hard round-eyed cheese made with undefined mesophilic DL-starter. *International Dairy Journal*, **3**, 343–357.
- Banks, J. (2004) The technology of low-fat cheese manufacture. *International Journal of Dairy Technology*, **57**, 199–207.

- Banks, J.M., Hunter, E.A. & Muir, D. (1994a) Sensory properties of Cheddar cheese: effect of fat content on maturation. *Milchwissenschaft*, **49**, 8–12.
- Banks, J.M., Law, A.J.R., Leaver, J. & Horne, D.S. (1994b) The inclusion of whey proteins in cheese – an overview. *Cheese Yield and Factors Affecting its Control*, Special Issue No. 9402, pp. 387–401, International Dairy Federation, Brussels.
- Bansal, N., Farkye, N.Y. & Drake, M.A. (2009) Improvement in the texture of low-fat Cheddar cheese by altering the manufacturing protocol. *Journal of Dairy Science*, **92** (E-Suppl 1), 362.
- Bansal, N., Fox, P.F. & McSweeney, P.L.H. (2008) Factors that affect the aggregation of rennet-altered casein micelles at low temperatures. *International Journal of Dairy Technology*, **61**, 56–60.
- Bauer, R., Hansen, M.B., Hansen, S., Øgendal, L., Lomholt, S.B., Qvist, K.B. & Horne, D.S. (1995) The structure of casein aggregates during renneting studied by indirect Fourier transformation and inverse Laplace transformation of static and dynamic light scattering data, respectively. *Journal of Chemical Physics*, **103**, 2725–2737.
- Bohlin, L., Hegg, P.O. & Ljusberg-Wahren, H. (1984) Viscoelastic properties of coagulating milk. *Journal of Dairy Science*, **67**, 729–734.
- Bremer, L.G.B. (1992) *Fractal Aggregation in Relation to Formation and Properties of Particle Gels*, PhD Thesis, Wageningen Agricultural University, Wageningen, The Netherlands.
- Bremer, L.G.B., van Vliet, T. & Walstra, P. (1989) Theoretical and experimental study of the fractal nature of the structure of casein gels. *Journal of the Chemical Society, Faraday Transactions*, **85**, 3359–3372.
- Brinkhuis, J. & Payens, T.A.J. (1984) The influence of temperature on the flocculation rate of renneted casein micelles. *Biophysical Chemistry*, **19**, 75–81.
- Bryant, A., Ustunol, Z. & Steffe, J. (1995) Texture of Cheddar cheese as influenced by fat reduction. *Journal of Food Science*, **60**, 1216–1219.
- Bynum, D.G. & Olson, N.F. (1982) Influence of curd firmness at cutting on Cheddar cheese yield and recovery of milk constituents. *Journal of Dairy Science*, **65**, 2281–2290.
- Choi, J., Horne, D.S. & Lucey, J.A. (2007) Effect of insoluble calcium concentration on rennet coagulation properties of milk. *Journal of Dairy Science*, **90**, 2612–2623.
- Creamer, L.K., Lawrence, R.C. & Gilles, J. (1985) Effect of acidification of cheese milk on the resultant Cheddar cheese. *New Zealand Journal of Dairy Science and Technology*, **20**, 185–203.
- Dabour, N., Kheadr, E., Benhamou, N., Fliss, I. & LaPointe, G. (2006) Improvement of texture and structure of reduced-fat Cheddar cheese by exopolysaccharide-producing lactococci. *Journal of Dairy Science*, **89**, 95–110.
- Dalgleish, D.G. (1980) Effect of milk concentration on the rennet coagulation time. *Journal of Dairy Research*, **47**, 231–235.
- Dalgleish, D.G. (1983) Coagulation of renneted bovine casein micelles: dependence on temperature, calcium ion concentration and ionic strength. *Journal of Dairy Research*, **50**, 331–340.
- Dalgleish, D.G. & Law, A.J.R. (1988) pH-induced dissociation of bovine casein micelles. I: Analysis of liberated caseins. *Journal of Dairy Research*, **55**, 529–538.
- Dalgleish, D.G., Brinkhuis, J. & Payens, T.A.J. (1981) The coagulation of differently sized casein micelles by rennet. *European Journal of Biochemistry*, **119**, 257–261.
- Daviau, C., Famelart, M.-H., Pierre, A., Goudéranche, H. & Maubois, J.-L. (2000) Rennet coagulation of skim milk and curd drainage: effect of pH, casein concentration, ionic strength and heat treatment. *Lait*, **80**, 397–415.
- De Marchi, M., Fagan, C.C., O'Donnell, C.P., Cecchinato, A., Dal Zotto, R., Cassandro, M., Penasa, M. & Bittante, G. (2009) Prediction of coagulation properties, titrable acidity, and pH of bovine milk using mid-infrared spectroscopy. *Journal of Dairy Science*, **92**, 423–432.
- Dejmek, P. (1987) Dynamic rheology of rennet curd. *Journal of Dairy Science*, **70**, 1325–1330.
- Devold, T.G., Vegarud, G.E. & Langsrud, T. (1995) Micellar size and protein composition related to genetic variants of milk proteins. Document No. 304, pp. 10–11, International Dairy Federation, Brussels.

- van Dijk, A.A., Folkertsma, B. & Guillonard, L.J.O. (2009) *Method for Producing Cheese Using Heat Treated Milk and a Protein Hydrolysate*. US Patent Application 2009081329.
- van Dijk, H.J.M. & Hersevoort, A. (1992) The properties of casein micelles. 5. The determination of heat-induced calcium phosphate precipitations in milk. *Netherlands Milk and Dairy Journal*, **46**, 69–76.
- van Dijk, H.J.M. & Walstra, P. (1986) Syneresis of curd. 2: One-dimensional syneresis of rennet curd in constant conditions. *Netherlands Milk and Dairy Journal*, **40**, 3–30.
- van Dijk, H.J.M. (1982) *Syneresis of Curd*, PhD Thesis, Wageningen Agricultural University, Wageningen, The Netherlands.
- Drake, M.A. & Swanson, B.G. (1995) Reduced- and low-fat cheese technology: a review. *Trends in Food Science and Technology*, **6**, 366–369.
- Drake, M.A., Boylston, T.D. & Swanson, B.G. (1996a) Fat mimetics in low-fat Cheddar cheese. *Journal of Food Science*, **61**, 1267–1270.
- Drake, M.A., Herrett, W., Boylston, T.D. & Swanson, B.G. (1995) Sensory evaluation of reduced fat cheeses. *Journal of Food Science*, **60**, 898–901.
- Drake, M.A., Herrett, W., Boylston, T.D. & Swanson, B.G. (1996b) Lecithin improves texture of reduced fat cheeses. *Journal of Food Science*, **61**, 639–642.
- Ekstrand B, Larsson-Raźnikiewicz, M. & Perlmann, C. (1980) Casein micelle size and composition related to the enzymatic coagulation process. *Biochimica et Biophysica Acta*, **630**, 361–366.
- Emmons, D.B., Lister, E.E., Beckett, D.C. & Jenkins, K.J. (1980) Quality of protein in milk replacers for young calves. V: Effect of method of dispersing fat on curd formation and whey syneresis. *Journal of Dairy Science*, **63**, 417–425.
- Everard, C.D., O’Callaghan, D.J., Fagan, C.C., O’Donnell, C.P., Castillo, M. & Payne, F.A. (2007) Computer vision and color measurement techniques for inline monitoring of cheese curd syneresis. *Journal of Dairy Science*, **90**, 3162–3170.
- Everard, C.D., O’Callaghan, D.J., Mateo, M.J., O’Donnell, C.P., Castillo, M. & Payne, F.A. (2008) Effects of cutting intensity and stirring speed on syneresis and curd losses during cheese manufacture. *Journal of Dairy Science*, **91**, 2575–2582.
- Everett, D.W. & Auty, M.A.E. (2008) Cheese structure and current methods of analysis. *International Dairy Journal*, **18**, 759–773.
- Fagan, C.C., Castillo, M., O’Callaghan, D.J., Payne, F.A. & O’Donnell, C.P. (2009) Visible-near infrared spectroscopy sensor for predicting curd and whey composition during cheese processing. *Sensing and Instrumentation for Food Quality and Safety*, **3**, 62–69.
- Fagan, C.C., Castillo, M., O’Donnell, C.P., O’Callaghan, D.J. & Payne, F.A. (2008a) On-line prediction of cheese making indices using backscatter of near infrared light. *International Dairy Journal*, **18**, 120–128.
- Fagan, C.C., Du, C.-J., O’Donnell, C.P., Castillo, M., Everard, C.D., O’Callaghan, D.J. & Payne, F.A. (2008b) Application of image texture analysis for online determination of curd moisture and whey solids in a laboratory-scale stirred cheese vat. *Journal of Food Science*, **73**, E250–E258.
- Fagan, C.C., Leedy, M., Castillo, M., Payne, F.A., O’Donnell, C.P. & O’Callaghan, D.J. (2007) Development of a light scatter sensor technology for on-line monitoring of milk coagulation and whey separation. *Journal of Food Engineering*, **83**, 61–67.
- Farell, H.M., Malin, E.L., Brown, E.M. & Qi, P.X. (2006) Casein micelle structure: what can be learned from milk synthesis and structural biology? *Current Opinion in Colloid and Interface Science*, **11**, 135–147.
- Fenelon, M., Guinee, T. & Reville, W. (1999) Characteristics of reduced-fat Cheddar prepared from the blending of full-fat and skim cheese curds at whey drainage. *Milchwissenschaft*, **54**, 506–510.
- Fife, R.L., McMahan, D.J. & Oberg, C.J. (1996) Functionality of low fat Mozzarella cheese. *Journal of Dairy Science*, **79**, 1903–1910.
- Flüeler, O. & Puhani, Z. (1979) Research on slow renneting milk. III: Experiments with model systems. *Schweizerische Milchwirtschaftliche Forschung*, **8**, 49–56.

- Flüeler, O. (1978) Research on slow renneting milk. I: Composition of the milk. *Schweizerische Milchwirtschaftliche Forschung*, **7**, 45–54.
- Forsingdal, K. & Thomsen, D. (1985) Summation and discussion of experience with cheesemaking from milk stored up to 5 days. *Meieriposten*, **74**, 57–62.
- Fox, P.F., Cogan, T.M. & Guinee, T.P. (2000) *Fundamentals of Cheese Science*, Aspen Publishers, Gaithersburg, MD.
- Garnsworthy, P.C., Masson, L.L., Lock, A.L. & Mottram, T.T. (2006) Variation of milk citrate with stage of lactation and de novo fatty acid synthesis in dairy cows. *Journal of Dairy Science*, **89**, 1604–1612.
- Ghosh, B.C., Steffl, A. & Kessler, H.-G. (1996) Rennetability of milk containing different heat-denatured whey protein. *Milchwissenschaft*, **51**, 28–31.
- Gouda, A., El-Zayat, A.I., and El-Shabrawy, S.A. (1985) Partition of some milk salts and curd properties as affected by adding sodium chloride to the milk. *Deutsche Lebensmittel-Rundschau*, **81**, 216–218.
- Grandison, A.S., Ford, G.D., Millard, D. & Anderson, M. (1985) Interrelationships of chemical composition and coagulating properties of renneted milks from dairy cows grazing ryegrass or white clover. *Journal of Dairy Research*, **52**, 41–46.
- Grandison, A.S. & Ford, G.D. (1986). Effects of variations in somatic cell count on the rennet coagulation properties of milk and on the yield, composition and quality of Cheddar cheese. *Journal of Dairy Research*, **53**, 645–655.
- Grandison, A.S., Ford, G.D., Owen, A.J. & Millard, D. (1984) Chemical composition and coagulating properties of renneted Friesian milk during the transition from winter rations to spring grazing. *Journal of Dairy Research*, **51**, 69–78.
- Green, M.L. (1987) Effect of manipulation of milk composition and curdforming conditions on the formation, structure and properties of milk curd. *Journal of Dairy Research*, **54**, 303–313.
- Green, M.L., Glover, F.A., Scurlock, E.M.W., Marshall, R.J. & Hatfield, D.S. (1981) Effect of use of milk concentrated by ultrafiltration on the manufacture and ripening of Cheddar Cheese. *Journal of Dairy Research*, **48**, 333–341.
- Green, M.L., Hobbs, D.G., Morant, S.V. & Hill, V.A. (1978) Intermicellar relationships in rennet-treated separated milk. II: Process of gel assembly. *Journal of Dairy Research*, **45**, 413–422.
- Green, M.L., Marshall, R.J. & Glover, F.A. (1983) Influence of homogenization of concentrated milks on the structure and properties of rennet curds. *Journal of Dairy Research*, **50**, 341–348.
- Guillaume, C., Gastaldi, E., Cuq, J.-L. & Marchesseau, S. (2004b) Effect of pH on rennet clotting properties of CO₂-acidified skim milk. *International Dairy Journal*, **14**, 437–443.
- Guillaume, C., Jiménez, L., Cuq, J.-L. & Marchesseau, S. (2004a) An original pH-reversible treatment of milk to improve rennet gelation. *International Dairy Journal*, **14**, 305–311.
- Guillemin, H., Trelea, I.A., Picque, D., Perret, B., Cattenoz, T. & Corrieu, G. (2006) An optical method to monitor casein particle size distribution in whey. *Lait*, **86**, 359–372.
- Guinee, T.P., Auty, M.A.E. & Fenelon, M.A. (2000) The effect of fat content on the rheology, microstructure and heat-induced functional characteristics of Cheddar cheese. *International Dairy Journal*, **10**, 277–288.
- Guyomarc'h, F. (2006) Formation of heat-induced protein aggregates in milk as a means to recover the whey protein fraction in cheese manufacture, and potential of heat-treatment milk at alkaline pH values in order to keep its rennet coagulation properties. A review. *Lait*, **86**, 1–20.
- Hallén, E., Allmere, T., Näslund, J., Andrén, A. & Lundén, A. (2007). Effect of genetic polymorphism of milk proteins on rheology of chymosin-induced milk gels. *International Dairy Journal*, **17**, 791–799.
- Heck, J.M.L., Schennink, A., van Valenberg, H.J.F., Bovenhuis, H., Visker, M.H.P.W., van Arendonk, J.A.M. & van Hooijdonk, A.C.M. (2009) Effects of milk protein variants on the protein composition of bovine milk. *Journal of Dairy Science*, **92**, 1192–1202.

- Hill, J.P., Paterson, G.R., Lowe, R. & Johnston, K.A. (1995) Effect of β -lactoglobulin variants on curd firming rate, yield, maturation and sensory properties of cheddar cheese. Document No. 304, pp. 18–19, International Dairy Federation, Brussels.
- Hindle, E.J. & Wheelock, J.V. (1970) The primary phase of rennin action in heatsterilized milk. *Journal of Dairy Research*, **37**, 389–396.
- van Hooydonk, A.C.M. & van den Berg, G. (1988) *Control & Determination of the Curd Setting During Cheesemaking; Influence of Milk Concentrate of UF on Enzymatic coagulation*, Document No. 225, pp. 2–10, International Dairy Federation, Brussels.
- van Hooydonk, A.C.M. (1987) *The Renneting of Milk: A Kinetic Study of the Enzymic and Aggregation Reactions*, PhD Thesis, Wageningen University, Wageningen, The Netherlands.
- van Hooydonk, A.C.M., Boerrigter, I.J. & Hagedoorn, H.G. (1986a) pH-induced physico-chemical changes of casein micelles in milk and their effect on renneting. 2: Effect of pH on renneting of milk. *Netherlands Milk and Dairy Journal*, **40**, 297–313.
- van Hooydonk, A.C.M., de Koster, P.G. & Boerrigter, I.J. (1987) The renneting properties of heated milk. *Netherlands Milk and Dairy Journal*, **41**, 3–18.
- van Hooydonk, A.C.M., Hagedoorn, H.G., and Boerrigter, I.J. (1986b) pH-induced physicochemical changes of casein micelles in milk and their effect on renneting. 1: Effect of acidification on physicochemical properties. *Netherlands Milk and Dairy Journal*, **40**, 281–296.
- van Hooydonk, A.C.M., Olieman, C. & Hagedoorn, H.G. (1984) Kinetics of the chymosin-catalysed proteolysis of kappa-casein in milk. *Netherlands Milk and Dairy Journal*, **38**, 207–222.
- Horne, D.S. (1987) Determination of the fractal dimension using turbidimetric techniques. Application to aggregating protein systems. Faraday discussions. *Royal Society of Chemistry*, **83**, 259–270.
- Horne, D.S., Muir, D.D., Banks, J.M., Leaver, J. & Law, A.J.R. (1995b) Effects of κ -casein phenotype on curd strength in rennet coagulated milks. Document No. 304, pp. 12, International Dairy Federation, Brussels.
- Horne, D.S., Muir, D.D., Leaver, J., McCreight, T.A. & Banks, J.M. (1995a) Effects of κ -casein phenotype on rennet coagulation time. Document No. 304, pp. 11, International Dairy Federation, Brussels.
- Hyldig, G. (1993) *Rennet coagulation – Effect of Technological Parameters on the Enzymatic Reaction and Gel Formation in Milk and UF Concentrates*, PhD Thesis, The Royal Veterinary and Agricultural University, Copenhagen, Denmark.
- Ikonen, T., Morri, S., Tyriseva, A., Ruottinen, O. & Ojala, M. (2004) Genetic and phenotypic correlations between milk coagulation properties, milk production traits, somatic cell count, casein content, and pH of milk. *Journal of Dairy Science*, **87**, 458–467.
- Jakob, E. & Puhan, Z. (1986) Differences between slow-renneting and normal renneting milk with special emphasis on the casein fraction. *Schweizerische Milchwirtschaftliche Forschung*, **15**, 21–28.
- Jakob, E. & Puhan, Z. (1992) Technological properties of milk as influenced by genetic polymorphism of milk proteins – a review. *International Dairy Journal*, **2**, 157–178.
- Jakob, E. (1994) Genetic polymorphism of milk proteins. Document No. 298, pp. 17–27, International Dairy Federation, Brussels.
- Johnson, M.E., Kapoor, R., McMahan, D.J., McCoy, D.R. & Narasimmon, R. (2009) Reduction of sodium and fat levels in natural and processes cheeses. Scientific and technological aspects. *Comprehensive Reviews in Food Science and Food Safety*, **8**, 252–268.
- Katsiari, M.C. & Voutsinas, P. (1994) Manufacture of low-fat Kefalograviera cheese. *International Dairy Journal*, **4**, 533–553.
- Keceli, T., Sahan, N. & Yasar, K. (2006). The effect of pre-acidification with citric acid on reduced-fat Kashar cheese. *Australian Journal of Dairy Technology*, **61**, 32–36.
- Kelly, A.L., Huppertz, T. & Sheenan, J.J. (2008) Pre-treatment of cheese milk: principles and developments. *Dairy Science and Technology*, **88**, 549–572.
- Kindstedt, P.S., Yun, J.J., Barbano, D.M. & Larose, K.L. (1995) Mozzarella cheese: impact of coagulant concentration on chemical composition, proteolysis, and functional properties. *Journal of Dairy Science*, **78**, 2591–2597.

- Kowalchuk, A.W. & Olson, N.F. (1977) Effects of pH and temperature on the secondary phase of milk clotting by rennet. *Journal of Dairy Science*, **60**, 1256–1259.
- Law, A.J.R. (1996) Effects on heat treatment and acidification on the dissociation of bovine casein micelles. *Journal of Dairy Research*, **63**, 35–48.
- Law, A.J.R., Leaver, J., Banks, J.M. & Horne, D.S. (1994) The effect of κ -casein genotype on the composition of whole milk. *Cheese Yield and Factors Affecting its Control*, Special Issue No. 9402, pp. 134–141, International Dairy Federation, Brussels.
- Lawrence, R.C. & Gilles, J. (1982) Factors that determine the pH of young Cheddar cheese. *New Zealand Journal of Dairy Science and Technology*, **17**, 1–14.
- Leitner, G., Silanikove, N., Jacobi, S., Weisblit, L., Bernstein, S. & Merin, U (2008). The influence of storage on the farm and in dairy silos on milk quality for cheese production. *International Dairy Journal*, **18**, 109–113.
- Relievere, J. (1977) Rigidity modulus as a factor influencing the syneresis of renneted milk gels. *Journal of Dairy Research*, **44**, 611–614.
- Lidberg, E. & Bredahl, B. (1990) The suitability of microfiltered cheese milk for the manufacture of Swedish hard cheese. *Nordisk Mejeriindustri*, **17**, 457–459.
- Lilbaek, H., Broe, M.L., Hoier, E., Fatum, T. Ipsen, R. & Sorensen, N.K. (2006) Improving the yield of Mozzarella cheese by phospholipase treatment of milk. *Journal of Dairy Science*, **89**, 4114–4125.
- Lodaite, K., Ostergren, K., Paulsson, M. & Dejmeck, P. (2000) One-dimensional syneresis of rennet-induced gels. *International Dairy Journal*, **10**, 829–834.
- Lodes, A., Buchberger, J., Krause, I., Aumann, J. & Klostermeyer, H. (1996) The influence of genetic variants of milk proteins on the compositional and technological properties of milk. 2: Rennet coagulation time and firmness of the rennet curd. *Milchwissenschaft*, **51**, 543–548.
- Lomholt, S.B. & Qvist, K.B. (1997) Relationship between rheological properties and degree of kappa-casein proteolysis during renneting of milk. *Journal of Dairy Research*, **64**, 541–549.
- Lomholt, S.B., Worning, P., Øgendal, L., Qvist, K.B., Hyslop, D.B. & Bauer, R. (1998) Kinetics of the renneting reaction followed by measurement of turbidity as a function of wavelength. *Journal of Dairy Research*, **65**, 545–554.
- López, M.B., Lomholt, S.B. & Qvist, K.B. (1998) Rheological properties and cutting time of rennet gels. Effect of pH and enzyme concentration. *International Dairy Journal*, **8**, 289–293.
- Lucey, J.A. & Fox, P.F. (1993) Importance of calcium and phosphate in cheese manufacture: a review. *Journal of Dairy Science*, **76**, 1714–1724.
- Lucey, J.A. & Horne, D.S. (2009) Milk salts: technological significance. *Advanced Dairy Chemistry, Volume 3: Lactose, Water, Salts and Minor Constituents* (eds P.L.H. McSweeney & P.F. Fox), pp. 351–389, Springer Science, New York.
- Lucey, J.A., Gorry, C. & Fox, P.F. (1994) Methods for improving the rennet coagulation properties of heated milk. *Cheese Yield and Factors Affecting its Control*, Special Issue No. 9402, pp. 448–456, International Dairy Federation, Brussels.
- Luyten, H. (1988) *The Rheological and Fracture Properties of Gouda Cheese*, PhD Thesis, Wageningen Agricultural University, Wageningen, The Netherlands.
- Luyten, H., van Vliet, T. & Walstra, P. (1991) Characterization of the consistency of Gouda cheese: rheological properties. *Netherlands Milk and Dairy Journal*, **45**, 33–53.
- Mariani, P., Pecorari, M., Fossa, E. & Fieni, S. (1981) Abnormal coagulation of milk, and its relationship with cell count and titratable acidity. *Scienza e Technica Lattiero Caseria*, **32**, 222–236.
- Marshall, R.J. (1982) An improved method for measurement of the syneresis of curd formed by rennet action on milk. *Journal of Dairy Research*, **49**, 329–336.
- Marshall, R.J. (1986) Increasing cheese yields by high heat treatment of milk. *Journal of Dairy Research*, **53**, 313–322.
- Mateo, M.J., Everard, C.D., Fagan, C.C., O'Donnell, C.P., Castillo, M., Payne, F.A. & O'Callaghan, D.J. (2009) Effect of milk fat concentration and gel firmness on syneresis during curd stirring in cheese-making. *International Dairy Journal*, **19**, 264–268.

- Maynes, J.R. (1992) *A New Method for Measuring Macroparticulate Systems Applied to Measuring Syneresis of Renneted Milk Gels*, PhD Thesis, Utah State University, Logan.
- McGann, T.C.A. & Pyne, G.T. (1960) The colloidal phosphate of milk. III: Nature of its interaction with casein. *Journal of Dairy Research*, **27**, 403–417.
- McMahon, D.J. & Brown, R.J. (1982) Evaluation of Formagraph for comparing rennet solutions. *Journal of Dairy Science*, **65**, 1639–1642.
- McMahon, D.J., Alleyne, M.C., Fife, R.L. & Oberg, C.J. (1996) Use of fat replacers in low fat Mozzarella cheese. *Journal of Dairy Science*, **79**, 1911–1921.
- McMahon, D.J., Brown, R.J., Richardson, G.H. & Ernstrom, C.A. (1984) Effects of calcium, Phosphate and bulk culture media on milk coagulation properties. *Journal of Dairy Science*, **67**, 930–938.
- Meersohn, M. (1989) Nitrate free cheese with Bactocatch. *North European Food and Dairy Journal*, **55**, 108–113.
- Mekmene, O., Le Graët, Y. & Gaucheron, F. (2009) A model for salt equilibria in milk and mineral-enriched milks. *Food Chemistry*, **116**, 233–239.
- Metzger, L.E. & Mistry, V.V. (1994) A new approach using homogenization of cream in the manufacture of reduced fat Cheddar cheese. 1: Manufacture, composition and yield. *Journal of Dairy Science*, **77**, 3506–3515.
- Mishra, R., Govindasamy-Lucey, S. & Lucey, J.A. (2005) Rheological properties of rennet-induced gels during the coagulation and cutting process: impact of processing conditions. *Journal of Texture Studies*, **36**, 190–212.
- Mistry, V.V. (2001) Low fat cheese technology. *International Dairy Journal*, **11**, 413–422.
- Mitchell, G.E., Fedrick, I.A. & Rogers, S.A. (1986) The relationship between somatic cell count, composition and manufacturing properties of bulk milk. II: Cheddar cheese from farm bulk milk. *Australian Journal of Dairy Technology*, **41**, 12–14.
- Mocquot, G., Alais, C. & Chevalier, R. (1954) Etude sur les défauts de coagulation du lait par la pression. *Annales de Technologie Agricole*, **3**, 1–44.
- Nájera, A.I., de Renobales, M. & Barron, L.J.R. (2003) Effects of pH, temperature, CaCl₂ and enzyme concentrations on the rennet-clotting properties of milk: a multifactorial study. *Food Chemistry*, **80**, 345–352.
- Nielsen, E.W. (1996) Introduction to the theoretical and empirical basis of the Danish cheese simulator (DCS). Document No. 308, pp. 42–51. International Dairy Federation, Brussels.
- Nielsen, K.O. (1982) Effect of cooling and pasteurization on renneting properties of milk and on the rigidity and syneresis properties of the gel. II: Syneresis properties of the gel. *Meieriposten*, **71**, 123–127, 162–163.
- Niki, R., Kohyama, K., Sano, Y. & Nishinari, K. (1994) Rheological study on the rennet-induced gelation of casein micelles with different sizes. *Polymer Gels and Networks*, **2**, 105–118.
- O'Callaghan, D.J., O'Donnell, C.P. & Payne, F.A. (2002) Review of systems for monitoring curd setting during cheesemaking. *International Journal of Dairy Technology*, **55**, 65–74.
- O'Keeffe, A.M., Phelan, J.A. & Mulholland, E. (1981) Effects of seasonality on the suitability of milk for cheesemaking. *Irish Journal of Food Science and Technology*, **5**, 73.
- O'Keeffe, A.M., Phelan, J.A., Keogh, K. & Kelly, P. (1982) Studies of milk composition and its relationship to some processing criteria. IV: Factors influencing the renneting properties of a seasonal milk supply. *Irish Journal of Food Science and Technology*, **6**, 39–47.
- Okigbo, L.M., Richardson, G.H., Brown, R.J. & Ernstrom, C.A. (1985a) Variation in coagulation properties of milk from individual cows. *Journal of Dairy Science*, **68**, 822–828.
- Okigbo, L.M., Richardson, G.H., Brown, R.J. and Ernstrom, C.A. (1985b) Casein composition of cow's milk of different chymosin coagulation properties. *Journal of Dairy Science*, **68**, 1887–1892.
- Pearse, M.J., Mackinlay, A.G., Hall, R.J. & Linklater, P.M. (1984) A microassay for the syneresis of cheese curd. *Journal of Dairy Research*, **51**, 131–139.
- Pearse, M.J., Linklater, P.M., Hall, R.J. & Mackinlay, A.G. (1985) Effect of heat induced interaction between beta-lactoglobulin and kappa-casein on syneresis. *Journal of Dairy Research*, **52**, 159–165.

- Peltola, E. & Vogt, P. (1959) The effect of cold aging on the renneting of milk. *Proceedings of the XV International Dairy Congress (London)*, Vol. 1, pp. 268–271.
- Peters, K.H. & Knoop, A.M. (1978) Structure alterations in rennet coagulum and cheese curd in cheesemaking from deep-cooled milk. *Milchwissenschaft*, **33**, 77–81.
- Poduval, V.S. & Mistry, V.V. (1999) Manufacture of reduced fat Mozzarella cheese using ultrafiltered sweet buttermilk and homogenized cream. *Journal of Dairy Science*, **82**, 1–9.
- Politis, I. & Ng Kwai Hang, K.F. (1988) Effect of somatic cell counts and milk composition on the rennet coagulation properties of milk. *Journal of Dairy Science*, **71**, 1740–1746.
- Pouliot, Y., Boulet, M. & Paquin, P. (1989) Observations on the heat-induced salt balance changes in milk. II: Reversibility on cooling. *Journal of Dairy Research*, **56**, 193–199.
- Pyne, G.T. & McGann, T.C.A. (1962) The influence of the colloidal phosphate of milk on the rennet coagulation. *Proceedings of the XVI International Dairy Congress*, Vol. B, pp. 611–616.
- Qvist, K.B. (1979a) Reestablishment of the original rennetability of milk after cooling. 1: The effect of cooling and LTST pasteurization of milk on renneting. *Milchwissenschaft*, **34**, 467–470.
- Qvist, K.B. (1979b) Reestablishment of the original rennetability of milk after cooling. 2: The effect of some additives. *Milchwissenschaft*, **34**, 600–603.
- Qvist, K.B. (1981) *Some Investigations Concerning the Physico-Chemical Properties of Milk in Relation to Cheese Manufacture and Regulation of Coagulum Firmness*, PhD Thesis, The Royal Veterinary and Agricultural University, Copenhagen, Denmark.
- Qvist, K.B., Thomsen, D. & Jensen, G.K. (1986) Manufacture of Havarti cheese from milk concentrated about 5-fold by ultrafiltration. *Beretning* **268**, pp. 1–55, Statens Mejeriforsøg, Hillerød, Denmark.
- Reimerdes, E.H. & Klostermeyer, H. (1976) Änderungen im Verhältnis Micelleneiweiß/Serumeiweiß bei der Kühlung von Milch. *Kieler Milchwirtschaftliche Forschungsberichte*, **28**, 17–24.
- Reimerdes, E.H., Pèrez, S.J. & Ringqvist, B.M. (1977a) Temperaturabhängige Veränderungen in Milch und Milchproducten. II: Der einfluss der Tiefkühlung auf käseerechnologische Eigenschaften der Milch. *Milchwissenschaft*, **32**, 154–158.
- Reimerdes, E.H., Pèrez, S.J. & Ringqvist, B.M. (1977b) Temperaturabhängige Veränderungen in Milch und Milchproducten. III: Die Thermisierung: ein korrigierender Schritt bei der Verarbeitung von tiefgekühlter Milch. *Milchwissenschaft*, **32**, 207–210.
- Riddel-Lawrence, S. & Hicks, C.L. (1989) Effect of curd firmness on stirred curd cheese yield. *Journal of Dairy Science*, **72**, 313–321.
- Rodríguez, J. (1998) Recent advances in the development of low-fat cheeses. *Trends in Food Science and Technology*, **9**, 249–254.
- Roefs, S.P.F.M., van Vliet, T., Van Den Bijgaart, H.J.C.M., de Groot-Mostert, A.E.A. & Walstra, P. (1990) Structure of casein gels made by combined acidification and rennet action. *Netherlands Milk and Dairy Journal*, **44**, 159–188.
- Romeih E., Michaelidou, A., Biliaderis, C. & Zerfiridis, G. (2002) Low-fat white-brined cheese made from bovine milk and two commercial fat mimetics: chemical, physical and sensory attributes. *International Dairy Journal*, **12**, 525–540.
- van Rooijen, R. (2008) Increase cheese yields and boost returns. *European Dairy Magazine*, **18**, 26–28.
- Schaar, J. (1984) Effects of κ -casein genetic variants and lactation number on the renneting properties of individual milks. *Journal of Dairy Research*, **51**, 397–406.
- Schmutz, M. & Puhán, Z. (1980) Chemisch-physikalische Veränderungen während der Tiefkühlagerung von Milch. *Schweizerische Milchwissenschaftliche Forschung*, **9**, 39–48.
- Shalabi, S.I. & Wheelock, J.V. (1976) The role of alfa-lactalbumin in the primary phase of chymosin action on heated casein micelles. *Journal of Dairy Research*, **43**, 331–335.
- Singh, H. & Waungana, A. (2001) Influence of heat treatment of milk on cheesemaking properties. *International Dairy Journal*, **11**, 543–551.
- Singh, H., Shalabi, S.I., Fox, P.F., Flynn, A. & Barry, A. (1988) Rennet coagulation of heated milk: influence of pH adjustment before or after heating. *Journal of Dairy Research*, **55**, 205–215.

- Solberg, S. (1991) Microfiltration of milk for cheesemaking. Testing of Bactocatch. *Meieriposten*, **80**, 603–605.
- Spangler, P.L., Jensen, L.A., Amundson, C.H., Olson, N.F. & Hill, C.G.J. (1991) Ultrafiltered Gouda cheese: effects of preacidification, diafiltration, rennet and starter concentration, and time to cut. *Journal of Dairy Science*, **74**, 2809–2819.
- Srinivasan, M. & Lucey, J.A. (2002) Effects of added plasmin on the formation and rheological properties of rennet-induced skim milk gels. *Journal of Dairy Science*, **85**, 1070–1078.
- Storry, J.E., Grandison, A.S., Millard, D., Owen, A.J. & Ford, G.D. (1983) Chemical composition and coagulating properties of renneted milks from different breeds and species of ruminant. *Journal of Dairy Research*, **50**, 215–229.
- Tervala, H.L., Antila, V. & Syvajarvi, J. (1985) Factors affecting the renneting properties of milk. *Meijeritieteellinen Aikakauskirja*, **43**, 16–25.
- Thomann, S., Schenkel, P. & Hinrichs, J. (2007) Effect of homogenization, microfiltration and pH on curd firmness and syneresis of curd grains. *Lebensmittel-Wissenschaft und -Technologie*, **41**, 826–835.
- Tijskens, E. & De Baerdemaker, J. (2004) Mathematical model of syneresis of cheese curd. *Mathematics and Computer Simulation*, **65**, 165–175.
- Todorova, D. (1996) Somatic cell counts and rennetability of ram milk from Black Oied cows. *Zhivitnow”dni-Nauki*, **33**, 65–67.
- Tokita, M., Hikichi, K., Niki, R. & Arima, S. (1982) Dynamic viscoelastic studies on the mechanism of milk clotting process. *Biorheology*, **19**, 209.
- Tsioulpas, A.L., Lewis, M.J. & Grandison, A.S. (2007) Effect of minerals on casein micelle stability of cows’ milk. *Journal of Dairy Research*, **74**, 167–173.
- Tunick, M.H., Mackey, K.L., Shieh, J.J., Smith, P.W., Cooke, P. & Malin, E.L. (1993a) Rheology and microstructure of low-fat Mozzarella cheese. *International Dairy Journal*, **3**, 649–662.
- Tunick, M.H., Malin, E.L., Smith, P.W., Shieh, J.J., Sullivan, B.C., Mackey, K.L. & Holsinger, V.H. (1993b) Proteolysis and rheology of low fat and full fat Mozzarella cheeses prepared from homogenised milk. *Journal of Dairy Science*, **76**, 3621–3628.
- Tyrisevä, A. (2008) *Options for Selecting Dairy Cattle for Milk Coagulation Ability*, PhD Thesis, University of Helsinki, Helsinki, Finland.
- Tyrisevä, A., Vahlsten, T., Ruottinen, O. & Ojala, M. (2004) Noncoagulation of milk in Finnish Ayrshire and Holstein-Friesian cows and effect of herds on milk coagulation ability. *Journal of Dairy Science*, **87**, 3958–3966.
- Udabage, P., McKinnon, I.R. & Augustin, M.A. (2001) Effects of mineral salts and calcium chelating agents on the gelation of renneted skim milk. *Journal of Dairy Science*, **84**, 1569–1575.
- Ustunol, Z., Kawachi, K. & Steffe, J. (1995) Rheological properties of Cheddar cheese as influenced by fat reduction and ripening time. *Journal of Food Science*, **60**, 1208–1210.
- Van Den Bijgaart, H.J.C.M. (1988) *Syneresis of Rennet-Induced Milk Gels as Influenced by Cheesemaking Parameters*, PhD Thesis, Wageningen Agricultural University, Wageningen, The Netherlands.
- Wade, T., Beattie, J.K., Rowlands, W.N. & Augustin, M.-A. (1996) Electroacoustic determination of size and zeta-potential of casein micelles in skim milk. *Journal of Dairy Research*, **63**, 387–404.
- Walstra, P. & van Vliet, T. (1986) The physical chemistry of curd making. *Netherlands Milk and Dairy Journal*, **40**, 241–259.
- Walstra, P. (1980) Effect of homogenisation on milk plasma. *Netherlands Milk and Dairy Journal*, **34**, 181–190.
- Walstra, P. (1993) The syneresis of curd. *Cheese: Chemistry, Physics and Microbiology* (ed. P.F. Fox), pp. 141–191, Chapman & Hall, London.
- Walstra, P., van Dijk, H.J.M. & Geurts, T.J. (1985) The syneresis of curd. 1: General considerations and literature review. *Netherlands Milk and Dairy Journal*, **39**, 209–246.

- Wedholm, A., Larsen, L.B., Lindmark-Mansson, H., Karlsson, A.H. & Andren, A. (2006) Effect of protein composition on the cheese-making properties of milk from individual dairy cows. *Journal of Dairy Science*, **89**, 3296–3305.
- Wheelock, J.V. & Kirk, A. (1974) The role of beta-lactoglobulin in the primary phase of rennin action on heated casein micelles and heated milk. *Journal of Dairy Research*, **41**, 367–372.
- White, J.C.D. & Davies, D.T. (1958) The relation between the chemical composition of milk and the stability of the caseinate complex. III: Coagulation by rennet. *Journal of Dairy Research*, **25**, 267–280.
- Wilson, G.A. & Wheelock, J.V. (1972) Factors affecting the action of rennin in heated milk. *Journal of Dairy Research*, **39**, 413–419.
- Wium, H., Pedersen, P.S. & Qvist, K.B. (2003) Effect of coagulation conditions on the microstructure and the large deformation properties of fat-free Feta cheese made from ultrafiltered milk. *Food Hydrocolloids*, **17**, 287–296.
- Worning, P. (1998) *Light Scattering in Dense Systems*, PhD Thesis, The Royal Veterinary and Agricultural University, Copenhagen, Denmark.
- Worning, P., Bauer, R., Øgendal, L. & Lomholt, S.B. (1998) A novel approach to turbidimetry of dense systems: an investigation of the enzymatic gelation of casein micelles. *Journal of Colloid and Interface Science*, **203**, 265–277.
- Zamora, A., Ferragut, V., Jaramillo, P., Guamis, B. & Trujillo, A. (2007) Effects of ultra-high pressure homogenization on the cheese-making properties of milk. *Journal of Dairy Science*, **90**, 13–23.
- Zisu, B. & Shah, N. (2007) Texture characteristics and pizza bake properties of low-fat Mozzarella cheese as influenced by pre-acidification with citric acid and use of encapsulated and ropy exopolysaccharide producing cultures. *International Dairy Journal*, **17**, 985–997.
- Zoon, P. (1994) Incorporation of whey proteins into dutch-type cheese. *Cheese Yield and Factors Affecting its Control*, Special Issue No. 9402, pp. 402–408, International Dairy Federation, Brussels.
- Zoon, P., van Vliet, T. & Walstra, P. (1988a) Rheological properties of rennet-induced skim milk gels. 1. Introduction. *Netherlands Milk and Dairy Journal*, **42**, 249–269.
- Zoon, P., van Vliet, T. & Walstra, P. (1988b) Rheological properties of rennet-induced skim milk gels. 2. Effect of temperature. *Netherlands Milk and Dairy Journal*, **42**, 271–294.
- Zoon, P., van Vliet, T. & Walstra, P. (1988c) Rheological properties of rennet-induced skim milk gels. 3. The effect of calcium and phosphate. *Netherlands Milk and Dairy Journal*, **42**, 295–312.
- Zoon, P., van Vliet, T. & Walstra, P. (1989) Rheological properties of rennet induced skim milk gels. 4. The effect of pH and NaCl. *Netherlands Milk and Dairy Journal*, **43**, 17–34.

5 The Production, Application and Action of Lactic Cheese Starter Cultures

E. Høier, T. Janzen, F. Rattray, K. Sørensen,
M.W. Børsting, E. Brockmann and E. Johansen

5.1 Introduction

The production of cheese involves a complex interaction between milk, rennet and bacteria. Since the bacteriological quality of milk varies considerably, most cheese is made using pasteurised milk. This process eliminates more than 99% of the bacteria present in the milk, including the lactic acid bacteria (LAB) that could give spontaneous acidification. In order to make a cheese with the desired properties, starter cultures are added to the milk; these can be produced in the dairy or purchased from a commercial starter culture supplier who can provide cultures in a variety of formats developed to match the technology used in the dairy.

The starter culture plays a crucial role during all phases of cheesemaking and during the maturation process. As the culture grows in the milk, it converts lactose to lactic acid. This ensures the correct pH for coagulation, in the press and in the final cheese curd. It also helps determine the final moisture content of the cheese. During the maturation period, the starter culture influences the development of flavour, aroma, texture and, where relevant, eye formation. Health-promoting probiotic bacteria are included in some starter cultures to provide an additional functionality to the cheese.

In this chapter, the range of LAB used in starter cultures will be described, their taxonomy and their role in the production of different types of cheese as well as details on the production and use of commercial starter cultures will be provided. In addition, the various strategies available to minimise bacteriophage problems and the use of molecular biology, genomics and recombinant deoxyribonucleic acid (DNA) technology, in combination with an understanding of the metabolism of LAB and high-throughput screening (HTS) methods, for the improvement of commercial starter cultures will be reviewed.

5.2 Historical background

It has been known for many centuries that milk becomes acid-coagulated following storage at ambient temperatures and that coagulated milk does not easily putrefy. To control the fermentation process, the practice of taking the best of the previous day's fermented product and using it as the inoculum for the next production was developed. Variations of this method are still seen in some traditional productions in which the whey from one day's cheese production is incubated and used as starter the next day.

Due to differences between regions in the specific technology used in the processing of milk, numerous cheeses were developed, such as Cheddar, Gouda and Mozzarella. These

products have one thing in common, namely that the LAB are responsible for the acidification. Due to climatic variation, products with thermophilic LAB developed primarily in the subtropical and tropical regions, while cheeses made with mesophilic LAB were developed in temperate regions. Today's starter cultures and strains have their origins in the cultures of the past, having been transferred from one generation to the next. To match the increasing demands of the dairy industry and the consumer, new starter cultures are constantly being developed. For example, the distinction between thermophilic and mesophilic cultures is considerably less important today due to the carefully controlled conditions in a modern cheese factory. New cheese varieties, for example those containing high levels of probiotic bacteria, have resulted from further development of starter cultures.

5.3 Production of starter cultures

Historically, starter culture production was carried out in the dairy using liquid cultures either propagated by the dairy or supplied by local culture producers. In the early 1960s, commercial starter culture companies developed the production technology to freeze-dry liquid cultures and produce concentrated frozen starter cultures for the direct inoculation of 500–1000-L bulk starter tanks at the dairy. Today, commercial starter companies offer an extensive range of frozen and freeze-dried concentrated cultures for direct inoculation of the cheese vat, eliminating the need for use of bulk starters. These are known as direct vat set (DVS) or direct-to-vat inoculation (DVI) cultures, and will be referred to as DVS cultures throughout this chapter.

Due to the demand placed on these cultures, the production procedures used by commercial starter companies have approached pharmaceutical standards in recent years. Pharmaceutical-grade fermentation equipment and designated processing areas are used in the factory combined with good manufacturing practices and an understanding of the critical control points. A typical production process is illustrated in Fig. 5.1, which consists of the following steps: (a) handling of inoculation material, (b) preparation of media, (c) propagation of cultures in fermenters under pH control, (d) concentration, (e) freezing, (f) drying and (g) packaging and storage. The culture collections of the suppliers are the basis of all fermentations. Cultures or single strains used as inoculation material are prepared under aseptic conditions, and transfers are kept to a minimum.

Growth media for the production of cultures are composed of selected milk components and supplemented with various nutrients, such as yeast extract, vitamins and minerals. The culture growth medium is heated to an ultra-high temperature and cooled to either 30 or ~40°C for mesophilic or thermophilic cultures, respectively. After inoculation of the culture, growth is optimised by maintaining the pH at 6.0–6.3 for mesophilic cultures and at 5.5–6.0 for thermophilic cultures by the addition of an alkali, such as NaOH or NH₄OH. Other critical parameters such as temperature, agitation rate and headspace gases in the fermenters are optimised for each strain. These conditions produce cell suspensions which are tenfold more concentrated than a normally acidified bulk starter. After fermentation, which is normally a batch fermentation in vessels with a capacity from 10 000 to 40 000 L, the contents are cooled, and the biomass is harvested by centrifugation or membrane filtration, giving a further 10–20-fold concentration of the cells.

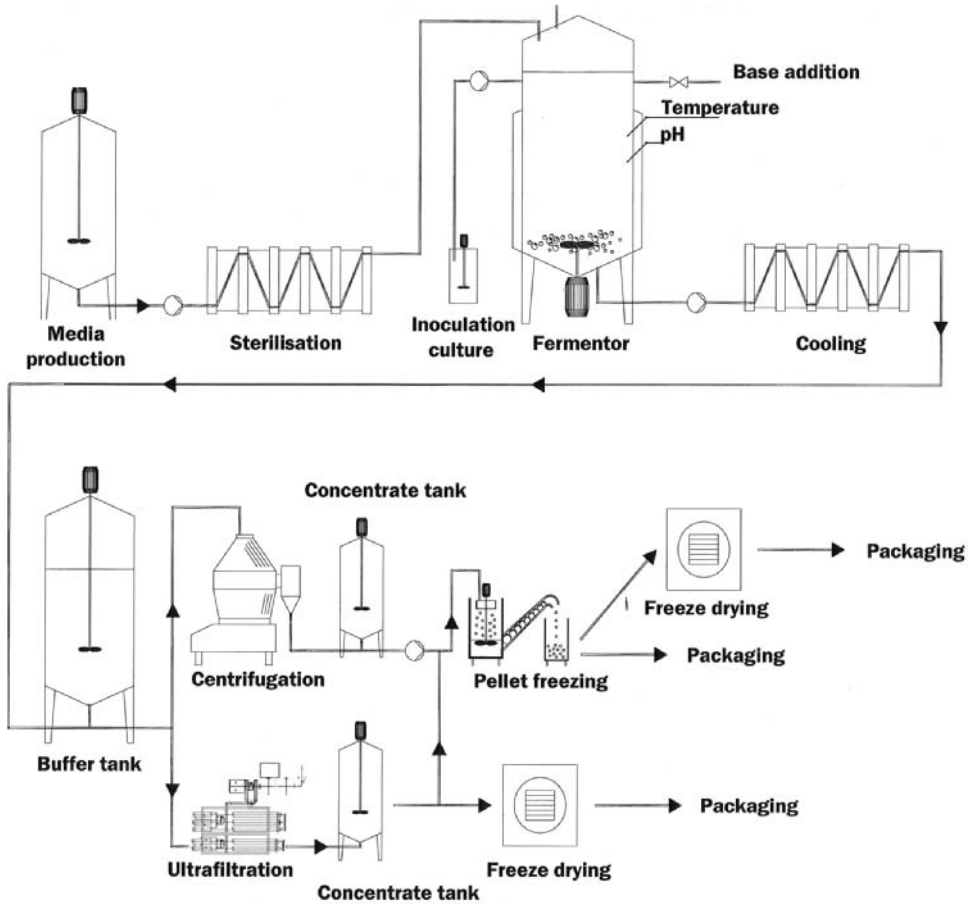

Fig. 5.1 Process flow of a typical starter culture production.

Due to the demand for economy of scale in the production of starter cultures, alternative methods, such as repeated-batch, fed-batch and continuous fermentation, have been tested by culture houses. Recently, a change from the traditional anaerobic fermentation to an aerobic respiration process has been introduced for some species (Pedersen *et al.*, 2005). This is based on the observation that *Lactococcus lactis* spp. is capable of respiration in the presence of oxygen and haem, resulting in the production of a higher biomass and a greatly reduced amount of lactic acid (Gaudu *et al.*, 2002). The presence of haem allows the formation of a membrane potential via an aerobic electron transfer chain (Brooijmanns *et al.*, 2007), giving a more efficient use of energy sources and resulting in a higher biomass production (Pedersen *et al.*, 2005).

After centrifugation, the concentrated bacterial cells can be either filled into cans and frozen in liquid nitrogen or pelleted by 'dripping' the concentrate into an agitated bath of liquid nitrogen. If the concentrate is to be freeze-dried, cryoprotective agents are added to the bacterial concentrate prior to freezing to increase survival rate. Some examples of

cryoprotective agents include ascorbate; monosodium glutamate; polyols such as mannitol, glycerol and sorbitol; and disaccharides, such as lactose and sucrose.

After freezing or freeze-drying and packaging in an inert gas atmosphere, the activity of the culture is retained for up to 12 and 24 months for frozen and freeze-dried starter cultures, respectively.

5.4 Range of LAB used as starter cultures

5.4.1 Traditional starter cultures

The LAB used in the cheese industry can be classified into two groups: the mesophilic group with an optimum growth temperature of about 30°C and the thermophilic group with an optimum growth temperature of 37°C or higher. The culture types for typical cheeses and the bacterial species which they contain are described in Table 5.1.

The mesophilic cultures are divided into LD cultures and O cultures. LD cultures contain citrate-fermenting bacteria (L = *Leuconostoc* species and D = *Lc. lactis* subsp. *lactis* biovar.

Table 5.1 LAB species in various culture types and typical product applications.

Culture types	Species names	Product application (cheeses)
Mesophilic		
O type	<i>Lactococcus lactis</i> subsp. <i>lactis</i> <i>Lactococcus lactis</i> subsp. <i>cremoris</i>	Cheddar, Feta and Cottage
LD type	<i>Lactococcus lactis</i> subsp. <i>lactis</i> <i>Lactococcus lactis</i> subsp. <i>cremoris</i> <i>Lactococcus lactis</i> subsp. <i>lactis</i> biovar. <i>diacetylactis</i> <i>Leuconostoc mesenteroides</i> subsp. <i>cremoris</i>	Gouda, Tilsitter and mould ripened soft cheeses
Thermophilic		
St. type	<i>Streptococcus thermophilus</i>	Mozzarella, stabilised Brie and Swiss
Yoghurt type	<i>Streptococcus thermophilus</i> <i>Lactobacillus delbrueckii</i> subsp. <i>bulgaricus</i>	Mozzarella and Pizza
<i>Lactobacillus</i> type	<i>Lactobacillus helveticus</i> <i>Lactobacillus delbrueckii</i> subsp. <i>lactis</i>	Swiss and Grana
Mixed types		
RST type	<i>Lactococcus lactis</i> subsp. <i>lactis</i> <i>Lactococcus lactis</i> subsp. <i>cremoris</i> <i>Streptococcus thermophilus</i>	Cheddar
FRC type	<i>Lactococcus lactis</i> subsp. <i>lactis</i> <i>Lactococcus lactis</i> subsp. <i>cremoris</i> <i>Streptococcus thermophilus</i> <i>Lactobacillus delbrueckii</i> subsp. <i>bulgaricus</i>	Feta and White brined

diacetylactis), which produce aroma and CO₂ from citrate. The O cultures contain only acid-producing strains, and produce no gas. The L cultures and D cultures also exist, but are only used to a minor degree in the cheese industry. Traditional, mesophilic O cultures are used in cheese processes, where the main focus is on a rapid and consistent acidification of the milk, for example in the production of Cheddar, Feta, Cottage cheese and other cheese types without 'eyes'. The LD cultures are used in most continental semi-hard cheeses such as Gouda, Tilsitter and Samsø and in soft cheeses such as Camembert and Port Salut. In all these cheeses, the LD cultures play a significant role in flavour and eye formation.

Thermophilic cultures almost always consist of *Streptococcus thermophilus* and, depending on the product, various lactobacilli species, such as *Lactobacillus delbrueckii* subsp. *lactis*, *Lactobacillus delbrueckii* subsp. *bulgaricus* or *Lactobacillus helveticus*. Exceptions are found in the production of traditional Italian soft Mozzarella cheese and stabilised Brie where the cultures only contain *S. thermophilus*. The characteristics of the *S. thermophilus* cultures can be quite different. The production of Mozzarella requires a very fast acidifying culture, while stabilised Brie requires a slow acidification profile, which stabilises at a high final pH.

Most *S. thermophilus* strains are unable to ferment the galactose moiety of lactose; instead, they excrete it into the cheese milk where it can have an impact on the final quality of the cheese. In the production of most Swiss cheeses, *S. thermophilus* is combined with galactose-fermenting lactobacilli, such as *Lb. helveticus*, which converts the galactose to lactic acid and contributes to the formation of specific flavour compounds.

In the production of the Mozzarella cheese used for pizza, combinations of *S. thermophilus* and *Lb. delbrueckii* subsp. *bulgaricus* have traditionally been used. However, the use of pure *S. thermophilus* has found increasing acceptance as the market demand has moved towards shorter make times and low proteolysis in the pizza cheese during storage. Accumulation of galactose promotes the browning caused by the Maillard reaction during the high-temperature cooking of the pizza. To reduce browning, galactose fermenting *Lb. helveticus* can be added to the culture in combination with process adjustments.

5.4.2 Probiotic starter cultures

While probiotic bacteria are best known in fermented milk and yoghurt (Tamime *et al.*, 2005), interest in adding probiotic bacteria to cheese has been increasing the last decade (Ross *et al.*, 2002, Heller *et al.*, 2003). One definition of probiotic bacteria is 'live micro-organisms which when administered in adequate amounts confer a health benefit on the host' (FAO/WHO, 2001). It is generally assumed that in order to provide a beneficial health effect, the probiotic bacteria must be viable at the time of consumption and remain viable throughout the gastrointestinal tract (Roy, 2005). European Union Regulation EC No. 1924/2006 on nutrition and health claims made on foods has led to increased focus on the clinical documentation available for probiotic strains (EU, 2006). Following analysis of the available scientific evidence, the recommended daily intake of probiotic bacteria has been increased from 10⁸ to 10⁹ colony forming units (cfu) day⁻¹ depending on the strain in question and the clinical evidence behind the health claims. This level can be readily obtained via cheese; for example, if a cheese contains 10⁸ cfu g⁻¹, an appropriate serving would be 10 g of cheese.

Some of the health benefits from probiotic bacteria include: (a) improving intestinal tract health, (b) enhancing the immune system, (c) synthesising and enhancing the bioavailability of nutrients, (d) reducing symptoms of lactose intolerance, (e) decreasing the prevalence of allergy in susceptible individuals and (f) reducing risk of certain cancers (Parvez *et al.*, 2006). The most extensively studied and widely used probiotic bacteria are *Bifidobacterium* and *Lactobacillus* species.

Cheese is a good carrier for probiotic bacteria because, compared to yoghurt, the product has a higher pH, more solid consistency, lower O₂ concentration and a higher buffering capacity, which protects the probiotic bacteria in the gastric juice (Ross *et al.*, 2005). The challenge in producing probiotic cheese is survival of the probiotic organisms during the long shelf life of the product. Survival in a cheese matrix is strain dependent, and the selected probiotic bacteria should have a high acid- and salt-tolerance and be compatible with the cheese starter culture. Furthermore, survival depends on the processing conditions, product matrix and storage conditions. A low cooking temperature during cheesemaking, high minimum pH, low oxygen and salt content in the cheese combined with low storage temperatures during maturation are optimal for survival of the probiotic bacteria (Gomes & Malcata, 1999; Roy, 2005).

Probiotic bacteria are normally added together with the starter culture or in the dressing for Cottage cheese. Yoghurt and fermented milk are generally inoculated at the desired final concentration due to the poor growth of probiotic bacteria in milk. During cheese manufacturing, a concentration of the milk takes place, which allows for a lower inoculation rate if the selected strain and manufacturing parameters are optimal. Considerations for the use of probiotics in a variety of cheese applications are given in Table 5.2.

The introduction of DVS cultures for direct inoculation of the cheese vat has allowed culture producers to launch new culture blends consisting of both thermophilic and mesophilic

Table 5.2 Considerations when applying probiotic bacteria to various cheese types.

Cheese type	Remarks	References
Cheddar cheese	Good application	McBrearty <i>et al.</i> (2001) and Phillips <i>et al.</i> (2006)
Continental-type semi-hard cheese	Good application	Gomes <i>et al.</i> (1995) and Bergamini <i>et al.</i> (2006)
Fresh cheese, Quark	Technologically good applications	Buriti <i>et al.</i> (2005)
Tvorag	Technologically good application	
Cottage cheese	Good if the probiotic bacteria are added to the dressing	Tratnik <i>et al.</i> (2000)
Soft cheese	Good, except for blue cheese with anaerobic probiotic strains	Vinderola <i>et al.</i> (2000)
Grana, Pasta Filata, Emmental	Not good applications due to high cooking temperature	
Feta/White brined cheese	Not a good application due to high salt concentration in final product	
Cream cheese	Not a good application due to high filling temperature	

strains designed for special cheese types (Table 5.1) as well as special cultures for the production of probiotic cheese (Table 5.2).

5.5 Taxonomy of LAB

Early taxonomic classification of LAB was based on characteristics such as carbohydrate fermentation patterns, gas formation, cell morphology, oxygen tolerance and optimal growth temperature (Orla-Jensen, 1919). This classification scheme is still partially in use today.

Later attempts to improve the classification system for LAB included various chemotaxonomic methods. Many organisms were characterised through comparative analysis of cell wall components (peptidoglycan and polysaccharides), lipids, guanine and cytosine (G+C) content of the DNA or through the serological study of surface antigens. While these data allowed differentiation and identification of LAB, the resulting classification did not represent the natural phylogenetic situation. Comparative sequence analysis of ribosomal ribonucleic acid (rRNA) made possible a study of the true genealogical relationship of LAB (Woese, 1987). Fig. 5.2 shows the phylogenetic relationships of the genera of the LAB, and some related bacteria based on 16S rRNA data.

Most of the genera generally included in the LAB today, namely *Carnobacterium*, *Enterococcus*, *Lactobacillus*, *Lactococcus*, *Leuconostoc*, *Pediococcus*, *Streptococcus* and *Weissella*, belong to the Gram-positive bacteria with low G+C content, the so-called Firmicutes. Only *Bifidobacterium*, which is generally considered to be a LAB, belongs to the Gram-positive bacteria with high G+C content, the so-called Actinobacteria (Ludwig & Klenk, 2001). One genus, important for cheese technology, which does not belong to the LAB, is *Propionibacterium*. This genus also belongs to the Actinobacteria. Closer relationships and species delineations are often analysed by DNA–DNA hybridisation, which gives an insight into the relatedness of the total genome of strains (Stackebrandt & Gobel, 1994). An increasing number of total genome sequences is becoming available for the LAB. This opens the possibility to study evolution in a much broader perspective and phylogenetic reconstructions based on several genes indicate some minor differences in branching order compared to the rRNA-based phylogeny (Makarova *et al.*, 2006).

5.5.1 Identification

Traditional species identification of LAB is based on carbohydrate fermentation patterns and biochemical characteristics. Although miniaturised strips with relevant reactions are commercially available, the technique is time-consuming, laborious and not always reliable because the results may be affected by minor differences in handling. For several species groups these identification systems cannot match the newer taxonomic developments. New species have been established based on rRNA sequence data or DNA–DNA hybridisation results for which reliable phenotypic methods of species determination are not available (e.g. the *Lb. acidophilus* group).

Identification methods based on DNA sequences are more reliable, since they are not dependent on growth conditions and are capable of differentiating difficult groups. As a



Fig. 5.2 Phylogenetic tree of LAB from the group of Gram-positive bacteria with low guanine plus cytosine (G+C) content and related bacteria based on 16S rRNA data. Note: The bar indicates 10% calculated sequence diversity. The tree was constructed with the help of the ARB programme package (Ludwig *et al.*, 2004).

result of this robustness together with the public availability of a comprehensive data set, sequence analysis of 16S rRNA genes has become one of the most widely used techniques in bacterial identification (Ludwig & Klenk, 2001). It can be desirable to identify one strain among the various strains of a species because of specific properties. For this purpose, various DNA fingerprinting techniques can be used (see the review by Krieg, 2001).

5.5.2 Species important in cheese making

Of the five species in genus *Lactococcus*, only the two subspecies *lactis* and *cremoris* of *Lc. lactis* are of major importance in cheese technology. *Lc. lactis* strains with the ability to ferment citrate used to have subspecies status as *Lc. lactis* subsp. *diacetylactis*. Because citrate utilisation is plasmid mediated, it is an unstable phenotype and not suitable for subspecies characterisation. These strains are now designated *Lc. lactis* subsp. *lactis* biovar. *diacetylactis*.

The only species of the genus *Streptococcus* relevant to commercial cheese production is *S. thermophilus*. The close relationship of this species to *S. salivarius* was clarified by

DNA–DNA hybridisation and consequently the species name *S. thermophilus* was revived (Schleifer *et al.*, 1991).

Strains of the genus *Leuconostoc* are important for eye and flavour development in cheese due to their ability to form CO₂ and diacetyl under certain conditions. Besides *Leuconostoc mesenteroides* subsp. *cremoris* and *Leuconostoc lactis*, *Leuconostoc pseudomesenteroides* or close relatives thereof are found in cheeses and cheese starters (Olsen *et al.*, 2007).

From the large and diverse genus *Lactobacillus*, only the thermophilic species *Lb. delbrueckii* subsp. *lactis*, *Lb. delbrueckii* subsp. *bulgaricus* and *Lb. helveticus* have a significant role in starter cultures. Weiss *et al.* (1983) combined the former *Lb. lactis*, *Lb. bulgaricus* and *Lb. delbrueckii* into one species, namely *Lb. delbrueckii*, on the basis of their high DNA homology. *Lb. helveticus* strains have occasionally been designated *Lactobacillus jugurti*.

Mesophilic lactobacilli such as *Lactobacillus casei*, *Lactobacillus plantarum*, *Lactobacillus brevis* and *Lactobacillus buchneri* are important components of the non-starter lactic acid bacteria (NSLAB) cheese flora and are present in matured cheese in numbers up to 10⁸ cfu g⁻¹ (Teuber, 1993).

The dairy propionibacteria species include *Propionibacterium freudenreichii*, *Propionibacterium jensenii*, *Propionibacterium thoenii* and *Propionibacterium acidipropionici*. *P. freudenreichii* has been divided into two subspecies *freudenreichii* and *shermanii* on the basis of nitrate reduction and lactose fermentation.

5.6 The types of lactic cultures

The culture types described in Table 5.1 can be produced in a variety of formats: (a) undefined mixed cultures, (b) defined multiple strain cultures and (c) in some cases, as single strain cultures (see the review by Tamime, 2002). Undefined mixed cultures consisting of an unknown number of strains are used especially in Europe for Continental-type cheeses, whereas the defined multiple strain cultures are mostly used in countries where Cheddar and similar types of cheeses are manufactured.

5.6.1 Development of mesophilic cultures

Originally, most cheese starter cultures were undefined mixed cultures. In modern cheesemaking, however, it is mainly the LD cultures which are used as direct descendants of the traditional undefined cultures. These LD cultures are maintained by commercial starter companies and are desirable to the cheese industry due to their flavour characteristics and phage insensitivity. Once developed, these cultures must be carefully preserved and produced in order to maintain the strain balance and phage insensitivity.

In the mid-1960s, it was observed that undefined mixed LD cultures propagated in the dairies were much more phage resistant than similar LD cultures propagated in the laboratory. This difference resulted from the numerous transfers of the laboratory starters in a phage-protected environment, allowing dominance by phage-sensitive strains (Stadhouders & Leenders, 1984). The key for culture houses today is to limit the number of culture transfers in the laboratory, preventing dominance by more phage-sensitive strains.

Another problem with regard to cheese quality occurred in New Zealand in the 1930s. During transport of cheese to European and Oriental markets, CO₂ produced from citrate by the undefined mixed starter cultures caused 'open texture' problems (Whitehead, 1953). To avoid these texture problems, the acid producers in the starters were isolated and used as single strain starters. Use of these starters resulted in cheese with a 'closed texture', but the starters were not consistent in acid production primarily due to phage problems. Pairing of single strains in the New Zealand culture system resulted in better control of production parameters. From the 1930s through to the 1960s, the use of single strain starter cultures was limited to Australia and New Zealand, with the exception of a few factories in Scotland and the United States.

The turning point in the switch to 'defined' multiple strain cultures occurred in the Cheddar industry in the 1970s, and has since progressed to all areas of fermented dairy products. Rationalisation of both milk production and transport systems led to an increase in the size of cheese factories. Amalgamation of smaller cheese plants into larger units, multi-filling of cheese vats and making the cheese 'by the clock' placed the starter under considerable stress during the cheesemaking day. Phage inevitably appeared, resulting in 'slow' or 'dead' vats. Research efforts in New Zealand, Australia, the United States and Ireland were directed towards the development of a multiple strain system, where strain substitution was the key to consistent culture performance. Strains were selected on the basis of their ability to survive repeated exposure to phage in the laboratory (Heap & Lawrence, 1976). In this culture system, strains were grown separately and blended before inoculation into the bulk starter tank. If a fast-replicating phage attacking one of the strains was detected, then that strain was withdrawn and replaced by a phage-unrelated strain. This system, originally consisting of six strains, was used without rotation.

In 1980, the large culture producers introduced DVS cultures for Cheddar production in Europe. Usually each culture contains three or four strains which have been selected for their phage robustness among other things. To secure consistency in production, a culture rotation system containing four to five phage-unrelated cultures is normally used. DVS cultures are used in most Cheddar-producing countries today.

5.6.2 *Use of DVS cultures*

During the past 25 years, cheesemakers around the world have become aware of the advantages offered by the direct addition of frozen or freeze-dried concentrated culture to the cheese vat. In the production of Cheddar, pizza, Cottage and white brine cheeses such as Feta, DVS cultures are well established. The use of DVS is estimated to be 20% in Germany, 65% in the United Kingdom and 25% in the United States, and to be a total of 30% of the total global cheese milk set.

DVS cultures can be used for practically all cheese types and require only minor changes, if any, to the cheesemaking process. At the beginning of cheese production, inoculation of the cheese milk with 1–2 mL 100 mL⁻¹ traditional bulk starter lowers the pH by 0.05–0.1 unit because of the lactic acid contained in the bulk starter. This pH drop does not occur with DVS cultures. In addition, some time is required for rehydration of the starter culture and, thus, DVS cultures have generally been perceived as having a longer

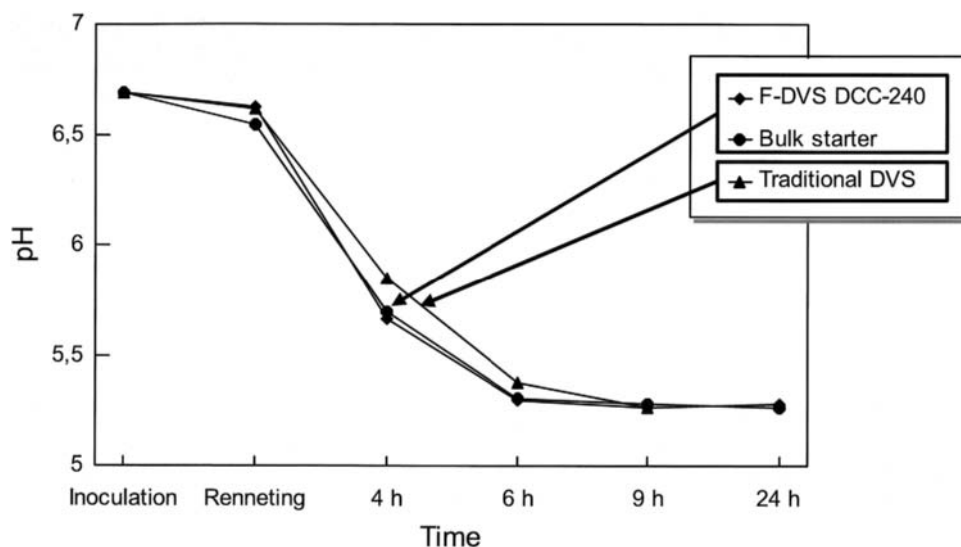

Fig. 5.3 The pH development in a Gouda-type cheesemaking using 2 mL 100 mL⁻¹ bulk starter or 0.02 g 100 g⁻¹ frozen DVSculture.

lag phase. The activity of modern DVS cultures are, however, normally higher than traditional bulk starter and the initial pH difference is overcome within a few hours (Fig. 5.3). In the production of continental cheese, it is normally sufficient to increase the pre-ripening temperature by 1°C and prolong the pre-ripening treatment by 5–10 min. In the production of Cheddar cheese using mesophilic O-type cultures, the pre-ripening time is usually prolonged by 10–20 min. In the later phase, the activity advances faster for DVS cultures than for bulk starter and, to control the minimum pH, a lower titratable acidity at the milling stage is used. New culture types have been developed in which the mesophilic O culture is mixed with *S. thermophilus*, resulting in a considerably faster acidification (Table 5.1).

There are several advantages to using DVS cultures. The risk of phage attack and of accumulation of bacteriophage in the dairy is reduced due to the elimination of the bulk starter propagation. Direct vat inoculation gives flexibility in the cheese production since this type of culture can easily be adapted to changes in milk volume or other changes in production planning. DVS cultures are put through an extensive quality control regimen before dispatch, assuring that the cultures have the required activity and bacteriological quality. Mixtures of strains can be predetermined to ensure consistent acid and flavour production, and blending of mesophilic, thermophilic and possibly probiotic strains into one starter culture can be done to give customised cultures with specific properties. These types of cultures would be difficult to produce in a bulk starter system due to the different growth conditions required or very laborious if the different strains were to be propagated separately at the dairy and then mixed. Many special DVS blends consisting of strains with variable growth conditions have been marketed for both cheese and fermented milk (Table 5.1).

Table 5.3 Screening criteria for LAB for cheese cultures.

Basic screening	Criteria-specific selected	Production
Acidification rate	Acidification rate in selected cheesemaking profiles	Ease of production with high cell densities and activity
Phage sensitivity	Proteinase and peptidase activity	Ease of concentration
DNA and plasmid profiles	Texture properties	Stability during freezing and drying
Species identification	Strain interactions	Storage stability
Flavour and off-flavour production in milk	Sugar fermentation profile	
Antibiotic resistance	Flavour screening in model cheese systems	

5.6.3 Selection of culture strains

Proper selection and characterisation of single strains prior to use is important in order to obtain the required performance in the final cheese manufacture. Selection criteria vary, but typically the main criteria are acidification rate at a fixed temperature and phage insensitivity (see Table 5.3). Genetic-based tests such as DNA analysis and plasmid profiles are applied together with phage relationships for dividing strains into different groups. It is undesirable to combine closely related strains in a defined culture, as these would be more likely to be susceptible to attack by a single phage.

Specific selection criteria are chosen based on the required characteristics of the final starter culture. Here, an understanding of the relevant metabolic capabilities of the various LAB can be quite helpful. Acidification rate measurements during the initial strain screening are complemented by measurements of the acidification and multiplication rate in pasteurised milk as well as during a simulated cheesemaking temperature profile. To balance flavour and reduce the risk of phage multiplication, temperature-sensitive and temperature-insensitive strains are used in starters for Cheddar cheese production. Candidate strains are also tested for their ability to perform satisfactorily in a culture production factory, usually using a small-scale pilot plant. Strains are then selected which fulfil the specified selection criteria.

An alternative to finding strains in nature which have a particular set of properties is to construct strains in the laboratory with the precise properties desired. This can be done by traditional bacterial genetics or using the techniques of modern molecular biology.

5.7 Modern approaches to the development of new starter cultures

5.7.1 Genomics and traditional bacterial genetics

The properties of an organism are encoded in the genes found in its DNA. The entire DNA content of an organism is called the genome. In recent years, it has become possible to determine the complete DNA sequence of any genome giving access to all of the genes

contained in a given cell. This newly developed scientific discipline is referred to as genomics. Complete genome sequences are available for many of the species found in starter cultures (Pfeiler & Klaenhammer, 2007). Analysis of the complete genome sequence of an organism provides considerable insight into the properties of the organism (Dellaglio *et al.*, 2005). For example, it allows a prediction of the complete metabolic capabilities of the cell. It also facilitates a number of techniques which can lead to a better understanding of the functionality of specific strains. These include comparative genome hybridisation, which allows comparison of many members of the same species, and transcriptomics, which allows a rapid determination of the changes in gene expression as environmental conditions change. Transcriptomics is especially useful for determining what happens to a cell during growth in milk (Smeianov *et al.*, 2007) or during the commercial production of a starter culture (Pedersen *et al.*, 2005). Possession of a complete genome sequence also allows a rapid confirmation of the absence of genes considered undesirable in the food chain as well as identification of genes, which contribute to the unique properties of specific strains. Undesirable genes include genes encoding the ability to synthesise biogenic amines and transmissible genes giving antibiotic resistance.

A bacterial genome often contains two types of DNA molecule, a relatively large molecule called the chromosome and a number of smaller molecules called plasmids. Bacteria have only one chromosome and only one copy of that chromosome per cell. Plasmids exist in multiple copies in the cell and LAB strains often contain several different plasmids. The genes on these plasmids are often highly relevant to the dairy environment, and can include genes for lactose fermentation, citrate transport, proteinase production and bacteriophage resistance.

Conjugation, a natural gene transfer mechanism, has been used to transfer a plasmid conferring bacteriophage resistance from one strain to another. The resulting strains retain the technological properties of the recipient strain and gain the superior bacteriophage resistance of the donor strain. Transfer of chromosomal genes can also occur. There is evidence that genetic exchange occurs between members of different genera of dairy LAB as well (Makarova *et al.*, 2006).

An alternative approach for strain construction is the use of recombinant DNA technology to transfer genes from one strain to another. The resulting strains will be genetically modified organisms (GMOs) and, as such, will be regulated by the rules and regulations in the particular countries in which the strains will be produced or used. Since significant differences in these rules exist in different regions and the rules are constantly being revised and clarified, researchers are advised to consult their local authorities before using GMOs in any dairy process.

5.7.2 Food-grade GMOs for the dairy industry

Dairy products contain viable LAB. If a starter culture contains a GMO, consumers of the resulting dairy products will eat viable GMOs. A proportion of the LAB that are consumed survive passage through the stomach, and can potentially colonise the human digestive tract. These considerations put considerable restraints on the type of genetic modification which would be considered food-grade and safe enough to be acceptable for use in dairy products.

A useful definition of food-grade states that a food-grade GMO must only contain DNA from the same genus and possibly small stretches of synthetic DNA (Johansen, 1999). By this definition, a food-grade *Lc. lactis* spp. GMO only contains DNA from the genus *Lactococcus* and possibly a small amount of synthetic DNA. The use of DNA from other genera of microorganisms would be acceptable in a broader definition of food-grade (Johansen, 1999), provided the donor organism has generally recognised as safe status. Using this definition, it would be acceptable to introduce DNA from *S. thermophilus* into a *Lc. lactis* spp. GMO.

Several types of genetic modifications can be done in a food-grade manner (Johansen, 2003). A gene can be deleted from a strain. A gene in a strain can be replaced with the same gene from another strain. New genes can be introduced into a strain, and the copy number and expression level of an existing gene can be increased through the use of food-grade cloning vectors (Sørensen *et al.*, 2000; Guldeldt *et al.*, 2001).

The use of recombinant DNA technology, food-grade or not, in the food industry continues to be controversial in some parts of the world. For this reason, starter cultures containing food-grade GMOs have not yet been commercialised. Instead, classical strain improvement continues to be the method of choice for developing strains with new characteristics. This is greatly facilitated by the use of laboratory automation.

5.7.3 Use of automated laboratory methods to develop new starter cultures

Traditionally, the isolation of new starter cultures has depended on the screening of thousands or tens of thousands of bacterial strains in order to find a small number of isolates with the desired technological characteristics. Screening of such large numbers of bacterial strains is labour intensive and slow, and in order to address these problems, HTS methods have been developed.

HTS uses the power of robotics to carry out repetitive laboratory manipulations in a rapid and reproducible fashion. This technology has experienced rapid growth and development in the last decade, with many equipment suppliers having developed dedicated robots for specific laboratory operations. One of the key differences between HTS and manual screening is that in HTS all assays are performed in (96- or 384-well) microtitre plates, which greatly facilitates automation and high sample throughput. One consequence of this is the volumetric scaledown of the screening assays, whereby 100–300 μL volumes are standard practice.

Material to be screened is plated on an appropriate agar medium on large plates (20 cm \times 20 cm), which have a capacity of around 3000 colonies plate⁻¹. A colony-picking robot is used for automated colony picking, and normally consists of three components. The first component comprises an imaging and software system which identifies and selects the colonies to be picked from the agar plates. Colonies can be selected on the basis of size, morphology, presence/absence of clearing zones or colour. The second component consists of a robotic arm with an attached picking head that picks the selected colonies and transfers them to microtitre plates. Colonies are picked and transferred at a rate of 3000–4000 colonies h⁻¹, which is about tenfold faster than can be performed manually. The third component of the colony-picking robot consists of an automated cleaning and sterilisation system for the picking head.

Once the bacterial strains have been picked and transferred to microtitre plates, a detailed analysis and characterisation can be performed using an analysis robot. The analysis robot can be used for measuring enzymatic activities, growth rates or various metabolites. The robot itself may be custom-made, and consists of pipetting stations, shakers, incubators and readers. In addition, other specialised equipment, such as a centrifuge, sonicator or a filtration unit, may be integrated into the analysis robot. These components are linked together via one or more robotic arms, which move the microtitre plates between the various components of the robot. The entire system is controlled by a sophisticated software programme.

Following the robotic screening, a small number of strains (10–50) with the requisite attributes are obtained. These candidate strains are further analysed to confirm that they do indeed perform as required. Only those strains, which pass the rigorous retesting and reanalysis, are evaluated in cheese trials. It is not uncommon to screen several thousand bacterial isolates and, at the end of the process, find that only one or two of them are suitable for cheese production.

HTS screening constitutes a unique system whereby new cheese cultures can be isolated and identified. A high sample throughput, low cost per sample and high degree of reproducibility is possible by exploiting the flexibility and power of robotics. In order to obtain the maximum benefits from traditional and molecular genetics, or HTS, it is necessary to understand the metabolic processes of LAB which are relevant for cheesemaking. Some of these are discussed in subsequent sections.

5.8 Biochemistry of acidification by LAB

5.8.1 Introduction

The long historical application of LAB in the production of a wide range of fermented foods and beverages is primarily due to their inherent high capacity to produce lactic acid from sugar and thereby provide an effective method for preservation of the food products. The production of lactic acid by LAB not only provides a competitive advantage when growing in their natural habitats, but also leads to the generation of metabolic energy which is required for growth. The acidification biochemistry and regulation of sugar metabolism in LAB have recently been reviewed (Neves *et al.*, 2005).

5.8.2 Sugar metabolism

When LAB are grown in milk or other lactose-containing media, the lactose is transported across the cellular membrane and into the cytoplasm either by the phosphoenol pyruvate-dependent phosphotransferase system (PEP-PTS) or by the lactose permease (Thompson, 1987). During transport by the PEP-PTS system, lactose is phosphorylated to lactose phosphate, which is hydrolysed to glucose and galactose-6-phosphate by phospho- β -galactosidase. In strains with a lactose permease, lactose is transported without modification and hydrolysed to glucose and galactose by β -galactosidase. Galactose is then phosphorylated

Table 5.4 Lactate production by various LAB.

Organism	Transport system	Pathway	Main fermentation products ^a	Lactate isomer
<i>Lactococcus</i> spp.	PEP-PTS	Homofermentative	4 lactate	L
<i>Streptococcus</i> spp.	Permease	Homofermentative	2 or 4 lactate ^b	L
Group I <i>Lactobacillus</i> spp.	Permease	Homofermentative	2 or 4 lactate ^b	D or DL
Group II and Group III <i>Lactobacillus</i> spp.	Permease	Heterofermentative	lactate ^c + ethanol + acetate + 2 CO ₂	D and/or L
<i>Leuconostoc</i> spp.	Permease	Heterofermentative	2 lactate + 2 ethanol + 2 CO ₂	D

^aMoles⁻¹ mole lactose fermented.

^b2 moles of lactate if galactose is stoichiometrically secreted, and 4 moles of lactate if galactose is fully metabolised.

^cThe stoichiometry of the fermentation products depends on the species and growth conditions.

and converted to glucose-6-phosphate. Glucose is phosphorylated to glucose-6-phosphate regardless of how lactose is transported.

There are two major pathways to metabolise glucose and they can be used to classify the LAB genera. In homofermentative LAB, such as *Lactococcus* spp., *Streptococcus* spp. and group I *Lactobacillus* spp., lactic acid is the main end product; while in heterofermentative LAB, such as *Leuconostoc* spp. and group II and group III *Lactobacillus* spp., lactic acid, CO₂, acetic acid and ethanol can be produced (Table 5.4). Lactate is an end product in both fermentative systems and can be produced as either L-(+)- or D-(-)-lactate or a mixture of the two, depending on the type(s) of lactate dehydrogenase the bacteria possess (Table 5.4).

The LAB possess the enzymes required for either homolactic or heterolactic fermentation, but there are differences in the way they take up and utilise various sugars, regulate individual steps in a pathway and switch between production of lactate only and mixed acid products. With the advent of genomics, it will be easier to understand and exploit the potential of the LAB to make desirable metabolic products from lactose (Pfeiler & Klaenhammer, 2007).

5.9 Proteolysis by LAB

5.9.1 *Proteases*

Proteolysis results in textural changes in the cheese by disruption of the protein matrix and in flavour development by the release of small peptides and free amino acids. In addition to the coagulant and plasmin, LAB starter cultures contribute in a significant way to proteolysis.

The proteolytic system of *Lc. lactis* spp. consists of a cell envelope-associated proteinase, known as lactocepin (PrTP), and several different intracellular peptidases. Based on specificity differences in the hydrolysis of casein by lactocepin, three different types of proteinases have historically been recognised. Type I lactocepin hydrolyses β -casein and κ -casein, but not α_{s1} -casein, type III hydrolyses β -casein, κ -casein and α_{s1} -casein, and type I/III has a mixture

of type I and type III specificity (Visser, 1993). However, the classification of lactocepins has been further refined, based on the hydrolysis of α_{s1} -casein (1–23), and now eight groups (a–h) have replaced the type I, III and I/III classification system (Exterkate *et al.*, 1993; Broadbent *et al.*, 2006). Lactocepain is often plasmid encoded and spontaneous proteinase-negative mutants occur through plasmid loss. For *S. thermophilus*, *Lb. delbrueckii* subsp. *bulgaricus* and *Lb. helveticus*, the cell envelope-associated proteinases are chromosomally encoded and therefore are a stable characteristic in these species (Gilbert *et al.*, 1996; Pederson *et al.*, 1999; Fernandez-Espla *et al.*, 2000).

Proteolysis is necessary for the development of the desired flavour of cheese. However, if the process becomes unbalanced, it can result in the development of a bitter taste. Bitterness is associated with elevated levels of hydrophobic peptides from the C-terminal region of β -casein (Lemieux & Simard, 1991). The overall level of bitterness in cheese depends on the relative rates at which bitter peptides are formed and degraded to non-bitter products by the intracellular peptidases of the starter. Certain *Lc. lactis* spp. strains (HP, Wg2), which have a type I lactocepain, are associated with the development of bitterness in Cheddar cheese and, consequently, strains are carefully selected in order to take account of the lactocepain type. Selection of starters with rapid lysis helps reduce the chance of bitterness developing in the cheese (Lortal & Chapot-Chartier, 2005). In addition, the presence of salt strongly influences the rate of formation and degradation of bitter peptides by the starter culture (Visser *et al.*, 1983).

Following proteolytic cleavage, the di-, tri-, and oligopeptides generated are transported into the cell by the corresponding peptide transport systems. These are encoded by *dtpT*, *dpp* and *opp* genes in *Lactococcus* spp. Similar systems are designated Ami, Ali and Opp systems in *S. thermophilus* and *Lactobacillus* spp. (Doeven *et al.*, 2005).

5.9.2 Peptidases of LAB

The peptides produced by the action of proteases are further digested by peptidases. The intracellular peptidases of *Lc. lactis* spp. include endopeptidases, aminopeptidases, dipeptidase, tripeptidase and proline-specific peptidases (Christensen *et al.*, 1999). The proline-specific peptidases are of particular relevance due to the abundance of proline residues in casein and the tendency of peptides containing proline to be bitter. Additional peptidases have been characterised in *Lb. helveticus* and *Lb. delbrueckii* subsp. *lactis* (Christensen *et al.*, 1999). Determination of the complete genome sequence of *Lb. helveticus* strain CNRZ32 allowed the identification of at least a dozen previously unknown enzymes involved in proteolysis (Broadbent & Steele, 2007).

The peptidases of LAB are intracellular, but can be released into the cheese matrix by cell lysis. Here they remain enzymatically active, contributing to the degradation of casein and affecting flavour development. LAB express enzymes that hydrolyse the peptidoglycan of their cell wall-facilitating autolysis. *Lc. lactis* spp. express an *N*-acetylglucosaminidase, the major autolysin AcmA, and three other glucosaminidases, AcmB, AcmC and AcmD (Steen *et al.*, 2007). In addition, several prophage-encoded lysins have been identified on the genomes of LAB (Makarova *et al.*, 2006).

5.9.3 Amino acid catabolism by LAB

Proteolysis and peptidolysis result in the generation of a pool of peptides and free amino acids in the cheese matrix. The free amino acid pool is catabolised by the starter and NSLAB into a wide range of volatile flavour compounds. There are a number of different pathways for amino acid catabolism, with each pathway producing different compounds (Yvon & Rijnen, 2001). The concentration and type of volatile flavour compounds, free amino acids and peptides are critical for the final flavour characteristics of the cheese (Smit *et al.*, 2005).

Transamination, in which free amino acids are converted to α -keto acids, is the first step of amino acid catabolism. The type of α -keto acid formed is dependent on the donor amino acid. In *Lc. lactis* spp. a branched-chain amino acid aminotransferase, active towards leucine, isoleucine, valine and methionine and an aromatic amino acid aminotransferase active towards phenylalanine, tyrosine and tryptophan have been identified (Christensen *et al.*, 1999). Transamination requires the presence of α -ketoglutarate as an amino acceptor. In cheese the amount of α -ketoglutarate is somewhat limiting, and thus directly influences the transamination reaction.

The α -keto acids can be further catabolised by α -keto acid decarboxylases or by hydroxy acid dehydrogenases to produce either aldehydes or hydroxy acids, respectively (Christensen *et al.*, 1999). The aldehydes formed are important flavour compounds, while the hydroxy acids generally are not. Subsequently, the aldehydes can be further converted into alcohols or carboxylic acids by alcohol dehydrogenases or aldehyde dehydrogenases, respectively.

The catabolism of methionine by LAB is a special case; it can be either transaminated by a branched-chain amino acid aminotransferase or eliminated by lyases. The lyase pathway produces important 'sulphury' notes, such as methanethiol (Bruinenberg *et al.*, 1997).

Interestingly, there is considerable strain variation in the amino acid catabolism by *Lc. lactis* spp. Non-industrial, 'wild-type' strains have a much greater complement of amino acid-converting enzymes than the typical dairy isolates. For example, *Lc. lactis* spp. B1157 has a highly active α -keto acid decarboxylase, which is absent in other strains, such as *Lc. lactis* spp. SK110. This observation underscores the importance of correct strain selection and combination in order to control flavour formation in cheese (Smit *et al.*, 2005).

5.10 Bacteriophage of LAB

Currently, there are no commercial starter cultures available which are completely resistant to all bacteriophage. Even if a culture appears phage insensitive when it is launched on the market, it is usually possible to detect bacteriophage after a period of time due to the rapid evolution of the phage.

During cheese production, problems with phage attack against *Lc. lactis* spp. are most common, followed by problems with phage attacking *S. thermophilus*. Phages against *Lactobacillus* spp. and *Leuconostoc* spp. in starter cultures represent only a minor problem during dairy fermentations.

5.10.1 Phage control during culture preparation

The testing of potential production strains with a representative phage collection gives an indication of the behaviour of the strains at the dairy. Strains which survive several cycles of the 'Heap and Lawrence' test (Heap & Lawrence, 1976) with a great number of purified phages are good candidates. Another way to predict the survival of a strain is to pretest whey samples from the dairy where the culture is to be introduced.

With the development of single strain cultures or defined mixed strain cultures, phage relationship is an important selection criterion (Table 5.2). When strains in a defined mixed culture are phage unrelated, that is they are not attacked by the same phage or phage group, a phage infection does not necessarily result in vat failure in the dairy. Other strains in the mixture can take over the acidification process. The use of different defined mixed strain cultures with phage-unrelated strains makes it possible to establish rotation systems, which minimise the risk of phage attack. The use of undefined mixed cultures is more problematic, since phage monitoring is more difficult and complete phage-unrelatedness and, therefore, cannot be easily achieved. However, the presence of a large number of strains gives greater security with regard to bacteriophage attack.

Modern aseptic technology during the production of starter cultures ensures that the cultures supplied to the dairies are phage-free. The inoculation material, as well as the final products, are tested with sensitive methods, such as the Heap and Lawrence test.

The occurrence of lysogenic strains, which have phage DNA integrated into their chromosomes as prophage, can be tested by hybridisation of chromosomal DNA with phage DNA or by mitomycin C induction of the prophage. Testing of 172 *Lc. lactis* spp. strains with mitomycin C revealed 51 strains, which released phage capable of propagating on indicator strains (Cuesta *et al.*, 1995). However, only one *S. thermophilus* strain out of 80 strains tested was shown to be lysogenic, and no indicator strain could be found for the phage produced (T. Janzen & I. Christoffersen, 1996, unpublished results from Chr Hansen A/S). Although lysogenic strains have been considered a source of lytic phage, the exact role of this infection pathway in dairy fermentations remains unclear (Jarvis, 1989). Even though conversion from a temperate phage to a lytic phage by mutation is conceivable, no evidence has been provided that this conversion is a source of lytic phage in a cheese plant.

5.10.2 Phage control in the dairy

Whereas the contamination of cheese vats from starter cultures can be excluded by the use of commercially defined multiple or single strain cultures, infection within the dairy cannot be completely avoided. The raw milk itself may contain bacteriophage, and these may not be completely inactivated by pasteurisation. Open cheese vats, when used, enable contamination with airborne phage. It has been shown that the air near whey separators can contain up to 6×10^6 phage m^{-3} (Neve *et al.*, 1994). Electron micrographs of common varieties of bacteriophage attacking *Lc. lactis* spp. are shown in Fig. 5.4.

Insufficient separation of the whey and milk-containing pipelines or the use of whey cream, which is not sufficiently heat treated, can lead to infection of the milk in the vat. In

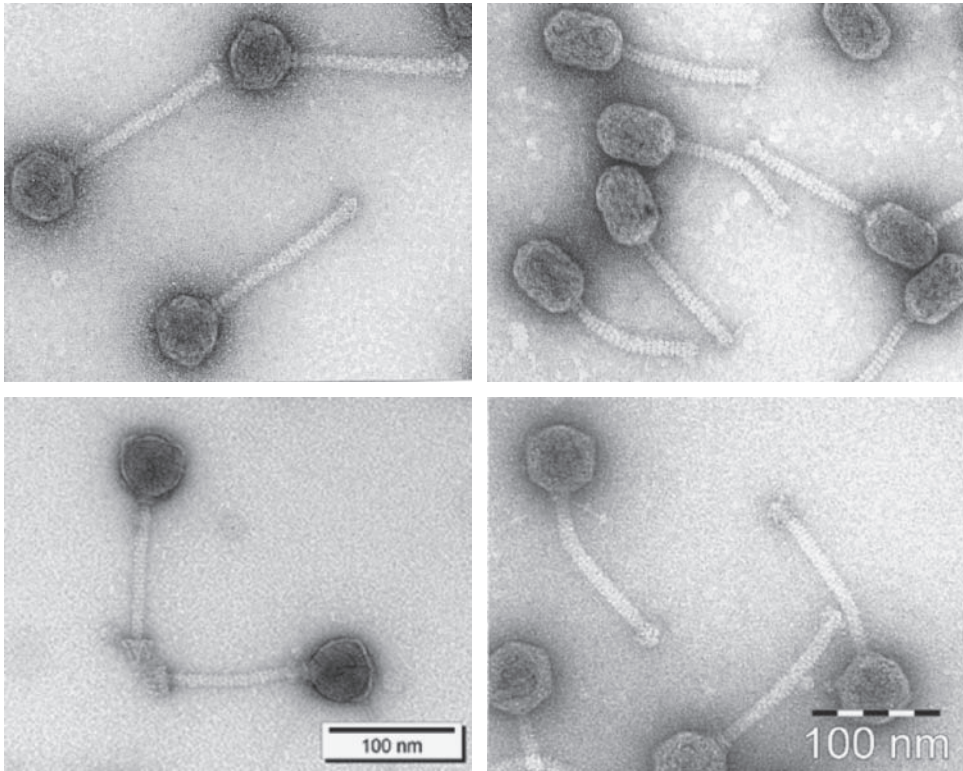

Fig. 5.4 Electron micrograph of common bacteriophage attacking *Lc. lactis* ssp. (Image provided by courtesy of Dr Horst Neve, Institute of Microbiology and Biotechnology, Max Rubner-Institute, Kiel, Germany.)

general, the sanitation of equipment and pipelines, the use of enclosed fermentation vessels and the prevention of contamination from the whey can minimise the risk of phage attack. A practice followed in some dairies is the use of starter cultures from different culture suppliers in rotation systems. Since the phage relationship of these cultures is not known, a build-up of phage may be the consequence.

When bulk starter cultures are used, they are often produced in separate rooms and in closed fermentation vessels. To increase security, these cultures are often prepared in phage-inhibitory media; these contain phosphates in order to chelate divalent cations, which are needed for the proliferation of most bacteriophage. DVS cultures, purchased from a commercial culture supplier, provide an alternative to bulk starter preparation and use of phage-inhibitory media.

5.10.3 Phage monitoring

The standard test for phage detection, which can easily be done in the dairy itself, is the inhibition test. The culture is 'infected' with whey and the pH is measured at the end of fermentation. A pH difference compared to the culture without added whey indicates an

inhibitory agent, which could be bacteriophage. Verification of the result by a standard plaque assay shows whether the inhibition was caused by phage or another agent, such as bacteriocins or antibiotics. Plaque test is only possible when defined cultures are used, since plaques are usually not visible if the cell lawn is made with a mixed culture. Using the plaque test, the exact phage titre can be measured and the development of the phage population can be monitored. When single strains or defined mixed cultures are used, a permanent phage monitoring can identify the strains which are most sensitive. These strains can then be replaced with strains from a different phage sensitivity group.

If undefined mixed cultures are used, a positive inhibition test can be verified by a Heap and Lawrence test. Here the whey, which is produced on the first test day, is used to infect the same culture on day 2. If this procedure is repeated a few times, phage is propagated on their host strains, and the level of inhibition increases. This would not be the case if the inhibition is caused by antibiotics or bacteriocins. Alternatively, phage can be detected in whey samples by polymerase chain reaction (PCR). For the three main phage species from *Lc. lactis* spp. 936, c2 and P335, a multiplex PCR method has been developed (Labrie & Moineau, 2000). All *S. thermophilus* phages belong to one DNA homology group, and have a similar morphology (isometric head, long tail). For *S. thermophilus* phage, a conserved DNA region has been identified, which is present in 80% of the investigated phage (Janzen & Jensen, 1996). These phages can be directly detected in whey samples with the corresponding PCR assay.

5.11 Development of phage-resistant starters

5.11.1 Isolation of spontaneous phage-resistant mutants

Spontaneous phage-resistant mutants arise with a frequency of ~ 1 per 10^7 cells. They are often characterised by a reduced adsorption of the phage to the cell, which can be the result of masking or the complete absence of the phage receptor. It is also possible to isolate phage-resistant variants which retain the normal phage adsorption capacity. A lower acidification rate is often observed with phage-resistant mutants, so a careful testing of the isolated mutants is necessary. Spontaneous phage-resistant mutants have been used commercially for decades.

5.11.2 Conjugal transfer of phage resistance plasmids

Strains with a good natural phage resistance often contain specific phage resistance genes. In *Lc. lactis* spp., these genes are often located on plasmids and can be transferred to other strains by conjugation. Strains CHCC1915 and CHCC1916 were constructed by conjugation, and contain the conjugative plasmid pCI750, which harbours the abortive infection system AbiG that confers resistance to phage species 936, the dominant *Lc. lactis* spp. phage species and partial resistance to the c2 species (O'Connor *et al.*, 1996). Both strains have been successfully used for many years.

5.11.3 *Inhibition of phage adsorption*

The phage infection protein (Pip) is a membrane protein, which is required for the adsorption of prolate-headed phage (Montville *et al.*, 1994). A number of spontaneous mutants with mutations in *pip* have been isolated, and are on the market. No phage mutants that overcome the phage-resistant phenotype of the *pip* strains have been found. Since the *pip* gene is present in most *Lc. lactis* spp. strains and the absence of the Pip protein does not result in a reduction in the growth or acidification rate, the use of *pip* mutants is a promising approach to controlling prolate-headed phage in the dairy industry.

5.11.4 *Prevention of phage DNA injection*

Following adsorption, injection of phage DNA occurs. Plasmid pNP40 encodes three phage resistance mechanisms, one of which blocks DNA penetration for phage c2 (Garvey *et al.*, 1996).

5.11.5 *Restriction and modification systems*

Incoming DNA is digested by a specific endonuclease in strains containing a restriction and modification (R/M) system. To prevent digestion of the host chromosomal DNA, the methylase component of the R/M system modifies the endonuclease recognition sites in the host genome. R/M systems are common in bacteria. In the genus of *Lactococcus*, the majority of them are plasmid encoded while they are chromosomally located in *S. thermophilus*.

R/M systems do not lead to a complete protection against bacteriophage. The efficiency of plating varies between 10^{-1} and 10^{-6} . Moreover, phages, which escape the R/M system, are modified by the methylase activity, and if they attack a strain harbouring the same R/M system, the phage DNA is protected from the endonuclease activity.

5.11.6 *Abortive infection*

In strains containing abortive infection (Abi) systems, phage infection is aborted some time after injection of phage DNA. Complete absence of plaques or a small number of pinpoint plaques are observed. The Abi activity generally leads to cell death without release of phage. The reduction in the efficiency of plating varies between 10^{-1} and 10^{-9} .

More than 20 Abi systems have been described (Allison & Klaenhammer, 1998). They are very diverse in terms of DNA sequence, gene organisation, regulation and the phage groups which are affected. The mode of action is still unclear for many of them.

5.11.7 *Additional routes to bacteriophage resistance*

A different type of natural phage defence system consisting of clustered regularly interspaced short palindromic repeats (CRISPR) and their associated *cas* genes was recently discovered in *S. thermophilus* (Barrangou *et al.*, 2007). CRISPR loci are composed of 21–48-bp conserved

direct repeats and non-repetitive spacers with homology to phage DNA. It was demonstrated that *S. thermophilus* strains challenged with virulent phage become resistant by integrating new spacers, which are derived from the phage genomes. However, it was also shown that phage mutants overcoming the resistance mechanism rapidly evolved (Deveau *et al.*, 2008).

Mutants of *Lc. lactis* subsp. *lactis* CHCC373 with total bacteriophage resistance were developed by inactivation of the *thyA* gene encoding the thymidylate synthase (Pedersen *et al.*, 2002). Such mutants are incapable of DNA replication without added thymidine. This mutation also abolishes the replication of phage DNA. Since RNA synthesis still occurs, the mutants are able to produce proteins and are therefore metabolically active. However, since cell division is abolished a higher inoculation rate is required.

5.12 Future perspectives in starter culture development

Cheese production worldwide is being consolidated into larger and larger factories. The ensuing use of large batch sizes puts demands on the starter culture in terms of acidification activity and reproducibility without loss of flavour or other attributes. At the same time, the various cheese manufacturers want to have product differentiation based on flavour and quality. Profit margins are small in a cheese factory, so innovations resulting in cost reduction will be quite welcome. Reduction of production times, from milk to the sale of the cheese, will have a big impact on the economics of cheese manufacture. Consumers have become very health conscious, and cheese with health benefits is highly desirable. For example, a low-fat cheese with a full-fat flavour and texture or cheese, which helps keep the digestive system in balance, reduces cholesterol or stimulates the immune system, have excellent market potential. Products with some of these properties have entered the market.

Reproducible, reliable, cost-effective production of cheese requires the use of starter cultures with constant composition, rapid acidification, superior bacteriophage resistance and which give the optimal yield and flavour in the shortest possible time. Research in all of these areas is in progress and will lead to a number of new types of starter culture. Due to persistent consumer scepticism, it is unlikely that these will contain GMOs. Rather, they will be made by traditional techniques, perhaps through the use of laboratory automation, or contain complex mixtures of strains, carefully blended to give the desired properties. Conjugation and other natural gene transfer methods may be used to combine the best properties of the best industrial strains.

The composition of a starter culture depends on how the culture is produced and maintained. For starters which are mixtures of several strains, or possibly different species, analysis after production may be necessary to ensure the correct composition. This is difficult for bulk starters, which are used immediately, but is routinely done by commercial starter culture suppliers. An alternative use by starter culture suppliers is to produce each strain as a pure single strain and then to blend them to give a mixture with the desired specifications. This flexibility does not exist for bulk starter, so the use of DVS cultures will increase, especially when complex starter cultures are used.

The future will bring a number of non-traditional starter cultures. Some of these will be made by mixing together strains or species in combinations not normally used in cheese

production. Acceptance of these cultures by the dairies depends on the acceptance of the cheeses by the end consumer. If the cheese is of a high quality and a reasonable price, consumer acceptance will follow. Additional benefits to the consumer, such as a reduced fat content or other health-promoting effects obtained by the inclusion of probiotic strains, without a reduction of the organoleptic properties will make the cheeses even more attractive.

References

- Allison, G. & Klaenhammer, T. (1998) Phage resistance mechanisms in lactic acid bacteria. *International Dairy Journal*, **8**, 207–226.
- Barrangou, R., Fremaux, C., Boyaval, P., Richards, P., Deveau, H., Moineau, S., Romero, D. & Horvath, P. (2007) CRISPR provides acquired resistance against viruses in prokaryotes. *Science*, **315**, 1709–1712.
- Bergamini, C., Hynes, E. & Zalazar, C. (2006) Influence of probiotic bacteria on the proteolysis profile of a semi-hard cheese. *International Dairy Journal*, **16**, 856–866.
- Broadbent, J., Rodríguez, B., Joseph, P., Smith, E. & Steele, J. (2006) Conversion of *Lactococcus lactis* cell envelope proteinase specificity by partial allele exchange. *Journal of Applied Microbiology*, **100**, 1307–1317.
- Broadbent, J. & Steele, J. (2007) Biochemistry of cheese flavor development: insights from genomics studies on lactic acid bacteria. *Flavor of Dairy Products* (eds K. Caldwell, M. Drake & R. McGorin), pp. 177–192, American Chemical Society, Washington, DC.
- Brooijmans, R., Poolman, B., Schuurman-Wolters, G., de Vos, W. & Hugenholtz, J. (2007) Generation of a membrane potential by *Lactococcus lactis* through aerobic electron transport. *Journal of Bacteriology*, **189**, 5203–5209.
- Bruinenberg, P., de Roo, G. & Limsowtin, G. (1997) Purification and characterization of cystathionine g-lyase from *Lactococcus lactis* subsp. *cremoris* SK11: possible role in flavour compound formation during cheese maturation. *Applied and Environmental Microbiology*, **63**, 561–566.
- Buriti, F., da Rocha, J. Saad, S. (2005) Incorporation of *Lactobacillus acidophilus* in Minas fresh cheese and its implications for textural and sensorial properties during storage. *International Dairy Journal*, **15**, 1279–1288.
- Christensen, J., Dudley, E., Pedersen, J. & Steele, J. (1999) Peptidases and amino acid catabolism in lactic acid bacteria. *Antonie van Leeuwenhoek*, **76**, 217–246.
- Cuesta, P., Suarez, J. & Rodriguez, A. (1995) Incidence of lysogeny in wild lactococcal strains. *Journal of Dairy Science*, **78**, 998–1003.
- Dellaglio, F., Felis, G., Torriani, S., Sørensen, K. & Johansen, E. (2005) Genomic characterisation of starter cultures. *Probiotic Dairy Products* (ed. A.Y. Tamime), pp. 16–38, Blackwell Publishing, Oxford.
- Deveau, H., Barrangou, R., Garneau, J., Labonte, J., Fremaux, C., Boyaval, P., Romero, D., Horvath, P. & Moineau, S. (2008) Phage response to CRISPR-encoded resistance in *Streptococcus thermophilus*. *Journal of Bacteriology*, **190**, 1390–1400.
- Doeven, M., Kok, J. & Poolman, B. (2005) Specificity and selectivity determinants of peptide transport in *Lactococcus lactis* and other microorganisms. *Molecular Microbiology*, **57**, 640–649.
- EU (2006) Regulation (EC) No. 1924/2006 of the European Parliament and of the Council of 20 December 2006 on nutrition and health claims made on foods. *Official Journal of the European Union*, **L404**, 9–25.
- Exterkate, F., Altling, A. & Bruinenberg, P. (1993) Diversity of cell envelope proteinase specificity among strains of *Lactococcus lactis* and its relationship to charge characteristics of the substrate-binding region. *Applied and Environmental Microbiology*, **59**, 3640–3647.

- FAO/WHO (2001) Report of a Joint FAO/WHO Expert Consultation on Evaluation of Health and Nutritional Properties of Probiotics in Food including Powder Milk with Live Lactic Acid Bacteria, Córdoba, Argentina (ftp://ftp.fao.org/esn/food/probio_report_en.pdf).
- Fernandez-Espla, M., Garault, P., Monnet, V. & Rul, F. (2000) *Streptococcus thermophilus* cell wall-anchored proteinase: release, purification, and biochemical and genetic characterization. *Applied and Environmental Microbiology*, **66**, 4772–4778.
- Garvey, P., Hill, C. & Fitzgerald, G. (1996). The lactococcal plasmid pNP40 encodes a third bacteriophage resistance mechanism, one which affects phage DNA penetration. *Applied and Environmental Microbiology*, **62**, 676–679.
- Gaudu, P., Vido, K., Cesselin, B., Kulakauskas, S., Tremblay, J., Rezaiki, L., Lamberet, G., Sourice, S., Duwat, P. & Gruss, A. (2002) Respiration capacity and consequences in *Lactococcus lactis*. *Antonie van Leeuwenhoek*, **82**, 263–269.
- Gilbert, C., Atlan, D., Blanc, B., Portalier, R., Germond, J., Lapierre, L. & Mollet, B. (1996) A new cell surface proteinase: sequencing and analysis of *prtB* from *Lactobacillus delbrueckii* subsp. *bulgaricus*. *Journal of Bacteriology*, **178**, 3059–3065.
- Gomes, A. & Malcata, F. (1999) *Bifidobacterium* spp. and *Lactobacillus acidophilus*: biological, biochemical, technological and therapeutical properties relevant for use as probiotics. *Trends in Food Science & Technology*, **10**, 139–157.
- Gomes, A., Malcata, F., Klaver, F. & Grande, H. (1995) Incorporation of *Bifidobacterium* spp. strain Bo and *Lactobacillus acidophilus* strain Ki in a cheese product. *Netherlands Milk and Dairy Journal*, **49**, 71–95.
- Guldfeldt, L., Sørensen, K., Strøman, P., Behrndt, H., Williams, D. & Johansen, E. (2001) Effect of starter cultures with a genetically modified peptidolytic or lytic system on Cheddar cheese ripening. *International Dairy Journal*, **11**, 373–382.
- Heap, H. & Lawrence, R. (1976) The selection of starter strains for cheesemaking. *New Zealand Journal of Dairy Science & Technology*, **11**, 16–20.
- Heller, K., Bockelmann, W., Schrezenmeir, J. & de Vrese, M. (2003) Cheese and its potential as a probiotic food. *Handbook of Fermented Functional Foods* (ed. E. Farnworth), pp. 203–225, CRC Press, Boca Raton.
- Janzen, T. & Jensen, O. (1996) Comparison of bacteriophages from *Streptococcus thermophilus* based upon a conserved DNA-region. *Abstracts of the Fifth Symposium on Lactic Acid Bacteria*, F17, Veldhoven, Holland.
- Jarvis, A. (1989) Bacteriophages of lactic acid bacteria. *Journal of Dairy Science*, **72**, 3406–3428.
- Johansen, E. (1999) Genetic engineering (b) Modification of bacteria. *Encyclopedia of Food Microbiology* (eds R. Robinson, C. Batt & P. Patel), pp. 917–921, Academic Press, London.
- Johansen, E. (2003) Challenges when transferring technology from *Lactococcus* laboratory strains to industrial strains. *Genetics and Molecular Research*, **2**, 112–116.
- Krieg, N. (2001) Identification of prokaryotes. *Bergey's Manual of Systematic Bacteriology* (eds G. Garrity, D. Boone & R. Castenholz), vol. 1, 2nd edn, pp. 33–38, Springer, New York.
- Labrie, S. & Moineau, S. (2000) Multiplex PCR for detection and identification of lactococcal bacteriophages. *Applied and Environmental Microbiology*, **66**, 987–994.
- Lemieux, L. & Simard, R. (1991) Bitter flavour in dairy products. I: A review of the factors likely to influence its development, mainly in cheese manufacture. *Lait*, **71**, 599–636.
- Lortal, S. & Chapot-Chartier, M.-P. (2005) Role, mechanisms and control of lactic acid bacteria lysis in cheese. *International Dairy Journal*, **15**, 857–871.
- Ludwig, W. & Klenk, H.-P. (2001) Overview: a phylogenetic backbone and taxonomic framework for prokaryotic systematics. *Bergey's Manual of Systematic Bacteriology* (eds G. Garrity, D. Boone & R. Castenholz), vol. 1, 2nd edn, pp. 49–65, Springer, New York.
- Ludwig, W., Strunk, O., Westram, R., Richter, L., Meier, H., Kumar, Y., Buchner, A., Lai, T., Steppi, S., Jobb, G., Förster, W., Brettske, I., Gerber, S., Ginhart, A.W., Gross, O., Grumann, S., Hermann, S., Jost, R., König, A., Liss, T., Lüßmann, R., May, M., Nonhoff, B., Reichel, B., Strehlow, R.,

- Stamatakis, A., Stuckmann, N., Vilbig, A., Lenke, M., Ludwig, T., Bode, A. & Schleifer, K.-H. (2004) ARB: a software environment for sequence data. *Nucleic Acids Research*, **32**, 1363–1371.
- Makarova, K., Slesarev, A., Wolf, Y., Sorokin, A., Mirkin, B., Koonin, E., Pavlov, A., Pavlova, N., Karamychev, V., Polouchine, N., Shakhova, V., Grigoriev, I., Lou, Y., Rohksar, D., Lucas, S., Huang, K., Goodstein, D., Hawkins, T., Plengvidhya, V., Welker, D., Hughes, J., Goh, Y., Benson, A., Baldwin, K., Lee, J., Diaz-Muniz, I., Dosti, B., Smeianov, V., Wechter, W., Barabote, R., Lorca, G., Altermann, E., Barrangou, R., Ganesan, B., Xie, Y., Rawsthorne, H., Tamir, D., Parker, C., Breidt, F., Broadbent, J., Hutkins, R., O'Sullivan, D., Steele, J., Unlu, G., Saier, M., Klaenhammer, T., Richardson, P., Kozyavkin, S., Weimer, B. & Mills D. (2006) Comparative genomics of the lactic acid bacteria. *Proceedings of the National Academy of Sciences of the United States of America*, **103**, 15611–15616.
- McBrearty, S., Ross, R., Fitzgerald, G., Collins J., Wallace, J. & Stanton C. (2001) Influence of two commercially available bifidobacteria cultures on Cheddar cheese quality. *International Dairy Journal*, **11**, 559–610.
- Montville, M., Ardestani, B. & Geller, B. (1994) Lactococcal bacteriophages require a host cell wall carbohydrate and a plasma membrane protein for adsorption and ejection of DNA. *Applied and Environmental Microbiology*, **60**, 3204–3211.
- Neve, H., Kemper, U., Geis, A. & Heller, K. (1994) Monitoring and characterization of lactococcal bacteriophages in a dairy plant. *Kieler Milchwirtschaftliche Forschungsberichte*, **46**, 167–178.
- Neves, A., Pool, W., Kok, J., Kuipers, O. & Santos, H. (2005) Overview on sugar metabolism and its control in *Lactococcus lactis*: the input from in vivo NMR. *FEMS Microbiological Reviews*, **29**, 531–554.
- O'Connor, L., Coffey, A., Daly, C. & Fitzgerald, G. (1996) AbiG, a genotypically novel abortive infection mechanism encoded by plasmid pCI750 of *Lactococcus lactis* subsp. *cremoris* UC653. *Applied and Environmental Microbiology*, **62**, 3075–3082.
- Olsen, K., Brockmann, E. & Molin, S. (2007) Quantification of *Leuconostoc* populations in mixed dairy starter cultures using fluorescence in situ hybridization. *Journal of Applied Microbiology*, **103**, 855–863.
- Orla-Jensen, S. (1919) *The Lactic Acid Bacteria*, Fred Host and Son, Copenhagen.
- Parvez, S., Malik, K., Kang, S. & Kim, H.-Y. (2006) Probiotics and their fermented food products are beneficial for health. *Journal of Applied Microbiology*, **100**, 1171–1185.
- Pedersen, M., Iversen, S., Sørensen, K. & Johansen, E. (2005) The long and winding road from the research laboratory to industrial applications of lactic acid bacteria. *FEMS Microbiological Reviews*, **29**, 611–624.
- Pedersen, M., Jensen, P., Janzen, T. & Nilsson D. (2002) Bacteriophage resistance of a $\Delta thyA$ mutant in *Lactococcus lactis* blocked in DNA replication. *Applied and Environmental Microbiology*, **68**, 3010–3023.
- Pederson, J., Mileski, G., Weimer, B. & Steele, J. (1999) Genetic characterization of a cell envelope-associated proteinase from *Lactobacillus helveticus* CNRZ32. *Journal of Bacteriology*, **181**, 4592–4597.
- Pfeiler, E. & Klaenhammer, T. (2007) The genomics of lactic acid bacteria. *Trends in Microbiology*, **15**, 546–553.
- Phillips, M., Kailasapathy, K. & Tran, L. (2006) Viability of commercial probiotic cultures (*L. acidophilus*, *Bifidobacterium* sp., *L. casei*, *L. paracasei* and *L. ramosus*) in cheddar cheese. *International Journal of Food Microbiology*, **108**, 276–280.
- Ross, R., Desmond, C., Fitzgerald, G. & Stanton, C. (2005) Overcoming the technological hurdles in the development of probiotic foods. *Journal of Applied Microbiology*, **98**, 1410–1417.
- Ross, R., Fitzgerald, G., Collins, K. & Stanton, C. (2002) Cheese delivering biocultures – probiotic cheese. *The Australian Journal of Dairy Technology*, **57**, 71–78.
- Roy, D. (2005) Technological aspects related to the use of bifidobacteria in dairy products. *Lait*, **85**, 39–56.

- Schleifer, K., Ehrmann, M., Krusch, U. & Neve, H. (1991) Revival of the species *Streptococcus thermophilus* (ex Orla-Jensen, 1919) nom. rev. *Systematic and Applied Microbiology*, **14**, 386–388.
- Smeianov, V., Wechter, P., Broadbent, J., Hughes, J., Rodríguez, B., Christensen, T., Ardö, Y. & Steele, J. (2007) Comparative high-density microarray analysis of gene expression during growth of *Lactobacillus helveticus* in milk versus rich culture medium. *Applied and Environmental Microbiology*, **73**, 2661–2672.
- Smit, G., Smit, B. & Engels, W. (2005) Flavour formation by lactic acid bacteria and biochemical flavour profiling of cheese products. *FEMS Microbiological Reviews*, **29**, 591–610.
- Sørensen, K., Larsen, R., Kibenich, A., Junge, M. & Johansen, E. (2000) A food-grade cloning system for industrial strains of *Lactococcus lactis*. *Applied and Environmental Microbiology*, **66**, 1253–1258.
- Stackebrandt, E. & Goebel, B. (1994) Taxonomic note: a place for DNA–DNA reassociation and 16S rRNA sequence analysis in the present species definition in bacteriology. *International Journal of Systematic Bacteriology*, **44**, 846–849.
- Stadhouders, J. & Leenders, G. (1984) Spontaneously developed mixed-strain cheese starters: their behaviour towards phages and their use in the Dutch cheese industry. *Netherlands Milk and Dairy Journal*, **38**, 157–181.
- Steen, A., van Schalkwijk, S., Buist, G., Twigt, M., Szeliga, M., Meijer, W., Kuipers, O., Kok, J. & Hugenholtz, J. (2007) Lytr, a phage-derived amidase is most effective in induced lysis of *Lactococcus lactis* compared with other lactococcal amidases and glucosaminidases. *International Dairy Journal*, **17**, 926–936.
- Tamime, A.Y. (2002) Microbiology of starter cultures. *Dairy Microbiology – The Microbiology of Milk and Milk Products* (ed. R.K. Robinson), pp. 261–366, John Wiley & Sons, Inc., New York.
- Tamime, A.Y., Saarela, M., Korslund Søndergaard, A., Mistry, V.V. & Shah, N.P. (2005) Production and maintenance of viability of probiotic micro-organisms in dairy products. *Probiotic Dairy Products* (ed. A.Y. Tamime), pp. 39–72, Blackwell Publishing, Oxford.
- Teuber, M. (1993) Lactic acid bacteria. *Biotechnology* (eds H. Rehm & G. Reed), 2nd edn, pp. 326–366, VCH Verlagsgemeinschaft, Weinheim.
- Thompson, J. (1987) Sugar transport in the lactic acid bacteria. *Sugar Transport and Metabolism in Gram-Positive Bacteria* (eds J. Reizer & A. Peterkofsky), pp. 13–38, Ellis Horwood Ltd., Chichester.
- Tratnik, L., Suskovic, J., Bozanic, R. & Kos, B. (2000) Creamed Cottage cheese enriched with *Lactobacillus* GG. *Mljekarstvo*, **50**, 113–123.
- Vinderola, G., Prosello, W., Ghiberto, D. & Reinheimer, J. (2000) Viability of probiotic (*Bifidobacterium*, *Lactobacillus acidophilus* and *Lactobacillus casei*) and nonprobiotic microflora in Argentinian Fresco cheese. *Journal of Dairy Science*, **83**, 1905–1911.
- Visser, S. (1993) Proteolytic enzymes and their relation to cheese ripening and flavour: an overview. *Journal of Dairy Science*, **76**, 329–350.
- Visser, S., Hup, G., Exterkate, F. & Stadhouders, J. (1983) Bitter flavour in cheese. 2: Model studies on the formation and degradation of bitter peptides by proteolytic enzymes from calf rennet, starter cells and starter cell fractions. *Netherlands Milk and Dairy Journal*, **37**, 169–180.
- Weiss, N., Schillinger, U. & Kandler, O. (1983) *Lactobacillus lactis*, *Lactobacillus leichmanii* and *Lactobacillus bulgaricus*, subjective synonyms of *Lactobacillus delbrueckii*, and description of *Lactobacillus delbrueckii* subsp. *lactis* comb. nov. and *Lactobacillus delbrueckii* subsp. *bulgaricus* comb. nov. *Systematic and Applied Microbiology*, **4**, 552–557.
- Whitehead, H. (1953) Bacteriophages in cheese manufacture. *Bacteriological Reviews*, **17**, 109–125.
- Woese, C. (1987) Bacterial evolution. *Microbiological Reviews*, **51**, 221–271.
- Yvon, M. & Rijnen, L. (2001) Cheese flavour formation by amino acid catabolism. *International Dairy Journal*, **11**, 185–201.

6 Secondary Cheese Starter Cultures

W. Bockelmann

6.1 Introduction

In contrast to surface-coated cheeses, such as Cheddar, Gouda and Edam, the outer layer of some surface-ripened cheese varieties is covered by a layer of moulds, yeasts and bacteria, which have a strong impact on the appearance, flavour and texture development of cheeses (Fig. 6.1). Surface-ripened cheeses have a long tradition and, without the scientific knowledge of the bacterial nature of the surface flora, a large variety of smear cheeses was produced long before 1900 (Fox *et al.*, 2004a, b). When cheeses were manufactured from raw milk – an important source for surface microorganisms – are exposed to air with a high relative humidity ($>95 \text{ g } 100 \text{ g}^{-1}$) they naturally tend to develop a smear layer on the surface of the product, typically consisting of yeasts and bacteria (Brennan *et al.*, 2002, 2004; Mounier *et al.*, 2005). Since the introduction of pasteurisation (72°C for 15 s), which has considerably improved food safety, the cheese milk flora has less influence on the surface microflora of cheeses (Holsinger *et al.*, 1997). Already in the nineteenth century, a fascinating paper on Brick cheese was published by Laxa (1899), where he described de-acidification of the cheese surface as a main function of yeasts, namely the genera *Oidium* and *Sacharomycetes* (probably *Geotrichum candidum* and *Debaryomyces hansenii*), which enables bacteria to build the smear on the surface of the cheese. Yellow-pigmented bacteria were first described as ‘*Bacillus 2*’ (probably *Microbacterium gubbeenense* or *Arthrobacter arilaitensis*) as well as the common enterobacterial contaminants (first reported as *Bacterium coli*).

Surface ripening of cheeses usually leads to short ripening periods of several weeks rather than months and to the development of a strong flavour in the product (Table 6.1). From their appearance, two main groups of surface-ripened cheeses exist: (a) mould-ripened cheeses, such as Camembert and Brie (Fig. 6.1a) with a white surface and (b) bacterial smear-ripened cheeses, such as Romadour, Tilsit, Gruyère and Grana Padano with an orange, pink-red or yellow-brown surface (Figs. 6.1f–6.1o). There are intermediate cheeses with a mould-like white colour caused by *Penicillium camemberti* or *G. candidum* combined with smear bacterial orange or brown streaks or patches, which are caused by smear bacteria. Examples of these cheeses are Rougette, Pont l’Évêque and St. Albray (Figs. 6.1d and 6.1e). In addition to surface-ripened cheeses, blue vein cheeses, such as Roquefort, Gorgonzola and Cambozola, have *Penicillium roqueforti* moulds growing in the inner surfaces of the cheeses, which are exposed to air due to piercing of the newly formed blocks of cheeses with needles at the beginning of the ripening period (Figs. 6.1b and 6.1c). Rather peculiar variety of cheeses are the acid curd type, which are smear-ripened (yellow type, Fig. 6.1p) or mould-ripened (Hausmacher type, Fig. 6.1o). Detailed description of the manufacturing stages including

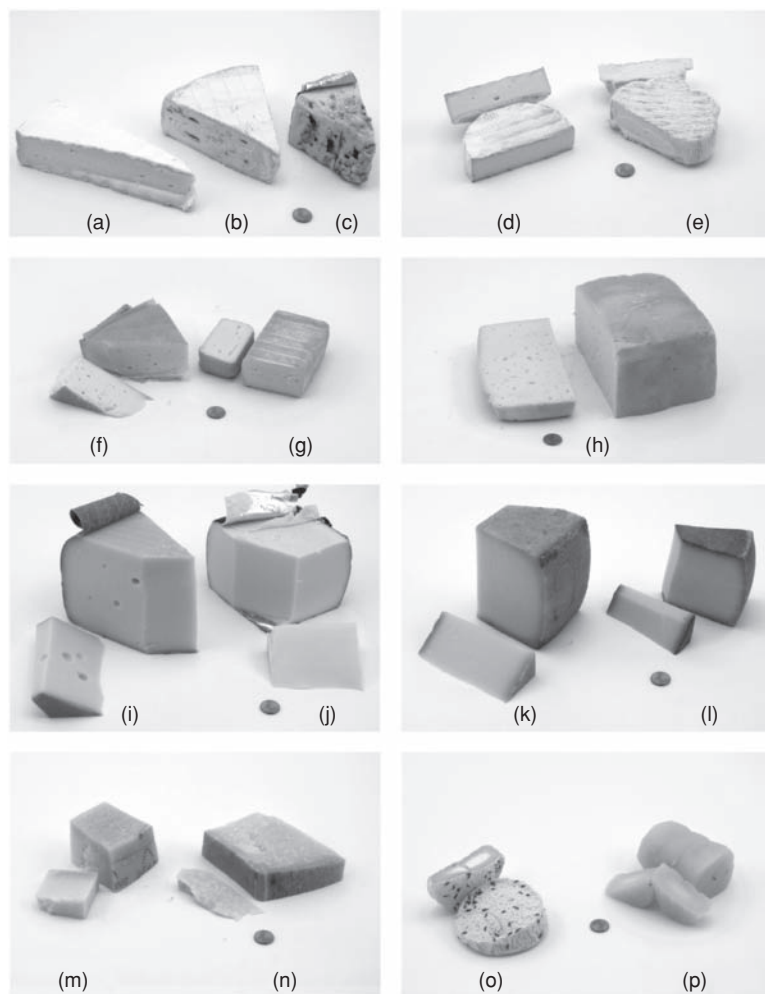

Fig. 6.1 Examples of surface-ripened cheeses. (a) Camembert- and Brie-type cheese with a uniform white *Penicillium camemberti* on the surface, (b) mild blue vein cheese, (c) very aromatic Roquefort cheese, (d) soft cheese with *P. camemberti* and smear microflora, (e) soft cheese made with *Geotrichum candidum* and smear microflora, (f) French soft cheese with a bright orange appearance, (g) German Limburg cheese with smear microflora and patches of *G. candidum*, (h) German Tilsit cheese with brown-red and pink areas, and a very smeary surface, (i, j) modern smear cheeses with limited 'wet' ripening, the surface is covered by wax and/or foil, (k, l) Swiss hard cheeses with smear microflora, (m, n) very old Italian cheeses – Grana Padano (2 years) and Parmigiano Reggiano (3 years) and (o, p) acid curd cheeses, traditional 'light' products with $<1 \text{ g } 100 \text{ g}^{-1}$ fat-in-dry matter (FDM), Hausmacher and yellow type. The euro (€) cent is shown for size estimation.

the physical, chemical, biochemical and sensory properties of cheese varieties are reported by Fox *et al.* (2004a, b).

The composition of the surface flora of cheeses shown in Tables 6.2 and 6.3 was analysed from the samples shown in Fig. 6.1. The results show that the yeasts, smear-type bacteria and staphylococci are present on the surface of the cheeses beside the mould flora, which

Table 6.1 Origin and ripening times of some surface-ripened cheese varieties.

Variety of cheese	Origin/country	Ripening period (months)
Mould-ripened soft cheeses		
Brie	France	1–5
Camembert	France	1–6
Neufchatel	France	>1
Blue vein cheeses		
Bavaria Blue	Germany	
Bleu d Auvergne	France	1–3
Gorgonzola	Italy	3–6
Roquefort	France	>3
Stilton	United Kingdom	4–6
Danablu	Denmark	
Bacterial surface-ripened cheeses		
Brick	United States	1–2
Bel Paesa	Italy	4–5
Havarti	Denmark	1–3
Limburger	Belgium	1
Monterey	United States	1–2
Munster	France	1
Saint Paulin	France	1–2
Taleggio	Italy	2
Tilsit	Germany	1–5
Romadour	Germany	1
Bacterial surface-ripened hard cheese		
Danbo	Denmark	1–2
Gruyère	France	4–12
Parmigiano Reggiano	Italy	36

contribute to a more full-flavour profile of the product. The possible sources for coryneforms and staphylococci in surface-ripened cheeses are most likely the natural flora of the brine, the air inside the cheese-processing plant and the wooden shelves used to stack the cheese for ripening (Jaeger *et al.*, 2002; Bockelmann *et al.*, 2006). The analysis of coryneforms (smear bacteria) of the cheeses shown in Fig. 6.1 was performed on modified milk agar (mMA), which differentiate bacterial groups according to colony morphology and colour after incubation for 7–11 days at 22–24°C (Hoppe-Seyler *et al.*, 2000). Yeasts were enumerated on yeast extract glucose chloramphenicol (YGC) agar, enterococci on kanamycin esculin azide (KEA) agar, enterobacteria on violet red bile dextrose (VRBD) agar and pseudomonads on *Pseudomonas* cetrimide fucidin cephalosporin selective (CFCD) agar containing Delvocid (0.1 g 100 g⁻¹) to suppress growth of yeasts and moulds. All agars used were purchased from Merck, Darmstadt, Germany. Single isolates of different colony types were further classified by using amplified ribosomal deoxynucleic acid (DNA) restriction analysis (ARDRA) (coryneforms, staphylococci, yeasts) or API-32C (BioMérieux, France; yeasts) for confirmation of putative species classification.

Table 6.2 Surface microflora of smear-ripened cheeses; mature cheeses were purchased in August 2008.

Viable cell counts expressed as cfu mL ⁻¹ and colony/cell morphology	(a) Camembert/Brie-type (approximately 4 weeks)	(b) German Blue cheese (mild) (approximately 4 weeks)	(c) Roquefort (approximately 4 weeks)	(d) German soft cheese with mould and smear (approximately 4 weeks)	(e) Smear'd French soft cheese (mild) (approximately 4 weeks)	(f) Smear'd French soft cheese (bright orange) (approximately 4 weeks)	(g) German Limburg cheese (approximately 4 weeks)	(h) Tilsit-type semi-soft cheese (approximately 10 weeks)
	Smear bacteria (mMA)							
Orange coryneforms	1.0 × 10 ⁷	1.3 × 10 ⁸	— ^a	2.7 × 10 ⁹	2.1 × 10 ⁵	— ^b	1.5 × 10 ⁷	2.7 × 10 ⁸
Beige-red coryneforms	1.0 × 10 ⁸	3.4 × 10 ⁸	— ^a	—	3.5 × 10 ⁴	4.8 × 10 ⁸	2.1 × 10 ⁸	7.3 × 10 ⁸
Yellow coryneforms	1.0 × 10 ⁸	4.5 × 10 ⁷	— ^a	—	—	—	2.4 × 10 ⁸	6.6 × 10 ⁸
Large rods	1.3 × 10 ⁸	1.3 × 10 ⁸	—	1.0 × 10 ⁸	—	3.8 × 10 ⁸	1.5 × 10 ⁷	7.7 × 10 ⁸
Small rods	—	—	—	2.0 × 10 ⁸	7.6 × 10 ⁸	—	4.8 × 10 ⁸	5.4 × 10 ⁸
Staphylococci (SK agar)								
White colonies	8.8 × 10 ⁵	9.3 × 10 ⁶	2.7 × 10 ⁸	3.0 × 10 ⁴	4.7 × 10 ³	7.5 × 10 ⁷	—	2.6 × 10 ⁸
Orange colonies	—	—	1.0 × 10 ⁷	—	—	—	—	—
Yeasts/moulds (YGC)								
DH-like white yeast colonies	1.8 × 10 ⁵	—	2.9 × 10 ⁵	7.1 × 10 ⁶	—	2.4 × 10 ⁷	4.5 × 10 ⁵	2.2 × 10 ⁵
<i>Geotrichum candidum</i> – like yeasts	2.4 × 10 ⁵	—	—	2.9 × 10 ⁶	6.9 × 10 ⁶	—	2.6 × 10 ⁶	1.4 × 10 ⁶
White-matt colonies	—	—	1.2 × 10 ⁶	1.6 × 10 ⁶	5.0 × 10 ⁸	—	—	—
Hair-like yeasts	—	—	—	—	—	—	—	—
Oval yeasts	—	—	—	1.0 × 10 ⁶	—	—	—	—
White moulds	2.1 × 10 ⁶	9.6 × 10 ⁵	—	—	—	—	—	—
Blue or green moulds	—	—	3.0 × 10 ⁴	—	—	—	—	—
Miscellaneous bacteria								
Enterococci (KAA)	1.8 × 10 ⁴	6.0 × 10 ²	—	1.8 × 10 ²	4.4 × 10 ⁵	1.7 × 10 ⁴	3.5 × 10 ⁵	—
Enterobacteria (VRBD)	7.4 × 10 ⁵	7.1 × 10 ⁵	—	3.6 × 10 ⁵	8.8 × 10 ²	1.9 × 10 ⁷	3.4 × 10 ⁴	1.4 × 10 ⁵
Pseudomonads (CFCD)	1.3 × 10 ⁶	4.1 × 10 ⁵	—	5.1 × 10 ⁴	—	—	—	—

Note: For sampling thin slices of the surface were cut; refer to text for abbreviations of the agar media.

^aMost likely present on modified milk agar (mMA) to some extent, not detectable because of high staphylococcal counts, growing also on mMA.

^bThe count is below the detection limit (100 cfu cm⁻²) or less than 1% of other microorganisms growing on the same selective agar.

Table 6.3 Surface microflora of smear-ripened cheeses; mature cheeses were purchased in August 2008.

Viable cell counts expressed as cfu mL ⁻¹ and colony/cell morphology	(i) 'Modern' semi-soft cheese (approximately 10 weeks)	(j) 'Modern' semi-hard cheese (15 weeks)	(k) Gruyère-type hard cheese	(l) Mountain hard cheese (approximately 1 year)	(m) Grana Padano (2 years)	(n) Parmigiano-Reggiano (3 years)	(o) Acid curd cheese 'Hausmacher' style (approximately 3 weeks)	(p) Acid curd cheese 'yellow type' (approximately 3 weeks)
Smear bacteria (mMA)	— ^a	—	4.9 × 10 ⁸	2.8 × 10 ⁹	3.2 × 10 ³	—	—	1.7 × 10 ⁸
Orange coryneforms	5.5 × 10 ⁶	3.1 × 10 ⁴	3.5 × 10 ⁷	1.0 × 10 ⁸	7.7 × 10 ³	2.5 × 10 ⁴	—	—
Beige-red coryneforms	—	—	1.2 × 10 ⁷	4.4 × 10 ⁸	1.0 × 10 ³	4.0 × 10 ⁴	—	—
Yellow coryneforms	—	7.3 × 10 ⁵	—	1.9 × 10 ⁸	3.2 × 10 ⁵	1.0 × 10 ⁴	—	1.9 × 10 ⁴
Large rods	1.1 × 10 ⁷	4.8 × 10 ⁵	—	—	1.2 × 10 ³	—	—	—
Small rods	—	—	—	—	—	—	—	—
Staphylococci (SK agar)	—	—	—	—	—	—	—	—
White colonies	9.2 × 10 ⁶	5.0 × 10 ⁴	1.4 × 10 ⁵	3.2 × 10 ⁷	1.5 × 10 ³	9.0 × 10 ³	3.9 × 10 ⁵	—
Orange colonies	—	—	—	2.2 × 10 ⁵	6.3 × 10 ²	4.3 × 10 ³	—	—
Yeasts/moulds (YGC)	—	—	—	—	—	—	—	—
DH-like white yeast colonies	—	—	7.9 × 10 ²	4.4 × 10 ²	3.7 × 10 ²	3.3 × 10 ²	3.7 × 10 ^{6b}	4.6 × 10 ^{6b}
<i>Geotrichum candidum</i> – like yeasts	—	—	1.0 × 10 ²	—	—	—	7.4 × 10 ⁶	1.0 × 10 ⁵
White-matt colonies	5.7 × 10 ³	—	—	—	—	—	7.6 × 10 ^{6b}	4.9 × 10 ^{6b}
Hair-like yeasts	—	—	—	—	—	1.3 × 10 ²	—	3.9 × 10 ⁶
Oval yeasts	—	—	—	—	1.5 × 10 ⁴	—	—	—
White moulds	—	—	1.5 × 10 ²	—	—	1.0 × 10 ²	—	—
Blue or green moulds	—	—	1.2 × 10 ⁵	1.8 × 10 ⁶	—	—	—	—
Miscellaneous bacteria	—	—	—	—	—	—	—	—
Enterococci (KAA)	1.0 × 10 ³	—	—	1.3 × 10 ⁶	—	—	—	4.8 × 10 ⁴
Enterobacteria (VRBD)	—	—	—	—	—	—	—	3.8 × 10 ²
Pseudomonads (CFCD)	—	—	—	—	—	—	—	1.0 × 10 ²

Note: For sampling thin slices of the surface were cut; refer to text for abbreviations of the agar media.

^aThe count is below the detection limit (100 cfu cm⁻²) or less than 1% of other microorganisms growing on the same selective agar.

^bFor acid curd cheeses, DH-like colonies most likely to represent *Kluyveromyces marxianus* and white-matt colonies most likely to represent *Candida krusei*.

Apart from the obvious presence of *P. camemberti* and *P. roqueforti* on Camembert and blue vein cheese varieties (Figs. 6.1a–6.1c), the composition of the surface flora is quite variable. The bacterial surface flora changes drastically over time, especially in the first weeks, and it can be imagined that a surface microflora of a hard cheese is different when analysed after one month or after 2–3 years. In addition, the microflora of cheese varieties at a certain age varies from batch to batch, without detectable optical or aromatic differences (results from the European Union [EU] demonstration project ‘*Definition and Characterisation of Starter Cultures for Surface Ripening of Smear Cheeses*’, CT2002–02461, 2003–2005). From the published data available, many naturally occurring bacterial and yeast species are described for various surface-ripened cheeses. This chapter concentrates on species, which are frequently isolated and have a potential to be used as surface starter cultures.

6.2 Surface-ripened cheeses

6.2.1 Examples of some popular varieties

As shown in Fig. 6.1a and 6.1b (see also Table 6.2), Camembert and German blue vein cheeses were produced from pasteurised milk. These cheeses possessed a typical smear flora consisting of orange (*Brevibacterium linens*), beige-red (*Corynebacterium* spp.) and yellow coryneforms (*Microbacterium gubbeenense* and *Brachybacterium alimentarium*) and staphylococci (*Staphylococcus equorum*). The Camembert cheese showed a typical flora composition of moulds (*P. camemberti*) and yeasts (*D. hansenii* and *G. candidum*). The level of contamination with enterobacteria, enterococci and pseudomonads was rather high for both samples. In general, lower counts are more common (100–1000 colony forming units (cfu) cm⁻²), and the pseudomonads counts are usually not detected.

The Roquefort cheese (Fig. 6.1c; Table 6.2) produced from raw milk showed high concentrations of staphylococci on (SK) agar (Schleifer & Kramer, 1980) and no coryneforms on mMMA. Since staphylococci also grow on mMMA, a low percentage of <1% of the bacterial flora can not be detected. It can be assumed that coryneforms were present at lower level in this type of cheese. The presence of white moulds was expected; however, the absence of blue moulds from the surface of the cheese (i.e. typical for Roquefort cheeses as it only grows internally or inside the block of cheese) was probably due to sampling – a thin slice of 1–2 mm thickness was cut off the surface and analysed, or possibly due to the dry salting of the rind, which makes the outer surface of the block of cheese dryer and containing high level of salt. In spite of the smeary appearance on the surface of the cheese, no enterobacteria, enterococci or pseudomonads were detected in Roquefort cheese.

Cheese varieties with a visible mixed flora of moulds and smear are shown in Figs. 6.1d and 6.1e. The white layer can consist of *Penicillium* spp. moulds or *G. candidum* (Table 6.2). The *Penicillium* layer of cheese (Fig. 6.1d) is clearly visible by direct microscopy, but did not show in the surface cell counts, probably due to low sporulation of the moulds. Figs. 6.1f and 6.1g shows typical smear-ripened soft cheeses. The smear may develop an orange colour on the surface of the cheese; however, the bright orange colour of some cheese varieties is due to the addition of artificial food colours (e.g. β -carotene). On most soft cheeses, *D. hansenii* and *G. candidum* are present, staphylococci are often missing. Yellow

coryneforms (*M. gubbeenense* and *A. arilaitensis*) are usually found in high numbers amongst the other coryneforms, e.g. brevibacteria and corynebacteria.

Tilsit cheese is a classical German variety with an open structure and a yellow-brown or brownish-pink surface colour (Fig. 6.1h). The smear flora is usually dominated by *Corynebacterium casei*, and high numbers of *S. equorum* and *D. hansenii* are also present. *G. candidum* is usually not part of the surface flora (Table 6.2) and, if present, the surface of the cheese tends to be less sticky, but visible *Geotrichum* spp. growth is considered to be a defect.

The wet ripening of 'modern' smear cheeses (Figs. 6.1i and 6.1j) is restricted to few weeks only. After 2–4 weeks, the cheeses are waxed and/or wrapped in foil before further ripening is continued. This leads to an odour reduction without considerable loss of taste and protects the cheeses from contamination in the ripening room. The surface flora of Dutch semi-hard and Danish semi-soft cheeses (Figs. 6.1i and 6.1j; see Tables 6.2 and 6.3) is usually similar to Tilsit cheeses, but *D. hansenii*, which is a typical component of the surface flora, was not found in these two mature samples.

The microflora on the surface of two hard cheese varieties made from raw milk (Figs. 6.1k and 6.1l; Table 6.3) was also similar to Tilsit cheese surface flora; however, apart from *M. gubbeenense*, a number of yellow coryneforms was identified as *B. alimentarium* and *Brachybacterium tyrofermentans*. It is of interest to note that these *Brachybacterium* spp. were not found Tilsit and Limburg cheeses analysed by Bockelmann *et al.* (1997c, 2003). The Italian Parmesan-type cheeses, 2–3 years old, are probably the oldest variety available on the market (Figs. 6.1m and 6.1n). The surface microflora was comparable to other hard cheeses consisting of different coryneforms, staphylococci and *D. hansenii* amongst other yeasts (Table 6.3).

Cheeses produced from acid curd (e.g. Quarg with a dry mass of $>30 \text{ g } 100 \text{ g}^{-1}$) are typical varieties of Germany and some other European countries. They are named as Harzer in Germany and Quargel in Austria, and some ripened varieties are covered with *Penicillium* moulds or *G. candidum*. The white surface appearance is shown in Fig. 6.1o. *G. candidum* is also present on many 'yellow type' cheeses; however, due to high counts of yeasts (*Kluyveromyces marxianus* and *Candida krusei*) and smear flora, no white growth of *G. candidum* is visible (Fig. 6.1p). Smear bacteria are present on all types of acid curd cheeses (Table 6.3).

6.2.2 Control of surface ripening

Apart from the influence of the physical and chemical parameters of the cheese milk, the starter cultures (conventional and secondary) and non-starter lactic acid bacteria (LAB) contribute significantly, especially the secondary starter cultures, to the complexity of flavour development and biochemical reactions in the product or during cheesemaking. Maintaining a high level of hygiene as well as a profound knowledge of the needs of a typical surface flora is essential during ripening because the cheese surfaces are exposed to an unsterile environment. Undesirable contaminants, such as enterococci, enterobacteria, pseudomonads and pathogenic *Listeria monocytogenes*, can grow as soon as the balance of the cheese microflora is disturbed. Understanding the microbial ecology of the cheese surface is a prerequisite for development of surface starter cultures and for control of surface ripening. In

case of mould-ripened cheeses with *P. camemberti* and *P. roqueforti* as predominant species, the microbiological situation is rather simple and a large variety of well-characterised fungal microorganisms are sold by starter culture companies. The microflora of smear cheeses is more complex. For a long a time, only *Debaryomyces hansenii* and *B. linens* were commercially available and traditionally used by smear-ripened cheese producers. The in-house microflora of a cheese plant (i.e. cheese brine, wooden shelves and air in the ripening rooms including mature smear-ripened cheeses) was, and still is, essential for the development of a complete and typical smear flora on the product. It can be imagined that with this setup a full control of surface ripening is not possible.

In the following subsequent sections, the ecology of the surface microflora of mould and smear-ripened cheeses is described together with recent changes in the taxonomy of yeasts and coryneforms. Existing commercial secondary starter cultures are described, and new concepts for further starter culture improvement regarding aroma and colour development and food protection are reviewed.

6.3 Classification of secondary starter cultures

6.3.1 Moulds and yeasts

The genus *Penicillium* belongs to the group of Ascomycetes and can develop sexual (ascospores) and asexual spores (conidiospores). A dense layer of mycelium of *P. camemberti*, which develops within days, protects the surface of Camembert- or Brie-type cheeses from contamination with pathogenic bacteria or undesirable moulds and is responsible for the development of the typical aroma and texture. For blue vein cheeses, piercing with needles creates aerobic areas inside the cheeses, which allows the growth of *P. roqueforti*.

Classification of some yeasts, moulds and smear bacteria is difficult because of the still changing taxonomy. White variants of *P. camemberti* have been used for the production of Camembert cheese since 1910, because they were more acceptable to consumers, whilst blue grey-coloured moulds, such as *Penicillium album* and *Penicillium glaucum* were predominant on cheeses in the nineteenth century (Fig. 6.2). The trade names *Penicillium candidum* or *Penicillium caseicolum* are common in the dairy industry for white variants of *P. camemberti*. Commercially available *P. camemberti* or *P. album* starter cultures are characterised by a non-white (grey, blue-grey) mycelium. The species name *P. camemberti* for white variants complies better with current taxonomy and are used in this chapter (Bartnicki, 1996).

The teleomorph form of the well-known yeast culture, *G. candidum*, was named *Galactomyces geotrichum* by Barnett *et al.* (2000), which was later changed to *Galactomyces candidus* (de Hoog & Smith, 2004). The species name *G. geotrichum* is still used for some strains with an unknown anamorph (de Hoog & Smith, 2004). An extensive study on *Geotrichum* classification was published recently by Gente *et al.* (2006); however, in this chapter the trade name *G. candidum* is used.

In general, the API-32 C test method is a suitable tool for yeast identification. Results can be confirmed by using the simple molecular method ARDRA described by Bockelmann *et al.* (2008). In some difficult cases, e.g. identification of *Candida inconspicua*, *C. krusei* and *Candida norvegensis*, ARDRA gives more reliable results. An excellent classification method for cheese-related yeasts, coryneforms and many other bacterial groups, is the

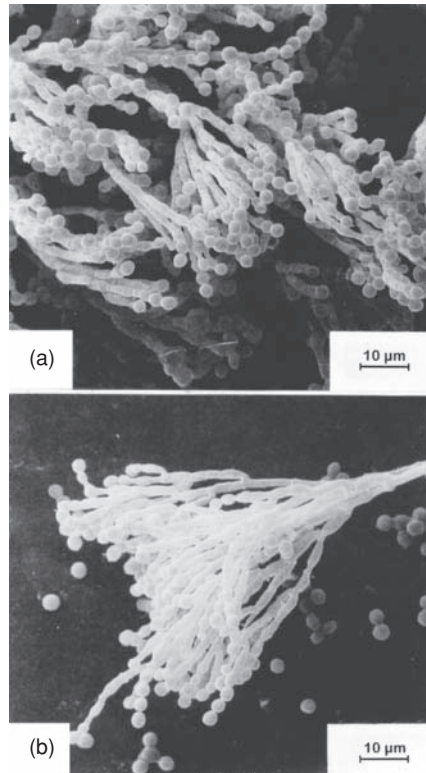

Fig. 6.2 Scanning electron microscopy of sporulating *Penicillium camemberti* used as secondary culture for Camembert- and Brie-type cheeses. Note: The bars indicate the different magnifications of the micrographs. (Reproduced by permission of H. Neve, personal communication, and Max Rubner Institute, Kiel.)

fourier-transform infrared (FT-IR) spectroscopy (Kummerle *et al.*, 1998; Oberreuter *et al.*, 2002). Suitable species databases are available at the ZIEL institute in Weihenstephan (University of Munich, Germany).

6.3.2 *Staphylococci*

The importance of certain cocci organisms during the ripening of smear cheeses is well documented. Langhus *et al.* (1945) found that micrococci grew to high numbers during the first week of ripening. Morris *et al.* (1951) reported that the surface microflora of Minnesota blue vein cheese included not only *B. linens*, but also micrococci. Mulder *et al.* (1966) found that the count of micrococci amounted to 3–6% of the total bacterial count of Limburger cheese. The presence of micrococci in various cheeses was also reported by Seiler (1986). Recent studies showed that the presence of *Micrococcus* spp. or *Kocuria* spp. is probably rather an exception than the rule (Bockelmann *et al.*, 2006).

Until the mid 1970s, all clumping, Gram-positive and catalase-positive cocci, which did not metabolise glucose under anaerobic conditions, were grouped into the genus *Micrococcus* (Evans & Kloos, 1972). In contrast to staphylococci (e.g. *Staphylococcus aureus*),

the micrococci were considered as a food-grade organisms. Subsequently, differences in the molecular structure of the cell wall and guanine–cytosine (G+C) content between the two genera were evident, sensitivity of staphylococci to lysostaphin and furazolidon, and resistance of staphylococci against bacitracin were used to distinguish between the genera *Micrococcus* and *Staphylococcus*. Both genera, however, are still grouped into the family of Micrococcaceae. Reference to micrococci even in recent papers is perhaps in order to acknowledge the non-pathogenic, food-grade status of isolates. However, it became clear in the past few years that practically all cocci isolated from smear-ripened cheese were *S. equorum*, *Staphylococcus saprophyticus* or *Staphylococcus xylosum*. (Bockelmann *et al.*, 2002, 2005, 2006). A simple and reliable method for identification of *Staphylococcus* spp. is using the ARDRA method (Hoppe-Seyler *et al.*, 2004). The ID32-Staph method (BioMérieux, France) is a helpful tool, but often gives wrong classification for the food-grade staphylococci species (*S. xylosum*, *S. equorum*). In addition, the FT-IR database for staphylococci is also available at the ZIEL institute in Weihenstephan (University of Munich, Germany).

6.3.3 *Coryneforms*

Different coryneform organisms have been identified in smear-ripened cheeses, and they are classified as follows.

Orange coryneforms

For a long time, all orange coryneforms were considered as *B. linens*. Recently, orange *Arthrobacter casei* was reported amongst the isolates of smear-ripened cheeses (Hoppe-Seyler *et al.*, 2007). It is unclear, which percentage of *A. casei* comprised in the population of orange coryneforms. Classification of *A. casei* from brevibacteria can be done by ARDRA; universal primers designed for *Arthrobacter*, *Microbacterium* and *Staphylococcus* do not develop a single polymerase chain reaction (PCR) product for *Brevibacterium* spp. (Hoppe-Seyler *et al.*, 2007). *B. linens* was described as a genetically heterogeneous species; based on 16S-23S rDNA restriction patterns, Hoppe-Seyler *et al.* (2007) described four genotypes of brevibacteria strains. Type 2 possesses the same restriction pattern as *Brevibacterium aurantiacum* described by Gavrish *et al.* (2004). The commercial *B. linens* strain SR3 (Danisco-Rhodia, Niebuell, Germany) and *B. linens* ATCC 9174, described as *B. linens* type 2 by Hoppe-Seyler *et al.* (2007) cannot be distinguished from *B. aurantiacum* by ARDRA (XmnI, TaqI patterns), perhaps both strains belong to this new species. The API-Coryne method (BioMérieux, France) is not helpful to identify any food-grade coryneforms, since the database concentrates on species with clinical importance. For brevibacteria and other coryneforms, ARDRA gives reliable results as long as known restriction patterns are obtained. For species identification of unknown electrophoresis patterns, sequencing of the 16S rDNA or FT-IR spectroscopy are good solutions to get a reliable classification.

Yellow coryneforms

Arthrobacter nicotianae was described as a typical component of smear-ripened cheeses, e.g. Tilsit cheese (Bockelmann *et al.*, 1997c). Using the ARDRA method, these yellow coryneforms were divided into two groups, *A. nicotianae* and *Microbacterium barkeri*

(Hoppe-Seyler *et al.*, 2003). The *M. barkeri* isolates of that study (strains CA12, CA15) were later reclassified later as *M. gubbeenense*, a new species first described by Brennan *et al.* (2001). Recent studies indicate that perhaps most or all *A. nicotianae* isolates may belong to the new species of *Arthrobacter arilaitensis* described by Irlinger *et al.* (2005). Other yellow-pigmented coryneforms, which are found on camembert and hard cheese varieties (Table 6.3), belong to *Biachy bacterium alimentarium* and *Biachy bacterium tyrofermentans* strains. TaqI restriction patterns clearly distinguish the *B. alimentarium* patterns (fragment sizes 600/800 bp) from the *M. gubbeenense* or *A. arilaitensis* patterns described by Hoppe-Seyler *et al.* (2003).

Beige coryneforms

Initially, *Corynebacterium ammoniagenes* was described as an essential component of a Tilsit smear flora (Bockelmann *et al.*, 1997c). Later it was found that the isolates belonged to the new species *C. casei* (Brennan *et al.*, 2001). This specie seems to be predominant on many types of smear-ripened cheeses, especially on semi-soft and hard varieties (Bockelmann *et al.*, 2005). In addition, *Corynebacterium variabile* is frequently isolated from the surface of smear cheeses. The species name *Corynebacterium mooreparkense* is no longer used, available strains were reclassified as *C. variabile* (Gelsomino *et al.*, 2005).

6.4 Commercially available secondary cheese starter cultures

6.4.1 Moulds

For mould cheeses, *P. camemberti* and *P. roqueforti* strains are available from commercial starter culture companies; in addition, *G. candidum* is frequently used. The starter cultures are inoculated directly into the cheese milk, or they are sprayed or brushed on the surface of freshly made cheeses. Coryneform bacteria, staphylococci and yeasts are used for the production of smear-ripened cheeses. They can be added to the cheese milk, more frequently, they are inoculated into the smear liquid (i.e. salt water or salt-containing whey solutions), which is used for smearing (i.e. brushing or spraying) of cheeses.

The following information, which was obtained from technical leaflets of starter culture companies, gives a brief summary of the currently available variety of secondary cheese starter cultures. Starter companies have been renamed or restructured extensively in the past few years. Today, companies from Western Europe offering a variety of secondary cheese starter cultures are (in alphabetical order):

- Cargill (www.cargill.com);
- Chr. Hansen (www.chr-hansen.com);
- Danisco A/S (www.danisco.com);
- Sacco srl (www.saccosrl.it).

At present, most secondary starter cultures are not marketed as liquid suspensions any more, but as freeze-dried preparations, which have considerable advantages concerning shipment and shelf life. For most starter cultures, storage at -18°C is recommended with

a shelf life of about 2 years for yeast and bacterial cultures; at 4°C, the maximum storage interval is 2 months.

Penicillium candidum (*camemberti*) is used for the manufacture of soft mould ripened cheeses, such as Camembert and Brie. Strains possess a white colour and are characterised by density of growth and height of mycelium on the surface of the cheese, proteolytic and lipolytic properties and resulting mild-to-aromatic flavour formation. The different strains are able to liberate specific aroma compounds, such as 2-methyl-1-propanol, 3-methyl-1-butanol, 2-methyl-butyric acid, methylketones and secondary alcohols. For some cheeses (acid-curd cheese, goat cheeses), strains with bluish-grey-coloured mycelium are available (trade name *P. camemberti*).

Penicillium roqueforti strains with a green to blue-green appearance are used for blue vein cheeses, such as Bavaria blue, Gorgonzola, Roquefort, Bleu d'Auvergne, Stilton and Petit Bleu. Apart from the appearance, *P. roqueforti* strains are chosen for speed of growth and differences in proteolytic and lipolytic activities. Aroma development ranges from 'mild' to 'very piquant'. For some cheeses, a white variant is available, which produce typical blue cheese aroma without having the blue-green pigments.

Verticillium lecanii and *Penicillium album* are used during the manufacture of special cheeses, such as Tomme (*V. lecanii*) and farmhouse cheeses (*P. album*), with a grey or blue-grey appearance.

G. candidum cultures are frequently used for mould and smear-ripened cheeses. The de-acidification potential of these yeasts stimulates growth of moulds on the cheese surface. *G. candidum* prevents the growth of *P. roqueforti* and excessive growth of *P. camemberti* on the cheese surface and leads to a more uniform mycelium when used for mould cheeses. Special strains with anti-*Mucor* or de-bittering properties are available. *G. candidum* strains can grow yeast-like or mould-like characteristics and are also used for the ripening of smear cheeses, especially soft smeared cheeses. *G. candidum* strains are characterised by proteinase, aminopeptidase and lipolytic activities and their ability to develop typical aroma compounds (methylketones, secondary alcohols, dimethylsulphide and phenylethanol).

6.4.2 Yeasts

D. hansenii is widely used for the ripening of smear cheeses, and it stimulates the growth of smear bacteria, mainly due to de-acidification of the cheeses (lactate degradation). Since yeasts are non-proteolytic, they have a de-bittering effect (aminopeptidase activities). Cultures can be used to replace the endogenous yeasts of the raw milk used for cheesemaking, which are inactivated by pasteurisation of the milk.

Various yeasts, for example, *Kluyveromyces lactis*, *K. marxianus*, *Candida utilis*, *Rhodospiridium infirmominatum*, *Candida colliculosa* and *Saccharomyces cerevisiae* can be used as blends to inoculate pasteurised milk, which mimic the natural yeast flora of raw milk and improve cheese flavour. Other functions of the added yeasts organisms are the neutralisation of the curd (lactate degradation) and galactose consumption.

K. marxianus and *C. krusei* as mixed starter culture is used to inoculate the cheese milk for production of acid curd cheeses. *K. marxianus* contributes to the aromatic properties of acid curd cheeses (fruity, ester flavours), and *C. krusei* contributes to the final aroma of acid

curd cheese (sulphury flavour); interaction of both species is necessary to obtain the typical aroma and texture of acid curd cheeses.

6.4.3 *Brevibacteria*

B. linens (BL) and *B. casei* (BC) belong to the typical surface flora of bacterial smear-ripened cheeses, and they are important aroma producers. Some strains have anti-fungal or anti-listeria effects. The main function of brevibacteria for cheese ripening is the formation of aromatic sulphur compounds, typical for smear-ripened cheeses. They are non-lipolytic and have medium (BC) or high (BL) proteolytic activities. Most *B. linens* strains have bright orange pigments, whilst *B. casei* strains are not pigmented.

6.4.4 *Staphylococci*

S. xylosus and *Staphylococcus carnosus* are used in certain varieties of cheese to optimise the texture and aroma development. They are used as cheese adjuncts starter cultures, or can be brushed or sprayed onto the cheese surface. These strains exhibit medium proteolytic and low lipolytic and aminopeptidase activities.

S. equorum is ubiquitous in cheese brines. It became available as starter culture only recently, and it has similar technological properties as *S. xylosus*, which is used to optimise the texture and aroma development in the cheese. In combination with *D. hansenii*, *S. equorum* supports the growth of other smear-type bacteria when the ripening of the cheese starts, and it has a mould-inhibiting effect (Jaeger *et al.*, 2002). In addition, it can contribute to colour development when pigmented strains are used.

6.4.5 *Coryneforms*

M. gubbeenense and *Arthrobacter* spp. (e.g. *arilaitensis*, *nicotianae* and *globiformis*) are yellow pigmented coryneforms. They contribute to cheese ripening by formation of aromatic sulphur compounds and possess proteolytic and lipolytic activities. For optimum performance, these starter cultures depend on the presence of yeasts and staphylococci on the cheese surface and, under proteolytic conditions, the water-soluble yellow pigments change to red-brown or pink pigments. *C. casei* are beige-pigmented coryneform bacteria and, the recently available commercial starter cultures, are mildly aromatic, grow fast on smear cheeses and protect the surface from mould growth.

6.4.6 *Mixed starter cultures*

Several mixed starter cultures for surface-ripened cheeses are available in the market. They contain coryneform bacteria (e.g. *B. linens*, *Arthrobacter* spp.), de-acidifying yeasts (*D. hansenii*) and staphylococci (*S. xylosus*) with or without the addition of *G. candidum*.

6.5 Surface ripening

6.5.1 Ripening strategies

Recent studies show that cheese brines are an important reservoir not only for yeasts (*D. hansenii*) and staphylococci (*S. equorum*), but also for the coryneforms organisms mentioned elsewhere (Bockelmann *et al.*, 2006). Generally, high concentrations of yeasts and staphylococci (>100 cfu mL⁻¹) and low concentrations of coryneforms (<100 cfu mL⁻¹) are found in the cheese brines. Thus, available secondary cheese starter cultures could already be inoculated into cheese brines, whenever the brine microflora is disturbed, e.g. due to sanitation of the brine. A mould-inhibiting effect of high concentrations of *D. hansenii* and *S. equorum* in cheese brines was demonstrated by Jaeger *et al.* (2002) for Tilsit-like smear cheeses.

Correct handling of smear cheeses during ripening and storage is essential. The ripening temperatures range from 8 to 15°C, and the humidity should be at least 95 g 100 g⁻¹. Some cheese varieties need a warm pre-ripening step at the start of the ripening period. For example, soft cheeses are ripened at 20°C and acid curd cheeses at >30 °C for 1 day. Excessive ventilation should be avoided. The first few days, when the cheese surface is still bare and not covered by the appropriate microflora, are critical for surface-ripened cheeses. *P. camemberti* spores inoculated into the cheese milk or sprayed onto the cheese surface, when grown will cover and protect the surface of the cheeses within few days.

For the ripening of smear cheeses, fast growth of the yeasts along with fast de-acidification of the cheese surface (lactate degradation) enables the acid sensitive smear bacteria to cover the cheese surface completely within days. For large and firm cheese varieties (e.g. Tilsit), the smear is applied using a circular, rotating brush, which is wetted when moving through the smear liquid. The smear liquid is made up of water or whey containing 3–6 g salt 100g⁻¹ to mirror the salinity of the cheeses. Smaller size soft cheeses are treated in a similar way; however, instead of brushing, the cheeses are sprayed. Alternatively, these cheeses can be dry salted with vapours or by manual rubbing the cheeses with salt. Repeated turning of the cheeses on the ripening shelves or racks and repeated surface treatment are most important for ripening.

For Tilsit cheese, a complete smear layer, consisting of yeasts, staphylococci, orange-, yellow- and beige-colour producer coryneforms, is obtained when the count is $\sim 10^9$ cfu cm⁻² and pH 7; typically, reached after 1 week of ripening (Bockelmann *et al.*, 2005). The bacterial counts are usually lower for cheeses having additional yeasts, such as *G. candidum*, *K. marxianus* or *C. krusei* (smear soft cheeses, acid curd cheeses; Bockelmann *et al.*, 2002, 2003). Traditionally, the addition of yeasts and *B. linens* to the smear liquid (i.e. salt water) is recommended by starter culture suppliers to minimise the risk of unwanted microorganisms growing on the cheeses. It is obvious that this does not reflect the composition of the smear cheese surface flora. This strategy is still successful, because the yeasts, staphylococci and smear bacteria are naturally present in cheese brines (Jaeger *et al.*, 2002; Bockelmann *et al.*, 2006). After brining, low concentrations of all-smear microorganisms are present on the cheese surface, which can develop a smear layer within days. The use of diluted brine for smearing is common for some smear cheese producers.

A very efficient way to start smear cheese ripening is the traditional so-called ‘old–young’ smearing technique. The smearing equipment (brushing or spraying) is used to treat mature cheeses first. All surface microorganisms have been transferred from the mature cheese to the smear liquid, when the smearing of young cheeses is started. Cell counts found in the smear liquid after smearing of aged cheeses are high, typically $>10^{10}$ cfu mL⁻¹. Thus, de-acidification and growth of yeasts and bacteria can proceed fast. The main disadvantage of old–young smearing technique is that the undesirable contaminants (e.g. moulds, enterococci, enterobacteria, pseudomonad, *Listeria* spp. etc.), if present, will also grow on the cheeses (Hahn & Hammer, 1990, 1993). Due to the long tradition of producing surface-ripened cheeses, it is known that with good manufacturing practice, these contaminants will not grow to cell counts that would pose a risk to consumers. Even so, product hygiene would be significantly improved if the old–young smearing strategy was avoided and defined surface starter cultures were used.

6.5.2 Yeasts and moulds

Surface ripening of smear cheeses begins with the growth of yeasts, which use lactate and increase the surface pH of the cheese (Eliskases-Lechner & Ginzinger, 1995). *D. hansenii* was found to be the predominant yeast species on the surface of smear cheeses in several studies (Bockelmann *et al.*, 1997c; Wyder & Puhon, 1999). Together with the yeasts, an acid tolerant staphylococci flora (*S. equorum*) is established in the first week of ripening. The pH increase due to the consumption of lactate, and the proteolytic properties and vitamin synthesis of the yeasts (pantothenic acid, niacin, riboflavin) stimulate the growth of the smear bacteria (Purko & Nelson, 1951; Szumski & Cone, 1962). At pH >6 , yellow coryneforms (*M. gubbeenense*), beige coryneforms (*C. casei*) and orange coryneforms (*B. linens*) begin to grow and eventually cover the whole surface of the cheese (Eliskases-Lechner & Ginzinger, 1995; Bockelmann *et al.*, 1997c). Scanning electron microscopy (SEM) shows the presence of yeasts and smear bacteria on the surface of a smear cheese amongst the thermophilic lactic starter bacteria (*Lactobacillus delbrueckii* subsp. *bulgaricus* and *Streptococcus thermophilus*) (Fig. 6.3).

The presence of moulds on the surface of the cheese is undesirable for most varieties of smear-ripened products. An incomplete smear layer permits the growth of, for example, *Penicillium commune* and *Fusarium* spp. (Bockelmann *et al.*, 1997b). The importance of the brine microflora for food safety was demonstrated in a study of Jaeger *et al.* (2002) where they showed that high concentrations of *D. hansenii* and *S. equorum* in the cheese brine inhibited the mould growth on the surface of semi-soft Tilsit cheeses.

The typical white areas of Limburg-type cheeses clearly show the presence of *G. candidum*, which is an essential part of the yeast flora of smeared soft cheeses (Valdes-Stauber *et al.*, 1996; Bockelmann *et al.*, 2003). Acid curd cheeses (yellow type, Harzer Kaese, Quargel) are characterised by two different yeasts growing in the core and on the surface, *K. marxianus* (anamorph: *Candida kefir*) and *Candida krusei* (teleomorph: *Issatchenkia orientalis*). High concentrations of *G. candidum* can also be present on yellow-type acid curd cheese; however, the cheeses still keep the yellowish-brown appearance because of

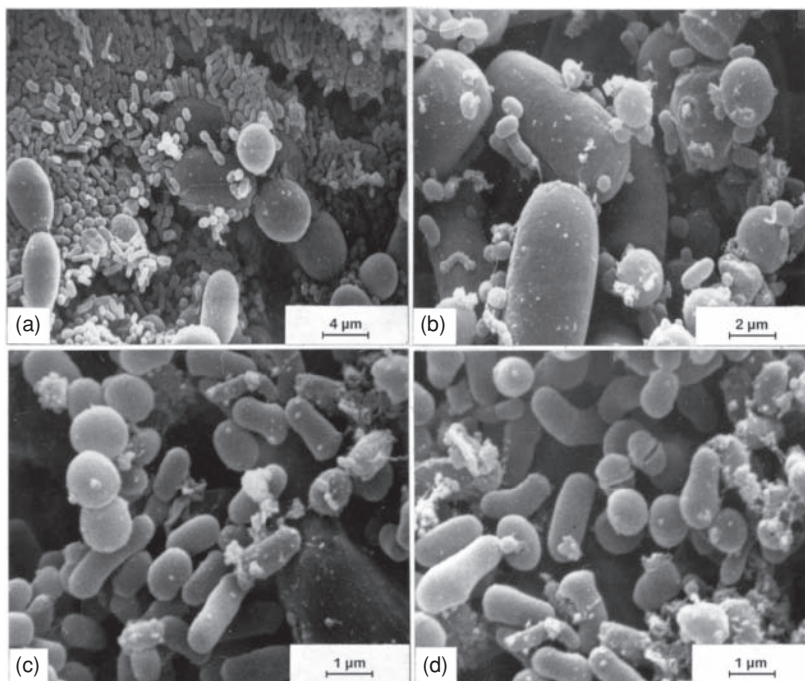

Fig. 6.3 Scanning electron microscopy of the smear of surface-ripened soft cheeses showing round or oval-shaped yeast (a) *Debaromyces hansenii*, rod-like yeast, (b) *Geotrichum candidum*, irregular-shaped rods (coryneforms), straight rods (*Lactobacillus delbrueckii* subsp. *bulgaricus*) and cocci (*Streptococcus thermophilus* or staphylococci); (a, c, d) Romadur cheese from South Germany and (b) soft cheese from France. The bars indicate the different magnifications of the micrographs. (Reproduced by permission of H. Neve, personal communication, and Max Rubner Institute, Kiel.)

high counts of *K. marxianus*, *C. krusei*, smear bacteria and staphylococci. The typical white surface of some acid curd cheese varieties are caused by *G. candidum* or *P. camemberti* (Fig. 6.1o).

Other yeasts identified on various smear cheeses were *Kluyveromyces*, *Rhodotorula minuta*, *Torulasporea delbrueckii* (previously known as *Saccharomyces delbrueckii*), *Trichosporon beigeli* and *Yarrowia lipolytica* (Eliskases-Lechner & Ginzinger, 1995); in some cheeses with low quality, *Y. lipolytica* was identified. In contrast, some studies on foil-ripened Raclette cheese showed a positive effect of *Y. lipolytica* on cheese ripening; however, results were observed in a cheese model system (Wyder & Puhon, 1999). For selected Swiss cheeses, the same authors showed that *D. hansenii* was predominant on the cheese surface. There was no difference between cheeses made from raw or pasteurised milk. Amongst 19 yeast species identified by Rohm *et al.* (1992), *D. hansenii* occurred most frequently, followed by *G. candidum*, *C. krusei* and *K. marxianus*. Several *Candida* species and *Y. lipolytica* were also isolated. Whilst on the surface of Reblochon cheeses, *Candida zeylanoides*, *Candida vini*, and *D. hansenii* were the predominant yeast species. In general, the total yeast counts

are $>10^7$ cfu cm⁻² in the first weeks of ripening, which may drop over several log units in longer ripened semi-hard cheeses.

6.5.3 *Staphylococci*

Staphylococcus spp. are salt- and acid-tolerant microorganisms, which can grow at the early stages of cheese ripening when the pH is still below 6 (Bockelmann *et al.*, 1997c), and they are found in all kinds of surface-ripened cheeses (see Tables 6.2 and 6.3). Like the yeasts, *S. equorum* is found in the cheese brine, sometimes in high cell counts (maximum 10^5 cfu mL⁻¹; Bockelmann *et al.*, 1997c). When the cheese brine is pasteurised frequently to reduce the yeast counts (a practice adopted by many soft cheese producers), no or very low concentrations of staphylococci are present (Bockelmann *et al.*, 2003). Species most frequently observed on smear cheeses are *S. equorum* (natural flora), *S. xylosus* (cultural flora) and the non-food-grade *S. saprophyticus* (natural contamination).

S. equorum and *S. xylosus* – According to Bockelmann *et al.* (2006), *S. equorum* seems to be the typical, naturally occurring species in cheese brines and on most smear cheeses. In a different study, all 150 cocci of a smeared Gouda cheese and a Bergkaese isolated from organic farmhouse cheese producer in Northern Germany were classified as *S. equorum* by ARDRA method (Hoppe-Seyley *et al.*, 2004). This was confirmed when staphylococci, which were isolated from French smeared soft cheeses of three different producers, were identified on species and strain level. The *S. equorum* flora consisted of a variety of strains, typical of a house flora, whereas all *S. xylosus* isolates showed identical DNA restriction patterns in pulsed field gel electrophoresis, which matched the pattern of a commercial *S. xylosus* strain, indicating that this organism was added as a starter culture (W. Bockelmann, unpublished results).

S. saprophyticus is a non-food-grade species, and it is repeatedly isolated from smear-ripened cheeses and the brine in low numbers (Bockelmann *et al.*, 2005). Acid curd cheese (Harzer cheese) seems to be an exception, where *S. saprophyticus* can be predominant in the staphylococcal surface flora and can grow to high counts (e.g. 10^9 cfu cm⁻²) (Bockelmann *et al.*, 2002).

6.5.4 *Smear bacteria (coryneforms)*

Mulder *et al.* (1966) reported that 90% of the microflora of Limburger cheese comprised coryneform bacteria as follows: (a) grey-white bacteria (*Corynebacterium* spp.) formed the dominant group, (b) orange-coloured bacteria (*B. linens*) constituted 9–24% and (c) staphylococci (*S. equorum*) count amounted to 3–6%. These early results have been confirmed by all later studies, which show that coryneforms are essential components of surface-ripened smear cheeses (Seiler, 1986; Eliskases-Lechner & Ginzinger, 1995; Bockelmann *et al.*, 1997c). The total surface counts of smear bacteria including staphylococci are typically $>10^9$ cfu cm⁻² for semi-soft cheese like Tilsit with predominant yeast, *D. hansenii*; whereas cheeses with a more complex yeast flora consisting of *D. hansenii* and *G. candidum* (e.g.

Limburg type) or consisting of *Kluyveromyces marxianus* and *C. krusei* (acid curd cheese) often show lower counts of smear bacteria (Bockelmann *et al.*, 2002, 2003).

Orange coryneforms

B. linens is supposed to be the typical orange-pigmented red-smear bacterium giving the cheeses their characteristic appearance and flavour. A maximum count of 30% was found by Eliskases-Lechner and Ginzinger (1995) for selected Austrian cheeses. Only 1–15% of the surface coryneforms isolated from German Tilsit cheeses were classified as *B. linens* (Bockelmann *et al.*, 1997c). Data shown in Tables 6.2 and 6.3 suggest that the counts of *B. linens* may either be undetectable or grow to high numbers on the surface of ripened cheeses. A direct contribution to orange or red cheese colours at concentrations $<10^9$ cfu cm^{-2} is not likely. Since *B. linens* produces high levels of volatile sulphur compounds (e.g. methanethiol), their rather low presence of the surface flora is probably desirable, limiting the otherwise intense sulphurous smell of cheeses. The production of high amounts of volatile flavour compounds (thiols) by *B. linens* may act against moulds growth (Lewis, 1982; Bloes-Breton & Bergère, 1997). Bacteriocin synthesis by some *B. linens* strains may inhibit pathogens, such as *L. monocytogenes*, on the surface of the cheese (Valdes-Stauber, 1991; Eppert *et al.*, 1997). In contrast to rennet cheeses, the acid curd cheeses (yellow type) often possess a dominant *B. linens* surface microflora with counts of $>10^9$ cfu cm^{-2} (Bockelmann *et al.*, 2002). The proportion of the recently described species of *A. casei*, in the orange coryneform flora is unknown; it seems that *B. linens* is predominant.

Beige coryneforms

On the surface of semi-soft or semi-hard cheeses the beige-coloured coryneforms are usually predominant on mature cheeses and can grow to counts of $>10^9$ cfu cm^{-2} . Recent results showed that *C. casei* is most frequently isolated. Compared to *B. linens*, *C. casei* is only slightly aromatic. Amongst other beige coryneforms, other *Corynebacterium* spp. are frequently isolated (Eliskases-Lechner & Ginzinger, 1995). The main role of the *Corynebacterium* spp. in smear-ripened cheeses seems to be their fast growth, thus protecting the cheese surface from contamination with unwanted microorganisms.

Yellow coryneforms

In the late 1890s, Laxa (1899) described the presence of yellow bacteria on the surface of Brick cheeses. Seiler (1986) isolated yellow coryneform bacteria, and they have since been classified as *Arthrobacter variabilis* and *A. nicotianae*. Eliskases-Lechner and Ginzinger (1995) described the presence of *Arthrobacter globiformis* on the surface of Austrian cheese, whilst Bockelmann *et al.* (1997c) isolated many *Arthrobacter* strains from Tilsit cheese, later classified as *A. nicotianae* and *M. gubbeenense* (Bockelmann *et al.*, 2005). Subsequently, the *A. nicotianae* isolates of the same study were renamed as *A. arilaitensis*, a species recently described by Irlinger *et al.* (2005). Identification of yellow coryneforms from Camembert cheese and hard cheeses (see Tables 6.2 and 6.3) showed the presence of *B. alimentarium*, *B. tyrofermentans* and *M. gubbeenense*. According to Bockelmann *et al.* (2005) and many

unpublished analyses of the Federal Research Centre of Nutrition and Food, Kiel, Germany, *M. gubbeenense* seems to be more abundant on Limburg and other soft cheeses than *A. arilaitensis*. The proportion of *Brachybacterium* spp. of yellow coryneforms on surface-ripened cheese is unclear; they may be more abundant in harder varieties. Yellow coryneforms play a role in colour and aroma development. The yellow pigments are changed to red-brown under the influence of proteolytic bacteria, e.g. *B. linens*. In cheese model systems, single strains of *A. arilaitensis*, *M. gubbeenense* and *B. linens* developed untypical smell but, when grown in co-culture either *A. arilaitensis* or *M. gubbeenense* with *B. linens*, they liberated typical sulphury smear cheese flavour. Furthermore, the mixed cultivation of *M. gubbeenense* and *B. linens* had a growth promoting effect on both species.

6.5.5 Food safety

The microbial quality of raw milk is not easy to maintain. Studies on the microbiological composition of raw milk from selected farms in the Camembert region of Normandy have shown a large percentage of samples to be contaminated with pathogens, apart from the usual non-starter bacteria. *S. aureus* (62%), *Escherichia coli* (80%), *Clostridium perfringens* (100%), *Salmonella* spp. (3%), *L. monocytogenes* (6%), *Yersinia enterocolitica* (36%) and *Campylobacter* spp. (1%) were detected (Desmasures *et al.*, 1997). El-Dairouty *et al.* (1990) demonstrated that, during the growth of *P. roqueforti* in the cheese, most bacterial counts decreased, but *Bacillus cereus* and *S. aureus* survived the whole period of ripening. This shows that the milk quality is of major importance for the manufacture of safe products made from raw milk.

6.5.6 Old–young smearing

Mature cheeses, with a perfect surface flora are an ideal source for smear bacteria and moulds. Traditionally, mature cheeses are brushed or sprayed in freshly cleaned smearing equipment. Smear water dripping off the cheese is recycled and used for treatment of freshly made cheeses. This so-called old–young smearing is criticised, because mature cheeses are rarely ‘perfect’. Apart from sporadically occurring *L. monocytogenes*, the contamination of mature cheeses with enterococci, enterobacteria and pseudomonads is common (Tables 6.2 and 6.3). These three groups of microorganisms are ideal for monitoring the microbial quality of the surface flora of smear-ripened cheeses. Detection of pseudomonads should not only include oxidase-positive species on CFCD agar (Merck, Darmstadt, Germany), but also oxidase-negative species, which can cause severe technological problems, e.g. extensive proteolysis in acid curd cheese is shown in Fig. 6.4. It is obvious that old–young smearing method is a contamination cycle; smear bacteria and yeasts as well as undesirable contaminants are transferred to young cheeses and are established in a cheese plant. Hahn and Hammer (1993) reported the sanitation of a Tilsit cheese production line by using a Hazard Analysis Critical Control Point (HACCP) system. Old–young smearing was determined to be the main factor responsible for the spreading of the non-pathogenic *Listeria innocua*. By a strict separation of smear machines for old and young cheeses, *Listeria* counts were significantly reduced.

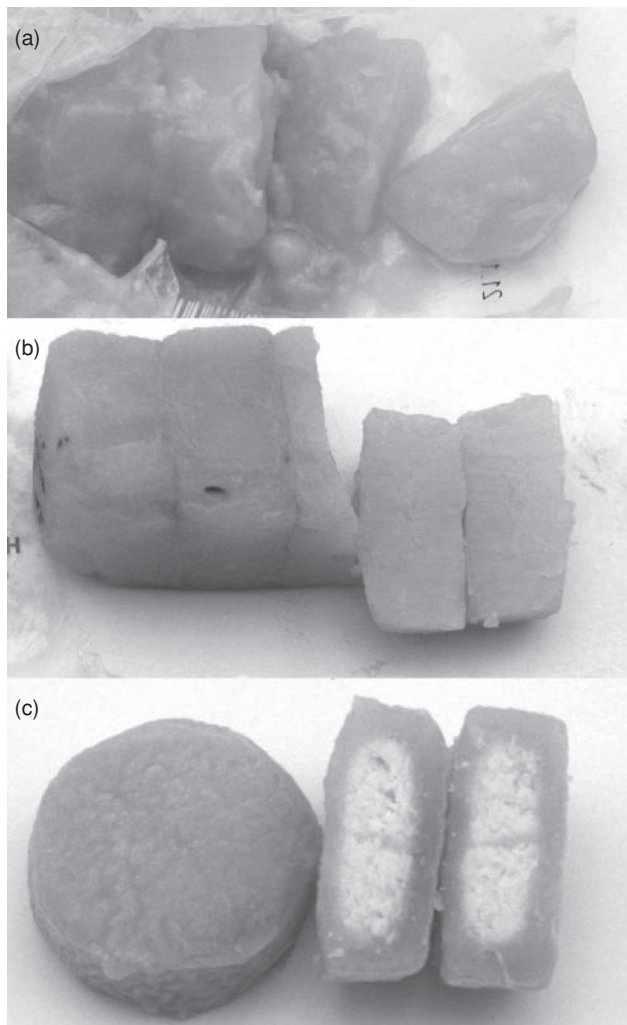

Fig. 6.4 Typical illustration of acid curd cheese (yellow type). (a) 4-week-old mature cheese suffering from a severe contamination with oxidase-negative pseudomonads ($>10^8$ cfu cm^{-2}) in addition to the 'normal' contamination with enterobacteria and enterococci, (b) 4-week-old mature cheese with an elastic texture, homogenous yellow-beige colour and a wet-sticky surface and (c) 2-week-old cheese still showing a crumbly, white 'Quarg-like' core and a dry-sticky yellow-beige surface.

For acid curd cheese, a different old–young cycle exists. The short ripening time of 1–3 days before packaging makes it necessary to add 2–4 g 100 g^{-1} 'mature' acid curd cheese to the Quarg paste (together with different salts) before moulding. This mature acid curd cheese is a special batch of a ripened product over 10–14 days, and it is known as 'culture-cheese' (Kulturkaese). For ripening of this batch, it is the normal practice to mix with another mature batch of culture cheese; hence, a contamination cycle is created. This has been the traditional practice, which explains the permanent level of bacterial contamination of acid curd cheeses with enterococci, enterobacteria, pseudomonads and *S. saprophyticus*.

6.5.7 *L. monocytogenes*

Many reports have been published on the occurrence of the pathogenic *L. monocytogenes* on the surface of smear-ripened cheeses. A review on the occurrence of listeria spp. in foods was published by Steinmeyer and Terplan (1996). Terplan *et al.* (1986) detected *L. monocytogenes* in 7% of 420 selected cheese samples from various European countries. Similar results were found by Canillac and Mourey (1993) and Brisabois *et al.* (1997). Pintado *et al.* (2005) found 46% of soft cheeses produced from raw sheep's milk were contaminated with *L. monocytogenes*. Noterman *et al.* (1998) showed that humans were frequently exposed to listeria and that almost all *L. monocytogenes* serovars in foods had virulent properties. However, food poisoning with *L. monocytogenes* is still a rare event because the intestinal barrier and specific immune defence mechanisms are highly effective in preventing infection (Noterman *et al.*, 1998).

Listeria are mainly found on surface-ripened soft and semi-soft cheeses, irrespective of the type of milk used (raw or pasteurised), which demonstrates that the milk may not be the main source of *L. monocytogenes* contamination (Terplan *et al.*, 1986). Studies on thermo-tolerance revealed that only small populations of *L. monocytogenes* were able to survive pasteurisation (Rowan & Anderson, 1998). However, with high initial levels of *L. monocytogenes* in raw milk before pasteurisation, the surviving pathogens may grow to high cell counts during the ripening and storage of soft cheeses, such as Camembert and Feta cheeses (Ramsaran *et al.*, 1998). This effect is more pronounced at the cheese surface, because the rapid increase in the surface pH of smear cheeses favours the growth of *L. monocytogenes*, which resides in ecological niches in cheese factories. The use of nisin could prevent the growth of listeria during cold storage, but initial cell counts were not reduced (Ramsaran *et al.*, 1998).

Smearing machines were found to be an important source of listeria contamination (Hahn & Hammer, 1993). The difficulty in disinfecting the ripening rooms and machinery to remove listeria from the cheese environment was detailed by Arizcun *et al.* (1998); they showed that *L. monocytogenes* grows in biofilms, which leads to a high resistance against antimicrobial agents and disinfectants. However, Ennahar *et al.* (1994) showed that irradiation of heavily contaminated cheeses totally eliminated *L. monocytogenes* without noticeable modifications of the organoleptic properties of the product. The elimination of pathogens in food by low-dose irradiation was reviewed by Radomyski *et al.* (1994). Zapico *et al.* (1998) used the combined effect of nisin and the lactoperoxidase system to reduce *L. monocytogenes* counts by up to 5.6 log₁₀ units mL⁻¹ milk.

6.5.8 Mould spoilage

The quality of surface-ripened cheeses can be severely affected by fungal contaminants. In a study of hard, semi-hard and semi-soft cheeses (mainly from Denmark, France, Greece and the United Kingdom), 371 fungal isolates were identified, of which 91% were *Penicillium* spp. (Lund *et al.*, 1995); *P. commune* occurred most frequently (42%) and was the most widespread. Most of the isolates (88%) found on the surface of the cheeses belonged to the following species: *P. commune*, *P. nalgiovense*, *P. verrucosum*, *P. solitum*, *P. roqueforti*,

Aspergillus versicolor, *P. crustosum*, *P. atramentosum*, *P. chrysogenum* and *P. echinulatum*. Some mould species show a consistent ability to produce mycotoxins – *P. commune* produced cyclopiazonic acid, *P. verrucosum* produced ochratoxin A, *A. versicolor* produced sterigmatocystin and *P. crustosum* produced penitrem A and roquefortine C (Lund *et al.*, 1995).

Fungal starter cultures, such as *P. camemberti*, *P. nalgiovense*, *P. roqueforti* and *Geotrichum candidum*, were tested for inhibitory effects on growth and secondary metabolite production of fungal contaminants (*P. commune*, *P. caseifulvum*, *P. verrucosum*, *P. discolor*, *P. solitor*, *P. coprophilum* and *Aspergillus versicolor*). Only *G. candidum* inhibited the growth of spoilage fungi on Camembert cheese. Secondary metabolite production by fungal contaminants was unchanged on cheese (Nielsen *et al.*, 1998). According to claims of starter cultures suppliers, antifungal properties can also be found in *Penicillium* starter cultures. For example, *P. camemberti* used for cheesemaking was reported to be a new source of brefeldin A, a macrolide antibiotic with antifungal, antiviral, antimitotic and antineoplastic properties (Abraham & Arfmann, 1992).

The only toxic metabolite known to be produced *in vitro* by *P. camemberti* is cyclopiazonic acid. *P. roqueforti* produces a much greater number of toxic metabolites *in vitro*, notably patulin, penicillic acid, PR toxin, mycophenolic acid, roquefortine and isofumigaclavine A and B. All of these toxins have occasionally been detected in commercial cheeses, but there is little risk to human health as they are present in cheeses at very low concentrations (e.g. $\mu\text{g g}^{-1}$ or mg kg^{-1}) and are only slightly toxic and not carcinogenic (Engel *et al.*, 1989; Siemens & Zawistowski, 1996). Results of Boysen *et al.* (1996) suggest that *P. roqueforti* should be reclassified into three species on the basis of molecular genetic and biochemical profiles: (a) *P. roqueforti* produces PR toxin, marcfortine and fumigaclavine A, (b) *P. carneum* synthesises patulin, penitrem A and mycophenolic acid amongst other secondary metabolites and (c) *P. paneum* produces patulin and botryodiploidin, amongst other secondary metabolites. These results demonstrate the importance of a thorough classification of fungal isolates used for food processing. This is still mainly performed by morphological analysis, but should be extended to molecular methods to confirm the identity of isolates and their mycotoxins synthesised. Strategies for safe use of fungi and fungal derivatives in food processing and the main factors leading to the development of mycotoxins were reviewed by LeBars and Le Bars (1998).

6.5.9 *Anti-listeria starter cultures*

According to Laporte *et al.* (1992), the presence of *P. roqueforti*, especially the strains that possess high proteolytic and lipolytic activities, tends to inhibit the survival of pathogenic microorganisms, such as *E. coli* and *S. aureus*. Some fungal metabolites in mould-ripened cheeses were reported to contain natural listeria inhibitors (Kinderlerer *et al.*, 1995). *G. candidum* produces two components, D-3-phenyllactic acid and D-D-3-indollic acid, which can inhibit *L. monocytogenes* (Dieuleveux *et al.*, 1998).

There is a widespread interest in the effect of bacteriocins of *B. linens* and other smear bacteria on the survival of *L. monocytogenes*. Bacteriocins of *B. linens* have been purified and characterised, and their mode of action was studied extensively (Valdes-Stauber & Scherer, 1994; Martin *et al.*, 1995; Siswanto *et al.*, 1996; Boucabeille *et al.*, 1997, 1998). A rather limited importance of these bacteriocins was attributed by Eppert *et al.* (1997), who found

that the action of bacteriocins of *B. linens* was insufficient to explain the almost complete inhibition of listeria caused by some undefined microbial flora derived from the surface of smear-ripened cheeses. Valdes-Stauber *et al.* (1996) analysed the nucleotide sequence and taxonomical distribution of linocin M18 from *B. linens*. Using PCR amplification, they were able to demonstrate that the structural gene from linocin M18 was present in three *Brevibacterium* spp., five *Arthrobacter* spp., and five *Corynebacterium* spp. Antagonistic effects against listeria were also described for *G. candidum* (Dieuleveux *et al.*, 1998), *Enterococcus faecalis*, *Enterococcus faecium*, *S. xylosus*, *Staphylococcus warneri* and coryneform bacteria (Ryser *et al.*, 1994; Giraffa *et al.*, 1995). An effect of the inhibitory substances was also observed on *S. aureus* (Richard, 1993).

A perhaps better source for anti-listeria activity than *B. linens* may be staphylococci or yeasts, which are the first microorganisms to grow on the surface of smear-ripened cheeses because they are acid tolerant and salt tolerant. *S. equorum* strain (WS2733) was first reported by Carnio *et al.* (2000) that possess anti-listeria activity. The strain synthesised the macrocyclic peptide antibiotic micrococcin P₁, which was effective against *L. monocytogenes*. The strain could not be used as a 'protective' starter culture for surface-ripened cheeses because the smear bacteria were also inhibited by micrococcin P₁. In a German research project on anti-listeria cultures (FEI project, FV14786, 2006–2008), the inhibitory agent produced by *S. equorum* strain was isolated, which inhibited *L. monocytogenes* in cheese model systems, but left the smear bacteria unaffected (Bockelmann *et al.*, 2006). Further studies will show the usefulness of the strain selection as a protective starter culture.

Four anti-listeria starter cultures are commercially available and consist of different lactic acid bacteria or *Listeria* phages. Two starter cultures, developed for meat and sausage, had a small inhibiting effect in a cheese model; *L. monocytogenes* counts were reduced by 2–3 log₁₀ units g⁻¹; one culture consisted of *Lactobacillus curvatus*, whilst the other was a mixture of *Pediococcus acidilactici*, *Staphylococcus carnosus* and *S. xylosus* (Bockelmann, unpublished data). Another commercial protective starter culture consisted of *Lactobacillus plantarum*. According to Loessner *et al.* (2003), this strain produced a pediocin that was effective against *L. monocytogenes*. The same authors also reported that no growth or in situ production of pediocin was necessary for *Listeria* inhibition, when the *L. plantarum* count was ~10⁷ cfu cm⁻². In the FEI project mentioned elsewhere, the anti-listeria activity on the cheese surfaces was confirmed. Another commercial protective starter culture is based on *L. monocytogenes* phages (Hagens & Loessner, 2007). The phage preparation was tested on Munster cheeses (Schellekens *et al.*, 2007), where it was found to reduce *L. monocytogenes* counts by at least 3.5 log₁₀ units g⁻¹. Results were also confirmed in the FEI project; at a phage concentration of >10⁷ cfu cm⁻², the reduction of *L. monocytogenes* counts was around 7 log₁₀ units cm⁻² in a cheese model and similarly efficient when used for the ripening of Limburg cheese.

6.6 Development of defined surface starter cultures

For mould cheeses, well-characterised sets of fungal starter cultures have been available in the market for a long time. In the past few years, more smear bacteria and yeasts have become commercially available. Recently introduced in the market are two starter cultures,

firstly, *S. equorum* for all kinds of smear-ripened cheeses, and secondly, a mixed yeast culture consisting of *K. marxianus* and *C. krusei* for ripening of acid curd cheeses (see Section 6.4.2). Several research projects were dedicated to the development of surface starter cultures for smear cheeses (EU CT98–4220, semi-soft cheeses, 1999–2000; FEI FV12780, soft cheeses, 2001–2003; FEI FV13018, acid curd cheeses, 2001–2003). In these projects, the minimum starter culture composition for different types of cheeses was defined, with the natural flora composition as the basis. In a Demonstration Project funded by the EU (CT02–02461, 2003–2005), it was shown for semi-soft and semi-hard cheeses that the concept of defined starter cultures was functional; the selected cheese varieties of two industrial partners, smeared with different defined starters and kept their typical appearance and aroma.

6.6.1 Surface starter cultures for semi-soft cheeses

Based on the typical composition of the surface flora of commercial Tilsit cheese, a defined surface starter culture consisting of five species was proposed after a large number of laboratory- and pilot-scale cheese trials were conducted. The starter cultures consisted of *D. hansenii*, *S. equorum*, *B. linens*, *M. gubbeenense* and/or *A. arilaitensis* and *C. casei* (Bockelmann *et al.*, 1997b, 2000). The minimum concentration of the total bacterial count in the smear solution was 10^7 cfu mL⁻¹ (Bockelmann *et al.*, 2005). Experimental cheeses were smeared once or twice in the first week of ripening, which allowed a de-acidification almost as fast as the old–young smeared control cheeses (Fig. 6.5a). The surface pH of 7.0 was achieved after one week, and the total bacterial count was $\sim 10^9$ cfu cm⁻², which was sufficient to protect the surface of the cheese from mould contamination. The surface microflora of the experimental cheeses, produced on pilot-scale and smeared with the defined starter culture mentioned above, resembled the old–young smeared control cheeses after 8 weeks of ripening, and the starter culture strains were detected on the cheese by pulsed field gel electrophoresis (Bockelmann *et al.*, 2007).

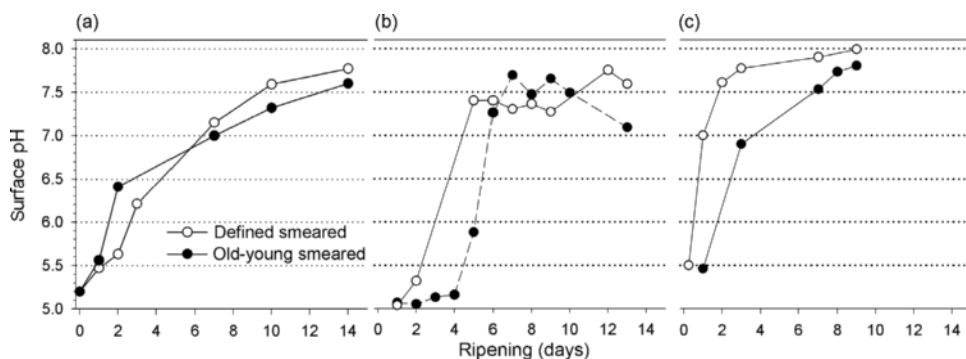

Fig. 6.5 Ripening of smear cheeses. Note: The de-acidification (i.e. smear development) of experimental (hollow symbols) defined-smear Tilsit (a), Limburg cheese (b) and acid curd cheese (c) was compared to old–young smeared commercial cheeses (filled symbols). Experimental cheeses were smeared with appropriate starter cultures described in the text. In addition, the starter cultures were added to the brine, and the pH values were taken with a flat-surface electrode.

The functionality of this five strain ripening starter culture was examined in an EU demo project (CT02–02461). Cheese trials on a laboratory-scale showed clearly that the cheese body itself contributed significantly to the typical aroma of the final product. In the same project, freshly made cheeses (Cave cheese, Klovborg, Caractère) at the industrial partners' production site were collected and transported to the research laboratory for the ripening experiments. All the industrial partners concluded that the three examined smear cheese varieties kept their typical different aromas in spite of using nearly the same defined surface starter cultures. An exception was *B. linens*, for one cheese type, the strain selection was critical (Bockelmann, unpublished data).

6.6.2 Surface starter cultures for smeared soft cheeses

The typical surface starter culture described above for the manufacture of Tilsit cheese proved to be not suitable for Limburg cheese ripening because of slow de-acidification and untypical appearance and aroma development (Bockelmann *et al.*, 2003). The presence of a second yeast, *G. candidum*, in the cheese milk (10^2 cfu mL⁻¹) and the resulting concentrations on the cheese surface, was essential for typical Limburg cheese ripening. Since no commercial starter cultures are used by cheese companies, *G. candidum* obviously belongs to the typical house microflora of soft cheese producers. Screening of *G. candidum* strains showed large differences between them regarding visual properties (white areas on the cheeses) and also the development of volatile flavour, which resembled *B. linens* (Bockelmann *et al.*, 2003).

In contrast to old–young smeared Tilsit-type cheeses, the de-acidification of the surface of commercial Limburg cheeses showed a long lag phase (Fig. 6.5 – filled symbols). It was found that soft cheese producers have to sterilise the brine on regular basis to reduce the high counts of *D. hansenii*, which then grew to a high counts on the cheese surface (personal communication of German soft-cheese producers). Because of the beneficial effect of high concentrations of yeasts and staphylococci on Tilsit cheese ripening, the cheese brines for experimental soft cheese trials were inoculated with *D. hansenii* and *S. equorum* at a level $\sim 10^4$ cfu mL⁻¹. As shown in Fig. 6.5 (hollow symbols), hardly any delay of de-acidification was observed. Even the un-smeared Limburg cheeses (i.e. control) were inoculated with *G. candidum*, *D. hansenii* and *S. equorum* via the cheese milk and brine showed normal de-acidification, but no typical colour and aroma development (Bockelmann *et al.*, 2003).

Starter culture development for soft cheeses concentrated on yellow pigmented bacteria (*M. gubbeenense*, *A. arilaitensis*), which were shown to produce a typical smear cheese flavour and colour in combination with *B. linens* and were found to be predominant on some commercial soft cheeses (Bockelmann *et al.*, 1997b, 1997c, 2003). A complete surface starter culture for smeared soft cheeses was proposed by Bockelmann *et al.* (2003), i.e. consist of *D. hansenii*, *G. candidum*, *S. equorum*, *B. linens*, *M. gubbeenense* or *A. arilaitensis*. *C. casei* could be used, but was found not essential for typical aroma development. Yeasts and staphylococci were inoculated into the cheese brine (approximately >100 cfu mL⁻¹), and the counts of the smear bacteria were adjusted to $>10^7$ cfu mL⁻¹ in the smear liquid. The bacterial surface cell counts after 1 week of ripening were lower compared to experimental semi-soft Tilsit cheeses, where 10^9 cfu cm⁻² are expected. However, the values were similar to the cell counts found on commercial Limburg cheeses (Bockelmann *et al.*, 2003). This

may be due to fast growth of *G. candidum* and *D. hansenii* on Limburg cheeses in the first week of ripening. After 2 weeks, the fully developed smear microflora had maximum cell counts of $\sim 10^9$ cfu cm⁻², which was evident (see also Goerges *et al.*, 2008).

6.6.3 Starter cultures for acid curd cheeses (yellow type)

Acid curd cheese (e.g. Quarg) is produced from skimmed milk mainly in Northern Germany, using thermophilic lactic acid bacteria (*L. delbrueckii* subsp. *bulgaricus* and *S. thermophilus*) (Bockelmann *et al.*, 2002). Acid curd cheeses are produced by different dairy companies in other German and European regions with ripening times of 1–3 days before packaging. This traditional separation of Quarg and cheese production is an advantage, if not a prerequisite, for the successful very short acid curd cheese ripening, because it adds an anaerobic ripening interval to the process. For example, farm house acid curd is produced under limited hygiene standards and, as a consequence, the product is usually contaminated/contains yeast flora, such as *K. marxianus* and *C. krusei* as the main dominating species (Bockelmann *et al.*, 2002). During distribution and storage, the farm house acid curd cheese tends to exhibit rapid development of the yeast microflora, which occurs under anaerobic conditions, i.e. $\sim 10^7$ cfu g⁻¹ after 5–7 days, accompanied with strong aroma development (Bockelmann *et al.*, 2002). The importance of this type of Quarg ripening step is visualised by (SEM); a close association between the yeasts and lactic acid bacteria is quite typical for ripened acid curd (Fig. 6.6a). After 1 day of ripening, the cheese surface is already covered by a slimy substance, which gives the cheeses protection from mould contamination (Fig. 6.6b) (Bockelmann *et al.*, 2002). This considerable amount of mucous substance produced by the yeasts in the core (Fig. 6.6c) and on the surface of the cheese probably contributes to the very elastic texture of ripened acid curd cheeses. The slime production is probably due to metabolic activities of *K. marxianus*, which shows clumping in shake liquid starter culture (Bockelmann, unpublished data). Ripening of acid curd cheeses is visible by conversion of the white, crumbly Quarg mass to a yellow-brown cheese starting at the surface, with a smooth and elastic texture in the mature product.

Using defined starter cultures, it was possible to produce acid curd cheeses without applying the traditional old–young contamination cycle (see Section 6.5.5). The first step was the dosage rate of *K. marxianus* and *C. krusei* (100 cfu mL⁻¹) to the milk used for acid curd production. Seasonal differences of the in-house yeast microflora are thereby avoided. A second application of yeasts can be done via the smear liquid (10⁶ cfu mL⁻¹), but it was not essential. Anaerobic ripening of the acid curd is necessary to obtain high yeast counts. Traditional acid curd cheeses are usually contaminated with *S. saprophyticus*, which may have a technological importance, e.g. for texture development (see Section 6.4.4) (Bockelmann *et al.*, 2002). The addition of food-grade *S. equorum* (10⁷ cfu g⁻¹) to the mixer of the acid curd and ripening salts before moulding simulated the presence of *S. saprophyticus* on commercial acid curd cheeses and suppressed the naturally occurring contaminants (Table 6.3; Bockelmann *et al.*, 2002).

As for all other smear cheeses, de-acidification of the cheese surface is essential for ripening to allow the development of a smear flora. The surface pH of acid curd cheese reaches pH 7 approximately after 1 week. When experimental cheeses were produced from

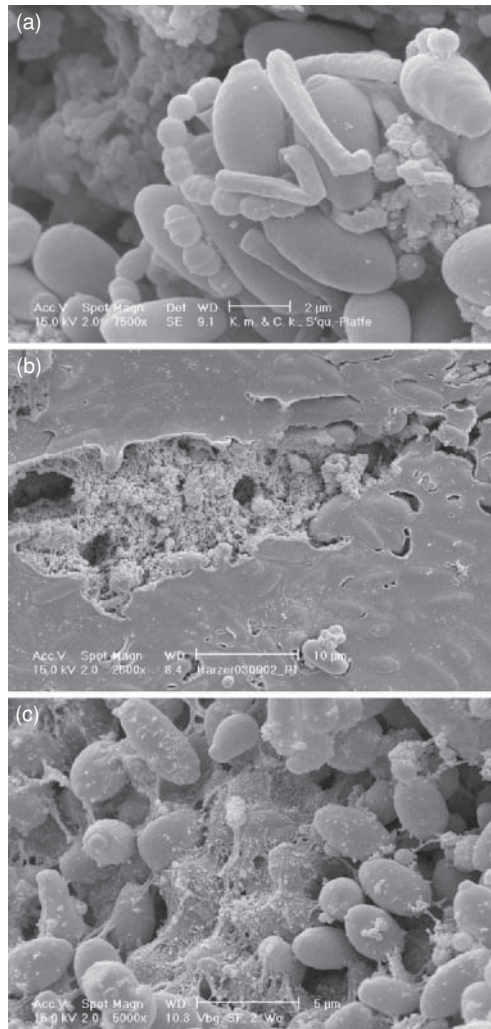

Fig. 6.6 Scanning electron microscopy of acid curd cheese. (a) Aggregates of yeast (*Kluyveromyces marxianus*, *Candida krusei*) and lactic acid bacteria (*Lactobacillus delbrueckii* subsp. *bulgaricus* and *Streptococcus thermophilus*) frequently found in ripened acid curd. The association may be due to galactose consumption of *K. marxianus* excreted by lactic acid bacteria. (b) View of the surface of a young acid curd cheese covered by a slimy substance (probably excreted by yeast) showing embedded yeast cells. (c) View into the core of a mature acid curd cheese with yeast cells in a maze of excreted mucous material, explaining the very elastic texture of acid curd cheeses. (Reproduced by permission of H. Neve, personal communication, and Max Rubner Institute, Kiel.)

ripened Quarg (i.e. stored for about 7 days), it was found that the presence of coryneform bacteria was not necessary for de-acidification; however, the presence of *S. equorum* had a beneficial effect (Bockelmann *et al.*, 2002).

In addition, the smell and taste of experimental cheeses ripened with just *K. marxianus*, *C. krusei* and *S. equorum* was quite typical with yeasty, alcoholic, ester fruity notes and with a slight sulphury (smear) flavour. Studies on Quarg cheese model systems showed that

C. krusei produced smear cheese-like (*B. linens* – like) flavour compounds, and *K. marxianus* developed alcoholic and very strong ester notes (glue-like). In co-culture (*K. marxianus* and *C. krusei*), a quite typical, mild acid curd cheese aroma was formed (Bockelmann *et al.*, 2002). When the surface of the experimental cheeses was sprayed with *B. linens*, the de-acidification of the cheese surface was fast, and the cheese developed a typical stronger sulphury smear cheese flavour. Thus, a secondary starter culture for acid curd cheese should consist of *K. marxianus*, *C. krusei*, *S. equorum* and *B. linens*, and applied at different points of production and ripening. *Corynebacterium* species (e.g. *C. casei*, *C. variabile*) can be used; their effect on ripening is unclear and not well established.

6.6.4 Colour development

The development of orange, red or brown colour on the surface of the smear-ripened cheeses can be caused by orange-pigmented *B. linens* or *S. equorum*, if the surface total viable count exceeds 10^9 cfu cm⁻², which may happen in acid curd cheeses, but rarely for other smear cheeses. The pigments of yellow coryneforms are more likely to contribute to cheese colour. It was shown that these pigments were water soluble, and tended to change to red-brown colour under the influence of proteolysis products. This effect could be demonstrated in cheese model systems, with the addition of either *B. linens* or casein hydrolysate to the secondary starter cultures of *M. gubbeenense* or *A. arilaitensis* (Bockelmann *et al.*, 1997a, b). Reversed phase (C18) HPLC analysis revealed several yellow and pink components (Bockelmann *et al.*, 1997a). It can be imagined that with combinations of yellow and pink colourants, orange, red and/or pink surface colours can be developed, as it is the case for colour inkjet printers equipped with yellow and magenta inks. It can be speculated that the pink areas of the Tilsit cheese shown in Fig. 6.1 and Table 6.2 were caused by high counts of *M. gubbeenense* and *B. linens*. The surface of the cheese was quite smeary, indicating strong proteolysis. In comparison, the German Limburg cheese showed high and low counts of *M. gubbeenense* and *B. linens*, respectively, resulting in an orange colour (see Fig. 6.1 and Table 6.2). The mechanisms of colour development are not well understood, but may contribute to cheese defects, such as brown and pink discolouration (Pelaez & Northholt, 1988; Asperger *et al.*, 1990).

6.6.5 Application of defined starter cultures

Naturally, specific microorganisms are applied via smearing or spraying the surface of the cheeses; the recommended cell counts of the yeasts and bacteria in the smearing solution are 10^6 cfu mL⁻¹ (minimum) and 10^7 cfu mL⁻¹, respectively. In addition, the brine microflora should be taken into consideration too. Intact cheese brines may have a microflora of yeasts and staphylococci (>100 cfu mL⁻¹) as well as coryneforms (10 – 100 cfu mL⁻¹) and have a beneficial effect on ripening of the cheese (Jaeger *et al.*, 2002; Bockelmann *et al.*, 2006). To achieve the desirable microflora in a freshly prepared brine, secondary starter cultures are added. In the cheese milk, a suitable *G. candidum* strain should be present for Limburg-type soft cheeses, and *K. marxianus* and *C. krusei* (100 cfu mL⁻¹) should be present for acid curd

cheeses. For the latter type cheese, *S. equorum* (10^6 cfu g^{-1}) should be added to the mixer where the Quarg and salt are mixed.

Treatment of cheeses with secondary starter cultures is much more expensive when compared to the old–young smearing method (i.e. no cost). In addition, defined smear-ripened cheeses need more care, probably shorter smearing intervals. However, secondary starter cultures are an ideal tool to minimise the growth of undesirable microorganisms on the surface of the cheese. Results of the pilot-scale cheese trials in the frame of EU projects showed that cheese varieties of industrial partners kept their typical aromatic and visual properties, accompanied with no detectable bacterial or fungal contamination. Strain selection seems to be critical for *B. linens* and *G. candidum*, and there are many strains to choose from the commercially available species.

It is worth mentioning that this chapter summarises the current research on smear starter cultures, which are not well represented on the starter culture market. For mould-ripened cheeses, many fungal strains are already available with very different optical and aromatic properties. Addition of smear starter cultures to mould cheeses produced from pasteurised milk could probably increase the aroma intensity of the product.

6.7 Proteolysis and lipolysis

The effects of rennet, starter bacteria and mould flora were studied by comparing the ripening of Camembert cheese with rennet-free and starter-free experimental cheeses (Takafuji & Charalambous, 1993). The effect of mould proteinases was marked by the degradation of β -casein, when the levels of mould proteinases activity increased after more than 2 weeks of ripening. The further breakdown of large peptides to small peptides and amino acids was attributed to the proteolytic activity of LAB (Law & Haandrikman, 1997). In Camembert cheese, α_{S1} -casein was degraded first by chymosin; as the content of the extracellular fungal proteinases increased within the first 10 days of ripening, degradation products of α - and β -casein were detected. The changes proceeded from the surface to the centre of cheeses, and the most abundant amino acids were glutamic acid, serine and proline (Iwasawa *et al.*, 1996).

In contrast to LAB, *P. camemberti* and *P. roqueforti* possess several extracellular proteolytic enzymes, a metalloproteinase (Gripon *et al.*, 1980) and an aspartic proteinase with a preference for hydrophobic and aromatic amino acid residues (Chrzanowska *et al.*, 1993, 1995). Extracellular carboxypeptidase activity is also present in *P. camemberti*, which cleaves peptides with aromatic acids in the C-terminal position (Auberger *et al.*, 1995). Due to the extracellular location, these enzymes contribute to cheese ripening by liberation of amino acids. They also have specificities, which give a de-bittering effect during cheese ripening. An intracellular prolyl aminopeptidase from *P. camemberti* has been purified and characterised (Fuke & Matsuoka, 1993); in addition, an aminopeptidase from *P. camemberti* has also been purified, which cleaves a wide range of substrates and is able to de-bitter the bitter peptide fraction from a peptic digest of casein (Matsuoka *et al.*, 1991). An extracellular carboxypeptidase and aminopeptidases with similar specificities were purified from *G. candidum* (Auberger *et al.*, 1997).

Apart from LAB, proteolytic enzymes of smear bacteria (mainly *B. linens*) were well studied (Ratray & Fox, 1999). Extracellular serine proteinases have been purified and

characterised from several strains of *B. linens* (Juhasz & Skarka, 1990; Rattray *et al.*, 1995). The cleavage specificity was determined for β - and α -casein (Rattray *et al.*, 1996). From several strains of *B. linens*, intracellular aminopeptidases were purified (Hayashi & Law, 1989). Analysis of casein breakdown in Tilsit cheeses revealed only a small additional effect of the surface flora, visible only at the surface (0–0.5 cm deep). However, the amount of low-molecular-weight peptides was markedly increased (Bockelmann *et al.*, 1998), and the authors concluded that the metabolism of peptides, and probably amino acids, liberated by all cheese bacteria was more important for the intense aroma of smear-ripened cheeses than additional casein degradation. Hayashi *et al.* (1990) partially purified proteinase and aminopeptidase preparations from *B. linens* and used them for Cheddar cheese ripening; the proteinase accelerated cheese ripening without causing bitterness. A combination of the aminopeptidase of *B. linens* and a commercial Neutrase[®] preparation resulted in a product that had a better score for flavour in sensory analysis of Cheddar cheese than the control cheese. It was concluded that both enzymes were promising for accelerating the cheese ripening. However, the effect observed might have been caused by other enzymes present in the partially purified preparation, e.g. amino acid converting enzymes, such as the L-methionine- γ -lyase, which liberates highly aromatic aroma compounds (Dias & Weimer, 1998).

Amino acid conversion in cheeses was reviewed by Hemme *et al.* (1982). In blue vein cheeses and Camembert, citrulline and ornithine are formed by conversion of arginine, glutamic acid is decarboxylated to γ -aminobutyric acid, and tyramine, histamine and tryptamine are formed by decarboxylation of amino acids. The presence of *B. linens* on the cheese surfaces could be beneficial, since these bacteria have been shown to possess deaminases, which metabolise biogenic amines (Leuschner & Hammes, 1998).

Esterases have been purified and characterised from *B. linens* by Lambrechts *et al.* (1995), and the effects of deaminases have been shown by Leuschner and Hammes (1998). During the ripening of Muenster cheese with supplementation of *B. linens*, the levels of added histamine and tyramine were reduced to less than 50% of the initial concentrations, indicating that the surface flora may have a beneficial effect in reducing biogenic amines.

Lipids are hydrolysed extensively in mould-ripened cheeses; 5–20% of triglycerides are degraded, depending on the type and age of cheese (Gripon, 1993). Lipolysis in Gorgonzola cheese was studied by Contarini and Toppino (1995). *P. camemberti* possesses an extracellular lipase, with an alkaline pH optimum (Alhir *et al.*, 1990), which is produced together with mycelial growth after several days of ripening. *P. roqueforti* possesses two lipases, one with an acidic and the other with an alkaline pH optimum (Gripon, 1993); the specificities of these two enzymes were found to be different in vitro, the alkaline lipase was shown to be more active on milk fat. The presence of these two lipases in *P. roqueforti* may suggest the obvious differences in the aroma of mould and blue vein ripened cheeses.

6.8 Aroma

The microflora of surface-ripened cheeses is more diverse when raw milk is used. In some countries, such as France, raw milk cheeses have a long tradition, and consumers appreciate the stronger taste of these cheese varieties. The majority of mould-ripened cheeses in Europe is produced from pasteurised milk, which helps to ensure a high level of food safety, but

leads to less intense aroma, which suits the majority of consumers, who seem to prefer mild products.

Muir *et al.* (1995) devised a protocol for characterising the aroma profile of hard and semi-hard cheeses. A modest number of attributes was found to describe the key characteristics of the cheese aroma, flavour and texture. All samples were adequately described in terms of nine aroma descriptors: overall intensity, creamy/milky, sulphurous/eggy, fruity/sweet, rancid, cowy/unclean, acidic, musty and pungent. By statistical analysis, it was shown that the descriptors (*aroma overall, intensity, musty, pungent* and *fruity*) were the most meaningful and clearly separated the blue vein cheeses (Danablu, Stilton and Gorgonzola) from the rest of the cheeses. White mould-ripened cheeses were not included in the study.

P. roqueforti produced lactones with peach odour from hydrolysed oils (Chalier & Crouzet, 1992). From soya bean oil, the volatile compounds, C₁₁–C₁₇ methyl ketones, saturated and unsaturated aldehydes, related to long-chain fatty acids and, in addition, terpenic, sesquiterpenic and other compounds were produced (Chalier & Crouzet, 1993). From copra oil, more methyl ketones were produced (Chalier *et al.*, 1993). In a study on French blue cheeses, the volatile flavour fraction of methyl ketones represented 50–75% of the total flavour profile; significant numbers of secondary alcohols and esters were present, especially in Roquefort cheeses (Gallois & Langlois, 1990). It was possible to accelerate the ripening of blue vein cheese by means of extracellular enzymes of *P. roqueforti*, which stimulated the formation of soluble nitrogenous compounds, free amino acids, volatile fatty acids and total carbonyl compounds. The ripening time could be reduced from 60 to 45 days (Rabie, 1989).

The volatile flavour compounds liberated by *P. camemberti* are mainly methyl ketones and corresponding secondary alcohols, fatty acids and alcohols (e.g. 3-methylbutanol, 2-methylbutanol, 3-octanol and 1-octen-3-ol), which contribute to the basic flavour of Camembert-like cheeses (Jollivet *et al.*, 1993). Strains can be grouped into aromatic groups, useful in their selection for cheesemaking. The alcohol, 1-octen-3-ol, is important for the mushroom note in the typical Camembert flavour (Jollivet *et al.*, 1993). Traditional raw milk Camembert is much more aromatic due to the additional raw milk microflora. Yeasts contribute to a rose-like odour (2-phenylethanol) at the beginning of ripening. Smear bacteria liberate highly aromatic sulphur and other compounds; the deamination of amino acids causes the production of ammonia.

Volatile aromatic sulphur compounds originating from cysteine and methionine are probably key components of smear-ripened cheese flavour, and contribute to the garlic note; the thioesters (e.g. *S*-methylthioacetate, thiopropanoate and thiobutyrate) are also important for the overall aroma (Cuer *et al.*, 1979). *B. linens* was shown to produce H₂S, methanethiol, dimethyldisulphide, *S*-methylthioacetate, 4-trithiapentane, and ethional. The presence of methionine led to the liberation of methanethiol, cysteine to H₂S (Cuer *et al.*, 1979). Dias and Weimer (1998) purified and characterised the L-methionine- γ -lyase responsible for the conversion of methionine to methanethiol, α -ketobutyrate and ammonia. The authors found that the enzyme was active under cheese conditions, but was susceptible to degradation by proteinases. In a different study, the importance of *B. linens* for the liberation of sulphur compounds was also determined (Wijesundera *et al.*, 1997); the addition of *B. linens* to aseptic cheese curd slurries showed rapid flavour development, giving distinct and strong cheese flavours. These differences in flavour could not be explained in terms of differences in the analysed non-sulphur volatile composition determined by static headspace analysis.

In a review, Dillinger (1997) described sulphur containing compounds, branched fatty acids (e.g. isobutyrate, isovalerate), branched alcohols (e.g. isobutanol, isopentanol) and benzene ring-containing compounds (e.g. phenylethanol, phenylpropionate) contributed to the typical aroma of Tilsit cheeses. The liberation of amino acids and amines in semi-hard and hard cheeses was studied by Lavanchy and Sieber (1993a, b). Steffen *et al.* (1993a, b) studied the ripening of Tilsit and Appenzell cheeses made from raw milk. Amongst other non-starter bacteria, propionic acid bacteria and enterococci were important. Of the free amino acids, glutamic acid, leucine, lysine, and proline were most abundant followed by isoleucine, phenylalanine and valine. The presence of histamine, tyramine and cadaverin was attributed to the presence of enterococci. According to Leuschner and Hammes (1998), one function of *B. linens* on the cheese surface could be the deamination of biogenic amines, which was demonstrated for the ripening of Muenster cheese. Most abundant organic acids in these raw milk smear-ripened cheeses were acetic acid, propionic acid and butyric acid (Steffen *et al.*, 1993b).

6.9 Conclusions

Food safety as well as a perfect appearance and typical aroma are key issues for cheese producers. Many fungal strains are available for mould-ripened cheeses. With more knowledge about the smear microflora obtained in the past few years, the marketing of smear starter cultures is slowly expanding. It is time for cheese producers to test and, if suitable, to use secondary starter cultures instead of relying on a variable in-house microflora. This will hopefully minimise economical losses or image damage due to technological or hygienic problems of surface-ripened cheeses.

References

- Abraham, W.R. & Arfmann, H.A. (1992) *Penicillium camemberti*, a new source of brefeldin A. *Planta Medica*, **58**, 484.
- Alhir, S., Markakis, P. & Chandan, R.C. (1990) Lipase of *Penicillium caseicolum*. *Journal of Agricultural and Food Chemistry*, **38**, 598–601.
- Arizcun, C., Vasseur, C. & Labadie, J.C. (1998) Effect of several decontamination procedures on *Listeria monocytogenes* growing in biofilms. *Journal of Food Protection*, **61**, 731–734.
- Asperger, H., Luf, W. & Brandl, E. (1990) Brown discolouration of soft cheese. *Brief Communications of the XXIII International Dairy Congress*, Vol. I, pp. 110, Montreal.
- Auberger, B., Lenoir, J. & Bergere, J.L. (1995) Characterization of the carboxypeptidase activity of *Penicillium camembertii*. *Sciences des Aliments*, **15**, 273–289.
- Auberger, B., Lenoir, J. & Bergere, J.L. (1997) Partial characterization of exopeptidases produced by a strain of *Geotrichum candidum*. *Sciences des Aliments*, **17**, 655–670.
- Barnett, J.A., Payne R.W. & Yarrow D. (2000) *Yeasts: Characteristics and Identification*, Cambridge University Press, Cambridge, United Kingdom.
- Bartnicki, G. (1996) Cell wall chemistry, morphogenesis and taxonomy in fungi. *Annual Review of Microbiology*, **22**, 87–108.
- Bloes-Breton, S. & Bergere, J.L. (1997) Volatile sulfur compounds produced by Micrococcaceae and coryneform bacteria isolated from cheeses. *Lait*, **77**, 543–559.

- Bockelmann, W., Fuehr, C., Martin, D. & Heller, K.J. (1997a) Colour development by Red-Smear surface bacteria. *Kieler Milchwirtschaftliche Forschungsberichte*, **49**, 285–292.
- Bockelmann, W., Heller, M. & Heller, K.J. (2008) Identification of yeasts of dairy origin by amplified ribosomal DNA restriction analysis (ARDRA). *International Dairy Journal*, **18**, 1066–1071.
- Bockelmann, W., Hoppe-Seyler, T., Jaeger, B. & Heller, K.J. (2000) Small scale cheese ripening of bacterial smear cheeses. *Milchwissenschaft*, **55**, 621–624.
- Bockelmann, W., Hoppe-Seyler, T., Krusch, U., Hoffmann, W. & Heller, K.J. (1997b) The microflora of Tilsit cheese. 2: Development of a surface smear starter culture. *Nahrung*, **41**, 213–218.
- Bockelmann, W., Hoppe-Seyler, T., Lick, S. & Heller, K.J. (1998) Analysis of casein degradation in Tilsit cheeses. *Kieler Milchwirtschaftliche Forschungsberichte*, **50**, 105–113.
- Bockelmann, W., Jaeger, B., Hoppe-Seyler, T.S., Lillevang, S.K., Sepulchre, A. & Heller, K.J. (2007) Application of a defined surface culture for ripening of Tilsit cheese. *Kieler Milchwirtschaftliche Forschungsberichte*, **59**, 191–202.
- Bockelmann, W., Koslowsky, M., Hammer, P. & Heller, K.J. (2006) Isolation of antilisterial staphylococci from salt brines and cheese surfaces. *Kieler Milchwirtschaftliche Forschungsberichte*, **58**, 187–202.
- Bockelmann, W., Krusch, U., Engel, G., Klijn, N., Smit, G. & Heller, K.J. (1997c) The microflora of Tilsit cheese. 1: Variability of the smear flora. *Nahrung* **41**, 208–212.
- Bockelmann, W., Willems, K.P., Neve, H. & Heller, K.J. (2005) Cultures for the ripening of smear cheeses. *International Dairy Journal*, **15**, 719–732.
- Bockelmann, W., Willems, P., Jaeger, B., Hoppe-Seyler, T.S., Engel, G. & Heller, K.J. (2002) Ripening of acid curd cheese. *Kieler Milchwirtschaftliche Forschungsberichte*, **54**, 317–335.
- Bockelmann, W., Willems, P., Rademaker, J., Noordman, W. & Heller, K.J. (2003) Cultures for the surface ripening of smeared soft cheeses. *Kieler Milchwirtschaftliche Forschungsberichte*, **55**, 277–299.
- Boucabeille, C., Letellier, L., Simonet, J.M. & Henckes, G. (1998) Mode of action of linenscin OC2 against *Listeria innocua*. *Applied and Environmental Microbiology*, **64**, 3416–3421.
- Boucabeille, C., Mengin, L.D., Henckes, G., Simonet, J.M., Heijenoort, J. & Van-Heijenoort, J. (1997) Antibacterial and hemolytic activities of linenscin OC2, a hydrophobic substance produced by *Brevibacterium linens* OC2. *FEMS Microbiology Letters*, **153**, 295–301.
- Boysen, M., Skouboe, P., Frisvad, J. & Rossen, L. (1996) Reclassification of the *Penicillium roqueforti* group into three species on the basis of molecular genetic and biochemical profiles. *Microbiology (Reading)*, **142**, 541–549.
- Brennan, N.M., Brown, R., Goodfellow, M., Ward, A.C., Beresford, T.P., Vancanneyt, M., Cogan, T.M. & Fox, P.F. (2001) *Microbacterium gubbeenense* sp. nov., from the surface of a smear-ripened cheese. *International Journal of Systematic and Evolutionary Microbiology*, **51**, 1969–1976.
- Brennan, N.M., Cogan, T.M., Loessner, M. & Scherer, S. (2004), Bacterial surface ripened cheeses. *Cheese: Chemistry, Physics and Microbiology* (eds P.F. Fox, P.L.H. McSweeney, T.M. Cogan & T.P. Guinee), vol. 2, 3rd edn, pp. 199–225, Elsevier Applied Science, London.
- Brennan, N.M., Ward, A.C., Beresford, T.P., Fox, P.F., Goodfellow, M. & Cogan, T.M. (2002) Biodiversity of the bacterial flora on the surface of a smear cheese. *Applied and Environmental Microbiology*, **68**, 820–830.
- Brisabois, A., Lafarge, V., Brouillaud, A., de Buyser, M.L., Collette, C., Garin Bastuji, B. & Thorel, M.F. (1997) Pathogenic micro-organisms in milk and dairy products: the situation in France and in Europe. *Revue Scientifique Et Technique – Office International Des Epizooties*, **16**, 452–471.
- Canillac, N. & Mourey, A. (1993) Sources of contamination by *Listeria* during the making of semi-soft surface-ripened cheese. *Sciences des Aliments*, **13**, 533–544.
- Carnio, M.C., Holtzel, A., Rudolf, M., Henle, T., Jung, G. & Scherer, S. (2000) The macrocyclic peptide antibiotic micrococcin P1 is secreted by the food-borne bacterium *Staphylococcus equorum* WS 2733 and inhibits *Listeria monocytogenes* on soft cheese. *Applied and Environmental Microbiology*, **66**, 2378–2384.

- Chalier, P. & Crouzet, J. (1992) Production of lactones by *Penicillium roqueforti*. *Biotechnology Letters*, **14**, 275–280.
- Chalier, P. & Crouzet, J. (1993) Production of volatile components by *Penicillium roqueforti* cultivated in the presence of soya bean oil. *Flavour and Fragrance Journal*, **8**, 43–49.
- Chalier, P., Crouzet, J. & Charalambous, G. (1993) Aroma compounds production by *Penicillium roqueforti*. *Food Flavors, Ingredients and Composition – Developments in Food Science*, **32**, 205–219.
- Chrzanowska, J., Kolaczowska, M., Dryjanski, M., Stachowiak, D. & Polanowski, A. (1995) Aspartic proteinase from *Penicillium camemberti*: purification, properties, and substrate specificity. *Enzyme and Microbial Technology*, **17**, 719–724.
- Chrzanowska, J., Kolaczowska, M. & Polanowski, A. (1993) Caseinolytic activity of *Penicillium camemberti* and *P. chrysogenum* proteinases. Factors affecting their production. *Milchwissenschaft*, **48**, 204–206.
- Contarini, G. & Toppino, P.M. (1995) Lipolysis in Gorgonzola cheese during ripening. *International Dairy Journal*, **5**, 141–155.
- Cuer, A., Dauphin, G., Kergomard, A., Dumont, J.P. & Adda, J. (1979) Production of S-Methylthioacetate by *Brevibacterium linens*. *Applied and Environmental Microbiology*, **38**, 332–334.
- Desmasures, N., Bazin, F. & Gueguen, M. (1997) Microbiological composition of raw milk from selected farms in the Camembert region of Normandy. *Journal of Applied Microbiology* **83**, 53–58.
- Dias, B. & Weimer, B. (1998) Purification and characterization of l-methionine gamma-lyase from *Brevibacterium linens* BL2. *Applied and Environmental Microbiology*, **64**, 3327–3331.
- Dieuleveux, V., Van Der Pyl, D., Chataud, J. & Gueguen, M. (1998) Purification and characterization of anti-*Listeria* compounds produced by *Geotrichum candidum*. *Applied and Environmental Microbiology*, **64**, 800–803.
- Dillinger, K. (1997) Analyse von Aromastoffen in geschmierten Käsen. *Deutsche Milchwirtschaft*, **48**, 399–401.
- El-Dairouty, R.K., Abd-Alla, E.S., El-Senaity, M.M., Tawfek, N.F. & Sharaf, O.M. (1990) Chemical and microbiological changes in Roquefort style cheese during ripening. *Ecology of Food and Nutrition*, **24**, 89–95.
- Eliskases-Lechner, F. & Ginzinger, W. (1995) The bacterial flora of surface-ripened cheeses with special regard to coryneforms. *Lait*, **75**, 571–583.
- Engel, G., Teuber, M. & von Egmond, H. (1989) Toxic metabolites from fungal cheese starter cultures (*Penicillium camemberti* and *Penicillium roqueforti*). *Mycotoxins in Dairy Products* (ed. H.P. van Egmond), pp. 163–192, Elsevier Applied Science, London.
- Ennahar, S., Kuntz, F., Strasser, A., Bergaentzle, M., Hasselmann, C. & Stahl, V. (1994) Elimination of *Listeria monocytogenes* in soft and red smear cheeses by irradiation with low energy electrons. *International Journal of Food Science and Technology*, **29**, 395–403.
- Eppert, I., Valdes-Stauber, N., Götz, H., Busse, M. & Scherer, S. (1997) Growth reduction of *Listeria spp.* caused by undefined industrial red smear cheese cultures and bacteriocin-producing *Brevibacterium linens* as evaluated in situ on soft cheese. *Applied and Environmental Microbiology*, **63**, 4812–4817.
- Evans, J.B. & Kloos, W.E. (1972) Use of shake cultures in a semi solid thioglycolate medium for differentiating staphylococci and micrococci. *Applied Microbiology*, **23**, 326–331.
- Fox, P.F., McSweeney P.L.H., Cogan, T.M. & Guinee, T.P. (eds.) (2004a) *Cheese: Chemistry, Physics and Microbiology, Volume 1: General Aspects*, 3rd edn, Elsevier Academic Press, London.
- Fox, P.F., McSweeney P.L.H., Cogan, T.M. & Guinee, T.P. (eds.) (2004b) *Cheese: Chemistry, Physics and Microbiology, Volume 2: Major Cheese Groups*, 3rd edn, Elsevier Academic Press, London.
- Fuke, Y. & Matsuoka, H. (1993) The purification and characterization of prolyl aminopeptidase from *Penicillium camemberti*. *Journal of Dairy Science*, **76**, 2478–2484.
- Gallois, A. & Langlois, D. (1990) New results in the volatile odorous compounds of French blue cheeses. *Lait*, **70**, 89–106.

- Gavrish, E.Y., Krauzova, V. I., Potekhina, N.V., Karasev, S. G., Plotnikova, E.G., Altyntseva, O.V., Korosteleva, L.A. & Evtushenko, L.I. (2004) Three new species of brevibacteria, *Brevibacterium antiquum* sp. nov., *Brevibacterium aurantiacum* sp. nov., and *Brevibacterium permense* sp. nov. *Microbiology*, **73**, 176–183.
- Gelsomino, R., Vancanneyt, M., Snauwaert, C., Vandemeulebroecke, K., Hoste, B., Cogan, T. M. & Swings, J. (2005) *Corynebacterium mooreparkense*, a later heterotypic synonym of *Corynebacterium variabile*. *International Journal of Systematic and Evolutionary Microbiology*, **55**, 1129–1131.
- Gente, S., Sohler, D., Coton, E., Duhamel, C. & Gueguen, M. (2006) Identification of *Geotrichum candidum* at the species and strain level: proposal for a standardized protocol. *Journal of Industrial Microbiology and Biotechnology*, **33**, 1019–1031.
- Giraffa, G., Carminati, D. & Tarelli, G.T. (1995) Inhibition of *Listeria innocua* in milk by bacteriocin-producing *Enterococcus faecium* 7C5. *Journal of Food Protection*, **58**, 621–623.
- Goerges, S., Mounier, J., Rea, M.C., Gelsomino, R., Heise, V., Beduhn, R., Cogan, T.M. & Scherer, S. (2008) Commercial ripening starter microorganisms inoculated into cheese milk do not successfully establish themselves in the resident microbial ripening consortia of South German red smear cheese. *Applied and Environmental Microbiology*, **74**, 2210–2217.
- Gripon, J.C. (1993) Mould-ripened cheeses. *Cheese: Chemistry, Physics and Microbiology* (ed. P.F. Fox), vol. 2, 2nd edn, pp. 111–136, Chapman and Hall, London.
- Gripon, J.C., Auberger, B. & Lenoir, J. (1980) Metalloproteinases from *Penicillium caseicolum* and *Penicillium roqueforti* – comparison of specificity and chemical characterization. *International Journal of Biochemistry*, **12**, 451–455.
- Hagens, S. & Loessner, M.J. (2007) Application of bacteriophages for detection and control of food-borne pathogens. *Applied Microbiology and Biotechnology*, **76**, 513–519.
- Hahn, G. & Hammer, P. (1990) Listerien-freie Käse – höhere Sicherheit für den Verbraucher. *Deutsche Milchwirtschaft*, **33**, 1120–1125.
- Hahn, G. & Hammer, P. (1993) The analysis of critical points (HACCP concept) as a tool of assuring quality and hygienic safety. *DMZ, Lebensmittelindustrie und Milchwirtschaft*, **114**, 1040–1048.
- Hayashi, K. & Law, B.A. (1989) Purification and Characterization of two aminopeptidases produced by *Brevibacterium linens*. *Journal of General Microbiology*, **135**, 2027–2034.
- Hayashi, K., Revell, D.F. & Law, B.A. (1990) Effect of partially purified extracellular serine proteinases produced by *Brevibacterium linens* on the accelerated ripening of cheddar cheese. *Journal of Dairy Science*, **73**, 579–583.
- Hemme, D., Bouillanne, C., Metro, F. & Desmazeaud, M.J. (1982) Microbial catabolism of amino acids during cheese ripening. *Sciences des Aliments*, **2**, 113–123.
- Holsinger, V.H., Rajkowski, K.T. & Stabel, J.R. (1997) Milk pasteurisation and safety: a brief history and update. *Revue Scientifique et Technique/Office International des Epizooties*, **16**, 441–451.
- de Hoog, G.S. & Smith, M.T. (2004). Ribosomal gene phylogeny and species delimitation in *Geotrichum* and its teleomorphs. *Studies in Mycology*, **50**, 489–515.
- Hoppe-Seyler, T., Jaeger, B., Bockelmann, W. Geis, A. & Heller, K.J. (2007) Molecular identification and differentiation of *Brevibacterium* species and strains. *Systematic and Applied Microbiology*, **30**, 50–57.
- Hoppe-Seyler, T., Jaeger, B., Bockelmann, W. & Heller, K.J. (2000) Quantification and identification of microorganisms from the surface of smear cheeses. *Kieler Milchwirtschaftliche Forschungsberichte*, **52**, 294–305.
- Hoppe-Seyler, T., Jaeger, B., Bockelmann, W., Noordman, W., Geis, A. & Heller, K.J. (2003), Identification and Differentiation of species and strains of *Arthrobacter* and *Microbacterium barkeri* isolated from smear cheeses with amplified ribosomal DNA restriction analysis (ARDRA) and pulsed field gel electrophoresis (PFGE). *Systematic and Applied Microbiology*, **26**, 438–444.

- Hoppe-Seyler, T., Jaeger, B., Bockelmann, W., Noordman, W., Geis, A. & Heller, K.J. (2004) Molecular Identification and differentiation of *Staphylococcus* species and strains of cheese origin. *Systematic and Applied Microbiology*, **27**, 211–218.
- Irlinger, F., Birnet, F., Delettre, J., Lefevre, M. & Grimont, P.A.D. (2005) *Arthrobacter bergerei* sp. nov. and *Arthrobacter arilaitensis* sp. nov., novel coryneform species isolated from the surfaces of cheeses. *International Journal of Systematic and Evolutionary Microbiology*, **55**, 457–462.
- Iwasawa, H., Hirata, A. & Kimura, T. (1996) Proteolysis in Camembert cheese during ripening. *Nippon Shokuhin Kogyo Gakkaishi – Journal of the Japanese Society for Food Science and Technology*, **43**, 703–711.
- Jaeger B., Hoppe-Seyler T., Bockelmann W. & Heller, K.J. (2002) The influence of the brine microflora on the ripening of smear cheeses. *Milchwissenschaft*, **57**, 645–648.
- Jollivet, N., Belin, J.M. & Vayssier, Y. (1993) Comparison of volatile flavor compounds produced by ten strains of *Penicillium camemberti* Thom. *Journal of Dairy Science*, **76**, 1837–1844.
- Juhász, O. & Skarka, B. (1990) Purification and characterization of an extracellular proteinase from *Brevibacterium linens*. *Canadian Journal of Microbiology*, **36**, 510–512.
- Kinderlerer, J.L., Bousher, A., Chandra, M. & Edyvean, R. (1995) The effect of fungal metabolites on *Listeria monocytogenes* in mould-ripened cheese. *Biodeterioration and Biodegradation*, **9**, 370–378.
- Kummerle, M., Scherer, S. & Seiler, H. (1998) Rapid and reliable identification of food-borne yeasts by Fourier-transform infrared spectroscopy. *Applied and Environmental Microbiology*, **64**, 2207–2214.
- Lambrechts, C., Escudero, J. & Galzy, P. (1995) Purification and properties of three esterases from *Brevibacterium* sp R312. *Journal of Applied Bacteriology*, **78**, 180–188.
- Langhus, W.L., Price, W.V., Sommer, H.H. & Frazier, W.C. (1945) The “smear” of Brick cheese and its relation to flavour development. *Journal of Dairy Science*, **28**, 827–838.
- Laporte, E., Guiraud, J.P. & Reverbel, J.P. (1992) Antimicrobial action associated with Roquefort cheese technology: effect of the *Penicillium roquefortii* strain. *Sciences des Aliments*, **12**, 729–741.
- Lavanchy, P. & Sieber, R. (1993a) Proteolyse in verschiedenen Hart- und Halbhartkäsen – 1. Freie Aminosäuren. *Schweizerische Milchwirtschaftliche Forschung*, **22**, 59–64.
- Lavanchy, P. & Sieber, R. (1993b) Proteolyse in verschiedenen Hart- und Halbhartkäsen – 2. Amine. *Schweizerische Milchwirtschaftliche Forschung*, **22**, 65–68.
- Law, J. & Haandrikman, A. (1997) Proteolytic enzymes of lactic acid bacteria. *International Dairy Journal*, **7**, 1–11.
- Laxa, O. (1899) Bakteriologische Studien über die Reifung von zwei Arten Backsteinkäse. *Centralblatt fuer Bakteriologie und Parasitenkunde*, **5**, 755–762.
- LeBars, J. & LeBars, P. (1998) Strategy for safe use of fungi and fungal derivatives in food processing. *Revue de Medecine Veterinaire*, **149**, 493–500.
- Leuschner, R.G.K. & Hammes, W.P. (1998) Degradation of histamine and tyramine by *Brevibacterium linens* during surface ripening of Munster cheese. *Journal of Food Protection*, **61**, 874–878.
- Lewis, B.A. (1982) Correlation between thiol production and antifungal activity by *Brevibacterium linens*. *Microbiology Letters*, **21**, 75–78.
- Loessner, M., Guenther, S., Steffan, S. & Scherer, S. (2003) A pediocin-producing *Lactobacillus plantarum* strain inhibits *Listeria monocytogenes* in a multispecies cheese surface microbial ripening consortium. *Applied and Environmental Microbiology*, **69**, 1854–1857.
- Lund, F., Filtenborg, O. & Frisvad, J.C. (1995) Associated mycoflora of cheese. *Food Microbiology*, **12**, 173–180.
- Martin, F., Friedrich, K., Beyer, F. & Terplan, G. (1995) Antagonistic effects of strains of *Brevibacterium linens* against *Listeria*. *Archiv für Lebensmittelhygiene*, **46**, 7–11.
- Matsuoka, H., Fuke, Y., Kaminogawa, S. & Yamauchi, K. (1991) Purification and debittering effect of aminopeptidase II from *Penicillium caseicolum*. *Journal of Agricultural and Food Chemistry* **39**, 1392–1395.

- Morris, H.A., Combs, W.B. & Coulter, S.T. (1951) The relation of surface growth to the ripening of Minnesota blue cheese. *Journal of Dairy Science*, **34**, 209–218.
- Mounier, J., Gelsomino, R., Goerges, S., Vancanneyt, M., Vandemeulebroecke, K., Hoste, B., Scherer, S., Swings, J., Fitzgerald, G.F. & Cogan T.M. (2005) Surface microflora of four smear-ripened cheeses. *Applied and Environmental Microbiology*, **71**, 6489–6500.
- Muir, D.D., Hunter, E.A. & Watson, M. (1995) Aroma of cheese. 1: Sensory characterisation. *Milchwissenschaft*, **50**, 499–503.
- Mulder, E.G., Adamse, A.D., Antheunisse, J., Deinema, M.H., Woldendorp, J.W. & Zevenhuizen, L.P.T.M. (1966) The relationship between *Brevibacterium linens* and bacteria of the genus *Arthrobacter*. *Journal of Applied Bacteriology*, **29**, 44–71.
- Nielsen, M.S., Frisvad, J.C. & Nielsen, P.V. (1998) Protection by fungal starters against growth and secondary metabolite production of fungal spoilers of cheese. *International Journal of Food Microbiology*, **42**, 91–99.
- Noterman, S., Dufrenne, J., Teunis, P. & Chackraborty, T. (1998) Studies on the risk assessment of *Listeria monocytogenes*. *Journal of Food Protection*, **61**, 244–248.
- Oberreuter, H., Seiler, H. & Scherer, S. (2002) Identification of coryneform bacteria and related taxa by Fourier-transform infrared (FT-IR) spectroscopy. *International Journal of Systematic and Evolutionary Microbiology*, **52**, 91–100.
- Pelaez, C. & Northholt, M. D. (1988) Factors leading to pink discolouration of the surface of Gouda cheese. *Netherlands Milk and Dairy Journal*, **42**, 323–336.
- Pintado, C.M.B.S., Oliveira, A., Pampulha, M.E. & Ferreira, M.A.S.S. (2005) Prevalence and characterization of *Listeria monocytogenes* isolated from soft cheese. *Food Microbiology*, **22**, 79–85.
- Purko, M. & Nelson, W.O. (1951) The liberation of water-insoluble acids in cream by *Geotrichum candidum*. *Journal of Dairy Science*, **34**, 477
- Rabie, A.M. (1989) Acceleration of blue cheese ripening by cheese slurry and extracellular enzymes of *Penicillium roqueforti*. *Lait*, **69**, 305–314.
- Radomycki, T., Murano, E.A., Olson, D.G. & Murano, P.S. (1994) Elimination of pathogens of significance in food by low-dose irradiation: a review. *Journal of Food Protection*, **57**, 73–86.
- Ramsaran, H., Chen, J., Brunke, B., Hill, A. & Griffiths, M.W. (1998) Survival of bioluminescent *Listeria monocytogenes* and *Escherichia coli* O157:H7 in soft cheeses. *Journal of Dairy Sciences*, **81**, 1810–1817.
- Ratray, F.P., Bockelmann, W. & Fox, P.F. (1995) Purification and characterization of an extracellular proteinase from *Brevibacterium linens* ATCC 9174. *Applied and Environmental Microbiology*, **61**, 3454–3456.
- Ratray, F. P. & Fox, P.F. (1999) Aspects of enzymology and biochemical properties of *Brevibacterium linens* relevant to cheese ripening: a review. *Journal of Dairy Science*, **82**, 891–909.
- Ratray, F.P., Fox, P.F. & Healy, A. (1996) Specificity of an extracellular proteinase from *Brevibacterium linens* ATCC 9174 on bovine α_{s1} -casein. *Applied and Environmental Microbiology*, **62**, 501–506.
- Richard, J. (1993) Effects of surface flora. *Revue Laitière Française*, **525**, 30–31.
- Rohm, H., Eliskases-Lechner, F. & Brauer, M. (1992) Diversity of yeasts in selected dairy products. *Journal of Applied Bacteriology*, **72**, 370–376.
- Rowan, N.J. & Anderson, J.G. (1998) Effects of above-optimum growth temperature and cell morphology on thermotolerance of *Listeria monocytogenes* cells suspended in bovine milk. *Applied and Environmental Microbiology*, **64**, 2065–2071.
- Ryser, E.T., Maisnier, P.S., Gratadoux, J.J. & Richard, J. (1994) Isolation and identification of cheese-smear bacteria inhibitory to *Listeria* spp. *International Journal of Food Microbiology*, **21**, 237–246.
- Schellekens, M. M., Wouters, J., Hagens, S. & Hugenholtz, J. (2007) Bacteriophage P100 application to control *Listeria monocytogenes* on smeared cheese. *Milchwissenschaft*, **62**, 284–287.
- Schleifer, K.H. & Kramer, E. (1980) Selective medium for isolating staphylococci. *Zentralblatt für Bakteriologie, Mikrobiologie und Hygiene*, **1**, 270–280.

- Seiler, H. (1986) Identification of cheese-smear coryneform bacteria. *Journal of Dairy Research*, **53**, 439–449.
- Siemens, K. & Zawistowski, J. (1996) Occurrence of PR imine, a metabolite of *Penicillium roqueforti*, in blue cheese. *Journal of Food Protection*, **56**, 317–319.
- Siswanto, H.P., Gratadoux, J.J. & Richard, J. (1996) Inhibitory potential against *Listeria spp.* and *Staphylococcus aureus* of a strain of *Brevibacterium linens* producing linenscin OC2. *Lait*, **76**, 501–512.
- Steffen, C., Schär, H., Eberhard, P., Glättli, H., Nick, B., Rentsch, F., Steiger, G. & Sieber, R. (1993a) Untersuchungen über den Reifungsverlauf von qualitativ gutem Käse – Appenzeller. *Schweizerische Milchwirtschaftliche Forschung*, **21**, 39–45.
- Steffen, C., Schär, H., Eberhard, P., Glättli, H., Rentsch, F., Nick, B., Steiger, G. & Sieber, R. (1993b) Untersuchungen über den Reifungsverlauf von qualitativ gutem Käse – Tilsiter aus Rohmilch. *Schweizerische Milchwirtschaftliche Forschung*, **21**, 46–51.
- Steinmeyer, S. & Terplan, G. (1996) Listerien in Lebensmitteln – eine aktuelle Übersicht zu Vorkommen, Bedeutung als Krankheitserreger, Nachweis und Bewertung – Teil I. *DMZ, Lebensmittelindustrie und Milchwirtschaft*, **5**, 150–155.
- Szumski, S.A. & Cone, J. (1962) Possible role of yeast endoproteinases in ripening surface-ripened cheeses. *Journal of Dairy Science*, **45**, 349–353.
- Takafuji, S. & Charalambous, G. (1993) Protein breakdown in Camembert cheese. *Food Flavors, Ingredients and Composition – Developments in Food Science*, **32**, 191–204.
- Terplan, G., Schoen, R., Springmeyer, W., Degle, I. & Becker, H. (1986) *Listeria monocytogenes* in milch und milchprodukten. *DMZ, Lebensmittelindustrie und Milchwirtschaft*, **107**, 1358–1368.
- Valdes-Stauber, N. (1991) Antagonistic effect of coryneform bacteria from red smear cheese against *Listeria* species. *International Journal of Food Microbiology*, **13**, 119–130.
- Valdes-Stauber, N. & Scherer, S. (1994) Isolation and characterization of linocin M18, a bacteriocin produced by *Brevibacterium linens*. *Applied and Environmental Microbiology*, **60**, 3809–3814.
- Valdes-Stauber, N., Scherer, S., Seiler, H. & Stauber, N.V. (1996) Identification of yeasts and coryneform bacteria from the surface microflora of brick cheeses. *International Journal of Food Microbiology*, **34**, 115–129.
- Wijesundera, C., Roberts, M. & Limsowtin, G.K.Y. (1997) Flavour development in aseptic cheese curd slurries prepared with single-strain starter bacteria in the presence and absence of adjuncts. *Lait (IDF Symposium: Ripening and Quality of Cheeses)*, **77**, 121–131.
- Wyder, M.T. & Puhani, Z. (1999) Investigation of the yeast flora in smear ripened cheeses. *Milchwissenschaft*, **54**, 330–333.
- Zapico, P., Medina, M., Gaya, P. & Nunez, M. (1998) Synergistic effect of nisin and the lactoperoxidase system on *Listeria monocytogenes* in skim milk. *International Journal of Food Microbiology*, **40**, 35–42.

7 Cheese-Ripening and Cheese Flavour Technology

B.A. Law

7.1 Introduction

This chapter examines the current state of knowledge of cheese flavour biochemistry and the technological options arising from this knowledge, which can give cheese manufacturers a measure of control over the balance of flavour (quality) in cheese and over the rate at which flavour develops. An overall knowledge of cheese-ripening agents and the principal classes of flavour compounds makes it possible to pinpoint those stages in normal maturation which are amenable to the development of control technology within the framework of the main events in the cheese-ripening process shown in Fig. 7.1.

7.2 The breakdown of milk proteins to flavour compounds in cheese

7.2.1 *Proteinase and peptidase enzymes (proteolytic systems)*

In Fig. 7.1, milk proteins are represented by casein. Obviously the caseins (α -, β - and κ -) are not the only proteins in milk; a small proportion of the whey proteins (mainly α -lactalbumin - α -La and β -lactoglobulin - β -Lg) are also trapped in the curd mass during coagulation and syneresis. In the normal course of cheese ripening, the latter proteins are not significantly broken down, as far as researchers can tell, whereas the caseins are extensively broken down by the coagulant, the indigenous milk enzymes (mainly plasmin) and the enzymes of the cheese microflora. This research field has recently been exhaustively reviewed (Law & Mulholland, 1995; Fox & McSweeney, 1997; Ganesan & Weimer, 2007); the present chapter is not concerned with the research data *per se*, excellent though they are, but with the insights they give to potential control technology through which to manipulate the course and speed of ripening in cheese.

As seen in Chapter 3, rennets of various types attack κ -casein to destabilise casein micelles and form the initial milk gel from which cheese is fabricated; moreover, the rennets are more or less trapped in the curd matrix and go on breaking down the other caseins as the cheese matures. The peptide bonds in these caseins, which are susceptible to rennet action during cheese ripening, are very well documented (Chapter 3). Although there are minor differences in the resulting peptide products in different cheese varieties, the amino acid sequences of the major chymosin-derived peptides are similar in most cheeses. These casein-derived peptides are either tasteless or bitter and do not contribute directly to the typical taste or flavour of

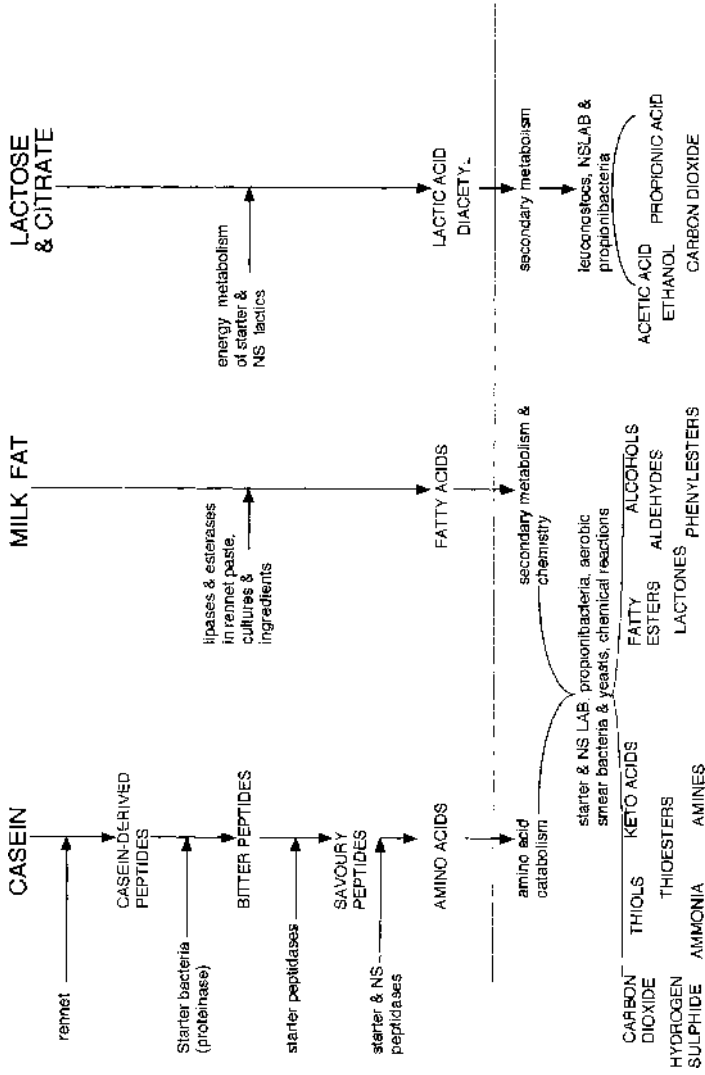

Fig. 7.1 Basic cheese-ripening biochemistry. The known biochemical events in the conversion of protein, fat and carbohydrates in cheese to flavour compounds. NS, non-starter; LAB, lactic acid bacteria.

cheese, but their production, particularly in the first weeks of cheese maturation, is essential to the softening of the rubbery, elastic cheese curd texture. They are also the substrates and precursors of peptides, which can be further broken down to small (2–3 amino acids long) acidic flavour-enhancing peptides and free amino acids; the latter have taste and are themselves the precursors of a range of volatile compounds, which collectively give cheeses their characteristic taste/aroma profiles (Fig. 7.1).

However, the essential function of coagulants is to gel the milk, and there is little scope for variation of coagulant concentration in cheese as a means of controlling ripening. Extra rennet would reduce cheese yield, change the balance between coagulation time and acidification and increase the production of bitter peptides beyond the capacity of the enzymes of the cheese microflora to degrade them.

The next three stages in the cascade of biochemical events in the breakdown of caseins to flavour compounds (Fig. 7.1) are mediated largely by the starter lactic acid bacteria (LAB), whose primary technological function is to acidify the curd in the cheese vat (Chapter 5). The ripening role for starter cultures emerged from basic research (summarised by Law & Sharpe, 1978), and is so well documented and understood that nowadays starter cultures are routinely screened by culture suppliers, not only for acidification power and bacteriophage resistance but also for their flavour potential, using both proprietary methods and published techniques (Bech, 1992; Smit *et al.*, 1995; Wijesundera *et al.*, 1997; Powell, 2007; Verschueren *et al.*, 2007). Indeed, the central importance of starter LAB in the flavour quality of hard and semi-hard cheese was encapsulated in the title of a conference paper by Crow *et al.* (1993) called ‘Starters as Finishers: Starter Properties Relevant to Cheese Ripening’. The know-how generated in the 1970s and 1980s forms the basis of most of the commercially developed flavour-enhancing systems for hard and semi-hard cheese today and the basis for the use of food-grade proteinases in enzyme-modified cheeses (EMCs) used to replace the mature cheese component of processed cheese to generate both texture and taste.

Thus, the Accelase™ range of cheese-ripening enzymes has been developed by Imperial Biotechnology Limited (IBT; now part of Danisco) following the original research and pilot-scale trials into the role of starter lactococci and commercial proteinases in Cheddar cheese ripening (Law & Wigmore, 1983). The technology has been extensively refined and developed by IBT since then and is described further in Section 7.7.3.

Based on the knowledge that starter lactococci are vital flavour-producing agents in cheeses, Chr. Hansen A/S in Denmark has developed a range of natural non-acidifying *Lactococcus* cultures (derived by selection from starter cultures) called CR™, which can be added to cheese milk before coagulation without interfering with the vat stage of manufacture, but which come into play after the cheese has been pressed and stored (Vindfeldt, 1993). They augment the normal starter biomass and increase ripening rates, as well as influencing the character of the basic cheese flavour profile by adding ‘sharpness’, ‘sweetness’ and/or ‘sulphurous’ notes (see Chapter 13). These cultures have advantages over enzyme technology as a means of controlling the flavour profile of ripened cheeses; they maintain the normal balance of starter-derived enzymes in the cheese and are natural cheese constituents (spontaneously occurring lactose-negative (Lac^{-ve}) variants of long established ‘generally regarded as safe’ [GRAS] cheese bacteria). Their use does not require declaration or any reference to advisory bodies, such as the Advisory Committee on Novel Foods and Processes (ACNFP). Their only disadvantage lies in the limited bulk of extra starter biomass that can be added to

cheese milk, both logistically and economically, which in turn limits their impact on taste intensification. The application of this cheese flavour technology is described in more detail in Section 7.7.4.

Within the control points offered by the casein breakdown cascade in cheese, it is known that the non-starter microflora also help to generate amino acids within the same overall pathway, although in the case of the adventitious non-starter lactic acid bacteria (NSLAB; lactobacilli, pediococci) this function is often limited by their relatively low biomass compared with that of the starter lactococci. Thus, lactococci normally reach biomass equivalents of $2\text{--}5 \times 10^9$ colony-forming units (cfu) g^{-1} in cheese at the time of pressing, whereas the population range of the secondary NSLAB rarely exceeds 100×10^6 cfu g^{-1} , and is sometimes restricted to 10×10^6 cfu g^{-1} , even in cheeses highly graded for flavour. Indeed, Reiter and Sharpe (1971) proved that only starter lactococci are necessary for the development of balanced typical flavour in Cheddar cheese, by experimentally excluding the non-starter flora in 'aseptic vat' pilot-scale cheesemaking. As far as cheese flavour technology is concerned, therefore, the control options presented by secondary flora in Cheddar and related varieties are based on adding distinctive flavour/aroma 'top notes' (e.g. sweet, nutty, fermented, cooked) to basic flavour characteristics. The culture supply companies sell cultures called adjuncts to do this, and they are already commercially successful (see Section 7.7.5). The main (potential) advantage of NSLAB adjunct cultures over enzymes and $\text{Lac}^{-\text{ve}}$ lactococci lies in their ability to grow in cheese, eliminating the problems of bulk addition and biomass production costs. Adjunct technology also has the potential to harness metabolic flavour pathways of viable cells (Broome, 2007a).

The mould cultures added to blue cheese varieties (e.g. Danablu, Roquefort, Stilton, Gorgonzola) and soft surface-ripened cheeses of the Brie/Camembert type (see Table 1.1) also break down casein- and chymosin-derived peptides to amino acids. However, this gives little scope for manipulating ripening and flavour development through their protein-degrading capacity; the overriding priority of this branch of cheese technology is the precise control of mould growth, to keep a fine balance between the optimum appearance of blue veins or white surface crust of the cheese and the development of lipid-derived and sugar-derived flavour notes (pungent, mushroom and buttery) *via* the metabolism of the living organisms, rather than the enzyme activity of static or dying populations. Even those aroma notes which can be traced back to casein-derived amino acids (garlic/sulphurous) are due to proteinase production and amino acid metabolism of the living, growing organisms, increasing the dependency of the entire spectrum of cheese quality on a natural, well-established growth process. Attempts to control flavour alone by manipulating these finely balanced interdependent events needs a better understanding of the physiology and metabolic control of the moulds than is currently available.

This is not to say that it is impossible to exert a degree of control over the flavour and aroma of mould-ripened cheeses by selecting from the inherent variability of enzyme production, pigment production and growth rate/metabolic ratios within the cultures available. Culture supply companies do this already, sometimes on a custom basis; Chr. Hansen A/S, for example supplies mould cultures selected by just such criteria within the SWING™ range. The limits of control by selection are, of course, set by existing narrow biodiversity, until the research base comes up with an acceptable (molecular genetic) method for changing existing traits and introducing new ones, in a way analogous to LAB molecular genetics (see

Chapter 5 and Section 7.7.6). The application of defined mould cultures and surface smear aerobic bacteria to control and reproduce flavour profiles within existing cheese technology is described in detail in Chapter 6.

7.2.2 *Amino acid catabolism*

The metabolic conversion of proteolytically liberated ('free') amino acids in cheese into volatile and non-volatile flavour compounds is not as amenable to control as is the proteolytic process described above. This is due, in part, to the relative lack of knowledge and understanding of the underlying metabolic pathways and enzymes involved in this aspect of cheese ripening, though the research base is beginning to deliver useful data for the technologists to use in selection and manipulation. For example, the enzymes involved in the release of the potent odorant, methanethiol, have been identified and isolated from starter lactococci and surface smear brevibacteria (Alting *et al.*, 1995; Bruinenberg *et al.*, 1997), paving the way for their enhancement by selection and/or genetic engineering. Also, several research groups have reported amino acid deaminases and transaminases in LAB, which can convert flavourless amino acids into aroma-bearing, short/branched-chain keto acids and ester precursors (e.g. Yvon *et al.*, 1997).

Since the first edition was written, there have been many new publications in the scientific literature which clearly show that many starter LAB and NSLAB strains and species produce amino acid catabolising enzymes, such as aminotransferases (ATs) that are specific for either branched-chain, aromatic or sulphur-containing amino acids (e.g. Ganesan & Weimer, 2007). Lactococcal enzyme systems driven by glutamate dehydrogenase and aspartate aminotransferase have also been implicated in (but not directly demonstrated as) part of flavour-related amino acid catabolism (Tanous *et al.*, 2005). Whilst it is obvious that enzymes, which remove amino groups from free amino acids, such as leucine, methionine and phenylalanine, are likely to initiate further conversions to flavour and aroma compounds, such as 3-methyl butanol (malty), methional (cheesy/cooked potato), sulphides and thiols (pungent) and aromatic esters (floral, sweet); none of these discoveries has yet led to new technology becoming openly available to cheesemakers. Hopefully the research/industry interface will soon yield new applicable innovations; indeed, a number of research authorities have claimed/predicted that screening of amino acid metabolising enzymes in NSLAB already provides a technological breakthrough in flavour adjunct technology. For example, Carunchia *et al.* (2006) have successfully enhanced nutty flavour notes in experimental cheese by using a malty strain of *Lactococcus lactis* subsp. *lactis* as culture adjunct. Also, researchers such as Thage *et al.* (2005) isolated from semi-hard cheeses, *Lactobacillus paracasei* strains with distinct and variable AT activities, then re-introduce them into experimental cheeses and demonstrate differences in the levels of suspected flavour/aroma compounds, such as diacetyl were produced during the maturation of these cheeses. However, there was no definitive flavour data to point to possible technological applications, and most strain additions had no effect at all on overall flavour compound profiles. This experience has been repeated with SLAB (e.g. Rijnen *et al.*, 2003) in many pilot studies reported in the last few years.

The failure of the research base to provide rational starter or flavour adjunct choices is reflected in the reviews of Broome (2007a,b) and Powell (2007). These are sound and

valuable records of progress in the research base, but they confirm the continuing failure of academic research to deliver industry outcomes.

Any reader interested in updated their knowledge of the field of amino acid metabolism in SLABs and NSLABs in the cheese environment should read the review of Ganesan and Weimer (2007), but should not expect find any applicable knowledge which would advance current LAB flavour culture technology, which remains dependent on ad hoc screening methods linked to pilot, then factory trials. That is not to say that this line of research will not eventually bear fruit, as evidenced by success in the use of a strain of *Lactobacillus helveticus* to reduce bitterness in maturing cheese, but this application is not yet sufficiently developed as a widely applicable mainstream technology (Soeryapranata *et al.*, 2007; Sridhar *et al.*, 2005). Also, *Lb. helveticus* is known to have amino acid decarboxylating systems that can cause cracking in hard cheese, so some form of attenuated culture or enzyme extract would be needed for universal mainstream cheese technology applications.

Until flavour chemists and biochemists find a way of working together to define the profiles that actually deliver cheese flavour and its desirable variations, the day of knowledge-based (as opposed to current ad hoc) applications of research to real technology seems as far off today as it was when the first edition of *Technology of Cheesemaking* was published. I have already pointed to the way forward in my review for the International Dairy Federation (Law, 2001), and this approach has been embraced in company research and development (R&D) programmes, but its technological outcomes will have to remain outside the public domain until the generated intellectual property has been exploited/protected. In this regard, the interested reader should note that in the last 10 years there has been substantial and valuable progress in the development of objective flavour vocabulary (especially for Cheddar cheese). This is rightly the subject of Chapter 13, and will not be covered here, but the reader may wish to gain some grounding by reading reviews, such as those of Drake (2007) and Cadwallader (2007). Also, although predictive modelling of flavour development is not a flavour/ripening technology in itself, attempts to use manufacturing parameters such as cheese vat temperature profiles, cutting/stirring regimes and starter/adjunct culture choice to predict the ripening of Gouda cheese have led to commercially available systems, summarised by Verschuere *et al.* (2007).

Despite lack of real progress in research-based flavour technology for LAB applications, there has been better progress in the field of smear cheeses. This area will be covered and updated by Chapter 6, whose author has pioneered applied research to improve the efficacy and reliability of aroma-producing bacteria. It is to be hoped that the leading researchers of surface-ripened cheese varieties will have followed up on the outstanding work of Khan *et al.* (1999) and Berger *et al.* (1999), who clearly demonstrated the powerful technique of combinatorial flavour library synthesis in determining the true origin of the flavour profile distinction between Camembert cheeses made with raw milk (and having a bacterial surface flora as well as surface moulds) and pasteurised milk devoid of aroma bacteria. To the author's knowledge, combinatorial flavour libraries have been used in applied research for the cheese industry in co-investment (research and development – R&D), but the outcomes are unlikely to be made known openly in the foreseeable future.

As we shall see, therefore, not all flavour control methods are based on the SLABs and NSLABs in cheese. For example, the ammonia released by surface mould deaminases of soft cheese is also a strong odorant and has an important function in softening the texture of

surface mould cheeses (Noomen, 1983); indeed, this mechanism works for commercial-sized surface smear cheeses by increasing the ammonia concentration in the ripening environment. The ammonia stimulates the surface flora by increasing surface pH, encouraging lactic acid and calcium ion diffusion to the surface and promoting proteolysis (Bachmann, 1996). Curd-neutralising yeasts (lactate utilisers) can also stimulate the growth and metabolism of *Brevibacterium linens* in surface smear cheese to accelerate the development of typical pungent aromatic notes (Arfi *et al.*, 2005). The culture companies are aware of this basic work and will no doubt convert the knowledge into new flavour cultures for cheesemakers in the future.

7.3 Breakdown of milk lipids in cheese

The lipolysis of milk fat (triglycerides) in cheese to free fatty acids (FFAs) by lipases from rennet paste, moulds and bacteria has a long tradition in cheese technology, particularly in the production of Italian hard cheeses, such as Parmesan. Indeed, the addition of animal enzymes, such as calf pregastric lipase, is traditional, and certain permitted microbial lipases are also used in modern Italian cheese technology. The commercial sources of the microbial lipases are usually food-approved strains of *Aspergillus* spp. or the same *Rhizomucor* strains as are used to produce microbial rennets (cf. Chapter 3).

Unfortunately for cheese technologists, putting lipases into cheese is not usually a successful way of enhancing its flavour profile. Such additions certainly increase flavour intensity, but usually at the expense of quality. The problem is that the cheeses which do not have obvious fatty acid (FA) flavour notes in their profiles (FFAs may contribute to the total profile, but not directly) are made rancid (sweaty and soapy) by lipases, especially the animal enzymes, which selectively release short-chain acids (butyric, caproic and capric) from milk fat. Some commercial enzyme suppliers have claimed to have lipases which release a Cheddar-like mixture of FFAs (Arbige *et al.*, 1986), but their lack of stand-alone commercial uptake for hard and semi-hard cheese technology testifies to their lack of efficacy. However, it is possible that enzymes of this type have found applications as components of enzyme blends of proteinases and lipases, which are formulated to give a balanced acceleration to flavour formation and, the enzymes described in this paper, should not be overlooked. In contrast to their lack of success in many varieties of cheese for direct consumption, the application of lipase to flavour control technology is well established in the manufacture of EMC (see Section 7.8). Moreover, the involvement of FA derivatives in flavour and aroma compounds in many cheese varieties suggests that the subtle addition of lipases blended with other ripening enzymes and/or cultures may have a future.

The classes of FA derivatives normally cited as cheese odorants include FA alcohol esters (fruity aromatic notes, floral, goaty); FA thioesters (cheesy, cooked vegetable); lactones (fruity soft notes, nutty); branched-chain keto acids (pungent cheesy); and unsaturated alcohols and ketones (mushroom-like). This last class is best represented in cheese by 1-octen-3-ol and 1-octen-3-one, derived from the metabolism of free linoleic acid by the surface mould, *Geotrichum candidum*. Cultures of this organism are commercially available for use with *Penicillium camemberti* to enhance the development of the white crust and the typical mushroom aroma of Brie and Camembert (see Chapter 6).

Although most technological developments in controlling lipolysis in cheese are based on moulds and/or their lipases, Holland *et al.* (2005) has suggested that the LAB have a role in flavour-related ripening mechanisms through their ability to catalyse ester synthesis in cheese. Also, LAB-mediated lipolysis (as a stage in ester synthesis) can be accelerated by manipulating rates of cell autolysis in cheese (Collins *et al.*, 2003).

In summary, there are opportunities for cheese flavour control technology through the control of fat breakdown in cheese, but these are not as varied and well understood as those arising from casein breakdown. The commercial opportunities and applications available are described in Section 7.8.

7.4 Lactose and citrate metabolism in cheese

Referring to the opening chapter of this volume, the central importance of lactose metabolism to lactic acid in the vat stage of cheesemaking suggests that there is little scope for manipulation without interfering with the very basis of the technology. This is partly correct, but the opportunities presented within the casein breakdown field by the introduction of selected lactobacilli into cheese are dependent on the fermentation of residual lactose in cheese, after the initial acidification by the starter culture in the vat. In effect, the lactose is converted to enzyme-rich biomass *in situ* and to 'secondary' lactose metabolites, such as carbon dioxide (CO₂), acetic acid and ethanol, all of which can modify the basic cheese flavour profile by more or less understood mechanisms. For example, ethanol reacts with FFA to produce fruity esters, such as ethyl hexanoate, in cheese; and acetic acid imparts added sharpness to cheese and reacts with methane thiol to produce a cheesy thiomethyl ester. However, the role of CO₂ in taste perception is not understood, though CO₂ production from citric acid, if controlled by the acidification technology and the ripening temperature, can be harnessed to control the texture, appearance and blue mould growth in cheese.

It is worth sounding a cautionary note here; the fermentation of residual lactose in the cheese matrix during storage/maturation by adventitious NSLAB can cause flavour defects such as excessive fruitiness and over acidification. Many of these lactobacilli from the local factory environment also produce CO₂ gas from the lactose, which, in pressed, vacuum-wrapped cheese blocks, causes unwanted cracks in the cheese structure and can inflate the wrapping like a balloon. This rather spoils the neat orderly space-saving stacks of curd blocks and causes stacks to fall, endangering store personnel. In New Zealand, such considerations have led to a branch of cheese technology, which has been developed to suppress NSLAB in Cheddar cheese by stringent factory air hygiene and rapid cooling of cheese blocks (to <10°C in 24 h) as soon as they have emerged from the block-former and been wrapped (Fryer, 1982). The cooled blocks are then kept for up to 2 weeks at about 6–8°C before they are transferred to a store at normal temperature. This procedure ensures that the population of NSLAB is held within a maximum limit of 1×10^6 cfu g⁻¹ cheese, at which level they cannot cause defects even if the cheeses are later force-ripened at 'elevated' temperature (see Section 7.7.1). However, this technology is only suited to the large-scale production of a uniformly high quality, clean-flavoured Cheddar of

predictable flavour profile and is not necessarily appropriate for flavour enhancement and diversification.

Lactose metabolism by the starter lactococci can be manipulated by genetic modification to enhance the production of volatile aroma compounds, such as diacetyl (buttery aroma), but this technology is not currently used in commercial cultures and, in the foreseeable future, it is more likely to find application in food flavour ingredient production than directly in cheese technology (for further information on this topic see Section 7.7.6).

7.5 The commercial drive for cheese-ripening and flavour technology

Chapter 2 of this volume gave an impression of the dynamic nature of the marketplace for cheese. One of the most important changes to influence the development of cheese technology has taken effect in recent years is manifested by the cheese manufacturing industry changing its attitude to customers from 'you will buy what we produce' to 'we produce what you will buy'. This change has been driven mainly by the buying power of supermarket retail chains, forcing manufacturers to cut costs, improve consistency and make cheeses with distinctive characteristics to underpin branding and brand loyalty within well-defined varieties.

However, there is also a direct influence from consumers at work. At the 'commodity' end of the market, cheese as a staple food does not have the healthy image it once had, whatever the nutritional facts may be. A significant proportion of consumers in countries with a tradition of high cheese consumption have taken note of government nutritional advice to reduce their calorie intake from foods high in saturated fat. This message has been reinforced by reports typified by that in the United Kingdom (UK) from the Committee on Medical Aspects of Food Policy, commissioned by the Department of Health, calling for reduced fat in the national diet. Consumers undoubtedly perceive cheese to be one of the foods to target for reduced intake but, ironically, the overall effect on the market has not been to drastically reduce consumption, but to make consumers more discriminating. They will not give up cheese, but they want to enjoy the risk of eating it and will select the cheeses with the most interesting flavour profiles rather than accept a standard bland flavour.

At the other end of the consumer spectrum, in the 'gourmet' sector, an increasing proportion of cheese is made with pasteurised milk in response to fears about pathogenic bacteria from raw milk multiplying in cheese. This generates particular difficulties for makers of high-value specialised traditional (artisanal) varieties; such cheesemakers refer to 'modern' milk supplies as 'dead' (Anonymous, 1995). Add to this factor the increasing use of clean stainless steel in enclosed factory environments with filtered air to eliminate natural microbiological variability, and the cheese industry has a dilemma; whether to make cheese boring and safe, or exciting and dangerous. With emerging cheese-ripening technologies, it may soon be possible to make cheese both exciting and safe, avoiding the dilemma and giving consumers the pleasure of eating cheeses with all the diverse flavours provided by complex microflora, using research-based knowledge and techniques to select out the ripening agents from the pathogenic and toxigenic agents.

7.6 Commercial opportunities created by cheese-ripening and flavour technologies

Obviously, the specific commercial outlets for cheese-ripening technology will be determined by the circumstances of particular businesses, so this discussion is generic. It serves as an introduction to the critical survey of available and emerging technologies, which follows in Section 7.7. The range of applications and corresponding opportunities is itemised in Table 7.1.

The potential to increase profits gained by faster cheese-ripening and reduced storage time is rather obvious, but the amounts of money involved are not easy to predict precisely, because they are heavily dependent on prevailing interest rates paid on the money tied up in the cheese inventory. As a rule of thumb, cheese companies usually reckon on about £ 25 tonnes⁻¹, or a little under US \$ 1 cent pound⁻¹ (at a prevailing interest rate of 8–9%), as the cost of holding hard and semi-hard cheese for 1 month in a ripening store. This figure does not hold true for cheeses which require special handling, such as mould-ripened and smear ripened cheeses, or cheeses with eyes, but it applies to a large proportion of world production. This means that any technology which can accelerate the ripening of cheese, such that it is ready for the mature market in 4 months instead of 10, will yield the manufacturer a gross saving of £150 tonnes⁻¹ or US \$ 6 cents pound⁻¹. This has to be set against the cost of the technology, of course, but this general level of saving is significant, especially in the production of bulk cheese for big retailers, where profit margins are small and where small price advantages can win orders against the competition. Applications in this commercial field can be either enzyme based or culture based, though enzymes are generally more effective, especially combined with a higher ripening temperature. The only known exception to this general rule can be seen in the use of attenuated cultures to restore and boost the ripening of Cheddar cheeses made with bacteriophage-resistant defined strain cultures. This natural resistance to phage also confers on them vigorous acid production in the vat and a low lysis rate in cheese, all of which adds up in practice to very reliable cheesemaking, but slow and uninteresting flavour development. This can be alleviated by the addition of attenuated strains, typified in the industry by the CRTM cultures described in Section 7.7.4.

Table 7.1 Commercial applications and opportunities created by new cheese-ripening and flavour technologies.

Application	Opportunity
Shorten cheese storage time (enzymes, temperature)	Higher profit margin and/or more competitive pricing
Control inventory (enzymes, temperature)	Supply from stock, cheeses of different maturity and flavour intensity
Flavour diversification (cultures)	New customers and maintained interest of existing customers
Improved flavour of low-fat cheeses (enzymes, cultures)	Expand a small but profitable product sector
New cheese-flavoured food ingredients (enzymes, cultures)	Diversification and expansion of business

Inventory control is also facilitated by cheese-ripening technology which accelerates the normal ripening process. Cheese manufacturers now have a means of planning amounts of mild, medium and mature cheeses in store at any time, through predictable, variable ripening rates. This technology could also be used to 'even out' the stock of mature cheese in countries which have marked seasonal variations in milk supply (e.g. Australia and Ireland), and to compensate for poor rates of flavour development in milk produced near the extremes of lactation cycles. Culture-based technology has not delivered sufficient acceleration of ripening for this type of application and temperature control or enzyme technology are therefore the methods of choice.

Flavour diversification applications are already in use in the Australian and UK hard cheese industry and in some mainland European countries for washed-curd cheese. This technology is culture- rather than enzyme based, and involves the addition of top notes to traditional flavour profiles, using selected strains of lactobacilli (*Lactobacillus casei*, *Lactobacillus plantarum* and *Lb. helveticus*). However, there is still enormous untapped commercial potential within this technology through the application of state-of-the-art isolation and identification techniques to natural cheese microflora (as discussed in detail in Section 7.7.5).

The food ingredients sector impact of cheese flavour and ripening technology is more difficult to predict because the underlying R&D is less well developed than it is in the cheese-ripening field. The well-understood flavours, such as blue cheese and Swiss-type cheese, can already be generated in semi-liquid, non-cheese formulations and used for cheese dips and as snack food flavourants (Kilcawley *et al.*, 1998), but collective chemical knowledge of other flavour profiles, such as mature Cheddar, Camembert and Gouda, is too primitive to underpin similar technology for these flavours as food ingredients. However, there are clear opportunities to control the ripening of the cheeses themselves arising from cheese flavour R&D, as discussed critically in the following review of ripening control methods (summarised in Table 7.2).

7.7 Methods for the controlled and accelerated ripening of cheese

7.7.1 Elevated storage temperatures

It seems self-evident that if a cheese is held in store at a higher than normal temperature it will ripen more quickly; the microorganisms in and on it will grow faster, and enzyme-catalysed reactions will accelerate according to well-known laws of biochemistry. The state of the art was reviewed by Law (1984), and nothing fundamentally new has emerged in the scientific or technical literature since then, though the earlier findings of Law *et al.* (1979), that the most significant effect of elevated temperature on Cheddar composition was in the increased growth rate of NSLAB, have since been confirmed by Grazier *et al.* (1991, 1993), who also presented modelling data for cooling gradients/rates in 20 and 290 kg cheese blocks. It is worth emphasising again that the scope for using elevated temperatures to speed up ripening comes from the relatively low temperatures (<10°C) which are normally used in cheese stores. Although some varieties are placed in 'warm' rooms for specified periods to develop particular characteristics (e.g. for eye formation in Swiss-type cheeses), low storage temperatures are generally a logical and beneficial element in the stability of cheese

Table 7.2 Cheese-ripening and flavour technology options for control.

Basic technology	Advantages	Disadvantages	Availability
Elevated temperatures	'Free' technology, relatively simple, low cost	Indiscriminate, no creative scope	Unlimited
High-pressure processing	Potential to give very rapid ripening, may boost efficacy of existing methods Selective for known maturity indices, proven efficacy	Hardware not yet developed Underdeveloped in-factory application technology	Research only Added food-grade enzymes Commercial food enzyme suppliers, IBT ^a London
Attenuated starter cultures	Boosts natural ripening process, safe and easy to use, proven efficacy for quality improvement	Limited flavour intensification, limited flavour range	Chr. ^b Hansen A/S Denmark
Culture adjuncts	Relatively inexpensive scope for flavour diversification	Possible atypical flavour and texture defects	All major culture suppliers ^c
Genetically modified starters	Absolute control of ripening biochemistry, consumer safety spin-off	Cost of regulatory compliance, consumer suspicion of GM technology	Public and company R&D laboratories for pilot trials

GM, genetically modified; R&D, research and development; IBT, Imperial Biotechnology Ltd.

^aThe AccelaseTM enzymes.

^bThe CRTM cultures and EnzobactTM.

^cMainly from *Lactobacillus* collections.

as a safe food. Thus, elevated temperature should be used with due consideration for its possible stimulatory effects on spoilage micro-organisms and pathogens, and should only be used on cheeses made from pasteurised milk in plants operating on very strict hygiene regimes. Information on the predicted effects of temperature on the growth of food bacteria is widely available, and proprietary systems, such as 'micromodel' (McLure *et al.*, 1994), provide such data in customer-interactive PC-compatible form. The general behaviour of pathogens in cheese has been summarised in an International Dairy Federation /Federation Internationale de Laiterie Bulletin (Spahr & Url, 1994).

Most practical attempts to control (speed-up) ripening using temperature have, thus, been made with the very stable hard and semi-hard varieties, such as Cheddar, Gouda and Edam, which have relatively simple LAB microflora. The experiments with Edam and Gouda were not very successful; at 16°C, Gouda cheese ripening was unbalanced, proteolysis proceeding too quickly and giving rise to bitter cheese. In the view of the present author, this is a predictable result of high populations of non-lysing starter lactococci left over from the normal low-scald washed-curd making process. The selection and use of easily lysed starter strains as acidifying cultures would probably overcome this problem (cf. Section 7.7.6). An additional complication in this type of cheese comes from the faster growth of *Clostridium tyrobutyricum*, when present as a contaminant, leading to high incidences of late blowing and slit openness.

Cheddar cheese maturation can be speeded up by raising temperatures in commercial cheese stores, though the really effective range of temperatures, around 15°C, are associated with lower preference from flavour panels and very rapidly-growing NSLAB, even though the overall flavours are more intense. However, a more recent report by Hannon *et al.* 2005 suggests that, where there is scope in the storage plant, cheddar ripening can be speeded up using combinations and successions of ripening temperatures. The study showed that mature flavour notes and corresponding gross indices of proteolysis were controllable by an initial period of high temperature (e.g. 20°C for 1 week), followed by normal ripening (8°C in this case) for 8 months. This procedure is claimed to gain 2 months' maturation with no loss of flavour balance, though no microbiological data were shown to investigate the potential of accelerated growth of harmful microorganisms. The industry consensus is that temperatures >12°C will also adversely affect body/texture grades in most cheese, particularly those carrying moistures of 37 g 100 g⁻¹ or more, even if no microbiological defects are evident (flavour taints, discolouration, gas formation) due to rogue lactobacilli. Cheeses made with active, phage-free starters and with good factory hygienic practice will stand-up to prolonged storage at up to 12°C in the course of inventory management. The biggest limitation of this method is inherent in its mechanism; it makes good cheese become good more quickly but potentially poor cheese will deteriorate more quickly as well, so cheeses have to be carefully graded and selected for 'forced ripening'. Moreover, there is no scope for flavour diversification, and 'warm' cheese would need to be transferred to a cool store en masse if the customer had a change of mind about the order. Transfer to a cool store may also be necessary prior to shipment with other foods in refrigerated containers/trucks; cheese is a very strong heat sink and in large quantities can overcome refrigeration systems.

On the plus side, there is no proprietary knowledge or technology to restrict the application of temperature control technology, as there is in some of the more sophisticated enzyme-based and culture-based methods. The technology itself does not involve any fundamental

changes in the cheese manufacturing plant, nor added-cost enzyme and culture components, unless the rapid-cooling technology advocated by Fryer (1982) (Section 7.4) is used, in which case a blast cooling tunnel should be installed immediately after the tower block-former, compulsory elements in this technology. It is unlikely that rapid cooling followed by warm forced ripening could be applied to the 290 kg (640 lb) blocks produced in some United States of America (USA) plants due to the steep temperature gradients which would be set up, with the associated uneven ripening (Reinbold & Ernstrom, 1985).

7.7.2 *Ultra-high-pressure technology*

There is now a sound body of evidence supporting the claim (Fuji Oil Company, 1991) that subjecting young cheese to very high pressure (100–1000 MPa) for a short period accelerates the rate at which it ripens. The food industry already has an interest in this branch of high-pressure processing technology because it has the potential to provide a new low-temperature method for eliminating spoilage and pathogenic microorganisms from foods which are structurally and nutritionally damaged by conventional heat treatments. To the knowledge of the present author at the time of writing, the major R&D programme, which is likely to influence cheese-ripening technology, is active within the European Union FAIR Programme (Projects FAIRCT96–1113 and FAIR-CT96–1175). The technology appears to work both by breaking open the starter culture cells in cheese to release their enzymes, and by activating the enzymes *per se*, to give very rapid increases in flavour-potentiating proteolysis (and probably other reactions, also).

7.7.3 *Enzyme additions*

The underlying scientific knowledge which has guided the development of enzyme-based cheese-ripening and flavour technology is reviewed in Sections 7.2, 7.3 and 7.4. Although enzymes have a long and well established history of use in EMC as a food flavouring and in processed cheese (Section 7.8), their direct application to the controlled ripening and flavour development of recognised cheese varieties for direct consumption is relatively new, lipase-containing Italian hard cheeses apart. As is the case with most good scientific ideas, technology transfer to the real world of process innovation and product manufacture presents unique and often unforeseen challenges. Thus, it was with proteolytic enzyme systems in cheese; Fig. 7.2 shows the stages in the manufacture of hard and semi-hard cheese, which could be the addition points for ripening enzymes. This diagram applies to any enzyme, but the process implications which have to be considered for proteinase enzymes are wider than they are for lipases, the other major option available now.

Proteinases, which are added to break down casein in cheese, are only needed in small amounts because, like all enzymes, they are catalysts, and a small quantity will convert a large quantity of its substrate. This is fine from the conversion efficiency point of view, but means mixing gram quantities of the active enzymes with tonnes quantities of cheese. Putting enzymes into the complex cheese matrix is hard enough in itself, but the problem of distributing such small amounts evenly in cheese is not at all trivial. From the mixing point of view, addition point 'a' (Fig. 7.2) would be ideal because this is the stage at which

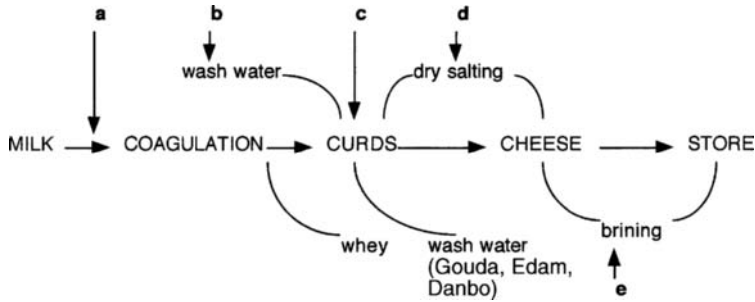

Fig. 7.2 Possible enzyme addition points during the manufacture of hard and semi-hard cheeses: (a) to the milk in the cheese vat, before coagulation, (b) in the wash water in the manufacture of washed curd cheeses, such as Edam, (c) to the cheese curd immediately after separation of the whey, (d) to the milled curd immediately before hooping and pressing (normally added with the dry salt) and (e) at the brining stage if dry-salting is not used.

all the other active ingredients are added (rennet and starter culture). However, the cheese-ripening proteinases, unlike rennets, will quickly start removing large soluble fragments of alpha- and beta-casein, which will be lost in the whey when it is separated from the curds, causing unacceptable losses in the yield of cheese. Also, this early breakdown of casein structure impairs its function in creating a gel network, and the resulting curds become soft and unworkable in the later stages of manufacture. Add to these problems, the estimated loss of up to 95% of the ripening enzymes in the whey, and it is clear that direct addition of enzyme via the milk is not an option.

Microencapsulation technology was developed in the author's laboratory to overcome all of these difficulties, using liposomes to entrap the enzymes and physically enmesh them into the casein matrix as the curd gel is formed (Kirby *et al.*, 1987). Although this technique is very effective in small-scale cheesemaking and has been adopted by numerous applied science investigators (Skie, 1994), the cost of the pure phospholipids necessary to make stable, high-capacity liposomes rules this out at present as an economically viable technological solution.

Other approaches to proteinase encapsulation have been summarised by Kailasapathy and Lam (2005), including the use of food-grade gums, and this seems to offer new opportunities for cheese-like products, though the cheese regulations would not currently permit gums as ingredients in natural cheese.

The closed-texture semi-hard cheeses typified by Gouda and Edam are made by a process which includes a curd 'washing' stage to replace some of the whey with water and reduce acidity. Although this stage (Fig. 7.2; point 'b') and the soft curd stage which follows (Fig. 7.2; point 'c') offer a further opportunity to introduce enzymes uniformly into the cheese matrix, they both create other problems through curd softening, yield reduction and loss of enzymes into the wash water. Addition point 'e' (Fig. 7.2) has been discounted without serious consideration because cheese researchers can predict that enzyme penetration into the very closed cheese structure at this late stage would be only millimetres. In practice, this makes washed curd cheese particularly difficult to ripen with enzymes. Although Wilkinson & Kilcawley (2005) suggested in their review that mechanical injection of enzymes may

offer new solutions to addition at the finished cheese stage, there are no such efficacious technologies on the market at this stage.

In dry-salted cheeses, the addition of enzymes to milled curd with the salt (Fig. 7.2; point 'd') was originally proposed by Kosikowski (1976) for laboratory-scale cheesemaking, and was successfully adapted to the 180 L vat scale by Law & Wigmore (1982, 1983). However, this technique is difficult to adapt and scale-up to automated dry-salting equipment in factories converting hundreds of thousands of litres per day; granulation of enzymes and salt together improves their distribution into the milled curd, but the inherent unevenness of salt distribution within many factory systems can cause uneven ripening within cheese blocks. IBT in the United Kingdom took up the option to develop the combined proteinase/peptidase technology (Law & Wigmore, 1983) in the form of Accelase™ and has developed a number of options to overcome and/or ease these enzyme incorporation problems, as well as widening the flavour options available by introducing additional enzymes to the original formula; the current commercial system, its composition, application and performance are described by Smith (1997). Accelase™ contains a cocktail of endo- and exopeptidases to ensure a progressive and balanced breakdown of caseins to non-bitter peptides, savoury enhancers and flavourgenic amino acids, in a way analogous to that shown in Fig. 7.1. To ensure that the proteolytic taste is not overwhelming, Accelase™ also contains lipases and unnamed flavour enzymes, which are presumably food grade.

IBT does not sell these enzymes individually, but offers a formulation based on the cheese type, coagulant in use, starter culture regime and market destination for the cheese (full-fat, reduced-fat, industrial or non-Cheddar). Commercial trial data published by IBT suggest that, Accelase™ treatment not only shortens the time to reach Cheddar maturity by half but also enhances typical Cheddar cheese flavour notes, and generally improves the balance of cheese flavour profiles. However, it is not clear from the published data how IBT has overcome the original problems of incorporating the enzymes into the curd evenly and efficiently without radical changes to the manufacturing technology.

7.7.4 *Attenuated starter cultures*

Although starter cultures are an obvious choice as ripening agents to control and accelerate the maturation of cheese (Fig. 7.1), their central role in the progressive acidification and syneresis of cheese curd precludes the simple approach of putting more culture in, to increase their normal ripening action; more culture means more/faster acid production and a different type of cheese. However, there are several ways of preventing or reducing the acidification function (attenuation) whilst retaining the cheese-ripening enzyme potential of starter cultures within the intact cellular structure, thus gaining an added technological advantage, in that the enzymes become naturally entrapped in the cheese matrix as it forms and are not lost in the whey. Cheddar cheese curd has the capacity to 'hold' two to three times the biomass of starter culture that is normally produced in the vat acidification stage, though the technological target to balance production economics with efficiency is two times the normal starter biomass.

Treatments which will prevent/curtail acid production in the cheese vat by starter cultures, yet preserve their ripening enzymes intact, include heating or freeze/thaw cycles; exposure to lysozyme under conditions which do not lyse the starter, but prevent energy metabolism

and render it sensitive to salt-induced lysis; and selection of natural variants, which cannot ferment lactose (Lac^{-ve}). These are not all adaptable to commercial flavour control products, and it is worth analysing their relative advantages and disadvantages before focusing on the method which has formed the basis of a culture on the market today (the CRTM cultures, produced by Chr. Hansen A/S, Denmark).

In the author's experience, strains of the mesophilic *Lactococcus* starter cultures are inherently variable in their response to heat or cold shock, not only between species and genera but also between strains; indeed, the condition and age of culture also has a profound effect on their response to these physical treatments. Thus, it is impossible to set a reliable process schedule for the general application of heat or cold shock technology for this group of cheese bacteria. This is unfortunate, because such approaches do not involve complex pre-treatment, and offer the potential of exploiting the natural enzyme balance which is normally present in ripening cheese. The situation is more promising with lactobacilli, to the extent that a product is on the market in Sweden and Finland, based on a heat-shocked strain of *Lb. helveticus* (EnzobactTM, made by Medipharm, Sweden). The attenuated culture accelerates the ripening of low-fat versions of traditional Swedish hard cheese, and the technology is based on the work of Ardo & Pettersson (1988).

Lysozyme is a naturally occurring enzyme extracted commercially from hen egg white and used in the cheese industry as a replacement for nitrite to control late blowing by *C. tyrobutyricum* in washed curd cheeses. It normally acts by lysing bacterial cells, but when pre-grown, resting cells of starter LAB are exposed to it in deionised water, the lysozyme only binds to the cells and stops their metabolism; it only lyses them if the ionic strength of the medium is raised to a concentration which corresponds roughly to that in cheese curd moisture when it is salted. Law *et al.* (1976) exploited this phenomenon to prove that the late stages of proteolysis in Cheddar cheese (amino acid production) are dependent on lysed/permeabilised cells rather than viable starter cells, and simultaneously demonstrated that proteolysis in cheese could be accelerated using this technique. However, although lysozyme is now a relatively inexpensive enzyme to use commercially, the pre-treatment process is somewhat laborious and not suitable for routine use in cheesemaking technology.

Natural variants of LAB, which have lost the ability to ferment lactose, provide a more practical and economically viable source of attenuated starters. They occur spontaneously in all starter cultures because the genetic information for their lactose-utilising system is not encoded on chromosomal deoxyribonucleic acid (DNA), but on easily-lost plasmid DNA. This is not a great problem to the bacteria when they are propagated in lactose-based media, because the variants are constantly selected out of the main population by their slow growth compared with the lactose fermenters. However, they can be isolated and grown on a glucose medium and put back into cheese together with the acidifying culture, with no change to the normal cheesemaking process. As every other part of these cultures is the same as a normal starter, this additional non-acidifying strain adds its ripening enzymes to those of the acidifying culture and boosts ripening. The technical development and range of commercial application of these cultures has been described by Vindfeldt (1993).

In essence, they are first selected using a rapidly ripened cheese model to determine their flavour profiles, then the lactose negative variants of the best ones are selected out for large-scale production in milk-based media. After fermentation, harvesting and concentration, they are packaged into amounts corresponding to their cheese-ripening power *per* litre of cheese

milk or kilogram of cheese and supplied as deep-frozen concentrates. They have only to be thawed and added directly to the milk in the cheese vat with the normal (acidifying) starter. They play no part in the curd-making stage but begin to act in the cheese store; no special plant technology is needed and because they are naturally occurring variants of established food bacteria there are no restrictions on use. These cultures will produce a mellow, 'round' finish to the flavour of sharp mature cheese, soften the sometimes harsh acidity of young cheese to give a high-quality mild cheese flavour, and add a slightly sweet flavour note to any basic Cheddar cheese flavour.

CRTM cultures cost about the same as good enzyme blends to buy, though they are less labour intensive to use than are enzymes and can be used 'off the shelf'. They can be applied to any cheese variety, irrespective of the acidification technology or method of curd formation, because addition is via the milk before curd formation and the cultures are well-tried dairy LAB with no defect-forming characteristics. They will boost the basic taste-forming process reliably to an extent that the introduction of top notes, using the culture adjunct technology described below, can become an added benefit, and the top notes are not allowed to unbalance the final cheese flavour profile. As more information emerges from research laboratories about the way in which starter bacteria produce aroma compounds from free amino acids, the technological potential of attenuated starters will increase to cover the top note function as well.

Attenuated starter strains blended in the form of the CRTM 213 culture from Chr. Hansen improve the flavour of low-fat (15 g 100 g⁻¹) Cheddar-type cheese (Banks *et al.*, 1993). It is worth clearing up some confusion which existed when this study was made, in that attenuated starters were sometimes called 'adjuncts' by users, but this term is now confined to non-starter cultures, added deliberately to add new notes to cheese flavour profiles (see Section 7.7.5). The trials in question demonstrated that the effectiveness of CRTM 213 in low-fat cheese is most pronounced at salt concentrations closer to those found in normal Cheddar (1.75 g 100 g⁻¹) than the reduced salt levels sometimes used to lower the saltiness of high-moisture, low-fat cheese. This is presumably because the higher salt concentrations cause the attenuated culture to lyse and release its ripening enzymes more quickly. Whatever the underlying phenomenon involved, the sensory data emerging from these trials has been very encouraging for cheese technologists; the CRTM culture significantly increased the maturity (flavour/texture combined) and characteristic Cheddar flavour scores in the treated cheeses. Their use also enhances a range of taste and aroma characteristics important to balanced flavour (creamy, sulphurous, nutty), whilst bitterness was markedly reduced.

7.7.5 Non-starter adjunct cultures

Although attenuated starter cultures are a reliable and effective way to increase and enhance the taste impact of most hard and semi-hard cheese varieties, the established role of the non-starter cheese microflora in adding top notes to cheese flavour profiles (see Section 7.2) has led to their exploitation as commercial adjunct flavour cultures, to be used either alone or with attenuated starters for complete control over flavour intensity and flavour character. The culture adjuncts have been selected and blended by the major culture suppliers to fit this specification and are mostly NSLAB (*Lb. casei*, *Lb. plantarum* and *Lb. helveticus*), though

aerobic smear bacteria such as *Brevibacterium linens* are also available for pilot-scale trials to give additional flavour notes.

There are some similarities between the flavour-enhancing effects of NSLAB, when used as adjunct cultures, and the attenuated starters, as demonstrated by Lynch *et al.* (1996), who showed that they boost proteolysis down to the level of free amino acids. However, the effects of adjunct cultures are not always predictable or controllable and their use is not adequately backed up by knowledge of the flavour biochemistry involved. For example, one 'side effect' already documented involves the ability of some lactobacilli to release small but significant amounts of CO₂ gas from free amino acids. NSLAB population dynamics in hard and semi-hard cheeses are such that any gas formed by this mechanism, rather than the via the more usual sugar fermentation route, cannot escape from the cheese matrix and causes cracks and splits in the cheese, leading to downgrading of appearance, and crumbliness when cut for retail packs (causing wastage and poor presentation).

On the positive side, many potential defect-forming traits have been screened out of the range of commercially applied adjuncts and, in spite of the lack of biochemical background knowledge, the NSLAB microfloras of different cheese factories can give their product distinctive flavours, which can be sold under a premium brand label. The research of culture companies in this area is confidential, of course, but it will certainly focus on precise DNA- and ribonucleic acid (RNA)-based taxonomy of the most efficacious isolates, so that the strains responsible for the flavour distinctions can be produced and blended faithfully and reproducibly for sale and use in customers' factories. In Europe, the science and technology base has taken a lead in this area of research through a European Union (EU)-funded project called 'FLORA' under the COST 95 umbrella. Non-starter microflora in varieties, such as Feta, Dutch-type semi-hard cheeses and surface smear cheeses, have been isolated and investigated for their ripening actions. This work has confirmed the universal contribution of NSLAB in Gouda, Feta, Emmental and Muenster cheese to reducing rennet and starter-derived peptides to amino acids.

The dominance of good surface smear microflora by coryneform bacteria, staphylococci and yeasts is also confirmed within this concerted action project. Bockelmann *et al.* (1997) have used the project data to show that a defined mixture of these microorganisms can reproduce and control the aroma and colour of cheese smears; this is the first step towards replacing the random and often unreliable smear technology, based on brining and wiping the cheeses with salt-laden cloths as sources of the active smear flora. This topic is covered in more detail in Chapter 6.

7.7.6 Genetically modified LAB

Genetically modified (GM) versions of common cheese bacteria have been used by researchers for the past 20 years in controlled laboratory experiments designed to deduce the biochemical basis of all of the industrially-vital functions of dairy LAB, including acid production, flavour and aroma production, protein utilisation, bacteriophage resistance and extracellular polysaccharide secretion. This knowledge base is so advanced now, that many GM LAB have been constructed using food-grade gene vectors and markers, which avoid foreign DNA, especially the antibiotic resistance markers, which were the mainstay of early

Table 7.3 Genetically modified cheese starter lactic acid bacteria for cheese-ripening and flavour technology.

Genetic modification	Change from wild type	Ripening/flavour effect
Lactose metabolism diverted by selective elimination and enhancement of key metabolic pathway enzymes	Increased production of diacetyl and acetic acid	Enhanced buttery flavour, sharper background taste
Changed proteinase and peptidase balance, selectively enhanced peptidase production	Specific increases in concentrations of aromagenic amino acid concentrations in cheese (e.g. glutamic acid, methionine, cysteine, proline, valine, glycine, leucine, tryptophan)	Reduction of bitterness, enhancement of overall taste intensity, increases in sweet, sulphurous, floral or nutty flavour notes
Introduction of cell lysis genes under control of externally triggered promoters (e.g. pH, temperature, salt concentration)	Controlled instantaneous lysis in cheese matrix	Faster release of intracellular flavour-producing enzymes (peptidases, esterases, amino acid-catabolic enzymes)

laboratory-based contained experiments. The current GM dairy strains available for trials from culture companies comply fully with all national/federal regulations covering GM organisms (GMOs) for food applications in the EU member states and the USA, and they all use self-cloning, homologous DNA technology (see Chapter 5 for a detailed account of this topic).

GM LAB which can be applied to cheese-ripening and cheese flavour technology have been changed with respect to either their sugar metabolism, peptidase production capacity or their rate of lysis in the matrix of freshly-made cheese. These modifications are summarised in Table 7.3, and described below in terms of their potential impact on cheese technology.

Metabolically altered strains of Lc. lactis spp. – Basic research into the enzymes and metabolic pathways, which LAB use to convert lactose and citric acid to lactic acid and aroma compounds, has paved the way for the development of new *Lactococcus* starter variants with greatly enhanced aroma potential. Most of the research is based on attempts to increase the flux of metabolic intermediates between pyruvic acid and lactic acid towards the production of dicarbonyls, such as diacetyl, and to acetic acid, by enhancing the expression of α -acetolactate synthase and suppressing its decarboxylase.

The resulting accumulation of acetolactate and its natural oxidation to diacetyl can be exploited to enhance the flavour and aroma of fresh, unripened soft cheeses. Lactate dehydrogenase mutants are also good aroma producers because they accumulate pyruvic acid, which the bacteria then metabolise to alternative end products both to protect themselves from toxic accumulation and to try to gain some energy. Both the diacetyl precursor, acetolactate and the flavour compound, acetic acid, are end products of this process, and additional mutations to the enzyme diacetyl reductase have further improved the aroma-forming capacity of these genetic variants. It is important to stress that, although permission to conduct trials on these strains is granted in several EU member countries and in the United States, they are not used in commercial cheesemaking and, if they were to be introduced, it would be necessary to label them to show the presence of cultures produced by GM,

even though the final strains in the cheese may not themselves contain any genetically engineered DNA. The industrial research and development in this field is confidential and none of the results of current pilot-scale trials is in the public domain, but the reader can grasp the basis and potential of the research from papers such as those of de Vos (1996) and Swindell *et al.* (1996). Both reports give details of genetic manipulations of *Lc. lactis* spp., in which metabolic routes from lactose to the key intermediates α -acetolactate and acetate are mutated to yield variants which accumulate aroma compounds at higher than normal concentrations.

Proteolytically altered strains of starter and non-starter LAB – Research-based information about the genetic manipulation and flavour potential of proteinases and peptidases of starter LAB is now widely available in the literature (see Chapter 5). We can expect that controlled cheesemaking experiments will soon reveal which combinations of these enzymes are best for avoiding bitterness, and for increasing the concentrations of key amino acids, such as glutamic acid (taste enhancer), proline (sweet), methionine and cysteine (precursors of a range of known cheese aroma compounds) and phenylalanine (floral aroma precursor). Indeed, overexpression of two general aminopeptidases in a commercial strain of *Lc. lactis* spp. has already increased the flavour quality and intensity of Cheddar and Dutch-type cheese (E. Johansen, personal communication; see Chapter 5 for more information), and natural proteinase-negative variants of commercial starters are an established part of bitterness avoidance.

Experimental data accumulated over many years of cheese R&D have shown how certain starters can produce more bitter peptides in cheese than others, and culture companies generally screen them out of their collections. However, some of the most reliable acid-producers have strong bitter peptide-producing proteinases, which they rely on for rapid growth in milk, so we cannot eliminate them without losing their usefulness in the vat. In such cases, the proteinase-negative variant option is not available, but genetically enhanced peptidase production will ensure that the bitter peptides cannot accumulate and cause the flavour defect. The emerging technology arising from this research does not necessarily have to be achieved by genetic manipulation *per se*; the knowledge generated by genetic engineering experiments can be used to determine the important enzyme activities by which to select naturally occurring peptidase variants from existing strain stocks.

Recent reports that starter LAB are not only responsible for the accumulation of free amino acids in cheese but can also catabolise them to volatile sulphur compounds, 'cheesy' branched-chain FAs and aromatic esters, add to the technological potential of genetic engineering and biochemical screening of starter strains.

Starter cultures genetically altered to lyse quickly in cheese – There is now an established positive link between the rate and extent to which starter cultures lyse and release enzymes into young cheese on the one hand, and the quality and speed of flavour development on the other (Crow *et al.*, 1995). Whilst this link provides cheese technology with an opportunity for flavour and ripening control through selection of starter strains whose natural cell wall lytic enzymes (lysins) are very active on cell death, such strains are not in themselves very useful commercially. They are easily damaged and lose acidification activity during the rigours of culture production (harvesting, freezing, drying, storage), they tend to be very sensitive to bacteriophage, and they are relatively slow acidifiers, especially at the critical late stages of curd texturisation at the approach to maximum scalding temperature.

This conflict between two important functionalities, robustness in production and flavour formation in ripening, can be overcome by GM technology, based on research on the gene-switching (promoter) mechanisms in LAB. The LAB have a range of environmentally-sensitive gene promoters, which respond to stimuli, such as changes in pH, salt concentration and temperature. The natural antimicrobial peptide, nisin, can also trigger gene expression at very low (non-inhibitory) concentrations. Normally, the promoters are linked to switching genes important to the life cycle and stress responses of the starter cells, but this natural phenomenon has now been used by molecular geneticists to make them lyse 'to order'. They have constructed lactococcal variants of good commercial starters, which contain the gene for bacteriophage lysin, under the strict control of one of these promoters, so that the lysine is not expressed until the cheesemakers want it to be, after the vat stage, and in the newly pressed cheese curd. This method for inducing lysis and enzyme release also has the effect of lysing any attenuated culture added to boost or modify flavour, so there is a synergy between the two technologies.

In practice, there are two commercial approaches to this method on trial; one is based on the original work of Gasson's group in the United Kingdom, in which a cloned bacteriophage lysin is triggered by osmotic shock in response to a critical pH, temperature or lactic acid concentration (for further detail on this subject see Chapter 5). The other approach has been developed and patented as the 'NICE' system by NIZO Food Research in The Netherlands, and depends on triggering cloned phage lysin by Nisin, either added in small ($\mu\text{g g}^{-1}$) amounts to the cheese curd or produced by the starter itself late in the cheesemaking process. The experimental and research basis of this technology is described in an article by de Ruyter *et al.* (1997). Although the 'NICE' system is not available as off-the-shelf technology, it is an inherently safe process (technologically and in terms of GM risk assessment) and, like any phage lysin cloning strategy, it also has the advantage of being applicable to the customers' favourite cheesemaking starter strains by custom modification.

7.7.7 Rules and regulations for GMOs in foods

The legal and regulatory framework controlling the construction and use of GM cultures in cheese (in countries whose legislation will permit this in principle and not all countries will at the time of writing) is common to that covering all GMOs in food. The underlying purpose is to allow research scientists and product technologists to construct genetic variants under safe conditions and to put them on trial outside the confines of the laboratory in a controlled manner, the environmental risks having been evaluated independently and permission granted if considered negligible. These laws and regulations vary from country to country, though at present the EU has the most stringent laws, short of outright prohibition, whereas the United States takes the view that there is no need for new regulations specific to any branch of food biotechnology, including GMOs; the safety of all foods and food products is controlled under existing statutes on plants, animals, pharmaceuticals, pesticides and toxins.

Thus, the EU has developed specific GMO regulations to circumscribe its Novel Foods Regulations, embodied in Directives 90/219/EEC ('Contained Use of GMOs') and 90/220/EEC ('Deliberate Release of GMOs into the Environment'). EU member states are obliged to adopt these directives as statute law and the United Kingdom has done so already

under its existing Health and Safety at Work Act (1992 and 1993: Contained Use of GMOs) and Environmental Protection Act (1993 Controlled [Deliberate] Release of GMOs into the Environment).

The European Commission has also spelled out the labelling requirements for foods containing GMOs and/or their products, all underpinned by a very precise definition of a GMO: *An organism, capable of replicating or transferring genetic material, in which the genetic material has been altered in a way that does not occur naturally by mating and/or natural recombination.* However, there were many aspects of the draft labelling regulations with which consumer groups strongly disagreed, mostly related to ingredients from plants (soya was the main case in point) altered for primary production efficiency, which were not originally to be labelled. However, this issue has now been resolved in favour of consumers in an EU Council Regulation passed in 1998, requiring 'all' food which 'actually has, or may have' (if the supplier cannot distinguish between GMO and non-GMO sources) parts of GMOs in them to be labelled clearly to that effect. Cheese technologists will also have to address this regulation in Europe when GM cultures come on-stream. It is already possible to make cheese flavour-enhancing cultures by GM methods involving food-grade gene vectors and markers (see Chapter 5) using only native DNA within a species. This is inherently safe, but lay consumers may classify this with genetic engineering involving 'foreign' gene insertions into existing chromosomal or plasmid DNA, unless the distinction can be explained and the labelling properly interpreted. There is a strong case for the cheese industry, culture suppliers and retailers to set up an information programme to allow consumers to make knowledge-based decisions about the benefits and perceived risks associated with new products containing GM cultures, however superior to the originals they may be in flavour and texture (Institute of Food Science and Technology, 1996).

Chapter 5 has a detailed technical appraisal of this field of regulation as it applies directly to the commercial development of potential GM starter Labs for flavour technology.

7.8 EMCs and cheese flavour products

Cheese flavour concentrates, flavour-building blocks and EMCs are used mainly in processed cheese (Fox & McSweeney, 1998), cheese-flavoured snack foods and cheese dips. The history of EMCs is quite short and probably started with the use of semi-refined lipases and proteinases to make Italian (Provolone) flavoured products in the 1950s. The use of animal and GRAS microbial enzymes to make EMCs was approved in the USA in 1969, and such products came into large-scale, regular use in processed cheese in 1970. Most of the major dairy ingredient and food flavour suppliers now have well defined product lines on the market, and the details of their manufacturing and formulation technology is clearly of a proprietary nature and not available for publication, but the general steps involved in making EMCs and flavour concentrates are generic and relatively simple (West, 1996) (Fig. 7.3).

Shredded young bland cheese, cheese off-cuts or salted cheese curd is mixed and homogenised/blended with emulsifying salts and water to a semi-liquid state (40–55 g solids 100 g⁻¹), pasteurised for 10 min at 72°C, and then cooled, ready for enzyme treatment or fermentation. The incubation temperature at this stage depends on the flavour reactions employed. For blue cheese flavour production, for example, a relatively low temperature

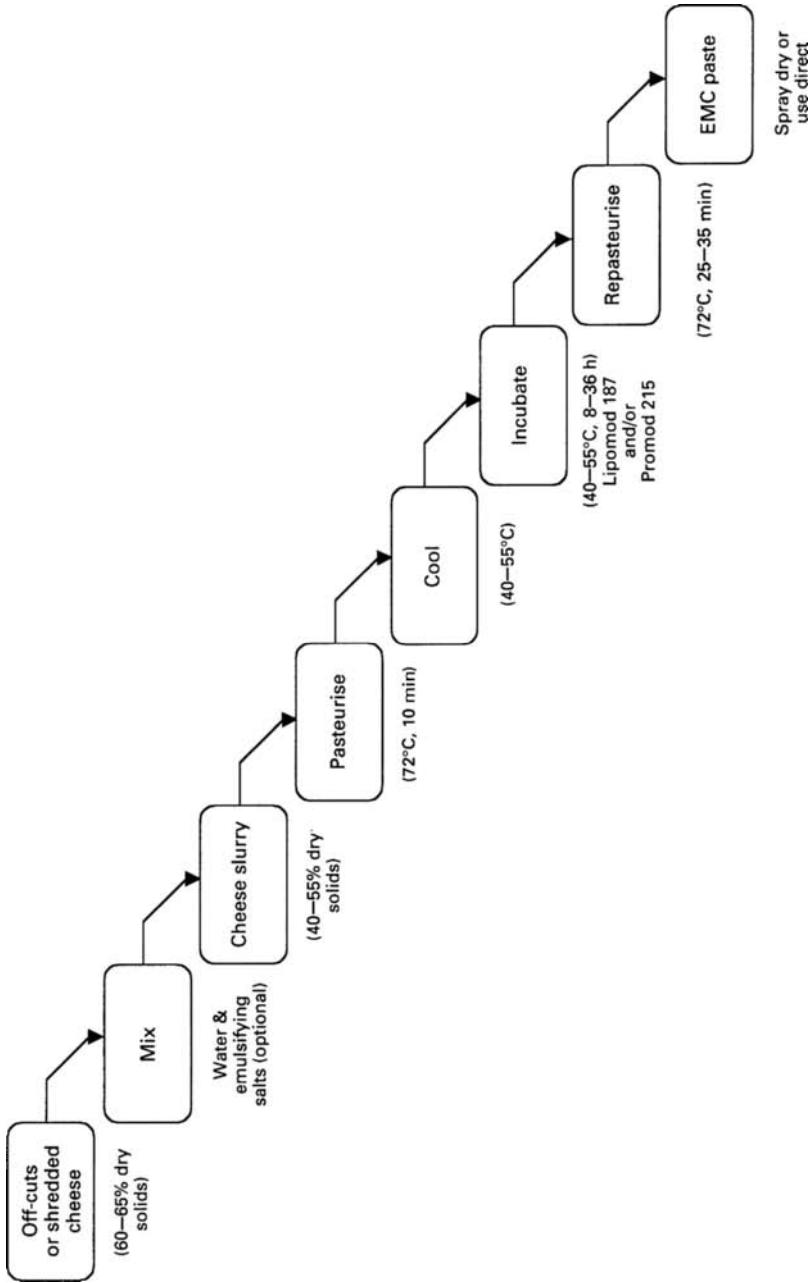

Fig. 7.3 Schematic representation of enzyme-modified cheese (EMC) production.

(approximately 25–27°C) is needed for the *Penicillium roqueforti* mould to germinate, grow and metabolise milk FAs to the characteristic methyl ketones, but pre-treatment with lipase to generate the FAs from the fat would require 40–55°C for maximum efficiency. However, some blue cheese flavour production schemes use lipolysed cream to add the FA notes after the fermentation (Tomasini *et al.*, 1995), eliminating the need for direct enzyme treatment and lowering the risk of microbial spoilage during this phase. When Cheddar, Parmesan, Romano, Swiss-type and Gouda flavours are the target, an enzyme treatment stage with lipases, proteinases and peptidases is essential; the choice of temperature then involves balancing the need for high temperature to inhibit the growth of spoilage microorganisms and to speed up the reactions, with that for lower temperatures to avoid denaturing the enzyme and causing a rapid tail-off of reaction rate with incubation time. In practice, this means temperatures in the range 40–55°C, but EMC producers would like to have high volume, inexpensive supplies of more robust enzymes from GRAS microorganisms, capable of operating for 8–36 h at temperatures up to 70°C (enzyme company R&D scientists, take note).

Whatever enzyme treatment regime is used, the treated cheese paste/slurry is next batch pasteurised (72°C for 30 min is normal) to ‘kill off’ the residual enzymes and any spoilage microorganisms, then spray-dried or packaged as a paste, depending on the water content, customer preference or its intended food application.

Some commonly used emulsifiers and phase stabilisers in EMC and flavour concentrate production are mono- and diglycerides, phosphate salts, citric acid (which also acts as an antibacterial agent and mould suppressor), xanthan gum, and natural antioxidants, such as plant oils and fat-soluble vitamins (e.g. tocopherols). Basic flavour and taste-building blocks usually have very strong ‘brothy’, *umami* notes from proteolysis and rancid/sweaty notes from lipolysis. These are attenuated by dilution into the final product, but they can be modified and refined by adding top notes to the concentrate in the form of ‘starter distillate’ (an intense buttery aroma produced by distillation- concentration of a *Lactococcus* fermentation; Chr. Hansen A/S, Denmark) and/or nature-identical chemical aromas (e.g. aldehydes, alcohols, lactones, amino acid derivatives) based on the knowledge of cheese chemistry available in-house from R&D or in the literature (e.g. the chemical signature of Camembert cheese aroma; Kubickova & Grosch, 1998a,b). Readers interested in a detailed survey of the technical and scientific literature on EMCs should consult Kilcawley *et al.* (1998) for further reading.

7.9 Acknowledgements

The author wishes to acknowledge the cooperation of Dr Stuart West (Biocatalysts Ltd, S. Wales, UK), Dr Mark Smith (Imperial Biotechnology Ltd., London, UK) and Dr Jeen Schuuringha (International Flavours & Fragrances, The Netherlands) in writing this chapter.

References

- Alting, A.C., Engels, W.J.M., van Schalwijk, S. & Exterkate, F.A. (1995) Purification and characterisation of cystathionine beta-lyase from *Lactococcus lactis* subsp. *cremoris* B78 and its possible role in flavour development in cheese. *Applied and Environmental Microbiology*, **61**, 4037–4042.

- Anonymous (1995) Les laits sont 'morts', vive les ferments. *Process*, **42**, 1103.
- Arbige, M.V., Freund, P.R., Silver, S.C. & Zelco, J.T. (1986) Novel lipase for Cheddar cheese flavour development. *Food Technology*, **April**, 91–98.
- Ardo, Y. & Pettersson, H.-E. (1988) Accelerated ripening with heat-treated cells of *Lactobacillus helveticus* and a commercial proteinase. *Journal of Dairy Research*, **55**, 239–245.
- Arfi, K., Leclercq-Perlat, M.N., Spinnler, H.E. & Bonnarme, P. (2005) Importance of curd-neutralising yeasts on the aromatic potential of *Brevibacterium linens* during cheese ripening. *International Dairy Journal*, **15**, 883–991.
- Bachmann, H.P. (1996) Accelerated ripening in cellars with high ammonia content. *Agrarforschung*, **3**, 357–360.
- Banks, J., Hunter, E. & Muir, D. (1993) Sensory properties of low-fat Cheddar cheese: effects of salt content and adjunct culture. *Journal of the Society of Dairy Technology*, **46**, 119–123.
- Bech, A.-M. (1992) Enzymes for accelerated cheese ripening. *Fermentation-Produced Enzymes and Accelerated Ripening in Cheesemaking*, Document No. 269, pp.24–28, International Dairy Federation, Brussels.
- Berger, C., Martin, N., Collin, S., Gijs, Pinaprez, G., Spinnler, H.E. & Vulfson, E.N. (1999) Combinatorial approach to flavour analysis. 2: Olfactory characterisation of a library of *S*-methyl thioesters and sensory evaluation of selected components. *Journal of Agricultural and Food Chemistry*, **47**, 3374–3379.
- Bockelmann, W., Hoppe-Seyler, T., Krusch, U., Hoffmann, W. & Heller, K.J. (1997) Development of a surface smear starter culture. *Nahrung-Food*, **41**, 213–218.
- Broome, M.C. (2007a) Adjunct culture metabolism and cheese flavour. *Improving the Flavour of Cheese* (ed. B.C. Weimer), pp. 177–198, CRC Press, Boca Raton.
- Broome, M.C. (2007b) Starter culture development for improved flavour. *Improving the Flavour of Cheese* (ed. B.C. Weimer), pp. 157–176, CRC Press, Boca Raton.
- Bruinenberg, P.G., de Roo, G. & Limsowtin, G.K.Y. (1997) Purification and characterisation of cystathionine-gamma lyase from *Lactococcus lactis* subsp. *cremoris* SK11: possible role in flavour compound formation during cheese maturation. *Applied and Environmental Microbiology*, **63**, 561–566.
- Cadwallader, K. (2007) Measuring cheese flavour. *Improving the Flavour of Cheese* (ed. B.C. Weimer), pp. 401–417, CRC Press, Boca Raton.
- Carunchia-Whetstein, M.E., Drake, M.A., Broadbent, J.R. & McMahon, D. (2006) Enhanced nutty flavour in cheese made with a malty *Lactococcus lactis* adjunct culture. *Journal Dairy Science*, **89**, 3277–3284.
- Collins, Y.F., McSweeney, P.L.H. & Wilkinson, M.G. (2003) Evidence of a relationship between autolysis of starter bacteria and lipolysis in Cheddar cheese during ripening. *Journal of Dairy Research*, **70**, 105–113.
- Crow, V.L., Coolbear, T., Gopal, P.V., Martley, F.G., McKay, L.L. & Riepe, H. (1995) The role of autolytic LAB in the ripening of cheese. *International Dairy Journal*, **5**, 855–875.
- Crow, V.L., Coolbear, T., Holland, R., Pritchard, G.G. & Martley, F.G. (1993) Starters as finishers: starter properties relevant to cheese-ripening. *International Dairy Journal*, **3**, 423–460.
- de Vos, W.M. (1996) Metabolic engineering of sugar metabolism in lactic acid bacteria. *Antonie van Leeuwenhoek*, **70**, 223–242.
- Drake, M.A. (2007) Defining cheese flavour. *Improving the Flavour of Cheese* (ed. B.C. Weimer), pp. 370–400, CRC Press, Boca Raton.
- Fox, P.F. & McSweeney P.L.H. (1997) Rennets: their role in milk coagulation and cheese-ripening. *Microbiology and Biochemistry of Cheese and Fermented Milk* (ed. B.A. Law), 2nd edn, pp. 1–49 Blackie Academic & Professional, London.
- Fox, P.F. & McSweeney, P.L.H. (1998) Chemistry and biochemistry of cheese. *Dairy Chemistry and Biochemistry* (eds. P.F. Fox and P.L.H. McSweeney), pp. 421–428, Blackie Academic & Professional, London.

- Fryer, T.F. (1982) The controlled ripening of Cheddar cheese. *Brief Communications of the 21st International Dairy Congress*, Vol. 1, pp. 485, Mir Publishers, Moscow.
- Fuji Oil Company Limited (1991) Method for accelerating cheese-ripening. **European Patent Application**, 91306976.1.
- Ganesan, B. & Weimer, B.C. (2007) Amino acid metabolism in relation to cheese flavour development. *Improving the Flavour of Cheese* (ed. B.C. Weimer), pp. 70–10, CRC Press, Boca Raton.
- Grazier, C.L., McDaniel, M.R., Bodyfelt, F.W. & Torres, J.A. (1991) Temperature effects on the development of Cheddar cheese flavour and aroma. *Journal of Dairy Science*, **74**, 3656–3663.
- Grazier, C.L., Simpson, R., Roncagliolo, S., Bodyfelt, F.W. & Torres, J.A. (1993) Modelling of time-temperature effects on bacterial populations during cooling of Cheddar cheese blocks. *Journal of Food Process Engineering*, **16**, 173–180.
- Hannon, J.A., Wilkinson, M.G., Delahunty, C.M., Wallace, J.M., Morrissey, P.A. & Beresford, T.P. (2005) Application of descriptive sensory analysis and key chemical indices to assess the impact of elevated ripening temperatures on the acceleration of Cheddar cheese ripening. *International Dairy Journal*, **15**, 263–273.
- Holland, R., Liu, S.-Q., Crow, V.L., Delabre, M.-L., Lubbers, M., Bennet, M. & Norris, G. (2005) Esterases of lactic acid bacteria and cheese flavour. *International Dairy Journal*, **15**, 711–718.
- Institute of Food Science and Technology (IFST) (1996) Regulatory status and labelling requirements: public perception – The case for communication. *Guide to Food Biotechnology* (ed. S. Roller), pp. 47–61, IFST, London.
- Kailasapathy, K. & Lam, S.H. (2005) Application of encapsulated enzymes to accelerate cheese ripening. *International Dairy Journal*, **15**, 929–939.
- Khan, J.A., Gijs, L., Berger, C., Martin, N., Pinaprez, G., Spinnler, H.E., Vulfson, E.N. & Collin, S. (1999) Combinatorial approach to flavour analysis. I: Preparation and characterisation of an S-methyl thioesters library. *Journal of Agricultural and Food Chemistry*, **47**, 3269–3273.
- Kilcawley, K.N., Wilkinson, M.G. & Fox, P.F. (1998) Enzyme-modified cheese. *International Dairy Journal*, **8**, 1–10.
- Kirby, C.J., Brooker, B.E. & Law, B.A. (1987) Accelerated ripening of cheese using liposome encapsulated enzyme. *International Journal of Food Science and Technology*, **22**, 355–375.
- Kosikowski, F.V. (1976) Flavour development by enzyme preparations in natural and processed cheese. United States Patent Application, 3 975 544.
- Kubickova, J. & Grosch, W. (1998a) Evaluation of flavour compounds of Camembert cheese. *International Dairy Journal*, **8**, 11–16.
- Kubickova, J. & Grosch, W. (1998b) Quantification of potent odorants in Camembert cheese and calculation of their odour activity values. *International Dairy Journal*, **8**, 17–23.
- Law, B.A. (1984) The accelerated ripening of cheese. *Advances in the Microbiology and Biochemistry of Cheese and Fermented Milk* (eds F.L. Davies and B.A. Law), pp. 209–228, Elsevier Applied Science, London.
- Law, B.A. (2001) Controlled and accelerated cheese ripening: The research base for new technologies. *International Dairy Journal*, **11**, 383–398.
- Law, B.A., Castanon, M.J. & Sharpe, M.E. (1976) The contribution of starter streptococci to flavour development in Cheddar cheese. *Journal of Dairy Research*, **43**, 301–311.
- Law, B.A., Hosking, Z.D. & Chapman, H.R. (1979) The effect of some manufacturing conditions on the development of flavour in Cheddar cheese. *Journal of the Society of Dairy Technology*, **32**, 87–90.
- Law, B.A. & Mulholland, F. (1995) Enzymology of lactococci in relation to flavour development from milk proteins. *International Dairy Journal*, **5**, 833–854.
- Law, B.A. & Sharpe, M.E. (1978) Streptococci in the dairy industry, in *Streptococci* (eds F.A. Skinner and L.B. Quesnel), pp. 263–278, Academic Press, London.

- Law, B.A. & Wigmore, A.S. (1982) Accelerated cheese-ripening with food-grade proteinases. *Journal of Dairy Research*, **49**, 137–146.
- Law, B.A. & Wigmore, A.S. (1983) Accelerated ripening of Cheddar cheese with commercial proteinase and intracellular enzymes from starter streptococci. *Journal of Dairy Research*, **50**, 519–525.
- Lynch, C.M., McSweeney, P.L.H., Fox, P.F., Cogan, T.M. & Drinan, F.D. (1996) Manufacture of Cheddar cheese with and without adjunct lactobacilli under controlled microbiological conditions. *International Dairy Journal*, **6**, 851–867.
- McLure, P.J., Blackburn, C.W., Cole, M.B., Curtis, P.S., Jones, J.E. & Legan, J.D. (1994) Modelling the growth, survival and death of microorganisms in foods; the UK Micromodel approach. *International Journal of Food Microbiology*, **23**, 265–275.
- Noomen, A. (1983) The role of the surface flora in the softening of cheeses with low initial pH. *Netherlands Milk and Dairy Journal*, **37**, 229–237.
- Powell, I. (2007) Starter culture production and delivery for cheese flavour. *Improving the Flavour of Cheese* (ed. B.C. Weimer), pp. 300–325, CRC Press, Boca Raton.
- Reinbold, R.S. & Ernstrom, C.A. (1985) Temperature profiles of Cheddar cheese pressed in 290 kg blocks. *Journal of Dairy Science*, **68**, 54–59.
- Reiter, B. & Sharpe, M.E. (1971) Relationship of the microflora to the flavour of Cheddar cheese. *Journal of Bacteriology*, **34**, 63–80.
- Rijnen, L., Yvon, M., van Kranenburg, R., Courtin, P., Verheul, A., Chambellon, E. & Smit, G. (2003) Lactococcal aminotransferases AraT and BcaT are key enzymes for the formation of aroma compounds from amino acids in cheese. *International Dairy Journal*, **13**, 805–812.
- Ruyter, P.G.G.A., de Kuipers, O.P., Meijer, W.C. & de Vos, W.M. (1997) Food-grade controlled lysis of *Lactococcus lactis* for accelerated cheese-ripening. *Nature Biotechnology*, **15**, 976–979.
- Skie, S. (1994) Developments in microencapsulation science application to cheese research and development: a review. *International Dairy Journal*, **4**, 573–595.
- Soeryapranata, E., Powers, J.R. & Unlu, G. (2007) Cloning and characterisation of debittering peptidases, PepE, PepO, PepO2, PepO3, and PepN of *Lactococcus helveticus* WSU19. *International Dairy Journal*, **17**, 1096–1106.
- Smit, G., Barber, A., van Spronsen, W., Van Den Berg, G. & Exterkate, F.A. (1995) Ch-easy model; a cheese-based model to study cheese-ripening. *Bioflavour 95* (eds P. Etievant and P. Schreier), pp. 185–190, INRA, Paris.
- Smith, M. (1997) Mature cheese in four months. *Dairy Industries International*, **62**(7), 23–25.
- Spahr, U. & Url, B. (1994) The behaviour of pathogens in cheese: summary of experimental data. Document No. 298, pp. 2–16, International Dairy Federation, Brussels.
- Sridhar, V.R., Hughes, J.E., Welker, D.L., Broadbent, J.R. & Steele, J.L. (2005) Identification of endopeptidase genes from the genomic sequence of *Lactobacillus helveticus* CNRZ32 and the role of these genes in the hydrolysis of model bitter peptides. *Applied and Environmental Microbiology*, **71**, 3025–3032.
- Swindell, S.R., Benson, K.H., Griffin, H.G., Renault, P., Erlich, S.D. & Gasson, M.J. (1996) Genetic manipulation of the pathway for diacetyl metabolism in *L. lactis*. *Applied and Environmental Microbiology*, **62**, 2641–2643.
- Tanous, C., Gori, A., Rijnen, L., Chambellon, E. & Yvon, M. (2005) Pathways for α -ketoglutarate formation by *Lactococcus lactis* and their role in amino acid catabolism. *International Dairy Journal*, **15**, 759–770.
- Thage, B.V., Broe, M.L., Petersen, M.H., Petersen, M.A., Bennedsen, M. & Ardo, Y. (2005) Aroma development in semi-hard reduced-fat cheese inoculated with *Lactobacillus paracasei* strains with different aminotransferase profiles. *International Dairy Journal*, **15**, 795–805.
- Tomasini, A., Bastillo, G. & Lebeault, J.-M. (1995) Production of blue cheese flavour concentrates from different substrates supplemented with lipolysed cream. *International Dairy Journal*, **5**, 247–257.

- Verschuere, M., Engels, W.J.M., Straastma, J., Van Den Berg, G. & de Jong, P. (2007) Modelling Gouda ripening to predict flavour development. *Improving the Flavour of Cheese* (ed. B.C. Weimer), pp. 537–563, CRC Press, Boca Raton.
- Vindfeldt, K. (1993) A new concept for improving the quality and flavour of cheese. *Scandinavian Dairy Information*, **7**, 34–35.
- West, S. (1996) Flavour production with enzymes. *Industrial Enzymology* (eds T. Godfrey & S. West), 2nd edn, pp. 209–224, Macmillan Press, Basingstoke.
- Wijesundera, C., Roberts, M. & Limsowtin, G.K.Y. (1997) Flavour development in aseptic cheese and slurries prepared with single strain starter bacteria in the presence and absence of adjuncts. *Lait*, **77**, 121–131.
- Wilkinson, M.G. & Kilcawley, K.N. (2005) Mechanisms of incorporation and release into cheese during ripening. *International Dairy Journal*, **15**, 817–830.
- Yvon, M., Thirouin, S., Rijnen, L., Fromentier, D. & Gripon, J.-C. (1997) An aminotransferase from *Lactococcus lactis* initiates conversion of cheese flavour compound. *Applied and Environmental Microbiology*, **63**, 414–419.

8 Control and Prediction of Quality Characteristics in the Manufacture and Ripening of Cheese

T.P. Guinee and D.J. O'Callaghan

8.1 Introduction

Cheese is a dairy product prepared by enzymatic-, acid-, and/or acid/heat-induced gelation of milk or reassembled milk prepared from dairy ingredients (FAO/WHO, 2007) and concentration of the resultant gel to the desired dry matter content by dehydration techniques, such as cutting, stirring, scalding, whey drainage and/or pressing. It is a quintessential convenience food, which is ready to eat (though it may also be heated/cooked), nutritious and satiating. A total of 500 (IDF, 1981) to 800 (Hermann, 1993) different cheese varieties have been listed, but undoubtedly there are many more considering regional variations of these varieties and the anonymity of some local varieties. They differ to varying degrees in nutritive value, appearance, flavour, texture and cooking properties. Consequently, cheese is capable of satisfying a diverse range of sensory and nutritional demands and, therefore, has very wide appeal. It is an extremely versatile product, which may be consumed directly or indirectly as an ingredient in other foods. Cheese is a major ingredient in the catering sector, where it is used in an extensive array of applications, including omelettes, quiches, sauces, chicken *cordon bleu* and pasta dishes. Cheese is also used extensively in the industrial food sector for the preparation of ready-to-use grated/shredded cheeses and cheese blends and for the mass production of cheese-based ingredients, such as processed cheese products, cheese powders and enzyme-modified cheeses. These ingredients are, in turn, used by the food service industry (e.g. burger outlets, pizzerias and restaurants) and by the manufacturers of formulated foods, such as soups, sauces and ready-prepared meals (Guinee & Kilcawley, 2004).

World production of cheese was estimated at $\sim 17.2 \times 10^6$ tonnes in 2008 (IDF, 2008; ZMP, 2008), and accounted for $\sim 25\%$ of total milk used. While cheese-like products are produced in most parts of the world, the principal cheese-producing regions are Europe, North America and Oceania (Table 8.1). Within these regions, the production and consumption of cheese varies widely with country, as does the proportion of milk used for cheese, which ranges from approximately $<20\%$ in New Zealand, Greece or Rumania to approximately $>90\%$ in Italy (Table 8.1). Approximately, 10% of total cheese production is traded on the global market, the major suppliers being the European Union (EU) ($\sim 38\%$), New Zealand ($\sim 21\%$) and Australia ($\sim 14\%$), and the major importers being Russia ($\sim 21\%$), Japan ($\sim 20\%$) and the United States ($\sim 19\%$) (IDF, 2008; ZMP, 2008).

Overall, cheese consumption has increased continuously worldwide since 2000 (14.75×10^6 tonnes) at a rate of $\sim 1.5\%$ per annum between 1990 and 2007, and 2.5% between 2000 and 2007 (Sørensen, 2001; Sørensen & Pedersen, 2005; IDF, 2008). The accelerated demand is being driven by a number of factors including (a) increases in global population

Table 8.1 Annual cheese production and consumption in various regions in 2007.

Region	Cheese production (× '000 tonnes)	Milk to cheese (% of total milk)	Consumption (kg person ⁻¹)
Europe	8904	40	—
Germany	2109	74	22.2
France	1726	71	24.3
Italy	1045	96	20.7
Netherlands	732	66	21.5
Poland	568	47	10.7
United Kingdom	375	27	12.2
Denmark	351	76	23.8 ^a
Ukraine	340	28	6.0
Spain	244	40	7.3
Switzerland	176	43	22.2
Austria	149	47	18.8
Ireland	127	24	6.1
Czech Republic	116	42	17.0
Sweden	109	36	18.4
Finland	102	44	19.1
Lithuania	91	46	—
Norway	84	54	15.4
Bulgaria	73	64	—
Hungary	72	41	10.6
Belgium	66	21	19.0 ^a
Rumania	62	11	—
Portugal	57	28	10.2
Slovakia	40	37	9.8
Estonia	31	45	18.7
Latvia	29	34	—
Slovenia	19	28	10.1
Greece	12	15	29.0
North America	5341	51	—
United States of America	4745	56	16.0
Canada	403	50	12.6
Mexico	193	19	2.6 ^b
Oceania	642	25	—
Australia	352	39	11.9
New Zealand	290	19	6.1
Others	2187	—	—
Brazil	580	23	—
Argentina	487	50	11.2
Russia	434	13	5.5 ^b
Kenya	243	69	—
Iran	230	25	4.6
Japan	125	16	2.0
Chile	70	28	—
China	18	0.5	—

Data compiled from ZMP (2008) and IDF (2008).

^aBased on data for 2003.

^bEstimates.

and per capita income (Sørensen & Pedersen, 2005), (b) changes in consumer lifestyle (e.g. eating out) and (c) the expansion of food service and snack food sectors allied with the versatile functionality of cheese, which enables it to be used as an ingredient in, and enhance the quality of, prepared foods/meals and snack foods. Simultaneously, there has been an increase in demand for more consistent quality, with respect to sensory properties (e.g. taste, tactile texture, aesthetic), usage characteristics (e.g. convenience, shreddability, melt, flowability), and nutrient profiling (e.g. ratio of saturated-to-unsaturated fatty acids, levels of calcium – Ca^{2+}). This is motivated by higher consumer expectations, health agencies, legislators, suppliers and retailers trying to gain more market share by differentiation of branded products.

The current chapter examines cheese quality, the factors affecting and broad-based strategies for improving quality consistency.

8.2 Principles of cheese manufacture

The production of rennet-coagulated cheese can be divided into two phases: (a) conversion of milk to curd and (b) conversion of curd to cheese. However, the key operations are summarised in Fig. 8.1.

Cheese is essentially a concentrated protein gel, which occludes fat and moisture. It is characterised by a longer shelf life than milk, from approximately 2 weeks for Quark, up to 18–36 months for Parmesan. The extended shelf life is due to the preserving effects of reducing moisture content, pH and redox potential, the addition of sodium chloride (NaCl), the depletion of lactose and the colonisation of the cheese with a starter culture added to the milk during cheesemaking.

Gelation of milk is brought about either by:

- acidification (e.g. using starter cultures or food-grade acids and/or acidogens), at a temperature of 20–40°C, to a pH value close to the isoelectric pH of casein, i.e. ~ 4.6 ;
- sensitisation of the casein to calcium via the hydrolysis of the principal micelle-stabilising casein, κ -casein, by the added acid proteinases, referred to generically as rennets (e.g. chymosin, pepsin) or
- a combination of acid and heat, e.g. heating milk to $\sim \text{pH } 5.6$ at $\sim 90^\circ\text{C}$.

Para- κ -casein is the principal structural component of the gel in rennet-curd cheeses. At the pasteurisation conditions (at 72°C for 15 s) generally applied to milk for rennet-curd cheese, $\leq 5 \text{ g } 100 \text{ g}^{-1}$ of total whey proteins are denatured and complex with β -casein (Lau *et al.*, 1990; Fenelon & Guinee, 1999), and are retained in the cheese curd. Even though higher pasteurisation temperatures lead to greater levels of whey protein denaturation and, hence, recovery in the cheese curd (Menard *et al.*, 2005; Donato & Guyomarc'h, 2009), they are generally undesirable as they impede rennet coagulation, lead to softer curds with poor syneresis (whey expulsion) and higher moisture levels, and give cheeses with impaired deformation characteristics and reduced heat-induced flow (Rynne *et al.*, 2004). However, a high heat treatment (HHT; 95°C for 2 min) is frequently applied in the manufacture of acid-coagulated cheeses (Quark and Cream cheese) and acid-heat coagulated cheeses (Ricotta,

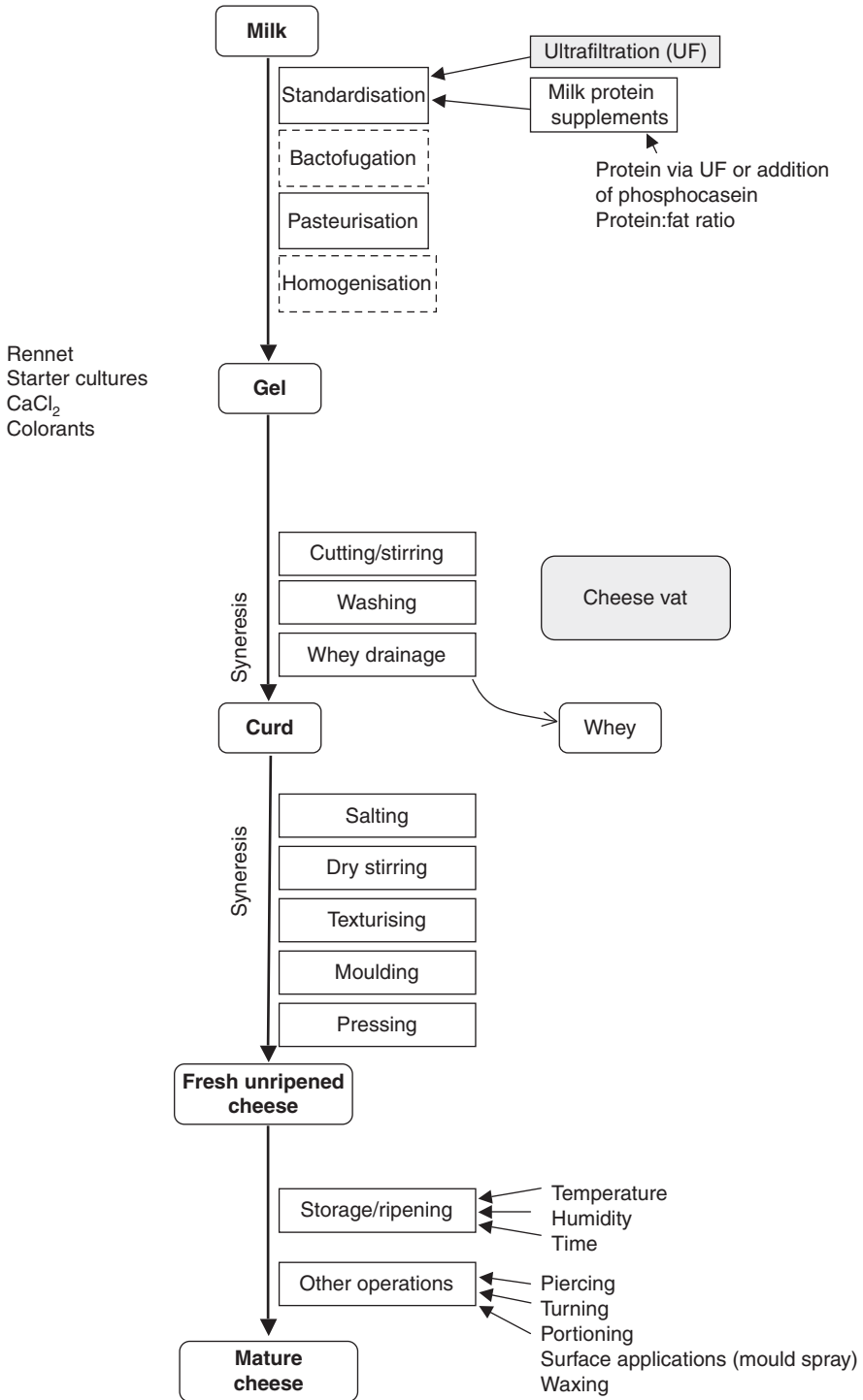

Fig. 8.1 Overview of cheese manufacturing operations.

Paneer, Mascarpone, some Queso-blanco types) and results in substantial denaturation of whey proteins. The denatured whey proteins interact and complex with the casein micelles and become part of the particulate gel formed on subsequent acidification (van Hooydonk *et al.*, 1987). This interaction has a marked influence on the gel structure and properties of acid-curd cheese varieties (Harwalkar & Kalab, 1980, 1981; Section 8.5.3).

The concentration and type of protein have a major influence on the micro-structure of acid- and rennet-coagulated milk gels, which on dehydration and concentration form the structural fabric of the cheese. The microstructure of the gel markedly affects its rheological and syneretic properties, the recovery of fat and protein from milk to cheese and the yield of cheese (Kaláb & Harwalkar, 1974; Schafer & Olson, 1975; Harwalkar & Kalab, 1980, 1981; Green *et al.*, 1981a,b, 1990a,b; Marshall, 1986; Banks & Tamime, 1987; McMahon *et al.*, 1993; Banks *et al.*, 1994a,b; Guinee *et al.*, 1995, 1998). The structure of the final cheese influences its rheological, textural and heat-induced functional properties (Green *et al.*, 1981a,b; Green, 1990a,b; Korolczuk & Mahaut, 1992; Guinee *et al.*, 1995, 2000a,b; McMahon *et al.*, 1996).

8.3 Cheese quality characteristics

8.3.1 Definition of cheese quality

In an overall context, cheese quality may be defined as the degree of acceptability of the product to the end user (Peri, 2006). Quality criteria involve different types of characteristics, including:

- sensory (taste, aroma, texture and appearance);
- physical (e.g. sliceability, crumbliness, hardness, springiness, mouth-feel);
- cooking (extent of flow, stringiness, browning);
- compositional/nutritional (contents of protein, fat, calcium, lactose, sodium);
- chemical (intact casein, free fatty acids (FFA), free amino acids) and
- safety (e.g. absence of pathogens, toxic residues, foreign bodies and conformity to approved levels of substances such as biogenic amines).

The specific combination of quality criteria depends on the application (Table 8.2). For example, the uniform presence of meandering blue veins, the sharp flavour of methyl ketones and brittle texture are key quality attributes for the consumer of Stilton cheese. In contrast, a bland flavour, elasticity, stringiness and a surface glistening are paramount to the consumer of Mozzarella on pizza pie. The manufacturer of block processed cheese (e.g. processed American Cheddar cheese) desires high levels of calcium and intact casein to impart good sliceability and moderate meltability to the final product.

8.3.2 Assessment of cheese quality

Assessment of cheese quality may be necessary in several situations, including research (mechanistic studies), product development, diagnostics and routine quality control (see

Table 8.2 Quality attributes of cheese.

Chemical	Physical	Sensory	Compositional/ nutritional	Safety
Primary proteolysis (gel electrophoretic profile, pH 4.6-soluble nitrogen, water-soluble nitrogen)	Fracture/elasticity properties (fracture stress, fracture strain, firmness/softness, adhesiveness/stickiness, springiness, cohesiveness, shredability, crumbliness, sliceability/portionability, chewiness, stringiness)	Flavour and aroma (mild, lactic, acid/sour, sweet, bitter, nutty, caramel, savoury, salty, mushroom, ketone, fruity, butyrate/francid)	Fat Protein Calcium Lactose Biogenic amines Sodium (salt) Calorific value	Absence of pathogens Total bacterial count Coliforms <i>Salmonella</i> spp. Yeast and moulds
Secondary proteolysis (low molecular weight peptides, free amino acids)	Appearance Colour (whiteness, yellowness) Eye features (size, distribution, smoothness, surface – sheen/matt) Visual texture (granularity, smoothness, mealy/particulate)	Appearance Visual texture (open, closed, granular, eyes, smooth, veined, mealy) Colour Mould coating Smear coating Shape Rind Tactile texture (moist, chewy, soft/firm/hard, rubbery, fragmental, mouth-coating, mealy, gritty/grainy, greasy/oily, astringency)		
Organic acids (lactic, acetic, propionic)	Cooking properties (melt time, melt appearance, surface sheen, scorched spots, colour, flow, stretch, free oil)			
Free fatty acids (butyric, caproic, caprylic, lauric, others)				
Methyl ketones				
Alcohols				
Lactones				
Esters				

Section 8.6). The assessment of quality depends on measurable criteria which provide information about the product in terms of its microstructure, composition, rheology, sensory properties and/or consumer acceptability. Examples of measurable criteria include:

- sensory characteristics of cheese at different maturation times using descriptive sensory analysis (DSA);
- intact casein content as an indicator of the processability of natural cheese into specific processed cheese type formulations, sauce formulations and cheese powders;
- specific chemical components, such as propionic acid and proline, or level of short-chain fatty acids (C₄–C₁₀), as indicators of quality in Swiss and Parmesan type cheeses, respectively;
- the cooking properties of heated cheese, using low amplitude strain rheometry, or empirical assays, such as extent of flow, stretchability and viscosity under defined conditions;
- texture-related rheological criteria, such as the fracture strain (as a measure of crumbliness in Stilton or Feta or Cheshire-type cheeses), or a squeeze-flow measure of ‘longness’ of string cheese;
- an aggregation index or shred score as a measure of the length, stickiness or fracturability of cheese shreds;
- viscosity under defined conditions as a measure of ease of spreadability of processed cheese spread or ripened Camembert type cheese;
- colour coordinates (L^* , a^* , b^* values – see Section 8.3.5; Commission Internationale de l’Éclairage, 1986) as a measure of the intensity or hue of a particular colour, e.g. whiteness in goat cheeses, and/or
- visual assessment of eyes in Swiss-type cheeses.

Numerous test methods are applied in both research and commercial laboratories to evaluate such criteria. These methods have been discussed in detail in various reviews (McSweeney & Fox, 1993; Fox *et al.*, 2000; Delahunty & Drake, 2004; Le Quéré, 2004; O’Callaghan & Guinee, 2004). Some of these are discussed briefly below.

8.3.3 Sensory tests

In practice, cheese is assessed and graded by cheese panellists and quality control personnel to ensure that its texture and flavour conform to a generally agreed consensus for the particular variety (van Hekken *et al.*, 2006; Sameen *et al.*, 2008).

Grading and quality scoring of cheese

Grading of cheeses for certain parameters (e.g. appearance, flavour, body and texture) or specific defects (e.g. bitterness, mottled appearance) on an agreed scale is carried out to determine the grade/acceptability of cheese for customised markets. Quality scoring remains the most widely used type of sensory evaluation in the cheese industry, where it is used to determine acceptability or rejection on the basis of scores obtained. Common examples include the following:

- Grading of Swiss-type cheese for eye size and distribution; vein distribution in blue mould-type cheeses;
- Visual assessment of melted cheese on a pizza pie for extent of flow, surface sheen, burning, blistering; assessment of shredded cheese (e.g. Mozzarella) for degree of curd fines/dust and degree of matting/clumping;
- Evaluation of cheese body/texture by manually working a cheese plug between the thumb and forefinger.

Based on these tests, scores are typically assigned indicating degree of acceptability, rejection or acceptance. Such scoring systems form the basis of quality control at commercial level, facilitating the trading of cheese between vendor and purchaser. This approach has also been used extensively to research the relationship between the composition of young Cheddar cheese and the grading quality of the mature cheese (Lelievre & Gilles, 1982; see Section 8.6).

Descriptive sensory analysis

According to Delahunty & Drake (2004), DSA refers to a collection of techniques that seek to discriminate between the sensory characteristics of a range of cheeses and to determine quantitative description of all the sensory differences that can be identified. The sensory characteristics are defined in terms of a lexicon of agreed attributes assigned by trained consumer panellists. Each attribute is scored on a linear scale and the resultant data are typically presented in the form of spider web diagrams or principal components loading plots, for the purpose of discriminating between cheeses. While DSA is mainly used as a tool for development of new cheeses, it also has potential as a quality control tool, provided that a standard cheese of acceptable quality is available for comparison with other samples. Thus, one may distinguish between ‘degree of excellence’ of cheeses, as determined by consumer acceptance testing/market research, and ‘difference from a standard’ as determined by consumer panels (Cardello, 1997; see also Chapter 13).

8.3.4 *Rheology and texture of cheese*

Cheese texture may be defined as a ‘composite sensory attribute’ resulting from a combination of physical properties that are perceived by the senses of touch (including kinaesthesia and mouth-feel), sight and hearing. It can be measured directly using a trained sensory panel; however, owing to the difficulty and cost in assembling sensory panels, they are not routinely used for gauging cheese texture. Instead, cheese texture is generally measured indirectly using rheological techniques (O’Callaghan & Guinee, 2004).

The rheology of hard or semi-hard cheese is commonly assessed by compression of a cylindrical or cubic cheese sample between two parallel plates of a texture analyser (Fenelon & Guinee, 2000; Everard *et al.*, 2007c). The cheese sample is placed on a base plate, and is compressed at a fixed rate (typically 20 mm min⁻¹) to a predetermined (e.g. 75% of its original height) by the mobile plate (cross head). The compression may be carried out in one or two cycles (bites). Analysis of the force – displacement or stress – strain

curves, often referred to as texture profile analysis, enables the determination of a number of rheological parameters, e.g. fracture stress, fracture strain, firmness and springiness, which are related to sensory textural characteristics, such as brittleness, shreddability, hardness and chewiness (O'Callaghan & Guinee, 2004; Dimitrelia & Thomareis, 2007). Everard *et al.* (2007b) showed that a three-point bending test could be used for a similar purpose. Torsion gelometry involves the application of large strain shear forces to a capstan-shaped sample, and has been used to discriminate between various types of hard cheese (Tunick & van Hekken, 2002).

Penetrometers and oscillation rheometers have been used for determining the viscosity of soft fresh cheeses and for showing the influence of the various processing steps, e.g. heat treatment, homogenisation, cooling, on-texture properties (Korolczuk & Mahaut, 1988; Sanchez *et al.*, 1996).

8.3.5 Colorimetry

Colour is an important measure of quality in the food industry because it is considered by consumers to be related to product freshness, ripeness, desirability and food safety (McCraig, 2002; Jeliński *et al.*, 2007). Colour measurement instruments, in accordance with the standards developed by the Commission Internationale de l'Éclairage, transform or filter reflected spectra to produce reproducible colour space coordinates, namely, L^* (index of whiteness), a^* (index of redness), and b^* (index of yellowness) (Commission Internationale de l'Éclairage, 1986; MacDougall, 2001). While colour measurements are normally carried out in a laboratory based instrument (HunterLab meter or Minolta Chroma meter), they can also be acquired by online instruments. Owing to ageing effects of light sources and detector systems, regular calibration of colorimetric equipment against colour standards is essential.

Colorimetry is used routinely in quality control and product development to assess the colour of curd and cheese. Colour is related to diet of cow, addition of colouring and cheese variety. Recent studies also highlight the potential role of colorimetry in assessing ripening of smear-ripened cheese (Dufossé *et al.*, 2005; Olson *et al.*, 2006) and for measuring defects, such as browning, during cheese maturation (Carreira *et al.*, 2002).

8.3.6 Image analysis

A wide variety of imaging techniques are now available for application in the food industry: online digital cameras/scanners, light and confocal laser scanning microscopes, hyper-spectral imaging systems, X-rays and ultrasonic devices. Image texture analysis may be defined as the characterisation of visual texture (e.g. rough or smooth), as estimated from the digital analysis of an image acquired using any of the above techniques. Its development was inspired by the use of computer-aided diagnosis, as a tool for pattern recognition in the medical field. The repeated patterns are detected through statistical analysis of spatial variation in pixel intensities (gray values), enabling information on surface characteristics such as colour, shape and dimensions to be obtained.

This rapidly developing area has potential for analysing cheese surfaces for features of relevance to quality control, such as roughness, smoothness, shininess, graininess, veins, cracks and slits, either independently of the human eye or as an aid to assessment using the human eye. Such patterns can be a very useful tool in assessing the quality of products where such features contribute to the aesthetic acceptance of the product, an example being the size and spatial distribution of eyes in Swiss-type cheese, and their aspect, glossiness and smoothness. Reported uses include the digital analysis of photographic images for the determination of shred size and quality of Cheddar cheese (Ni & Gunasekaran, 1998); eye dimensions in Emmental cheese and slits in Cheddar cheese (Caccamo *et al.*, 2004); the development of early gas defects in Ragusano cheese (Melilli *et al.*, 2004), and formation of calcium lactate crystals on the surface of naturally smoked Cheddar cheese (Rajbhandari & Kindstedt, 2005, 2008). A comparison of studies on Swiss-type cheese (Caccamo *et al.*, 2004; Eskelinen *et al.*, 2007) suggests that ultrasonics is not as yet as advanced as optical-imaging techniques for the application of image analysis in quality control.

Image texture analysis has been shown to have potential as a process control tool for monitoring syneresis in a cheese vat (Everard *et al.*, 2007a,c; Fagan *et al.*, 2008). A wide variety of approaches is emerging for image texture analysis, as illustrated by the fact that five different techniques were compared in that study.

8.4 Cheese quality: influence of chemical composition of milk

The quality of cheese is influenced by many aspects of milk quality: milk composition, microbiology, somatic cell count (SCC), enzymatic activity, and chemical residues (O'Keeffe, 1984; Walsh *et al.*, 1998a,b; Fox & Guinee, 2000; Auldist *et al.*, 2004; Fox & Cogan, 2004; Downey & Doyle, 2007; Guinee *et al.*, 2007a,b) (Fig. 8.2). The impact of these influences (milk composition) and factors affecting them (stage of lactation) are discussed in detail in Chapter 1, and will be only briefly referred to here.

Perhaps the single most important factor affecting cheese quality and yield is the composition of the milk, particularly the concentrations of fat and casein, which represent $\sim 94 \text{ g } 100 \text{ g}^{-1}$ of cheese dry matter in the case of Cheddar. These factors together with calcium and pH, have a major influence on several aspects of cheese manufacture, especially rennet coagulability, gel strength, curd syneresis and, hence, cheese composition and cheese yield. The composition of milk supplied to the cheese factory is influenced many factors including species, breed, individuality, nutritional status, health and stage of lactation. However, modern processing techniques enable the processor to standardise several aspects of milk composition and to thereby mitigate the effects of varying milk composition, for example:

- Milk casein content by ultrafiltration (UF)/microfiltration (MF), or the addition of micellar casein powders (Guinee *et al.*, 2006);
- Casein-to-fat ratio via online component measurement and standardisation;
- pH at set by online addition of acidulant or acidogen;
- Calcium ion content by addition of commercial preparations of calcium chloride, and
- rennet to casein ratio.

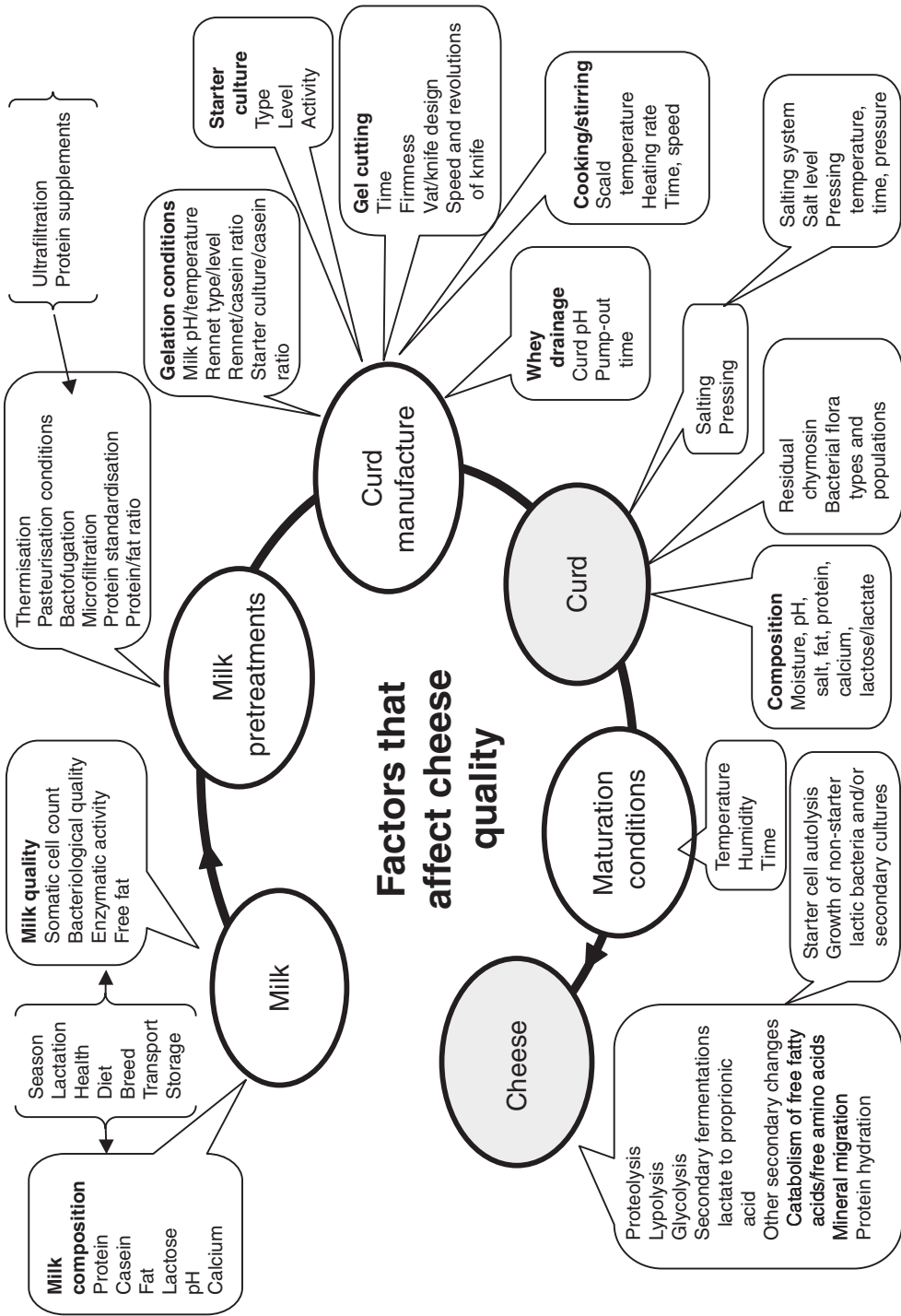

Fig. 8.2 Overview of factors affecting cheese quality.

However, despite these highly standardised operating procedures in modern cheese manufacture, cheese composition can still vary due to variations in milk, which can not be corrected readily by the manufacturer, for example differences in casein micelle size, in levels of individual caseins, genetic polymorphs of individual caseins, degrees of phosphorylation of α_s -casein and glycosylation of κ -casein, colloidal-calcium-to-casein ratio; levels of enzymatic activity and levels of hydrolysed serum-soluble casein degradation products (O'Keeffe, 1984; Politis & Ng-Kwai-Hang, 1988; Auld et al., 1996, 2004; Klei et al., 1998; Walsh et al., 1998a,b; Sevi et al., 1999; Williams, 2002; Albenzio et al., 2004; Andreatta et al., 2007; Mazal et al., 2007; Vianna et al., 2008). Hence, cheese quality is not only affected by the concentration of major cheesemaking constituents in milk, but also by the intactness and composition of individual caseins, the integrity of casein structural unit (casein micelle) and its equilibrium with the milk salts. This is scarcely surprising as cheese may be considered as a concentrated restricted-volume, periodic repeating gel-based structure, the structure of which are largely controlled by protein–protein and protein–mineral interactions.

8.5 Cheese quality: effect of milk pre-treatments and manufacturing operations

Given milk of satisfactory quality and composition, the cheese manufacturer has a range of operations available, by which he can affect the quality of the final cheese (Fig. 8.2). These are discussed below.

8.5.1 Cold storage of milk prior to pasteurisation at the cheese factory

In modern cheese plants, milk is often cold-stored at the factory for 1–3 days depending on the time of year and the manufacturing schedules. Moreover, the milk may be held for 1–3 days on the farm prior to collection. Hence, milk can be cold-stored for 2–5 days prior to processing. During storage and transportation, the cold milk is subjected to varying degrees of shear due to pumping, flow in pipelines and agitation.

Cold storage of milk, also referred to as cold ageing, results in a number of physico-chemical changes that impair rennet coagulation properties of the milk, reduce cheese yield, and adversely affect cheese quality. These changes have been extensively researched and reviewed (Hicks et al., 1982; Dalgleish & Law, 1988, 1989; Cromie, 1992; Shah, 1994; Van Den Berg et al., 1998; Renner-Nantz & Shoemaker, 1999; Roupas, 2001), and include:

- solubilisation of micellar caseins, especially β -casein, and colloidal calcium phosphate (CCP), both of which contribute to an increase in serum casein;
- an increase in the count of psychrotrophic bacterial species (e.g. *Pseudomonas* and *Bacillus* spp.), and ensuring activities of their proteinases and lipases, many of which are thermostable to high temperature/short time and ultra high temperature treatments and survive in the resultant cheese;

- an increased susceptibility of serum casein to hydrolysis by proteinases from various sources, e.g. psychrotrophic bacteria, somatic cells and/or plasmin, and a concomitant increase in non-protein nitrogen (N), which is soluble and not retained in the curd during cheese manufacture;
- physical damage to the milk fat globule membrane by agitation and/or localised freezing, and hydrolysis of structure-forming phospholipids by phospholipases from psychrotrophic bacteria; and
- hydrolysis of milk fat tri-acylglycerols by lipases from psychrotrophic bacteria, resulting in an increase in the level of FFAs and decrease in the level of milk fat (Hicks *et al.*, 1982).

It is generally agreed that cold storage impairs rennet coagulation properties (Fox, 1969; Renner-Nantz & Shoemaker, 1999), increases the losses of N and fat in the cheese whey, reduces cheese yields (Olson, 1977; Hicks *et al.*, 1982; Weatherhup *et al.*, 1988; Van Den Berg *et al.*, 1998), and/or leads to the development of off flavours such as rancidity and bitterness during maturation (Chapman *et al.*, 1976; Cousin & Marth, 1977; Law *et al.*, 1979; Lalos & Roussis, 1999, 2000). However, there is disagreement between reported studies as to the duration of cold storage and the total viable bacterial count at which the latter effects become notable, which varies from $\sim 10^4$ to 10^6 (Hicks *et al.*, 1982) to $>10^7$ colony-forming units (cfu) mL⁻¹ cheese milk (Law *et al.*, 1976). Inter-study discrepancies may be related to variations in experimental conditions, e.g. milk source, pre-handling and temperature history of milk prior to experimentation, milk pH, SCC, bacterial species/strains of psychrotrophic bacteria in milk, storage temperature and time, and cheese making conditions. Fox (1969) concluded that the large variation in the rennet coagulation time of cold-aged milk from individual cows is probably a consequence of differences in composition, microbiological status and SCC.

In contrast to the above, prolonged storage of milk at low temperature has been reported to lead to a reduction in rennet coagulation time and increase in curd-firming rate (Zalazar *et al.*, 1993; Seckin *et al.*, 2008). These effects were associated with very high total bacterial counts (TBC; e.g. 10^8 cfu mL⁻¹ after 6–7 days storage at 4–5°C), a reduction in milk pH (e.g. from ~ 6.65 to ~ 5.9 after 6 days), and a large increase in the concentration of soluble sialic acid. Presumably the increased susceptibility of milk to coagulation under these extreme conditions resides in the production of high levels of bacterial proteinases capable of coagulating the milk and the removal of sialic acid from the κ -casein at the micelle surface, a change expected to reduce surface charge and hydration of the casein micelles.

The effects of cold storage may be divided into those that are generally (a) reversible on heating, including temperature-induced dissociation/solubilisation of calcium phosphate and micellar casein, and (b) irreversible on heating, comprising enzyme-hydrolysis of casein, phospholipids and triacylglycerols.

The chemical changes (i.e. increases in serum casein and ratio of soluble Ca to micellar Ca) associated with cold storage are almost complete after 24 h in freshly drawn milks, preserved with sodium azide to prevent bacterial growth during storage (Qvist, 1979). These changes are largely reversed by pasteurisation (72°C for 15 s), milder heat treatments (e.g. 50°C for 300 s) and/or an increase in ionic calcium (by 1 mM) by addition of calcium chloride

(CaCl₂) (Fox, 1969; Reimerdes *et al.*, 1997). In contrast, enzymatic-induced hydrolysis of casein that accompanies cold storage beyond 24 h and its adverse effects of curd forming properties (longer gelation times, reduced gel strength) and cheese yield changes are in the main irreversible. This is because peptides resulting from casein hydrolysis are soluble in the serum phase (as non-protein N), do not coagulate on renneting and are largely lost in the cheese whey. Moreover, the reduction in the content of intact casein reduces the rate of curd firming and leads to a softer curd at cutting. In commercial practice, where the coagulum is usually cut at a fixed time after rennet addition rather than at a given firmness, this alteration in curd formation is conducive to curd shattering, high losses of fat in the cheese whey, and reduced cheese yields.

In the EU, the permitted TBC in milk for the manufacture of dairy products has been reduced from $\leq 4 \times 10^5$ cfu mL⁻¹ in 1994 to $\leq 1 \times 10^5$ cfu mL⁻¹ in 1998 (EU, 1992). Improved dairy husbandry practices combined with the more stringent standards for TBC and SCC are conducive to reducing the degree of storage-related proteolysis and lipolysis in milk. The fact that the chemical changes that occur on cold-storage are reversed by pasteurisation therefore suggests that, with modern milk production practices, cold-storage of milk for several days probably has little influence on its cheesemaking properties (Swart *et al.*, 1987).

8.5.2 *Thermisation*

Thermisation refers to the heat treatment of milk at sub-pasteurisation temperatures (typically 50–70°C for 5–30 s) on reception at the dairy to reduce the viable bacterial load in the milk and minimise changes in quality and processability prior to conversion into product. This greatly reduces the development/occurrence of bacterial-associated enzymatic activities in the milk during subsequent cold storage, as reflected by lower levels of peptides and FFAs in the stored milk (Gilmour *et al.*, 1981; Zalazar *et al.*, 1993; Seckin *et al.*, 2008). Consequently, thermisation generally improves the yield and quality of cheeses prepared from milks that have been cold stored (Dzurec & Zall, 1986a,b; Lalos *et al.*, 1996; Zalazar *et al.*, 1988; Girgis, *et al.*, 1999). Hence, it has been suggested that, where milk is stored for long periods at farm level, on-farm thermisation (74°C for 10 s) may prove advantageous for cheese yield (Zall & Chen, 1986). Temperatures of 65°C or slightly higher are recommended for optimum effects (Muir, 1996).

8.5.3 *Milk pasteurisation and incorporation of in situ denatured whey proteins*

Inactivation of pathogens

Pasteurisation involves heating at temperatures sufficient to inactivate the most heat-resistant pathogenic bacteria that may be potentially present in the raw milk (i.e. *Mycobacterium tuberculosis* and *Coxiella burnetii*), and to thereby make it and its products safe for human consumption (Kelly *et al.*, 2005). It typically involves heating at 72–75°C for 15–30 s in a continuous flow plate heat exchanger. Other pathogens that may occur in milk (e.g.

Listeria monocytogenes, enterotoxigenic strains of *Escherichia coli*, e.g. *E. coli* O157 H7, *Shigella*, *Erwinia*, *Campylobacter*, *Staphylococcus*, *Salmonella* spp.) are also inactivated by pasteurisation. In addition, pasteurisation also eliminates non-pathogenic indigenous microflora (e.g. lactic acid bacteria – LAB), and causes partial/complete inactivation of indigenous/microbial enzymes, which otherwise contribute to the development of more diverse and regionally desired flavour and aroma profiles in raw milk cheese compared to their pasteurised milk equivalents (Hickey *et al.*, 2007). Hence, substantial quantities of cheese (guesstimated at 5–10% of total cheese) continue to be manufactured from raw milk (especially in France, Germany, and Southern European countries). This is acceptable provided that the cheese is aged for a minimum of 60 days, and is in compliance with Public Health Authority Regulations and Standards, for example EU (1992). Many of these cheeses are hard, low moisture (<38 g 100 g⁻¹) cheese varieties (Parmigiano Reggiano, Swiss Emmental, Gruyère de Comté) the manufacture of which conforms to modern hygiene practices, involves heating the curd and whey to relatively high temperatures (50–55°C), transferring the curds while hot into the cheese moulds/forms, and slow cooling (Fox & Cogan, 2004). Such conditions and the composition of the cheeses (e.g. relatively low pH, 5.3; low moisture, <38 g 100 g⁻¹; pH, 5.4, and/or salt content, 2–10 g 100 g⁻¹ in moisture phase) are unfavourable to the growth of pathogenic bacteria. For more detailed reviews on the safety and quality aspects of raw milk cheeses, the reader is referred to Beuvier and Buchin (2004) and Donnelly (2004).

Effects on coagulation and cheesemaking characteristics of milk

Apart from its effects on pathogenic bacteria, pasteurisation also reverses cold ageing (as discussed in Section 8.5.2), and affects cheese composition, texture, and yield to an extent dependent on the temperature used. Pasteurisation of milk (72°C for 15 s) results in a low level (≤5% of total) denaturation of whey proteins, which complex with the κ-casein, and are retained in the cheese curd where they contribute to a Cheddar cheese yield increase of ~0.1–0.4 g 100 g⁻¹ milk (Fenelon & Guinee, 1999). However, most (~94–97 g 100 g⁻¹ depending on the cheese moisture level) of the native whey proteins, which account for 20 g 100 g⁻¹ of the true milk protein of milk, are lost in the cheese whey. Unlike casein, native whey proteins are stable to rennet treatment and acidification to pH 4.6 and, thus, remain soluble in whey during the manufacture of rennet- and acid-curd cheeses. Theoretically, if all whey proteins were retained, without adversely affecting cheese moisture or quality, a yield increase of ~12 % (i.e. 10.7 versus 9.54 kg 100 kg⁻¹) would be achievable for Cheddar cheese with ~380 g kg⁻¹ moisture while retaining the casein to fat ratio constant at ~0.76.

Consequently, increasing cheese yield by denaturation and complexation of whey proteins with casein and their recovery to cheese via HHT of the milk at temperatures considerably higher than those normally used during pasteurisation (e.g. 75–90°C for 1–10 min) is an area that has received much attention (Schafer & Olson, 1975; Marshall, 1986; Banks *et al.*, 1987, 1994a,b; Lau *et al.*, 1990; Rynne *et al.*, 2004; Guinee *et al.*, 1995, 1996, 1998; Lo & Bastian, 1998; Hinrichs, 2001; Singh & Waugana, 2001; Guinee, 2003; Celik *et al.*, 2005; Huss *et al.*, 2006; Donato & Guyomarc'h, 2009). In situ denaturation of whey proteins by HHT (80–95°C for 1–10 min) is widely used in the commercial manufacture of fresh acid-curd cheeses, e.g. Quarg, Fromage Frais, Cream cheese, with typical heat treatments ranging from 72°C for

15 s to 95°C for 120–300 s. The level of whey protein denaturation and the yield of Quarg (18 g moisture 100 g⁻¹) for these treatments are ~3 g 100 g⁻¹ and 18.6 kg 100 kg⁻¹, and ~70 g 100 g⁻¹ and 21.3 kg 100 kg⁻¹, respectively. In addition to improving yield of these products, the inclusion of HHT-induced denatured whey proteins also promotes smoother and firmer consistency, creaminess, reduced syneresis, and enhanced nutritional status (Hinrichs, 2001). This effect is generally attributed to the heat-induced denaturation of whey proteins and their binding to the casein micelles, via disulphide interaction, to the κ -casein; thus, the denatured whey proteins become part of the casein-denatured whey protein gel, which may be considered as a complex gel. Consequently, the level of gel-forming protein is increased and a more uniform, homogenous gel is formed, with the inclusion of whey proteins limiting the degree of fusion of casein micelles (and casein phase separation) that might otherwise occur. Following subsequent exposure of the acid-induced milk gel to dehydration and whey separation (e.g. by gel cutting/breakage/stirring followed by whey drainage/expulsion and by whey drainage through perforated mould/cheese cloth or by subjecting to centripetal/centrifugal force), these properties (e.g. smooth uniform consistency) are transferred to the resultant fresh cheese curd where they are highly desirable in high moisture (>65 g 100 g⁻¹), low pH (~4.6), products such as low-fat Quark, low-fat Cream cheese, fresh-cheese preparations, and fresh-cheese based desserts (e.g. Shirkhand-type products). Compared to the acid-induced gels from HHT milk, acid gels from conventionally pasteurised milk are softer (as reflected by a substantially lower storage modulus, G') owing to the lower level of gel forming protein, a greater of casein fusion, and discontinuity of the network (higher degree of phase separation). However, on whey separation, the fresh curd from pasteurised milk is generally heavier, firmer, less smooth, more curdy/granular and prone to some wheying-off, especially where a small quantity of rennet has also been used (Fox *et al.*, 2000). These attributes are desirable in some fresh cheeses, where curdyness/granularity and/or slight whey separation are suggestive of traditional cheeses, which have semi-hard and slightly brittle texture, for example, of some acid-curd, fresh reduced-fat cheeses, and ripened varieties (Sauremilchkäse-types: Harzer, Mianzer, Olmützer) (Schulz-Collins & Senge, 2004).

In contrast to its effect on acid gelation, HHT treatment of milk impairs the rennet gelation characteristics, as reflected by a longer gelation time and lower elastic shear modulus of the resultant gels (Ustunol & Browne, 1985; Guinee *et al.*, 1996, 1997; Bulca *et al.*, 2004). These effects are observed even where the HHT is moderate compared to that applied during the manufacture of acid-curd cheeses, as discussed above, e.g. temperatures of 75–87°C for 26 s, to give levels of whey protein denaturation ranging from ~5 to 34 g 100 g⁻¹ of total whey proteins. The poorer rennetability of HHT milk has been attributed to a number of factors including *inter alia* a slower hydrolysis of κ -casein (Ferron-Baumy *et al.*, 1991), an increased steric impedance to aggregation of *para*-casein micelles owing to the attachment of denatured whey proteins, a lower surface hydrophobicity of micelles (Lieske, 1997), and/or a depletion in the concentration of ionic calcium, heat-induced precipitation of calcium phosphate (Ustunol & Browne, 1985). However, these effects may be offset somewhat by various means, to restore rennet coagulability and obtain a firmness suitable for gel cutting within a time suitable in commercial manufacture: (a) increase in gelation temperature, (b) high protein concentration, (c) addition of CaCl₂, (d) slight reduction in pH (0.1–0.2 units), and/or (e) extending the set-to-cut time. Despite this, the curds obtained from rennet-induced HHT milk gels tend to be remain weaker and brittle during the stirring/heating

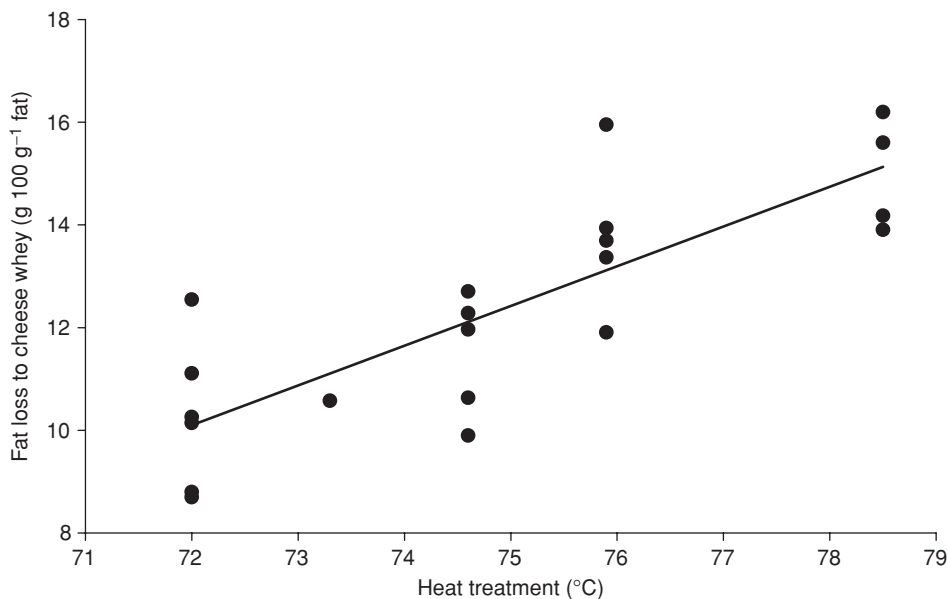

Fig. 8.3 Fat lost to cheese whey during the manufacture of Cheddar cheese made from milks pasteurised at different temperatures and times (15–46 s); all milks were standardised to a protein-to-fat ratio of 0.96 (correlation coefficient, $r = 0.82$). (T.P. Guinee, unpublished data.)

stages of cheese manufacture, are prone to shattering, and tend to knit/mat more poorly during cheddaring and pressing. Consequently, the curd particles are prone to shattering in the cheese vat resulting in higher losses of milk fat to cheese whey (Fig. 8.3). HHT of milk leads to increased retention of denatured whey proteins and moisture in the resultant cheeses (Banks *et al.*, 1994a,b; Guinee *et al.*, 1995, 1997; Lo & Bastian, 1998; Rynne *et al.*, 2004; Celik *et al.*, 2005) (Table 8.3). This may be desirable in some situations, for example, in reduced fat cheeses where it promotes reduced firmness/rigidity, and a softer, creamier texture. However, HHT of milk impairs the ability of heated cheese to flow (spread) or stretch (Banks *et al.*, 1994a) to a degree which depends on the extent of denaturation in the range 5–34 g 100 g⁻¹ of total whey protein (Guinee, 2003; Rynne *et al.*, 2004); little or no effect is observed at 9 g 100 g⁻¹ denaturation (~ 0.6 g whey protein 100 g⁻¹ cheese) while the cheese is essentially flow- and stretch-resistant at 34 g 100 g⁻¹ (~ 3 g whey protein 100 g⁻¹ cheese) (Table 8.3).

Heat-induced interactions between whey proteins and casein micelles

In view of optimising the inclusion and recovery of whey proteins to rennet-curd cheese varieties, there has been a renewed vigour to elucidate the mechanism of interaction of denatured whey proteins and casein, and the impact of the resultant complexes on the structure/rheology of both acid- and/or rennet-induced milk gels (Guinee *et al.*, 1996; Lucey *et al.*, 1998; Garcia-Risco *et al.*, 2002; Anema & Li, 2003a,b; Guyomarc'h *et al.*, 2003; Vasbinder *et al.*, 2003; Anema *et al.*, 2004; Bulca *et al.*, 2004; Menard *et al.*, 2005; Parker

Table 8.3 Effect of milk heat treatment temperature on whey protein denaturation and properties of half-fat Cheddar cheese.

	Heat treatment (°C for 26 s)			
	72	77	82	87
Milk				
Whey protein denaturation (g 100 g ⁻¹ of total whey protein)	3	8	20	34
Cheese				
Denatured whey protein (g 100 g ⁻¹)	0.2	0.6	1.4	2.2
Moisture (g 100 g ⁻¹)	45.2	47.3	48.8	49.9
Firmness (N)	380	320	300	280
Fracture stress (kPa)	450	350	300	250
Flow (%)	260	250	160	50
Stretch (cm)	35	32	25	7

Adapted from Rynne *et al.* (2004).

et al., 2005; Guyomarc'h, 2006; Jean *et al.*, 2006; Molle *et al.*, 2006; Renan *et al.*, 2006; Considine *et al.*, 2007; Lakemond & van Vliet, 2008; Donato & Guomarc'h, 2009). HHT of milk results in denaturation of whey proteins (β -lactoglobulin – β -lg, α -lactalbumin – α -la) that interact with κ -casein via thiol-catalysed disulphide interchange, to an extent that increases with the temperature and duration of the heat treatment. However, for a given HHT, the structure, size and location of the resultant whey-protein casein complexes is dependent on the pH of the milk at heating and the casein-whey protein ratio. On HHT at pH 6.5, about 70 g 100 g⁻¹ of denatured whey proteins complex with the κ -casein attached to micelle surface, leading to the formation 'whey-protein-coated' casein micelles that are larger (by ~35 nm) than the native casein micelle. However, as the pH of the milk at HHT is increased to 7.2, followed by cooling and readjustment of pH to 6.5, κ -casein (and to a lesser extent α ₂-casein) is increasingly dissociated from the micelle surface (presumably due to increased negative charge), and interacted with denatured unfolded whey proteins in the serum to form κ -casein-whey protein particles (κ -CnWPPs) that are soluble in the serum phase of milk; simultaneously, the average particle size of the milk decreases. Moreover, the average size of the κ -CnWPPs decreases as the pH of the milk during HHT is increased. Hence, HHT treatment results in a transition from a mono-modal protein particle system containing casein micelles to a system with a number of particles types of different composition, structure, size and surface charge depending on the magnitude of the HHT and pH at HHT: native casein micelles; κ -casein depleted casein micelles; whey-protein-covered micelles, and κ -CnWPPs, and/or whey protein aggregates. In addition, the nature of protein interactions within complexes probably also changes, with the contribution of covalent disulphide bonds expected to decrease at the expense of electrostatic bond types as the pH of HHT is reduced.

It is of relevance to cheese manufacture that the κ -CnWPPs: (a) have a surface charge in milk serum at pH 7.0 of –17 mV, and are therefore likely to repel other particles and casein micelles at native milk pH, (b) are stable to centrifugation of milk at 22 000 g in the pH range 6.2–6.7, and hence are not likely to precipitate or flocculate on standing, (c) have higher surface hydrophobicity than that of native casein micelles, suggesting that

their precipitation on acidification may be initiated before reaching pH 4.6, (d) are stable to flocculation following rennet hydrolysis in the absence of the κ -casein-depleted micelle (obtained by centrifugation of the HHT milk) and (e) are unstable to rennet treatment in HHT milk (in the presence of κ -casein-depleted micelles) and are therefore recovered with the curd during rennet-curd cheese manufacture.

Consequently, it may be expected that altering the pH of milk during HHT treatment, followed by readjustment to normal pH (6.5–6.7) after cooling, would alter the size distribution and type of protein particles and, therefore, the structure and rheology of resultant gels (Walstra & van Vliet, 1986; Horne *et al.*, 1996) and cheese products.

Increasing the milk pH (6.2–7.1) prior to HHT (90°C for 30 min) generally increased the gelation pH, the elastic shear modulus, permeability coefficient and coarseness of the resultant acid-induced milk gels (Anema *et al.*, 2004; Lakemond & van Vliet, 2008). Factors contributing to the higher gel strength from HHT milks prepared at high pH may include a greater interactivity of the κ -casein depleted micelles as the pH was reduced, a higher proportion of disulphide–interchange interactions in the final gel structure, a decrease in the average particle size of participating particles, an increase in the number of particle types involved in gel formation and the possibility for a greater number of collisions between the interacting particles.

While increasing the pH of milk during HHT treatment from 6.5 to values in the range 6.9–7.2 also increases the elastic shear modulus of rennet-induced milk gels (Vasbinder & de Kruif, 2003; Menard *et al.*, 2005), the effect is relatively small and likely to be of limited practical benefit for cheese manufacture where a high level of whey protein incorporation is required (e.g. 70 g 100 g⁻¹ of total). At first approximation this may be considered surprising, considering that κ -CnWPPs in milk serum (prepared by centrifugation of HHT milk at 22 000 g), are stable to precipitation/aggregation on rennet treatment. However, the κ -CnWPPs are recovered with the curd (pellet) obtained by centrifugation (at ~2000 g) of the gel obtained following rennet treatment of HHT milk under quiescent conditions similar to those implied during conventional cheese manufacture (pH 6.55; rennet addition levels of ~0.12 mL L⁻¹ Chymax[®] Plus rennet, equivalent to ~11 chymosin units) (O’Kennedy & Guinee, unpublished results). Analysis of the milk serum by reverse-phase high-performance liquid chromatography, following rennet treatment, showed a marked reduction in the level of serum-soluble casein and whey protein compared to that found in the milk serum from a rennet-untreated sample of the same milk prepared by centrifugation at 22 000 g. The degree of reduction of serum whey protein following renneting was dependent on the initial pH of heating even though renneting was carried out at a constant pH (6.55). The higher the pH of heating (in the range 6.3–7.2) the greater the amount of denatured whey aggregates remained in the serum phase following renneting. Vasbinder & de Kruif (2003) reported that ~40 g 100 g⁻¹ of the whey proteins denatured on HHT treatment of milk at pH 6.9 remained soluble in the serum obtained on rennet treatment of the milk under model conditions designed to fractionate the denatured whey proteins into casein micelle bound and serum-soluble, but which differed substantially from those applied during normal cheesemaking conditions: (a) very high rennet levels (1 g 100 g⁻¹, compared to levels applied during cheese manufacture of ~0.03 g 100 g⁻¹), (b) renneting temperature (15 min at 21°C followed by 15 min at 31°C), and (c) continual agitation. Moreover, while the rennet coagulation properties (pH 6.5) of milk heated at pH 7.2 were improved relative to that of milk heated at

pH 6.5, the renneting characteristics of both, as monitored using low amplitude oscillation rheometry, were nonetheless severely impaired relative to those of pasteurised milk and were not considered suitable for cheese manufacture under standard conditions. The effect of increasing pH (e.g. from 6.6 to values in the range 6.9–7.1) during HHT on the rennet coagulation properties of HHT milk at pH 6.55 may be due to a combination of factors such as: (a) the interfering effects of κ -CnWPPs, which on rennet treatment are not prone to coagulation at pH 6.55, in isolation, but may provide a steric impedance to fusion and knitting together of aggregates of κ -casein depleted casein micelles into a gel, and (b) a lower ability of κ -casein depleted casein micelles to form a gel in HHT milk compared to native casein micelles in pasteurised milk (we are unaware of any published studies comparing both).

Undoubtedly, maximising the recovery of whey proteins to cheese from HHT milk will necessitate further studies to unravel the mechanism by which denatured whey proteins impact on the rennet coagulation properties.

8.5.4 Bactofugation

Bactofugation refers to the centrifugation of milk at high g -force (8000–10 000 g) to remove heat-resistant bacterial spores (e.g. *Clostridium* and *Bacillus* spp.) that survive pasteurisation, and thereby improve quality (Houran, 1964). It is claimed that up to 90–95% of spores, which have a higher density than the milk, can be removed by bactofugation (Sillén, 1987). In addition to sporeformers, bactofugation can also remove bacterial vegetative cells, such as *E. coli* (Kosikowski & Fox, 1968). The sludge containing the spores, which amounts to ~2–3% of the feed volume, is high heat treated (130–140°C) for a few seconds and then added back to the cheese milk.

Its main use in cheese manufacture is in the treatment of milks used for the production of eye cheeses, especially Emmental-type cheeses and to a lesser extent, Gouda and Leerdammer. These cheeses are susceptible to defects where the milk is contaminated with clostridia spores which survive pasteurisation, vegetate and grow in the cheese in the anaerobic environment. The primary source of contamination is the faeces from cows fed on poor quality silage (Dasgupta & Hull, 1989; te Giffel *et al.*, 2002). *Clostridium tyrobutyricum* if present in the cheese milk can lead to a defect known as ‘late blowing’, which involves the fermentation of lactic acid into butyric acid, acetic acid, carbon dioxide (CO₂) and hydrogen (H₂) late in the maturation process (after the hot-room ripening period) when the cheese has undergone proteolysis and, consequently, lost much of its early elasticity. Excessive gas production at this time leads to the production of numerous large eyes that are rough in appearance, splits and/or cracks; simultaneously, the production of butyric acid leads to the development of objectionable odour. The defect is prevalent in cheeses where the following manufacturing conditions and compositional characteristics favour the growth of clostridia: (a) the use of milk from cows fed on silage, (b) lack of bactofugation or clarification pre-treatment of the cheese milk, (c) scalding of curd at high temperatures (>45°C), and low-salt content (<1 g 100 g⁻¹) and high pH. In addition to bactofugation, other treatments used to reduce the incidence of late blowing associated with *C. tyrobutyricum* include the addition of sodium nitrite (KNO₃; NaNO₃) or lysozyme.

8.5.5 Clarification

Milk may be also clarified in a centrifugal separator (clarifier) to remove suspended matter including dirt, epithelial cells, leucocytes, corpuscles and bacteria sediment as a sludge (Fjaervoll, 1968; Lehmann *et al.*, 1991). It differs from bactofugation in that it generally does not remove/separate particles of size $< \sim 10 \mu\text{m}$ and, hence, bacteria or spores. Formerly when milk quality was relatively poor, clarification was practiced to improve cheese quality (Combs *et al.*, 1924). However, owing to the vast improvement in hygiene of modern milk production and quality of milk delivered to dairies practices (see Chapter 1), clarification of milk for cheesemaking is generally not practiced. Moreover, clarification can result in protein losses in the sludge of up to $0.012 \text{ g } 100 \text{ g}^{-1}$, which from a yield efficiency perspective is undesirable.

8.5.6 Standardisation of protein-to-fat ratio

Bovine milk varies considerably in its composition and in the relative proportions of fat and protein throughout the cheesemaking season (Barbano & Sherbon, 1984; Banks & Tamime, 1987; Bruhn & Franke, 1991; Auldust *et al.*, 1998; O'Brien *et al.*, 1999; Guinee *et al.*, 2007b), owing to factors, such as breed, stage of lactation, diet, environment and season. Consequently, milk for cheesemaking is standardised by adjusting the protein-to-fat ratio (PFR) and/or by increasing the protein level (milk protein standardisation) so as to offset the effects of the naturally occurring variation in milk composition on product composition and quality, and to conform to end product specifications.

Protein-to-fat ratio

Most of the well-known cheese varieties are required to have levels of moisture and fat-in-dry matter (FDM) that comply with those specified in legal 'standards of identity'. For example, Cheddar cheese is required to have a maximum moisture content of $39 \text{ g } 100 \text{ g}^{-1}$ and a minimum FDM of $48 \text{ g } 100 \text{ g}^{-1}$ in the United Kingdom (Her Majesty's Stationary Office, 1996), while the corresponding levels in the United States as specified in the Code of Federal Regulations are 39 and $50 \text{ g } 100 \text{ g}^{-1}$, respectively (Food and Drug Administration – FDA, 2003). Standardisation of FDM in effect corresponds to standardisation of the PFR, since protein forms the bulk of the non-fat dry matter ($>80 \text{ g } 100 \text{ g}^{-1}$) portion.

While the moisture content of cheese, and hence the levels of fat and protein, is determined mainly by the manufacturing protocol, the PFR is controlled mainly by adjusting the protein/fat (or casein/fat) ratio in the cheese milk. Once the protein and fat levels in the particular variety are known, then the required PFR in the cheese milk may be calculated by the equation below:

$$\frac{P_m}{F_m} = \frac{\text{Protein in cheese/protein recovery factor}}{\text{Fat in cheese/fat recovery factor}} \quad (8.1)$$

where P_m and F_m correspond to the protein and fat levels in the standardised cheese milk, and the protein and fat recovery factors refer to the fraction of these components recovered during cheese manufacture. Recovery factors are influenced by many factors including milk

composition, manufacturing technology, operations and practices (Fox *et al.*, 2000) and, hence, can vary within a variety and between varieties. Using data for commercial Cheddar cheese composition ($\text{g } 100 \text{ g}^{-1}$) (~ 25 protein, ~ 33 fat) (Guinee *et al.*, 2000c) and the respective recovery factors of 0.91 and 0.76 for milk fat and milk protein to cheese for modern Cheddar cheese plants (Guinee *et al.*, 2005), the required protein to fat in standardised milk (using Equation 8.1), is ~ 0.9 , which is equivalent to $\sim 3.66 \text{ g fat } 100 \text{ g}^{-1}$ for a $3.3 \text{ g protein } 100 \text{ g}^{-1}$. However, both the protein/fat ratio of cheese milk and FDM (and protein/fat ratio) of cheese vary significantly in practice.

Increasing the PFR increases the levels of cheese moisture, protein, Ca, and P, but significantly reduces the levels of moisture in non-fat substances (MNFS), FDM, and salt in moisture (S/M) (for a fixed rate of dry-salt addition in the case of Cheddar cheese). The opposite effects of PFR on MNFS and moisture in cheese reflect the depressive effect of milk fat (globules) on the permeability and syneresis of the rennet milk gels (Dejmek & Walstra, 2004) on one hand, and the dilution effect of fat on the volume fraction of moisture and protein in the cheese on the other. Owing to the impact of cheese composition on the texture, sensory properties, and quality (O'Connor, 1974; Fox 1975; Pearce & Gilles, 1979; Lelievre & Gilles, 1982; Amenu & Deeth, 2007; Guinee *et al.*, 2008), it is obvious that standardisation of PFR of the cheese milk is essential to optimise quality and consistency. In addition, the recovery of fat decreases as the PFR is reduced (Fig. 8.4), an effect attributed to a dilution effect of the protein matrix of the gel (curd) at the higher fat levels, which attenuates the ability of the protein matrix to retain occluded fat globules during gel cutting and stirring and curd handling. Conversely, the recovery of water from milk to cheese increases, as do the actual and moisture-adjusted cheese yields (Guinee *et al.*, 2007a), both effects due to the concomitant increase in the fat content (and, hence, cheesemaking solids) as the PFR is reduced (Fig. 8.4).

Milk protein level

Seasonal changes in the content of milk casein, and hence protein, have a major impact on its rennet gelation and curd-forming properties (Banks & Tamime, 1987; Auldust *et al.*, 1996; O'Brien *et al.*, 1999), and are thus conducive to inconsistencies in cheese yield (Guinee *et al.*, 2006, 2007b) and quality (Lawrence *et al.*, 2004). These effects can be particularly manifest in large modern cheese plants (e.g. processing $>1 \text{ M L milk d}^{-1}$) where coagulant and starter culture are added to milk on a volume basis (rather than on a casein basis), the rennet gel tends to be cut on the basis of time rather than on gel firmness or gel-firming rate, and other steps, such as speed and duration of cut programme, are fixed. With such practices, low milk protein content can lead to a of curd firming rate, cutting the gel when it is underset, shattering of curd particles during cutting and early stages of stirring, smaller curd particles, higher moisture loss and lower moisture cheese. Investigation of the effect of varying firmness at cut from 0.5 to 80 Pa (as measured using low strain amplitude oscillation) has shown that increasing firmness increased the levels of moisture and MNFS and reduced the pH and contents of protein and S/M of experimental Cheddar cheeses (Fig. 8.5). This is consistent with the reduced rate of syneresis from rennet gels as the value of storage modulus, G' , at cutting increases (van Vliet *et al.*, 1991). The higher levels of moisture and MNFS reflect a reduced tendency of the stiffer gel structure at cutting to rearrange (with the

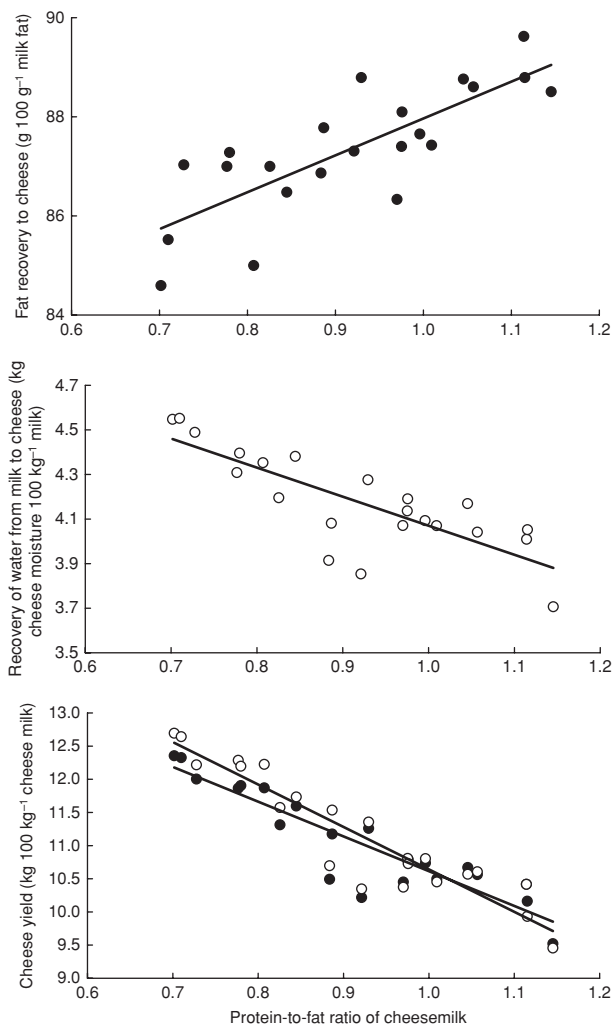

Fig. 8.4 Effect of protein-to-fat ratio of cheese milk on the recoveries of fat (●) and water (kg cheese moisture 100 kg^{-1} of milk) (○) from milk to cheese, and on cheese yields: actual yield (▲) and moisture-adjusted ($38.5 \text{ g } 100 \text{ g}^{-1}$) yield (△). (Compiled from data by Guinee *et al.*, 2007a)

formation of new bonding sites) and hence, to contract and synerese. The reduction in S/M suggest a greater dilution of added salt and loss of added salt (and whey though the curd bed) as the moisture level of the curd increases at salting (Sutherland, 1974; Gilles, 1976). The lower pH is consistent with the higher level of moisture (and lactic acid; Shakeel-Ur-Rehman *et al.*, 2004) and the reduced level of protein (and buffering capacity) (Rynne *et al.*, 2007).

In these circumstances, standardisation of milk protein, or casein, to a target value across the cheesemaking season would provide a very effective means of minimising the effects of natural seasonal-related variations in milk composition on cheese composition, quality, and manufacturing efficiency. Consequently, the standardisation of milk protein by low concentration factor ultrafiltration (LCFUF) of skimmed milk is now widely practiced in several

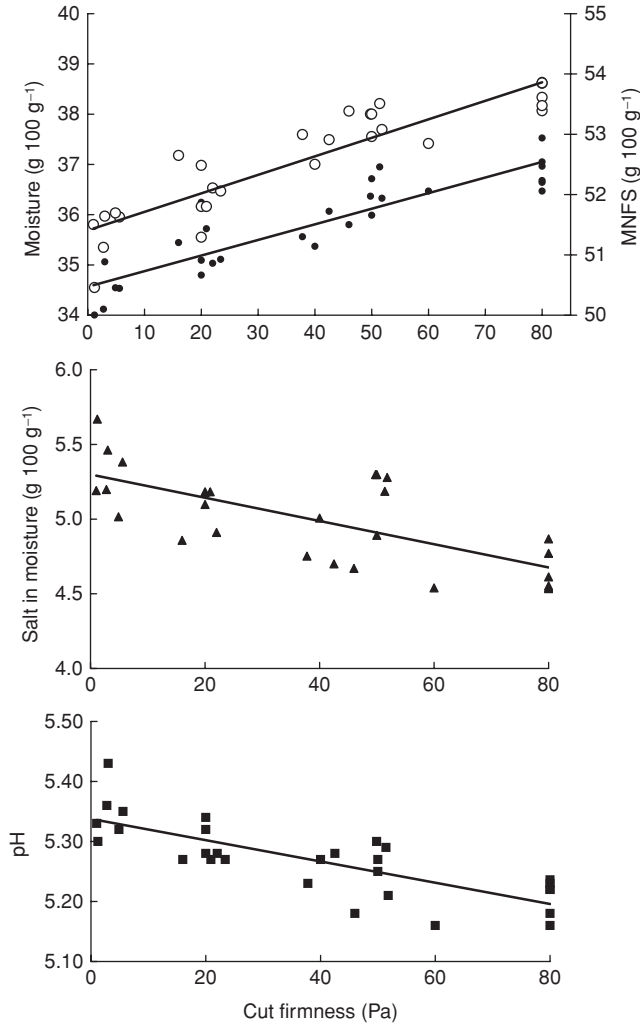

Fig. 8.5 Effect of gel firmness at cutting on the levels of moisture (●), moisture in non-fat substances (MNFS; ○), salt in moisture (▲) and pH (■) in Cheddar cheese. The firmness of the gel corresponds to the elastic shear modulus (G') as measured using low-amplitude shear oscillation rheometry. (T.P. Guinee, unpublished results.)

countries (Govindasamy-Lucey *et al.*, 2004; Mistry & Maubois, 2004). This essentially involves a slight increase in milk protein content from its natural level ($3\text{--}3.5\text{ g }100\text{ g}^{-1}$) to levels $<4.5\text{ g }100\text{ g}^{-1}$. At higher protein levels ($>5.0\text{ g }100\text{ g}^{-1}$), the curd-firming rate is very rapid, making it very difficult to avoid oversetting and stiffening of the gel (curd) during cutting (Fig. 8.6), tearing of the curd before end of cut cycle, ensuing shattering of curd particles, very high losses of curd fines and fat in the cheese whey, small curd particles, dry cheese, poor yield and quality (Guinee *et al.*, 1994). Moreover, the higher ratio of curd to whey makes it difficult to stir, achieve the desired rate of heat transfer, prevent clumping, and pump out.

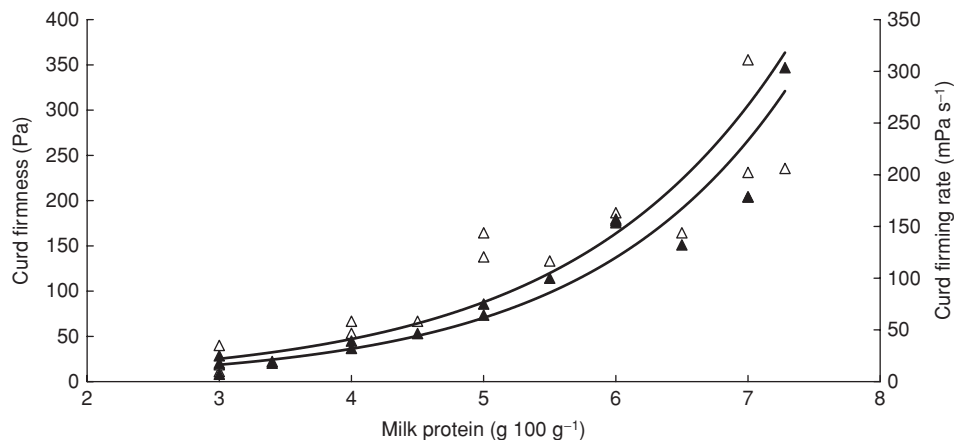

Fig. 8.6 Curd firmness (Δ) and curd-firming rate (\blacktriangle) of rennet-treated skim milk as a function of milk protein level, which was varied by ultrafiltration. The firmness of the gel corresponds to the elastic shear modulus (G') as measured using low amplitude shear oscillation rheometry. (Compiled from data by Guinee *et al.*, 1997.)

Increasing the protein content of milk by LCFUF from typical levels of 3.3 to 4.0 to 4.5 g 100 g⁻¹ gives a shorter gelation time, an increase in curd-firming rate, and reductions in the time required to obtain a given firmness and set-to-cut time (Fig. 8.6). When cutting the milk gel based on a fixed firmness value, then increasing the milk protein level by UF standardisation leads to lower levels of moisture (Fig. 8.7) and MNFS and a higher level

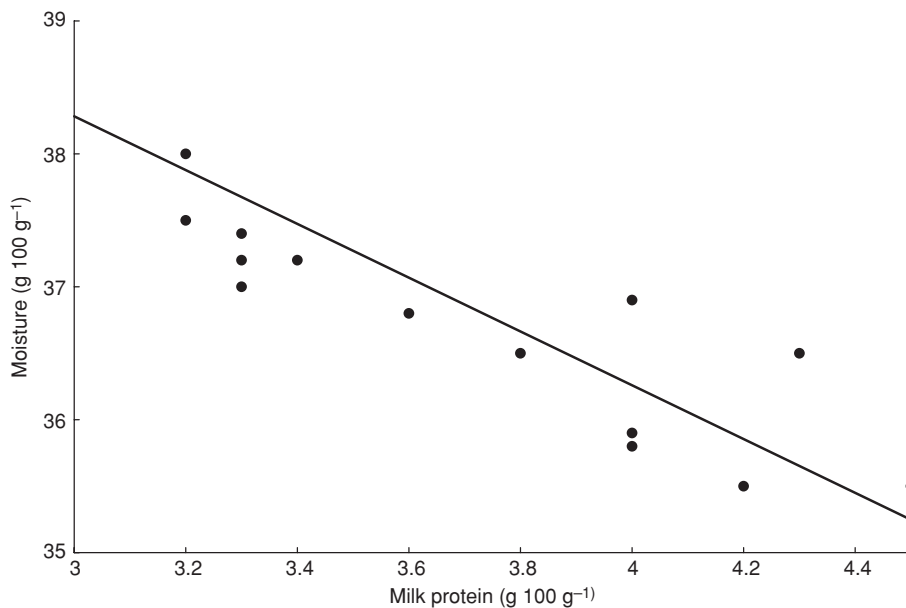

Fig. 8.7 Moisture content of Cheddar cheese as a function of milk protein level, which was altered by ultrafiltration. (Compiled from data by Guinee *et al.*, 1996.)

of fat (Bush *et al.*, 1983; Guinee *et al.*, 1994, 1996, 2006). Consequently, LCFUF has been recommended as a means of overcoming the defect of 'elevated moisture' in Cheddar cheese from late lactation milk (Broome *et al.*, 1998a). The degree of moisture reduction is equivalent to $\sim 0.2 \text{ g } 100 \text{ g}^{-1}$ per $0.1 \text{ g } 100 \text{ g}^{-1}$ increase in milk protein. Tentative explanations for the inverse relationship between milk protein content and cheese moisture when cutting at defined firmness value may include *inter alia* the:

- increase in the ratio of casein to soluble salts at coagulation and the ensuing more rapid aggregation of the *para*-casein micelles, leading to a coarser and more porous gel network, which would be more porous and prone to syneresis on cutting and stirring (Green *et al.*, 1981a);
- the increases in the number and volume fraction of curd particles in the curd/whey mixture, which would favour greater curd particle collision, opportunity for local deformation of the matrix within each curd particle, rearrangement of the protein matrix into a more compact structure (Dejmek & Walstra, 2004) and, hence, more syneresis, especially during cutting and the early stages of stirring.

In contrast to the above, cheese manufacturers frequently report an opposite trend to the above, i.e. the moisture content of cheese (e.g. Cheddar, Mozzarella) increases as the protein level is increased using LCFUF. However, this discrepancy appears to be due to the commercial practice of cutting the rennet gel after a fixed time, rather than on the basis of curd firmness, despite differences in milk protein level in the cheese milk. Consequently, cutting the gel of LCFUF standardised milk after a standard time (similar to control milk) leads to a firmer gel at cut, and an increase in moisture content to a degree that increases with milk protein level, as discussed above (Fig. 8.5). In commercial practice, the moisture content of cheese made from protein-standardised milk can be normalised to control values very easily by slight alterations of make procedure, e.g. cut firmness, curd particle size, cut/stirring programme, cooking rate, scald temperature, curd-handling protocols.

Guinee *et al.* (2006) reported that the percentage milk fat recovered to Cheddar cheese increased significantly from ~ 88.5 to $90.5 \text{ g } 100 \text{ g}^{-1}$ on increasing the level of milk protein from 3.3 to $4.0 \text{ g } 100 \text{ g}^{-1}$, an effect that may be related to a possible reduction in the porosity of the protein matrix and its permeability to enclosed fat globules during cutting and early stages of stirring when fat loss is most pronounced. Consequently, the normalised yield of moisture-adjusted cheese (*per* 100 kg of cheese milk adjusted to reference levels of fat and protein) in the UF standardised milk was higher than that of the control.

LCFUF standardisation of milk protein upwards generally results in lower rates of primary proteolysis when rennet is added on a volume basis at a similar level to the control non-concentrated milk. The lower proteolysis, as reflected by decreases in levels of nitrogen solubility at pH 4.6 or in $5 \text{ g } 100 \text{ g}^{-1}$ tungsto-phosphoric acid and an increase in the level of residual caseins, in particular β -casein (Green *et al.*, 1981b; Guinee *et al.*, 1994, 1996; Broome *et al.*, 1998b), may be attributed to a number of concomitants including the reduction in the rennet to casein ratio and, hence, residual rennet activity in the cheese (Creamer *et al.*, 1987), the lower level of MNFS, and lower surface area-to-volume ratio of the coarser protein matrix (Green *et al.*, 1981b; Guinee *et al.*, 1995). The reduction of proteolysis is unlikely to be affected by the inhibitory effect of proteinase/peptidase concentrated by UF (Hickey

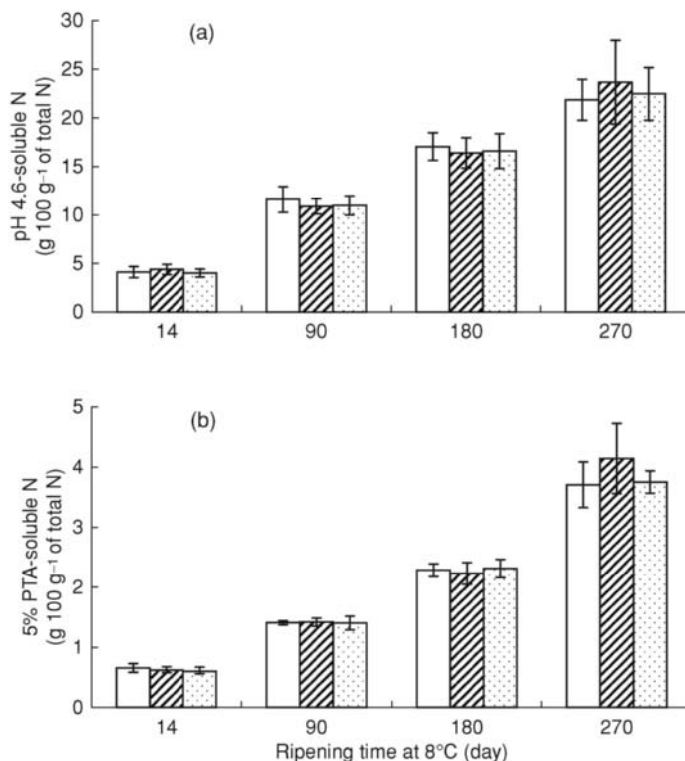

Fig. 8.8 Mean levels of pH 4.6-soluble N (a) and 5% phosphotungstic acid (PTA)-soluble N (b) in Cheddar cheeses made in triplicate from control milk with 3.3 g 100 g⁻¹ protein (open bar), milk fortified to 4.4 g 100 g⁻¹ protein either micellar casein powder (hatched bar) or made from low-concentration ultrafiltered milk (spotted bar). All cheeses were made from milks with equal ratios of protein to fat, starter culture to casein and rennet to casein. (T.P. Guinee, unpublished results.)

et al., 1983) and/or the inhibition of the native proteinase, plasmin, by β -lactoglobulin (Qvist *et al.*, 1987; Bech, 1993) owing the very low concentration factor of whey proteins in cheese from LCFUF milk (~ 0.3 – 0.35 g 100 g⁻¹ for rennet curd cheeses). However, when LCFUF standardised cheese milk is rennet-treated to give the same rennet-to-casein ratio as in the control milk, the levels of proteolysis in the LCFUF and control cheeses are similar (Fig. 8.8; Govindasamy-Lucey *et al.*, 2004).

8.5.7 Homogenisation

Homogenisation of milk is a process whereby the native fat globules are disrupted by passing the milk through small orifices (valves) in series at 45–50°C and at pressures, typically in the range 15–25 MPa. It reduces fat globule size, and increases the surface area of the fat by a factor of 5–6. The native protein–phospholipid membrane of the fat globules is sheared off in the process and replaced by a protein layer consisting of casein micelles, sub-micelles and whey proteins; this layer around the newly formed fat globules is frequently denoted the

recombined fat globule membrane (RFGM). The RFGM enables the fat globule to behave as a fat-filled protein particle (FFPP), which can become an integral part of the gel network during acid- and rennet-induced gelation of milk.

The role of milk of milk homogenisation in rennet-curd cheese manufacture has been extensively investigated (Jana & Upadhyay, 1991, 1992; 1993; Tunick *et al.*, 1993; Metzger & Mistry, 1994; Rudan *et al.*, 1998; Guinee *et al.*, 2000a; Nair *et al.*, 2000; Oommen *et al.*, 2000; Madadlou *et al.*, 2007; Thomann *et al.*, 2008). The effect of homogenising the milk on the quality of certain cheese varieties will follow.

Fresh, acid-curd cheese manufacture

Homogenisation of milk is an integral part of the manufacturing process for soft, high-fat, acid-curd cheeses such as Cream cheese and Neufchatel (Kosikowski & Mistry, 1997), as it prevents creaming (flocculation of fat globules) during the relatively long gelation time (>4 h), and contributes to the formation of a homogeneous, thick, creamy texture in the end product (Mahaut & Korolczuk, 2002). The texture characteristics ensue from the participation of the FFPPs in the formation of a composite acid gel, which has a greater number of protein–protein interactions and is stiffer and more uniform than the corresponding gel from non-homogenised milk (van Vliet & Dentener-Kikkert, 1982; Ortega-Fleitas *et al.*, 2000).

Rennet-curd cheese manufacture

Homogenisation of milk or cream is not widely practiced in the manufacture of rennet curd cheeses because of its adverse effects on curd firmness and associated defects in the resultant cheeses:

- Poorer ability of the curd particles to knit and mat during manufacture;
- Increased tendency of moulded curds to break/crack easily, making curd handling more difficult (in the case of Cheddar cheese, the curd tends to shatter during milling, and because of its larger surface area-to-volume ratio absorbs more of the added salt);
- Increased moisture content (e.g. 1–2% at total pressures of ≥ 20 MPa);
- Altered curd rheology and texture, with the cheese being more easily fractured (lower fracture strain), less elastic, ‘shorter’ and ‘bitty’;
- Impaired cooking properties of the melted cheese as reflected by its lack of surface sheen on melted cheese, markedly lower degrees of flow/spread and stringiness, and increased tendency to dry out/burn;
- Increased propensity to the development of rancid flavours in the cheese, owing to an increased access of indigenous or microbial lipases in the cheese to the milk fat and the resultant production of FFAs.

These defects are discussed in more detail below. However, there are some applications where homogenisation is necessary and/or desirable: (a) cheeses made from recombined milk (formed by low-pressure homogenisation (e.g. total pressure of ~ 10 MPa) of oils (butter oil and/or vegetable oils) in aqueous dispersions of milk protein

(e.g. reconstituted or reformed skimmed milks) in countries where the demand for cheese-making exceeds the local supply of fresh milk, (b) blue vein cheese, where the casein-based fat globule membrane allows access to lipases from the mould to the fat and thereby enhance the formation of FFAs which are the main substrate for the production of methyl ketones which are very important for flavour, and (c) increasing the whiteness of some cheeses (Feta-type, blue-type cheeses) by low-pressure homogenisation of a portion of the milk containing the fat.

Effects on curd forming properties

Homogenisation of cheese milk at first and second stage pressures in the range 5–25 MPa and 1–5 MPa, respectively, gives a slight reduction in the time to onset of gelation (gelation time, GT) of rennet-treated milk, and slight increases in the gel firming rate ($\sim 0.3 \text{ Pa min}^{-1}$) and elastic shear modulus, G' , of the resultant gels at a given time from gelation onset (Guinee *et al.*, 1997), as measured using non-destructive low amplitude strain rheometry (within the linear viscoelastic limit of the forming gel). The magnitude of these effects tends to increase with protein concentration (Thomann *et al.*, 2008). Yet, homogenisation of milk at 5–25 MPa significantly impairs the curd tension (CT), as reflected by large reductions (two to three-fold) in the force required to cut the gels, as measured using large strain deformation texture analysis (Maxcy *et al.*, 1955; Ghosh *et al.*, 1994; Thomann *et al.*, 2008). Moreover, the application of techniques (addition of calcium chloride, reducing pH from 6.6 to 6.1, increasing rennet temperature from 30 to 40°C, and/or increasing rennet dosage three-fold) that enhance the curd tension of non-homogenised milk have only a minor effect and do not re-establish curd tension adequately. Full restoration of the curd tension of homogenised milks requires an increase in milk protein level by a factor of 1.5–2.0, for example, by addition low-heat skimmed milk powder or membrane concentration of the homogenised milk. The opposite responses of G' and CT are unexpected and probably reflect differences in the magnitude and type of the forces being measured using both techniques. The former is a measure of the stress generated on the application of low strains (typically 0.015) of the forming gel, and as such reflects the force stored in strands of the gel when strained within the linear viscoelastic limit. In contrast, cutting involves the measurement of the stress required (by the knife) to penetrate, and in effect fracture (break), the surface of the formed gel (Luyten *et al.*, 1991b). In addition, homogenisation of milk induces a number of other effects which may contribute to the opposite trends in G' and CT:

- Dilution in the number of, and concentration of, casein micelles in the bulk serum phase;
- A spreading of casein along the surfaces of fat globules and a concomitant increase in the surface area of casein per κ -casein molecule, estimated to increase from 40 m² in homogenised milk to $\sim 80 \text{ m}^2$ in homogenised milk (Robson & Dalgleish, 1984; Thomann *et al.*, 2008);
- A reduced level of κ -casein hydrolysis required to induce destabilisation of the FFPPs;
- A change in the type (e.g. casein micelles in the bulk-phase milk compared to casein micelles and FFPPs in the homogenised milk) and size-distribution of casein particles participating in gel formation, and of the interactions between them;

- A change in structure from a uniform filled gel comprising a *para*-casein gel network encasing non-interactive native fat globules from non-homogenised milk, to a complex gel network comprising of fused *para*-casein micelles, *para*-casein micelles and FFPS, and/or fused FFPS from the homogenised milk.

It is probable that these changes increase the specific volume of the network in homogenised milk gels (owing to the incorporation of fat) and simultaneously increase the number soft-spots (fat filled interiors of the FFPS) within the strands of the gel network from homogenised milk. Such a transition may be conducive to improved gel forming properties (e.g. increasing G') of the homogenised milk as measured by straining the gel structure within the linear viscoelastic limit, but to a lower CT of the resultant gel when subjected to strains that fracture the structure.

8.5.8 Addition of calcium chloride

Bovine milk contains ~ 3 ionic Ca^{2+} which is sufficient to induce gelation of rennet-altered cheese milk. However, the addition of CaCl_2 at levels of $\sim 0.2 \text{ g L}^{-1}$, i.e. $\sim 1.8 \text{ mM Ca}^{2+}$, to milk is common commercial practice, especially if the cheese milk displays poor rennet coagulation and curd forming characteristics. Poor rennet coagulability of milk can be the result of a variety of factors, such as low protein level in milk, late lactation milk, high pH (>6.7), prolonged holding of milk at low temperature prior to cheese manufacture, high SCC, high enzymatic activity, and/or elevated pasteurisation temperature. Some of these factors are associated with a reduction in the levels of ionic and/or micellar calcium, an increase in the dissociation of casein from the casein micelle to the serum, and/or hydrolysis of the casein to proteose peptones and other soluble peptides by plasmin and/or proteinases from somatic cells. Deterioration of the coagulation properties is undesirable in cheese manufacture, especially in large modern dairy plants where the rennet gel tends to be cut on the basis of time rather than on gel firmness or gel-firming rate.

Addition of CaCl_2 generally improves the rennet coagulation properties, as reflected by a reduction in rennet gelation time and increases in curd-firming rate and curd firmness (Erdem, 1997; Landfeld *et al.*, 2002). The positive effects of CaCl_2 on rennet coagulation properties are due to the following effects on the cheese milk (Guinee, 2008):

- Increase in the concentrations of ionic Ca^{2+} and CCP;
- An increased attractive force between *para*-casein molecules due to calcification of ionised glutamate and aspartate residues;
- A concomitant decrease in pH (at least in commercial cheese manufacture, where pH readjustment is not practiced), resulting from the interaction of Ca^{2+} ions with soluble sodium phosphate salts and resulting in an increase in the hydrogen ion activity.

In contrast, the curd-firming rates and curd firmness plateau at addition rates of 2–9 mM CaCl_2 and decrease again at levels greater $\geq 9 \text{ mM CaCl}_2$ ($\sim 1 \text{ g L}^{-1}$). The decrease in curd firmness at the higher Ca^{2+} levels may be due to a marked increase in ionic strength, an effect

that would shield potential interaction sites. As expected, the addition of calcium chelating agents (e.g. EDTA, sodium phosphates) reduces gel firmness.

Depending on the cheese manufacturing protocol (firmness of gel at cutting, cut programme), the addition of CaCl_2 may also increase the level of milk fat recovered to cheese, cheese moisture (Fagan *et al.*, 2007a) and cheese yield (Wolfschonn-Pombo, 1997). The increase is likely to be due to the more rapid curd-firming rate, which would increase rigidity of the gel/curd during the early stages of syneresis, thereby limiting the ability of the matrix to rearrange and express whey.

8.5.9 Milk gelation

The quiescent gelation of milk by the addition of rennet (as in rennet-curd cheeses), acid (in fresh acid curd cheeses) or acid-heat (in acid-heated coagulated cheeses) is a *sine qua non* in cheese manufacture. It leads to controlled limited interaction of the destabilised milk proteins resulting in the formation of gel, which enables separation of the whey through subsequent operations (e.g. cutting, scalding, further acidification, centrifugation) and thereby facilitates the recovery of the protein, fat, colloidal ash and some of the serum (whey) in the form of a curd which can be further transformed to cheese via the superimposition of further unit operations (pressing, texturisation, salting, pressing) and maturation under defined conditions.

In the manufacture of rennet-curd cheeses, the milk is typically set with the quantities of starter cultures and rennet being added at a rate *pro-rata* with the milk volume. However, such a practice may lead to variations in the gel firmness at cutting, acidification rate during manufacture, composition of the curd and quality of the resultant cheese, especially when using milk displaying seasonal variations in milk composition (pH calcium, and especially protein; see Section 8.5.6). To minimise such variations and ensure more consistent composition and quality, rennet and starter cultures should be added at levels that kept *pro-rata* with the level of milk protein.

Reduction in the rennet-to-casein ratio (i.e. mg rennet g^{-1} casein) have been found to reduce the extent of increase of salt ($4 \text{ g NaCl } 100 \text{ g}^{-1}$)-soluble protein and the extent of degradation of α_{s1} -casein in Gouda cheese during storage (Visser, 1977; Visser & de Groot-Mostert, 1977). Consistent with these trends are the decreases in the degree of proteolysis in Cheddar cheese made from milks where the protein content has been increased without increasing the level of added rennet (Guinee *et al.*, 1994; see Section 8.5.6).

The pH at different stages of cheese manufacture is controlled by the opposing effects of lactic acid, which depresses pH, and the buffering capacity of calcium phosphate paracasein, which tends to maintain the pH at the original value of the cheese milk. Hence, for a given rate of lactic acid production by the starter cultures, the ratio of lactic acid to protein load in the cheese vat determines the pH, and is controlled by the protein level of the cheese milk. Consequently, in modern cheese manufacture, where many of the cheesemaking operations are carried on the basis of time rather than some objective parameter (e.g. pH), a variation in starter to casein ratio (owing to seasonal changes in milk protein or ultrafiltration of the cheese milk) is expected to affect pH at whey drainage, which can have marked effects on the composition and physical properties of the resultant cheese (Lawrence *et al.*, 1987; Tunick

et al., 2007). Similarly, variation in the activity of starter cultures can adversely effect curd composition, with a slow activity resulting in higher-than-normal losses of phosphate leading to lower pH cheese (Czulak *et al.*, 1969).

8.5.10 Curd-cutting programmes

The role of curd cutting and stirring in syneresis

The coagulum, which forms after the rennet-induced aggregation of *para*-casein micelles, tends to shrink, e.g. under its own weight, expressing whey. This shrinkage accelerates on cutting the coagulum into pieces of the order of 1 cm cube, due to a reduction in the distance that whey has to travel through the *para*-casein matrix to reach a surface where it is released. The concomitants of curd shrinkage are increases in whey volume and in the ratio of whey to curd and a reduction in curd moisture (Fig. 8.9a). The curd particles are usually stirred in the increasing volume of expelled whey for a predetermined length of time during which the majority of syneresis takes place, even though the rate of syneresis decreases with time (Fig. 8.9b). Hence, in commercial manufacture the whey is drained off (pumped out) after a

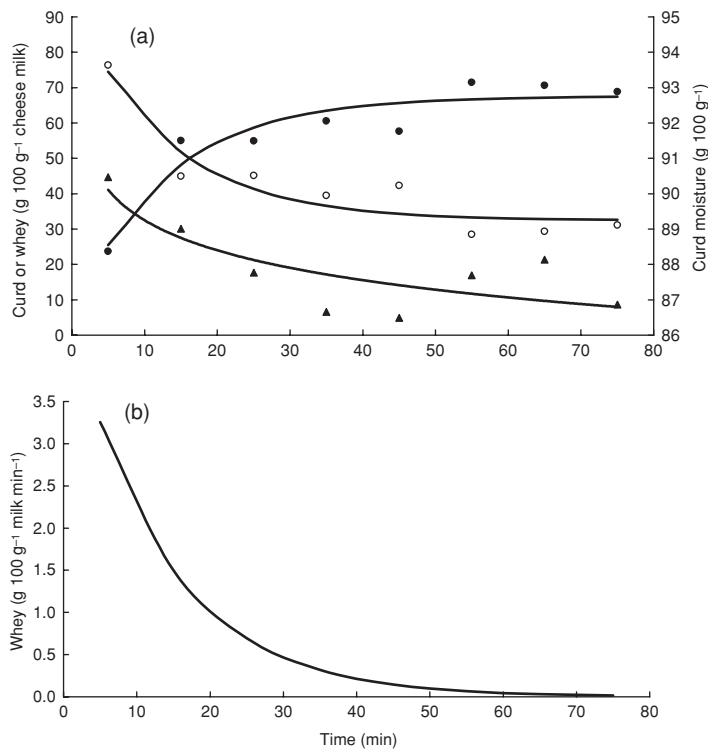

Fig. 8.9 Effect of stirring time on (a) weights of whey (●) and curd (○) and curd moisture (▲), and (b) rate of syneresis. The curd was made in an experimental vat with controlled cutting and stirring from milk with protein and fat levels of 3.2 and 1.4 g 100 g⁻¹, respectively. (D.J. O'Callaghan, unpublished results.)

given time, e.g. typically at 90 min after cutting in the case of Cheddar cheese. The drained whey accounts for $\sim 80 \text{ mL } 100 \text{ mL}^{-1}$ of the milk volume, with further whey being removed during moulding, pressing and/or dry-stirring operations.

The relationship between degree of syneresis and distance through which whey has to travel (\sim curd particle size) is expressed in Darcy's equation, in the following form for one-dimensional flow,

$$v = \left(\frac{B}{\eta}\right) \times \left(\frac{p}{l}\right) \quad (8.2)$$

where v is the velocity of the whey, B is the permeability coefficient of the gel (index of porosity), η is the viscosity of the whey, p is the pressure exerted by the contracting network on the enclosed whey and l is the distance through which the whey has to travel to the surface (index of curd particle size). The result is a two-phase mixture of curd and whey.

According to Dejmek & Walstra (2004), cutting disrupts the gel structure creating cracks in the gel, which initiate syneresis by creating new interactions between *para*-casein molecules. The extent of cutting determines the size of curd particles, which is inversely related to the velocity of whey exudation (Equation 8.2), and directly related to moisture content of the final curd (Whitehead & Harkness, 1954; Czulak *et al.*, 1969; Fig. 8.9b). In addition, smaller curd particles provide more surface area for syneresis, which together with the increased velocity of whey release, increases the rate of syneresis. Consequentially, smaller curd particles shrink more rapidly than larger ones. Other studies have confirmed a reduction in degree of shrinkage of curd particles as curd particle size increases for rennet induced gels (Grundelius *et al.*, 2000; Lodaite *et al.*, 2000). However, a very low curd particle size at cutting can lead to a large amount of curd fines becoming drained with the whey, an overall reduction in moisture content and a concomitant reduction in cheese yield. Hence, for a particular cheese variety and manufacturing technology there is a critical curd particle size distribution (e.g. 60% of curd particles $>$ than 2 mm for Cheddar cheese) below which losses are excessive. However, in large-scale manufacture, whey is centrifuged and curd fines are returned to the de-wheying belt to clarify whey for further processing (e.g. for whey as an ingredient in infant formula or for the manufacture of whey protein concentrates/isolates) and to recover valuable cheese solids.

Curd particle size is determined by the cut programme, which defines the number of cutting periods (cycles), speed of cutting and overall cutting time. Johnston *et al.* (1998) found that curd particle size distribution is mainly determined by the total number of revolutions (or passes) of the cutting knives, and for a particular vat, small curd particles (fines) are minimised at a particular number of revolutions. They concluded that, if the number of cutting revolutions were below optimum, large curd particles remained after cutting, and these particles disintegrated or shattered during subsequent stirring leading to the formation of numerous small curd particles that released more fat into the whey. Increasing the number of cutting revolutions beyond the optimum leads to progressively smaller curd particles, greater overall surface area of curd and, hence, more curd fines during subsequent stirring.

In traditional cheesemaking, the coagulum was cut using knives or harps in a number of intersecting strokes, e.g. along X , Y and Z axes to produce neatly defined cubes of curd. The resultant curd particles were allowed to sit quiescently for a defined period referred

to as healing (e.g. 5–15 min), after which stirring commenced. Mechanical cutting on the other hand, normally involves rotation of sharp cutting knives about a single axis, either horizontal or vertical. However, in modern commercial plants, mechanical cutting practices differ significantly from those employed in traditional farmhouse cheese manufacture. In order to obtain a reasonably uniform shape and distribution of curd particle size, cutting is carried out in a defined sequence of rotating movements, known as a cutting programme.

Gel-cutting programmes (traditional method)

In traditional cheese manufacture, and still in most reported experimental studies, the gel was cut manually using knives or harps and the resultant curd particles were allowed to sit quiescently in the whey to induce healing (strengthening) of the freshly exposed curd particle surfaces and thereby avoid breakage, curd fines, and losses in the whey. During this period, referred to as healing, syneresis proceeds rapidly and the curd particles heal, i.e. become firmer and develop a surface film, which is essentially an outer layer with a higher casein-to-fat ratio than the interior. The combined effects of the film and the cushioning effect of the expressed whey limit the damage inflicted on the curd particles by impact with the agitators/vat surfaces and velocity gradients during the initial phases of stirring. Hence, healing reduces the tendency of curd particles to shatter, i.e. fracture of the particle along its weakest points into smaller particles with jagged edges. The surface film becomes progressively stronger, as a consequence of the dehydrating effects of heat, acid and stirring (which creates pressure gradients over the surface, forcing new aggregation sites in the interior of the curd particle), and seals the fat and casein within the curd particles. The skin develops into the curd granule junction in the moulded cheese curd, which is readily recognisable on microstructural analysis of the cheese (Kimber *et al.*, 1974).

Gel-cutting programmes (commercial practice)

In commercial cheese manufacture, the traditional cutting and curd particle healing practices no longer apply. Instead the gel is subjected to a cut programme, comprising cut cycles (during which the knives rotate at fixed speeds) that may, or may not, be interspersed with short rest periods (15–20 s) depending on factors, such as cut firmness, vat design and geometry and knife speed. The knife speed is increased during successive cut cycles. During a rest period or a lapse period between successive cuttings of a particular section of curd by the knife, the strips of curd settle and distort under their own weight. Hence, when cutting resumes, the angle of cutting relative to the previously formed surfaces ensures that much smaller pieces of curd are formed.

As discussed in Section 8.5.6, the firmness of the gel at cutting has a major influence on composition but also on the level of curd fines and fat losses. As the curd is suspended in whey after the first cutting cycle, effective cutting depends on the curd firmness being within an acceptable window, since too weak a curd will crumble into fine particles and too firm a curd will resist cutting and tear (Everard *et al.*, 2008). Likewise, there will be an optimum cutting programme for a particular vat design and cheesemaking recipe, as too much cutting will produce large amounts of casein fines and increased fat losses to whey, and under-cutting

will produce curd particles that are large and which in turn will tend to shatter during the stirring of the curd, which follows the cutting operation (Johnston *et al.*, 1998).

8.5.11 *Stirring and cooking*

Following gel cutting, the curd particles in the expelled whey are stirred slowly at first (to minimise shattering) and then more rapidly as the curd particles firm. Simultaneously curd particles become heavier due to shrinkage and tend to sink, unless stirring speed is increased. Stirring at the correct speeds serves a number of functions: (a) prevent curd particle settling and matting, (b) provides pressure gradients across the surface of the curd particles, which in turn conduces interactions and rearrangement within the gel matrix and, hence, syneresis and (c) facilitates heat transfer from the heated jacket of the cheese vat to the curd/whey contents.

The rate of syneresis decreases with time (Rynne *et al.*, 2008), owing to a reduction in the rate of gel rearrangement and constraining of the curd matrix; however, the overall level of whey expressed increases with time (Fig. 8.9a; Lawrence, 1959; Marshall, 1982; Rynne *et al.*, 2008), and cheese moisture content decreases (Whitehead & Harkness, 1954; Czulak *et al.*, 1969). A similar trend has been reported for the level of syneresis from acid milk gels (Lucey *et al.*, 1997). Patel *et al.* (1972) reported slight increases in syneresis with increased agitation speed.

For most rennet-curd cheeses, the temperature of the vat curd/whey mixture is raised from ~30 to 33°C at gelation to the scald temperature, which varies with cheese type: ~37°C for Gouda, 39–40°C for Cheddar; ~42°C for Mozzarella and Kachkaval, 52–54°C for Emmental, 55–57°C for Gruyère de Comté. The process of raising the temperature is referred to as cooking or scalding, and the temperature chosen depends on the desired moisture content, variety, and the optimum growth temperature of the starter cultures used; mesophiles, such as *Lactococcus* spp. have an optimum of ~28–32°C, while higher temperatures in the range 45–50°C favour the growth of thermophilic bacteria, such as *Streptococcus thermophilus* (Fox *et al.*, 2000). Generally, there is an inverse relationship between moisture content of curd and cooking temperature (Patel *et al.*, 1972; Walstra *et al.*, 1985), with higher temperatures favouring low moisture (Whitehead & Harkness, 1954). Consequently, the curds for some high moisture cheeses, such as Brie and Camembert, are not cooked.

A gradual increase in temperature is desirable as otherwise a condition similar to case hardening is obtained, leading to excessive moisture retention and low curd pH (due to the increase in lactose and, hence, lactate to buffering ratio of the curd). Generally, rates of 1°C per 3–5 min are common, with the lower rates leading to more syneresis and moisture loss.

The decrease in pH of the curd, accompanying the fermentation of lactose to lactic acid by the starter cultures during heating and stirring, enhances the level of syneresis (Patel *et al.*, 1972; van Vliet *et al.*, 1991; Daviau *et al.*, 2000; Rynne *et al.*, 2008). The positive effects of pH reduction and heat in promoting syneresis may be attributed to an increase in casein interaction, as affected by the decrease in negative charge and increase in hydrophobicity. The make procedures of rennet-curd cheeses ensure that the effects of scald temperature and pH reduction are balanced to give a curd with the desired dry matter content and physical characteristics (e.g. firmness, resilience). While pH reduction promotes a decrease in negative charge, which is conducive to casein aggregation, it also leads to a partial solubilisation

of the CCP, which may have the opposite effect, i.e. favour an increase in casein hydration. However, for most rennet curd cheeses, the overall solubilisation of CCP in the cheese vat is relatively low ($<35 \text{ g } 100 \text{ g}^{-1}$ of total CCP) because of the relatively high pH at whey drainage (>5.8) and increase in temperature during cooking (which for most rennet-curd cheeses is $>35^\circ\text{C}$); hence, the increase in *para*-casein hydration is considered too low to impair syneresis. Indeed, the slight solubilisation of CCP favours a certain degree of flow of the casein matrix within individual curd particles and thereby promotes the opportunity for matrix rearrangement and syneresis. An opposite effect occurs in cheeses, such as Gruyère de Comté and Parmigiano Reggiano, where the high scald temperature (55°C) promotes the precipitation of serum calcium and phosphate (as insoluble calcium phosphate), a high degree of protein interaction, and curd particles that are very dry, hard, and 'mealy textured'.

The degree of pH reduction prior to whey drainage has a major effect on calcium to casein ratio of the curd, the degree of casein hydration (or conversely casein aggregation), the level of curd moisture, and the quality of the final cheese (Lawrence *et al.*, 1984, 1987; Guinee, 2003; Lucey *et al.*, 2003; Kindstedt *et al.*, 2004; Johnson & Lucey, 2006). *Ceteris paribus*, reducing the pH of the curd at whey separation leads to: (a) lower levels of calcium phosphate in the curd, (b) higher levels of moisture and lactose (and hence, lactic acid) in the curd, (c) a higher ratio of lactate-to-buffering capacity, and lower cheese pH (d) higher retention of residual chymosin (coagulant) activity, and (e) higher levels of proteolysis in the final cheese.

Increasing the holding time of the curd in the whey, especially at relatively low temperatures ($<35^\circ\text{C}$), until the pH reaches a level of 5.3–5.5 where a substantial portion of the CCP is dissolved, promotes the formation of wetter, softer, less resilient (elastic) curd particles and cheese. Hence, in general high moisture cheeses, such as Blue and Brie, tend to be cooked to more moderate scald temperatures (e.g. $<35^\circ\text{C}$) and separated from the whey at lower pH than hard cheese types such as Cheddar and Emmental for which the respective scald temperatures and pH values at whey drainage are ~ 6.15 – 6.4 and 39°C and ~ 6.3 – 6.5 and 50°C . For a similar reason, the relatively low temperature (22 – 30°C) and low pH (4.6 – 5) of the curd at whey separation in the manufacture acid-curd cheese, such as Quark and Cream cheese, ensure that these cheeses form a soft, smooth, non-granular, structural continuum.

8.5.12 *Curd washing: standardisation of lactose level in the moisture phase of the curd*

The pH of cheese has a major impact on its quality via its effects on enzymatic activity, protein hydrolysis, degree of protein hydration, and rheological properties. The principal factors affecting cheese pH are calcium phosphate level, buffering capacity, deamination reactions, ammonia production, and lactate concentration. The level of lactate in cheese depends primarily on the level of lactose in the milk which is fermented to lactate, mainly the L(+) isomer, at a rate dependent on the salt-in-moisture level in the cheese and the salt sensitivity of the starter culture strains used (Thomas & Crow, 1983; Turner & Thomas, 1980). Other factors affecting the concentration of lactate in cheese include the moisture content (Rynne *et al.*, 2007) and level of curd washing (in washed-curd cheeses, such as Gouda and Edam) (Van Den Berg *et al.*, 2004).

Curd washing is applied in the manufacture of Dutch-style cheeses including Gouda, Edam and Maasdammer, and some Swiss/Dutch-style cheeses such as Samsø, Havarti and Danbo (Davis, 1976; Kosikowski & Mistry, 1997). It generally involves removal of part (30–45% of the milk volume) of the whey after cutting and its replacement by hot water (55–60°C). It is a means of dilution of the lactose content in the moisture phase of the cheese curd and thereby controlling the concentration of lactate in, and pH, of the curd; the pH of the final cheese is controlled *inter alia* by the levels of whey removal and water addition. Owing to the lower level of lactose in the cheese moisture and hence lactate, washed curd cheeses have relatively high pH (≥ 5.3) when fresh, have a mild flavour (lower levels of lactic acid), and have characteristic elastic and long bodies, which make them ideal for slicing; the relatively high pH favours less proteolysis by the coagulant (Visser, 1977; Guinee & Wilkinson, 1992), which is an acid proteinase. In contrast, the higher lactose in the moisture phase of Cheddar cheese results in lower pH (~ 5.15 – 5.25), which contributes to a more acid flavour, higher levels of primary proteolysis, and a shorter (more brittle) texture less suitable for slicing (Luyten *et al.*, 1991a); however, other factors are also of course associated with the differences in flavour and texture, including *inter alia* differences gross composition of cheeses, buffering capacity (as affected by levels of protein and phosphate), manufacturing process (in particular the milling and dry-salting of Cheddar curd compared to the brine salting of Gouda curd loaves), and starter cultures used (Lawrence *et al.*, 2004; Van Den Berg *et al.*, 2004).

For a given level of lactose and, hence, lactic acid in washed curd cheeses, the level of wash water used depends on the lactose content of the cheese milk, the volume of whey removed (Wr), and may be calculated by the equations below:

$$LW2 = LW1 \left[\frac{100 - C - Wr}{100 - C - Wr + WWa} \right] \quad (8.3)$$

where $LW2$ is the desired lactose level ($\text{g } 100 \text{ g}^{-1}$) in the moisture phase of the curd; $LW1$ is the lactose level ($\text{g } 100 \text{ mL}^{-1}$) in the moisture phase of the milk, derived from the lactose level in the milk ($\text{g } 100 \text{ g}^{-1}$); C is the curd weight on removal of the whey, expressed as $\text{g } 100 \text{ g}^{-1}$ of milk, estimated from the non-diffusible colloidal components (fat, casein, colloidal ash) in the curd by assigning recovery factors (~ 0.96 for fat, 0.96 for protein, and 0.98 for colloidal ash) at the time of water addition; Wr is the weight of whey removed, expressed as $\text{g } 100 \text{ g}^{-1}$ of milk; WWa is weight of wash water added, expressed as $\text{g } 100 \text{ g}^{-1}$ of milk.

The WWa may in turn be obtained by rearrangement of Equation 8.3:

$$WWa = \frac{(LW1 - LW2)(100 - C - Wr)}{LW2} \quad (8.4)$$

The lactate content of commercial Cheddar cheese can vary dramatically (Fig. 8.10), an effect attributed to the variation in the lactose content of cheese milk (as all of the lactose in curd is generally fermented to lactate by the starter culture) (Guinee *et al.*, 2008). There is an inverse relationship between pH of Cheddar cheese and total lactate content (Huffman & Kristoffersen, 1984; Shakeel-Ur-Rehmana *et al.*, 2004, Guinee *et al.*, 2008; Fig. 8.11), with pH decreasing by ~ 0.05 pH units for every $0.1 \text{ g } 100 \text{ g}^{-1}$ in lactate. Huffman and Kristoffersen (1984) reported that high lactate ($\sim 0.8 \text{ g } 100 \text{ g}^{-1}$ at 90 days) and low lactate ($\sim 0.5 \text{ g}$

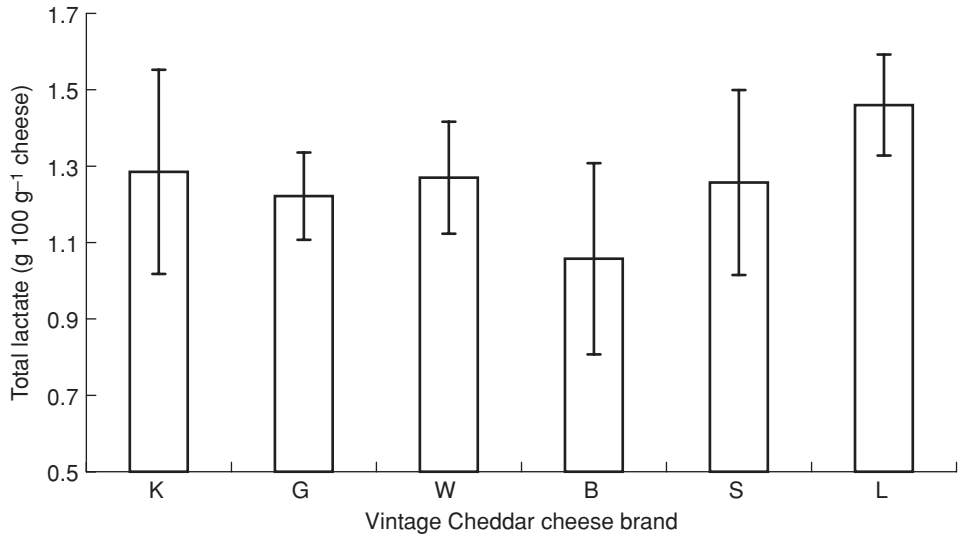

Fig. 8.10 Total lactate levels in six different retail brands (K, G, W, B, S and L) of vintage Cheddar cheeses; six replicate samples of each brand were procured at monthly intervals; the error bars show standard deviations. (Compiled from data by Guinee *et al.*, 2008.)

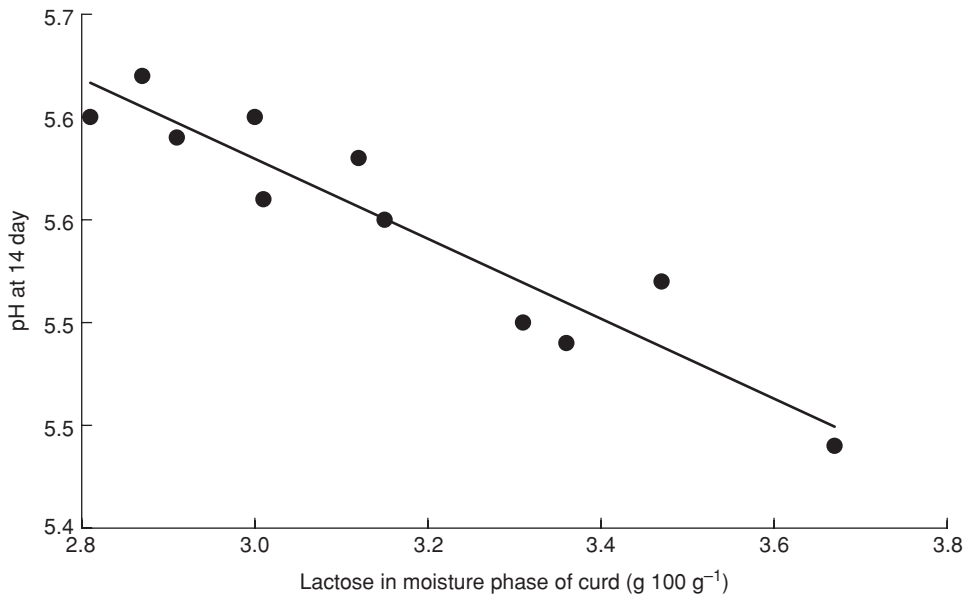

Fig. 8.11 pH of Cheddar cheeses as a function of lactose level in the moisture phase of the cheese, which were varied by altering the level of wash water added to the curd. The level of wash water was calculated using Equation 8.4 (Section 8.5.12) and the curd: (diluted) whey ratio was kept constant by removing a volume of whey equal to the level of wash water added. (T.P. Guinee, unpublished data.)

100 g⁻¹) Cheddar cheeses received higher flavour scores than the corresponding control cheeses over a 9 month ripening period; however, the lactate level of the control Cheddar (~0.75 g 100 g⁻¹) were much lower than those (~1.1–1.4 g 100 g⁻¹) reported elsewhere for Cheddar cheese (Turner & Thomas, 1980; Thomas & Crowe, 1983; Jordan & Cogan, 1993; Guinee *et al.*, 2008). In contrast, Shakeel-Ur-Rehman *et al.* (2004) found that Cheddar cheeses made from milks with artificially high (by fortification with lactose powder) or low (by curd washing) levels of lactose received lower scores for flavour/texture than the control at 120 and at 180 days, respectively. Defects associated with cheeses were unclean flavours and a coarse body in the high-lactose cheeses at 180 days, and flat, bland flavour in the low-lactose cheeses at 120 days (attributed to the possible loss of flavour compounds during washing). It is noteworthy that a major portion of the FFAs present in Cheddar cheese are produced by the starter cultures in the vat during manufacture, despite the significant losses during whey drainage (Hickey *et al.*, 2007). It is expected that curd washing would undoubtedly increase such a loss, and thereby reduce the typical savoury flavour of the Cheddar cheese, especially when young.

8.5.13 *Whey drainage and remaining operations*

Whey drainage (or separation) refers to the physical removal of whey from the curd particles. It is achieved by various means in the commercial manufacture of rennet curd cheeses (Bennett & Johnston, 2004):

- Filling the curd/whey mixture into perforated moulds (as in the case of soft cheeses, such as Brie or Camembert) where the curd is allowed to press under its own weight while being turned periodically;
- Pumping the curd/whey mixture: (a) onto perforated screens followed by conveyance onto perforated rotating belts where the curd bed is mechanically agitated or raked, as in Cheddar and other dry-salted cheeses, (b) into batch pre-press vats, comprising perforated base plates, overhead perforated plates that are pressed onto the top of the curd layer beneath the whey, and a system of removal of free whey once the curd bed is consolidated and (c) into semi-continuous pre-pressing moulding systems such as the Casomatic[®], essentially comprising cylindrical columns into which the curd/whey mixture is dispensed, a pressing piston for pre-pressing the curd beneath the whey, perforated bands that enable whey drainage, a curd cutting, moulding and discharge system.

In the manufacture of acid-curd cheeses, whey separation from the broken/cut gel is typically achieved by centripetal separator in the case of low-fat products, such as Quark (~0 g fat 100 g⁻¹) or Fromage Frais or centrifugal separators for higher fat products, such as Cream cheese (~33 g fat 100 g⁻¹) (Schulz-Collins & Senge, 2004). Whey separation may be facilitated by heating the curd whey mix from the fermentation temperature of ~22–30°C in the case of Quark cheese, or to 75–85°C for Cream cheese, which has a much lower PFR. UF is used to a lesser extent for whey removal.

For all cheeses, optimisation of the curd/whey separation technology and its operation is essential to ensure the desired composition (e.g. moisture level), knitting characteristics, physical characteristics (e.g. correct level of air inclusion or omission), and final quality. Little

or no published information is available on the effects of technology, as applied commercially, on cheese quality. This is scarcely surprising because of the difficulty in simulating the effects, in pilot-scale manufacture, of unit process variables as applied commercially on the composition/quality of cheese, e.g. curd particle velocities/period of knife rotation, pump-out time/pressure of pump on curd particles, temperature of curd during curd-handling operations, and applied force/pressure during pressing. However, from the authors' commercial experience, such optimisation is within the domain of proprietary state-of-the-art know-how.

Following whey removal, the individual curd particles knit together into a cohesive curd mass, to an extent depending on temperature, pressure, time. Further expulsion of whey from the curd and concentration of dry matter content continue during the remaining cheesemaking operations, e.g. cheddaring, salting and pressing. The extent of whey expulsion and salt uptake are affected by numerous parameters including *inter alia* curd temperature, curd pH, curd dimensions, method of salting, pressure, time (Sutherland, 1974; Gilles, 1976). Similarly, the degree of coalescence of fat globules and pooling can be altered by varying the temperature load applied during pressing (Richoux *et al.*, 2008). This is likely to impact on the cooking properties (Guinee & Kilcawley, 2004) and, based on the findings of Laloy *et al.* (1996), to influence the distribution of starter bacteria and their enzymes released into the cheese matrix on autolysis and hence, to have knock-on effects on proteolysis and ripening rates. Consequently, the type and level of processes to which the curd is subjected following whey removal are likely to have a major impact on the composition and quality of the final cheese (Law, 1999; Fox *et al.*, 2000; Guinee & Fox, 2004; Guinee & O'Kennedy, 2007).

Further discussion of the effect of these operations on cheese quality is a very extensive area and is beyond the scope of this chapter; the reader is referred to some textbooks for a more complete discussion (Reinbold, 1972; Robinson & Tamime, 1991; Kosikowski & Mistry, 1997; Robinson & Wilbey, 1998; Anonymous, 2003; Bennett & Johnston, 2004; Tamime, 2006).

8.6 Cheese quality: effect of cheese composition

The composition of cheese has a marked influence on all aspects of quality, including sensory properties, texture, and cooking properties (Fig. 8.2; Creamer & Olson, 1982; Pagan & Hardy, 1986; Luyten, 1988; Rüegg *et al.*, 1991; Visser, 1991; Fenelon *et al.*, 2000; Lawlor *et al.*, 2001, 2003; Watkinson *et al.*, 2001; 2004; Euston *et al.*, 2002; Delahunty & Drake, 2004; Guinee & Fox, 2004; Amenu & Deeth, 2007; Tunick *et al.*, 2007). This trend is consistent with the effects of composition on the extent of calcium solubilisation, protein hydration, enzyme activity, glycolysis, proteolysis, lipolysis, and microbiology (Geurts *et al.*, 1972; Fox *et al.*, 1996; Guo *et al.*, 1997; Reid & Coolbear, 1998; Gobbetti *et al.*, 1999a,b; Guinee & Fox, 2004). However, the level of effect on changing one or more compositional parameters depends on the cheese variety and characteristic (e.g. texture, cooking property, taste) of the cheese being observed. For example a 30% reduction in calcium level in Quark (from ~9.2 to 6.2 mg Ca²⁺ g⁻¹ protein) is unlikely to have any effect on the textural or sensory properties, whereas a corresponding reduction in Mozzarella (from ~28 to 19 mg Ca²⁺ g⁻¹ protein) or Emmental (from ~34 to 24 mg Ca²⁺ g⁻¹ protein) would significantly reduce shredability, chewiness, elasticity, stringiness, springiness, and eye formation (in case of Swiss). Similarly, a reduction of 0.1–0.2 units in the typical pH of Mozzarella (~5.5) and Emmental (~5.5)

would be likely to adversely affect the latter characteristics and quality, but to have less of an effect on some low pH cheeses, such as Quarg or Cheshire. However, a similar reduction in pH from ~ 4.8 to 4.6 in Cottage cheese coincides in an undesirable loss of chewiness and granularity, and a tendency towards a ‘mushy’ texture, owing to the increase in protonation of aspartate and glutamate residues and the ensuing loss of casein-bound calcium.

Owing to the interaction of different compositional parameters (e.g. pH, total calcium and ratio of soluble-to-colloidal calcium, moisture, fat and protein), it is difficult to study the exact effects of altering any one compositional parameter, or targeted changes in a group of selected parameters on quality. Consequently, with the exception of Cheddar cheese, there have been very few published studies attempting to relate composition to quality of different cheese varieties. Five major studies have considered the effects of composition (including level of salt or S/M) and quality/grading scores of mature Cheddar cheese. These involved the analysis of 300 commercial Scottish Cheddar cheeses (O’Connor, 1971), 24 commercial Cheddars salted at different rates (O’Connor, 1973a,b), 12 commercial Cheddar cheeses salted at different rates (O’Connor, 1974), an unspecified number of experimental and commercial New Zealand Cheddars (Gilles & Lawrence, 1973), 123 commercial Irish Cheddars (Fox, 1975), 486 experimental New Zealand Cheddar chesses (Pearce & Gilles, 1979), and $\sim 10\,000$ commercial New Zealand Cheddar cheeses (Lelievre & Gilles, 1982). These studies have identified four ‘key compositional parameters’ (KCPs), namely the levels of S/M, MNFS, pH and FDM, whose impacts on quality are inter-dependent. Additionally, two key process parameters (KPPs), namely the rate and extent of acid production in the cheese vat, were identified as having a large impact on quality and in determining the ranges of the four KCPs, which are necessary to give good quality (Gilles & Lawrence, 1973; Lawrence *et al.*, 1984). The KPPs determine the proportions of the colloidal calcium and phosphate of milk that are retained in, and the buffering capacity of, the cheese.

While these studies agree that the four KCPs are major determinants of Cheddar cheese quality, they disagree on the relative importance of these parameters. However, they concur that defined levels of S/M are critical for quality:

- Cheddar grade deteriorates rapidly at S/M levels $< 3.0\text{ g } 100\text{ g}^{-1}$ and $> 6\text{ g } 100\text{ g}^{-1}$ (Table 8.4);
- Highest grades are achieved with S/M values in the range of $\sim 4.7\text{--}5.7\text{ g } 100\text{ g}^{-1}$, which is equivalent to a salt content of $\sim 1.7\text{--}2.1\text{ g } 100\text{ g}^{-1}$ for a cheese with 37.5 g moisture 100 g^{-1} ;
- The effect of salt level on quality is very dependent on the values of the other three KCPs and the two KPPs.

However, the exact effect between composition and the four key compositional parameters on grade depended on manufacturing plant and season of year (Lelievre & Gilles, 1982). Such a trend is expected because of inter-plant differences in: (a) manufacturing procedures (e.g. adding rennet or starter cultures on a volume basis or casein basis, and pH at different stages of manufacture), (b) types/levels of rennet, starter cultures and/or starter cultures adjunct used and (c) environmental non-starter lactic acid bacterial flora. This highlights the complexity of trying to establish general correlations between composition and quality of different varieties.

Table 8.4 Relationships between composition (determined at 14 days) and the quality of mature Cheddar cheese

	Second grade	First grade	Second grade
Salt in moisture	4	4.7	5.7
Moisture in non-fat substances	50	52	54
Fat in dry matter	50	52	56
pH	5.0	5.1	5.3

Based on Lawrence *et al.* (1984).

8.7 Cheese quality: effect of ripening

8.7.1 Overview of the ripening process

Ripening refers to the biochemical, microbiological, structural, physical and sensory changes that occur during storage post manufacture and transform the fresh curd to a cheese with the desired characteristics. It has a major effect on the quality of most cheese varieties (Fig. 8.2), apart from those belonging to the category of unripened cheese including fresh acid curd cheeses (Quark and Cream cheese) and some ingredient cheeses. However, even here storage can influence quality depending on temperature, humidity and packaging. For example, low dry matter fresh cheeses with a high water to protein ratio (e.g. Quark) are prone to wheying-off over time especially if temperatures are relatively high ($>8^{\circ}\text{C}$), while storage may also affect the physical properties (e.g. shred) of ingredient cheese as a result of protein hydrolysis or polymer interactions.

For most rennet curd cheeses, ripening is a critical process and varies from ~ 4 weeks for Camembert to 2 years in the case of mature Parmesan cheese. During this period, the cheese undergoes a number of changes, which facilitate the transformation (Fox *et al.*, 1996; McSweeney, 2004): (a) glycolysis (sugar metabolism), (b) proteolysis (hydrolysis of protein and peptides), (c) lipolysis (hydrolysis of triacylglycerols), and (d) mineral equilibrium. These changes are in turn associated with related changes in pH, protein hydration, fat coalescence, and swelling of the casein matrix, to an extent depending on the cheese variety.

Glycolysis

Glycolysis involves the metabolism of sugars or sugar derivatives by the enzymes of starter cultures or secondary cultures (Fox *et al.*, 2000). In cheese, one or more of the following may occur, depending on the cheese variety:

- Conversion of residual lactose to L(+)-lactate by the starter cultures in most cheeses;
- The racemisation of L(+)-lactate to insoluble D(-)-lactate by non-starter lactic acid bacteria (NSLAB) (Rynne *et al.*, 2007), which in Cheddar cheese can result in the formation of calcium lactate crystals (Kubantseva *et al.*, 2004);
- The conversion of lactate to propionic acid, acetic acid, CO_2 and H_2O by *Propionibacterium* spp. in Swiss-type cheeses, resulting in an increase in pH, the formation of nutty flavour and eye formation;

- The conversion of lactate to cell biomass by *Geotrichium* and *Penicillium* spp. at the surface of Camembert-type cheeses, resulting in lactate and pH ingredients in the cheese that are central to the progressive protein hydration and softening from the surface to the centre.

The presence of residual lactose persisting in cheese during maturation is undesirable as it makes the cheese less suitable for lactose intolerant consumers (Lomer *et al.*, 2008), and also because it can be used as a growth substrate by NSLAB, which can affect unpredictable flavour and quality, especially when present in high numbers, for example, $>10^8$ cfu g⁻¹ (Beresford & Williams, 2004). In most cheese varieties, there is generally no residual lactose as it is converted to lactate by the starter culture within a week after manufacture. However, unfermented lactose may remain if the salt concentration is high (e.g. >6 g S/M 100 g⁻¹), and the salt-sensitivity of the starter cultures is low (Guinee & Fox, 2004), or when the lactose level in the cheese milk is increased to artificially high levels by fortification with lactose (Shakeel-Ur-Rehmann *et al.*, 2004) or skimmed milk powder. The ratio of lactate to buffering capacity is a major factor controlling cheese pH, which in turn affects many parameters that impact on cheese quality (protein hydration, activity of peptidases and proteinases, ratio of salt to acid forms of FFAs, flavour, texture and cooking properties). Hence, its regulation, for example, by the manufacturing process (pH at dry salting and/or extent of curd washing) and type of starter cultures used is critical (see Section 8.5.12).

Proteolysis

Proteolysis involves the hydrolysis of the casein to peptides and free amino acids by residual chymosin (~5–10% of total chymosin activity added), starter cell proteinases, and peptidases. The increase in the concentrations of free amino acids, resulting from the hydrolysis of peptides to free amino acids, has been found to coincide with the development of typical background cheesy flavour in most hard varieties. The early hydrolysis of α_{s1} -casein at the Phe₂₃–Phe₂₄ peptide bond, by residual chymosin, results in a marked weakening of the *para*-casein matrix and reductions in fracture stress and firmness (de Jong, 1976, 1977; Creamer & Olson, 1982). The sequence of residues 14–24 of α_{s1} -casein is strongly hydrophobic and confers intact α_{s1} -casein with strong self-association and aggregation tendencies in the cheese environment (Creamer *et al.*, 1982). Its cleavage is generally considered to be a major factor contributing to the decrease in the rubberiness of young internal-ripened hard cheeses, such as Cheddar, Gouda, and Mozzarella, and their conversion to smooth-bodied mature cheeses. However, a reduction in the ratio of colloidal to soluble calcium during cheese maturation during early ripening is also considered to be a contributory factor (O'Mahony *et al.*, 2005). However, the increase in soluble calcium during ripening of cheese is more likely to ensue from the increase in proteolysis (which leads to higher concentration of serum soluble peptides containing calcium attached to amino acid residues such as serine phosphate, glutamate and aspartate) rather than from any appreciable solubilisation of casein-bound calcium to soluble calcium. In addition to its effect on texture/rheology, proteolysis also has a major impact on the cooking properties of cheese, with an increase in proteolysis generally coinciding with increases in the levels of protein hydration, free fat and of heat-induced flowability (Guinee, 2003). The degree of stretchability of the melted cheese also

increases progressively with proteolysis to a level, which depends on the variety (e.g. at a level of pH 4.6 soluble N of $\sim 7 \text{ g } 100 \text{ g}^{-1} \text{ N}$ in Cheddar cheese compared to $14 \text{ g } 100 \text{ g}^{-1} \text{ N}$ in low-moisture Mozzarella), and thereafter decreases. Differences between cheese varieties in the level of primary proteolysis at which stretchability decreases may be related to the differences in degree of aggregation of the intact casein (as affected by temperatures applied to the curd, presence/absence of texturisation process), and in the hydrophobicity of the peptides in the cheese. Richoux *et al.* (2009) reported a power law relationship between the stretchability of Swiss-type cheese and the hydrophobicity of peptides in the pH 4.6 soluble nitrogen cheese extract.

Lipolysis

Fat is a major component in most cheese varieties, apart from some low fat fresh acid cheeses, such as Quark and Cottage cheese, and contributes directly and indirectly to rheology, texture, cooking properties and flavour (Guinee & McSweeney, 2006). During ripening, triacylglycerols may be degraded to FFAs and di- and mono-glycerides by lipases and esterases from various sources: (a) milk (lipoprotein lipase), (b) rennet paste (pre-gastric esterase), (c) starter cultures (intracellular lipases released on autolysis), (d) secondary starter organisms (*Penicillium roqueforti*, smear bacteria – refer to Chapter 6 for more detail), (e) NSLAB and (f) added pre-gastric esterase. The level of lipolysis and concentration of FFA differs with cheese variety (Collins *et al.*, 2004). It is high in cheeses the manufacture of which involves the use of strongly lipolytic secondary cultures (Blue cheese, $\sim 3500 \text{ mg } 100 \text{ g}^{-1} \text{ FFA}$) and rennet paste or pre-gastric esterase extracts (Romano, $\sim 1100 \text{ mg } 100 \text{ g}^{-1} \text{ FFA}$). In contrast, levels of FFA are low to moderate in cheeses, such as Gouda ($\sim 36 \text{ mg } 100 \text{ g}^{-1} \text{ FFA}$) and Cheddar ($\sim 100 \text{ mg } 100 \text{ g}^{-1} \text{ FFA}$). Indeed, high levels in the latter varieties can lead to rejection because of atypical rancidity. Hence, a recent survey of mature Cheddar cheeses showed that the level of FFA as a percentage of milk fat in all cheeses ($0.2\text{--}0.5 \text{ g } 100 \text{ g}^{-1} \text{ fat}$) was lower than that ($2 \text{ g } 100 \text{ g}^{-1} \text{ fat}$) considered necessary to induce rancid off flavours in cheeses such as Cheddar and Gouda (Gripon, 1993; Guinee *et al.*, 2008).

In addition to their direct contribution to cheese flavour, FFA also act as precursors for a range of other volatile flavour compounds, such as *n*-methyl ketones (alkan-2-ones), secondary alcohols, hydroxyacids, lactones, esters and thioesters (Guinee & McSweeney, 2006).

8.7.2 *Factors affecting ripening*

The changes that occur during ripening are significantly influenced by storage conditions (time, temperature, packaging), with the magnitude of the effects depending on the manufacturing process used (e.g. salt distribution, level of rennet retention), composition (e.g. pH, levels of S/M and Ca^{2+}) and microbiology. Increasing ripening temperature accelerates all ripening-related reactions and changes, which may be desirable (e.g. development of typical flavour and texture) or undesirable (development of off-flavours). Hence, while the earlier development of the desired physical and sensory properties at higher storage temperature is desirable, the tendency to the development off-flavours (e.g. sourness) and the

deterioration in some physical properties (e.g. firmness, stretchability) (Guinee, 2003) reduce cheese acceptability.

The humidity of the environment must be controlled for the ripening of many varieties, mainly those with a surface microflora, such as smear cheeses (Port Salut, Erosom) and mould ripened cheeses (Camembert, Blue). Its regulation, which involves cycling at different stages (85–94% in Camembert), is essential for controlling: (a) extent of surface drying, (b) moisture loss, (c) growth of the surface flora, (d) development of correct surface skin and (e) the and the levels of textural/flavour changes (Spinnler & Gripon, 2004; Hélias *et al.*, 2007). In contrast, some brine-salted cheeses are stored at lower relative humidity (80–85% in Emmental cheese) to encourage development of a rind, which protects the cheese against undesirable surface growth and the loss of moisture (weight) (Fox & Cogan, 2004). However, today many of the well-known dry-salted (e.g. Cheddar cheese) and brine-salted (e.g. Gouda, low-moisture Mozzarella, rindless Swiss) varieties are coated or wrapped in plastic to prevent weight loss and to protect the surface of the cheese against undesirable bacterial growth.

8.8 Quality assurance in cheese manufacture

8.8.1 Background

Cheesemaking technology has advanced considerably leading to cheese with more consistent composition and quality. The impetus towards more consistent cheese is driven by consumer demands for consistent sensory characteristics on repeat purchase and in having more knowledge in relation to the intake of specific nutrients (such as fat and salt). Moreover, the consumer is in a position to discriminate between a wider choice of alternative branded cheeses, making inconsistency unattractive and placing the onus on the producer to deliver a more consistent product. Nevertheless, moderate variations occur in cheese composition leading, in turn, to intra-brand differences in microbiological, chemical and quality characteristics (Guinee *et al.*, 2008). Some variation is inevitable considering the complex nature of cheese manufacture which is a dynamic process involving the fermentation of lactose to lactic acid simultaneously with protein aggregation and syneresis, all of which are influenced by the interactive effects of a myriad of variables (Fig. 8.2). Moreover, inconsistency can also ensue from seasonal variation in milk composition, starter culture activity and manufacturing protocol. Seasonal variation in the casein content of milk is conducive to variation in the composition and quality of the resultant cheese, especially where the manufacturing practice is to add starter culture and rennet on the basis of milk volume, rather than on the basis of casein load. In large modern factories, the cutting of the gel on the basis of time rather than curd firmness, leads to variations in moisture, pH and salt uptake by the curd during manufacture and in the final product (Fig. 8.5). Similarly, variations in starter culture activity can lead to differences in pH of the curd at different stages of manufacture (e.g. at whey drainage and at salting), which in turn can affect salt uptake (Guinee & Fox, 2004) and calcium content (Czulak *et al.*, 1969; Tunick *et al.*, 2007), and differences in the cooking properties (Kindstedt *et al.*, 2004). In modern cheese factories, minimising such in-process and product variation is a key goal of the quality assurance function.

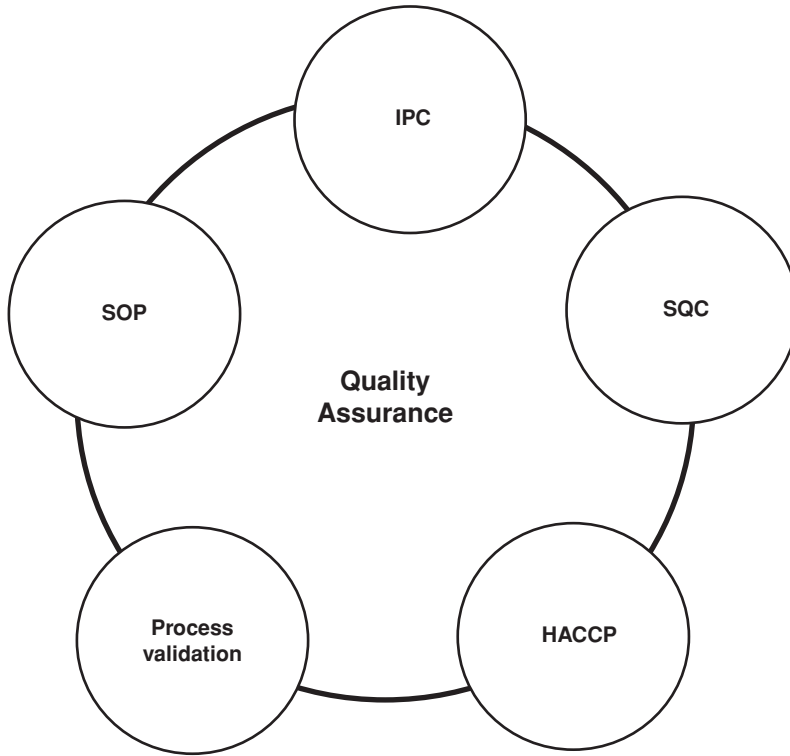

Fig. 8.12 Key elements of a quality assurance system. HACCP, hazard analysis through critical control point; IPC, in-process control; SOP, standard operating procedure; SQC, statistical quality control.

8.8.2 Key concepts in quality assurance

Quality assurance refers to the overall process ensuring that the product complies with quality, manufacturing, ingredient and ethical standards required by the customer and by legislation. A quality assurance system is an integration of several supporting systems (Fig. 8.12), including the following:

- Process validation;
- Standard operating procedure (SOP);
- In-process control (IPC);
- Key performance indicators (KPIs);
- Statistical quality control (SQC);
- Continuous quality improvement (CQI).

Process validation is necessary to verify that strategic components of the manufacturing technology carry out their intended function and perform as specified at plant design and commissioning. Process validation may be carried out at the level of a unit operation within the manufacturing process, for example, cheese vat, curd mill, curd press. In the case of the

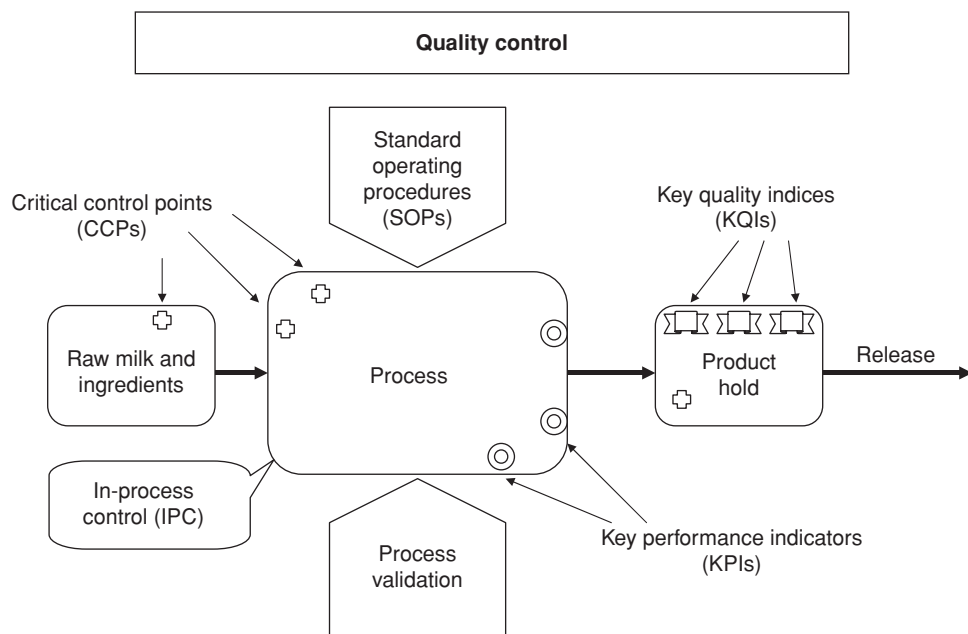

Fig. 8.13 Schematic of quality assurance in cheese manufacture.

cheese vat, validation may involve verification of its ability to deliver a particular curd particle size distribution from milk renneted under specific conditions. If the size distribution deviates outside the specified range, the actions required may include servicing, maintenance of the cheese-vat, knives and/or process modification, for example, a change to cutting programme.

SOP is essentially a list of instructions to be undertaken in a specific manufacturing process. For example, in the conversion of milk to cheese an *SOP* will detail the instructions required, and the actions to be performed at each stage of the process (Fig. 8.13). The list may specify the ranges of a number of variables, such as the following:

- SCC and TBC of raw milk;
- PFR of cheese milk;
- Protein level of cheese milk;
- Pasteurisation temperature;
- pH of cheese milk;
- Homogenisation pressures (optional step);
- pH at set (rennet addition);
- Rennet type;
- Ratio of casein or protein to rennet and to starter cultures;
- Firmness at cut and set-to-cut time;
- Cut programme (number of revolutions, speeds, duration);
- Stirring programme (stirring speed, time, speed increase over time);
- Cooking programme (scald temperature, rate of heating);
- pH of curd at whey drainage;

- Pumping conditions (flow-rate);
- Pre-pressing conditions: (a) curd to whey ratio, (b) pumping velocity, (c) pressure (by press-plate or height of whey column), (d) time and (e) temperature;
- Salting, i.e. ratio of salt to curd (ratio of cheese to volume of brine or weight of curd to dry salt).

A batch record for a consignment of cheese will include the SOP and the documentation showing compliance, date of manufacture and other details of the production run, which can be used for traceability and quality assurance.

IPC refers to the process of monitoring/testing and documenting of KPI measures (Fig. 8.13). Typically, *IPC* in the cheese industry involves the routine undertaking of various measurements, either on-line by sensors/monitors (e.g. temperature/pH level, flow-rate, pump speed, pressure) or off-line by a dedicated laboratory associated with the cheese production line (e.g. titratable acidity of milk and whey, curd pH, salt content of curd immediately after the block-former).

A major concern in the manufacture of dairy products including cheese is the prevention of contaminants entering the product. Contaminants could be 'biological' (e.g. *Salmonella* spp., *E. coli*, *Clostridium botulinum*, viral infections), 'chemical' (residues of cleaning agents, insecticides and other chemicals), or 'physical' (foreign bodies, such as splinters of metal, glass, or other materials). The biological factors can be monitored by periodic swabbing of surfaces, by bioluminescence adenosine triphosphate tests and by monitoring the quality of air. Practical strategies for control of contaminants include (a) effective cleaning systems, (b) disinfection of the working environment, (c) implementing personal hygiene programmes and (d) by air filtration and other air quality measures. Building design should facilitate biological control by separating wet and dry areas and separating pre-pasteurisation from post-pasteurisation areas. The environmental conditions of storage areas of product and packaging must be controlled from a microbiological perspective. It is important to eliminate all residues of cleaning and disinfection agents from product contact surfaces before processing starts. The risk of foreign bodies (splinters of glass, metals and plastics) entering cheese can be controlled by X-ray scanners, metal detectors and computer vision systems.

Hazard analysis through critical control points (HACCPs) is a verifiable control system to ensure compliance to product specifications concerning food safety. It involves the monitoring of critical points (CPs) at which a safety hazard to the consumer could arise. CPs that can be controlled by in-process corrective actions are identified as critical control points (CCPs). The purpose of HACCP is to assure safety by only accepting product that conforms to measurable/acceptable CCPs. A HACCP system can be integrated with a quality management system (Fig. 8.13).

KPI may be defined as the measure of a critical parameter at any particular stage of the process that indicates that the process is in control in accordance with a target range of values (Fig. 8.13). In the context of quality control, a KPI parameter (e.g. pH at whey drainage) is considered critical in the sense that it is indicative of acceptable quality for one or more aspects of the end product (e.g. meltability of the cheese).

SQC refers to a system of testing, and associated documentation, to ensure that the final product complies with specifications as required by customers and legislation. As discussed

in Section 8.3, parameters of importance in cheese quality may be categorised as physical, chemical, sensory and safety characteristics (Table 8.5). The combination and level/intensity of the parameters is dependant on the variety and brand of cheese and the target market/use (e.g. mature blue cheese used in *cordon bleu* poultry dishes). Certain parameters, the testing of which forms the basis of quality control on the end product, may be described as critical to acceptability and must fall within defined specifications. These may be referred to as critical quality control parameters or key quality indices (KQIs). Examples include customised degrees of stringiness in Mozzarella variants for different pizza brands, levels of propionic acid and eye formation in brands of Leerdamer and Emmental cheeses, methyl ketone flavour and vein orientation in blue type cheeses. A product batch is released for despatch once a representative sample has passed the appropriate SQC tests. Owing to differences in product specification and associated critical control parameters, a cheese deemed unsuitable for one end user may be deemed suitable for another.

CQI refers to the standards for cheese, which are continuously becoming more demanding, in response to an increasing consumer awareness of nutrition, health and safety. Examples include the push for reduced level of sodium in foods, including cheese, and the demand by processed cheese manufacturers for natural cheese with with levels of intact casein, calcium and pH. This creates an impetus towards continuous quality improvement, which may embrace several aspects of manufacture, such as milk quality, milk protein standardisation, more accurate level of salt addition, more consistent acid production by starter cultures. Systems to progress CQI include the following:

- Milk quality improvement (reducing SCC);
- Process improvement/adaptation and incorporation of new cheese technologies, for example, milk protein standardisation by using membrane filtration or the use of load cells in place of height sensing devices in estimating curd weight during continuous salting of Cheddar cheese;
- More comprehensive validation of unit operations in the cheesemaking process (e.g. curd chip size distribution following milling);
- Uptake of on-line automated control/in-process sensors for monitoring KQIs, such as curd firmness, pH, moisture at particular stages of manufacture;
- Use of statistical process control (e.g. Six Sigma) to monitor deviation from target values;
- Uptake of more advanced technology for reducing inconsistencies, for example, protein standardisation of cheese milk using UF or addition of native casein powders, or use of phage-hardened starter cultures and growth-enhancing media to minimise the effects of varying acid development (e.g. variation in salt uptake);
- Improved collaboration between academia and manufacturing, facilitating the embedding of new improved concepts in cheese manufacture;
- Modelling of commercial processes with a view to optimising product quality and yield, for example, the effects of storage temperature and humidity on weight loss during the ripening of Camembert.

Long-term process modelling, in combination with on-line monitoring, is seen as an approach for optimising process control and improving cheese quality, for example, narrowing the control limits for sodium concentration in individual cheese varieties. The feasibility

Table 8.5 Tests for evaluation of cheese quality.

Chemical	Physical	Sensory	Compositional/ nutritional
Nitrogen solubility in different solvents	Rheological/texture properties	Cheese grading	Fat
Water, pH 4.6, trichloroacetic acid, tungstophosphoric acid	<i>Large strain deformation (normal force)</i> Texture analyser/texture profile analysis (TPA), compression, bending, penetration, extensimetry, spreadability	Triangle tests	Protein
Free amino acid analysis	<i>Large strain deformation (shear force)</i> Torsion gedometry, shear stress, shear strain, shear rigidity, spreadability	Descriptive sensory analysis	Calcium
Petide profiling,	Low strain deformation	Flavour and aroma, appearance, visual texture, tactile texture	Lactose
Reverse-phase HPLC,	<i>Rheometer/texture analyser</i>	Biogenic amines	Sodium (salt)
Gel electrophoresis,	Viscosity	Calorific value	
Size exclusion chromatography	Shredability/gratability		
Organic acids	Aggregation index, curd fines, image analysis, sliceability/portionability		
Lactic, acetic, propionic	Colour assessment (colorimeter)		
Free fatty acid analysis	<i>Visual texture</i> Image texture analysis, hyperspectral imaging		
	Microstructure		
	Confocal laser scanning microscopy, scanning electron microscopy, transmission electron microscopy		
	Eye features		
	Image analysis, tomography		
	Cooking characteristics		
	Melt time, extent of flow, Schreiber, Arnott, Price Olson, image analysis, melt fluidity (loss tangent), stretchability		

of this approach is enhanced by a number of factors, including the development of process analytical technology and its validation in the pharmaceutical industry (Singh *et al.*, 2009), and rapid developments in instrumentation and online monitoring techniques. While this approach affords a significant opportunity to improve product quality, its uptake in the cheese industry undoubtedly will be influenced by scale of operation and by the rigours of compliance demands. The role of modelling in this context is discussed below.

In addition, quality improvement at a practical level can be assisted by providing plant operators, supervisors and managers with graphical trends of KPIs, to see whether a particular deviation in performance is part of a trend or an isolated occurrence. It is also useful to show target lines, around which the KPIs should lie, and limits between which they should lie, based on past performance and/or theoretical limits. Thus, a target line for cheese yield or fat loss would be calculated from milk composition, based on previous performance in that factory, and actual yield could be overlaid on such a chart, showing how much it exceeds or falls short of the target.

8.8.3 Control and prediction of quality characteristics of curd and cheese

The use of mathematical models in predicting cheese quality

Cheesemakers have known for a long time that it is possible to influence the rapidity of ripening cheese, i.e. development during storage of the unique flavours and textures which are characteristic of individual varieties, by altering the storage conditions (i.e. temperature and humidity) (Lawrence *et al.*, 1987; Hélias *et al.*, 2007). Nevertheless, they are aware that risks and limitations can be associated with such efforts, for example, while increasing storage temperature may accelerate protein hydrolysis, formation of free amino acids and more rapid ripening, it may also accelerate the growth of spoilage microorganisms and the development of flavour defects. However, the overall effects of temperature on cheese quality are interactive with other product variables, including *inter alia*, contents of moisture, lactate and calcium; pH; types and populations of NSLAB and autolytic properties of starter cultures. Hence, it is difficult for the cheesemaker to predict the response to particular process variables. Modelling techniques are used to assist the cheesemaker in predicting the outcome of process changes on quality, based on recorded data, consisting of measured process/product variables (ripening temperature, humidity) and quality responses (weight loss during ripening, fracture properties, grading score, colour hue and intensity).

Two types of approach to such process modelling have been cited. The first approach, a mechanistic approach, sometimes referred to as white box modelling, is based on physicochemical relationships. Examples include: (a) salt/moisture diffusion using the Maxwell–Stefan equation (Payne & Morison, 1999), (b) heat resistance data on specific microorganisms to model pasteurisation effectiveness (Schutyser *et al.*, 2008), (c) the Arrhenius equation for the influence of temperature on viscosity of soft cheese (Gunasekaran & Ak, 2003) or (d) the use of water sorption data for water activity. The second, an empirical approach, sometimes described as a black box approach, is based on regression of a quality parameter against one or more product/process variables, using a database of historical

measurements. The empirical approach may involve artificial neural networks, fuzzy logic, multiple linear regression or principal component analysis. Applications in cheese include the prediction of: (a) sensory characteristics of processed cheese by using near-infrared (NIR) reflectance (Blazquez *et al.*, 2006), (b) ripening time of ewe's milk cheese on the basis of capillary electrophoretograms of casein degradation (Albillos *et al.*, 2006), (c) melting characteristics of processed cheese from spectroscopic analysis (Garimella Purna *et al.*, 2005), (d) the determination of geographic origin of Emmental cheese by using fluorescence spectroscopy (Karoui *et al.*, 2004), (e) techniques for estimating chemical parameters, such as determination of moisture or sodium chloride contents of processed cheese by using ultra high frequency dielectrics (Fagan *et al.*, 2005) and (f) quality-related chemical parameters in Saint-Nectaire cheese by using fluorescence spectrometry (Karoui & Dufour, 2008).

Either approach has its limitations when applied to food systems. The mechanistic approach is limited in modelling complex food systems where their physico-chemical behaviour may not be fully described. For example, while sodium chloride diffusion can be simply described by an equation (Fick's law for unidimensional diffusion) the medium in which the diffusion is taking place (moisture in a cheese matrix) is difficult to characterise owing to structural inhomogeneities and changes during diffusion, complexity of diffusion pathways, interactive effects of compositional (pH, calcium) and environmental parameters (e.g. temperature, relative humidity), and the simultaneous diffusion of several components (sodium chloride, calcium and lactate). However, where it is possible to relate quality indices to fundamentals of physics and chemistry, reliable predictions may be made, even outside the range of previous measurements. On the other hand, empirical relationships are only valid within the range of variability of the historical data and are also limited according to the accuracy of that data and may be invalidated by process changes or recipe changes. In practice, a hybrid approach, namely, a combination of empirical and mechanistic modelling is often used, i.e. models which account for some physico-chemical effects using established laws or principles but which require fitting to historical data to determine unknown coefficients and/or to allow for other factors in an empirical manner (Verschuere *et al.*, 2001; Roupas, 2008).

Genetic programming techniques applied to pH and microbial measurements during the ripening of Camembert cheese have been found to enhance human expertise in determining the different stages of maturation (Barrière *et al.*, 2008).

Emerging on-line techniques for measurement of quality and/or maturity

Prediction of quality/maturity of cheese is a complex phenomenon as it is influenced by the dynamic interactive effects of a large array of compositional, microbial and physical criteria. Consequently, predictive modelling requires rapid acquisition of data on a comprehensive range of parameters. Ideally, this necessitates the use of on-line equipment for data measurement, acquisition and modelling. A number of such approaches have been applied for quality prediction in cheese and are discussed briefly below. These approaches, which may be generally referred to as chemometrics, involve acquisition of large amounts of data on a range of product variables and processing/modelling using advanced statistical techniques.

Electronic nose

Cheese manufacturers and quality control managers rely on human assessors (graders or sensory panels) to quantify cheese quality. Hence, much research has been undertaken to supplement sensory assessment with the use of instruments, such as an 'electronic nose', 'electronic tongue' or optical instruments to sense colour and texture (in a visual sense).

The so-called electronic nose is a promising technology for establishing sensory acceptance based on the measurement of chemical parameters (e.g. peptides, alcohols, ketones, free amino acids, and FFAs), known to affect quality and sensory characteristics at certain threshold concentrations. Electronic noses based on mass spectrometry provide rapid discrimination of cheeses on the basis of volatile or aroma compounds (Frank *et al.*, 2004; Vitova *et al.*, 2006; Hayaloglu *et al.*, 2008). They have been used to differentiate Emmental cheeses from various countries of origin (Pillonel *et al.*, 2003) and to discriminate cheeses by their microbial population (Kocaoglu-Vurma, *et al.*, 2008). Electronic noses based on gas sensor array technology in combination with artificial neural networks have also been demonstrated as rapid on-line techniques for such applications (Haugen, 2001; Tothill *et al.*, 2001). These techniques cannot substitute for the use of sensory panels as they require calibration against a sensory panel, the only reference method, but they can leverage the use of sensory panels in carrying out online sensing of aroma and taste. Such techniques have also been used to screen *Lactococcus lactis* strains isolated from different sources for their potential use in starter cheese cultures, based on their aroma generation (Gutiérrez-Méndez *et al.*, 2008).

Spectroscopy

The use of infrared and other spectroscopic approaches as quality control tools in cheesemaking has been reported. Fagan *et al.* (2007b,c,) successfully used mid-infrared spectroscopy to discriminate between the sensory texture characteristics of processed cheeses made with different compositions and different emulsifying salt levels. The spectra of the processed cheeses, acquired at wave lengths in the range 2.5–15.6 μm , were analysed with respect to the corresponding sensory data using partial least-squares regression. NIR analysis was carried out on milk, curd and cheese samples obtained at CCPs to obtain rapid determinations of composition (fat, protein, moisture) to monitor conformity to targets throughout the production process (Adamopoulos *et al.*, 2001). Blazquez *et al.* (2004) showed that composition of processed cheese could be determined using NIR. Revilla *et al.* (2009) showed that NIR reflectance could be used to determine the Warner–Bratzler shear (a measure of force required to cut) in cheese made from ewe's milk.

Biosensors

The use of biosensors in the food industry has been reviewed (Kress-Rogers, 2001). Essentially, biosensors incorporate a biologically active material capable of reacting with some biochemical component of the food and generating a response signal (electrical or luminescent) which can be used for detection of an attribute or contaminant. While the authors are not aware of biosensors being currently used for monitoring cheese quality, it is envisaged that they will form a major tool in quality assessment in the future cheese industry (Warsinke

et al., 2001). Biosensors have been developed for detection of specific microorganisms (Schmidt & Bilitewski, 2001). However, in general their sensitivity has not been adequate to provide assurance to consumers on the absence of pathogens.

8.8.4 Robots in cheese manufacturing

As the manufacture of cheese has progressed from traditional farmhouse practice to large industrial scale, most of the formerly manual steps have been automated, for example, the filling of the vat, the cutting of the coagulum, the stirring of the curd, the draining of the whey, and the pressing and salting of curd (Fergusson, 1991; Bennett & Johnston, 2004). Robots can be employed to assist with handling and packaging operations, e.g. where they would carry blocks of cheese from storage to a packing line, cut it to the required size and shape, weigh and pack it for the consumer, assemble the packs into larger units, which are in turn palletised by robot and made ready for loading or storage. Robotic systems with vacuum grippers have been developed for handling wax-covered cheese rounds (McGovern, 2008).

8.9 Conclusions

At its simplest, cheese manufacture may be described as a two-step process involving the conversion of milk to a concentrated protein-based matrix that is then transformed to cheese with the desired varietal characteristics. Both stages are highly complex, involving enzymatic alteration/degradation of the basic components (protein, fat) via the use of enzymes added exogenously (rennet, pre-gastric esterase), or derived from the cultures used in manufacture. Curd manufacture involves the application of a range of unit operations (pasteurisation, gelation, cutting, acidification, cooking, salting) to milk, resulting in its transformation from a low dry matter colloidal dispersion of fat globules and calcium phosphate casein particles to a concentrated calcium phosphate paracasein matrix occluding fat and moisture. The curd is transformed to the ripened cheese by a series of concerted biochemical, microbiological, structural, physical and sensory changes that are regulated by the composition of the matrix and the ripening conditions, for example, temperature and humidity.

Owing to this complexity, it is essential that the raw material, the unit operations and ripening conditions are strictly controlled to ensure that the desired properties are consistently achieved. This requires an effective QA system involving all stages of the process. The essential elements of such a quality control system include the establishment of SOPs and documentation systems, product sampling and testing protocols and information feedback from SQC to manufacturing. However, a *sine qua non* to any QA system is an in-depth knowledge of the underlying chemistry, microbiology, enzymology and technology of the entire process.

A more rigorous approach to QA system is warranted in cheese manufacture arising from more international trading, which results in much greater distances between the producer and the consumer and places more dependence on standards, such as Codex Alimentarius; larger scale manufacturing with more automation and less opportunity for human intervention, and increasing awareness of food, health and security concerns on the part of the consumer,

who consequently requires more assurance about food quality. In response to such demands, more elaborate quality control systems are being integrated with cheese manufacture. These systems span the entire cheese manufacturing line, beginning with the quality of raw milk and other ingredients entering a factory, and following a chain of analysis through milk pasteurisation, storage, renneting, curd handling, salting, pressing, storage and maturation and indeed, other operations which may apply for a particular client, such as slicing and packing. Laboratory-based analysis is being supplemented by an increasing amount of on-line, in-process analysis and tracking for both process control and quality control. Indeed, better control of the unit operations which make up a cheese manufacturing line is one of the keys to reducing variation (e.g. in moisture and salt) enabling cheese to be made which will more consistently comply with user expectations. Further developments in analytical techniques are emerging which will undoubtedly play a major role in quality control in the future, such as infrared spectroscopy, fluorescence spectroscopy, image texture analysis and biosensors.

References

- Adamopoulos, K.G., Goula, A.M. & Petropakis, H.J. (2001) Quality control during processing of Feta cheese – NIR application. *Journal of Food Composition and Analysis*, **14**, 431–440.
- Albenzio, M., Caroprese, M., Santillo, A., Marino, R., Taibi, L. & Sevi, A. (2004) Effects of somatic cell count and stage of lactation on the plasmin activity and cheese-making properties of ewe milk. *Journal of Dairy Science*, **87**, 533–542.
- Albillos, S.M., Busto, M.D., Perez-Mateos, M. & Ortega, N. (2006) Prediction of the ripening times of ewe's milk cheese by multivariate regression analysis of capillary electrophoresis casein fractions. *Journal of Agricultural and Food Chemistry*, **54**, 8281–8287.
- Amenu, B. & Deeth, H.C. (2007) The impact of milk composition on Cheddar cheese manufacture. *Australian Journal of Dairy Technology*, **62**, 171–184.
- Andreatta, E., Fernandes, A.M., Veiga-dos-Santos, M., Goncalves de Lima, C., Mussarelli, C., Marques, M.C. & Fernandes-de-Oliveira, C.A. (2007) Effects of milk somatic cell count on physical and chemical characteristics of mozzarella cheese. *Australian Journal of Dairy Technology*, **62**, 166–170.
- Anema, S.G. & Li, Y. (2003a) Association of denatured whey proteins with casein micelles in heated reconstituted skim milk and its effect on casein micelle size. *Journal of Dairy Research*, **70**, 73–83.
- Anema, S.G. & Li, Y. (2003b) Effect of pH on the association of denatured whey proteins with casein micelles in heated reconstituted skim milk. *Journal of Agricultural and Food Chemistry*, **51**, 1640–1646.
- Anema, S.G., Lowe, E.K. & Lee, S.-K. (2004) Effect of pH at heating on the acid-induced aggregation of casein micelles in reconstituted skim milk. *Lebensmittel Wissenschaft und Technologie*, **37**, 779–787.
- Anonymous (2003) *Dairy Processing Handbook*, 2nd and revised edition of G. Bylund (1995), Tetra Pak Processing Systems AB, Lund.
- Auldust, M.G., Johnston, K.A., White, N.J., Fitzsimons, W.P. & Boland, M.J. (2004) A comparison of the composition, coagulation characteristics and cheesemaking capacity of milk from Friesian and Jersey dairy cows. *Journal of Dairy Research*, **71**, 51–57.
- Auldust, M.J., Coats, S., Sutherland, B.J., Mayes, J.J., McDowell, G.H. & Rogers, G.L. (1996) Effects of somatic cell count and stage of lactation on raw milk composition and the yield and quality of Cheddar cheese. *Journal of Dairy Research*, **63**, 269–280.
- Auldust, M.J., Walsh, B.J. & Thomson, N.A. (1998) Seasonal and lactational influences on bovine milk composition in New Zealand. *Journal of Dairy Research*, **65**, 401–411.

- Banks, J.M., Law, A.J.R., Leaver, J. & Horne, D.S (1994a) The inclusion of whey proteins in cheese – an overview. *Cheese Yield and Factors Affecting its Control*, Special Issue 9402, pp. 48–54, International Dairy Federation, Brussels.
- Banks, J.M., Law, A.J.R., Leaver, J. & Horne, D.S. (1994b) Sensory and functional properties of cheese: incorporation of whey proteins by pH manipulation and heat treatment. *Journal of the Society of Dairy Technology*, **47**, 124–131.
- Banks, J.M., Stewart, G., Muir, D.D. & West, I.G. (1987) Increasing the yield of Cheddar cheese by the acidification of milk containing heat-denatured whey protein. *Milchwissenschaft*, **42**, 212–215.
- Banks, J.M. & Tamime, A.Y. (1987) Seasonal trends in the efficiency of recovery of milk fat and casein in cheese manufacture. *Journal of the Society of Dairy Technology*, **40**, 64–66.
- Barbano, D.M. & Sherbon, J.W. (1984) Cheddar cheese yields in New York. *Journal of Dairy Science*, **67**, 1873–1883.
- Barrière, O., Lutton, E., Baudrit, C., Sicard, M., Pinaud, B. & Perrot, N. (2008) Modeling human expertise on a cheese ripening industrial process using GP. *Lecture Notes in Computer Science*, **5199**, 859–868.
- Bech, A.M. (1993) Characterising ripening in UF-cheese. *International Dairy Journal*, **3**, 329–342.
- Bennett, R.J. & Johnston, K.A. (2004) General aspects of cheese technology. *Cheese, Chemistry, Physics and Microbiology, Volume 2: Major Cheese Groups* (eds P.F. Fox, P.L.H. McSweeney, T.M. Cogan and T.P. Guinee), 3rd edn, pp. 23–50, Elsevier Academic Press, Amsterdam.
- Beresford, T.P. & Williams, A. (2004) The microbiology of cheese ripening. *Cheese: Chemistry, Physics and Microbiology, Volume 1: General Aspects* (eds P.F. Fox, P.L.H. McSweeney, T.M. Cogan and T.P. Guinee), 3rd edn, pp. 287–317, Elsevier Academic Press, Amsterdam.
- Beuquier, E. & Buchin, S. (2004) Raw milk cheeses. *Cheese: Chemistry, Physics and Microbiology, Volume 1: General Aspects* (eds P.F. Fox, P.L.H. McSweeney, T.M. Cogan and T.P. Guinee), 3rd edn, pp. 319–345, Elsevier Academic Press, Amsterdam.
- Blazquez, C., Downey, G., O'Callaghan, D., Howard, V., Delahunty, C., Sheehan, L. & O'Donnell, C. (2006) Modelling of sensory and instrumental texture parameters in processed cheese by near infrared reflectance spectroscopy. *Journal of Dairy Research*, **73**, 58–69.
- Blazquez, C., Downey, G., O'Donnell, C., O'Callaghan, D. and Howard, V. (2004) Prediction of moisture, fat and inorganic salts in processed cheese by near infrared reflectance spectroscopy and multivariate data analysis. *Journal of Near Infrared Spectroscopy*, **12**, 149–158.
- Broome, M.C., Tan, S.E., Alexander, M.A. & Manser, B. (1998a) Low-concentration-ratio ultrafiltration for Cheddar cheese manufacture. I: Effect on seasonal cheese composition. *Australian Journal of Dairy Technology*, **53**, 5–10.
- Broome, M.C., Tan, S.E., Alexander, M.A. & Manser, B. (1998b) Low-concentration-ratio ultrafiltration for Cheddar cheese manufacture – II: Effect on maturation. *Australian Journal of Dairy Technology*, **53**, 11–16.
- Bruhn, J.C. & Franke, A.A. (1991) Raw milk composition and cheese yields in California: 1987 and 1998. *Journal of Dairy Science*, **74**, 1108–1114.
- Bulca, S., Leder, J. & Kulozik, U. (2004) Impact of UHT or high heat treatment on the rennet gel formation of skim milk with various whey protein contents. *Milchwissenschaft*, **59**, 590–593.
- Bush, C.S., Caroutte, C.A., Amundson, C.H. & Olson, N.F. (1983) Manufacture of Colby and brick cheeses from ultrafiltered milk. *Journal of Dairy Science*, **66**, 415–421.
- Caccamo, M., Melilli, C., Barbano, D.M., Portelli, G., Marino, G. & Licitra, G. (2004). Measurement of gas holes and mechanical openness in cheese by image analysis. *Journal of Dairy Science*, **87**, 739–748.
- Cardello, A.V. (1997) Perception of food quality. *Food Storage Stability* (eds I.A. Taub & R.P. Singh), pp.1–37, CRC Press, Boca Raton.
- Carreira, A., Dillinger, K., Eliskases-Lechner, F., Loureiro, V., Ginzinger, W. & Rohm, H. (2002) Influence of selected factors on browning of Camembert cheese. *Journal of Dairy Research*, **69**, 281–292.

- Celik, S., Bakirci, I. & Ozdemir, S. (2005) Effects of high heat treatment of milk and brine concentration on the quality of Turkish white cheese. *Milchwissenschaft*, **60**, 147–151.
- Chapman, H.R., Sharpe, M.E. & Law, B.A. (1976). Some effects of low-temperature storage of milk on cheese production and Cheddar cheese flavour. *Dairy Industries International*, **41**(2), 42–45.
- Commission Internationale de l'Éclairage (CIE), Central Bureau Kegelgasse 27A-1030, Vienna.
- Collins, Y.F., McSweeney, P.L.H. and Wilkinson, M.G. (2004) Lipolysis and catabolism of fatty acids in cheese. *Cheese: Chemistry, Physics and Microbiology, Volume 1: General Aspects* (eds P.F. Fox, P.L.H. McSweeney, T.M. Cogan & T.P. Guinee), 3rd edn, pp. 373–389, Elsevier Academic Press, Amsterdam.
- Combs, W.B., Martin, W.H. & Hugglar, N.A. (1924) Clarification of milk for cheese making. *Journal of Dairy Science*, **7**, 524–529.
- Considine, T., Patel, H.A., Anema, S.G., Singh, H. & Creamer, L.K. (2007). Interactions of milk proteins during heat and high hydrostatic pressure treatments – A review. *Innovative Food Science and Emerging Technologies*, **8**, 1–23.
- Cousin, M.A. & Marth, E.H. (1977) Cheddar cheese made from milk that was precultured with psychrotropic bacteria. *Journal of Dairy Science*, **60**, 1048–1056.
- Creamer, L.K., Iyer, M. & Lelievre, J. (1987) Effect of various levels of rennet addition on characteristics of Cheddar cheese made from ultrafiltered milk. *New Zealand Journal of Dairy Science and Technology*, **22**, 205–214.
- Creamer, L.K. & Olson, N.F. (1982) Rheological evaluation of maturing Cheddar cheese. *Journal of Food Science* **47**, 631–636.
- Creamer, L.K., Zoerb, H.F., Olson, N.F. & Richardson, T. (1982) Surface hydrophobicity of α_{s1} -I, α_{s1} -Casein A and B and its implications in cheese structure. *Journal of Dairy Science* **65**, 902–906.
- Cromie, S. (1992) Psychrotrophs and their enzyme residues in cheese milk. *Australian Journal of Dairy Technology*, **47**, 96–100.
- Czulak, J., Conochie, J., Sutherland, B.J. & van Leeuwen, H.J.M. (1969) Lactose, lactic acid and mineral equilibria in Cheddar cheese manufacture. *Journal of Dairy Research*, **36**, 93–101.
- Dalgleish, D.G. & Law, A.J.R. (1988) pH-induced dissociation of bovine casein micelles. I: Analysis of liberated caseins. *Journal of Dairy Research*, **55**, 529–538.
- Dalgleish, D.G. & Law, A.J.R. (1989) pH-induced dissociation of bovine casein micelles. II: Mineral solubilization and its relation to casein release. *Journal of Dairy Research*, **56**, 727–735.
- Dasgupta, A.P. & Hull, R.R. (1989) Late blowing of Swiss cheese: incidence of *Clostridium tyrobutyricum* in manufacturing milk. *Australian Journal of Dairy Technology*, **44**, 82–87.
- Daviau, C., Famelart, M.H. Pierre, A., Goudédranche, H., Maubois, J.-L. & Fox, P.F. (2000) Rennet coagulation of skim milk and curd drainage: effect of pH, casein concentration, ionic strength and heat treatment. *Lait*, **80**, 397–415.
- Davis, J.G. (1976) *Cheese*, Vol. **III**, pp. 586–592, 702–731, Churchill Livingstone, Edinburgh.
- Dejmek, P. & Walstra, P. (2004) The syneresis of rennet-induced curd. *Cheese: Chemistry, Physics and Microbiology, Volume 1: General Aspects* (eds P.F. Fox, P.L.H. McSweeney, T.M. Cogan and T.P. Guinee), 3rd edn, pp. 71–103, Elsevier Academic Press, Amsterdam.
- Delahunty, C.M. & Drake, M.A. (2004) Sensory character of cheese and its evaluation. *Cheese: Chemistry, Physics and Microbiology, Volume 1: General Aspects* (eds P.F. Fox, P.L.H. McSweeney, T.M. Cogan and T.P. Guinee), 3rd edn, pp. 455–487, Elsevier Academic Press, Amsterdam.
- Dimitreli, G. & Thomareis, A.S. (2007) Texture evaluation of block-type processed cheese as a function of chemical composition and in relation to its apparent viscosity. *Journal of Food Engineering*, **79**, 1364–1373.
- Donato, L. & Guyomarc'h, F. (2009). Formation and properties of the whey protein/kappa-casein complexes in heated skim milk – A review. *Lait – Dairy Science and Technology*, **89**, 3–29.

- Donnelly, C.W. (2004). Growth and survival of microbial pathogens in cheese. *Cheese: Chemistry, Physics and Microbiology, Volume 1: General Aspects* (eds P.F. Fox, P.L.H. McSweeney, T.M. Cogan and T.P. Guinee), 3rd edn, pp. 541–559, Elsevier Academic Press, Amsterdam.
- Downey, L. & Doyle, P.T. (2007) Cow nutrition and dairy product manufacture – implications of seasonal pasture-based milk production systems. *Australian Journal of Dairy Technology*, **62**, 3–11.
- Dufossé, L., Galaup, P., Carlet, E., Flamin, C. & Valla, A. (2005) Spectrocolorimetry in the CIE L*a*b* colour space as useful tool for monitoring the ripening process and the quality of PDO red-smear soft cheeses. *Food Research International*, **38**, 919–924.
- Dzurec, C.A. & Zall, R.R. (1986a) On-farm heating of milk increases Cottage cheese yields. *Cultured Dairy Products Journal*, **21**(1), 25–26.
- Dzurec, C.A. & Zall, R.R. (1986b) Why Cottage cheese yields are increased when milk is heated on the farm. *Cultured Dairy Products Journal*, **21**(3), 8–9.
- Erdem, Y.K. (1997) The effect of calcium chloride concentration and pH on the clotting time during the renneting of milk. *Gida*, **22**, 449–455.
- Eskelinen, J.J., Alavuotunki, A.P., Haeggström, E. & Alatossava, T. (2007) Preliminary study of ultrasonic structural quality control of Swiss-type cheese. *Journal of Dairy Science*, **90**, 4071–4077.
- EU (1992) Council Directive 92/46/EEC of 16 June 1992 laying down health rules for the production and placing on the market of raw milk, heat-treated milk and milk-based products. *Official Journal of the European Commission*, **L268**, 1–32.
- Euston, S.R., Piska, I., Wium, H. & Qvist, K.B. (2002) Controlling the structure and rheological properties of model cheese systems. *Australian Journal of Dairy Technology*, **57**, 145–152.
- Everard, C.D., O'Callaghan, D.J., Fagan, C.C., O'Donnell, C.P., Castillo, M. & Payne, F.A. (2007a) Computer vision and color measurement techniques for inline monitoring of cheese curd syneresis. *Journal of Dairy Science*, **90**, 3162–3170.
- Everard, C.D., O'Callaghan, D.J., Mateo, M.J., O'Donnell, C.P., Castillo, M. & Payne, F.A. (2008) Effects of cutting intensity and stirring speed on syneresis and curd losses during pilot scale cheese making. *Journal of Dairy Science*, **91**, 2575–2582.
- Everard, C.D., O'Callaghan, D.J., O'Kennedy, B.T., O'Donnell, C.P., Sheehan, E.M. & Delahunty, C.M. (2007b) A three-point bending test for prediction of sensory texture in processed cheese. *Journal of Texture Studies*, **38**, 438–456.
- Everard, C.D., O'Donnell, C.P., O'Callaghan, D.J., Sheehan, E.M., Delahunty, C.M., O'Kennedy, B.T. & Howard, V. (2007c) Prediction of sensory textural properties from rheological analysis for process cheeses varying in emulsifying salt, protein and moisture contents. *Journal of the Science of Food and Agriculture*, **87**, 641–650.
- Fagan, C.C., Castillo, M., Payne, F.A., O'Donnell, C.P. and O'Callaghan, D.J. (2007a) Effect of cutting time, temperature, and calcium on curd moisture, whey fat losses, and curd yield by response surface methodology. *Journal of Dairy Science*, **90**, 4499–4512.
- Fagan, C.C., Du, C.-J., O'Donnell, C.P., Castillo, M., Everard, C.D., O'Callaghan, D.J. & Payne, F.A. (2008) Application of image texture analysis for online determination of curd moisture and whey solids in a laboratory-scale stirred cheese vat. *Journal of Food Science*, **73**, E250–E258.
- Fagan, C.C., Everard, C., O'Donnell, C.P., Downey, G. & O'Callaghan, D.J. (2005). Prediction of inorganic salt and moisture content of process cheese using dielectric spectroscopy. *International Journal of Food Properties*, **8**, 543–557.
- Fagan, C.C., Everard, C., O'Donnell, C.P., Downey, G., Sheehan, E.M., Delahunty, C.M. & O'Callaghan, D.J. (2007b) Evaluating mid-infrared spectroscopy as a new technique for predicting sensory texture attributes of processed cheese. *Journal of Dairy Science*, **90**, 1122–1132.
- Fagan, C.C., Everard, C., O'Donnell, C.P., Downey, G., Sheehan, E.M., Delahunty, C.M., O'Callaghan, D.J. & Howard, V. (2007c) Prediction of processed cheese instrumental texture and meltability by mid-infrared spectroscopy coupled with chemometric tools. *Journal of Food Engineering*, **80**, 1068–1077.

- FAO/WHO (2007) Codex general standard for cheese. *Milk and Milk Products*, CODEX STAN A-6-1978, Revised 1-1999, Amended 2006, pp. 53-59. Communication Division the Food and Agriculture Organization of the United Nations, Rome. (www.codexalimentarius.net/web/standard-list).
- FDA (2003) Code of Federal Regulations Part 133: Cheese and related products. *Food and Drugs 21, Code of Federal Regulations, Parts 100-169*, US Government Printing Office, Washington, DC. (www.gpoaccess.gov/CFR/INDEX.HTML).
- Fenelon, M.A. & Guinee, T.P. (1999) The effect of milk fat on Cheddar cheese yield and its prediction, using modifications of the Van Slyke cheese yield formula. *Journal of Dairy Science*, **82**, 2287-2299.
- Fenelon, M.A. & Guinee, T.P. (2000) Primary proteolysis and textural changes during ripening in Cheddar cheeses manufactured to different fat contents. *International Dairy Journal*, **10**, 151-158.
- Fenelon, M.A., Guinee, T.P., Delahunty, C., Murray, J. & Crowe, F. (2000) Composition and sensory attributes of retail Cheddar cheeses with different fat contents. *Journal of Food Composition Analysis*, **13**, 13-26.
- Fergusson, P.H. (1991) Principles of unit operations: cheese vats. *International Journal of Dairy Technology*, **44**(4) 91-94.
- Ferron-Baumont, C., Maubois J.L., Garric, G. & Quiblier J.P. (1991) Coagulation présumé du lait et des rétentats d'ultrafiltration. Effets de divers traitements thermiques. *Lait*, **71**, 423-434.
- Fjaervoll, A. (1968) The theory and use of centrifugal machines in the dairy industry. *Journal of the Society of Dairy Technology*, **21**, 180-189.
- Fox, P.F. (1969) Effect of cold-ageing on the rennet-coagulation time of milk. *Irish Journal of Agricultural Research*, **8**, 175-182.
- Fox, P.F. (1975) Influence of cheese composition on quality. *Irish Journal of Agricultural Research*, **14**, 33-42.
- Fox, P.F. & Cogan, T.M. (2004) Factors that affect the quality of cheese. *Cheese: Chemistry, Physics and Microbiology, Volume 1: General Aspects* (eds P.F. Fox, P.L.H. McSweeney, T.M. Cogan and T.P. Guinee), 3rd edn, pp. 583-608, Elsevier Academic Press, Amsterdam.
- Fox, P.F. & Guinee, T.P. (2000) Processing characteristics of milk constituents. *Proceedings of the British Society of Animal Science Occasional Publication No. 25*, (eds R.E. Agnew and A.M. Fearon), pp. 39-68, British Society of Animal Science, Edinburgh.
- Fox, P.F., Guinee, T.P., Cogan, T.M. & McSweeney, P.L.H. (2000) *Fundamentals of Cheese Science*, Aspen Publishers, Inc., Gaithersburg, MD.
- Fox, P.F., O'Connor, T.P., McSweeney, P.L.H., Guinee, T.P. & O'Brien, N.M. (1996) Cheese: physical, biochemical, and nutritional aspects. *Advances in Food and Nutrition Research*, **39**, 163-328.
- Frank, D.C., Owen, C.M. & Patterson, J. (2004) Solid phase microextraction (SPME) combined with gas chromatography and olfactometry-mass spectrometry for characterization of cheese aroma compounds. *Lebensmittel Wissenschaft und Technologie*, **37**, 139-154.
- García-Risco, M.R., Ramos, M. & López-Fandino, R. (2002) Modifications in milk proteins induced by heat treatment and homogenization and their influence on susceptibility to proteolysis. *International Dairy Journal*, **12**, 679-688.
- Garimella Purna, S.K., Prow, L.A. & Metzger, L.E. (2005) Utilization of front-face fluorescence spectroscopy for analysis of process cheese functionality. *Journal of Dairy Science*, **88**, 470-477.
- Geurts T.J., Walstra, P. & Mulder, H. (1972) Brine composition and the prevention of the defect 'soft rind' in cheese. *Netherlands Milk and Dairy Journal*, **26**, 168-179.
- te Giffel, M.C., Wagendorp, A., Herrewegh, A. & Driehuis, F. (2002) Bacterial spores in silage and raw milk. *Antonie van Leeuwenhoek*, **81**, 625-630.
- Ghosh, B.C., Steffl, A., Hinrichs, J. & Kessler, H.G. (1994) Rennetability of whole milk homogenized before or after pasteurization. *Milchwissenschaft*, **49**, 363-367.
- Gilles, J. (1976) Control of salt in moisture in Cheddar cheese. *New Zealand Journal of Dairy Science and Technology*, **11**, 291-211.

- Gilles, J. & Lawrence, R.C. (1973) The assessment of Cheddar cheese quality by compositional analysis. *New Zealand Journal of Dairy Science and Technology*, **8**, 148–151.
- Gilmour, A.M., MacEhinney, R.S., Johnston, D.E. & Murphy, R.J. (1981) Thermisation of milk – some microbiological aspects. *Milchwissenschaft*, **36**, 457–461.
- Girgis, E.S., Abd-El-Ghany, I.H.I, Yousef, L.M. & Mohammed, L.M. (1999) Effect of milk pretreatment and storage conditions on the properties and keeping quality of Ras cheese. *Egyptian Journal of Dairy Science*, **27**, 153–166.
- Gobbetti, M., Lanciotti, R., de Angelis, M., Corbo, M.R., Massini, R. & Fox, P.F. (1999a) Study of the effects of temperature, pH and NaCl on the peptidase activities on non-starter lactic acid bacteria (NSLAB) by quadratic response surface methodology. *International Dairy Journal*, **9**, 865–875.
- Gobbetti, M., Lanciotti, R., de Angelis, M., Corbo, M.R., Massini, R. & Fox, P.F. (1999b) Study of the effects of temperature, pH, NaCl and a_w on the proteolytic and lipolytic activities of cheese-related lactic bacteria by quadratic response surface methodology. *Enzyme and Microbial Technology*, **25**, 795–809.
- Govindasamy-Lucey, S., Jaeggi, J.J., Bostley, A.L., Johnson, M.E. & Lucey, J.A. (2004) Standardization of milk using cold ultrafiltration retentates for the manufacture of Parmesan cheese. *Journal of Dairy Science*, **87**, 2789–2799.
- Green, M.L. (1990a) The cheesemaking potential of milk concentrated up to four-fold by ultrafiltration and heated in the range 90–97°C. *Journal of Dairy Research*, **57**, 549–557.
- Green, M.L. (1990b) Cheddar cheesemaking from whole milk concentrated by ultrafiltration and heated to 90°C. *Journal of Dairy Research*, **57**, 559–569.
- Green, M.L., Glover, F.A., Scurlock, E.M.W., Marshall, R.J. & Hatfield, D.S. (1981a) Development of structure and texture in Cheddar cheese. *Journal of Dairy Research*, **48**, 343–355.
- Green, M.L., Glover, F.A., Scurlock, E.M.W., Marshall, R.J. & Hatfield, D.S. (1981b) Effect of use of milk concentrated by ultrafiltration on the manufacture and ripening of Cheddar cheese. *Journal of Dairy Research*, **48**, 333–341.
- Gripon, J.C. (1993) Mould-ripened cheeses. *Cheese: Chemistry, Physics and Microbiology, Volume 2: Major Cheese Groups* (ed. P.F. Fox), 2nd edn, pp. 207–259, Chapman & Hall, London.
- Grundelius, A.U., Lodaite, K., Östergren, K., Paulsson, M. and Dejmek, P. (2000) Syneresis of submerged single curd grains and curd rheology. *International Dairy Journal*, **10**, 489–496.
- Guinee, T.P. (2003) Role of protein in cheese and cheese products. *Advanced Dairy Chemistry, Volume 1: Proteins* (eds P.F. Fox and P.L.H. McSweeney), pp. 1083–1174, Kluwer Academic – Plenum Publishers, New York.
- Guinee, T.P. (2008) Why is calcium chloride often added to milk for cheesemaking? *Cheese Problems Solved* (ed. P.L.H. McSweeney), pp. 69–71, Woodhead Publishing, Cambridge, UK.
- Guinee, T.P., Auty, M.A.E. & Fenelon, M.A. (2000a) The effect of fat on the rheology, microstructure and heat-induced functional characteristics of Cheddar cheese. *International Dairy Journal*, **10**, 277–288.
- Guinee, T.P., Auty, M.A.E., Mullins, C., Corcoran, M.O. & Mulholland, E.O. (2000b) Preliminary observations on effects of fat content and degree of fat emulsification on the structure-functional relationship of Cheddar-type cheese. *Journal of Texture Studies*, **31**, 645–663.
- Guinee, T.P., Fenelon, M.A., Mulholland, E.O., O’Kennedy, B.T., O’Brien, N. & Reville, W.J. (1998) The influence of milk pasteurization temperature and pH at curd milling on the composition, texture and maturation of reduced fat Cheddar cheese. *International Journal of Dairy Technology*, **51**, 1–10.
- Guinee, T.P. & Fox, P.F. (2004) Salt in cheese: physical, chemical and biological aspects. *Cheese: Chemistry, Physics and Microbiology, Volume 1: General Aspects* (eds P.F. Fox, P.L.H. McSweeney, T.M. Cogan, and T.P. Guinee), 3rd edn, pp. 207–259, Elsevier Academic Press, Amsterdam.
- Guinee, T.P., Gorry, C.B., O’Callaghan, D.J., O’Kennedy, B.T., O’Brien, N. & Fenelon, M.A. (1997) The effects of composition and some processing treatments on the rennet coagulation properties of milk. *International Journal of Dairy Technology*, **50**, 99–106.

- Guinee, T.P., Harrington, D., Corcoran, M.O., Mulholland, E.O. & Mullins, C. (2000c) The composition and functional properties of commercial Mozzarella, Cheddar and analogue Pizza cheese. *International Journal of Dairy Technology*, **53**, 51–56.
- Guinee, T.P., Kelly, J. & O'Callaghan, D.J. (2005) Cheesemaking efficiency. *Moorepark End of Project Report DPRC No. 46*, Teagasc, Dublin.
- Guinee, T.P. & Kilcawley, K.N. (2004) Cheese as an ingredient, in *Cheese: Chemistry, Physics and Microbiology, Volume 2: Major Cheese Groups* (eds P.F. Fox, P.L.H. McSweeney, T.M. Cogan and T.P. Guinee), 3rd edn, pp. 395–428, Elsevier Academic Press, Amsterdam.
- Guinee, T.P., Kilcawley, K.N. & Beresford, T.P. (2008) How variable are retail brands of Cheddar cheese in composition and biochemistry? *Australian Journal of Dairy Technology*, **63**, 50–60.
- Guinee, T.P. & McSweeney, P.L.H. (2006) Significance of milk fat in cheese. *Advanced Dairy Chemistry, Volume 2: Lipids* (eds P.F. Fox and McSweeney, P.L.H.), 3rd edn, pp. 377–440, Springer Science +Business Media, New York.
- Guinee, T.P., Mulholland, E.O., Kelly, J. & O'Callaghan, D.J. (2007a) Effect of protein-to-fat ratio of milk on the composition, manufacturing efficiency, and yield of Cheddar cheese. *Journal of Dairy Science*, **90**, 110–123.
- Guinee, T.P., O'Brien, B. & Mulholland, E.O. (2007b) The suitability of milk from a spring-calved dairy herd during the transition from normal to very late lactation for the manufacture of low-moisture Mozzarella cheese. *International Dairy Journal*, **17**, 133–142.
- Guinee, T.P., O'Callaghan, D.J., Pudja, P.D. & O'Brien, N. (1996) Rennet coagulation properties of retentates obtained by ultrafiltration of skim milks heated to different temperatures. *International Dairy Journal*, **6**, 581–596.
- Guinee, T.P. & O'Kennedy, B.T. (2007) Reducing salt in cheese and dairy spreads. *Reducing Salt in Foods: Practical Strategies* (eds D. Kilcast & F. Angus), pp. 316–357, Woodhead Publishing, Cambridge, UK.
- Guinee, T.P., O'Kennedy, B.T. & Kelly, P.M. (2006) Effect of milk protein standardization using different methods on the composition and yields of Cheddar cheese. *Journal of Dairy Science*, **89**, 468–482.
- Guinee, T.P., Pudja, P.D. & Mulholland, E.O. (1994) Effect of milk protein standardization, by ultrafiltration, on the manufacture, composition and maturation of Cheddar cheese. *Journal of Dairy Research*, **61**, 117–131.
- Guinee, T. P., Pudja, P. D., Reville, W.J., Harrington, D., Mulholland, E.O., Cotter, M. & Cogan, T.M. (1995) Composition, microstructure and maturation of semi-hard cheeses from high protein ultrafiltered milk retentates with different levels of denatured whey protein. *International Dairy Journal*, **5**, 543–568.
- Guinee, T.P. & Wilkinson, M.G. (1992) Rennet coagulation and coagulants in cheese manufacture. *Journal of the Society of Dairy Technology*, **45**, 94–104.
- Gunasekaran, S. & Ak, M.M. (2003) *Cheese Rheology and Texture*, CRC Press, Boca Raton, FL.
- Guo, M.R., Gilmore, J.K.A. & Kindstedt P.S. (1997) Effect of sodium chloride on the serum phase of Mozzarella cheese. *Journal of Dairy Science*, **80**, 3092–3098.
- Gutiérrez-Méndez, N., Vallejo-Cordoba, B., González-Córdova, A.F., Nevárez-Moorillón, G.V. & Rivera-Chavira, B. (2008) Evaluation of aroma generation of lactococcus lactis with an electronic nose and sensory analysis. *Journal of Dairy Science*, **91**, 49–57.
- Guyomarc'h, F. (2006) Formation of heat-induced protein aggregates in milk as a means to recover the whey protein fraction in cheese manufacture, and potential of heat-treating milk at alkaline pH values in order to keep its rennet coagulation properties – A review. *Lait*, **86**, 1–20.
- Guyomarc'h, F., Law, A.J.R. & Dalgleish, D.G. (2003) Formation of soluble and micelle-bound protein aggregates in heated milk. *Journal of Agricultural and Food Chemistry*, **51**, 4652–4660.
- Harwalkar, V.R. & Kalab, M. (1980) Milk gel structure. XI: Electron microscopy of glucono- δ -lactone-induced skim milk gels. *Journal of Texture Studies*, **11**, 35–49.

- Harwalkar, V.R. & Kalab, M. (1981) Effect of acidulants and temperature on microstructure, firmness and susceptibility to syneresis of skim milk gels. *Scanning Electron Microscopy*, **III**, 503–513.
- Haugen J.E. (2001) Electronic noses in food analysis. *Advances in Experimental Medicine and Biology*, **488**, 43–57.
- Hayaloglu, A.A., Brechany, E.Y., Deegan, K.C. & McSweeney, P.L.H. (2008). Characterization of the chemistry, biochemistry and volatile profile of Kufllu cheese, a mould-ripened variety. *Libensmittel Wissenschaft und Technologie*, **41**, 1323–1334.
- van Hekken, D.L., Drake, M.A., Molina Corral, F.J., Guerrero Prieto, V.M. & Gardea, A.A. (2006) Mexican Chihuahua cheese: sensory profiles of young cheese. *Journal of Dairy Science*, **89**, 3729–3738.
- Hélias, A., Mirade, P.S. & Corrieu, G. (2007) Modeling of Camembert-type cheese mass loss in a ripening chamber: main biological and physical phenomena. *Journal of Dairy Science*, **90**, 5324–5333.
- Hermann, L. (1993) Selecting the right cheese. *Food Product Design*, **2**(March), 66–80.
- Hickey, D.K., Kilcawley, K.N., Beresford, T.P. & Wilkinson, M.G. (2007) Lipolysis in Cheddar cheese made from raw, thermized and pasteurized milks. *Journal of Dairy Science*, **90**, 47–56.
- Hickey, M.W., van Leeuwen, H., Hillier, A.J. & Jago, G.R. (1983) Amino acid accumulation in Cheddar cheese manufactured from normal and ultrafiltered milk. *Australian Journal of Dairy Technology*, **38**, 110–113.
- Hicks, C.L., Allauddin, M., Langlois, B.E. & O’Leary, J. (1982) Psychrotrophic bacteria reduce cheese yield. *Journal of Food Protection*, **45**, 331–334.
- Hinrichs, J. (2001) Incorporation of whey proteins in cheese. *International Dairy Journal*, **11**, 495–503.
- Her Majesty’s Stationary Office (1996) *The Food Labelling Regulations 1996*, SI 1996 No. 1499, Her Majesty’s Stationary Office, London.
- van Hooydonk, A.C.M., Koster P.G. & Boerrigter, I.J. (1987) The renneting of heated milk. *Netherlands Milk and Dairy Journal*, **41**, 3–18.
- Horne, D.S., Banks, J.M. & Muir, D.D. (1996) Genetic polymorphism of milk proteins: understanding the technological effects. *Hannah Research Institute Yearbook 1996*, pp. 70–78, Hannah Research Institute, Ayr, Scotland.
- Houran, G.A. (1964) Utilization of centrifugal force for removal of microorganisms from milk. *Journal of Dairy Science*, **47**, 100–101.
- Huffman, L. M. & Kristoffersen, T. (1984) Role of lactose in Cheddar cheese manufacturing and ripening. *New Zealand Journal of Dairy Science and Technology*, **19**, 151–162.
- Huss, M., Dodel, W. & Kulozik, U. (2006) Partial denaturation of whey proteins as a means of increasing soft cheese yields. *Deutsche Milchwirtschaft*, **57**, 1007–1010.
- IDF (1981) *Catalogue of Cheeses*, Document No. 141, pp. 3–40, International Dairy Federation, Brussels.
- IDF (2008) *The World Dairy Situation 2008*, Document No. 432, International Dairy Federation, Brussels.
- Jana, A.H. & Upadhyay, K.G. (1991) The effects of homogenization conditions on the textural and baking characteristics of buffalo milk Mozzarella cheese. *Australian Journal of Dairy Technology*, **46**, 27–30.
- Jana, A.H. & Upadhyay, K.G. (1992) Homogenisation of milk for cheesemaking – a review. *Australian Journal of Dairy Technology*, **47**, 72–79.
- Jana, A.H. & Upadhyay, K.G. (1993) A comparative study on the quality of Mozzarella cheese obtained from unhomogenized and homogenized buffalo milk. *Cultured Dairy Products Journal*, **28**(1), 16, 18, 20–22.
- Jean, K., Renan, M., Famelart, M.H. & Guyomarc’h, F. (2006) Structure and surface properties of the serum heat-induced protein aggregates isolated from heated skim milk. *International Dairy Journal*, **16**, 303–315.

- Jeliński, T., Du, C.J., Sun, D.W. & Fornal, J. (2007) Inspection of the distribution and amount of ingredients in pasteurised cheese by computer vision. *Journal of Food Engineering*, **83**, 3–9.
- de Jong, L. (1976) Protein breakdown in soft cheese and its relationship to consistency. 1: Proteolysis and consistency of 'Noordhollandase Meshanger' cheese. *Netherlands Milk and Dairy Journal*, **30**, 242–253.
- de Jong, L. (1977) Protein breakdown in soft cheese and its relation to consistency. 2: The influence of rennet concentration. *Netherlands Milk and Dairy Journal*, **31**, 314–327.
- Johnson, M.E. & Lucey, J.A. (2006) Calcium: a key factor in controlling cheese functionality. *Australian Journal of Dairy Technology*, **61**, 147–153.
- Johnston, K.A., Luckman, M.S., Lilley, H.G. & Smale, B.M. (1998) Effect of various cutting and stirring conditions on curd particle size and losses of fat to the whey during Cheddar cheese manufacture in OST vats. *International Dairy Journal*, **8**, 281–288.
- Jordan, K.N. & Cogan, T. M. (1993) Identification and growth of non-starter lactic acid bacteria in Irish Cheddar cheese. *Irish Journal of Agricultural and Food Research*, **32**, 47–55.
- Kaláb, M. & Harwalkar, V.R. (1974). Milk gel structure. II: Relation between firmness and ultrastructure of heat-induced skim-milk gels containing 40–60% total solids. *Journal of Dairy Research*, **41**, 131–135.
- Karoui, R. & Dufour, E. (2008) Development of a portable spectrofluorometer for measuring the quality of cheese. *Dairy Science and Technology*, **88**, 477–494.
- Karoui, R., Dufour, E. Pillonel, L., Picque, D., Cattenoz, T. & Bosset, J.O. (2004) Determining the geographic origin of Emmental cheeses produced during winter and summer using a technique based on the concatenation of MIR and fluorescence spectroscopic data. *European Food Research and Technology*, **219**, 184–189.
- Kelly, A.L., Deeth, H.C. & Data, N. (2005) Thermal processing of dairy products. *Thermal Food Processing: Modelling, Quality Assurance, and Innovation* (ed. D.W. Sun), pp. 265–298, Marcel Dekker, New York.
- Kimber, A.M., Brooker, B.E., Hobbs, D.G. & Prentice, J.H. (1974) Electron microscope studies of the development of structure in Cheddar cheese. *Journal of Dairy Research*, **41**, 389–396.
- Kindstedt, P.S., Carić, M. & Milanović, S. (2004) Pasta-filata cheeses. *Cheese: Chemistry, Physics and Microbiology, Volume 2: Major Cheese Groups* (eds P.F. Fox, P.L.H. McSweeney, T.M. Cogan and T.P. Guinee), 3rd edn, pp. 251–277, Elsevier Academic Press, Amsterdam.
- Klei, L., Yun, J., Sapru, A., Lynch, J., Barbano, D., Sears, P. & Galton, D. (1998) Effects of milk somatic cell count on Cottage cheese yield and quality. *Journal of Dairy Science*, **81**, 1205–1213.
- Kocaoglu-Vurma, N.A., Harper, W.J., Drake, M.A. & Courtney, P.D. (2008) Microbiological, chemical, and sensory characteristics of Swiss cheese manufactured with adjunct lactobacillus strains using a low cooking temperature. *Journal of Dairy Science*, **91**, 2947–2959.
- Korolczuk, J. & Mahaut, M. (1988) Studies on acid cheese texture by a computerized constant speed, cone penetrometer. *Lait*, **68**, 349–362.
- Korolczuk, J. & Mahaut, M. (1992) Effect of whey protein addition and heat treatment of milk on the viscosity of UF fresh cheese. *Milchwissenschaft*, **47**, 157–159.
- Kosikowski, F.V. & Fox, P.F. (1968) Low heat, hydrogen peroxide and bacto-fugation treatments of milk to control coliforms in Cheddar cheese. *Journal of Dairy Science*, **51**, 1018–1022.
- Kosikowski, F.V. & Mistry, V.V. (1997) *Cheese and Fermented Milk Foods, Volume 1 – Origins and Principles*, F.V. Kosikowski L.L.C., Westport.
- Kress-Rogers, E. (2001) Chemosensors, biosensors, immunosensors and DNA probes: the base devices. *Instrumentation and Sensors for the Food Industry* (eds E. Kress-Rogers & C.J.B. Brimelow), pp. 553–623, Woodhead Publishing, Cambridge, UK.
- Kubantseva, N., Hartel, R.W. & Swearingen, P.A. (2004) Factors affecting solubility of calcium lactate in aqueous solutions. *Journal of Dairy Science*, **87**, 863–867.
- Lakemond, C.M.M. & van Vliet, T. (2008) Rheological properties of acid skim milk gels as affected by the spatial distribution of the structural elements and the interaction forces between them. *International Dairy Journal*, **18**, 588–593.

- Lalos, G.T. & Roussis, I.G. (1999) Quality of a Graviera-type cow cheese and a low-fat cow plus ewe cheese from raw and refrigerated cow's milk. *Milchwissenschaft*, **54**, 674–676.
- Lalos, G.T. & Roussis, I.G. (2000) Quality of full-fat and low-fat Kefalograviera cheese from raw and refrigerated ewes' milk. *Milchwissenschaft*, **55**, 24–26.
- Lalos, G.T., Voutsinas, L.P., Pappas, C.P. & Roussis, I.G. (1996) Effect of a sub-pasteurization treatment of cold stored ewe's milk on the quality of Feta cheese. *Milchwissenschaft*, **51**, 78–82.
- Laloy, E., Vuilleumard, J.C., El Soda, M. & Simard, R. E. (1996) Influence of the fat content of Cheddar cheese on retention and localization of starters. *International Dairy Journal*, **6**, 729–740.
- Landfeld, A., Novotna, P. & Houska, M. (2002) Influence of the amount of rennet, calcium chloride addition, temperature, and high-pressure treatment on the course of milk coagulation. *Czech Journal of Food Sciences*, **20**, 237–244.
- Lau, K.Y., Barbano, D.M. & Rausmussen, R.R. (1990) Influence of pasteurization on fat and nitrogen recoveries and Cheddar cheese yield. *Journal of Dairy Science*, **73**, 561–570.
- Law, B.A. (ed.) (1999) *Technology of Cheesemaking*, Sheffield Academic Press, Sheffield.
- Law, B.A., Andrews, A.T., Cliffe, A.J., Sharpe, M.E. & Chapman, H.R. (1979). Effect of proteolytic raw milk psychrotrophs on Cheddar cheese-making with stored milk. *Journal of Dairy Research*, **46**, 497–509.
- Law, B.A., Sharpe, M.L. & Chapman, H.R. (1976) The effect of lipolytic Gram-negative psychrotrophs in stored milk on the development of rancidity in Cheddar cheese. *Journal of Dairy Research*, **43**, 459–468.
- Lawlor, J.B., Delahunty, C.M., Sheehan, J. & Wilkinson, M.G. (2003) Relationships between sensory attributes and the volatile compounds, non-volatile and gross compositional constituents of six blue-type cheeses. *International Dairy Journal*, **13**, 481–494.
- Lawlor, J.B., Delahunty, C.M., Wilkinson, M.G. & Sheehan, J. (2001) Relationships between the sensory characteristics, neutral volatile composition and gross composition of ten cheese varieties. *Lait*, **81**, 487–507.
- Lawrence, A.J. (1959) Syneresis of rennet curd. 1: Effect of time and temperature. *Australian Journal of Dairy Technology*, **14**, 166–169.
- Lawrence, R.C., Creamer, L.K. & Gilles, J. (1987) Texture development during cheese ripening. *Journal Dairy Science*, **70**, 1748–1760.
- Lawrence, R.C., Gilles, J., Creamer, L.K., Crow, V.L., Heap, H.A., Honoré, C.G., Johnston, K.A. & Samal, P.K. (2004) Cheddar cheese and related dry-salted cheese varieties. *Cheese: Chemistry, Physics and Microbiology, Volume 2: Major Cheese Groups* (eds P.F. Fox, P.L.H. McSweeney, T.M. Cogan and T.P. Guinee), 3rd edn, pp. 71–102, Elsevier Academic Press, Amsterdam.
- Lawrence, R.C., Heap, H.A. & Gilles, J. (1984) A controlled approach to cheese technology. *Journal of Dairy Science*, **67**, 1632–1645.
- Le Quéré, J.-L. (2004) Cheese flavour: instrumental techniques. *Cheese: Chemistry, Physics and Microbiology, Volume 1: General Aspects* (eds P.F. Fox, P.L.H. McSweeney, T.M. Cogan & T.P. Guinee), 3rd edn, pp. 489 – 510, Elsevier Academic Press, Amsterdam.
- Lehmann, H.R., Dolle, E. & Zettler, K.-H. (1991) Centrifuges for milk clarification and bacteria removal. *Technical Scientific Documentation No. 12*, 2nd edn. Westfalia Separator AG, Marketing Separation Technology Advertising/Communication, Oelde.
- Lelievre, J. & Gilles, J. (1982) The relationship between the grade (product value) and composition of young commercial Cheddar cheese. *New Zealand Journal of Dairy Science and Technology*, **17**, 69–75.
- Lieske, B. (1997) Influence of preliminary treatments on structural properties of casein micelles affecting the rennetability. *Lait*, **77**, 201–209.
- Lo, C.G. & Bastian, E.D. (1998) Incorporation of native and denatured whey protein into cheese curd for manufacture of reduced-fat Havarti-type cheese. *Journal Dairy Science*, **81**, 16–24.
- Lodaite, K., Ostergren, K., Paulsson, M. & Dejmek, P. (2000) One-dimensional syneresis of rennet-induced gels. *International Dairy Journal*, **10**, 829–834.

- Lomer, M.C., Parkes, G.C. & Sanderson, J.D. (2008) Review article: lactose intolerance in clinical practice – myths and realities. *Alimentary Pharmacology and Therapeutics*, **27**(2) 93–103.
- Lucey, J.A., Johnson, M.E. & Horne, D.S. (2003) Invited review: perspectives on the basis of the rheology and texture properties of cheese. *Journal of Dairy Science*, **86**, 2725–2743.
- Lucey, J.A., Tamehana, M., Sing, H. & Munro, P. (1998) Effect of interactions between denatured whey proteins and casein micelles on the formation and rheological properties of acid skim milk gels. *Journal of Dairy Research*, **65**, 555–567.
- Lucey, J.A., van Vliet, T., Grolle, K., Geurts, T. & Walstra, P. (1997) Properties of acid casein gels made by acidification with glucono-delta-lactone. II: Syneresis, permeability and microstructural properties. *International Dairy Journal*, **7**, 389–397.
- Luyten, H. (1988) *The rheological and Fracture Properties of Gouda Cheese*, PhD Thesis, Wageningen Agricultural University, Wageningen.
- Luyten, H., van Vliet, T. & Walstra, P. (1991a) Characterization of the consistency of Gouda cheese: rheological properties. *Netherlands Milk and Dairy Journal*, **45**, 33–53.
- Luyten, H., van Vliet, T. & Walstra, P. (1991b) Characterization of the consistency of Gouda cheese: fracture properties. *Netherlands Milk and Dairy Journal*, **45**, 55–80.
- MacDougall, D.B. (2001) Principles of colour measurement for food. *Instrumentation and Sensors for the Food Industry* (eds E. Kress-Rogers & C.J.B. Brimelow), pp. 63–84, Woodhead Publishing, Cambridge, UK.
- Madadlou, A., Mousavi, M.E., Khosrowshahi, A., Emam-Djome, Z. & Zargarani, M. (2007) Effect of cream homogenization on textural characteristics of low-fat Iranian White cheese. *International Dairy Journal*, **17**, 547–554.
- Mahaut, M. & Korolczuk, J. (2002) Effect of homogenisation of milk and shearing of milk gel on the viscosity of fresh cheeses obtained by ultrafiltration of coagulated milk. *Industries Alimentaires et Agricoles*, **119**(11), 13–17.
- Marshall, R.J. (1982) An improved method for measurement of the syneresis of curd formed by rennet action on milk. *Journal of Dairy Research*, **49**, 329–336.
- Marshall, R. (1986) Increasing cheese yields by high heat treatment of milk. *Journal of Dairy Research* **53**, 313–322.
- Maxcy, R.B., Price, W.V. & Irvine, W.B. (1955) Improving curd forming properties of homogenized milk. *Journal of Dairy Science*, **38**, 80–86.
- Mazal, G., Vianna, P.C.B., Santos, M.V. & Gigante, M.L. (2007) Effect of somatic cell count on Prato cheese composition. *Journal of Dairy Science*, **90**, 630–636.
- McCraig, T.N. (2002) Extending the use of visible/near-infrared reflectance spectrophotometers to measure colour of food and agricultural products. *Food Research International*, **35**, 731–736.
- McGovern, E. (2008) Cruise control option eases robotic conveying [online]. *Food Engineering*, November, p. 75. Available at: http://www.foodengineeringmag.com/Articles/Field_Reports/BNP_GUID.9-5-2006_A.10000000000000465484.
- McMahon, D.J., Alleyne, M.C., Fife, R.L. & Oberg, C.J. (1996) Use of fat replacers in low fat Mozzarella cheese. *Journal of Dairy Science*, **79**, 1911–1921.
- McMahon, D.J., Yousif, B.H. & Kalab, M. (1993) Effect of whey protein denaturation on structure of casein micelles and their rennetability after ultra-high temperature processing of milk with or without ultrafiltration. *International Dairy Journal*, **3**, 239–256.
- McSweeney, P.L.H. (2004) Overview of cheese ripening: introduction and overview. *Cheese: Chemistry, Physics and Microbiology, Volume 1: General Aspects* (eds P.F. Fox, P.L.H. McSweeney, T.M. Cogan and T.P. Guinee), 3rd edn, pp. 348–360, Elsevier Academic Press, Amsterdam.
- McSweeney, P.L.H. & Fox, P.F. (1993) Cheese: methods of chemical analysis. *Cheese: Chemistry, Physics and Microbiology, Volume 1: General Aspects* (ed. P.F. Fox), 2nd edn, pp. 341–388, Chapman & Hall, London.
- Melilli, C., Barbano, D.M., Caccamo, M., Calvo, M.A., Schembari, G. & Licitra, G. (2004) Influence of brine concentration, brine temperature, and presalting on early gas defects in raw milk pasta filata cheese. *Journal of Dairy Science*, **87**, 3648–3657.

- Menard, O., Camier, B. & Guyomarc'h, F. (2005) Effect of heat treatment at alkaline pH on the rennet coagulation properties of skim milk. *Lait*, **85**, 515–526.
- Metzger, L.E. & Mistry, V.V. (1994) A new approach using homogenization of cream in the manufacture of reduced-fat Cheddar cheese – 1. Manufacture, composition and yield. *Journal of Dairy Science*, **77**, 3506–3515.
- Mistry, V.V. & Maubois, J.-L. (2004) Application of membrane separation technology to cheese production. *Cheese: Chemistry, Physics and Microbiology, Volume 1: General Aspects* (eds P.F. Fox, P.L.H. McSweeney, T.M. Cogan, and T.P. Guinee), 3rd edn, pp. 261–285, Elsevier Academic Press, Amsterdam.
- Molle, D., Jean, K. & Guyomarc'h, F. (2006) Chymosin sensitivity of the heat-induced serum protein aggregates isolated from skim milk. *International Dairy Journal*, **16**, 1435–1441.
- Muir, D.D. (1996) The shelf-life of dairy products: 1. Factors influencing raw milk and fresh products. *Journal of the Society of Dairy Technology*, **49**, 24–36.
- Nair, M.G., Mistry, V.V. & Oommen, B.S. (2000) Yield and functionality of Cheddar cheese as influenced by homogenization of cream. *International Dairy Journal*, **10**, 647–657.
- Ni, H. & Gunasekaran, S. (1998) A Computer vision method for determining length of cheese shreds. *Artificial Intelligence Review*, **12**, 27–37.
- O'Brien, B., Mehra, R., Connolly, J.F. & Harrington, D. (1999) Seasonal variation in the composition of Irish manufacturing and retail milks. 1: Chemical composition and renneting properties. *Irish Journal of Agricultural and Food Research*, **38**, 53–64.
- O'Callaghan, D.J. & Guinee, T.P. (2004) Rheology and texture of cheese. *Cheese: Chemistry, Physics and Microbiology, Volume 1: General Aspects* (eds P.F. Fox, P.L.H. McSweeney, T.M. Cogan & T.P. Guinee), 3rd edn, pp. 511–540, Elsevier Academic Press, Amsterdam.
- O'Connor, C.B. (1971) Composition and quality of some commercialized Cheddar cheese. *Irish Agricultural Creamery Review*, **24**(6), 5–6.
- O'Connor, C.B. (1973a) The quality and composition of Cheddar cheese. Part I: Effect of various rates of salt addition. *Irish Agricultural Creamery Review*, **26**(10), 5–7.
- O'Connor, C.B. (1973b) The quality and composition of Cheddar cheese. Part II: Effect of various rates of salt addition. *Irish Agricultural Creamery Review* **26**(11), 19–22.
- O'Connor, C.B. (1974) The quality and composition of Cheddar cheese. Part III: Effect of various rates of salt addition. *Irish Agricultural Creamery Review*, **27**(1), 11–13.
- O'Keefe, A.M. (1984) Seasonal and lactational influences on moisture content of Cheddar cheese. *Irish Journal of Food Science and Technology*, **8**, 27–37.
- Olson, N.F. (1977) Factors affecting cheese yields. *Dairy Industries International*, **42**(4), 14–15, 19.
- Olson, D.W., van Hekken, D.L., Tunick, M.H., Soryal, K.A. & Zeng, S.S. (2006) Effects of aging on functional properties of caprine milk made into Cheddar- and Colby-like cheeses. *Small Ruminant Research*, **70**, 218–227.
- O'Mahony, J.A., Lucey, J.A. & McSweeney, P.L.H. (2005) Changes in the proportions of soluble and insoluble calcium during the ripening of Cheddar cheese. *Journal of Dairy Science*, **88**, 3101–3114.
- Oommen, B.S., Mistry, V.V. & Nair, M.G. (2000) Effect of homogenisation of cream on composition, yield, and functionality of Cheddar cheese made from milk supplemented with ultrafiltered milk. *Lait*, **80**, 77–91.
- Ortega-Fleitas, F.O., Reinery, P.L., Rocamora, Y., Real-del-Sol, E., Cabrera, M.C. & Casals, C. (2000) Effect of homogenization pressure on texture properties of soy cream cheese. *Alimentaria*, **313**, 125–127.
- Pagana M.M. & Hardy J. (1986) Effect of salting on some rheological properties of fresh Camembert cheese as measured by uniaxial compression. *Milchwissenschaft*, **41**, 210–213.
- Parker, E.A., Donato, L. & Dalgleish, D.G. (2005) Effects of added sodium caseinate on the formation of particles in heated milk. *Journal of Agricultural and Food Chemistry*, **53**, 8265–8272.
- Patel, M.C., Lund, D.B. & Olson, N.F. (1972). Factors affecting syneresis of renneted milk. *Journal of Dairy Science*, **55**, 913–918.

- Payne, M.R. & Morison, K.R. (1999) A multi-component approach to salt and water diffusion in cheese. *International Dairy Journal*, **9**, 887–894.
- Pearce, K.N. & Gilles, J. (1979) Composition and grade of Cheddar cheese manufactured over three seasons. *New Zealand Journal of Dairy Science and Technology*, **14**, 63–71.
- Peri, C. (2006). The universe of food quality. *Food Quality and Preference*, **17**, 3–8.
- Pillonel, L., Ampuero, S., Tabacchi, R. & Bosset, J.O. (2003) Analytical methods for the determination of the geographic origin of Emmental cheese: volatile compounds by GC/MS-FID and electronic nose. *European Food Research and Technology*, **216**, 179–183.
- Politis, I. & Ng-Kwai-Hang, K.F. (1988) Association between somatic cell count of milk and cheese-yielding capacity. *Journal of Dairy Science*, **71**, 1720–1727.
- Qvist, K.B. (1979) Reestablishment of the original rennetability of milk after cooling. I: The effect of cooling and HTST pasteurization of milk and renneting. *Milchwissenschaft*, **34**, 467–470.
- Qvist, K.B., Thomsen, D. & Høler, E. (1987) Effect of ultrafiltered milk and use of different starters on the manufacture, fermentation, and ripening of Havarti cheese. *Journal of Dairy Research*, **54**, 437–446.
- Rajbhandari, P. & Kindstedt, P.S. (2005) Development and application of image analysis to quantify calcium lactate crystals on the surface of smoked Cheddar cheese. *Journal of Dairy Science*, **88**, 4157–4164.
- Rajbhandari, P. & Kindstedt, P.S. (2008) Characterization of calcium lactate crystals on cheddar cheese by image analysis. *Journal of Dairy Science*, **91**, 2190–2195.
- Reid, J.R. & Coolbear, T. (1998) Altered specificity of lactococcal proteinase PI (Lactocepine I) in humectant systems reflecting the water activity and salt content of Cheddar cheese. *Applied Environmental Microbiology*, **64**, 588–593.
- Reimerdes, E.H., Perez, S.J. & Ringqvist, B.M. (1997). Temperaturabhaengige veraenderungen in milch und milchprodukten. II: Der einfluss der tiefkuehlung auf kaesereitechnologische eigenschaften der milch. *Milchwissenschaft*, **32**, 154–158.
- Reinbold, G.W. (1972) *Swiss cheese varieties*, Pfizer Inc., New York.
- Renan, M., Mekmene O, Famelart, M.H., Guyomarc'h, F., Arnoult-Delest, V., Paquet, D. & Brule, G. (2006) pH-dependent behaviour of soluble protein aggregates formed during heat-treatment of milk at pH 6.5 or 7.2. *Journal of Dairy Research*, **73**, 79–86.
- Renner-Nantz, J.J. & Shoemaker, C.F. (1999) Rheological properties of chymosin-induced skim milk gels as affected by milk storage time and temperature. *Journal of Food Science*, **64**, 86–89.
- Revilla, I., González-Martín, I., Hernández-Hierro, J.M., Vivar-Quintana, A., González-Pérez, C. & Lurueña-Martínez, M.A. (2009). Texture evaluation in cheeses by NIRS technology employing a fibre-optic probe. *Journal of Food Engineering*, **92**, 24–28.
- Richoux, R., Aubert, L., Roset, G., Briard, B., Kerjean, J.-R. & Lopez, C. (2008). Combined temperature-time parameters during the pressing of curd as a tool to modulate the oiling-off of Swiss cheese. *Food Research International*, **41**, 1058–1064.
- Richoux, R., Aubert, L., Roset, G. & Kerjean, J.R. (2009) Impact of the proteolysis due to lactobacilli on the stretchability of Swiss-type cheese. *Dairy Science and Technology*, **89**(1), 31–41.
- Robinson, R.K. & Tamime, A.Y. (1991) *Feta and Related Cheeses*, Woodhead Publishing, Cambridge, UK.
- Robinson, R.K. & Wilbey, R.A. (1998) *Cheesemaking Practice R. Scott*, 3rd edn, Aspen Publishers, Gaithersburg.
- Robson, E.W. & Dalgleish, D.G. (1984) Coagulation of homogenized milk particles by rennet. *Journal of Dairy Research*, **51**, 417–424.
- Roupas, P. (2001) On-farm practices and post farmgate processing parameters affecting composition of milk for cheesemaking. *Australian Journal of Dairy Technology*, **56**, 219–232.
- Roupas, P. (2008) Predictive modelling of dairy manufacturing processes. *International Dairy Journal*, **18**, 741–753.

- Rudan, M.A., Barbano, D. M., Guo, M.R. & Kindstedt, P.S. (1998) Effect of modification of fat particle size by homogenization on composition, proteolysis, functionality, and appearance of reduced-fat Mozzarella cheese. *Journal of Dairy Science*, **82**, 661–672.
- Rüegg, M., Eberhard, P., Popplewell, L.M. & Peleg, M. (1991) Melting properties of cheese. *Rheological and Fracture Properties of Cheese*, Document No. 268, pp. 36–43, International Dairy Federation, Brussels.
- Rynne, N.M., Beresford, T.P., Kelly, A.L. & Guinee T.P. (2004) Effect of milk pasteurization temperature and *in situ* whey protein denaturation on the composition, texture and heat-induced functionality of half-fat Cheddar cheese. *International Dairy Journal*, **14**, 989–1001.
- Rynne, N.M., Beresford, T.P., Kelly, A.L. & Guinee, T.P. (2007) Effect of milk pasteurisation temperature on age-related changes in lactose metabolism, pH and the growth of non-starter lactic acid bacteria in half-fat Cheddar cheese. *Food Chemistry*, **100**, 375–382.
- Rynne, N.M., Beresford, T.P., Kelly, A.L. & Guinee, T.P. (2008) Effect of exopolysaccharide-producing culture on coagulation and synergetic properties of rennet-induced milk gels. *Australian Journal of Dairy Technology*, **63**, 3–7.
- Sameen, A., Anjum, F.M., Huma, N. & Nawaz, H. (2008) Quality evaluation of Mozzarella cheese from different milk sources. *Pakistan Journal of Nutrition*, **7**, 753–756.
- Sanchez, C., Beauregard, J.L., Chassagne, M.H., Bimhenet, J.J. & Hardy, J. (1996) Effects of processing on rheology and structure of double cream cheese. *Food Research International*, **28**, 541–552.
- Schafer, H.W. & Olson, N.F. (1975) Characteristics of Mozzarella cheese made by direct acidification from ultra-high temperature processed milk. *Journal of Dairy Science*, **58**, 494–501.
- Schmidt, A. & Bilitewski, U. (2001) Biosensors for process monitoring and quality assurance in the food industry. *Instrumentation and Sensors for the Food Industry* (eds E. Kress-Rogers & C.J.B. Brimelow), pp. 714–739, Woodhead Publishing, Cambridge.
- Schulz-Collins, D. & Senge, B. (2004) Acid- and acid/rennet-curd cheeses. Part A.: Quark, Cream cheese and related varieties. *Cheese: Chemistry, Physics and Microbiology, Volume 2: Major Cheese Groups* (eds P.F. Fox, P.L.H. McSweeney, T.M. Cogan and T.P. Guinee), 3rd edn, pp. 301–328, Elsevier Academic Press, Amsterdam.
- Schutyser, M.A.I., Straatsma, J., Keijzer, P.M., Verschueren, M. & de Jong, P. (2008). A new web-based modelling tool (Websim-MILQ) aimed at optimisation of thermal treatments in the dairy industry. *International Journal of Food Microbiology*, **128**, 153–157.
- Seckin, A.K., Kinik, O. & Gursoy, O. (2008) The effect of the occurrence of psychrotrophic bacteria on sialic acid content of milk. *Milchwissenschaft*, **63**, 49–52.
- Sevi, A., Albenzio, M., Taibi, L., Dantone, D., Massa, S. & Annicchiarico, G. (1999) Changes of somatic cell count through lactation and their effects on nutritional, renneting and bacteriological characteristics of ewe's milk. *Advances in Food Sciences*, **21**, 122–127.
- Shah, N.P. (1994) Psychrotrophs in milk: a review. *Milchwissenschaft*, **49**, 432–437.
- Shakeel-Ur-Rehman, Waldron, D. & Fox, P.F. (2004) Effect of modifying lactose concentration in cheese curd on proteolysis and in quality of Cheddar cheese. *International Dairy Journal*, **14**, 591–597.
- Sillén, G. (1987) Modern bactofuges in the dairy industry. *Dairy Industries International*, **52**(6), 27–29.
- Singh, H. & Waugana, A. (2001) Influence of heat treatment of milk on cheesemaking properties. *International Dairy Journal*, **11**, 543–551.
- Singh, R., Gernaey, K.V. & Gani, R. (2009) Model-based computer-aided framework for design of process monitoring and analysis systems. *Computers and Chemical Engineering*, **33**, 22–42.
- Sørensen, H.H. (2001) General trends 1990–1999. *World Market for Cheese 1990–1999*, Document No. 359, pp. 8–20, International Dairy Federation, Brussels.
- Sørensen, H.H. & Pedersen, E. (2005) General trends 1995–2004. *World Market for Cheese 1995–2004*, Document No. 402, 5th edn, pp. 8–32, International Dairy Federation, Brussels.

- Spinnler, H.-E. & Gripon, J.-C. (2004) Surface mould-ripened cheeses. *Cheese: Chemistry, Physics and Microbiology, Volume 2: Major Cheese Groups* (eds P.F. Fox, P.L.H. McSweeney, T.M. Cogan and T.P. Guinee), 3rd edn, pp. 157–174, Elsevier Academic Press, Amsterdam.
- Sutherland, B.J. (1974) Control of salt absorption and whey drainage in Cheddar cheese manufacture. *Australian Journal of Dairy Technology*, **29**, 86–93.
- Swart, G.J., Downes, T.E.H., Van Der Merwe, N.L. & Gibbard, H.M. (1987) The effect of thermization on yield and quality of Cheddar cheese. *Suid Afrikaanse Tydskrif vir Suiwelkunde*, **19**(3), **32**, 91–98.
- Tamime, A.Y. (ed.) (2006) *Brined Cheeses*, Blackwell Publishing, Oxford, UK.
- Thomann, S., Schenkel, P. & Hinrichs, J. (2008). The impact of homogenization and microfiltration on rennet-induced gel formation. *Journal of Texture Studies*, **39**, 326–344.
- Thomas, T.D. & Crow, V.L. (1983) Mechanism of D(–)-lactic acid formation in Cheddar cheese. *New Zealand Journal of Dairy Science and Technology*, **18**, 131–141.
- Tothill, I.E., Piletsky, S.A., Magan, N. & Turner, A.P.F. (2001) New biosensors. *Instrumentation and Sensors for the Food Industry*, (eds E. Kress-Rogers and C.J.B. Brimelow), pp. 760–776, Woodhead Publishing, Cambridge, UK.
- Tunick, M.H., Guinee, T.P., van Hekken, D.L., Beresford, T.P. & Malin, E.L. (2007). Effect of whey drainage pH on composition, rheology, and melting properties of reduced-fat Cheddar cheese. *Milchwissenschaft*, **62**, 443–446.
- Tunick, M.H., Malin, E.L., Smith, P.W., Shieh, J.J., Sullivan, B.C., Mackey, K.L. & Holsinger, V.H. (1993) Proteolysis and rheology of low-fat and full-fat Mozzarella cheeses prepared from homogenized milk. *Journal of Dairy Science*, **76**, 3621–3628.
- Tunick, M.H. & van Hekken, D.L. (2002) Torsion gelometry of cheese. *Journal of Dairy Science*, **85**, 2743–2749.
- Turner, K.W. & Thomas, T. D. (1980) Lactose fermentation in Cheddar cheese and the effect of salt. *New Zealand Journal of Dairy Science and Technology*, **15**, 265–276.
- Ustunol, Z. & Browne, R.J. (1985) Effects of heat treatment and posttreatment holding time on rennet clotting of milk. *Journal of Dairy Science*, **68**, 526–530.
- Van Den Berg, G., Boer, F. & Allersma, D. (1998) Consequences of cold storage of milk. *Voedingsmiddelentechnologie*, **31**(8), 101–104.
- Van Den Berg, G., Meijer, W.C., Dusterhoft, E.-M. & Smit, G. (2004). Gouda and related cheeses. *Cheese: Chemistry, Physics and Microbiology, Volume 2: Major Cheese Groups* (eds P.F. Fox, P.L.H. McSweeney, T.M. Cogan & T.P. Guinee), 3rd edn, pp. 103–140, Elsevier Academic Press, Amsterdam.
- van Vliet, T. & Dentener-Kikkert A. (1982) Influence of the composition of the milk fat globule membrane on the rheological properties of acid milk gels. *Netherlands Milk and Dairy Journal*, **36**, 261–265.
- van Vliet, T., van Dijk, H.J.M., Zoon, P. & Walstra, P. (1991) Relation between syneresis and rheological properties of particle gels. *Colloid and Polymer Science*, **269**, 620–627.
- Vasbinder, A.J. & de Kruif, G. (2003) Casein-whey protein interactions in heated milk: the influence of pH. *International Dairy Journal*, **13**, 669–677.
- Vasbinder, A.J., Rollema, H.S. & de Kruif, C.G. (2003) Impaired rennetability of heated milk; study of enzymatic hydrolysis and gelation kinetics. *Journal of Dairy Science*, **86**, 1548–1555.
- Verschuere, M., Verdurmen, R. & de Jong, P. (2001) Use of hybrid models for predicting and controlling food properties. *Proceedings of the II International Symposium on Application of Modelling as an Innovative Technology in the Agri-Food Chain* (eds M. Hertog and B.R. MacKay), pp. 129–134, International Society for Horticultural Science, Palmerston North, New Zealand.
- Vianna, P.C.B., Mazal, G., Santos, M.V., Bolini, H.M.A. & Gigante, M.L. (2008) Microbial and sensory changes throughout the ripening of Prato cheese made from milk with different levels of somatic cells. *Journal of Dairy Science*, **91**, 1743–1750.

- Visser, F.M.W. (1977) Contribution of enzymes from rennet, starter bacteria and milk to proteolysis and flavour development in Gouda cheese. 3: Protein breakdown: analysis of the soluble nitrogen and amino acid nitrogen fractions. *Netherlands Milk and Dairy Journal*, **31**, 210–239.
- Visser F.M. & de Groot-Mostert, E.A. (1977) Contribution of enzymes from rennet, starter bacteria and milk to proteolysis and flavour development in Gouda cheese. 4: Protein breakdown: a gel electrophoretic study. *Netherlands Milk and Dairy Journal*, **31**, 247–264.
- Visser, J. (1991) Factors affecting the rheological and fracture properties of hard and semi-hard cheese. *Rheological and Fracture Properties of Cheese*, Document No. 268, pp. 49–61, International Dairy Federation, Brussels.
- Vitova, E., Loupancova, B., Zemanova, J., Stoudkova, H., Brezina, P. & Babak, L. (2006) Solid-phase microextraction for analysis of mould cheese aroma. *Czech Journal of Food Sciences*, **24**, 268–274.
- Walsh, C.D., Guinee, T.P., Harrington, D., Mehra, R., Murphy, J. & FitzGerald, R.J. (1998a) Cheese-making, compositional and functional characteristics of low-moisture part-skim Mozzarella cheese from bovine milks containing kappa-casein AA, AB or BB genetic variants. *Journal of Dairy Research*, **65**, 307–315.
- Walsh, C.D., Guinee, T.P., Reville, W.D., Harrington, D., Murphy, J.J., O’Kennedy, B.T. & FitzGerald, R.J. (1998b) Influence of κ -casein genetic variant on rennet gel microstructure, Cheddar cheese-making properties and casein micelle size. *International Dairy Journal*, **8**, 1–8.
- Walstra, P., van Dijk, H.J.M. & Geurts, T.J. (1985) The syneresis of curd. 1. General considerations and literature. *Netherlands Milk and Dairy Journal*, **39**, 209–246.
- Walstra, P. & van Vliet, T. (1986) The physical chemistry of curd making. *Netherlands Milk and Dairy Journal*, **40**, 241–259.
- Warsinke, A., Pfeiffer, D. & Scheller, F.W. (2001) Commercial devices based on biosensors. *Instrumentation and Sensors for the Food Industry* (eds E. Kress-Rogers and C.J.B. Brimelow), pp. 740–759, Woodhead Publishing, Cambridge, UK.
- Watkinson, P., Coker, C., Crawford, R., Dodds, C., Johnston, K., McKenna, A. & White, N. (2001) Effect of cheese pH and ripening time on model cheese textural properties and proteolysis. *International Dairy Journal*, **11**, 455–464.
- Watkinson, P., Coker, C., Dodds, C., Hewson, S., Kuhn-Sherlock, B. & White, N. (2004) The effect of moisture and ripening time on model cheese textural properties and proteolysis. *IDF Cheese Symposium: Ripening, Characterization and Technology*, Prague, Czech Republic, March 21–25, p. 17 (abstract), International Dairy Federation, Brussels.
- Weatherhup, W., Mullan, M.A. & Kormos, J. (1988) Effect of storing milk at 3 or 7°C on the quality and yield of Cheddar cheese. *Dairy Industries International*, **53**(2) 16–17, 25.
- Whitehead, H.R. & Harkness, W.L. (1954) The influence of variations in cheese-making procedure on the expulsion of moisture from Cheddar curd. *Australian Journal of Dairy Technology*, **9**, 108–107.
- Williams, R.P.W. (2002) The relationship between the composition of milk and the properties of bulk milk products. *Australian Journal of Dairy Technology*, **57**, 30–44.
- Wolfschoon-Pombo, A.F. (1997) Influence of calcium chloride addition to milk on the cheese yield. *International Dairy Journal*, **7**, 249–254.
- Zalazar C.A., Meinardi, C.A., Bernal-de-Zalazar, S. & Candiotti, M. (1988) The effect of previous heat treatment on the keeping quality of raw milk during cold storage. *Microbiologie – Aliments – Nutrition*, **6**, 373–378.
- Zalazar, C.A., Meinardi, C.A., Palma, S., Suarez, V.B. & Reinheimer, J.A. (1993) Increase in soluble sialic acid during bacterial growth in milk. *Australian Journal of Dairy Technology*, **48**, 1–4.
- Zall, R.R. & Chen, J.H. (1986) Thermalizing milk as opposed to milk concentrate in a UF system affects cheese yield. *Milchwissenschaft*, **41**, 217–218.
- ZMP (2008) *ZMP Martbilanz Milch: Deutschland, EU, Welt*, ZMP Zentrale Markt- und Preisberichtsstelle HmbH, Bonn.

9 Technology, Biochemistry and Functionality of Pasta Filata/Pizza Cheese

P.S. Kindstedt, A.J. Hillier and J.J. Mayes

9.1 Introduction

Pasta filata (stretched curd) cheeses encompass a wide range of cheese varieties, such as Mozzarella, Provolone, Scamorza, Caciocavallo, which originated primarily in the northern Mediterranean region (Italy, Greece, the Balkans and Turkey). The defining feature of all pasta filata cheeses is the unique thermising and texturing process that occurs at the end of cheesemaking, when the curd is immersed in hot water, whey or salt brine and worked mechanically into a hot plastic consistency, followed by moulding into a desired shape and size. The impact of stretching on the characteristics of the final cheese is striking and multifaceted, involving the reorganisation of curd architecture, changes in the chemical composition and a thermal treatment that profoundly influences the microbiological, biochemical, physico-chemical and functional characteristics of the cheese during ageing. Thus, pasta filata cheeses differ fundamentally from other cheese varieties in several important respects, which explains why they have been traditionally grouped as a distinct category.

Among the pasta filata cheeses, pizza cheese is dominant and has shown extraordinary worldwide growth in production and consumption during the past 20 years, fuelled primarily by the rising popularity of pizza. This sharp rise in production has been accompanied by large increases in plant production capacities, with many cheese plants routinely producing 100 tonnes or more of pizza cheese per day. Cheesemaking on this scale requires precise control over all aspects of the manufacturing process, especially the activity of the starter culture and the conditions during stretching. This created a pressing need for a better understanding the scientific and technological basis of pizza cheese manufacture. This chapter describes the recent research as well as the fundamentals of the technology of pasta filata cheese. Although most of the published reports in this area are specific to pizza cheese (of which Mozzarella is a type), many of the principal findings will apply to other pasta filata cheeses as well.

9.2 Measuring functional properties of pizza cheese

9.2.1 *Background*

The functional properties of pizza cheese (e.g. meltability, stretchability, elasticity, free-oil formation, blister formation and browning) are readily observed by consumers and hence, the measurements of these properties are fundamental to research in this area. It is well

documented that pizza cheese undergoes changes in functionality and texture during ageing. For example, fresh pizza cheese made with starter has a firm texture, melts poorly and has limited stretch, making it unsuitable for baking on pizza. As the cheese ripens over a period of 1–3 weeks, physicochemical and proteolytic changes, as described in Sections 9.4.2 and 9.4.3, cause the texture to gradually soften and the cheese to attain satisfactory melt and stretch properties. This ageing of the cheese continues until the melted cheese becomes too soft for use on pizza. The window of suitable functionality can vary from weeks to months, depending on the composition, heat treatment during stretching and moulding and storage temperature.

9.2.2 Measurement of functionality

The functionality of pizza cheese can be measured subjectively by manufacturers and buyers by baking the cheese on a pizza base topped with tomato sauce and observing the properties described above. However, as these properties are impacted by the time and temperature of baking and the configuration of the oven (e.g. convection versus forced draft impingement), there is a need for more defined and reproducible tests of these properties.

The *melt* characteristics of pasta filata cheeses are often measured by the Arnott (Arnott *et al.*, 1957) and Schreiber (Kosikowski & Mistry, 1997) tests where discs of cheese are melted under standard conditions in a convection oven and changes in the diameter of the discs after heating are determined. Park *et al.* (1984) compared these methods along with two modifications by using microwave heating and found little correlation between the methods. As expected, results were affected by both heating time and oven temperature in the conventional oven and the power of the microwave. Wang *et al.* (1998) developed the University of Wisconsin (UW) meltmeter, for objectively measuring melt (flow) of discs of cheese in a lubricated squeeze flow configuration. The same group improved the design at a later stage to obtain the melt profile of a cheese by monitoring the height and temperature of a disc of cheese as it was heated in an oven (Muthukumarappan *et al.*, 1999), compared to only measuring the disc height at a fixed temperature with the UW meltmeter. The improved device is known as the UW melt profiler.

Melt tests using discs of cheese are generally unsuitable for measuring the melt properties of brine-salted pizza cheeses as gradations of moisture and salt from the outside to the centre of brine-salted cheeses make it impossible to cut discs as representative samples (Kindstedt *et al.*, 1992). Shredding a representative block sample of a brine-salted cheese overcomes the gradations of moisture and salt. Melt tests using shredded cheese as the sample have measured either the distance shredded cheese flows down a glass tube on melting (Oberg *et al.*, 1992b; McMahon *et al.*, 1993) or the time taken for cheese shreds to disappear and form a molten mass in an oven (Guinee *et al.*, 1997).

The *stretch* characteristics of pasta filata cheeses are generally determined by measuring how far the melted cheese will stretch when a constant force is applied either vertically or horizontally. However, these approaches may be disadvantaged by non-uniform moisture and temperature losses during stretching. A recently developed ring and ball method, where the stretch of the cheese is measured in a mineral oil bath, overcomes these variations in

moisture and temperature, but the method is unsuitable for brine-salted cheeses because of the gradations in salt and moisture described above (Hicsasmaz *et al.*, 2004).

The potential of pasta filata cheese to release *free-oil* when heated (e.g. as an ingredient on pizza) is generally measured using a modified Babcock test (Kindstedt & Rippe, 1990). It is thought that these methods do not extract the fat held in emulsified form by the casein in the cheese (Kindstedt & Rippe, 1990; McMahon *et al.*, 1993).

The *blister colour* of pizza cheese can be assessed either directly on baked pizza (Matzdorf *et al.*, 1994) or indirectly by heating the cheese in a boiling water bath (McMahon *et al.*, 1993). The colour is then assessed either subjectively by comparison to colour charts or objectively using a colour meter (McMahon *et al.*, 1993; Matzdorf *et al.*, 1994). Image analysis of pizza bakes was first reported by Yun *et al.* (1994b), where objective measurements of the size and distribution of blisters on pizza were made by evaluating photo slides of pizza by using a digital image analyser. Computer vision technology has been used successfully to assess browning of cheese on heating (Wang & Sun, 2003).

The helical viscometry method developed by Kindstedt and Kiely (1992) provides an objective measure of the apparent viscosity of the melted cheese that can be directly related to the required functionality of the cheese. However, more complex methods have been described to assess the functional properties of pizza cheese. These generally involve rheological assessment of specific parameters and are not always directly related to consumer perception. These techniques have been extensively reviewed (Rowney *et al.*, 1999; Muliawan & Hatzikiriakos, 2007).

9.3 Manufacture of pizza cheese

The basic manufacturing scheme for pizza cheese is very similar to that for Cheddar cheese as far as the milling stage. For example, the cheese milk is inoculated with starter culture, coagulated with rennet, the coagulum is cut and followed by cooking, draining the whey, matting and cheddaring of the curd, and milling. Indeed, the equipment lines used by large industrial manufacturers of Cheddar and pizza cheese are often nearly identical, and typically include: (a) horizontal or vertical enclosed vats for coagulating the milk and cooking the curd and (b) large enclosed conveyor belt systems for draining and matting the curd and developing the proper acidity (Anonymous, 2003). A major difference in the production of curd for pizza cheese, however, is that acidification by the starter occurs far more rapidly in most procedures, resulting in much shorter make times. Thus, it is not unusual to find make times of <2.5 h from coagulant addition to the start of stretching (McCoy, 1997). Stretching takes place after the cheddared curd has developed an optimum level of acidity.

9.3.1 Treatment of milk

Pizza cheese is normally consumed after only a very brief, but important, period of ageing; therefore, from the standpoint of microbiological safety, it is essential that pizza cheese is made from pasteurised milk (i.e. heated at 72°C for 15 s). In addition, higher than normal pasteurisation temperatures can be used to increase cheese yield through denaturation and incorporation of whey proteins (Lelievre, 1995). Improved cheese yield may also be achieved

by adding denatured whey proteins to the milk before rennet addition, where permitted. However, homogenisation of milk for pizza cheese manufacture is not normally practised commercially.

Milk that is used to manufacture pizza cheese is almost always standardised to a specific protein-to-fat (P/F) or casein-to-fat (C/F) ratio to produce cheese of a desired fat-in-dry matter (FDM) content, which is normally specified by the buyer of the cheese (Barbano, 1986). The FDM is important to buyers because it affects various functional properties, such as firmness and shreddability, meltability and free-oil formation (Kindstedt & Rippe, 1990; Rudan & Barbano, 1998b). The economics of cheesemaking are strongly influenced by the specific method used to standardise the C/F ratio (Barbano, 1996a). Standardisation by the addition of casein (as opposed to the removal of fat) results in increased cheese yield per volume of milk, and thus more cheese produced per vat and per plant production day, which represents a powerful economic incentive for this mode of standardisation (Wendorff, 1996). Casein can be added to the cheese milk in the form of low-heat, non-fat dry milk (NDM) or condensed skimmed milk (or casein or milk protein concentrate, if permitted). The use of milk protein concentrate powder as the casein source appears to be increasing, with a report of the fortification of the protein level of the milk to $5.4 \text{ g } 100 \text{ g}^{-1}$ resulting in a higher level of protein retention when making Mozzarella, without adversely affecting the quality of pizza cheese (Harvey, 2006).

In the United States of America (USA), standardisation by addition of NDM was widely used in the 1990s (Yun *et al.*, 1998). According to Wendorff (1996), about $15\text{--}20 \text{ g } 100 \text{ g}^{-1}$ of the solids in cheese milk can be supplied by NDM ($1.5\text{--}2.0 \text{ g } 100 \text{ mL}^{-1}$ of NDM) without detrimentally affecting the functional characteristics of pizza cheese, provided that the NDM is reconstituted in water or skimmed milk under appropriate time and temperature conditions before addition to the cheese milk.

Yun *et al.* (1998) found that adding up to $3 \text{ g } 100 \text{ mL}^{-1}$ NDM to the milk, without changing any of the cheesemaking parameters, resulted in a lower moisture ($46.7 \text{ g } 100 \text{ g}^{-1}$ versus $48.4 \text{ g } 100 \text{ g}^{-1}$) and higher calcium level. However, overall, the changes in functionality caused by the addition of up to $3 \text{ g } 100 \text{ g}^{-1}$ NDM were relatively small and could probably be reduced even further by (a) increasing the starter inoculum (to decrease total make time and thereby increase the moisture content of the NDM fortified cheeses) and (b) decreasing the draining pH (to decrease the calcium content of the NDM-fortified cheeses).

The use of membrane filtration of milk to increase the cheese solids in the milk (i.e. fat and casein) prior to cheesemaking appears to be increasing. The use of ultrafiltration (UF) to increase the true protein level in standardised milk to about $4 \text{ g } 100 \text{ g}^{-1}$ throughout the year is almost universal in the manufacture of pizza cheese in bulk cheese plants in Australia. This minimises the impact of seasonal variation in milk protein level, results in increased throughput and facilitates the use of the permeate from the UF step in other products.

Microfiltration (MF) is an emerging technology to fractionate the whey proteins from the casein before making cheese. While it is not expected to significantly increase protein recovery in the cheese by incorporation of whey proteins, it will increase plant capacity and reduce the amount of rennet used (Papadatos *et al.*, 2003). Furthermore, the sterile MF permeate can be used to produce a high-quality serum (whey) protein concentrate (Maubois, 1997). Pizza cheese produced from reconstituted MF milk powder was reported to have the same composition and properties as control pizza cheese (Garem *et al.*, 2000). Preliminary

trials on the potential of using MF to highly concentrate skim milk (concentration factors of 6–9) for pizza manufacture have been reported by Ardisson-Korat & Rizvi (2004). The MF retentate was mixed with cream and acidified with glucono- δ -lactone (GDL) prior to preparation of the curd in an Alcurd continuous cheese coagulator (Alfa Laval). The required moisture of the cheese was obtained by including a syneresis step that produced ~10% the volume of whey produced in conventional manufacture. Because of the lack of starter and decreased rennet-to-protein ratios, there was considerably less proteolysis in the MF cheese. This resulted in cheeses with less melt and initially less stretch than commercial cheese controls. The decrease in stretchability over time was greater in control cheese than in the MF cheese so that after ~30 days the stretchability of the MF cheese was greater than that of the control; pizza bakes were not reported. However, the yield advantage of incorporating whey proteins in the cheese when using UF retentate is lost when using MF retentate, and careful analysis of the economics of high-concentration MF for pizza cheesemaking would be required.

A novel method for increasing the yield of Mozzarella has been reported by Chr. Hansen and Novo enzymes where treatment of the cheese milk with phospholipase resulted in reduced fat losses in both the cheese whey and cooker/stretcher water (and thus improved fat retention in the cheese) and higher moisture retention in the cheese (Lilbaek *et al.*, 2006).

9.3.2 Starter culture

The traditional starters for Pizza cheese are the thermophiles, e.g. *Lactobacillus delbrueckii* subsp. *bulgaricus* and *Streptococcus thermophilus*. *Lactobacillus helveticus* is often used in place of *Lb. delbrueckii* subsp. *bulgaricus*, primarily to limit the browning of pizza cheese during baking. *Lb. helveticus*, unlike *Lb. delbrueckii* subsp. *bulgaricus* and most strains of *S. thermophilus*, is able to ferment galactose when lactose is present and is, thus, used to prevent the accumulation of galactose in the final cheese (Oberg *et al.*, 1991; McCoy, 1997). Galactose accumulation is problematical because of its role in browning during baking. Successful efforts to isolate galactose-fermenting thermophilic streptococci that prevent galactose accumulation in pizza cheese when used in combination with *Lb. helveticus*, and thereby limit potential browning have also been reported (Johnson & Olson, 1985; Matzdorf *et al.*, 1994; Mukherjee & Hutkins, 1994).

Pizza cheese can also be manufactured with the mesophilic starters typically used in the manufacture of Cheddar (i.e. *Lactococcus lactis* subsp. *lactis* and *Lactococcus lactis* subsp. *cremoris*), but it has a blander flavour than the typical acetaldehyde flavour obtained when using thermophilic starters. In either case, the starter must produce enough acid prior to stretching of the curd to attain the necessary combination of pH and calcium content for stretching in a relatively short time (to ensure sufficiently high moisture). This can be achieved with mesophiles by keeping the cheesemaking temperature close to the optimum temperature for growth (~30°C). Pizza cheese made with mesophilic starter will normally have a longer total manufacturing time unless a very large inoculum of very active starter is used. In general, thermophilic starters are used much more widely throughout the world than mesophilic starters for pizza cheese.

Role of starter culture

The principal role of the starter is to produce enough lactic acid during cheesemaking to transform the unstretchable curd into one that will stretch in hot water. Curd stretch appears to be governed primarily by the amount of calcium that is available for casein cross-linking (Lucey & Fox, 1993; Kosikowski & Mistry, 1997). Too much casein-associated calcium results in a tough curd that tears and fractures during stretching, whereas too little calcium results in a complete loss of structure and stretch. The level of casein-associated calcium is determined by two key factors: (a) the amount of total calcium (per unit of casein) in the curd and (b) the distribution of total calcium between the casein-associated and serum-soluble states. The latter is governed by the pH of the curd; i.e. high pH favours calcium in the casein-associated state, whereas low pH favours calcium in the soluble state (Lawrence *et al.*, 1987). Therefore, the two parameters that best define the requirements for curd stretch are the ratio of calcium to protein and the pH of the curd at the time of stretching. These parameters are inversely related, meaning that curd with low calcium/protein ratio (e.g. curd produced through direct acidification prior to renneting, as described in Section 9.5.1) requires relatively high pH (e.g. 5.6–5.7) for stretching, whereas curd with high calcium/protein ratio (e.g. curd produced under slow acid conditions and high draining pH) requires relatively low pH (e.g. 5.1–5.2) for stretching. The schedule of acid production by the starter has a profound influence on the chemical composition and functionality of the final cheese.

Two important features that define the schedule of acidification are: (a) the overall rate of acid production and (b) the amount of acid produced before whey drain versus after whey drain. The overall rate of acid production is important because it determines the total manufacturing time, which in turn influences the amount of syneresis during manufacture and therefore the moisture content of the final cheese (Barbano *et al.*, 1994b). A shorter make time, achieved by faster acid production, generally results in cheese with higher moisture content. Indeed, manipulating the total make time is one of the more effective strategies that the cheesemaker can use (along with changing the cooking/cheddaring temperature and changing the conditions of salting) to tailor the moisture content of the final cheese. The amount of acid produced before versus after whey drainage is essentially defined by the pH at rennet addition and at draining. More than any other parameter, the pH at rennet addition and at draining influence the calcium/protein ratio in the final cheese because most of the calcium losses to the whey occur by the time of draining (Kindstedt *et al.*, 1993; Lucey & Fox, 1993). Thus, lower pH at rennet addition and drainage results in a lower calcium/protein ratio in the final cheese, provided that other manufacturing conditions, such as stretching pH, remain unchanged. In summary, the starter culture, through its contribution to the schedule of acidification, has a major impact on the moisture and calcium contents of the final cheese, which have major implications for functional characteristics and the ageing time required to develop optimum functionality. For example, the combination of a very rapid rate of acidification (short make time) and low draining pH results in a pizza cheese with high moisture content and low calcium/protein ratio. Higher moisture content and lower calcium/protein ratio both favour a softer unmelted texture and a less fibrous and less chewy melted consistency (Yun *et al.*, 1993d, 1995b, 1998). Consequently, such cheese will require only limited ageing to develop optimum functionality.

Rapid acidification can be achieved by using a very active starter, such as one propagated under conditions of external pH control or a large rate of inoculation (Brothersen, 1986; Barbano *et al.*, 1994b) or by pre-acidifying the milk before renneting (Guinee *et al.*, 2002). At the other extreme, the combination of a slow rate of acidification (long make time) and high draining pH results in a low moisture content and high calcium/protein ratio. Such cheese will be very firm and will melt to a tough, chewy consistency that requires extended ageing for optimum functionality.

The critical role played by pH in the manufacture and functionality of pizza cheese suggests that attention should be paid to ensure pH measurements are accurate and comparable between plants (Buss, 1991). Many variables affect the accuracy of pH readings in cheesemaking, including the buffer temperature at calibration, dilution of the curd or cheese with water for measuring pH and the type of electrode. The temperature of the buffers used to calibrate the pH meter must be similar to the curd temperature to avoid inaccurate pH readings for the curd. Temperature compensators on pH meters are not a suitable substitute (Sherbon, 1988). Diluting curd or cheese with water is a common practice before measuring pH. Increasing the ratio of water compared to cheese beyond 30 g 100 g⁻¹ results in higher pH values (Upreti *et al.*, 2004). For example, the pH of a 1:1 slurry of water and cheese is about 0.1 pH units higher than the pH of the cheese. Quinhydrone electrodes result in a lower pH of about 0.1 pH units compared to the more widely used glass electrodes (M. Johnson, personal communication).

Rod-to-cocci ratio

Lb. delbrueckii subsp. *bulgaricus* and *S. thermophilus* are typically grown together in a loosely defined ratio. The cells can be easily differentiated on the basis of morphology, with lactobacilli cells being rod shaped and streptococci being coccoid. These organisms are almost always used in combination because of their well-known associative growth behaviour, which enables them to produce acid much more rapidly when grown together than single strain (Oberg & Broadbent, 1993). Maximum growth rates occur in the pH range approximately 5.5–6.0 for *S. thermophilus* and 5.0–5.5 for *Lb. delbrueckii* subsp. *bulgaricus* (Brothersen, 1986). Therefore, pH manipulation can be used during propagation of a mixed thermophilic culture to control the rod/cocci ratio. The introduction of external pH control systems has made it possible for industrial cheesemakers to gain effective control over the ratio of rods to cocci grown together in bulk starter culture (Brothersen, 1986; Oberg & Broadbent, 1993). Alternatively, rod and cocci strains can be propagated as separate cultures and then combined in the desired ratio for cheesemaking. Changing the rod/cocci ratio of the starter has two important consequences for cheesemaking. First, it influences the schedule of acidification – *S. thermophilus* produces acid much more rapidly than *Lb. delbrueckii* subsp. *bulgaricus* in the pH range that occurs during cheesemaking (Brothersen, 1986; McCoy, 1997). Consequently, *S. thermophilus* dominates the starter population in the curd by the end of cheesemaking regardless of the rod/cocci ratio in the initial starter culture, which typically ranges from about 1:1 to 1:5 in commercial practice (Yun *et al.*, 1995a). Nevertheless, the rate of acidification during cheesemaking is affected by the initial ratio; i.e. a high proportion of rods in the initial starter results in a slower rate of acidification and longer make time, when all other conditions, including the total rate of inoculation, are held constant (Yun

et al., 1995a). In commercial practice, a longer make time is usually not practical or desirable; therefore, an increase in the rod/cocci ratio would normally be accompanied by an increase in total starter inoculum to maintain a constant make time. Thus, in commercial practice, when the rod/cocci ratio of the starter is changed, the total number of starter bacteria that are added to the cheese milk is also changed. This has important implications for the population of rods in the final cheese. For example, Yun *et al.* (1995a) demonstrated that a higher rod/cocci ratio in the starter resulted in a higher rod population in the final cheese, when the total number of starter bacteria added to the cheese milk was held constant. Presumably, a higher rod/cocci ratio in the starter combined with a higher rate of inoculation (to maintain a constant make time) would lead to even higher populations of rods in the final cheese. Thus, the second important consequence of changing the rod/cocci ratio of the starter is the effect on the population of rods in the final cheese. The population of rods is important because of the implications for proteolysis during ageing. *Lb. delbrueckii* subsp. *bulgaricus* is far more proteolytic than *S. thermophilus* (Oberg & Broadbent, 1993; McCoy, 1997). Therefore, a higher population of viable rods in the final cheese will result in a higher rate of proteolysis associated with the starter (Yun *et al.*, 1995a). Starter-associated proteolysis and its impact on functional characteristics are discussed in Sections 9.4.2 and 9.4.4.

9.3.3 Coagulant

Various coagulants from different sources are used commercially to manufacture pizza cheese (Kindstedt, 1993). Calf rennet, consisting mainly of chymosin with a small percentage of bovine pepsin, is the traditional coagulant and is still widely used throughout the world, particularly in countries where pure chymosin, produced by recombinant deoxyribonucleic acid (DNA) technology, is not permitted or not accepted in the market. Pure chymosin is now widely used in the United States and many other countries. Microbial rennets, derived from *Rhizomucor miehei*, *Rhizomucor pusillus* and *Cryophenectria parasitica*, also continue to be used, although their use in some markets has declined considerably with the introduction of pure chymosin (see Chapter 2). There has been a resurgence in the use of *R. miehei* coagulants in Australia in the past 10 years due, in part, to the wider market for whey products made from cheese coagulated with this coagulant. A more purified form of this coagulant is claimed to overcome the yield disadvantage of previous *R. miehei* coagulants compared to chymosin. Furthermore, these coagulants are manufactured with a range of heat labilities, providing another parameter for controlling the shelf life of pizza cheese.

As in all cheesemaking, the primary role of the coagulant in the manufacture of pizza cheese is to coagulate the milk and thereby initiate the process of selective concentration that ultimately establishes the chemical composition of the cheese. In traditional pizza cheese, produced with starter culture, the coagulant also has a secondary, but very important, role in the development of optimum functional characteristics during ageing (Yun *et al.*, 1993d). Consequently, the activity and specificity of the particular coagulant used in cheesemaking, as well as its thermal stability and extent of heat inactivation during stretching, have important impacts on proteolysis, functional characteristics and ageing behaviour (Oberg *et al.*, 1992a; Kindstedt, 1993; Yun *et al.*, 1993a, 1993d; Kindstedt *et al.*, 1995a), as discussed in Sections 9.3.5 and 9.4.4. Interestingly, the amount of coagulant (chymosin) added to the cheese milk

can be reduced by at least 40% from traditional recommended levels, with relatively little impact on the proteolytic and functional changes in the cheese during ageing (Kindstedt *et al.*, 1995b).

9.3.4 Cooking and cheddaring

The primary functions of the cooking, draining and cheddaring steps in the making of pizza cheese are to control the moisture and calcium contents in the curd at stretching and in the final cheese. This is accomplished, in part, by controlling the starter activity and schedule of acidification (i.e. total make time and draining pH), as discussed previously. Beyond this, the temperature during cooking and cheddaring is one of the most useful parameters that the cheesemaker can employ to change the moisture content of the final cheese. In general, lower cooking and cheddaring temperature results in less syneresis and higher moisture content in the final cheese. However, thermophilic starters show optimal acid production in the temperature range of approximately 42–45°C, which is at or above the cooking/cheddaring temperatures normally used in the making of pizza cheese (Oberg & Broadbent, 1993; McCoy, 1997). Therefore, lower cooking/cheddaring temperatures also tend to result in slower rates of acid production and longer make times and hence greater opportunity for syneresis (Yun *et al.*, 1993c). Consequently, the effect of changing the cooking/cheddaring temperature on cheese moisture content will be greatest when steps are taken to maintain a constant make time. For example, Yun *et al.* (1993c) reported that the moisture content of Mozzarella cheese was increased by about 2 g 100 g⁻¹ when cooking/cheddaring temperature was decreased from 44 to 38°C. However, in that study, acid production by the starter was slower at the lower temperature, thereby adding an additional 30 min to the total make time at 38°C. Presumably, if the total make time at 38°C had been held constant (e.g. by adding more starter to the cheese milk), the increase in cheese moisture content with decreasing cooking/cheddaring temperature would have been greater than 2 g 100 g⁻¹. Near the end of cheddaring, a pH ‘window’ opens, which spans perhaps 0.2–0.3 pH units, within which the curd can be stretched. For example, curd stretch may commence at about pH 5.3 and continue until the pH drops below 5.0, at which point, structure and stretch are completely lost. The propensity of the curd to stretch at a particular pH can vary, and can be subjectively assessed by heating a sample of the curd in water at about 70°C and gently drawing the heated curd apart to observe the extent of stretching.

Stretching at the low end of the suitable pH range (sometimes referred to in the industry as stretching the curd when it is ‘ripe’) results in lower pH values and slightly lower moisture content and calcium/protein ratio in the final cheese. Yun *et al.* (1993b, 1993e) observed that stretching at lower pH resulted in cheese with lower apparent viscosity values during ageing, indicating a less fibrous and chewy melted consistency that required less ageing to attain optimum functionality. Presumably, these differences in functionality were caused by the combined effect of slightly lower calcium/protein ratio and less calcium in the casein-associated state (due to lower cheese pH). Conversely, stretching at the high end of the pH range (sometimes referred to in the industry as stretching the curd when it is ‘green’) resulted in higher cheese pH, slightly higher moisture content and calcium/protein ratio and higher apparent viscosity values during ageing, indicative of a more structured, fibrous and chewy

melted consistency that required longer ageing to attain optimum functionality (Yun *et al.*, 1993b, 1993e). Thus, ageing requirements can be manipulated by changing the stretching pH. These results are consistent with the industry practice of stretching the curd when it is 'green' to favour slower ageing and longer shelf life and when it is 'ripe' if the cheese is to be used quickly. Of course, in large industrial situations it may take 30 min or more of continuous feed into the mixer for all of the curd from a single vat to be processed, during which time the un-stretched curd continues to decrease in pH and calcium content. Therefore, the individual blocks of cheese that are produced from a single vat of milk will range in character from 'more green' to 'more ripe', depending on the time at which the curd entered the mixer. Thus, it is important to process the entire vat as quickly as possible and to remain within the pH window where stretching is possible.

9.3.5 *Stretching and moulding*

The heating and stretching of the acidified curd is the defining operation in the manufacture of pasta filata pizza cheese. Stretching has a profound impact on the microstructure and chemical composition (and yield) of the cheese, and it also represents a substantial heat treatment, all of which affect the functional characteristics of the cheese. Stretching is typically performed using continuous single- or twin-screw mechanical mixers that contain hot water coupled with steam injection systems. Stretching involves two stages: During the first stage, curd enters the mixer and is quickly warmed by the hot water to a temperature range of at least 50–55°C, which is necessary to transform the curd into a plastic and workable consistency. The temperature of the mixer water may vary widely, ranging approximately 55–85°C, depending on the design of the equipment and the operating conditions (e.g. auger speed). In the second stage, the plastic curd is worked by the auger(s) or series of augers into a unidirectional fibrous ribbon of plastic curd. The hot plastic curd then exits the mixer and is transported by an auger(s) to the moulding machine, where it is forced under pressure into a mould which gives the cheese its shape. The moulder also serves a pre-cooling function, so that the block will retain its shape when removed from the mould.

A recent development in equipment for continuously stretching the curd is the use of a swept surface mixer, known as a Rotatherm (Smith *et al.*, 2006). The Rotatherm uses steam infusion in place of hot water for heating the curd into the plastic and workable consistency, thus eliminating the need for a reservoir of heating water with its associated cheese solids.

Effect on microstructure

Stretching transforms the amorphous three-dimensional protein matrix of the cheese curd into a network of parallel-aligned protein fibres, as can be readily seen by scanning electron microscopy (SEM) or confocal laser scanning microscopy (CLSM) (McMahon *et al.*, 1993; Oberg *et al.*, 1993; Auty *et al.*, 2001). Serum and fat droplets accumulate in the open channels that separate the bundles of protein fibres, resulting in partial alignment of the fat and serum phases of the cheese. Therefore, it is not surprising that the rheological properties of pizza cheese are anisotropic in nature, i.e. having different properties when evaluated parallel versus perpendicular to the fibre direction (Ak & Gunasekaran, 1997). Stretching gives rise to an unmelted texture that is remarkably springy and elastic and a melted consistency that is highly

structured, fibrous and chewy. It is possible to make a variation of pizza cheese that is not stretched but rather pressed into block form (Chen *et al.*, 1996). Indeed, a significant amount of pressed curd cheese is produced in the USA for the pizza industry. Non-stretched pizza cheese can be made to melt and stretch by controlling the calcium/protein ratio and pH of the cheese in the same manner as for pasta filata pizza cheese (Lawrence *et al.*, 1987). However, the un-melted texture of non-stretched pizza cheese lacks the fibrous anisotropic character of pasta filata pizza cheese and the melted consistency is less structured, fibrous and chewy because such cheese lacks the organized protein fibres that are created during stretching.

Effect on chemical composition

Substantial moisture and fat losses may occur during stretching and moulding if the operating conditions in the mixer and moulder are not properly controlled (Nilson, 1973). It is particularly important to balance the speed of the auger(s) in the mixer with the temperature of the stretching water, so that the two are compatible. Specifically, the curd must be given enough time to attain a plastic and workable consistency before it is subjected to the rigorous shearing forces of the auger(s). If the auger speed is too fast and the stretching water temperature too low, the curd temperature will be too low and the curd will not deform sufficiently when the work of the auger(s) commences. Under these conditions, the curd will tear and lose fat, and in severe cases, moisture to the stretching water. The end result is lower fat and moisture contents in the final cheese, resulting in lower cheese yield. The balance between auger speed and stretching water temperature is especially critical when relatively low stretching water temperatures are employed. If the auger speed is increased too much without increasing the stretching water temperature commensurately, or the stretching water temperature is decreased too much without decreasing the auger speed commensurately, significant fat and moisture losses may occur. For example, Renda *et al.* (1997) varied the auger speed while holding stretching water temperature constant at 57°C (i.e. at the low end of normal temperature range). When the auger speed was increased from 5 to 19 revolutions *per* minute (rpm), the moisture content of the resulting cheeses decreased by nearly 3 g 100 g⁻¹ and the FDM content decreased by about 2.5 g 100 g⁻¹, due to fat and moisture losses to the stretching water. In a different study, Barbano *et al.* (1994a) varied the stretching water temperature while holding the auger speed constant at 12 rpm (i.e. mid-range speed). When the stretching water temperature was decreased from 74 to 57°C, the FDM content of the resulting cheeses decreased by about 2 g 100 g⁻¹ due to fat losses to the stretching water. The moisture content decreased only slightly under these conditions; however, the temperature effect on moisture content would probably have been greater had the auger speed been higher than 12 rpm. Excessive auger speed is less problematical when the stretching water is at the high end of the normal temperature range, because heat transfer occurs more rapidly and less time is needed to transform the curd to a plastic consistency (Kindstedt *et al.*, 1995a). However, the combination of very low auger speed and very high stretching water temperature should be avoided because higher fat losses may occur (Barbano *et al.*, 1994a).

Thermal effects

The temperature history of the curd during stretching is determined by the temperature of the stretching water and the time that the curd is exposed to the stretching water (Yun *et al.*,

1994a; Kindstedt *et al.*, 1995a; Renda *et al.*, 1997). The latter is determined, in the main, by the mixer design and the auger speed at which the mixer is operated. Upon entering the hot water in the mixer, the curd typically increases in temperature until it reaches some maximum temperature (below that of the water) before leaving the water near the exit of the mixer. It is not unusual to find temperature differentials of 10–20°C between the stretching water and the cheese at the exit of the mixer. In general, the faster the augers are operated on a particular model of equipment, the greater the temperature differential. The temperature of the hot plastic curd slowly decreases during transport to the moulder. The extent of temperature loss is determined by factors, such as: (a) the distance between the mixer and moulder, (b) time spent in the buffer vessel that feeds into the moulder and (c) exposure to ambient atmosphere. In general, temperature loss must be kept to a minimum because the curd must remain plastic and deformable to fuse into a uniform block that is free of folds and creases and to withstand the shearing forces of the auger that feeds the moulder (Nilson, 1973). Therefore, the total thermal treatment of the curd includes not only the residence time in the mixer but also the time from the exit of mixer to when cooling occurs in the moulder. Exceptions to this include systems that eliminate the moulder altogether by extruding the curd from the mixer directly into chilled brine (Barz & Cremer, 1993). The temperature history (i.e. time/temperature treatment) of the curd during stretching profoundly influences two aspects of the final cheese that are fundamental to the ageing process: starter culture activity and residual coagulant activity. Both *S. thermophilus* and *Lb. delbrueckii* subsp. *bulgaricus* are able to survive the stretching process and remain metabolically active when stretching is performed at the low end of the stretching temperature range (e.g. 55°C curd temperature) (Yun *et al.*, 1995a). Survival of metabolically active starter bacteria is best measured directly using selective microbiological plating techniques (Yun *et al.*, 1995a). However, indirect approaches also provide useful information, such as the measurement of titratable acidity (TA) in the cheese, which is directly influenced by fermentation of residual lactose and galactose by the starter, and the measurement of secondary proteolysis products that are soluble in 12 g 100 g⁻¹ trichloroacetic acid (TCA), which are mostly produced by the starter (Barbano *et al.*, 1993, 1994b). During a series of systematic studies on stretching water temperature and auger speed, Yun *et al.* (1994a) and Kindstedt *et al.* (1995a) demonstrated that small increases in curd temperature during stretching within a critical range (i.e. from approximately 62 to 66°C) resulted in precipitous declines in levels of TA and TCA-soluble nitrogen in the final cheese. They concluded that the survival of metabolically active thermophilic starter bacteria is highly temperature dependent within this critical range; consequently, small differences in stretching temperature may result in large differences in starter activity in the final cheese. Presumably, temperature sensitivity varies to some degree among starter strains. The residual coagulant activity in the pizza cheese is largely responsible for primary proteolysis in pizza, and thus strongly influences the shelf life of pizza cheeses of similar composition. Residual coagulant activity can be either monitored directly by a high-pressure liquid chromatography (HPLC) method (Hurley *et al.*, 1999) or indirectly by measuring the products of primary proteolysis that are soluble at pH 4.6 (Barbano *et al.*, 1993). As with the starter culture, the coagulant activity in pizza cheese is temperature dependent and varies with extent of heat inactivation during stretching. Chymosin remains active when stretching is performed at the low end of the normal temperature range (e.g. 55°C curd temperature) (Barbano *et al.*, 1993; Yun *et al.*, 1993a; Kindstedt *et al.*, 1995a). Likewise, coagulants derived from *R. miehei*

and *C. parasitica* can also be heat stable at 55°C and remain active after stretching (Yun *et al.*, 1993a; Kindstedt *et al.*, 1995a). Coagulants derived from *R. miehei* are manufactured with varying levels of heat lability, which gives the manufacturer some flexibility in the thermal treatment required in the stretching step to achieve the desired degree of inactivation of the coagulant. This heat lability is pH dependent, and the thermal treatment required to inactivate the coagulant in the curd during stretching will be different to that required to inactivate the coagulant in whey processing. All coagulants are progressively inactivated at higher stretching temperatures. Increases in curd (coagulated with chymosin) temperature during stretching, from approximately 62 to 66°C, resulted in precipitous declines in levels of pH 4.6-soluble nitrogen during ageing, suggesting large-scale inactivation of chymosin at the higher temperatures (Yun *et al.*, 1994a; Kindstedt *et al.*, 1995a). In summary, both coagulant and starter activity appear to be extremely temperature dependent in this critical range. Thus, a difference of a few degrees in curd temperature during stretching can make a dramatic difference in the microbiological and proteolytic characteristics of pizza cheese during ageing.

9.3.6 Brining/salting

Salt has a complex and multifaceted function in pizza cheese. In addition to promoting moisture expulsion during the salting process, salt affects the microbial, physicochemical, functional and flavour characteristics of the cheese (Wendorff & Johnson, 1991; Kindstedt *et al.*, 1992; Guo *et al.*, 1997; Paulson *et al.*, 1998). During salting, the salt is absorbed by the curd and moisture is simultaneously expelled, but the relationship between the two processes can vary widely depending on the method of salting. Salting may be performed by brining or by direct addition to the curd.

Brine salting

Brining is the traditional method of salt incorporation for pizza cheese. Residence time in the brine and brine concentration are key parameters that affect total salt uptake and moisture loss during brining (Nilson, 1968; Guinee & Fox, 1993). For pizza cheese, the brine should be maintained at near saturation (i.e. approximately 26 g 100 mL⁻¹) to maximise the rate of salt absorption while minimising microbial growth (especially yeast and mould) in the brine. Ideally, the brine should be replenished continuously with salt, as salt is absorbed by, and moisture is released from, the cheese. In addition, continuous circulation of the brine is essential to prevent the formation of local areas of dilution around the cheese surface (Wendorff & Johnson, 1991). An important difference in the brining of pasta filata/pizza cheese compared to other cheeses is that low temperatures (e.g. 1–4°C) are employed to provide for rapid cooling of the warm cheese (Nilson, 1968). Pizza cheese usually enters the brine after a brief period of cooling in the moulder. At this stage, the temperature at the centre of the cheese is often still quite warm, depending on the size of the block (e.g. 40–50°C); therefore, much of the total cooling occurs during brining (Nilson, 1968, 1973). Under these conditions, brine temperature has only a small effect on salt uptake, but a large effect on moisture loss (Nilson, 1968). For example, Nilson (1968) reported that moisture losses increased from 1.48 g 100 g⁻¹ at 0.5°C to 4.27 g 100 g⁻¹ at 21°C, when 1.1 kg blocks

of Mozzarella cheese were brined for 12 h. Moisture loss can be minimised by maintaining constant low brine temperature combined with continuous circulation to prevent localised temperature gradients in the brine surrounding the cheese surface. Newly prepared brine that is used for the first time can detrimentally affect the quality of the pizza cheese, unless the brine pH and calcium content are adjusted to prevent changes in calcium distribution and loss of calcium from the cheese during brining. This can be accomplished by acidifying the fresh brine with food-grade lactic or acetic acid to the approximate pH of the cheese (e.g. 5.2) and by increasing the calcium content of the brine (e.g. to $0.06 \text{ g } 100 \text{ g}^{-1}$) through the addition of food-grade calcium chloride (Wendorff & Johnson, 1991; McCoy, 1997). The latter is particularly important to prevent the development of soft rind defect, which occurs when calcium at the cheese surface leaches into the brine and the casein becomes highly solvated (Geurts *et al.*, 1972).

During brining, most cheeses develop a large decreasing salt gradient from the surface to the centre and a corresponding decrease in moisture content in the opposite direction (Guinee & Fox, 1993). Pizza cheese develops a typical salt gradient from surface to centre; however, moisture distribution may be quite complex and variable depending on the temperature conditions and moisture losses during brining (Nilson, 1968; Kindstedt *et al.*, 1990; Farkye *et al.*, 1991). During ageing, the moisture distribution may become even more complex depending on the interplay of three conditions that may occur in the cheese: persistent gradients of salt, temperature and pH. Salt content is always high at the cheese surface immediately after brining. This creates an osmotic pressure differential that causes an outward migration of moisture to the cheese surface (Guinee & Fox, 1993). In addition, temperature gradients that persist in the cheese due to incomplete cooling during brining (i.e. warm at the centre, cool at the surface) may serve as an additional driving force for the outward migration of moisture (Reinbold *et al.*, 1992). Finally, pH gradients (i.e. lower pH at the centre, higher pH at the surface) that develop as a result of persistent temperature gradients may create an additional driving force for the outward migration of moisture (Reinbold *et al.*, 1992). Thus, the confluence of these three factors (i.e. salt, temperature and pH gradients) may explain why some pizza cheeses, especially large blocks (e.g. 10 kg) that are difficult to cool rapidly, develop extremely high moisture content at the surface during ageing, resulting in a defective soft, wet surface (Kindstedt *et al.*, 1996).

Direct salting

Salt can be incorporated into pizza cheese by direct addition to the curd immediately before stretching, during stretching or between stretching and moulding (Fernandez & Kosikowski, 1986; Barbano *et al.*, 1994b; Anonymous, 2003). All of these approaches can be combined with an abbreviated brining step to provide cooling or, if an alternative method of cooling is used, eliminate the need for brine salting altogether (D.M. Barbano, personal communication). The addition of salt to the curd between stretching and moulding minimises salt whey losses after salting, and thus increases moisture retention in the cheese. However, this process is not as widely practiced as salting curd immediately before stretching, presumably because it is a more difficult process to set up in a commercial plant. Addition of salt before stretching has the potential to result in much greater moisture losses (e.g. $4\text{--}5 \text{ g } 100 \text{ g}^{-1}$) than when salting is accomplished by low temperature brining (e.g. $1\text{--}2 \text{ g } 100 \text{ g}^{-1}$) (Barbano *et al.*,

1994b). Therefore, the moisture content of the final cheese will be significantly lower unless steps are taken to produce a higher moisture curd at salting and/or improve the retention of salt. Improving salt retention results in less moisture loss in the form of salt whey and similar principles apply to retention of salt in pizza curd as in cheddar curd. Lower curd moisture, smaller curd particle dimensions at the milling step, addition of salt in two or more applications or using stirred curd in preference to milled curd contribute to improving salt retention. Dilute brine, at a similar concentration to the salt in moisture level in the pre-salted curd, is typically used in the mixer at the commencement of manufacture to prevent the salt in pre-salted curd from being washed out of the curd by the mixer water (Barbano *et al.*, 1994b). Furthermore, the mixer-operating conditions (i.e. auger speed and stretching water temperature) need to be carefully evaluated when salt is added before stretching because salting results in a tougher curd that generally requires a lower auger speed and/or higher temperature during stretching. Whether salt is added before or after the mixer, it is important to optimise the moulder operation because salted curd is tougher and more prone to resist fusion into a uniform block than unsalted curd.

9.3.7 Process control in pizza cheese manufacture

As mentioned elsewhere, precise control over all aspects of the manufacturing process is required in cheese plants of large capacity to ensure a consistent product that meets the expectations of the customer. Barbano (1999) identified the following parameters as critical to achieve consistent functionality:

- Good quality milk (low somatic cell and bacteria counts).
- Control of the casein (protein)-to-fat ratio and total level of protein in the milk. Standardising milk to a constant protein level by UF as well as a constant P/F ratio is almost universal in Australian cheesemaking plants particularly in light of the large seasonal variation in milk composition in the principal dairying areas. This practice has contributed to improvements in the consistency of cheese composition through improved consistency of manufacture (e.g. more consistent coagulum firmness at cutting and more consistent curd depth during cheddaring).
- Control of the pH at rennet addition and whey drainage. The pH levels at these points of manufacture essentially determine the calcium level in cheese, which in turn has a profound effect on the initial structure of the cheese as described in Sections 9.3.2 and 9.5.1.
- Control of the residence time and cheese temperature during and at the end of stretching.
- Control of the rate and final temperature of cooling after moulding. The thermal history of the curd during plasticising and cooling after moulding essentially determine the level of residual rennet activity and survival of the starter culture in the finished cheese, as described in Section 9.3.5.

The thermo-mechanical treatment received by the curd in the cooker/stretcher is a critical step in pizza cheese manufacture. Mulvaney *et al.* (1997) determined the mechanical energy consumed during the thermo-mechanical process and concluded that it is possible to manipulate the process to control the rheological and functional properties of pizza cheese,

while Yu and Gunasakaran (2005) demonstrated that the microstructure of the cheese, as determined by SEM, was strongly dependent on the thermo-mechanical treatment.

Attard and Sutherland (2002) determined the curd residence time by feeding alternate lots of coloured (using annatto) and uncoloured curd into a pilot-scale cooker/stretcher and measuring the colour distribution in the cheese. They used this method to show that curd exiting the cooker/stretcher stuck to the stainless steel outlet of the cooker/stretcher, causing large variations in the residence time. Teflon coating of the outlet overcame these variations (D.R. Attard & B.J. Sutherland, personal communication). While Yu and Gunasakaran (2004) developed a mathematical model to analyse viscous flow inside a deep-channel single-screw stretcher and suggested that this information could be used to develop new stretcher design and operation strategies to improve and control pizza cheese functionality and yield. In addition, Ferrari *et al.* (2002) redesigned the cooker/stretcher and moulding system to stretch and form the cheese in 5–10 g dimensions, with resultant savings in energy consumption and resources (e.g. equipment, water and time) and a ready-to-use product for the customer. They claimed a tenfold reduction in the cooling time.

9.3.8 Factors affecting cheese yield

Although the above discussion of pizza cheese manufacture has cited a number of factors relevant to cheese yield, a thorough discussion of factors affecting cheese yield is beyond the scope of the present chapter. The International Dairy Federation (IDF) has published extensive texts on factors affecting the yield of cheese (IDF, 1991, 1994, 2000). More specifically to pasta filata yield, Barbano (1996b) has described the factors to consider in maximizing yield of Mozzarella and has discussed a new yield formula for Mozzarella cheese. Barbano (1996b) also discussed the factors which influence fat, casein plus calcium phosphate and other milk solids recovery.

9.4 Microbiological, proteolytic and physicochemical properties

It is well established that pizza cheese made by traditional methods (i.e. with the use of starter culture) must undergo a brief period of ageing, typically 1–3 weeks at $\sim 4^{\circ}\text{C}$, to develop optimum functional characteristics (McMahon *et al.*, 1993; Kindstedt, 1993). During the 1990s, substantial progress was made towards understanding the microbiological, proteolytic and physicochemical properties that contribute to this functional transformation during ageing.

9.4.1 Microbiological properties

Microbiological evaluations of starter-free (e.g. directly acidified) Mozzarella cheese suggest that non-starter bacteria remain at negligible levels in pizza cheese when low bacterial count milk is used for cheesemaking and when the cheese is cooled rapidly after stretching (Barbano *et al.*, 1993). *S. thermophilus* and *Lb. delbrueckii* subsp. *bulgaricus* are able to survive the stretching process and remain viable during ageing, provided that the stretching temperature does not exceed the critical range, as discussed previously (Yun *et al.*, 1995a; Kindstedt

et al., 1995a). Thus, the microflora of pizza cheese is normally overwhelmingly dominated by the starter bacteria. However, exceptions may occur when the cheese milk contains high populations of non-starter bacteria and the cheese is subject to slow cooling after stretching, which may result in high populations of non-starter bacteria and the potential for soft body defect (Hull *et al.*, 1983; Ryan, 1984).

Viable starter bacteria in pizza cheese are proteolytically active during ageing and make important contributions to secondary proteolysis, as discussed in Section 9.4.2. The starter also continues to ferment lactose in the cheese in the first days after stretching, and residual lactose declines rapidly to negligible levels. In contrast, galactose is fermented very slowly and may persist for long periods in pizza cheese when *S. thermophilus* and *Lb. delbrueckii* subsp. *bulgaricus* are used as starter because of the poor ability of these organisms to ferment galactose (Hull *et al.*, 1983; Hutkins *et al.*, 1986; Johnson & Olson, 1985; Mukherjee & Hutkins, 1994). Galactose levels decline more rapidly when the starter includes *Lb. helveticus* (Johnson & Olson, 1985; Hickey *et al.*, 1986). Measurement of the TA of pizza cheese provides a simple means to evaluate total carbohydrate fermentation by the starter during ageing (Barbano *et al.*, 1994b). The TA of pizza cheese usually increases during ageing, except when a high stretching temperature is employed, in which case carbohydrate fermentation by the starter virtually ceases and TA values remain constant, presumably due to thermal inactivation of the starter (Yun *et al.*, 1994a; Kindstedt *et al.*, 1995a). The pH of pizza cheese may decrease, remain the same or increase during ageing, which has been a source of confusion in the industry. Comparison of pH and TA values during ageing may help to explain the variable behaviour of cheese pH. For example, in various controlled cheesemaking studies, it has generally been observed that decreases in cheese pH were accompanied by relatively large increases in TA during ageing (Barbano *et al.*, 1994b, 1995; Yun *et al.*, 1998). However, when TA increased only slightly or remained constant during ageing, cheese pH either remained constant or increased (Yun *et al.*, 1994a; Barbano *et al.*, 1995; Kindstedt *et al.*, 1995a). This suggests that the pH of pizza cheese will tend to decrease when there is rapid acid production by the starter (due to residual carbohydrate fermentation). However, when acid production is limited (e.g. if the starter is inactivated), other reactions that also occur during ageing which favour a rise in pH, such as proteolysis and possibly shifts in mineral distribution, evidently dominate and give rise to increasing cheese pH (Lucey & Fox, 1993). *Lb. delbrueckii* subsp. *bulgaricus* is a stronger acid producer at low pH than *S. thermophilus*. Therefore, it is likely that the former plays a dominant role in carbohydrate fermentation and TA increase in pizza cheese during ageing. The results of Yun *et al.* (1995a), who observed lower pH values during ageing in cheese that contained higher populations of *Lb. delbrueckii* subsp. *bulgaricus* and lower populations of *S. thermophilus* (but were otherwise similar in composition), support this view. Presumably, higher rod population resulted in greater carbohydrate fermentation and acid production and hence lower pH as ageing progressed. The rate of carbohydrate fermentation by *Lb. delbrueckii* subsp. *bulgaricus* during ageing is apparently strain dependent. Barbano *et al.* (1995) observed large differences in the pH and TA values of Mozzarella cheeses that were made using the same strain of *S. thermophilus* but different strains of *Lb. delbrueckii* subsp. *bulgaricus*, and which were otherwise similar in composition. Not surprisingly, cheese made with *Lb. helveticus* in the same study had the lowest pH and highest TA values, consistent with the superior ability of *Lb. helveticus* to ferment galactose.

9.4.2 *Proteolytic properties*

The initial breakdown of caseins to large peptides (i.e. primary proteolysis) in pizza cheese occurs primarily through the action of the coagulant on α_s -caseins when chymosin or *R. miehei* coagulant are used in cheesemaking and on both α_s - and β -caseins when *C. parasitica* coagulant is used (Barbano *et al.*, 1993; Yun *et al.*, 1993a; Dave *et al.*, 2003). Some evidence suggests that the starter culture may also hydrolyse intact β -casein to a small but significant extent during ageing (Barbano *et al.*, 1995). However, the principal contribution of the starter culture to casein breakdown occurs in the form of secondary proteolysis (i.e. the subsequent hydrolysis of primary peptides to smaller peptides and free amino acids). Thus, a proteolytic synergy occurs between the coagulant and the starter as it does in most other cheese varieties. For example, when the initial hydrolysis of intact caseins by the coagulant fails to occur (e.g. when the coagulant is inactivated during manufacture), the starter culture is severely restricted in its ability to form small peptides and amino acids (Barbano *et al.*, 1993). Conversely, when pizza cheese contains active coagulant but no active starter culture (e.g. in directly acidified Mozzarella), large peptides accumulate but few small peptides and amino acids are produced (Barbano *et al.*, 1993).

The rates of both primary and secondary proteolysis in pizza cheese can vary greatly depending on the proteolytic activity of the coagulant, the extent to which the coagulant and starter culture are heat inactivated during stretching, and the ripening temperature (Yun *et al.*, 1993a, 1994a; Kindstedt *et al.*, 1995a; Feeney *et al.*, 2001; Dave *et al.*, 2003). Proteolysis rate increases with increasing moisture content in the cheese and increasing storage temperature (Yun *et al.*, 1993c; Feeney *et al.*, 2001). The effect of cheese pH on proteolysis is more complex. Proteolysis does not appear to be affected by differences in cheese pH when Mozzarella cheese is made with starter culture and other aspects of composition are held constant (Yun *et al.*, 1993b, 1993c; Cortez *et al.*, 2002). In contrast, when Feeney *et al.* (2002) and Sheehan and Guinee (2004) used direct acidification and other manufacturing conditions to vary the pH of Mozzarella and reduced-fat Mozzarella cheeses, respectively (while holding moisture and calcium contents nearly constant), they observed that primary proteolysis decreased with increasing pH. However, the manufacturing conditions used by these investigators to vary the cheese pH may have introduced confounding factors, such as differences in residual rennet levels or degree of casein aggregation that influenced proteolysis and functional characteristics independent of the pH effect (Feeney *et al.*, 2002; Sheehan & Guinee, 2004). *Lb. delbrueckii* subsp. *bulgaricus* is far more proteolytic than *S. thermophilus*; therefore, it is not surprising that secondary proteolysis was substantially elevated in pizza cheese that contained a higher population of proteolytic rods, but was otherwise similar in composition (Yun *et al.*, 1995a). Substantial differences in proteolytic activity occur among strains of *Lb. delbrueckii* subsp. *bulgaricus*; therefore, the specific strain(s) of rod used in the starter culture can significantly affect secondary proteolysis in pizza cheese (Oberg & Broadbent, 1993; Barbano *et al.*, 1995).

9.4.3 *Physicochemical properties*

The physicochemical changes that take place during the first weeks after manufacture can be thought of as a gradual partial reversal of the abrupt changes in physicochemical state that occur when the curd is plasticised and stretched. During stretching, high curd temperature

strongly favours hydrophobic protein-to-protein interactions, which cause the *para*-casein matrix to aggregate and contract. This in turn triggers partial phase separation of protein and water within the curd structure (Pastorino *et al.*, 2002). The application of shearing forces to the heated curd then aligns the aggregated *para*-casein matrix into dense elastic fibres that are separated by channels containing free serum and fat globules (McMahon *et al.*, 1999). Cheese with lower fat content and thus greater volume fraction of the casein matrix forms thicker *para*-casein fibres with fewer inclusions of fat-serum channels between them (Merrill *et al.*, 1996; McMahon *et al.*, 1999), resulting in a firmer, less meltable cheese (as described in Section 9.5.3).

High stretching temperature also favours protein-to-calcium interactions (Pastorino *et al.*, 2002), which appear to be temperature dependent, as evidenced by lower calcium concentration in the serum phase of the cheese with increasing stretching temperature (Kindstedt *et al.*, 1995a). The resulting temperature-induced shift in calcium distribution from the soluble to casein-associated state presumably has the effect of strengthening protein-to-protein interactions and reinforcing the dense *para*-casein fibres through calcium cross-linking (Kindstedt *et al.*, 1995a; Pastorino *et al.*, 2002).

The formation of dense, highly cross-linked *para*-casein fibres that are interrupted by channels filled with free serum and fat globules results in newly manufactured cheese with poor water-holding capacity. The amount of expressible serum obtained by centrifugation under defined conditions (i.e. $12\,500 \times g$ for 75 min at 25°C) provides a useful measure of water-holding capacity (Guo & Kindstedt, 1995). Typically, about 20–30 g 100 g^{-1} of the total moisture content of pizza cheese can be expressed by centrifugation during the first few days after manufacture, but levels usually decrease to zero within 2 weeks of ageing at 4°C, due to increased water-holding capacity. During this brief period of ageing, the composition of the expressible serum changes considerably, with notable increases in calcium concentration and levels of intact (i.e. un-hydrolysed) casein (Guo & Kindstedt, 1995; Guo *et al.*, 1997; Kindstedt & Guo, 1998).

Thus, a partial reversal of protein-to-protein (hydrophobic) and protein-to-calcium interactions occurs during ageing as both casein molecules and casein-associated calcium ions dissociate from the *para*-casein fibres (Kindstedt & Guo, 1998). Concomitantly, protein–water interactions increase through NaCl-mediated solvation of the *para*-casein fibres (Guo *et al.*, 1997; Paulson *et al.*, 1998). At the microstructural level, these changes can be observed by SEM or CLSM as swelling of the *para*-casein fibres (Auty *et al.*, 1998, 2001; McMahon *et al.*, 1999; Guinee *et al.*, 2002). Swelling and the accompanying decreases in protein-to-protein interactions and calcium cross-linking progressively weaken the *para*-casein fibres, thereby triggering the transformation to a softer and less elastic (un-melted) cheese that melts to a more flowable and stretchable consistency (Metzger *et al.*, 2001b; Guinee *et al.*, 2002).

It is also important to note that structural and functional changes during ageing are strongly influenced by the total calcium content and pH of the cheese. Reducing the total calcium content of the cheese (while holding the pH constant) results in more swollen, hydrated *para*-casein fibres immediately after stretching and during subsequent ageing, which gives rise to a softer (un-melted) cheese with a more flowable and stretchable melted consistency (Metzger *et al.*, 2001a; Guinee *et al.*, 2002). Reducing the cheese pH (while holding total calcium content constant) causes calcium to shift from the casein-associated to soluble state, which results in a softer (un-melted) cheese with a more flowable and stretchable melted consistency, provided the pH does not fall below about 5.0 (Kindstedt *et al.* 2001; Guinee

et al., 2002). Subsequent studies that used various experimental conditions to alter cheese calcium content and/or cheese pH have supported these findings (Pastorino *et al.* 2003; Joshi *et al.*, 2003, 2004; Sheehan & Guinee, 2004).

9.4.4 *Functionality changes during storage*

Newly manufactured pasta filata/pizza cheese made with starter culture generally melts to a tough and fibrous consistency with limited ability to flow and stretch. The young cheese typically dehydrates during pizza baking, often resulting in case hardening and scorching of the cheese shreds. Such cheese generally requires from 1 to 3 weeks of refrigerated ageing to develop desirable melt and stretch on pizza. Physicochemical changes (as described in Section 9.4.3) are a major driving force behind this functional development (Kindstedt *et al.*, 2004). Proteolysis also contributes to the striking functional transformation that occurs during this brief but necessary period of ageing, although the effects of proteolysis and physicochemical changes usually occur concomitantly and are thus confounded and difficult to measure independent of one another. Guinee *et al.* (2001) found that the melt time and apparent viscosity of low moisture Mozzarella decreased and the flowability increased during ageing when the storage temperature was increased from 0 to 15°C. Overall, functionality changes were accelerated as storage temperature was increased, which they attributed to concomitant increases in the hydrolysis of intact caseins. The degree to which particular coagulants affect functional properties by their proteolytic action has been relatively well studied (Yun *et al.*, 1993a; Dave *et al.*, 2003). However, Yun *et al.* (1993a) found that Mozzarella cheese made with *C. parasitica* coagulant had greater meltability and released more free-oil upon melting than cheese made with *R. miehei* protease or pure chymosin, which they attributed to greater breakdown of β -casein in cheese made with *C. parasitica* coagulant. Consistent with this, Dave *et al.* (2003) reported that Mozzarella cheese made with *C. parasitica* coagulant had greater meltability than cheese made with chymosin, and they observed that meltability was more strongly correlated to the hydrolysis of β -casein than of α_s -casein. The amount of residual coagulant would also be expected to affect proteolysis during storage and thus the functional properties of Mozzarella cheese. Therefore, any manufacturing parameter which impacts upon residual coagulant activity in the final cheese should be considered; i.e. pH at whey drain, cooking temperature, stretching water temperature and residual time in the cooker/stretcher. Non-enzymatic browning of cultured Mozzarella cheese at high temperatures, such as during pizza baking, generally increases during ageing due in part to secondary proteolysis by the starter culture. In contrast, browning in directly acidified Mozzarella is very limited due to absence of secondary proteolysis products of starter culture origin (Kindstedt *et al.*, 2004).

9.5 Non-traditional methods of manufacture

9.5.1 *Direct acidification*

In the 1960s, Breene *et al.* (1964) developed a procedure for making pizza cheese in which milk acidified with organic/inorganic acids replaced bacterial fermentation. Directly acidified pizza cheese was sufficiently different from cultured cheese that it was unable to establish

a large presence in the pizza cheese market. Research continued in this field (Keller *et al.*, 1974; Kim *et al.*, 1998; Paulson *et al.*, 1998) and a renewed interest in directly acidified pizza cheese emerged in the 1990s, due to the ability to produce higher moisture cheeses with unique properties, particularly its less structured mouth-feel when eaten, an attribute favoured in some Asian markets. Lower levels of colloidal calcium phosphate bound to the casein in directly acidified pizza cheese contribute to the less structured mouth-feel.

Care needs to be taken with the choice of acid when making this type of cheese as some acids are strong chelators and cause curd demineralisation (Keller *et al.*, 1974). The optimum pH for stretching of directly acidified cheese is higher than for cultured cheeses and depends on the acidulant used, indicating that curd demineralisation takes place at a higher pH. Milk temperature during acidification is generally around 4°C, but vigorous mixing of the acid with the milk at higher temperatures is possible and more convenient for commercial-scale manufactures. Higher moisture levels are possible in directly acidified cheese as the time and temperature constraints imposed by use a starter culture do not apply. Furthermore, directly acidified pizza cheese generally has a softer body and melt characteristics (than pizza cheese made with cultures) during the first weeks after manufacture. Therefore, directly acidified pizza cheese may require less (or no) ageing to attain desirable functionality.

9.5.2 Cheese blends

Pizza makers are increasingly making use of shredded cheese blends consisting of pizza cheese and other fuller flavoured and/or lower cost shredded cheese types. Not surprisingly, the addition of non-pasta filata cheeses to pizza cheese has an effect on the functional properties of the blend. The functional properties of the blend lie between the individual cheese properties depending on the ratio (Kiely *et al.*, 1992). Thus, it is possible to tailor-make a blend by adding a non-pizza cheese to the blend with the desired characteristics, whether it is increased flavour, reduced cost, or a variation of the functional properties.

9.5.3 Low-fat pizza cheese

Considerable research conducted on the manufacture of low-fat pizza cheeses in the 1990s has continued in response to market demand for reduced/low-fat foods (Tunick *et al.*, 1991, 1993, 1995; Merrill *et al.*, 1994). Rudan *et al.* (1999) progressively reduced the fat content of pizza cheese from 25 to 5 g 100 g⁻¹, using the same make procedure, and found that reduced fat levels resulted in significantly decreased moisture in the non-fat substance, melt, opacity of the un-melted cheese, decreased free-oil levels and significant increases in the levels of TPA hardness. Furthermore, Pizza bakes suggested that the minimum amount of fat required for pizza cheese to function properly during pizza baking was between 10 and 15 g fat 100 g⁻¹. The low-fat pizza cheese (5 g fat 100 g⁻¹) showed limited melt and fusion of the shreds, while the high degree of scorching of individual shreds and lack of blister formation gave the pizza an atypical burnt appearance. These data are consistent with Rudan and Barbano's (1998a) postulate that the undesirable functional characteristics of low- and non-fat pizza cheese are due, in part, to the lack of free-oil release during baking, which allows the casein matrix to dehydrate, leading to excessive browning and limited meltability.

The application of a thin, hydrophobic surface coating, such as a vegetable oil (~ 0.9 g fat 100 g⁻¹ of cheese) to shreds of low- and reduced-fat pizza cheese, acted as a physical barrier to dehydration and resulted in similar melt and browning properties to full-fat pizza cheese (Rudan & Barbano, 1998a). While the application of the surface coating improved the appearance of the melted cheese, the post-melt mouth-feel remained excessively tough and chewy.

Metzger & Barbano (1999) developed a novel method to measure the level of post-melt chewiness of pizza cheese by blending a sample of cheese with water in a laboratory stomacher (typically used to prepare cheese samples for microbiological analysis) and passing the slurry through a stack of sieves. For non-chewy cheese, a large percentage of cheese was broken into small pieces and passed through the sieves. The opposite was the case for chewy cheese.

Metzger *et al.* (2000, 2001b, 2001a) evaluated the effect of pre-acidifying milk to pH 6.0 or 5.8 with acetic or citric acid on the post-melt chewiness of low-fat pizza cheese. Pre-acidification with citric acid to a pH of 5.8 resulted in the most calcium being lost from the milk and was the most effective treatment for reducing the levels of TPA hardness, apparent viscosity and post-melt chewiness. Indeed, the TPA hardness and apparent viscosity levels for the low-fat pizza cheese after 2 days storage at 4°C were comparable to the levels for normal-fat pizza cheese after 30 days storage at 4°C.

McMahon and Oberg (2000) described the production of a fat-free or low-fat pizza cheese with excellent melting properties in the fresh cheese by a direct acidification method, preferably with GDL added part way through cheesemaking.

Perry *et al.* (1997, 1998) identified various strategies including higher milk pasteurising temperature, pre-acidification to a pH of 6.0, use of fat replacers and the use of exopolysaccharide (EPS) starter cultures to increase the moisture content of low-fat pizza cheese to improve the melt of the cheese. While EPS cultures resulted in increased moisture levels of about 2 g 100 g⁻¹ and increased melt as determined by an objective melt test, the use of these cheeses in pizza bakes were not reported. However, a novel approach to controlling the texture and functionality of low-fat pizza cheese is to add emulsifying salts typically used in processed cheese manufacture (e.g. trisodium citrate), at the salting step for dry-salted pizza cheese, as demonstrated by Mizuno and Lucey (2005).

Rudan *et al.* (1998) reported that the low level of opacity of un-melted low-fat pizza cheese could be significantly improved by homogenising the cream (e.g. 20 g fat 100 g⁻¹) at 13.8 MPa first stage and 3.45 MPa second stage before incorporating the cream into the cheese milk. Similar homogenisation conditions for the cheesemaking milk resulted in excessive curd smashing during cheesemaking. Interestingly, there was little correlation between the objective melt test and melt on a pizza bake for the low-fat cheeses in this trial, raising speculation that an objective melt test may be of little value for predicting the melt properties of low-fat pizza cheese on pizza.

9.5.4 *Imitation (analogue) pizza cheese*

Pizza cheese appears to be the dominant type of cheese analogue produced worldwide, and their production is comprehensively discussed in two recent reviews of cheese analogues

(Bachmann, 2001; Guinee *et al.* 2004). Typically, the protein ingredients in cheese analogues include rennet caseins, caseinates and/or more recently, milk protein sources from filtration technologies combined with milk fat and/or vegetable oils as the fat source. The ingredients are generally combined with emulsifying salts using process cheese manufacturing methods, resulting in a more stable product than natural cheese. Extruders have also been used to impart specific characteristics in the analogue pizza cheese. While the use of vegetable oils appears well established, the substitution of casein with vegetable protein appears to be more problematic, due to a combination of flavour and texture defects.

Ennis & Mulvihill (1999, 2001) investigated both the variability of commercial rennet caseins in pizza cheese analogues and the variability of rennet caseins manufactured from seasonal milks. They developed a model to predict the performance of rennet caseins in analogues and found that caseins prepared from mid-lactation milks generally performed better in pilot-scale analogue manufacture than caseins prepared from early- and late-lactation milks. Further studies by O'Sullivan & Mulvihill (2001) suggested that variations in heat treatment of skimmed milk prior to rennet casein manufacture or variations during rennet casein manufacture may influence its performance in pizza cheese analogue performance. Mounsey & O'Riordan (2001) investigated the partial substitution of rennet casein with a range of vegetable starches and concluded that rice starch appears to have the greatest potential.

9.5.5 Processed pizza cheese

Rizvi *et al.* (1999) have patented a method of preparing processed pizza cheese that does not require any ageing or refrigeration during storage. The key to the method appears to be the use of an extruder to stretch and cook emulsified curd to establish an appropriate fibrous structure. According to Kapoor & Metzger (2008), the emulsifying salt, sodium aluminium phosphate, is becoming popular in the manufacture of rennet casein-based Mozzarella-type imitation process cheese varieties, since it provides desirable functional properties for imitation process cheese that is used to replace Mozzarella on frozen pizza.

References

- Ak, M.M. & Gunasekaran, S. (1997) Anisotropy in tensile properties of Mozzarella cheese. *Journal of Food Science*, **62**, 1031–1033.
- Anonymous (2003) *Dairy Processing Handbook*, 2nd and revised edition of G. Bylund (1995), Tetra Pak Processing Systems AB, Lund.
- Ardisson-Korat, A.V. & Rizvi, S.S.H. (2004) Vatless manufacturing of low-moisture part-skim Mozzarella cheese from highly concentrated skim milk microfiltration retentates. *Journal of Dairy Science*, **87**, 3601–3613.
- Arnott, D.R., Morris, H.A. & Combs, W.B. (1957) Effect of certain chemical factors on the melting quality of process cheese. *Journal of Dairy Science*, **40**, 957–963.
- Attard, D. & Sutherland, B.J. (2002) Transit time in a cooker/stretcher. *Australian Journal of Dairy Technology*, **57**, 167.
- Auty, M.A.E., Guinee, T.P., Fenelon, M.A., Twomey, M. & Mulvihill, D.M. (1998) Confocal microscopy methods for studying the microstructure of dairy products. *Scanning*, **20**, 202–204.

- Auty, M.A.E., Twomey, M., Guinee, T.P. & Mulvihill, D.M. (2001) Development and application of confocal scanning laser microscopy methods for studying the distribution of fat and protein in selected dairy products. *Journal of Dairy Research*, **68**, 417–427.
- Bachmann, H.P. (2001) Cheese analogues: a review. *International Dairy Journal*, **11**, 505–515.
- Barbano, D.M. (1986) Impact of seasonal variation in milk composition on Mozzarella cheese yields and composition. *Proceedings of the 23rd Annual Marschall Italian Cheese Seminar*, pp. 64–78, Madison.
- Barbano, D.M. (1996a) Product yield formulae: evaluation of plant efficiency and decision making for fortification. *Proceedings 1996 Marschall Italian Speciality Cheese Seminar*, pp. 25–34, Madison.
- Barbano, D.M. (1996b) Mozzarella cheese yield: factors to consider. *Proceedings Seminar on Maximizing Cheese Yield*, pp. 29–38, Centre for Dairy Research, Madison.
- Barbano, D.M. (1999) Controlling functionality of Mozzarella cheese through process control. *Proceedings Marschall Italian and Specialty Cheese Seminar*, pp. 1–7, Madison.
- Barbano, D.M., Chu, K.Y., Yun, J.J. & Kindstedt, P.S. (1993) Contributions of coagulant, starter, and milk enzymes to proteolysis and browning in Mozzarella cheese. *Proceedings of the 30th Annual Marschall Italian Cheese Seminar*, pp. 65–79, Madison.
- Barbano, D.M., Hong, Y., Yun, J.J., Larose, K.L. & Kindstedt, P.S. (1995) Mozzarella cheese: impact of three commercial culture strains on composition, yield, proteolysis and functional properties. *Proceedings of the 32nd Annual Marschall Italian Speciality Cheese Seminar*, pp. 41–55 Madison.
- Barbano, D.M., Yun, J.J. & Kindstedt, P.S. (1994a) Effect of stretching temperature and screw speed on Mozzarella cheese yield. *Proceedings of the 31st Annual Marschall Italian Cheese Seminar*, pp. 1–11, Madison.
- Barbano, D.M., Yun, J.J. & Kindstedt, P.S. (1994b) Mozzarella cheesemaking by a stirred-curd, no brine procedure. *Journal of Dairy Science*, **77**, 2687–2694.
- Barz, R.L. & Cremer, C.P. (1993) Process of making acceptable Mozzarella cheese without aging. **US Patent Application**, 5 200 216.
- Breene, W.M., Price, W.V. & Ernstrom, C.A. (1964) Manufacture of pizza cheese without starter. *Journal of Dairy Science*, **47**, 1173–1180.
- Brothersen, C. (1986) Application of external pH control in the manufacture of Italian cheese starter. *Proceedings of the 23rd Annual Marschall Italian Cheese Seminar*, pp. 6–24 Madison.
- Buss, F. (1991) Eleven causes of inaccurate pH measurement. *UW Dairy Pipeline*, **3**(4), 7–8 (Centre for Dairy Research and the University of Wisconsin, Madison).
- Chen, C.M., Jaeggi, J.J. & Johnson, M.E. (1996) Comparative study of pizza cheese made by stretched and non-stretched methods. *Journal of Dairy Science*, **79**(Suppl 1), 118.
- Cortez, M.A.S., Furtado, M.M., Gigante, M.L. & Kindstedt, P.S. (2002) Effect of post-manufacture modulation of cheese pH on the aging behavior of Mozzarella cheese. *Journal of Dairy Science*, **85**(Suppl 1), 256.
- Dave, R.I., Sharma, P. & McMahon, D.J. (2003) Melt and rheological properties of Mozzarella cheese as affected by starter culture and coagulating enzymes. *Lait*, **83**, 61–67.
- Ennis, M.P. & Mulvihill, D.M. (1999) Compositional characteristics of rennet caseins and hydration characteristics of the caseins in a model system as indicators of performance in Mozzarella cheese analogue manufacture. *Food Hydrocolloids*, **13**, 325–337.
- Ennis, M.P. & Mulvihill, D.M. (2001) Rennet caseins manufactured from seasonal milks: composition, hydration behaviour and functional performance in pilot scale manufacture of mozzarella cheese analogues. *International Journal of Dairy Technology*, **54**, 23–28.
- Farkye, N.Y., Kiely, L.J., Allshouse, R.D. & Kindstedt, P.S. (1991) Proteolysis in Mozzarella cheese during refrigerated storage. *Journal of Dairy Science*, **74**, 1433–1438.
- Feeney, E.P., Fox, P.F. & Guinee, T.P. (2001) Effect of ripening temperature on the quality of low moisture Mozzarella cheese. 1: Composition and proteolysis. *Lait*, **81**, 463–474

- Feeney, E.P., Guinee, T.P. & Fox, P.F. (2002) Effect of pH and calcium concentration on proteolysis in Mozzarella cheese. *Journal of Dairy Science*, **85**, 1646–1654.
- Fernandez, A. & Kosikowski, F.V. (1986) Hot brine stretching and molding of low-moisture Mozzarella cheese made from retentate-supplemented milks. *Journal of Dairy Science*, **69**, 2551–2557.
- Ferrari, E., Gamberi, M., Manzini, R., Pareschi, A., Persona, A. & Regattieri, A. (2002) Redesign of the Mozzarella cheese production process through development of a micro-forming and stretching extruder system. *Journal of Food Engineering*, **59**, 13–23.
- Garem, A., Schuck, P. & Maubois, J.L. (2000) Cheesemaking properties of a new dairy-based powder made by a combination of microfiltration and ultrafiltration. *Lait*, **80**, 25–32.
- Geurts, T.J., Walstra, P. & Mulder, H. (1972) Brine composition and the prevention of the defect 'soft rind' in cheese. *Netherlands Milk and Dairy Journal*, **26**, 168–179.
- Guinee, T.P. & Fox, P.F. (1993) Salt in cheese: physical, chemical and biological aspects. *Cheese: Chemistry, Physics and Microbiology* (ed. P.F. Fox), vol. 1, 2nd edn, pp. 257–302, Chapman and Hall, London.
- Guinee, T.P., Carič, M. & Kaláb, M. (2004) Pasteurized processed cheese and substitute/imitation cheese products. *Cheese: Chemistry, Physics and Microbiology* (eds P.F. Fox, P.L.H. McSweeney, T.M. Cogan and T.P. Guinee), vol. 2, 3rd edn, pp. 349–394, Chapman and Hall, London.
- Guinee, T.P., Feeney, E.P. & Fox, P.F. (2001) Effect of ripening temperature on the quality of low moisture Mozzarella cheese. 2: Texture and functionality. *Lait*, **81**, 475–485.
- Guinee, T.P., Feeney, E.P., Auty, M.A.E. & Fox, P.F. (2002) Effect of pH and calcium concentration on some textural and functional properties of Mozzarella cheese. *Journal of Dairy Science*, **85**, 1655–1669.
- Guinee, T.P., Mulholland, E.O., Mullins, C. & Corcoran, M.O. (1997) Functionality of low-moisture Mozzarella cheese during ripening. *Proceedings of the 5th Cheese Symposium*, pp. 15–23, Teagasc, Dublin.
- Guo, M.R., Gilmore, J.A. & Kindstedt, P.S. (1997) Effect of sodium chloride on the serum phase of Mozzarella cheese. *Journal of Dairy Science*, **80**, 3092–3098.
- Guo, M.R. & Kindstedt, P.S. (1995) Age-related changes in the water phase of Mozzarella cheese. *Journal of Dairy Science*, **78**, 2099–2107.
- Harvey, J. (2006) Protein fortification of cheese milk using milk protein concentrate – yield improvement and product quality. *Australian Journal of Dairy Technology*, **61**, 183–185.
- Hickey, M.W., Hillier, A.J. & Jago, G.R. (1986) Transport and metabolism of lactose, glucose, and galactose in homofermentative lactobacilli. *Applied and Environmental Microbiology*, **51**, 825–831.
- Hicsasmaz, Z., Shippelt, L. & Rizvi, S.S.H. (2004) Evaluation of Mozzarella cheese stretchability by the ring-and-ball method. *Journal of Dairy Science*, **87**, 1993–1998.
- Hull, R.R., Roberts, A.V. & Mayes, J.J. (1983) The association of *Lactobacillus casei* with a softbody defect in commercial Mozzarella cheese. *Australian Journal of Dairy Technology*, **38**, 78–80.
- Hurley, M.J., O'Driscoll, B.M., Kelly, A.L. & McSweeney, P.L.H. (1999) Novel assay for the determination of residual coagulant activity in cheese. *International Dairy Journal*, **9**, 553–558.
- Hutkins, R., Halambeck, S.M. & Morris, H.A. (1986) Use of galactose-fermenting *Streptococcus thermophilus* in the manufacture of Swiss, Mozzarella and short-method Cheddar cheese. *Journal of Dairy Science*, **69**, 1–8.
- IDF (1991) *Factors Affecting the Yield of Cheese*, Special Issue 9301, International Dairy Federation, Brussels.
- IDF (1994) *Cheese Yield and Factors Affecting its Control*, Special Issue 9402, International Dairy Federation, Brussels.
- IDF (2000) *Practical Guide for Control of Cheese Yield*, Special Issue 0001, International Dairy Federation, Brussels.
- Johnson, M.E. & Olson, N.F. (1985) Non-enzymatic browning of Mozzarella cheese. *Journal of Dairy Science*, **68**, 3143–3147.

- Joshi, N.S., Muthukumarappan, K. & Dave, R.I. (2003) Effect of calcium on physicochemical properties of fat-free Mozzarella cheese. *Journal of Food Science*, **68**, 2289–2294.
- Joshi, N.S., Muthukumarappan, K. And Dave, R.I. (2004) Effect of calcium on microstructure and meltability of part skim Mozzarella cheese. *Journal of Dairy Science*, **87**, 1975–1985.
- Kapoor, R., & Metzger, L.E. (2008) Process cheese: scientific and technological aspects – a review. *Comprehensive Reviews in Food Science and Food Safety*, **7**, 194–214.
- Keller, B., Olson, N.F. & Richardson, T. (1974) Mineral retention and rheological properties of Mozzarella cheese made by direct acidification. *Journal of Dairy Science*, **57**, 174–180.
- Kiely, L.J., McConnell, S.L. & Kindstedt, P.S. (1992) Melting behaviour of Mozzarella and non-Mozzarella cheese blends. *Cultured Dairy Products Journal*, **27** (2), 24–29.
- Kim, J., Schmidt, K.A., Phebus, R.K. & Jeon, I.K. (1998), Time and temperature of stretching as critical control points for *Listeria monocytogenes* during production of Mozzarella cheese. *Journal of Food Protection*, **61**, 116–118.
- Kindstedt, P.S. & Guo, M.R. (1998) A physicochemical approach to the structure and function of Mozzarella cheese. *Australian Journal of Dairy Technology*, **53**, 70–73.
- Kindstedt, P.S. & Kiely, L.J. (1992) Revised protocol for the analysis of melting properties of Mozzarella cheese by helical viscometry. *Journal of Dairy Science*, **75**, 676–682.
- Kindstedt, P.S. & Rippe, J.K. (1990) Rapid quantitative test for free-oil (oiling off) in melted Mozzarella cheese. *Journal of Dairy Science*, **73**, 867–873.
- Kindstedt, P.S. (1993) Effect of manufacturing factors, composition and proteolysis on the functional characteristics of Mozzarella cheese. *Critical Reviews in Food Science and Nutrition*, **33**, 167–187.
- Kindstedt, P.S., Caric, M. & Milanovic, S. (2004) *Pasta-Filata Cheeses in Cheese: Chemistry, Physics and Microbiology* (eds P.F. Fox, P.L.H. McSweeney, T.M. Cogan and T.P. Guinee), vol. 2, 3rd edn, pp. 251–277, Chapman and Hall, London.
- Kindstedt, P.S., Duthie, C.M. & Farkye, N.Y. (1990) Diffusion phenomena in brine salted Mozzarella cheese. *Journal of Dairy Science*, **73**(Suppl 1), 81.
- Kindstedt, P.S., Guo, M.R., Viotto, W.H., Yun, J.J. & Barbano, D.M. (1995a) Effect of screw speed and residence time at high stretching temperature on composition, proteolysis, functional properties and the water phase of Mozzarella cheese. *Proceedings of the 32nd Annual Marschall Italian Speciality Cheese Seminar*, pp. 56–72, Madison.
- Kindstedt, P.S., Kiely, L.J. & Gilmore, J.A. (1992) Variation in composition and functional properties within brine-salted Mozzarella cheese. *Journal of Dairy Science*, **75**, 2913–2921.
- Kindstedt, P.S., Kiely, L.J., Barbano, D.M. & Yun, J.J. (1993) Impact of whey pH at draining on the transfer of calcium to Mozzarella cheese. *Cheese Yield and Factors Affecting its Control*, Special Issue 9402, pp. 29–34, International Dairy Federation, Brussels.
- Kindstedt, P.S., Larose, K.L., Gilmore, J.A. & Davis, L. (1996) Distribution of salt and moisture in Mozzarella cheese with soft surface defect. *Journal of Dairy Science*, **79**, 2278–2283.
- Kindstedt, P.S., Yun, J.J., Barbano, D.M. & Larose, K.L. (1995b) Mozzarella cheese: impact of coagulant concentration on chemical composition, proteolysis and functional characteristics. *Journal of Dairy Science*, **78**, 2591–2597.
- Kindstedt, P.S., Zielinski, A., Almena-Aliste, M. and Ge, C. (2001) A post-manufacture method to evaluate the effect of pH on mozzarella cheese characteristics. *Australian Journal of Dairy Technology*, **56**, 202–207.
- Kosikowski, F.V. & Mistry, V.V. (1997) *Cheese and Fermented Milk Foods*, Vol. 1 and 2, 3rd edn, L.L.C., Westport.
- Lawrence, R.C., Creamer, L.K. & Gilles, J. (1987) Texture development during cheese ripening. *Journal of Dairy Science*, **70**, 1748–1760.
- Lelievre, J. (1995) Whey proteins in cheese: an overview, in *Chemistry of Structure-Function Relationships in Cheese* (eds E.L. Malin and M.H Tunick), pp. 359–365, Plenum Press, New York.

- Lilbaek, H.M., Broe, M.L., Hoier, E., Fatum, T.M., Ipsen, R. & Sorensen, N.K. (2006) Improving the yield of Mozzarella cheese by phospholipase treatment of milk. *Journal of Dairy Science*, **89**, 4114–4125.
- Lucey, J.A. & Fox, P.F. (1993) Importance of calcium and phosphate in cheese manufacture: a review. *Journal of Dairy Science*, **76**, 1714–1724.
- Matzdorf, B., Cuppett, S.L., Keeler, L. & Hutkins, R.W. (1994) Browning of Mozzarella cheese during high temperature baking. *Journal of Dairy Science*, **77**, 2850–2853.
- Maubois J.-L. (1997) Current uses and future perspectives of MF technology in the dairy industry. *Implications of Microfiltration on Hygiene and Identity of Dairy Products – Genetic Manipulation of Dairy Cultures*, Document No. 320, pp. 37–40, International Dairy Federation, Brussels.
- McCoy, D.R. (1997) Italian type cheeses. *Cultures for the Manufacture of Dairy Products*, pp. 75–83, Chr Hansen Inc., Milwaukee.
- McMahon, D.J. & Oberg, C.J. (2000) Manufacture of lower-fat and fat-free pizza cheese. **US Patent Application**, 6 113 953.
- McMahon, D.J., Fife, R.L. & Oberg, C. (1999) Water partitioning in mozzarella cheese and its relationship to cheese meltability. *Journal of Dairy Science*, **82**, 1361–1369.
- McMahon, D.J., Oberg, C.J. & McManus, W. (1993) Functionality of Mozzarella cheese. *Australian Journal of Dairy Technology*, **48**, 99–104.
- Merrill, R.K., Oberg, C.J. & McMahon, D.J. (1994) A method for manufacturing reduced fat Mozzarella cheese. *Journal of Dairy Science*, **77**, 1783–89.
- Merrill, R.K., Oberg, C.J., McManus, W.R., Kalab, M. and McMahon, D.J. (1996) Microstructure and physical properties of a reduced fat mozzarella cheese made using *Lactobacillus casei* ssp. *casei* adjunct culture. *Lebensmittel-Wissenschaft und Technologie*, **29**, 721–728.
- Metzger, L.E. & Barbano, D.M. (1999) Measurement of post melt chewiness of Mozzarella cheese. *Journal of Dairy Science*, **82**, 2274–2279.
- Metzger, L.E., Barbano, D.M., Kindstedt, P.S. & Guo, M.R. (2000) Effect of milk preacidification on low fat mozzarella cheese. 1. Composition and yield. *Journal of Dairy Science*, **83**, 648–658.
- Metzger, L.E., Barbano, D.M. & Kindstedt, P.S. (2001a) Effect of milk preacidification on low fat mozzarella cheese. 3: Post-melt chewiness and whiteness. *Journal of Dairy Science*, **84**, 1357–1366.
- Metzger, L.E., Barbano, D.M., Kindstedt, P.S. & Guo, M.R. (2001b) Effect of milk preacidification on low fat mozzarella cheese. 2: Chemical and functional properties during storage. *Journal of Dairy Science*, **84**, 1348–1356.
- Mizuno, R. & Lucey, J.A. (2005) Effects of two types of emulsifying salts on the functionality of non-fat pasta filata cheese. *Journal of Dairy Science*, **88**, 3411–3425.
- Mounsey, J.S. & O’Riordan, E.D. (2001) Characteristics of imitation cheese containing native starches. *Journal of Food Science*, **66**, 586–591.
- Mukherjee, K.K. & Hutkins, R.W. (1994) Isolation of galactose-fermenting thermophilic cultures and their use in the manufacture of low-browning Mozzarella cheese. *Journal of Dairy Science*, **77**, 2839–2849.
- Muliawan, E.B. & Hatzikiriakos, S.G. (2007) Rheology of mozzarella cheese. *International Dairy Journal*, **17**, 1063–1072
- Mulvaney, S., Rong, S., Barbano, D.M. & Yun, J.J. (1997) Systems analysis of the plasticization and extrusion processing of Mozzarella cheese. *Journal of Dairy Science*, **80**, 3030–3039.
- Muthukumarappan, K., Wang, Y.C. & Gunasekaran, S. (1999) Estimating softening point of cheeses. *Journal of Dairy Science*, **82**, 2280–2286.
- Nilson, K.M. (1968) Some practical problems and their solution in the manufacture of Mozzarella cheese. *Proceedings of the 5th Annual Marschall Italian Cheese Seminar*, pp. 1–7, Madison.
- Nilson, K.M. (1973) A study of commercial mixer-cookers and molders in use today. *10th Annual Marschall Italian Cheese Seminar*, pp. 1–6, Madison.

- O'Sullivan M.M. & Mulvihill, D.M. (2001) Influence of some physico-chemical characteristics of commercial rennet caseins on the performance of the casein in Mozzarella cheese analogue manufacture. *International Dairy Journal*, **11**, 153–163.
- Oberg, C.J. & Broadbent, J.R. (1993) Thermophilic starter cultures: another set of problems. *Journal of Dairy Science*, **76**, 2392–2406.
- Oberg, C.J., McManus, W.R. & McMahon, D.J. (1993) Microstructure of Mozzarella cheese during manufacture. *Food Structure*, **12**, 251–258.
- Oberg, C.J., Merrill, R., Brown, R.J. & Richardson, G.H. (1992a) Effects of milk-clotting enzymes on physical properties of Mozzarella cheese. *Journal of Dairy Science*, **75**, 669–675.
- Oberg, C.J., Merrill, R.K., Brown, R.J. & Richardson, G.H. (1992b) Effects of freezing, thawing and shredding on low-moisture, part-skim Mozzarella cheese. *Journal of Dairy Science*, **75**, 1161–1166.
- Oberg, C.J., Merrill, R., Moyes, L.V., Brown, R.J. & Richardson, G.H. (1991) Effect of *Lactobacillus helveticus* cultures on physical properties of Mozzarella cheese. *Journal of Dairy Science*, **74**, 4101–4107.
- Papadatos, A., Neocleous, M., Berger, A.M. & Barbano, D.M. (2003) Economic feasibility evaluation of microfiltration of milk prior to cheesemaking. *Journal of Dairy Science*, **86**, 1564–1577.
- Park, J., Rosenau, J.R. & Peleg, M. (1984) Comparison of four procedures of cheese meltability evaluation. *Journal of Food Science*, **49**, 1158–1162.
- Pastorino, A.J., Dave, R.I., Oberg, C.J. & McMahon, D.J. (2002) Temperature effect of structure-opacity relationships of non-fat Mozzarella cheese. *Journal of Dairy Science*, **85**, 2106–2113.
- Pastorino, A.J., Ricks, N.P., Hansen, C.L. & McMahon, D.J. (2003) Effect of calcium and water injection on structure-function relationships of cheese. *Journal of Dairy Science*, **86**, 105–113.
- Paulson, B.M., McMahon, D.J. & Oberg, C.J. (1998) Influence of sodium chloride on appearance, functionality and protein arrangements in non-fat Mozzarella cheese. *Journal of Dairy Science*, **81**, 2053–2064.
- Perry, D.B., McMahon, D.J. & Oberg, C.J. (1997) Effect of exopolysaccharide-producing cultures on moisture retention in low-fat Mozzarella cheese. *Journal of Dairy Science*, **80**, 799–805.
- Perry, D.B., McMahon, D.J. & Oberg, C.J. (1998) manufacture of low fat Mozzarella cheese using exopolysaccharide-producing starter cultures. *Journal of Dairy Science*, **81**, 563–566.
- Reinbold, R.S., Ernstrom, C.A. & Hansen, C.L. (1992) Temperature, pH and moisture profiles during cooling of 290 kilogram stirred-curd Cheddar cheese blocks. *Journal of Dairy Science*, **75**, 2071–2082.
- Renda, A., Barbano, D.M., Yun, J.J., Kindstedt, P.S. & Mulvaney, S.J. (1997) Influence of screw speeds of the mixer at low temperature on characteristics of Mozzarella cheese. *Journal of Dairy Science*, **80**, 1901–1907.
- Rizvi, S.S.H., Shukla, A. & Srikiatden, J. (1999) *Processed Mozzarella Cheese*, **US Patent Application**, 5 925 398.
- Rowney, M., Roupas, P., Hickey, M. & Everett, D. (1999) Functionality of Mozzarella cheese: a review. *Australian Journal of Dairy Technology*, **54**, 94–102.
- Rudan, M.A. & Barbano, D.M. (1998a) A dynamic model for melting and browning of Mozzarella cheese during pizza baking. *Australian Journal of Dairy Technology*, **53**, 95–97.
- Rudan, M.A. & Barbano, D.M. (1998b) A model of Mozzarella cheese melting and browning during pizza baking. *Journal of Dairy Science*, **81**, 2312–2319.
- Rudan, M.A., Barbano, D.M., Yun, J.J. & Kindstedt, P.S. (1998) Effect of fat particle size (homogenization) on low fat Mozzarella cheese chemical composition, proteolysis, functionality, and appearance. *Journal of Dairy Science*, **81**, 2065–2076.
- Rudan, M.A., Barbano, D.M., Yun, J.J. & Kindstedt, P.S. (1999) Effect of fat reduction on chemical composition, proteolysis, functionality, and yield of mozzarella cheese. *Journal of Dairy Science*, **82**, 661–672.

- Ryan, J.J. (1984) Soft body Mozzarella. *Proceedings of the 21st Annual Marschall Italian Cheese Seminar*, pp. 97–101, Madison.
- Sheehan, J.J. & Guinee, T.P. (2004) Effect of pH and calcium level on the biochemical, textural and functional properties of reduced-fat Mozzarella cheese. *International Dairy Journal*, **14**, 161–172
- Sherbon, J.W. (1988) Physical properties of milk. *Fundamentals of Dairy Chemistry* (ed. N.P. Wong), 3rd edn, pp. 409–460, Van Nostrand Reinhold, New York.
- Smith R.M., Sorley A.G. & Kirkby M.W (2006) *Method and Apparatus to Produce a Pasta Filata Cheese*, World International Property Organisation Patent Application, WO 2006/026811 A2.
- Tunick, M.H., Mackay, K.L., Shieh, J.J., Smith, P.W., Cooke, P. & Malin, E.L. (1993) Rheology and microstructure of low-fat Mozzarella cheese. *International Dairy Journal*, **3**, 649–662.
- Tunick, M.H., Mackay, K.L., Smith, P.W. & Holsinger, V.H. (1991) Effects of composition and storage on the texture of Mozzarella cheese. *Netherlands Milk and Dairy Journal*, **45**, 117–125.
- Tunick, M.H., Malin, E.L., Smith, P.W. & Holsinger, V.H. (1995) Effects of skim milk homogenization on proteolysis and rheology of Mozzarella cheese. *International Dairy Journal*, **5**, 483–491.
- Upreti, P., Metzger, L. & Buhlmann, P. (2004) Glass and polymeric membrane electrodes for the measurement of pH in milk and cheese. *Talanta*, **63**, 139–148.
- Wang, Y.C., Muthukumarappan, K., Ack M.M. & Gunasekaran, S. (1998) A device for evaluating melt/flow characteristics of cheese. *Journal of Textural Studies*, **29**, 43–55.
- Wang, H. & Sun, D. (2003) Assessment of cheese browning affected by baking conditions using computer vision. *Journal of Food Engineering*, **56**, 339–345.
- Wendorff, W. & Johnson, M. (1991) Care and maintenance of salt brines. *Proceedings of the 28th Annual Marschall Italian Cheese Seminar*, pp. 63–69, Madison.
- Wendorff, W. (1996) Effect of standardizing on the characteristics of Mozzarella cheese. *Maximizing Cheese Yield*, pp. 39–45, Centre of Dairy Research, University Wisconsin, Madison.
- Yu, C. & Gunasakaran, S. (2004) Modeling of melt conveying in a deep-channel single-screw cheese stretcher. *Journal of Food Engineering*, **61**, 241–251.
- Yu, C. & Gunasakaran, S. (2005) A systems analysis of pasta filata process during Mozzarella cheese making. *Journal of Food Engineering*, **69**, 399–408.
- Yun, J.J., Barbano, D.M., Larose, K.L. & Kindstedt, P.S. (1994a) Effect of stretching temperature on chemical composition, microstructure, proteolysis and functional properties of Mozzarella cheese. *Journal of Dairy Science*, **77**(Suppl 1), 34.
- Yun, J.J., Barbano, D.M., Larose, K.L. and Kindstedt, P.S. (1998) Mozzarella cheese: impact of non-fat dry milk fortification on composition, proteolysis and functional properties. *Journal of Dairy Science*, **81**, 1–8.
- Yun, J.J., Barbano, D.M., Bond, E.F. & Kalab, M. (1994b) Image analysis method to measure blister size and distribution on pizza. *Proceedings of the 31st Annual Marschall Italian Cheese Seminar*, pp. 33–38, Madison.
- Yun, J.J., Barbano, D.M. & Kindstedt, P.S. (1993a) Mozzarella cheese: impact of coagulant type on chemical composition and proteolysis. *Journal of Dairy Science*, **76**, 3648–3656.
- Yun, J.J., Barbano, D.M. & Kindstedt, P.S. (1993b) Mozzarella cheese: impact of milling pH on chemical composition and proteolysis. *Journal of Dairy Science*, **76**, 3629–3638.
- Yun, J.J., Barbano, D.M., Kiely, L.J. & Kindstedt, P.S. (1995a) Mozzarella cheese: impact of rod to coccus ratio on chemical composition, proteolysis and functional characteristics. *Journal of Dairy Science*, **78**, 751–760.
- Yun, J.J., Barbano, D.M., Kindstedt, P.S. & Larose, K.L. (1995b) Mozzarella cheese: impact of whey pH at draining on chemical composition, proteolysis, and functional properties. *Journal of Dairy Science*, **78**, 1–7.

- Yun, J.J., Kiely, L.J., Barbano, D.M. & Kindstedt, P.S. (1993c) Mozzarella cheese: impact of cooking temperature on chemical composition, proteolysis and functional properties. *Journal of Dairy Science*, **76**, 3664–3673.
- Yun, J.J., Kiely, L.J., Kindstedt, P.S. & Barbano, D.M. (1993d) Mozzarella cheese: Impact of coagulant type on functional properties. *Journal of Dairy Science*, **76**, 3657–3663.
- Yun, J.J., Kiely, L.J., Kindstedt, P.S. & Barbano, D.M. (1993e) Mozzarella cheese: impact of milling pH on functional properties. *Journal of Dairy Science*, **76**, 3639–3647.

10 Eye Formation and Swiss-Type Cheeses

A. Thierry, F. Berthier, V. Gagnaire, J.R. Kerjean,
C. Lopez and Y. Noël

10.1 Introduction

10.1.1 Which kinds of cheese?

Emmental (Emmentaler) is the best-known Swiss-type cheese around the world and is referred to as Swiss cheese in the United States, Canada, Australia and New Zealand. In 2007, the revised definition of Emmental cheese by the Codex Alimentarius Commission of the Food and Agriculture Organisation (FAO) of the United Nations is as follows: *Emmental is a ripened hard cheese, usually manufactured as wheels and blocks of weights from 40 kg or more, adapted to various use conditions. The body of the cheese has an elastic texture, with regular cherry to walnut sized gas holes, or eyes. The activity of propionic acid bacteria is essential to eye formation* (FAO, 2007).

Emmental cheese is produced in many countries using different cheesemaking procedures, such as preliminary treatment of the milk, extent of mechanisation, curd-cooking temperature, starter cultures blend, weight and shape of the cheeses, and ripening/maturation conditions.

Historically, Emmental cheese was born in the mountain valley – Tal in German – of the River Emme in the Canton of Bern in Switzerland in the thirteenth century. In the past, Swiss cheesemakers would have disseminated the cheese recipe when they settled in different countries. In 2006, Emmental cheese was accepted as an Appellation d'Origine Contrôlée (AOC) product and was officially registered in Switzerland. However, its registration as a Protected Denomination of Origin at European level is under negotiation. The cheese is exclusively produced in Switzerland from raw cow's milk fed with hay and not silage, has a wheel shape with a natural rind and is ripened in traditional cellars. A minimum of 4 months of ripening time is required. A 12-month-old AOC Emmental cheese ripened in natural cellar is specially labelled as '*affiné en grotte*' (<http://www.emmentaler.ch>).

The 'Swiss-type cheese' designation is not defined at international level, and there is a lack of consensus regarding the cheese varieties to be included in this group (Reinbold, 1972; Mocquot, 1979; Steffen *et al.*, 1993; Martley & Crow, 1996; Kosikowski & Mistry, 1997; Grappin *et al.*, 1999; Fröhlich-Wyder & Bachmann, 2004). The term Swiss-type cheese is used to refer to hard or semi-hard cheeses with round regular eyes and propionic fermentation beside the lactic starter cultures. Hence, some authors include in this group some semi-hard cheeses from Northern Europe, such as Maasdammer (evolved from traditional Dutch cheeses), Jarlsberg in Norway, Grevéost in Sweden and Samsøe in Denmark (Steffen *et al.*, 1993; Røge, 1993). In all these cheeses, propionibacteria are present in large

numbers (Reinbold, 1972). Some other researchers consider Swiss-type cheeses as hard cheese varieties that are manufactured with a technology close to that of Emmental cheese, including a cooking stage $>50^{\circ}\text{C}$, the use of thermophilic lactic starter cultures that produce various degrees of gas holes (sometimes no eyes at all) and containing various strains of propionibacteria, such as Gruyère in Switzerland, Comté and Beaufort in France, Bergkäse in Austria, Appenzeller in Switzerland (Mocquot, 1979). However, some cheese varieties, such as Gouda-type cheese with eyes are due to the production carbon dioxide (CO_2) from citrate fermentation only, and they are classified into the Dutch-type cheese family and not into Swiss-type cheese family (Walstra *et al.*, 1993).

10.1.2 *Manufacture and chemical composition*

Emmental cheese is mainly manufactured from cow's milk, but buffalo's milk or mixtures of cow's and buffalo's milks can also be used (FAO, 2007). Curd-cooking temperature is commonly at 50°C , but other values are also approved by the Codex Alimentarius Commission standard. Flavour and texture properties of ready-for-consumption Emmental cheese result from a minimum of 2-month ripening time at temperature varying possibly between 10 and 25°C (FAO, 2007). In addition, Emmental cheese is obtained by microbial fermentation using: (a) thermophilic lactic acid producing bacteria for the primary (lactose) fermentation and (b) propionic acid producing bacteria for the secondary (lactate) fermentation. The curd/whey mixture is heated after cutting to a temperature significantly above the coagulation temperature, i.e. 30°C , and the cheese is manufactured and/or sold with or without a hard dry rind. Typical flavour is mild, nut-like and sweet, more or less pronounced. Minimum propionic acid content of ripened cheese is $150\text{ mg } 100\text{ g}^{-1}$ and minimum calcium content is $800\text{ mg } 100\text{ g}^{-1}$. The minimum fat-in-dry matter (FDM) content is $45\text{ g } 100\text{ g}^{-1}$, while the minimum dry matter depends on the FDM content, for example, cheeses with $45\text{--}50\text{ g FDM } 100\text{ g}^{-1}$ should have minimum dry matter of $60\text{ g } 100\text{ g}^{-1}$ (FAO, 2007). Besides propionic acid, many volatile compounds are considered to be major contributors in Emmental cheese flavour, such as short-chain fatty acids, mainly due to the activity of propionibacteria. Table 10.1 summarises the main features of Swiss-type cheeses.

10.1.3 *Scope of the present chapter*

Openness formation related to CO_2 gas production is a desirable feature in Emmental and other Swiss-type cheeses, but eye formation (e.g. openness is due to the production of gas) is also a defect in many cheese varieties. The production of CO_2 is related as an end product of propionic fermentation, but can also result from the activity of undesirable gas-producing microflora, such as coliforms, yeasts or clostridia. Defective open texture in cheese is due to undesirable gas production, often associated with undesirable tastes, for example, hydrogen resulting from the undesirable butyric acid fermentation by *Clostridium tyrobutyricum*; this aspect is not reviewed in this chapter.

This chapter focuses mainly on Emmental cheese, but most of the information is applicable to other hard and semi-hard cheese varieties with propionic fermentation. This

Table 10.1 Main features of Swiss-type cheese varieties.

	Emmental-type		Gruyère-type		Others	
Examples of cheese varieties	Emmental (Steffen <i>et al.</i> , 1993) Swiss cheese (Kosikowski & Mistry, 1997)		Gruyère (Steffen <i>et al.</i> , 1996) Comté (Grappin <i>et al.</i> , 1993) Berkäse (Jaros & Rohm, 1997) Beaufort (Chamba <i>et al.</i> , 1994)		Appenzeller (Steffen <i>et al.</i> , 1996) Jarlsberg (Rage, 1993)	
Lactic acid bacteria starters	←	←	← Thermophilic bacteria	←	←	
Heating temperature	←	←	50–60°C	←	<50°C	
Salting type	Brine		(Brine or dry) + smear		Brine (+ smear for Appenzeller)	
Ripening	2 months minimum (warm room at 19–24°C during 4–6 weeks)		Gruyère: 6 months (warm room at 18°C during 4–6 weeks) Comté: 4 months minimum (warm room at 16–18°C during 6–8 weeks) Beaufort: 7 months at 10–14°C (no warm room) Berkäse: 6 months at 13–15°C (no Warm room)		Appenzeller: 4–6 months at 10–14°C Jarlsberg: 3 months minimum (warm room at 20°C during 20 days)	
Main characteristics (approximate range)	(MNFDM 52 g 100 g ⁻¹ ; FDM 45 g 100 g ⁻¹) + ← (2.5–5 g kg ⁻¹) – ← (primary) – ← (0.5 g 100 g ⁻¹) + ← (many, large)		moisture/fat (MNFDM 54 g 100 g ⁻¹ ; FDM >48 g 100 g ⁻¹) propionic fermentation (<0.5 g kg ⁻¹) → – proteolysis (secondary) → + salt (1.5 g 100 g ⁻¹) → + eyes (no) → –			
Tentative rank	Emmental	Jarlsberg	Gruyère	Comté	Bergkäse	Beaufort-Appenzeller

MNFDM, moisture in non-fat dry matter; FDM, fat-in-dry matter.

review mainly deals with the development of desirable eye formation in hard and semi-hard cheeses associated with propionic fermentation and covers the global mechanisms of eye formation (Section 10.2), the role of bacteria in gas production (Section 10.3) and the changes of the texture and structure of the cheese (Section 10.4).

10.2 Open texture and eye formation

10.2.1 Gas production – a sign of quality

Eye (also referred to as openness) formation due to gas production is a major sign of the quality of Swiss-type cheeses. The openness properties (nature, size and number of gas holes) contribute to the typical feature of each cheese variety. The gas holes are normally round shaped and shiny eyes. The size of the eye varies widely, from large (1–3 cm in diameter) to small (0.5–1 cm in diameter), depending on the cheese variety, as well as number and spacing of eyes within the cheese (block or loaf or wheel). Emmental-type cheeses have many large eyes, Gruyère-type cheeses have a fewer small nut-sized eyes, while Beaufort usually has no eyes (blind).

Kosikowski & Mistry (1997) described in detail the defective openness of Swiss-type cheeses. Eye-shape defects are slits or cracks, checks, picks or splits. In excess, they result in difficult cheese slicing, which is not desirable for sale and prevents pre-packaging, though it is often associated with nice taste. Excessive number of eyes (overset) is undesirable, as well as too few eyes (underset) except for Beaufort, which is normally 'blind'. Defects concern also the appearance of eyes, with loss of shining lustre (dull and dead eyes) or crinkled nutshell eye surface (shell).

Eye formation in Swiss-type cheese is determined by CO₂ gas production, and the hole nucleation and growth in the protein matrix with appropriate mechanical and physico-chemical properties. Cohesion, elongation viscosity and fracture properties of Swiss-type cheese, which induce a soft and elastic texture, play a major role in openness formation. Physico-chemical properties, as defined by composition, determine the structural properties of the cheese and influence openness. Eye formation is a dynamic process, associated with textural changes in ripening time, and also with gradient phenomena (water, salt, enzyme activity) within the block/wheel of the cheese.

Limited number of studies have been dedicated to cheese openness despite the attention paid by the industry to this quality property. Early studies dealt with defective openness, especially slits. Keilling (1939) has focused on the role of acidification in slit formation of Comté cheese, while the role of fat has been dismissed. Reiner *et al.* (1949) attempted to apply a mechanical approach to explain slit formation in Comté cheese. Hettinga *et al.* (1974) studied the role of propionibacteria growth on split defect of Swiss cheese. Grillenberger & Busse (1978) measured higher levels of lactic and propionibacteria counts in Emmental cheeses with slits than those without slit, but they did not conclude on any causative relationship between the microflora level and the defect. More recently, White *et al.* (2003) evaluated starter cultures combinations to explain and reduce slits formation in Swiss-type cheese. Some studies dealt with CO₂ production. Flückiger (1980) measured the gas production and the rheological properties of ten Emmental cheeses for 5 months; he described the

different stages of openness formation. Methods of measurement of CO₂ content in cheese were reviewed extensively and critically by Girard and Boyaval (1994). Steffen *et al.* (1993) summarised the knowledge about Swiss-type cheeses. Grappin *et al.* (1993) discussed the conditions required for eye and slit formation in Comté cheese. Martley and Crow (1996) reviewed the role of microorganisms contributing to gas production and cheesemaking practices on cheese openness. Caccamo *et al.* (2004) tested image analysis to evaluate cheese openness.

Eye formation and gas production – Clark (1917) demonstrated that there is no direct link between the place of gas production and the place of eye formation, and suggested that the main conditions of openness were appropriate gas production, the presence of weak points ‘primers’, or nuclei, in the body of the cheese and an appropriate texture. As there is no relation between the place of gas production and the place of eyes, primers are the origin of the place of eyes. The nature of nuclei is still unknown.

In normal conditions, openness results from the production of gas, mainly CO₂ due to the fermentative activity of propionibacteria of the lactate during the ripening of Swiss-type cheeses (Hettinga & Reinbold, 1972; Flückiger, 1980; Martley & Crow, 1996). Gases other than CO₂ are present in cheese, originated from the residual air in milk and remaining during the cheesemaking process. If oxygen of this residual air is consumed by the starter cultures, nitrogen remaining in cheese (0.055–0.095 MPa) is critical to reach the overpressure required for eye formation in Dutch-type cheese (Akkerman *et al.*, 1989), but should not play a great role in Swiss-type cheese due to the high level of CO₂ being produced. Some production of hydrogen could also contribute to cheese openness.

Sources of CO₂ production other than propionic fermentation, even limited, are recognised. Carbon dioxide is already present in milk even in the udder ~0.40 mmol CO₂ 100 g⁻¹ and then decreases during cheesemaking (Flückiger, 1980). Before propionic fermentation in warm room, Emmental cheese would contain 10–15 mL CO₂ 100 g⁻¹, i.e. 4–6 mmol CO₂ 100 g⁻¹, possibly related to lactic fermentation because native milk flora and some starter cultures can produce CO₂. Amino acids decarboxylation, already pointed out by Flückiger (1980) as a possible source of gas, was identified as responsible for late slit formation in mature Dutch-type cheese made with selected starter strains (Zoon & Allersma, 1996).

Eye formation requires gas production both at a high rate and with a minimum level – CO₂ production of 1 L day⁻¹ in a 75 kg Emmental cheese wheel with rind at 23°C (warm room) does not cause eye formation because CO₂ diffusion is about 2 L day⁻¹. Opening occurs when the rate of CO₂ production in the cheese is over 2 L day⁻¹ (Clément, 1984a,b; Fröhlich-Wyder & Bachmann, 2004).

Carbon dioxide firstly diffuses within the cheese, then outside the cheese – Main gas production in the cheese starts during the growth of propionibacteria in warm ripening rooms and induces diffusion within the wheel/block then out of it. Flückiger (1980) measured 130–150 L 100 kg⁻¹ Swiss Emmental cheese during 5 months of ripening, with 70–80% of CO₂ produced in warm rooms. Similar results were observed in Emmental cheese during ripening for 50 days (Clément, 1984a,b); ~125 L of CO₂ were produced in 75 kg Emmental cheese with more than 95% was produced in warm ripening rooms. Both studies gave similar CO₂ gas distribution in the cheese: ~50% of the CO₂ was dissolved in the

cheese matrix, 15–20% within the holes, and 30% diffused through the rind, whose permeability would balance the gas sharing (Flückiger, 1980). The produced gas saturates the aqueous phase before eye formation starts. The rind or the packaging material used to wrap rindless cheeses forms a barrier to gas allowing the cheese body to open. The produced CO₂, estimated from either the consumed lactates or the produced volatile fatty acids by using the classical Fitz's equation (Fitz, 1878), have failed to reach the level measured in cheese; Flückiger (1980) already suggested another source of CO₂ production and questioned the overall CO₂ production in cheese, the metabolism of propionibacteria and the decarboxylation of amino acids. Currently published data does not give recent information about the production of CO₂ during ripening of Swiss-type cheese, but measuring methods are now available. Girard & Boyaval (1994) measuring the heterogeneity of CO₂ content in the cheese wheel by using a gas/solid chromatography analyser equipped with a thermal conductivity detector, suggested that local overpressure would induce eye growth from preliminary hole.

Flückiger (1980) demonstrated the effects of temperature, type of lactic starter cultures and relative humidity on the produced CO₂ and given off by Emmental cheese wheels. Gas production goes up then decreases slowly if the temperature of warm room remains steady. Rapid bacterial growth results in a higher gas production level. Recent knowledge about gas production through microbial fermentation is reported in the subsequent section.

Decreasing the temperature in the cold storage room drops the diffusion of CO₂ outside the cheese (Flückiger, 1980). Investigations with a limited number of Comté cheeses (C. Achilleos, E. Notz and Y. Noël, unpublished results) have confirmed that the eye formation and growth occur in the warm room, while the slit formation appears mainly in the cold room and possibly earlier at the very end of the warm room.

The solubility of CO₂ in Emmental cheese was estimated to 34 mmol kg⁻¹ at 12°C and ~36 mmol kg⁻¹ at 22°C (Flückiger, 1980); thus, with 60 mmol kg⁻¹, there is an oversaturation of CO₂ in Emmental (Pauchard *et al.*, 1980), inducing an overpressure of about 0.1–0.15 MPa to compare to an estimated overpressure of 0.02–0.06 MPa in the Dutch-type cheese Gouda (Akkerman *et al.*, 1989).

It is well known that lower relative humidity in ripening room induces drier rind of cheese, less permeable to gas transfer outside the wheel. Consequences on the balance between internal pressure and diffusion remain unclear, but it is known that relative humidity should not be too low to avoid or limit the risks of defective openness.

10.2.2 Eye formation

A nucleus is necessary for the eye formation (Clark, 1917). It could be an air bubble attached to a solid curd particle, but the nucleation is not yet clearly understood. The requirement is supported by several semi-empirical technical works:

- The classical monograph about Swiss cheese varieties (Reinbold, 1972);
- Light microscopy and digital image analyses of curd-granules from cheese slices (Rüegg & Moor, 1987);

- A study about defective openness in Dutch-type cheese (Akkerman *et al.*, 1989);
- A study of openness and split defects in Comté cheese (Berdagué & Grappin, 1989);
- Original observations of openness by using scanning electron microscopy (SEM) (Rousseau & Le Gallo, 1990);
- Technical ripening studies (Clément, 1984a,b).

Solid casein particles could induce local weakness (Kerjean & Roussel, 1991). Three types of nuclei, presumably in combination, could initiate the eye hole formation in the body of the cheese: (a) solid particles from milk or produced during ripening (e.g. crystals), (b) microbiological gas pockets produced during pressing and salting by heterofermentative LAB or at the beginning of ripening by amino acids decarboxylation (Rousseau & Le Gallo, 1990) and (c) brittle curd-grains junction (Clark, 1917). J.L. Bergère (INRA, personal communication) observed that using milk with reduced total microflora ('clean' milk) for cheesemaking induced less openness in cheeses, but adding test particles, such as wool strands, did not promote more openness in cheese. Cheesemakers also report that the introduction of draining-off under vacuum by reducing the residual air in cheese resulted in poor eye formation in final product; thus, control of vacuum limits, neither too low nor too high, allows better eye formation.

10.2.3 Cheese cohesion

Cheese mechanical properties must allow eye formation at the right time of quick gas production. Two conditions must be fulfilled: (a) a high resistance to breaking (fracture stress) and (b) a sufficient aptitude to flow (elongational viscosity) (Walstra, 1991). Both texture properties vary differently over ripening time, while elongational viscosity is depended on initial texture (mechanical properties), fracture stress quickly decreases during ripening.

10.3 Gas formation through propionic fermentation

10.3.1 Main sources of gas in Swiss-type cheeses

Propionic acid bacteria (PAB) have a predominant role in gas (CO₂) production. During the ripening at warm temperature (18–24°C), PAB grow and ferment the lactate produced by lactic acid starter cultures during the manufacturing stages to CO₂, acetate and propionate. The main features of this bacterial group are detailed in subsequent section. PAB metabolism is the main source of CO₂, but LAB activities can also result in an accumulation of CO₂ in cheese before PAB grow.

Among LAB, facultative heterofermentative lactobacilli were identified as CO₂ producers in Swiss-type cheeses (Martley & Crow, 1996). These heterofermentative lactobacilli are present in abundance in the different Swiss-type cheese varieties (Comté, Emmental and Bergkäse) where they have been investigated (Eliskases-Lechner *et al.*, 1999; Thierry *et al.*,

1999; Berthier *et al.*, 2001). The count of heterofermentative lactobacilli may reach up to 10^8 colony-forming units (cfu) g^{-1} in Swiss-type cheeses within the first week of ripening and before the PAB start to grow, regardless of the use of raw or pasteurised milk and of their addition or not as selected starter cultures. The main species in Swiss-type cheese are *Lactobacillus paracasei* and *Lactobacillus rhamnosus*.

Heterofermentative lactobacilli produce CO_2 from citrate and/or perhaps amino acids (Martley & Crow, 1996). Certain strains of lactobacilli, such as *Lb. paracasei* and *Lb. rhamnosus*, are able to use citrate, which increase the number of small eyes to the desired level in experimental Bergkäse cheese manufactured under controlled conditions without PAB, compared to heterofermentative lactobacilli strains that are unable to use citrate (Weinrichter *et al.*, 2004). All the citrate content present in the cheese matrix was metabolised into acetate, formate and CO_2 in the ratio of 2/1/1. About 10 mmol kg^{-1} of CO_2 was produced within a few weeks from the beginning of ripening.

Besides CO_2 gas production, other gases can be formed in the cheese. For example, hydrogen (H_2) production results from the growth of some undesirable *Clostridium* species, which ferment lactic acid to butyric acid, acetic acid, CO_2 and H_2 . The high yield of production of H_2 and its low solubility in water results in the formation of a blowing defect. The improvement of hygienic milk production, in particular for cows fed with silage – a reservoir of clostridia spores, and/or the elimination of spores by bacterofugation of micro-filtration of the milk helps to prevent the blowing defect. Ammonia (NH_3) gas may also be formed from the deamination of amino acids, but this phenomenon is not documented for Swiss-type cheeses.

10.3.2 Taxonomy, ecology and presence of PAB in cheese

PAB are classified, on the basis of 16S r-ribonucleic acid/deoxynucleic acid (rRNA/DNA) homology studies, in the class of Actinobacteria, which comprises high guanine plus cytosine (G+C) content of Gram-positive bacteria (Stackebrandt *et al.*, 1997). The genus *Propionibacterium* comprises two distinct groups from different habitats: firstly, strains typically found on human skin, referred to as the ‘acnes group’, and secondly, strains isolated from milk and dairy products, referred to as ‘dairy’ or ‘classical’ PAB strains. The dairy group of propionibacteria comprises four species, *Propionibacterium freudenreichii* spp., *Propionibacterium acidipropionici*, *Propionibacterium jensenii* and *Propionibacterium thoenii* (Cummins & Johnson, 1986) (<http://www.bacterio.cict.fr/>). Three propionibacteria species have been isolated from ‘new’ biotopes; they have been recently described as *Propionibacterium cyclohexanicum*, *Propionibacterium microaerophilum* and *Propionibacterium australiense*, and they were isolated from spoiled orange juice (Kusano *et al.*, 1997), olive mill wastewater (Koussemon *et al.*, 2001) and granulomatous bovine lesions (Bernard *et al.*, 2002), respectively. 16S rRNA gene sequence analysis has shown that *P. cyclohexanicum* and *P. australiense* are phylogenetically related to *P. freudenreichii* spp., whereas *P. microaerophilum* is related to *P. acidipropionici*. However, none of these three new species has been reported in dairy products. Dairy propionibacteria are generally enumerated in lactate-yeast extract-peptone containing media, incubated at 30°C under anaerobic condition

for at least 6 days. Genotypic methods are available to identify propionibacteria at the genus, species and strain levels, including polymerase chain reaction (PCR)-based methods (Meile *et al.*, 2007). The main phenotypic keys for their differentiation and detailed description of the different species characteristics are described in the Bergey's Manual (Cummins & Johnson, 1986).

PAB were first isolated from Emmentaler cheese at the beginning of the twentieth century by von Freudenreich and Orla-Jensen (von Freudenreich & Orla-Jensen, 1906). They are present in raw milk at populations ranging from 5 to more than 10^5 cfu mL⁻¹ (Carcano *et al.*, 1993; Thierry & Madec, 1995). The four dairy species of PAB are found in raw milk, with a prominence of *P. freudenreichii* (Fessler *et al.*, 1999b). *P. freudenreichii* grows in Swiss-type cheese during the ripening period in warm room (18–24°C), and reach populations as high as 5×10^9 cfu g⁻¹ cheese. *P. freudenreichii* is the main specie that grows in Swiss-type cheese, while *P. jensenii* is the main specie identified in Leerdammer cheese (Britz & Riedel, 1994).

The use of PAB as starter cultures is widespread in Swiss-type cheese manufacture. The inoculation level of PAB in cheese milk varies from 10^3 to 10^6 cfu mL⁻¹ milk, according to the technology of cheesemaking. When the count of PAB in 1-day-old cheese is below 5×10^2 cfu g⁻¹, brown spots defect may appear in Emmentaler cheese and also in Appenzeller, Sbrinz, Raclette and Tilsit cheeses (Baer *et al.*, 1993; Fessler *et al.*, 1999a). In some Swiss-type cheeses like Comté (in France), manufactured from raw milk, propionic fermentation is only due to the indigenous PAB microflora present in raw milk.

10.3.3 Metabolism of PAB

P. freudenreichii grows during ripening at warm temperature and ferments lactate to CO₂, acetate and propionate. Many carbohydrates can be metabolised by *P. freudenreichii*, but lactate is the main carbon source for PAB in cheese. Lactate is produced by the LAB in two isomeric forms: D(-)- and L(+)-lactate. The two lactate isomers compete for two transport systems, with an optimum activity at pH 6.0 and <4.0, respectively. Interestingly, lactate transport is still efficient at 0–2°C. Lactate is converted to pyruvate by two specific membrane-bound nicotinamide adenine dinucleotide (NAD)-independent L(+)- and D(-)-lactate dehydrogenases. Pyruvate can be metabolised through nine pathways in *Propionibacterium freudenreichii* subsp. *shermanii* (Deborde, 1998), which yield different ratio of end products including CO₂.

The stoichiometry of the conversion of lactate depends on the conditions and on the bacterial strain. According to Fitz's equation (Fitz, 1878), the molar ratio of propionate/acetate is 2.0 (Fig. 10.1, pathway 1). In this pathway, 1 mol of lactate is converted to acetate and CO₂ via the activity of pyruvate dehydrogenase, while 2 mol are converted into propionate via the Wood–Werkman cycle. In cheese, the ratio of propionate/acetate is lower than 2 (Crow & Turner, 1986). This can be explained by the occurrence of two other pathways: firstly, the fixation of CO₂ (Wood, 1981), which leads to the formation of succinate at the expense of propionate and CO₂ (Fig. 10.1, pathway 2), and secondly, the conversion of aspartate to succinate during lactate fermentation (Fig. 10.1, pathway 3) (Crow & Turner, 1986). The use of these different pathways modulates the yield in CO₂.

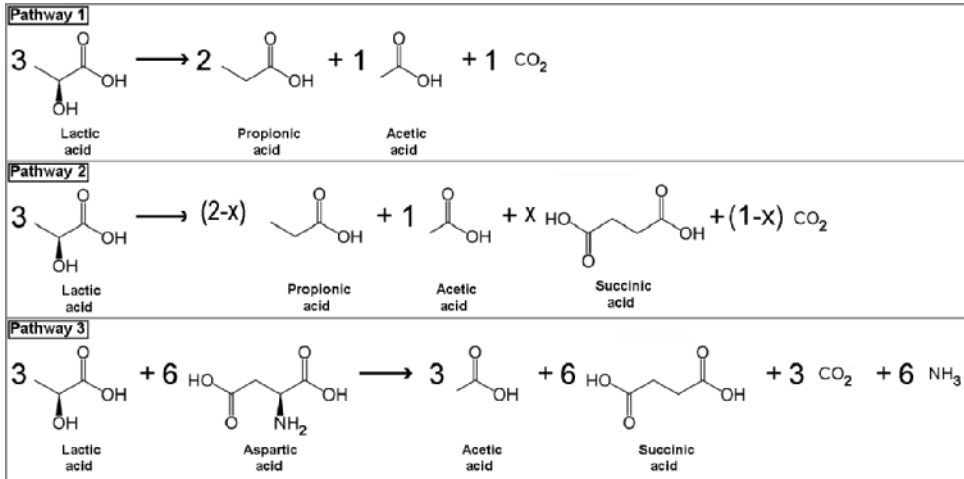

Fig. 10.1 Pathways of lactate conversion in *Propionibacterium freudenreichii* subsp. *freudenreichii*. (Adapted from Crow & Turner, 1986.)

The ability of *P. freudenreichii* subsp. *freudenreichii* to metabolise aspartate in the presence of lactate is strain dependent, and is an important criterion of choice of strains. Aspartate is converted to fumarate via an aspartase activity. Fumarate is then reduced to succinate, with a concomitant of adenosine triphosphate production (Crow, 1986). This pathway results in a greater proportion of the lactate being fermented to acetate and CO₂ rather than to propionate. Emmental cheese made with PAB starter cultures that have weak aspartase activity will contain greater concentration of residual lactate and consequently, lower concentrations of acetate and propionate resulting in the formation of smaller number and size of eyes than cheeses made with starter cultures with a strong aspartase activity (Wyder *et al.*, 2001). The concentrations of aspartate + asparagine were 6.7 and 0.7 mmol kg⁻¹ in 12-month-old Swiss Emmental cheeses made with PAB with weak and strong aspartate activity, respectively, and the corresponding concentrations of succinate of 5.1 and 17.7 mmol kg⁻¹ (Wyder *et al.*, 2001). In the same cheeses, the lactate concentrations were 47.0 and 11.3 mmol kg⁻¹, propionate concentrations of 63.2 and 83.6 mmol kg⁻¹, and acetate concentrations of 47.6 and 58.7 mmol kg⁻¹, respectively. Emmental cheeses made with PAB starter cultures with weak aspartase activity are also less prone to ‘late fermentation’, i.e. undesirable propionic fermentation that may occur during cold ripening, in particular in Emmental cheeses ripened for several months at 10–13°C. Moreover, as mentioned before, the production of CO₂ can also result from the activity of some other bacterial species present in cheese. The continuous variations in the nutritional and physicochemical environment of PAB cells along the ripening can also influence the different metabolic pathways used by the cells.

Several other strain-dependent abilities influence gas formation by PAB. The sensitivity of strains to salt concentration (Richoux *et al.*, 1998), their ability to grow or perform propionic fermentation at different temperatures (Hettinga *et al.*, 1974) and the strain-to-strain interactions with LAB.

10.3.4 Influence of LAB on propionibacteria

PAB grow in the curd, which has been greatly modified by the combined action of endogenous, added starter cultures and microbial enzymes, and can therefore be influenced by the LAB grown before PAB. Thermophilic lactic starter cultures (*Streptococcus thermophilus*, *Lactobacillus delbrueckii* subsp. *lactis* and/or *Lactobacillus helveticus*) grow in the curd during the pressing step, and non-starter lactic acid bacteria (NSLAB) grow over the first few weeks of ripening.

Many conflicting reports have been published regarding the influence of thermophilic LAB on the growth and fermentative action of PAB in cheese (Hettinga & Reinhold, 1972; Chamba, 1994). Several factors could be involved in this effect: (a) differences of pH at the end of the acidification stage, (b) the ratio of lactate isomers produced by lactic starter cultures and (c) the products of LAB proteolytic activity. Early studies showed that propionic fermentation was stimulated by *Lb. helveticus* compared with *Lb. delbrueckii* subsp. *lactis*. These results were explained by a higher proportion of L(+)-lactate in cheeses made with the former species, which produces L(+) and D(-) isomers, contrary to *Lb. delbrueckii* subsp. *lactis*, which produces only D(-)-lactate (Hettinga & Reinhold, 1972). In cheese assays combining several strains of lactic-propionic in pairs, *Lb. delbrueckii* subsp. *lactis* was found to enhance propionic fermentation compared to *Lb. helveticus* in all cases, with the level of propionate produced after 3 weeks up to four times higher with the former lactobacilli (Chamba, 1994). In the European project (FAIR No. 96-1024) dedicated to the study of the mechanisms of interactions between LAB and PAB, modified whey model was used. The main conclusions of this project were that the stimulation of PAB by LAB depended on (a) the particular pair of PAB and LAB used and (b) the production of several peptides by the LAB from casein (Condon & Cogan, 2000).

The influence of facultative heterofermentative lactobacilli on PAB in cheese has been studied by comparing cheeses with or without inoculation with selected strains of lactobacilli. The lactobacilli strains were able to use citrate and slowed down the growth of PAB and the production of propionic acid in experimental Swiss-type cheeses (Fröhlich-Wyder *et al.*, 2002; Weinrichter *et al.*, 2004). At the same time, the lactobacilli significantly increased the number of eyes observed at 40 days of ripening (mid-warm room) in the experimental Swiss-type cheese (i.e. due to production of CO₂) and decreased both the number and the size of eyes at 180 days of ripening showing a slow rate of propionic acid fermentation or growth inhibition of PAB (Fröhlich-Wyder *et al.*, 2002). The inhibitory effect shown in cheese with two strains of *Lactobacillus casei* and *Lb. rhamnosus* was observed in the cheese juice extracted from the product inoculated with the same NSLAB strains (Jimeno *et al.*, 1995). In the same study, Jimeno *et al.* (1995) reported that the inhibition could be due to the combined negative effect of copper (released in the aqueous phase of cheese as citrate is consumed) and of the products (formate, acetate and diacetyl) of citrate fermentation by NSLAB. Selected strains of *Lb. casei* and *Lb. rhamnosus* are currently used in Switzerland to limit the so-called late fermentation observed in Swiss Emmental cheese (Fröhlich-Wyder & Bachmann, 2004). With Swiss cheese made in the United States, White *et al.* (2003) observed that a proper combination of the *Lb. helveticus* and *P. freudenreichii* subsp. *shermanii* starter culture can reduce slits, especially in cheese with high moisture content.

In conclusion, the results obtained regarding the influence of LAB on PAB underline the complexity of the mechanisms involved, which are not fully elucidated. Numerous factors are involved and interact, and the interactions seem more strain- than species-dependent (Thierry *et al.*, 1999; Condon & Cogan, 2000). The influence of LAB is however likely to be less important than those due to differences in technological parameters (NaCl, ripening temperature) in cheeses.

10.3.5 Relationship between eye formation and flavour development

Swiss-type cheeses have a typical flavour described as ‘sweet’ and ‘nutty’ (Langsrud & Reinbold, 1973; Paulsen *et al.*, 1980). Flavour development and eye formation both occur during the ripening period, but are not directly related. This can be explained by several factors. Firstly, the formation of Swiss-type cheese flavour can occur in the absence of eyes, if all the conditions (appropriate rate and level of gas formation, limitation of the diffusion by the rind, appropriate cheese texture) are not right for eye formation. Secondly, the formation of gas mainly occurs during the ripening period in the warm room, whereas flavour compounds can be formed at different periods of cheese manufacture and ripening. Thirdly, gas formation is mainly due to the activity of PAB in Swiss-type cheeses, whereas the formation of some flavour compounds can result from the activity of other bacteria present in the cheese.

Gas production, inducing eye formation, is concomitant during ripening in warm room with the formation of propionic and acetic acids. These two volatile acids are considered as flavour-impact compounds in Emmental cheese, but many other volatile and non-volatile compounds are involved in the balanced Emmental cheese flavour. Other fatty acids with 4–12-carbon chain length are thought to play a role in Emmental flavour. Neutral volatile compounds like furanones (4-hydroxy-2,5-dimethyl-3(2*H*)-furanone, 5-ethyl-4-hydroxy-2-methyl-3(2*H*)-furanone), esters (ethylbutanoate, ethyl,3-methylbutanoate, ethylhexanoate), ketones (2,3-butanedione, 2-heptanone, 1-octen-3-one), aldehydes (3-methylbutanal, methional) and some other compounds (δ -d \acute{e} calactone, skatole, 2-sec-butyl-3-methoxy-pyrazine) are also considered as flavour-impact compounds in Emmental cheese (Preininger & Grosch, 1994; Preininger *et al.*, 1996; Rychlik *et al.*, 1997). In addition, some sapid compounds are involved in the basic cheese taste; they include organic acids (lactic and succinic acids), amino acids (especially glutamic acid) and minerals.

The formation of some flavour compounds can continue later during the ripening period. The intensity of odour, aroma, saltiness and sourness increased during ripening for 3–12 months in Emmental cheese (Fr \ddot{o} hlich-Wyder & Bachmann, 2004). For example, esters compounds showed the largest increase, followed by 2-heptanone and short-chain fatty acids (Rychlik *et al.*, 1997; Fr \ddot{o} hlich-Wyder & Bachmann, 2004). In small-scale (1/100) Swiss cheeses, ~20% of products of propionic acid fermentation were produced during the cold ripening period (8 weeks at 4°C), whereas ~60% of branched short-chain fatty acids originating from isoleucine/leucine catabolism, and ~80% of esters were produced over the same period (Thierry *et al.*, 2005). Ester compounds are thought to contribute to the ‘fruity’ note in Emmental cheese (Preininger & Grosch, 1994; Preininger *et al.*, 1996; Richoux *et al.*, 2008), and their presence has also been associated with the sweet odour of this cheese (Ben

Lawlor *et al.*, 2001). Short- and medium-chain fatty acids derived from lipolysis are also considered as important flavour compounds in Emmental cheese (Chamba & Perréard, 2002).

Propionibacteria have a dominant role in the formation of CO₂ and several flavour compounds, such as propionic and acetic acids, but also free fatty acids derived from lipolysis and branched-chain fatty acids linked with the metabolism of branched-chain amino acids (Thierry *et al.*, 2005). However, flavour compounds are also produced by the other bacteria present in Emmental cheese ecosystem, including non-starter microflora. Raw milk microflora contributes to the formation of a more intense overall aroma (Grappin *et al.*, 1999).

10.4 Cheese structure and eye formation

A good close-knit texture will allow eye formation and hole growth in Swiss cheese. Cheese cohesion is crucial and determined by mechanical properties, elongational viscosity and fracture stress, resulting from chemical composition (water, minerals, fat and protein) as well as proteolysis changes during ripening. Changes in mechanical properties during cheese ripening are major factors contributing to obtain the right openness instead of slit formation.

10.4.1 Mechanical properties and eye formation of cheese

Measurements applied to eye formation

Blanc and Hättenschwiler (1973) pioneered the measurement of growth of identified holes during ripening of Gruyère and Emmental with X-ray tomography and transmission. Later, Rousseau and LeGallo (1990) studied the nucleation of eye formation in Emmental cheese by using SEM. The spherical voids observed at the beginning of warm room ripening might be considered as potential nuclei because they increased in number during this period, but decreased later suggesting gas migration towards the biggest holes. Nuclear magnetic resonance (NMR) imaging, at high resolution, was explored by Rosenberg *et al.* (1992) to detect and evaluate eye features. Potentialities of this non-destructive technique were demonstrated by examining Swiss-type cheeses during ripening. Versatility of this spectroscopic technique results in further active research investigations (Duce *et al.*, 1995) to detect holes and cracks in cheese. Mahdjoud *et al.* (2003) investigated the curd junctions in the cheese matrix by using NMR, and they detected air pockets at early stage of ripening and also CO₂ micro-bubbles inside the curd granules in relation with microbial activities.

Measurement of mechanical properties

Rheology allows the measurement of cheese mechanical properties, which play a key role in eye formation. Compression testing is a simple way to measure these properties under controlled conditions. By using the test at the ripening temperature, the actual properties linked to eye formation can be evaluated, which gives information to better understand the phenomenon in relation with biochemical and microbiological changes. Relaxation testing (another rheological technique) gives mechanical response of cheese paste on long time scale, to explore properties of cheeses in relation with openness. Ultrasonic techniques are

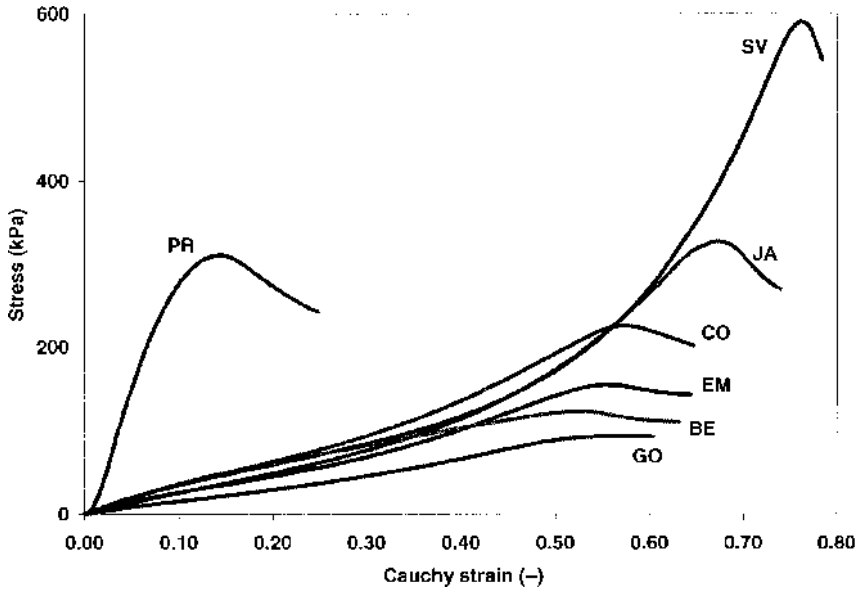

Fig. 10.2 Typical compression profiles obtained with Swiss-type cheeses (Emmental (EM) from Switzerland, Comté (CO) and Beaufort (BE) from France, Jarlsberg (JA) from Norway, Svenbo (SV) from Denmark), Parmigiano Reggiano (PR, from Italy) and a Dutch-type cheese (GO, from the Netherlands).

promising to overcome the destructive nature of sampling with rheology. Early investigations used a wide-angle low-frequency sensor to study cheese openness (Nassar *et al.*, 2004). Recently, Eskelinen *et al.* (2007) investigated with success ultrasonic technique (single-transducer 2-MHz longitudinal mode pulse-echo setup) to monitor the gas–solid structure of cheese during ripening, with the perspective of on-line monitoring.

Mechanical properties and eye formation

Swiss-type cheeses have elastic properties, high deformability (i.e. high fracture strain) and quite high fracture stress expressing high mechanical resistance. Their body is neither too soft nor too tough, and their mechanical properties are associated to high cohesion. Fig. 10.2 shows the compression profiles obtained with different hard cheeses with or without eyes and illustrates mechanical behaviour of cheeses in relation with openness. High deformability means high cohesion due to bonds between curd particles as strong as bonds within particles for Swiss-type cheeses (Emmental, Comté, Beaufort, and Jarlsberg). Low fracture strain of Parmigiano Reggiano is related to its low cohesion, which is due to bonds weaker between clusters of curd particles resulting from the cheesemaking process.

Cheese cohesion and mechanical properties are influenced by interactions between minerals, water and protein, in relation with pH, especially pH at 1 day, which affects the structural state of protein. Lawrence *et al.* (1987) pointed out that the relationship between pH at 1 day and eye development promoted in the pH range of 5.15–5.45. Carbon dioxide production increases with pH, but below this range too soft consistency result in blind cheese. Over this range, too tough consistency increases fracture and slit formation.

Relationship studies between rheological properties and openness of mature cheese are delicate because sampling to assess mechanical properties of cheese must avoid eye location. Due to the heterogeneity of the cheese block or wheel, this means that only properties of the blind part of cheese with eyes can be measured with rheological methods, and not those around the eyes. We have compared mechanical properties of three mature Comté cheeses selected on their different types of openness: (a) one blind (i.e. no gas holes), (b) one with round eyes and (c) one with slits (Noël *et al.*, 1996). The cheese with slits was significantly more rigid and resistant than the others. The cheese with eyes tended to have higher elastic properties in relaxation, i.e. on long time scale and a lower deformability in compression than the blind cheese, while cheeses with eyes and the blind had similar elastic properties in compression, i.e. on shorter time scale.

10.4.2 Changes during ripening and eye formation

Proteolysis

During cheese ripening, proteolysis is essential for the development of the texture. Mechanical properties are related to the composition of cheeses and proteolysis (Creamer & Olson, 1982). Among the three main French Swiss-type cheeses, Emmental has higher level of native caseins than Comté and Beaufort (Grappin *et al.*, 1999). These differences are strongly related to the curd-cooking temperature as well as to the salt in moisture content, and their consequences on the activities of the proteolytic enzymes (plasmin and chymosin). More native caseins in the protein matrix contribute to the increased firmness and deformability of the cheese, properties that are appropriate to openness. Berdagué and Grappin (1989) have reported a significant correlation between proteolysis in depth, which was measured by phosphotungstic-acid soluble nitrogen (PTASN), and the intensity of slit defect in Comté cheese. Enhancement of both proteolysis and gas production with a limited increase of ripening temperature was also related to slit defect (Grappin *et al.*, 1993). Based on the same cheese variety, Bouton *et al.* (1996) have related the intensity of openness (number and size of eyes) to an interaction between raw milk origin and starter type, and it was associated with a higher propionic acid level and a higher proteolytic activity of the starter. This was confirmed in Swiss Emmental cheese by the study of Fröhlich-Wyder *et al.* (2002), who concluded that the enhanced proteolysis due to *Lb. helveticus* would induce a higher pH, and consequently promote a better growth for propionibacteria with finally a weaker texture producing cracks instead of eyes. A weaker texture was also observed when more pronounced proteolysis was identified in Bergkäse cheese in presence of heterofermentative lactobacilli, i.e. *Lb. rhamnosus* (Weinrichter *et al.*, 2004). This could be related to the higher content of small peptides and amino acids in Comté cheeses that would result in less cohesive, less elastic and deformable texture throughout ripening (Notz, 1997).

By comparing brine and surface salting, Grappin *et al.* (1993) have evaluated the effect of salt level on the primary proteolysis as well as on eye and slit formation in Comté cheese. Slit intensity was related to higher level of PTASN. It is safe to assume that the salt could disturb eye formation through its various effects on water mobility, mineral balance, interactions between water, minerals and proteins, enzyme activities and bacterial growth.

In general, intensified proteolysis leads to accelerated ripening, which is desired when the storage ability is preferred. In Emmental cheesemaking, strong proteolysis together with intense propionic acid fermentation may, however, be the primary cause of late fermentation defects (Gagnaire *et al.*, 2001). Finally, current knowledge about the relationships between proteolysis and openness remains limited. Neither the nature of the peptides produced nor the proteolytic enzymes have been directly related to openness.

Fat

The effect of fat level on the texture and openness properties of Comté-type cheese models (1 and 45 kg) was investigated at pilot scale (Notz *et al.*, 1998). The increase of elasticity and decrease of mechanical resistance of mature cheeses were related to the higher fat content, which was associated to a higher moisture content of cheese due to a lower drainage (i.e. reduced whey drainage volume). Interestingly, higher fat content was related to a reduction of propionic acid fermentation and the resulting cheeses were blind (no gas holes). Investigations of fat structure during ripening of Emmental cheese might open perspectives for more investigation of eye formation (Lopez *et al.*, 2006). In particular, the presence of crystallised fat may contribute to slit formation instead of eye.

Changes of rheological properties during ripening

Changes in relation with openness were studied by Flückiger (1980) on Emmental by using compression followed by a 5-min relaxation. An indicator of firmness was estimated as the stress at 33% of deformation. An 'index of elasticity' was measured as the percentage of the reduction of stress after 5-min relaxation time. Stress and strain at fracture were also measured. The tests were made on cheese samples during the ripening at the actual temperature of the ripening room (no temperature adjustment before testing) and also after temperature testing adjustment at 15 and 20°C. Clearly, measurements at 15 and 20°C revealed lower changes of the mechanical properties of the cheeses, while the measurements at the temperature of the ripening room gave a better view of the actual mechanical properties during the formation of the eyes. The 'index of elasticity' decreased all along the ripening period, independently of the temperature level. The 'index of firmness' of the cheeses has the lowest values during the ripening period in the warm room. Stress at fracture changed lightly before the warm room and then decreased sharply at the beginning of this ripening stage, but values remained approximately ten times the index of firmness. Interestingly, fracture strain increased at the beginning of the warm-room stage and then decreased all along the ripening in warm room with a rapid change due to the following transfer to the storage or cooling room. During the ripening period and when the production of gas is high, cheeses had the lowest firmness and a higher elastic modulus, but in fact were neither too rigid nor too elastic. They were more deformable, i.e. supporting higher deformation before breaking and also showing a relative resistance to fracture. Thus, in the warm room, cheeses have the most appropriate mechanical properties for eye formation, and it is also the best stage for the production of gas by propionibacteria. As a result, formation and growth of eyes are mainly observed during this ripening step in X-rays studies, while slit formation occur rarely at this stage, but more often later during the cold storage step (C. Achilleos, E. Notz and Y. Noël, unpublished results).

10.4.3 Eye formation and slit development

Eyes in Emmental cheese were observed by Rüegg and Moor (1987) by using microphotography, and we have made similar observations with Comté cheese. A limited number of curd particle layers are deformed around the round eye apparently initiated between the particles, and the deformation is isotropic. Gas pressure exerts mechanical stress over long time scale on the viscoelastic curd particles surrounding the eyes, promoting viscous deformation or flow. In a theoretical approach, Akkerman *et al.* (1989) have related the gas overpressure p to the flow rate of the cheese mass (the biaxial elongational rate $d\varepsilon/dt$), and the viscous component (the biaxial elongational viscosity η) by using the classical equation $p = \eta d\varepsilon/dt$. A slit would be formed instead of an eye, if the local overpressure p is higher than the local cheese fracture stress. This approach does not allow predicting easily the slit formation (Walstra, 1991). The heterogeneous distribution of the CO₂ content observed in a piece of Emmental cheese by Girard & Boyaval (1994) supports the fact that openness is related to local phenomenon. Fig. 10.3 shows the fracture pattern of the cross section of a slit in experimental Comté-type cheese. The pattern has concentric folds of paste and radial tracks. It would suggest an initial local defect of cohesion initiating the crack, which might progress within the cheese possibly by successive even rapid steps, marked by the successive folds, while the gas might flow through particular radial tracks. The fracture stress of a cheese results from all the previous changes occurring during ripening, and is linked to composition, proteolysis, pH change, interactions between components, etc. Theoretical studies by Langley & Green (1989) observed fracture within composite models made of milk protein gels filled by small glass spheres recovered by either hydrophilic or hydrophobic material. Fracture occurred at the border between the protein matrix and the filling material when bonds were hydrophobic,



Fig. 10.3 The fracture pattern of the cross section of a slit in Comté-type cheese.

while it occurred within the protein matrix when bonds were hydrophilic. Progression of slit development through curd particles, already observed in Dutch-type cheeses (Luyten & van Vliet, 1996), would seem to occur also in mature Comté cheese (C. Achilleos, E. Notz and Y. Noël, unpublished results). Slits are oriented in the direction perpendicular to the pressing axis, as the main axis of the curd particles. Interestingly, fracture stress and strain measured in compression were lower in the perpendicular direction (Grappin *et al.*, 1993). A linear relation was established between the mechanical anisotropy and the slit intensity evaluated on 35 Comté cheeses. An indicator of anisotropy was derived from the difference in fracture strain values measured in both perpendicular and parallel directions to pressing.

Slit formation, which occurs mainly during the cold storage stage, results from a combination of an increase of the internal pressure and a low resistance to fracture (Zoon & Allersma, 1996). Several phenomena could contribute to slit formation. First, late production of CO₂, also called secondary fermentation, linked to the metabolism of particular strains of propionibacteria and more active at low temperature, was already related to slit defect in Swiss cheese by Hettinga *et al.* (1974), but fermentation from citrate might also contribute. Interestingly, in a Dutch-type cheese, crack formation was related to late CO₂ production originated from decarboxylation of glutamic acid by particular strain of starter cultures (Zoon & Allersma, 1996). Second, the solubility of CO₂ in the different phases changes with temperature, modulating the internal pressure. For example, fat solubilises less CO₂ when the temperature is low (Akkerman *et al.*, 1989), contributing to increase the internal pressure. Third, the mechanical properties of the cheese matrix change with temperature. The drastic decrease of temperature between the warm room and the cold storage room induces an increase of the rigidity, a decrease of fracture strain and stress, resulting in a more fragile cheese. Finally, proteolysis, combined with local pH change, would induce a heterogeneous distribution of weaker internal bonds in the cheese, which may originate primer slits in the future.

10.5 Conclusions

Eye formation is a critical dynamic process requiring several conditions, including initial quality of milk, microflora, technological conditions controlling further mechanical properties both of cheese and gas production and associated to local properties and phenomena. First, an appropriate number of microscopic void spaces between curd particles should be present early in the young cheese, often being air bubbles, which will act as nuclei. Second, the mechanical resistance of bonds between curd particles (cohesion) should be high enough to support the internal overpressures without breaking, which is appropriate cheese cohesion. Third, cheese curd particles should support deformations without breaking, especially plastic flow deformation at rather long time scales, which means appropriate chemical properties of the cheese structure as well as proteolysis level when the eyes grow. Moreover, cheese should have isotropic mechanical properties around the growing eye, which could mean that similar types of bonds are equally distributed in the area, but a limited number of layers of curd particles are concerned. Fourth, the cheese matrix must be locally saturated with gas allowing the creation of a local overpressure, which would stress the curd particles around the gas

pocket. Fifth, the final condition would be the right synchronisation of gas production during ripening with the appropriate mechanical, structural and biochemical (especially degree and intensity of proteolysis) properties of the cheese. Propionibacteria, which are responsible for gas production in Swiss-type cheese, should be active at the right time to produce gas at the right rate and level to obtain good openness. If gas production occurs during the warm ripening room when the cheese mechanical properties are the most appropriate, with high elasticity, high deformability and low mechanical resistance, then the holes are with good openness with round-shaped eyes. We can assume that no openness or cracks will occur if one of these conditions, which depend on so many factors during the process, fails. In order to transform these basic conditions controlling the eyes formation in a general knowledge which would allow controlling the manufacturing practises on a scientific basis, it would be useful to organise and model the relationships between these conditions and their influence on quality of these holes, i.e. number, size, repartition, visual aspect.

Nevertheless, nucleation phenomena and location of gas production related to the location of bacteria are not fully elucidated. Levels of CO₂ produced in cheese with time, diffusion to particular gas pockets in relation to cheese structure, yield of CO₂ content to allow local overpressure in relation with fracture properties, heterogeneity of gas distribution in cheese block/wheel, and solubility of CO₂ with ripening temperature would contribute to elucidate mechanisms of slit formation. Relationships between propionibacteria activities, gas production and mechanical properties of Swiss-type cheeses need more studies to reduce openness defects in cheese wheels or blocks as well as in portions. Development of the use of non-destructive techniques, such as X-ray scanning, NMR imaging or ultrasounds would contribute to increase knowledge about eye development during ripening. Knowledge about the metabolic pathways of amino acids degradation, the enzymes involved and the actual role of PAB in the production of flavour compounds of Swiss-type cheese have made major progress during the last years, allowing the selection of PAB starter cultures. Investigation appears limited about the mechanical part and gas production related to openness, while functional properties of cheese draw more scientific interest (Everett & Auty, 2008).

Eye formation would require a multidisciplinary approach and a multidimensional analysis of analytical data in order to elucidate mechanisms of formation of well-shaped holes as well as slits or cracks. The potential of tools, such as neural networks and fuzzy logic in cheesemaking (Norbac, 1994; Charnomordic *et al.*, 1998) were explored to relate the process and the final cheese openness. If such research strategies would offer opportunities to develop a better management of openness and more generally cheese quality, nowadays in practise, openness is managed through pragmatic approaches with control of cheesemaking parameters. The desired openness is promoted through control of milk quality, gas-producing microflora, and mainly the dynamic changes of ripening temperature to initiate gas saturation in the cheese body, then a strong and quick over saturation in warm room.

References

- Akkerman, J.C., Walstra, P. & van Dijk, H.J.M. (1989) Holes in Dutch-type cheese. Conditions allowing eye formation. *Netherlands Milk and Dairy Journal*, **43**, 453–476.

- Baer, A., Ryba, I. & Grand, M. (1993) Ursachen des Entstehung von braunene Tupfen im Käse. *Schweizerische Milchwirtschaftliche Forschung*, **22**, 3–7.
- Ben Lawlor, J., Delahunty, C.M., Wilkinson, M.G. & Sheehan, J. (2001) Relationships between the sensory characteristics, neutral volatile composition and gross composition of ten cheese varieties. *Lait*, **81**, 487–507.
- Berdagué, J.L. & Grappin, R. (1989) Affinage et qualité du gruyère de Comté. VII Caractéristiques de présentation: ouverture et défaut de lainure des fromages. *Lait*, **69**, 173–181.
- Bernard, K.A., Shuttleworth, L., Munro, C., Forbes-Faulkner, J.C., Pitt, D., Norton, J.H. & Thomas, A.D. (2002) *Propionibacterium australiense* sp. nov. derived from granulomatous bovine lesions. *Anaerobe*, **8**, 41–47.
- Berthier, F., Beuvier, E., Dasen, A. & Grappin, R. (2001) Origin and diversity of mesophilic lactobacilli in Comté cheese, as revealed by PCR with repetitive and species-specific primers. *International Dairy Journal*, **1**, 293–305.
- Blanc, B. & Hättenschwiler, J. (1973) Neue Möglichkeiten für die Anwendung der Radiologie in der Käseertechnologie. *Schweizerische Milchwirtschaftliche Forschung*, **2**, 1–16.
- Bouton, Y., Guyot, P. & Dasen, A. (1996) Influence des interactions entre le lait et le levain lactique sur l'affinage et la qualité du fromage comté. *International Dairy Journal*, **6**, 997–1013.
- Britz, T.J. & Riedel, K.H.J. (1994) *Propionibacterium* species diversity in Leerdammer cheese. *International Journal of Food Microbiology*, **22**, 257–267.
- Caccamo, M., Melilli C., Barbano, D.M., Portelli G., Marino, G. & Licitra, G. (2004) Measurement of gas holes and mechanical openness in cheese by image analysis. *Journal of Dairy Science*, **87**, 739–748.
- Carcano, M., Lodi, R., Todesco, R. & Vezzoli, F. (1993) Propionic acid bacteria in milk for Grana cheese. *Latte*, **18**, 914–919.
- Chamba, J.F. (1994) Interactions between thermophilic lactic acid bacteria and propionibacteria: influence on Emmental cheese characteristics. *Actes du Colloque Lactique 94*, 7–9 September, Adria Normandie, Caen, France.
- Chamba, J.F., Delacroix-Buchet, A., Berdagué, J.L. & Clément, J.F. (1994) Une approche globale de la caractérisation des fromages: l'exemple du fromage de Beaufort. *Sciences des Aliments*, **14**, 581–590.
- Chamba, J.F. & Perréard, E. (2002) Contribution of propionibacteria to lipolysis of Emmental cheese. *Lait*, **82**, 33–44.
- Charnomordic, B., Glaudel, M., Renard, Y., Noël, Y. & Vila, J.P. (1998) Knowledge-based fuzzy control in Food Industry: a decision support tool for cheesemaking. *International Conference on Engineering of Decision Support Systems in Bio-industries (Bio-Decision 98)*, February 23–27, p. 10., CD-Rom.
- Clark, W.M. (1917) On the formation of eyes in Emmental cheese. *Journal of Dairy Science*, **1**, 91–113.
- Clément, J.F. (1984a) *Production du CO₂ et Formation de L'ouverture*, Etude SS 84/5/C – 1984, pp. 1–40, Actilait, Bourg en Bresse.
- Clément, J.F. (1984b) *Synthèse Actuelle des Connaissances sur L'affinage*, Etude SS 84/07 – 1984, pp. 1–34, Actilait, Bourg en Bresse.
- Condon, S. & Cogan, T.M. (2000) *Stimulation of Propionic Acid Bacteria by Lactic Acid Bacteria in Cheese Manufacture*, End of Project report DPRC No. 32, Dairy Products Research Centre, Moorepark.
- Creamer, L.K. & Olson, N.F. (1982) Rheological evaluation of maturing Cheddar cheese. *Journal of Food Science*, **47**, 631–636, 646.
- Crow, V.L. (1986) Metabolism of aspartate by *Propionibacterium freudenreichii* subsp. *shermanii*: Effect on lactate fermentation. *Applied and Environmental Microbiology*, **52**, 359–365.
- Crow, V.L. & Turner, K.W. (1986). The effect of succinate production on other fermentation products in Swiss-type cheese. *New Zealand Journal of Dairy Science and Technology*, **21**, 217–227.

- Cummins, C.S. & Johnson, J.L. (1986) Genus I. *Propionibacterium* Orla-Jensen 1909. *Bergey's Manual of Systematic Bacteriology* (eds P.H.A. Sneath, N.S. Mair, M.E. Sharpe & J.G. Holt), pp. 1346–1353, Williams & Wilkins, Baltimore, MD.
- Deborde, C. (1998) *Etude du Métabolisme Carboné primaire de Bactéries Propioniques Laitières par Résonance Magnétique Nucléaire in vivo du 13C: des voies Métaboliques aux Tests de Performance des Souches Industrielles*, PhD thesis, Ecole Nationale Supérieure Agronomique de Rennes/Agrocampus Ouest, Rennes.
- Duce, S.L., Amin, H.G., Horsfield, M.A., Tyszka, M. & Hall, L.D. (1995) Nuclear magnetic resonance imaging of dairy products in two or three dimensions. *International Dairy Journal*, **5**, 311–319.
- Eliskases-Lechner, F., Ginzinger, W., Rohm, H. & Tschager, E. (1999) Raw milk flora affects composition and quality of Bergkase. 1: Microbiology and fermentation compounds. *Lait*, **79**, 358–396.
- Eskelinen, J.J., Alavuotunki A.P., Haeggstöm E. & Alatosava T., (2007) Preliminary study of ultrasonic structural quality control of Swiss-type cheese. *Journal of Dairy Science*, **90**, 4071–4077.
- Everett D.W. & Auty, M.A.E. (2008) Cheese structure and current methods of analysis. *International Dairy Journal*, **18**, 759–773.
- FAO (2007) Standard for Emmental Cheese, CODEX STAN 269–1967, revised in 2007, <http://www.codexalimentarius.net/download/standards/288/CXS269e.pdf>.
- Fessler, D., Casey, M.G. & Puhan, Z. (1999a) Identification of propionibacteria isolated from brown spots of Swiss hard and semi-hard cheeses. *Lait*, **79**, 211–216.
- Fessler, D., Casey, M.G. & Puhan, Z. (1999b) Propionibacteria flora in Swiss raw milk from lowlands and alps. *Lait*, **79**, 201–209.
- Fitz, A. (1878) Über Spaltpilzgährungen. *Berichte der deutschen chemischen Gesellschaft*, **11**, 1890–1899.
- Flückiger, E. (1980) CO₂-und Lochbildung im Emmentalerkase. *Schweizerische Milchzeitung*, **106**, 473–480.
- Fröhlich-Wyder, M.T. & Bachmann, H.P. (2004) Cheeses with propionic acid fermentation. *Cheese: Chemistry, Physics and Microbiology* (eds P.F. Fox, P.L.H. McSweeney, T.M. Cogan & T.P. Guinee), vol. 2, 3rd edn, pp. 141–156, Elsevier, London.
- Fröhlich-Wyder, M.T., Bachmann, H.P. & Casey, M.G. (2002) Interaction between propionibacteria and starter/non-starter lactic acid bacteria in Swiss-type cheese. *Lait*, **82**, 1–15.
- Gagnaire, V. Boutrou, R. & Léonil, J. (2001) How can peptides produced from Emmental cheese give some insights on the structural features of the paracasein matrix? *International Dairy Journal*, **11**, 449–454.
- Girard, F. & Boyaval, P. (1994) Carbon dioxide measurement in Swiss-type cheeses by coupling extraction and gas chromatography. *Lait*, **74**, 389–398.
- Grappin, R., Beuvier, E., Bouton, Y. & Pochet, S. (1999) Advances in the biochemistry and microbiology of Swiss-type cheese. *Lait*, **79**, 3–22.
- Grappin, R., Lefier, D., Dasen, A. & Pochet, S. (1993) Characterizing ripening of Gruyère de Comté: influence of time × temperature and salting conditions on eye and slit formation. *International Dairy Journal*, **3**, 313–328.
- Grillenberger, G. & Busse, H. (1978) Flore bactérienne de l'Emmental présentant des lainures. *Brèves communications. 20ème Congrès International du Lait*, pp. 774–775, FIL France – Congrilait, Paris.
- Hettinga, D.H. & Reinbold, G.W. (1972) The propionic-acid bacteria – a review. II: Metabolism. *Journal of Milk and Food Technology*, **35**, 358–372.
- Hettinga, D.H., Reinbold, G.W. & Vedamuthu, E.R. (1974) Split defect of Swiss cheese. I: Effect of strain of propionibacterium and wrapping material. *Journal of Milk and Food Technology*, **37**, 322–328.
- Jaros, D. & Rohm, H. (1997) Characteristics and description of Vorarlberger Bergkäse. 2: Appearance and texture properties. *Milchwissenschaft*, **52**, 625–629.
- Jimeno, J., Lazaro, M.J. & Sollberger, H. (1995) Antagonistic interactions between propionic acid bacteria and non-starter lactic acid bacteria. *Lait*, **75**, 401–413.

- Keilling, J. (1939) Considérations sur la lainure des fromages à pâte cuite. *Le Fromager Polinois*, 2.
- Kerjean, J.R. & Roussel, E. (1991) Procédé pour fabriquer des fromages à pâte pressée cuite ou non cuite à ouvertures. French Patent Application 91 121 00.
- Kosikowski, F.V. & Mistry, V.V. (1997) *Cheese and Fermented Milk Foods, Volume I: Origins and Principles*, 3rd edn, pp. 226–251, F.V. Kosikowski L.L.C., Wesport, CT.
- Koussemon, M., Combet-Blanc, Y., Patel, B.K., Cayol, J.L., Thomas, P., Garcia, J.L. & Ollivier, B. (2001) *Propionibacterium microaerophilum* sp. nov., a microaerophilic bacterium isolated from olive mill wastewater. *International Journal of Systematic Evolutionary Microbiology*, **51**, 1373–1382.
- Kusano, K., Yamada, H., Niwal, M. & Yamasato, K. (1997) *Propionibacterium cyclohexanicum* sp. nov., a new acid-tolerant omega-cyclohexyl fatty acid-containing propionibacterium isolated from spoiled orange juice. *International Journal of Systematic Bacteriology*, **47**, 825–831.
- Langley, K.R. & Green, M.L. (1989) Compression strength and fracture properties of model particulate food composites in relation to their microstructure and particle-matrix interaction. *Journal of Texture Studies*, **20**, 191–207.
- Langsrud, T. & Reinbold, G.W. (1973) Flavor development and microbiology of Swiss cheese. A review. III. Ripening and flavor production. *Journal of Milk and Food Technology*, **36**, 593–609.
- Lawrence, R.C., Creamer, L.K. & Gilles, J. (1987) Texture development during cheese ripening. *Journal of Dairy Science*, **70**, 1748–1760.
- Lopez, C., Maillard, M.B., Briard-bio, V., Camier, B. & Hannon, J.A. (2006) Lipolysis during ripening of Emmental cheese considering organization of fat and preferential localization of bacteria. *Journal of Agriculture and Food Chemistry*, **54**, 5855–5867.
- Luyten, H. & van Vliet, T. (1996) Effect of maturation on large deformation and fracture properties of (semi-)hard cheeses. *Netherlands Milk and Dairy Journal*, **50**, 295–307.
- Mahdjoud, R., Molegnana, J., Seurin, M.J. & Briguët, A. (2003) High resolution magnetic resonance imaging evaluation of cheese. *Journal of Food Science*, **68**, 1982–1984.
- Martley, F.G. & Crow, V.L. (1996) Open texture in cheese: the contributions of gas production by microorganisms and cheese manufacturing practices. *Journal of Dairy Research*, **63**, 489–507.
- Meile, L., Le Blay, G. & Thierry, A. (2007) Contribution to the safety assessment of technological microflora found in fermented dairy products. Part IX. *Propionibacterium* and *Bifidobacterium*. *International Journal of Food Microbiology*, **126**, 316–320.
- Mocquot, G. (1979) Reviews of the progress of dairy science: Swiss-type cheese. *Journal of Dairy Research*, **46**, 133–160.
- Nassar, G., Nongaillard, B. & Noël, Y. (2004) Measurement of cheese texture and opening by ultrasound technique. *IDF Symposium on Cheese: Ripening, Characterization & Technology*, 21–25 March 2004, Prague, Czech Republic.
- Noël, Y., Achilleos, C. & Aliste, M.A. (1996) Application of stress relaxation to study openness of hard cheese. *Fat Replacer – Ripening and Quality of Cheeses*, Document No. 317, pp. 50, International Dairy Federation, Brussels.
- Norback, J.P. (1994) Natural language computer control of crucial steps in cheesemaking. *Australian Journal of Dairy Technology*, **49**, 119–122.
- Notz, E. (1997) *Caractérisation et Évolution Pendant L'affinage des Propriétés Chimiques, Biochimiques et Rhéologiques Initiales du Comté et Influence sur la Qualité Finale de la Texture et de L'ouverture*, Etude ITG DC1997/10/BC, Actilait, Bourg en Bresse.
- Notz, E., Noël, Y., Bérodiér, A. & Grappin, R. (1998) Influence of fat on texture and colour of Comté cheese. *Poster presented at the 25th International Dairy Congress*, Aarhus, Denmark.
- Pauchard, J.P., Flückiger, E., Bosset, J.O. & Blanc, B. (1980) CO₂-Löslichkeit, -Konzentration bei Entstehung der Löcher und -Verteilung im Emmentalerkäse. *Schweizerische Milchwirtschaftliche Forschung*, **9**, 69–74.
- Paulsen, P.V., Kowalewska, J., Hammond, E.G. & Glatz, B.A. (1980) Role of microflora in production of free fatty acids and flavor in Swiss cheese. *Journal of Dairy Science*, **63**, 912–918.

- Preininger, M. & Grosch, W. (1994) Evaluation of key odorants of the neutral volatiles of Emmentaler cheese by the calculation of odour activity values. *Lebensmittel Wissenschaft und Technologie*, **27**, 237–244.
- Preininger, M., Warmke, R. & Grosch, W. (1996) Identification of the character impact flavour compounds of Swiss cheese by sensory studies of models. *Zeitschrift für Lebensmittel -Untersuchung und -Forschung*, **202**, 30–34.
- Rage, A. (1993) IV Norwegian cheese varieties – North European varieties of cheese. *Cheese: Chemistry, Physics and Microbiology* (ed. P.F. Fox), vol. **2**, 3rd edn, pp. 257–260, Chapman & Hall, London.
- Reinbold, G.W. (1972) *Swiss Cheese Varieties*, Pfizer Inc, New York.
- Reiner, M., Scott Blair, G.W. & Mocquot, G. (1949) Sur un aspect du mécanisme de formation des lainures dans le fromage de Gruyère de Comté. *Lait*, **29**, 351–357.
- Richoux, R., Faivre, E. & Kerjean, J.R. (1998) Effet de la teneur en NaCl sur la fermentation du lactate par *Propionibacterium freudenreichii* dans des minifromages à pâte cuite. *Lait*, **78**, 319–331.
- Richoux, R., Maillard, M.B., Kerjean, J.R., Lortal, S. & Thierry, A. (2008) Enhancement of ethyl ester and flavour formation in Swiss cheese by ethanol addition. *International Dairy Journal*, **18**, 1140–1145.
- Rosenberg, M., McCarthy, M. & Kauten, R. (1992) Evaluation of eye formation and structural quality of Swiss-type cheese by Magnetic Resonance imaging. *Journal of Dairy Science*, **75**, 2083–2091.
- Rousseau, M. & Le Gallo, C. (1990) Etude de la structure de l'emmental au cours de la fabrication, par la technique de microscopie électronique à balayage. *Lait*, **70**, 55–66.
- Rüegg, M. & Moor, U. (1987) The size distribution and shape of curds granules in traditional Swiss hard and semi-hard cheeses. *Food Microstructure*, **6**, 35–46.
- Rychlik, M., Warmke, R. & Grosch, W. (1997) Ripening of Emmental cheese wrapped in foil with and without addition of *Lactobacillus casei* subsp. *casei*. III: Analysis of character impact flavour compounds. *Lebensmittel Wissenschaft und Technologie*, **30**, 471–478.
- Stackebrandt, E., Rainey, A. & Ward-Rainey, N.L. (1997) Proposal for a new hierarchic classification system, *Actinobacteria* classis nov. *International Journal of Systematic Bacteriology*, **47**, 479–491.
- Steffen, C., Eberhard, P., Bosset, J.O. & Rüegg, M. (1993) Swiss-type varieties. *Cheese: Chemistry, Physics and Microbiology* (ed. P.F. Fox), vol. **2**, 2nd edn, pp. 83–110, Elsevier Applied Science Publishers, London.
- Thierry, A. & Madec, M.N. (1995) Enumeration of propionibacteria in raw milk using a new selective medium. *Lait*, **75**, 315–323.
- Thierry, A., Maillard, M.B., Richoux, R., Kerjean, J.R. & Lortal, S. (2005) *Propionibacterium freudenreichii* strains quantitatively affect production of volatile compounds in Swiss cheese. *Lait*, **85**, 57–74.
- Thierry, A., Salvat-Brunaud, D. & Maubois, J.-L. (1999) Influence of thermophilic lactic acid bacteria strains on propionibacteria growth and lactate consumption in an Emmental juice-like medium. *Journal of Dairy Research*, **66**, 105–113.
- von Freudenreich, E. & Orla-Jensen, O. (1906) Über die in Emmentalerkäse stattfindene Propionsäuregärung. *Zentralblatt für Bakteriologie, Mikrobiologie und Hygiene*, **17**, 529–546.
- Walstra, P. (1991) Rheological foundation of eye or slit formation. *Rheological and Fracture Properties of Cheese*, Document No. 268, pp. 16–25, International Dairy Federation, Brussels.
- Walstra, P., Noomen, A. & Geurts, T.J. (1993) Dutch-type varieties. *Cheese: Chemistry, Physics and Microbiology* (ed. P.F. Fox), Vol. **2**, 2nd edn, pp. 39–82, Elsevier Applied Science Publishers, London.
- Weinrichter, B., Sollberger, H., Ginzinger, W., Jaros, D. & Rohm, H. (2004) Adjunct starter properties affect characteristic features of Swiss-type cheeses. *Nahrung Food*, **48**, 73–79.
- White S.R., Broadbent J.R., Oberg C.J. & McMahon D.J. (2003) Effect of *Lactobacillus helveticus* and *Propionibacterium freudenreichii* ssp. *shermanii* combinations on propensity for split defect in Swiss Cheese. *Journal of Dairy Science*, **86**, 719–727.

- Wood, H.G. (1981) Metabolic cycles in the fermentation by propionic acid bacteria. *Current Topics in Cellular Regulation – 1981* (eds R.W. Estabrook & P. Srera), pp. 255–287, Academic Press, New York.
- Wyder, M.T., Bosset, J.O., Casey, M.G., Isolini, D. & Sollberger, H. (2001) Influence of two different propionibacterial cultures on the characteristics of Swiss-type cheese with regard to aspartate metabolism. *Milchwissenschaft*, **56**, 78–81.
- Zoon, P. & Allersma, D. (1996) Eye and crack formation in cheese by carbon dioxide from decarboxylation of glutamic acid. *Netherlands Milk and Dairy Journal*, **50**, 309–318.

11 Microbiological Surveillance and Control in Cheese Manufacture

P. Neaves and A.P. Williams

11.1 Introduction

The food industry, in general, seems to regard cheese as a single commodity and shows little understanding of the compositional and technological variations found amongst the different varieties of cheese. The numerous varieties of cheese produced around the world, ranging from the Parmesan and Cheddar types, to Brie, Camembert and Stilton, and to fresh cheeses, such as Cottage cheese and Mozzarella di Bufala, possess widely differing compositional attributes that have a major impact on the microbiology of the finished product. The microbiology of 'cheese' is, therefore, diverse, and its study usually requires a knowledge not only of the composition of the product but also of the conditions of production and maturation or storage specific to the individual dairy that produced it and, in some cases, even the time of year that cheesemaking occurred.

Consequently, different types of cheese carry different levels of microbiological risk; pathogens are more likely to survive or grow in soft cheeses than in the harder varieties, but the relationship between the milk producer and the cheesemaker is also important, especially for cheese made from unpasteurised milk, as the greater the control the latter has over the former, the less the risk of pathogen contamination of the cheesemaker's major raw material. Examples of the relative microbiological risk associated with different cheeses are shown in Fig. 11.1 in which category A cheeses represent the lesser risk at the thick end of the wedge and category D varieties pose the greater risk at the thin end. Category E cheeses fall off the end of the wedge and probably should not be made, not necessarily because their composition or production conditions make them dangerous but, for cheese made from unpasteurised milk, more likely in cases where the cheesemaker has little or no knowledge of the hygienic condition of his/her milk supply.

The cheesemaking process occurs naturally in the gastrointestinal tract of infant mammals. Maternal milk is coagulated by chymosin (rennet) and stomach acid, and the resultant curd is digested by peptic and lipolytic enzymes to provide a source of nutrition that is easily assimilated. In other words, cheese is a natural manifestation of milk spoilage and evolved into the forms that we know today as a means of preserving milk in times of plenty for use when milk supplies were restricted. Clearly, some cases of food poisoning and even death occurred along the way, but eventually it became apparent that most people who consumed cheese remained apparently healthy on most occasions. As cheese consumption expanded, it was soon realised that the conversion of milk into cheese also yielded a diverse array of desirable flavours, aromas and textures that are highly valued by the consumer. Today, many people consider that cheese contributes to a healthy diet and the last 15 years have even seen

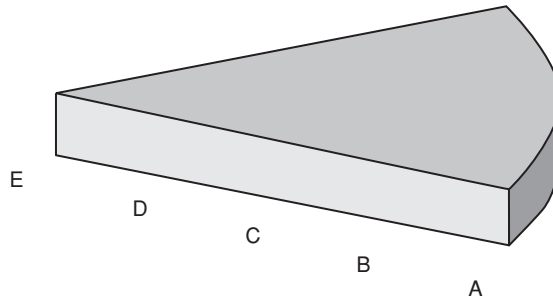

- A Hard cheese matured >60 days, e.g. Parmesan
- B English Acid Territorial matured <60 days, e.g. Cheshire
- C Semi-hard Dutch style, e.g. Gouda
- D Mould-ripened soft cheese, e.g. Gorgonzola, Camembert
Washed-rind, soft and semi-soft cheese, e.g. Chaumes, Epoisses
- E Cheeses that probably should not be made ...

Fig. 11.1 The 'cheese safety wedge', showing examples of cheese varieties that pose different levels of microbiological risk.

a proliferation of so-called probiotic cheese products containing microorganisms, such as *Lactobacillus acidophilus* and *Bifidobacterium* spp., which are reputed to 'aid digestion' and are considered by many to form a 'natural part of a healthy diet'.

Microbiological surveillance and control, therefore, encompasses three distinct aspects:

- Studies of the 'beneficial' organisms that contribute to the organoleptic characteristics and 'healthiness' of cheese (starter cultures, starter adjuncts and secondary starter cultures);
- Control of organisms that lead to quality defects (bacteriophages, spoilage bacteria and moulds);
- Prevention of contamination with agents that can result in food-borne disease (pathogenic bacteria and their toxins) or indicate poor hygiene of production (hygiene indicator organisms).

Many food microbiologists, it seems, are of the opinion that some types of cheese, especially when made from unpasteurised milk, are potentially dangerous products, to be consumed with caution or, preferably, banned from sale (Djuretic *et al.*, 1997). As a ready-to-eat product that is usually consumed without cooking immediately prior to consumption, cheese has been regarded as 'high risk' by many public health microbiologists (Anonymous, 1998a). However, it is worth remembering that cheese has a remarkably good safety record, and a review of the food-poisoning statistics for England and Wales reveals that cheese causes only around 1.6% of the total number of food-poisoning outbreaks recorded (Evans *et al.*, 1998).

Nonetheless, there is a concern that the market for cheese is growing and diversifying, which may increase the risk of food-borne disease. Increasingly, supermarkets are stocking cheeses produced by small, often farmhouse, cheesemakers, either in the United Kingdom, in the European Union (EU) countries or in ‘emerging’ countries, whose premises and control of production hygiene are likely to differ from those of the large dairy companies. In addition, the last two decades have seen a small number of cheese-related episodes of food poisoning or contamination with food-poisoning bacteria. Even though the number of cases constitutes a minute fraction of the general food-poisoning statistics, these incidents have been highly publicised since they have involved the more emotive pathogens, such as *Listeria monocytogenes*, *Escherichia coli* O157 and *E. coli* O26. Whilst diarrhoea due to *Salmonella* spp. is by no means a pleasant experience even for a healthy adult, the loss of an infant’s kidney function due to infection with *E. coli* O157 has very much more serious consequences for the victim. Thus, the control of organisms that may cause severe illness in a rapidly diversifying sector of the food industry is the dairy microbiologist’s challenge for the future.

11.2 Milk for cheese manufacture

In 1982, the United Kingdom (UK) pioneered the concept of a farmer quality payment scheme, in which the price paid for raw cow’s milk was related to its hygienic quality, as judged by the total bacterial count (TBC) at 30°C. Nowadays, many countries operate similar schemes, and much of the raw milk supply worldwide is assessed for hygienic quality using either the TBC or the FOSS Bactoscan™ (an instrumental method of making a direct count of individual viable microbial cells; Harding, 1995a).

In the UK, the Bactoscan™ count for raw milk is generally considered to equate to approximately five to eight times the TBC colony count. In the original UK scheme, farmers received a premium payment if their bulk tank milk had a TBC of $\leq 20\,000$ colony forming units (cfu) mL⁻¹ or a deduction for TBC counts $> 100 \times 10^3$ cfu mL⁻¹. Over the last few years, however, the hygienic quality of the UK milk supply has improved significantly, despite the outbreaks of foot and mouth disease in 2001 and 2008, when stock movement was severely restricted and animal husbandry standards suffered, and many UK farms now produce bulk tank milk with Bactoscan™ counts of $< 20 \times 10^3$ cells mL⁻¹ (TBC $\approx < 2500\text{--}4000$ cfu mL⁻¹). Somatic cell counts (SCC) of bulk tank milk have also declined dramatically and in 2008, the UK average bulk tank SCC was 197 000 cells mL⁻¹ (Anonymous, 2009a), well below the EU legislative limit of 400×10^3 cells mL⁻¹.

This perpetual improvement in the hygiene of ex-farm milk is seen as a major factor in enhancing the quality of milk products. Harding (1995b) reported that SCC in excess of 100×10^3 cells mL⁻¹ may have an adverse effect on cheese yield, whilst Gram-negative psychrotrophs in raw milk need to reach levels of 10^6 cfu mL⁻¹ to produce sufficient protease activity to reduce the yield in soft cheeses by 5% or more. Nevertheless, the current interest in cheese made from unpasteurised milk has focused attention on the importance of including farm hygiene in the cheesemaker’s Food Safety Plan; in particular, Hazard Analysis Critical Control Point (HACCP) system may include animal health and milking hygiene as critical control points (CCPs) for the milk producer.

The natural microflora of raw milk includes several groups of microorganisms that are relevant to the cheesemaker, although the prevalence of these specific groups is rarely monitored routinely because milk production and deliveries tend to be systematic and routine Bactoscan™ results are usually sufficient to demonstrate the consistent quality of the milk supply. Nonetheless, when high Bactoscan™ results occur, a breakdown of the microflora into its constituent bacterial groups may provide useful evidence for any investigation into the cause.

Spoilage organisms, non-starter lactic acid bacteria (NSLAB) and pathogenic bacteria may contaminate raw milk from a variety of sources on the farm and during transport to the dairy. Because farming is essentially an ‘outdoor’ activity, almost anything to which the milk is exposed may present a potential source of microorganisms. However, the major sources of microbial contamination are likely to be the following:

- The farm environment, including the farmer, animal bedding, water supplies and slurry;
- Milking equipment, bulk tanks, pipelines and road tankers;
- Milk-producing animals, especially those suffering from mastitis or enteric diseases.

The spoilage microflora of raw milk stored at temperatures of <10°C comprises Gram-negative psychrotrophic bacteria, such as *Pseudomonas* and related genera as well as *Acinetobacter* and related genera; these organisms ultimately being responsible for overt spoilage. However, in ex-farm bulk tank milks that have been stored for <24 h, this group of organisms may comprise anything between 1 and 100% of the TBC, depending on the particular farm. Because these species are detected by the Bactoscan™ test and, in most cases, by the TBC, routine monitoring for specific spoilage organisms provides little useful additional information.

NSLAB are contaminants of raw milk and dairy equipment and some, but not all, are destroyed by pasteurisation (i.e. 72°C for 15 s). When these organisms contaminate the curd, they grow during maturation of hard cheese, such as Cheddar, and may make a significant contribution to cheese flavour. Many producers of specialist cheeses consider that the microorganisms that contribute to the unique characteristics of their product are specific to an individual milk supply; yet, despite studies extending over several decades, there are no routine tests for these organisms.

The presence of pathogens in milk for cheese manufacture is clearly of major concern to the cheesemaker but the control measures for these organisms depend, to a large extent, on whether the milk is to be pasteurised or not. Most milk-borne pathogens are sensitive to pasteurisation, since this heat process was developed to eliminate non-spore-forming (i.e. vegetative) pathogens from milk (Harding, 1995c); their presence in raw milk destined for pasteurisation is, therefore, of little consequence and routine tests are rarely undertaken for pathogens in raw milk that is destined for heat-processing. Nevertheless, the makers of raw milk cheeses must consider the potential for contamination of their major raw material with a range of pathogens, mainly from veterinary sources. Since the increasing numbers of pathogenic species that may potentially contaminate raw milk seems never-ending, historically, raw milk cheese producers in the UK have considered that routine monitoring of their milk supplies is not cost-effective and that control of animal welfare, farm hygiene and milking practice offers a more practical approach. Conversely, producers of raw milk, higher-risk cheeses in other

European countries generally operate a high level of raw milk surveillance for organisms, such as *Salmonella* spp., *Listeria* spp., *Staphylococcus aureus* and *E. coli* (known as ‘the big four pathogens’). Because tests for these species are now well-established, routine testing of UK milk supplies destined for the manufacture of higher-risk, raw-milk cheeses is becoming more commonplace, especially as the cheesemaker has an obligation to demonstrate ‘due diligence’ and HACCP verification under UK and EU food hygiene legislation.

Dairy herds worldwide are monitored for the presence of antibodies to the ‘traditional’ milk-borne pathogens, such as *Brucella* spp. and *Mycobacterium tuberculosis*, as an indication of animal infection, but the milk itself is not tested for the presence of these pathogens since the tests are complex and low levels of contamination are unlikely to be detected. In the UK, bovine tuberculosis (TB) due to *Mycobacterium bovis* had been considered a problem of the past, but its re-emergence in locations with high badger populations is of increasing concern and, in 2008, the government’s Department for Environment, Food and Rural Affairs (DEFRA) convened a Bovine TB Eradication Group for England whose remit is to ‘... review the current TB strategy and control measures and develop a plan for reducing the incidence of bovine TB from cattle in England and moving towards eventual eradication’ (Anonymous, 2009b).

One potential ‘emerging pathogen’ that the cheesemaker should be aware of, whether or not the milk is pasteurised, is *Mycobacterium avium* subsp. *paratuberculosis* (MAP). In cattle, this organism causes Johne’s disease, a chronic enteritis, and it has been associated with Crohn’s disease in humans, although the evidence for a causative role is inconclusive (Neaves, 1998). However, the organism is also considered to survive a milk pasteurisation process of 72°C for 15 s, which, together with its potential for human pathogenicity, has fuelled an intense interest by the dairy industry worldwide since the control measure for this organism, if one is needed, must be animal health.

It is clear that monitoring of the milk supply for every organism imaginable is inappropriate, especially when the milk is to be pasteurised. Control must, therefore, be accomplished through the seven principles of HACCP system (Anonymous, 2003a) and the ‘farm-to-fork’ approach to food safety, now well established, which focuses the cheesemaker’s attention on the raw materials as well as the process parameters.

Much attention is now being focused on farm hygiene, including the use and control of the antimicrobial agents that play a vital role in maintaining the welfare of farm animals and ensuring the hygienic quality of raw milk, but are detrimental to the activity of starter cultures during cheese manufacture. Dairy cattle may be treated with antimicrobial agents for either therapeutic or prophylactic purposes and antimicrobial agents can, therefore, contaminate the bulk tank milk, almost always through human error, the most likely source being intramammary infusions. Lactating cow therapies are administered to treat cases of clinical mastitis that occur during the period of milk production, whilst dry cow therapies are administered to prevent mastitic infections in the dry udder, contributing to the maintenance of low SCC. Since around one million cases of mastitis occur in the United Kingdom each year (Hillerton, 1998), the use of intramammary infusions is extensive. Control at the farm has to be achieved by ensuring that milk from the treated animal is kept separate throughout the entire withdrawal period designated for the preparation used. In cases of ‘off-label’ use (for example if two or more antibiotic preparations are administered to an animal

simultaneously), the designated withdrawal period must be extended (Anonymous, 2009c). Since cheese starter cultures are sensitive to antimicrobial agents, particularly β -lactams, and may be inhibited if these are present in the cheese milk, the presence of antimicrobial residues can create considerable problems for the cheesemaker, a 'slow vat' not only causing quality defects but also potentially permitting the survival or proliferation of pathogenic bacteria. Thus, control of antibiotics in milk destined for cheese manufacture is strictly monitored, both by the primary purchaser (usually the haulier) and by the dairy, to protect both organoleptic quality and consumer safety.

11.3 Heat treatment

The aim of pasteurisation is to inactivate the vegetative pathogens that may be found in raw milk, although it also eliminates many milk spoilage organisms, which are very heat sensitive. When pasteurisation was developed for milk treatment in the early part of the twentieth century, the most heat-resistant vegetative pathogen in raw milk was considered to be *M. tuberculosis*, and the standard minimum heat process of 72°C for 15 s (as defined in EU legislation; Anonymous, 2005b) inactivates this organism (Harding, 1995c). However, two 'new' food-borne organisms have emerged that have cast doubt on the validity of this heat process. In the late 1980s, the possibility that *L. monocytogenes* might survive pasteurisation was considered and much debate ensued. The dairy industry, internationally, eventually agreed that the survival of this organism depends on the level of raw milk contamination, and unless $>10^8$ cfu mL⁻¹ are present in the raw milk, pasteurisation is considered to eliminate this organism effectively (Prentice & Neaves, 1988). During the 1990s, the debate reopened with the emergence of a potential association between MAP and Crohn's disease. Laboratory studies suggested that MAP might survive pasteurisation, whilst pilot-plant experiments suggested that it may be eliminated (Neaves, 1998). In 1998, this led some European dairies to extend the holding period at 72°C from 15 to 25 s, though this time appears to have been based on organoleptic considerations rather than an accurate and precise knowledge of the heat resistance of the organism. Subsequently, Grant *et al.* (1999) reported that a heat-treatment temperature of 90°C is required for inactivation of MAP. Today, the time-temperature combinations that inactivate MAP remain unclear, though a minimum heat process of 72°C for 15 s is still considered satisfactory by most dairy and public health microbiologists to ensure the microbiological safety of milk.

As with raw milk quality, monitoring of the efficiency of pasteurisation is based largely on physical and chemical measurements rather than on tests to detect possible surviving microorganisms. Pasteuriser performance is monitored on a daily basis by inspecting time-temperature chart records and by checking the operation of the flow diversion valve, which operates automatically to prevent milk entering the pasteurised milk tank if the pasteurisation temperature falls below a preset minimum. On a less frequent (usually annual) basis, tests should be made of the structural integrity of the pasteuriser plate pack assembly, by means of pressure test, electrolyte differential analysis or the use of helium gas, to ensure that microorganisms cannot contaminate the milk in the cooling stages of the heat process (Varnam & Evans, 1996).

Verification of correct pasteurisation is made by daily or less frequent testing of the pasteurised milk for the activity of alkaline phosphatase, an indigenous milk enzyme that, in the case of cow's milk, is only just inactivated by the standard pasteurisation process. The presence of active enzyme in pasteurised milk indicates that the minimum time–temperature combination has not been achieved or that the pasteurised milk has been recontaminated with raw milk; however, the interpretation of the phosphatase test is less straightforward for sheep and goat milk. Since the inactivation of alkaline phosphatase follows a logarithmic decline, the concentration of active enzyme following pasteurisation can never be zero; the inactivation kinetics are concentration dependent so the greater the enzyme activity in raw milk, the greater the concentration post heat treatment. Raw sheep's milk contains a higher level of alkaline phosphatase than is found in raw cow's milk whilst raw goat's milk has a lower level (Harding, 1995c); therefore, sheep's milk that has been adequately pasteurised may fail a phosphatase test, whilst goat's milk that has not been adequately pasteurised might pass a phosphatase test.

For several decades, pasteurisation has been effective in protecting public health and most dairy technologists and microbiologists have considerable confidence in its reliability. Conversely, many public health microbiologists report that pasteurisation failure, due to either poorly maintained equipment or poor process control, is a frequent cause of food poisoning from cheese and other dairy products. Whilst some cheese-associated outbreaks of disease, such as a UK outbreak of *Salmonella* infections associated with the manufacture of Cheddar cheese from pasteurised milk (Anonymous, 1997), have clearly been due to organisms surviving an improperly managed heat process, there is also a significant possibility that the milk, curd or cheese may be recontaminated at any one of the many stages of cheesemaking after pasteurisation. The nature of curd handling and cheese maturation is such that, in all but the largest cheese factories, the product is exposed to the environment and to the human sources of microbial contamination, and the majority of these production stages do not possess a CCP that is 'absolute'. The possibility of product contamination at one or more of these stages should, therefore, be actively considered.

Although most large-scale cheese production employs the full pasteurisation process, a significant proportion of cheese production worldwide uses milk that has received either a lesser heat treatment or no heat process at all. Sub-pasteurisation heat treatments, known as thermisation, encompass a wide range of time–temperature combinations and were originally designed to prolong the shelf life of raw milk prior to use. Nowadays, however, large-scale production of cheeses, such as Emmental, employs thermised milk, even though the requirement to prolong the storage of raw milk no longer exists. This is because the severity of any heat process applied to milk prior to or during cheesemaking has a major effect on the characteristics of the final product, since it largely determines, for example, the extent of protein denaturation, the destruction of endogenous milk enzymes and the composition of the competing microflora. Whatever the reason for making cheese from unpasteurised or thermised milk, some pathogenic contaminants in raw milk, particularly some Gram-positive bacteria, such as *L. monocytogenes*, may survive a sub-pasteurisation process, and a comprehensive hazard analysis is, therefore, necessary to establish whether or not an existing cheesemaking process has appropriate control measures to ensure consumer safety.

11.4 Cheesemaking

The complex nature of the stages in cheese production that occur after the milk has been pasteurised (see Chapter 1) inevitably exposes the curd to many potential sources of contamination with microorganisms, which may either be hazardous to the consumer or pose a threat to the quality of the product itself. For almost all types of cheese, the main consideration for ensuring a high standard of production hygiene during cheesemaking is the avoidance of recontamination from the production environment, from staff and from process equipment. It is only on rare occasions that spore-forming pathogens, survivors of pasteurisation, have caused illness due to growth during cheesemaking, although an outbreak of botulism did occur as a result of inadequate cooling during the manufacture of Mascarpone cheese (Williams & Neaves, 1996).

The importance of raw milk hygiene is well known to those involved in cheesemaking but the microbiological quality of other ingredients must not be overlooked, since these are usually added after the milk has been heat-treated. Apart from milk, the main constituents of cheese comprise salt, starter cultures (mould and/or bacterial) and rennet (derived from either animal, bacterial or fungal sources), all of which may be considered 'low-risk' ingredients under most circumstances. Suppliers of these ingredients should be able to provide microbiological specifications for their products and/or certificates of conformance, and occasional microbiological tests of these ingredients on receipt should be sufficient to confirm their hygienic quality.

Cheesemakers who propagate their own bacterial starter cultures must take special precautions to ensure that the cultures do not become contaminated with adventitious microorganisms, either bacteria, moulds or bacteriophage, and should consider this aspect of cheesemaking as high risk. Microbial contaminants that gain access to the mother culture or the bulk starter will be propagated, together with the starter strains themselves, and will infect the milk in the cheese vat. Should the contaminant be a bacteriophage to which one or more of the starter strains are sensitive, cheese of poor quality will be produced and the cheesemaker is likely to suffer economic losses; however, if the contaminant is an organism, such as *S. aureus* or *E. coli*, the potential food-poisoning outbreak may have much more serious consequences. The propagation of starter cultures must, therefore, be undertaken using full aseptic technique. Cultures should not be propagated indefinitely, and the cheesemaker should revert to a fresh culture from a commercial 'culture house' at regular intervals.

The avoidance of 'slow vats' is an important aspect where the production of curd employs rapid acidification. 'Slow vats', when the starter culture fermentation fails to proceed at its normal rate, can have consequences for both quality and safety, the latter being of particular importance for the production of raw milk cheeses. Since the textural and flavour characteristics of cheese are, in part, related to the rate of acid development, a 'slow vat' can result in poor body, gassiness or an uncharacteristic buttery flavour when the cheese was intended to have a crumbly texture and sharp, acidic flavour. However, more importantly, a slow rate of acid production can permit the growth of *S. aureus*, which, if its numbers increase to 10^6 cfu mL⁻¹ or more, may produce the emetic staphylococcal enterotoxin. *S. aureus* is a widespread organism, being found on the skin and in the nasopharynx of both humans and milk-producing animals and, therefore, has many potential routes by which it can infect the cheese vat.

Inhibition of the starter cultures resulting in a 'slow vat' can have several causes, notably the presence of antimicrobial agents in the milk, infection with bacteriophage or simply an ageing starter culture that has been propagated by the cheesemaker for several months. In addition to high standards of production hygiene, control of each of these aspects is essential to ensure that, should a low level of *S. aureus* contamination be present in the cheese vat, it is not permitted to multiply to a level where enterotoxin could be produced. It is important that cheesemakers who employ rapid acidification operate a documented 'slow-vat procedure' whereby the actions to be taken are defined in the event that the curd fails to achieve a minimum acidity within a given time for Cheddar cheese (this is often defined as a titratable acidity of 0.4 g lactic acid 100 mL⁻¹ within 5 h from addition of rennet to milling).

The concept of a 'slow vat' is not applicable to all types of cheese, however. The production of most mould-ripened cheeses and many lactic cheeses routinely employs a slow (usually overnight) fermentation that would be considered hazardous by Cheddar cheese standards. For these types of cheese, a 'slow vat' procedure is inappropriate and it has to be accepted that these cheeses present a higher risk of sustaining the growth of pathogens than the more robust, rapidly acidifying hard cheese. The production of such cheeses requires meticulous hygiene standards together with design of premises that is desirable but not essential for the manufacture of more robust cheeses.

The control of hygiene within the dairy comprises not only the obvious elements of sanitising utensils and production equipment and maintaining high standards of personal hygiene but also attention to less obvious but equally essential factors, such as air management, monitoring of water supplies and control of cleaning equipment. Both mould and bacteriophage contamination of curd can, and often do, result from a failure to control the flow and quality of air within the dairy. Airborne mould contamination may arise from external sources, such as agricultural air, especially when surrounding crops are being harvested or stored; the species found are distinctive, including some penicillia and *Cladosporium* spp. amongst others. In addition, air from rooms in which cheeses are being matured or handled can contain high numbers of mould spores. Therefore, contamination of air in cheese production areas should be monitored by means of 'exposure plates' containing a suitable mould isolation medium, such as dichloran creatine sucrose bromocresol agar (CREAD; Frisvad *et al.*, 1992), exposed for 30–60 min. Bacteriophage contamination of air cannot, however, be detected so readily since virus particles are not self-replicating and so do not grow on microbiological media. The techniques used for their detection are too complex to be undertaken on a routine basis and their control is, therefore, accomplished by ensuring that aerosols from whey, or from farm animals, in the case of on-farm cheese manufacture, are not drawn into the cheese production areas.

The use of potable water for food-manufacturing operations is a legal requirement within the EU, although the definition of 'potable' is open to some local variations. Water might not only carry microbial contamination itself but can also spread contamination on equipment, floors, drains and other sources within the dairy. The microbiological quality of process water should, therefore, be monitored regularly, the minimum level of testing being for coliforms/*E. coli*, though total colony counts at 22 and 37°C can provide additional useful information.

The microbiological quality of brine is sometimes overlooked by cheesemakers. Following concerns in the 1980s over the salt-tolerant pathogen, *L. monocytogenes*, microbiological control measures have become well established (Prentice, 1989). These include periodic

changing or pasteurisation of the brine to prevent the build-up of microbial contamination, although pasteurisation may be impractical unless a batch pasteuriser is available. Since brines come into direct contact with cheese, they should be monitored for hygienic quality, at least until sufficient data have been collected to demonstrate that they do not support the growth or survival of organisms such as the coliforms, *E. coli* and *Listeria* spp. Clearly, it is also important that brines are prepared at the correct salt concentration (see Chapter 1), which should be accurately maintained and monitored throughout the life of the brine.

One final aspect of hygienic control in cheesemaking (or elsewhere in the food industry) that often seems to be overlooked is the use of high-pressure hoses. Although these are effective for removing product residues from equipment surfaces, floors, etc., the aerosols they generate can be significant in spreading microbial contamination from the floors and walls of the production room to product contact surfaces. Therefore, high-pressure hoses should never be used in the presence of exposed product and should preferably be replaced with low-pressure hoses or floor-scrubbing machines that do not generate aerosols.

11.5 Maturation of the curd

The maturation of cheese in rooms or caves is another complex step in cheese production and one at which microbial contamination and growth can occur. The type of microbial contamination of concern at this stage depends greatly on the variety of cheese being produced, because growth of contaminants is affected by a combination of factors, including cheese composition, rind or surface protection, maturation temperature, humidity, air flow and environmental hygiene.

The relatively high humidity and maturation temperatures required for the production of the mould-ripened soft cheeses and washed-rind cheeses, together with the shift towards a more neutral pH value that occurs as the mould- or bacterial-ripening flora develop, are conducive to the survival and growth of psychrotrophic bacterial pathogens, such as *L. monocytogenes*. Conversely, the more acid, hard cheeses, such as Cheddar, traditionally form a dry outer rind that protects the cheese from environmental contamination and inhibits bacterial growth. Even where an outer rind is not formed, as in bulk block Cheddars, the correct application of a cheese bag serves a similar function.

Contamination with pathogenic bacteria may occur not only from shelving, especially wooden shelving, but also from walls, floors, drains and chillers units (Jervis, 1998). Bacterial contamination is controlled by regular sanitation of all surfaces within the room, but only after all maturing product has been removed. Mould contamination of the walls of maturing rooms can also pose a threat to product quality. However, the control of mould growth is more complex and requires not only good environmental hygiene but also the correct balance of salt, moisture content and curd texture within the product, together with accurately controlled maturation temperature and humidity, correct air flow being an important element. In the case of the mould-ripened varieties, the aim is to allow the 'desirable' mould (*Penicillium roqueforti* for blue cheeses or *Penicillium camemberti* for surface-ripened cheeses) to develop, thus competitively excluding the slower growing adventitious contaminants. This occurs because the 'desirable' moulds are more salt-tolerant than the contaminant species and, in the case

of *P. roqueforti*, more resistant to carbon dioxide, providing it with an ecological advantage in the micro-aerobic interior of a maturing blue cheese.

Many cheese varieties, however, are not intended to be mould-ripened and surface mould growth on block Cheddar, acid English territorial or Dutch cheeses, creates an unacceptable quality defect. After pressing of the curd, such cheeses are generally protected from mould contamination by a wax coat or by vacuum packing. Mould growth is inhibited primarily by the exclusion of air, although surface coating of the cheese by an antimycotic agent, such as sorbic acid or pimaricin (also known as natamycin and sold commercially as Delvocid[®]; DSM Food Specialties, Delft, or Natamax[™], Danisco A/S, Copenhagen), may provide an additional inhibitory effect. Such methods of preventing mould growth, however, may not be entirely effective, since many moulds are capable of scavenging the traces of oxygen that may remain in the interstices of loose curds or along irregularities of the cheese surface or 'ears' in the cheese bag. In addition, and inevitably, one mould species, *Penicillium discolor*, is significantly resistant to natamycin. Thus, packaging and preservatives are no substitute for good environmental hygiene but help to reinforce the quality and safety of cheese surfaces on which the levels of microbial contamination are initially low.

The use of chemical preservatives in cheese manufacture is generally limited and the necessary quality of most cheese production is maintained by assuring a high standard of hygiene. However, some Dutch and Swiss cheeses, as well as the Italian Grana Padano, may require the use of a chemical preservative to prevent bacterial spoilage. These cheeses have a semi-hard/hard composition and relatively high pH value, making them vulnerable to gas production during maturation by butyric anaerobes, notably *Clostridium tyrobutyricum*. Since these spoilage organisms are spore-forming bacteria, they cannot be eliminated from raw milk by pasteurisation and they are, therefore, controlled by (a) ensuring good farm hygiene, (b) restricting the use of silage as cattle feed and (c) the addition of potassium nitrate to the cheese milk to inhibit spore germination during cheese maturation and storage. More recently, lysozyme has been available commercially to replace nitrate, which has been associated with production of carcinogens in stored cheese (International Dairy federation (IDF), 1990; Law & Goodenough, 1995). Lysozyme, however, is often derived from albumin, which introduces a potential egg allergen hazard.

Bactofugation is a well-established technique that employs centrifugation as a process for removing bacterial spores from raw milk (Anonymous, 2003b), but perhaps more widely used nowadays is microfiltration (MF), a process in which bacterial spores are separated from skimmed milk by filtering through membranes. Since milk fat cannot be filtered, the milk is first separated; the skimmed retentate from MF (optional) is mixed with the cream, heat treated at high temperature to inactivate the vegetative cells and bacterial spores, cooled to the temperature of the skimmed permeate and the two are then recombined and pasteurised before cheesemaking. At least three systems are commercially available: (a) 'Bactocatch' (Bindith *et al.*, 1996), (b) 'Tetra Therm ESL' (Larsen, 1996) and (c) 'Pure-Lac[™]' (Fredsted *et al.*, 1996).

11.6 Specialist cheeses and cheese products

As a result of the rapidly expanding market for cheese and cheese products, the microbiology of cheese is diversifying. Some aspects of current trends in cheese technology and marketing

need to be discussed, since they have a significant impact on product safety and quality. Other aspects may be entirely local and should be addressed only by the diligent application of HACCP principles as required by EU legislation.

11.6.1 *Cheeses made from unpasteurised milk*

Because the market for cheeses made with unpasteurised milk is expanding, there is increasing concern that their safety should equal that for cheeses made from pasteurised milk. The natural habitat of many food-borne pathogens is the gastrointestinal tract of milk-producing animals, where illness may not be manifest (*E. coli* O157, for example, may reside as a harmless commensal); however, gastrointestinal disease is sometimes obvious and thus the animals' health, milking hygiene and ex-farm storage of milk are points of exceptional importance in the production of raw milk cheeses. Accurate control of the milk fermentation also forms a CCP to minimise the multiplication of pathogenic bacteria. However, even if the pH value of the curd falls within a few hours, as with Caerphilly cheese, some pathogens, such as *E. coli*, may survive (Anonymous, 1998b).

E. coli and *Salmonella* spp. have, however, been reported to die slowly during the maturation of hard cheeses (El-Gazzar & Marth, 1992), and so for these products the attainment of a minimum maturation time forms an integral part of the HACCP plan. This factor forms the basis of the US legislation that requires all imported cheeses made from unpasteurised milk to be matured for at least 60 days, so that *Salmonella* spp., at levels that might be encountered naturally, will be presumed to have died before the cheese is consumed.

The UK Specialist Cheesemakers Association (SCA) many of whose members produce cheese, on-farm, from unpasteurised milk, has published a Code of Best Practice that discusses the hazards commonly encountered by small cheesemaking enterprises and provides guidance and advice as to some of the options available to smaller businesses to ensure the safety, quality and legality of their products (SCA, 2007).

11.6.2 *Grated cheese for manufacture*

Cheese is not only purchased by the consumer to be eaten as a 'primary' commodity, but is also used extensively in the manufacture of more complex products, such as pizza and recipe dishes and indeed, these ingredients are increasingly produced in convenience packs for retail sale. Cheese for pizza manufacture may be produced by one dairy, grated by another and sold to a third food manufacturer in a nitrogen gas atmosphere or vacuum packaged to extend the shelf life of the grated product. Each food processor is likely to add microbiological contamination to the product and will require his or her own 'portion' of the total product shelf life, in spite of the fact that the 'primary product' possesses only one shelf life.

As a result, cheese for pizza manufacture must be produced and subsequently handled under exceptionally hygienic conditions to ensure that the grated product can meet its shelf life requirements. Gas-flushing is often assumed to form an adequate control measure in preventing the growth of adventitious mould contamination. However, a typical gas-flushing process may have a target of <2% residual oxygen content with an acceptable maximum of <5%. Despite good temperature control, psychrotrophic moulds, such as *Penicillium* spp.,

Cladosporium spp. and *Phoma* spp., are capable of slow growth in such gas atmospheres and may produce microcolonies or threads of growth within the designated shelf life of the grated cheese. Such microcolonies may be too few to be detected by conventional mould colony counting techniques and are likely to pass unnoticed by production staff assembling pizzas. However, by the time the pizza has reached the end of its designated shelf life, these microcolonies have been demonstrated to grow to a diameter that is observable by the consumer, resulting in an increased level of customer complaints. The solution to the problem is to limit the shelf life of the grated cheese to ensure that mould microcolonies cannot develop before the pizza is assembled, in other words, to ensure the maintenance of 'one shelf life'.

11.6.3 Cheese with additives

In recent years, many cheesemakers, especially artisan cheesemakers, have responded to consumer demands for more diverse varieties by adding flavour ingredients to their cheeses and, together with smoked cheese, products with added herbs such as parsley or chives, garlic, spices such as chilli or cumin, black pepper, dried fruits or even lavender or truffles are increasingly popular. Yet the microbiological status of these raw materials is often overlooked. It is important to undertake a risk assessment on added ingredients, especially herbs and spices as these may grow in or near the soil and may be sourced from developing countries where hygienic control measures may be less advanced than in the EU and North America. Spices may carry an exceptionally high microbiological loading, especially of bacterial spores, but pathogens, such as *Salmonella* spp., *L. monocytogenes* and *E. coli*, may also be present. Since flavour ingredients are often added to the curd without a heat treatment, they must be considered as ready-to-eat foods and need to be considered high risk. Wood smoke is a less tangible ingredient that in general, carries a low microbiological risk, though if the process is sub-contracted to a smokery that also handles raw fish or raw poultry then the microbiological risk may be not so low. Chemical hazards too may need to be assessed; the origin of the wood should be established as, although it may be unusual for a smokery to generate smoke from second-hand wood, it would be undesirable, for example, to use wood that has been treated with wood preservative.

11.6.4 Processed cheeses

Processed cheeses are generally of near neutral pH value and may be packaged in an anaerobic environment. Outbreaks of botulism due to the consumption of processed cheese spread have been reported (Jarvis & Neaves, 1977), and such products must, therefore, receive a sterilisation process that will eliminate spores of this *Clostridium botulinum* in the final product or contain preservatives that achieve the appropriate effect. Some spoilage clostridia are more heat-resistant than *C. botulinum* and may, therefore, survive and grow if low temperatures are not maintained throughout the product shelf life. To control the growth of surviving anaerobic spore-formers, processed cheeses may be preserved by the addition of nisin, a natural antibiotic produced by *Lactococcus lactis* subsp. *lactis*.

11.7 Cheese defects

The cheesemaker naturally expects to produce high-quality cheeses, but a major cause of quality defects in cheese is the presence and/or growth of microorganisms. Microorganisms may be present in the raw milk or other ingredients although, as stated previously, these are perhaps the least likely sources of the spoilage microflora. A more likely source of microbiological contamination is within the dairy itself, and post-heat-process contamination with spoilage agents (especially moulds) constitutes a significant risk to the microbial spoilage of cheese. Microbiological contamination may occur by entering the curd during its manufacture and subsequent handling, by contaminating the maturing cheese or even by contaminating the finished product during dispatch and transport. One of the characteristics of cheese manufacture, however, is that the fresh curd may be matured for several weeks, months or even years, which enables even slow-growing microorganisms to manifest themselves. Thus, a spoilage problem often appears long after the cheese was produced and creates difficulties for the investigator in ascertaining the precise circumstances under which the cheese was made.

Although gas production by coliforms has been a classical cause of 'early blowing' in many types of cheese, this rarely occurs nowadays because these organisms are easily destroyed by pasteurisation, and post-pasteurisation contamination is generally well-controlled. Similarly, for some decades, bacteriophage attack has been considered to be a problem of the past because of improvements in production hygiene and in the development of resistant starter cultures coupled with regular rotation to prevent build-up of bacteriophage infections (IDF, 1991; see also Chapter 5).

However, although the resistance of starter cultures to bacteriophages can be increased by manipulation of their growth media and conditions, part of the success is undoubtedly due to improvements in dairy hygiene, especially the management of airflow. The cheese industry is currently experiencing an expansion of the market for artisan cheeses of varied character, often manufactured in conditions typical of farmhouse production a generation ago. Several factors, including failure to understand primary sources of bacteriophages or management of airflow, especially in farmhouse cheese manufacture, together with propagation of starter mother cultures for extended periods, may lead to a revival of conditions that could result in a reemergence of bacteriophage problems. The inhibition of citrate-fermenting starter cultures by bacteriophages (or for that matter, antibiotics) is well-known to permit residual levels of citric acid to remain in the curd. Heterofermentative NSLAB are capable of fermenting citrate with the production of carbon dioxide. As a result, gassing may occur, with splits and fissures developing; in Parmesan production, inhibition of starter cultures is said to be a cause of explosion of entire wheels weighing more than 24 kg.

The involvement of yeasts in the maturation and spoilage of many cheese types is complex, and in many cases it is difficult to differentiate between increases in numbers resulting in flavour enhancement or the presence of species resulting in flavour or textural deterioration. Thus, for example, yeasts are considered to contribute to flavour development within and on the surface of Gorgonzola and Camembert (Nunez *et al.*, 1981; see Chapter 6). From the literature, it is clear that the dominant species of yeasts in cheese belong to the genera *Kluyveromyces* and *Debaryomyces* (lactose-fermenters), as well as a variety of other moderately salt-resistant species, depending largely on the type of cheese and, indeed, the region of

production (Fleet, 1990). Although there is evidence of the beneficial activities of yeasts as contributors to aroma and flavour, excessive growth is also implicated in undesirable changes, including softening, early blowing of Parmesan cheese (Romano *et al.*, 1989) and various forms of discoloration or slime formation. This latter may not always be considered a defect as it is a desired attribute when occurring on the surface of ripening Roquefort cheese as a result of growth of *Debaryomyces hansenii* (Besancon *et al.*, 1992). Purchasing specifications often pose problems for less-informed food technologists, who may be tempted to set a universal specification for yeasts in all types of cheese. Yeast levels of $\sim 10^4$ cfu g⁻¹ are not uncommon in some traditional, mature hard cheeses and have no deleterious effect; however, such a level in vacuum-packed block Cheddar at the start of ripening could result in loosening of the cheese bags during maturation due to the production of metabolic carbon dioxide.

Despite the considerable potential for bacteriophages and yeasts to bring about the spoilage of cheese, most defects in modern cheese production are associated with mould spoilage. Mould growth on cheese, both during ripening and in the hands of the consumer, has long been considered inevitable. However, food mycologists have now come to realise that cheese actually possesses a very specific fungal flora (known as the 'associated mycoflora' or, less edifyingly, as the 'funga'), and this enables them to consolidate their knowledge and to control problems.

The ripening environment varies tremendously, some cheeses developing a total coating of mould whilst others, such as waxed cheeses, show hardly any. The most common spoilage agents of British cheeses are, in fact, *Penicillium commune*, which is actually the wild type of the white Camembert mould, and *P. roqueforti*, which is used in the manufacture of blue cheeses. Other mould species are not uncommon, mostly other closely related species of penicillia, but also species of *Cladosporium* where cheese surfaces have become damp and a particular association with *Phoma*-type moulds causing 'thread-mould' defect in vacuum-packed, block Cheddar-type cheese. In other countries and on diverse types of cheese, there are also distinctive associated mycoflora, including *Aspergillus versicolor* on some Dutch cheeses, *P. discolor* on cheeses treated with natamycin as an antifungal agent and *Penicillium verrucosum*, the only potential ochratoxin A producer found in the cheese environment.

It cannot be overemphasised that the recognition of mould species on cheese is an essential prerequisite for the understanding and control of problems. Thus, for example, unwanted growth of *P. roqueforti* or *P. camemberti* may indicate cross-contamination from mould-ripened cheeses or an equivalent environment. Equally, other species of *Penicillium* would be highly undesirable, on both aesthetic and safety grounds, in place of the former moulds in association with a mould-ripened cheese. Thus, we have to distinguish between significant and non-significant moulds and take special account of our knowledge of the conditions that they require for growth. For example, in sampling a piece of cheese, it might well be possible to isolate and grow spores of both blue penicillia and highly toxigenic aspergilli as adventitious contaminants. However, the penicillia are capable of extensive growth and spoilage of cheese, whereas many aspergilli are incapable of growth under any conditions in which cheese might reasonably be expected to be stored. It should also be mentioned that significant levels of mould contamination are frequently misunderstood. All too often, specifications such as <100 cfu g⁻¹ are seen, whereas, in fact, a contamination rate of 1 cfu 1000 cm⁻² of a block cheese surface or indeed 1 cfu 10 g⁻¹ of cheese in a pizza topping might represent unacceptable contamination rates. In such cases, product specifications, as

is so often the case, become meaningless and reliance must be made on diligent application of preventative HACCP principles.

Finally, two popular misconceptions about mould growth on cheese need clarification. Firstly, whilst some of the moulds that grow are known to be potential mycotoxin producers, repeated analysis of cheese showing mould growth has failed to demonstrate significant or persistent quantities of mycotoxins beneath the rind of correctly manufactured cheese without fissures, in spite of the potential for mycotoxin production by the species of mould observed (Pitt & Hocking, 1997). Secondly, and contrary to uninformed popular belief, the moulds most commonly associated with cheese spoilage do not produce the antibiotic penicillin. Penicillin is only produced in significant quantities by 1 of the 150 or more known species of *Penicillium* (now known as *Penicillium chrysogenum*) as well as in minute traces by its domesticated counterpart *Penicillium nalgiovense*, which is used as a starter culture for the production of certain fermented sausages of the salami type (Pitt & Hocking, 1997). *P. chrysogenum* itself is one of the commonest mould species on earth, yet surprisingly is rare as a food spoilage agent and is not currently used in mould fermentations.

11.8 Prevention and control

As mentioned previously, microbiological problems associated with cheese manufacture can be summarised in three categories: (a) failure to make the product as intended, (b) defects resulting in spoilage or loss of quality of the finished product and (c) contamination that may result in an unsafe product. It has also been emphasised that these problems are likely to be highly variable, depending on the type of cheese, source of milk, processing, season of the year, geographical location and storage, distribution and consumption. It is therefore impossible to generalise about the prevention and control of problems but rather to advocate that the HACCP approach be applied to maintenance of safety and adapted, as appropriate, in conjunction with good manufacturing practice (GMP) (often referred to as prerequisite programmes) for the maintenance of product quality and prevention of spoilage. The HACCP system is well-understood and documented and is now adopted as a legal requirement in most countries involved in cross-boundary commerce; indeed, the requirement of food businesses to implement HACCP is now enshrined in EU food hygiene legislation (Anonymous, 2004).

The essence of the system, as refined by the Codex Alimentarius Commission of the World Health Organisation (Anonymous, 2003a), is actually a strictly rigid set of seven principles refined into a logical sequence of activities that, when applied to a food business, results in a unique safety management system, applicable only to that operation and reviewed and maintained in accordance with any changes occurring within that operation. Various generic HACCP-type studies relating to particular industries have been published but these are often inappropriate for the safety management of individual food businesses.

In cheesemaking, as with the manufacture of other products, there will be certain ingredients or process steps for which the prevention of contamination or control of microbial growth will represent CCPs within that process. It is essential that particular details of the entire process are considered individually to take into account the wide variety of processing and maturation conditions that are encountered. As a first example, milk quality (milk being the primary ingredient) may make either a major or a minor contribution to safety and quality

of the final product. Where pasteurisation is used, many significant pathogenic and spoilage microorganisms are inactivated and knowledge of the thermal death characteristics and likely contamination levels for specific organisms is required. On the other hand, in the absence of pasteurisation, systems must be in place to ensure either the absence of those organisms in the cheese milk or that the manufacturing process results in their destruction or reduction to acceptable levels. In the manufacture of unpasteurised milk cheeses, the complexity of safety issues is increased by the co-existence of an extensive microbial population that is considered by some to assist in the development of the individual characteristics of such cheeses, but may also compete with and suppress pathogens that might well cause problems in pasteurised milks lacking the associated microflora. Much of this information is admittedly speculative, although compellingly logical; however, the dynamics of bacterial growth in mixed culture has been documented and is known as the Jameson effect (Jameson, 1962). The existence of the Jameson effect reinforces the view that cheese manufacture must not be considered generically but at the individual production level.

During the cheesemaking process, a number of major problems can arise, again depending on the type of cheese process and manufacturing environment. We have already discussed 'slow vats' as a result of, for example, ineffective starter or bacteriophage contamination. The opportunities for prevention of problems are obvious, if not necessarily inexpensive. For example, it is often said that repeated subculture of a starter will enhance acid development and curd formation, yet this is just the circumstance which, when carried out ineffectively, can result in gross contamination leading to starter failure or presence of pathogens. However, this dilemma can be avoided by using direct-to-vat inoculation (DVI) or direct vat set (DVS) starter cultures (see Chapter 5).

During the cheesemaking process, extraneous contamination can also occur from a number of sources, most typically the indiscriminate use of high-pressure hoses, bad management of air and lapses of personal hygiene. Contamination may, therefore, be diverse and may include *S. aureus*, of significance during 'slow vats' and *L. monocytogenes* originating from the environment, especially in aerosols, as well as bacteriophages and spoilage moulds originating from farmyard or production area air. However, even in industrial-scale production, problems are not eliminated simply because of the scale of the process. Although air, water and personal hygiene may cause fewer problems, other effects may result in large-scale loss of production, as occurred, for example, in a block Cheddar manufacturing process when a decision was made to save money by reducing the strength of sanitiser used. The result was the universal contamination of cheese blocks with green thread mould.

The need for HACCP does not end with the initial manufacturing process but continues throughout the maturation and subsequent storage stages. Consideration must be given to the growth, survival or death of any significant contaminants present at the time of cheese manufacture, as well as the possibility of new contamination occurring during maturation. The control of microbial growth during maturation and throughout the subsequent shelf life is largely brought about by storage at a low temperature and controlled humidity. However, the microbial growth that brings about the desirable organoleptic changes during maturation of necessity may require a higher temperature than that permitted for storage of this type of food during its shelf life. This creates a dilemma because there may be no clear definition of where maturation ends and shelf life begins. Where an entire cheese is sold to a distributor who cuts and packs it into smaller portions, there may be a reasonably clear distinction

between maturation and shelf life, at which point the product storage temperature can be adjusted. However, many artisan cheeses are distributed intact, then further ripened, by either an affineur or the retailer, then cut by the retailer at point of sale and sold to the consumer at varying stages of ripeness. Such a wide variety of possible maturation conditions poses a particular challenge for those in the cheese industry who are involved in the preparation of HACCP documentation or establishing shelf life, especially when faced with the need to balance safety with the organoleptic desires of different consumers.

11.9 End-product testing and environmental monitoring

Not all pathogenic microorganisms are significant in cheese production and the importance of those that are significant depends to some extent on the cheese variety and the potential for growth, or indeed death during maturation and shelf life. The most significant pathogens in most cheese production are probably *L. monocytogenes*, *S. aureus* and *Salmonella* spp., as these all have well-established associations with food-borne disease and have all been isolated from cheese.

The significance of *E. coli* depends to a large extent on the strain that is present, since *E. coli* is not a single organism but a group of diverse strains, whose common origin is the digestive tract of humans and animals. Many *E. coli* appear to have little or no pathogenic potential but the emergence of *E. coli* O157 as a severe pathogen, and its isolation from some raw milk cheeses has become a cause for concern for cheesemaking. Indeed, the range of serogroups within the Shiga-toxigenic *E. coli* (STEC) group that poses a cause for concern and, in addition to *E. coli* O157, now includes serogroups O26, O91, O103, O111, O113 and O128 is expanding.

In certain soft cheeses, such as Mascarpone cheese or complex products such as cheese in oil, especially if fresh garlic has been added, *C. botulinum* may also be of concern; conversely, one of the few pathogens that has, so far, not been associated with cheese is *Bacillus cereus*.

11.9.1 End-product testing

Traditionally, the control of dairy product hygiene has been accomplished by the retrospective testing of finished product samples and for many decades, this control strategy had been considered adequate. However, the constant improvements in production hygiene that have occurred in recent decades have markedly reduced the incidence of microbial contaminants in finished products, and many microbiological methods have insufficient sensitivity for detecting levels of final product contamination that are considered to be commercially significant. In addition, increased knowledge of the epidemiology of food-borne disease has revealed that, for many pathogens, the infectious dose is considerably lower than was previously thought, in some cases (for example, *E. coli* O157) possibly fewer than 100 cells g⁻¹ (ACMSF, 1995).

In modern cheese production, microbiological safety of the finished product is, therefore, achieved through the application of HACCP to ensure that microbiological contamination does not build up to hazardous levels. The sixth of the seven principles of HACCP, as defined

by the Codex Alimentarius Commission (Anonymous, 2003a), is to 'establish procedures for verification to confirm that the HACCP system is working effectively'; therefore, end-product testing now forms part of the method for verifying that the process has been undertaken according to prerequisite programmes and HACCP rather than being the means of controlling production hygiene.

Further complications arise because cheese may be manufactured under a wide range of production conditions: (a) from either pasteurised, thermised or raw milk; (b) in some cheeses the starter cultures have a rapid rate of acid production, whilst for others the pH of the curd falls quite slowly; and (c) some cheeses are brined, whilst others are dry salted. Thus, the levels of specific organisms that might be expected in cheese depend on many factors and the presence of an organism may be acceptable in one type of cheese but of concern in another (for example, low levels of *S. aureus*).

For organisms, such as *Salmonella* spp., the infectious dose in cheese can be very low and an end-product specification of 'absent in 25 g' is appropriate for all types of cheese. At the other end of the scale, *S. aureus* can be consumed in relatively high numbers by most healthy adults without causing food poisoning. This is because staphylococcal food poisoning from cheese occurs as a result of the consumption of enterotoxin that is produced when the organism grows to high levels during cheese production. Staphylococcal enterotoxin is only released in significant quantities when the organism has grown to a population of 10^6 cfu g^{-1} and thus the consumption of 10^3 cfu g^{-1} would be unlikely to result in food poisoning (Ash, 1997). However, during the production of hard cheeses made from pasteurised milk, contamination and growth of *S. aureus* (or, more correctly, coagulase-positive staphylococci) can be controlled, since the organism can be eliminated from raw milk by pasteurisation and contamination from production staff can be prevented by ensuring high standards of personal hygiene. For this product, an end-product specification of <50 cfu g^{-1} is, therefore, reasonable. Conversely, for raw milk soft cheeses, low levels of *S. aureus* might well be present in the milk and can increase during a long, slow fermentation; EU legislation, therefore, specifies a target level of 10^4 cfu g^{-1} in cheese, with a maximum permitted level of 10^5 cfu g^{-1} in no more than two out of five samples (Anonymous, 2005a).

Specifications for *E. coli* are also complex and are further complicated by the emergence of *E. coli* O157, which is not only particularly hazardous but also has a low infectious dose and is not detected by most routine *E. coli* methods. *E. coli* O157 should, therefore, be regarded as a separate organism from 'conventional' strains of *E. coli*. Routine tests for 'conventional' *E. coli* are used as indicators of faecal contamination and thus the possible presence of enteric pathogens, such as *Salmonella* spp. or *Shigella* spp. Tests for 'conventional' *E. coli* are, however, also used as indicators of *E. coli* O157 because the latter is likely to be found in raw milk only at very low levels and because current detection methods are relatively unrefined. Specific tests for *E. coli* O157 are, therefore, often inappropriate. Indeed, in EU food hygiene legislation, Commission Regulation (EC) No. 2073/2005 (Anonymous, 2005a) states that 'The Scientific Committee on Veterinary Measures relating to Public Health (SCVPH) issued an opinion on verotoxigenic *E. coli* (VTEC) in foodstuffs on 21 and 22 January 2003. In its opinion it concluded that applying an end-product microbiological standard for VTEC O157 is unlikely to deliver meaningful reductions in the associated risk for the consumers'. Nevertheless, commercial specifications are set for *E. coli* O157 in cheese and tend to follow the example set by *Salmonella* spp., 'absent in 25 g' being the norm.

As in the case of *S. aureus*, end-product specifications for 'conventional' *E. coli* in cheese depend on the types of cheese; <10 cfu g⁻¹ might be appropriate for Cheddar made from pasteurised milk compared with $<10^3$ cfu g⁻¹ for Camembert made from raw milk. Interestingly, because of the complexity of establishing a specification for *E. coli* in cheese, the former EU legislative limit of 10^5 cfu g⁻¹ for *E. coli* in soft cheese (Anonymous, 1992) was abandoned in 2006, and the current EU legislation (Anonymous, 2005a) sets no limit for *E. coli* in these products.

As with other pathogens, the significance of *L. monocytogenes* in cheese depends on the numbers present and the potential for growth, since the infective dose for healthy adults is thought to be high, possibly $>10^6$ total organisms (Farber & Peterkin, 1991), though in susceptible individuals, $<10^3$ total organisms may be sufficient to cause disease (Anonymous, 2006). Therefore, it is probable that contamination of cheese with up to 10^2 cfu g⁻¹ at the point of consumption poses no significant risk for most consumers. *L. monocytogenes* does not grow during the maturation of hard cheeses and levels of contamination $<10^2$ cfu g⁻¹ are, therefore, not considered to pose a significant hazard, though such products made under conditions of GMP would be expected to achieve a standard of 'absent in 25 g'. However, in mould-ripened soft cheeses, *L. monocytogenes* can grow due to the rise in pH value during maturation, and for these products a standard of 'absent in 25 g' at the point of dispatch is a mandatory criterion set in EU legislation (Anonymous, 2005a); this legislation also requires the cheesemaker to be able to demonstrate that the numbers of *L. monocytogenes* in the product will not exceed the limit of 10^2 cfu g⁻¹ throughout the shelf life.

L. monocytogenes is one of several species in the genus *Listeria*, most of which have no known pathogenic potential. The significance of detecting other *Listeria* spp., especially in mould-ripened cheese, has therefore been the subject of intense debate. On the one hand, non-pathogenic listerias may be regarded as benign in themselves and their presence is of no consequence. On the other, they may be considered as 'indicator organisms', their detection alerting the cheesemaker to possible contamination with *L. monocytogenes*. The debate is further complicated by the inclusion of criteria for *L. monocytogenes* within EU legislation (Anonymous, 2005a), whilst there are no criteria for other *Listeria* spp.

The presence of coliforms or the wider group, the family Enterobacteriaceae, in cheese is universally regarded as an index of hygiene, especially in cheese made from pasteurised milk, but the levels to be expected depend on the type of cheese, its degree of maturation and the method of production. Enterobacteriaceae tend to die out during the maturation of acidic, hard cheeses and should not be present at high levels (for example $<10^2$ cfu g⁻¹) in mature, hard cheese, especially when made from pasteurised milk. Mould-ripened soft cheeses made from pasteurised or thermised milk should not contain high levels of Enterobacteriaceae, as these organisms are destroyed by even very mild heat processes and their presence thus indicates poor dairy hygiene. However, in soft cheeses made from raw milk, Enterobacteriaceae may constitute a significant proportion of the natural microflora; it is possible that in such cheeses, competition between different members of the Enterobacteriaceae may, in accordance with the Jameson Effect, exclude, or at least prevent the multiplication of, pathogens, such as *E. coli* O157 and, some may argue, their presence is not entirely unacceptable and may even be desirable.

A further complication arises because some manufacturers of mould-ripened soft cheese, whether made from raw or pasteurised milk, add a ripening culture of *Hafnia alvei*, a

slow lactose-fermenting member of the Enterobacteriaceae, as it produces the 'cabbagey' or 'farmyard' flavour that many consumers find desirable. This creates significant problems for the microbiology laboratory, since most routine laboratory techniques do not distinguish between adventitious contaminants and organisms added intentionally.

Because yeasts and moulds are detected by a single microbiological test, it is often assumed that these two groups of microorganisms have the same ecology. In fact, the sources and significance of yeasts and moulds in cheese are, to a large extent, different, and thus the two groups should be considered independently.

The significance of yeasts in cheese depends on the type of cheese, the nature of its production and the intended storage conditions. In traditionally produced Cheshire types or Cheddar types that possess a natural rind, a level of 10^4 cfu g^{-1} might be considered normal, the yeasts contributing to the flavour development. However, if the same type of cheese is produced without rind in vacuum-packaged blocks, an initial level of 10^2 cfu g^{-1} or below could have severe consequences for product quality, producing copious amounts of carbon dioxide within the cheese bag. The more cheese is handled, the more microbiological contamination is likely to occur; the large market for grated cheese or cheese off-cuts destined for manufacture (for example, for use as pizza toppings) can impose considerable hygienic constraints for the dairy that produced the original product. At the point of pizza assembly, a yeast specification of around 10^4 cfu g^{-1} may be acceptable for grated cheese, since the final product may have a relatively short shelf life (for example, 7 days at $<5^\circ C$). Therefore, the dairy producing the grated product must work to a more hygienic limit and may set a purchasing specification of 10^3 cfu g^{-1} ; this, in turn, may mean that an acceptable specification at the point of manufacture is 10^2 cfu g^{-1} . Given the exposed nature of many cheesemaking processes and the opportunities for environmental contamination, a dairy that intends to produce cheese for manufacture may have to operate to the most stringent hygienic regimes if product quality is to be assured, more so than for cheese destined directly for retail.

Very low levels of mould contamination on cheese can have severe consequences, even on mould-ripened cheeses, if contamination occurs with the wrong mould. A single mould spore landing on the surface of a large (for example, up to 80 kg) block of Cheddar or Emmental, for example, can eventually colonise the entire cheese surface, if it is allowed to germinate and produce its spreading mycelium under favourable conditions. Thus, end-product testing for moulds often results in a false sense of security, since a test with a detection limit of 10^1 or 10^2 cfu g^{-1} cannot be expected to detect 1 mould spore 80 kg^{-1} of cheese. Test methods routinely employed for the detection of moulds may also be inappropriate; pour plate techniques are often used to achieve a perceived greater sensitivity (detection limit 10^1 cfu g^{-1}) without considering that obligately aerobic moulds produce visible colonies most rapidly when inoculated onto the surface of a pre-poured agar medium, a method whose detection limit is generally no better than 10^2 cfu/g unless special techniques are employed (see Section 11.10).

11.9.2 *Environmental monitoring*

The high standards of hygiene employed in the majority of dairies nowadays mean that the levels of product contamination likely to occur are too low to be detected by end-product

testing. A much more secure means of demonstrating that cheese has been produced under hygienic conditions (for example, using HACCP) is, therefore, to monitor the microbiological status of the environment in which cheesemaking, maturation and storage take place by testing swabs collected from appropriate locations or, in the case of airborne contaminants, exposure plates of an appropriate agar. Swabbing exercises have, for many years, formed an intrinsic part of microbiological investigations and remain an essential element. Routine environmental monitoring for pathogenic organisms and spoilage organisms now forms part of the hygienic control of routine cheese manufacture, at least in the larger cheesemaking establishments.

Swabs should be taken from areas of the dairy most likely to harbour microorganisms ('environmental swabs') as well as from product contact surfaces. Environmental swabs are usually examined for specific pathogens, notably *Salmonella* spp., *Listeria* spp. and *E. coli*, whilst product contact swabs are generally examined for indicator organisms and may be taken either post-cleaning or pre-production, depending on the timing of the cleaning schedule. In most dairies, suitable locations for environmental swabs may include: (a) refrigeration units, (b) floors (especially wet areas), (c) drains and (d) footbaths and Wellington boots; whilst product contact surfaces may include:

- Inspection hatches on milk storage vessels;
- Valves and associated pipework;
- Cheese vats and curd-cutting equipment;
- Cheese moulds or presses;
- Shelving in maturation rooms.

Samples of brine may fall into either category and may be tested for *E. coli* and *Listeria* spp., whilst the hands of production staff may be examined for *S. aureus*. The results of hand swabs need to be interpreted with caution; however, as *S. aureus* is a natural inhabitant of skin so its presence is not necessarily indicative of poor personal hygiene. Testing hand swabs for coliforms or Enterobacteriaceae may provide more useful results as these organisms are not naturally present on skin so their detection denotes the potential for cross-contamination. Exposure plates should be made by placing open agar plates, for 30–60 min, in appropriate locations within the dairy and it is important that this is done during normal production as the movement of staff can dramatically increase airborne microbial contamination.

The major drawback of an environmental monitoring programme that employs conventional microbiological methods is that the results only become available several days after the swab was taken, delaying the implementation of corrective action and limiting the accountability of cleaning and production staff. In the case of environmental swabs tested for pathogens, this does not generally pose a major problem since the product should never come into direct contact with these swab sites. However, for product contact surfaces, a more immediate test result is highly desirable. The development of proprietary rapid tests that can measure the presence of adenosine triphosphate (ATP) has permitted an assessment of equipment hygiene to be made within a few minutes (Jervis, 1998). Rapid hygiene monitoring tests employ bioluminescence techniques. The 'first generation' of these measured 'microbial' ATP and attempted to relate this to numbers of organisms but, for most ATP tests, around 10^4 total organisms must be present on the swab for the microbial ATP to be

detectable, and a product contact surface could, therefore, harbour significant levels of microbial contamination that may remain undetected after cleaning. 'Second-generation' tests that measure 'total' ATP, which comprises both 'microbial' ATP and 'somatic' ATP (from product residues) were, therefore, developed since the presence of any ATP on a product contact surface at levels exceeding the baseline GMP expectations indicates that cleaning has been inadequate. Nowadays, simplified, 'third-generation', rapid hygiene monitoring tests exist that detect (product) protein residues, the presence of which indicates that the surface is unclean. The main advantage of rapid techniques thus resides, not in their accuracy or sensitivity, but in the 'visibility' of the method and the 'instant results' provided, which ensure that production and cleaning staff are 'policed', and are motivated to undertake cleaning tasks diligently, even though some rapid test swab results may have minimal scientific validity.

11.10 Microbiological techniques

For any food-borne microorganism, the range of analytical methods available seems almost as diverse as the number of food microbiologists, each analyst having his or her favourite variant. However, the dairy industry has been fortunate in having standardised many of its methods, largely through the work of the IDF; for a general description of the microbiological tests used in the dairy industry and the significance of the organisms they detect, the reader is referred to Neaves and Langridge (1998).

Microbiological tests fall into two categories: enumeration and detection (presence/absence) tests. Enumeration tests are not especially sensitive but provide a quantitative estimate of the numbers of organisms present in a sample, whereas detection methods are generally more sensitive, but provide a qualitative result only. The choice of method depends *inter alia* on the organism sought, the level of contamination expected and the market for which the product is destined (for example, manufacture or direct consumption); unfortunately, however, the need for a rapid result often plays a role, microbiologists being encouraged to use methods that provide a result quickly when a longer, perhaps more sensitive, method would be scientifically more appropriate, although generally more expensive.

Enumeration methods are used to estimate the levels of general bacterial contaminants (total viable count – TVC) and indicator organisms (coliforms or Enterobacteriaceae) as, for these groups, it is more important for the result to be quantitative than it is to have a test with a very low limit of detection. Detection methods are used for the more hazardous bacterial pathogens, such as *Salmonella* spp. and *L. monocytogenes*. Several organisms, however, fall between these two extremes, and for the less hazardous pathogens, such as *S. aureus* or *E. coli*, either type of method may be appropriate. For these organisms, the choice depends largely on the type of sample. For example, a test on cheese for sale to the general public might employ a simple enumeration method, since low levels of contamination may not be significant but for products destined to be used in baby foods, the ability to identify very low levels of contamination is essential and a detection method may be more appropriate.

Most microbiological tests employ selective, diagnostic media that suppress the growth of non-target organisms and provide characteristic colonial morphologies that help to identify the organism sought. Such media are, however, imperfect and a choice has to be made between the additional costs and time delays imposed by the confirmation of 'presumptive positives'

and the possible consequences of failing to detect any contamination present. In general, the constraints imposed by confirmation tests tend to be less commercially detrimental than a 'false-negative' result, especially in the case of pathogens, such as *Salmonella* spp., where failure to detect the organism can not only endanger the consumer but also (and, to some, more importantly) bankrupt the business.

The agar-plating technique used throughout the food industry for enumeration can detect a wide range of microorganisms, and is effective for bacteria and yeasts, since their unicellular growth habit enables the analyst to calculate a colony count. Bacteriologists, however, have attempted to employ colony-counting methods for the detection of food-borne moulds, much to the dismay of many food mycologists. The mycelial growth habit of moulds enables a single spore contaminating, for example, a block of Cheddar cheese to colonise, in time, the entire surface of the block, making the colony count technique meaningless. The colony count derived from a piece of non-sporing mycelium depends largely on the extent of maceration that occurs during sample preparation; a poorly macerated sample might yield a count of one or two propagules, whilst a well-macerated sample might yield a count of several hundred. However, if the mycelium had been allowed to sporulate on the cheese before sampling, a count of several million propagules would be found. All of these results could be derived from a sample contaminated initially by a single mould spore; thus, the significance of mould counts depends on the extent of mould growth that occurred before the sample was examined.

A yeast and mould colony count may have some significance for routine use, where successive batches of cheese are examined at an early stage of maturation, and an unusually high count indicates a deviation from the norm, but it has little relevance for the investigation of mould spoilage problems, where recognition and identification of the mould species present may be necessary to distinguish the natural mycoflora from the spoilage moulds. At present, however, such investigations are often severely hampered by the overpurification of commercial mycological growth media, creating atypical colours and distorted morphologies, thus making identification difficult or even impossible. The remedy is to add trace metals (copper and zinc) to all mycological media, the most convenient source of which is usually tap water.

The desire to use pour plate techniques instead of spread plates often stems from the perceived need to use a more sensitive method, since pour plates generally permit the examination of a larger aliquot of sample than spread plates. What is often not appreciated is the fact that moulds are essentially obligate aerobes and prefer to colonise solid surfaces and, therefore, grow well on spread plates but poorly in the depths of a pour plate medium. Despite its apparent sensitivity, the pour plate technique may fail to detect low levels of mould contamination and is not the most suitable method for detecting mould contamination of cheese. Modern mycological media contain antibiotics to inhibit bacteria and inhibitors, such as dichloran, to restrict rampant growth by some mould species; they are incubated for at least 5 days at 25°C to allow the development of slow-growing species (Pitt & Hocking, 1997).

For many decades, the development of 'rapid' microbiological methods has been a goal of those working in the food industry, perhaps the 'original' rapid methods being the dye reduction tests employing resazurin or methylene blue that are used for milk. These tests were first introduced over 60 years ago and are still in use today; however, for the production of many dairy products, they are no longer appropriate because hygiene standards have improved immensely and refrigeration is now in widespread use. As a result, the number of organisms that contaminate cheese and cheese milk has declined dramatically, well beyond the detection

limit of the test, and also the types of organisms have changed; many of those capable of growth under refrigeration do not bring about the dye reduction reaction. During the past two decades, attempts have been made to replace dye reduction tests with bioluminescence techniques, and their application to environmental monitoring has already been discussed (Section 11.9.2). An attempt was also made to employ bioluminescence techniques to assess the hygienic quality of tanker milk on arrival at the dairy, with the aim of producing a 'national standard' for acceptance or rejection (Bell *et al.*, 1996) by assessing the concentration of microbial ATP in raw milk. However, in this study, it proved impossible to obtain an acceptable 'national' correlation with the colony count technique, although some individual supplies showed a reasonable correlation. Thus, despite the considerable efforts of dairy microbiologists, the development of reliable, cost-effective and rapid methods is still awaited.

Cheese poses a particular challenge to sampling plans for microbiological examinations, since the distribution of contaminating microorganisms is often irregular. *L. monocytogenes* on a blue cheese, for example, has been shown to be distributed as 'microcolonies' present on the external surfaces only (Fleming & Bruce, 1998). In this investigation, tests by several laboratories that may have sampled internal portions of the cheese or single portions of crust yielded low counts of the organism, whilst the use of the systematic, structured IDF sampling plan (Anonymous, 2008) to select five core and five surface portions from each cheese consistently detected the organism in high numbers. Thus, a failure to employ a statistical sampling plan that recognises the irregular distribution of microorganisms in cheese is likely to result in a failure to detect microbial contamination and may have dire consequences if the organism sought is one of the more dangerous pathogens.

The different sectors of the food industry have evolved numerous variations in microbiological techniques to accommodate each sector's food commodities, and many food microbiologists have a passionate relationship with their own particular variations. However, the World Trade Organisation (WTO) requirement for international standardisation is now encouraging attempts to harmonise microbiological test methodologies through the work of the harmonisation of the IDF Standing Committee on Microbiological Methods. In recent years, the IDF has worked in increasingly close collaboration with the International Organisation for Standardisation, and this relationship has done much to destroy psychological barriers and develop 'horizontal' microbiological methods that are acceptable to microbiologists working in different food sectors. As a result, the existing, commodity-based, 'vertical' methods have now largely disappeared and 'harmonised' methods have been accepted, to the benefit of the food industry as a whole and in accordance with EU Regulations (Anonymous, 2005a).

11.11 Conclusions

Cheese is not a single commodity and the many cheese varieties to be found have diverse compositional properties. The microbiology of cheese is, therefore, complex and depends on many factors, often related to the production conditions of an individual dairy and sometimes even the time of year that cheesemaking occurred. Microbiological surveillance and control encompasses three distinct aspects: (a) studies of the 'beneficial' organisms that contribute to the organoleptic characteristics and 'healthiness' of cheese (starter cultures, starter adjuncts

and ripening cultures), (b) control of organisms that lead to quality defects (bacteriophages, spoilage bacteria and moulds) and (c) prevention of contamination with agents that can result in food-borne disease (pathogenic bacteria and their toxins) or indicate poor hygiene of production (hygiene indicator organisms).

The hygienic quality of raw milk in many countries has improved immensely in recent decades, though there is evidence to suggest that this may be of little consequence to dairies that make cheese from pasteurised milk. For the producer of raw milk cheeses, however, the minimisation of pathogens in the raw milk supply must be considered a critical aspect that determines the safety of the final product.

Both pathogenic bacteria and spoilage organisms can contaminate cheese at any stage of production and maturation; therefore, production hygiene must be given an importance equal to that of raw milk hygiene if contamination with pathogens and quality defects are to be avoided. Clearly, the presence of pathogenic contaminants may endanger the consumer, but the growth of spoilage moulds can also result in major economic losses.

Because low levels of microbial contamination can have major consequences for the cheesemaker, HACCP systems based on the seven principles as described by the Codex Alimentarius Commission are now becoming widespread, though the absence of 'absolute' CCPs during the production and maturation of cheese made from unpasteurised milk can complicate their implementation. End-product testing is no longer an acceptable means of microbiological control but should be employed as part of the procedure to verify that the HACCP system is operational. Monitoring environmental hygiene is considered to be a much more effective means of controlling microbiological contamination and is assuming an increasing importance. To satisfy the requirements of the WTO, microbiological techniques are being harmonised throughout the food industry and much benefit is to be gained from such standardisation.

Finally, whilst cheesemakers must react to current concerns over food poisoning incidents involving dangerous and emotive organisms, such as *E. coli* O157, it must not be forgotten that cheese is a comparatively safe commodity with an excellent track record, as demonstrated repeatedly by UK public health statistics. Its many varieties provide an immense appeal to the consumer and the control of organisms that may cause severe human illness within this rapidly diversifying sector of the food industry is, therefore, the dairy microbiologist's challenge for the future.

References

- ACMSF (1995) *Report on Verotoxin-producing Escherichia coli*, (Advisory Committee on the Microbiological Safety of Food). <http://acmsf.food.gov.uk/acmsfrep/acsmsfreports>.
- Anonymous (1992) Council Directive 92/46/EEC of 16 June 1992 laying down the health rules for the production and placing on the market of raw milk, heat-treated milk and milk-based products. <http://eur-lex.europa.eu/en/index.htm>.
- Anonymous (1997) *Salmonella gold-coast* and Cheddar cheese: update. *Communicable Disease Report Weekly*, **7**(11), 93, 96.
- Anonymous (1998a) Food Safety and Cheese. *International Food Safety News*, **7**(2), 6–10.
- Anonymous (1998b) *Escherichia coli* O157 in Somerset. *Communicable Disease Report Weekly*, **8**(19), 167.

- Anonymous (2003a) Hazard Analysis and Critical Control Point (HACCP) system and guidelines for its application. *Codex Alimentarius Basic Food Hygiene Texts*, Food and Agriculture Organization of the United Nations/World Health Organisation, Rome, pp. 33–45 <http://www.codexalimentarius.net/web/publications.jsp?lang=en>.
- Anonymous (2003b) *Dairy Processing Handbook*, 2nd and revised edition of G. Bylund (1995), pp. 307–309, Tetra Pak Processing Systems AB, Lund.
- Anonymous (2004) Regulation (EC) No 852/2004 of the European Parliament and of the Council of 29 April 2004. <http://eur-lex.europa.eu/en/index.htm>.
- Anonymous (2005a) Commission Regulation (EC) No 2073/2005 of 15 November 2005 on microbiological criteria for foodstuffs. (<http://eur-lex.europa.eu/en/index.htm>).
- Anonymous (2005b) Commission Regulation (EC) No 2074/2005 of 5 December 2005 laying down implementing measures for certain products under Regulation (EC) No 853/2004 of the European Parliament and of the Council and for the organisation of official controls under Regulation (EC) No 854/2004 of the European Parliament and of the Council and Regulation (EC) No 882/2004 of the European Parliament and of the Council, derogating from Regulation (EC) No 852/2004 of the European Parliament and of the Council and amending Regulations (EC) No 853/2004 and (EC) No 854/2004. (<http://eur-lex.europa.eu/en/index.htm>).
- Anonymous (2006) *Bad Bug Book*, Federal and Drug Administration. <http://www.cfsan.fda.gov/~mow/intro.html>.
- Anonymous (2008) *Milk and milk products – Guidance on sampling*. Joint International Standard ISO 707/IDF 050, International Dairy Federation, Brussels.
- Anonymous (2009a) Datum, the Market Information Service of DairyCo. <http://www.mdcdatum.org.uk/MilkSupply/milkquality.html>.
- Anonymous (2009b) Department for Environment, Food and Rural Affairs (DEFRA). <http://www.defra.gov.uk/animalh/tb/partnership/eradication-group/index.htm>.
- Anonymous (2009c) *Compendium of Data Sheets for Animal Medicines, Withdrawal Periods for Veterinary Products*, National Office of Animal Health Ltd., Enfield, UK. (<http://www.noahcompendium.co.uk/Compendium/Overview/-41030.html>).
- Ash, M. (1997) *Staphylococcus aureus* and staphylococcal enterotoxins. *Foodborne Microorganisms of Public Health Significance*, (eds A.D. Hocking, G. Arnold, I. Jensen, K. Newton and P. Sutherland), 5th edn, pp 313–332, Australian Institute of Food Science and Technology Inc., NSW Branch, Food Microbiology Group, North Sydney.
- Bell, C., Bowles, C.D., Toszeghy, M.J.K. & Neaves, P. (1996) Development of a hygiene standard for raw milk based on the Lumac ATP-bioluminescence method. *International Dairy Journal*, **6**, 709–713.
- Besancon, X., Smet, C., Chabaliere, C., Rivemale, M., Reverbel, J.P., Ratomahenina, R. & Galzy, P. (1992) Study of surface yeast flora of Roquefort cheese. *International Journal of Food Microbiology*, **17**, 9–18.
- Bindith, O., Cordier, J.L. & Jost, R. (1996) Cross-flow microfiltration of skim milk: germ reduction and effect on alkaline phosphatase and serum proteins, *Proceedings of the IDF Symposium Heat Treatments and Alternative Methods*, 6–8 September 1995, pp. 222–231, International Dairy Federation, Brussels.
- Djuretic, T., Wall, P.G. & Nichols, G. (1997) General outbreaks of infectious intestinal disease associated with milk and dairy products in England and Wales: 1992 to 1996. *Communicable Disease Report Review*, **7**(3), R41–R45.
- El-Gazzar, F.E. & Marth, E.H. (1992) *Salmonellae*, salmonellosis and dairy foods: a review. *Journal of Dairy Science*, **75**, 2327–2343.
- Evans, H.S., Madden, P., Douglas, C., Adak, G.K., O'Brien, S.J., Djuretic, T. & Wall, P.G. (1998) General outbreaks of infectious intestinal disease in England and Wales: 1995 and 1996. *Communicable Disease and Public Health*, **1**(3), 165–171.

- Farber, J.M. & Peterkin, P.I. (1991) *Listeria monocytogenes* – a food-borne pathogen. *Microbiological Reviews*, **55**, 476–511.
- Fleet, G.H. (1990) Yeasts in dairy products: a review. *Journal of Applied Bacteriology*, **68**, 199–221.
- Fleming, J. & Bruce, J. (1998) Judging bacteriological risks in food. *International Food Safety News*, **7**(1), 2–5.
- Fredsted, L.-B., Rysstad, G. & Eie, T. (1996) Pure-LacTM: the new milk with protected freshness and extended shelf life *Proceedings of the IDF Symposium Heat Treatments and Alternative Methods*, 6–8 September 1995, pp. 104–125, International Dairy Federation, Brussels.
- Frisvad, J.C., Filtenborg, O., Lund, F. & Thrane, U. (1992) New selective media for the detection of toxigenic fungi in cereal products, meat and cheese. *Modern Methods in Food Mycology* (eds R.A. Samson, A.D. Hocking, J.I. Pitt and A.D. King), pp. 275–284, Elsevier, Amsterdam.
- Grant, I.R., Ball, H.J. & Rowe, M.T. (1999) Effect of higher pasteurization temperatures, and longer holding times at 72°C, on the inactivation of *Mycobacterium paratuberculosis* in milk. *Letters in Applied Microbiology*, **28**, 461–465.
- Harding, F. (1995a) Hygienic quality, *Milk Quality* (ed. F. Harding), pp. 40–59, Blackie Academic & Professional, London.
- Harding, F. (1995b) The impact of raw milk quality on product quality, *Milk Quality* (ed. F. Harding), pp. 102–111, Blackie Academic & Professional, London.
- Harding, F. (1995c) Processed milk, *Milk Quality* (ed. F. Harding), pp. 112–132, Blackie Academic & Professional, London.
- Hillerton, J.E. (1998) Mastitis treatment – a welfare issue. *Proceedings of the British Mastitis Conference*, 7 October 1998, pp. 3–8, Institute for Animal Health, Compton, CA.
- IDF (1990) *Use of enzymes in cheesemaking*, Document No. 247, pp. 24–38, International Dairy Federation, Brussels.
- IDF (1991) *Practical Phage Control*, Document No. 263, International Dairy Federation, Brussels.
- Jameson, J.E. (1962) A discussion of the dynamics of salmonella enrichment. *Journal of Hygiene Cambridge*, **60**, 193–207.
- Jarvis, B. & Neaves, P. (1977) Safety aspects of UHT processed foods: thermal resistance of *Clostridium botulinum* spores in relation to that of spoilage organisms and enzymes. *Technical Circular No. 644*, Leatherhead Food Research Association, Leatherhead, UK.
- Jervis, D.I. (1998) Hygiene in milk product manufacture. *The Technology of Dairy Products* (ed. R. Early), 2nd edn, pp. 405–435, Blackie Academic & Professional, London.
- Larsen, P.H. (1996) Microfiltration for pasteurised milk. *Proceedings of the IDF Symposium Heat Treatments and Alternative Methods*, 6–8 September 1995, pp. 232–239, International Dairy Federation, Brussels.
- Law, B.A. & Goodenough, P.W. (1995) Enzymes in milk and cheese production. *Enzymes in Food Processing* (eds G.A. Tucker and L.F.J. Woods), pp. 114–143, Blackie Academic & Professional, Glasgow, UK.
- Neaves, P. (1998) *Mycobacterium paratuberculosis*. *International Food Safety News*, **7**(6), 2–3.
- Neaves, P. & Langridge, E.W. (1998) Laboratory control in milk product manufacture. *The Technology of Dairy Products*, (ed. R. Early), 2nd edn, pp. 368–404, Blackie Academic & Professional, London.
- Nunez, M., Medina, M., Gaya, P. & Dias-Amado, C. (1981) Les leuvres et les moisissures dans le fromages bleu de Cabrales. *Lait*, **61**, 62–79.
- Pitt, J.I. & Hocking, A.D. (1997) *Fungi and Food Spoilage*, 2nd edn, Blackie Academic & Professional, London, UK.
- Prentice, G.A. (1989) Living with *Listeria*. *Journal of the Society of Dairy Technology*, **42**, 55–58.
- Prentice, G.A. & Neaves, P. (1988) *Listeria monocytogenes in food*, Document No. 223, International Dairy Federation, Brussels.
- Romano, P., Grazia, L., Suzzi, G. & Giudici, P. (1989) The yeasts in cheesemaking. *Yeast* **5**(special issue), S151–S155.

- SCA (2007) *The Specialist Cheesemakers Code of Best Practice*, 2nd edn, Specialist Cheesemakers Association, London. (www.specialistcheesemakers.co.uk).
- Varnam, A.H. & Evans, M.G. (1996) Control of pathogenic micro-organisms in food: management aspects, *Foodborne Pathogens – An Illustrated Text*, 2nd edn, pp. 387–425 Manson Publishing, London.
- Williams, A.P. & Neaves, P. (1996) Editorial. *International Food Safety News*, **5**(7), 1.

12 Packaging Materials and Equipment

Y. Schneider, C. Kluge, U. Weiß and H. Rohm

12.1 Introduction

It is generally acknowledged that the packaging sector accounts for ~2% of the gross national product in developed countries and that approximately 50% of this market is related to food packaging (Ahvenainen, 2003). In the broader sense, the main functions of a food package are to surround and to enhance a particular product and to protect its contents against a varying number of hazards that might show a significant negative impact during storage, distribution or retailing. With respect to food materials (Fig. 12.1), these functions were defined by the Codex Alimentarius Commission in 1985: *Food is packaged to preserve its quality and freshness, add appeal to consumers and to facilitate storage and distribution* (Robertson, 2006).

In this context, the protection of a raw material or a processed product means to avoid exchanges with the environment (which can be considered as being physical, ambient or human; Lockheart, 1997) as regards to the transfer of moisture, heat, light, gases and volatiles leading to product deterioration. In addition, the packaging material also aims to protect the product from external biological sources, presumably causing adulteration, contamination or spoilage (Saravacos & Kostaropoulos, 2002; Vaclavik & Christian, 2003; Walstra *et al.*, 2006). Inertness is required in both directions; i.e. the migration from compounds or chemicals of the packaging material into the food must occur at a negligible (or at least tolerable) level, as is required that the packaging material is inert towards contents of the packed food (for example, no corrosion or adhesion). Extrinsic product cues refer to properties of the package, which are important from an economic or practical point of view, and comprise the external appearance of a package and its practicability and usefulness (easy-opening or re-closable, or 'boil-in-the-bag' – products), communication – the information which is transmitted through the package, ecological appropriateness, but also its price or the suitability for technological processes in retail or bulk units. Increasing demands with respect to product safety and shelf life extension, but also with respect to convenience have undoubtedly contributed to the significant expansion of the food packaging market.

Bearing in mind the difference between package (a physical unit that contains the product), packaging (the process of preparing goods for transport or delivery) and packing (the enclosure of one or more particular items in a package or a container), a distinction has to be made between various levels of packaging (Robertson, 2006). Whereas primary packages are in direct contact with the product, thus providing the primary protective barrier, secondary packages are mainly used as distribution carriers, even if used in retail outlets (for example, a cardboard box containing a particular number of packed cheeses). Depending on the size

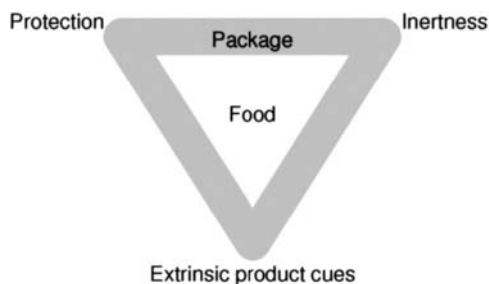

Fig. 12.1 Main functions of food packaging.

of the transport units, tertiary or quaternary packages might help to endorse the handling of these secondary units.

There are a number of factors interacting with the selection of packaging materials for a particular food commodity (Fellows, 2000; Brennan & Day, 2006). Packaging materials are entitled to:

- prevent the food from mechanical damage caused during handling and transport by, for example, vibration on belts or compression loads when stacked. Outer or secondary packaging (such as timber boxes used in cheese-ripening stores) might be useful to avoid product damage;
- affect the permeability of water vapour, gases (e.g. O₂, N₂, CO₂, H₂) or volatiles in or out. Weight loss or uptake might be controlled, as is the shelf life by creating a low-oxygen atmosphere in modified atmosphere packaging;
- provide an effective barrier against temperature, light or microorganisms;
- ensure chemical compatibility between packaging material and contents as no hazards must arise from a presumable leaching of toxic substances out of the packaging material and into the product; and
- affect the growth rate of microorganisms inside the packages by controlling the permeability of gases.

As regards hard or semi-hard cheeses, one may consider that the primary function of packaging can be completely different. When referring to the packaging of blocks or wheels of different size (starting with a few kilograms, including standardised euro blocks of 15 kg with 500 × 300 × 100 mm in size and, finally, also comprising wheels of hard cheese up to 100 kg), the main target to be assured is ripening. Rindless cheese ripening, i.e. the ripening of the product within a plastic film wrap, was developed around 1950 primarily to enhance processibility and mechanisation, but also to increase cheese yield. Compared to traditional cheese ripening, moisture loss and the inedible fraction of the cheese are significantly reduced when the products are subjected to maturation in plastic films. However, rindless ripening is only applicable for cheeses where the surface microflora does not play an essential role for establishing the typical characteristics of the product. It is also clear that, because of the metabolic activity of the microorganisms involved in cheese ripening, the properties of the films used for rindless ripening differ, to a large extent, from the materials used in the packaging of consumer portions, which are sold in retail outlets. In this particular issue,

packages are flushed with carbon dioxide, nitrogen or a mixture thereof before sealing, thus replacing regular atmosphere, generating a protective environment and increasing the shelf life by a factor of 2–4 (Sivertsvik *et al.*, 2002; Lyijynen *et al.*, 2003).

12.2 Cutting of the cheese

From the engineering point of view, cutting can be considered as a mechanical unit operation for the size reduction of semi-solid or soft solid materials by applying external forces. Typically, the separation is induced by the relative motion between a mechanical tool, usually a knife or a blade with a particular shape, and the product. The separating tool continuously penetrates the material with a predefined velocity, with or without removing material, and generates two cut faces. Cutting usually results in product sections of predefined size and geometry; however, size and shape of the products may vary considerably, starting with large pieces when separating cheese wheels or blocks up to producing slices, dices or stripes. Usually, on industrial scale, the cutting process is immediately followed by packaging.

The separation task itself, but also the particular material properties, shows a significant impact on the method of and the equipment used in cutting (Brennan *et al.*, 1990). General requirements for the cutting process are related to quality as well as to efficiency:

- defined shape of cutting segments (slices, dices, stripes);
- defined weight or volume of these segments;
- smooth cutting surfaces; and
- appropriate operational capacity.

12.2.1 Characteristics and features of food cutting

The main aim of the cutting process is to break internal bonds in a material by stressing structural elements due to the progressive motion of a mechanical tool. The stress within the material to be cut is directly proportional to the applied force, and inversely related to the contact area. Cutting starts when the total stress exceeds the internal strength of the cutting material. Food products are predominantly characterised by viscoelastic deformation properties, associated with stress relaxation and creep compliance. These time-dependent effects are responsible for the scattering of the deformation energy due to the expansion of the deformation field as well as due to decreasing stress levels in the close vicinity of the cutting edge (separation zone). Therefore, the cutting velocity must exceed the stress relaxation velocity to reach the fracture limit.

Generally, the process of cutting viscoelastic solids, such as cheese, is affected by (Atkins *et al.*, 2004):

- the combination of biaxial, elastic and plastic deformation of the food matrix surrounding the cutting edge;
- fracture near the cutting line; and
- friction along the cutting tool flanks.

12.2.2 Parameters affecting cutting performance

Apart from geometrical and other special properties of the cutting tool (including wedge angle, blade fineness, displacement volume, edge shape, material, roughness or coatings), cutting velocity, and direction of the applied force, the efficiency of a cutting system and the resulting cutting force depend, to a large extent, on the mechanical properties of the product to be cut (Atkins *et al.*, 2004).

Cheese properties

The mechanical properties of cheese are largely influenced by the classification with respect to moisture content (very hard, hard, semi-hard, soft and fresh cheeses), its individual composition and state (fat content, degree of maturation, eye and rind formation, and particular ingredients, such as spices, nuts or seeds) and temperature. It is typical for most cheeses that high-friction forces occur during cutting, and that they easily stick to the cutting tool. In the worst case, the stress caused by friction exceeds the fracture strength of the material, thus leading to tearing effects along the cutting planes, associated with smearing and crumbling (Brown *et al.*, 2005).

Cutting movement and cutting angle

The cutting movement is determined by the direction of the relative motion between the cutting tool and the product. The direction of the relative motion itself is a function of the cutting angle λ between the edge axis and the axis which is perpendicular to the cutting direction (Raeuber, 1963). The tangent of the cutting angle represents the so-called slice-and-push ratio, the ratio of cutting velocities tangential and perpendicular to the cutting edge (v_t and v_n in Fig. 12.2, respectively). The guillotine cut ($\lambda = 0$) may be considered as a basic configuration, where a single-motion component acts perpendicular to the cutting edge. When a motion component acting tangential to the cutting edge is added ($0 < \lambda < 90^\circ$), the forces originating from product deformation and fracture effects usually diminish. On the

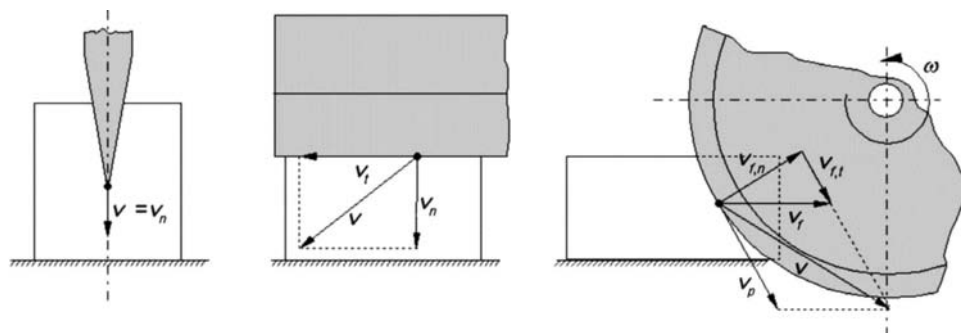

Fig. 12.2 Principle of cutting: Guillotine cut and slicing cut with straight blades (left and middle), and slicing cut with disc blade (right). v , cutting velocity; v_f , feeding velocity; v_p , peripheral velocity. Indices: n , normal component; t , tangential component.

other hand, friction force components become more important with increasing cutting angles, especially when considering materials with pronounced friction effects such as most cheeses. Consequently, the cutting angle should be adjusted to fit the fracture and friction properties of a particular cheese (Atkins *et al.*, 2004; Atkins & Xu, 2005). From a constructional point of view, a slicing motion may be achieved by combining normal and tangential linear drives or rotating blades with linear or curved cutting edges, i.e. with disc or sickle-shaped blades, with or without linear feed drive (Atkins, 2006).

12.2.3 *Cutting velocity*

While the moving direction is usually determined by the construction of the cutting machine, throughput and quality of the cuts might be influenced by varying cutting velocity, and by superpositioning secondary motions. Nowadays, for practical purpose, the cutting velocity is used as a capacity measure and is specified in cuts per unit time, including the time for cutting, repositioning of the cutting tool and product feed. Basically, however, the cutting velocity is the velocity with which the cutting front moves through a product, and which is represented by the speed vector resulting from normal and tangential or from linear and rotational motions. For soft viscoelastic solids, an increase in the cutting velocity causes material strengthening and an increase in cutting forces (Goh *et al.*, 2005; Zahn *et al.*, 2006). On the other hand, time-dependent deformation and relaxation effects decrease with increasing cutting velocities, and the stress in front of the cutting tip increases immediately. Consequently, separation with less material deformation can be achieved. However, the increase in applied velocity is limited by viscous contributions and stickiness in viscoelastic materials where structural damages should be avoided. Similar high-speed effects are also used in ultrasonic cutting configurations. It is typical for this technique that, besides the conventional feed movement, the cutting tool is excited by an ultrasonic vibration (usually in the 20–50 kHz, with amplitudes approximately 5–30 μm). The specific micro-motion characteristics support the cutting process by focussing the energy at the cutting front and by reducing friction interactions (Schneider *et al.*, 2002, 2008; Zahn *et al.*, 2005; Lucas *et al.*, 2006).

Design and positioning of cutting tools

The blade material itself, and lateral forces acting on the blade are responsible for the evolution of friction between the product and the knife along the wedge and the flank, and friction significantly contributes to the formation of the plastic deformation zone. For a satisfactory cutting performance, plastic deformation must be minimised to avoid irreversible damage of the cutting segments. This can be achieved by keeping the wedge angle, the blade fineness and the contacting flank area as small as possible. Otherwise, the cutting tool needs a sufficient firmness to resist the cutting forces (Linke & Kluge 1993; Atkins *et al.*, 2004; McCarthy *et al.*, 2007). As the geometry of the cutting tool and the relative motion determine the cutting force, straight blades or blades with constant or variable curvature (sickle shape) are preferably used. Straight blades for intermittent cutting procedures may be arranged in grid- or star-shaped assemblies. In case of rotating curved tools, the radius of the blade and the rotational speed determine the circumferential velocity. This circumferential velocity

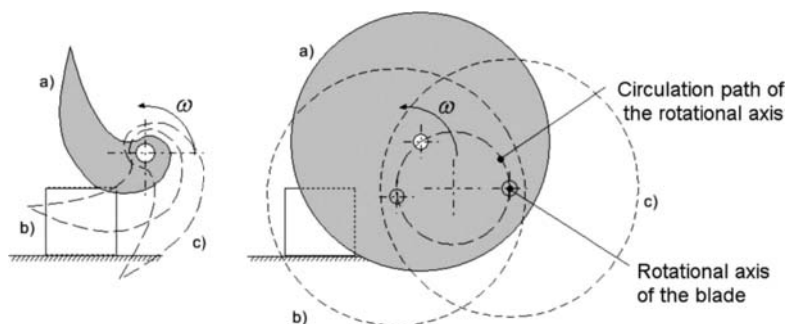

Fig. 12.3 Slicing units with sickle-shaped and disc blades. Note: 'a)' and 'b)' are cutting position and 'c)' is feeding position.

is constant for disc-shaped blades (constant radius), but varies along the cutting edge of sickle blades (variable radius) while the slice–push ratio depends on curvature geometry. Consequently, the blade profile has to be adapted to meet the product's requirements. The feed of the product is in plane with the blade axis for disc blades where the product passes the blade singularly, and out of plane with the axis for sickle blades and eccentrically rotating disc blades (Fig. 12.3). For these geometries, cutting and feeding for the following cutting sequence can be realised within a single revolution of the sickle blade or within a single revolution of the centre of the rotating disk. In addition, the slice–push ratio is determined by the relative positioning of the feed line towards the rotation axis of the cutting blade (Atkins & Xu, 2005; Atkins, 2006). A reduction of the contact area between product and tool can be achieved by:

- inclined positioning of the cutting wedge axis against the moving axis;
- recessions along the tool flanks;
- anti-adhesive coatings (i.e. polytetrafluorethylene); and
- replacing conventional blades by wire systems (Fig. 12.4).

Wire systems are characterised by a steady-state cutting phase once the cutting wire has penetrated the cheese because of the absence of extensive friction areas. With increasing

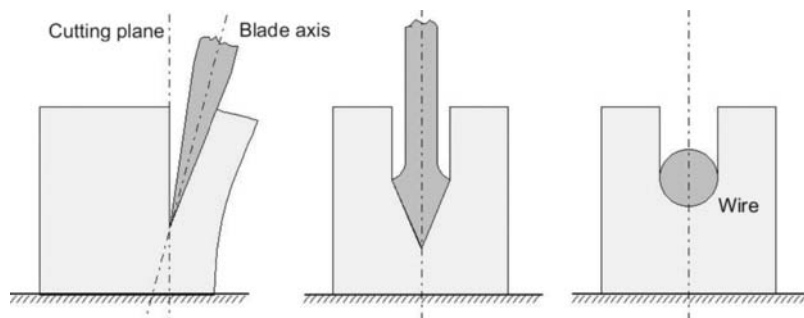

Fig. 12.4 Technical methods for friction reduction – inclined positioning (left), recessions in the tool flanks (middle) and wire-cutting systems (right).

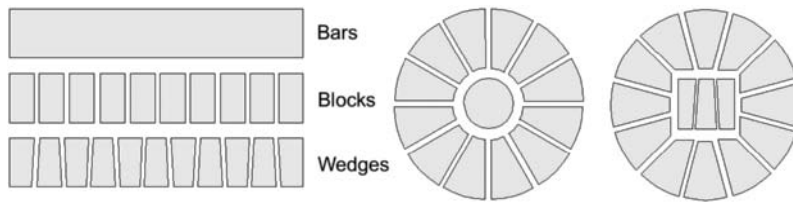

Fig. 12.5 Cutting patterns for partitioning of cheese blocks and wheels.

wire diameter, an increase of the cutting energy *per* unit area, but also a decrease of the cutting surface quality due to tearing effects may be expected (Kamyab *et al.*, 1998; Goh *et al.*, 2005; Dunn *et al.*, 2007). Wire system devices usually are single taut or slack wires or multiple row or criss-cross combinations (Dunn *et al.*, 2007).

12.3 Applications of cutting

Apart from semi-mechanised units used in retail outlets or by catering services, cutting assemblies are highly automated and usually consist of a central cutting unit, which may be combined with peripherals for feeding, depositing, discharging, distributing and packaging of the cheese product. Starting with blocks (0.1–0.6 m in length) or wheels (from 0.1 up to 0.8 m in diameter) cheeses are stepwise cut into smaller segments for further use.

12.3.1 Partitioning and segmentation

Separating into segments is, in most cases, the first step in size reduction, which can be applied to hard, semi-hard and soft cheeses without problems. The process results in bars or wedges, which are used as feed of further cutting units or for final packaging of wholesale or retail units; the weight of the individual pieces may vary from ~100 g up to several kilogrammes (Fig. 12.5). For separating cheese blocks or wheels, the method of choice is the intermittent guillotine cut with a repositioned tool. Prior to cutting the block or wheel is centred on a cutting board with slots which are consistent with the desired segmenting pattern. Depending on the mechanical properties of the cheese and on the demands on precision it might be necessary to punch a circular or square hole in the centre before the division of the wheel starts. To separate a wheel with a single cut, the cutting device must be equipped with several blades or wires arranged in parallel or radial positions. In systems equipped with only one cutting blade, subsequent cutting steps are realised through rotation of the cutting board or by parallel and/or angular adjustment of the single cutting tool (i.e. wedge blade, wire, ultrasonic blade) while it is repositioned. In this context, ultrasonic cutting units meet the specific requirements regarding high-precision cutting and handling of soft and highly adhesive cheeses, for example, Brie and Gorgonzola cheeses as well as fragile or crumbling products like Feta cheese.

Separating into sections with a defined mass is facilitated by additional equipment for weighing, for the optical measurement of height and shape of the blocks and wheels and for

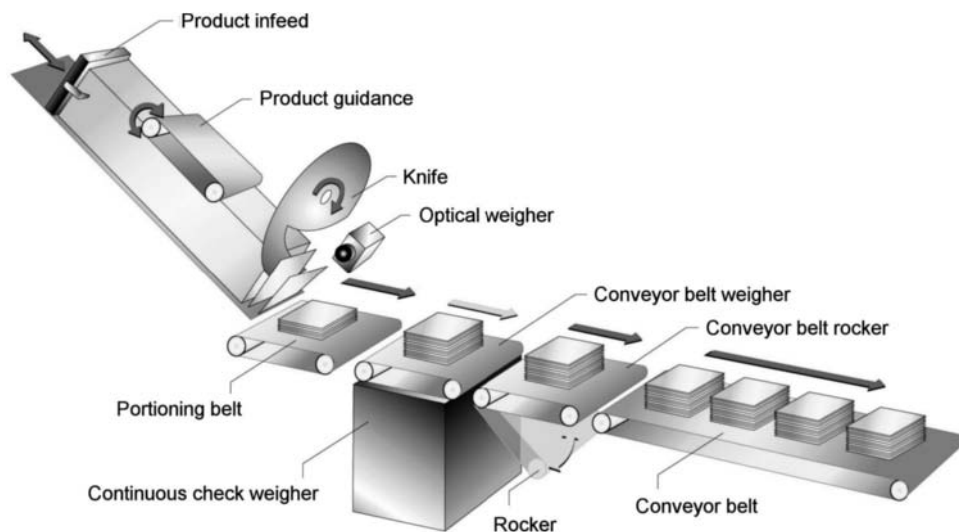

Fig. 12.6 Operation principle of a slicer. (Reproduced by permission of ELAU AG, Marktheidenfeld, Germany.)

calculating an optimum cutting pattern. Under such circumstances, the use of rotating sickle blades may be beneficial. Blades are positioned with the rotating axis lateral to the cheese wheel and the cutting edge is operating in radial direction. The wheel has to be adjusted by the calculated angular positioning for each cut. The cutting capacity of such units typically is 50–150 sections per minute.

12.3.2 Slicing

Slicing, which is mainly applied to hard and semi-hard cheeses, is a procedure in which the pre-cut bars are separated into slices of constant thickness. The cheese bars are guided and fixed automatically on inclined feeding units (Fig. 12.6). Slicers operate with curved rotating blades. After each cut, the product is moved for the desired distance, corresponding to slice thickness (usually <3 mm), and the cutting capacity is more than $1000 \text{ cuts min}^{-1}$ for well-adapted systems. Because of the inclined product supply, the slices fall off by gravity, and are then deposited by weight or number on trays. If the cheese is very sticky or adhesive, the slices are separated from each other by parchment or plastic inter-layers. The arranged bulks are then transferred to the packing equipment.

12.3.3 Dicing

Dicing represents a step-by-step process where the bulk material is cut into thick slices, then into stripes, and finally diced. Technically, dicing is made by combining slicing, circular and crosscut knives or knife spindles (Fig. 12.7). The size of the cubes can be controlled by using adapted cutting spindles, and by adjusting the slice thickness or the rotational speed of the

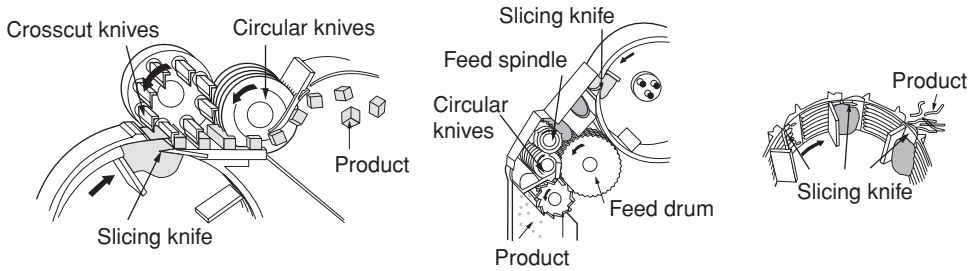

Fig. 12.7 Principle of dicing and shredding. (Reproduced by permission of Urschel Laboratories, Inc., Valparaiso, USA.)

cutting spindle. The cubes or stripes are used for snacks, salads and delicatessen products. Primarily, dicing is used for hard and semi-hard cheeses.

12.3.4 Shredding

Shredding is the cutting procedure resulting in the smallest product sections and, usually, centre punches, border cuts or inaccurate cheese sections with structure defects are comminuted. Contrary to dicing the shreds are not defined in length, but the cross section is determined by the shape of the blades. Usually, the bulk segments are guided towards tangentially positioned blades in a rotating cutting drum (Fig. 12.7) and the cheese is rasped into stripes or shreds. A number of differently profiled blades for oval, crescent, square or V-shaped shreds are available. Hard and semi-hard cheeses can easily be processed, mainly to be used for pizza topping and in convenience food, but also for retail sale.

12.4 Packaging of cheeses

12.4.1 Specific requirements

The selection of materials for cheese packaging requires knowledge on the following aspects:

- the properties of the product, which are relevant for the packaging process (e.g. number, form and size), the influence of the intrinsic processes which, in the case of cheese, is obviously maturation; and
- the influence of extrinsic factors on the properties of the cheese which, in case of light, might be a change in flavour or colour.

A significant impact on the required properties and hence, selection of packaging materials is the main objective of the package, whether it is intended to protect the cheese during the maturation stage or to conserve the product to the satisfaction of the end user in the household. Due to the metabolism of the microflora during maturation, there is some carbon dioxide production the amount of which obviously depend on the cheese characteristics

(carbon dioxide may originate not only from lactobacilli which produce CO₂ in traces, but also from secondary starters, as is the case for propionic acid bacteria in various hard or semi-hard cheese varieties). Hence, a transfer of carbon dioxide through the packaging material(s) is necessary to avoid bulging/blowing of the package (Kammerlehner, 2003). To avoid surface softening or extensive mass losses, the water vapour and gas permeability of the packaging material used for maturation have to be selected by considering the specific properties of a particular cheese variety. Other functional properties of the packaging material used for the maturation of the cheese are to protect the product from contamination and to avoid the uptake and/or release of volatiles. Furthermore, the material selection is affected by processing properties of the packaging material, which comprise mechanical stability, firmness, heat scalability, machine runability, ecological and economical constraints, and by demands expressed by the retail market and the end consumer.

12.4.2 Packaging materials

Apart from the processing properties of a particular packaging material, including susceptibility to thermoforming, sealing temperature of composites, tensile strength and elongation until fracture, it is mainly the resistance against permeability of various gases (mainly oxygen, carbon dioxide and nitrogen) and water vapour, which determines its appropriateness for cheese packaging. The permeability coefficients can be calculated from steady-state permeation of a permeant with a constant diffusive flux per unit of time and area. The permeation coefficient or permeability P is:

$$P = \frac{Qx}{At(p_1 - p_2)} \quad (12.1)$$

where Q is the total volume of the permeant in mol, x is the thickness of the packaging material in m, A is the surface of the packaging material in m², t is the time in s, and $\Delta p = p_1 - p_2$ is the difference of the vapour pressure of the permeating gas on both sides of the packaging material in Pa. In other words, the dimension of P in SI units is mol m m⁻² s⁻¹ Pa⁻¹ (Robertson, 2006). Unfortunately, this SI unit is rarely used and the permeability of gases is, for example, given as mL or g permeant passing through 1 m² of a material within 24 h at a given pressure difference of 0.1 MPa (1 bar) (Bergmair *et al.*, 2004). Frequently, the packaging material thickness is fixed to 100 μm; the volume is usually standardised for $\Delta p = 1$ bar and $T = 25^\circ\text{C}$. Permeability coefficients given in British or American units can be converted into any other unit by means of appropriate conversion factors. The volume or permeant then corresponds to:

$$Q = \frac{P}{x} At \Delta p \quad (12.2)$$

where P divided by x refers to permeance and the rest of the symbols are similar to those shown in Equation 12.1.

The above given permeability is, however, only valid under the assumption that diffusion is at a steady-state, one dimensional and concentration independent; in addition, the permeation

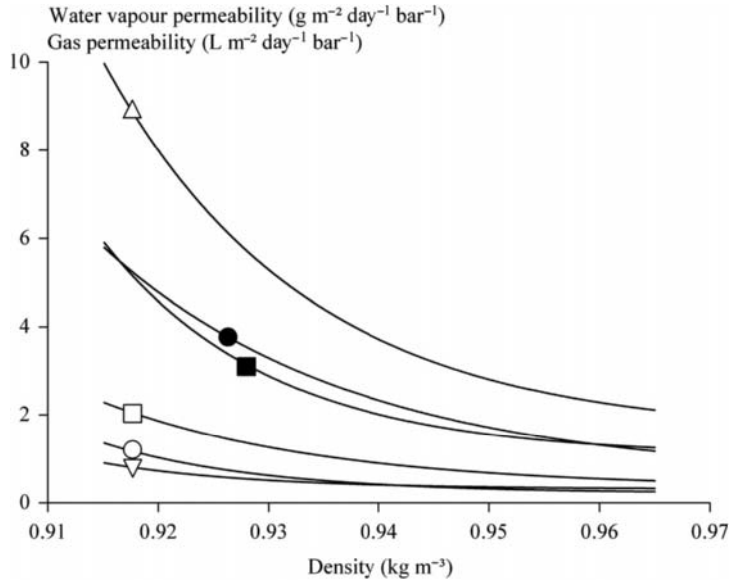

Fig. 12.8 Permeability of polyethylene (PE) as a function of density at 23°C (open symbols) and 40°C (closed symbols). Note: ● and ○, water vapour; ■ and □, oxygen; △, carbon dioxide; ▽, nitrogen. The data are based on a layer thickness of 100 μm . (Redrawn from published data of Dominghaus, 2005, with kind permission of Springer Science and Business Media.)

through pores is not considered. The permeability of an entire package made of a particular material with a known thickness is, accordingly, given as permeant volume per day and 0.1 MPa (1 bar). The gas and water vapour permeability of polyethylene (PE) as a function of PE density is shown in Fig. 12.8.

Gas or water vapour permeability may be reduced and processing properties of mono-layer materials may be improved by combining two or more mono-layer materials into composites (methods are coextrusion, coating or laminating), and also by metallisation with aluminium (Al) foil or silicium oxide (SiO_x); usually, permeability reduction is >90%. The permeability of a composite can be calculated from P and x of the contributing materials:

$$P = \frac{x_1 + x_2 + \dots + x_n}{\frac{x_1}{P_1} + \frac{x_2}{P_2} + \dots + \frac{x_n}{P_n}} = \frac{x_T}{\frac{x_1}{P_1} + \frac{x_2}{P_2} + \dots + \frac{x_n}{P_n}} \quad (12.3)$$

where the indices refer to material 1, 2, ..., n , and x_T is the thickness of the composite. In case of n different layers of equal thickness x , this equation reduces to:

$$P = \frac{nx}{\frac{x}{P_1} + \frac{x}{P_2} + \dots + \frac{x}{P_n}} \quad (12.4)$$

As Q is inverse proportional to x (Equation 12.2) it also follows that:

$$\frac{P_1}{P_2} = \frac{x_2}{x_1} \quad (12.5)$$

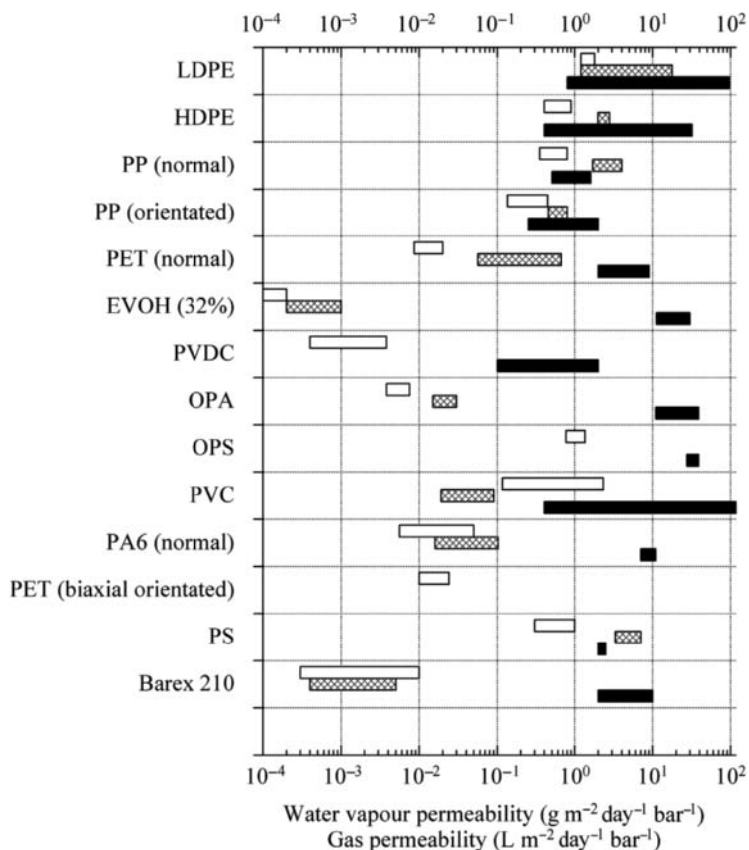

Fig. 12.9 Permeability of selected packaging materials. Note: open bars, oxygen; hatched bars, carbon dioxide; black bars, water vapour. The data are based on a layer thickness of 100 μm . For abbreviations of laminates, refer to Table 12.1.

Minimum and maximum values for oxygen, carbon dioxide and water vapour permeability were collected from various sources (Jenkins & Harrington, 1992; Tamime, 1993; Strehle, 1997; Buchner, 1999; Piringer, 2000; Nentwig, 2006; Walstra *et al.*, 2006), and are shown in Fig. 12.9. The large variation in the published data (larger than one magnitude in many cases) implies that many factors contribute to the packaging material permeability and single-literature values are of limited use, and only may contribute to permeability estimation. Presumable factors of influence are, among others, the physical state of the packaging material (crystallinity, microorientation), which is affected during processing, differences in thickness, especially around edges, the exact chemical composition of the material, particularly type and concentration of additives and its density, which are rarely known. In addition, real environmental conditions scarcely comply with conditions in the laboratory.

Table 12.1 illustrates some selected materials used for the packaging of cheeses and are classified with respect to their chemical structure. Materials supplied by the industry are usually adapted for the specific use or a specific cheese variety. Primary packages are laminates of thermoplastic polymers, cardboard, cardboard/plastic or cardboard–aluminium foil and

Table 12.1 Plastic materials used for food packaging.

Classification	Abbreviation	Chemical declaration
Cellulose derivatives	CA	Cellulose acetate
	NA	Cellulose film, cellophane
Polyolefins	PE	Polyethylene
	LDPE	Low-density polyethylene
	HDPE	High-density polyethylene
	PP	Polypropylene
	OPP	Orientated polypropylene
Ethylene copolymers	EAA	Ethylene-acrylic acid
	EVA	Ethylene vinyl acetate
	EVOH	Ethylene vinyl alcohol
Polyesters and polyamide	PEN	Polyethylene naphthalate
	PEDT	Polyethylene dioxithiophene
	PET	Polyethylene terephthalate
	PA	Polyamide
	OPA	Orientated polyamide
Substituted olefins	PVC	Polyvinyl chloride
	PVDC	Polyvinylidene chloride
	PVAC	Polyvinyl acetate
	PS	Polystyrene

NA, none applicable.

waxes. The materials used in laminates can be widely varied and combined, both with respect to the single-layer chemistry, layer number and layer thickness to fulfil the target requirements. Typical laminates are, for example, polyamide/polyethylene (PA/PE), PE/PA/PE, polyethylene terephthalate (PET)/PE, oriented polyamide (OPA)/PE, polystyrene/ethylene vinyl alcohol (PS/EVOH), PE/PE or PE/Barex, which is an acrylonitrile/methacrylate copolymer. Oxygen diffusion-blocking layers are mainly EVOH, PET and Barex and to some extent, polyvinylidene chloride (PVDC). When using aluminium foil laminates, gas and water vapour permeability are practically negligible (Tables 12.2 and 12.3).

12.4.3 Packaging of hard and semi-hard cheeses

Maturation packages

With respect to subsequent packaging, one has to distinguish between 'traditional' cheeses with a dry rind, which protects the interior of the product from the environment and rindless cheeses which usually, during ripening, are wrapped in plastic films. In case of cheeses with a rind, enhanced moisture losses during proceeding maturation or any infestation with pests may be prevented by coating the cheese wheels with coloured paraffin wax, mixtures of beeswax and microcrystalline paraffin and hot-melts made from paraffin wax and synthetic polymers. Also used are synthetic dispersions made from low-molecular weight polymers/copolymers of ethylene, polyvinyl acetate, esters of maleic or fumaric acid when combined with thickeners and many more (Sturm, 1998; Strehle, 1997; Spreer, 2006).

Table 12.2 The specifications of some laminated packaging material used to pack cheese.

Intended use	Laminate		Permeability ($\text{cm}^3 \text{m}^{-2} \text{day}^{-1} \text{bar}^{-1}$, $\text{g m}^{-2} \text{day}^{-1} \text{bar}^{-1}$)			
	Composition ^a	Thickness (μm)	O ₂	CO ₂	N ₂	H ₂ O
Packages for cheese maturation						
	Coextruded with PA and a PE sealing layer	110	100	360	60	<1.0
	Lower film (PA/PE)	54/116	13	46	8	1.5
	Upper film (PE/PA)	30/100	22	80	13	1.5
	Lower film (PE/PA/PE)	62/20/128	9	32	6	—
	Upper film (OPP/PE/PA)	40/70/90	27	95	15	2.0
Retail packages for sliced cheeses (with no gas production, e.g. Cheddar)						
	Lower films PET/PE or PET/PE	300/50 250/50	12 14	60 42	7 9	1.5 1.0
	Upper films PET/PE or PET/PET/PE	36/70 12/23/54	35 40	128 160	21 20	2.0 8.0
Retail packages for sliced cheeses (with slight gas production, e.g. Gouda) using hard box pack (RC) ^b						
	Cover film (OPET ^b /PE)	23/75	85	340	43	2.0
	Trough film (PET/HM/PE) with migration barrier	200/25/25	5	20	2.5	1.5
	Tubular bag (OPA/PE)	15/40	60	240	30	4.0
Retail packages for sliced cheeses (with high gas production, e.g. Emmental) using hard box pack (RC)						
	Cover film (OPET/PE)	40/60	550	2200	275	1.5
	Trough film (PET/HM/PE) with migration barrier	200/25/25	5	20	2.5	1.5
	Tubular bag (OPA/PE)	10/50	90	360	45	4.0
Retail packages for cheese portions without gas production						
	Tubular bag (OPA/PE)	15/40	4	16	2	4.0
Retail packages for cheese portions with low gas production						
	Cover film (OPA/PE)	15/40	60	240	30	5.0
	Bottom film (PA/PE)	15/120	40	160	20	1.5
	Tubular bag (OPA/PE)	15/40	60	240	30	5.0
Retail packages for grated cheese, e.g. Emmental						
	Tubular bag (OPA/PE)	15/40	60	240	30	5.0

^aFor abbreviations of laminates, refer to Table 12.1.

^bRC, re-closable; HM, hot melt; OPET, oriented polyethylene terephthalate.

On the other hand, it is frequently desired to increase productivity by preventing the loss of moisture during maturation. Such cheeses might be considered as less 'traditional' by the well-informed consumer but nevertheless, it is the state of the art for most mass products. In this case, the cheese blocks are dried at the surface after brining, and then packed under medium vacuum (50–70 kPa) in tubular bags, side-sealed bags or wraps, which are then closed by means of hot sealing or metal clips. Heat shrinking the packaging material at 85–92°C after wrapping the block of cheese ensures a tight contact between surfaces/edges of the product and the packaging material (Sturm, 1998). It is an absolute prerequisite to achieve an adequate balance between the packaging material and the cheese variety with respect to water vapour permeability and the permeation of gases, such as carbon dioxide (CO₂) and ammonia

Table 12.3 Some examples of aluminium foil containing composites.

Layer	Material ^a	Layer thickness (μm)
Outre layer	PE	1230
	PA	15–25
	PP	12–25
	Cellophane	28–45
	Paper ^b	20–100 g m ⁻²
Barrier layer	Aluminium foil film	<20
	Aluminium foil ribbon	>20
Inner (sealing) layer	PE	15–100
	PA	15–100
	Hot melt	5–20

^aFor abbreviations of laminates, refer to Table 12.1.

^bThickness defined by specific weight.

(NH₃), and volatile compounds which emerge during ripening. The ratio of the permeability coefficients for O₂ and CO₂ should be in the range of 1:4 to 1:8 (Kammerlehner, 2003), and a sufficient resistance against fat, lactic acid and salt is necessary. As mono-layers do not usually provide all the properties/requirements to protect the cheese varieties against gas and water vapour permeabilities, it is common to use coextruded multilayer materials, which comprise PA or PVDC barrier layers (e.g. PA/PE, PE/PA/PE, PE/PVDC/PE) or laminated compounds with a PET outer layer (Sturm, 1998).

Consumer packages

Cheeses which are ready for consumption are usually cut into small portions or slices and then hermetically packed in plastic laminates, frequently by applying a slight vacuum or by using gas flushing (e.g. a mixture of CO₂ and N₂) to prevent the growth of moulds on the surface of the product. It is obvious that the functional properties of the packaging materials must be target oriented not only with respect to the particular cheese variety but also with respect to processing properties machine runability and, in most cases, the packaging materials comes from rolls and is either formed to achieve tubular bags or is thermoformed (deep drawn) and, after placing cheese slices into the tray, covered and sealed with an appropriate upper layer. Materials for tubular bags are, in most cases, coextruded PET/PE-, OPA/PE- or PET/PVDC/PE-compounds. The materials used for thermoforming of the trays may exemplarily be simple two-layer products made from PS/PE or PET/PE, and also complex compounds consisting of low-density polyethylene (LDPE)/PVDC/OPA/PE or PS/EVOH/PE/PP layers. Apart from PVDC or EVOH, metallised foils may also serve as barrier layers. Upper layers for thermoformed trays are usually compounds of PE with PA or PET (Sturm, 1998; Strehle, 1997). Packing layers, which are sometimes used to separate cheese slices, thus avoiding their adherence, are oriented polypropylene (OPP)- or PET films or papers coated with PVDC dispersions or PE.

Besides the resistance against water vapour and gas permeabilities, it is an additional prerequisite for packages intended for grated cheese to protect from light due to the highly increased specific surface area. Packaging bags are compounds made with EVOH, PVDC,

OPA or PET barrier layers, frequently in combination with light-absorbing pigmentation or printing. In addition, metallised compounds may be used. Tinplate cans or glass vials may be used as alternative whereas, due to their restricted barrier capacity, cans made of PP, PVC or PS are of limited use.

12.4.4 Packaging of soft cheeses

Soft cheeses are produced in much smaller units than semi-hard or hard cheeses and according to the microorganisms involved in maturation, may be distinguished in smear-ripened soft cheeses (Limburger), soft cheeses with surface mould (Camembert) and blue vein soft cheeses, such as Gorgonzola, Stilton or Roquefort. It is mainly the typical characteristics of these cheese varieties which, apart from the resistance against salt, acid, ammonia and gas exchange, require a different type of packaging materials. Low water vapour permeability ensures that excessive moisture loss is avoided and that the water activity remains in a range which is necessary for the growth of microorganisms contributing to maturation. Because of the low mechanical resistance, which further decreases during ripening, soft cheeses are usually covered in secondary packages made from cardboard or wood.

In particular, Limburger-type cheeses with a surface-smear flora are characterised by a high water activity and require materials which retain the moisture inside the package. Typical packaging materials are compounds with an inner layer which, in many cases, is a coated paper or parchment and an outer layer frequently consisting of cellophane, OPP or PET films (Sturm, 1998), which are permeable to oxygen but relatively impermeable as regards water vapour. Similar materials, but with a higher gas and water vapour permeability to ensure mould growth, are used for Camembert-type cheeses – perforated lacquered aluminium foils, aluminium foils laminated on LDPE-coated tissue paper, perforated lacquered cellophane laminated on paraffin-coated paper and plastic-paper compounds, such as PET films on cellulose paper with PE/EVA lamination. However, when packing wedges of Brie or Camembert cheeses, the packaging materials need to be impermeable to gas and water vapour because of the initial absence of moulds on the cut surfaces. Similarly, blue vein cheeses do also need impermeable gas packaging materials to avoid the growth of mould outside the main mould channels. Subsequent to the main maturation period Protected Designation of Origin (PDO) Roquefort is, after cutting, wrapped with an aluminium foil to minimise oxygen transfer and the growth of *Penicillium roqueforti* (M. Ress, 2007, personal communication).

12.5 Packaging machines

12.5.1 Control of the packaging process

In general, packaging refers to a procedure where an individually processed item and a packaging container are merged into a package, thus being a final production step in the manufacturing industry. Containments are either formed by the packaging machine from the packaging material provided, which is fed to the machine from, for example, a web roll or a stack of package blanks, or pre-formed containers are fed to the packaging machine. Starting with a single primary packaging unit, where the packaging material is in direct

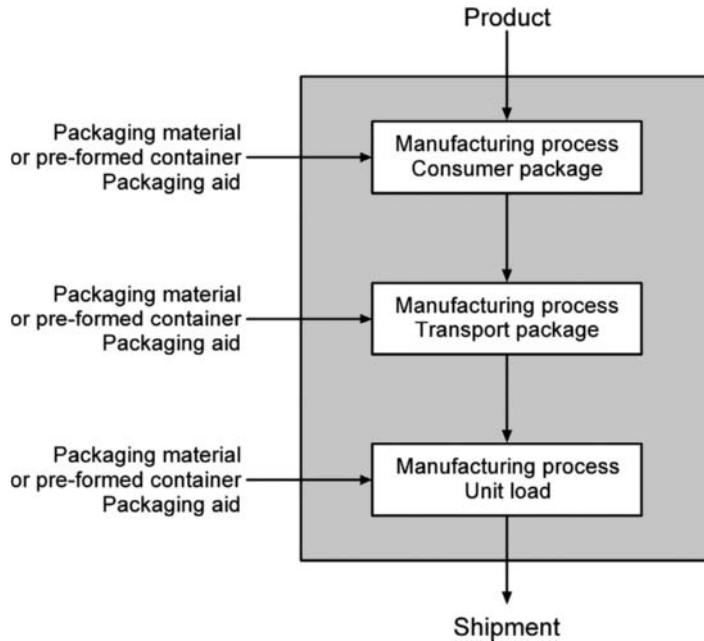

Fig. 12.10 Schematic illustration of the various steps of the packaging process.

contact with the contained product, the entire process covers a number of steps (Fig. 12.10), including the final making of the tertiary packages, e.g. loading units, such as stretch-wrapped pallets (Bleisch *et al.*, 2003). Convenience for the individual – this may be a supermarket chain but also the end consumer – purchasing a particular product that further requires secondary packages, which hold a number of primary packages, are built on a different size level. In case of processed cheese, a 90 mm × 90 mm × 2 mm slice wrapped in plastic or aluminium foil represents the primary package. Ten slices packed in a surrounding foil, showing company labels, ingredients, sell-by-date, European Article Number (EAN) code etc., make a retail package offered on the shelf of a supermarket, frequently in cardboard boxes which themselves represent larger secondary packages.

In packaging, the entire process may cover different processing steps, such as forming of the packaging material into the packaging container, filling of the product, and sealing of the package to ensure integrity and protection, and the overall system of packing is known as form-fill-and-seal (FFS). Preceding operations are necessary to ensure a continuous flow of the packaging material and the product, and labelling is a subsequent step. A particular package as an outcome of a particular chain of processing steps may then become the product, which is collected into larger packages in the next step of packaging.

It is the main task of the packaging machine to perform the packaging process. At the same time, the packaging machine interacts with both the packaging material and the product to be packed by:

- providing the packaging material;
- forming the packaging container;

- filling the product into the packaging container; and
- closing the package, thus resulting in the final package with the desired quality.

12.5.2 Machinery for cheese packaging

Besides other aspects, it is the intrinsic properties of the product, i.e. mainly the shape and firmness in case of cheese, which are responsible for the selection of a particular packaging operation and consequently, of a particular packaging machine. Cheese sections of various sizes or sliced cheese may be packed using wrapping machines, FFS machines or fill-and-seal (FS) machines; for the latter system of packing, the empty packaging containers are produced elsewhere. Shredded cheese is usually packed by means of combined FFS machines or by single filling machines followed by sealing machines.

Wrapping machines refer to the type of packaging system where a machine envelopes highly viscous fluids (e.g. hot processed cheese or cream cheese) or pieces of soft, semi-soft or hard cheese completely in a packaging blank made of paper, plastic film or aluminium or any composite of these materials. Wrapping machines may further be classified by the type of wrapping; in cheese packaging, mainly wraparound machines, either performing fold wrapping or seal wrapping, are used.

Machines for producing fold wraps of highly viscous fluids

In the cheese industry, machines used for the production of fold wraps for highly viscous fluids are basically used to fill hot processed cheese into blanks laminated with aluminium foil (Fig. 12.11). Here, the blank is folded into an open packaging container with a circular, triangular or rectangular base area by means of a forming stack. This container is then transported to the filling station within the cavity of a rotating feeding plate. After filling, the container is closed by folding the overlapping sides of the film. The result is a full wrap or single blank wrap which, to enhance mechanical resistance, may be sealed especially when composite films or aluminium foil laminates are used.

Furthermore, the wrapping process can be modified by using two blanks. In this case, the product is filled into the freshly formed packaging container as described above. The cover blank is then either folded around the bottom container or, especially when circular packages are produced, flanged around the flank of the package. In case of covers with a special shape, these are sealed onto the packaging container and folded after filling (Sturm, 1998).

Machines for producing fold wraps for cheese blocks

Wrapping of dimensionally stable blocks of cheese with varying sizes can be achieved by applying one of the following processing principles (Fig. 12.12):

- A piece of cheese is positioned close to a running web of the packaging material, which is cut and folded; or

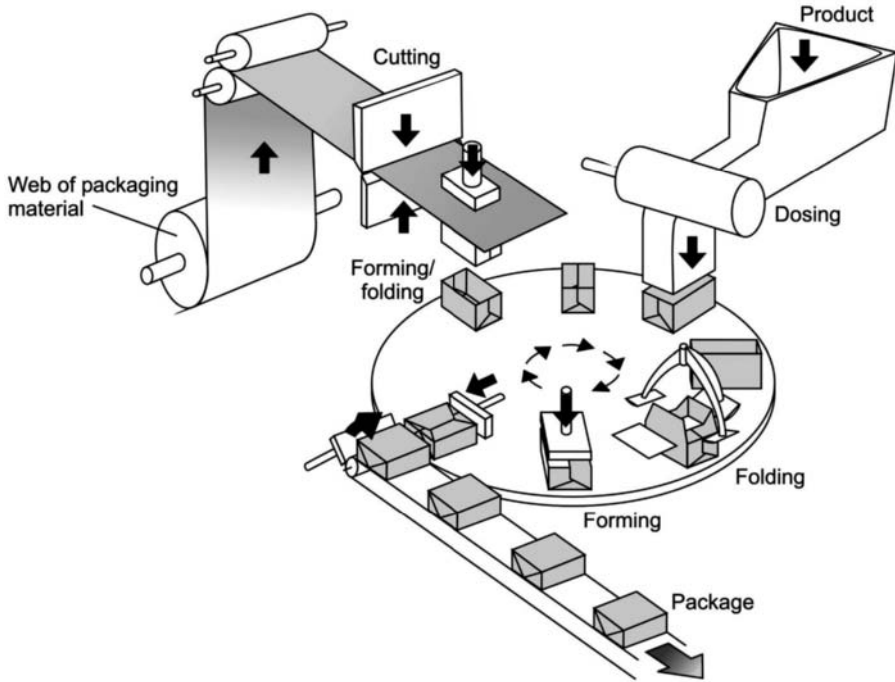

Fig. 12.11 Wrapping machine for highly viscous materials (processed cheese, butter and margarine).

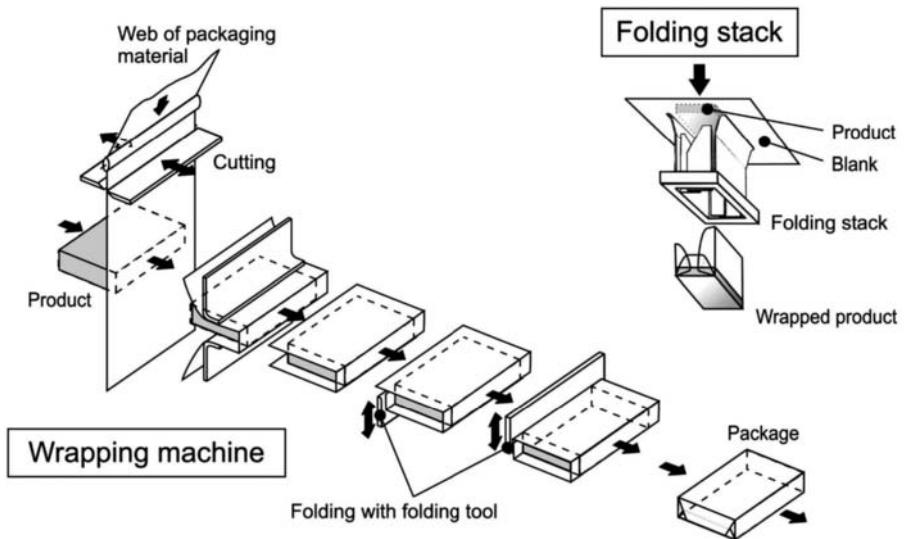

Fig. 12.12 Layout of a wrapping machine and a folding stack.

- A blank is positioned above the cheese piece. Blank and cheese are then pushed into a stack for forming the wrap; or
- A piece of cheese is pushed onto the blank and through a folding stack for finalising the package.

When composite materials are used for packaging, the containers are usually sealed to ensure a tight closure and to improve mechanical stability of the package. The gluing of labels, i.e. showing the nutritional information of the product, onto the bottom fold of the package may also help to attain these goals.

Machines for producing multipacks by the wraparound method

The wraparound method of packaging is mainly applied to wrap groups or stacks of more or less rigid packages to produce multi-packages or shipping packages using blanks of corrugated cardboard. A pre-fabricated blank with creases, notches and/or clearances is removed from a stack and folded around the grouped packages. Finally, the sides of the package are glued by using hot-melt technique. This method of packaging can be classified with respect to the relative arrangement of the contact surfaces of the blank and product stack:

- Pushing of the product onto the stack, thus attaching the top, bottom or front surface before full or partial wrapping; or
- Wrapping in two steps, including the preparation of separate top and bottom lids.

FFS machines

Any process running on a FFS machine comprises the forming of the packaging container, feeding and disposing of the product and finally, the sealing of the package. Machines classified within this group tubular bags either vertically or horizontally; other types, which are intended for the production of sachets, are thermoforming machines, or are machines for the production of fold wraps for highly viscous fluids.

The packaging container for a tubular bag FFS machine is formed from the material delivered by a web drawn from a roll. The web is continuously formed into a tube by a special forming tool (e.g. a forming shoulder or a forming stack) and the overlapping borders are sealed, thus resulting in the longitudinal seam. During subsequent cross-sealing, the head seam of the preceding filled package, as well as the bottom seam of the following empty bag, is formed. The two consecutive bags are separated by a cutting knife, which operates between the two sealing tools.

It is possible to design FFS machines to deliver the tubular bags vertically or horizontally, either in continuous or semi-continuous operation, and shape, size and type of the bags may vary considerably by, for example, having a side gusset or not (Fig. 12.13). The filling process may be concluded by applying an inert gas mixture to achieve the required gas composition within the package. In case of bags with side gussets, additional sealing may contribute to an enhanced stiffness of the package.

It is, besides using simple seams, also possible to supply tubular bags with sophisticated closures. Common applications for such closures are double seams or special devices with

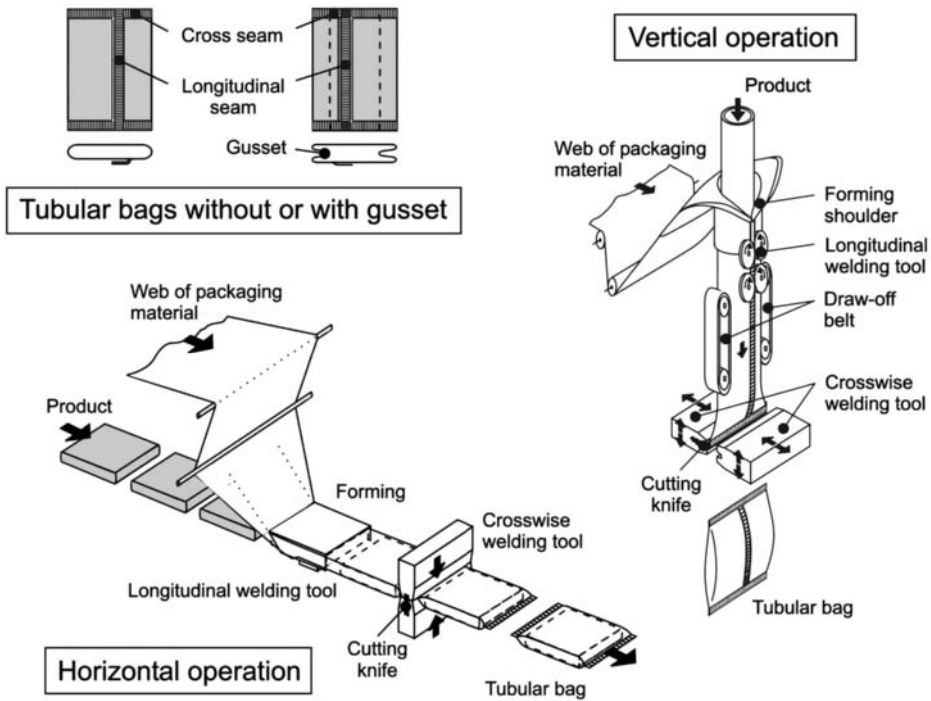

Fig. 12.13 Horizontal and vertical tubular bag forming, and outline of tubular bags.

added value such as withdrawal aids (e.g. tear-perforation) or re-closures (e.g. slide closures or adhesion closure).

Usually, shredded cheese or mozzarella in brine are packed by vertical bag FFS machines whereas, on the other hand, blocks of varying size of form-stable cheese are packed by means of bag FFS machines operating horizontally.

FFS machines, which produce side-sealed bags, usually operate vertically (as concerns the direction of product flow) from a web of packaging material that is folded, vertically sealed, filled, and closed; finally, the packages are separated from each other (Fig. 12.14). Alternatively, the packaging material may be provided from two webs; here, an additional sealing step is necessary. In any case, the final result is a quadrangular bag sealed on either three or four sides.

When form-stable products, such as cheese blocks, are packed with this type of machine, the packaging material is displaced from two webs. As a rule of thumb, a piece of cheese is placed on the lower web. The cheese is then covered by the upper packaging film coming from the other web and the arrangement is sealed at its four sides. Finally, the single bags are cut from the tube. When it is possible to hot-form the lower sheet of packaging material to a cavity, the process is called thermoforming.

Thermoforming FFS machines

With this particular type of packaging machine, flat trays or cups are formed from a web of the packaging material by hot- or thermoforming machines (Fig. 12.15). Subsequent to

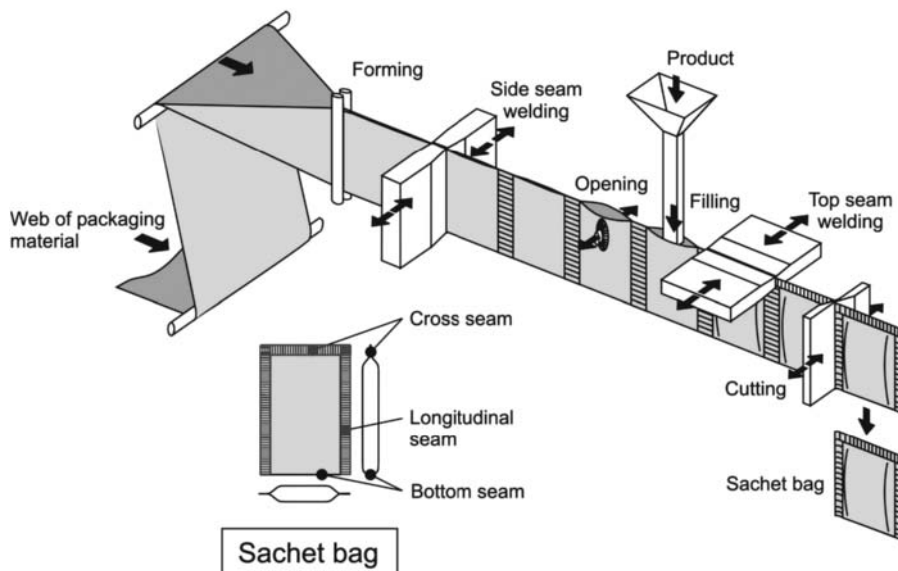

Fig. 12.14 Form-fill-and-seal (FFS) machine for side-sealed bags.

the forming step, the trays or cups are filled with semi-hard or hard cheeses in pieces or slices and processed cheese, Cream cheese or Quarg, respectively. Multi-part cups allow the positioning of at least two products, for example, cheese with any convenience dips. The filled trays or cups are then sealed with a second film of another packaging material and are subsequently separated.

For the production of the trays and cups, a thermoplastic film is heated and formed either by vacuum or by external pressure into the required shape. The rigidity of the packaging container is achieved as the packaging material cools rapidly. The in-line forming of plastic films is basically suitable for cups and bowls of small size but with extraordinary forming depth and shape.

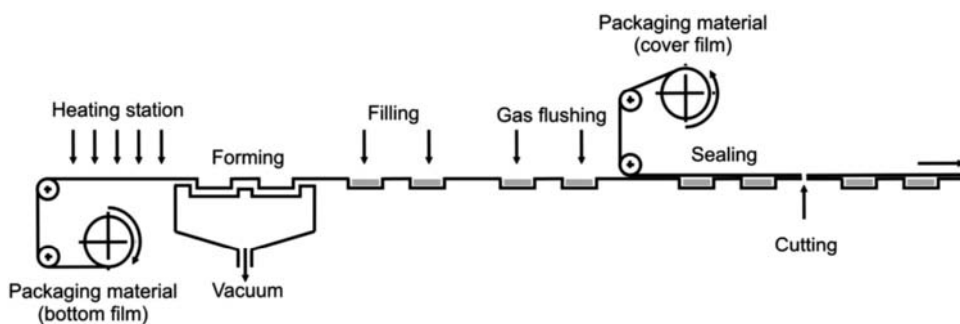

Fig. 12.15 Thermoforming fill-and-seal machine.

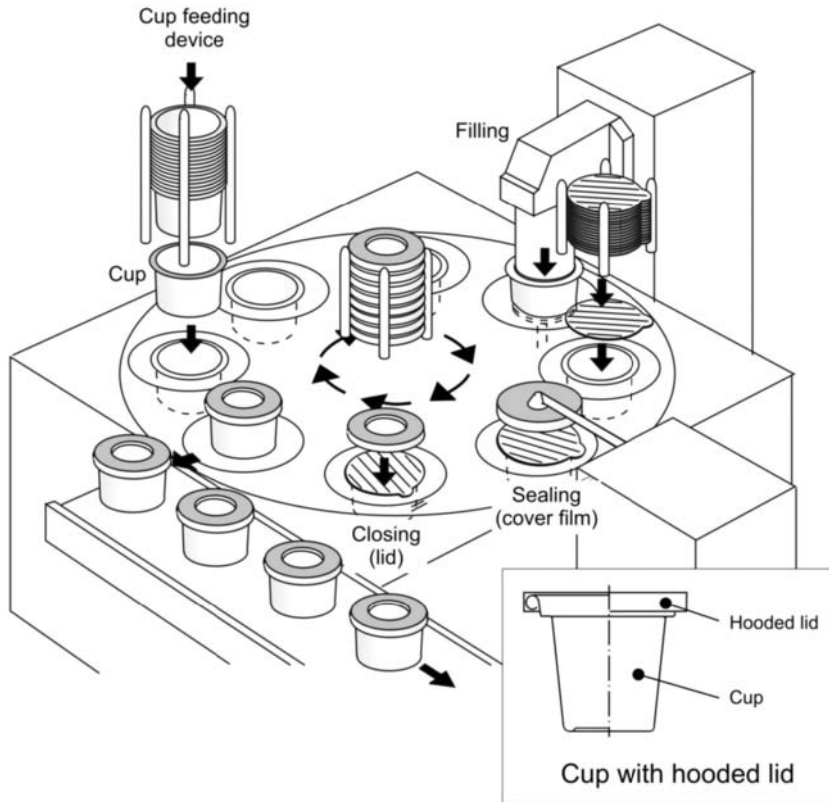

Fig. 12.16 Fill-and-seal machine operating with pre-formed cups.

Fill- and seal (FS) machines

FS machines are mainly used when it is necessary to fill a particular product into pre-formed packaging containers like cups, bowls, tubes or boxes. As shown in Fig. 12.16, cups or bowls are produced separately by a thermoforming machine and can be fed to an FS machine. Subsequent to filling in an aseptic environment, the cups are closed by sealing with laminated aluminium foil films or by attaching tear-open lids. This type of machine is frequently used for packaging different varieties of fresh cheeses and Quarg.

When packing processed cheese into tubes, the pre-formed packaging containers made of lacquered aluminium foil are transported to the FS machine, filled and then closed (Fig. 12.17). In case of vertical filling, the filling tip is positioned in the close vicinity of the shoulder of the tube. During filling, the tip is moved upwards to the bottom of the tube. This procedure assures a bubble-free filling and concurrently avoids any contamination of the filling tip.

To fill cardboard boxes with, for example, one or more pre-packed pieces of semi-hard or hard cheese, another type of FS machine is used. Usually, boxes are fed as flat blanks to the packaging machine where the erected boxes are then filled and closed. In case of cheese, this technique is frequently used to produce multi-packs or shipping packages.

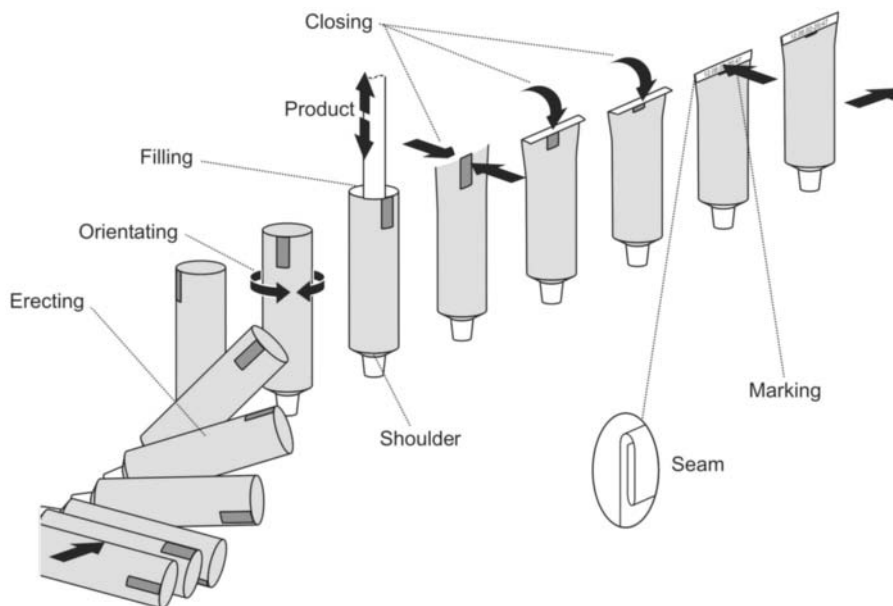

Fig. 12.17 Fill-and-seal machine for tubes.

The underlying principle of FS machines when using cardboard boxes for secondary packages may be summarised as follows:

- A pre-formed, lengthwise glued, folded box is fed towards the filler, erected, filled with the product (e.g. already wrapped in plastic film or sealed in film envelope) and closed by inserting straps or glue (Fig. 12.18); or
- A pre-formed, lengthwise glued, folded box is fed towards the filler, erected, filled with the product (e.g. already wrapped in plastic film or sealed in film envelope) from the top side and closed by placing the top hood which is already attached to the box; or
- Pre-formed box components (bottom and top) made of cardboard or chipboard are fed towards the filler, filled with the product and closed by fitting the top.

Preformed rigid cans made from tin-plated or lacquered sheet of mild steel can be used for the packaging of grated or shredded cheese. After feeding the cans towards the filler, the product is dispatched into the can, frequently under inert gas. After applying metal tops by clinching, additional plastic tops can be provided for convenient re-closure by the consumer once the package has been opened.

12.5.3 Miscellaneous methods of cheese packaging

Apart from the packaging techniques mentioned for wrapping, filling and closing, there are some other operation principles and machinery which are sometimes used in context of cheese. For example, preformed tubes made of composites are filled with processed cheese,

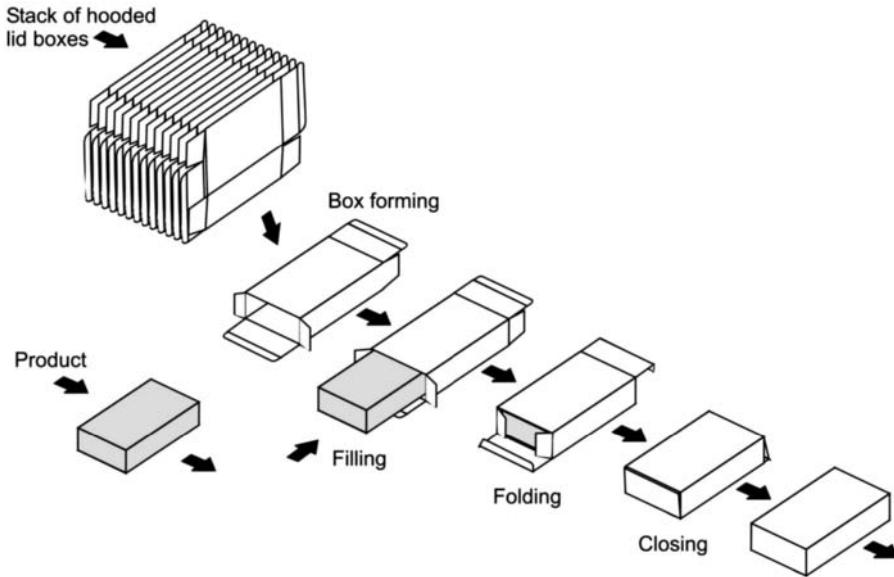

Fig. 12.18 Fill-and-seal machine for cardboard boxes.

and then tightly closed by means of metal clips. For slices of processed cheese, some different operation principles can be applied:

- Hot processed cheese is filled into a tube of a composite material, then squeezed to obtain flat slices, and finally cooled (hot pack operation); or
- Hot processed cheese is dosed directly onto the plastic film, which is folded and sealed afterwards; or
- Single cheese slices are positioned in trays with or without thin layers which separate the individual slices of the product.

Finally, the packaging of stacks of single, individually packed slices of cheeses can be done by using a horizontal FFC machine or by using trays made with a thermoforming machine.

12.6 Conclusion

Packaging in the broad sense, placed in between maturation and consumption, is the last essential step in cheesemaking technology and usually covers both size reduction and the packaging process in the narrow sense. The equipment and type and intensity of size reduction largely depends on the use of the cheese, whether it is intended for further processing or for the end consumer. In modern production units, cutting and packaging sub-units are located in close vicinity or even combined into one single unit and operated in controlled environmental condition because of the increasing demands for product shelf life. Another challenge for

the future is the harmonisation of package functionality, by fulfilling the classical protection task but also ensuring that consumer demands towards convenience are satisfied.

References

- Ahvenainen, R. (2003) Introduction. *Novel Food Packaging Techniques* (ed. R. Ahvenainen), pp. 1–2, Woodhead Publishing, Cambridge, UK.
- Atkins, A.G. (2006) Optimum blade configurations for the cutting of soft solids. *Engineering Fracture Mechanics*, **73**, 2523–2531.
- Atkins, A.G. & Xu, X. (2005) Slicing of soft flexible solids with industrial applications. *International Journal of Mechanical Sciences*, **47**, 479–492.
- Atkins, A.G., Xu, X. & Jeronimidis, G. (2004) Cutting, by ‘pressing and slicing’, of thin floppy slices of materials illustrated by experiments on Cheddar cheese and salami. *Journal of Materials Science*, **39**, 2761–2766.
- Bergmair, J., Washüttl, M. & Wepner, B. (2004) *Prüfpraxis für Kunststoffverpackungen*, Behr’s Verlag, Hamburg.
- Bleisch, G., Goldhahn, H., Schrickler, G. & Vogt, H. (2003) *Lexikon Verpackungstechnik*, Behr’s Verlag, Hamburg.
- Brennan, J.G., Butters, J.R., Cowell, N.D. & Lilley, A.E.V. (1990) *Food Engineering Operations*, Elsevier, London.
- Brennan, J.G. & Day, B.P.F. (2006) Packaging. *Food Processing Handbook* (ed. J.G. Brennan), pp. 291–350, Wiley-VCH, Weinheim.
- Brown, T., James, S.J. & Purnell, G.L. (2005) Cutting forces in foods: experimental measurements. *Journal of Food Engineering*, **70**, 165–170.
- Buchner, N. (1999) *Verpackung von Lebensmitteln*, Springer, Berlin.
- Domininghaus, H. (2005) *Die Kunststoffe und ihre Eigenschaften*, 5th edn, Springer-Verlag, Heidelberg.
- Dunn, P.D., Burton, J.D., Xu, X. & Atkins, A.G. (2007) Paths swept out by initially slack flexible wires when cutting soft solids; when passing through a very viscous medium; and during regelation. *Proceedings of the Royal Society Series A Mathematical, Physical and Engineering Sciences*, **463**, 1–20.
- Fellows, P. (2000) *Food Processing Technology*, Woodhead Publishing, Cambridge, UK.
- Goh, S.M., Charalambides, M.N. & Williams, J.G. (2005) On the mechanics of wire cutting of cheese. *Engineering Fracture Mechanics*, **72**, 931–946.
- Jenkins, W. & Harrington, J. (1992) *Lebensmittelverpackungen aus Kunststoff*, Behr’s Verlag, Hamburg.
- Kammerlehner, J. (2003) *Käsetechnologie*, Freisinger Künstlerpresse, Freising.
- Kamyab, I., Chakrabarti, S. & Williams, J.G. (1998) Cutting cheese with wire. *Journal of Materials Science*, **33**, 2763–2770.
- Linke, L. & C. Kluge (1993) Schneiden von Lebensmitteln. *Lebensmitteltechnik*, **25**, 12–16.
- Lockheart, A.E. (1997) A paradigm for packaging. *Packaging Technology and Science*, **10**, 237–252.
- Lucas, M., MacBeath, A., McCulloch, E. & Cardoni, A. (2006) A finite element model for ultrasonic cutting. *Ultrasonics*, **44**, 503–509.
- Lyyjynen, T., Hurme, E. & Ahnainen, R. (2003) Optimized packaging. *Novel Food Packaging Techniques* (ed. R. Ahvenainen), pp. 441–458, Woodhead Publishing, Cambridge, UK.
- McCarthy, C.T., Hussey, M. & Gilchrist, M.D. (2007) On the sharpness of straight edge blades in cutting soft solids. Part I: Indentation experiments. *Engineering Fracture Mechanics*, **74**, 2205–2224.
- Nentwig, J. (2006) *Kunststoff-Folien*, Hanser Verlag, München.
- Piringer, O.-G. (2000) Permeation of gases, water vapor and volatile organic compounds. *Plastic Packaging Materials for Food* (eds O.-G. Piringer & A.L. Baner), pp. 239–286, Wiley-VCH, Weinheim.

- Raeuber, H.J. (1963) Grundlagen des Schneidens von Lebensmitteln. *Die Lebensmittel-Industrie*, **10**, 217–220.
- Robertson, G.L. (2006) *Food Packaging – Principles and Practice*, CRC Press (Francis & Taylor Group), Boca Raton, FL.
- Saravacos, G.D. & Kostaropoulos, A.E. (2002) *Handbook of Food Processing Equipment*, Kluwer Academic/Plenum Publishers, New York.
- Schneider, Y., Zahn, S. & Linke, L. (2002) Qualitative process evaluation for ultrasonic cutting of food. *Engineering in Life Sciences*, **2**, 153–157.
- Schneider, Y., Zahn, S. & Rohm, H. (2008) Power requirements of the high-frequency generator in ultrasonic cutting of foods. *Journal of Food Engineering*, **86**, 61–67.
- Sivertsvik, M., Rosnes, J.T. & Bergslien, H. (2002) Modified atmosphere packaging. *Minimal Processing Technologies in the Food Industry* (eds T. Ohlsson & N. Bengtsson), pp. 61–86, Woodhead Publishing, Cambridge, UK.
- Spreer, E. (2006) *Technologie der Milchverarbeitung*, Behr's Verlag, Hamburg.
- Strehle, G. (1997) *Verpacken von Lebensmitteln*, Behr's Verlag, Hamburg.
- Sturm, W. (1998) *Verpackung milchwirtschaftlicher Lebensmittel*, Edition IMQ, Kempten.
- Tamime, A.Y. (1993) Modern cheesemaking: hard cheeses. *Modern Dairy Technology – Advances in Milk Products* (ed. R.K. Robinson), Vol. 2, 2nd edn, pp. 49–220, Elsevier Applied Science, London.
- Vaclavik, V.A. & Christian, E.W. (2003) *Essentials of Food Science*, Kluwer Academic/Plenum Publishers, New York.
- Walstra, P., Wouters, J.T.M. & Geurts, T. (2006) *Dairy Science and Technology*, 2nd edn, CRC Press (Francis & Taylor Group), Boca Raton, FL.
- Zahn, S., Schneider, Y. & Rohm, H. (2006) Ultrasonic cutting of foods: Effects of excitation magnitude and cutting velocity on the reduction of cutting work. *Innovative Food Science and Emerging Technologies*, **7**, 288–293.
- Zahn, S., Schneider, Y., Zücker, G. & Rohm, H. (2005) Impact of excitation and material parameters on the efficiency of ultrasonic cutting of bakery products. *Journal of Food Science*, **70**, E510–E513.

13 The Grading and Sensory Profiling of Cheese

D.D. Muir

13.1 Introduction to cheese-grading systems

Grading schemes for cheese have been developed over the years for the use and benefit of cheesemakers and cheese technologists. Grading is a tool to measure the reliability and reproducibility of the plant and/or process, and a guide to the optimum storage and marketing strategy for the cheese – should it be sold relatively quickly as mild cheese or will it improve with long maturation to become a premium mature cheese (and points in between)? These grading systems depend on defect-based judgements and have served the industry well for inventory management, but there is an increasing need for a more informative system based on positive attributes, which characterise consumer demands and preferences (largely identified by the buyers working for supermarket-sized retailers). The factory grading systems cannot meet this need and new methods of sensory assessment will have to be found to enable manufacturers to produce what the consumer wants.

This chapter critically reviews the grading schemes which are currently used in the major cheese-producing countries, speculates on how they might be developed further and then considers in-depth the scientific basis of advances in sensory assessment and how these might be used by the cheese industry.

13.2 Fundamentals of sensory processing

Some knowledge of the fundamentals of sensory processing is required, since these have important implications for understanding the types of cheese-grading system to be adopted, and what are its strengths and limitations.

13.2.1 *The three dimensions of sensory experience*

Cheese, like all food products, has three sensory dimensions when eaten:

- Character (or ‘quality’) relates to the type of sensation experienced when cheese is eaten, for example, in flavour, whether the cheese is ‘creamy’, ‘bitter’, ‘acid’, ‘salty’, ‘unclean’ etc. Character varies between cheese types, within cheese types and even between batches of the same cheese. Primarily, flavour character is mediated through the olfactory (smell) sense, although cheeses can also vary markedly in texture, a kinaesthetic dimension;

- Quantity relates to the amount, degree or intensity of a sensation. In cheese, intensity may be rated quantitatively on some kind of scale, for instance: mild–medium–strong; a 9-point scale or an undifferentiated rating scale with anchors only at the end (the exact scale is not of concern here). Taste attributes vary markedly with intensity, whereas variation in the intensity of olfactory attributes is less marked;
- Acceptability (or liking) is the degree to which a sensation is liked or disliked. The degree of acceptability can vary from extremely positive (e.g. ‘wonderful’) to extremely negative (e.g. ‘horrible’); thus, like intensity, acceptability can be rated quantitatively on some kind of scale.

Physiologically, acceptability is transduced through a neural pathway that is somewhat independent of, and parallel to, the neural pathways used for the transduction of character and quality. Thus, when a piece of cheese is tasted, the acceptability – the degree to which the cheese is liked or disliked – is registered as an immediate, intuitive response; the taster does not have to think about it. In contrast, discerning character and intensity requires mental processing (and sometimes memory retrieval). Only after some introspection can it be said, for instance, that the cheese is very salty or it has an Emmental-like flavour.

Acceptability is more closely linked to human emotional response; it is extremely important to remember that, in the chemical senses (taste and smell), acceptability has primacy – in everyday life, it is the dominant response. Acceptability is the driver, the motivator and largely dictates our behaviour with respect to food and drink. In the long term, we eat and drink what gives us pleasure; we do not persevere with a food item if we do not like it, no matter how nutritionally sound it may be.

Acceptability is, however, volatile. It can change with time (with age, for example). Consumers can ‘learn’ to like flavours that are not liked on initial exposure (e.g. the flavour of strong blue cheese). The overriding consideration is that it invokes some kind of value judgement, whereas character and intensity are relatively ‘value-free’ dimensions of information.

13.2.2 *Integration versus selection of sensory information*

Perception of acceptability is independent of character and intensity. In general, a stimulus must have some perceptible character and intensity for it to stimulate a hedonic response. However, the hedonic response can also limit the description of character and intensity. This natural instinct must be trained out of professional sensory assessors who are expected to make objective assessments of sensory character, irrespective of their personal likes or dislikes.

When a product is perceived as extremely acceptable, the sensory system integrates information from all sensory channels, and there is little available to consciousness other than ‘it tastes great’ (i.e. the hedonic response). The only words that seem appropriate are hedonic words, such as ‘excellent’, ‘exquisite’ etc; the product is, literally, too good for words.

In contrast, when the product is sub-optimal, there are product defects available in consciousness and the sensory system selects information. These defects have character and intensity and there is ample vocabulary for defects. This effect, it seems, is a hard-wired feature of human sensory processing; no amount of training, practice or experience can overcome it, and it does raise some issues for grading.

It means that far more can be said about a product with problems (a product that is not well liked) than can be said about a good product (a product that is very acceptable); a good product is simply good. Comments on flavour character are bound to be very limited when the product is good; in many cases there will be nothing to say at all (other, that is, than 'flowery' hedonic comments).

Understanding and differentiating between character and intensity, on the one hand, and pleasantness, on the other, is vital to the understanding of grading systems.

13.3 Grading systems: defect versus attribute grading

Most grading systems encompass all three dimensions of sensory experience discussed in the previous section. Their main 'plank' is a single overall value judgement of quality (stemming from overall acceptability), although this single value is supposedly arrived at by the addition of separate values for flavour, body/texture and colour/condition. Whether experienced graders really do arrive at total grade points by addition, or whether it is more of an overall judgement which can be post-rationalised, is not entirely clear. In addition to this value judgement, graders sometimes make notes on flavour character(s) and their intensity.

The following is a summary of the basis of grading systems in those countries which have developed widely used schemes recognised by the majority of producers of Cheddar-type cheese.

13.3.1 *The Australian grading system*

The stimulus for development of an Australian grading system was apparently the export of cheese to the United Kingdom in the 1930s. In the main, grading became the responsibility of the Commonwealth Department of Primary Industry, and in the 1960s and 1970s, there were approximately 35 graders in full-time employment.

In this scheme, trainee dairy graders were expected to have a Dairy Diploma and at least 4 years of factory experience. So, even before commencing training in grading, they were 'dairy people' with a background and experience in the dairy industry. There were then 2–4 years of on-the-job training before a grader was considered qualified.

In this system, products (e.g. butter and cheese) are graded on a 100-point scale as follows: 50 points maximum for flavour, 30 points maximum for body/texture and 20 points maximum for colour/condition. Note that the system compels the grader to make the value judgements on quality; indeed, notes on flavour character and their intensity are incidental. Although there is theoretically a possible score range of 0–100, in practice scores tend to range 87–94.

When products are graded below 93, the grader comments on the character of the defect (e.g. bitter) and its intensity (very slight, slight, definite and pronounced). This practice is consistent with the comment in the previous section that, when a product is really good (i.e. 94 on this scale), there is little that can be said about it.

Because graders primarily make a value judgement on quality, and this judgement is decided by the number of defects in the product, this might be called a 'defect-orientated' grading system.

13.3.2 *The UK grading system*

The grading system in the United Kingdom, where still used, is based on that originally used by the National Association of Creamery Proprietors and Dairymen. Like most other systems devised and run by the producers, it is designed to monitor the process against a standard and points are deducted for defects. The graders in this scheme also use 100 points, awarding them on the basis of the following qualities and quality maxima: 45 points maximum for flavour and aroma, 40 points maximum for body and texture, 5 points maximum for colour and 10 points maximum for outside appearance.

Cheeses are graded as 'extra selected' for 93 points and above, provided they have 41 points or above for flavour and aroma. 'Selected' cheese must score in the range 85–92, with at least 38 for flavour and aroma. The cheeses with the poorest quality, yet still saleable as cheese, are called 'graded', scoring 70–83 total, with no stipulation on the flavour and aroma score. Cheeses scoring less than 70 total are not graded at all and would normally be sent for processing.

When this system was widely used, it was normal to grade cheese initially at 6–8 weeks, so that the best cheeses could be kept longest in store, with the confidence that they would mature into premium-priced cheese without developing defects.

The UK cheese industry has developed a maturity/intensity grading system by consensus, using the National Dairy Council as a vehicle, to introduce a universal 'flag' or 'kite mark' to be used on pre-packed retail cheese, guiding the consumer as to whether the cheese is 'mature', 'medium' or 'mild'.

13.3.3 *The US grading system*

The US system, developed by the American Dairy Science Association (ADSA), is conceptually similar to the Australian system: 45 points maximum for flavour, 30 points maximum for body/texture, 15 points maximum for finish and 10 points for colour.

The US Federal system is very similar to that of the ADSA and recognises four grades of cheese as follows: (a) Grade AA ≥ 93 , (b) Grade A 92, (c) Grade B 90–91 and (d) Grade C 89. Clearly, these are also defect-oriented grading systems.

13.3.4 *The Canadian grading system*

This system, developed by the Canadian Department of Agriculture (CDA), is defect oriented and very similar to the US grading system: 45 points maximum for flavour, 25 points maximum for body/texture, 15 points maximum for closeness, 10 points maximum for colour and 5 points for finish. In addition, there are written descriptors for guidance on how cheese should be scored.

13.3.5 *The International Dairy Federation grading system*

This defect-oriented system consists of a six-point scale, which ranges from 'conforming to the pre-established sensory specifications' (5) to 'unfit for human consumption' (0). A description of defects is listed for guidance.

13.3.6 *The New Zealand grading system*

The New Zealand system differs from the others described so far. It is ‘attribute-oriented’ rather than defect-oriented. In this system, the grader’s role is more akin to an objective detection instrument than to an arbiter of quality.

As with previous systems, graders are left to discern cheese character notes and their intensity, but the system does not compel the grader to then make a value judgement on quality. In terms of the three sensory dimensions discussed previously, only character and intensity are scored; the hedonic/value judgement is deliberately avoided.

This more objective system of attribute grading was introduced in 1993 because (a) defect grading was considered to focus unduly on negative attributes of the product (as was explained previously, there is no other type that can be focused on) and (b) there was no obvious link between the value judgement of the NZ grader and the end consumer (85% of New Zealand dairy industry production being exported).

Attribute grading is a modified descriptive profiling technique, in which trained assessors score the intensity of a number of individual attributes on a 0–9 scale (0 = absent, 9 = intense). Mean scores are calculated across (at least three) assessors and compared against sensory specifications, the sensory specifications having been determined by consumer research with the appropriate end consumers.

Lack of agreement between the grader’s value judgement and that of the end consumer was clearly the stimulus to the shelving of the traditional grading system. In the parlance of psychological testing, there was a question mark over the validity of the grader’s judgement. This is an important issue and will be taken up in a later section.

13.4 The direct link: cheesemaking to consumer

It is interesting to consider if it would be possible to bypass graders and grading by linking physical/instrumental measures directly to consumer preference, but the industry at large is not optimistic that this can be done. Over the years, claims have been made that emerging techniques, such as gas chromatography and high-performance liquid chromatography, will provide chemical profiles that can be correlated with flavour quality. Alternately, equally optimistic claims have been made that rheological measurement would offer prediction of the mouth-feel of cheese. To date, no satisfactory instrumental methods have been devised to adequately predict sensory character. The electronic nose is a more recent method to attract attention as a replacement for human sensory judges. However, these ‘noses’ have failed to fulfil early claims, but advancing technology may reverse this position (Payne, 1998; Drake *et al.*, 2003). Until the link between instruments and sensory character is realised, a need will remain for grading – or some form of human sensory evaluation.

13.4.1 *The link between cheesemaking, grading and the consumer*

Currently, most large cheese plants grade cheese by employing contract (often ex-government or ex-association) graders, in-house personnel (who have often learned by association with graders) or employees who have completed a cheese-grading course. Of these options,

ex-government/professional association graders are generally seen to hold advantages, in that they have a vast experience, and in being exposed to a wide range of product, are less susceptible to in-house drift (i.e. the ‘cellar palate’ blindness to defects, caused by habituation within the company). Also, most industry graders have factory/processing experience. Thus, in addition to their grading function, they are often skilled diagnosticians and quality assurance troubleshooters (they know the most likely cause of flavour and texture problems which – effectively, though not now formally – downgrade cheese and therefore reduce its value). However, whilst absolutely appreciative of these (ex)-graders, few in the industry would welcome a return to the old days of institutionalised grading. Many people in the industry believe that, provided grading expertise is available on a contract basis, they have the best of both worlds – a process-monitoring/inventory management system without the rigid value-determining scoring system.

These same people are, however, realistic enough to recognise that this ‘best-of-both-worlds’ scenario cannot go on forever; ex-graders are a diminishing human resource, which is not being replaced by training (the profession does not now formally exist), and access to their expertise will become increasingly limited. There is genuine concern in the industry about what will happen when the services of these highly trained and experienced graders are no longer available.

In terms of grading systems, most manufacturers use one or more of the traditional 0–100 scales, although a minority are using other defect-orientated systems (e.g. 1–5 scales). The New Zealand grading system is also being used in Australia. Many people in the industry are satisfied with the time-honoured 0–100 scale; others are not. It must be said though, that the use of this scale is determined more by tradition (default) than by conscious choice; it is widely acknowledged that the current system does not work well for research purposes, and that attribute systems would be a step forward and would move grading closer to a system which grouped and/or valued cheeses according to consumer-perceived quality parameters. In any case, the need for factory-based grading is not as great as it once was; with major advances in processing technology (automation, process control, plant and materials hygiene etc.), cheese can now be made a more consistently than it could even 10 years ago. This view may seem cavalier or complacent to those with a quality assurance focus, but differing values between production and quality control are, of course, ingrained in all business.

13.4.2 *The link between grading and consumer*

There is some uncertainty within the cheese industry that cheese grades and consumer preference are linked and also in the industry’s knowledge of what the consumer wants. The existing empirical and anecdotal evidence points to the link being weak. Thus, there is concern about the validity of cheese grading; is the grading measuring what we think it is measuring? Do the cheese grades genuinely reflect market values? Is a 94-point cheese really perceived to be a choice cheese by consumers, compared to a 92- or 93-point cheese? One Australian study (McBride & Hall, 1979) suggested that there is little or no correlation between graders’ scores and consumer preference. The cheese most liked by consumers in this study was scored at only 87 by graders – not by any means a premium cheese in any of the 0–100 systems. A single study is never definitive, however, and this one was not without

flaws (e.g. this study contained no first-rate cheeses, and this absence may have diminished the chance of correlation).

The philosophy of the link between grading and consumer is not compatible with defect orientation; what may be a flavour defect to the grader (e.g. 'fruity') may be a positive attribute to the consumer; there is even anecdotal evidence that the 'catty' defect, a very serious flaw in the graders' list, adds to the enjoyment of 'sharp' or 'tasty' cheese flavour in mature, very high-value Cheddars, as far as some consumers are concerned. Thus, the grader's notion of perfection at any one session may be out of line with that of the end consumer, even though he or she can advise in good faith that something atypical has occurred in the manufacturing/maturation process.

Do graders' scores therefore correlate with consumer preference? The fact that cheese continues to sell well suggests that grading cannot be far off the mark. However, this does not preclude a major improvement in sales should the grading system be improved.

13.4.3 *The cheesemaking – grading link*

The link between cheesemaking and grading appears to be effective. Here, the skilled grader is really more than a grader, in being able to diagnose the cause of sensory problems in cheese and provide invaluable feedback to production. In this quality-assurance scenario, a defect mindset (information selection) is entirely appropriate, and the current defect-orientated scoring system is appropriate.

To reiterate on this discussion of cheese grading as it is currently practised, the current evidence suggests that the main weakness in cheese grading is its lack of market validation. The dairy industry is not alone in having such a problem. As industries worldwide strive to become more consumer driven rather than product driven ('to make what we can sell, rather than sell what we can make'), gaps such as this are sure to appear. Thus, the next step is to collect empirical data from the market place. To fully exploit this information it is crucial that objective assessments of sensory character are available.

13.5 Introduction to sensory profiling of cheese

The consumer holds the key to a prosperous cheese industry because, if no one buys milk products, there is no future. The decision to purchase is influenced by many factors, including perceived healthiness, packaging and value for money. Nevertheless, if the sensory profile – appearance, smell, flavour and mouth-feel – does not match, or exceed, the customer's expectations, the product will fail in the marketplace. Thus, it is important that the sensory profile of cheese can be measured accurately. Sensory profiling of cheese can be a powerful tool in other ways. It allows products to be classed into type. For example, farmhouse Cheddar made from raw milk may be differentiated from factory-produced cheese made from pasteurised milk (Muir *et al.*, 1997). Profiling can be useful in establishing brand identity and in positioning new products. Moreover, it is essential for matching existing products.

Elements of sensory assessment

Sensory profiling is an objective technique. Although it uses human assessors as the measuring instruments, when implemented in a rigorous and structured way, the end results have confidence limits comparable with physicochemical measurements of comparable complexity.

There are four key elements common to any analytical procedure. Firstly, the property of the object being assessed must be defined. This may be a comparatively simple measurement, such as fat content, or a more complex characteristic, such as rheological profile. In sensory terms, the properties to be assessed are the sensory attributes and together they comprise a sensory vocabulary. Secondly, sample preparation and presentation to the measuring instrument are an important element of any analytical method. This is the protocol for sensory assessment. Thirdly, the measuring instrument must be calibrated. Assessors must be selected and trained. In addition, the 'calibration factor' of the measuring instrument, irrespective of type, must be monitored. Finally, the unadjusted output of the analytical device is converted into an index or indices, which have practical utility. In sensory terms, data might take the form of ratings for a series of attributes or an overall picture in the form of a sensory space map.

Each of these aspects will be considered in turn and examples of the application of sensory profiling to cheese are described.

13.6 Sensory vocabulary

The construction of a sensory vocabulary for a class of food, i.e. cheese, butter, fermented milk, raspberries, olive oil or coffee, is not straightforward. The end use of the results of the profiling determines the complexity of the vocabulary. For example, where profiling is used to monitor the quality of a distinct product, such as a single well-defined cheese variety, the list of attributes may be too long to reflect the fine detail required (see Bérodiér *et al.*, 1997). On the other hand, where a broad-brush but discriminant picture is required, a shortened vocabulary may be appropriate (McEwan *et al.*, 1989; Muir & Hunter, 1992). Methods are available to refine complex vocabularies into their essential elements (e.g. Hunter & Muir, 1993; Muir *et al.*, 1994), and some success has been achieved in constructing vocabularies that have utility in an international context (Nielsen *et al.*, 1997; Hunter & McEwan, 1997).

An efficient vocabulary should describe all the properties of the product such as appearance, smell, flavour and mouth-feel. It should give equal balance to 'good' and 'bad' attributes. Vocabularies based only on product deficiencies when compared to a standard may have a limited use in quality assurance but discount a product of a superior profile to the standard. The vocabulary should be precise. There should be no ambiguity in the interpretation of terms, at least amongst the panel of assessors and the end users of the sensory information. Finally, vocabularies should be capable of evolution. For example, if a new stimulus is profiled and the assessors detect an attribute which is currently absent from the list of terms, a mechanism should be in place to incorporate this new attribute within the vocabulary. Moreover, where ratings for a particular attribute are consistently low and do not discriminate between samples, the attribute should be deleted from the vocabulary.

Table 13.1 Typical vocabulary for profiling a wide variety of cheese types.

Odour	Flavour	Mouth-feel	General
Intensity	Intensity	Firm	Maturity
Cream	Cream	Rubber	Acceptability
Egg	Sour	Crumbly	
Fruit	Egg	Grainy	
Rancid	Fruit	Coating	
Acid	Rancid		
Musty	Bitter		
Pungent	Unclean		
Unclean	Salt		
	Other		

13.6.1 *A working vocabulary for cheese*

A vocabulary that has been useful for characterizing different varieties of cheese is shown in Table 13.1. This vocabulary is similar to that developed after a series of ring trials in a number of European laboratories with special interests in cheese and in sensory profiling. A particular difficulty lies in translation between languages of seemingly simple descriptors for an attribute of the cheese. Where descriptors developed in one language are being applied in another, it is prudent to translate from language 'A' to language 'B', and then to translate, using an independent translator, back from language 'B' to language 'A'. The results should be compared with the initial vocabulary to ensure that the original meaning has been retained. Where possible, terms should be used that can be associated with chemical reference material, e.g. bitterness with caffeine or quinine. In this context, two valuable guidelines have been published dealing with cheese texture (Lavanchy *et al.*, 1994) and the aroma and flavour of cheese (Bérodier *et al.*, 1997).

13.6.2 *Evolution of the vocabulary*

Inclusion of the term 'other' is a valuable aid to ensuring that the vocabulary is comprehensive. Assessors are invited to describe any attribute of the test sample not included in the vocabulary and to rate the intensity of the additional attribute. The results are inspected and, if a number of assessors independently define a new attribute and if the ratings are significantly greater than zero, the additional term may be added to the vocabulary. The ability of this new attribute to provide useful information about the sensory profile of further sample sets is assessed and, if found useful, the new term is promoted to the main vocabulary.

13.7 Sample preparation and presentation

13.7.1 *Environment*

Attention must be paid to the protocol for evaluation of samples. The key objective is to present the stimulus to the assessor in stress-free circumstances, with no distractions. The

environment must be clean and comfortable. The temperature, lighting and air supply should be controlled. Fresh, odour-free conditions are essential.

13.7.2 Isolation

Assessors must be isolated from each other. Even where no vocal contact is made, the sight of a fellow judge grimacing as a sample is consumed can bias results.

13.7.3 Rating of samples

Rating of the attributes should be simple. When paper forms are used, a scale of length 125–150 mm is appropriate. Experience has shown that given appropriate anchor points (absent, extremely strong), assessors can be trained to use such scales with consistency. Such a scale is appropriate for a trained panel of assessors, but is difficult to explain to consumers. In that case, there is much merit in using a structured scale.

13.7.4 Presentation order

The presentation of test samples is critical. The assessor should not be able to identify the test subject by virtue of its coding and, if possible, care should be taken in the coding itself. For, example, the use of ‘A’, ‘B’ and ‘C’ as codes may subliminally order the samples in the assessor’s mind. In addition, the order of presentation of samples for assessment should be arranged to allow estimation of (and allowance to be made for) order of tasting effects. These effects are well documented and strategies for evaluation have been advanced both for sensory testing with a trained panel (Muir & Hunter, 1991/1992) and preference evaluation using large consumer panels (MacFie *et al.*, 1989). In contrast to presenting samples in random order, presentation is arranged such that every sample is assessed an equal number of times in each of the possible orders. By basing the design on that of a William’s Latin Square (Williams, 1949), information on first-order carry-over effects can also be deduced. A corollary to this approach is that samples are evaluated one at a time in a predetermined order. An example of a design balanced for order is shown in Table 13.2.

Table 13.2 Design of experiment to profile four cheeses with optimum efficiency.^a

	Rate 1st	Rate 2nd	Rate 3rd	Rate 4th
Assessor 1	Cheese A	Cheese B	Cheese D	Cheese C
Assessor 2	Cheese B	Cheese C	Cheese A	Cheese D
Assessor 3	Cheese C	Cheese D	Cheese B	Cheese A
Assessor 4	Cheese D	Cheese A	Cheese C	Cheese B

Data based on a William’s Latin Square.

^aEach sample is rated the same number of times; each assessor rates every sample; each sample is rated once in every order; each sample is preceded by every other sample.

Care must be taken to avoid operator fatigue. Sessions in which four samples are evaluated present no difficulty to an experienced assessor. However, if the test material is very strongly flavoured, e.g. blue, mould-ripened cheese, it is more appropriate to reduce the number of samples tested in a single session. Consumption of a plain water biscuit or segment of apple followed by rinsing the mouth with cold clean water moderates the effect of carry-over. Water quality is important – soft or deionised still water should be used.

13.8 Assessor selection

13.8.1 *Internal versus external panels*

Assessor selection poses an important dilemma. Ideally, a sensory panel should be made up of independent specialists, chosen for their sensory acuity and with no competing duties. However, the direct costs of employing an external panel may preclude this course of action and the panel may have to be drawn from staff of the host organisation. This course of action has two disadvantages: firstly, it is inevitable that other duties within the organisation will deny the employee freedom to attend the panel sessions when required; secondly, a smaller pool of prospective candidates will be available from which to make a selection. Nevertheless, irrespective of whether the panel is selected from outside or within the organisation, certain basic selection procedures should be used to optimise performance.

13.8.2 *Pre-selection procedure*

Initial selection should be based on a questionnaire. The following details should be ascertained:

- The age and sex of the prospective assessor should be established. This information is used to attain the required balance of sex and age distribution.
- The general health of the applicant should be gently probed. Direct questions, such as ‘Do you suffer from diabetes?’ should be avoided and substituted by queries such as ‘Do you take any medication?’ and ‘Do you suffer from any condition, which requires a specific diet?’ These questions are necessary to ensure that medication does not interfere with the assessor’s performance or prejudice an existing medical condition.
- Smokers of tobacco should be excluded because there is evidence that smoking prejudices sensory acuity. For example, smokers are often insensitive to bitterness.
- To avoid other difficulties, assessors with moral or religious objections to consumption of certain types of food or beverage should also be excluded from a panel.
- The attitude of prospective panelists to consumption of a wide range of contrasting types of food and beverage should be established by questionnaire. For example, assessors are invited to indicate their personal attitude to a range of food types, including cheese, milk and meat products, fruit and vegetables, baked goods and confectionery, which should be as extensive as possible. This basic information allows pre-selection of assessors with few potential problems and with an open mind.

13.8.3 *Initial testing*

Potential assessors who satisfy all the pre-selection criteria should be invited to the laboratory for an intensive series of tests.

Sense of taste – The first series of tests is designed to establish that the assessor has sensitive taste receptors and can detect the basic tastes; sweet, salt, sour and bitter. The solutions required for this are sucrose, common salt, citric acid and either caffeine or quinine, to represent the taste sensations sweet, salt, sour and bitter, respectively. Assessors are asked to taste them and record the taste they detect, if any. Assessors who are insensitive to a particular stimulus are unsuitable and should not be considered further. If a choice of assessors of equivalent sensitivity is available, the test should be repeated and assessors with the best overall performance chosen for further testing.

Sense of smell – The next test is designed to establish that assessors have a well-developed sense of smell. Samples of Danish blue cheese, Parmesan and Edam are finely grated and opaque containers with airtight lids are half filled with grated cheese, completely covered with a layer of cotton wool and the container sealed. The sealed containers are equilibrated for at least an hour at room temperature. A series of tests should be carried out, in which the assessor is presented with five randomly coded containers. Three containers should be of one variety and two of another. Three sets of five containers should be prepared: Set 1 of Danish Blue versus Parmesan; Set 2 of Danish Blue versus Edam and Set 3 of Edam versus Parmesan. Assessors are presented with each set in turn and asked to classify the samples within each set into two groups. Assessors should be expected to correctly classify all samples. However, a single misclassification may be accepted. Successful assessors pass on to the next test.

Ability to rank samples – The third test establishes the ability of the assessor to rank samples in order of flavour intensity. A set of five cheese samples differing in maturity (e.g. mild, medium, mature, extra-mature and vintage Cheddar) are presented to the assessor, who is asked to rank the samples in ascending order of flavour intensity. Once again, assessors should be able to perform this task without error.

Descriptive ability – Finally, assessors are presented with a set of four contrasting samples of cheese, e.g. Cheddar, Parmesan, Gruyère and Jarlsberg, and are invited to describe the main characteristic of each sample. This test is less objective than the initial three evaluations, but establishes whether or not an assessor is capable of intelligent description of an unknown product.

13.8.4 *Acclimatisation and confirmation*

Assessors who perform adequately in the above series of tests are recruited to the panel for a 3- or 6-month probationary period. During this time, the probationer is familiarised with the established protocols used in the laboratory and their performance is continually assessed.

During the training period, assessors should be trained to follow instructions with care, to record information accurately and to experience as wide a range of sensory assessments of cheese as is possible. Whenever appropriate, newly recruited assessors should be allowed access to reference material and should be encouraged to discuss difficulties with the other

panel members. This is particularly important to establish an unambiguous use of the sensory vocabulary.

13.8.5 *Monitoring assessors' performance*

In an analogous way to routine calibration of an analytical instrument, it is essential to apply quality assurance procedures to sensory panels. However, objective assessment of the performance of sensory assessors is a particularly complex task. Ideally, three separate aspects should be considered:

- Self-consistency, i.e. the consistency of an assessor in using the scale by which an attribute is rated;
- Alignment of an individual assessor with the other panel members and
- The relationship of the profiles derived from the panel to equivalent profiles derived from other panels carrying out a similar profiling task.

There are no universally recognised methods for measurement of these indices of performance. However, in our laboratories the problem has been approached in a variety of ways as described in Section 13.9.9.

13.9 Integrated design and analysis of data

13.9.1 *The design, data capture and analysis of the sensory-profiling protocol*

Analysis of sensory data can be streamlined. A system for design, data capture and analysis of the sensory-profiling protocol (DDASPP) has been developed by Bio-Mathematics and Statistics Scotland (BioSS), Hannah Research Institute and Scottish Crop Research Institute in a Scottish Office sponsored initiative (Williams *et al.*, 1996). DDASPP comprises integrated software with four main elements:

- Firstly, there is a design facility that generates kitchen sheets. These define the coding and order of presentation of samples to assessors within each session.
- Secondly, DDASPP has a module that is mounted on individual personal computers within each testing booth. This module instructs assessors in the detail of the testing protocol, invites assessors to rate individual attributes, records their response, time stamps the file and collates the resulting data.
- Thirdly, a check programme is used to match the design and results files and to check for inconsistencies.
- Finally, a modular suite of programs takes the validated results file and carries out a univariate analysis that generates a matrix of sample by attribute mean values (and confidence limits). The results may be further refined by Principal Component Analysis (PCA). Alternately, individual assessor data can form the basis of a generalised procrustes

Table 13.3 Cheese types used in illustrative example.

Sample	Code	Sample	Code
Cheddar, mature	Ch1	Gruyère	Gru
Cheddar, medium	Ch2	Emmental	Emm
Cheddar, mature	Ch3	Edam	Eda
Cheddar, mature	Ch4	Leerdamer	Lee
Cheddar, mature	Ch5	Gouda	Gou
Cheddar, mature	Ch6	Jarlsberg	Ja
Cheddar, mild	Ch7	Parmigiano Reggiano	Par
Cheddar, mild	Ch8	Grana Padano	Gra

analysis (GPA). In both cases, annotated output is generated in tabular and graphical form. Assessor plots for each sensory modality and bi-plots for individual attributes are also implemented in associated modules. This system will be commercialised as 'kwik sense'.

DDASPP has been successfully used for profiling a wide range of cheese types, including semi-hard and hard varieties, soft cheese (including cottage and fromage frais), blue mould-ripened cheese and processed cheese analogues. The elements of the data analysis are considered in turn.

13.9.2 Preliminary treatment

A special feature of sensory profile data is their complexity. For example, a typical profiling experiment, such as that used to provide data for this chapter, might comprise 9600 units of data, made up of 16 samples (Table 13.3) \times 25 attribute ratings \times 12 assessors \times 2 replicates. From this matrix, analysis of variance is used to calculate mean ratings for each sample by every attribute (400 results). Our usual method of analysis is to fit a mixed model separately to each variate by using the residual maximum likelihood (REML) technique (Patterson & Thompson, 1971; Horgan & Hunter, 1992). The analysis is carried out in DDASPP and provides tables of means and standard errors of the means. This information is of value for comparison of differences in a few selected attributes. For example, the intensity of flavour attributes for different types of cheese may be compared using results from a single sensory assessment (see Table 13.4). Alternatively, changes in a single attribute may be monitored during the ripening of cheese. In this case, information from a series of sensory assessments is amalgamated (Muir *et al.*, 1992, 1996; Banks *et al.*, 1993, 1994).

A particular difficulty lies in the interpretation of results when there are many samples and many attributes. Spider charts and star charts can aid interpretation. In a star chart, one vector is assigned to each attribute, and for each sample, the length of the vector is scaled to reflect the relative magnitude compared to the other samples in the set. A star chart is shown for the flavour characteristics of a sample set of cheese (Fig. 13.1).

Star charts are particularly useful for monitoring quality because they highlight deviations from the norm. However, they present a biased view of the overall profile because the scaling operation obscures differences in magnitude of individual attributes.

Table 13.4 Mean rating for flavour attributes of cheese.

Type of cheese	Intensity	Creamy	Sour	Eggy	Fruity	Rancid	Bitter	Unclean	Salty
Cheddar, mature	75.2	35.4	30.1	18.9	6.2	11.6	42.5	16.4	50.8
Cheddar, medium	52.6	43.9	18.0	9.6	13.7	2.9	28.7	0.2	44.6
Cheddar, mature	77.2	41.2	31.8	13.1	6.9	6.2	42.9	4.7	48.5
Cheddar, mature	81.0	33.9	38.3	8.0	8.1	4.3	38.9	3.6	53.7
Cheddar, mature	78.4	28.7	33.7	24.2	11.6	15.7	42.0	21.3	53.1
Cheddar, mature	71.4	41.4	31.1	15.3	5.6	6.2	40.1	4.9	52.9
Cheddar, mild	43.3	38.4	15.5	6.9	6.0	0.4	12.1	0.2	36.2
Cheddar, mild	45.4	31.6	28.2	7.3	6.2	6.8	26.1	2.1	37.0
Gruyère	69.0	27.2	36.6	40.7	15.7	18.1	30.3	35.9	34.6
Emmental	56.2	23.2	27.9	23.1	29.7	11.3	34.3	13.0	23.3
Edam	52.1	38.4	23.3	10.3	8.7	3.8	23.4	4.2	50.5
Leerdamer	43.6	31.0	15.3	8.5	19.1	3.5	17.5	3.8	25.5
Gouda	49.3	43.0	17.6	14.8	11.3	3.4	20.4	0.0	41.9
Jarlsberg	44.6	30.4	18.1	10.9	22.6	6.4	20.6	6.7	20.0
Parmigiano Reggiano	62.7	23.9	38.5	15.9	40.5	12.1	38.7	5.1	41.7
Grana Padano	63.7	25.5	27.0	11.1	47.0	2.8	30.3	0.1	36.9

13.9.3 Sensory space maps

More powerful ways of representing differences between samples rely on the construction of sensory space maps. These maps may encompass all the attributes profiled or may focus on a single modality, e.g. flavour. The starting point for these maps is a series of locations (one for each sample) in a notional multi-dimensional space, where the number of dimensions equals the number of attributes. Most observers are incapable of visualising locations within spaces of more than three dimensions and many people are only comfortable with two.

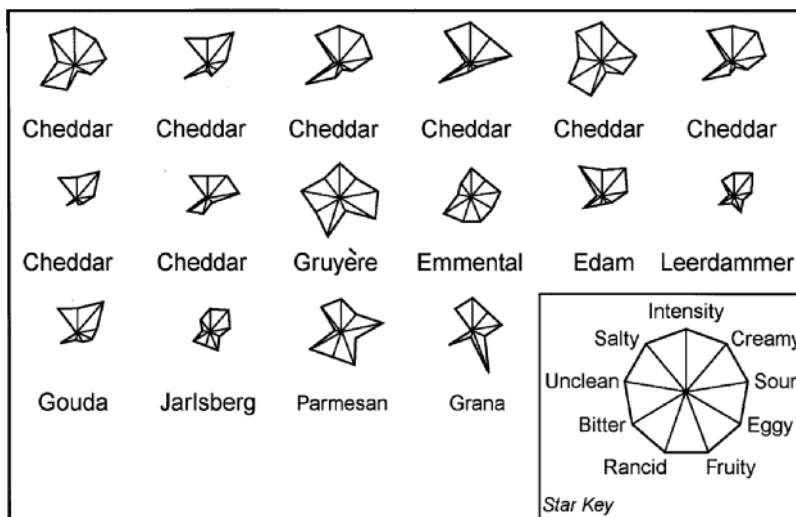

Fig. 13.1 Star charts of flavour attributes of a selection of hard and semi-hard cheeses.

This problem is resolved by simplifying the results and projecting higher dimensions onto a two-dimensional space. Two main ways of carrying out this task are readily accessible to the sensory scientist. The first is based on PCA (Jolliffe, 1986) and the second is based on GPA (Naes & Risvik, 1996). PCA relies on assessors rating samples according to a common vocabulary and sensory maps produced by this route are usually straightforward to interpret. On the other hand, GPA can derive a consensus configuration when assessors have rated the test stimuli according to personal vocabularies (the requirements for training assessors are less demanding in this case). However, unambiguous interpretation of the maps derived from GPA with individual vocabularies is sometimes difficult. When GPA is used to simplify ratings on a fixed vocabulary, interpretation is straightforward and in comparison to PCA, extra information can sometimes be deduced (Hunter & Muir, 1995).

13.9.4 *Principal Component Analysis*

PCA is a statistical technique that extracts a small number of latent factors to explain the major variation in a data set (Jolliffe, 1986). For example, a large attribute set (e.g. 23 attribute ratings) might be reduced to a small number of latent factors, typically <5, called principal components, which explain the main variance within the attribute ratings. Each principle component (PC) is orthogonal, i.e. uncorrelated, to the other PCs and each PC is described by a linear combination of all attributes of the form:

$$\text{PC score} = v_1(\text{rating}_1) + v_2(\text{rating}_2) + \dots + v_n(\text{rating}_n) \quad (13.1)$$

where v is the vector loading and ratings are sample ratings for up to n attributes.

The PCs are extracted in a hierarchical manner. The first PC is computed to maximise the variance explained. This information is then subtracted from the initial data matrix and a second PC is derived from the residuals. Further PCs are derived in the same way. Clearly, the residuals comprise both structured information and noise. The initial dimensions therefore have a higher information content than the later PCs. Selection of the appropriate number of PCs to explain the maximum amount of variance can be carried out in several ways. The simplest technique involves inspection of a scree diagram; i.e. a plot of variance explained as a function of the number of PCs. A more objective assessment can be made by using a validation method (test set, leverage correction or cross validation).

Each test sample has a unique set of values for the attribute ratings. Substitution of these ratings into Equation 13.1 yields a score for each sample on that PC. The sample scores are used to construct sensory space maps. Clearly, samples will be located close together in sensory space only if their scores on the relevant PCs are similar. An example of a sensory space map is presented in Fig. 13.2. PCA was carried out on the sample data (Table 13.4; 16 rows \times 9 columns; 'other' was excluded). The data were not pre-scaled; i.e. the covariance matrix was used, because pre-scaling suppresses valuable information concerning the relative magnitude of attributes. The scores for the cheese samples are plotted for the first two principal components explaining 49 and 28 of the variance, respectively (Fig. 13.2).

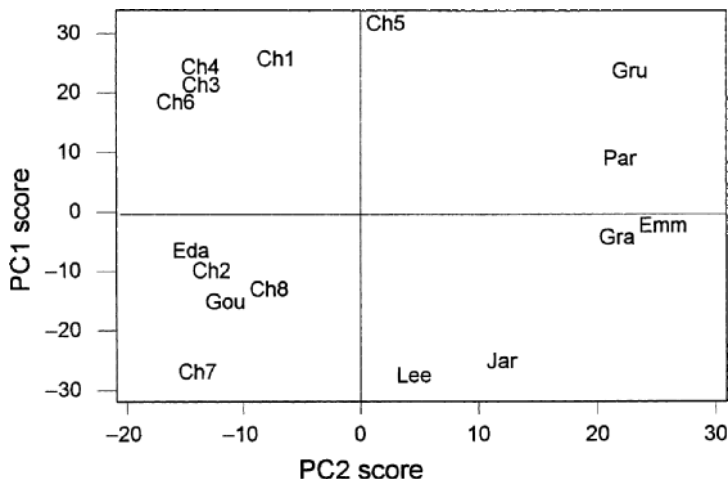

Fig. 13.2 Sensory space map for cheese flavour constructed from the sample scores on principal components (PC) 1 and 2 (variance explained 49 and 28%, respectively). Sample codes are given in Table 13.3.

13.9.5 Interpretation of sensory dimensions

The clustering on the sensory space maps implies that the samples have similar ratings for the attributes that contribute most to the PCs used to form the sensory space map. The magnitude of a vector loading reflects the relative importance of the attribute with which it is associated. Different attributes may make contrasting contributions to adjacent PCs (e.g. Fig. 13.3). An alternative measure of the contribution of an attribute to a PC may be deduced from the correlation of the sample ratings with the PC scores (see Fig. 13.4). A parallel analysis was

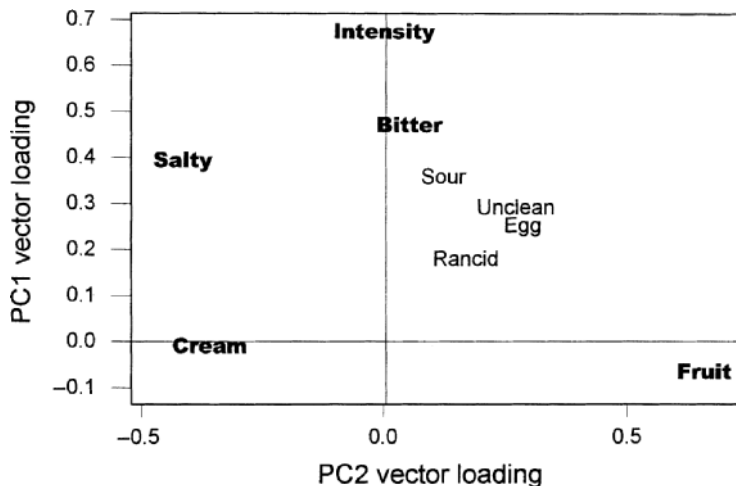

Fig. 13.3 Vector loadings corresponding to sensory dimensions in sensory space map shown in Fig. 13.2. Vector loadings are taken from principal component (PC) analysis.

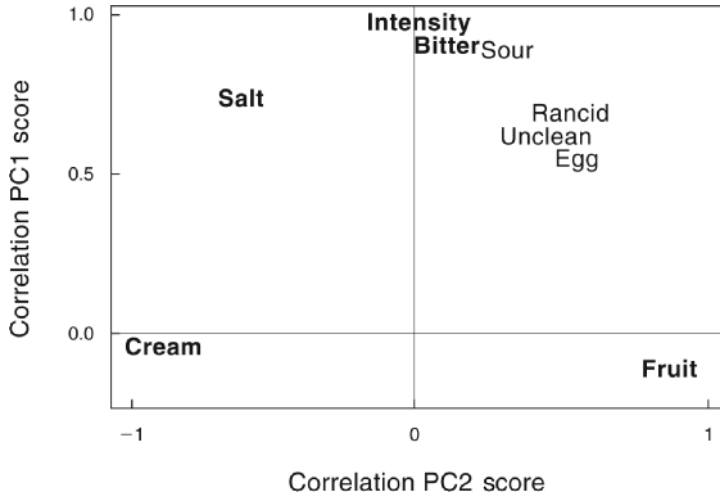

Fig. 13.4 Use of correlation of principal component (PC) scores with attribute ratings to interpret sensory dimensions shown in Fig. 13.2.

carried out using all the sensory attributes. A sensory space map is shown in Fig. 13.5 for the first two dimensions (73% variance). The interpretation of the dimensions was less clear-cut (Fig. 13.6) than for flavour alone. Moreover, separation of some samples was poor (Cheddar and Gruyère). However, these samples were separated in a sensory map of dimensions three and four (Fig. 13.7). A further 19% variance was explained by these PCs.

In sensory profiling where all attributes are rated on a uniform scale (0–100), no transformation of the ratings is necessary (i.e. PCA is performed on the covariance matrix.)

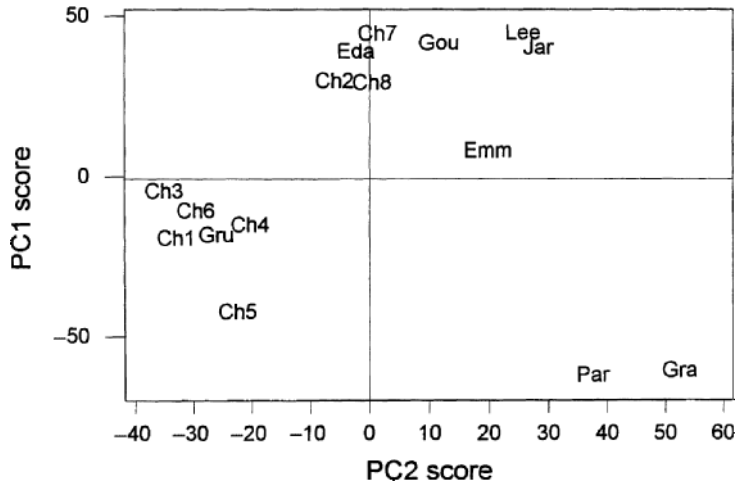

Fig. 13.5 Sensory space map for all attributes of cheese. Constructed from the sample scores on principal components (PC) 1 and 2 (variance explained 48 and 25%, respectively). Sample codes are given in Table 13.3.

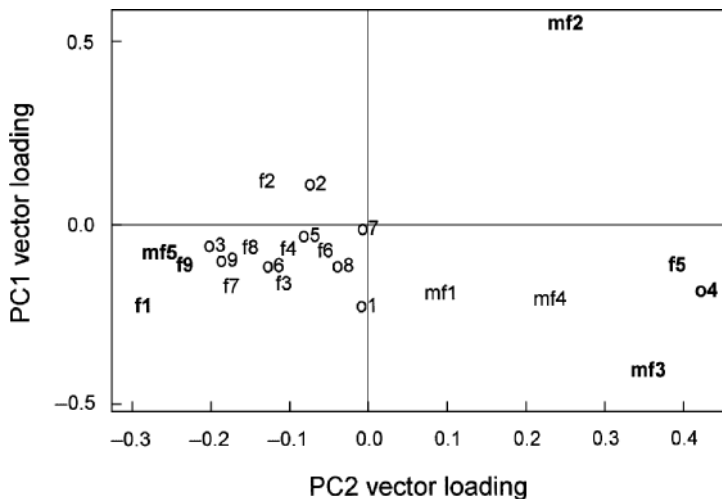

Fig. 13.6 Vector loadings corresponding to sensory dimensions in sensory space map shown in Fig. 13.5. PC, principal component.

13.9.6 Generalised Procrustes Analysis (GPA)

When GPA is applied, the individual sample configurations in multi-dimensional sensory space are aligned to a consensus configuration by a series of mathematical transformations that may include centering, scaling, rotation and reflection. Several good examples of this treatment have been reported for free-choice profiling of cheese and other products. (Williams & Langron, 1984; Guy *et al.*, 1989; McEwan *et al.*, 1989; Gains & Thomson, 1990). Once the consensus configuration is optimised, it is simplified by PCA. GPA scores are used to plot

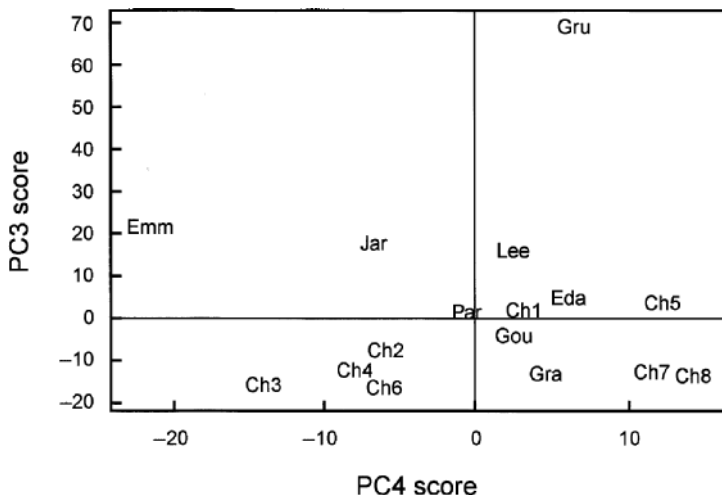

Fig. 13.7 Sensory space map for all attributes of cheese. Constructed from the sample scores on principal components (PC) 3 and 4 (variance explained 16 and 3%, respectively). Sample codes are given in Table 13.3.

sensory space maps. (The problem of assigning attributes to dimensions, and one method of resolution, is given above. An alternate approach uses the weightings for each attribute given by each assessor to be assigned to each of the consensus dimensions.) The significance of GPA dimensions and sample score plots is derived in the same way that has been described above for the results of PCA.

13.9.7 *Interpretation of sensory space maps*

Unlike geographical maps, sensory space maps are not absolute. They are influenced by the frame of reference. For example, if a map is constructed for blue, mould-ripened cheese, the PCs reflect important variation in attribute ratings within the sample set. A different picture may emerge when blue cheese is profiled together with a much wider range of cheese varieties. In this case, different attributes may dominate the equivalent PCs. This important caveat underlines the principle that, when sensory space maps from different sample types are to be compared, it is prudent to include common reference samples in every profiling experiment and it is essential to carry out a conjoint PCA.

13.9.8 *Multivariate prediction*

Principal component regression (PCR) is an extension of the principles of PCA. In multiple linear regression, a predictive equation for a response variable is derived using a set of predictor variables. There is a danger of overfitting the model and difficulties arise when predictors are intercorrelated. PCR decomposes the matrix of sample by predictor values into PC scores and uses these scores in the prediction model. By definition, PC scores are orthogonal, i.e. uncorrelated. In an analogous manner to identifying PCs of significance (see above), validation techniques allow a logical choice of the appropriate number of dimensions to be included in predictive models and reduce the likelihood of overfitting. Moreover, validation tests provide a robust estimate of the predictive value of the model. In addition to PCR, partial least squares regression methods (PLS1 and PLS2) provide a useful tool for constructing predictive models. The potential to cast light on the key attributes of cheese associated with perceived maturity is one application of multivariate regression. The panel can be trained to rate overall maturity by using a range of cheese that has been ripened for periods ranging from a few weeks to over 2 years. A prediction model can be constructed (using PCR or PLS1 regression) to relate perceived maturity of the cheese to the individual attribute ratings. Examination of the regression coefficients, sometimes referred to as beta-coefficients, highlights the attributes that make the greatest contribution to the predictive model. A model predicting the perceived maturity of the test set of cheeses (Table 13.3) explained over 99% of the variance using five factors (Table 13.5) but after cross validation, the variance explained fell to 95.6%. A conservative model using only two factors still explained over 91% of variance. The corresponding regression coefficients are shown in Fig. 13.8. The overall flavour intensity and the rating for rubbery texture dominated the prediction model.

In contrast to maturity, the acceptability of cheese is a subjective choice rather than an objective measurement. Assessors cannot be trained to make the appropriate ratings but will

Table 13.5 Prediction model for maturity derived from attribute ratings (partial least squares regression).

Number of factors	Calibration	Validation
1	87.9	83.0
2	94.4	91.0
3	98.3	91.8
4	98.6	94.4
5	99.3	95.6

Variance explained by model.

rank samples according to personal preference. As a result, a trained panel will only reflect the population as a whole if the distribution of ratings associated with a sample set coincides with the ratings of a large and representative cross-section of the general population. Such a coincidence is unlikely. On the other hand, the general public do not have the ability to profile cheese accurately. To overcome this difficulty, acceptability ratings are collected for a special sample set from a large group (50–500) of untrained subjects. These ratings are related to profile results derived from measurements made by a trained panel of assessors on the same sample set. Because comprehensive consumer data are not currently available for cheese, the technique is illustrated here using acceptability ratings from the Hannah-trained panel. In an analogous treatment to that used to model maturity, acceptability was modelled by PLS1 regression. In this case, the model was a poorer fit to the data (Table 13.6).

Although 97.6% of variance was fitted in a five-factor calibration, examination of the results after cross validation suggested overfitting and a prediction model using three factors (68.7% variance) was selected. A wider range of attributes contributed to the model for acceptability than for maturity (Fig. 13.9). Creamy and salty characters were important positive attributes whilst bitter flavour and rubbery mouth-feel detracted from acceptability.

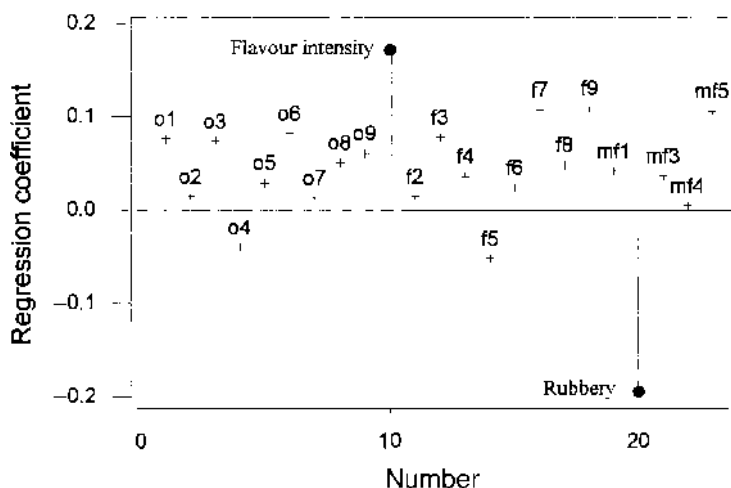

Fig. 13.8 Regression coefficients for model predicting perceived maturity from attribute ratings. Based on partial least squares regression model with two factors, explaining 94.4% of variance after cross validation.

Table 13.6 Prediction model for acceptability derived from attribute ratings (partial least squares regression).

Number of factors	Calibration	Validation
1	71.7	37.1
2	80.8	57.5
3	84.5	68.7
4	95.0	66.2
5	97.6	67.1

Variance explained by model.

Although this example illustrates the method for probing consumer acceptability, caution must be exercised. The sample set encompassed a limited range of stimuli and the assessors were not representative of the population as a whole. For a wider discussion on analysis of consumer acceptability (see MacFie & Thomson, 1994).

13.9.9 Measurement of assessors' performance

It is relatively simple to estimate self-consistency of assessors within an individual profiling experiment. Analysis of the replicated measurements for each attribute yields an estimate of the confidence limit that can be associated with the assessor mean ratings. Nevertheless, interpretation of the data is not straightforward because assessors may perform well in rating some attributes but poorly in others. A bi-plot subroutine in DDASPP allows the spread of responses between individual assessors to be visualised for each attribute within the vocabulary (Fig. 13.10). This plot is particularly useful because a wide spread of individual responses pinpoints attributes where there is disagreement within the pool of assessors. The disagreement may result from unfamiliarity with the sensory stimulus; inconsistency on the

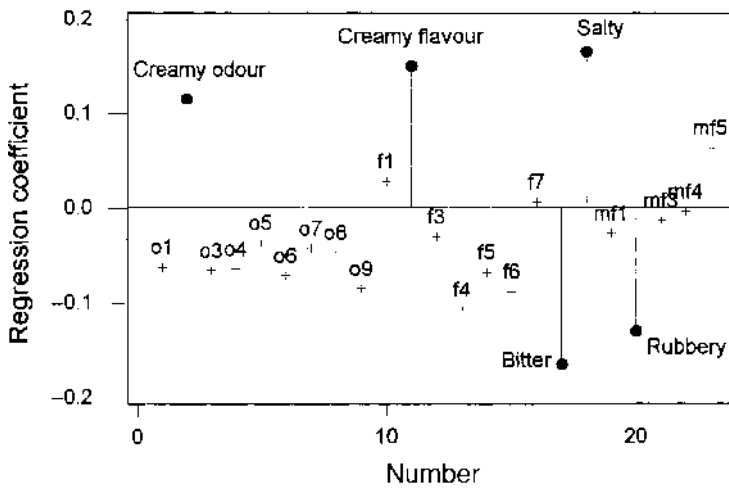

Fig. 13.9 Regression coefficients for model predicting acceptability from attribute ratings. Based on partial least squares regression model with three factors, explaining 68.7% of variance after cross validation.

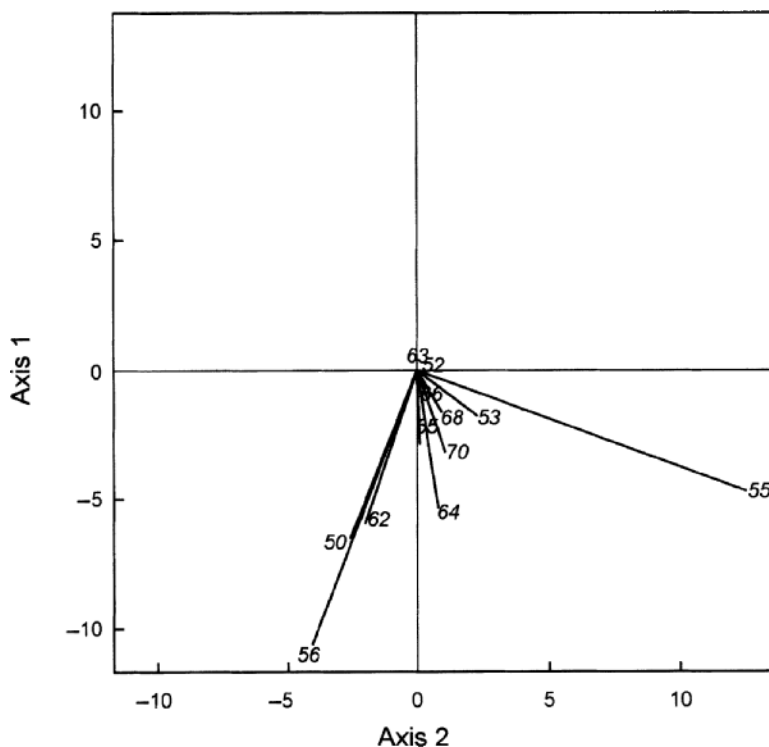

Fig. 13.10 Orientation of individual assessors within the sample of a bi-plot for a single sensory attribute. A narrow envelope encompassing the vectors for individual assessors indicates close agreement.

part of some assessors or ambiguity in the descriptor used to rate the underlying attribute. The performance of the panel may be improved by further training or by selection of an unambiguous term to describe the attribute in question.

A more sophisticated, multi-dimensional approach is also implemented in DDASPP in the form of an assessor plot. Pairwise GPA is used to compute the relative distance between every pair of assessors, and these distances are transformed into an assessor plot showing the relative orientation of assessors to each other. A robust estimate of the domain, within the assessor plot, likely to occur by chance (i.e. the 95% confidence limit) is also computed. Assessors located outside this domain are deemed to have atypical performance within this trial (Fig. 13.11). If an assessor regularly falls outside the expected domain in the assessor plot for a particular product type, it is valuable to examine the bi-plots (described above) to establish if the assessor has atypical ratings for all attributes or if a specific descriptor is causing difficulty. Remedial action takes the form of training or in the worst case, exclusion from the panel.

When a sequential series of sensory profiles is to be measured (for example, over the ripening period of a cheese), it is necessary to employ a performance index which is independent of the stimuli (i.e. sample sets). The isotropic-scaling factor that can be deduced for each assessor by GPA of profile data has merit in such circumstances (Hunter & Muir, 1997). A scaling factor is computed for every assessor for each profile. The temporal consistency

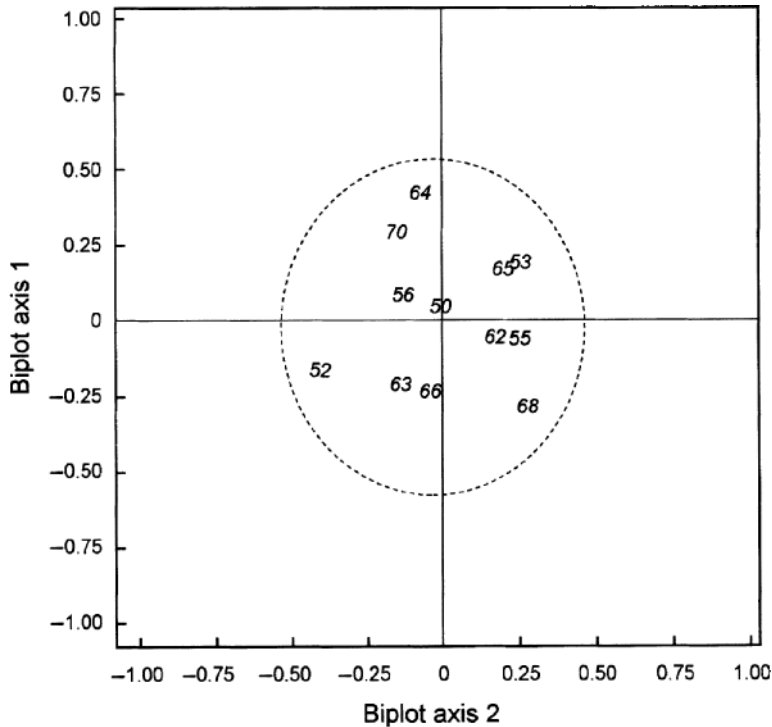

Fig. 13.11 Assessor plot showing relative alignment of assessors for the overall profile of cheese. Ellipse indicates region within which assessors are expected to fall if differences between assessors are random (95% confidence interval).

of the assessor's performance can be usefully visualised by plotting the appropriate indices as a control chart. A typical example is presented in Fig. 13.12. The scaling indices are graphed sequentially and confidence limits are computed on the expectation that deviations from the mean are haphazard. Excursions beyond the confidence limits denote other effects (for example, the assessor's performance might have been influenced by illness). In general, assessors are remarkably consistent over extended time periods. Nevertheless, there is variation between assessors in the degree of fluctuation about the mean value.

The agreement of assessors with the consensus view can also be deduced from a GPA. The correlation of the sample scores (on the significant factors) for an individual assessor with the equivalent scores for the consensus configuration provides another robust estimate of performance. Once again, it is illuminating to arrange the correlation data in the form of a control chart (Fig. 13.12). In the example shown, the assessors were unfamiliar with the product (dessert apples) at the outset of the experimental series. However, there is clear evidence that assessors agreed more closely with each other as the number of profiles in the sequence increased.

Finally, the extent of agreement of the panel with other expert panels familiar with sensory profiling should be established. This can be estimated by arranging for a common sample set to be evaluated by two or more panels. For example, a Scottish panel (at Hannah Research Institute) and a Norwegian panel (at The Norwegian Food Research Institute, Matforsk)

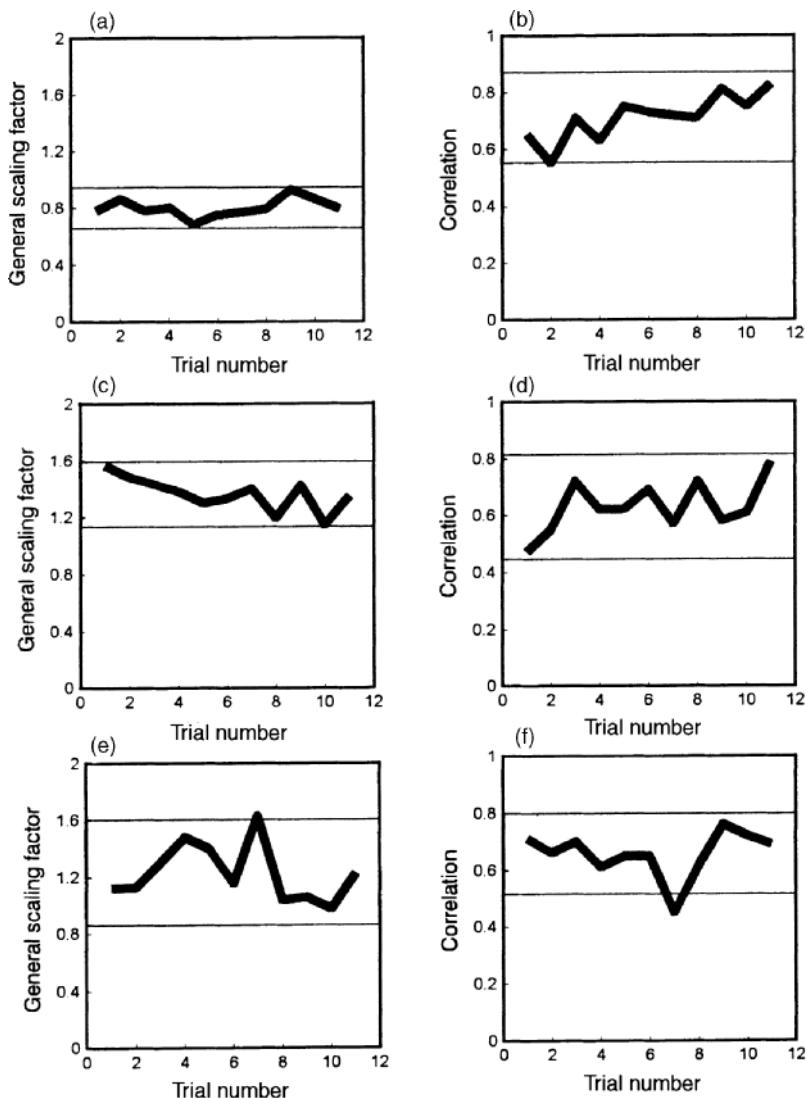

Fig. 13.12 Indices of assessor performance: (a, c, e) scaling factor from generalised procrustes analysis and (b, d, f) correlation of assessor's profile with consensus.

evaluated a common set of 12 varieties of cheese (Table 13.7; Hirst *et al.*, 1994). In the time available, only a limited amount of training was possible and as a result, the experimental vocabularies were not fully aligned (see Tables 13.8 and 13.9). The correspondence of the panels may be judged in two ways. Firstly, prediction models can be constructed (using PLS2) for each attribute in the Scottish vocabulary based on the sample ratings for each attribute in the Norwegian vocabulary. The equivalent process can be repeated to obtain prediction models for the Norwegian data based on the Scottish ratings. The variance explained by these predictions (after cross validation) is summarised in Tables 13.8 and 13.9 for flavour

Table 13.7 Cheese samples used in comparison of a Norwegian and Scottish sensory panel.

Sample	Code	Sample	Code
Jarlsberg	A	Norvegia	G
Cheddar, extra-mature	B	Cheddar, mature	H
Jarlsberg, reduced-fat	C	Cheddar, Norsk	I
Cheddar, extra-mature	D	Cheddar, reduced-fat	J
Norvegia	E	Norvegia	K
Cheddar, mild	F	Cheddar, reduced-fat	L

Table 13.8 Prediction of flavour ratings (for cheese) of Norwegian panel from the Scottish profile, and flavour ratings of the Scottish panel from the Norwegian profile.

	Variance explained (%)	
	Predicted results: Norwegian panel from the Scottish profile	Predictor: Scottish panel from the Norwegian profile
Intensity	94.1	82.6
Creamy	88.1	Poor model
Acid/sour	61.2	93.1
Sulphur	Not used	80.7
Fruity	Not used	Poor model
Rancid	Not used	64.0
Bitter	69.3	56.0
Cow	Not used	37.7
Salty	71.9	63.3
Sweet	72.0	73.0
Ammoniacal	53.1	Not used
Other	47.2	Not used

Variance explained, after cross validation, by the optimum partial least squares regression method 2 (PLS2) prediction model for individual attributes.

Table 13.9 Prediction of mouth-feel ratings (for cheese) of Norwegian panel from the Scottish profile, and mouth-feel ratings of the Scottish panel from the Norwegian profile.

	Variance explained (%)	
	Predicted results: Norwegian panel from the Scottish profile	Predictor: Scottish panel from the Norwegian profile
Firm/hard	47.2	25.1
Rubbery	93.9	94.2
Pasty/doughy	87.9	32.1
Grainy	60.6	67.9
Mouth coating	Not used	88.7
Sticky	84.9	Not used

Variance explained, after cross validation, by the optimum partial least squares regression method 2 (PLS2) prediction model for individual attributes.

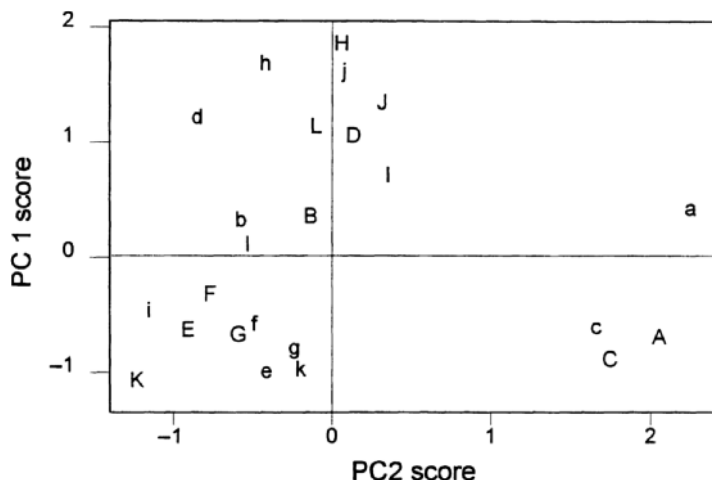

Fig. 13.13 Superimposed sensory space maps of cheese flavour for Norwegian panel (lower case) and Scottish panel (upper case). Sample codes are given in Table 13.7. PC, principal component.

and mouth-feel, respectively. There was clearly a measure of agreement between the panels despite the difficulties with vocabulary.

This view is reinforced by the sensory maps shown in Figs. 13.13 and 13.14. The results of the individual panels were simplified by PCA (covariance matrix) and the sample scores on the first two PCs were scaled (by dividing the scores by the variance) and superimposed in a common sensory space map. Maps are shown for the sample spaces on the basis of the flavour and mouth-feel profiles (Figs. 13.13 and 13.14, respectively). Although this analytical treatment is unsophisticated, it illustrates that despite differences in vocabulary, the panels perceived the underlying character of the cheese samples in a remarkably similar way. Later, more extensive studies have reinforced this view.

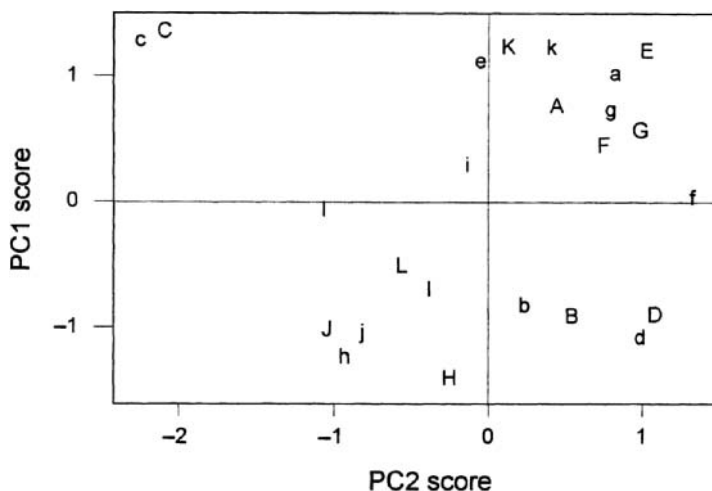

Fig. 13.14 Superimposed sensory space maps of mouth-feel of cheese for Norwegian panel (lower case) and Scottish panel (upper case). Sample codes are given in Table 13.7. PC, principal component.

13.10 Sensory character of commercial cheese

To answer some of the main questions raised earlier, an extensive survey of the sensory character of Cheddar cheese at the point of ultimate sale to the consumer has been carried out. Whilst it was not possible to associate grading results with detailed sensory character, some important (and encouraging) points emerged. These are illustrated by consideration of results gathered over a 3-year period for 254 samples of Cheddar cheese purchased from supermarkets in Scotland. The cheese was profiled by an expert sensory panel by using the methods described above. The list of descriptors is shown in Table 13.1. Only those relating to aroma (odour) and flavour are considered here because these modalities make the greatest contribution to the acceptability of Cheddar cheese.

13.10.1 Comparison of maturity declaration on cheese packaging with sensory panel ratings

The consumer anticipates that information contained on the cheese packaging should reflect the nature of the contents. In the case of Cheddar cheese, most consumers are familiar with a maturity index – mild, medium, mature, extra-mature and vintage. This is largely determined by the cheese grader who categorises cheese early in its maturation period and determines the age at which the cheese should be sold. This judgement is critical because if an unsuitable cheese is ripened for too long, unacceptable flavour defects may develop.

Consumers anticipate that there should be a relation between maturity index (as determined by the label on the cheese packaging) and the intensity of flavour and aroma. Nevertheless for the 254 samples tested, when the relation between the maturity score (determined by the sensory panel) and the maturity index on the label was compared, the level of concordance was disappointing. Dot plots of individual maturity scores for each of the categories – mild, medium, mature, extra-mature and vintage are shown in Fig. 13.15. In every category (mild, medium etc.), the descriptions on the packaging encompass such a wide range of perceived maturity scores to be unhelpful. Clearly, the consumer is often misled by the label. The ambiguity lies in the term ‘maturity’. It may be interpreted as denoting either the ‘length

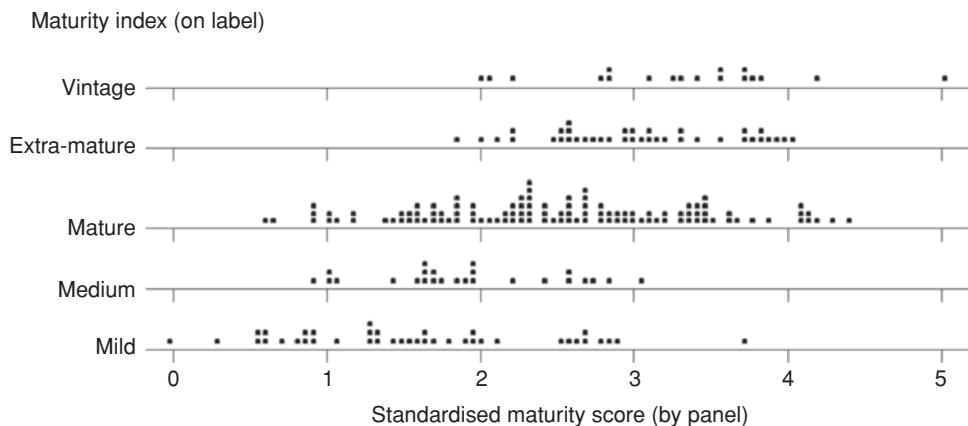

Fig. 13.15 Distribution of sensory panel scores for maturity by index on cheese packaging.

of the period during which the cheese has been ripened' or 'the strength of the aroma and flavour intensity'. On one hand, the Grader will make his (or her) judgement on the basis of ripening time and this judgement will form the basis of the information on the packaging. On the other hand, the consumer usually equates ripening time with flavour intensity – a relation that is valid only in specific well-defined cases because those versed in the art of cheese manufacture will routinely influence ripening rate by manipulation of a battery of processing variables. This clearly is a problem that requires addressing.

13.10.2 Discrimination amongst cheese types

The profiles of the 254 samples also provided a unique opportunity to investigate the diversity of flavour amongst Cheddar cheese of different origin. The methodology for sensory profiling and data analysis has already been detailed. To identify the key discriminant factors, the data matrix of 254 sets of the attributes shown in Table 13.1 (excluding overall aroma and flavour intensity) was analysed using PCA with factor rotation (varimax routine). The factor score coefficients were examined to establish the relative importance of individual attributes to each factor. Over 75% of the variance was accounted for by five factors: Factor 1 comprised unclean, pungent and acid/sharp aroma; Factor 2 was dominated by sulphur/egg flavour and aroma; Factor 3 was associated with creamy/milky flavour and aroma; Factor 4 with fruity/sweet flavour and aroma and Factor 5 with acid/sour flavour.

As a result, five traits were chosen to describe the aroma and flavour of Cheddar cheese: acid (acid/sour flavour), creamy (creamy milky aroma and flavour), barnyard (unclean aroma and flavour), sulphur (sulphur/egg aroma and flavour) and fruity (fruity/sweet aroma and flavour). Together with maturity, which closely reflected both overall aroma and flavour intensity, most of the variation between the samples was encompassed.

To further aid comparison amongst cheese types, the ratings for each of the key attributes were transformed to a common scoring system. The sensory ratings for each attribute were transformed onto a common scale from 0 to 5 units in length. Each part of the scale was then associated with a score and a corresponding descriptor (Table 13.10). Where aroma and flavour scores were recorded for the same underlying attribute, e.g. fruity/sweet, an average value was computed to give a character score. In the case of acid/sour flavour and perceived maturity, the scores were determined by the ratings or a single attribute. Unclean character was renamed 'barnyard'. As a result, a set of 6 scores was computed for every cheese sampled.

Table 13.10 Scoring system used for cheese classification.

Description	Score	Range (standardised)
Very mild	0	0–0.499
Mild	1	0.500–1.499
Medium strength	2	1.500–2.499
Strong	3	2.500–3.499
Very strong	4	3.499–5.000

Table 13.11 Classification of cheese.

Group	Acid	Creamy	Barnyard	Number	Percent (%)
1a	Low	Low	Low	52	20.5
2a	Low	High	Low	75	29.5
3a	High	Low	Low	57	22.4
4a	High	High	Low	31	12.2
1b	Low	Low	High	8	3.1
2b	Low	High	High	1	0.4
3b	High	Low	High	21	8.3
4b	High	High	High	9	3.5
Total				254	100.0

An initial review of the tables of scores suggested that Cheddar cheese could be classified into eight arbitrary groups based on acid, creamy and barnyard scores. The groupings and the proportion of cheese falling into each group are shown in Table 13.11. Cheese classified within group a (low levels of barnyard character) occurred much more frequently than cheese classified with higher levels of this trait. On the other hand, the distribution of both acid and creamy character was more evenly divided. Given that the samples were representative of consumer demands this finding suggests that farmhouse cheese where Barnyard character was more prevalent (Muir *et al.*, 1997) is a specialist taste.

Examples of application of this system of cheese classification for a selection of individual cheeses are shown in Table 13.12. The distribution of cheese types within the country of manufacture revealed significant differences (Table 13.13). For example, a higher proportion of cheese manufactured in Scotland fell into Groups 2 and 4 (64%) than for cheese manufactured in England (24%). That is Scottish Cheddar cheese is distinguished by its creamy character. In addition, barnyard character was almost absent from Scottish cheese (occurring in only 4% of samples) whilst cheese of Welsh origin was characterised as having barnyard trait in 56% of samples tested. The comparable figures for English, Irish and Canadian cheese were 22, 18 and 25%, respectively. Discussion with an industry expert, active in cheese selection over the period in which the sensory evaluation of the cheese took place, confirmed that positive discrimination took place to minimise the level of barnyard score in cheese manufactured in Scotland. This finding demonstrates the value of grading and selection based on sensory character in the development of 'brand' identity. A more recent example of brand identity based on flavour profile within the Scottish market is the 'seriously strong' brand which has become popular in the retail market. Other examples include the development of English farmhouse brands.

13.11 Development of flavour lexicons

It could be argued that the classification of Cheddar cheese by means of a small number of attributes is unnecessarily restrictive and is characteristic of the approach of northern Europeans (United Kingdom, Germany, Denmark and Norway), who favour a minimalist approach to flavour lexicons. This is in sharp contrast to that advocated in southern Europe – France, Switzerland, Italy and Spain – where extended vocabularies are preferred. The

Table 13.12 Examples of cheese classification.

Group	Retail store	Description	Sensory classification by score					
			Cream	Sulphur	Fruity	Barnyard	Acid	Maturity
1a	ASDA	Scottish mild coloured	2	0	1	0	2	1
1a	Tesco	Mild cheese ^a	1	0	0	1	0	0
1a	M&S ^b	Scottish mild coloured	2	1	2	0	2	2
1b	ASDA	Irish mature	2	2	1	2	2	2
1b	Tesco	Mature coloured ^a	2	2	1	2	2	2
1b	Kerrygold	Dubliner (Irish)	2	1	4	2	2	2
2a	ASDA	Scottish mature	4	1	1	0	2	3
2a	Tesco	Irish mature	3	1	1	1	2	1
2a	M&S	Ayrshire soft and creamy (Scottish)	4	1	1	1	2	2
2b	Tesco	Mature yet mellow ^a	3	1	1	2	2	1
3a	ASDA	Canadian	2	2	1	1	3	4
3a	Tesco	Scottish extra-mature	2	1	2	1	4	3
3a	Safeway	Canadian extra-mature	2	0	1	1	3	4
3b	ASDA	English extra-mature	2	3	1	3	3	4
3b	Tesco	Extramature ^a	2	2	1	3	3	2
3b	M&S	West Country farmhouse (English)	1	3	2	4	4	4
4a	ASDA	Mull of Kintyre extra-special mature (Scottish)	4	2	3	1	3	4
4a	Tesco	Canadian extra-mature	3	2	2	1	4	4
4a	M&S	Scottish mild	4	2	3	1	3	4
4b	Tesco	Classic mature ^a	3	2	2	2	3	3
4b	Morrisons	Vintage white ^a	3	3	1	3	3	4
4b	Tesco	Seriously strong ^a	3	2	2	2	3	3

^aCountry of origin was not listed on the label.

^bMarks & Spencer.

Table 13.13 Distribution of cheese sensory types within country of manufacture.

	Group				Barnyard	
	1	2	3	4		
	Acid level	Low		High		Low
Creamy level	Low	High	Low	High	Low	Elevated
England	22	13	54	11	78	22
Ireland	24	29	29	18	82	18
Scotland	18	43	17	21	96	4
Wales	11	22	67	0	44	56
Canada	8	8	58	25	75	25
Own label	33	31	21	15	87	13
Total	24	30	30	16	86	14

Table 13.14 Comparison of flavour lexicons.

Drake <i>et al.</i> (2001, 2005)	Scottish retail survey
Cooked/milky	Creamy/milky
Whey	Creamy/milky
Diacetyl	Creamy/milky
Milk fat/lactone	Creamy/milky
Fruity	Fruity/sweet
Sulphur	Sulphur/egg
Brothy	
Free fatty acid	Rancid
Nutty	
Catty	
Cow/barny	Pungent, musty, unclean
Sweet	Fruity/sweet
Sour	Acid/sour
Salty	Salty
Bitter	Bitter
Umami	

argument hinges on the underlying approach. That is, whether it is preferable to use the most restricted lexicon that encompasses the majority of the variation or to include as many cheese types as possible in the greatest detail.

For example, Drake and her colleagues describe a ‘flavour wheel’ approach to developing a descriptive language for Cheddar cheese (Drake *et al.*, 2001, 2005; Singh *et al.*, 2003; Drake & Civille, 2006; Drake, 2007). Their lexicon includes a substantial number of terms that apply only to special types of Cheddar cheese. Nevertheless, when the lexicons developed by Drake and her co-workers are compared with that used in the survey of Cheddar cheese from Scottish retail outlets reported here, the similarities are striking (Table 13.14). It could be argued that the omissions from the vocabulary used in the Scottish survey are limited to ‘catty’, ‘nutty’ and ‘brothy’ (‘umami’). However, catty flavour is regarded as a defect by the cheese buyers for retailers in the United Kingdom and as a result, cheese of this type is seldom found in major retail outlets. On the other hand, nutty character is found but principally amongst farmhouse cheese (Muir *et al.*, 1997). Brothy character is recognised as a background feature of most if not all Cheddar cheese, but has not been widely identified as a discriminant attribute.

In conclusion, the minimalist lexicon adopted here provides discrimination without complexity and compares well with other flavour vocabularies developed independently and using different approaches.

13.12 Overview

The overall objective of grading and sensory characterisation of cheese is to supply the consumer with a clearly defined product that matches their expectations. Current grading systems have been shown to be fairly robust and provide invaluable information on the preliminary categorisation of cheese according to its optimum ripening time. However, all is

not perfect at the point of sale. It was noted that the description of the cheese on the label was an unreliable guide to the perceived maturity as assessed by sensory profiling, for example, Fig. 13.15.

‘Maturity’ is better described by the period of ripening or ‘ripeness’ – a measurement that is entirely objective – than by the ambiguous term applied at present. Thus, a label declaration along the lines ‘*This product has been ripened for a period of not less than 9 months*’ would be more meaningful than the terms used in current practice (mild, medium etc.). A scheme could be agreed on an industry wide basis that would set appropriate ripening periods to coincide with mild, medium, mature, extramature and vintage.

The consumer would also benefit from a standardised flavour intensity (maturity) score based on ratings from a trained panel. Because standardisation between sensory panels is difficult to achieve, the primary standard for flavour intensity could be based on chemical measurement. It is well known that measurement of the extent of protein breakdown during ripening is highly correlated with sensory ratings for flavour intensity and perceived maturity (Sousa *et al.*, 2001). As a result, by careful correlation with sensory ratings from a trained panel (or panels), chemical measurements could be transformed into predictions of flavour intensity. Such objective methods would undoubtedly provide more useful information to the consumer than that provided by the current systems that provide largely haphazard values.

If a higher level of sophistication is required for description of the nature as opposed to the intensity of the flavour profile, the grouping system used in this work is commended. Cheese can readily be grouped on the basis of acid, creamy and barnyard character and these three flavour traits adequately describe most of the Cheddar cheese currently in the retail market. This system clearly identified differences in cheese of different origin (see Table 13.13), and has utility in developing brand identity.

It is acknowledged that fine Cheddar cheese with less usual flavour profiles is regularly produced by small farmhouse producers. Nevertheless, such products tend to be sold from specialist cheese shops and are seldom found in the major retail outlets. The grouping system proposed here will only characterise such products in part and a full or extended profile is required to adequately describe the flavour profile of such cheese. Notwithstanding this caveat, the question should also be put ‘*When does the character of product differ so much from the norm that the cheese can no longer be described as of the Cheddar type?*’

13.13 Acknowledgements

Robert McBride is thanked for provision of the information on cheese-grading systems. D.D. Muir wishes to acknowledge the expert collaboration of E.A. Hunter in developing the experimental strategy and tools to advance the sensory profiling of cheese.

References

- Banks, J.M., Hunter, E.A. & Muir, D.D. (1993) Sensory properties of low-fat Cheddar cheese: effect of salt content and adjunct culture. *Journal of the Society of Dairy Technology*, **46**, 119–123.
- Banks, J.M., Hunter, E.A. & Muir, D.D. (1994) Sensory properties of Cheddar cheese: effect of fat content on maturation. *Milchwissenschaft*, **49**, 8–12.

- Bérodier, F., Lavanchy, P., Zannoni, M., Casals, J., Herrero, L. & Adamo, C. (1997) *Guide to the Smell, Aroma and Taste Evaluation of Hard and Semi-hard Cheeses*, G.E.CO.TE.F.T., Poligny.
- Drake, M.A. (2007) *Defining cheese flavour. Improving Flavour of Cheese* (ed. B.C. Weimer), pp. 370–400, Woodhead Publishing, Cambridge, UK.
- Drake, M.A. & Civille, G.V. (2006) Flavour lexicons. *Comprehensive Reviews in Food Science and Food Safety*, **2**, 33–40.
- Drake, M.A., Gerard, P.D., Kleinhenz, J.P. & Harper, W.J. (2003) Application of an electronic nose to correlate with descriptive sensory analysis of aged cheddar cheese. *Lebensmittel-Wissenschaft und-Technologie*, **36**, 13–20.
- Drake, M.A., McIngvale, S.C., Gerard, P.D., Cadwallader, K.R. & Civille, G.V. (2001) Development of a descriptive language for cheddar cheese. *Journal of Food Science*, **66**, 1422–1427.
- Drake, M.A., Yates, M.D., Gerard, P.D., Delahunty, C.M., Sheenan, E.M., Turnbull, R.P. & Dodds, T.M. (2005) Comparison of differences between lexicons for descriptive analysis of cheddar cheese flavour in Ireland, New Zealand, and the United States of America. *International Dairy Journal*, **15**, 473–483.
- Gains, N. & Thomson, D.M.H. (1990) Sensory-profiling of canned lager beers using consumers in their own homes. *Food Quality and Preference*, **2**, 39–47.
- Guy, C., Piggott, J.R. & Marie, S. (1989) Consumer-profiling of Scotch whisky. *Food Quality and Preference*, **1**, 69–73.
- Hirst, D., Muir, D.D. & Naes, T. (1994) Definition of the sensory properties of hard cheese: a collaborative study between Scottish and Norwegian panels. *International Dairy Journal*, **4**, 743–761.
- Horgan, G.W. & Hunter, E.A. (1992) *REML for Scientists*, Biomathematics and Statistics Scotland, The University of Edinburgh, Edinburgh.
- Hunter, E.A. & McEwan, J.A. (1997) Evaluation of an international ring trial for sensory profiling of hard cheese. *Food Quality and Preference*, **9**, 343–354.
- Hunter, E.A. & Muir, D.D. (1993) Sensory properties of fermented milks: objective reduction of an extensive sensory vocabulary. *Journal of Sensory Studies*, **8**, 213–227.
- Hunter, E.A. & Muir, D.D. (1995) A comparison of two multivariate methods for analysis of sensory profile data. *Journal of Sensory Studies*, **10**, 89–104.
- Hunter, E.A. & Muir, D.D. (1997) Assessor performance in a sequential series of sensory-profiling experiments. *Proceedings 5èmes Journées Européennes Agro-Industrie et Methods Statistiques*, pp. 7.1–7.10, December 1977, Paris, France.
- Jolliffe, I.T. (1986) *Principal Component Analysis*, Springer-Verlag, New York.
- Lavanchy, P., Bérodier, F., Zannoni, M., Noeël, Y., Adamo, C., Squella, J. & Herrero, L. (1994) *A Guide to the Sensory Evaluation of Texture of Hard and Semi-hard Cheeses*, INRA, Paris.
- McBride, R.L. & Hall, C. (1979) Cheese grading versus consumer acceptability: in inevitable discrepancy. *Australian Journal of Dairy Technology*, **34**, 66–68.
- McEwan, J.A., Moore, J.D. & Colwill, J.S. (1989) The sensory properties of Cheddar cheese and their relationship with acceptability. *Journal of the Society of Dairy Technology*, **42**, 112–117.
- MacFie, H.J.H., Bratchell, N., Greenhoff, K. & Valliss, L.V. (1989) Designs to balance the effect of order of presentation and first order carry-over effects in hall tests. *Journal of Sensory Studies*, **4**, 129–148.
- MacFie, H.J.H. & Thomson, D.M.H. (1994) *Measurement of Food Preference*, Blackie Academic and Professional, London.
- Muir, D.D. & Hunter, E.A. (1991/1992) Sensory evaluation of Cheddar cheese: order of tasting and carry-over effects. *Food Quality and Preference*, **3**, 141–145.
- Muir, D.D. & Hunter, E.A. (1992) Sensory evaluation of Cheddar cheese: the relation of sensory properties to perception of maturity. *Journal of the Society of Dairy Technology*, **45**, 23–30.
- Muir, D.D., Banks, J.M. & Hunter, E.A. (1992) Sensory changes during maturation of fat-reduced Cheddar cheese: effect of addition of enzymically active attenuated starter cultures. *Milchwissenschaft*, **47**, 218–222.

- Muir, D.D., Banks, J.M. & Hunter, E.A. (1996) Sensory properties of Cheddar cheese: effect of starter type and adjunct. *International Dairy Journal*, **6**, 407–423.
- Muir, D.D., Banks, J.M. & Hunter, E.A. (1997) A comparison of the flavour and texture of Cheddar cheese of factory and farmhouse origin. *International Dairy Journal*, **7**, 479–485.
- Muir, D.D., Hunter, E.A., Banks, J.M. & Horne, D.S. (1994) Sensory properties of hard cheese: identification of key attributes. *International Dairy Journal*, **5**, 157–177.
- Naes, T. & Risvik, E. (1996) *Multivariate Analysis of Data in Sensory Science*. Elsevier, Amsterdam.
- Nielsen, R.G., Zannoni, M., Bérédier, F., Lavanchy, P., Lorenzen, P.C., Muir, D.D. & Silvertsen, H.K. (1997) Progress in developing an international protocol for sensory profiling of hard cheese. *International Journal of Dairy Technology*, **51**, 57–64.
- Patterson, H.D. & Thompson, R. (1971) Recovery of inter-block information when block sizes are unequal. *Biometrika*, **58**, 545–554.
- Payne, J.S. (1998) Electronic nose technology. *Food Science and Technology Today*, **12**, 196–200.
- Singh, T.K., Drake, M.A. & Cadwallader, K.R. (2003) Flavour of Cheddar cheese: A chemical and sensory perspective. *Comprehensive Reviews in Food Science and Food Safety*, **2**, 139–162.
- Sousa, M.J., Ardo, Y. & McSweeney, P.L.H. (2001) Advances in the study of proteolysis during cheese ripening. *International Dairy Journal*, **11**, 327–345.
- Williams, A.A. & Langron, S.P. (1984) Use of free-choice profiling for evaluation of commercial ports. *Journal of Science and Food Agriculture*, **35**, 558–568.
- Williams, E.J. (1949) Experimental designs balanced for the estimation of residual effects of treatments. *Australian Journal of Science and Research*, **A2**, 149–168.
- Williams, S.A.R., Hunter, E.A., Parker, T.G., Shankland, C.E., Brennan, R.M. & Muir, D.D. (1996) DDASP: a statistically-based system for design, data capture and analysis with the sensory profiling protocol. *Proceedings 3ème Congrès Sensometrics*, 19–21 June 1996, pp. 48.1–48.3, Nantes.

Index

Note: Italicised *f* and *t* refer to figures and tables.

- Abi, *see* abortive infection (Abi) systems
- ability to rank samples, 451
- abortive infection, 187
- abortive infection (Abi) systems, 187
- acid-curd cheese manufacture, 287
- acid-induced gelation, 13–15
- ADSA, *see* American Dairy Science Association
- AMAFE, *see* Association of Manufacturers of Natural Animal-derived Food Enzymes
- American Dairy Science Association, 443
- aroma, 222–4
- assessor selection, cheese, 450–52
 - acclimatisation and confirmation, 451–2
 - initial testing, 451
 - internal *versus* external panels, 450
 - monitoring performance, 452
 - pre-selection procedure, 450
- Association of Manufacturers and Formulators of Enzyme Products (AMFEP), 111
- Association of Manufacturers of Natural Animal-derived Food Enzymes, 111
- attribute ratings, 460–61*t*
- The Australian grading system, 442
- automated laboratory methods, 179–80

- bactofugation, 279
- Bio-Mathematics and Statistics Scotland, 452
- BioSS, *see* Bio-Mathematics and Statistics Scotland
- bovine serum albumin, 6
- brevibacteria, 205
- brine salting, 342–3
- BSA, *see* bovine serum albumin

- Canadian Department of Agriculture, 443
- the Canadian grading system, 443

- Candida krusei*, 199, 200, 204, 206, 208, 210, 216, 218–9, 219*f*
- casein
 - milk composition, 3–6
- caseinomacropeptide, 111
- casein-to-fat (C/F), 333
- CCPs, *see* critical control points
- CDA, *see* Canadian Department of Agriculture
- ceftiridime fucidin cephalosporin selective, 195
- CFCD, *see* ceftiridime fucidin cephalosporin selective
- cheese flavour products, 253–5 (*see also* cheese ripening)
- cheesemaking technology
 - basics, 70–76
 - fundamentals, 69–70
 - process, 391–3
 - reduced-fat versions of traditional
 - background, 88
 - reduced version of, 88–90
 - research role, 95–6
 - ripening/maturation
 - adventitious microflora in cheese, 87–8
 - diversity arising from composition, 87
- stages
 - addition of the starter culture, 78–80
 - coagulation and cutting, 80–81
 - dry surface salting, 85–6
 - heat treatment of milk, 78
 - hooping and salting, 83–4
 - moisture control, 81–3
 - pressing, 86
 - standardisation of milk, 77–8
- whey technology
 - composition of cheese whey, 91
 - lactose recovery, 95
 - membrane filtration technology, 91–3
 - pretreatment, 93–4

- cheesemaking technology (*Cont.*)
 WPC production, 94–5, 94t
 World market, 68–9
- cheese manufacture, 386–9
 acid-induced gelation, 13–15
 with additives, 396
 basic technology, 70–76
 characteristics
 assessment of, 264–6
 colorimetry, 268
 definition, 264
 image analysis, 268–9
 rheology and texture, 267–8
 sensory tests, 266–7
- chemical residues
 antibiotics, 43–4
 mycotoxins, 44
 other residues, 45
- cutting, 415–19
 applications of, 419–21
 characteristics and features of food cutting, 415
 dicing, 420–21
 parameters affecting cutting performance, 416–17
 partitioning and segmentation, 419–20
 shredding, 421
 slicing, 420
 velocity, 417–19
- defects, 397–9
 defined, 9–10
 effect of pretreatment
 addition of calcium chloride, 289–90
 bactofugation, 279
 clarification, 280
 cold storage of milk, 271–3
 curd-cutting programmes, 291–4
 homogenisation, 286–9
 milk gelation, 290–91
 protein-to-fat ratio standardisation, 280–86
in situ denatured whey protein, 273–9
 stirring and cooking, 294–5
 thermisation, 273
- efficiency, 47–9
 end-product testing, 401–4
 environmental monitoring, 404–6
 enzymatic activity of milk
 of bacterial lipases to lipolysis, 42
 of lipolysis in the dairy industry, 42–3
 lipolytic activity, 40–42
 lysosomal proteinases of somatic cells, 38–9
 plasmin proteinase, 37–8
 proteinases from psychrotrophic bacteria, 39–40
 proteolytic activity, 36–7
 grading systems, 442–4
 Australian, 442
 Canadian grading system, 443
 International Dairy Federation grading system, 443
 New Zealand grading system, 444
 UK grading system, 443
 US grading system, 443
- Grated cheese for manufacture of, 395–6
 heat treatment, 389–90
 made from unpasteurised milk, 395
 major categories, 75–6t
 manufacture principles, 262–4 (*see also* cheese manufacture)
 mean rating for flavour attributes of, 454t
 microbiological techniques, 406–8
 milk composition
 cow nutrition effects, 27–8
 effect of milk frequency, 30–31
 effect of parity, 30
 effect of season, 30
 genetic variants of, 29–30
 stage of lactation, 28–9
 milk composition influence, 269–71
 milk for, 386–9
 packaging, 421–8
 of hard and semi-hard cheeses, 425–8
 machinery for, 430–36
 machines
 control of, 428–30
 materials, 422–5
 miscellaneous methods of, 436–7
 of soft cheeses, 428
 specific requirements, 421–2
 various steps of, 429f
 prevention and control, 399–401
 processed cheeses, 396
 properties, 416f
 quality of, *see* cheese quality
 of reduced-fat cheese, 89–90
 with reduced-fat content, 154–6
 rennet-induced gelation, 10–13
 scoring system, 468t
 classification of, 469–70t
 somatic cell count, 34–6

- specialist, 394–6
- types used in illustrative example, 453*t*
- yield estimation, 1
- cheese products, 394–6
- cheese-ripening
 - for accelerated and controlled
 - genetically modified LAB, 249–52
 - non-starter adjunct cultures, 248–9
 - commercial drive, 239
 - commercial opportunities created by, 240–41
 - methods for accelerated
 - attenuated starter cultures, 246–8
 - elevated storage temperatures, 241–4
 - enzyme additions, 245–6
 - rules and regulations for GMOs in foods, 252–3
 - ultra-high-pressure technology, 244
 - quality prediction, 260–62
- cheese sensory processing
 - distribution of, 470*t*
 - integration *versus* selection of, 441–2
 - three dimensions of, 440–41
- chymosin, 102, 103*t*
- citrate metabolism in cheese, 238–9
- clustered regularly interspaced short palindromic repeats, 187
- CMP, *see* caseinomaclopeptide
- coagulants
 - analysis, 107–10
 - application
 - handling and use of, 116
 - trades in use, 115–16
 - cheese ripening, 123–4
 - cheese yield difference, 122*t*
 - choice, 124–5
 - controlling and curd fitness, 119
 - heat liability, 123*t*
 - kinetics of milk, 112–15
 - legislation and approval, 110–11
 - milk quality, 116–19
 - molecular aspects
 - aspartic proteinases, 101–2
 - specific types, 102–3
 - performance of different types, 119–23
 - stability and destabilisation of the casein micelles, 111–12
- types
 - animal origin, 99–100
 - fermentation-produced chymosin, 100–101
 - microbial coagulants, 100
 - vegetable coagulants, 101
- typical dosage difference between, 121*t*
- commercial cheese sensory character, 467–8
 - development of flavour lexicons, 469–71
 - discrimination amongst cheese types, 468–9
 - maturity declaration on cheese packaging
 - with sensory panel ratings, 467–8
- Comté-type cheese, 376*f*
- confocal scanning laser microscopy, 133*f*, 339
- consumer, cheese making, 444–6
 - cheesemaking – grading link, 446
 - link between cheesemaking, grading and the consumer, 444–5
 - link between grading and consumer, 445–6
- continuous quality improvement, 305, 306*f*
- coryneforms, 205
- CQI, *see* continuous quality improvement
- CRISPR, *see* clustered regularly interspaced short palindromic repeats
- critical control points, 307
- CSLM, *see* confocal scanning laser microscopy
- ‘culture-cheese’ (Kulturkaese), 212
- culture strain selection, 177
- curd
 - controlling factors
 - cutting time, 151
 - pH, 149–50
 - rennet concentration, 149
 - temperature, 150–51
 - washing of the curd, 151
 - effect of milk composition
 - β -Lactoglobulin, 142
 - casein micelle size, 141
 - genetic polymorphism of milk proteins, 141–2
 - glycosylation, 141–2
 - lactational variation and somatic cell count, 142–3
 - variations in main components, 140–41
- effects of milk pre-treatment
 - combined with heat treatment, 148
 - cooling, 143–4
 - high heat treatment, 144–6
 - homogenisation, 147
 - pH adjustment by carbon dioxide injection, 146–7
 - phospholipase addition, 147–8
- factors affecting aggregation
 - casein concentration, 131
 - ions, 132–3
 - pH, 131–2

- curd (*Cont.*)
 rennet concentration, 130–31
 temperature, 132
 formation of a gel, 133–5
 on-line measurement of
 curd setting, 152
 gelation and cutting time controlling,
 152–3
 of syneresis, 153–4
 rheological properties of rennet gels
 calcium chloride and sodium chloride, 137
 interactions between technological
 parameters, 137–8
 pH, 137
 rennet concentration, 136
 renneting skimmed milk, 135 *f*
 temperature, 136
 syneresis
 calcium chloride, 140
 dimensions of the gel or curd grains, 139
 modelling of, 138–9
 pH, 139–40
 rennet concentration, 139
 temperature, 140
 curd-cutting programmes, 291–4
 commercial practice, 293–4
 role in stirring in syneresis, 291–3
 traditional method, 293
 curd forming properties, 288–9
 curd maturation, 393–4
- D. hansenii*, 204
 data capture and analysis of the
 sensory-profiling protocol
 (DDASPP), 452
 defect-orientated, 442
 Derjaguin theory, 112
 descriptive ability, 451
 direct salting, 343–4
 direct-to-vat inoculation (DVI), 167
 direct vat set (DVS), 167
 DVS culture use, 175–7
- end-product testing, 401–4
 enzyme-modified cheese (EMC), 253–5, 254 *f*
 enzymes production technology
 description, 103–6
 formulation, standardisation and quality
 control, 106–7
 general background, 103
 EPS, *see* exopolysaccharide
- exopolysaccharide, 351
 eye formation, 363–6
 cheese cohesion, 366
 cheese structure and, 372–7
 changes during ripening, 374–5
 eye formation and slit development, 376–7
 mechanical properties, 372–4
 definition, 363
 description, 365–6
 and gas production, 364
 gas production – a sign of quality, 363–5
 measurements applied to, 372 *f*
 mechanical properties, 372–4
- fat-filled protein particle, 287
 fat-in-dry matter, 194 *f*, 281, 333
 FDM, *see* fat-in-dry matter
 ‘fermentation-produced chymosin’, 99, 109
 FFPP, *see* fat-filled protein particle
 FFS, *see* form-fill-and-seal
 flavour lexicons, 469–71, 471 *t*
 Food and Agriculture Organisation (FAO), 360
 form-fill-and-seal
 description, 429, 434, 436 *f*
 machines
 description, 432–3
 transformation, 434–6
 FPC, *see* ‘fermentation-produced chymosin’
 fresh cheese manufacture, 287
- Generalised Procrustes Analysis (GPA), 458–9
 genetically modified organism (GMO), 99, 178
 good manufacturing practice (GMP), 399
- HACCP, *see* hazard analysis critical control
 points
 hazard analysis critical control points, 95, 211,
 307
 high-pressure liquid chromatography (HPLC),
 341
 high-throughput screening methods, 166
 homogenisation
 effects on curd forming properties, 288–9
 fresh, acid-curd cheese manufacture, 287
 rennet-curd cheese manufacture, 287–8
 HTS methods, *see* high-throughput screening
 methods
- in-process control (IPC), 305, 306 *f*, 307
 integrated design and analysis, cheese, 452–66
 of assessors’ performance, 461–6

- Generalised Procrustes Analysis (GPA), 458–9
- interpretation of sensory dimensions, 456–8
- multivariate prediction, 459–61
- PCA, 455–6
- preliminary treatment, 453–4
- of sensory-profiling protocol, 452–3
- sensory space maps, 454–5, 459
- The International Dairy Federation grading system, 443
- International Dairy Federation (IDF), 107
- Jameson effect, 400
- κ -casein hydrolysis, 113–14
- ‘key compositional parameters’ (KCPs), 299
- key performance indicators, 305, 306*f*
- key quality indices, 308
- Kluyveromyces lactis*, 204
- Kluyveromyces marxianus*, 99*t*, 105–6, 199, 204, 206–9, 216, 218–9, 219*f*
- KPIs, *see* key performance indicators
- KQIs, *see* key quality indices
- LAB, *see* lactic acid bacteria
- lactic acid bacteria, 166, 199
- bacteriophage of
- phage control during culture preparation, 184
- phage control in the dairy, 184–5
- phage monitoring, 185–6
- on propionibacteria, 370–71
- proteolysis by
- aminoacid catabolism, 183
- peptidases of, 182
- proteases, 181–2
- taxonomy
- identification, 172–3
- species, 173–4
- lactic cheese starter cultures
- acidification by, 180–81
- background, 166–7
- composition of, 188–9
- modern approaches
- automated laboratory methods, 179–80
- food-grade GMOs for the dairy industry, 178–9
- traditional bacterial genetics, 177–8
- phage-resistant starters, 186
- abortive infection, 187
- additional routes to bacteriophage resistance, 187–8
- conjugal transfer of phage resistance plasmids, 186
- inhibition of phage adsorption, 187
- isolation, 186
- prevention of phage DNA injection, 187
- restriction and modification systems, 187
- probiotic, 170–72
- production, 167–9
- proteolysis by, 181–3
- taxonomy, 172–4
- traditional, 160–70
- types
- culture strain selection, 177
- development of mesophilic cultures, 174–5
- DVS culture use, 175–7
- Lactobacillus casei*, 174, 241, 370
- Lactobacillus delbrueckii*, 75*t*, 169*t*, 170, 208*f*, 219*f*, 334, 370
- Lactobacillus helveticus*, 9, 76*t*, 169*t*, 170, 236, 334, 370
- Lactobacillus plantarum*, 174, 215, 241
- lactocepin (PrtP), 181
- Lactococcus lactis*, 75*t*, 168, 169*t*, 179, 181*t*, 235, 312, 334, 996
- lactose metabolism in cheese, 238–9
- Landau theory, 112
- Leuconostoc mesenteroides*, 169*t*, 174
- lipoprotein lipase, 8
- LPL, *see* lipoprotein lipase
- microfiltration (MF), 92, 333–4
- milk
- authenticity, 23
- composition
- casein, 3–6
- cow nutrition effects, 27–8
- in different parameters, 19–22
- effect of milk frequency, 30–31
- effect of parity, 30
- effect of season, 30
- gelation characteristics, 2*t*
- genetic variants of, 29–30
- lipids, 8–9
- mineral, 7–8
- optimising manufacturing procedures, 18–19
- protein, 6–7
- stage of lactation, 28–9
- definition, 15–16

- milk (*Cont.*)
- microbiology of, 22–3
 - contamination from outside mammary gland, 32–3
 - contamination from within mammary gland, 31–2
 - hygienic milk production on-farm, 31
 - storage conditions, 33
 - in pizza cheese, 332–4
 - protein level, 281–6
 - safety/public, 16–18
 - sensory, 23
 - milk frequency, 30–31
 - milk gelation, 290–91
 - milk lipids
 - in cheese, 237–8
 - as milk composition, 7–8
 - milk pasteurisation
 - effects on coagulation and cheesemaking characteristics, 274–6
 - inactivation of pathogens, 273–4
 - interactions between whey proteins and casein micelles, 276–9
 - milk protein breakdown
 - amino acid catabolism, 235–7
 - milk lipids in cheese, 237–8
 - proteolytic systems, 231–5
 - mineral
 - as milk composition, 7–8
 - moisture in non-fat substances (MNFS), 281, 283 *f*
 - moulding
 - effect on chemical composition, 340
 - effect on microstructure, 339–40
 - thermal effect, 340–42
 - moulds, 44, 71, 73, 83, 85, 193, 198, 200–204, 207, 234, 238, 274, 298, 385, 395, 398, 448
 - N-acetylgalactosamine (GalNAc), 5
 - N-acetylneuraminic (sialic) acid, 5
 - NANA, *see* N-acetylneuraminic (sialic) acid
 - Nanofiltration (NF), 92
 - NDM, *see* non-fat dry milk
 - the New Zealand grading system, 444
 - non-fat dry milk, 333
 - non-starter lactic acid bacteria, 387
 - NSLAB, *see* non-starter lactic acid bacteria
 - Overbeek theory, 112
 - PAB, *see* propionic acid bacteria
 - PCA, *see* principal component analysis
 - PDO, *see* protected designation of origin
 - Penicillium album*, 200, 204
 - Penicillium camemberti*, 193, 194 *f*, 237, 393
 - Penicillium glaucum*, 200
 - PEP-PTS, *see* phosphoenol pyruvate-dependent phosphotransferase system
 - phage infection protein, 187
 - phage-resistant starters
 - abortive infection, 187
 - additional routes to bacteriophage resistance, 187–8
 - conjugal transfer of phage resistance plasmids, 186
 - inhibition of phage adsorption, 187
 - isolation, 186
 - prevention of phage DNA injection, 187
 - restriction and modification systems, 187
 - PHE, *see* plate heat exchange
 - phosphoenol pyruvate-dependent phosphotransferase system, 181
 - phosphotungstic-acid soluble nitrogen, 374
 - Pip, *see* phage infection protein
 - pizza cheese, 330–32
 - functional properties
 - background, 330–31
 - measurement of functionality, 331–2
 - manufacture, 332–5
 - brining/salting, 342–4
 - coagulant, 337–8
 - cooking and cheddaring, 338–9
 - factors affecting cheese yield, 345
 - process control in, 344–5
 - starter culture, 334–7
 - stretching and moulding, 339–42
 - treatment of milk, 332–4
 - microbial properties
 - concept, 345–6
 - functionality changes during storage, 349
 - physicochemical properties, 347–9
 - proteolytic properties, 347
 - non-traditional methods of manufacture, 349–52
 - cheese blends, 350
 - direct acidification, 349–50
 - imitation (analogue) pizza cheese, 351–52
 - low-fat pizza cheese, 350–51
 - processed pizza cheese, 352
 - plate heat exchange, 93
 - principal component analysis, 452

- principal component regression (PCR), 459
- Principle of cutting, 416*f*
- propionic acid bacteria, 366
- propionic fermentation, 366–72
- influence of LAB on propionibacteria, 370–71
 - metabolism of PAB, 368–9
 - relationship between flavour development and, 371–2
 - Swiss-type cheeses, 366–7
 - taxonomy, ecology and presence of PAB in cheese, 367–8
- protected designation of origin, 428
- protein-to-fat (P/F), 333
- description, 280–81
 - milk protein level, 281–6
- protein-to-fat ratio (PFR), 280
- proteolysis, 374–5
- PTASN, *see* phosphotungstic-acid soluble nitrogen
- quality milk production, 45–7
- recombined fat globule membrane, 287
- REML, *see* residual maximum likelihood
- rennet
- application
 - handling and use of, 116
 - trades in use, 115–16
 - approximate conversion, 108*t*
 - commonly used, 99*t*
 - controlling and curd fitness, 119
 - milk quality, 116–19
 - molecular aspects
 - aspartic proteinases, 101–2
 - specific types, 102–3
 - performance of different types, 119–23
 - types
 - animal origin, 99–100
 - fermentation-produced chymosin, 100–101
 - microbial coagulants, 100
 - vegetable coagulants, 101
 - typical dosage difference between, 121*t*
- rennet-curd cheese manufacture, 287–8
- rennet-induced gelation, 10–13
- rennin units (RU), 107
- residual maximum likelihood, 453
- reverse osmosis (RO), 92
- RFGM, *see* recombined fat globule membrane
- Rod-to-cocci ratio, 336–7
- sample preparation and presentation, 448–50
- environment, 448–9
 - isolation, 449
 - presentation order, 449–50
 - rating of samples, 449
- scanning electron microscopy, 207, 339
- secondary cheese starter cultures, *see* Surface-ripened cheeses
- aroma, 222–4
 - classification of
 - coryneforms, 202–3
 - moulds and yeasts, 200–201
 - Penicillium camemberti*, 201*f*
 - staphylococci, 201–2
 - commercially available
 - brevibacteria, 205
 - coryneforms, 205
 - mixed starter cultures, 205
 - moulds, 203–4
 - staphylococci, 205
 - yeasts, 204–5
 - development of
 - for acid curd cheeses (yellow type), 218–20
 - application, 220–21
 - colour development, 220
 - for semisoft solids, 216–17
 - for smeared soft cheeses, 208*f*, 217–18
 - proteolysis and lipolysis, 221–2
 - secondary fermentation, 377
- SEM, *see* scanning electron microscopy
- sense of smell, 451
- sense of taste, 451
- sensory-profiling protocol, 452–3
- sensory space maps, 454–5, 458*f*, 466*f*
- sensory vocabulary, 447–8
- evolution of vocabulary, 448
 - working vocabulary for cheese, 448
- slicer operating principle, 420*f*
- SQC, *see* statistical quality control
- standard operating procedure (SOP), 305, 306*f*
- Staphylococcus aureus*, 32, 39, 201, 211, 214–5, 388, 391–2, 400, 405–6
- Staphylococcus thermophilus*, 14, 75*t*, 79, 169*t*, 170, 174, 176, 179, 182–5, 187–8, 218, 219*f*, 334, 341, 346, 370
- starter culture, 1, 9–10, 12, 14*f*, 19, 43, 74, 78–9, 116, 166–7, 175, 334–7, 396
- addition of, 78
 - approaches for development, 177

- starter culture (*Cont.*)
 - future perspectives, 188–9
 - lab methods, 179–80
 - LAB range, 169–72
 - probiotic, 170–72
 - process flow chart, 168 *f*
 - production of, 167
 - role, 335–6
- statistical quality control, 305, 306 *f*
- stretching
 - effect on chemical composition, 340
 - effect on microstructure, 339–40
 - thermal effect, 340–42
- surface-ripened cheeses
 - anti-listeria starter cultures, 214–15
 - control of, 199–200
 - examples, 194 *f*
 - food safety, 211
 - L. monocytogenes*, 213
 - mould spoilage, 213–14
 - old–young smearing, 212, 212 *f*,
216 *f*
 - origin and ripened times of, 195 *t*
 - popular varieties, 198–9
 - smear bacteria (coryneforms), 209–11
 - smear ripened, 192, 196 *t*, 197
 - staphylococci, 209
 - strategies, 206–7
 - yeasts and moulds, 207–9
- Swiss-type cheeses, 366–7
 - main features of, 362 *t*
 - typical compression profiles obtained with
Swiss-type cheeses, 373 *f*
- thermal effects, 340–42
- thermoforming fill-and-seal machine, 434 *f*
- total bacterial count (TBC), 386
- trichloroacetic acid (TCA), 341
- UK grading system, 443
- US grading system, 443
- UW melt profiler, 331
- Verwey theory, 112
- violet red bile dextrose (VRBD), 195
- whey protein
 - denaturation, 277 *t*
 - as milk composition, 6–7
- whey protein concentrate (WPC), 92
- whey technology
 - composition of cheese whey, 91, 91 *t*
 - lactose recovery, 95
 - membrane filtration technology, 91–3
 - pre-treatment, 93–4
 - WPC production, 94–5
- World Trade Organisation (WTO), 408
- WPC production, 94 *t*, 94–5
- yeast, 75 *t*–76 *t*, 85, 88, 105–6, 167, 193–5,
196 *t*–197 *t*, 198, 200, 204–5, 209,
216, 218

Food Science and Technology



GENERAL FOOD SCIENCE & TECHNOLOGY AND FOOD PROCESSING

Food Flavour Technology 2E	Taylor	9781405185431
Food Mixing: Principles and Applications	Cullen	9781405177542
Functional Food Product Development	Smith	9781405178761
Confectionery and Chocolate Engineering	Mohos	9781405194709
Industrial Chocolate Manufacture and Use (4th Edition)	Beckett	9781405139496
Chocolate Science and Technology	Afoakwa	9781405199063
Essentials of Thermal Processing	Tucker	9781405190589
Calorimetry in Food Processing: Analysis and Design of Food Systems	Kaletunc	9780813814834
Fruit and Vegetable Phytochemicals	de la Rosa	9780813803203
Water Properties in Food, Health, Pharma and Biological Systems	Reid	9780813812731
Nutraceuticals, Glycemic Health and Type 2 Diabetes	Pasupuleti	9780813829333
Nutrigenomics and Proteomics in Health and Disease	Mine	9780813800332
Food Science and Technology (textbook)	Campbell-Platt	9780632064212
IFIS Dictionary of Food Science and Technology 2nd Edition	IFIS	9781405187404
Sensory Evaluation: A Practical Handbook	Kemp	9781405162104
Statistical Methods for Food Science	Bower	9781405167642
Drying Technologies in Food Processing	Chen	9781405157636
Biotechnology in Flavor Production	Havkin-Frenkel	9781405156493
Frozen Food Science and Technology	Evans	9781405154789
Sustainability in the Food Industry	Baldwin	9780813808468
Kosher Food Production 2nd Edition	Blech	9780813820934
Dictionary of Flavors 2nd Edition	DeRovira	9780813821351
Whey Processing, Functionality and Health Benefits	Onwulata	9780813809038
Nondestructive Testing of Food Quality	Irudayaraj	9780813828855
High Pressure Processing of Foods	Doona	9780813809441
Concept Research in Food Product Design and Development	Moskowitz	9780813824246
Water Activity in Foods	Barbosa-Canovas	9780813824086
Food and Agricultural Wastewater Utilization and Treatment	Liu	9780813814230
Multivariate and Probabilistic Analyses of Sensory Science Problems	Meullenet	9780813801780
Applications of Fluidisation in Food Processing	Smith	9780632064564
Encapsulation and Controlled Release Technologies in Food Systems	Lakkis	9780813828558
Accelerating New Food Product Design and Development	Beckley	9780813808093
Chemical Physics of Food	Belton	9781405121279
Handbook of Organic and Fair Trade Food Marketing	Wright	9781405150583
Sensory and Consumer Research in Food Product Design and Development	Moskowitz	9780813816326
Sensory Discrimination Tests and Measurements	Bi	9780813811116
Food Biochemistry and Food Processing	Hui	9780813803784
Handbook of Fruits and Fruit Processing	Hui	9780813819815
Food Processing - Principles and Applications	Smith	9780813819426
Food Supply Chain Management	Bourlakis	9781405101684

SEAFOOD, MEAT AND POULTRY

Handbook of Seafood Quality, Safety and Health Effects	Alasalvar	9781405180702
Fish Canning Handbook	Bratt	9781405180993
Fish Processing - Sustainability and New Opportunities	Hall	9781405190473
Fishery Products: Quality, safety and authenticity	Rehbein	9781405141628
Thermal Processing for Ready-to-Eat Meat Products	Knipe	9780813801483
Handbook of Meat Processing	ToIdra	9780813821825
Handbook of Meat, Poultry and Seafood Quality	Nollet	9780813824468

BEVERAGES & FERMENTED FOODS/BEVERAGES

Beverage Industry Microfiltration	Starbard	9780813812717
Wine Quality: Tasting and Selection	Grainger	9781405113663
Handbook of Fermented Meat and Poultry	ToIdra	9780813814773
Microbiology and Technology of Fermented Foods	Hutkins	9780813800189
Carbonated Soft Drinks	Steen	9781405134354
Brewing Yeast and Fermentation	Boulton	9781405152686
Food, Fermentation and Micro-organisms	Bamforth	9780632059874
Wine Production	Grainger	9781405113656
Chemistry and Technology of Soft Drinks and Fruit Juices 2nd Edition	Ashurst	9781405122863
Technology of Bottled Water 2nd Edition	Senior	9781405120388
Wine Flavour Chemistry	Clarke	9781405105309

BAKERY & CEREALS

Whole Grains and Health	Marquart	9780813807775
Gluten-Free Food Science and Technology	Gallagher	9781405159159
Baked Products - Science, Technology and Practice	Cauvain	9781405127028
Bakery Products Science and Technology	Hui	9780813801872
Bakery Food Manufacture and Quality 2nd Edition	Cauvain	9780632053278
Pasta and Semolina Technology	Kill	9780632053490

For further details and ordering information, please visit www.wiley.com/go/food

Food Science and Technology from Wiley-Blackwell

FOOD SAFETY, QUALITY AND MICROBIOLOGY

The Microbiology of Safe Food 2nd Edition	Forsythe	9781405140058
Food Safety for the 21st Century	Wallace	9781405189118
Microbial Safety of Fresh Produce	Fan	9780813804163
Biotechnology of Lactic Acid Bacteria: Novel Applications	Mozzi	9780813815831
HACCP and ISO 22000 - Application to Foods of Animal Origin	Arvanitoyannis	9781405153669
Food Microbiology: An Introduction 2nd Edition	Montville	9781405189132
Management of Food Allergens	Coutts	9781405167581
Campylobacter	Bell	9781405156288
Bioactive Compounds in Foods	Gilbert	9781405158756
Color Atlas of Postharvest Quality of Fruits and Vegetables	Nunes	9780813817521
Microbiological Safety of Food in Health Care Settings	Lund	9781405122207
Control of Food Biodeterioration	Tucker	9781405154178
Advances in Thermal and Nonthermal Food Preservation	Tewari	9780813829685
Biofilms in the Food Environment	Blaschek	9780813820583
Food Irradiation Research and Technology	Sommers	9780813808826
Preventing Foreign Material Contamination of Foods	Peariso	9780813816395
Aviation Food Safety	Sheward	9781405115810
Food Microbiology and Laboratory Practice	Bell	9780632063819
Listeria 2nd Edition	Bell	9781405106184
Preharvest and Postharvest Food Safety	Beier	9780813808840
Shelf Life	Man	9780632056743
HACCP	Mortimore	9780632056484
Salmonella	Bell	9780632055197

PACKAGING

Packaging Research in Food Product Design and Development	Moskowitz	9780813812229
Packaging for Nonthermal Processing of Food	Han	9780813819440
Packaging Closures and Sealing Systems	Theobald	9781841273372
Modified Atmospheric Processing and Packaging of Fish	Otwell	9780813807683
Paper and Paperboard Packaging Technology	Kirwan	9781405125031
Food Packaging Technology	Coles	9781841272214
Canmaking for Can Fillers	Turner	9781841272207

DAIRY FOODS

Technology of Cheesemaking 2nd Edition	Law	9781405182980
Dairy Fats	Tamime	9781405150903
Bioactive Components in Milk and Dairy Products	Park	9780813819822
Milk Processing and Quality Management	Tamime	9781405145305
Dairy Powders and Concentrated Products	Tamime	9781405157643
Cleaning in Place	Tamime	9781405155038
Advanced Dairy Technology	Britz	9781405136181
Dairy Processing and Quality Assurance	Chandan	9780813827568
Structure of Dairy Products	Tamime	9781405129756
Brined Cheeses	Tamime	9781405124607
Fermented Milks	Tamime	9780632064588
Manufacturing Yogurt and Fermented Milks	Chandan	9780813823041
Handbook of Milk of Non-Bovine Mammals	Park	9780813820514
Probiotic Dairy Products	Tamime	9781405121248

INGREDIENTS

Enzymes in Food Technology 2nd Edition	Whitehurst	9781405183666
Food Stabilisers, Thickeners and Gelling Agents	Imeson	9781405132671
Glucose Syrups - Technology and Applications	Hull	9781405175562
Handbook of Vanilla Science and Technology	Havkin-Frenkel	9781405193252
Fish Oils	Rossell	9781905224630
Weight Control and Slimming Ingredients in Food Technology	Cho	9780813813233
Prebiotics and Probiotics Handbook	Jardine	9781905224524
Food Colours	Emerton	9781905224449
Sweeteners	Wilson	9781905224425
Sweeteners and Sugar Alternatives in Food Technology	Mitchell	9781405134347
Emulsifiers in Food Technology	Whitehurst	9781405118026
Food Additives Data Book	Smith	9780632063956

FOOD LAWS & REGULATIONS

BRC Global Standard - Food	Kill	9781405157964
Food Labeling Compliance Review 4th Edition	Summers	9780813821818
Guide to Food Laws and Regulations	Curtis	9780813819464
Regulation of Functional Foods and Nutraceuticals	Hasler	9780813811772

OILS & FATS

Trans Fatty Acids	Dijkstra	9781405156912
Rapeseed and Canola Oil - Production, Processing, Properties and Uses	Gunstone	9781405116251
Vegetable Oils in Food Technology	Gunstone	9781841273310
Fats in Food Technology	Rajah	9781841272252
Edible Oil Processing	Hamm	9781841270388

For further details and ordering information, please visit www.wiley.com/go/food